

# The Sustainable Village



### MICROENTERPRISES

- 4 MicroBusiness Ideas

### WATER

- 17 Pumping
- 32 Storage
- 34 Treatment
- 43 Distillers
- 44 Water Saving
- 46 Rainwater

### ENERGY

- 47 Hydrogen
- 48 Hydro Electric
- 50 Wind Generators
- 53 Generators, Motors, Etc.
- 55 Photovoltaics
- 65 Trackers and Mounts
- 68 Laptop and Flashlight Chargers
- 69 Dry Cell Batteries and Chargers
- 73 Inverters
- 80 Power Conditioning
- 81 Converters
- 82 Deep Cycle Batteries
- 85 Battery Chargers and Accessories
- 88 Voltage Regulators
- 94 System Components

### LIGHTING

- 99 DC Lighting
- 108 Lanterns
- 109 Flashlights
- 111 Outdoor Lighting
- 113 Commercial Lighting

### TOOLS

- 116 Tools
- 118 Farm and Ranch
- 121 Remote Medical

### REMOTE MEDICAL

- 121 Centrifuge, Refrigeration

### APPLIANCES

- 123 Washing Machines
- 125 Cooking
- 127 Kitchen
- 129 Sewing
- 130 Refrigerators
- 134 Communications
- 137 Entertainment

### CONSERVATION

- 140 Composting Toilets
- 146 Greywater Systems

### HEATING AND COOLING

- 148 Insulation
- 150 Fans and Solar Cooling
- 154 Solar Water Heating
- 160 Woodstoves
- 161 Space Heating
- 163 Solar Space and Water Heating

### ECOLOGY

- 165 Home
- 166 Personal Care
- 167 Alternative Transportation
- 168 Shelter
- 170 Educational Toys/Gifts

### BOOKS

- 171 Composting Toilets/Greywater
- 172 Appropriate Technology
- 173 Make Your Own
- 174 Ecology and Environment
- 175 Hydronic Heating
- 176 Remote Medical
- 177 Water
- 179 Hydro and Wind Power
- 180 Solar Electric
- 181 Solar Cooking
- 181 Renewable Energy
- 182 Alternative Transportation
- 183 Biogas
- 183 Alternative Building
- 187 Gardening, Farming, Forestry

### INDEX ..... 190

**The Sustainable Village**  
 717 Poplar Ave  
 Boulder, CO 80304  
 Tel 303-998-1323 • 888-317-1600  
 email us at:  
 info@thesustainablevillage.com

**Website:** For our complete inventory of over 8,000 products: [www.thesustainablevillage.com](http://www.thesustainablevillage.com).

**Printed** on 100% recycled paper (40% post consumer waste) with soy based ink.



**Key to symbols:**  
 Freight collect - too big for UPS.

## Sustainable Journal Entries . . .

**Sept. 10th, 2001, late afternoon.** I conclude an agreement to sell my remaining 49.9% interest in Jade Mountain, Inc., which had recently merged with Real Goods into Gaia Energy Tech. I start seriously considering my retirement plan of focusing on my book business ([www.awrbooks.com](http://www.awrbooks.com)).

**Sept. 11th, early morning.** I wake up to the news of the terrorist attacks on the World Trade Center and Washington, D.C. It's such an obvious attack on business that it makes me wonder how the business community could respond. What are the "roots of terrorism"? What conditions conspire in the creation and education of a terrorist?

**Sept. 14th.** I read an article about an Afghani mother of several children who is asked what she plans to do given the possibility of bombing raids by the US. She answers that it would be a blessing if she and her children were killed, that their lives are too miserable, poor and hopeless for them to care about staying alive.

**Sept. 15th.** Instead of retiring, I decide to start a new business dedicated to using appropriate technology products in ways to provide more education, health care, small businesses, and new opportunities for people living in remote areas of developing countries.

**October 1st.** Sustainable Village Articles of Organization filed.

**October 31st.** Jade Mountain moves out and The Sustainable Village takes over the space at 717 Poplar Avenue.

**November 5th.** First employee, Alden Taylor, starts.

**December 12th.** We're back and running with 16 people and new projects in Columbia, Nigeria, Iceland, The United Arab Emirates, Nepal, Indonesia, Kenya, and Tibet.

**December 14th.** New working partnership with members from the International Hospital for Children, representatives from the US and Pakistani governments, Engineers Without Borders-USA, and the Rocky Mountain Institute to improve and develop Afghani refugee camps using appropriate technology and sustainable development.

Steve Troy  
Founder and Manager,  
The Sustainable Village

## Sustainable Development in Action

We have eyes to see, ears to hear, hearts to feel and hands to act. Our world has escalating problems that we can no longer ignore. One billion people struggle to survive on one dollar a day, 80% of the global population lives in sub-standard housing, 70% are unable to read, and 50% of everyone on the planet suffers from malnutrition.<sup>1</sup> 35,000 children die from hunger daily, and every major ecosystem is in measurable decline.

It is possible to eradicate hunger and illiteracy as well as provide clean water, sanitation, education and health care for everyone. The UN Development Agency estimates it would require an additional \$40 billion annually, intelligently spent. We have the technological solutions; it's time for implementation.

No one country or organization alone can solve these global issues. It's up to all of us, the global community. We can increasingly network and leverage our strengths in partnership with each other. One important step is for the thousands of public and private organizations already involved to proactively share information, understanding and resources. Worldwide sustainability will require the largest public/private collaboration in history; forged out of necessity, global in its reach and unparalleled in its purpose.

The Sustainable Village works to implement positive, small-scale solutions to global problems. We leverage renewable energy, appropriate technology and microenterprise ideas to improve quality of life, save money, create jobs, increase productivity and protect the environment. These antidotes to poverty, social injustice and poor education also prevent the all-too-common cycle of violence.

Additionally, sustainable development solutions address multiple social problems simultaneously. Public sector problems are inextricably linked and require comprehensive, systemic solutions. For example, a single project can create jobs, reduce the spread of disease, economize resources and produce clean energy.

The Sustainable Village connects organizations, projects, volunteers and knowledge. We provide technological services required for international sustainable development projects.

---

*Worldwide sustainability will require the largest public/private collaboration in history; forged out of necessity, global in its reach and unparalleled in its purpose.*

---

Focusing on developing countries, we aid projects dealing with energy generation, public health, sustainable agriculture, safe water, long-distance communications and micro-enterprise employment. All of our profits go toward funding and promoting renewable energy and micro-enterprise activities.

### PROJECT FUNDING AND NETWORKING

We connect projects with funding sources and contacts doing similar work. We charge for – as well as donate – services and equipment.

### SYSTEM DESIGN AND ENGINEERING

We engineer all types of sustainable development systems: from solar, wind, bio-mass and micro-hydro electricity generation to rainwater catchment, water

purification and communications. We have the expertise to identify the appropriate technology and design for almost all requirements and budgets. We have 35 years experience and thousands of successful installations worldwide.

### EQUIPMENT AND PARTS SUPPLY

With the largest selection of renewable energy equipment in the world and long-standing relationships with over 1000 manufacturers, we can ensure the most economical systems.



The Sustainable Village: offering the physical, financial and intellectual tools for visions of sustainability to become reality.

<sup>1</sup> Calculations by Dr. Philip Harter of the Stanford University School of Medicine.

## INTERNATIONAL DELIVERY

We help organizations get all the hardware they need to remote locations.

## INSTALLATION AND TRAINING

We provide our own on-site installation experts or we can network organizations with experts living in the same countries as their projects. We also help train people to install and maintain renewable energy and sustainable development systems.

## WEB SITE DEVELOPMENT, PRINT PRODUCTION AND MARKETING

Our veteran graphics and marketing staff help renewable energy and sustainable development organizations improve their Internet presence, communications materials and marketing. We charge groups that can afford these services and use the profits to help groups doing important work but on shoestring budgets.

*The Sustainable Village offers the physical, financial and intellectual tools for visions of sustainability to become reality.*



## History and Heritage

We're a new organization with old and deep roots in sustainability. Steve Troy, one of the pioneers in appropriate technology, began working in the development field in 1966.

Since that time he has founded or co-founded 14 businesses including Jade Mountain, Real Goods, Planetary Solutions and Gaiam Energy Tech. He created The Sustainable Village specifically to do this important work in developing countries.

## Partners, Customers and Suppliers

We work with local and international non- and for-profit organizations, religious and secular groups, governments and individuals - anyone working with sustainable development. We network and share resources, leveraging each other's skills so that we can all go further. We search out the best suppliers of renewable energy and appropriate technology products and constantly update our web site with our latest discoveries. We supply tools for manufacturing products in developing countries and import the goods back for distribution in the US: products "Made with Renewable Energy."

## An Invitation to You

Do you see, hear and feel our planet's challenges and want to take action? If so, please partner with us. Are you involved in a sustainable development project that could use seasoned expertise in engineering, hardware procurement, delivery, installation or communications? We could make it easier and less expensive. Do you have a good idea for a project, product or micro-enterprise? Please let us know so we can share it with our global audience. We want to make sustainable development happen in every way possible. It would be an honor to serve and work with you.

Sincerely and Enthusiastically,

Barrett C. Brown  
International Development Director



## Micro-Enterprising

Very small businesses called micro-enterprises are built on dreams and hard work, but the assistance they need is often in short supply. Nowhere is this more apparent than in parts of the world where equipment, transportation and reliable electricity and telecommunications can be hard to come by. This catalog and our accompanying web site serve as tools to foster new opportunities for rural entrepreneurs.

We complement the partnership between micro-enterprises and their supporting organizations. Our mission is to forge new connections that will enable micro-entrepreneurs to locate the resources they need, increase their customer base and expand into new markets. We can link your organization to people ready to help. If you need a portfolio of micro-enterprise opportunities to offer to communities, or are looking for one yourself, we'll get you started. If you want to expand your organization's reach, we'll make the introductions. If you're creating a product or a new micro-enterprise, we'll explore offering it to the world via our business-to-business network, web site and catalog.

Micro-enterprises are critical to eradicating poverty on the planet. **One idea, one job, one family, one community at a time: let's do it.**

## Appropriate Technology in Action!

Mohammed Bah Abba, Nigeria

Mohammed Bah Abba discovered a way to use inexpensive, locally available materials to make simple refrigeration systems. Easy to make, inexpensive, and requiring no electricity, they still work incredibly well – eggplants stay fresh for 27 days instead of the normal 3, peppers and tomatoes last 21 days or more; and African spinach that normally spoils in just 1 day, lasts for 12. By putting a smaller clay pot inside a larger one with wet sand in between, he found that the natural evaporation creates a refrigeration process with a cost of only 30 cents! We're experimenting to help improve this process by testing a solar powered fan blowing across the top of the pots as well as using a third outside pot filled with water.



### Perfect Power for the Next 5 Billion Years

The best form of energy on earth is actually not on the earth but rather sitting 93 million miles out in space in the form of the giant fireball we call the sun. A ball of gases over a million times larger than Earth, the sun is essentially a giant nuclear fusion reactor with temperatures that reach 27 million °F. As it slowly converts all its hydrogen into helium, incredible amounts of light and heat are released. Every year, in fact, the sun bathes Earth in the energy equivalent of 200 million power stations. That's 15,000 times more than all the energy currently used by the human race.

Yet only 6/100 of 1% of this energy is used, and most of that is consumed by Earth's plants, the original solar collectors, who turn sunlight into food via photosynthesis.

Photovoltaics (PVs), also called solar cells, are the most common way to capture the sun's energy. Made of semi-conducting materials, these cells release electrons when struck by the photons in sunlight. Efficient PV materials can turn up to 15% of the light they receive into electricity.

With additional research, experts believe that PVs could supply most of our heating and electrical needs within 40 years using just 0.3-0.4% of our land area. This is an area the Department of Energy says is equal to the amount now devoted to coal production.

Free, limitless, non-polluting, and available to varying degrees everywhere on the surface of our planet, solar power is destined to assume a critical role in the creation of a sustainable economy.

### Heat Wave

Our atmosphere acts like a giant greenhouse. As the sun's energy hits the Earth and bounces off, some of it is trapped and held by carbon dioxide and other gases in the air. Perfected over millions of years, this delicate system regulates our climate. Since the industrial revolution, however, humankind has altered the balance by adding more carbon dioxide to the atmosphere than it would normally contain and thereby increasing its ability to trap and hold additional heat.

The results of this additional heat accumulation are called global warming or climate change. Since the 1890s, atmospheric levels of carbon dioxide have grown by 25% and are increasing at about 0.5% per year. Researchers predict that a doubling of carbon dioxide will raise the earth's temperature from between 3 to 8 degrees F. The 10 warmest years ever have occurred in the last 15 years. In the last 150 years, average global surface temperatures have risen 0.5° to 1.1°. Because a rise of even a few degrees in average temperatures will have dramatic effects on sea levels, precipitation, and local climates, preventing global warming is crucial. You can help make a difference by conserving energy and fuels (the primary human sources of carbon dioxide). Drive less, take public transportation, practice all possible forms of energy efficiency at home, and plant trees to absorb excess CO<sub>2</sub>. It's the surest way to avoid a dangerously permanent heat wave.

### Alternative Energy: An Economical Solution

At first glance, alternative energy systems are more expensive than conventional, grid power. Most utility companies only charge about 10¢/kWh. But how much

does utility power really cost? Not included in that 10¢ are the tons of carbon dioxide going into our atmosphere. Not included are the repairs to our highways from trucks carrying coal and gas thousands of miles each day. Not included are the pollutants to our water, earth, and air. Not included are the health care expenses resulting from pollution - asthma, emphysema, the unknown effects of proliferating cancer producing chemicals. Not included are the costs of toxic waste dumps, acid rain, smog, ozone depletion and global warming. Most of these hidden costs are subsidized by our government and paid for by our taxes. But they're real costs. And how long before the government with its astronomical deficit has to give these costs back to where they belong - to the people using energy?

Think of these real costs when you consider using more energy efficient lights or appliances. When you consider building a passive solar house or installing a solar electric system. When you consider extra insulation, water saving fixtures, a greywater system, a demand water heater or an electric vehicle.

We tend to look at decisions from a purely personal point of view. With just a little more perspective, though, it's not hard to see how our choices influence taxes and where government dollars go. For example, conserving water may not directly effect our monthly utility bills at all. But think of the tax dollars that go into purifying it, pumping it, dispersing it, and disposing of the waste water.

Although more than 10¢/kWh, alternative energy is both an economical solution and a sound investment in the future.

— Steve Troy

## Solar Installation and Maintenance Business

All the benefits of solar systems can fall apart into frustration without good installation and proper maintenance.

We've heard of systems installed with the solar panels in the shade or turned away from the sun. People frequently reverse polarity on expensive inverters and burn them up. Simple and easy-to-fix problems like a corroded battery terminal or a rodent-chewed wire, will prevent an expensive solar electric system from working properly. And although solar modules last more than 20 years, many systems in remote locations cease to function after just a year or two - often because of something as simple as a battery without water.

The world needs thousands of solar installation and maintenance businesses. Lighting allows microentrepreneurs to extend their working day and generate more income. If you live in a remote area without conventional, centralized grid power or in a place without reliable power, there may be an opportunity to start a Solar Installation and Maintenance Business.

Begin with a tool to evaluate potential sites like the Solar Pathfinder. Learn the math or get a software program like the Solar



*Elike Nuku from our partner Gold River Solar installing a back up power system for a bank in Ghana.*

Worksheet to determine PV and battery sizing. Get a good book like Photovoltaics or Solar Electric Systems for Africa that takes you through the installation process step-by-step. You'll need a good meter like the Fluke 87 or at least an inexpensive Pocket Multimeter. Start with installing a small system for yourself, something you can live with, use everyday and learn from. You may want to make some of your own equipment like battery and inverter cables, mounts, power centers, and charge controllers (see small scale PV equipment manufacturing). Invite your friends and neighbors to see your system in action and explain how it works. After a few completed small jobs, you may want to try something on a bigger scale - maybe a whole house or small waterpumping installation. Branch out into wind systems.

**Here are some items that could help you get started:**

- **Solar Pathfinder (PV904)**
- **Solar Worksheet (PV315)**
- **Photovoltaics (BK340)**
- **Solar Electric Systems for Africa (BK144)**
- **Fluke 87 Meter (MT170)**
- **Pocket Multimeter (MT5268)**
- **Wind-measurement and analysis tools**
- **Components you can make yourself**





*Solar-powered electronics repair, Bangladesh (Allderdice, DOE/NREL)*



*Solar shop in Nepal (DOE/NREL)*

## Micro-manufacturing Solar Electric Components

Importing parts, instead of finished goods, to assemble solar electric and other appropriate technology components yourself can save high freight charges and give you control of delivery times and your income. First, check your country's duties on parts imported for manufacturing.

After some time studying, you can learn to make your own battery cables, charge controllers, junction boxes, power centers, PV mounting racks, and wiring harnesses. If you're a solar installer, this will add to your sales margin and insure wires are cut to the exact length and that you have the correct number of battery interconnects. (Sometimes installations are delayed weeks because of a \$2-\$3 part.) If you have a store, making your own components will give you some productive work between customers. It will increase your profit margins and make it easier to provide faster and more customized service. A strong crimping tool designed for up to 6/0 wire is essential for this work. You'll also need a heavy-duty wire cutter and high quality soldering iron though these may be more easily found locally. We can supply all the small parts you'll need plus charge controller innards, shrink tubing, fuses, electric boxes, etc. When the small component manufacturing is well underway, you can branch out and try making things like small portable power packs, DC fans and lights, solar trailers, and even 12V refrigerators.

**These items could help you get started:**

- 6/0 crimping tool
- Heavy duty wire cutter

- DC Soldering Iron
- DC Welder
- DC Drill
- Wire
- Terminals, shrink tube, inline fuses
- Electrical Boxes
- Charge Controller circuit board
- DC refrigerator/freezer compressor
- DC fan motor
- Instructions for making 12V Christmas Tree lights
- Solar Electric system (depends on location and use)

## Battery Recharging Station

In remote areas, batteries represent infinite possibilities - light, music, education, tools, water, kitchen appliances, television, games, the list goes on and on. Batteries are expensive though and the solar systems required to recharge them are beyond many people's financial means. Research done by the National Renewable Energy Laboratory shows that even in very low income, remote areas people spend US\$7 to US\$10 per month on flashlight batteries and kerosene. For that amount or less, you could rent rechargeable flashlight batteries, deep cycle solar batteries, or a solar powered lantern or flashlight and include the periodic recharging service. If people already have batteries, you could charge a small amount for bringing them back up to a full charge.

**A microentrepreneur might choose to offer any of these services:**

- Solar Lantern Rental
- Flashlight battery recharging
- Deep Cycle battery recharging
- Battery rental including necessary recharging
- Old battery reconditioning
- Battery sales
- Rental of DC, battery-powered equipment

Solar-powered battery rechargers can be customized to fit the most frequently used batteries in your area (for example, 120 AA batteries, 80 C batteries, 60 D, 40 9-Volt, or any combinations can be charged together in the same charger). We have special chargers and a reconditioning liquid for rejuvenating old, "dead" 12V batteries. And, of course, a variety of solar electric systems for recharging various numbers of deep cycle batteries.

**These items could help you get started:**

- **10 watt Flashlight Battery Charger (BC102)**



- **Customized, larger version**
- **Rechargeable Batteries**
- **Solar Lantern (SF6394)**
- **Solar Flashlight (SF3244)**
- **Pulse Battery Reconditioning Charger (PV4185)**
- **Battery Liquid Reconditioner (RB911)**
- **Solar Electric System - depending on size and budget**
- **DC-powered equipment**



## Village Grinder

A small, local grain processing service can help families with plots of land keep more of their crops each harvest. Customers can drop off their wheat, corn, seeds, or favorite grindable on their way to work or to visit a friend. On their way back home, they'll stop by and pick up their flour or cornmeal. Charge a fee or trade for a part of what you grind. Partner with a delivery service to pick up, deliver, and sell your goods. Choose between solar, hand or foot-powered grinding equipment. Over time, you'll learn to grind for different consistencies for different recipes.

Learn preservation techniques and provide new products like nut butters.

Expand into canning and preserving fruits and vegetables with a Village Dehydrator. If you trade your grinding services for a small percent of what you grind, you could run a small food store on the side. Partner with a local bakery enterprise with a



*Market day in Bankpruga, Ghana  
(DOE/NREL, Roger Taylor)*

solar oven and use some of your flour to bake tasty treats for your customers and family. Add vitamins and any nutrients missing from the local diet. If your area has specific health problems resulting from dietary deficiencies, you could investigate funding from religious and health organizations.

**These items could help you get started:**

- **Complete Foot-Powered Grinding Kit (TL5500)**
- **or smaller, with inverter (IN6428)**
- **or smaller Country Living Mill (KT4486)**
- **optional DC motor and solar power for above**





Wood shop in Guatemala (DOE/NREL)



Wood shop in Ghana (DOE/NREL)



Sharpening  
with Multipurpose  
Independence Tool

## Appropriate Technology Wood Shop

Processing trees in the same area where they are grown makes it possible to cut many less trees and still create more and higher paying local jobs. Each tree becomes more valuable for the local economy and, as a result, everyone has more incentive to nurture and replant the forest. This is a great model for microenterprises in regions fighting to increase incomes and slow deforestation. Small one and two-person mills can cut logs into boards. A multipurpose independence tool adds the ability to run a full-service wood shop without electricity. Where shaping boards and drilling holes become long, difficult projects by hand, the independence tool expands the wood shop's capabilities help people accomplish their building projects in a fraction of the time. And the finished material will look and feel high quality. You can sharpen tools, grind and sand rough edges, even make furniture. Carve bowls, turn intricate table legs, or produce tourist gift items - the list of finished goods is limited only by your imagination. With more time and experience, move on to bigger projects like recycling used lumber by laminating small pieces into strong beams. As the business grows, you can invest in power generating equipment such as solar, wind, or micro-hydro that will let you produce more and higher quality products as well as amenities like lights, music and refrigeration.

**These items could help get you started:**

- **Multipurpose Independence Tool Kit (TL5500)**
- **Table Saw Attachment**
- **Grinder Attachment (TL7669)**
- **Lathe Carving Tools**
- **Drill Bits**
- **Small Saw Mill**
- **Solar Electric Lighting System**
- **Large Alternative Energy System for bigger tools**



## Appropriate Technology Village Water Shop

Do you live in a place with limited water? If so, you can use the tools here to help your community collect an extra supply and make it last longer. Customers can come to you or you can make regular deliveries. Start with a small rainwater collection system to collect the run off from your roof. Many places have more than enough water when it's raining but not enough later. A good catchment system helps level out these natural cycles. You can expand this to save rain that falls over a large area. We have great books with illustrated details for building rainwater catchment and water storage tanks with locally available materials. Add a well pump and keep your water supply steady during long stretches without rain. We have plans for how to make your own hand or solar pump. The cost of pumping systems typically increases with the amount of water required per day. Start with what you can afford. No well? Another business opportunity might be to use small, inexpensive well drilling equipment that digs wells as deep as 60 meters.

Purify the water to make sure it's safe and tastes good. Depending on the location, this could be a business in itself - even in an urban environment. According to a new report by the U.N. sponsored World Commission on Water for the 21st Century, one billion people worldwide do not have access to safe water. Water purification needs are different in almost every area. We can help you plan the most appropriate and cost-effective system for your unique situation. Now that you've harvested and taken care of a good water supply, help it last longer by encouraging or selling water saving appliances and fixtures. We have low-flow shower heads, urinals, no-water-use toilets,

drip irrigation, and greywater systems for reusing water a second time. We also have super water-saving appliances. Not conserving our precious potable water supplies is a world-wide problem. The next development in your water business could be delivery. We have a great book on making your own delivery cart, you could make or buy a bicycle-powered version, or use a truck. Our collapsible tanks come in many sizes designed to fit into the back of a cart or vehicle. They're light weight and fold flat when not in use but hold up to 15142 liters (4000 gallons).

### Here's what you'll need:

- **Rainwater Collection - save, treat, and store rainwater for future use**
- **Water storage tanks - make your own storage from locally available materials**
- **Hand and solar well pumps - keep your water supply steady during long stretches without rain**
- **Well drilling equipment - inexpensive wells as deep as 60 meters**
- **Portable tanks - easy delivery service**
- **Water Purification - make sure your water stays clean and healthful**
- **Pressure Pumps - easily move the water from place to place**
- **Greywater Systems - Treat and reuse water**
- **Products to help save water**
- **Solar Electric system - power pumps and purification equipment (cost depends on location and use)**



*Delivering water in Africa  
(DOE/NREL)*

*"We think that the only way of overcoming the world crisis is using 1st world experience without going through the same mistakes, plus a deep respect toward Nature."*

*- RDL, Mexico City*

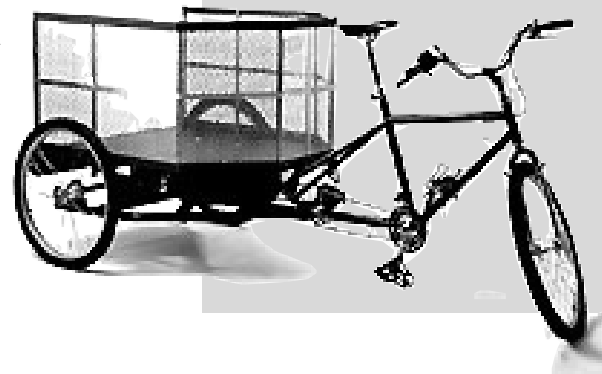



*Waterstation in Africa  
(DOE/NREL)*



*Water station Mauritania  
(Simens Solar)*

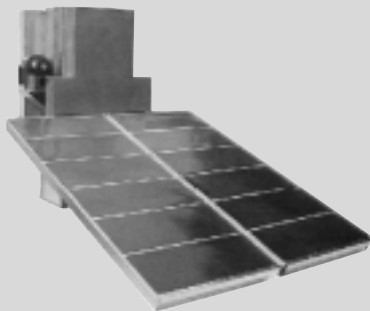

*"Thank you, the information was useful for my research about pesticides, environment and society in Andean places in Venezuela."*

*- Ms. Carina Salazar*

## Appropriate Technology Water Pumping Station

This is a larger, more commercial or municipal version of the Solar Water Shop. With more funding and human resources it is possible to build a village scale water system. Groups can build large rainwater collection tanks, farm and village water pumping systems, and multi-family water testing and purification facilities. Based on individual water use, the entire community can pay back start up costs as well as financing maintenance and expansion projects. Lack of sufficient water is a major

worldwide problem. In many countries, lack of potable water causes extreme hardship and contributes to numerous health problems. You could start a new business that would help solve some of these water shortage problems. In some places, local and international grants and loans are available for projects like this. Please contact us with your project requirements, we'll try to match it with the appropriate organization or grant.

## Village Dehydrator

During certain times of the year, many villages have an abundance of food. At other times, people may suffer from hunger, malnutrition or even starve. Preserving food during the times of abundance helps stretch supplies for the lean times. With a solar dehydrator, fruits and vegetables quickly dry without concern for mold or rain making it possible to preserve a larger amount of the harvest in a faster and more efficient way. Solar dehydrating systems let you start the drying process on site rather than needing to transport the crop to a different location. In coffee processing, for example, solar drying means shorter, on-site drying at a lower temperature - 56°C (122°F) instead of the conventional 79°C (158°F). It minimizes deterioration and spoilage from excessive moisture and can save up to 30% of the harvest. (Coffee goes stale within 7 days of roasting making it more acidic with a more sour, bitter taste.) Solar drying eliminates the need for firewood and helps slow deforestation - 16,000 acres of rain forest are stripped away for this purpose each year. It provides value



to small farmers because dried beans sell for a higher price than green beans. The ability to store crops and wait for better prices, instead of the need to sell within a few days of harvesting is a great poverty-reduction strategy.

**These items could help you get started:**

- **AirFlo Dehydrator or larger solar water dehydration system for larger production**
- **Solar Electric Fan System for larger production**
- **Electric Bicycle Delivery Truck**

## Appropriate Technology Medical Clinic

Operating a medical clinic requires trained staff, specialized equipment, supplies and a good deal of resources. Some non-electrical options exist, but without power, most commonly available medical equipment will not work. Keeping vaccines viable is a major problem. With some research, the tools and ideas below can become part of a customized community plan to combat local health issues. A community determined to improve local health care might approach a religious organization or non-profit to partner with for a long term project.

In the graphic to the right, solar-powered refrigerators on pushable carts are launching a mass vaccination program in Zaire. Only 46 kg., they are portable and make huge inroads in reducing the area's high rate of infant mortality. Each one needs only one solar panel and meets vaccine storage requirements for a population center of 100,000 people. Two hours of sun on a 3 amp solar panel provides enough energy to run the refrigerator for one full day. A 100 amp battery stores enough power for one week of operation without sun while only discharging 50 percent. It never needs defrosting and has only one moving part. Highly durable, some studies suggest that PV powered refrigerators are more reliable than kerosene or any other "fuel" powered refrigerator. The larger #FV044 weighs more (73 kg.) but makes ice that can act as a backup cooling source when no power is available.

Other portable medical equipment include Manual, Crank, and Solar Centrifuges. They make it possible to provide comprehensive blood testing without power. The Spectrum Mini-Centrifuge ties to a tree or building and works like a

child's toy top. Simple and inexpensive, it gives accurate blood sample diagnosis of anemia, dehydration, and tropical disease when used by trained health care workers. The Jabric cranks and adds capacity for larger clinics.

An endeavor of this complexity needs partnerships to succeed. International organizations coordinate volunteer doctors and dentists to visit remote clinics. Other groups donate medical supplies. If your community is having difficulty locating organizations to support your work, please contact us.

**Here are some products that may help you get started:**

- **Spectrum Centrifuge (MD222)**
- **Vaccine Refrigerator (FV44)**
- **Solar Electric System (depends on location and use)**
- **Solar Microscope (MD221)**
- **Remote Medical & Dental Books**
- **LED Lighting System**
- **Assorted Bandages, medicines, etc.**



Solar medical clinic, Peru (DOE/NREL)



Portable Medical Clinic in Zaire.



*I have just returned from Wasolo, Zaire, Africa. After having worked there with a protestant mission for about 8 weeks as their physician, it became evident that they were very inefficient in their use of fuels for electricity. There is the potential to save about 500 US\$ per month in fuel costs by converting the Operating Room to full time 12 Volt power from Solar Panels and batteries, like our home in Lawrence and Jamaica."*

*-Dr. Roger Johnson*



*Solar-sewn clothes, Ghana  
(DOE/NREL, Roger Taylor)*



*Solar sewing shop, Nepal  
(Allderdice, DOE/NREL)*

## Appropriate Technology Sewing Shop

Clothes always seem to need mending and children never seem to stop growing. A good sewing machine opens the possibility to a business mending and making clothes or other handicrafts. Start with repairing your own clothes. Move on to helping your family and friends. After you have mastered the basic techniques, you may be able to start trading or charging for your

services. While still doing repairs, try making something from the beginning. Step-by-step do more difficult projects. Over time, you can grow your business from local to other villages to exporting. Start with a basic treadle sewing machine. It only needs "foot power" so the expense to get started will be minimal. Add a small solar electric system for light so you can work in the evening and still see clearly on dark days. If you want to sew heavy fabric and leather, advance to the high-pressure Multi-Purpose Independence Tool and the treadle head. Later you could get a DC motor and power this by adding to your solar electric system. As the business grows, you could use solar power industrial, electric machines with a battery and inverter system and have many people working at the same time.

### These items could help you get started:

- **Treadle Sewing Machine, complete (AA1957)**
- **DC Motor (GN620)**
- **Solar Electric System for Lighting (depends on location and use)**
- **Multi-Purpose Independence Tool Kit**
- **Head only (AA1958)**
- **Solar Electric system for machines (depends on location and use)**



## Solar Laundromat

In unelectrified communities, women and girls can spend hours each week washing their family's clothes. If women are working outside of the home and girls are encouraged to go to school, there may be an opportunity to offer laundry services as a business. Machines that wash and spin clothes come in a variety of sizes and prices. Hand operated equipment is fairly inexpensive. A solar electric system adds quite a bit of cost, but also increases capacity while reducing the manual labor required. A rainwater catchment system can help supply the water, and a greywater recycling system will assure the highest water efficiency. Rent use of the machine(s) or do it yourself and charge extra. A good washing machine not only saves time and physical labor, it also helps clothes last longer, helps prevent disease transmission, conserves water supplies and prevents water pollution. A good quality, horizontal axis washing machine cleans by pushing water through the clothes - you don't have the harsh, abrasive, rubbing action that wears fabrics thin starting holes. With a machine, you can use hotter water that kills germs and stops the spread of

disease. Another benefit with this method is the ability to reuse the water. Since it's hot, you can use it to preheat incoming cold water or in cold climates circulate it in greenhouses through PEX pipe at the root zone of plants. You can expand in many ways. If you have already found a good way to heat and reuse hot water, it would be fairly simple to offer a hot shower or bath for your customers. While you're cleaning their clothes, they could work on their bodies. You could also combine your business with a small sewing shop. You will already have the cleaned clothes, you could fix tears and restore buttons while waiting for your clients to return.

**Here are some of the equipment options you might consider:**

- **Staber 2000 (AA699)**
- **Other Energy-efficient Washing Machines**
- **Hand-powered Washers and Wringers**
- **Inverters**
- **Solar Electric System Estimate (depends on location and use)**
- **Hot Water Heating Systems**
- **Optional Spin Dryer**
- **Optional Rainwater Collection System**
- **Optional Greywater System**

## Well Drilling, Pump Installation Service

We can't live without water. Providing more wells in remote areas can improve standards of living and possibly slow the disturbing trend toward urbanization. Simple well drilling equipment is a relatively inexpensive investment with far-reaching benefits. Beyond just drilling the well, you could install the pipe, pump and storage system. Learn about dowsing and ways to locate good water sources. Depending on well depth and amount of water needed, you could

also learn how to make your own hand pumps from locally available materials. After you develop a business plan to provide this essential service, there may be funding sources or lenders interested in working with you.

**Here's are some suggestions on ways to start:**

- **Well drilling equipment**
- **Pump making books and articles**
- **Hand pumps**
- **Solar pumps**
- **Making your own storage tanks**
- **Storage systems**
- **Dowsing information**



*Washing clothes with solar-pumped water, India (DOE/NREL, Roger Taylor)*

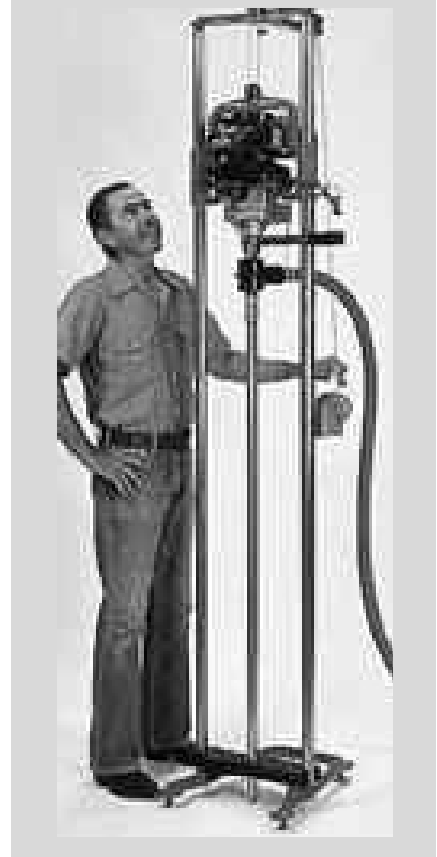



*Isaac solar powered ice maker.*

## Ice House Business

Ice in remote, tropical locations opens doors to many important opportunities. Scarce food supplies can stretch from times of availability into times of scarcity. Valuable harvests can be preserved until transportation becomes available. Meat and fish can be frozen and sold later or transported to communities where these foods are scarce. A renewable energy powered ice business could serve local farmers, fishers or hunters to help them get more of their products to market. For local customers, you could rent storage lockers. Start with a simple, basic system and slowly expand as

you gain experience. Find and talk to potential customers before you begin. Research the various possible uses for ice in your area and the value it may have. We have solar ice making systems designed for village, farm, or medical clinic use that use different technologies and create varying yields.

**These items could help you get started:**

- **solar ice making equipment**
- **solar modules**
- **refrigerators**
- **freezers**
- **compressors**
- **deep cycle batteries**

## Appropriate Technology Library Service

Help people find the information they need. Learning a better way to do a project can save hours of time and a great deal of money.

Discovering the best way to deal with a crop pest can save a harvest. Finding out how to repair a machine allows the work to go on. Sharing information about hygiene and water and food preparation can prevent illnesses. New building techniques, crop drying, beekeeping, transportation, biogas, aquaculture, sanitation...the list goes on and on. Information may be one of the most valuable commodities a business could offer.

Start collecting books containing information that is valuable to your community. Save up or get a loan for the Appropriate Technology Library on CD ROM. With a computer and this CD set, you will have access to over 150,000 pages from over 1050 books and documents on appropriate technology for remote areas. Everything from health care and forestry to energy, water supply, agriculture, and transportation.

You can rent out time to let

people do their own research or do the work yourself and charge based on the information you find. For example, you could research how to combat a difficult crop pest problem in return for a percentage of the saved harvest.

You could research how to make a hand or animal powered deep well pump for a share in the water.

Schedule classes and discussions. Invite experts to give seminars. The possibilities are endless and potential benefits to your community vast. Plus a meaningful job for you!

**Here are some examples of what you'll need:**

- **(BK1772) Appropriate Technology Sourcebook on CD-ROM**
- **AT Library on CD-ROM (BK6912)**
- **Used iMac computer with CD rom drive (we can get this for you)**
- **Used Macintosh 6100 w/ CD rom drive (AA7349)**
- **Solar Electric system (depends on location and use) SC5617**
- **How-to and appropriate technology books**



*Learning to make solar ovens in Africa (DOE/NREL)*



*Sharing information in Ghana (DOE/NREL, Roger Taylor)*

## Mobile Music

Music and sunshine have much in common. They both help create the background that makes life wonderful. They both transcend national boundaries, cultures, and politics. They both give reality to the notion of our common, shared humanity.

Sunshine can also make music more available in remote locations and create an income for musicians. Portable audio systems run from a solar-charged DC battery and provide amplification and sound control for both instruments and voice. As a less expensive alternative, the equipment can plug into a vehicle through the cigarette lighter receptacle. You might have to park on a hill to get the car started again though. An upgrade to the car system would involve a simple and inexpensive battery isolator. With one of these installed, two batteries would charge while driving but you would only drain power from the secondary one (preferably a deep cycle type). A portable battery pack gives independence from the vehicle - you can move off down that trail and find just the perfect meadow or clearing. Solar panels extend the battery life and music time. You can size a solar system based on the maximum amount of concert or practice time you would like. Solar trailers can provide enough music for all day and late-into-the-night concerts.

Most remote villages and communities more than welcome a traveling minstrel or band. With the

right equipment, numerous musical opportunities unfold. Not musically inclined? Consider renting equipment. Besides renting and sizing products for musicians, sound systems help everyone from missionaries wanting to extend their message to educators and health professionals teaching classes to families and groups wanting to enliven their parties. You could do everything from helping people learn more about health care and farming practices to uplifting their hearts with wonderful, live music.

**Here's a list of equipment that could help:**

- **Portable PA Systems (CM8030-32, CM8055)**
- **Speakers, microphones, accessories**
- **Portable power systems (SC6812)**
- **Karaoke Systems (CM8051-2)**
- **Battery isolators and combiners (SC651, SY655-58)**
- **Electric guitars and other musical instruments**
- **Solar electric panels (PV1797-8, PV1965)**
- **DC to AC inverters (IN3887-88)**
- **Solar Trailers (PS6095, PS6518)**

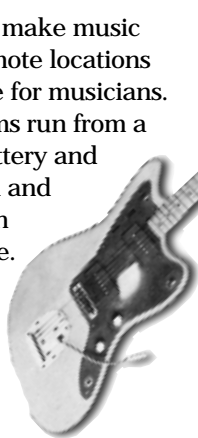

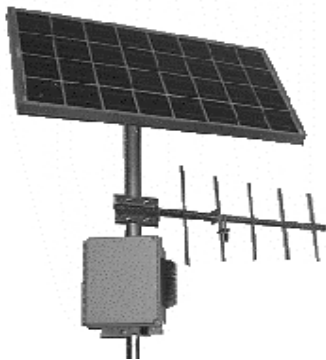

## Telephone Service

Lack of communication services isolate businesses, development organizations and entire communities. Recent advances in telecommunication technologies offer solutions that can help businesses find new buyers, keep family members in touch, and help remote communities in times of emergency - all at costs within the reality of small business ventures.

New satellite systems offer telephone service as well as email and internet access to many more parts of the world. Advanced long range phone systems can extend an existing service 80 to 160 kilometers. These systems can be as simple as a voice-only single line to as complex as a multi-line, multi-channel pbx system with fast internet access. A micro-entrepreneur in a remote village could set up a solar-powered satellite connected phone system and charge for phone calls. Email and internet access could be available for a different rate. If a regular telephone line is available in a nearby city or business, a long range phone system might be less expensive, if it is possible to have the phone company install a second line. If a second line is available, plug the remote phone system base into the new phone line, run a cable to a roof-mounted antenna, and shoot the signal to your remote

location. Costs vary based on required features, terrain, and distance. If cellular service is available, solar power can charge the cellular phone batteries and keep them in good working order.

This business can start small with a single line phone and gradually expand to accommodate the potential number of users.

**These items could help you get started:**

- **Single line, voice-only telephone line**
- **High-speed, internet-capable phone line**
- **Satellite system**
- **Solar power system - depending on size and budget**
- **Telephone booth**
- **PBX, multi-line**
- **Emergency Call Box**
- **Repeater system for extra long distance**



## Appropriate Technology Video Theater

In Colombia, a few remote communities are using PV systems that were provided to power rural health clinics to operate video theaters at night. A small admission is charged and the revenue is being used to pay for maintenance and repairs at the clinics. The theater provides entertainment, supports better health care services and encourages community participation.

With a relatively low budget, you could set up the most popular place for miles and miles. With a small solar electric system, you can power a video projector that will take VHS and other video formats and project them onto a 100" diagonal screen. Buy inexpensive used videos and schedule a series of movies. These systems are small and portable, so you can serve more than one community. Our Eiki video projector/player takes inputs from cameras, speakers, a separate VCR and projects sharp, high contrast images. A built-in amplifier and speaker provides sound. A less expensive way to start could use

filmstrips instead of videos. We have 12V filmstrip and slide projectors that are less expensive. Start with a system within your budget and slowly expand as your new business grows.

Everyone recognizes the importance of education but motivating people to take the time and trouble is a challenge. Mixing education with entertainment makes the job much easier. We have a wide selection of health and educational filmstrips. You could offer a service for schools, medical clinics, or a local community center. Government and aid organizations that stress the importance of education may be a source of funding or loans.

**Here are some examples of equipment what you might want:**

- **Video Projector**
- **Your Favorite Movies - don't forget the educational ones! (request our list of titles)**
- **Filmstrip and Slide Projectors**
- **Movie Screen**
- **Sound Equipment**
- **Solar Electric System (depends on location and use)**
- **Simple, Inexpensive Structure**



## Shurflo SubPump

### Lower Cost and Better Features!

Longer life, higher efficiency, smaller and lighter weight, easier to rebuild, all plastic construction prevents problems caused by minerals in water. Easier installation—now only 6 lbs. Includes handy water tight quick disconnect plug that makes hook-up easy and water-protected without splicing. Dry-run capability—you won't have to worry about harming the pump if your well runs too low. This pump makes a solar pumping system comparable in cost and performance to a generator-run system—but without the noise, fuel costs and maintenance. Easy to install in 3 to 4 hours and lightweight enough to move for seasonal pumping. Hook directly to solar modules for daytime pumping or attach to a battery for on-demand water. Positive displacement triple-diaphragm pump with new internal bypass. Rebuild kits (#WP324) Maximum submersion 100', max amps 4.0. Outlet port 1/2" barbed fitting, inlet 50 mesh stainless steel screen. 12" long, 3.75" diameter, 6 lbs., 12/24V DC. Use 1/2" pipe.



**SubPump #WP200 \$695**  
**Replacement Motor #WP6305 \$175**

Total Head	Shurflo SubPump Output			
	Flow Rate @ 24V	Average GPD	Array Size Watts	Current Amps
20	117 GPH	702	58	1.5
40	114 GPH	702	58	1.5
60	109 GPH	654	78	2.1
80	106 GPH	636	89	2.4
100	103 GPH	618	99	2.6
120	101 GPH	606	104	2.8
140	99 GPH	594	115	3.1
160	98 GPH	588	123	3.3
180	93 GPH	558	135	3.6
200	91 GPH	546	141	3.8
230	82 GPH	492	155	4.1

- Add 50% for summer pumping with solar tracker
- GPD (gallons per day) figures can increase by as much as three times with battery bank system
- Above figures include LCB

## SubPump Controller

### More features and lower cost!

Makes pumping systems so efficient they can even operate in rain. The new, "Basic" controller increases water output 20-50% by matching the current and voltage available into the best combination for the pump. Optional float switch automatically stops pump when your storage tank fills. "Deluxe" controller has 12 or 24V operation, on/off switch, water tight enclosure and cable inlets as well as high/low water level sensors and cable to prevent operation when well water gets too low.

**Basic Controller #WP201 \$132**  
**Deluxe Controller #WP3770 \$325**



## Solar Water Pumping Glossary

### Solar Pump Components

**Centrifugal Pump** - A pumping mechanism that spins water to push it out by centrifugal force.

**Piston Pump** - A type of pump in which water is drawn in and forced out of one or more chambers, by pistons.

**Positive Displacement Pump** - Any mechanism that seals water in a chamber, then forces it out by reducing the volume of the chamber. Examples: piston & diaphragm pumps. Used for low volume and high lift. Contrast with "centrifugal". Synonyms: volumetric pump, force pump.

**Jet Pump** - A surface-mounted centrifugal pump that uses an "ejector" (venturi) device to augment its suction capacity. The ejector may be down in the well, to assist the pump in overcoming the limitations of suction. (Some water is diverted back down the well, causing an increase in energy use.)

**Multi-Stage Centrifugal** - A centrifugal pump with more than one impeller and chamber used to produce higher pressure. Conventional AC deep well submersible pumps and higher power solar submersibles work this way.

**Submersible Pump** - A motor/pump assembly designed to be placed entirely below the water surface.

**Surface Pump** - A pump that is not submersible. It must be placed no more than about 7m above the surface of the water in the well.

**DC Motor, Brush-Type** - The traditional DC motor, in which small carbon blocks called "brushes" conduct current into the spinning portion of the motor. Used in DC surface pumps and in some DC submersible pumps. Brushes wear after years of use, and may be easily replaced. It is a variable-speed motor, well suited to direct solar power.

**DC Motor, Brushless** - High-technology motor used in some DC submersibles. An electronic system eliminates the need for brushes.

**Induction Motor (AC)** - The type of electric motor used in conventional AC water pumps. It requires a high surge of current to start and a stable AC voltage supply, making it relatively expensive to run from by solar power.

**Pump Controller** - An electronic device which varies the voltage and current of a PV array to match the needs of an array-direct pump. It allows the pump to start and to run under low sun conditions without stalling. Electrical analogy: variable transformer. Mechanical analogy: automatic transmission. Sometimes called Current Booster.  
 — Continued on Page 24

## SubPump Water Pipe and Wire

The pipe recommended by Shurflo to use with their pump. Reinforced clear 1/2" vinyl tubing rated for drinking water and 200 psi. Flexible and easy to use. NSF and FDA approved. Use #WP2984 to join sections of pipe.

**50' rolls #WP203 \$ 57.50**  
**Pipe Couplings #WP2984 \$ 1**  
**100' rolls #WP1440 \$ 96**  
**10/2 Sub Pump Wire #SC103 \$ 0.72**



## SolarJack Quad Submersible

Up to 2220 gallons per day without a battery system!  
(And only two solar modules!)

Another breakthrough in efficient solar water pumping. Delivers as much water as other systems that cost thousands of dollars. Uses as little as 35 watts. Install below water level in a pond, river, cistern, or into a ground water well. Pollution-free, corrosion-free, self-lubricating, and quiet. Diaphragm type positive displacement pump made from marine grade bronze and #304 stainless steel. High quality! Requires minimum 4.5" well casing.

#WP603 \$790

SolarJack Quad Output				
Total head GPD	Flow Rate 2-48W PV	Fixed GPD	Tracking 8 hours GPD	Tracking 10 hours
0	222 GPH	1332	1776	2220
10	213 GPH	1278	1704	2130
20	204 GPH	1224	1632	2040
30	197 GPH	1181	1574	1968
40	190 GPH	1138	1517	1896
50	185 GPH	1109	1478	1848
60	180 GPH	1080	1440	1800
70	174 GPH	1044	1392	1740
80	170 GPH	1022	1363	1704
90	167 GPH	1001	1334	1668
100	162 GPH	972	1296	1620

- Figures up to 50' head based on using two 48 watt module
- Figures 60'-70' head based on using two 60 watt modules
- Figures 80'-100' head based on using four 40 watt modules
- All numbers assume panels wired in series for 24V

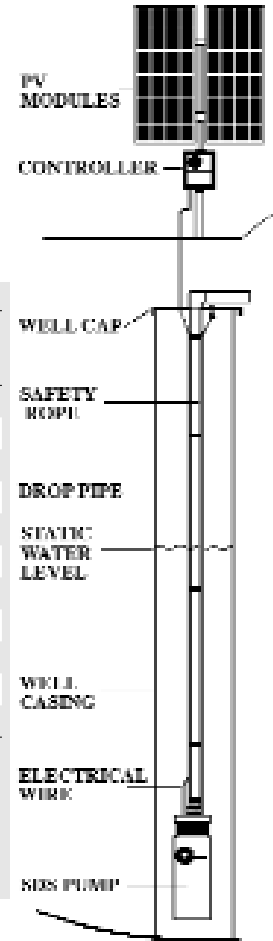

## SolarJack Duplex Submersible

High efficiency diaphragm type positive displacement pumps made from marine grade bronze and stainless steel. Submerge up to 100' below water level and pump up from 230'. They work with as little as 35 watts of solar power and from 12 to 30 volts. 3.8" OD, 10.75" long, 14 lbs.

#WP3820 \$730

SolarJack Duplex Submersible			
Total Head	Amps	Fixed GPD	Tracking
0	1.17	493	822
20	1.31	457	762
40	1.48	428	714
60	1.65	407	678
80	1.82	389	648
100	2.00	371	618
120	2.16	356	594
140	2.33	342	570
160	2.50	331	552
180	2.68	317	528
200	2.85	310	516
220	3.00	299	498
230	3.10	295	492

## Power Control Center

Boost current for low light starting and running, provide easy wiring and safety controls, status lights, and a weather proof enclosure. The second controller listed here takes the 12V DC in a battery bank and steps it up to 30V for optimum efficiency. Use the Dry Run Stop to turn pump off when water table drops too low, the float switch to stop pumping when a storage tank fills. The installation kits listed include everything you need from the pump to the top of the well—10/3 pump wire, safety rope, pipe, and fittings.

For Solar Direct Applications	#WP604	\$320
For 12V Battery Applications	#WP3215	\$260
Dry Run Stop Electrodes	#WP3216	\$11
Float Switch	#WP1142	\$49

## Installation Kits:

Duplex Sand Shroud	#WP3821	\$45
Quad Sand Shroud Round	#WP3822	\$72
Quad Sand Shroud Square	#WP3823	\$63
Splice Kit	#WP3824	\$12
Duplex Install Kit 25'	#WP3825	\$128
Duplex Install Kit 50'	#WP3834	\$171
Duplex Install Kit 75'	#WP3827	\$212
Duplex Install Kit 100'	#WP3828	\$259
Duplex Install Kit 150'	#WP3830	\$359
Duplex Install Kit 175'	#WP3831	\$458
Duplex Install Kit 200'	#WP3832	\$502
Duplex Install Kit 225'	#WP3833	\$550
10/3 Pump Wire	#WP3221	\$1.24



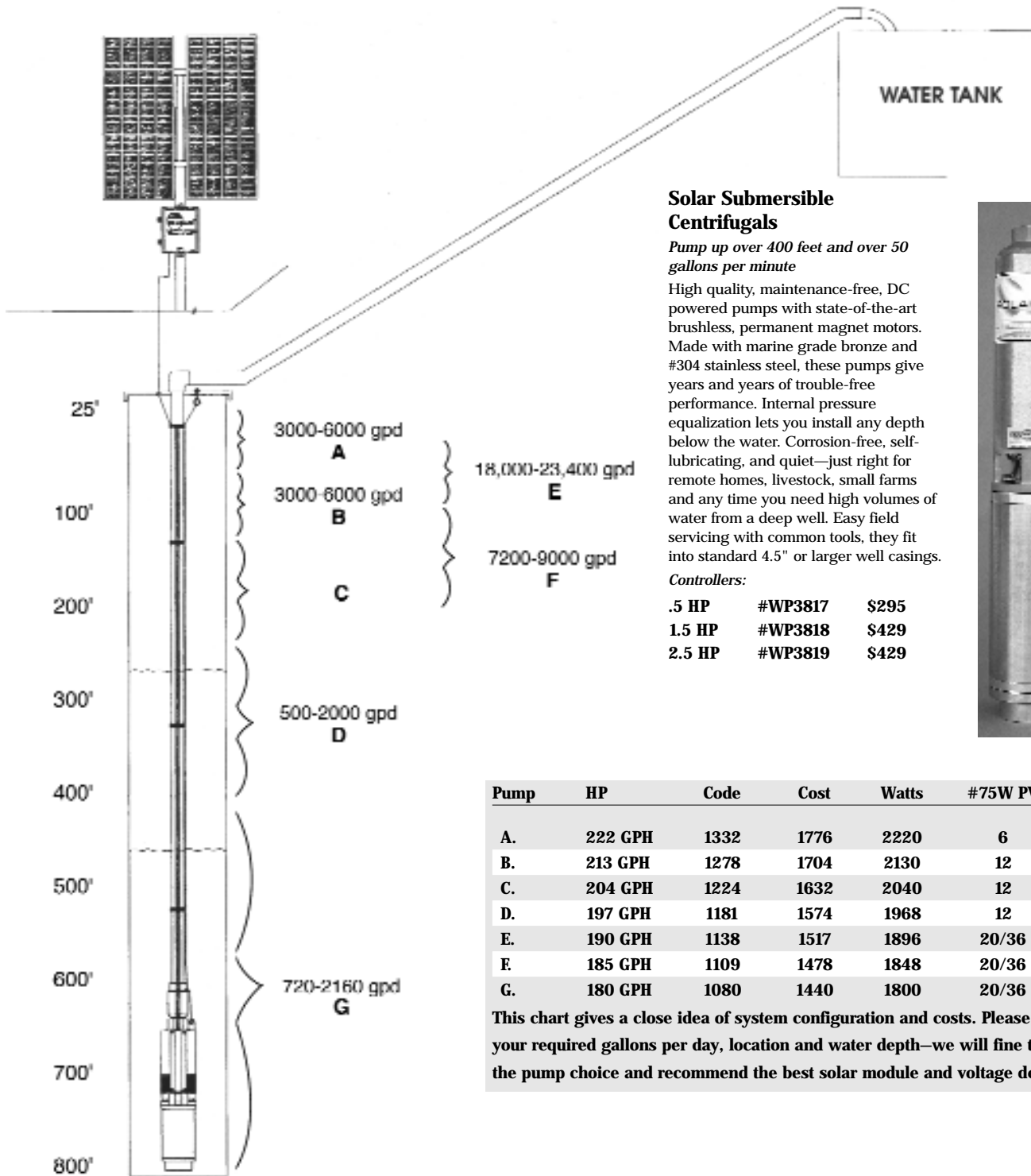

## Solar Submersible Centrifugals

*Pump up over 400 feet and over 50 gallons per minute*

High quality, maintenance-free, DC powered pumps with state-of-the-art brushless, permanent magnet motors. Made with marine grade bronze and #304 stainless steel, these pumps give years and years of trouble-free performance. Internal pressure equalization lets you install any depth below the water. Corrosion-free, self-lubricating, and quiet—just right for remote homes, livestock, small farms and any time you need high volumes of water from a deep well. Easy field servicing with common tools, they fit into standard 4.5" or larger well casings.

*Controllers:*

.5 HP	#WP3817	\$295
1.5 HP	#WP3818	\$429
2.5 HP	#WP3819	\$429



Pump	HP	Code	Cost	Watts	#75W PV
A.	222 GPH	1332	1776	2220	6
B.	213 GPH	1278	1704	2130	12
C.	204 GPH	1224	1632	2040	12
D.	197 GPH	1181	1574	1968	12
E.	190 GPH	1138	1517	1896	20/36
F.	185 GPH	1109	1478	1848	20/36
G.	180 GPH	1080	1440	1800	20/36

**This chart gives a close idea of system configuration and costs. Please send your required gallons per day, location and water depth—we will fine tune the pump choice and recommend the best solar module and voltage design.**

## Estimating Your Daily Water Requirements

**People:** 10 to 100 gallons (40 to 400 l) per person per day, depending on lifestyle and conservation measures

**Cattle:** 10-30 gallons (40-120 l) per day in dry weather

**Small Animals:** 1/4 gallon per day per 25 lb. body weight (1 l per 10 kg)

**Poultry:** 6 to 12 gallons (20 to 50 l) per hundred birds per day

**Young Trees:** 15 gallons (55 l) per day in dry weather

These figures will vary with local conditions.

*"I just wanted to thank you for all the assistance you've given us. Of all the companies we have dealt with, yours excels at providing courteous service and insight."*

- R. Stiers, Fiji

# SOLAR WATER PUMPING

## Sunmotor M3 Floating Pump

An easy way to pump water from any surface source. Sunmotor Floating Solar Pump supplies livestock, irrigates gardens, or aerates a pond. Floating pump needs no priming—just drop in water, connect to solar array. Three models—M3 (75 watts, pumps up to 23 vertical feet, flows up to 6 GPM). M10 (300 watts, 65 feet, up to 12 GPM). M20 (300 watts, 35 feet, up to 29 GPM).

### Sunmotor M3

**Floating Pump Kit:** #WP4117 \$995

### Sunmotor M10

**Floating Pump Only** #WP4118 \$1,780

### Sunmotor M20

**Floating Pump Only** #WP4119 \$1,780

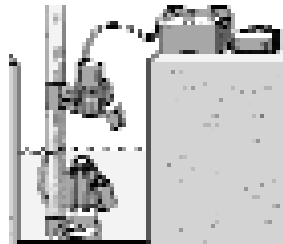
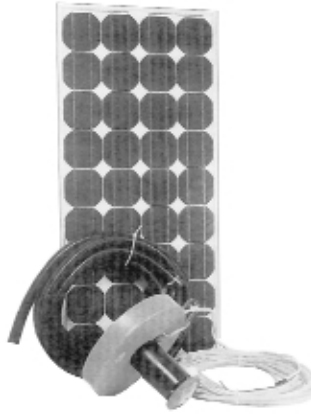

## 12V Battery Back-Up Sump Pump System

No more flooded basement during a power outage. 12 volt sump pump removes up to 20 GPM using a 12 volt deep cycle battery as power. Built in charger maintains battery at full charge while home AC power available. Water level sensor turns unit on as needed, and

alarm notifies you of water intrusion. Intended as a backup to your standard sump pump system.

#WP5135 \$197

## The Guardian

### Water Powered Sump Pump

Eliminate basement flooding without electricity! This unique pump uses standard water pressure to keep your basement dry even during a power failure. Use as an emergency back-up in tandem with your conventional sump pump or by itself in new construction. Rated for intermittent or continuous use. 3/4" I.D. Copper water supply and main 50 psi inlet pressure. With a 5' lift, it pumps 780 GPH, with 15' lift- 490 GPH. Inlet size 1" FIP thread. With each gallon of fresh water, it pumps 2 gallons of sump water. 3/4 I.D. Copper. USA

#WP7654 \$520

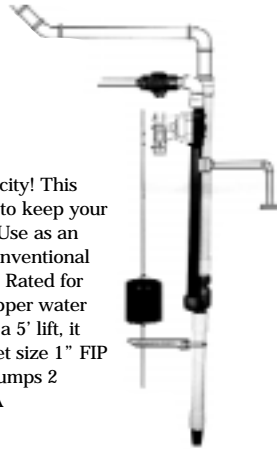

## Sling Pumps

### Pump water from streams without power

Use the force of your river or creek to pump up to 4000 gallons per day and up to 82' of head. The force of the flowing water rotates the anchored pump and pushes air and water through the feeder hose into your storage tank. No gasoline or electricity required! Only one moving part. Also great for aerating fish ponds because pumped mixture is half water half air.



	#WP735	#WP736	#WP737
<b>Maximum head</b>	<b>26'</b>	<b>82'</b>	<b>49'</b>
<b>GPD @2'/sec. flow</b>	<b>832</b>	<b>1056</b>	<b>1585</b>
<b>Required depth</b>	<b>12"</b>	<b>18"</b>	<b>18"</b>
	<b>\$550</b>	<b>\$750</b>	<b>\$750</b>



## Amazon 4 GPM Submersible

Small 12V pump pushes water up to 33'. Although only 1.1 pounds with a 1.5" diameter, pumps 4 GPM at open flow. Includes 13' of cable with battery clips and has 1/2" connections. Can't run dry. Max. 7 amps.

#WP100 \$77

## Congo Submersible & Inline Pump

Compact and powerful: just 1.6" in diameter and 6 3/4" long, yet it's good for 8 GPM at 14 PSI. Self-priming, and suitable for both fresh and salt water applications.

#WP1302 \$88



## Niagara Portable Pumping Kit

A quick shower, portable watering, drinking water, bilge/storm water clearance, container filling/emptying, car/boat wash down—only 3 amps at 12V and yet 32' head (14 psi) and 2.8 GPM. Kit includes pump, 12' cable and battery clips, 9' lay-flat food quality hose, storage pouch, and adjustable on/off nozzle that provides strong jet of water or fine spray.

#WP103 \$47

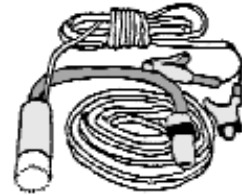

## Brass Pony Pump

Compact, durable pumps deliver up to 5 GPM—up to 40 feet head at 1.5 GPM. 12V DC, draws 6.5-10 amps. Easily overhauled, come with two replacement impellers. Pump fresh or saltwater, connect to garden hose or 3/8" water pipe. Cast bronze, hard chrome plated.

**Brass Pony Pump** #WP4574 \$80

**Ready-To-Install**

**Self-Priming Kit** #WP4575 \$90

## Shurflo Surface Pumps

Great for pumping uphill out of a creek, pond, lake, spring, or storage tank. Low pressure model pumps up to 100 vertical feet, high pressure up to 200'. Medium-duty usage when 100 gallons a day or less needed. Low pressure adjusts between 40-60 psi, self-priming up to 12'. High pressure adjusts between 80-100 psi and also primes 12'. 12 or 24V.

**100' lift** #WP300 \$99

**200' lift** #WP301 \$108

**200' lift, 24V** #WP3548 \$128

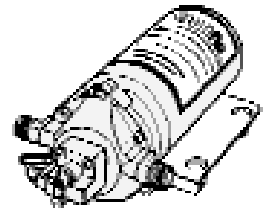

Low Pressure Pump		
PSI open	GPM 1.64	Amps 3.3
10	1.56	3.9
20	1.46	4.6
30	1.26	5.2
40	0.35	5.6
45	0.10	5.7

High Pressure Pump		
PSI open	GPM 1.76	Amps 3.4
20	1.6	5.0
40	1.46	6.6
60	1.32	8.0
80	1.20	9.3
100	1.07	10.6

## Pressure Pumps

Increase or create water pressure in your house, boat, RV, or cabin. Pump out of your storage tank, pond, stream, spring, or lake. Pressure pumps take your water and add some power behind it, so showers work better, toilets refill faster.

Typical pressurized/on demand home water system

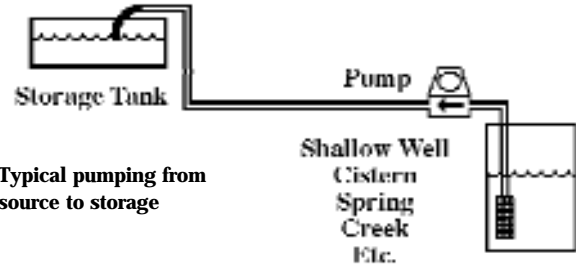
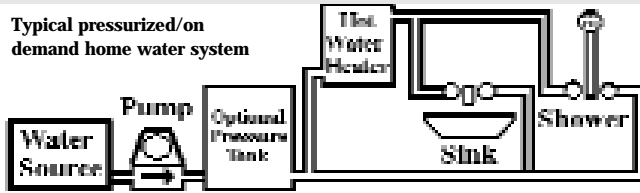

### Shurflo Nautilus

#### Single-fixture water pump

Great pump for RV's, boats and weekend cabins. Tough, positive displacement pump with high-torque motor. Does not have pressure switch—use with manual. 1 GPM, 1.2-2.5 amps at 12V. Includes waterproof splice connectors. 4.79" x 2.6" x 1.92"

#WP311 \$53

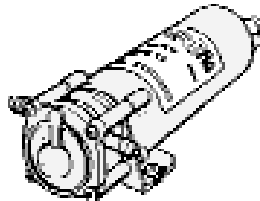

### Shurflo Electric Faucet Combo

A great, simple way to set up a pressure water system... just add water! Pump takes water (cold or heated up to 176°F) from any bucket or tank, lifts it to the faucet. Pump and faucet are connected to a 12 volt battery. Turn the faucet switch, the pump kicks on and gives you flow to 1.8 GPM. 25 watt draw.

#WP5246 \$95



### Shurflo Two-Fixture Automatic Demand Pump

1.6 GPM, 3-6 amps, 60 psi. Automatically comes on at 45 psi (when you open a valve) and off at 60 psi (when you close a valve). Triple chamber diaphragm pump with double-ball bearings for smooth consistent flow. Dry primes up to 6' and can run dry without damage. For intermittent use—get Turbo model for frequent or long-term use. 1/2" MPT, 6 lbs., 8.38" x 4.5" x 4". 12V.

#WP312 \$89

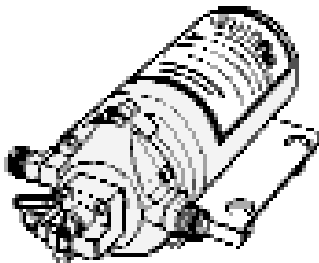

### Shurflo 24V DC and 120 vac Turbo Pumps

For 24V systems or super long life at 12V

Use a 24V pump in panel-direct systems with an LCB for longer life and higher efficiency. They work fine with just one 3-amp panel. At 12V you have the same pressure with half the amps and half the flow.

<b>1 GPM, No Switch</b>	<b>#WP314</b>	<b>\$46</b>
<b>3 GPM, 40 psi</b>	<b>#WP315</b>	<b>\$136</b>
<b>3.6 GPM, 50 psi Outdoor</b>	<b>#WP316</b>	<b>\$250</b>
<b>115 vac Model, 3.3 GPM, 40 psi</b>	<b>#WP154</b>	<b>\$128</b>

### Shurflo Turbo

Pump over 100' of head, up to 3.6 GPM, and 45 psi

One of the best pumps to use for both high-pressure on-demand systems and pumping out of a surface water source. Heat sinks cool the pump for maximum life and better performance. Ball bearings instead of steel sleeve like competitive models. At open flow you get 3.5 GPM and use 5.5 amps; at 30 psi, 3.45 GPM and 8 amps, at 50 psi 2.8 GPM and 11 amps. Completely rebuildable—replacement parts in stock. 12V.

#WP303 \$190



### Shurflo Outdoor Turbo

Similar to Shurflo Turbo specs but dipped for outdoor applications. 3.6 GPM, 50 psi switch. 12V.

#WP306 \$244

### Shurflo Economy Turbo

Like Shurflo Turbo but with steel sleeve and without the heat fins. 3 GPM and 40 psi demand switch. 12V.

#WP302 \$115

### Shurflo Power Twin Pump

Highest flowrate pump from Shurflo!—up to 7 gpm at open flow! Unique two head design pumps twice the water of our popular Turbo pump (WP303). Self-priming to 12 feet, built in pressure switch, 45 psi max. Just the pump for pressurizing your home or cabin. Peak 19 amps at 45psi, 9.8 amps at open flow. 12v.

#WP7001 \$384



## Dankoff Solar Water Pumps

For locations without power lines, solar pumps offer a clean and simple alternative to fuel-burning engines, generators and windmills. They pump the most during the driest sunny weather, requiring no fuel deliveries and very little maintenance.

Windy Dankoff pioneered solar pump manufacturing in 1983 and today—with over 100 models, high standards of quality, and fine

instructions—they're a favorite with our customers from the Amazon to the Yukon, Africa, India, and Asia. They use one-third to one-half the energy of conventional AC pumps run by an inverter—it's amazing to see one of these pumps turn under a cloudy sky, as it pushes water up a high hill. Full specification sheets available on request for individual pumps or order our 100-page Water Pumping Booklet.

#PI108 \$15



## Solar Centrifugal

*Pump up to 30,000 gallons per day*

For irrigation or livestock watering. Maximum lift 110'—great for pumping from wells, streams, lakes, ponds, tanks, or irrigation ditches. 1/2 HP does up to 40 GPM and 45' head; 3/4 HP up to 50 GPM and 83' head; 1 HP does 50 GPM and 110' head. Simple, serviceable design and cast-iron/bronze construction assure reliable performance anywhere in the world.

<b>1/2 HP</b>	<b>#WP744</b>	<b>\$705</b>
<b>3/4 HP</b>	<b>#WP745</b>	<b>\$735</b>
<b>1 HP</b>	<b>#WP746</b>	<b>\$735</b>

## DC Power for Water Pumping

DC powered pumps are made specifically for renewable energy sources. They are finely tuned for optimum efficiency, and they do not require connection to an inverter. A properly applied DC pump will use only 20 to 50% of the energy of a typical AC pump powered by inverter!

**What if you don't want to pull out a "perfectly good" AC well pump? Consider this hybrid approach:**

- Select a suitable inverter and power system to handle the AC pump (and other home loads).
- Add a storage tank to the system, sufficiently sized to store several days' water supply.
- Connect the existing AC well pump to the storage tank
- Install a DC pump to supply pressure

**This system has numerous advantages:**

- The well pump only starts occasionally, perhaps less than once per day. It need not be running at the same time as the washing machine or other large appliances. Thus, a smaller inverter can be used to run the pump. A few hours' running can supply sufficient water for several days to a week.
- The water pressurizing stage will take advantage of the high efficiency of DC pumps.
- With less frequent hard starts, all components of the system are more reliable; there will be no dimming lights and less energy is wasted.
- In case of a well pump or an inverter failure, water is still available from storage.

## TSP 1000™

**Solar Submersible Deep Well Pump NEW:**

The Dankoff TSP 1000 uses solar-electric power to pump as much as 9000 gallons (35 cu. m.) per day from as deep as 230 feet (70 m) for livestock, community water, irrigation, remote camp sites, and more. The TSP-1000 has been accepted by several international aid programs, with more than 1500 in use. Its superior efficiency results in far lower system costs than competing solar submersibles.

TSP 1000 is the most powerful positive displacement submersible pump on the market. It is more energy-efficient than any centrifugal impeller submersible, and does not lose its lift capacity at slow speeds. This pump combines the time-tested, positive displacement helical rotor with new electronic motor technology.

- Lift to 230 feet (70 m)
- Volume to 25 gpm (95 lpm)
- Fits into a 4" well casing
- Uses a 300-600 watt solar array
- Helical rotor pump for superior efficiency
- Brushless electronic motor
- Tolerates most silt and mineral conditions.

Options:

- Low-Level Sensor Probes and cable
- Float Switch for full tank shutoff

Warranty: Four years against defects in material and workmanship

**#WP8010 \$4,600**





## Solar Slowpump

The Slowpump pushes water as high as 450 vertical feet. It runs on very low power, with or without batteries, to supply between 200 and 2600 gallons per day. These pumps ease the strain on your solar electric system by pumping at low currents throughout the day. The vane pump mechanism housed in forged brass lasts for years of all-day running. Filtration is very important to protect this type of pump. For PV-direct (non-battery) array watts must exceed pump watts by 20% or more, and a current booster controller required. Can be hung by a rope in a large diameter well, suspended within 20 feet of the water. Use 12 or 24V 1/4 HP Slowpumps above the line in the chart and 1/2 HP Slowpumps if your specs are below the line. Specify 12 or 24V.

#2503 (12 or 24V) 1/4 HP#WP401	\$550	1/2 HP #WP3898	\$695
#1308 (12 or 24V) 1/4 HP#WP3472	\$475	1/2 HP #WP3897	\$695
#1322 (12 or 24V) 1/4 HP#WP3473	\$475	1/2 HP #WP3896	\$695
#2507-12V 1/4 HP #WP400	\$475		
#2507-24V 1/4 HP #WP3980	\$475		
#2507-48V 1/4 HP #WP3981	\$475		
#2507-110V 1/4 HP #WP3982	\$620		
#2607-12 1/2 HP #WP3983	\$695		
#2607-24 1/2 HP #WP3984	\$695		
#2607-48 1/2 HP #WP3985	\$750		
#2607-110 1/2 HP #WP3986	\$750		
In-Line Filter #WP540	\$44		

Total Head	#1322 GPM Watts	#1308 GPM Watts	#2503 GPM Watts	#2507 GPM Watts
20	0.51 27	1.25 30	2.50 48	4.00 57
40	0.51 32	1.25 48	2.50 60	3.95 78
60	0.51 36	1.20 54	2.40 78	3.90 102
80	0.49 40	1.20 60	2.30 93	3.90 120
100	0.49 45	1.20 66	2.30 105	3.85 144
120	0.48 50	1.20 70	2.25 121	3.80 165
140	0.47 56	1.20 75	2.20 138	3.65 195
160	0.47 62	1.20 84	2.20 153	
180	0.47 66	1.18 93	2.15 165	
200	0.45 74	1.16 101	2.15 180	
240	0.44 90	1.14 117	2.15 204	
280	0.41 102	1.12 135		
320	0.41 120	1.10 153		
360	0.41 134	1.05 171		
400	0.40 150	1.00 198		
440	0.39 168			

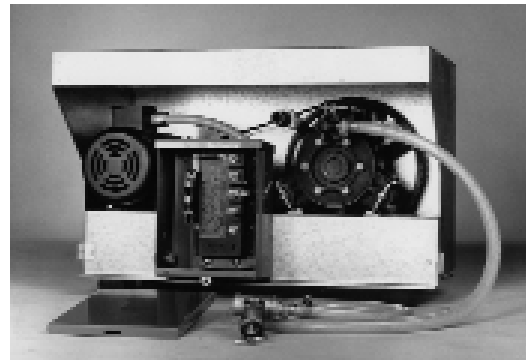

## Solaram Surface Pump

*Our most powerful surface pump*

Pushes water uphill as much as 1000 vertical feet, to supply as much as 5400 gallons per day. Prices range from \$2200 to \$3500. Request specification sheet.

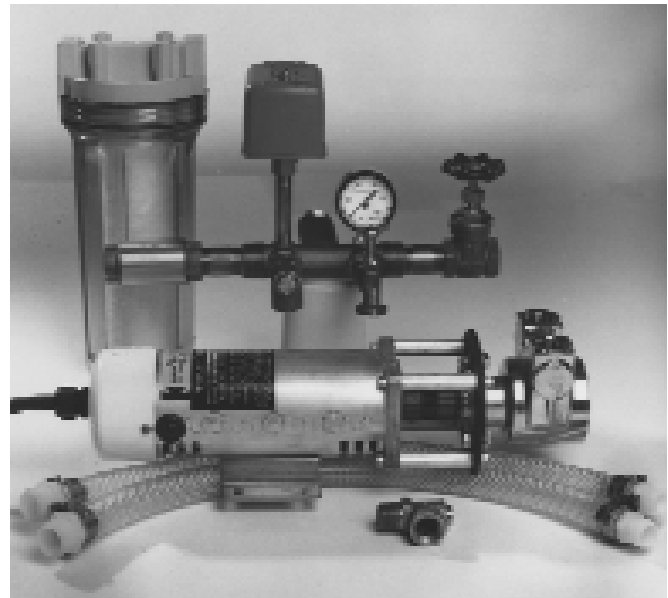

## Flowlight Booster Pump

*"City water pressure" for homes with 12 or 24V power systems*

The forged brass vane mechanism in this pump lasts much longer than plastic pumps, without the pulsating noise. In a small family home, it typically uses less energy than supplied by one 40 watt PV panel. Flow rate at 30-50 psi stays at 4.5 GPM. Includes flexible hose connectors for easy installation. Draws c. 15 Amps @ 12V (7.5A @ 24V). Filtration and pressure tank required. Easy Installation Kit includes pressure switch, gauge, control valves and tank tee—everything you need to quickly install. Standard Model 10' maximum suction lift at sea level, Slow Speed Model 20', 3.5 GPM.

12V	#WP330	\$540
24V	#WP3648	\$540
115 vac	#WP3649	\$630
Slow Speed Model	#WP3650	\$520
Easy Installation Kit	#WP3647	\$98
In-Line Filter	#WP540	\$44

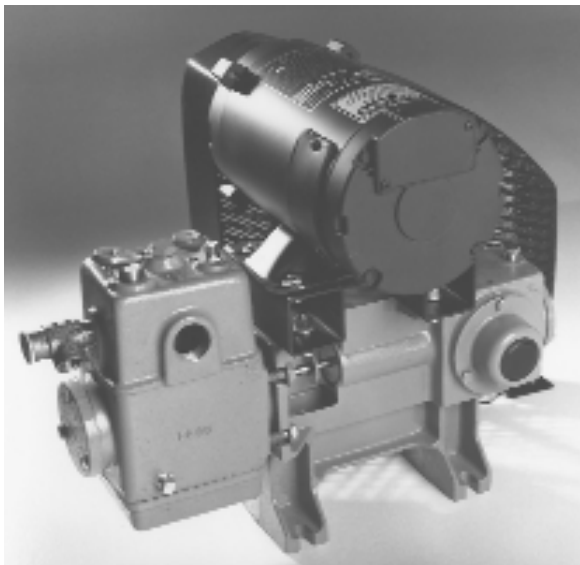

## Solar Water Pumping Glossary (continued)

### Water Well Components

**Borehole** - Synonym for water well, especially outside of North America.

**Casing** - Plastic or steel tube that is permanently inserted in the well after drilling. Its size is specified according to its inside diameter.

**Drop Pipe** - The pipe that carries water from a pump in a well, up to the surface.

**Perforations** - Slits cut into the well casing to allow groundwater to enter. May be located at more than one level, to coincide with water-bearing strata in the earth.

**Safety Rope** - Plastic rope used to suspend the pump, primarily in case of pipe breakage.

**Submersible Cable** - Electrical cable designed for in-well submerision. In U.S.A., size is specified by American Wire Gauge (AWG), in which a higher number indicates smaller wire. Elsewhere it is specified in millimeters.

### Water Well Characteristics

**Drawdown** - Lowering of the level of water in a well due to pumping.

**Recovery Rate** - Rate at which groundwater refills the casing after the level is drawn down. This is the term used to specify the production rate of the well.

**Static Water Level** - Depth to the water surface in a well under static conditions (not being pumped).

### Pump System Engineering

**Friction Loss** - The loss of pressure due to flow of water in pipe. This is determined by 3 factors: pipe size (inside diameter), flow rate, and length of pipe. It is determined by consulting a friction loss chart. See total dynamic head.

**Head** - See synonym: vertical lift.

**Submergence** - Distance beneath the static water level, at which a submersible pump is set. Synonym: immersion level.

**Total Dynamic Head** - vertical lift + friction loss in piping (see friction loss).

**Vertical Lift** - The vertical distance that water is pumped. Total vertical lift = vertical lift from surface of water in the source, up to the discharge in the tank. Synonym: static head.

**Note:** Horizontal distance does NOT add to the vertical lift, except in terms of pipe friction loss. NOR does the volume (weight) of water contained in pipe or tank. Submergence of the pump does NOT add to the vertical lift in the case of a centrifugal type pump. In the case of a positive displacement pump, it may add to the lift somewhat.

Copyright 1996 by Dankoff Solar Products, Inc.  
Used with permission by The Sustainable Village

## Solar Force Piston Pump

*Most efficient pump in this range*

Provides as much as 5600 gallons per day, lifting as high as 220 feet or pressurizing to 100 psi, without a battery system. Great for irrigation, fire protection, or a pressurized water system for one large or several small houses. Ultra efficiency reduces power system costs 25-75%. 25' suction capacity. Built for decades of reliable use at remote locations—only needs maintenance every 2-6 years. 20 year life expectancy, tolerates silty water, you can even operate it by hand.

*The first number after the model # indicates voltage, the letter "B" stands for battery system, "PV" for photovoltaic.*

3010 - 12B	#WP3946	\$975	3020 - 120 vac	#WP3954	\$1275
3010 - 24B	#WP3947	\$975	3040 - 120 vac	#WP3955	\$1275
3020 - 12B	#WP3948	\$1250	3020 - 12PV	#WP3956	\$1390
3020 - 24B	#WP3949	\$1250	3020 - 24PV	#WP3957	\$1390
3020 - 48B	#WP3950	\$1250	3020 - 48PV	#WP3958	\$1390
3040 - 12B	#WP3951	\$1250	3040 - 12PV	#WP3959	\$1420
3040 - 24B	#WP3952	\$1250	3040 - 24PV	#WP3960	\$1420
3040 - 48B	#WP3953	\$1250	3040 - 48PV	#WP3961	\$1420

Total Vertical Lift				Model 3010			Model 3020			Model 3040		
Feet	Meters	PSI	Kg/ Sq.Cm	GPM	LPM	Watts	GPM	LPM	Watts	GPM	LPM	Watts
20	6.1	8.7	0.61	5.9	22.3	77	5.2	19.7	110	9.3	35.2	168
40	12.2	17.4	1.22	5.6	21.3	104	5.2	19.7	132	9.3	35.2	207
60	18.3	26	1.83	5.3	20.2	123	5.1	19.3	154	9.2	34.9	252
80	24.4	35	2.44	5.0	19.7	152	5.1	19.3	182	9.2	34.9	286
100	30.5	43	3.05	5.1	9.2	171	5.0	18.9	202	9.1	34.5	322
120	36.6	52	3.66	4.9	18.7	200	5.0	18.9	224	9.1	34.5	364
140	42.7	60	4.27	4.9	18.7	226	5.0	18.9	252	9.1	34.5	403
160	48.8	70	4.88				4.9	18.6	269			
180	54.9	78	5.49				4.9	18.6	280			
200	61.0	87	6.1				4.8	18.2	308			
220	67.1	96	6.71				4.7	17.8	314			





Vertical Lift Feet Meters	Model 5218			Model 5222			Model 5226			Model 5230		
	LPM	GPM	Watts	LPM	GPM	Watts	LPM	GPM	Watts	LPM	GPM	Watts
25 8	10.1	2.7	84	12.3	3.3	103	13.7	3.6	108	25.0	6.6	212
50 15	9.6	2.5	96	11.7	3.1	117	12.9	3.4	124	23.3	6.2	220
75 23	9.0	2.4	108	11.0	2.9	132	12.4	3.3	138	21.0	5.5	229
100 30	8.9	2.1	114	10.9	2.9	139	12.0	3.2	151	18.8	5.0	40
125 38	8.3	2.2	126	10.1	2.7	154	11.6	3.1	166			
150 46	7.7	2.0	138	9.4	2.5	169	11.0	2.9	180			
175 53	7.3	1.9	144	8.9	2.3	176	10.7	2.8	192			
200 61	7.1	1.8	156	8.7	2.3	191	10.4	2.7	210			
250 76	6.5	1.7	168	7.9	2.1	205	9.6	2.5	229			
300 91	5.8	1.5	180	7.1	1.9	220						
350 107	5.4	1.4	192	6.6	1.7	235						
400 122	5.0	1.3	198	6.1	1.6	242						
450 137	4.7	1.2	204									
500 152	4.2	1.1	216									
550 168	4.1	1.1	219									
600 183	3.7	1.0	222									

(Performance measured at 60V—typical working voltage from a 48V nominal PV array. The total rated power of the array must exceed watts indicated by 25% or more, for a non-battery system.)

## SunRise Submersible Solar Water Pump

- Simple and reliable design with no batteries required
- Sealed piston mechanism
- Fits a wide range of needs: deep wells, surface water, long pipelines, pressurizing and portable applications
- All-metal construction, made in Europe
- 5-10 year maintenance interval, field-serviceable

A breakthrough in deep well solar pumping—uses less than 300 watts of power (1/3 HP). Most solar pumps use centrifugal impellers, requiring much more power. The patented sealed piston mechanism forces water up allowing it to pump at low speeds with weak sunlight. More reliable and long-lasting than diaphragm-type submersibles, the SunRise uses a special controller and remote float switch circuit to prevent storage tank overflow. An optional converter allows the pump to run from a 24V home battery system. Install by hand or by machine (like a conventional AC pump). 48V, 2-year warranty.

<b>SunRise 5218</b>	<b>#WP1449</b>	<b>\$1850</b>
<b>SunRise 5222</b>	<b>#WP4722</b>	<b>\$1850</b>
<b>SunRise 5226</b>	<b>#WP1450</b>	<b>\$1850</b>
<b>SunRise 5230</b>	<b>#WP1451</b>	<b>\$2150</b>

Required for all array direct systems:

<b>SunRise Controller</b>	<b>#WP3945</b>	<b>\$430</b>
Required for battery use (even with a battery bank):		
<b>SunRise Controller</b>	<b>#WP5012</b>	<b>\$340</b>
Accessories:		
<b>AC Converter – 115V to 60V</b>	<b>#IN4620</b>	<b>\$340</b>
<b>Submersible Pump Disconnect</b>	<b>#WP4152</b>	<b>\$35</b>
<b>Damping Line</b>	<b>#WP4157</b>	<b>\$29</b>
<b>3/4" Polyethylene 100" Roll</b>	<b>#WP3706</b>	<b>\$50</b>
<b>3/4" Polyethylene 300" Roll</b>	<b>#WP3707</b>	<b>\$150</b>
<b>3/4" Polyethylene 500" Roll</b>	<b>#WP3708</b>	<b>\$250</b>
<b>SunRise Float Switch Cable</b>	<b>#WP3714</b>	<b>\$ 0.30</b>
<b>Fuse FRN-R (4.5 Amp)</b>	<b>#WP6572</b>	<b>\$10</b>
<b>Fuse Holder for Battery Systems</b>	<b>#WP6573</b>	<b>\$10</b>

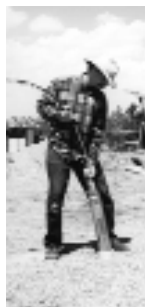

## FAQ's – Solar Water Pumping

### Q. Are solar pumps more expensive than conventional AC choices?

A. Solar pumps are perceived to be expensive, because their initial cost is high. If your water sources are remote from power lines, add up your long-term costs of feeding and fixing generators, repairing windmills, etc., including time and transportation to well sites. Now consider the savings with a solar pump that only needs attention every 5 to 10 years.

### Q. I've never even seen one of these things (SunRise Solar Pump). How do we install it?

A. Installation is nuts and bolts assembly, basic plumbing, and simple wiring. No special equipment is needed to lower the pump by hand. Instructions are very thorough. We have shipped hundreds of solar submersibles to pump dealers, ranchers and homeowners. Sometimes they call us to ask a question or two, and sometimes they only call to order more!

### Q. Why do the solar pumps I look at pump so many less gallons per minute than the 240 vac ones I'm familiar with?

A. Conventional high voltage pumps are designed to pump as many gallons per minute as possible because manufacturers assume unlimited grid power is available. Normally solar pumps aren't designed this way because it would necessitate a huge solar array. They will provide an equal amount of gallons per day without the high and inefficient energy demands of a big GPM capacity.

### Q. Why isn't solar pumping more popular?

A. It's a new technology, with special requirements. The nature of variable electricity in the form of direct current (DC) is quite different from conventional, steady alternating (AC) current. Using it economically dictates utilizing the long solar day, drawing a minimum of power. This means pumping slower than conventional pumps. Pumping at rates of less than 6 GPM requires different mechanisms from the conventional (centrifugal), unless we have power (money) to burn. Small solar pumps are unique, both electrically, and mechanically. Solar pumping offers numerous advantages but requires more information and engineering.

# SOLAR WATER PUMPING

## Grundfos Solar Pumps

Grundfos quality comes to solar water pumping. The largest manufacturer of submersible pumps in the world, Grundfos has a reputation for making the best AC pumps. Their DC SunSub series carries on that reputation. Stainless steel construction for durability and centrifugal design—much longer life than diaphragm pumps. Very competitive price and separate models for various depths of well—two power ranges. 1/3 HP (400 watts maximum) pumps from as deep as 40 meters depending on the model. 1.5 HP (2000 watts max) from as deep as 200 meters. Pump requires a Grundfos controller, which features maximum power tracking. Specifically designed for narrow depth ranges and optimum efficiency—nominal power from 150–1950. Require a 45–120VDC solar array coupled to the pump through a Grundfos inverter/controller. Flow rates to 6000 GPH—these are high volume pumps!

### Controllers:

**Grundfos SA1500 Deep Well Controller** #WP3460 \$1,239  
**Grundfos SA400 45–90V DC Cont, 400 Watts** #WP5654 \$892



Head	GPM	Max watts	Item #	
30 ft	20	400	#WP5642	\$700
15 ft	16	200	#WP5644	\$700
8 ft	8	250	#WP5646	\$700
80 ft	8.4	400	#WP5649	\$840
100 ft	3	250	#WP5652	\$700
130 ft	3.7	400	#WP5653	\$700

Head	GPM	Max watts	Item #	
30 ft	83	1920	#WP3459	\$956
390 ft	7.8	1920	#WP5655	\$975
15 ft	43	512	#WP5656	\$865
130 ft	28	1920	#WP5657	\$860
225 ft	15	1920	#WP5658	\$865
390 ft	6.8	1680	#WP5659	\$1025
655 ft	3.7	1920	#WP5660	\$1050
390 ft	7.8	1920	#WP5803	\$956

## 12V Hot Water Pumps

Circulate hot water through a solar collector or coiled pipe

Use for domestic hot water, hot tub, spa, house heating, or woodstove hot water. Paired with solar electric modules, these March (first 3) and Hartell (last 2) pumps circulate water when the sun is shining and let the water drain back at night. No need for expensive controllers, sensors, heat exchangers—let the natural rhythms of the sun take care of it for you!



Model	Max GPM	Max Head	Volts	Watts
#WP920	5.5	7.1	12/24	12 \$240
#WP921	7.5	15.5	12	40 \$256
#WP3376	7.5	15.5	24	40 \$256
#WP922*	2.7	10.5	12	12 \$99
#WP923	2	3	12	7–12 \$215
#WP924**	5	10	12	18–22 \$305

\*cold water only\*\*brushless motor

## SID-Servo I

El-SID Zone/Injection pumps keep hydronic systems working during power failures

Integrate a small battery and El-SID into hydronic heating systems and stay warm during power failures. The Sid Servo is capable of blending up to 3.3gpm of very hot water making it applicable to very large floor systems. The El-SID uses such a small amount of power, a small battery (with or without solar module) will keep the hot water moving for long periods of time. This pump includes a built-in dual sensor and speed control. Use one pump per zone.

#WP3863 \$462

## El-SID 12V Circulation Pumps

Runs on low cost 5 watt PV module

Ideal for solar water heating as well as hydronic radiant floor zones. Stainless steel and bronze pump without seals and a driver without any moving parts equals long life without maintenance. Efficiency is hard to believe but the 1.7 GPM pump works great with just a 5 watt amorphous solar module (like our \$69 #PV3106). Use a 5 watt single crystal module for the 2.2 GPM version and either a 10 watt single crystal or a 12–15 watt amorphous (\$115 #PV3107) for the 3 GPM model. In locations with frequent hard freezes, use a 20 watt panel. Use the new #WP3218 with a 12V battery as a zone pump in hydronic heating systems. With these pumps, replace spring-loaded check valves with the floating-ball type like our #HW320. (Install as shown.)

1.7 GPM	#WP1763	\$197
2.2 GPM	#WP1521	\$215
3.0 GPM	#WP1522	\$215
3.0 GPM Battery	#WP3218	\$219

The 24 volt zone pump has a built in speed regulator. It starts spinning at about 4 volts and gains speed until it hits full speed at 20 Volts. From 20 volts to 35 volts it runs at a constant full-speed. This means: as the batteries discharge the pump will continue to supply the same flow into each zone, thereby eliminating any sensation of temperature change, to the inhabitants. Size batteries generously, for minimum voltage drop.

24V Battery pump #WP6403 \$275



1.

## 1. Solar Island Fountain Pump

Easily add the delightful sound, color, and aeration of falling water in your garden or on your deck. Just float our newly improved Solar Island in a sunny pond, swimming pool, or deckside water barrel. It sprays up to 20" of water and 20 gallons per hour operating as long as you have direct sunlight. No wires - the fully integrated solar panel and filtered pump does it all. Includes a selection of fountain heads for various spray patterns. 13" diameter

#WP6794 \$98

## 2. Solar Pump Kit

Quick and easy to fit, the 12 v , 6 watt solar pump is activated by the 5 watt solar panel as long as there is sufficient daylight. Pump can be used as a fountain with max height of head 1.2 m @400 litres per hour.

#WP6795 \$144

## 3. and 4. Bamboo Water Falls

### Bamboo Solar Fountain Accessories

AHH...the serenity of cascading waterfalls and trickling streams in your own backyard. You'll be enchanted by these oriental bamboo fountain fixtures - there's nothing like the sound of flowing water on a hot day to cool your mind and relax your body. The Cascading Waterfall drops water from one to the next mini-pool. The Falling Log slowly fills until it gets near full. Then the weight makes it fall down and start filling up again. You can put a smooth rock under it and make a "Zen Clock" that changes duration between clicks with differing amounts of time as the sun moves across the sky. Designed for attaching to our solar pump kit (WP6795).

Cascading Waterfall #WP6896 \$29

Falling Log #WP6897 \$29



2.



## Aquasolar Fountain Pump

*A garden fountain powered by the sun!*

Quality German-made pump operates from one 10 watt solar panel. Pumps up to 2 gallons per minute, lifts to 6 feet. Pump housing has integral filter screen to keep debris out.

#WP6341 \$160

## 120 vac Fountain Pumps

Install a garden fountain without breaking your energy budget. Continuous duty pumps operate without oil—no potential for water contamination. Motor is fully encapsulated in epoxy. Four interchangeable spray heads allow different spray patterns. From 70 GPH with 2.5' lift to 900 GPH and 9.8' lift. And low power use—only 6 to 82 watts. Waterfall/drainage pumps 1/4 to 1/2 HP.

70 GPH, 6 watts #WP4782 \$19

175 GPH, 23 watts #WP4783 \$48

265 GPH, 26 watts #WP4784 \$62

460 GPH, 42 watts #WP4785 \$80

900 GPH, 82 watts #WP4786 \$100

29 GPM, 1/4 HP #WP4787 \$142

37 GPM, 1/3 HP #WP4788 \$164

66 GPM, 1/2 HP #WP4789 \$186

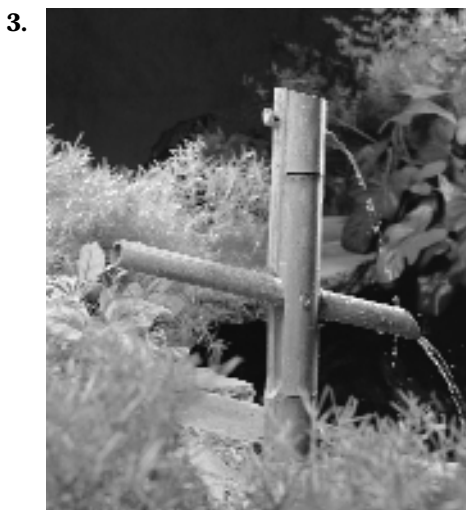

3.



4.

## Pond and Fountain Clarifier



Natural microbes for a healthy, clean pond or fountain. Organic and safe alternative to chlorine and harsh cleaning chemicals, this microbial formula improves water clarity, eliminates scum and reduces odor and organic sediment. Use it on decorative fountains, ponds and lakes to reestablish the ecological equilibrium in water. Naturally biodegradable and completely non-toxic to humans, animals, fish and aquatic life. Use 3 Tbsp. per 100 gallons on initial use, and 1 Tbsp. per 100 gallons for maintenance every 2 weeks in water temperatures ranging from 50°-100°F (11°-43°). 1 lb

#WC7675 \$19



# HAND/FOOT WATER PUMPING

## Guzzler Hand Water Pumps

Pump up to 30 gallons per minute

No electricity or gasoline required—just a little muscle power and the WP742 pumps up to 30 GPM (more than a liter per stroke) with 12 ft. suction lift and 12 ft. delivery head. (WP740 up to 10 GPM and WP741 up to 15 GPM). Large valve openings make pumping jobs fast—WP740 uses 1" hose, WP741 1 1/2" hose, and WP742 2" hose. Reinforced diaphragms and flapper valves insure durable, dependable, and smooth pumping.

<b>10 GPM</b>	<b>#WP740</b>	<b>\$49</b>
<b>15 GPM</b>	<b>#WP741</b>	<b>\$59</b>
<b>30 GPM</b>	<b>#WP742</b>	<b>\$290</b>

<b>Pair of Stainless Steel Band Clamps</b>	<b>#WP6285</b>	<b>\$6</b>
<b>1.5" Wire Reinforced Hose (per foot)</b>	<b>#WP6287</b>	<b>\$5</b>



## Guzzler Foot Pump

Your legs are stronger than your arms—why not use them to pump your water? Guzzler foot pumps bring the same rugged reliability as their hand pumps, but are designed for you to operate with your feet. Maximum depth to water same as hand models, but you can move a lot more water without getting tired.

<b>Pump</b>	<b>#WP4814</b>	<b>\$133</b>
<b>1.5" Port</b>	<b>#WP6158</b>	<b>\$141</b>

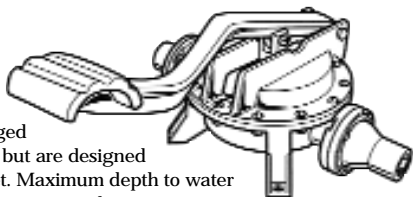

## Kant Freeze Hand Pump

For pumping water out of the ground when it's less than 20 feet deep.

Also pulls water horizontally: deduct 1 foot from depth for every 50 feet of horizontal distance. Cast iron cylinder with imperfections removed (for better appearance). Red finish. Raise handle to drain pump and protect from freeze damage. Leather may freeze to walls when extremely cold, rendering pump temporarily inoperable. 16" high.

<b>#WP1472</b>	<b>\$105</b>
----------------	--------------

## Dempster Hand Pumps

Hand pumps made in the USA for decades. Simple, rugged design. Cast iron pump head can lift water from 100 feet below ground. Flange base allows mounting to any flat surface. Plain spout model fills a bucket at the pump. CS model allows connection to garden hose or pipe for pressurizing a tank. Requires drop pipe (you provide) plus cylinder and pump rod to complete installation.

<b>Dempster 23F Hand Pump</b>	<b>#WP4535</b>	<b>\$505</b>
<b>Dempster 40F Hand Pump</b>	<b>#WP4536</b>	<b>\$462</b>
<b>Dempster 23F (CS) Hand Pump</b>	<b>#WP4546</b>	<b>\$554</b>
<b>Dempster 40F (CS) Hand Pump</b>	<b>#WP4547</b>	<b>\$509</b>
<b>Dempster 2" All Brass Flush Cap Well Cylinder:</b>	<b>#WP4542</b>	<b>\$205</b>
<b>Dempster 5' 7/16" Pump Rods, Threaded &amp; Coupled:</b>	<b>#WP4537</b>	<b>\$13</b>



## Simple Pumps

Hand pumping to 300 feet deep!

Worried about a water emergency? The solution is simple—the "Simple Pump". It installs alongside your existing electric well pump and delivers up to three gallons of water per minute. Output pressure up to 100 psi—you can pressurize your house water system. Use alone in 2" and 4" wells, with an electric pump with large well casing. Includes pump head, cylinder and well cap. Durable brass and aluminum construction, 5-year warranty. Looks good, works great!

<b>Simple Pump – Lever Handle Model</b>	<b>#WP5536</b>	<b>\$549</b>
<b>Top Drop Pipe – 9' length</b>	<b>#WP5569</b>	<b>\$29</b>
<b>Standard Drop Pipe – 9' length</b>	<b>#WP5570</b>	<b>\$29</b>
<b>2" Pitless Well Cover</b>	<b>#WP5578</b>	<b>FREE</b>
<b>4" Pitless Well Cover</b>	<b>#WP5577</b>	<b>FREE</b>
<b>6" Pitless Well Cover</b>	<b>#WP5571</b>	<b>FREE</b>
<b>8" Pitless Well Cover</b>	<b>#WP5574</b>	<b>FREE</b>
<b>6" 3-Port w/1/4 Port (jet pump)</b>	<b>#WP5572</b>	<b>Included in pump price</b>
<b>6" 3-Port w/Custom Port (jet pump)</b>	<b>#WP5576</b>	<b>\$25</b>
<b>8" 3-Port w/1/4 Port (jet pump)</b>	<b>#WP5573</b>	<b>Included in pump price</b>
<b>8" 3-Port w/Custom Port (jet pump)</b>	<b>#WP5575</b>	<b>\$40</b>



## 12V Gearmotor Attachment

Power a Simple Pump from solar and draw water from as low as 500'. Only uses 5.5 amps but pumps 1-2 gpm.

<b>#WP5624</b>	<b>\$497</b>
----------------	--------------



## Simple Pump T-Handle Model Pump

A less expensive version of the Simple Pump for wells up to 80 feet deep! Up to 3 GPM.

<b>#WP5540</b>	<b>\$389</b>
----------------	--------------

## Simple Pump Check Valve/Gauge

Screws into your Simple Pump outlet. Attach a standard garden hose to the fitting shown and the other end to your house and you are ready to pump up your house pressure tank and watch the pressure as you go. All without electricity! Comes with female hose swivel, 3/4 NPT and 0-100 psi gauge.

<b>#WP5801</b>	<b>\$49</b>
----------------	-------------

## Well Bucket

When power goes out, your electric well pump is worthless. Pull pump out of the well, tie a rope to the well bucket, and start lifting water out of the well. Bucket fills with water when you drop it, seals itself when you lift. More than 2 gallons with each filling. Requires a 5 inch minimum well diameter. PVC.

<b>#WP4685</b>	<b>\$36</b>
----------------	-------------

## 2" Well Bucket

Water by hand without having to pull your installed pump

The small diameter of this well bucket lets it fit into a common well without the extra work of pulling an installed pump. It's light, easy to use, and holds 1.5 gallons.

<b>#WP6299</b>	<b>\$72</b>
----------------	-------------



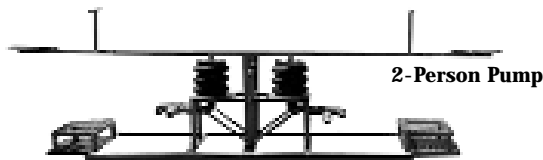

2-Person Pump

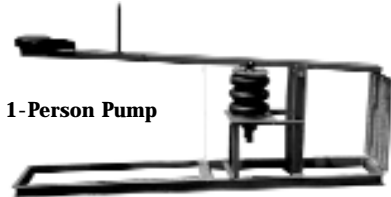

1-Person Pump

## Soiltech Surface Transfer Pumps

Use your legs to pump lots of water!

Using a teeter-totter principle, raise and lower the seat to pump up to 30 gallons per minute (40 gallons per minute for the 2-person pump). Intended for shallow water sources—suction lifts to ten feet and lift to 20 feet head. Adjustable spring tension allows wide variation in operator size and weight. Tolerant of a wide range of water quality too. The operator's weight does the pumping work—all you need do is lift your own body weight.

- 1-Person Pump #WP4883 \$1,570
- 2-Person Pump #WP4884 \$2,240

## Soiltech Hand Wheel Pump

Hand pump water from deep wells—down to 150 feet. Operated by rotating a wheel, geared and counterweighted to minimize your effort in lifting water. Fill pails at the pump, or push water uphill to the house or garden. Designed for long life with rust resistant coating. Compatible with new or existing windmills.

#WP4886 \$1,908



### Soiltech Basic Pump

Simple, reliable hand pumping from shallow wells of less than 100 feet. Fill pails at the pump, or push water uphill to the house or garden. Designed for long life with rust resistant coating. Compatible with new or existing windmills.

#WP4887 \$690

## Soiltech Pump Jack

Solar or wind generated electricity, combined with this surface Soiltech unit, let you pump up to 1200 gallons per hour. A pump jack permits you to lift large quantities of water to the surface. Works like a hand pump, with drop pipe, pump rod and a well cylinder (sold separately).

#WP4888 \$2,588

## High Lifter Gravity Pumps

Use water to pump water (no other power required)

These pumps can provide up to 1200 gallons per day and lift water over 1000' straight up. A piston uses the pressure of water flowing downhill to pump a portion of the water up higher than the original water source. No priming needed. When there's water, the High Lifter starts itself. Easy to install, this pump will work for many years with little attention.

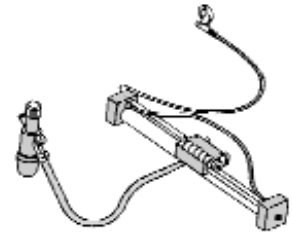

- 9.1:1 Ratio Pump #WP790 \$835
- 4.5:1 Ratio Pump #WP1648 \$895

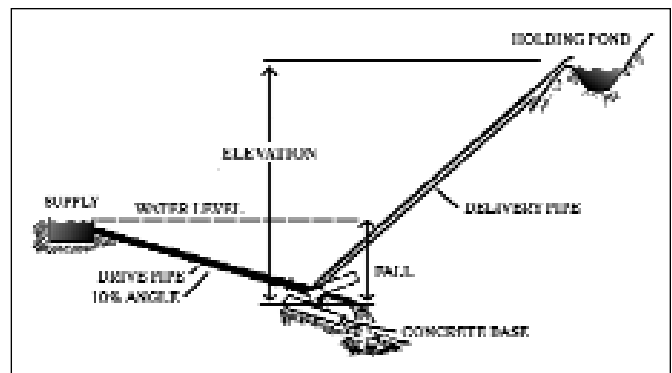

## Gravi-Chek Motorless Pump

For every one foot of fall, lift water 30'. The closest thing to a perpetual motion machine—as long as water falls to the Gravi-Chek, a continual supply of water moves uphill. The water pressure itself supplies the power. A buoyant floating ball design creates a "water hammer" effect and improves performance over the old style ram pumps. It reduces the fall requirement to only 2' and increases the fall to lift ratio. Also less likely to clog, more efficient, and lighter weight (aluminum instead of cast iron).

- 1" 300–600 GPD, 5 gal/min+ #WP750 \$372
- 2" 2000–3000 GPD, 35 gal/min+ #WP751 \$868
- 4" 8000–12,000 GPD, 137 gal/min+ #WP752 \$1,681

## AeroVironment

Universal Solar Pump Controller—Power AC pumps from solar systems with super efficiency

Versatile, high-performance microprocessor controlled, variable speed motor controller for solar powered pumping operations using standard off-the-shelf pumps with 3 phase or 3 wire single phase AC motors. The ASPC 2000 will operate AC pump motors from 1/2 HP to 2 HP at any standard voltage—115, 208, 230 vac, 50 or 60 Hz. ASPC 5000 also available for up to 5 HP AC motors. 97% efficiency!

- ASPC-2000 #WP3049 \$1,625
- ASPC-5000 #WP3050 \$2,999

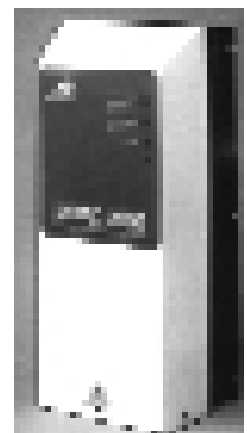

# WIND/GRAVITY WATER PUMPING

## Stauffer "Positive" Pump

Install in the discharge line of an existing electric pump and use pressurized air to pump your water when the power fails, or use as an independent system. Provides up to 125 psi (up to 300' of head) per pump and you can "stack" every 250' for up to 1500' of vertical lift or over a mile of horizontal pumping! Use a standard pressure tank or a propane tank for the air and charge it with 120 vac, 12V DC, solar, or the Bowjon wind mill. Submerge pump at least 3 feet below the static water level (15' best). No problem if run dry.

Stauffer "Positive Pump"	#WP5981	\$415
250' - 3/8" Air Pipe for Bowjon Pump	#WP4353	\$47
250' - 1/2" Air Pipe for Bowjon Pmp + Adptrs	#WP4354	\$60

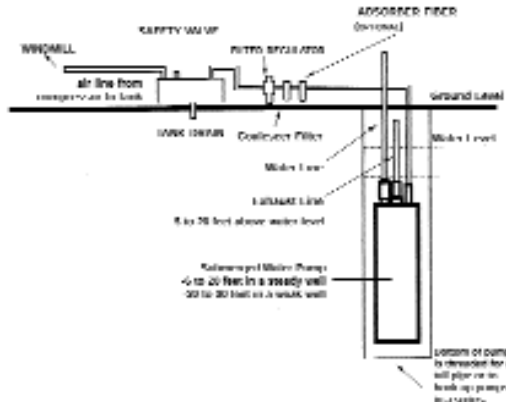

## Bowjon RV4 Rancher

For larger scale irrigation projects, the Bowjon RV4 pumps up to 20 gpm - with 10 hours of wind, that's 12,000 gallons per day! Install up to 1/4 mile away from your water source and take advantage of better wind conditions. Starts pumping with only a 4-7 MPH wind and self-governing high wind turn out assembly withstands wind speeds up to 120 MPH. Includes a V4 cylinder compressor and five blades with an 8' 8" diameter.

#WP5984 \$2,195

## Bowjon Wind-Powered Water-Lift Systems

Use the wind to pump your water! Mount the Bowjon in a windy area up to 1/4 mile from your well. Handles sandy or dirty water without wear or loss in efficiency. Compressor is on the surface and always accessible for maintenance. Fits in well diameter as small as 2", no problem if it runs dry. Best results if submerged 70% of lift—50% if lift is more than 150'. Rancher pumps up to 300' and 600 gph. Homesteader pumps 200' and 400 gph. (\$485 without wind turbine)

Rancher	#WP990	\$1,895
Homesteader	#WP991	\$1,595
Air-Lift Pump	#WP6630	\$98

## Bowjon Wind Generator

*High output from low wind speeds!*

The special Bowjon blade designed for high-torque water pumping also produces high output power generation at low wind speeds - in as little as 3 MPH. Recent tests (though not a confirmed specification yet) show a 70 watt output in only a 5 MPH wind! And it quickly goes up—360 watts with 8 MPH and 750 watts in only a 12-15 MPH wind! This is revolutionary and multiplies the number of sites appropriate for a wind generator. Towers don't need to be as high and installation gets much easier and even feasible in residential areas. Add the Air Injection Pump (#WP994) or the Positive Pump (#WP5981) for pressure systems and you can switch back and forth between battery charging and water pumping. Specify 12, 24, or 48V DC.

#WG5982 \$3,200

## Bowjon Solar Air Compressor

Use just two 110 watt solar modules and get performance close to the R2 Rancher, up to 10 gpm and 125 psi. Includes compressor/motor package, air injection pump, hanging rope, and 250' of air line. Also works with the Bowjon Positive Pump.

Solar Air Compressor:	#WP5986	\$950
Wind-Powered Stauffer Air Pump, 3.5":	#WP994	\$375

## Bowjon 10' Blade Option

A longer blade and bigger tail means capturing wind sooner—operation at lower wind speeds. Add this option to the Rancher, the RV4 Rancher, or the Bowjon Wind Generator and start your system in just a 3-4 MPH wind. You lose a little in high winds but get extra in lower.

#WP5985 \$75

## Bowjon Towers

22' x 2" center pipe trussed on three sides with 1/2" cold roll steel. 6" rungs every 18" with a triangle ever 2' for easy installation. Includes all adapters to mount the Bowjon mill.

Lightweight, strong, no guy wires needed! Upgrade tower includes a hinge 5' from the bottom and eye hook. With this assembly, you can use a come-along to easily ratchet the tower up and down.

Basic Tower	#WP5393	\$450
Upgrade Tower	#WG6027	\$795



## Water Pumping F.A.Q.'s

**Q. When I know the total pressure, how can I translate this into vertical lift?**

A. The basic formula is 2.31 psi=1 vertical foot. Since you know the head, just divide by 2.31 for a psi (pounds per square inch) figure. In reverse, if you already have a water pipe installed, you can use a pressure gauge at the bottom to find your head—just multiply the psi reading times 2.31 to get vertical feet.

**Q. How can I tell how much vertical distance I need to pump from my water source to my storage tank?**

A. If you have or can borrow a transit, this will be easier. If not, just use a line level. Start at your water source and look along the plane of the level to a landmark (a rock, stick, another person). Walk to the landmark and repeat the process. Count how many times you did this and multiply it by the distance from the ground to your eye. This will give you the "total head" you need to pump. Another way (in cases of great lifts) is to walk the distance carrying an altimeter. If a water line is already in place and if you have a pressure gauge, you can tell by measuring the pressure at the bottom of the pipe when it is full of water.

**Q. Why is solar pumping so great?**

A. Solar pumps operate anywhere that the sun shines, and the longer it shines, the more they produce. When it's cloudy out, they produce less water, but then you need less. The sun is the natural source of energy for independent water supply. Photovoltaic panels have no moving parts and last for decades. The challenge is to make the systems efficient, simple and reliable.



## HydraDrills

*Everything you need to drill your own water well*

A simple process—the 4 HP gasoline engine drives a drill bit while a swivel attachment lets you circulate water through the pipe stem to wash the cuttings back to the surface. Separate 3 HP pumping unit forces that water down the hole. Power head is guided by a frame, which allows you to control the drilling. As the bit descends, you add additional drill stem sections. Once you've drilled the pilot hole to full depth, a series of reamer bits open it up to the desired diameter. Drills through clay, sand, or even through rock (slowly) Kit includes all equipment needed to drill wells as deep as 60 meters, up to 4" diameter. Requires an existing source of water on the surface.

<b>Power Unit 60 Meters</b>	<b>#WP4205</b>	<b>\$3,200</b>
<b>Power Unit 75M Pkg</b>	<b>#WP4206</b>	<b>\$3,725</b>
<b>Commercial 75M Pkg</b>	<b>#WP4207</b>	<b>\$4,400</b>

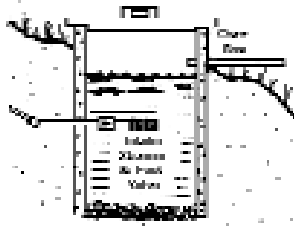

## Pumping Accessories

<b>10" In-Line Fltr</b>	<b>#WP540</b>	<b>\$44</b>
<b>10" Fltr Crtrdgs/2-pk</b>	<b>#WP3988</b>	<b>\$12</b>
<b>30" Intake Filter/Ft Valve</b>	<b>#WP542</b>	<b>\$70</b>
<b>30" Fltr Crtrdgs/3-pk</b>	<b>#WP543</b>	<b>\$44</b>
<b>Intake Strnr/Ft Valve</b>	<b>#WP544</b>	<b>\$73</b>
<b>Dry Run Switch</b>	<b>#WP545</b>	<b>\$50</b>
<b>Pressure Switch</b>	<b>#SC4694</b>	<b>\$18</b>
<b>Shurflo Filter Screen</b>	<b>#WP304</b>	<b>\$5.75</b>
<b>Shurflo Upper Housing</b>	<b>#WP310</b>	<b>\$8</b>
<b>Shurflo Pump Head</b>	<b>#WP323</b>	<b>\$68</b>
<b>Shurflo Diaphragm Kit</b>	<b>#WP309</b>	<b>\$21</b>
<b>Shurflo Valve Kit</b>	<b>#WP313</b>	<b>\$15</b>
<b>Shurflo Sub Rebuild Kit</b>	<b>#WP324</b>	<b>\$69</b>

## Pressure Tanks

Pressure tanks give you adjustable high pressure and make life much easier for your pump. Pre-charged air cushion starts pump when air pressure is low. When water fills the tank, pump stops. When you need water, pressure in the air chamber forces water into your system. The larger the tank, the less frequently the pump goes on. Water in tank about 33% tank size. Accumulator small but reduces pulsation, pressure spikes, and overheating.



<b>Accumulator</b>	<b>#WP459</b>	<b>\$31</b>
<b>2 gallon</b>	<b>#WP450</b>	<b>\$59</b>
<b>6.5 gallon</b>	<b>#WP451</b>	<b>\$130</b>
<b>14 gallon</b>	<b>#WP452</b>	<b>\$178</b>
<b>20 gallon</b>	<b>#WP453</b>	<b>\$210</b>
<b>88 gallon</b>	<b>#WP455</b>	<b>\$430</b>



## The Ginny

*Fuel gauge for wells & cisterns*

How much water do you have in your cistern? How quickly is your well recovering? Get a Ginny and stop guessing! Handy indoor mounting. Kit includes gauge, check valve, pump and instructions; you supply inexpensive copper tubing. Easy installation when installed with new cistern.

<b>0-34" water</b>	<b>#WT5924</b>	<b>\$49</b>
<b>0-60" water</b>	<b>#WT3208</b>	<b>\$84</b>
<b>0-200" water</b>	<b>#WT3210</b>	<b>\$84</b>

## Economical Barrel Strainer

Drawing water from a pond, lake, cistern or storage tank? This strainer keeps debris out of your pump, saving costly repairs. 2 1/2" female threads for easy installation, heavy gage aluminum construction means nothing to corrode. Lightweight. Designed to allow full capacity pumping.

**#WC6804 \$120**



## Automatic Pump Stop

Attach to a float switch or water level sensor. Keeps your pump from running dry or turns off when water tank full. Water level sensor either turns pump off when it gets wet or on when it gets dry (specify which you need). Mount on the inside or outside of a storage tank or watering trough and connect to your pump. (22 g wire okay for 300'). Waterproof, solid state, requires no power supply. PV-direct only.

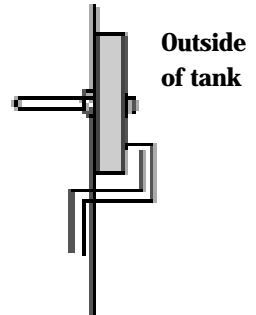

<b>Pump Stop - 3 Amp</b>	<b>#WP510</b>	<b>\$99</b>
<b>Pump Stop - 7 Amp</b>	<b>#WP511</b>	<b>\$120</b>
<b>Water Level Sensor</b>	<b>#WP512</b>	<b>\$62</b>



## Float Switches

Use these in a storage tank to automatically start and/or stop your pump. Just make the cable longer or shorter to adjust the start and stop levels. Please specify the type of pump and control.

<b>Off when full</b>	<b>#WP1142</b>	<b>\$49</b>
<b>On when full</b>	<b>#WP4606</b>	<b>\$49</b>

## Linear Current Boosters

Increase the real power (current) from your solar panels with this electronic device—up to 800% when starting induction load motors like fans and water pumps! Eliminates impedance mismatches between power source and load—motor performance typically increases by 40%+. Pumps start working sooner in the morning, keep going later at night and improve output during cloudy weather. Most positive displacement pumps even operate on cloudy days. (Not much difference in battery charging systems unless batteries are frequently low.)

<b>12V 3.5 Amp</b>	<b>#WP500</b>	<b>\$77</b>
<b>24V 3.5 Amp</b>	<b>#WP504</b>	<b>\$77</b>
<b>12-30V 3.5 Amp</b>	<b>#WP505</b>	<b>\$132</b>
<b>12-24V 5 Amp</b>	<b>#WP6460</b>	<b>\$110</b>
<b>12-24V, 7 Amp</b>	<b>#WP506</b>	<b>\$121</b>
<b>12-50V, 20 Amp</b>	<b>#WP507</b>	<b>\$523</b>
<b>36-190V, 10 Amp</b>	<b>#WP503</b>	<b>\$275</b>

# WATER STORAGE

## Polyethylene Storage Tanks

*Easy and affordable water storage*

Simple and inexpensive but high quality, high density polyethylene with a UV inhibitor for either in or outside storage. Specially designed closed top eliminates spills common with other similar containers. FDA approved.

55 gallon (24" x 37") #WT5089 \$52  
 30 gallon (20" x 30") #WT5088 \$66

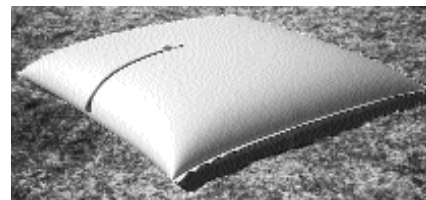

## Unit Liner Emergency Water Storage Tank

Made of FDA food grade 30mil PVC, this collapsible tank can be placed almost anywhere for use. Stick it in an extra bedroom, the garage, under the porch, outside on the ground, or in the back of your truck! Folds up for easy storage when empty. Filled and emptied through a resealable fill spout. No connections needed. Net wt. (empty) is 17 lbs. 6' x 6' x 1' high when full.

#WT5677 \$135

## Accessories:

### P50PX Pump

Fits all 15, 30 and 55 Gallon containers with either 3/4" and 2" openings, dispenses 16 oz. per stroke. Includes glass ball check, suction tubing, clamps and an inverted spout option to prevent dripping when not in use.

#WP5090 \$30

### Bung Wrench

Easy opening for 15, 30 and 55 Gallon containers. Rugged one-piece design.

#TL5091 \$15

## Polyethylene Tanks

*Low cost, long life, FDA approved for drinking*

Light weight, ultraviolet inhibitors for outdoor use, life expectancy of 25 years. Resist corrosion with tremendous strength and stress resistance. Repairable—just use heat to soften and reshape. Smooth surface for easy cleaning.

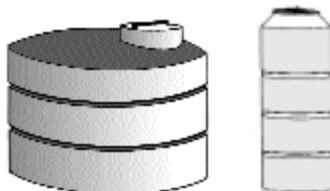

Capacity	Code #	Dia x H	Lid	
65 gallons	#WT310	23" x 41"	4"	\$160
175 gallons	#WT311	29" x 65"	8"	\$247
550 gallons	#WT312	65" x 45"	8"	\$496
1200 gallons	#WT313	90" x 51"	15"	\$690
2000 gallons	#WT314	90" x 77"	15"	\$1,110

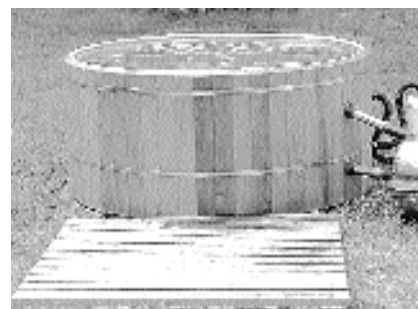

## Cedar Hot Tubs/Storage Tanks

Clear, kiln dried Western Red Cedar tanks patterned after a centuries old design—high quality that insures constant even pressure, the best possible leak free seal, as well as years and years of service. Highly resistant to decay, and smells wonderful while you're soaking. Staves reinforced by 1/2" rolled steel hoops every vertical foot—built strong as a barrel! And easy to assemble in from one to four hours. Shipping on tanks may be high—call for quote.

282 gal., 4' x 4' #WT200 \$1,137  
 463 gal., 5' x 4' #WT201 \$1,413  
 470 gal., 6' x 3' #WT5286 \$1,427  
 950 gal., 7' x 4' #WT202 \$2,174  
 1193 gal., 7' x 5' #WT5315 \$2,514  
 1250 gal., 8' x 4' #WT5316 \$2,702

## Underground Storage Tank

Light weight for easy transportation and installation, self locking covers. Easily connected components are ideal for campgrounds, resorts, vacation homes and construction sites. Suitable for potable water. Complies with U.S. Food & Drug Admin. regulation 21 CFR 177.1520(c) 3.1 & 3.2. New sizes now available.



Capacity	Size	Manway"	part#	Price
325	54"D x 51"	1- 20"	WT7471	\$460
550	64"D x 64"	1- 20"	WT7472	\$720
600	101" x 51" x 58"	1- 20"	WT7473	\$771
1000	86" x 65" x 68"	2- 20"	WT7474	\$1,479
1200	102" x 60" x 58"	2- 20"	WT7475	\$1,326
1250	132" x 80" x 35"	2- 20"	WT7303	\$1,250
1250	86" x 76" x 68"	2- 20"	WT7477	\$1,727
1700	143" x 56" x 66"	2- 20"	WT7478	\$1,670

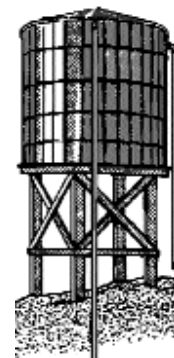





## Kolaps-A-Tanks

*Take your water with you!*

Bring FDA approved drinking water anywhere you can drive a pick-up or flatbed truck. Ideal for livestock and irrigation. Less expensive than fiberglass or poly tanks, the first Kolaps-A-Tanks made are still in the field after years of service. Easily carried by one person when empty. When filled hold up to 1340 gallons. Fold and store even the largest into an 18" x 18" x 18" carton. 1.5" gate valve mounted on 8" PVC extension pipe for easy draining. Big 10" diameter flexible sleeve on top makes tank easy to fill.

Capacity	Code #	Size	
73 gallons	#WT100	40" x 50" x 12"	\$300
275 gallons	#WT101	80" x 73" x 16"	\$400
525 gallons	#WT102	65" x 98" x 18"	\$500
800 gallons	#WT103	72" x 120" x 24"	\$600
1140 gallons	#WT104	84" x 144" x 24"	\$800
1340 gallons	#WT105	84" x 168" x 24"	\$900
<b>275 Gal Kolaps-A-Tank for Fuels:</b>			
	#WT4686	80" x 73" x 16"	\$1,393

## Portable Irrigation Tanks

Quick, portable water storage. A pump breaks down, a water line breaks, a spring dries up just when your garden really needs water—our portable irrigation tanks to the rescue! Also great for fire-fighting. They almost double the capability of a single tanker by freeing it to return for more water. PVC coated nylon materials resist chemical contamination, mildew, rot, and solar heat exposure. Can withstand -40° to 140° temperatures and severe outdoor exposure. Unload from truck and set up in seconds. Heavy-duty fold-out frame for sturdy tank support.



600 gallons	#WT124	\$496	2100 gallons	#WT121	\$729
1000 gallons	#WT125	\$580	3000 gallons	#WT122	\$955
1500 gallons	#WT126	\$657	4000 gallons	#WT123	\$1,160

## 5 Gallon Collapsible Plastic Water Container

Classic, folding design and twist action spigot.  
#WT5606 \$7.50



## Bulkhead Fittings

Quick and easy fittings for storage tanks.

3/4"	#WP915	\$9
1-1/4"	#WP916	\$12
2"	#WP917	\$18

## 200 Gallon Water Bag

20 mil thick water bags made from food grade vinyl FDA approved for storage of potable drinking water. 200 gallons of water when full, but only weighs 10 pounds when shipped or empty. Fill by attaching the 6 inch hard plastic fill spout (enclosed in the kit) to one of the two openings. Attach a common garden hose to the other end of the fill spout. An on/off lever lets you control the flow.

#WT5168 \$150

## Ozone Systems for Tanks and Cisterns

*Solves bad water problems*

Ozonates, circulates and filters holding tanks up to 20,000 gallons. Uses ultraviolet to generate ozone—no more problems from bacteria, iron, manganese, low pH, hydrogen sulfide, taste, odor, or color. Great for rainwater harvesting!

#WC1350 \$1,400

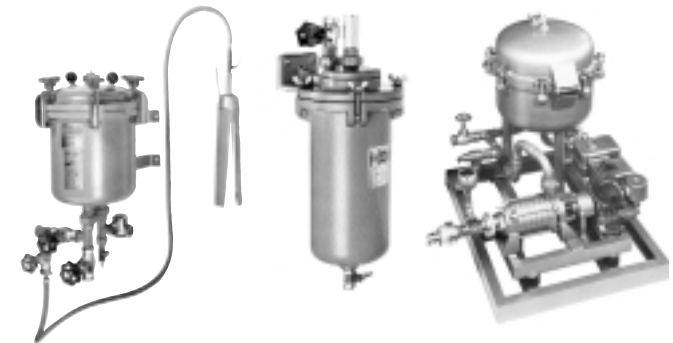
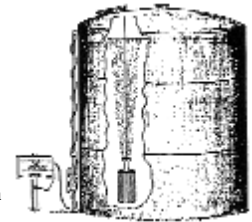

## Katadyn Industrial Filters

Eliminate the organisms that cause such diseases as typhoid, dysentery, cholera and giardia from your drinking water. These filtration units provide safe, bacteria-free drinking water without changing the mineral and salt composition of the natural water. Operates on water pressure; no power needed. Smaller filters hook up to either end of the water tubing. Filter candles are durable and last years before replacement, saving you the expense of costly spare parts. Great for large-scale commercial ventures or remote medical clinics. A minimum pressure of 2 bar (29 psi) should be available. The MOT Filter includes a pump, an engine or motor, and an MF-31 Filter is intended for Armed Forces, Civil Defense or catastrophe use.



MF-3 Filter with 3 elements, No. 4	#WC7596	\$17,327
MF-3 Filter with 3 elements, No. 5	#WC7597	\$18,710
MF-7 Filter with 7 elements, No. 4	#WC7594	\$4,769
MF-7 Filter with 7 elements, No. 5	#WC7595	\$5,278
MF-31 Filter with 31 elements, No. 4	#WC7596	\$17,327
MF-31 Filter with 31 elements, No. 5	#WC7597	\$18,710
MF-54 Filter with 54 elements, No. 4	#WC7598	\$27,482
MF-54 Filter with 54 elements No. 5	#WC7599	\$29,739

**MOT Katadyn Filters priced per system configurations**

## Water Bottle Purifiers

A convenient alternative to pump-style purifiers. No hassle over unpacking, assembling, pumping and separate containers - just scoop or fill up the water with your bottle. The 3 component

VirusStat® water purification cartridge attached to the cap inside removes over 99.9% of waterborne cysts and protozoa like Giardia and Cryptosporidium. It also kills over 99.9999% of waterborne bacteria and 99.99% of waterborne viruses, as determined under the U.S. EPA microbial water purification protocol. The 26 oz. bottle fits into any standard bottle holder and takes up minimal space in travel packs and suitcases. The Mackenzie has the same features and a 34 oz. bottle.

<b>Orinoco</b>	<b>#WC8661</b>	<b>\$39</b>
<b>Mackenzie</b>	<b>#WC8752</b>	<b>\$44</b>



**Orinoco**

**Mackenzie**

## The Exstream Sungari

Easily take your water purification system anywhere. The Sungari personal water purification system includes an insulated torso pack with zippered compartment - store either the various VirusStat® components or a number of other small accessories used when traveling and/or outdoors (medical kit, maps, travel dictionary, snacks etc.). The 26 oz. bottle offers a convenient alternative to pump-style purifiers - no hassle over unpacking, assembling, pumping and separate containers. Just scoop or fill up the bottle from any fresh water source available, squeeze and sip. The VirusStat® water purification cartridge attached to the cap inside, removes over 99.9% of waterborne cysts and protozoa like Giardia and Cryptosporidium. It also kills over 99.9999% of waterborne bacteria and 99.99% of waterborne viruses, as determined under the U.S. EPA microbial water purification protocol.

Bottle also fits into any standard bottle holder and takes up minimal space in travel packs and suitcases and treats 26 gallons (100 liters) per replacement cartridge (4-6 weeks when used exclusively). EPA registered, 14.25 oz. Outstanding for day hiking, international travel, fishing and extreme biking.

**#WC8753 \$59**

## VirusStat Kit

### Complete Purifier Kit

Cartridges designed for Exstream personal water purification systems (Orinoco, MacKenzie, Sungari). They deliver 26 gallons (100 liters) of pure water - an entire month's worth (a gallon a day) of microbe-free water for an extended trip or expedition. Lasts about 5 months with moderate use. VirusStat® water cartridges are EPA registered and remove over 99.9% of waterborne cysts and protozoa like Giardia and Cryptosporidium. It also kills over 99.9999% of waterborne bacteria and 99.99% of waterborne viruses. Essential for extended travel in regions with questionable water quality. Includes Cyst Filter and Prefilter.

**#WC8756 \$32**

## Exstream Microfilters

Chemical free microfiltration protection for backcountry hiking, biking and paddlesports. Protection against waterborne cysts such as Giardia and some of the smallest bacteria such as Brevundimonas diminuta. Intended for use in backcountry and other low-density environs that present a lower risk of waterborne viruses. For high-density areas and international travel, an EPA-registered microbial water purifier that provides viral protection such as the Exstream Orinoco or Mackenzie is recommended. Advanced Bactacell cartridge utilizes a 0.2 micron membrane to remove more than 99.99999% of pathogenic bacteria such as Brevundimonas diminuta. Cyst filter removes over 99.95% of protozoan cysts such as giardia and cryptosporidium as well as worms, larvae, eggs and other contaminants larger than 1 micron. 100% chemical-free. No silver, iodine or bacteriostatic disinfectants. The Bactacell System delivers 390 refills (200 liters / 52 gallons) per replaceable cartridge. The Deschutes 26 oz. sports flask fits into standard water bottle holsters and cages, the Yukon has same features, 1 liter (34 oz.) capacity.

<b>Deschutes</b>	<b>#WC8754</b>	<b>\$34</b>
<b>Yukon</b>	<b>#WC8755</b>	<b>\$39</b>

## BactaCell Kit

### Complete Microfilter Kit

Advanced Bactacell cartridge utilizes a 0.2 micron membrane to remove more than 99.99999% of pathogenic bacteria such as Brevundimonas diminuta. 100% chemical-free. No silver, iodine or bacteriostatic disinfectants. For the Deschutes Water Bottle Microfilter (WC8754), the Bactacell System delivers 390 refills (200 liters / 52 gallons) per replaceable cartridge. For the Yukon Water Bottle Microfilter (WC8755), the Bactacell System delivers 265 refills (200 liters / 52 gallons) per replaceable cartridge.

**#WC8757 \$28**

## The Cyst Filter

Attaches to the middle of an Exstream VirusStat microbial water purification cartridge - you can repeatedly replace throughout the life of the VirusStat system. It removes pathogens such as protozoan cysts (Giardia and Cryptosporidium) and particulates larger than 1 micron in size. A must for extended travel in regions with questionable water quality. Removes pathogens and particulates larger than one micron.

**#WC8758 \$16**

## Exstream Prefilter

Attach to the bottom of a VirusStat microbial water purification cartridge, the activated coconut carbon granules will reduce pesticides and herbicides while removing sediment & organic contaminants that create unpleasant tastes and odors. Extends the life of the cyst filter & removes impurities that cause unpleasant water taste.

**#WC8759 \$16**



Personal Water Treatment Systems



**Yukon**

**Deschutes**

## Urban Water Store Franchise

Everyone drinks and uses water. In places with poor water quality, this provides an opportunity to both create a profitable business as well as a major service to the community. We have many products and systems for small applications; but, if you're in an urban environment and want to have a complete system up and running quickly, consider this



Water Store Franchise. It provides a complete retail opportunity for entrepreneurs and provides clean, affordable water to specific community requirements. If you have a water source readily available, but it contains pathogenic (disease causing) organisms, the WaterHealth International is what you need. Back up generator or optional solar/wind power allow functioning where the grid is unreliable or nonexistent. The core of the franchise is the UVWaterworks ultraviolet disinfection technology. It can produce up to 5,500 gallons (20,818 liters) per day. The franchise includes all equipment, installation, training, maintenance, testing and certification program, and all needed inventory for each specific country and region. The investment break-even point is normally only 6 months or less!

#WC8011 \$25,000

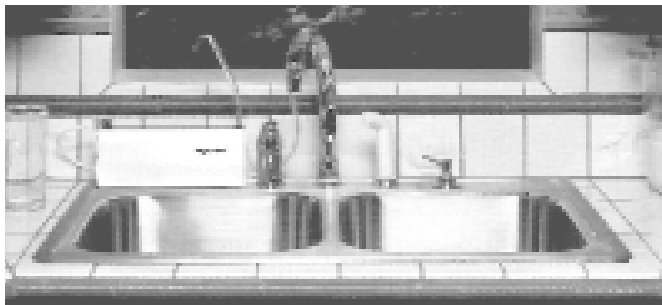

## H2O 2U

*Saves space, portable, great value*

Installs in minutes, no plumbing, cutting or drilling—easy to take with you traveling! Ultra-compact design to fit behind a kitchen or bathroom faucet and save counter space. 0.5 µM absolute particle rating combines the performance of ceramic and activated carbon for broad microbiological reduction (including E. Coli, giardia and Cryptosporidium) as well as chlorine, taste and odor. Replaceable filter cartridges last up to 4 months (1000 gallons). 1+ GPM flow. Includes diverter valve and universal adapter for international fittings. 2.1" x 3.63" x 9.9".

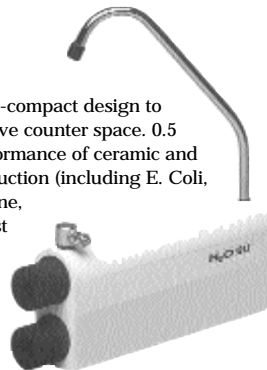

**H2O 2U #WC1843 \$92**

**Replacement Filters**

**Set of 2 #WC1845 \$32**

*"More than 63% of rural household water supplies - supplying some 39 million people (in the USA) - were considered unsafe."*

**Cornell University study**

## PureTap Filter Systems

Unique system traps and flushes contaminants—filter cartridges last up to six times longer while removing far more impurities. Double carbon one-micron filters (activated solid carbon block) take out chlorine, giardia, VOC's and many other harmful contaminants (POU models also remove lead and heavy metals) as well as bad odors and taste, while keeping in healthy minerals. In an independent lab test, water from a PureTap had 63% less bacteria than from conventional filters.



2-Stage Systems have an auto shut-off valve that stops water when it's time to change filters. Quick-connect fittings for easy installation, see-thru housing and flow meter. Use the 15-25 GPM POE (Point-of-Entry) model for whole-house system, including bathtubs and showers. Highest quality, 10-year warranty.

<b>PureTap Single-Stage POU System</b>	<b>#WC1857</b>	<b>\$179</b>
<b>PureTap 2-Stage POU System</b>	<b>#WC1131</b>	<b>\$329</b>
<b>PureTap 2 Stage POU/UV System</b>	<b>#WC5854</b>	<b>\$625</b>
<b>Replacement Filter – Stage 1</b>	<b>#WC1804</b>	<b>\$32</b>
<b>Replacement Filter – Stage 2</b>	<b>#WC1805</b>	<b>\$23</b>
<b>PureTap POE System</b>	<b>#WC1855</b>	<b>\$1,350</b>
<b>PureTap Three-Stage/POE UV</b>	<b>#WC5184</b>	<b>\$3,594</b>

## Pura Household Water Filter

This water filter removes far more contamination per dollar spent than any other household brand we researched: Multi-Pure, NSA, Ametek, Amway. (We have no other multi-levels or distributors between you and the manufacturer to consecutively raise the price.) Step #1 filtration cartridge immediately filters super fine particles other filters miss—giardia cysts, asbestos fibers, and the commonly sized radioactive particles. In other 2-stage systems the first stage only catches larger particles. Important because when the water flows to the second stage (the solid carbon block), small particles will clog the microscopic passageways. When this happens, contaminants get past the carbon and into the drinking supply. Our extra fine sediment filter prevents this happening for much longer and lets you know when to replace filters by slowing water flow. The second filter removes most modern organic chemicals including chlorination by-products, pesticides, solvents, and a myriad of other chemicals picked up by falling rain.

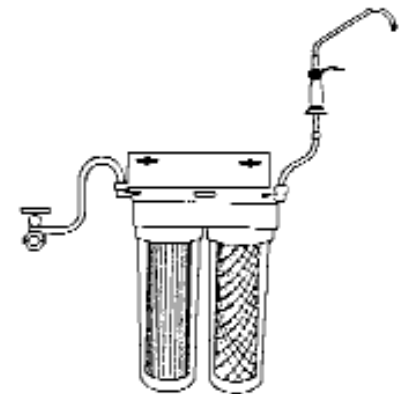

<b>Under Sink</b>	<b>#WC100</b>	<b>\$200</b>
<b>Sediment Filter</b>	<b>#WC4607</b>	<b>\$8</b>
<b>Carbon Filter</b>	<b>#WC4608</b>	<b>\$22</b>
<b>Carbon Filter for Undersink (Blue)</b>	<b>#WC6104</b>	<b>\$22</b>

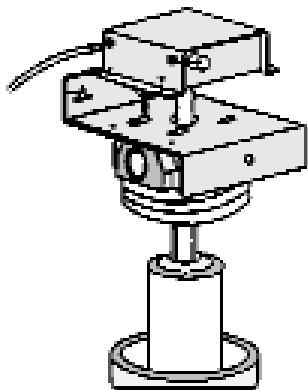

## Ultraviolet Water Filter

Common water filters remove odors, bad tastes, and sediment but don't kill harmful bacteria and viruses. This ultraviolet system from PURA destroys more than 99.9% of all bacteria. Great for cabins, wells, RV's and other untreated water supplies. The UV1 filters 2 GPM. It has clear housing, a solid carbon block as well as ultraviolet filtration. The UV2 adds a sediment filter. UV-1 and UV-2 are available in blue or clear. UV20 gives 10 GPM and uses 22 watts. Add \$59 for 12V.

<b>UV-1</b>	<b>#WC150</b>	<b>\$395</b>
<b>UV-2</b>	<b>#WC151</b>	<b>\$350</b>

### Replacement UV Bulb

<b>for UV-1 or UV-2</b>	<b>#WC4050</b>	<b>\$48</b>
<b>UV20 (AC Model)</b>	<b>#WC153</b>	<b>\$518</b>
<b>UV20 (12V-UV only)</b>	<b>#WC4052</b>	<b>\$554</b>
<b>UV20 w/sediment fltr</b>	<b>#WC154</b>	<b>\$618</b>
<b>UV20 w/carbon filter</b>	<b>#WC155</b>	<b>\$638</b>
<b>UV20 w/car &amp; sed. fltr</b>	<b>#WC156</b>	<b>\$727</b>

### Replacement 20" UV

<b>Bulb for UV20</b>	<b>#WC157</b>	<b>\$63</b>
----------------------	---------------	-------------

## Replacement Filters

We use these particle and carbon elements in our UV Series Water Filters. You can also substitute the ceramic filter for the particle element. Cleanable, they remove giardia and particles down to 1 micron. You could replace one of the filters in our system with a lead filter or add a third housing.

### For UV-1 and UV-2

<b>Particle Filter</b>	<b>#WC101</b>	<b>\$6</b>
<b>Carbon Filter</b>	<b>#WC102</b>	<b>\$27</b>
<b>Ceramic Filter</b>	<b>#WC105</b>	<b>\$39</b>
<b>Lead Filter</b>	<b>#WC104</b>	<b>\$28</b>

### For UV20

<b>Particle Filter</b>	<b>#WC3113</b>	<b>\$11</b>
<b>20" Carbon Filter</b>	<b>#WC3114</b>	<b>\$28</b>



## Pura BigBoy Series

### High flow, 3-way water treatment

The same highest quality water as the standard Pura UV systems but now with capacity expandable up to 60 GPM. Basic models produce 15 GPM and a special rack setup lets you plumb a multiple of units together with a special manifold. All models feature UV treatment 99.9% effective against illness-causing bacteria and viruses. UVBB-2 adds 5 micron sediment filtration. UVBB-3 adds 5 micron sediment and carbon block filtration for better taste, odor and removal of chlorine and chemical contaminants.

<b>UVB3 Under Counter Filter</b>	<b>#WC4366</b>	<b>\$550</b>
<b>UVBB-1</b>	<b>#WC3735</b>	<b>\$627</b>
<b>UVBB-2</b>	<b>#WC3736</b>	<b>\$756</b>
<b>UVBB-3</b>	<b>#WC3737</b>	<b>\$876</b>
<b>30 GPM w/2 Prefilters</b>	<b>#WC3791</b>	<b>\$1,945</b>
<b>45 GPM w/2 Prefilters</b>	<b>#WC3792</b>	<b>\$2,230</b>
<b>60 GPM w/2 Prefilters</b>	<b>#WC3793</b>	<b>\$2,840</b>
<b>Repl. 5 micron</b>		
<b>Sediment Cartridge</b>	<b>#WC3738</b>	<b>\$65</b>
<b>Repl. 10 micron</b>		
<b>Carbon Block Filter</b>	<b>#WC3739</b>	<b>\$90</b>

## O-SO PURE 3-Stage UV POU System

Triple treatment to remove most contaminants including bacteria and viruses. Sediment filters remove sand, silt, and other particulates, then carbon second stage removes chlorine and other chemicals. Treated water is then exposed to high intensity ultraviolet to destroy bacteria and viruses. System can be fitted with 5" or 10" filters to suit your space allowances. Filter elements and UV are all replaceable. Operate on 120 vac or 12V DC. Three year warranty.

### O-SO Pure 3-Stage UV POU System

<b>#WC5183</b>	<b>\$425</b>
<b>Replacement 5" Sediment Filter</b>	<b>#WC5849 \$6.50</b>
<b>Replacement 5" Carbon Filter</b>	<b>#WC5851 \$16</b>
<b>Replacement 10" Sediment Filter</b>	<b>#WC5853 \$8.25</b>
<b>Replacement 10" Carbon Filter</b>	<b>#WC5852 \$20</b>
<b>Replacement Bulb</b>	<b>#WC5856 \$40</b>

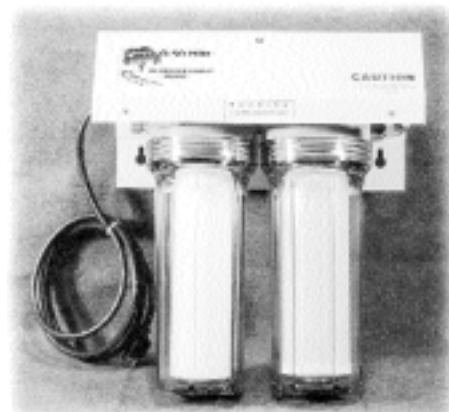

## UV "AddOn"

An easy addition to water treatment systems that require disinfection. Use almost anywhere, a unique power supply makes installation simple, space requirements minimal and lamp changes easy. 1 gpm flow rate, stainless steel body, 3/8" inlet/outlet quick connect fittings. 12" x 4" x 3.5". 120 vac standard, 12V DC by special request.

<b>#WC7172</b>	<b>\$200</b>
----------------	--------------



*"20% of 1000 public water supply wells across the nation (USA) were found to be contaminated to some degree."*

**- U.S. Environmental Protection Agency**

## CleanSource Countertop w/Digital Meter

No more guessing at filter changes. Digital readout monitors water flow through filter, tells you how many gallons, liters, or months remain before filter needs replacement. Also reads out water flow rate in gallons or liters per minute. Unit sits next to your faucet, connects to faucet outlet in place of existing aerator screen. Single element filter combines polypropylene for sediment and carbon block for chlorine and other volatile chemicals.

#WC5339 \$108



## PUR Ultimate

*Top quality filtration, easy faucet mounting*

This advanced filter eliminates 99.99% of cryptosporidium and giardia and reduces trihalomethanes by 95%, lead by 98%, mercury by 85%, atrazine by 95% and lindane, asbestos and particulates by 99%. Each easy-change filter cartridge provides 2-3 months of filtration. Filter-use indicator and automatic shut-off prevent filter overuse. Design includes a swivel sprayer, an easy-tilt bypass feature for unfiltered water, 2 adapters for different faucets and a bonus replacement filter. For cold water use. 5 1/4" L x 2 5/16" W. USA.



**PUR Ultimate** #WC7807 \$60  
**2 replacement filters** #WC7808 \$45

## What is Water Pasteurization?

Pasteurization is the process of disinfecting food or liquids by heat or radiation. Disinfection means the destruction of disease-causing microorganisms.

The word "Pasteurization" was named after the French doctor Louis Pasteur, the father of modern medicine. In 1864, Pasteur demonstrated that wine diseases are caused by micro-organisms that can be killed by heating the wine to 55°C/131°F for several minutes. Applied to beer and milk, this process, called "pasteurization", soon came into use throughout the world. Pasteur's research proved that sufficiently heating a substance destroys all disease causing germs. Pasteurization has been accepted as completely safe for more than 135 years!

Today, throughout the world, beverages such as milk, fruit juice, beer and wine are disinfected through pasteurization. Consumers are familiar with and trust the process of pasteurization. Pasteurization is a function of time and temperature. If heat is applied for a long period of time, disinfection will occur at a lower temperature. At higher temperatures, disinfection occurs in a shorter period of time.

Safe Water Systems use the time-honored technique of pasteurization to disinfect water that is microbiologically contaminated. Laboratory testing confirms an effectiveness of 99.999% in disinfecting water that contains disease-causing micro-organisms, including bacteria, viruses, worms and protozoa. According to an NREL report, these systems are superior to chlorine, slow sand filtration, ceramic filters, roughing filters, and UV radiation. Chlorine treatment, rated "poor" at destroying worms and protozoa, may be bad for one's health, and leaves a chemical taste in the water.

The Family Sol-Saver model, our batch solar water pasteurizer, disinfects water by combining heat pasteurization with UV radiation. The water is typically heated for 2-3 hours. Once the temperature reaches 62°C/143°F, the thermal indicator wax melts, confirming that pasteurization has occurred.

The Sol-Saver model is our flow-through solar water pasteurizer. Since the water spends only a short time in the system, the thermal control valve is designed to open at a higher temperature of 74.9°C/175°F. At this point the disinfected water is released from the solar collector.

### Disadvantages of boiling water

In many countries, firewood, charcoal and other fuels are used to boil water. The burning of fossil fuels has been linked to air pollution, ozone damage, deforestation, soil erosion, and flooding. Families in developing nations spend up to 25-30% of income on firewood or water purchases. Many families gather wood or other fossil fuels because they cannot afford to purchase them. It can take 6-8 hours or more for men, women or children to gather enough fuel to cook the daily meal and boil the water.

### Advantages of solar water pasteurization

99.999% effective in destroying water-borne pathogens, this process destroys disease-causing bacteria, viruses, protozoa and worms. It uses only the heat of the sun - no electricity, chemicals or fossil fuels. It prevents air pollution, ozone damage, deforestation, and soil erosion and is excellent for use during emergencies and natural disasters, a guarantee that your family will always have safe drinking water. Low maintenance with no replacement parts costs, the Sol-Saver can be used as a foundation for a business in developing countries: the owner can be a "water seller" in the community.

### Limitations of solar water pasteurization

Pasteurization requires sunny weather (or the Wood-Saver model), cannot operate in freezing conditions, does not remove chemical pollutants from water, and does not remove minerals or salt from water (does not desalinate).

### Water Purification Systems Compared

Type of System	Taste/Odors	Chlorine	Bacteria	Viruses	Cysts	Toxic Metals	Organics	Nitrates
carbon block	yes	yes	-	-	yes	-	yes	-
ceramic	no	no	yes	-	yes	no	no	-
KDF/carbon	yes	yes	yes	-	yes	yes	yes	-
distillation	yes	yes	yes	yes	yes	yes	-	yes
reverse osmosis	yes	yes	-	-	yes	yes	yes	yes
ultra violet	-	-	yes	yes	no	-	-	-
UV/carbon	yes	yes	yes	yes	yes	yes	yes	no



### Drinking Water Systems

Protect yourself from such diseases as cholera, hepatitis and dysentery, as well as parasites such as Giardia found in contaminated water. These compact, lightweight antimicrobial water purifiers eliminate all viruses, all bacteria and all protozoa from any fresh water source.

### PUR Scout Purifier

Easiest to operate. Eliminates all bacterial, viral, or particulate hazards. 400 litre capacity, 1 liter per minute flow rate. Weighs 14 oz. Now with anti-clog technology and dirt shield.

#WC4766 \$89

Replacement Filter

#WC5886 \$40

### PUR Carbon Cartridge

Add to Explorer and Scout purifiers to remove nasty odors and tastes from filtered water. Also useful for removing chlorine from town water.

#WC5561 \$23

Carbon Refill

#WC6406 \$7



### PUR Hiker Microfilter

Removes Giardia and all but the smallest bacteria. Simple design, easy to pump. Guaranteed not to clog. Filters up to 200 gallons at 1 quart per minute. Optional upgrade to a purifier with the Voyageur cartridge. Compact, only 11 oz. in a 6 1/2" x 2 3/8" inch package. 0.3 micron final filter. Prefilter removes sediment to minimize clogging. Float-on inlet hose keeps it out of the mud.

#WC5559 \$58

Replacement Filter #WC6535

\$29.95



### PUR Voyageur Purifier

1 liter per minute. 0.3 micron final filtration step removes all viruses, bacteria, and Giardia. Meets EPA standards for water purifiers. Prefilter removes sediment to minimize clogging. Float-on inlet hose keeps it out of the mud. Compact, only 11 oz. in a 6 1/2" x 2 3/8" package. Good for up to 100 gallons on a single filter cartridge.

#WC5558 \$75

Replacement Filter

#WC6379 \$39

### PUR Explorer Purifier

Water purification for large groups. Explorer pumps 1.5 liters per minute. Double action, pumps on in and out strokes. Cleans itself without disassembly. 0.3 micron final filtration step removes all viruses, bacteria, and Giardia. Meets EPA standards for water purifiers. Prefilter removes sediment to minimize clogging. Float-on inlet hose keeps it out of the mud. Optional carbon cartridge removes odor and taste. Weighs 20 oz, 10 3/4" x 2 1/4". Good for up to 100 gallons on a single filter cartridge.

#WC5557 \$128

Replacement Filter #WC6125



\$39.85



### Survivor Reverse Osmosis Systems

*Safe, pure water anywhere*

World's smallest hand-operated desalinators, perfect for storage in an airplane or life raft. Easy to operate—uses sophisticated technology to produce fresh drinking water from the sea for as long as you need it. The 06 weighs just 2.5 lbs and with an average of 40 strokes per min produces 1 oz/2 min. The Survivor 35 with 30 strokes per minute produces 1.2 gallons. The PowerSurvivor operates at 12V DC, draws 8 amps, and delivers 3.3 gallons per hour. It removes all contaminants, even salt, and leaves pure drinking water.

Survivor 06 #WC400 \$585

Survivor 35 #WC401 \$1,550



## Katadyn Expedition Filter

Instantly 2-3 l/min (3.5 to 6 pints/min.) of disinfected drinking water, anywhere. Katadyn type KFT filter (ceramic, silver, and silver quartz filling). Katadyn filters have unique multiple safety features and are the only ones that prevent dangerous disease causing germs from growing through the ceramic body, even after years of use. Contamination of ceramic filter is prevented through bacteriostatic silver, finely dispersed and fixed throughout the ceramic material by Katadyn's proprietary manufacturing process. No chemicals are used in disinfection process. Life span of filter will be determined by the degree of contamination of the water being filtered. Filter element can be regenerated by simple brushing of the dirty ceramic filter. This can usually be done 200-300 times, greatly increasing the lifespan of the filter. Up to 13' of delivery head. Mineral and salt concentration and composition remain unchanged. Does not desalinate or deal with hardness. Weight: 10 lbs, 13 oz. Nickel and brass plated pump and filter housing. Stand is surface treated steel.

<b>Expedition Filter</b>	<b>#WC4679</b>	<b>\$1,140</b>
<b>Replacement Filter</b>	<b>#WC4680</b>	<b>\$90</b>

## Katadyn Mini Filter

Now available two ways—with a ceramic or activated carbon filter. Use ceramic to remove bacteria and other microorganisms, activated carbon to reduce the chemical content and restore fresh taste. Ceramic treats up to 2,000 gallons and carbon up to 500 gallons. Both versions compact, lightweight (8 oz.), and portable. 7" x 3.5" x 1.75".

<b>Carbon</b>	<b>#WC168</b>	<b>\$69</b>
<b>Ceramic</b>	<b>#WC162</b>	<b>\$89</b>



## Katadyn Siphon Filter

Inexpensive gravity filter removes all bacteria and parasites from water—1 gallon per hour without power. Just place filter element(s) in bucket of raw water with exit tube(s) hanging down into a bottle or container to collect

filtered water. Ideal for camps, cabins, foreign living, and emergencies. Same technology as our other Katadyn filters with 0.2 micron ceramic element. Only weighs 2 lbs. but filters up to 5,000 gallons of water. 4" x 2".

**#WC166 \$69**

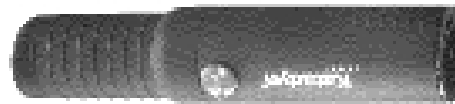

## Katadyn Combi Filter

A unique two filter system in one portable unit. Ceramic filter eliminates bacteria and microorganisms while activated carbon removes harmful chemicals. Use both filters together or just the ceramic by itself. Combi-Plus includes sink add-on kit. 19 oz. 2.4" diameter x 10.4".

<b>Combi Filter</b>	<b>#WC169</b>	<b>\$159</b>
<b>Combi-Plus Filter</b>	<b>#WC4550</b>	<b>\$199</b>
<b>Replacement Ceramic Cartridge</b>	<b>#WC4502</b>	<b>\$75</b>
<b>Replacement Carbon Cartridges (2-Pack)</b>	<b>#WC4172</b>	<b>\$19</b>

## Katadyn Pocket Filter

After 52 years (on the market since 1950), this filter still has a reputation as the finest available for extreme conditions— for world travel, expeditions, mountain tours and disaster relief assistance worldwide. The only personal water filter backed up with a 20 year (lifetime in the USA) warranty. The recently upgraded design has a round pump handle grip with a shock absorber making pumping painless and comfortable. The ceramic element has a pore size of 0.0002mm (0.2 micron) and reliably holds back all pathogenic bacteria and protozoa such as: giardia, cryptosporidium, salmonella, amoebas, e-coli etc. Clean the used ceramic element by brushing the surface with an abrasive pad. An included measuring gauge makes it easy to know when you need to brush. 5.3 cm (2") diameter, 25 cm (10") high, 550 g (20 oz.)

**#WC163 \$249**



## Camp Filter

Tired of pumping the water yourself? Here's a simple solution: our 10 liter Ortlieb water bag attached to this Katadyn Syphon water filter. Just hang it from a tree and in just 2-3 hours you have 10 liters of clear, safe drinking water without one pump stroke. Effective against all bacteria and protozoa including cholera, giardia, crypto and e-coli, you can even use very muddy water because it's so easy to clean. Includes 10 liter (2.6 gal.) Ortlieb water bag, Katadyn Syphon with 2 m (6.5 ft.) hose, cleaning pad, measuring gauge, bag adapter and instructions. 19 oz.

**#WC8465 \$108**

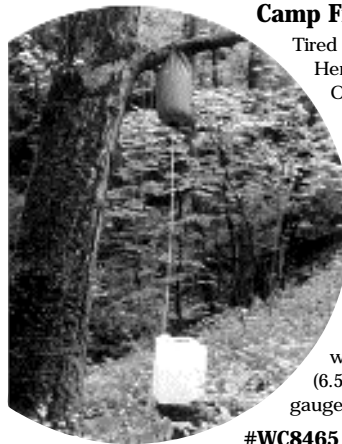

## Sports Bottle

Whether you fill it at the office or from a mountain stream, our Sports Bottle will provide you with the peace of mind that comes with safe, great tasting water. Its advanced filtration system removes chlorine, sand, sediment, heavy metals such as lead, copper and mercury, and more than 99% of cryptosporidium, giardia, cysts, VOCs and pesticides, leaving you with clean, refreshing water. Featuring a pop-up cap for easy drinking and a 25-fluid oz. capacity, the lightweight bottle travels anywhere. Filters last for 200 gals., or 1,280 refills. 10"H. 2 7/8" Diameter. Weighs 4.5 oz. USA.

**#WC7877 \$29**



## Katadyn Drip Filter

Effective elimination of all known problem parasites and bacteria without the use of unhealthy chemicals or filter elements that require frequent replacement. Just clean the 0.2 micron ceramic filter elements for up to 10,400 gallons. Popular with missionaries and others living in countries with no plumbing and low or undependable water pressure. Untreated water slowly drips through 2 ceramic elements providing 6 gallons per day. Used by the Red Cross, the armed forces of many nations (including the U.S.), the UN, WHO, and the US Forest Service. Use distillation or ultraviolet if viruses in the water. Highest quality.

**Complete Drip Filter** #WC164 \$275  
**Replacement Cartridge** #WC1682 \$75

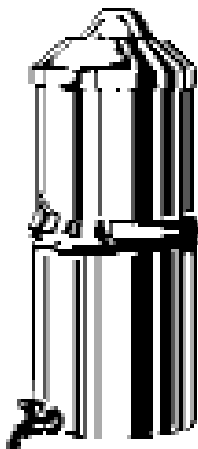

## Doulton Berkefeld Gravity Filters

*For use where a main water supply does not exist or is unreliable.*

Water purification with a history going back to 1815, including a special commission from Queen Victoria in 1835 that resulted in King Edward VII knighting Henry Doulton in 1902. Similar to the large gravity flow Katadyn but with stainless steel housing, the standard system has four 7" silver-impregnated ceramic/carbon filters that produce 15 or 30 gallons of safe drinking water per day and the "Big Berkey" with 9" filters does up to 37 gallons per day. Because of the carbon, it takes out taste and odor that Katadyn misses but doesn't last as long. The stainless design looks better than Katadyn but isn't as durable.

**7" Standard Filter** #WC5180 \$259  
**9" Big Berkey** #WC5199 \$279  
**7" Replacement Filters** #WC5171 \$35  
**9" Replacement Filters** #WC5198 \$42



## Mission Drip Filter

Inexpensive but in an emergency this simple system can supply drinking water for a family of 5 to 10 people. Mix chlorine in the top 5 gallon plastic bucket and let the water drip down through activated charcoal and polypropylene filters for safe water in the lower spigoted 5 gallon bucket.

**Drip filter** #WC5901 \$66  
**Carbon filter replacement** #WC5913 \$12  
**Sediment filter replacement** #WC5914 \$6

## Portable Mini Filter

*Safe water without all the work*

Most portable water filters require lots of pumping and hard work. It's good exercise but if you would like to use your energy in different ways, try this new filter. It has a stainless steel upper and lower chamber separated by a special ceramic filter. Just fill the upper chamber with untreated water. It flows through the ceramic filter element and safe, filtered water collects in the lower chamber, ready for drinking. Tested to remove 98% of lead, 95% of insecticides and herbicides, 91% of chlorine and 99.99% of cryptosporidium, giardia, cholera, typhoid, shigella, and E. coli. The stainless mini filter produces up to half a liter of great tasting water per hour. Lightweight and compactible, it includes a nylon carrying case and provides the ultimate in protection wherever you roam. Filters 1/2 liter per hour, 2500 gallons per replacement filter. 11 1/2" H x 3 5/8" Dia, 2.1 lbs. England.

**Portable Mini Filter** #WC7688 \$85  
**Replacement filter** #WC7689 \$49



## "La Natural" Drip Water Filter/Cooler

*Purify and keep your water cool at the same time*

This terra cotta water purification system uses the Doulton Berkefeld 6" activated-carbon, ceramic candle to purify water in the same way as the popular Katadyn and Berkefeld Gravity Filters. It also uses an evaporation principle to lower water temperature 10-20 degrees. The small version has a 1 gallon tank, 1 candle, and purifies 6 gallons per day. The larger model has 2 candles, purifies 12 gallons a day, and holds 2 gallons but has a clear plastic reservoir. Fully tested and approved to NSF specifications.

**"La Natural" - Small** #WC5780 \$120  
**"La Natural" - Large** #WC5781 \$200  
**Replacement Candle** #WC5828 \$33

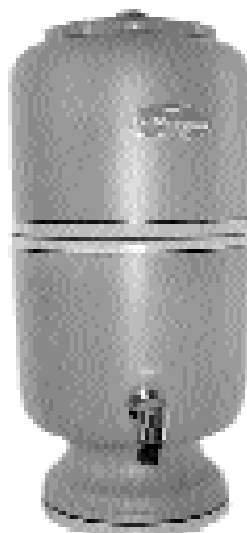

## Sports Bottle

*Mobile water filtration bottle*

A compact, light way to always have fresh, clean water with you anywhere. Instead of carrying heavy water with you, just fill this unbreakable bottle and filter as you drink. It holds 24 oz. and each replaceable element filters 200 gallons—more than 1,000 refills of great tasting, clean water! It reduces and/or removes bad taste, odor, sediment, chlorine, cryptosporidium, giardia, lead, heavy metals, mercury, VOC's, THM's, pesticides and more. Tested by EPA & state registered laboratories and meets or exceeds EPA, ANSI/NSF protocol. 30 Day Warranty.

#WC3662 \$24







## Shower-Clean Triple Filtration Shower

Use when you're concerned about more than just chlorine. The Shower-Clean also removes odors, bacteria, organic waste, trihalomethanes, VOC's, and common carcinogens such as carbon tetrachloride, chloroform, benzene, and vinylidene chloride. Removes chlorine for years instead of months like other filters. Special design makes shower head even higher than before installation. Three filtering systems: 5 micron sediment filter, granular activated carbon, and "MicroClean", a state-of-the-art bacteriostatic filter medium. Up to 3 GPM flow. Average filter life 2 years.

### Shower-Clean Triple (non-replaceable)

#WC200 \$95



## Sprite Economy Dechlorinator

Chlorine chemically bonds with protein making hair brittle and dry, sensitive skin dry and flaky. Strong medical evidence also links chlorine with heart attacks. We absorb more chlorine during a shower than by drinking the same amount of water. This economy Shower Master lasts for an average 15,000 gallons. 2.5 GPM low flow shower head.

#WC205 \$39



## Shower/Bath Adapter

Use your shower filter for bath water too

Special valve arrangement lets you shower as usual and when you want to take a bath simply divert the water to fill your tub with chlorine free water. Includes 60" hose and hand held shower head. Also great to bathe children and pets.

#WC3663 \$21

## TurboShower

New improved design now has a replacement cartridge that changes in seconds. Instead of throwing away a shower filter or using it longer than it works, just replace the inexpensive cartridge. A spinning vortex design allows greater contact time with the CuZn Copper-Zinc media. This means more chlorine removal (up to 99%) and longer life (up to 26,000 gallons, almost twice as long as other filters). Works best with a low-flow shower head like our 2.5 GPM "Earth Massage". 3-5 GPM flow rate. Lifetime housing guarantee.

**Filter only** #WC282 \$42

**Filter w/Earth Massage**

**Showerhead** #WC283 \$57

**Cartridge** #WC3795 \$19

## Handheld Massage Shower Filter

All the features of a deluxe handheld showerhead - soothing pulse massage, a long cord, swivel handle holder for handheld or adjustable stationary use, easy installation and maximum headroom - plus: hidden in the handle a copper/zinc KDF filter that removes 99% of both free and combined chlorine, iron oxides and odors. And although you'd never notice it, a water saving flow rate of only 2.25 gallons per minute. Easy-change and recyclable filters last 5-6 months. 10"L x 1 1/2"D. 1.125 lbs. USA.

**Chrome** #WC7685 \$48

**White** #WC7686 \$40

**2 Replacement filters** #WC7687 \$26

## Bathtub Faucet Filter

Take a relaxing bath without chlorine and without having to lower the water temperature by filling the tub with a shower head. This unique sphere with Filter Foam Power Disk technology attaches with a sturdy vinyl strap under the tub faucet. Water flows into openings in the top and emerges 95% chlorine free. You'll notice a wonderful difference in water quality. Lasts 1 year and includes a container to keep the bath ball submerged when not in use. 4" diameter. USA.

#WC7684 \$39

## Rio Vita Shower Filter

More features, longer life, LED indicator

A new shower filter with the best features we've found - almost twice as much KDF media for longer life, an LED indicator that tells when to change cartridges, special design for more headroom, and a shut off valve to stop the water without changing the hot/cold water mix. Easy to install without tools and fits all shower heads, even hand-helds.

**Rio Vita** #WC7130 \$58

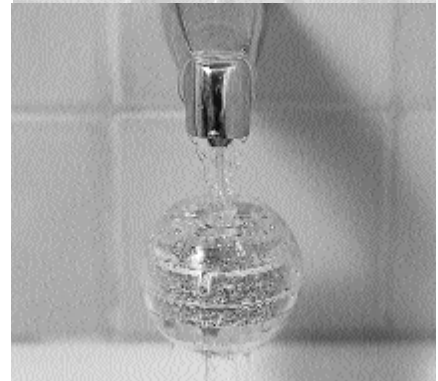

## AquaMate

Pure water for gardens & RV's

At home in your backyard or on a camping or RV trip, the AquaMate assures that both you and your plants have good water. Brass hose fittings and swivel make attaching to hose or faucet easy. Chlorine kills microorganisms plants need to grow properly—the AquaMate removes chlorine from over 25,000 gallons of water plus reduces or eliminates lead, sulfur, rust, scale, and mineral build-up.

**AquaMate** #WC284 \$46  
**Replacement Cartridge** #WC3795 \$19



## Floatron Solar Powered Pool Filter

80% less chlorine

Use the same ionization process developed by NASA for the Apollo spacecraft to keep your pool clean, clear and healthy with the minimum amount of chlorine. Safe, non-toxic, eliminates the irritations, odors, bleaching, expense, and maintenance associated with chlorine. Electrode typically lasts two years.

**Floatron** #WC925 \$325  
**Spare Electrode** #WC1982 \$50

## Watercheck Water Tests

Test for 73 contaminants, add 20 more for pesticides and herbicides, or test for lead only. We send you a sampling kit that you mail to an independent lab. They send you a detailed report of their tests and recommendations.

**Standard Watercheck** #WC910 \$130  
**Pesticide Option** #WC911 \$30  
**Lead Test** #WC912 \$26



## Aerobic 07 Stabilized Oxygen

Destroy bacteria, fungi, and viruses in drinking water. Stabilized oxygen is a simple, chlorine-free way to purify potable water. Just filter the water as well as possible, add 6 drops of Aerobic 07 for each gallon of water (one ounce for 55 gallons), and allow to stand for about an hour. 2.3 oz.

#HP200 \$18



## Home Water Analysis Kit

Accurate results in minutes

Ideal for checking your water, filters or water softeners, an easy-to-use color-change tests let you check once each for chlorine, lead, bacteria (including E. coli and coliform), iron, bacteria, hardness, pH, alkalinity, nitrates, nitrites, iron, copper and hydrogen sulfide—all. Certified by a lab that conforms to EPA standards, this kit contains no toxic ingredients and includes access to a US toll-free hotline for advice and information on water problems and treatments. Kit includes 2 test strips which may be

used before and after treatment or for separate testing. Includes an 800 number if you have questions about your tests.

#WC8178 \$35

## No Enemy

An old saying goes, "Water has no enemies." Friendly water picks up small amounts of almost everything. Water reflects the amount of pollution in our world. The proliferation of pesticides, solvents, chemical fertilizers, giardia, toxic waste dumps, and radioactive contamination in rain creates serious health problems because of the run-off into our water systems. Chlorine, used in most city water supplies in a gross effort to correct all these contaminants, causes even more problems. Dr. Weston Price in his book, Chlorine, Coronaries, Cholesterol, makes a strong case that chlorine in our drinking water, rather than cholesterol by itself, causes the modern high incidence of heart attacks. Eskimos with high cholesterol diets have few heart attacks. Coronaries rarely occurred until chlorine became a common water purifier. Prevent the main personal impact of water pollution by installing and properly maintaining a good water filter.

## Acid Rain

90% of acid rain is caused by humans—mainly from burning coal and oil.

Acid rain increases infant mortality, reduces proper lung functioning, causes at least 50,000 premature deaths each year, acidifies lakes and rivers causing fish species to die out, leaches heavy metals that get into fish making them toxic to humans, and damages tree foliage and soil.

Acid rain damaged more than half of Germany's forests and has caused extensive damage to maple trees in Canada and New England.

Acid rain moves hundreds of miles in wind streams. Half of the acid rain in Canada comes from the US.

According to an EPA study, acid rain accounts for \$6 billion in damages to buildings, statues and monuments each year in just 17 Eastern and Mid-Western states.

"Acid rain poses a direct threat to our entire nation, not just to Canada or New England as we once believed. Acid deposition falls on North Carolina's mountains, Florida's lakes, Colorado's parks, Indiana's towns. It has corroded the Statue of Liberty, acidified Pennsylvania's trout streams, and damaged Vermont's maple trees. But most importantly, acid rain poses a clear and present danger to our lungs—and to our children's lungs."

—Michael Fischer,  
Sierra Club, Executive Director

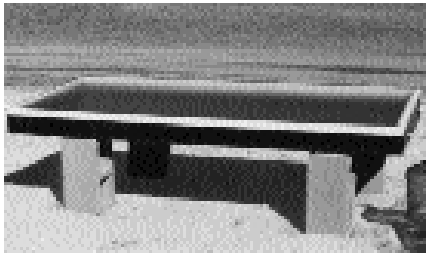

## Sunwater Solar Distillers

*Portable and affordable. No power required!*

*Use for battery water in remote places without stores.*

Pure, delicious drinking water—normally more pure than any bottled water. Eliminates salts, minerals, bacteria and radioactive minerals. Greatly reduces chlorine, pesticides, THM's and chemical fertilizers but in rare cases of extreme contamination may also require carbon filtration. Great for replacing battery water for alternative energy systems in remote areas.

**2-Person, 5 liters/day #WC361 \$510**  
**3/4-Person, 8 liters/day #WC362 \$750**



## Water Distillers

In the same way nature lifts pure water through evaporation and returns it in the form of rain, distillers lift water in the form of vapor and return it purified after condensation. Distillation is simple and very efficient: virtually all contaminants are left behind. Our distillers use high quality stainless steel parts, operate on 117 vac, and include built-in self-sterilization. The Aqua Clean fits neatly on a counter and produces 3 qts. per 4.5 hours. The Midi D has a 5 gal. storage tank, connects to any waterline and is available with automatic timer control. Produces 1 gallon each 3.5 hours. Aqua D-2000 produces 11 gallons per day and has a 10 gallon storage tank.

**Aqua D-2000 #WC302 \$1,500**  
**AquaClean #WC300 \$459**  
**Replacement**  
**Heating Element #WC4188 \$49**  
**Midi D—auto version #WC3515 \$1,110**

## Airwell Distiller

Capture the moisture that's around you—and drink it! Plant material, soil, raw water, sea water—all have pure water waiting to be extracted. The Airwell Distiller uses anything with moisture, evaporates and collects it. Makes 3 to 7 pints of distilled water per day. Requires no internal or external power source—operates from natural evaporation. Portable and packable. Made entirely from food grade materials.

**#WC5157 \$70**



## Tapworks

### One Gallon Water Distiller

Simple and inexpensive water distiller for low usage (makes one gallon every 8 hours). Easy to use—just plug in, fill with water and attach storage container. Water heats to 212°F killing bacteria and other organisms. Steam rises into a cooling coil leaving contaminants behind. Purified water percolates through carbon polishing filter into storage container.

**120 Volt #WC310 \$199**  
**220 Volt #WC311 \$230**  
**Carbon Filter #WC6807 \$10**



## e-Still

### Non Electric Water Distiller

With a Pure Survival e-Still in the house, you will never have to worry again about storing bottled water for an emergency. Great for camping, remote living, emergency preparedness—a stainless steel distiller with no moving parts! Use with any type of stove—gas, electric, wood, a propane burner or camping cook stove, in a home fireplace or outdoor camp fire, on a charcoal grill. One 16.5 oz. propane bottle lasts for 8 batches—steam condenses into 1.5 gallons of 99.9% pure distilled water. You get 24 ounces in just 34 minutes, one gallon in 40–45 minutes (production batch time varies with the heat source).

**#WC5372 \$184**



## SolSaver

*Portable, affordable, no power required!*

Disinfect microbiologically contaminated water without electricity, pumps, chemicals, or boiling - 99.999% effective! An average sunny day produces 200 gallons (757 liters) of drinking water. Easy set-up - you only need basic hand tools. Additional components necessary include a tank for contaminated water, a sanitary holding tank for pasteurized water, pipe & pipe fittings. Use a filter for very dirty water.

**#WC3272 \$2,000**

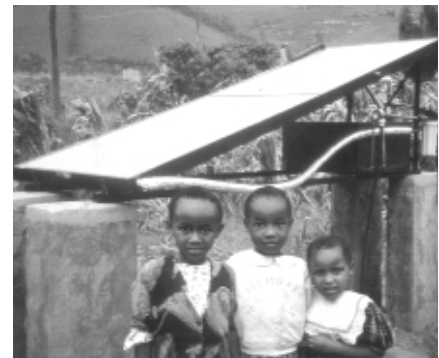

## Family SolSaver

*2-3 hours of direct sunlight produces 3.5 gallons H2O.*

Easy set-up and operation. Just pour contaminated water into the unit, place in a sunny location. A visual indicator shows when pasteurization complete. Constructed from lightweight, ultraviolet resistant, high density, black polypropylene blowmolded to create a double-walled heat resistant collector. Covered by an insulating twin-walled transparent polycarbonate glazing which allows sun to enter the heating chamber while at the same time minimizing heat loss. 18" x 48" x 2.5", 16 lb. (6.4 kg), when full of water 45 lb. (20 kg).

**#WC3271 \$125**

## Saving Water

Water makes up 71% of the human body and remains a basic foundation for all human civilization. While more than 1.7 billion people worldwide don't have an adequate supply of safe drinking water, the average person in the U.S. uses 2 to 4 times more water than the average person in Europe. 35 states pump their underground water supplies faster than they refill, sometimes causing sink holes that swallow cars and houses and destroying the aquifers. California's Sacramento River delta that supplies the California Aqueduct sinks about 3 inches each year. In Mexico City the main aquifer drops up to 11 feet each year, in Beijing the water table annually goes down 6.5 feet. Wasted water aggravates water shortages, overloads septic systems, and causes problems for sewage treatment facilities. Water is too precious to waste.

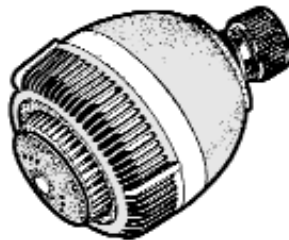

### Earth Massage Low Flow Showerhead

*Feels like the most deluxe shower, only uses 2.5 GPM*

Adjusts from fine spray to pulsating jet "turbo massage" —just right for everyone. Three different spray patterns stay consistent from low to high water pressures and give great rinsing efficiency. Self-cleaning, lifetime warranty. White.

<b>White</b>	<b>#WS109</b>	<b>\$17</b>
<b>Chrome &amp; Gold</b>	<b>#WS1339</b>	<b>\$25</b>

### Aqua Helix 1/2 GPM Shower Head

*Never run out of hot water again*

This new shower head works great for me but my teenage daughters hate it - it sure wakes them up in the morning though! (I'm not torturing them, they have a different shower now.) The nozzle rotates at up to 1500 RPM's so the trick is getting a good adjustment with the sliding sleeve and the shower's volume control. It saves an incredible amount of water and water-heating energy, over 35,000 gallons a year with a family of 5 each taking one ten-minute shower per day.

**#WS3066 \$27**



### Incredible Head Low-Flow Showerheads

Conventional showerheads use from 6 to 10 GPM. Our deluxe "Incredible Head" uses 2 GPM but delivers the full flow feeling of a normal shower. Annual savings result in up to 18,000 gallons of water per person and up to 70% on energy costs. Includes "Soap-Up" on/off control for extra savings.

**#WS100 \$14**

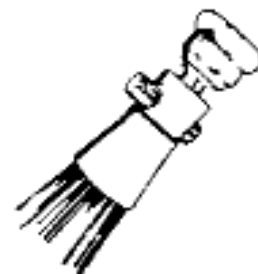

### Economy Low Flow Shower Head

Nothing fancy, just bare-bones savings of up to 80% of the water you normally use with each shower. Built in on/off button. Solid, durable construction, easy to install. Chrome plated solid brass.

**#WS101 \$9**



### Shower-For-Two

*Conserve water—share a shower!*

Two water-saving showerheads and a 2 foot adjustable arm for an exceptionally luxurious double shower. Easy no-tool installation. Adjustable height is great for children too! Chrome plated solid brass construction. Each use 2.5 gallons per minute.

**#WS166 \$49**

### Downpour Rain Shower

*Big spray pattern for great rinsing action.*

Chrome plated solid brass construction. Head also pivots a full 180 degrees for maximum coverage. Adjustable 15" arm. 2.5 GPM.

**#WS1664 \$25**

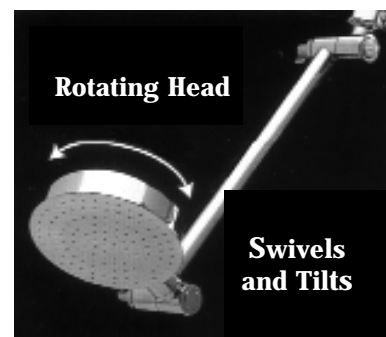

### Rotating Head

**Swivels and Tilts**

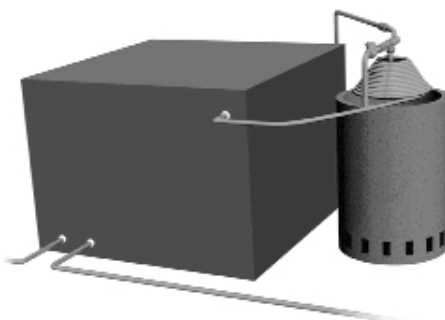

### Wood Saver

Easily disinfect microbiologically contaminated water without electricity, pumps, chemicals or boiling. Pasteurization has proven to be 99.999% effective for inactivating disease-causing bacteria, viruses and micro-organisms. Even sewage-laden water is completely disinfected but pasteurization does not eliminate chemical pollutants. The WoodSaver provides low cost, safe drinking water where wood, coal, charcoal or other fuels are readily available while dramatically reducing the amount of fuel required, helping to eliminate the needless consumption of shrinking natural resources. It provides more than 30 gallons(113 liters) of disinfected water per hour. Use as an independent, stand-alone product or combine with the SolSaver Solar Water Pasteurizer's heat exchanger and used as a backup heating source. Lasts more than 15 years - no parts to wear out or break down and regular maintenance is limited to occasionally wire-brushing the burner coil.

**#WC3273 \$1,425**

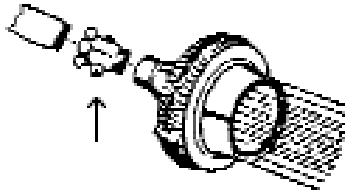

### Soap-Up Saver

This handy control lets you quickly turn a shower on and off without needing to re-mix hot and cold water. You won't have to waste water while you shampoo and soap up. Fits common 1/2" thread on standard, hand-held and massaging showers.

#WS102 \$4



### Spraydius

Turn ordinary faucets into versatile, powerful cleaning water wisks. Double jointed to reach all corners of the sink and either sprays or aerates. Uses 2.5 GPM and includes male and female threads to fit most faucets.

#WS150 \$10



### Kitchen Faucet Aerator

Special on/off lever lets you adjust for temperature without leaving the faucet running. Uses 1.5 GPM (conventional aerator uses 3-4 GPM).

#WS103 \$7.95



### Automatic Faucet Control

*Eliminate wasted water and stop leaky faucets!*

This handy unit automatically turns water on when pressure is applied to the faucet rod. When you release the rod, water instantly shuts off, eliminating any waste of water. More effective than low-flow aerators which merely reduce water waste. Easy to install and simple to use.

#WS140 \$12

### High-Low Shower

Adjust showers up for your tallest guest and down for your shortest child. 12" arm swings up and down 18" and adjusts in two places. Also makes it easy to take a shower without getting your hair wet. Use existing shower head or one of our low-flow models. Chrome finish.

#WS104 \$26

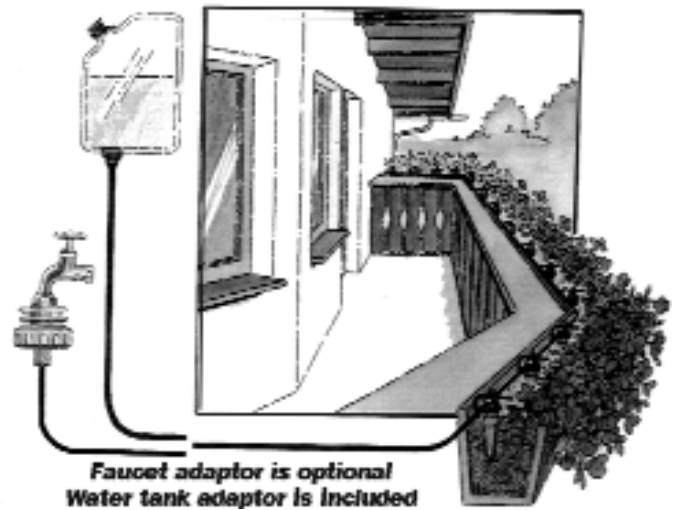
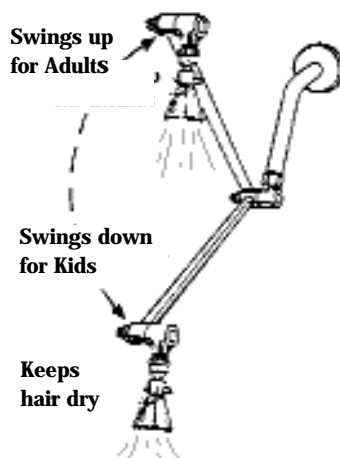

Faucet adaptor is optional  
Water tank adaptor is included

### Blumat Outdoor Kits

*An always-ready drink for your outside plants*

The automatic convenience of Blumat plant savers—now for outdoor plants as well! Great for planter boxes on decks where the smaller amount of soil lets plants dry out too fast. A Blumat system will always give your plants just the right amount of water—even when you're on vacation!

<b>Complete Kit</b>	#DI300	\$59
<b>2 Extra Sensors</b>	#DI302	\$11
<b>Pressure Reducer</b>	#DI301	\$28
<b>Distributor Dripper (Pack of 10)</b>	#DI4869	\$15
<b>10m Extra Feeding Tube</b>	#DI303	\$12
<b>Hose Branch Plus Ell-Piece (Pack of 2)</b>	#DI4868	\$3
<b>Shut-Off Valve</b>	#DI4867	\$4



### Blumat Plant Saver

Take a vacation and let your plants look after themselves. The Blumat Plant Saver ensures a constant supply of water. They automatically supply just the right amount—never too much or not enough. Take a vacation from plant watering while you stay at home too. Your plants will love it. They won't experience the drying out that stunts growth or the over-watering that squeezes the air out of the soil and keeps them from "breathing" properly. Add fertilizer to the water supply. This slow, continual feeding encourages prolific growth.

<b>3 Plant Savers</b>	#DI902	\$9.25
<b>Case 25 Plant Savers</b>	#DI304	\$52.50

**Easy to Use—Just fill with water and put into your flower pot.**

*"What a wonderful company. My heart is glowing...Thank you for putting a spark in my life that may well become a fire.*

*Now that's Appropriate Technology!"*

- Jaremi Alexander



## Syphoon

Use this non-clogging downspout insert in your gutters to prevent leaves and other debris from collecting in your rainwater catchment system. Engineered design allows up to 25 gallons old rainwater to be siphoned per minute - even when the gutter tough is clogged. Made with rustproof Polypropylene, they are 6 1/2 inches long, and are packaged in quantities of five.

#WC6792 \$19

## Floating Suction Filters

Get water from the cleanest point in your storage system —just below the water surface. Improves the quality of your rainwater and protects pumps from drawing up sediment without a need for pre-filtering. The floating ball lets the suction point rise and fall as well as preventing the filter from sinking to the bottom. Includes a float, fine filter housing with a non-return valve and sealed hose nozzle, 1" hose connections.

#WC7004 \$192

Nantucket Gray #WT7153 \$84



## Save-the-Rain Diverter

Divert your rainwater to a storage barrel or drain as usual with this handy down spout diverter. Galvanized steel construction for years of use. Fits any downspout.

#WT6993 \$18

## Stormwater Catch Basin

Collect rainwater, not leaves and sediment. Filter rainwater for later use. Water enters 4" inlet, through 1/8" poly screen basket and out. Filter screen lifts out for easy cleaning. Larger size needs less cleaning. Corrosion-resistant construction. Up to 160 GPM capacity.

24" x 8" diameter #WT1258 \$108

36" x 12" diameter #WT1259 \$228



## Downpipe Filter Collectors

Unique, European design minimizes maintenance with a patented "adhesive filtration" principle that filters away dirt, particles, moss, leaves, and insects down the drain while collecting more than 90% of the rainwater. Almost impossible to block—filtering happens automatically. The standard filter is designed for roofs up to 150 sq. meters and has a fine, .18 mm mesh. The less expensive Garden filter has a coarser, 400 micron mesh. Top quality, stainless steel. Germany.

Standard #WC7003 \$215

Garden filter #WC7002 \$325

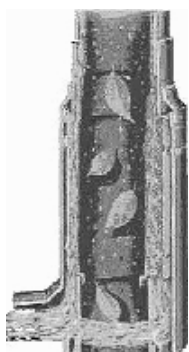

## Rainwater Catchment Systems for Domestic Supply

Learn to design, construct and implement a rainwater catchment system from numerous examples around the world. This book focuses on the implementation of roof and ground catchment systems for either total or supplementary household water systems. Covers all aspects of design including sizing, gutters, materials, construction techniques, training, operation and maintenance. Many drawings, photo's and step by step instructions on several household rainwater tanks.

#BK6713 \$25



## Rainwater Harvesting

The collection of rainfall and runoff in rural areas. Clearly illustrated details for building rainwater catchment and water storage tanks with locally available materials. Oriented for people in developing countries but excellent information for anyone needing more water. Great hope for the thousands of scattered, small communities in semi-arid countries not served by centralized water. Case studies of work in Africa, India and Southeast Asia. 216 pages.

#BK117 \$22



## Rainwater Collection for the Mechanically Challenged

Great primer for not only Rainwater Harvesting but all aspects of water management—from a cistern to the kitchen sink. Topics include calculating gallons of rainwater collected from a given roof size, choosing a cistern, water purification, pressure pumps and tanks, and the basic plumbing and electrical skills needed to put it all together. Written in a down-home style with lots of clear (often humorous) illustrations. Highly recommended! 50 pages.

#BK3118 \$17.95



## Build Your Own Ferro-Cement Water Tank

During the last 24 years, the author has built more than 70 of these inexpensive and extremely strong water storage tanks. They are still holding water without a leak and will last longer than we will. Suggests uses, gives detailed instructions and material lists. 58 pages.

#BK310

\$14



## Great American Rain Barrels

An old classic in recycled plastic. Catch your rainwater for watering your garden. Your plants will love this naturally soft water. Huge 60 gallon capacity, rugged 3/4" thick recycled polyethylene. Includes overflow fitting, drain plug, screw-on cover, and spigot. \$19 shipping

Forest Green #WT6992 \$84

Earth Brown #WT7152 \$84

Nantucket Gray #WT7153 \$84



## Electrolyzers

Use extra PV, wind or hydro power to make hydrogen for welding, cooking or heating

Just add water and electricity—this Electrolyzer produces pressurized hydrogen you can save in a simple storage tank (hot water, propane, or compressed air). Use for welding, cutting, cooking, heating, running engines, or supplying electricity with a fuel cell. With a wind generator producing 10–40A, you produce 1/8 to 1/2 cubic foot of hydrogen per hour. Includes one electrolyzer, 3' hydrostatic control, and directions. 7 1/4' x 10' x 14', 30 lbs. 1-year warranty.

#GN3109 \$225

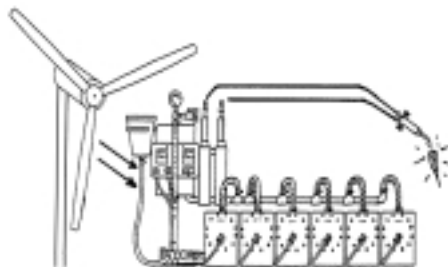

## Double-Bubbler

Use with a water electrolyzer for H2 or O2 flow indication, scrubbing of caustic residuals in gas from alkaline electrolyzer, and reverse water/electrolyte flow prevention at night when solar power used to power electrolyzer. Also functions as reverse-flow gas leak detector when there is no gas production. Holds water in clear see-through Acrylic tubes. Maximum pressure rating: 4 bar gauge [58 psig]. Max.temp 52 C [125 F]. Min.temp 1deg.C [34 deg.F] with H2O scrub. Rated for up to 1 Normal Cubic Meter [35.5 scf] gas production/day. Use 2 for a complete electrolyzer system, one for H2 and one for O2. GN7672 valve kit recommended. For outdoor use only.

#GN5512 \$560

*Option: DBV adds valve kit with two stainless steel 1/4" NPT valves and street tee for drain/fill/vent operations (recommended for Double-Bubblers).*

## Double-Bubbler Valve Kit

Valve kit with two stainless steel 1/4" NPT valves and street tee for drain/fill/vent operations.

#GN7672 \$245

## Flash-back Arrestor-Brass

#GN7366 \$134

## Relief-Check Valve- 50 to 150 psig adjustable

#GN7367 \$83

## Hydro-Que Hydrogen BBQ Grill

Hydrogen gas fueled table-top barbeque. For outdoor use only. Includes high quality stainless flow control valve, brass flashback arrestor, and ss bar-burner. Laser drilled for use with hydrogen. Comes with top cover, handles, and heat diffuser. Does not use lava rocks. Not equipped with low Nox burner. Includes s.s. temperature gauge. Hydro-que™ Model HQ-5.

#AA5511 \$444



## Micro Solar Hydrogen

### Energy System Experimenter's Kit

We can power the world with just sunshine and water! Solar cell turns light into electricity that powers a small electrolyzer. This breaks water into oxygen and hydrogen. Then a micro fuel cell turns the hydrogen back into electricity and water vapor that drives a small motor. All devices made with see-through construction so you can see the gas flows. With just sunshine and water you can run the motor continuously for hours at a time. A great way to learn and teach how this non-polluting and completely renewable energy system can soon become a part of the world's future. Help that happen by sharing your ideas and experiment results with the American Hydrogen Association (info included).

#ST911 \$333

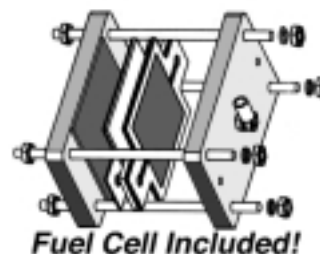

## Electrolyzer Purification Train

Use to purify water electrolyzer H2 or O2 products prior to storage or use. Mounted on a stainless plate for easy system integration, includes 2 stainless water coalescers, 1 brass flashback arrestor, 1 catalytic recombiner [converts H2 contaminant in O2, or O2 contaminant in H2, back into water], 2 stainless water purge/drain valves for coalescers, 2 stainless pressure gauges, and stainless interconnecting fittings. For outdoor use only. Maximum pressure rating: 4 bar gauge [58 psig]. Rated for up to 1 Normal cubic meter [35.5 scf] gas production/day. Min.temp=1 deg.C. Normally, 2 of these units are used to make a complete water electrolyzer purification system, one for H2 and one for O2.

#GN7371 \$2,850

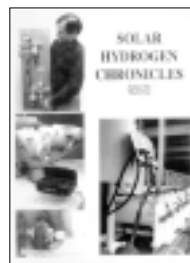

## Solar Hydrogen Chronicles

You've heard it for years. Hydrogen is the fuel of the future—infinately renewable, non-polluting. Guess what—the future is now! This book gives you hands-on articles compiled from Home Power, to show you how you can start your own transition to the hydrogen economy. Excellent resource, thought provoking reading.

#BK4825 \$36

## Fuel From Water

How to make, store and use hydrogen. Plans for making your own electrolyzer and modifying engines to run on hydrogen. Detailed information on basic theory, applications and safety. The basic source and reference book for anyone interested in this most promising alternative to fossil fuels. 244 pages.

#BK591 \$25

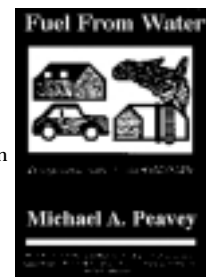

## FAQ's—Hydro Electric

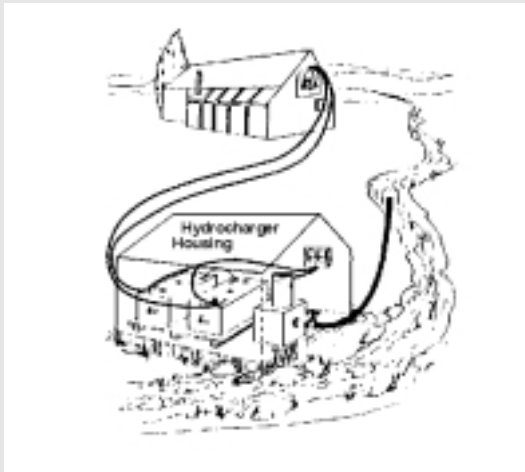

From falls of water as low as 3 feet with flows as small as 12 GPM, hydro systems can take your creek, spring, pond, river, or runoff water and turn it into clean, efficient electricity. This can put a lid on rising power bills or create a completely independent power system at the lowest cost. In areas with high rainfalls in the winter and sunny summers, hydro combines naturally with solar electricity for year-round independence.

**Q. How much water and pressure do I need for a small hydro system to work?**

**A.** In general, the more the better. Practically, you need at least 3 feet of fall with a 12gpm water flow. If you have higher fall (pressure), you can get by with much less water.

**Q. How much power can I get from my hydro site?**

**A.** Multiply the head (total vertical drop) X the GPM available, then divide by 10 to calculate the potential in watts.

**Q. How can I tell how much fall I have at my site?**

**A.** If you have or can borrow a transit, this will be easier. If not, just use a line level. Start at your best possible hydro location and look along the plane of the level to a landmark (a rock, stick, another person). Walk to the landmark and repeat the process. Count how many times you did this and multiply it by the distance from the ground to your eye. This will give you the total head you have available.

**Q. When I know the total head, how can I translate this into pressure.**

**A.** The basic formula is 2.31 psi = total head. Since you know the head, just divide by 2.31 for a psi (pounds per square inch) figure.

**Q. Given a site with sufficient head and flow is the biggest issue with keeping the turbine turning at a constant (or nearly constant) speed?**

**A.** If there's lots of water power available, or no way to store water uphill, varying the load on the alternator to keep the frequency constant seems to fit better than solenoid operated diverters.

FAQ's continued on Next Page

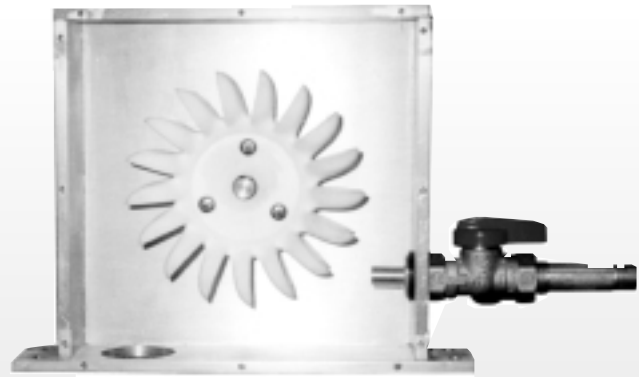

### Pelton Wheel Turbines

These "impulse" type turbines work best for high RPM sites—high-head, low flow. They include a waterproof housing with jets aimed at the Pelton Wheel cups. Adjust turbine speed by adjusting needles inside the jets or opening/closing a valve in the inlet pipe.

output	wheel only	complete
150 Watts 12V DC	#HY511 \$260	#HY512 \$570
300 Watts 12/24 DC	#HY513 \$439	#HY514 \$975
500 Watts 12/24 DC	#HY515 \$674	#HY516 \$1,485
1 kW 24V DC	#HY6110 \$1,220	#HY611 \$2,475
1.5 kW 24V DC	#HY517 \$1,485	#HY518 \$3,300
2.5 kW 48V DC/AC	#HY519 \$2,220	#HY520 \$4,950
5 kW AC 48V DC/AC	#HY521 \$3,350	#HY522 \$8,920
10 kW 120/240 VAC	#HY523 \$5,912	#HY524 \$16,900

### Stream Engines

*Higher output, longer life, new bronze runner*

Huge improvements over our old Stream Engines—more efficient (+10%), more adjustable to maximize changing ratio of water available to fall, brushless pm alternator, only one moving part (should last 15-20 years without maintenance), water cooled, specify flow and head available. DC voltage up to 400V. With sufficient water, the 4-nozzle model gives more power. It also makes reconfiguring for different seasons easier— instead of changing nozzles, you just close valves.

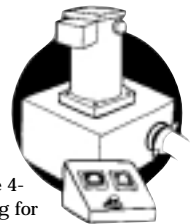

2-Nozzle Stream Engine	#HY1820	\$1,695
4-Nozzle Stream Engine	#HY5951	\$1,884
Replacement Pelton Wheel (up to 1/2" jet)	#HY205	\$100
Replacement Turgo Wheel (up to 1" jet)	#HY204	\$550
High Voltage Option (48V+)	#HY5581	\$150
Extra Nozzle	#HY3213	\$40



### Microset Water Turbines

Expensive but high output: 1-20 kW with water drops between only 3-40 feet and 1.3—380 gallons per second. Designed to supply total electricity needs of 4-6 average homes and larger sizes for up to 17 average homes. The generator also serves as a pump, enabling you to lift water and start a syphon flow through the turbine. That removes the need for elaborate water handling weirs and ducts. Running water can be the most valuable energy asset you have!

#HY4334 \$40,000



The Cuttyhunk windmill used to work this way, with a one-byte output from a TRS-80 controlling 8 binary-weighted 1 kW to 128kW air-cooled resistors with series switches in parallel with the alternator. Water cooled resistors can be simpler and smaller. The control algorithm was simple: if the frequency is too high, increase the binary output count to increase the load; too low, decrease it.

**Q. Is the main reason to do hydro (if you already have a utility company connection) to make money with the "excess"?**

**A.** And reduce air pollution. Water heating seems a good load as well. It takes 2.3 kWh to boil away a gallon of water. The Cuttyhunk people had plans to heat island houses electrically with dynamic load switching as a less wasteful alternative to their desk-sized resistor bank under the windmill.

**Q. When the hydro site is located more than 300 feet from the house, is it better to use a higher voltage, AC system?**

**A.** If there's lots of water power available, and the alternator rpm changes relatively slowly, it seems better to send well-regulated 120/240VAC, with the shunt regulator inside the house, with a lightning arrestor in series, but no batteries or inverters, and use the excess power for heating water, etc. Some water wheels are more controllable than others. A Pelton wheel with no load might run 6 times faster than under full load, but other types might only run 20% faster.

## Water Wheel

A water wheel can power a generator and produce electricity or hook direct for water pumping, grain grinding, or lumber milling. An 11' wheel, generating 2 hp, gives you 1.5 kilowatts but you need lots of water, up to 120 gpm. Available in redwood, cedar, or myrtle. Superb craftsmanship makes these wheels last for decades. Call us with your water specs and we'll help you choose a size and style. Different sizes available—roughly \$310 per diameter foot if smaller than 11', \$50/ft. if larger.



**11' Wheel #HY5160 \$3,100**

## Harris Hydroelectric

200–600' Head, up to 350 watts

The Harris system gives you efficient power from higher falls and flows. It can work with falls up to 600' and flows up to 200 GPM. Depending on your situation, multiple nozzles can give you two to four times as much power from the same fall. Send us details on your fall, water flow, distance from hydro to point of use, and size of pipe if already installed. We will recommend which Harris to use and estimate power output. For 24V add \$50, for low head \$40, for high output \$160.



**1 nozzle #HY100 \$750**  
**2 nozzle #HY101 \$850**  
**4 nozzle #HY102 \$975**

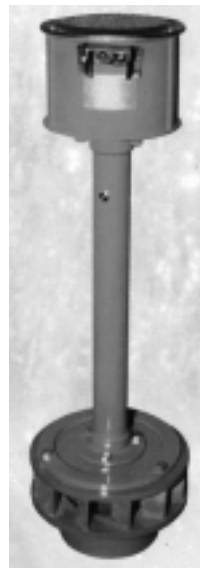

## PowerPal Low-Head Micro-Hydro

Finally, an economical source of electricity from low head rivers and streams. Just 5 feet of head and 550 gallons per minute will produce nearly 250 watts of continuous power! (Or, 650 watts with the medium unit and 1100 GPM, 1000 watts with the large model and 2150 GPM). Simple design, sturdy construction and heavy duty industrial bearings allows you to install it and forget about it! Price includes electronic controls to protect loads from voltage variations. Brushless permanent magnet Alternators produce single phase AC electricity.



**Small #HY8173 \$790**  
**Medium #HY8174 \$1,400**  
**Large #HY8175 Call for price**

## Flexible PVC

Avoid friction loss and a maze of elbows. 1/2" & 3/4" have a 3' bend radius, 1 1/2" a 4' and 2" a 5'.

**1/2" 100' #CT137 \$57**    **1 1/4" 50' #CT135 \$82**  
**3/4" 100' #CT134 \$68**    **1 1/2" 50' #CT140 \$96**  
**1" 50' #CT136 \$60**    **2" 50' #CT141 \$134**

**Special solvent cement #CT144 \$4.50**

## Aquair Submersible Generator

Up to 2.4 kW per day from any fast-running stream

With as little as 13" of running water, you can generate more power than twelve 50+ watt solar panels—8.3 amps, 24 hours a day—from water moving at 9 mph (a slow jog). Uses a low-speed, high-output alternator mounted in an oil-filled housing. Also works great in a tideway or in a slightly different configuration on a boat. Can use a PV charge controller and comes with 15' of wire.

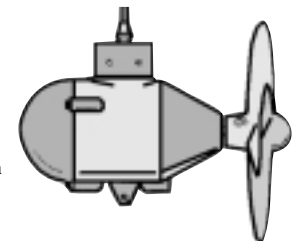

**12V #GN460 \$995**  
**24V #GN3516 \$1,195**  
**Vert. mount #GN2900 \$175**

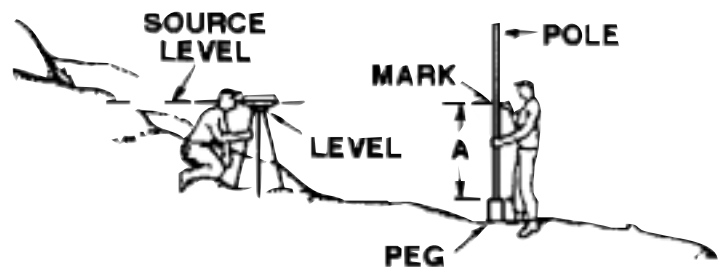

## Custom Hydro Systems

For larger systems, send your specifications

In general, for Hydro systems larger than the ones on this page, we customize components to your site. Tell us the amount of water available (gpm), the fall from source to hydro (psi or head), the length and size of pipe installed if any, distance from hydro to point of use, the maximum amount of power you could use and if you want to sell electricity back to the power company. Free flyer shows how to measure head and flow.



Whisper 12V Air 403 Wind Generator

## Air 403 Wind Generator

*Quieter, more power, less cost per watt*

A great product gets even greater! New blade and alternator give more power at a lower speed, while running more quietly. Light weight and easy installation. Marine models are corrosion protected. The new Industrial model handles the harshest conditions. With improved cooling, stronger blades, and heavier wiring, this unit shrugs off 100 mph sustained winds and arctic cold. 400 peak watts.

<b>12V Air 403</b>	<b>#WG4490</b>	<b>\$595</b>
<b>24V Air 403</b>	<b>#WG4493</b>	<b>\$595</b>
<b>48V Air 403</b>	<b>#WG4494</b>	<b>\$595</b>
<b>Circuit Breaker (24V)</b>	<b>#WG6193</b>	<b>\$24</b>
<b>Rotor Blades (set of 3)</b>	<b>#WG4791</b>	<b>\$96</b>
<b>Stop Switch</b>	<b>#WG3931</b>	<b>\$21</b>
<b>12V Circuit Breaker</b>	<b>#WG3932</b>	<b>\$24</b>

*Towers: Please ask for free price list/spec sheet.*

*"Protect the wiring between your AIR403 and batteries. Interlocked pair of 60 amp breakers also let you work on the generator without danger of shock"*

<b>Shutoff/Circuit Breaker</b>	<b>#WG6307</b>	<b>\$100</b>
--------------------------------	----------------	--------------

## Air X Marine w/Internal Controller

*More power in lower windspeeds*

A great design gets even better. A new internal PWM controller starts battery charging at a low 500 rpm - the regular models require 850 rpm. This means much better energy output in lower windspeeds. An improved blade torque controller reduces flutter and the lower stress design protects electronics from excessive heat build up. 500 watts max output.

<b>12V</b>	<b>#WG8021</b>	<b>\$875</b>
<b>24V</b>	<b>#WG8022</b>	<b>\$875</b>
<b>36V</b>	<b>#WG8023</b>	<b>\$875</b>
<b>48V</b>	<b>#WG8024</b>	<b>\$875</b>

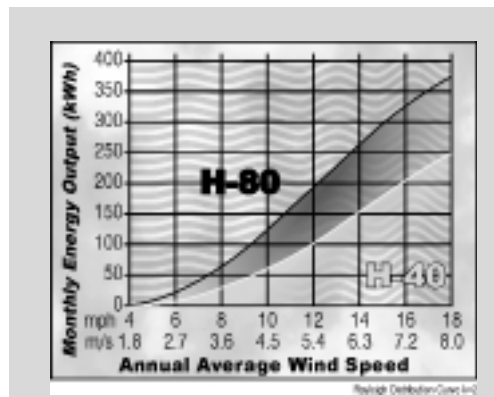

Whisper 80 Wind Generator

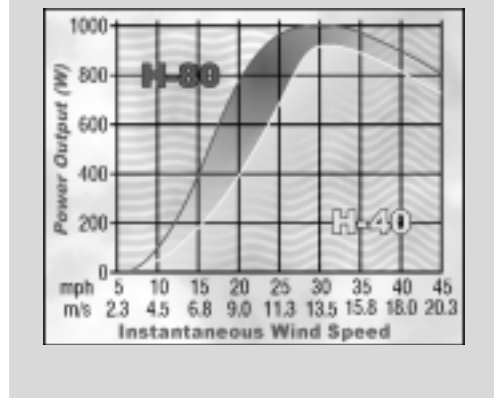

Whisper 175 (48 Volt)

## World Power Wind Generators

### Quantum leap in wind generator system design

World Power started making wind generators in 1978 and now has more years of experience than any other supplier. These systems have both the industry's highest power-to-weight ratio and the lowest cost per watt. They've also introduced more technological innovations and revolutionized wind generator design. New improvements include combining the most efficient, slow speed, PM alternator with a perfectly matched airfoil propeller that assures both maximum output in low winds and the smoothest running in turbulent wind conditions. A unique "angle governor" solves common problems with folding tail and tilt-up governors and greatly extends power output. Easy-to-change output voltage represents another exclusive feature with World Power—you can change your system voltage later and still use the same wind generator (12-48V range). High quality components make these systems last for decades.

A totally new design with a cast aluminum shroud. Only three moving parts -- easy to install, no scheduled maintenance necessary, the lowest cost per watt and highest power-to-weight ratio. A big step forward in wind generator design. Unique tilt-up governing provides good output in high winds and assures survival to hurricane-force winds. All models start charging with 7 mph winds and operate at either 12-24V or 64-240V. 3 new models - 500 watt "Mariner" for boats & small systems, mid-range 1300 for high winds, and high output whisper H8500.

<b>Whisper H40</b>	<b>#WG3687</b>	<b>\$1,690</b>
<b>Whisper 80</b>	<b>#WG501</b>	<b>\$2,790</b>
<b>Whisper H80</b>	<b>#WG3979</b>	<b>\$3,390</b>
<b>Whisper 175</b>	<b>#WG502</b>	<b>\$4,990</b>
<b>Whisper 175 (48 Volt)</b>	<b>#WG5757</b>	<b>\$6,290</b>
<b>Anchors for Whisper H40 Tower (set of 4)</b>	<b>#WG4245</b>	<b>\$220</b>
<b>Whisper Installation Manual</b>	<b>#WG4133</b>	<b>\$10</b>

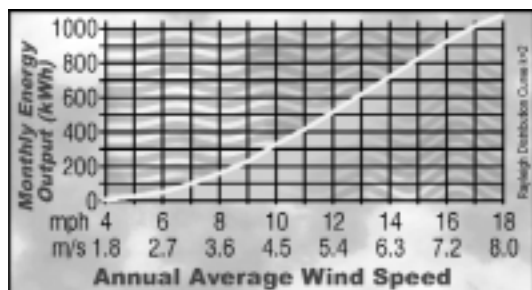

### Tower Kits

Basic tower kit includes tilt base and 2 each extra long threaded couplings with eyelets. Complete tower kit adds 500' of guy wire, wire thimbles, wire clips, base anchors, and "U" guide.

<b>Basic Tower Kit</b>	<b>#WG118</b>	<b>\$275</b>
<b>Complete Tower Kit</b>	<b>#WG119</b>	<b>\$840</b>

### Whisper H40 & 80

Tower Kit		Pipe only	
21'	#WG3303 \$1,200	#WG5871	\$273
42'	#WG3304 \$1,500	#WG5872	\$410
63'	#WG3305 \$1,860	#WG5873	\$683
84'	#WG3306 \$2,460	#WG5874	\$819
105'	#WG3307 \$2,880	#WG5875	\$1,092
126'	#WG3308 \$3,360	#WG5876	\$1,229

Whisper H40 Wind Generator



Whisper H40 Detail



### Whisper 175

Tower Kit		Pipe only	
21'	#WG3339 \$1,800	#WG5877	\$408
42'	#WG3340 \$2,220	#WG5878	\$612
63'	#WG3341 \$2,760	#WG5879	\$1,021
84'	#WG3342 \$3,600	#WG5880	\$1,225
105'	#WG3343 \$4,200	#WG5881	\$1,633
126'	#WG3344 \$4,980	#WG5882	\$1,837

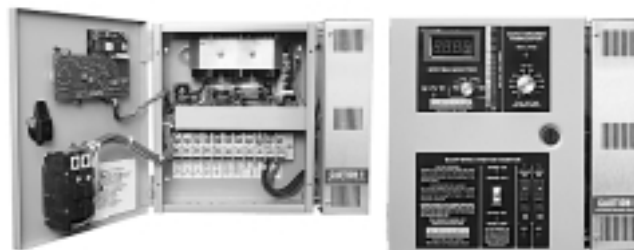

### EZ-Wire System Center

The new World Power EZ-Wire Center makes installing a wind system almost as easy as PV - and actually makes adding solar modules completely simple. It connects together, controls, and monitors the wind generator, solar panels, battery and load. You can stop the wind propeller, shut off the solar charging, and quickly monitor your entire system. Also great for PV-only systems—add wind at any time in the future. A bright, 6-function LED meter reads battery charge in %, volts and amps plus wind, solar and load amps. Just connect your wire and start producing your own, non-polluting energy! Included with World Power Wind Generators but also available separately. All user selectable for 12, 24, 32, 36, or 48V. Larger sizes available.

<b>90 Amp</b>	<b>#WG3688</b>	<b>\$490</b>
<b>90 Amp w/Diversion Regulator</b>	<b>#WG3689</b>	<b>\$590</b>

# WIND GENERATORS

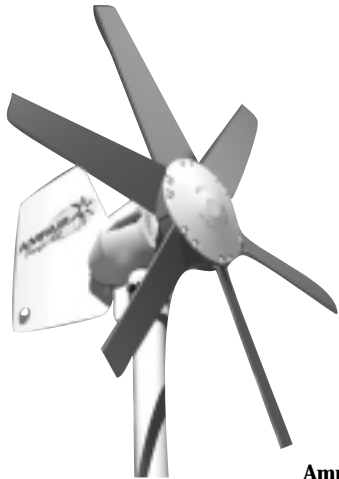

## Ampair Pacific

### No hassle wind power

Small and sleek but extremely rugged, these wind generators produce up to 100 watts continuously. They start charging with only an 8 mph wind and do fine even with wind speeds over 100 mph. No brakes or furling needed, guaranteed at any windspeed. Mount on a roof, boat, or best on a pole. Just connect to a battery and forget! 36" blade diameter, 19" turning radius, 12.6 kg. The Ampair regulator doesn't shunt power but automatically disconnects when the battery bank is full.

<b>Ampair 12V</b>	<b>#WG8394</b>	<b>\$995</b>
<b>Ampair 24V</b>	<b>#WG8395</b>	<b>\$995</b>
<b>12V Regulator</b>	<b>#RG8396</b>	<b>\$149</b>
<b>24V Regulator</b>	<b>#RG8409</b>	<b>\$149</b>

## Bergey XL 24V 1 kW Wind Turbine

Bergey high quality at low, very affordable price. Small, but this generator packs a big punch when it comes to performance and value. The highest efficiency yet achieved in a small wind turbine - 38% lower cost per average energy output than other wind machines in this size (request comparison analysis sheet). Slow turning and quiet, a breakthrough airfoil technology with super-magnet alternator and exclusive low wind speed boost electronics. Ideal for remote homes and rural electrification programs. Includes PowerCenter Controller and five-year warranty. Optional enhanced turbine corrosion protection for marine sites available. The 120 and 230 vac models add optional on-board 500W Sine Wave Inverter to the PowerCenter (not for grid connection).



<b>24 VDC</b>	<b>#WG7585</b>	<b>\$1,495</b>
<b>120V, 60 Hz</b>	<b>#WG7586</b>	<b>\$1,945</b>
<b>230V, 50 Hz</b>	<b>#WG7587</b>	<b>\$1,945</b>

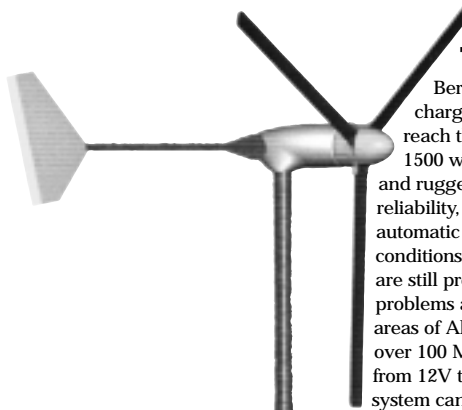

## Bergey Wind Turbines

Bergey generators start charging in 8 MPH winds and reach their maximum output of 1500 watts at 30 MPH. Simple and rugged, designed for high reliability, low maintenance, and automatic operation in all weather conditions, many of these generators are still producing power without problems after years of use in remote areas of Alaska that get winds well over 100 MPH. Versions are available from 12V to 120V DC and a 120V AC system can be used as a utility interconnect. New 850 watt model

includes all the high quality features of the larger sizes.

<b>24V 1500 Watt</b>	<b>#WG300</b>	<b>\$4,700</b>
<b>12V 1500 Watt</b>	<b>#WG301</b>	<b>\$4,900</b>
<b>1500 Watt for Water Pumping</b>	<b>#WG302</b>	<b>\$4,900</b>
<b>Utility Intertie</b>	<b>#WG303</b>	<b>\$19,500</b>

## Air Tower Kits

Specially designed tower kit for the AIR line of wind generators. Takes all the guesswork out of installing an AIR module and provides everything you need except the 1 7/8" steel tubing (easily available from a local chain link fence company). Kit includes: base connector, guy cable set, base staples, cable clamps and thimbles, nuts and bolts. All rated to withstand 120 mph wind when using c-40 pipe!

<b>27 Kit</b>	<b>#WG7444</b>	<b>\$168</b>
<b>45 Kit</b>	<b>#WG7445</b>	<b>\$260</b>

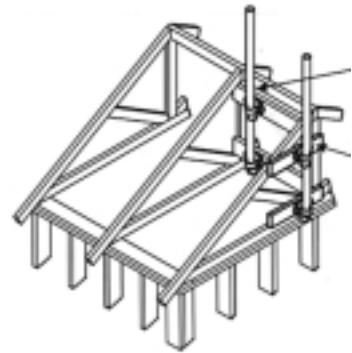

## Tilt-up Tubular Towers

Install these high-quality, affordable towers in just a few hours - they rarely require any concrete work. Includes guy anchors, guy wires and associated hardware, ginpole, and galvanized tubular tower sections (either 6 3.5 or 6 4.5 diameter). Wiring not included.

<b>30 ft.</b>	<b>#WG7588</b>	<b>\$490</b>
<b>42 ft.</b>	<b>#WG7589</b>	<b>\$690</b>
<b>64 ft.</b>	<b>#WG7590</b>	<b>\$990</b>
<b>84 ft.</b>	<b>#WG7591</b>	<b>\$1,190</b>
<b>104 ft.</b>	<b>#WG7592</b>	<b>\$1,490</b>

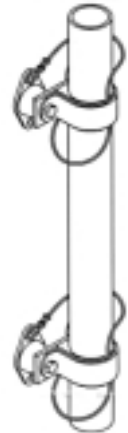

## Individual Roof Mount Kit

No Room for a Tower? Simple roof top tower mount offers easy installation for an AIR wind module. Design includes vibration isolation mounts that reduce mechanically transmitted noise by 80%. Installs on the side of the building or through the roof. Kit includes everything except pole and mounting bolts.

**#WG7447 \$128**

## Small Wind-Electric Systems - A Few Basic Rules

If tree growth at the site is not influenced by the prevailing wind (at least slightly visible flagging), and the wind is not a frequent nuisance, then the energy potential does not justify the investment.

At most locations, wind energy is less consistent than PV, and usually peaks at different times. Wind is best used in a hybrid system with PV.

The generator must be placed higher than all obstructions within 500 feet in all directions, by at least 30 feet plus the blade radius.

For a tower structure, budget 1 to 2 times the cost of the generator. Tower height is crucial for two reasons: (1) Adding tower height is the cheapest way to gain greater and more consistent energy yield. (2) Turbulence is greatly reduced with height. Turbulence is the equivalent of rocks on a highway. Sudden shifts in wind direction cause vibrations and stresses that greatly reduce reliability as well as energy output.

Note: The AIR 404 Wind Module can be mounted onto a building in some cases, because it is very small and specially designed, and is vibration-dampened. Consider this only if the building's roof clears surrounding obstacles by at least 15 feet, and gets high exposure to steady, not gusty, prevailing winds. In some cases, there can be an acceleration of prevailing wind over the rooftop that can add to the wind energy potential. © Windy Dankoff



## Kestrel 1000 Pocket Wind Meter

Track current, average, and max wind speed with measurement units to fit your application- knots, meters per second, Kilometers per hour, miles per hour, feet per minute or beaufort force. The pocket size Kestrel 1000 is built to withstand daily use and the toughest weather conditions. Lightweight, waterproof and floats. Uses replaceable CR2032 coin cell batteries, typical life 400 hours.

#MT6305 \$108

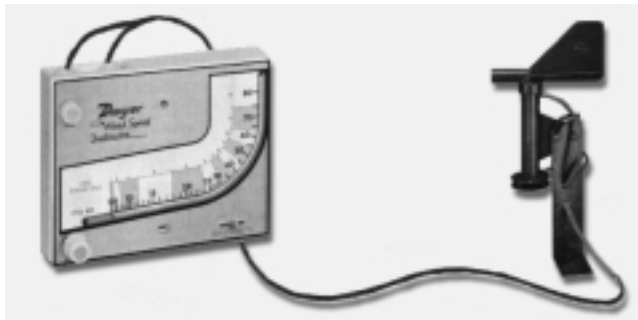

## Wind Speed Indicator

Test how much power you will get from a wind generator before buying one. This accurate indicator includes a pick up vane and 50' of connecting tube. Rent for \$10/week.

#WG400 \$64

## Wind Totalizer

Displays wind speed and total wind up to 10,000 miles (equals 6 months of 23 mph wind). Internal battery operates 10+ years. Includes 3-cup sensor, 60' cable, stub mast, reset switch, instructions. Rent for \$25/week.

#WG401 \$255

## Complete Wind Measurement System

*Complete, ready-to-install wind measurement package.*

Convenient, reliable, and all components compatible and ready to start giving you accurate data. Everything you need! Includes 30 meter TallTower with gin pole, guywires, anchors and all installation hardware; 9200 NRG logger, 32 KByte DataChips, locking steel shelter box enclosure, Maximum #40 anemometers with protective terminal boots, #200P wind direction vanes, sensor stub masts with brackets, sensor side mount booms, #2C and #3C wind speed sensor cables, and a grounding kit with lightning spike and 33 meters of copper grounding wire.

#WG8771 \$3,895

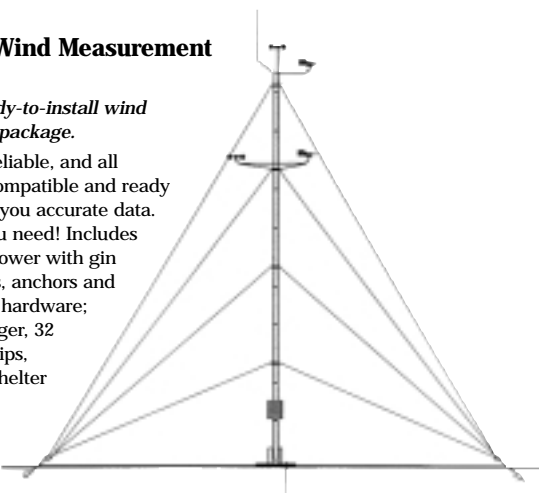

## DC Dual Fuel Generators

Use either propane or gasoline in the same high quality generator. Propane fueled gensets have

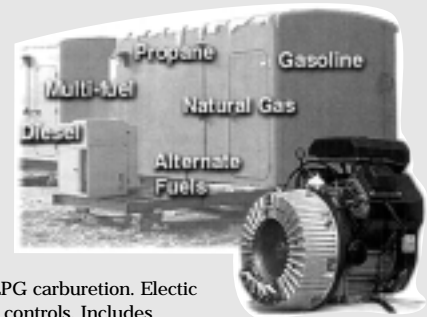

vapor withdraw LPG carburetion. Electric start with manual controls. Includes alternators and engines as listed, model 710 voltage regulator. Generator mounted in an open frame, enclosures available as option. Fuel supply pressure required is 6-8 ounces. Standard voltages 24 or 48V DC, others available by quote request.

<b>2kW - 3.5 kW Kawasaki 290 Engine with Model 3500 Alternator and Air Cooling .....</b>	<b>#GN8672</b>	<b>\$4,132</b>
<b>5kW - 6.5kW Kawasaki 501D Engine with Polar Model 6250 Alternator and Water Cooling .#GN8673</b>		<b>\$6,285</b>
<b>5kW - 6.5kW Kohler Command 18 Engine with Polar Model 6250 Alternator and Air Cooling .....</b>	<b>#GN8674</b>	<b>\$6,432</b>
<b>6kW - 7.5kW Kawasaki 620D Engine with Polar Model 6250 Alternator and Water Cooling .#GN8675</b>		<b>\$6,510</b>
<b>7kW - 10kW Kawasaki 620D Engine with Polar Model 6255 Alternator and Water Cooling .#GN8676</b>		<b>\$7,230</b>

## DC Diesel Generators

Diesel Generators with electric start and manual controls. Includes alternators and engines as listed, model 710 voltage regulator. Generator mounted in an open frame, enclosures available as option. Standard 24 or 48V DC, others available by quote request. Not supplied with fuel tanks.

<b>1kW - 2.5kW Yanmar L40 Engine with 3500 Alternator and Air Cooling .....</b>	<b>#GN8678</b>	<b>\$4,737</b>
<b>2kW - 3.5kW Yanmar L70 Engine with 3500 Alternator and Air Cooling .....</b>	<b>#GN8679</b>	<b>\$5,084</b>
<b>5kW - 6.5kW Lister Petter LPA2 Engine with 6250 Alternator and Air Cooling .....</b>	<b>#GN8681</b>	<b>\$9,490</b>
<b>5kW - 6.5kW Lombardini 903 FOCS Engine with 6250 Alternator and Water Cooling .....</b>	<b>#GN8682</b>	<b>\$7,504</b>
<b>5kW - 7.5kW Lister Petter LPW2 Engine with 6250 Alternator and Water Cooling .....</b>	<b>#GN8683</b>	<b>\$9,890</b>
<b>7kW - 10kW Lombardini 903 FOCS Engine with 6255 Alternator and Water Cooling .....</b>	<b>#GN8684</b>	<b>\$8,715</b>
<b>7kW - 10kW Lister Petter LPW2 Engine with 6255 Alternator and Water Cooling .....</b>	<b>#GN8685</b>	<b>\$10,466</b>

## Advantages of DC over AC Generators

1. A lower cost to install and operate.
2. Considerably smaller in size.
3. Simpler in design, considerably less maintenance, and more reliable.
4. Provide a more stable frequency and voltage.
5. More fuel-efficient - the longest run time with the least amount of fuel.
6. Can be connected in parallel and load share.
7. Provide a current limit control.
8. No reliability-lowering transfer switch required.
9. Deliver the high currents at low voltages required for battery charging and operating DC loads - no battery chargers or power supplies required.
10. In UPS systems, they connect directly to the battery bank so there are fewer problems with on site permitting.

## Windstream Power Systems

### Human Power Generator

A small, dependable human-power generator - perfect for emergencies, power failures, marine and off-grid applications. Pedal or crank by hand to charge 12V batteries or run small appliances. As easy to operate as an ordinary bicycle. Use it to charge your car's dead battery, run emergency back-up lighting, or ask your children to pedal enough power to watch their favorite television programs. Great exercise, energy saving, and experiential learning about power!

#GN8747 \$497

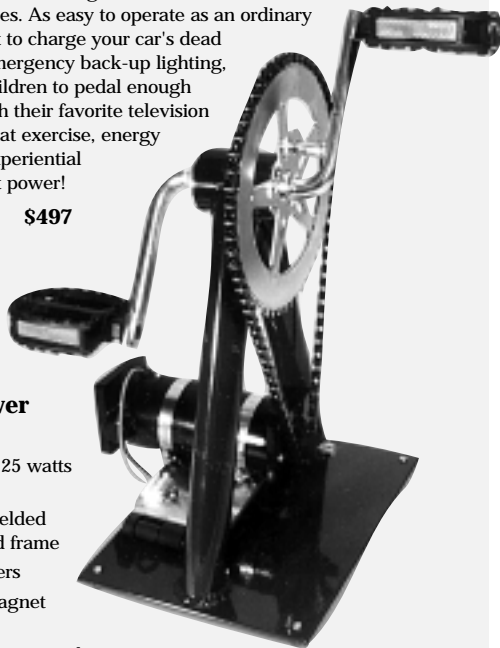

### Human Power Generator

- generate 50-125 watts (1/6th HP)
- heavy duty welded steel base and frame
- rubber bumpers
- permanent magnet DC generator
- rugged one-piece crank arm
- detachable pedals (hand cranks optional)
- two-year warranty

### Low RPM Permanent Magnet DC Generators

Build your own wind generator, steam, hydro, pedal power, animal power, tidal power or new invention with our high quality stainless steel brushless generators. Models rated from 80 to 1000 watts.

<b>4 amp</b>	<b>#GN107</b>	<b>\$198</b>
<b>5 amp</b>	<b>#GN108</b>	<b>\$249</b>
<b>20 amp</b>	<b>#GN109</b>	<b>\$489</b>



### GenMate

Use your generator to recharge your batteries or to start a pump when water is needed—automatically! Set generator start and stop voltage, low battery alarm setpoint, number of crank attempts. For water pumping connect to a float or pressure switch.

#SC566 \$458



### 1 HP Steam Engine

Power from steam, a tried-and-true old technology whose times may come again. Use as a back-up generator for cloudy days without wind or as a sole power source. In cold places and during the winter, use the generated heat for hot water and space heating. You'll still need a boiler—see video below. Max RPM: 700, 1.5" bore, stroke is 2.25". Crankshaft dia.: 5/8", flywheel dia.: 7.5", steam intake & exhaust: .25" pipe. Roller bearing endurance limits: 860 lb. static load cap., 350 lb. @ 600rpm, fully interchangeable parts, sealed bearings throughout, custom valving. RPM's to 1200.

#GN4159 \$1,050

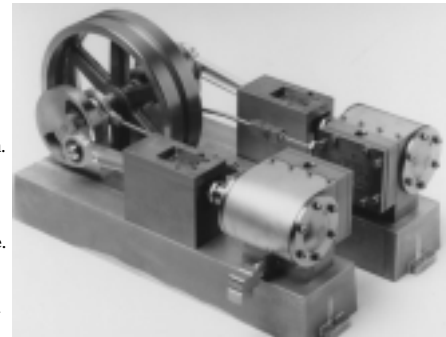

### DC Motors

Use to convert belt driven pumps, power tools, sewing machines and other appliances to DC. For continuous duty, use the same HP as original AC motor. When running less than 10 minutes at a time under full load, you can use half the HP of an AC motor. Four pole, four brush, with ball bearings. Shaft 2" x 5/8" diameter. 1800 RPM, specify 12 or 24V. 1/2V motor matches single solar cell.

<b>1/2 V</b>	<b>#GN623</b>	<b>\$7</b>
<b>1/4 HP</b>	<b>#GN620</b>	<b>\$255</b>
<b>1/2 HP</b>	<b>#GN621</b>	<b>\$272</b>
<b>1 HP</b>	<b>#GN622</b>	<b>\$350</b>

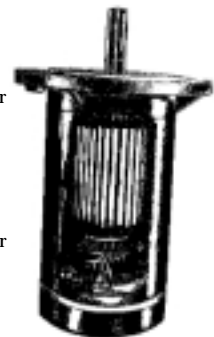

### Shurflo Mini DC Motors

Perfect for applications calling for a miniature DC motor. All models 3" diameter with single 0.3122" diameter "D" shafts. CCW rotation, viewed from shaft. Ball bearings on output shaft end. 2100-2600 no-load RPM.

<b>12V, 0.04 HP</b>	<b>#GN1883</b>	<b>\$75</b>
<b>12V, 0.1 HP</b>	<b>#GN1884</b>	<b>\$80</b>
<b>12V, 0.12 HP</b>	<b>#GN1885</b>	<b>\$140</b>
<b>24V, 0.05 HP</b>	<b>#GN1886</b>	<b>\$75</b>
<b>24V, 0.1 HP</b>	<b>#GN1887</b>	<b>\$90</b>
<b>24V, 0.12 HP</b>	<b>#GN1888</b>	<b>\$140</b>

### Prioritizer

*Don't buy a generator or inverter that's too big!*

Normally, you need to add up all your electrical loads and size an inverter to run them all at the same time. This can lead to spending thousands of dollars for a "worst case" energy demand that may never happen. The prioritizer lets you pick a few large draw, low priority loads (like your freezer) and turns those off temporarily to meet the electrical demand for a high priority appliance (like a water pump). When the water pump turns off, the freezer automatically comes back on. Handles up to six 20 amp circuits (4 primary, 2 secondary). 120/240 vac. Warranted for a full year.

#SC6875 \$1,975



## United Solar Marine Modules

Go anywhere, no matter how remote, without power worry! These modules face the harshest environments and still recharge batteries without hookups or noisy generators. They keep batteries charged while the boat is not in use and you can mount them just about anywhere because they're flexible and conform to any curved surface, even canvas covers and dodgers. Put them where people walk or where things might hit them—they won't break! Toss them on deck and then stow them below. Less than 1/8" thick. If a panel goes over-board, you can get it back—they float. 15.2V (32W 15.6V), 3 year warranty. Second listing has steel rigid frame (not flexible).

### Flexible Frame:

<b>5.5 Watt Panel</b>	<b>8" x 28"</b>	<b>1.5 lbs.</b>	<b>#PV405</b>	<b>\$108</b>
<b>11 Watt Panel</b>	<b>16" x 28"</b>	<b>2.5 lbs.</b>	<b>#PV411</b>	<b>\$175</b>
<b>32 Watt Panel</b>	<b>56" x 17"</b>	<b>5.0 lbs.</b>	<b>#PV3196</b>	<b>\$320</b>

### Rigid Frame:

<b>5.5 Watt Panel</b>	<b>8" x 28"</b>	<b>1.5 lbs.</b>	<b>#PV1268</b>	<b>\$89</b>
<b>11 Watt Panel</b>	<b>16" x 28"</b>	<b>2.5 lbs.</b>	<b>#PV1269</b>	<b>\$169</b>
<b>21 Watt Panel</b>	<b>16" x 51"</b>	<b>8.3 lbs.</b>	<b>#PV1270</b>	<b>\$200</b>
<b>2.8 Watt Panel, 6V</b>	<b>11" x 8"</b>	<b>2 lbs.</b>	<b>#PV5348</b>	<b>\$62</b>

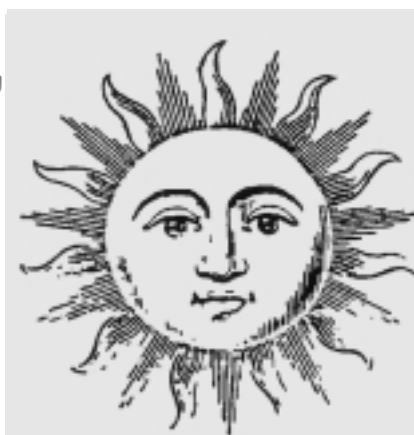
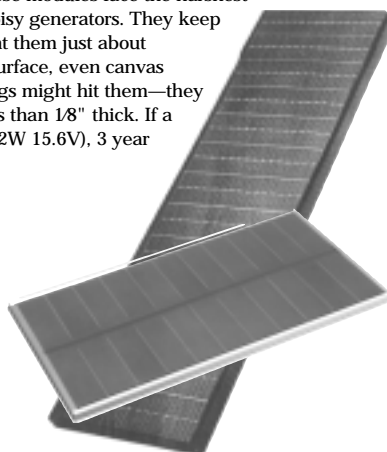

## Photovoltaics

Photovoltaics give you power wherever you need it. Run your home with solar electricity or use it in remote areas for water pumps and tools. Photovoltaics bring electricity to shop or field and can charge your cell phone, radio or flashlight batteries—quietly, neatly and maintenance-free. Solar panels carry on through rain, dust and snow and work 30-40 years. Everyone should have at least one!



## Uni-Solar Modules

- \* Non-breakable
- \* Shadow tolerant
- \* 20% extra power the first year
- \* Best output in low light, overcast

Larger modules at a lower price—and sure to be available. New "triple-junction" solar cells made with 3 layers of semiconductor junctions for higher efficiency – bottom layer absorbs red light, middle green and the top blue. Bypass diodes for shade tolerance. Weather proof junction box made to accept conduit. Full 20-year warranty.

<b>64 watt</b>	<b>4.1A</b>	<b>15.6V</b>	<b>24 lbs.</b>	<b>29" x 53.8"</b>	<b>#PV1797</b>	<b>\$348</b>
<b>42 watt</b>	<b>2.7A</b>	<b>15.6V</b>	<b>21 lbs.</b>	<b>20" x 53.8"</b>	<b>#PV1965</b>	<b>\$260</b>
<b>32 watt</b>	<b>2.05A</b>	<b>15.6V</b>	<b>13 lbs.</b>	<b>15" x 53.8"</b>	<b>#PV1798</b>	<b>\$225</b>

## StayPut Fastening Kits

Non corrosive, weather proof, and almost indestructible mounting kits for Uni-Solar modules. Easy to snap modules on and off but maintains a strong, secure connection. Use with the fused battery cable for complete portability.

### StayPut Canvas Mount Kits

<b>6 piece for 32 watt</b>	<b>#PV2901</b>	<b>\$10</b>
<b>4 piece for 5 and 11 watt modules</b>	<b>#PV2902</b>	<b>\$9.50</b>

### StayPut Hard Mount Kits

<b>6 piece for 32 watt</b>	<b>#PV2903</b>	<b>\$9</b>
<b>4 piece for 5 and 11 watt modules</b>	<b>#PV2904</b>	<b>\$6</b>

### StayPut Canvas Mount Kits

<b>Extension Cord, 10 ft. SAE to SAE connector</b>	<b>#PV2906</b>	<b>\$14</b>
<b>SAE to Male Lighter Plug Adapter</b>	<b>#PV2906</b>	<b>\$11</b>



StayPut Canvas Mount Kits



StayPut Hard Mount Kits

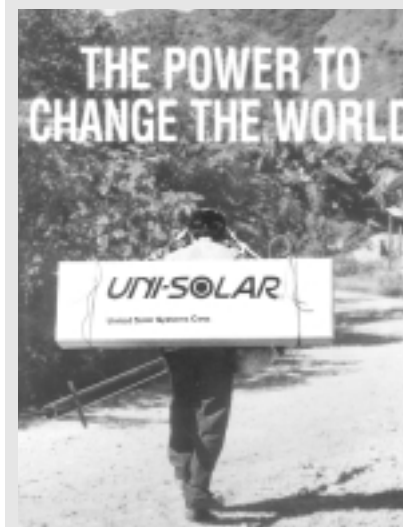

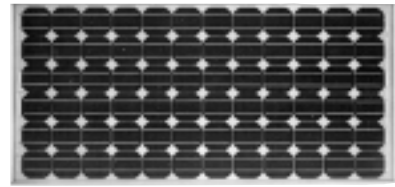

## Siemens High Output Modules

Ideal for grid-connected installations, configured for 24V. Fewer modules needed for an installation and still easy for one person to carry and install. The same high quality, single crystalline PowerMax technology used in other Siemens modules. The junction box has cage clamps with spring tension and knock outs to accommodate 1/2" NPT fittings. 25-year limited warranty.

- #PV8660 130W, 3.95A, 33V, 32" x 64" x 1.6", 32.6 lbs. \$660
- #PV8662 140W, 4.25A, 33V, 32" x 64" x 1.6", 32.6 lbs. \$707
- #PV8663 150W, 4.4A, 34V, 32" x 64" x 1.6", 32.6 lbs. \$777

## Siemens SR Series Modules

Siemens SR series modules use single-crystal silicon cells and have a 25 year pro-rated warranty. On site, you can change from 12 to 6V battery charging if necessary. Junction box accepts conduit, cable, or wire. Built-in bypass diodes for better performance during partial array shading. UL listed.

- SR100 Siemens Solar Module #PV3600 \$579
- SR90 Siemens Solar Module #PV3602 \$504
- SR50 Siemens Solar Module #PV3601 \$329

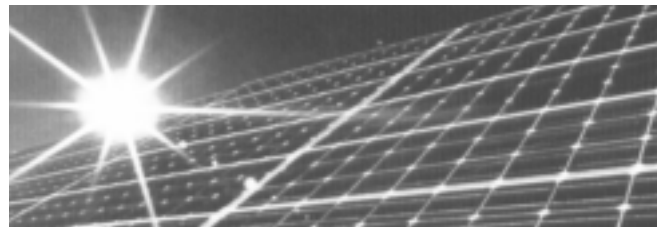

## Siemens Prochargers

*Higher Output, Lower Cost*

Made with new larger, more efficient "Power Max" solar cells. The same single crystal technology as Arco/Siemens M series modules at a much lower price per watt. Frames are lighter weight but quality is good. These single crystal cells outperform semi-crystalline and polycrystalline versions in overcast sky conditions. They generate charging voltages in as little as 5% of "full noon" sunlight. All models equipped with aluminum frames and conduit ready junction boxes. Good for larger systems. All 17V, 10-year warranty.

- #PV184 SP18, 18 watt, 1.1 amp 24.9" x 10.8" \$208
- #PV185 SP36, 36 watt, 2.1 amps 24.9" x 28.8" \$292
- #PV186 SP75, 75 watt, 4.4 amps 47.3" x 20.8" \$455

SR 50

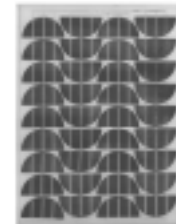
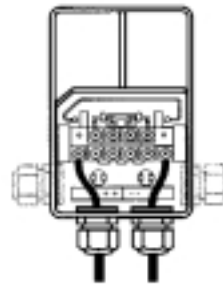

Easy-to-wire junction box

SR 100

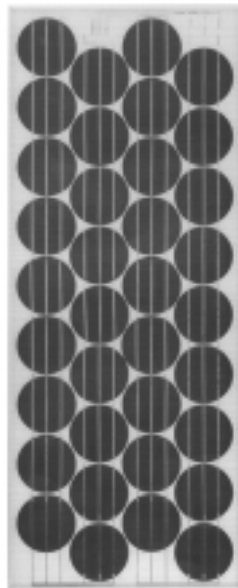
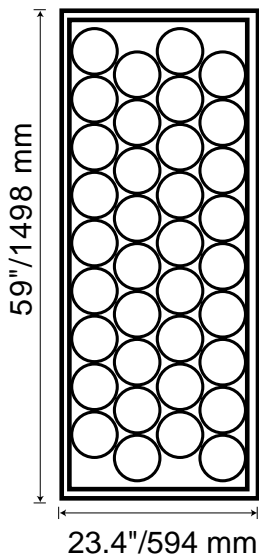

### Siemens Solar Modules Specifications

Model	SR100 (PV3600)	SR90 (PV3602)	SR50 (PV3601)
Watts	100	90	50
Amps	5.9	5.4	2.95
Volts	17.0	17.0	17.0
Size	59 x 23.4 x 1.6	59 x 23.4 x 1.6	30.8 x 23.4 x 1.34
Weight	24	24	12.6
Price	\$560	\$504	\$290

### Siemens Solar Modules Specifications

Model	SM50H (#PV175)	SM46 (#PV165)	SM55 (#PV155)
Watts	48	45	53
Amps	3.0	3.4	3.05
Volts	16.0	14.5	17.4
Size	48 x 13 x 1.4	42.4 x 13 x 1.4	50.9 x 13 x 1.4
Weight	11.6	10.5	12.6
Price	\$381	\$364	\$400
Typical Uses	most common	1-2 panel systems	for hot areas & pumping





### Phoenix 14 watt Solar Modules

Our partner in Kenya has sold over 10,000 of these 14 watt modules every year since 1994. They provide enough power for light, music and some television time. Life is more simple in Africa but even in the most urban city, this panel can find a place - powering a water fountain, a backyard light, a security alarm. Also great for RVs, boats, cabins, or your special experimental project. High quality ISO9001 design, 6 year warranty, unique and easy-to-use wire connection and mounting system. A great panel for a low price. 36.4" L x 12.4" W x 1.14" D, 9.5 lbs.

**PV6828 \$80**

### AstroPower Single Crystal Modules

Manufactured using high efficiency single-crystal solar cells based on silicon wafers recycled from the semiconductor industry—the best wafers money can buy. They give superior performance with very low energy "investment" for the solar cell processing. Large, easy-to-use junction box and strong tempered glass in rugged anodized aluminum frame designed to fit standard trackers and mounting racks. UL listed, 10-year warranty.



#### 75 Watt Single Crystal:

17 volts, 4.4 amps, 20.7" x 47.2" x 1.4", 18.1 lbs. #PV3969 \$419

#### 120 Watt Single Crystal:

16.9 volts, 7.1 amps, 26" x 58.1" x 1.4", 26.1 lbs. #PV3970 \$649

### Astropower

Astropower is the world's largest independent, publically owned manufacturer of PV cells and modules—not a subsidiary of any nuclear, oil and gas, or other large multinational conglomerate. Based on a radically new wafer manufacturing process, APex™ modules combine the cost savings potential promised by thin films with the stability and performance of traditional crystalline silicon products. Continuous sheets of polycrystalline silicon grow at high speed to the exact thickness required, eliminating costly and wasteful ingot sawing. Module efficiency of 8.5% is well above the typical 4% of amorphous silicon modules and close to the 11-12% range typical for single and multi-crystalline silicon. Tested in use around the world since 1994.

### Photowatt Solar Modules

*Huge break-through in price, highest quality*

Just a few months ago, \$4.25/watt was a bench-mark number for high-volume wholesale orders. Now we can offer this as a small-quantity retail price. And these modules are high quality with great features. Wire the junction box for either 12 or 24V output – easier installation in 24V+ systems and you can expand one module at a time. Use with a 24V water pumping system during the summer and then with a 12V home lighting system during the winter. Glass-on-glass construction provides reinforced protection, strength, and reliability under the most exacting climactic conditions of temperature and/or humidity for at least 25 years.

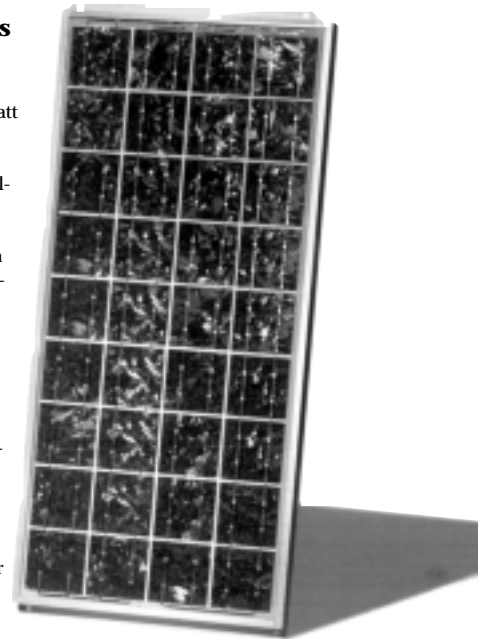

Model	Watts	Volts	Amps	Size (")	Wt (lbs.)	Price	
#PV4848	100	34.4	2.9	52.55 x 26.5	23.2	\$499	
#PV4246	100	Module – UL Listed					\$630
#PV6010	75	17.3	4.6	50.7 x 21.88	28.6	\$370	
#PV7842	75	Module – UL Listed					\$390
#PV4246	49	17.3	3.0	41.2 x 17.07	20.2	\$240	
#PV4847	40	17.0	2.8	41.2 x 17.07	20.2	\$219	
#PV6012	20	16.0	1.38	28.4 x 14.6	11.5	\$208	
#PV6011	10	17.0	0.7	22.9 x 10.3	7.5	\$140	

### Photowatt 49 Watt Solar Modules

Super high quality multi-crystalline cells encapsulated between two sheets of tempered, high transmission glass. Glass on both the front and back ensures optimum performance in extreme climate conditions - both high temperature and high humidity. This also dissipates the heat in hot areas increasing output. Proven through years of utility service, now available for home use. 41" x 17" x 2.4" (1060 x 485 x 60 mm), 20.2 lbs. (9.2 kg), 49 watts, 17.3V, 3.0A. A great bargain!

#PV4246 \$240

100W Module- UL listed #PV7841 \$520

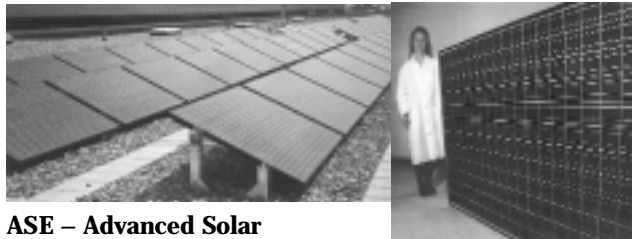

### ASE – Advanced Solar Encapsulant

*For battery based systems*

300 watt large area module means faster installation with fewer parts. Each module has 216 cells and includes bypass diodes after 18 cells in series. Sunlight resistant module interconnects ensure quick and proper series connections. 17.5 Volts Peak, 17.1 Amps Peak. 107 lbs., 50.5" x 74.5" x 2" (46.6 Kg., 1283 x 1892 x 51 mm). 10 year, 10% Limited Warranty.

#PV3554 \$1,890

### Utility Interface Mega-Modules for utility

intertied systems (no batteries) #PV3555 \$1,440

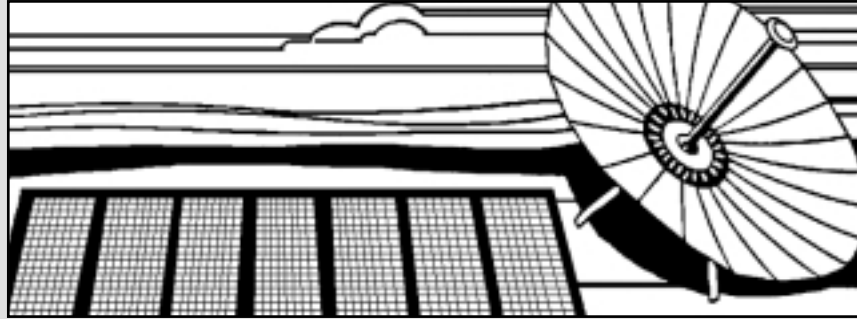

## Solarex Solar Modules

Solarex gives the longest warranty (20 year warranty on MSX Series, 10 year warranty on VLX Series) and now has UL approval. Semi-crystalline cells and dual voltage capability (12 or 6 volt). Large and versatile weatherproof junction box makes installation easy. Made in the US by a US company.

Model	Watts	Volts	Amps	Size	Item #	Price
MSX-64	64	17.6	3.66	44" x 20"	#PV217	\$420
MSX-60	60	17.1	3.5	44" x 20"	#PV211	\$382
MSX-53	53	16.7	3.17	44" x 20"	#PV212	\$357
MSX-50	50	17.1	2.92	37" x 20"	#PV213	\$335
MSX-40	40	17.1	2.34	30" x 20"	#PV215	\$275
MSX-77	77	16.9	4.56	44" x 26"	#PV219	\$475
MSX83	83	17.1	4.85	44" x 24"	#PV1938	\$490
VLX32	32	17.1	1.86	23" x 20"	#PV232	\$232
VLX53	53	17.2	3.08	37" x 20"	#PV1940	\$325
MST43 MV	43	71	0.616	48.4" x 26.3"	#PV5426	\$225

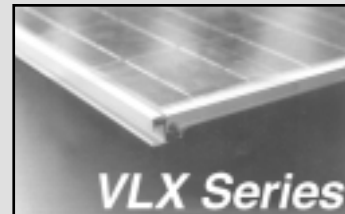
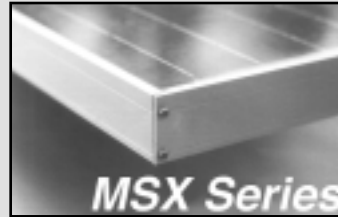

## Solarex Portable Photovoltaics

No need to worry about breakage while traveling with these lightweight solar panels—extremely rugged, sturdy and made without glass (amorphous panels, listed at right, are glass). Only .38" thick, they easily slip into a small space. Great for scientific expeditions, boating, camping, recreational vehicles, and mobile communications. Includes 3-meter, 18-2 output cable with weatherproof jacket.

### Solarex Amorphous (For small 12V charging systems)

Item #	Watts	Amps	Size	Price	Item #	Watts	Amps	Size	Price
#PV205	4.5	.27	10.88" x 10.63"	\$108	#PV201	1.4W	17.5	4.9" x 13"	\$39
#PV210	10	.59	17.63" x 10.63"	\$135	#PV271	2.2W	15	6.8" x 13.8"	\$54
#PV218	18.6	1.13	19.63" x 17.63"	\$226	#PV272	5.1W	17.5	13.7" x 13.7"	\$69
#PV230	30	1.77	24.38" x 19.63"	\$284	#PV273	10.2W	17.5	26.6" x 12.3"	\$109

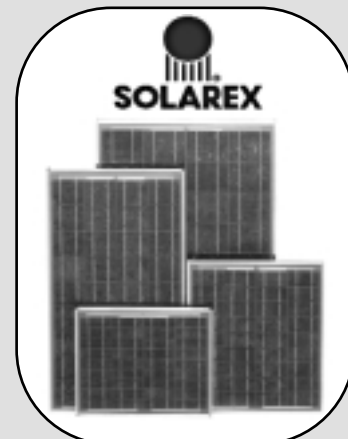
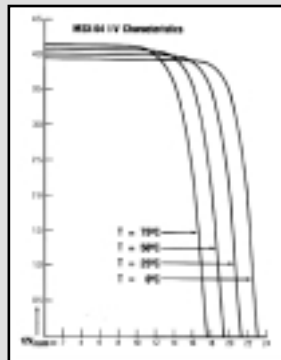
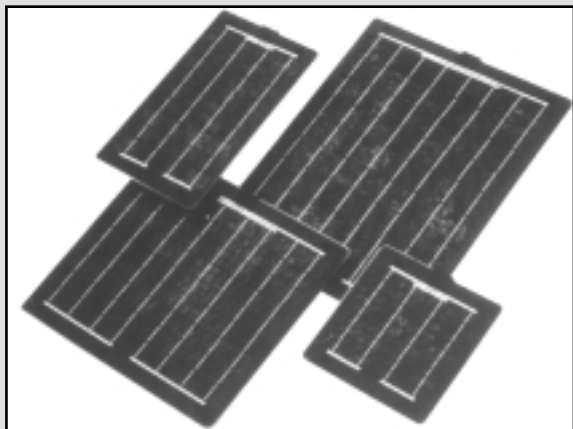

## Mini-Panels

Direct solar operation of portable radios, toys, fans, mini-motors, whatever your imagination dreams up! Same cells as those used in space satellites. Lightweight and durable design encapsulated, temperature and weather resistant.



NASA single crystal (For 6V and under systems):

Model	Milliamps/Volts	Size (")	Price
#PV601	50/6.0V	3 1/4 x 2 1/2	\$26
#PV602	100/3.0V	3 1/4 x 2 1/2	\$24
#PV603	200/1.5V	3 1/4 x 2 1/2	\$19
#PV604	50/8.5V	2 1/8 x 3 3/4 x 3 1/16"	\$34
#PV605	100/8.5V	4 1/8 x 5 1/2 x 3 1/16"	\$48
#PV1537 (LED Panel)	12V	4.6 x 6.75	\$50
#PV6938	225/8.5V		\$49
#PV6939	350/8.5V		\$42
#PV6940	60/18V, 12V only		\$59



## Mega SolarVerter®

Free, portable plug-in power for larger electronic devices—CD players, boom boxes, large radios, cell phones, anything that stays in the same volt and amp range. Each includes a 12' cord. High quality.

For Use With (typical):	Volts/Milliamps	Item #	Price
Portable Radio (Recharges 6 AA or less)	9v/150mA	#CM3771	\$63
...w/Cassette Deck (Recharges 4 "C" cells or less)	6v/220mA	#CM3772	\$59
...w/Cassette Deck & CD Player (Recharges 6 "D" cells or less)	9v/600mA	#CM3773	\$154



## SolarVerter®

Solar radio power

Everything you need to solar-power a portable radio! (2xAAA, AA or C cell.) Kit includes 6 different power plugs to fit most models, adjustable stand and unique adapter for models that don't have a DC input jack. Charges your batteries, great with Freeplay radios. 4V @ 150 mA.

#CM3398 \$36

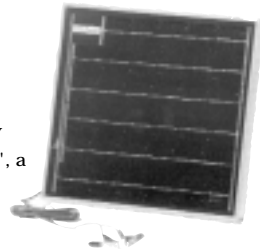

## SolarVerter® 12750

Trickle charge your car, boat or RV battery

Framed panel measures just over 14" x 15", a scant 1" thick. Produces 750 milliamps @ 17 1/2 volts. Convenient alligator clips connect directly to your battery posts.

#CM5106 \$155

## Individual Cells

Use for experiments, science projects or a new invention that will save the world! All cells are .42 volt under load. Round single-crystal. (10-pack)

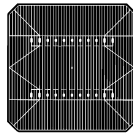

Round	Model #	Price	Rectangular	Model #	Price
.35 Amp	#PV960	\$26	.3 Amp	#PV966	\$20
.40 Amp	#PV961	\$19	.45 Amp	#PV967	\$26
.65 Amp	#PV962	\$26	.6 Amp	#PV968	\$23
1.2 Amp	#PV963	\$43	1.1 Amp	#PV969	\$38
2.2 Amp	#PV965	\$70	1.2 Amp	#PV970	\$50
2.5 Amp	#PV1280	\$110 (tabbed 4" round only)			
3.5 Amp	#PV1281	\$110			

## Super Cells

Model	Milliamps/Volts	Size	Quantity	Price
#PV6941	.10/.5V	2 X 2 cm	10 cells	\$8.75
#PV6943	25	.5 x 2 cm	6 cells	\$9.50
#PV6944	60	1 x 2.5 cm	5 cells	\$9.50
#PV6945	125	2 x 2.5 cm	4 cells	\$10.50
#PV6946	175	3 x 2.5 cm	3 cells	\$10.50
#PV6947	250	2 x 5 cm	2 cells	\$10.50
#PV6948	400	3 x 5 cm	2 cells	\$15
#PV6949	500	4 x 5 cm	2 cells	\$16

## Power Jack Adapter

Solar power for portables without input jacks

Provides a DC input method for portables that don't already have jacks. Easy installation—clips to existing battery terminals. Accepts 5.5mm x 2.1mm power plugs.

#CM3399 \$9

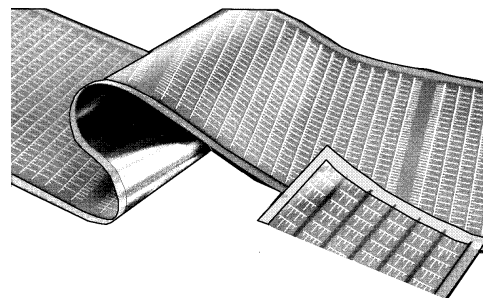

## Thin Film Solar Modules

As thin, light and flexible as a piece of paper!

Amazing to hold these solar modules in your hand—they bend, flop around and

feel as light as a feather. Great for traveling or transporting to a remote location. Unbreakable, encapsulated for outdoor use, solderable tinned copper leads. Polyester models are extremely flexible and lightweight. Tefzel units are more durable for outdoor use. Frequently long wait on Tefzel models (up to 2 months); quick shipping on polyester.

Tefzel

Model	Voltage	Current	Size	Price
#PV650	1.5	50mA	2 x 3.25"	\$9
#PV651	3.0	100mA	3.25 x 5.5"	\$18
#PV652	6.0	50mA	2 x 10.25"	\$18
#PV653	6.0	100mA	3.5" x 11.5"	\$29
#PV654	15.0	50mA	3.5 x 12"	\$31

Polyester

Model	Voltage	Current	Size	Price
#PV658	1.5	50mA	1.35" x 3"	\$5
#PV659	3.0	50mA	1.35" x 4.5"	\$7
#PV660	6.0	50mA	1.35" x 10"	\$12

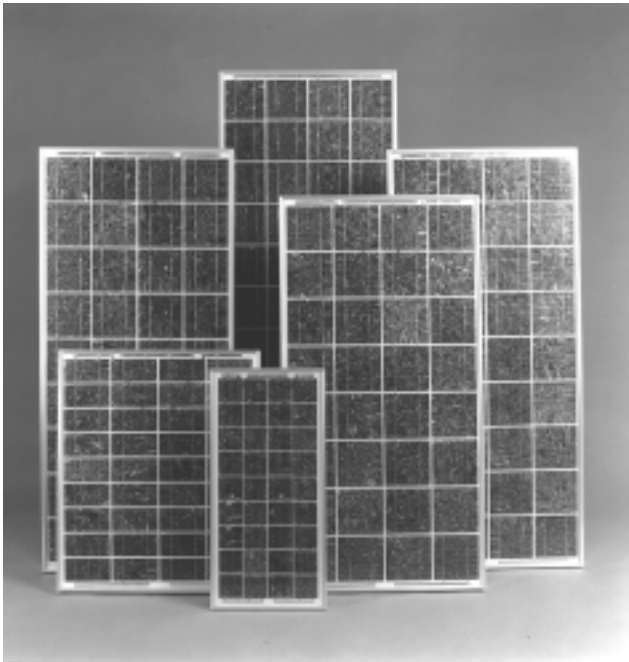

## Kyocera Solar Modules

Kyocera began research in photovoltaics in 1975 and has installed thousands of systems throughout the world since 1978. These multicrystal modules also have an exceptionally high 14% efficiency. The most commonly used 60 watt module is perfect for homes, large systems, and all standard solar electric applications. The self-regulating 35 watt size works best in small systems. Use the 80 and 120 watt sizes for waterpumping, hot area installations and large projects. The 40 watt size powers small applications and maintains batteries. All Kyocera sold in 2-packs. Please add an additional charge for crating single modules.

Model	Watts	Volts	Amps	Size (")	Wt (lbs.)	Price
#PV2898	120	16.9	7.10	56.0 x 25.7	26.2	\$685
#PV2897	80	16.9	4.73	38.4 x 25.7	21.1	\$462
#PV2891	60	16.9	3.55	29.6 x 25.7	17.2	\$355
#PV2890	40	16.9	2.34	20.7 x 25.7	13.2	\$240
#PV2889	35	15.0	2.33	18.5 x 25.7	10.6	\$225

## Quality Assurance

Kyocera multicrystal photovoltaic modules exceed government specifications for the following tests:

- Thermal cycling test
- Thermal shock test
- Thermal/Freezing and high humidity cycling test
- Electrical insulation test
- Hail impact test
- Mechanical, wind and twist loading test
- Salt mist test
- Light and water exposure test
- Field exposure test.

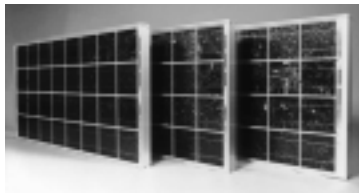

## Dr. Kazuo Inamori



When Kazuo Inamori founded Kyocera in 1959, he dedicated the company to his motto "Respect the Divine and Love People". He describes his most fundamental standard as, "It isn't what is beneficial for Kyocera, or what is good for me as an individual that really matters ... we have to carry out the right decision ... surpassing shallow ideas about profit and loss to the corporation." Contradicting more conventional business philosophy and in spite of Kyocera's humble beginnings, this principle has brought the company to sales of over \$7 billion with more than 37,000 employees. They've built "the world's greenest office building" with 1896 installed solar electric modules that eliminate 107 tons of CO2 emissions.

Other achievements include the installation of more domestic grid tie systems than any other company in the world, the development of a solar electric commuter vehicle, and numerous environmental product improvements like digital cameras that eliminate the use of harmful chemicals, printers that need no disposable cartridges eliminating a huge source of waste and pollution, and ceramic parts for gas turbine engines that make them more efficient and reduce NOx emissions by an astounding 90%. Kyocera is living proof that a company can stay true to its vision, help people and the environment, and still stay successful in the business world. Dr. Inamori recently retired to pursue Zen meditation and study the "deepening of his philosophy and heightening of his soul."

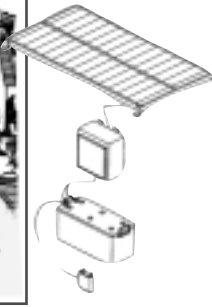
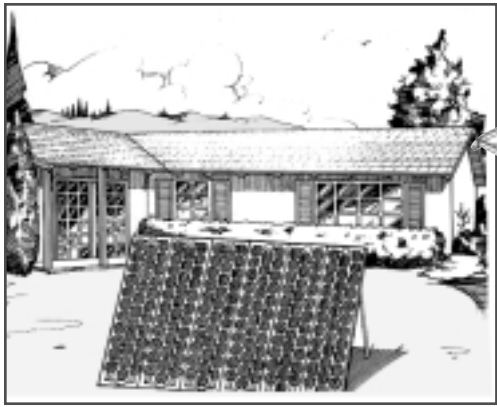

## Home Power Systems

How much does a solar electric system cost? Different people's solar electric systems vary as much as different people's houses or utility bills. The best way to design a system is to list all the appliances and lights you think you will use, find out how much power each uses, and estimate how long per average day you will use them. Multiply the watts each uses by the hours of daily usage. Add the totals to get your daily energy requirement. Our PV Design & Sizing booklet will help you determine this as well as battery bank size and other components. The systems listed here will give you a rough idea about capabilities and corresponding costs.



<b>384 Watt Hour/Day System</b>	<b>#PS3913</b>	<b>\$752</b>
<b>2880 Watt Hour/Day System</b>	<b>#PS3915</b>	<b>\$4,280</b>
<b>5760 Watt Hour/Day System</b>	<b>#PS3916</b>	<b>\$8,400</b>
<b>14,400 Watt Hour/Day System</b>	<b>#PS3917</b>	<b>\$12,500</b>



## Marine Solar Electric Systems

Nowhere is a steady, reliable source of electricity more vital than when traveling on water. In most marine settings, solar power is abundant without obstruction from trees and buildings. Solar electric power for ships and boats is a natural—the most reliable source of electricity on earth matched with the most critical of loads. Send for a free flyer that includes a list of components in these systems.

<b>Battery Maintenance</b>	<b>#PS3921</b>	<b>\$108</b>
<b>32 Watt System</b>	<b>#PS3922</b>	<b>\$409</b>
<b>32 Watt Add-On Kit</b>	<b>#PS3923</b>	<b>\$333</b>
<b>64 Watt System</b>	<b>#PS3924</b>	<b>\$690</b>
<b>64 Watt Add-On Kit</b>	<b>#PS3925</b>	<b>\$584</b>

## 6/12V Modules

Performs at 6 or 12V DC, 1.18 watt. Perfect for a wide variety of small, sealed lead-acid or NiCad battery recharging applications. Compact size: 4.5" x 5.35", 8 oz (13.6 x 11.6 cm / 230 cm.)

**#PV2913 \$42**



## BP Panels

High efficiency, top quality solar modules. British Petroleum makes these to high industry standards. Monocrystalline silicon cells for excellent power density. Stainless steel fasteners, anodized aluminum frames, gasketed junction box for corrosion protection. UL listed. 75 Watt: Peak power voltage 17.1V DC, peak short circuit current 4.6 amps. Dimensions 46.77 x 20.87 x 1.52 inches. 90 watt: Peak power voltage 18.5V DC, peak short circuit current 5.2 amps. 90 watt panel has the same dimensions as the 75 watt, but grid is laser grooved and buried to allow more light to strike the solar cells. Weight 17.64 lbs. EVA encapsulated. 20 year warranty. UL listed.

<b>75W</b>	<b>#PV4053</b>	<b>\$440</b>
<b>90W</b>	<b>#PV6372</b>	<b>\$548</b>
<b>12V 120W</b>	<b>#PV9005</b>	<b>\$650</b>
<b>24V 120W</b>	<b>#PV9006</b>	<b>\$650</b>
<b>24V 150W</b>	<b>#PV9017</b>	<b>\$789</b>

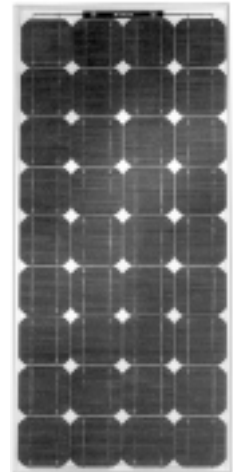

## Solar Trailer

A complete solar system ready to travel. Power a wedding in a beautiful mountain meadow, have your own private party, concert or dance in your favorite hide-away. Run your house, office or business during a power outage. The solution to a myriad of problems for a relief organization effort in an emergency. 800 watts of solar produces up to 5kW/hrs./day. Enough battery storage to run an average house for 2-3 days without sun. The 3kW back-up 100 amp gasoline battery charger takes over in cloudy weather or if you need extra power. We customize smaller or larger versions for specific applications and rent this one.

**#PS6095 \$18,000**

# PACKAGED SYSTEM KITS

## RV Power System

*Escape the Asphalt Campgrounds!*

Our RV power system has everything you need to provide portable, pollution-free power any place you feel like parking. All the fusing, voltage regulation, metering, and plugs you need in one sturdy attractive green metal enclosure. Unbreakable 64 watt solar module means no worries from road debris. Durable corrosion-resistant aluminum mounting rails and maintenance-free, clean Gel battery by Trojan, the best name in solar batteries. 300 watt inverter for your AC needs, three 15 amp DC plugs for 12volt accessories. Need more power? Upgrade by adding another 64 watt solar module #PV1797.

#SC6812

\$1,095

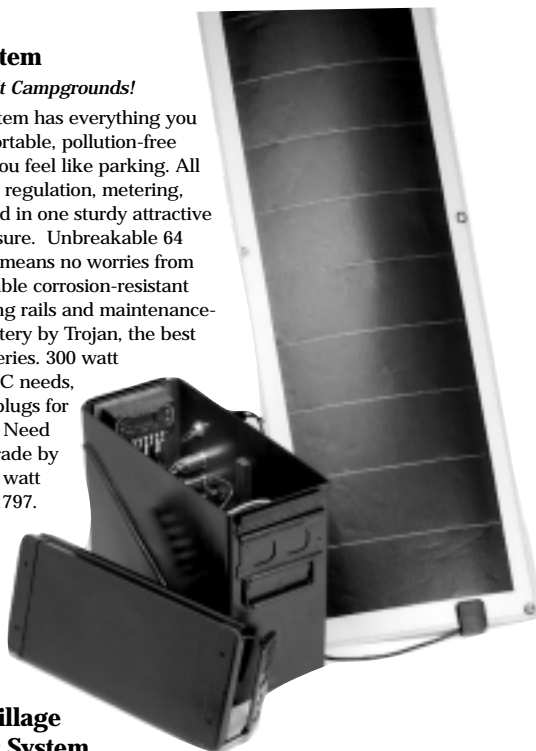

## Sustainable Village Marine Power System

Plug into the Sun! Our Marine power system has everything you need for portable, pollution-free power on land or sea! You can even walk on the 32 watt unbreakable solar module. An innovative mounting system makes installing the panel fast, easy and still simple to remove for "shore leave". Includes a Sustainable Village Power Center enclosure with fusing, regulation, meters plus a maintenance-free Trojan Gel battery, 300 watt inverter for your AC needs, three 15 amp DC plugs for 12 volt accessories. Need more power? Upgrade by adding more Unisolar 32's (PV3196). The controller will handle up to 4 more modules.

#SC6813 \$1,175

## PortaWattz Power Pac

*Take the PortaWattz Power Pac with you wherever you need power.*

The PortaWattz Power Pac is a portable power supply that offers both 12VDC and 120VAC. It features an 18AHr battery, PortaWattz 300 inverter, AC charger, automotive cable set and an easy-to-carry plastic housing. It has a display with recharge indicator, and LEDs that provide quick battery level checks. As a DC power source, the Power Pac can power a cell phone for up to 24 hours, and using the AC inverter, can run a laptop computer for 6 hours or a portable stereo for 16 hours. If connected to a car battery it can run appliances even longer. Replaceable battery is sealed and spill-proof.

#IN6673 \$240



## EN-R-PAK

A different sort of portable generator. En-R-Pak combines photovoltaics with a ruggedly packaged battery/inverter combination (#PS4634 and #PS4635 also include a wind turbine)—a unique, fully integrated electrical power system. Easily connected to your electrical loads, rechargeable either from solar or grid power. Call, write or email for more information about configurations and specifications.

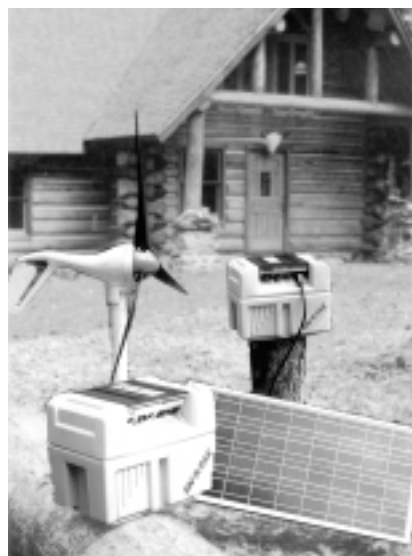

AC/DC, 1-50-Watt Panel	#PS4631	\$1,649
AC/DC, 2-50-Watt Panels	#PS4632	\$2,157
AC/DC, 1-50-Watt Panel, 46" Wind Turbine	#PS4635	\$2,665
DC Only, 1-50 Watt Panel	#PS4587	\$1,165
DC Only, 2-50 Watt Panels	#PS4633	\$1,558
DC Only, 1-50 Watt Panel, 46" Wind Turbine	#PS4634	\$2,725
Extra 50 Watt PV Panel	#PS6698	\$563

## Cabin Power Center

Installing a small PV system? Simplify the process. Our Cabin Power Center puts the necessary components into a single place with plug and play connections. A fused disconnect switch lets you turn off power from the PV array and the battery from the rest of the system. A strong 12" by 12" enclosure houses a 16 amp charge controller to protect the batteries, a terminal strip for quickly connecting all your components, a fused DC circuit with a triple receptacle on the outside of the box (up to 30 amps of total load) and a built-in lightning arrester. An easy-to-read volt and amp meter lets you know what your system's doing.

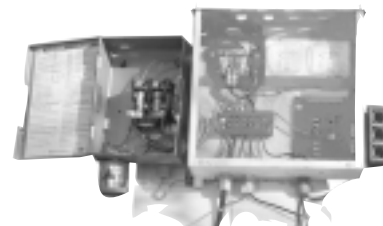

#SC5304 \$450

## Power Zone Portable Power System w/Built-In Inverter

*Power when and where you need it!*

The Power Zone gives you a 200-Watt Uninterrupted Power Source (UPS) for any emergency that comes your way! This portable, rechargeable AC/DC power source provides all the power you need to run 12 volt appliances. The built-in 140 j39 watt power inverter can even run selected 110 volt appliances. It can even start your car and charge its battery! Features automatic emergency light, two 6W fluorescent bulbs for up to 16 hours of lighting, LED indicators for energy reserve/charge status and circuit breaker. Holds charge for four months. Includes booster cables. Convenient size of 12" W x 9.5" H x 4.1" D. 1-year limited warranty.



200W Power System w/Inverter #PS6014 \$200



SC8501 Portable Energy System powering a cellular telephone and laptop computer in a remote construction site

## Ideal for:

- Emergency power
- Disaster relief power
- Remote power
- Camping and boating
- Tool sheds, barns
- Construction sites
- Farms
- Field work

## Sample Usage per Day:

(Watt hours = estimated wattage of appliance x hours of run time)

Appliance	Wattage X	Run Time	= Watt Hours
2 - 15 watt lights	15W x	8 hours (4 hours each)	= 120 Wh
1 Television	50W x	2 hours	= 100 Wh
1 Fan	25W x	4 hours	= 100 Wh

**TOTAL Wh per day usage = 320 Wh**

Estimated operating time: 5 days ( 3 days with sun and 2 days without sun). Estimated recharge time: 4.5 full sun days for a completely discharged system.



## SunWize Portable Energy System

Operate or charges laptop computers, cellular telephones, PDAs and other communication devices with solar power. High performance solar cells encapsulated in polymer for a

lightweight, weather-resistant and highly durable portable energy source. Each system includes an OPTI-Meter, a patented LCD metering system that makes it easy to position the unit in the best sunlight to achieve the highest power. A multi-volt controller regulates power flow while assuring proper voltage. It has an 18 volt supply for laptop computers and an additional output for other electronic devices. Includes the special controller, two computer cables, a multiple four-plug pinwheel cable, a self-storing 10-foot cord and a nylon storage bag. Increase capacity with the system doubler and create a personal, portable network! Solar output 9.9 watts, system output 8.5 watts. 10.5" L x 15.5" W x .56" D, 2.5 lbs.

<b>Portable Energy System</b>	<b>#PS8501</b>	<b>\$530</b>
<b>System Double</b>	<b>#PS8738</b>	<b>\$425</b>

## Portable Energy System Features:

- Lightweight and portable - only weighs 2.5 lbs. including wire and stand
- Weather resistant
- Totally automatic
- Maintenance free - no moving parts
- SunWize™ OPTI-Meter reads light intensity and measures power output
- Built-in stainless steel stand to allow for continuous angle adjustment
- Self-storing 10' flexible, low loss connecting cable
- Standard laptop connector cables included
- Easy grip handle
- Solar module output rate at 9.9 watts; system output rated at 8.5 watts
- Size 10.5 x 15.5 x .56
- Multi-volt controller weighs 4 ounces

## SunWize Portable Power Generators

Transportable battery power - generates AC or DC electricity to run small appliances like lights, small televisions, fans and laptop computers. A 12 amp controller monitors the charge to avoid under and over charging the battery and a meter displays battery charge status. Each unit includes one 120 vac socket and 2 DC sockets for 12V loads up to 90 watts each. Switch the internally mounted inverter on or off to generate AC electricity as needed. The rugged, non-breakable enclosure is corrosion and weather-resistant. Just plug in the included solar module to charge the battery. All three sizes have a 150 watt inverter and the same dimensions, 21" L x 15" W x 12" H. The small one has a 60 Ah battery, the other two 100 Ah.



**With 36 watt PV, 53 lbs. #PS8667 \$1,290**

**With 50 watt PV, 74 lbs. #PS8668 \$1,492**

**With 75 watt PV, 74 lbs. #PSC8669 \$1,690**

## Portable Power Generator Features:

- Completely assembled and factory tested
- Portable and ready to use
- Simple 'plug and go' operation
- External inverter switch (AC model only)
- PV module mounting accessories
- 120VAC socket with outdoor cover (AC model only)
- Internal 150-watt, 120VAC inverter (AC model only)
- Battery meter indicates state-of-charge
- Sockets separately fused
- Corrosion and weather-resistant, rugged, non-breakable enclosure
- Designed for DC charging by solar panels
- 2-DC sockets for 12V loads up to 90W each
- Environmentally friendly

## Uni-Solar® Solar Shingles

Works and looks like a conventional roofing shingle but also produces clean, non-polluting electrical power. Mount on regular roof decking and felt underlay with common roofing nails. They install with consecutive overlapping layers, each shingle fits over the inactive top 7" of the previous one. As sunshine warms them up, a special adhesive bonds the shingles together forming a weather resistant roof covering. The bottom of each shingle has 12" electrical wires that connect below the roof deck. Made from Uni-Solar Triple Junction amorphous silicon cells, they meet shingle wind load tests and include bypass diodes. 10 year warranty to produce not less than 90% of rated power. 17.3 watts, 8.6 volts, 2.0 amps, 1.4 lbs/sq.ft., 12" x 86.4."

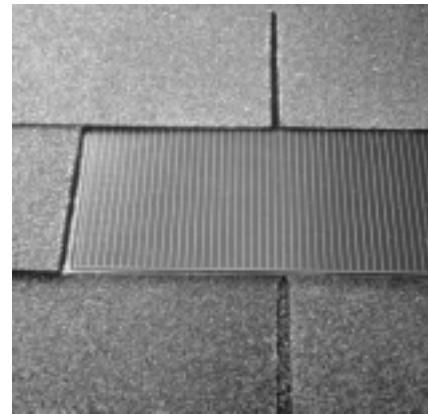
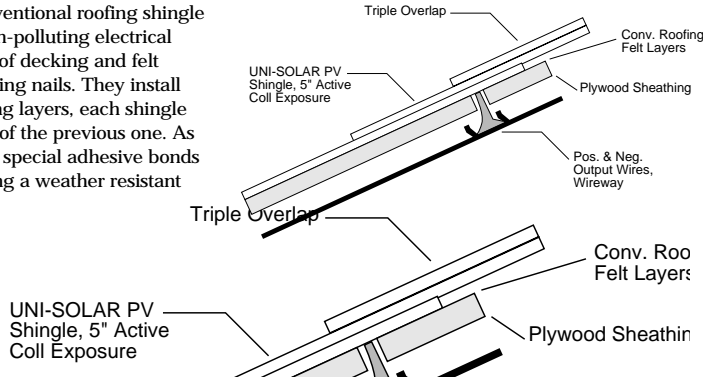

#PV3576 \$160



## Uni-Solar Laminates, 60 watt

*Easy install, low shipping charges, best price per watt*

"Peel-and-stick" photovoltaic solar electric roofing panels - flexible, lightweight and architecturally attractive. And thin-film, amorphous-silicon prove to be the most economical, total solar electric system. 16" wide, comes rolled for less expensive shipping.

60-watt #PV7624 \$298

120-watt #PV7625 \$608

## Standing Seam Roofing Panels

United Solar's Metal Panels combine the appeal of a structural roofing product with the solar electric capabilities of PV. Designed for ease of installation, this solar panel is integrated into the roof following the specifications of conventional standing seam panels. System design and installation are made based on user needs.



60 Watt	Structural Panels	#PV4895	\$366
120 Watt	Structural Panels	#PV4896	\$715
60 Watt	Architectural Panels	#PV4898	\$360
120 Watt	Architectural Panels	#PV4897	\$715

## Solar Power: A Historical Perspective

Isn't it ironic that so many people, politicians, and officials consider solar power a "new", "alternative", "untested" technology—one that still needs more research and testing? Since the earliest days of civilization, people used solar energy. Even cavepeople chose their dwellings to best use the sun. Ancient Greeks, Persians, and Chinese used solar architecture and designed entire cities with solar principles. Romans in the second century B.C. used the sun to heat their public baths.

Hero of Alexandria made a solar pump in the first century A.D. Leonardo da Vinci made plans for industrial applications of solar power in the early 1500's. European scientists made solar ovens in the 1700's. The photovoltaic effect was discovered way back in 1839! In the 1860's and 70's a French inventor made the first solar engine, a solar pump that moved over 500 gallons of water an hour and a device that used the sun to make ice. In 1904 a solar water pump in California steadily did 1,500 GPM. 1904 also saw the first commercial solar power plants. In 1913 Egypt had a 55 HP solar engine pumping 6000 GPM. World War I intervened, however stopping development.

In 1900 over 1600 homes in California used solar water heaters. One company in the 1920's was selling over 1000/year. By 1941 more than half the population of Miami, Florida used solar heated water. The World War II governmental freeze on copper, however, stalled the US solar water industry and rapidly falling gas prices after the war almost completely killed it.

Inexpensive coal and gas prices as well as utility promotions from 1945 to 1968 caused a 500% increase in electricity generation and decreasing interest in solar. Unfortunately this trend continued with little regard for the environmental consequences. Until recognizing the dangers and difficulties with waste disposal, an infatuation with the possibilities of cheap nuclear power further diverted interest and solar research development.

Today, we may need solar power more than at any other time in history. As the developing world rushes towards the "progress" achieved in the west, the negative environmental consequences became more critical. If the rest of the world used as much energy and resources as North America, we would need two extra planets to provide enough resources. Today's US pollution levels from power plants: one billion tons of carbon dioxide, 6 million tons of nitrogen oxides, and over 5 million tons of sulfur oxides going into the atmosphere each year.

Solar Energy's story stretches beyond human recorded history for a reason: In many ways the use of solar power paralleled the success or failure of the civilization. For example, switching from solar architecture to wood heat was a significant contributing factor in the fall of the Roman Empire. Throughout history civilizations have nurtured solar energy to their advantage or ignored it to their peril. Though the question may be the same, given modern population, technology and lifestyle, the consequences of our decision become increasingly critical.



		POLE TOP RACKS																		
		ASTROPOWER			BP SOLAR				KYOCERA				PHOTOWATT				SIEMENS			UNI-SOLAR
# OF MODULES	6105 7105	1106 1206	250/70/75 585/90	SX-50-65	SX75/ 80/85	SX110 120	KC40/50 60/70/80	KC120	PWX500	PWX750	PW1000	SM46/ 50/55	SP70/75	SR50	SR90/100	140/150	US32	US42	US64	
1 Item #	TM7032	TM6463	TM7032	TM7026	TM8544	TM8548	TM6463	TM8546	TM7026	TM7035	TM8545	TM7026	TM7032	TM7032	TM7032	TM8547	TM8544	TM8547	TM6722	
Price	\$106	\$109	\$106	\$103	\$117	\$126	\$109	\$123	\$103	\$113	\$116	\$103	\$106	\$106	\$106	\$112	\$117	\$112	\$119	
2 Item #	TM6464	TM7053	TM6464	TM8549	TM8550	TM8554	TM7053	TM8552	TM7040	TM7048	TM7055	TM6463(a)	TM6464	TM8551	TM8551	TM8555	TM6722(a)	TM8553	TM6722	
Price	\$127	\$139	\$127	\$122	\$136	\$220	\$139	\$153	\$118	\$134	\$146	\$109	\$127	\$133	\$133	\$205	\$119	\$210	\$119	
3 Item #	TM8555	TM7065	TM7059	TM8553	TM8554	TM7048	TM7065	TM7071	-	TM7069	TM6675	TM8549 (a)	TM8555	TM8556	TM8556	TM8558	TM7055(a)	TM7073	TM85	
Price	\$205	\$225	\$205	\$210	\$220	\$255	\$225	\$245	-	\$220	\$235	\$122	\$205	\$215	\$215	\$245	\$146	\$245	\$210	
4 Item #	TM6730	TM7018	TM6730	TM7065	TM7071	TM7027	TM7017	TM7021	TM7065	TM7073	TM7018	TM7053(a)	TM6730	TM8558	TM8558	TM8560	TM7069(a)	TM7025	TM7073	
Price	\$230	\$295	\$230	\$225	\$245	\$345	\$285	\$320	\$225	\$245	\$295	\$139	\$230	\$245	\$245	\$360	\$220	\$320	\$245	
6 Item #	TM8559	TM6141	TM8559	TM7025	TM7027	TM7038	TM6729	TM7034	TM7025	TM7029	TM6141	TM6675(a)	TM8559	TM6137	TM7033	TM7041	-	TM7039	TM7027	
Price	\$335	\$395	\$335	\$320	\$345	\$450	\$385	\$420	\$320	\$350	\$395	\$235	\$335	\$365	\$390	\$575	-	\$455	\$345	
8 Item #	TM8561	TM7043	TM8561	TM6729(a)	TM7034	TM7051	TM7043	TM7044	TM6729(a)	TM7037	TM7043	TM7018(a)	TM8561	TM7039	TM7044	TM8564	-	TM7050	TM7041	
Price	\$410	\$595	\$410	\$385	\$420	\$685	\$595	\$620	\$385	\$425	\$595	\$295	\$410	\$455	\$620	\$720	-	\$660	\$575	
10 Item #	TM7043	TM7054	TM7046	TM7042(a)	TM7044	TM8566	TM7052	TM7057	TM7042(a)	TM7046	TM7054	TM7029(a)	TM7043	TM7050	TM7051	TM8567	-	TM8565	TM7051	
Price	\$595	\$730	\$625	\$475	\$620	\$815	\$705	\$755	\$475	\$625	\$730	\$350	\$595	\$660	\$685	\$845	-	\$790	\$685	
12 Item #	TM8563	TM7063	TM8563	TM7045(a)	TM7051	-	TM7062	TM8567	TM7045(a)	TM7054	TM7063	TM6141(a)	TM8563	TM7060	TM7061	-	-	-	TM8566	
Price	\$695	\$820	\$695	\$600	\$685	-	\$795	\$845	\$600	\$730	\$820	\$395	\$695	\$760	\$785	-	-	-	\$815	
14 Item #	TM8565	-	TM8565	TM7060(a)	TM7061	-	-	-	TM7052 (a)	TM7063	-	TM 7039 (a)	TM8565	-	-	-	-	-	-	
Price	\$790	-	\$790	\$760	\$785	-	-	-	\$705	\$820	-	\$455	\$790	-	-	-	-	-	-	
16 Item #	-	-	-	TM7062(a)	-	-	-	-	TM8565 (a)	-	-	TM7043 (a)	-	-	-	-	-	-	-	
Price	-	-	-	\$795	-	-	-	-	\$790	-	-	\$595	-	-	-	-	-	-	-	

		POLE SIDE RACKS																		
		ASTROPOWER			BP SOLAR				KYOCERA				PHOTOWATT				SIEMENS			UNI-SOLAR
# OF MODULES	6105 7105	1106 1206	250/70/75 585/90	SX-50-65	SX75/ 80/85	SX110/ 120	KC40/50 60/70/80	KC120	PWX500	PW750	PW1000	SM46/ 50/55	SP70/75	SR50	SR90/100	140/150	US32	US42	US64	
1 Item #	TM7010	TM8515	TM7010	TM7009	TM8511	TM8520	TM7012	TM8516	TM8509	TM7011	TM8518	TM8507	TM7010	TM8514	TM8521	TM8508	TM8513	TM8519		
Price	\$106	\$137	\$106	\$103	\$117	\$156	\$109	\$146	\$63	\$113	\$145	\$65	\$106	\$135	\$152	\$73	\$112	\$153		
2 Item #	TM7014	TM7015	TM7014	TM8523	TM8524	TM8532	TM7015	TM8529	TM7013	TM8525	TM8528	TM8517	TM7014	TM8526	TM8533	TM5105	TM7016	TM8531		
Price	\$184	\$225	\$184	\$174	\$184	\$255	\$225	\$245	\$159	\$189	\$235	\$142	\$184	\$220	\$240	\$158	\$235	\$245		
3 Item #	TM8533	TM7022	TM8533	TM7016	TM8532	TM8540	TM7022	TM8537	TM7016	TM8535	-	TM8523(a)	TM8533	TM7020	TM8541	TM8527	TM8539	TM8539		
Price	\$240	\$270	\$240	\$235	\$255	\$310	\$270	\$290	\$235	\$255	-	\$174	\$240	\$250	\$310	\$230	\$300	\$300		
4 Item #	TM8538	TM8542	TM8538	TM7022	TM8537	-	TM8542*	-	TM7022	TM8539	-	TM7015(a)	TM8538	TM8542*	-	TM8534	-	-		
Price	\$280	\$330	\$280	\$270	\$290	-	\$330	-	\$270	\$300	-	\$225	\$280	\$330	-	\$250	-	-		

\*SR50 only

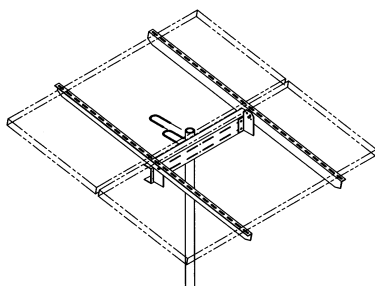

Small Pole Top Series

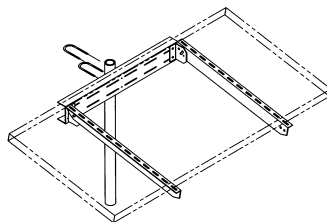

Small Pole Side Series

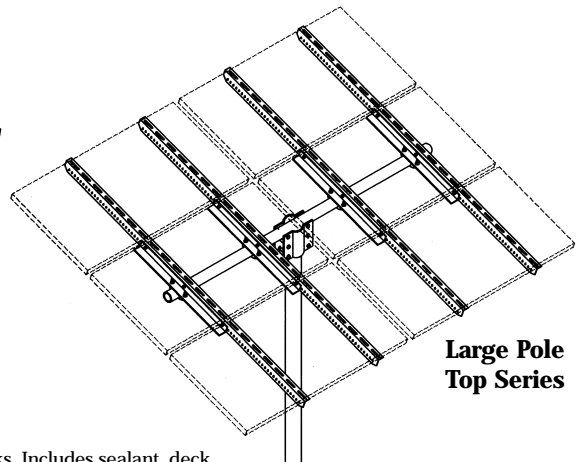

Large Pole Top Series

### PV RoofJacks™

Makes mounting PV modules on pitched asphalt shingle roofs fast and easy without leaks. Includes sealant, deck fasteners, and sealing washers. Use the optional plastic wire guards for chafe-free wire pass-through and mounting pin assemblies to simplify attachment to any framed module. Use the one-sided east/west RoofJacks™ at the east or west end of a row of modules. Standard RoofJacks™ go between adjacent modules.

**Standard** #TM3782 \$26  
**For East/West Mounting** #TM3783 \$26

# PHOTOVOLTAIC MOUNTS



## LOW PROFILE GROUND/ROOF RACKS WITH ADJUSTABLE LEGS (FIXED LEGS AND FLUSH MOUNT ALSO AVAILABLE)

	ASTROPOWER		BP SOLAR			KYOCERA	PHOTOWATT			SIEMENS				UNI-SOLAR
# OF MODULES	6105 7105	1106 1206	250/70/75 585/90	SX50-65 SX75-85	SX110/ 120	KC 40/50/60 60/70/80/120				SM46/ 50/55		SR50/ 90/100	SP130/ 140/150	US42/64
4 Item #	TM8595	TM7310	TM8595	TM7301	TM7316	TM7310	TM7301	TM7304	TM7310	-	TM8595	TM7307	TM8598	TM7316
Price	\$250	\$275	\$250	\$245	\$345	\$275	\$245	\$255	\$275	-	\$250	\$265	\$355	\$345
5 Item #	TM7310	TM7319	TM7313	TM7310	TM8601	TM7319	TM7307	TM7313	TM7319	-	TM7310	TM7316	-	TM8601
Price	\$275	\$365	\$335	\$275	\$395	\$365	\$265	\$335	\$365	-	\$275	\$345	-	\$395
6 Item #	TM8598	TM7325	TM8598	TM7316	-	TM7325	TM7313	TM7319	TM7325	TM7301 (a)	TM8598	TM7322	-	-
Price	\$355	\$405	\$355	\$345	-	\$405	\$335	\$365	\$405	\$245	\$355	\$390	-	-
8 Item #	TM7328	TM8610	TM7328	TM7325	-	TM8610	TM8601	TM7328	TM8610	TM-7310 (a)	TM7328	TM8607	-	-
Price	\$415	\$445	\$415	\$405	-	\$445	\$395	\$415	\$445	\$275	\$415	\$435	-	-
10 Item #	-	-	-	-	-	-	-	-	-	U-LP144ADJ(a)	-	-	-	-
Price	-	-	-	-	-	-	-	-	-	\$380	-	-	-	-
12 Item #	-	-	-	-	-	-	-	-	-	U-LP176ADJ(a)	-	-	-	-
Price	-	-	-	-	-	-	-	-	-	\$415	-	-	-	-

### UniRac Standard in PV Module Racks

Choose from Adjustable Ground Roof, Pole Top or Pole Side Models.  
(Other configurations available by special order. Consult your Sustainable Village representative for details).

### All UniRac feature -

- High corrosion resistance in harsh climates. All aluminum and galvanized steel components. Stainless steel fastener hardware throughout. Never any painted metal parts.
- Universal PV module mounting design. UniRac's unique slotted rail design means fast and easy installations of any and all PV modules.
- Designed for high wind loads. Up to 120 mph on most models.
- Fast and low cost delivery. We ship all UniRacs via UPS within 3 days of your order.



## GROUND/ROOF UNIRACS WITH ADJUSTABLE LEGS (FIXED LEGS AND FLUSH MOUNT ALSO AVAILABLE)

	ASTROPOWER		BP SOLAR			KYOCERA	PHOTOWATT			SIEMENS				UNI-SOLAR
# OF MODULES	6105 7105	1106 1206	250/70/75 585/90	SX50-65 SX75-85	SX110/ 120	KC 35/40/ 60/80/120				SM46/ 50/55		SR50/ 90/100	SP130/ 140/150	US42/64
1 Item #	TM4455	TM4456	TM4455	TM8568	TM8571	TM4456	TM8568	TM4455	TM4456	TM8568	TM4455	TM4455	TM8571	TM8571
Price	\$90	\$95	\$90	\$85	\$100	\$95	\$85	\$90	\$95	\$85	\$90	\$90	\$100	\$100
2 Item #	TM6405	TM5860	TM6405	TM8574	TM6148	TM5860	TM4457	TM6405	TM5860	TM4456 (a)	TM6405	TM8577	TM8580	TM6148
Price	\$130	\$150	\$130	\$120	\$160	\$150	\$110	\$130	\$150	\$95	\$130	\$140	\$165	\$160
3 Item #	TM8580	TM6545	TM8580	TM6148	TM7089	TM6545	TM6148	TM6714	TM6545	TM8574 (a)	TM8580	TM7084	TM5799	TM7089
Price	\$165	\$210	\$165	\$160	\$220	\$210	\$160	\$170	\$210	\$120	\$165	\$185	\$255	\$220
4 Item #	TM8583	TM7094	TM8583	TM6545	TM7100	TM7094	TM6545	TM7089	TM7094	TM5860 (a)	TM8583	TM5799	TM8586	TM7100
Price	\$215	\$265	\$215	\$210	\$340	\$265	\$210	\$220	\$265	\$150	\$215	\$255	\$355	\$340
6 Item #	TM8586	TM7109	TM8586	TM7100	-	TM7109	TM7097	TM7103	TM7109	TM6545 (a)	TM8586	TM7106	-	-
Price	\$355	\$415	\$355	\$340	-	\$415	\$325	\$370	\$415	\$210	\$355	\$385	-	-
8 Item #	-	-	-	TM7109	-	-	TM8589	-	-	TM 7094 (a)	-	-	-	-
Price	-	-	-	\$415	-	-	\$400	-	-	\$265	-	-	-	-
10 Item #	-	-	-	-	-	-	-	-	-	TM 7106 (a)	-	-	-	-
Price	-	-	-	-	-	-	-	-	-	\$340	-	-	-	-



## ADJUSTABLE RV RACKS

	ASTROPOWER		BP SOLAR			KYOCERA	PHOTOWATT			SIEMENS				UNI-SOLAR		
# OF MODULES	6105 7105	1106 1206	250/70/75 585/90	SX75 SX50-65	SX110 80/85	120 60/70/80/120				SM46/ 50/55		SR50/ 90/100	SP130 140/150	US32	US42/64	
1 Item #	TM7179	TM7180	TM7179	TM7178	TM7178	TM7181	TM7180	TM7178	TM7179	TM7180	TM7178	TM7179	TM7179	TM7181	TM7178	TM7181
Price	\$65	\$70	\$65	\$60	\$60	\$75	\$70	\$60	\$65	\$70	\$60	\$65	\$65	\$75	\$60	\$75
2 Item #	TM7186	TM7182	TM7186	TM7184	TM7184	TM8653	TM7182	TM7188	TM7186	TM7182	TM7180(a)	TM7186	TM8652	-	TM7178	TM7181
Price	\$90	\$100	\$90	\$85	\$85	\$110	\$100	\$80	\$90	\$100	\$70	\$90	\$95	-	\$60	\$75



## Solar Trackers

Solar trackers follow the path of the sun. On a clear summer day, PV panels on a tracker make up to 50% more power than panels on a fixed mount. In temperate latitudes, a tracker gives you a yearly averaged 25% power increase. Water pumping systems benefit the most from tracking since trackers increase PV output the most during the summer when more water is needed.

## Zomeworks Universal Trackers

Just 6 trackers, but you can use them for every type and combination of solar modules made! This means quicker shipping time (each one no longer has to be made to order) and lower prices. You can also change module types later and still use your old tracker. Instead of holes, these trackers use a new stainless steel "J Clip" that attaches to the rails. Zomeworks trackers are maintenance free, built to last, and easy to install. A change in a liquid's temperature causes the panels to move. No drive motors, gears, or pistons mean not much to wear out. 10 year warranty.

Type	Size	Maximum # Modules					
ASE	50 DG	3	6	10	12	14	18
	300 DG	1	2	2	4	4	6
Astropower	1106/1206	2	4	6	8	10	12
	6105/7105	3	6	8	10	12	14
BP	590/275	3	6	8	10	12	14
Helios	75W	3	6	10	12	14	18
Kyocera	80/120W	2	4	6	8	10	12
	51W	3	6	8	10	14	18
Photowatt	49W	2	4	6	8	10	12
	95W	2	4	6	8	10	12
Siemens	90/100W	2	4	6	8	10	12
	75W	3	6	8	10	12	14
Solarex	SM55/50H	4	8	12	16	20	24
	SR50	2	4	6	8	10	12
Unisolar	77/80/83W	2	4	6	8	10	12
	53/60/64W	3	6	8	10	12	16
Pole size	42/64W	2	4	4	6	8	10
	32W	4	8	10	12	16	20
Code #		2.5"	4"	6"	6"	6"	6"
		#TM3855	#TM3856	#TM3872	#TM3873	#TM3874	#TM3875
		\$490	\$860	\$1,235	\$1,360	\$1,295	\$1,850

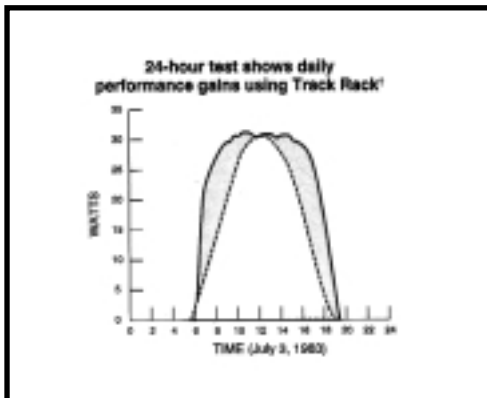
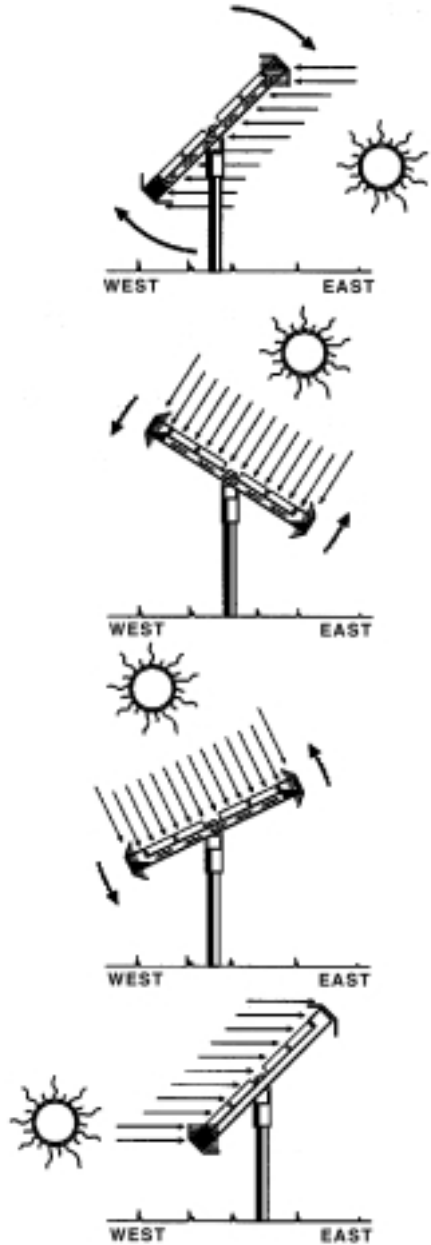

12-month test records improvement in average daily output (watt-hours) using Track Rack!

	Adjustable Elevation Angle		Fixed Elevation Angle	
	Tracking	Fixed	Tracking	Fixed
July 1983	270	207	242	184
August	263	204	252	195
September	219	179	219	178
October	209	172	204	172
November	226	196	215	185
December	183	160	168	149
January 1984	193	167	177	155
February	255	207	244	197
March	271	211	265	209
April	304	224	296	219
May	288	217	267	200
June	250	194	225	172
<b>ANNUAL DAILY AVERAGE</b>	<b>244</b>	<b>195</b>	<b>231</b>	<b>185</b>

# LAPTOP BATTERY CHARGERS

## "The Professional" Solar Charger - 13 Watts

This solar charging station is convenient to use with over 300 portable computers, anywhere there is daylight.

- It runs and charges many other portable devices, such as cellular phones, cam corders, radio equipment, etc.
- The Professional delivers at its peak 13 watts of power, while being lightweight and small enough to fit inside your computer carrier.
- It recharges the internal battery of your computer or portable device, and is also capable of running an external charger for your batteries.
- Standard 8' (3.05 meters) cord allows you to sit in the shade while your computer is charged by the sun.
- Full one-year warranty and 30-day money-back guarantee.



#BC1285 \$348

## Economy Notebook Chargers

Four basic models that will work for almost every laptop. If the brand you have isn't listed here, look on the AC adapter cube. It should give the output voltage required and the plug polarity. We can also customize a solar panel for you. "Y" cords will power both computer and printer. Also great for powering/recharging portable radios, cassette players, boom boxes, etc. Includes 6' cord.



**For Macintosh Powerbook 100-series (not 190) & others up to 8V.**  
8" x 10", 5 watts, includes plug #BC151 \$125

**For BondWell 200, Toshiba 1000, Tandy, 8V-11V**  
10" x 10", 7 watts, includes plug #BC152 \$155

**For Toshiba T-1910, 14 - 18V Laptops**  
15" x 10", 12 watts, includes plug #BC154 \$180

**For Small HP Inkjet Printer**  
"Y" cord - use w/ 7+ watt panels #BC155 \$15

**For 11 - 15V Laptops**  
13" x 10", 10 watts, includes plug #BC153 \$159

**For 18V Laptops, Windbook 486, Toshiba T1900s**  
15" x 10", 12 watts, includes plug #BC160 \$188

**For up to 24V Packard Bell & Mac**  
13" x 10", 10 watts, includes plug #BC159 \$215

## Solar Cell Phone Charger

Small, light, and foldable allowing the cell phone battery to remain fully charged while outside. Folded dimensions only 5" x 2.75" x .5". Includes 4' cord and fold-out leg for a good solar angle. High quality 5.5 v or 9V AstroPower ceramic PV module produces 1.2 watts. The trick is matching your cell phone adapter to the cord. Send us the brand, model number, and battery voltage and we'll include the correct plug. This takes a little longer though, please allow 2-3 weeks.



#PV8450 \$55

## The Expedition Solar Charger - 22 Watts

This "Expedition grade" solar charger delivers at its peak 22 Watts of power and runs the most "power-hungry" portable computers.

- This is the ultimate solar charger and runs and recharges power coolers, charging systems for RV's, and practically all laptops.
- The Expedition is a multipurpose charger that allows you to stay mobile while connected using the sun's free energy.

#BC5278 \$464

## Power Plant Notebook Battery

*Don't let time run out!*

Extend your laptop run time up to 8 hours, cellular phone up to 40 hours of talk time, camcorders for up



to 10 hours. All with a small, slim portable battery pack just .86" thick and 10" x 7.2" weighing 3.9 lbs. Recharge with included 120 VAC adapter or optional 12V DC charger or solar module.

#RB3797 \$215

## Laptop Flight Adapter

*Plug your laptop into an airplane's power socket*

Just attach your DC auto plug to this adapter and you can use the EmPower socket common on the armrest in airplanes to power and/or recharge your laptop. 9.5" L, 1.5 oz

#SC8181 \$12.85



## Smart Adapter

Accessories are available to recharge from your automobile battery. Our SmartAdapter, which allows you to recharge many different computers or devices with the swap of a cord is sold separately.

*Specify model of computer to be used with upon ordering. Not all portable computers are supported.*

#PV5625 \$79

## Sun Catcher Mobile Power



### Sun Catcher Sport and Executive

*Ultimate mobility and unlimited power.*

If you rely on mobile equipment, this will give you more peace of mind. Small but powerful solar charger only measures 8.25" X 5" and weighs less than a pound! Great for cell/mobile phones, PDA's, GPS, games, digital music players and more. Includes DC power cord and a battery power backup for uninterrupted power.

**Sport (Ballistic Nylon), blue or green #CM7451 \$109**  
**Executive (Leather), black #CM7452 \$119**

### SolarVerter® 12600 For Cell Phones

*Plug into the sun and keep talking*

Any cell phone or device that plugs into a car's cigarette lighter can now run from sunshine. Foldable solar panels produce 111/2 volts @ 600 milliamps. Charge your phone's battery or operate directly from solar electricity. Folds into a compact package the size of a standard sheet of paper and 3/12" thick. Convenient pouch allows easy storage of your cell phone with the SolarVerter®.

**#CM5107 \$250**



### PEPower CD Battery

*Rechargeable battery pack for portable CD players*

All day music! Portable CD players consume AA batteries at an amazing rate—both expensive and a nuisance when you're caught without back-ups. The PEPower runs over 5 times longer than AA batteries. Use your CD player all day, all night, or both! Recharge with your CD player's AC or 12V DC adapter over 500 times—you could replace over 5,000 AA batteries with one PEPower CD Battery! The size of a CD jewel case, it works for all players that use two AA batteries and retains 97%+ of the charge for over a month.

**#RB3652 \$37**



### Aladdin Hand-Powered Generator

*Recharge a cell phone, batteries, play radios, always have light*

The world's first and only hand held and operated, regulated generator. A smart super chip optimizes instant battery charging just by squeezing - cellular phones, CB radios, rescue lights, rechargeable CD players, radios, tape players, DVD units, radar units and just about anything with rechargeable batteries. A white LED attachment fits on for use as a flashlight. Bright enough to see from two miles away, just a few squeezes gives several minutes of light - it doesn't stop when you do like the Forever Flashlights! Includes a universal cigarette lighter (auto type) connector for connection to all cellular phones. 2 minutes squeezing equals 20 minutes talk time. Never worry about a dead cell phone battery again! 5.3" x 1.65" x 0.98" 3.7 oz. Optional leather carrying case has three compartments so you can keep the generator, attachments, and a cell phone all together.



**Hand-Powered Generator #BC7986 \$64**  
**Carrying Case #BC8005 \$11**

### Power Booster

*Solarize your cellular phone!*

Continually charge your cellular phone. If you use your system for 10 minutes every hour or less, you'll never run out of power while the sun is shining! Triples standby time and increases talk time up to 100%. Costs only a little more than an original battery but greatly extends battery life. Completely discharged batteries recharge fully in 4 hours but can be used in as little as 60 minutes. Customizable for almost any cell phone. Fully compatible with conventional cell phone battery chargers too—no tools or modifications required.

**Power Booster 8000 – for Motorola Flip-Phone: #CM1477 \$39**  
**Power Booster 8500 – for Startac Flip-Phone: #CM4378 \$39**  
**Power Booster 9700 – for 5100–6100 Series Nokia Cell Phone #CM5405 \$39**  
**Power Booster 9600 – for 2120–2160 Series Nokia Cell Phone #CM5782 \$39**



*"I'd like you to know that your business almost seems just a dream here in this concrete and fossil fuel jungle next to the trash heap in okc. Really, thanks for being real."*

—Onyx

# DRY CELL BATTERY CHARGERS

## The Best, Biggest & Fastest Solar Nicad Charger

Charge a large number of batteries quickly. The small size (5 watt) holds four C, four D and either four or eight AA batteries. (You need to fill one or both holders). It will charge four D's in 1 day and eight in 2 days. The large size (10 watt) holds eight D, six C, eight AA, and two 9V batteries. It can charge eight D's in 1 day. Includes external cord with RCA plug. Both sizes will also run radios and small appliances. Special order customized versions for unique applications (e.g. all AA, all 9V, half C, half D, etc.). Handcrafted in the U.S.



- |   |                |              |
|---|----------------|--------------|
| <b>5 Watt Charger</b>                                   | <b>#BC101</b>  | <b>\$129</b> |
| <b>5 Watt Charger w/4-C, 4-D, 8-AA Batteries</b>        | <b>#BC6022</b> | <b>\$215</b> |
| <b>10 Watt Charger</b>                                  | <b>#BC102</b>  | <b>\$190</b> |
| <b>10 Watt Charger w/6-C, 8-D, 8-AA, 2-9V Batteries</b> | <b>#BC6023</b> | <b>\$369</b> |

## Mini Battery Chargers

*Fast chargers for AAA, AA, C & D batteries*

These battery chargers really work—in just one day of sun they fully recharge two C or D batteries or four AAA or AA. Our new models use the highest efficiency NASA solar cells and an LED indicator light to confirm charging. AA, C, or D model 200 mA, AAA, AA 100 mA.



- |                                 |               |             |
|---------------------------------|---------------|-------------|
| <b>For one 9V</b>               | <b>#BC166</b> | <b>\$30</b> |
| <b>For two AA, C, or D</b>      | <b>#BC333</b> | <b>\$42</b> |
| <b>For up to four AA or AAA</b> | <b>#BC334</b> | <b>\$42</b> |

## Button Battery Charger

Revitalize used mercury batteries with solar power. Pays for itself quickly—saves the expensive batteries used in cameras, alarms, hearing aids, watches, test instruments, computer games, calculators, remote controls. Includes handy suction cup for hanging in a sunny window.

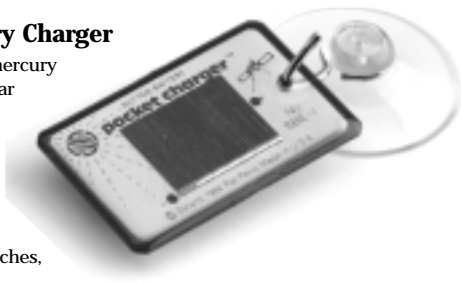

**#BC300 \$21**

## Multiple Battery Charger

Switch back and forth for 3, 6, 9 or 12V mobile phones, toys, radios, and games - or recharge AA and 9 volt batteries. Output ratings are correspondingly 200/100/50/30 mA. Includes barrel plug, mini-alligator clips and a 4-way jack with the most common plug types. An LED indicator light shows and confirms charging.



**#PV8431 \$36**

## BatterySAVER PowerPack

The solar charger of all solar chargers! A true portable power center for lightweight power applications when you're on the go! From running your Walkman without batteries on the beach to recharging your cellular phone in the middle of nowhere, this product is a true lifesaver for people who need portable power but can't connect to mains power when

they need it. Charges up to 4 AA nicads in as little as 12 hours of direct sunlight, with storage capacity for 4 additional batteries. 6V/12V switchable, power socket to plug in 12V accessories (cell phones, computers), cigarette lighter connector to help maintain your vehicle's 6V or 12V battery. Multi-jack to run various small electronics (portable radios, CD players, etc.), alligator clamps for 6V gel cell battery charging and built-in carry handle. Tilting solar panel maximizes sunlight exposure. Lightweight and weather resistant.

- |                               |                |             |
|-------------------------------|----------------|-------------|
| <b>BatterySAVER PowerPack</b> | <b>#BC5337</b> | <b>\$40</b> |
| <b>BatterySAVER AA TRAVEL</b> | <b>#BC5338</b> | <b>\$20</b> |



## Sunwatt Solar Charger

Any place you find yourself, you can still keep your flashlight batteries charged. In one day of full sun, this solar flashlight battery charger can recharge up to 6 AA nicad batteries. In 2 days it can charge 2 Ds and 3 Cs at the same time. Cases made from recycled plastic by Penobscot Indians in U.S. 2V, .25A.

**#BC100 \$32**



## Toxic Battery Breakdown

Disposable batteries account for 130,000 annual tons of solid waste that leach toxic heavy metals like mercury, nickel, lithium and magnesium into groundwater and soil. That's why rechargeable batteries and battery-free solar devices are better. In addition, to saving over 90% of the costs of disposable batteries during their lifetime, they save the resources used to make disposables and prevent the pollution caused when those batteries are thrown away.



**Use This . . . Instead of this!**

## Rechargeable Nickel Metal Hydride Dry Cells

Each year Americans throw away over 2 billion flashlight and toy batteries. In a city of 500,000 people this means almost 9000 pounds of mercury entering our air, earth, and water. Batteries corroding in landfills also leak silver, lead, nickel, and cadmium—all dangerous toxins. NiMH's on the other hand, have no harmful effects for the environment! Using NiCad rechargeable batteries translates into great financial saving and a fraction of the toxic, discarded batteries in our landfills. On the downside though, Nicads contain cadmium, one of the most toxic heavy metals. We believe the future of rechargeable batteries belong to Nickel Metal Hydride (NiMH) technology. They on average last 6000 hours and keep 80% of their charge at -20 degrees (lead acid batteries only maintain 20% and NiCad 40%). You can reuse these NiMH batteries longer than NiCads, they don't have the NiCad "memory effect", and though they initially cost a little more, over a period of time they yield even bigger savings. They don't run out of power as fast as NiCads but faster than alkaline "throw-away" batteries—it's good to have a second set charging while using your first. Always store batteries in a cool place when not in use.



## NiMH Universal Cordless Phone Batteries

All the advantages of NiMH battery technology for your cordless phone. (No toxic heavy metals to worry about, no memory effect, better performance) And one of just three sizes will fit any cordless phone. Each pack includes all available connectors allowing them to fit every cordless phone (per pack size). Each pack has 3 high quality AA NiMH cells - the standard and hardcase 1100 mAh, the shortcase 600 mAh.

<b>Standard</b>	<b>#RB7693</b>	<b>\$14</b>
<b>Short AA</b>	<b>#RB7694</b>	<b>\$14</b>
<b>Hardcase</b>	<b>#RB7695</b>	<b>\$14</b>

## Battery Tester

Test AAA, AA, C, D, 6V, 9V, 12V or button batteries—alkaline, zinc-carbon, or NiCad. No power required.

**#BC3065 \$7**

*"Thank-you for the wonderful edition . . . It is a marvelous way of serving the developing world, by providing them power through appropriate technology and through more appropriate knowledge."*

*- R. Rajaiah, India*

## NIMH Batteries

*Huge price decrease!*

Nickel metal hydride batteries - the best choice. Big improvement over nicads that contain toxic cadmium and only recharge about half as many times. Longer service, higher capacity (+ 25%) and virtually no negative environmental impact when they finally wear out.

<b>AAA</b>	<b>#RB7710</b>	<b>\$2</b>
<b>AA</b>	<b>#RB7709</b>	<b>\$2</b>
<b>C</b>	<b>#RB7708</b>	<b>\$5</b>
<b>D</b>	<b>#RB7707</b>	<b>\$6</b>

## Harding Battery Packs with AA/AAA Charger

*Standard Kit*

16 Hour Overnight Charger and 4 standard 1300mAh AA NIMH batteries.

**#BC6395 \$25**

*Deluxe Kits*

8 Hour Overnight Charger and 4 AA 1300mAh NIMH batteries.

**#BC6444 \$35**

8 Hour Overnight Charger and 4 AAA 550mAh NIMH batteries

**#BC6633 \$40**

*Premium Gold Kit*

8 Hour Overnight Charger and 4 AA 1500mAh NIMH batteries.

**#BC6448 \$40**

# BATTERY CHARGERS

## Powersonic Nicads

Designed for industrial applications, Powersonic Nicads have higher capacities and longer life than Panasonic and other brands commonly found in stores. Heavy plates permit high discharge rates and stable performance over a wide range of temperatures. In a cool place, these batteries will keep over 60% of their energy for more than 8 months.



AAA	180 mAh	#RB104	\$2.75
AA	850 mAh	#RB100	\$6
C	2000 mAh	#RB101	\$10
D	4000 mAh	#RB102	\$2.75
9V	110 mAh	#RB105	\$5

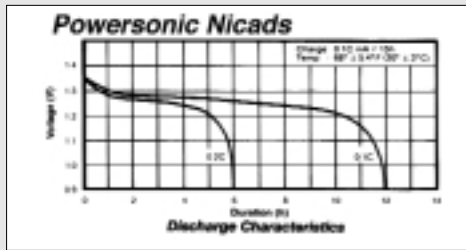

## Battery Adapter

Handy, adaptable sleeve for using AA or C batteries in something that normally uses a D size. Just insert a AA or take the inner cylinder out and use a C battery. Includes 2 sets.

#BA5509 \$7



## Battery Tester

Test AAA, AA, C, D, 6V, 9V, 12V or button batteries—alkaline, zinc-carbon, or NiCad. No power required.

#BC3065 \$7

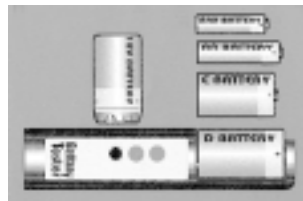

## Solargizer Solar Chargers

Solargizers don't just maintain and clean batteries but also recharge them. It monitors your battery and automatically recharges as needed, turns itself off to avoid over-charging, and at the same time extends battery life with a high frequency pulsation.

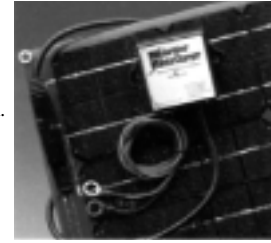

2W, 1/4 Amp Solar Charger #PV4182 \$200

5W, 1/2 Amp Solar Charger #PV4183 \$320

10W, 1 Amp Solar Charger #PV4184 \$590

## 24V Solargizer

The same improved battery performance, efficiency, and long life as the 12V Solargizer—now for 24V systems. Ideal for construction equipment, farm implements, and tractor-trailers. Each unit has 38" lug attachments, 25 feet of wire, and a special mounting kit. 10 year warranty.



#PV4046 \$184

## PowerPulse

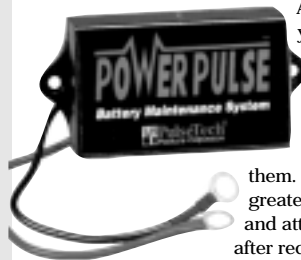

A Solargizer without the PV module—provide your own power source. Designed for use with deep cycle batteries in RV's, golf carts, even industrial applications like airport ground support equipment, electric vehicles, and more. Lead acid batteries will provide peak performance and reliability when you need them. They extend battery service life and provide greater charge acceptance so batteries recharge faster and attain optimum voltage. Cool down takes less time after recharging too. Also available for 36, 48, and 72V systems.

12V #PV4802 \$70

24V #PV4609 \$119

## Industrial 12V Solargizer

For batteries subjected to greater power demands. The solar panel is virtually indestructible and incorporates the finest quality single grown photovoltaic cell available. The entire unit is weatherproof and easy to install. It's also available with two and three-wire



versions for use on parallel battery systems. (While the multiple-wire versions are installation options, using one single-wire unit per 12 volt battery is still the most effective means of eliminating sulfation buildup and related problems. Never use multiple-wire units on a set of batteries in parallel with an isolator. In that case, use one single-wire unit per battery only!) The circuit box includes an LED light that indicates the circuit is energized and the unit is working. This system handles up to 12 volts and is ideal for heavily used or stored vehicles, cars, boats, construction and farm equipment, motorcycles, commercial vehicles, and deep-cycle products.

#PV4610 (w/ring terminals) \$85

#PV4687 (w/alligator clips) \$85



## Power Quality – Sine Wave vs. “Modified Sine Wave”

Some inverters produce “cleaner” power than others. Simply stated, “sine wave” is clean; anything else is dirty. A sine wave has a naturally smooth geometry, like the track of a swinging pendulum. It is the ideal form of AC power. The utility grid produces sine wave power in its generators and (normally) delivers it to the customer relatively free of distortion. A sine wave inverter can deliver cleaner, more stable power than most grid connections.

How clean is a “sine wave”? The manufacturer may use the terms “pure” or “true” to imply a low degree of distortion. The facts are included in the inverter’s specifications. Total harmonic distortion (THD) lower than 6 percent should satisfy normal home requirements. Look for less than 3 percent if you have unusually critical electronics, as in a recording studio for example.



**Back-Up Power**

Other specs are important too. RMS voltage regulation keeps your lights steady. It should be plus or minus 5 percent or less. Peak voltage (Vp) regulation needs to be plus or minus 10 percent or less.

A “modified sine wave” inverter is less expensive, but it produces a distorted square waveform that resembles the track of a pendulum being slammed back and forth by hammers. In truth, it isn’t a sine wave at all and more accurately called “modified square wave.”

The “modified sine wave” has detrimental effects on many electrical loads. It reduces the energy efficiency of motors and transformers by 10 to 20 percent. The wasted energy causes abnormal heat which reduces the reliability and longevity of motors and transformers and other devices, including some appliances and computers. The choppy waveform confuses some digital timing devices.

About 5 percent of household appliances simply won’t work on modified sine wave power at all. A buzz will be heard from the speakers of nearly every audio device. An annoying buzz will also be emitted by some fluorescent lights, ceiling fans, and transformers. Some microwave ovens buzz or produce less heat. TVs and computers often show rolling lines on the screen. Surge protectors may overheat and should not be used.



**On the Job**

In recent years, true sine wave inverters have become more efficient and more affordable. Some people compromise by using a modified wave inverter to run their larger power tools or other occasional heavy loads, and a small sine wave inverter to run their smaller, more frequent, and more sensitive loads. Modified wave inverters in renewable energy systems have started fading into history.

### Efficiency

It is not possible to convert power without losing some of it, mainly in the form of heat. Efficiency is the ratio of power out to power in, expressed as a percentage. If the efficiency is 90 percent, 10 percent of the power is lost in the inverter. The efficiency of an inverter varies with the load. Typically, it will be highest at about two thirds of the inverter’s capacity. This is called its “peak efficiency.” The inverter requires some power just to run itself, so the efficiency of a large inverter will be low when running very small loads.

In a typical home, there are many hours of the day when the electrical load is very low. Under these conditions, an inverter’s efficiency may be around 50 percent or less. The full story is told by a graph of efficiency vs. load, as published by the inverter manufacturer. This is called the “efficiency curve.” Read these curves carefully. Some manufacturers cheat by starting the curve at 100 watts or so, not at zero!

Because the efficiency varies with load, don’t assume that an inverter with 93 percent peak efficiency is better than one with 85 percent peak efficiency. If the 85 percent efficient unit is more efficient at low power levels, it may waste less energy through the course of a typical day.

## Inductive Loads and Surge Capacity

Some loads absorb the AC wave’s energy with a time delay (like towing a car with a rubber strap). These are called inductive loads. Motors are the most severely inductive loads.



**Off the Grid**

They are found in well pumps, washing machines, refrigerators, power tools, etc. TVs and microwave ovens are also inductive loads. Like motors, they draw a surge of power when they start.

If an inverter cannot efficiently feed an inductive load, it may simply shut down instead of starting the device. If the inverter’s surge capacity is marginal, its output voltage will dip during the surge. This can cause a dimming of the lights in the house, and will sometimes crash a computer.

Any weakness in the battery and cabling to the inverter will further limit its ability to start a motor. A battery bank that is undersized, in poor condition, or has corroded connections, can be a weak link in the power chain. The inverter cables and the battery interconnect cables must be big, and I mean REALLY big, perhaps the size of a large thumb! The spike of DC current through these cables is many hundreds of amps at the instant of motor starting. Follow the inverter’s instruction manual when sizing the cables, or you’ll cheat yourself. Coat battery connections with a protective coating to reduce corrosion.

### Idle Power

Idle power is the consumption of the inverter when it is on, but no loads are running. It is “wasted” power, so if you expect the inverter to be on for many hours during which there is very little load (as in most residential situations), you want this to be as low as possible. Typical idle power ranges from 15 watts to 50 watts for a home-size inverter. An inverter’s spec sheet may describe the inverter’s “idle current” in amps. To get watts, just multiply the amps times the DC voltage of the system.



**At Sea**

## Low Switching Frequency vs. High Switching Frequency

Manufacturers build inverters in two ways. Each creates differences in weight, cost, surge capacity, idle power, and noise.

A low switching frequency inverter is big and heavy (about 20 pounds per kilowatt), and more expensive. It has the high surge capacity (four to eight times the continuous capacity) needed to start large motors. Beware of the acoustical buzz that low switching frequency inverters make. If you install one near a living space, you may be unhappy with the noise.

A high switching frequency inverter is much smaller and lighter (generally about 5 pounds per kilowatt), and also less expensive. It has less surge capacity, typically about two times the continuous capacity. It produces little or no audible noise. The idle power is generally higher. If the inverter is



**On the Road**

oversized for motor starting, its idle power will be higher yet, and may be prohibitive. Most homes that have a well pump or other motors greater than 1 HP will find a low switching frequency inverter to be more economical.

Both types of inverter have their virtues. Some people “divide and conquer” by splitting their loads and using two inverters. This adds a measure of redundancy. If one ever fails, the other one can serve as backup.

© Windy Dankoff, Dankoff Solar Products, Inc.

## Inverters

Inverters take DC power from a battery bank and change it into AC (regular household) power. This allows you to run almost any AC appliance from your solar, hydro, wind, or generator charged batteries. With an inverter you can run small equipment like computers and TVs or large appliances like washing machines and water pumps. An inverter will power AC tools if you're building a house away from power lines and then run appliances when the house is finished. On boats and ships an inverter provides power while saving space and fuel. In RVs and motor homes an inverter can eliminate the need to carry a bulky generator. You can also use an inverter to protect yourself against power blackouts. Even if the power goes out in an AC home, an inverter system will insure water, lights, and other necessities.

### Trace SW-Series II Sine Wave Inverters

As Trace Engineering's top-of-the-line models, the SW-series deliver sine wave power without compromise. Motorized equipment runs without a hitch, and audio equipment, light fixtures and power transformers don't buzz. High efficiency, high surge ability and low idle current draw. Series II improvements include easier programming, enhanced reliability, easier AC wiring and conduit access, and improved generator start capability which handles more generator types. Stack (two) 120 VAC inverters for 220/240 systems. Used as battery chargers, they offer 3-stage, temperature-compensated charging for maximum battery life. High efficiency design ensures better charging, even with smaller generators. When connected to a generator or power grid, the SW inverter synchronizes it's waveform to that of the AC source, making it an ideal choice for grid-intertie (requires approval of your local utility,) or backup systems. 120 VAC, 60Hz output unless otherwise noted. Powder-coated steel enclosure rated for indoor use. 2-year warranty. 52D x 68.6W x 39.5H (centimeters). ETL certified to UL standards will make an electrical inspector in the U.S. happy.



<b>SW4024: 24V input, 4000VA output</b>	<b>#IN111</b>	<b>\$3,495</b>
<b>SW4048: 48V input, 4000VA output</b>	<b>#IN1788</b>	<b>\$3,210</b>
<b>SW5548 48V input, 5500 VA output</b>	<b>#IN1381</b>	<b>\$3,770</b>

### 220VAC, 50Hz SW-Series Inverters

Same great features as above, but with 220V, 50Hz output.

<b>SW3024E: 24V input, 3300VA output</b>	<b>#IN165</b>	<b>\$3,495</b>
<b>SW3048E: 48V input, 3300VA output</b>	<b>#IN1789</b>	<b>\$3,495</b>
<b>SW4024W: 24V input, 4000VA output (2-wire 220VAC only)</b>	<b>#IN113</b>	<b>\$3,145</b>

Many other models for International use are available; contact us with your requirements.

### Accessories for SW-Series

<b>Outdoor enclosure for (1) inverter. ETL listed</b>	<b>#IN1790</b>	<b>\$371</b>
<b>25' LCD remote control</b>	<b>#IN175</b>	<b>\$295</b>
<b>50' LCD remote control</b>	<b>#IN176</b>	<b>\$329</b>
<b>Stacking interface</b>	<b>#IN181</b>	<b>\$39</b>
<b>AC or DC Conduit Box</b>	<b>#IN178</b>	<b>\$90</b>
<b>Battery Temperature Sensor for Charger</b>	<b>#IN169</b>	<b>\$30</b>

### Trace PS2512 Sine wave Inverter

Whatever your application—stand-alone alternative energy, utility tie, generator support, or backup power—Trace's new PS Series Sine wave Inverter/Charger will provide unparalleled value at a great price! The PS Series has a continuous output of up to 2.5 kW; UL, cUL and CE certification or compliance. PS Series models are available with 12 or 24 VDC input and 120 VAC/60 Hz or 230 VAC/50 Hz output. PS inverters include a powerful 3-stage battery charger which is designed to recharge most types of batteries in as short a time as possible. The PS series is simple to operate, all inverter and battery charger functions are factory preset—this inverter is ready to produce power and recharge batteries. A simple four-position switch controls basic user functions—Off, Search, On and Battery Charger Only. Specify voltage.

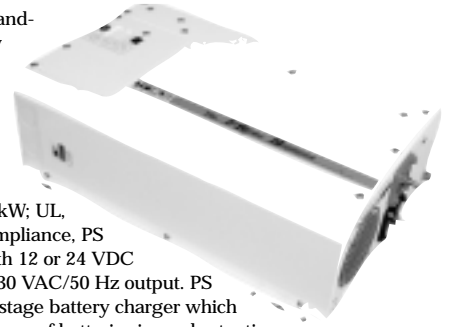

<b>12V</b>	<b>#IN7112</b>	<b>\$2,165</b>
<b>24V</b>	<b>#IN7232</b>	<b>\$2,165</b>

### Comparison Chart

Model	Continuous Power	AC Outlet Voltage/Frequency	Max Charger Amps	Certifications
#PS2512	2500 Watts	120 VAC 60 Hz	100 amps	UL, cUL
#PS2512	2500 Watts	120 VAC 60 Hz	50 amps	UL, cUL
#SW2512	2500 Watts	120 VAC 60 Hz	150 amps	ETL, cETL
#SW4024	4000 Watts	120 VAC 60 Hz	120 amps	ETL, cETL
#SW4048	4000 Watts	120 VAC 60 Hz	60 amps	ETL, cETL
#SW5548	5500 Watts	120 VAC 60 Hz	75 amps	ETL, cETL
#SW2612E	2600 Watts	230 VAC 50 Hz	150 amps	CE
#SW3024E	3100 Watts	230 VAC 50 Hz	100 amps	CE
#SW3048E	3100 Watts	230 VAC 50 Hz	50 amps	CE
#SW4548E	4500 Watts	230 VAC 50 Hz	60 amps	CE

### Glossary of Inverter Terms

- Absorption Charge** - The second stage of three-stage battery charging. Voltage remains constant and current tapers as internal battery resistance increases during charging. (Ensures complete charging).
- Bulk Charge** - The first stage of three-stage battery charging. Current is sent to batteries at the maximum rate they will accept while voltage rises to full charge level.
- Float Charge** - The third stage of three-stage battery charging. After batteries reach full charge, charging voltage is reduced to a lower level to reduce gassing (boiling of electrolyte) and prolong battery life. This is often referred to as a maintenance charge, since rather than charging a battery it keeps an already-charged battery from self-discharging.
- Ground Fault Protection (GFP)** - A circuit protection device that prevents the flow of electrical current to earth if a short circuit is present. Usually required in wet locations - e.g. for outdoor, kitchen and bathroom circuits.
- Hertz (Hz)** - The frequency, or number of times per second, that the flow of AC electricity reverses itself. Also referred to as cycles.
- High Battery Protection** - A control circuit that disconnects charge current flowing to battery(s) when voltage reaches a dangerously high threshold. Prevents damage created by excess gassing (or boiling) of electrolyte.
- Line-tie** - An electrical system that is connected to a utility distribution grid. For example, Trace SW line-tie inverters are designed to connect to and interact with utility power.

## Trace DR-Series Inverters: modified sine wave power, economical prices

Efficient (94% peak efficiency), economical power for most household appliances and tools. DR-series inverters all feature 3-stage battery chargers like their SW-series counterparts (temperature compensation is optional), as well as high surge ratings: Over 2x their continuous power rating! Low idle current too: 0.045 amps typical. Suitable for utility-backup use: Plug into utility power or rev up your generator, and the DR inverter starts charging your batteries and automatically transfers your AC power to your AC electrical system. When your AC input power fails, transfer to inverter power is automatic. 120 VAC, 60Hz output unless otherwise noted. Powder-coated steel enclosure for all models measures 21.6 x 18.4 x 54.6 (centimeters). ETL certified to UL standards.

<b>DR1512: 12V input, 1500VA output</b>	<b>#IN114</b>	<b>\$1,029</b>
<b>DR1524: 24V input, 1500VA output</b>	<b>#IN115</b>	<b>\$979</b>
<b>DR2412: 12V input, 2400VA output</b>	<b>#IN1261</b>	<b>\$1,395</b>
<b>DR2424: 24V input, 2400VA output</b>	<b>#IN117</b>	<b>\$1,395</b>
<b>DR3624: 24V input, 3600VA output</b>	<b>#IN1262</b>	<b>\$1,595</b>
<b>Conduit box for DR series</b>	<b>#IN171</b>	<b>\$69</b>
<b>RC/4 remote for DR &amp; M series</b>	<b>#IN177</b>	<b>\$60</b>
<b>220V/240, 50 Hz DR-Series inverters:</b>		
<b>DR1512E: 12V input, 1500VA output</b>	<b>#IN162</b>	<b>\$1,029</b>
<b>DR1524E: 24V input, 1500VA output</b>	<b>#IN163</b>	<b>\$895</b>
<b>DR2424E: 24V input, 2400VA output</b>	<b>#IN164</b>	<b>\$1,395</b>



Many other models for International use are available; contact us with your requirements.

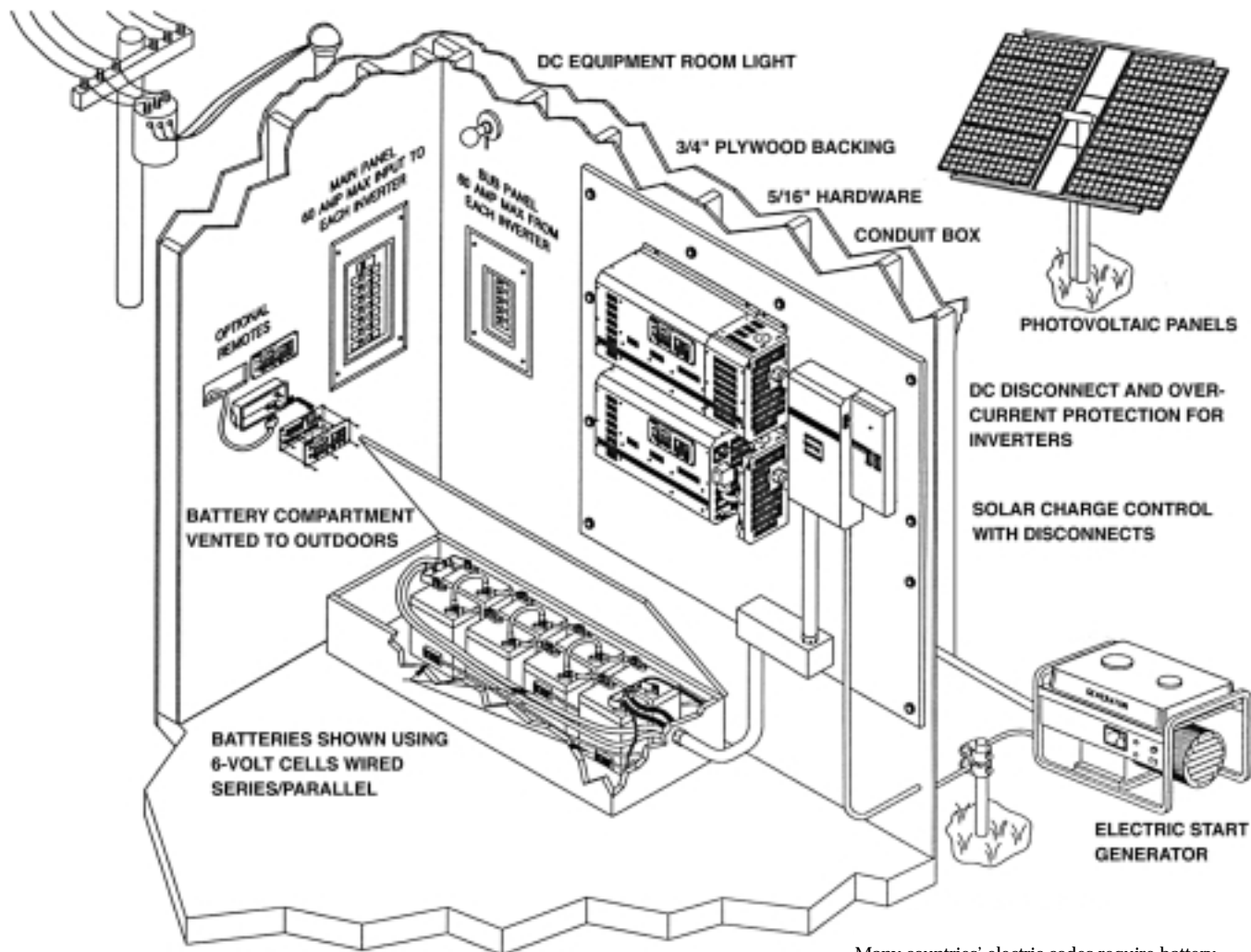

Many countries' electric codes require battery negative, inverter chassis and panel boxes to be connected to earth ground.



## Trace Power Panel Systems

One integrated system for all components, wiring and circuitry. Trace "System-in-a-box" to go with their inverters and eliminate component conflicts. Everything pre-wired—just connect your charging sources and battery bank. Assures code compliance in U.S. and careful integration with Trace inverters. Includes all NEC/UL required AC & DC overcurrent protection and disconnects, C40 charge controllers (work with solar, wind, or hydro), 60 amp AC system bypass, flexible conduit for connection to battery enclosure. All prices include inverters (one or two). Add C40 Charge Controllers based on number of modules (none included). Optional plastic shipping container/battery box. Dimensions: 39.4" H x 42.95" W. Weight: varies

#IN1619 \$215

### For DR Series (modified sine wave)

1.5 kW 12V	#IN1595	\$1,772
1.5 kW 24V	#IN1596	\$1,718
1.5 kW 12V 230 VAC 50 Hz	#IN1597	call
1.5 kW 24V 230 VAC 50 Hz	#IN1598	\$1,718
2.4 kW 12V	#IN1599	\$2,250
2.4 kW 24V	#IN1600	\$2,400
2.4 kW 24V 230 VAC 50 Hz	#IN1601	\$2,093
3.0 kW 12V 120/240 VAC	#IN1602	\$3,317
3.0 kW 24V 120/240 VAC	#IN1603	\$3,211
3.6 kW 24V	#IN1604	\$2,208
4.8 kW 12V 120/240 VAC	#IN1605	\$3,958
4.8 kW 24V 120/240 VAC	#IN1606	\$3,960
7.2 kW 24V 120/240 VAC	#IN1607	\$4,390

### For SW Series (sine wave)

2.5 kW 12V	#IN1608	\$3,737
3.0 kW 24V 230 VAC 50 Hz	#IN1609	\$4,622
3.0 kW 48V 230 VAC 50 Hz	#IN1610	\$4,622
4.0 kW 24V	#IN1611	\$5,352
4.0 kW 48V	#IN1612	\$4,622
4.2 kW 48V 230 VAC 50 Hz	#IN1613	\$5,208
5.0 kW 12V 120/240 VAC	#IN1614	\$6,621
5.5 kW 48V	#IN1615	\$5,208
8.0 kW 24V 120/240 VAC	#IN1616	\$8,341
8.0 kW 48V 120/240 VAC	#IN1617	\$8,341
11.0 kW 48V 120/240 VAC	#IN1618	\$9,510

## Trace "Tiger" Series Inverters

A spectacular value for a high quality inverter. Continuous power output—delivers rated power for ongoing use, not just for a short time like lower quality inverters. And quiet! Automatic transfer from utility to inverter power when the power goes out and other optional features usually found only in high end units like temperature compensated charging and remote control. All models easily installed. LED display keeps you in touch with inverter and battery condition.

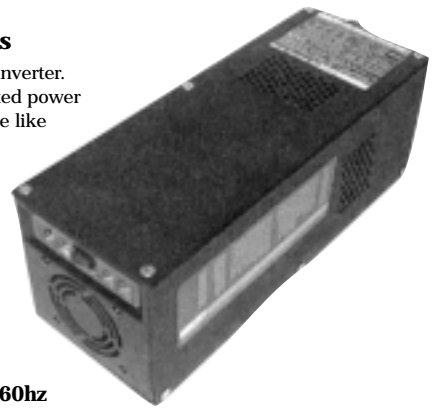

**Trace TS512: 500W-12V DC, 120/60hz**  
#IN4737 \$395

**Trace TS512SB: 500W-12V DC w/ 15amp charger and AC transfer relay, 120/60hz**  
#IN4738 \$495

**Trace TS524: 500W-24V DC, 120/60hz** #IN4739 \$395

**Trace TS524SB: 500W-24V DC w/ 15amp charger and AC transfer relay, 120/60hz**  
#IN4740 \$495

**Trace TS412E: 400W-12V DC, 230/50hz** #IN4741 \$395

**Trace TS412ESB: 400W-12V DC w/15amp charger and AC transfer relay, 230/50hz**  
#IN4742 \$495

**Trace TS424E: 400W-24V DC, 230/50hz** #IN4743 \$395

**Trace TS424ESB: 400W-24V DC w/15amp charger and AC transfer relay, 230/50hz**  
#IN4744 \$495

## UX-Series Inverters

Powerful new Trace compact upgrade of the 600/800 series with higher power ratings and UL listing. Combination inverter/charger (standby) models include built-in battery charger and automatic mode switching that provides true "set it and forget it" operation. Optional battery charger built into standby("SB") models has 3-stage, constant current/constant voltage design that automatically activates when a source of AC electricity becomes available.



UX612 600VA	#IN3248	\$550
UX1112 1100VA	#IN3249	\$799
UX1412 1400VA	#IN3250	\$840
600 Watt w/Charger	#IN3939	\$650
1100 Watt w/Charger	#IN3940	\$875
1400 Watt w/Charger	#IN3941	\$940
UX1112E 230VAC, 50Hz	#IN3251	\$775
UX512E 230VAC, 50Hz	#IN3252	\$550
UX1112E-SB	#IN3942	\$829
UX512E-SB	#IN3943	\$650

## Trace Power Modules (PM)

*Solar energy “building blocks”*

Similar to Trace Engineering’s Power Panels, but enclosed in lockable cabinets. Powder-coated cabinets stack up to 4 high. Many options available, including outdoor/tropical kits. Modules are pre-assembled, except for inverters—order separately. Two people can easily carry. Includes complete cabinet with top and doors, all mounting hardware, all wiring between breakers and inverter, DC battery disconnect, AC input/output/bypass breakers, DC shunt and bonding block, AC neutral and grounding blocks. Just add inverters, C40 charge controllers, and batteries to complete the system. Please contact us with your requirements.

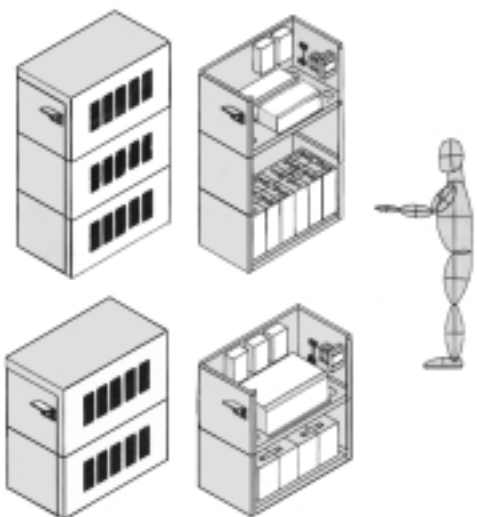

## Trace Power Modules

#IN3617 \$1,120

SW2512, SW4024, or SW5548—ordered as separate line item:

# of inverters: 1

Max. # optional C40’s and/or DC input/output breakers: 3

Max. # optional AC breakers (in addition to in/output/bypass): 4

#IN3618 \$1,120

SW4048—ordered as separate line item:

# of inverters: 1

Max. # optional C40’s and/or DC input/output breakers: 3

Max. # optional AC breakers (in addition to in/output/bypass): 4

#IN3619 \$1,845

SW2512, SW4024, or SW5548—ordered as separate line item:

# of inverters: 2

Max. # optional C40’s and/or DC input/output breakers: 7

Max. # optional AC breakers (in addition to in/output/bypass): 8

#IN3620 \$1,845

SW4048—ordered as separate line item:

# of inverters: 2

Max. # optional C40’s and/or DC input/output breakers: 7

Max. # optional AC breakers (in addition to in/output/bypass): 8

#IN3621 \$1,120

DR2412 or DR3624—ordered as separate line item:

# of inverters: 1

Max. # optional C40’s and/or DC input/output breakers: 3

Max. # optional AC breakers (in addition to in/output/bypass): 4

#IN3622 \$1545

DR2412 or DR3624—ordered as separate line item:

# of inverters: 2

Max. # optional C40’s and/or DC input/output breakers: 2

Max. # optional AC breakers (in addition to in/output/bypass): 1

#IN3623 \$1,120

DR1512, DR1524, or DR2424—ordered as separate line item:

# of inverters: 1

Max. # optional C40’s and/or DC input/output breakers: 3

Max. # optional AC breakers (in addition to in/output/bypass): 4

#IN3624 \$1,545

DR1512, DR1524, or DR2424—ordered as separate line item:

# of inverters: 1

Max. # optional C40’s and/or DC input/output breakers: 2

Max. # optional AC breakers (in addition to in/output/bypass): 1

#IN3628 \$245

Trace PM Optional C40 charge controller

# INVERTERS

## Exeltech MX Series

Start small and add to your inverter capacity as your system and financing evolve. The Master module produces 1000 watts of pure sine wave power and makes up to 5 kW with 120 VAC output (soon to increase to 20 kW), up to 40 kW at 240 VAC, and up to 60kW 240 VAC, 3 phase. Each one has a 2200 watt surge capacity and only uses 20 watts on no-load standby. A manual power adjustment lets you turn off modules not in use, further reducing no-load draw. And each module works independently for the most reliable system—no single malfunction will cause the entire system to fail. You can upgrade or replace modules with the system on line and not have any interruption of power. Precisely regulated output voltage doesn't vary when input voltages fluctuate. Maximum distortion only 2%—super clean sine wave. Extremely compact and light weight—each module weighs only 7.5 lbs., 7" H x 15" D x 7" W.

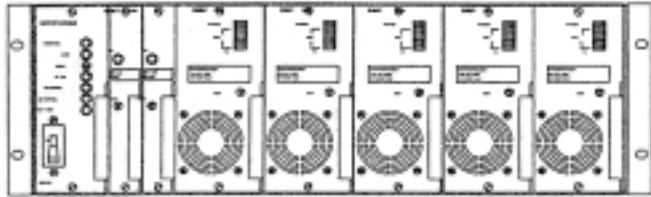

Master Module 12V	#IN3879	\$944
Master Module 24V	#IN3880	\$1,020
Master Module 32/48/66/108V	#IN3881	\$1,231
Power Module 12V	#IN3882	\$890
Power Module 24V	#IN3883	\$992
Power Module 32/48/66/108V	#IN3884	\$1,212
Cage (4000)	#IN4113	\$520
6-Unit Cage	#IN4696	\$600

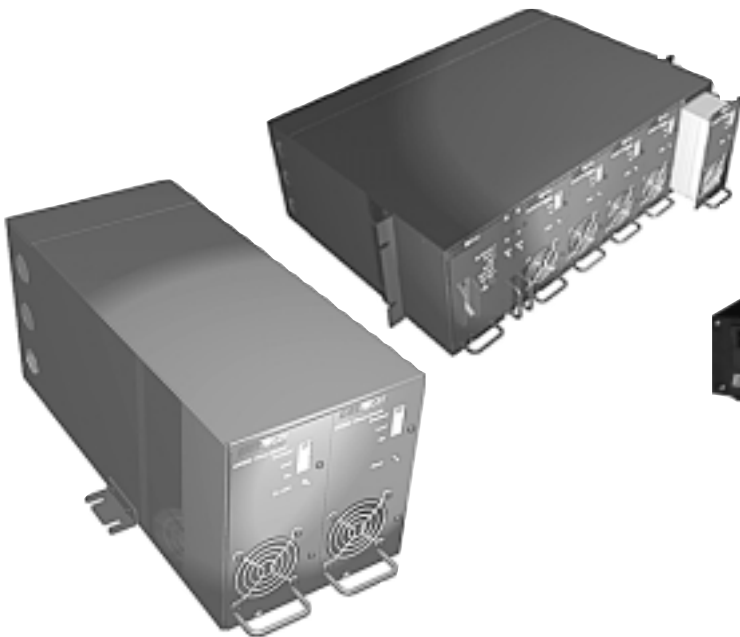

## Exeltech Inverters

### True sine wave output

Most inverters create problems in sensitive electronics such as TVs, stereos, radios, and VCRs. While much better than the old style square wave inverters, modified sine wave inverters still cause buzzing and lines on audio and video equipment.

Exeltech power output is often better than that of standard wall outlets in most homes or offices. Although you still may need a larger inverter for your less sensitive loads, also having an Exeltech can vastly improve the quality of your entertainment. Also great for computers and sensitive test equipment.



12V, 250 Watts	#IN700	\$425
24V, 250 Watts	#IN3876	\$493
12V, 250 Watts, 230 vac 50 Hz	#IN3892	\$450
24V, 250 Watts, 230 vac 50 Hz	#IN3893	\$450
24V, 600 Watts, 230 vac 50 Hz	#IN3888	\$650
12V, 1100 Watts	#IN3180	\$748
24V, 1100 Watts	#IN3181	\$816
32/48/66/108V (specify voltage)	#IN3182	\$975
Exeltech Marine Conformal Coating	#IN3195	\$75

## Exeltech XP 600

### More power, lower price

The new Exeltech produces 100 watts more than their old 500 watt version and costs less. Super good regulation and true sine wave output—anything that will work from a utility power supply will work with this inverter (up to 600 watts). 1100 watt surge, 15 watt no-load power draw, 85-90% efficiency, 8 lbs. 7.7" x 3.6" x 11.77".



12V, 600 Watts	#IN6428	\$625
XP600 – 24V	#IN3878	\$694
XP600 – 48V	#IN4529	\$694
12V, 230 vac 50 Hz	#IN3887	\$760
24V, 230 vac 50 Hz	#IN3888	\$650



## Exeltech MX 125 Portable Sine Wave Inverters

### Premium-quality power to go

True sine-wave inverters closely mimic utility-supplied power. Result? Finicky electronic devices run without a hitch. Traditionally, this premium quality power meant premium price. This new Exeltech changes that plus includes built-in cigarette lighter plug, compact dimensions and light weight for maximum mobility. 125 watts, high/low voltage protection. 6.75" x 4.65" x 2", 2 lbs.

12V	#IN1430	\$225
24V	#IN3183	\$245
12V, 230 vac 50 Hz	#IN3889	\$260
24V, 230 vac 50 Hz	#IN3890	\$260

	#IN1430	#IN700	#IN6428	#IN3879	#IN3180	(Master plus Power Modules)			
Continuous Output	125	250	600	1000	1100	2000	3000	4000	5000
Surge	125	625	1100	2200	2200	4400	6600	8800	11,000
No-Load Draw	5	6	8	20	20	(40)	(60)	(80)	(100)
Efficiency	85 to 90% all models					85 to 90% all models			



## AC Power Inverter/Charger System

*Building blocks for a new alternative in alternative energy*

A total alternative energy power inverter system package for stand-alone or utility-intertie operation. Combines state-of-the-art components and user-friendly features for the most reliable system. Highly flexible, modular design allows modules to be configured in any order. The 4500 watt continuous output UL listed inverter has pure sine-wave 120/240 split-phase output with a peak surge of 56 amps. The 4-stage charger supports various types of lead acid batteries, includes an automatic generator control, and accepts grid or generator input. Remotely program the inverter or charger with "digital signal processing". Optional modules include a DC distribution box with solar controller and an AC distribution panel. Utilizing internal wiring raceways, these units mate with the inverter in any order, creating a sleek, modular design and eliminating most external conduit. Clean, simple installation.

<b>System</b>	<b>#IN8411</b>	<b>\$4488</b>
<b>AC Panel</b>	<b>#IN8925</b>	<b>\$1,195</b>
<b>DC Box</b>	<b>#IN8924</b>	<b>\$1,295</b>



## PowerPro Inverters

*230 vac, 50 Hz for International applications*

Inexpensive but good quality inverters for European power sources. The small size has an on-off switch that controls the DC power coming into the unit instead of the more common kind of switch that only controls the AC output. You can leave the inverter plugged in without losing power. The larger size has a miniature cooling fan, DC input terminals and hard-wire cables with 20 amp fuse and battery clips. Wattage ratings reflect continuous ratings

with efficiency of 90% (not the short-term output numbers commonly given with low-end inverters). Low battery alarm, battery low shutdown, short circuit, overload, and thermal protection. 1 year warranty. Large size has a continuous power rating of 200 watts, peak power 300, surge to 400 watts; standby current of 0.24 amps; 7.88" x 2.76" x 1.73", 1.2 lbs.

<b>125 Watt 12V</b>	<b>#IN4521</b>	<b>\$130</b>
<b>125 Watt 24V</b>	<b>#IN4381</b>	<b>\$140</b>
<b>200 Watt 12V</b>	<b>#IN4661</b>	<b>\$180</b>
<b>200 Watt 12V-115VAC</b>	<b>#IN6387</b>	<b>\$160</b>

## PowerStar Upgradable

*400-, 700-, and 1300 Watt Inverters*

Get a small inverter now and add a module for more power later. Extra cost is only the price difference between the two sizes. Small size (3.15" x 3.3" x 11") and weight (less than 5 lbs.) is a big advantage in many situations. Very quiet and efficient. 400 watt unit has a 3000 watt surge rating that starts and runs 1/4 horsepower motors. 1300 watt has 6000 watt surge and will continuously operate a full size microwave, any 1500 watt appliance, or a worm-drive circular saw. Idle current a tiny 60 mA. 2 year warranty. Good for NiCad batteries.

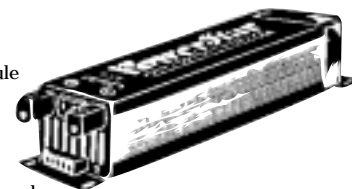

<b>400W Inverter</b>	<b>#IN501</b>	<b>\$340</b>
<b>700W Inverter</b>	<b>#IN502</b>	<b>\$390</b>
<b>1300W Inverter</b>	<b>#IN503</b>	<b>\$550</b>
<b>700W Module</b>	<b>#IN520</b>	<b>\$207</b>
<b>1300W Module</b>	<b>#IN521</b>	<b>\$519</b>

## Car-cord Inverter

Perfect size (and price) inverter for those small electronic devices you need to run while on the road. Simply plug into the cigarette lighter or the 12V accessory receptacle in the car and run your laptop, CD or DVD player, boom box, adding machine, etc. Low voltage safety shutoff prevents car battery drainage. 60 watts continuous, 75 watt surge capability.

**#IN7453 \$39**



## 120V DC Inverter

SW4120: 120V input, 4000VA output. Based upon a Trace 4000-series inverter. 120V DC input is well suited for situations where batteries or solar modules must be located a long distance from the inverter.

**#IN1382 \$3,200**



## Portawatt

*Lowest cost for reliable economy inverters*

Prowatt recently introduced this economy inverter line. They seem to be more reliable than the more expensive versions. They all have automatic shut-down when a battery bank dips too low. The 140 and 300 watt models have attached 12V cigarette lighter plugs and the two larger sizes are set up for direct battery connection. Watt ratings are for continuous use and they can handle larger amounts of power for short periods. 12V DC input 120 VAC output.

<b>140 Watt</b>	<b>#IN3079</b>	<b>\$66</b>
<b>300 Watt</b>	<b>#IN4076</b>	<b>\$95</b>
<b>600 Watt</b>	<b>#IN6607</b>	<b>\$170</b>
<b>1000 Watt</b>	<b>#IN3077</b>	<b>\$408</b>
<b>1750 Watt</b>	<b>#IN3076</b>	<b>\$596</b>
<b>3000 Watt</b>	<b>#IN6608</b>	<b>\$950</b>

## Automatic Voltage Switchers

Connect between unstable grid power and an electrical appliance for constant protection. The most complete power protection device, these special switches constantly monitor grid power. When the electricity supply fails or there is a voltage fluctuation beyond preset acceptable limits (in a 230 vac system, when voltage drops below 190V or rises over 260V; 93V and 132V for 120 vac systems), it disconnects your appliance before the low or high voltage can hurt it. Monitoring continues and the main supply is reconnected only when supply resumes and/or the voltage stabilizes. As a further safeguard, the supply only reconnects when the voltage remains stable for a predetermined time - normally one minute. LEDs show at a glance the state of the system. The switch activates within one cycle of the supply except when the mains voltage goes below the lower limit by less than about 20% in which case it reacts in about 0.5 seconds. This prevents disconnect as a result of the initial voltage drop on start up but still detects rapid main voltage switchings, fluctuations and brown-outs. Brown-out response time only 16.7 milliseconds. The 120 vac model has a USA socket, the 230 vac a UK 3 round pin, hard wire in the combination 30 amp 100 amp versions. Many different models (including three phase) and other socket types available on request. 230 vac, 20 amps (PC7962)

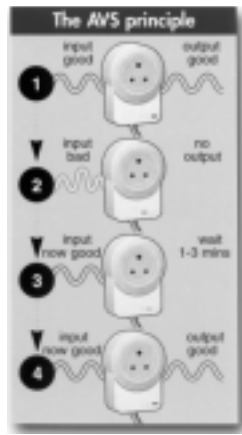

<b>120 vac, 15 amps</b>	<b>#PC7963</b>	<b>\$128</b>
<b>120/230 vac, 30 amps</b>	<b>#PC7964</b>	<b>\$162</b>
<b>120/230 vac, 100 amps</b>	<b>#PC7965</b>	<b>\$340</b>

## Power Converter for Answering Machines

Many telephone answering machines work on DC power, but they buzz due to grounding of the 12V power source. This transformer isolates your 12V battery bank from the phone line power, so phones don't buzz. 11V output typical from 13V input. Most answering machines are marked as 9V but have internal regulation and protection. Easy 4-wire hookup—you supply your own power connector.

**#IN1867 \$44**

## Voltage Stabilizers

Correct "Bad" voltage - reduce when high, increase when low - and keep your appliances "happy" with a long life. Designed for the typically erratic power supplies in developing countries, these highest quality stabilisers provide excellent protection for TVs, video players, music systems, computers, fax machines, PABX phone systems, satellite equipment, refrigerators, coolers, freezers, air conditioners, and all office equipment. It protects against sags and brown outs, over voltage, under voltage, voltage fluctuations, surges and spikes, even extreme over and under-voltage. Less expensive than our Automatic Voltage Regulators but slower switching, less input range, and less accurate output control. Fine for most equipment but better to use AVR for more expensive, more sensitive appliances, music and lab equipment. Specify UK, FR, SCH, UK15 socket, direct wire 50A+. 240 vac.



<b>2 amps</b>	<b>#PC7968</b>	<b>\$148</b>
<b>4 amps</b>	<b>#PC7969</b>	<b>\$172</b>
<b>8 amps</b>	<b>#PC7970</b>	<b>\$406</b>
<b>50 amps</b>	<b>#PC7973</b>	<b>\$1,608</b>
<b>15 amps</b>	<b>#PC7971</b>	<b>\$520</b>
<b>20 amps</b>	<b>#PC7972</b>	<b>\$652</b>
<b>100 amps</b>	<b>#PC7974</b>	<b>\$1,984</b>

## PureAC Grid Filters

*Clean up your power and protect sensitive electronics*

Heat pumps, air-conditioners, vacuum cleaners, fluorescent lamps, photocopiers, computers, power tools, TVs and lightning cause surges, spikes and RFI (radio frequency interference). This causes sensitive electronic equipment to be damaged or malfunction in unpredictable ways. The PureAC Grid Filters remove these harmful disturbances and deliver clean power to your valuable equipment. They incorporate large, high capacity metal oxide varistors (MOVs) to clamp harmful voltage spikes to a safe level while a capacitor network filters out RFI. They clamp spikes up to 480 Joules and will attenuate noise typically from 15dB @ 100KHz up to 30dB at 1MHz. Just plug the PureAC into a wall socket and your equipment into it. LEDs indicate status. Designed specifically for the "rough" power common in developing countries. 250 vac 50 Hz, UK13 output socket.



<b>750 watt model</b>	<b>#PC7966</b>	<b>\$79</b>
<b>1600 watt model</b>	<b>#PC7966</b>	<b>\$94</b>
<b>3100 watt model</b>	<b>#PC7966</b>	<b>\$108</b>

## Faxguard

Protect your modem, fax machine or telephone against all voltage problems. Lightning and unstable grid power can conduct high-energy power surges over telephone line connections to the heart of your sensitive electronic equipment, often with devastating effects. Even when switched off, damage can range from data corruption to system destruction. The Faxguard protects your equipment all the time - from everyday spikes and power back surge right through to a lightning strike. It disconnects when voltage exceeds 265V and automatically reconnects after voltage stays within safe limits for at least 30 seconds. Includes full surge and spike protection, LED indicators, ultra fast acting transient voltage suppressor. 230 vac, 3 prong UK type socket.

**#PC7966 \$86**

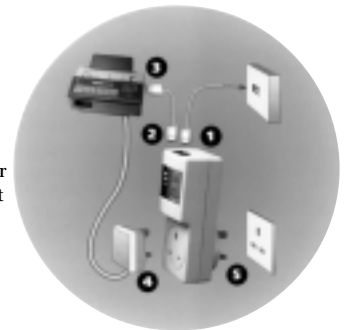

## Inline Surge Protectors

Fast and easy protection for vulnerable microprocessors and electronic components. Just plug this small component into your computer, scanner, printer, stereo, or domestic appliance and then plug your power cord into it. It will prevent the everyday spikes and surges from reaching your sensitive equipment. It quickly reacts and clamps the high voltage level, sending it safely away to the ground. Afterwards, it automatically resets itself. 230 vac, 10 amps, 40 grams, 80x37x27 mm. Power consumption 0.6W. Standard connector C13 to C14 kettle style, optional C7 to C8 or C5 to C6.

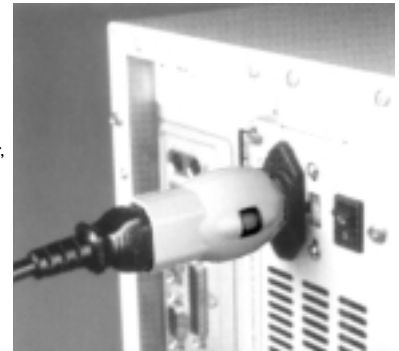

**#PC8182 \$29**





## Electronic Converter

Run computers and electronics direct. Power low voltage electronic equipment from 12 or 24V battery bank. Output adjustable down to 1.5 volts, 78% efficient. Also powers equipment direct from solar modules and prevents spikes and line surges. Great for answering machines, stereos, cassette players, portable TVs, laptop computers, cellular telephones, fluorescent lights. 2 amp includes plug-in receptacle and on/off switch, 8 amp model has separate box and 2 receptacles.

**2 Amp #SC518 \$79**  
**8 Amp #SC520 \$175**



## DC to DC Converters

Take regulated DC output from a 12 or 24V battery bank. The Vanner Voltmaster takes 1/2 the voltage from the 24V bank. This could supply too high a voltage for sensitive electronic components. Instead, this converter takes input voltage from between 22-30V and gives you a steady 12.8V output. The 12V converter takes voltages between 11-16 and gives 24.

**20 Amps #SC503 \$396**  
**12V, 10 Amps #SC505 \$350**  
**24V, 50 Amps #SC504 \$549**



## DC-DC Converter

Affordable 12V from 24V battery bank. Dependable, high quality converter at a fraction of the cost. Not as efficient but great for temporary loads. 10A continuous, 16A surge. Easy 3-wire hookup.

**#RG1479 \$49**



## Small 240/120V Travel Adapters

50 watt converter for electronic or motorized appliances like electric shavers, radios, cassette players, calculators and tape recorders. 1600 watt is a solid state converter designed for use with heating appliances like hair dryers and coffee makers.

**50 Watt Converter #IN230 \$15**  
**1600 Watt Converter #IN232 \$17**



## AC to DC Converters

Run your DC loads when you have an AC source

<b>4 Amp #IN1267 \$39</b>	<b>20 Amp #IN1271 \$166</b>
<b>8 Amp #IN1268 \$59</b>	<b>32 Amp #IN1272 \$210</b>
<b>10 Amp #IN1269 \$82</b>	<b>48 Amp #IN1273 \$315</b>
<b>15 Amp #IN1270 \$97</b>	<b>75 Amp #IN1274 \$453</b>
<b>24V 12 Amp #IN6138 \$210</b>	

## Multi-Voltage 12V

Power Adapters Use to power portable tape decks, stereos, radios and anything using 1.5, 3, 4.5, 6, 7.5, 9, or 12 volts. Be careful about overpowering they burn right up. Not recommended for sensitive electronics because not current limiting (use the linear power supply in Entertainment/Communication section). High Power model has 6' cord and 3 amp output at 12V, .9 at 9V, and .5 at 6-7.5V. Fused cigarette lighter plug.

**High Power Adapter #IN901 \$17**

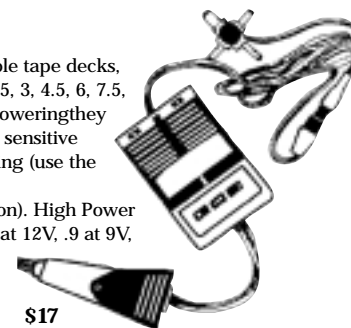

## Universal Battery Eliminator

Replaces dozens of other AC bricks. Perfect for most small battery-powered stereos and other small electronics. 6-way power plug, even 9V battery clip. Switchable polarity & voltage: 3, 3.5, 6, 7.5, 9 & 12V DC @ 300mA. Works great with our CD player battery pack and countless other small electronics.

**#IN3669 \$14**

## 2000 mA Multi-Voltage Power Adapter

The 2000 mA version is powerful enough for CD and DVD players as well as games and other digital car toys.

**#IN7454 \$26**



## Power Converter for Answering Machines

Many telephone answering machines work on DC power, but they buzz due to grounding of the 12V power source. This transformer isolates your 12V battery bank from the phone line power, so phones don't buzz. 11V output typical from 13V input. Most answering machines are marked as 9V but have internal regulation and protection. Easy 4-wire hookup—you supply your own power connector.

**#IN1867 \$44**



## Global Power Travel Kit

World travelers will appreciate having all the voltage adapters needed for anywhere they end up. Bring all your favorite small appliances and electronics and safely plug in from Sri Lanka to Sierra Leone. Ideal for electric shavers, hair dryers, battery chargers, CD players. Kit comes with 5 global plug types. Powerful enough for CD, DVD players and games.

**#IN7455 \$26**

# DEEP CYCLE BATTERIES

## Batteries for Solar Systems

Batteries are the weak link in a Home Power System. A car battery might only last a few months. A golf cart battery maybe 2-3 years, Gel Cell batteries 3-5, Trojan L-16s 8-12 years. Our chloride industrial strength batteries last up to 20 years and Lineage 2000 up to 70 years! In general, the higher the price, the longer the life. Most people choose Trojan L-16 (our "State of the Art" described on this page). For certain situations though, other types are better. Some of the best choices follow.



### Classic L-16

The "classic" is the old style L-16, a proven workhorse in the battery industry. It has the most amp hours per dollar spent but none of the new features described above. Polyurethane case, no handles. 350 amp hours.

**Classic L-16 #RB5753 \$166**  
**27TMH,12v Battery 115AH #RB5141 \$99**

## Trojan SG 90 - 12v, 90 Amp, Gell Cell

The best name in Solar batteries now offers sealed, maintenance-free Gel technology. Don't want to deal with venting a lead acid bank? Worried about corrosive battery acid splashing out during transport? Go Gel! We like these batteries so much, we build them into our mobile power systems. 86 amp hours, 12volts. 61 lbs.

**#RB5714 \$190**



## Trojan L-16

*State-of-the-art home power batteries*

Most deep-cycle batteries are made for either a fast charge such as from a generator (high antimony) or for a slow, trickle charge such as from a PV system (low antimony). To get the best of both worlds, use the Trojan L-16 ( 6V, 360 amp hour now, with extra heavy duty plates) and store power from solar electric modules as well as from a gasoline generator, hydro or wind system. They last up to 10 years and, in this price range, are the best batteries to use. New Trojan batteries made almost completely from recycled materials: 80% of the plastic, 100% of the lead. The new Polyon case won't split or crack and has handles. The grid design reduces water consumption and requires less maintenance. And the all-new High Capacity model has the same great quality as the L-16 with a few improvements—higher 395 amp hour capacity, dual post configuration for easy installation and use. Higher capacity translates into saving space and a reduction in battery cables. The new, advanced and much stronger case holds up much better during both rough transportation and freezing weather conditions. Other batteries are called "L16s" but none measure up to Trojan quality. For some places in the continental U.S. we include shipping in our price. 124 lbs (99 lbs. moist/dry) 11-11/16" L, 7" W, 16-11/16"H.



**Trojan L-16 #RB500 \$189**  
**Trojan L-16 High Capacity #RB4129 \$230**  
**Trojan L-16 Moist/Dry #RB4134 \$220**

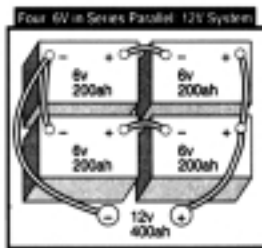
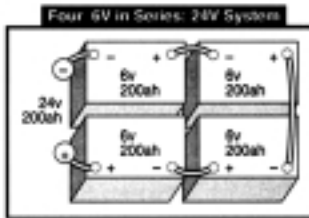
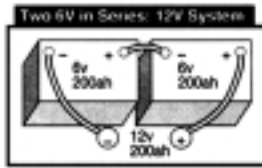
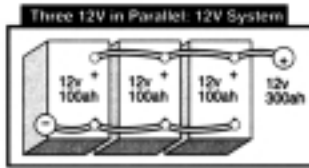

## Trojan 6V

*Golf Cart Batteries*

This little brother of the Trojan L-16 won't last as long but with good care can give you 4-5 years of service. Additional charge for dry batteries. 66 lbs. wet, 53 lbs. moist/dry (T-125). 1038 L x 718 W x 11316 H.



**220 Amp - Wet #RB1173 \$77**  
**220 Amp - Moist/Dry #RB502 \$87**  
**235 Amp #RB505 \$85**

## TEMPERATURE VS. CAPACITY

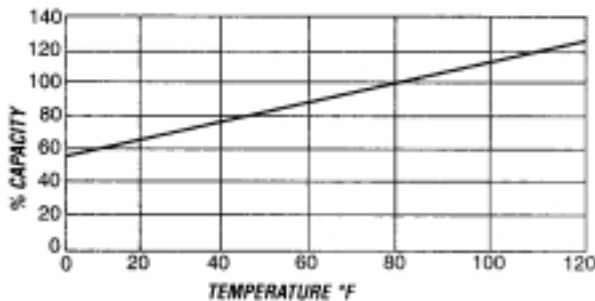

The electrolyte temperature directly affects capacity.

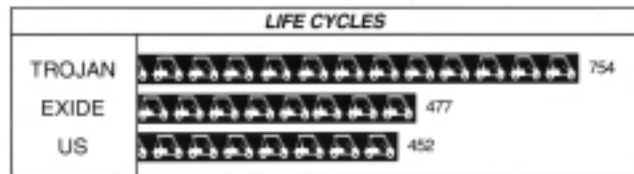

Test conducted per BCI test procedures.

## Powerersonic

There's never a need to add electrolyte, as gases generated during over-charge are recombined in a unique "oxygen cycle". Leak proof, so it requires no special precautions or shipping containers. High discharge rate, useable in any position, long life—over 1200 cycles at 30% average discharge. Works over a wide temperature range, too: -40°C to +50°C!

12V	.....	.8 Amp	.....	#RB3418	.....	\$.21
12V	.....	1.2 Amp	.....	#RB3419	.....	\$.21
12V	.....	2.2 Amp	.....	#RB3321	.....	\$.22
12V	.....	2.3 Amp	.....	#RB3420	.....	\$.37
12V	.....	2.9 Amp	.....	#RB3421	.....	\$.27
12V	.....	3 Amp	.....	#RB3278	.....	\$.24
12V	.....	5 Amp	.....	#RB150	.....	\$.29
12V	.....	7 Amp	.....	#RB149	.....	\$.22
12V	.....	8 Amp	.....	#RB3359	.....	\$.40
12V	.....	10 Amp	.....	#RB151	.....	\$.42
12V	.....	12 Amp	.....	#RB3423	.....	\$.48
12V	.....	12 Amp*	.....	#RB3424	.....	\$.46
12V	.....	18 Amp	.....	#RB152	.....	\$.57
12V	.....	26 Amp	.....	#RB3225	.....	\$.79
12V	.....	28 Amp	.....	#RB153	.....	\$.89
12V	.....	33 Amp	.....	#RB3425	.....	\$.84
12V	.....	40 Amp	.....	#RB154	.....	\$.112
12V	.....	75 Amp	.....	#RB438	.....	\$.172
12V	.....	100 Amp	.....	#RB157	.....	\$.184
8V	.....	3.2 Amp	.....	#RB3417	.....	\$.24
6V	.....	.5 Amp	.....	#RB3406	.....	\$.16
6V	.....	1 Amp	.....	#RB3407	.....	\$.13
6V	.....	1.3 Amp	.....	#RB3408	.....	\$.12
6V	.....	2.8 Amp	.....	#RB3429	.....	\$.15
6V	.....	3 Amp	.....	#RB3409	.....	\$.16
6V	.....	3.2 Amp	.....	#RB3277	.....	\$.17
6V	.....	4.5 Amp*	.....	#RB3319	.....	\$.11
6V	.....	4.5 Amp**	.....	#RB3410	.....	\$.13
6V	.....	5 Amp	.....	#RB3411	.....	\$.16

Maintenance-Free Batteries.  
Great for small applications.



6V	.....	5 Amp	.....	#RB3430	.....	\$.20
6V	.....	6.5 Amp	.....	#RB159	.....	\$.20
6V	.....	7 Amp	.....	#RB332	.....	\$.15
6V	.....	8 Amp***	.....	#RB3412	.....	\$.21
6V	.....	8 Amp	.....	#RB3431	.....	\$.22
6V	.....	9.5 Amp	.....	#RB3413	.....	\$.22
6V	.....	12 Amp	.....	#RB3414	.....	\$.21
6V	.....	12 Amp	.....	#RB161	.....	\$.22
6V	.....	20 Amp	.....	#RB162	.....	\$.62
6V	.....	36 Amp	.....	#RB3416	.....	\$.52
4V	.....	4.5 Amp	.....	#RB3402	.....	\$.14
4V	.....	4.5 Amp	.....	#RB3427	.....	\$.17
4V	.....	7 Amp	.....	#RB3403	.....	\$.13
4V	.....	9 Amp	.....	#RB3404	.....	\$.11
4V	.....	10 Amp	.....	#RB3405	.....	\$.16

\*Faston Terminal

\*\*Insulated, stranded wire leads terminated w/amp housing

\*\*\*Sealed L.A. (Fast on or wire lead)

## Deka Deep-Cycle Batteries

Gel cell batteries  
with higher capacity ratings

Use for applications where adding water is impossible or too difficult and many days without recharging likely.

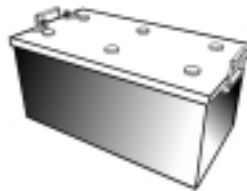

6V, 190AH	8.5" x 12.85" x 7.2"	72 lbs	#RB3201	\$167
12V, 98 AH	12.75" x 6.75" x 9.88"	64 lbs	#RB3202	\$167
12V, 210 AH	20.75" x 8.5" x 10"	135 lbs	#RB3203	\$346
12V, 265 AH	20.75" x 11" x 10"	168 lbs	#RB3204	\$396

## Optima "Yellow Tops"

The best battery for EV's!

Superior power, longer life, double the cycles. Get up to 2500 cycles with a 30% discharge, 350 with a 100% discharge. 50 amp size 10" L x 6.8" W x 7.8" H, 42.9 lbs.

50 amp	#RB611	\$177
90 amp	#RB6113	\$260



## Gel One Deep Cycle Battery

The fastest charging, highest efficiency

Recharge up to 90% in as little as 3.5 hours. Resist permanent sulfation — recover even after 30 days when completely discharged. Ideal in systems with big loads that shorten the life of most deep cycle batteries. Completely sealed no-spill, no-fill, no-slosh, gelled electrolyte. All 12V.

86A	#RB553	\$234
225A	#RB555	\$486

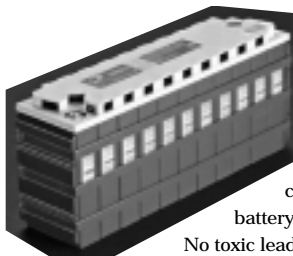

## GM/Ovonic NiMH Batteries

The battery you've been waiting for!

Tired of 200 year old battery technology? Plunge into the 21st century with the FIRST high capacity Nickel Metal Hydride (NiMH) battery available! Virtually unaffected by cold! Deep discharge capacity allows this

battery to replace a 200+ amp hour lead acid battery!

No toxic lead or cadmium to harm the environment.

Developed for the electric vehicle market, Sustainable Village brings the NiMH to the world of solar. 13.2 volts, 85 amp/hours. "Requalified" ones were used and reconditioned at the factory, 82 amp/hours. Sporadic availability.

Standard	#RB6726	\$2,200
Requalified	#RB6725	\$600

## Surrette Deep Cycle Batteries

*High cycle life, thick plates, and large liquid reserve*

Comparable to the Trojan L16 but heavier and unsurpassed in reliability and warranty - 24 month full, the next 60 months pro-rated. Thick lead alloy flag terminals, packaged in a structural rib molded container with lifting rope handles. Dry charged model for export - longer shelf life without charging, lighter, nothing to spill. 6V, 438Ah.

**Regular** #RB8736 \$211  
**Dry Charged** #RB8795 \$211



## Surrette Solar Batteries

Designed for up to 20 years of service in renewable energy applications by a company with more than 60 years experience. Modular and non-breakable dual container construction prevents acid leakage, extends life, reduces connections and failure points, as well as increasing charging efficiency. Thick plates with the highest density active material give excellent cycling service with an average life of at least 15 years backed by a pro-rated, 10-year warranty and free replacement if problems within 3 years. An extra large liquid reserve means less maintenance and "enveloped separators" eliminate separator misalignment, treeing or shorting. Disassemble the entire battery with a 1/2" wrench for easy mobility. Individual cells user-replaceable - just bolt into place. Amp ratings at 100 hour rate, all 6V.

**682 AH , 22" L x 11.25"**  
**W x 18.25" H. 318 lbs.** #RB8797 \$555  
**854 AH , 22" L x 11.25"**  
**W x 18.25" H. 318 lbs.** #RB8796 \$694  
**1025 AH , 22" L x 11.25"**  
**W x 18.25" H. 318 lbs.** #RB320645 \$833

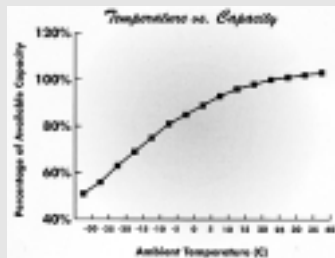
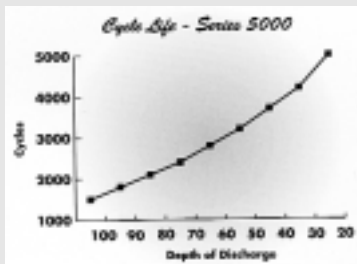

## IBE Batteries

### IBE 2V Industrial Cells

*High capacity, long life, fast charging, large battery systems*

Use these batteries if you want the longest life - they're rated for 1500 cycles when you take them all the way down to an 80% depth of discharge and for 5000 cycles if you only take them down on an average of 20% of rated capacity. The plate thickness is c. 43% greater than normal low antimony batteries. A heat sealed cell cover eliminates the major source of electrolyte leakage and reduces corrosion build-up. They include flag type terminals on positive and negative posts for easy installation. All cells have heavy-duty individual painted-steel cell cases with handles. Five year full replacement plus three year limited warranty. All three sizes are 24" H and 7" W. In order the widths are 6.25", 9.62", 12.62" and the weights 124 lbs., 176 lbs., 232 lbs.

**1020 AH** #RB6531 \$305  
**1530 AH** #RB6273 \$435  
**2040 AH** #RB8798 \$596

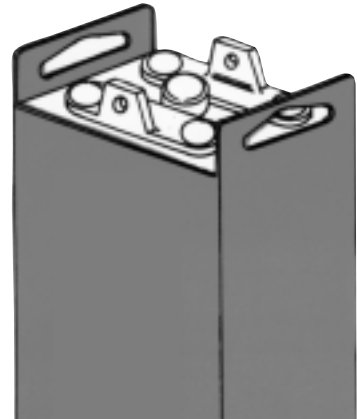
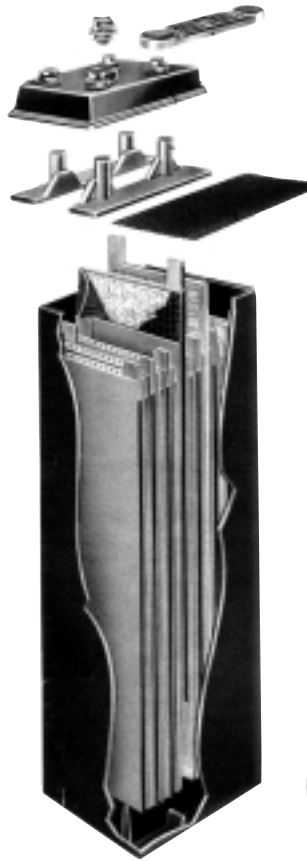



## Powersonic Chargers

Small chargers for small 6 and 12V batteries. These automatic dual rate chargers sense battery requirements and switch back and forth from fast to float modes. This makes recharge time short and at the same time keeps batteries safe from being overcharged. Fool-proof recharging! Wall mount plug-in for 1.25 Amp and lower sizes, counter top with input cord for 4 Amp and higher. LED indicators provide protection against reverse polarity and short-circuits. Specifically designed for sealed lead-acid batteries.

Model	Volts	Amps	Weight	Cost
#BC600	6	.3	.5 lbs.	\$48
#BC601	6	.5	.8 lbs.	\$49
#BC602	6	4.0	6 lbs.	\$158
#BC603	12	.25	.5 lbs.	\$44
#BC604	12	.5	.8 lbs.	\$48
#BC1685	12	.8	1.36 lbs.	\$52
#BC1686	12	2.0	4.5 lbs.	\$138
#BC606	12	4.0	6 lbs.	\$158
#BC607	12	10	9 lbs.	\$330

## IBE Battery Chargers

*High capacity, fast charging for large battery systems*

Top quality, industrial, solid state chargers with 5-year warranty and adjustable, filtered output. Tapering charge reduces gassing and water loss. Includes 8' output cables and 10" AC line cord. Models for 12-120V DC, 120 & 220 vac. 2nd number is recommended battery size.

12V, 115A, 595AH	#BC440	\$890
12V, 150A, 765AH	#BC441	\$1,050
12V, 200A, 1000AH	#BC442	\$1,285
12V, 270A, 1350AH	#BC443	\$1,792
24V, 115A, 595AH	#BC444	\$1,125
24V, 150A, 765AH	#BC445	\$1,279
24V, 200A, 1000AH	#BC446	\$1,500
24V, 270A, 1350AH	#BC447	\$1,960



## Lester Battery Chargers

*Fully automatic chargers increase battery life 25% or more!*

A patented electronic timing device senses the charge condition and fully and properly charges batteries every time. No dials to adjust, no switches to operate, and no difficult decisions about how long to charge! No overcharge, no plate damage, and greatly reduced water usage keep each battery cell active and healthy. The following list describes some of the most popular models but Lester makes a charger for almost every type of battery bank.

12V 10 Amp	#BC501	\$260
12V 20 Amp	#BC502	\$289
12V 50 Amp	#BC503	\$390
12V 50 Amp	#BC504	\$426
12V 75 Amp	#BC6363	\$613
24V 10 Amp	#BC505	\$275
24V 40 Amp	#BC506	\$425
48V 50 Amp	#BC507	\$770



## TrueCharge

*A smart battery charger*

Features and quality found in super expensive charging systems at a lower price. The TrueCharge adjusts charging for battery temperature, changes voltage for different kinds of batteries, equalizes to recondition, and has separate terminals for charging two different battery banks (20 & 40 amp models only). They include a bar graph ammeter, ready & charging indicators, and many safety features. Can easily pay for itself in longer battery life. Ratings in continuous figures —10 amp model charges batteries faster and more accurately than 20 and 30 amp rated taper chargers. 12V.

10 Amp	#BC116	\$270
20 Amp	#BC117	\$390
40 Amp	#BC118	\$556

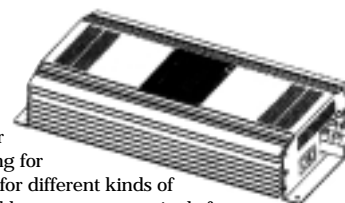

## Batteries: How to Keep Them Alive for Years and Years ...

Though most consider lead-acid batteries the "weak link" in renewable energy systems, today's renewable energy batteries are better than ever, and so are the devices that regulate and protect them. Battery failures are rarely the fault of the batteries themselves! Follow these guidelines to avoid the vast majority of all battery problems.

1. Size the battery bank and PV array properly - the battery bank - as a minimum - to a capacity of 5 days of load. The PV array, to produce (on average) 30% more energy than the load requires.
2. Buy high-quality batteries, selected for your needs. You get what you pay for! Good deep-cycle batteries can be expected to last for 5 to 15 years, and sometimes more. Cheap batteries can give you trouble in half that time.
3. Connect the two main cables to opposite corners of the battery bank, and maintain symmetry in wire size and lengths. This will help to distribute current evenly through the bank.
4. Arrange batteries to maintain even temperature distribution throughout the bank. Avoid uneven exposure to heat sources. Leave at least 1/2 inch of air space around each battery, to promote even cooling.
5. Apply a finish charge at least every 3 weeks (bring every cell to 100% charge).
6. Prevent corrosion. Once corrosion gets hold, it is hard to stop. The good news -- it is easy to prevent! Apply a non-hardening sealant to all of the metal parts of the terminals BEFORE ASSEMBLY.
7. Moderate the temperature. Batteries lose approximately 25% of their capacity at a temperature of 30°F (compared to a baseline of 77°F). At higher temperatures, they deteriorate faster.
8. Install the batteries over a floor drain, or in a space without a floor, so that they can be rinsed with water easily. Washing the battery tops (about twice per year) will remove accumulated moisture (acid spatter) and dust.
9. Avoid multiple parallel strings
10. Use a charge controller, power center or battery charger with temperature compensation
11. Use an inverter or charge controller with a low-voltage disconnect or get a separate one. Discharging a battery to exhaustion will cause immediate, irreversible loss of capacity and life expectancy.
12. Bring batteries to a full state-of-charge at least every 3 weeks
13. Install a System Monitor. Would you drive a car with no dashboard? Metering is not just "bells and whistles".
14. Add water as needed. Most batteries require additional water every 6 to 12 months.

Batteries are the heart of your power system. They may demand your attention occasionally, but your relationship with them need not be a struggle. With a proper installation, a little understanding and some simple maintenance, your batteries will live a long and healthy life.

Windy Dankoff

©2001 Dankoff Solar Products, Inc.

# BATTERY CHARGERS

## Solargizer Solar Chargers

Solargizers don't just maintain and clean batteries but also recharge them. It monitors your battery and automatically recharges as needed, turns itself off to avoid over-charging, and at the same time extends battery life with a high frequency pulsation.



**2W, 1/4 Amp Solar Charger**

#PV4182 \$226

**5W, 1/2 Amp Solar Charger**

#PV4183 \$343

**10W, 1 Amp Solar Charger #PV4184 \$636**



performance, efficiency, and long life as the systems. Ideal for construction equipment, trailers. Each unit has 3/8" lug attachments, mounting kit. 10 year warranty.

## Industrial 12V Solargizer

For batteries subjected to greater power demands. The solar panel is virtually indestructible and incorporates the finest quality single grown photovoltaic cell available. The entire unit is weatherproof and easy to install. It's also available with two and three-wire versions for use on parallel battery systems. (While the multiple-wire versions are installation



battery is still the most common and related problems. Connects in parallel with an existing battery only!) The circuit is energized and the battery is ideal for heavy machinery and farm equipment, marine products.

Recover dead and useless batteries, keep your new battery bank alive longer... desulfate and recharge at the same time—and fast, up to 20 amps. Produces an efficient charge while protecting the battery from damage while the pulse technology helps eliminate sulfate buildup. For all 12-volt batteries including gel cell and sealed "maintenance free". One year warranty. You'll see amazing improvements in aging batteries. Keep your car's starting battery working, too. Works with 120 and 240 VAC input.

#PV4185 \$750



## Five Stage Microprocessor Battery Chargers

*Highest quality yet affordable battery chargers to insure the longest battery life*

A multi-stage charging system gently ramps up to the required output charge level and avoids "battery bashing". They charge at a constant current rate until battery voltage reaches the optimum level. At that point the microprocessor continually regulates the voltage until batteries reach 100%. Then it transitions to "Float Mode" trickle charging where it stays for 28 days or returns to "Constant Current Charging" if the batteries go down from being used. A 5-LED display eliminates guessing about battery condition or state of charge. Before beginning the charge cycle, they test for shorted cells, a sulfated battery, a wrong battery type and high internal resistance. Standard features include reverse battery, short circuit, thermal runaway, input and output overload protection. And no problem leaving it connected when not in use - battery drain less than 1 mA.

- Multi-Charge Stages
- Full 3- or 5-LED Display
- Complete Charge Protection
- Slow (soft) Start
- Minimal Loading
- Pre-Qualification Test
- Minimal Loading

**12V, 30 watt #BC8457 \$79**

**24V, 30 watt #BC8460 \$79**

**12V, 720 watt #BC8461 \$141**

**24V, 720 watt #BC8462 \$333**

**36V, 720 watt #BC8463 \$434**

## PowerPulse

A Solargizer without the PV module—] Designed for use with deep cycle batteries in industrial applications like airport ground vehicles, and more. Lead acid batteries and reliability when you need them. They provide greater charge acceptance so they reach optimum voltage. Cool down takes less time. Available for 36, 48, and 72V systems.

**12V #PV4802 \$84**

**24V #PV4609 \$136**





## Battery Cables

Use #4 battery cables with 500 watt inverter or smaller, 2/0 with larger inverters. On L-16s we use 7" cable for series connections and 12" for parallel.

12" #4	#SC116	\$3	24" #4	#SC125	\$5
7" #2/0	#SC117	\$8	7" #4/0	#SC4039	\$10
12" #2/0	#SC118	\$10	12" #4/0	#SC4081	\$12
20" #2/0	#SC119	\$12	24" #4/0	#SC6491	\$15
Stainless Steel Nuts & Bolts			#SC4082	\$38	

## Compression Terminals

Connect large gauge wire without soldering or special tools. Just cut insulation off the end of your cable, put into the terminal, and tighten with a wrench. Solid brass.

#6 wire	#SC950	\$5
#4 wire	#SC951	\$5
#1/0 wire	#SC952	\$6
#2/0 wire	#SC953	\$8.50
#4/0 wire	#SC954	\$8

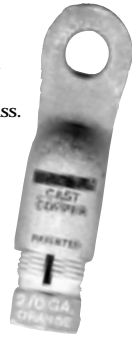

## Quick Connect Battery Terminal

Easily detach cables from battery posts—just twist knob! Makes it easy to move batteries or detach to prevent electrical drain.

#SC3469 \$6



## 8 Gauge to 4/0 Crimping Tool

Make your own battery and inverter cables

Use a hammer or vise with this heavy duty crimping tool and make strong, solderless connections on wire sizes up to 4/0.

<b>Crimping Tool</b>	#SC962	\$29
<b>2/0 Battery Terminals</b>	#SC966	\$0.90
<b>4/0 Battery Terminals</b>	#SC967	\$1.45



## PowerVent

*Simple battery box ventilating*

Automatic ventilation when batteries charging but no cold outside air can enter your battery box! Just attach to PVC vent pipe and the PowerVent's 2.2 watt fan takes over. Requires Simple Switch or Trace sine wave inverter. Great for added safety and warmer batteries.

<b>Power Vent 12V</b>	#FC1478	\$74
<b>Power Vent 24V</b>	#FC1482	\$74
<b>Power Vent 48V</b>	#FC5647	\$124
<b>Simple Switch 12V</b>	#SC1483	\$80
<b>Simple Switch 24V</b>	#SC1484	\$80



## Battery Reconditioner

Restore old batteries, make new ones last longer. Add 4 oz. of this new liquid chemical to each battery cell in a 80lb. golf cart battery. Bigger batteries are going to take more. A 240lb. will take 36 oz. Acts as a buffer to remove sulfation from the plates and as a catalyst to improve efficiency of cycling chemistry. Can enhance performance of older batteries to near-new condition and greatly extend the life-cycles of newer batteries. We've seen dramatic results.

<b>12 oz Bottle</b>	#RB1895	\$16
<b>1 Gallon</b>	#RB911	\$84

## Battery Enclosure

Heavy duty polyethylene, lockable battery box with 5 year warranty. Holds up to four Trojan L16s or up to six Trojan T105 or six Group 27 type batteries. 37" x 23" x 21", 24 lbs.

#BA4817 \$164

## Aeromax Battery Boxes

*A safe and durable housing for your battery bank*

Protects you from corrosive vapors, routine hydrogen emissions as well as unexpected events like a battery meltdown. Helps maintain batteries at their optimum temperature. Manufactured of tough aerospace epoxies, E-glass, and foam insulator core in a 1 1/4" thick wall composite construction. Lid mounted Hydrogen venting system allows for safe and hazard free battery storage for years of contained use at extremely affordable prices. Battery box should never be moved with batteries in box.

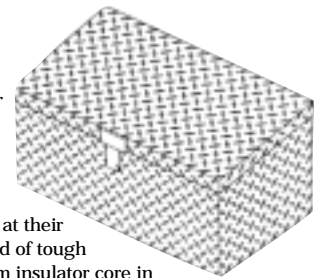

#BA5064—Holds 12 Trojan T-105's	\$360
#BA5065—Holds 12 L-16's	\$599

## Battery Boxes

The Group 27 boxes hold the marine battery style. The first one is co-polymer resin and the second aluminum with a clear powder coat (32" x 14" x 15", 32 lbs.). Both L16 boxes are polyester resin with reinforced fiberglass. 29" x 49" x 14", 60 lbs. and 43" x 51" x 24", 110 lbs.

<b>2 - Group 27</b>	#BA3926	\$100
<b>4 - Group 27</b>	#BA3927	\$266
<b>4 - L16</b>	#BA3928	\$488
<b>8 - L16</b>	#BA3929	\$592

## Hydrocaps

*Stop corrosion and hydrogen build-up*

Hydrocaps catalytically recombine the hydrogen and oxygen gases given off during battery charging and turn them back into pure water for the battery. Reduces the need to refill battery water, extends electrolyte life. Send for special Hydrocap Order Form (#PI4201).

#SC969 \$11

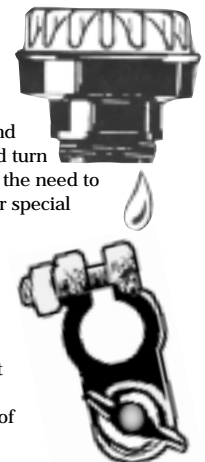

## Battery Terminals

Convert conventional post-type battery to wing-nut connection. Greatly simplifies battery hook-ups in small systems. Just crimp ring terminal on the end of a wire, slip over post and tighten wing nut.

#SC959 \$2

## Charge Controllers

Charge controllers protect your batteries from overcharging. Most of our more popular solar panels have outputs high enough to overcharge your batteries if left unattended. The charge controller automatically disconnects or tapers the incoming voltage as your battery reaches maximum charge. Most models also prevent current from flowing back into your panels at night and draining power out of your batteries. The PWM Difference: PWM = Pulse-Width Modulation. Most solar charge controllers don't do much: when your batteries reach a certain voltage, the charge controller disconnects the PV array to prevent battery damage due to overcharging. Controllers cycle on and off briefly throughout the day. Unfortunately, when they disconnect your array, you're losing energy. PWM controllers offer much more precise control by tapering, rather than shutting off, energy from the PV array. Result? Up to 20% more power from your solar modules! PWM also does a better job assuring that batteries reach their full state of charge potential with less water consumption.

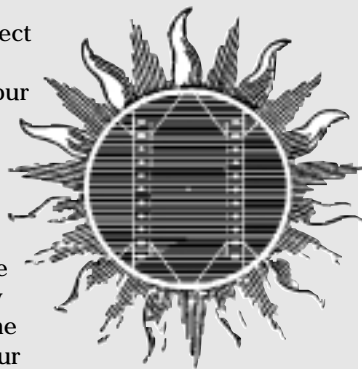

## BZ Charge Controller

PWM charging with maximum controlability. Easy installation, reverse polarity and short circuit protection. Minimizes battery water usage, maximizes charging from your array. Comes with #10 wire leads installed. Completely solid state switching, no relays to wear out. 5 year warranty.



<b>12V adjustable, 8 Amp</b>	<b>#RG5112</b>	<b>\$45</b>
<b>Industrial – 12V adjustable, 16 Amps</b>	<b>#RG5120</b>	<b>\$65</b>
<b>Industrial – 24-32V adjustable, 16 Amps</b>	<b>#RG5122</b>	<b>\$75</b>
<b>Industrial – 48-56V adjustable, 16 Amps</b>	<b>#RG5124</b>	<b>\$85</b>
<b>Plus – 48V fixed, 16 Amp</b>	<b>#RG5127</b>	<b>\$100</b>
<b>Plus – 12-24V adjustable, 32 Amp</b>	<b>#RG5128</b>	<b>\$120</b>
<b>Plus – 48V fixed, 32 Amp</b>	<b>#RG5129</b>	<b>\$140</b>
<b>Panel Meter – 12V fixed</b>	<b>#RG5130</b>	<b>\$40</b>
<b>Panel Meter – 24V fixed</b>	<b>#RG5131</b>	<b>\$45</b>
<b>Panel Meter – 48V fixed</b>	<b>#RG5132</b>	<b>\$50</b>

## Flexcharge NC25A

99.5% efficient, 5-year warranty

A new multi-use charge controller! One economical controller for many different charging sources-PV, hydro, wind, gas generator (handles spike and surges up to 1500VA). Much less expensive than the EnerMax or TDRs. So efficient, it's like adding an extra solar panel for an hour per day. Attach divert feature and use extra power for water heating, a pump, fan, etc. Adjust voltage for different kinds of batteries or different temperatures. Micro equalizing on daily basis, low battery indicator, separate voltage sense wires for most accurate charge regulation. Expandable to hundreds of Amp 5 and available in 12 - 48V configurations.

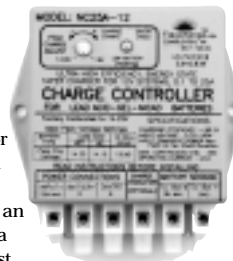

<b>12V 25A w/divert</b>	<b>#RG540</b>	<b>\$137</b>
<b>24V 25A w/divert</b>	<b>#RG2982</b>	<b>\$145</b>
<b>12V 60A</b>	<b>#RG541</b>	<b>\$272</b>
<b>12V 60A w/divert</b>	<b>#RG542</b>	<b>\$345</b>
<b>12V 100A</b>	<b>#RG543</b>	<b>\$360</b>
<b>12V 100A w/divert</b>	<b>#RG544</b>	<b>\$485</b>

## Flexcharge Voltage Regulators

High charging efficiency, precise voltage regulation, easy installation, and small size (2" x1.5" x1") with numerous options. Expandable to handle up to 100 amps of charging current and to simultaneously charge up to 5 isolated battery banks. Add to a diode and use as a charge divert regulator. Starts charging with only 5mA of solar panel output and gains 13-20 watt/hours per day over typical 8 amp regulators. Accepts multiple charging sources (with expanded option only) like a combination of solar panels, wind generator, and outboard motor all charging simultaneously and still only takes 5mA for the system. Use the PV7D for dual battery bank systems.

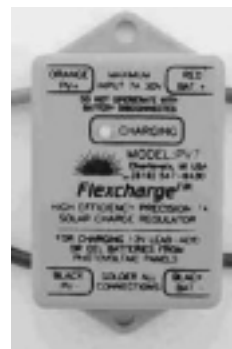

<b>PV7-12V</b>	<b>#RG3787</b>	<b>\$67</b>	<b>PV7-24V</b>	<b>#RG3789</b>	<b>\$66</b>
<b>PV7D-12V</b>	<b>#RG3788</b>	<b>\$78</b>	<b>PV7D-24V</b>	<b>#RG3790</b>	<b>\$78</b>

## Prostar Controllers

Microprocessor controlled pulse width modulation (RG1489 only), industrial rated components for highest reliability and efficiency. Deluxe models have PV & load disconnect, LCD metering, alarm, lighting control, 2 prioritized LVDs. Auto 12/24V.



- LCD meters • Temperature comp
- PV & load disconnect • Low battery disconnect
- Automatic equalization

<b>6 Amp, 12V PWM</b>	<b>#RG1489</b>	<b>\$55</b>
<b>6 Amp, 12V PWM w/LVD</b>	<b>#RG3197</b>	<b>\$60</b>
<b>12 Amp</b>	<b>#RG771</b>	<b>\$120</b>
<b>20 Amp</b>	<b>#RG772</b>	<b>\$145</b>
<b>30 Amp</b>	<b>#RG773</b>	<b>\$175</b>
<b>12 Amp Deluxe</b>	<b>#RG774</b>	<b>\$212</b>
<b>20 Amp Deluxe</b>	<b>#RG775</b>	<b>\$220</b>
<b>30 Amp Deluxe</b>	<b>#RG776</b>	<b>\$250</b>

## SunSaver 20 Amp Controller with LVD

#RG6615 \$100

## 5 Amp Charge Controller

#RG6269 \$29





## Heliotrope - 30 Amp Controllers

*High quality regulators, numerous features, perfect for RV's*

These controllers have almost everything - pulse width modulation "taper" charge, selectable 12 or 24V from 13.2 to 28.4V DC in 0.2 volt increments, selectable auto-equalize or auto-float, battery temperature compensation, LED status for charging, charged or overtemp, LCD for battery voltage, solar amps. Dual battery bank charging with RV-30D - two charge controllers in one! Shunts not included.

<b>Basic controller</b>	<b>#RG8405</b>	<b>\$225</b>
<b>Dual Battery controller</b>	<b>#RG8407</b>	<b>\$260</b>

### Keep your system running smoothly with these great features:

- 1) Pulse Width Modulation "Taper" Charge Strategy - maintains batteries at the highest state-of-charge with the least amount of battery water consumption.
- 2) Selectable State-of Charge - 12 or 24 VDC operation. Set anywhere from 13.2 VDC to 14.2VDC in 0.2 volt increments (double these values for 24 volt setting).
- 3) Selectable "Auto-Equalize" or "Auto-Float" - choose "equalize" for flooded lead-acid batteries, OR, choose "float" for sealed lead-acid batteries (like "absorbed glass mat" or "Gel" batteries).
- 4) Battery Temperature Compensation - automatically adjusts charge setpoint with included, external sensor and helps prevent excess water loss or plate sulfation build-up.
- 5) Light Emitting Diodes - gives "at-a-glance" system status: "charging", "charged" or "overtemp".
- 6) Liquid Crystal Display - gives digital readout of battery voltage, solar charging amps, and optional Net Amps via a 3-position switch.
- 7) Optional Net Amps (only on RV-30SE) - utilizing an optional "shunt", the net amperage entering or leaving the batteries can be displayed.

- 8) Dual Battery Bank Charging (only on RV-30D) - allows simultaneous charging of both the "cranking" and "house" battery banks. Literally

Two charge controllers in one!  
The RV-30D is only available in 12V DC version.

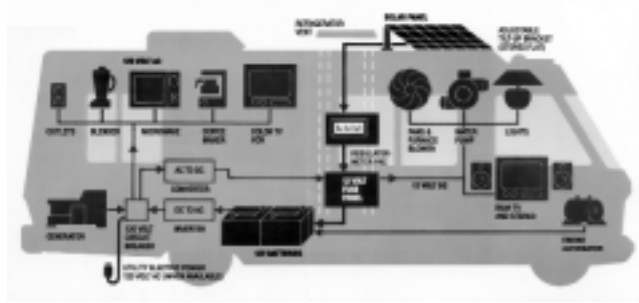

## Solar Guard

Handy combination meter and charge controller ideal for boats, and small houses. 14 amp charge controller with easy-to-read, expanded scale, 2% accuracy amp and volt meters. Extra terminal for trickle charging a secondary battery bank. Flush or surface mount. User adjustable setpoints, surge protection, automatic battery equalization, schottky blocking diode. 2 year warranty.

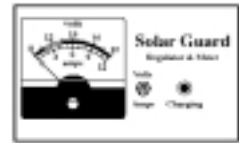

**#RG4150 \$139**

## Dual-Battery Charge Controllers

8 or 16 amp regulators charge and protect two independent battery banks from a single solar source.

<b>8 Amp</b>	<b>#RG202</b>	<b>\$99</b>
<b>16 Amp</b>	<b>#RG203</b>	<b>\$152</b>

## Start your own utility company!

In many places and although there's a tremendous need, people can't afford to buy and install a complete solar electric system. They can afford the \$5 to \$10 a month they're paying for kerosene and flashlight batteries though. The Sun Cash lets you set up a solar system for a remote home or a small village and charge a monthly fee based on useage. People can have as much electricity as they can afford and you will create personal income and new jobs!

**#RG7978 \$235**



## SHS Load/Charge Controllers

Make your own solar charge controllers. A great microbusiness or simple way to avoid high duty for importing a finished product. Designed with the most remote location in mind - every effort to make this as durable and "bullet-proof" as possible.

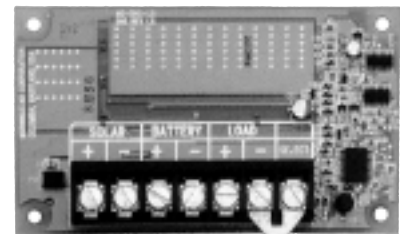

Combines the proven SunSaver design with a microcontroller for automatic system protection capabilities. High quality LED indicators provide maximum reliability, with short circuit and reverse polarity protection and high overload capability of 1.25.100% solid state, featuring temperature compensated and highly accurate setpoints. Designed for local integration into the system battery box and to World Bank specifications.

<b>6.5 amps solar/10 amps load</b>	<b>#RG7482</b>	<b>\$66</b>
<b>10 amps solar/15 amps load</b>	<b>#RG7483</b>	<b>\$75</b>

# VOLTAGE REGULATORS

## Trace Charge Controllers

Optimize your battery charging by using Trace's C40 and C12 charge controllers. Pulse-width modulation controller utilizes a 3-stage charging technology for optimum battery charging. C40 also automatically equalizes batteries each month, has LEDs that show no-power, active array, normal or equalization charging, and load diversion for use with wind and hydro systems. Optional digital meter shows volts, amps and amp-hours.

The Trace C12 is similar to the C40, but offers smaller 12A capacity, low voltage disconnect, automatic timer, and auto battery equalization. The C12 also offers a unique auto on at dusk, off at dawn lighting control with adjustable timer. Perfect for small systems, outdoor area and sign lighting, telecommunications. 12V only.

The classic Trace C30A charge controller handles up to 30 amps and works with either 12 or 24V systems, and it offers manually controlled battery equalization. C30 is an adjustable low-voltage disconnect and good for automatic generator starting. Remote Meter Kits For C40 are equipped with 4" square faceplate which fits a standard electrical box.

<b>C40 - 40A, 12-48V</b>	<b>#RG1379</b>	<b>\$195</b>
<b>C35 - 12/24V, 35 amps</b>	<b>#RG4753</b>	<b>\$160</b>
<b>C60 - 12/24V, 60 amps</b>	<b>#RG7666</b>	<b>\$232</b>



## Lyncom PV20 regulator

*State of the art charge controllers that don't break the bank! Lyncom's 3 series of controllers will cover any PV need.*

All have the following standard features:

- Low voltage disconnect for loads (except "C" models)
- Pulse Width Modulation for optimum charging
- Reverse Polarity Protection
- Temperature Compensation
- Lightning Transient Protection
- Selection of battery type between flooded and sealed.
- Name identifies Amp Capacity, followed by a letter code:
  - "C" : charge only, no low voltage disconnect.
  - "T": includes a timer circuit ideal for lighting systems.
  - "M": digital meter that reads battery voltage, PV current and load current.

SR series is the entry level, best for 1 or 2 panel systems. PV series adds an on-board microprocessor, over-temperature protection and overvoltage protection. The N series adds load short-circuit protection, auto battery equalization (for flooded battery) and 12/24 volt Auto Select.

<b>SR7</b>	<b>#RG6591</b>	<b>\$47</b>
<b>SR7C</b>	<b>#RG6592</b>	<b>\$41</b>
<b>SR12</b>	<b>#RG6593</b>	<b>\$54</b>
<b>SR12C</b>	<b>#RG6594</b>	<b>\$47</b>
<b>SR12M</b>	<b>#RG6595</b>	<b>\$98</b>
<b>PV12</b>	<b>#RG6596</b>	<b>\$65</b>
<b>PV20</b>	<b>#RG6597</b>	<b>\$98</b>
<b>PV12T</b>	<b>#RG6598</b>	<b>\$88</b>
<b>PV20T</b>	<b>#RG6599</b>	<b>\$108</b>
<b>PV12M</b>	<b>#RG6600</b>	<b>\$124</b>
<b>PV20M</b>	<b>#RG6601</b>	<b>\$152</b>
<b>N25</b>	<b>#RG6602</b>	<b>\$126</b>
<b>N25M</b>	<b>#RG6603</b>	<b>\$166</b>
<b>N25T</b>	<b>#RG6604</b>	<b>\$155</b>
<b>N35</b>	<b>#RG6605</b>	<b>\$166</b>
<b>N35M</b>	<b>#RG6606</b>	<b>\$186</b>

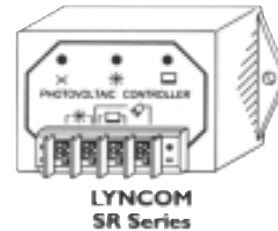

## Accessories:

<b>Face Plate Meter Kit for C40</b>	<b>#RG1429</b>	<b>\$90</b>
<b>50' Remote Meter - C40</b>	<b>#RG1752</b>	<b>\$115</b>
<b>100' Remote Meter - C40</b>	<b>#RG1753</b>	<b>\$135</b>
<b>Power Panel-Face Plate Meter (Installed)</b>	<b>#RG4503</b>	<b>\$90</b>

## Digital Meter

Displays volts/amps. Mounts to front of C40/C60 controllers.

<b>Digital Meter</b>	<b>#RG1429</b>	<b>\$90</b>
<b>Remote Display for C40, C50</b>	<b>#RG4755</b>	<b>\$115</b>

*"About two years ago or more we bought a Trace C30A charge regulator from you. We are missionaries living in the jungle and depend completely upon solar power for lights, tape recorders, desktop computers etc. The Trace charger has performed flawlessly even in this steamy tropical climate".*

*-GT, Bukidnon, Philippines*

## EnerMaxer III

*Universal Voltage Controller*

Keeps batteries safe when charged by any combination of wind, hydro, PV, or gas generator. Provides ideal taper charge and maintains float voltage accuracy within .1 volt. Adjust voltage to the type, age, and condition of your batteries for maximum life. Diverts extra power when battery reaches optimum voltage—no wasted power! Requires diversion load (water heater, pump, fans, etc.). 12, 24, 32, or 36 volt charging systems up to 50 amps.

<b>Universal Voltage Controller: 60A, 48V</b>	<b>#RG6319</b>	<b>\$390</b>
<b>Water Heating Elements: 50/25A, 12 or 24V</b>	<b>#RG3583</b>	<b>\$116</b>



## Power Tracking Charge Controllers

MPPT controllers extract additional power from your PV array, under certain conditions. They work in a way similar to a transmission in a car. When the transmission is in the wrong gear, the wheels do not receive maximum power. That's because the engine is running either slower or faster than its ideal speed range. The purpose of the transmission is to couple the engine to the wheels in a way that lets the engine run in a favorable speed range in spite of varying acceleration and terrain.

Let's compare a PV module to a car engine. Its voltage is analogous to engine speed. Its ideal voltage is that at which it can put out maximum power. This is called its maximum power point. (It's also called peak power voltage, abbreviated  $V_{pp}$ ).  $V_{pp}$  varies with sunlight intensity and with solar cell temperature. The voltage of the battery is analogous to the speed of the car's wheels. It varies with battery state of charge, and with the loads on the system (any appliances and lights that may be on). For a 12V system, it varies from about 11 to 14.5V. In order to charge a battery (increase its voltage), the PV module must apply a voltage that is higher than that of the battery. If the PV module's  $V_{pp}$  is just slightly below the battery voltage, then the current drops nearly to zero (like an engine turning slower than the wheels). So, to play it safe, typical PV modules are made with a  $V_{pp}$  of around 17V when measured at a cell temperature of 25°C. They do that because it will drop to around 15V on a very hot day. However, on a very cold day, it can rise to 18V!

What happens when the  $V_{pp}$  is much higher than the voltage of the battery? The module voltage is dragged down to a lower-than-ideal voltage. Traditional charge controllers transfer the PV current directly to the battery, giving you NO benefit from this added potential. Now, let's make one more analogy. The car's transmission varies the ratio between speed and torque. At low gear, the speed of the wheels is reduced and the torque is increased, right? Likewise, the MPPT varies the ratio between the voltage and current delivered to the battery, in order to deliver maximum power. If there is excess voltage available from the PV, then it converts that to additional current to the battery. Furthermore, it is like an automatic transmission. As the  $V_{pp}$  of the PV array varies with temperature and other conditions, it "tracks" this variance and adjusts the ratio accordingly. Thus it is called a Maximum Power Point Tracker.

What advantage does MPPT give in the real world? That depends on your array, your climate, and your seasonal load pattern. It gives you an effective current boost only when the  $V_{pp}$  is more than about 1V higher than the battery voltage. In hot weather, this may not be the case unless the batteries are low in charge. In cold weather however, the  $V_{pp}$  can rise to 18V. If your energy use is greatest in the winter (typical in most homes) and you have cold winter weather, then you can gain a substantial boost in energy when you need it the most!

Here is an example of MPPT action on a cold winter day: outside temperature is 20°F (-7°C), wind is blowing a bit, so the PV cell temperature rises to only around 32°F (0°C).  $V_{pp}$  = 18V. Batteries are a bit low, and loads are on, so battery voltage = 12.0. Ratio of  $V_{pp}$  to battery voltage is 18:12 = 1.5:1. Under these conditions, a theoretically perfect MPPT (with no voltage drop in the array circuit) would deliver a 50% increase in charge current! In reality, there are losses in the conversion just as there is friction in a car's transmission. Reports from the field indicate typical increases of 20 to 30%.

Windy Dankoff. ©2001 Dankoff Solar Products, Inc.

## MPPT Charge Controllers

*Maximum Power Point Tracking: the next step in charge controllers*

Panels operate at 17V, charging batteries at 14V. This loss in voltage transfers into a loss of efficiency. MPPT varies the charging voltage and current for maximum efficiency -over 33% increase in charge current under normal conditions. Use a higher voltage array (and smaller wire) with a lower voltage battery bank. An essential component when your house is in the shade and you have to install solar panels far away. Other combinations are available, call for details.



<b>12 or 24V array, 12V, 15 Amp output</b>	<b>#RG5680</b>	<b>\$220</b>
<b>12 or 24V array, 12V, 30 Amp output</b>	<b>#RG5668</b>	<b>\$386</b>
<b>12 or 24V array, 12V, 60 Amp output</b>	<b>#RG5748</b>	<b>\$475</b>
<b>36 or 48V array, 24V, 8 Amp output</b>	<b>#RG5681</b>	<b>\$255</b>
<b>36 or 48V array, 24V, 20 Amp output</b>	<b>#RG5672</b>	<b>\$410</b>
<b>36 or 48V array, 24V, 40 Amp output</b>	<b>#RG5749</b>	<b>\$500</b>

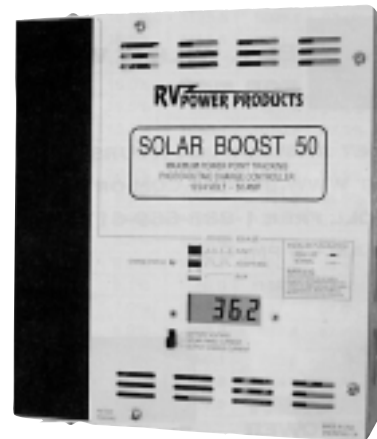

## SolarBoost 50

*More Power!*

Maximize your power production with this MPPT (maximum power point tracking) controller. Most PV panels produce 17V, but a full battery rarely goes above 13V. With most charge controllers, you lose this 4V potential. MPPT electronically "trades" higher voltage for higher amperage. More power actually makes it into your batteries. The SolarBoost can also change voltage from a 24V solar array to a 12V battery bank. Use your 12V appliances even if you expand to a large solar array! Higher voltage means smaller (and less costly) wire size. Good sized housing gives plenty of room to wire and will accept up to 1/0 guage. Makes installation a breeze. Rated at 50 amps after boost, so maximum array size is 40 amps@24V. Highly recommended. 12/24 V DC.

<b>SolarBoost 50</b>	<b>#RG8314</b>	<b>\$399</b>
<b>w/digital display</b>	<b>#RG8316</b>	<b>\$469</b>
<b>SolarBoost 2000 21A, 12V</b>	<b>#RG8317</b>	<b>\$249</b>
<b>SolarBoost 50 - 30A, 48V</b>	<b>#RG8318</b>	<b>\$549</b>
<b>Temperature Compensation probe</b>	<b>#RG8364</b>	<b>\$39</b>

# VOLTAGE REGULATORS

## Tri-Metric Meter

*The most information for the lowest cost*

Translating battery voltage into battery state of charge—a difficult task. What voltage means varies based on temperature, time since last charge or discharge, if charging or discharging, and with rate of charge or discharge. The Tri-Metric meter solves this mystery. It adds amps you generate and subtracts amps you use giving an extremely accurate state of charge. Also gives volts, amps, when system charging, and if system reaches full charge voltage. 12 to 48V. Highly recommended. Shunts required. Accurate to 1%, 4.75" high.



<b>Tri-Metric Meter</b>	<b>#MT450</b>	<b>\$165</b>
<b>100 Amp Shunt</b>	<b>#MT311</b>	<b>\$26</b>
<b>300 Amp Shunt</b>	<b>#MT6332</b>	<b>\$35</b>
<b>500 Amp Shunt</b>	<b>#MT312</b>	<b>\$35</b>
<b>1000 Amp Shunt</b>	<b>#MT6334</b>	<b>\$72</b>
<b>Wiremold Double Gang Box</b>	<b>#MT6335</b>	<b>\$13</b>

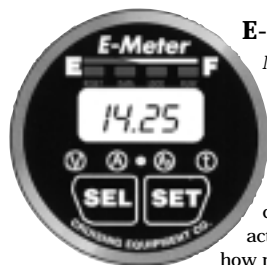
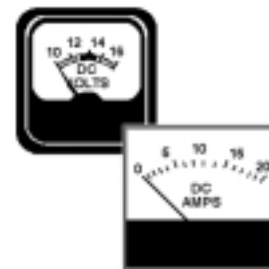

## E-Meter

*New reading as a % of charge with digital precision*

A breakthrough in versatility, information and cost. Complete, accurate (99.95%) data on your battery bank. Displays amp-hours, volts, amps, kilowatt-hours, state of charge, consumption rate, and more. Also acts as a digital ammeter, letting you know how much power each DC load draws. Optional

RS-232 computer output. For 12-36V systems (\$90 extra for 48V+) 0-50V, requires 500 amp shunt. Excellent all-around meter which we highly recommend!

**#MT470 \$194**

## Battery Energy % Gauge

Portable percentage meter lets you instantly measure how long your battery power will last, when you need to recharge, and how long to recharge. Just attach clamp to negative, touch red probe to positive and read fuel-gauge type scale. 12V.

**#MT200 \$24**



## Digital System Monitor

Instant feedback on system performance—amps in, amps out, and battery voltage. Positive or negative display tells if inverter is in battery charger or inverter mode. Mounts in standard electrical box and only uses .005 amps. Add \$6 for surface mount enclosure and order appropriate shunt. Use 7 conductor 22 gauge cable between Vista 3 and shunt. Shunt assemblies include two shunts, copper bus-bar connector, and bolts.



<b>Digital System Monitor</b>	<b>#MT114</b>	<b>\$175</b>
<b>Surface Mount Enclosure</b>	<b>#MT120</b>	<b>\$6</b>
<b>100 Amp Shunt</b>	<b>#MT122</b>	<b>\$65</b>
<b>200 Amp Shunt</b>	<b>#MT123</b>	<b>\$99</b>
<b>500 Amp Shunt</b>	<b>#MT119</b>	<b>\$65</b>

## FAQ's—PV

**Q. How much PV do I need for my house?**

**A. How much PV you need depends on your power loads and their duty cycles. If you wanted to completely replace your current electrical purchases from the utility company with a PV system, you could look at your kWh usage on your electric bills for a year, calculate a daily average, and divide that by the number of average daily sun hours for your location. (3600 kWh/yr divided by 365 days/yr equals approximately 10 kWh/day, divided by 5 sun-hours per day (for locations in middle America), equals 2 kW. This would indicate that a 2-kW system would, over the course of an average year, produce enough energy to replace the power you are currently using. However, if you design an energy efficient home, you could cut the annual electricity usage dramatically, reducing the size of the system. In the real world, the majority of home systems range from 1 kW to 2 kW. Where you live, if you are on the grid or off, and how you live, will dictate the size of your system and its ultimate cost and value.**

**Q. How long will PV last?**

**A. PV modules have been tested in controlled settings and in the field, with results showing module lifetimes in excess of 20 years. Other system components have varied lifetimes (batteries can last 2-15 years, and power electronics are the most sensitive components).**

—Mark Fitzgerald

*"Thanks for all the help you have been to me in the past. I have been very satisfied with everything I've gotten from you, as well as your prompt, efficient service."*

— GC, Burkina Faso

**12/24 Digital Voltmeter**

Measures system voltage. 1% accuracy! Easy 2-wire hookup. Consumes just 0.008 amps. 40V max. 9.5-36V, 3" x 2" x 1.5".

#MT151 \$48



**Digital Amp Meter**

Easy, accurate reading of amps in or out of your system. Includes 100A/100mV shunt. Requires 4 conductor wire, 3" x 2" x 1". 12 or 24V.

#MT3101 \$74

**Digital Kilowatt Hour Meter**

Measure AC kW/hrs. consumed or delivered. Also records peak kilowatts. Easy to use. Maximum power it can measure is 1800 watts.

#MT4758 \$159

**Battery Capacity Meter**

See battery condition at a glance

Automatically translates voltage into a figure for % of charge. Colored LED scale makes it quick and easy to see battery condition. Different colors signify different percentage of charge while a flashing red LED on the bottom signals low battery, a flashing green on the top float charge, and a flashing red on the top equalization charge. Calibrated to better than 0.5% accuracy. Includes Velcro strips for mounting, 5' of cable and battery terminal rings. 2" x 4."

12V BCM #MT222 \$47

24V BCM #MT3179 \$47

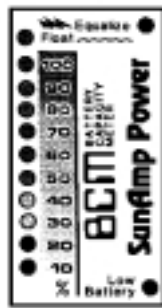

**Watts Up? Meter**

*Sizing without guess work*

Costs for an alternative energy system directly correlate to the amount of power your appliances use. If you estimate too high, you wind up spending much more than necessary. If you estimate too low, you will run out of power—often at inconvenient times! Determining your power usage gets difficult because manufacturers frequently use watt or amp ratings much higher than actual. And appliances like refrigerators automatically turn on and off during the day. Just plug your AC load into this meter and discover the accurate numbers. Watts Up? measures loads between 20 and 1800 watts.

#MT3531 \$119

See page 14 for color pictures in use.

**VA Meter**

Know what your renewable energy system is doing. Displays operating voltages up to 30V DC, and current to 30 amps. Also monitors battery bank and tells you when batteries are fully charged. Bright LDC readout changes every two seconds between volts and amps. Highest quality components, 10 year limited warranty.

#MT5134 \$129

**OmniMeter+**

*Every metering, monitor, and logging feature possible plus charge and load control*

A powerful computer that tells you everything you need to know about your power system and more. Answers questions like, "How full is my battery, how fast is it charging or discharging, what was the voltage last night at 2 AM?," etc. Also includes load control and a computerized charge controller that customizes for any battery at any temperature at any charge rate, even hundreds of amps! Use a modem to "talk" to your system while away or for us to troubleshoot for you. The OmniMeter has too many features to list here—request our free flyer for more details. 10-60V DC.

#MT111 \$783

**OmniLink+**

#MT112 \$150

**OmniLarm**

#MT113 \$77



**Prewired Meter Kit**

The basic information you need to know about your system all

in one attractive, easy to read, simple to install package. Specify wall or flush mount, 12/24V, maximum amps: 10, 15, 20, 30.

Flush Mount #MT812 \$66

Wall Mount #MT813 \$72

**Meter Lights**

Tired of trying to read your meters in the dark? Try these state of the art electroluminescent lights. Uses any input from 3-18V DC and as little as 6 mA's. One inverter can power up to three meter lights.

1.5" Light #MT5909 \$18

2.5" Light #MT5910 \$18

3.5" Light #MT5911 \$18

4.5" Light #MT5912 \$18

Inverter #MT5908 \$18

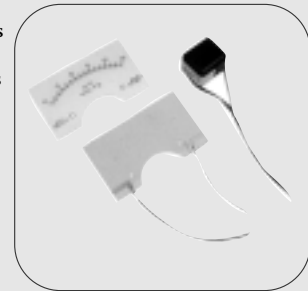

**Dual Deflection Ammeters**

Just hang these induction meters on electrical wire and read amperage. No need for direct electrical connection. Shows both power drawn off and put in on a zero-center scale. 75-0-75 meter also shows 400-0-400, Direct read need inline installation.

**Dual Deflection**

35-0-35 #MT141 \$24

60-0-60 #MT1406 \$25

75-0-75 #MT140 \$27

**Direct Read**

20-0-20 #MT1266 \$19

30-0-30 #MT4044 \$22

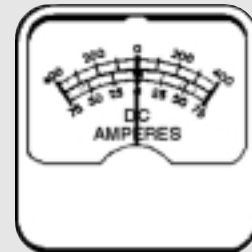

# SYSTEM COMPONENTS

## 16 Amp Low Voltage Disconnects

Nothing kills a battery faster than over-discharging it. You can ride herd on over-discharging with a meter, or you can let this little box do it for you. Connect up to 16 amps of 12V DC load through it. When the battery gets to 11 volts LVD, disconnect the load. When it recharges to 12.4 volts, the load comes back on. Many inverters have this protection built in, and so do some high end charge controllers. If you don't have those, this is an inexpensive way to keep your batteries healthy for a longer time.

<b>16 Amp IVD, 12V – Preset Points</b>	<b>#SC5582</b>	<b>\$71</b>
<b>16 Amp IVD, 12V – Tunable</b>	<b>#SC5817</b>	<b>\$88</b>
<b>16 Amp IVD, 24V – Preset Points</b>	<b>#SC5583</b>	<b>\$70</b>
<b>16 Amp IVD, 24V – Tunable</b>	<b>#SC5586</b>	<b>\$88</b>



## 12V Extension Cords

Clamp these heavy clips to 12V battery terminals and run the DC receptacle up to 10' away. Great for a quick light, TV, radio, or appliance. Also available with cigarette lighter receptacle instead of clips and 15' cord or with a 15' coiled and retractable cord.

<b>10' Cord w/clips, 10 Amps</b>	<b>#SC300</b>	<b>\$11</b>
<b>15' Coiled Cord w/DC receptacle, 13 Amps</b>	<b>#SC302</b>	<b>\$10</b>

## Module Interconnect Cable Assemblies

The proper module connection greatly increases system reliability and performance - especially in severe climates. These pre-assembled interconnects have tin-plated copper fork terminals for a #10 stud, crimped and soldered to #10 AWG stranded copper wire with adhesive "melt-wall" shrink tubing heat sealed over the crimp connection. All cables have UL type TC, 600V, 90-degree C ratings and a black PVC sunlight resistant jacket. They include corrosion resistant, non-metallic, liquid-tight cable strain relief connectors for 1/2 inch KO (KC Series) and are PG 13. Overall lengths pre-sized for best appearance. Two-wire cable assemblies have red and black conductors used for 12V system parallel connections and series/parallel connections on 24V or 48V systems. Three-wire assemblies have red/black/blue conductors, typically used for a 24V series/parallel connection of last module in a 4-panel assembly. Single conductor cables have type XLP, typically used for series connections on pole mounted arrays. Model numbers indicated as AWG - conductor and length (in inches).

<b>Kyocera single conductor 10-1 x 30R</b>	<b>#SC8697</b>	<b>\$22</b>
<b>Kyocera single conductor 10-1 x 30B</b>	<b>#SC8698</b>	<b>\$22</b>
<b>Kyocera double conductor 10-2 x 30</b>	<b>#SC8700</b>	<b>\$22</b>
<b>Kyocera triple conductor 10-3 x 30</b>	<b>#SC8701</b>	<b>\$29</b>
<b>Uni-Solar double conductor 10-2 x 22</b>	<b>#SC8702</b>	<b>\$19</b>
<b>Uni-Solar triple conductor 10-3 x 22</b>	<b>#SC8703</b>	<b>\$20</b>
<b>Uni-Solar single conductor 10-1 x 34R</b>	<b>#SC8704</b>	<b>\$20</b>
<b>Uni-Solar single conductor 10-1 x 34B</b>	<b>#SC8705</b>	<b>\$20</b>
<b>Uni-Solar double conductor 10-2 x 34</b>	<b>#SC8706</b>	<b>\$20</b>
<b>Uni-Solar triple conductor 10-3 x 34</b>	<b>#SC8707</b>	<b>\$22</b>
<b>PowerValue double conductor 10-2 x 26</b>	<b>#SC8708</b>	<b>\$21</b>
<b>PowerValue triple conductor 10-3 x 26</b>	<b>#SC8709</b>	<b>\$26</b>
<b>PowerValue double conductor 10-2 x 30</b>	<b>#SC8710</b>	<b>\$20</b>
<b>PowerValue triple conductor 10-3 x 30</b>	<b>#SC8711</b>	<b>\$21</b>
<b>KC Series double conductor 10-2 x 30</b>	<b>#SC8712</b>	<b>\$31</b>
<b>KC Series triple conductor 10-3 x 30</b>	<b>#SC8713</b>	<b>\$31</b>

## DC Dimmer & Heater Control

Set just the right amount of power for lights and heating elements while maintaining 98% efficiency on all settings. Includes on-off switch plus continuously adjustable voltage control. Wall plate mount for easy installation (ivory color standard). 24-volt and 24-to-12 volt versions are also available at no extra charge: Please specify when ordering. Plug-in (cigarette lighter outlet) versions also available, for an additional cost.

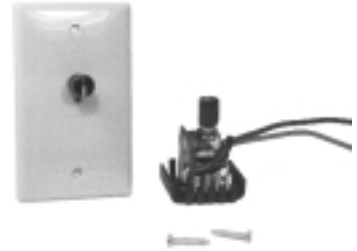

<b>4 Amps</b>	<b>#SC984</b>	<b>\$39</b>
<b>8 Amps</b>	<b>#SC985</b>	<b>\$45</b>
<b>9.5 Amps</b>	<b>#SC986</b>	<b>\$48</b>
<b>11 Amps</b>	<b>#SC987</b>	<b>\$54</b>

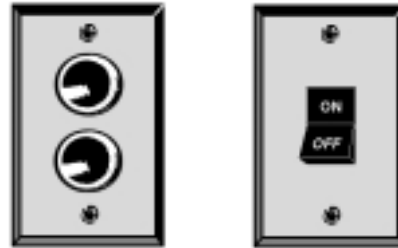

## SDC Outlets & Switches

Switches made for 120 vac carbon up when used in DC systems. You lose power and switches eventually stop working. With inverter systems that also use DC equipment, it's essential to keep the different voltages separate - you don't want to plug a DC light into a 120 vac receptacle! These car cigarette lighter type outlets prevent un-DC-educated visitors from burning things up. Use the plastic, less expensive versions for light loads. The metal versions have ivory coatings, a UL rated switch (in versions with a switch), and all-soldered, electrically insulated components. The metal receptacles are rated for 10A at 12V and the switches for 15A at 12 or 24V.

<b>Single Receptacle plastic</b>	<b>#SC200</b>	<b>\$6.50</b>
<b>Single Receptacle metal</b>	<b>#SC8972</b>	<b>\$12</b>
<b>Double Receptacle metal</b>	<b>#SC8940</b>	<b>\$18</b>
<b>Single Switch plastic</b>	<b>#SY7650</b>	<b>\$5.50</b>
<b>Single Switch metal</b>	<b>#SC8973</b>	<b>\$8</b>
<b>Double Pull/Double Throw</b>	<b>#SC203</b>	<b>\$11</b>
<b>Receptacle/Switch Combo</b>	<b>#SC8974</b>	<b>\$18</b>

## Universal 4-Way Adapter

Adapts from cigarette lighter receptacle to the 4 most common jack styles.

<b>#SC3474</b>	<b>\$4.50</b>
----------------	---------------

## Double Outlet

Plug into a 12V receptacle with two different appliances.

18 gauge wire. 8 amps maximum.

<b>#SC304</b>	<b>\$7</b>
---------------	------------

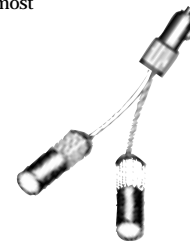

*"I'm very impressed with the broad scope you have on how to use technology for the planet. I know that the only way people are going to be able to keep living on this planet in the future is if we stop polluting and wasting, and start living in sync with nature."*

- Gaelan Brown



## Inverter Cables

An inverter loses much of its rated power without the proper cable connecting it to your battery system. Use #4 wire for 12V inverters up to 800 watts (up to 5'), 2/0 for inverters rated up to 1700 watts, 4/0 for 2500 watt inverters and 6/0 for larger sizes. Use the UL rated version if you have a strict code inspector.

UL 2/0	#SC5276	\$5
UL 4/0	#SC5248	\$6
4/0 5' pair w/400 Amp fuse	#SC133	\$139
UL 4/0 5' pair w/400 Amp fuse	#SC5703	\$190
4/0 10' pair w/400 Amp fuse	#SC5702	\$166
UL 4/0 10' pair w/400 Amp fuse	#SC5706	\$266
4/0 5' pair – no fuse	#SC5700	\$44
UL 4/0 5' pair – no fuse	#SC5704	\$94
4/0 10' pair – no fuse	#SC5701	\$76
UL 4/0 10' – no fuse	#SC5705	\$176
2/0 5' pair w/200 amp fuse	#IN135	\$104
2/0 5' pair – no fuse	#SC5709	\$60
UL 2/0 5' – w/200A fuse	#SC5710	\$134
UL 2/0 5' pair – no fuse	#SC5713	\$90
2/0 10' pair w/200 amp fuse	#SC5707	\$138
2/0 10' pair – no fuse	#SC5708	\$88
UL 2/0 10' pair w/200A fuse	#SC5711	\$198
UL 2/0 10' pair – no fuse	#SC5712	\$148

## Battery, Inverter, Powercenter Cable

Big, heavy, multi-stranded copper wire for connecting batteries, inverters, disconnects, and powercenters. Thick insulation resists grease, oil, gas, and movement.

2/0	#SC143	\$5
4/0	#SC144	\$4.50
6/0	#SC145	\$7.75

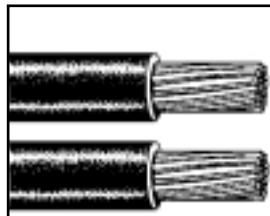

## Diodes

By-pass diodes for 24V+ photovoltaic systems. Protects output from shaded or damaged modules in a series string. Blocking diodes to prevent current from going the wrong way (i.e. from the batteries back into the night sky).

By-Pass Diode For Kyocera LA-51	#PV2914	\$6
By-Pass Diodes for Solarjack SJ-5100	#PV2915	\$6
By-Pass Diode for Uni-Solar US32/42/64	#PV2916	\$6
3 Amp Blocking Diode & Fuse (5A)	#PV2917	\$22
Schottky 10 Amp Blocking Diode	#SC900	\$14
Schottky 60 Amp Blocking Diode	#SC902	\$28

## PV to Battery Wire

Low voltage requires larger wire than typical 115 vac wire runs. Because larger wire is harder to work with, we recommend using this multi-stranded wire rated for outdoor, under water, and direct burial. Specify red or black for single conductor.

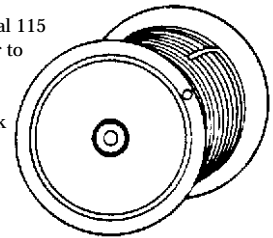

# 4	#SC100	\$0.95
# 2	#SC101	\$1.45
# 12/2	#SC102	\$ .48
# 10/2	#SC103	\$ .72
# 8/2	#SC104	\$1.60
# 6/2	#SC105	\$1.92

## Meter Wire

Six conductor twisted-pair copper wire for Trimetric and Amp-Hour Plus meters. Use 22 gauge to mount a meter up to 50' from your battery bank, the 18 gauge for up to 150'.

18 gauge	#SC141	\$ .65
22 gauge	#SC142	\$ .45

## Submersible Pump Wire

10/3	#WP3221	\$1.24
------	---------	--------



## 110 vac Plug to 12V DC Adapter

Convert standard AC table lamps to 12V using this simple plug and a 12V bulb. Use with AC fixtures up to 15 amps.

#SC306	\$3
--------	-----

## 12V Replacement Plugs

Includes two solderless terminals—just crimp and push in plug.

#SC322	\$1.50
--------	--------

## 3-Prong DC Plugs & Receptacles

NEC approved for low voltage, fit standard wiring boxes and receptacle covers, 15 amp rating. Stronger, more secure connection than the cigarette lighter type. Different prong configuration than both regular 117 vac plugs and the 240V 20 amp plugs common on power tools.

Plug	#SC451	\$8
Receptacle	#SC452	\$7.50

## Atex 12V Soldering Irons

Most soldering irons take 2-3 minutes to heat up but this high quality English version is ready in 45 seconds. Comes with battery clips, slim, cool handle with rubber finger grips, and long-life, iron plated tip. Uses 2.2 amps.

#SC910	\$39
--------	------

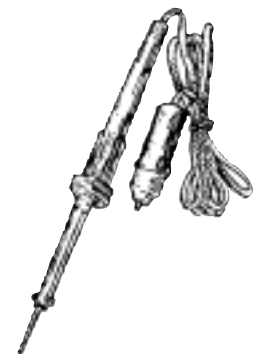

*"Congratulations! I'm really glad to know there are people like you. I think very close to you. Your thoughts and attitude are rare and if a small part of the mankind were like you, we would be living in a different and much better world."*

- Marco Lzcio - Brazil

# SYSTEM COMPONENTS



## Power Centers Guaranteed to Pass Building Inspections!

Pulse took their power center technology, teamed up with Trace and came up with these new, state-of-the-art products. UL listed and designed for single and dual Trace SW or DR inverters, they install in as little as 30 minutes and take the guesswork out of designing and installing an alternative energy system. They pay for themselves in reduced installation time and cost: no mistakes! All your PV system controls, metering and overcurrent protection combined in one compact, attractive enclosure. Prewired, preassembled, tested and certified to meet the strictest U.S. NEC safety standards

### Pulse Power Centers

Make your system installation easy and code compliant. These new Trace Power Centers represent the next level of U.S. integrated system design. They have a PWM60 amp charge controller built in for your PV, LED's for battery level indication, a shunt and remote terminal block for easy remote meter installation, U.S. code approved disconnects, and simple connections to wire your inverter and battery bank. Optional features include an additional 60 Amp controller for up to 120 Amps of input and GFDI ground fault interrupt for roof mounted PV.

UL listed, PWM 60 controller, 250 A breaker, AC 60 Amp inverter bypass switch, Remote terminal block, 500 amp shunt. Take the headaches out of your system installation! Field selectable for 12, 24, or 48V systems. Use the PC250 for single inverter systems, the PC500 for dual inverters. 5 year warranty.

<b>PC250</b>	<b>#SY5902</b>	<b>\$1,495</b>
<b>PC500</b>	<b>#SY5903</b>	<b>\$1,995</b>

#### Options:

<b>2nd 60A Controller</b>	<b>#RG5904</b>	<b>\$199</b>
<b>2 wire Generator Start</b>	<b>#IN5906</b>	<b>\$139</b>
<b>GFDI</b>	<b>#IN5907</b>	<b>\$149</b>

### Safe-T-Pull Disconnect

The safety protection of a Powercenter without the cost. UL listed class T fused disconnect (the heart of the Ananda Power-centers) without all the additional features and consequent cost. Use to separate all system components or for multiple inverters, big battery chargers, when retrofitting or up-grading existing PV systems to newer or larger capacity equipment. Order fuses separately.

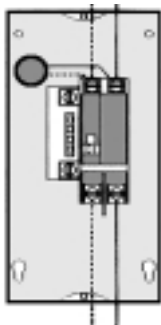

<b>200 Amp, 1 Pole</b>	<b>#SY104</b>	<b>\$345</b>
<b>200 Amp, 2 Pole</b>	<b>#SY105</b>	<b>\$325</b>
<b>200 Amp, 3 Pole</b>	<b>#SY106</b>	<b>\$391</b>
<b>Two 200 Amp, 2 Pole</b>	<b>#SY107</b>	<b>\$394</b>
<b>400 Amp, 1 Pole</b>	<b>#SY108</b>	<b>\$352</b>
<b>400 Amp, 2 p Pole</b>	<b>#SY109</b>	<b>\$489</b>
<b>400 Amp, 3 Pole</b>	<b>#SY110</b>	<b>\$588</b>

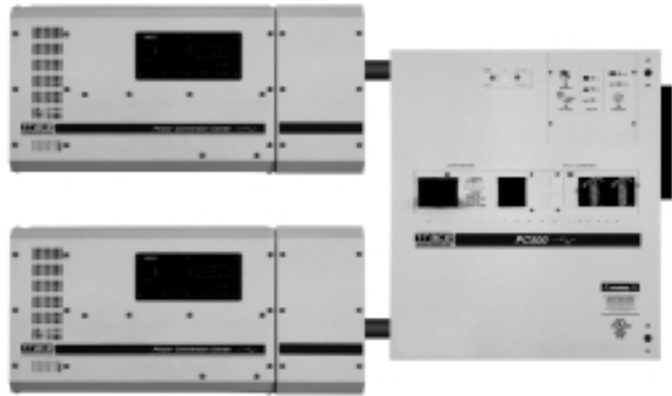

### Pulse Charge Controllers

Use with almost any battery type and manually switchable for 12 to 48V systems—all setpoints adjustable. Pulse-Width Modulation technology for a better control of the battery charge process and all the TC series controllers offer 3-stage charging: Bulk, Absorb, and Float. Trace estimates that these controllers give you 15% more power charging than you get with a conventional controller. 12Amp units (12 or 24V only) have Low Voltage Disconnect for battery protection. The TC60 is also an excellent choice for wind or hydro systems when used as a diversion load, 60 amp breaker included. Also use as a low-voltage disconnect but not at the same time you're using it as a charger.



<b>TC60 Charge Controller</b>	<b>#RG4752</b>	<b>\$329</b>
<b>TC25 Charge Controller</b>	<b>#RG5890</b>	<b>\$119</b>
<b>TC12 - 24V w/LVD</b>	<b>#RG5889</b>	<b>\$89</b>
<b>TC12 - 12V w/LVD</b>	<b>#RG5888</b>	<b>\$85</b>

### Solar Array Junction Box

Connect the smaller gauge wire that connects your solar modules together with the larger wire you need to reach the battery bank. Rainproof pullout switch lets you disconnect the array while you're working on your system. Four handy lugs accept wire sizes between 2g-12g. Also has grounding connection lugs that bypass the pullout switch. Includes outdoor rated metal box with sliding cover. 6 knockouts, 60 amps.



**#SY259 \$29**

### Multi-Wire Junction Boxes

Hinged NEMA 4X boxes. Small box primary wire size #8 to 2/0 and secondary #6 to #14. Large J-Box #6 to 6/0 primary and #4 to #14 secondary. Indoor versions don't have NEMA 4X enclosures. Lugs for 6 sets of input wires.

<b>Small Outdoor Junction Box</b>	<b>#SY257</b>	<b>\$97</b>
<b>Indoor Enclosure Box, 12"x12"x4"</b>	<b>#PS4711</b>	<b>\$34</b>
<b>Indoor Enclosure Box, 12"x12"x4", Hinge Cover</b>	<b>#SC5146</b>	<b>\$38</b>
<b>Indoor Enclosure Box, 8"x 8"x 4", Hinge Cover</b>	<b>#SC5145</b>	<b>\$22</b>
<b>1-Way Distribution Block (No Box)</b>	<b>#SY4523</b>	<b>\$24</b>
<b>2-Way Distribution Block (No Box)</b>	<b>#SY4524</b>	<b>\$46</b>



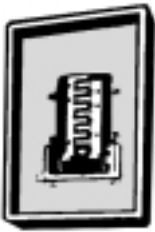

## DC Load Center

*These 100 amp DC Load*

Centers have UL listing and U.S. building code approval. Unlike our small fuse boxes, these heavy duty load centers use standard household breakers that can switch each circuit on and off. They hold up to six 15 amp breakers that you order separately. Rated for up to 48V DC. Also approved for AC systems.

<b>Load Center</b>	<b>#SY150</b>	<b>\$43</b>
<b>20A Breaker</b>	<b>#SY156</b>	<b>\$11</b>
<b>15A Breaker</b>	<b>#SY153</b>	<b>\$11</b>
<b>30A Breaker</b>	<b>#SY155</b>	<b>\$11</b>



## Fuse & Breaker Boxes

A fuse or breaker box means a safer system. If circuits overload or short, it may cause damage to your appliances or start a fire. These inexpensive boxes provide a safety link for your system. Recommended only for boats, mobile, and small systems. ATC.

<b>6 Circuit DC Fuse Box</b>	<b>#SY100</b>	<b>\$18</b>
<b>9 Circuit DC Fuse Box</b>	<b>#SY101</b>	<b>\$23</b>
<b>12 Circuit DC Fuse Box</b>	<b>#SY4035</b>	<b>\$54</b>



## ATC Fuse Box

12 circuit metal fuse block with hinged cover. Input lugs for up to 4 gauge wire, output circuits up to 10 gauge wire. Negative bus. 2" x 5 1/2" x 8 3/4".

<b>6 Circuit</b>	<b>#SY198</b>	<b>\$49</b>
<b>9 Circuit</b>	<b>#SY197</b>	<b>\$71</b>

## ATC Inline Fuse Holder

Quick protection for single circuits. Includes waterproof cover – use indoor or out.

**#SY195 \$2**

## Safety Switches

Use these U.S. code-approved fused switches to shut off your solar array or to disconnect your load.

<b>30 Amp</b>	<b>#SY160</b>	<b>\$48</b>
<b>60 Amp</b>	<b>#SY175</b>	<b>\$87</b>
<b>30 Amp Outdoor</b>	<b>#SY178</b>	<b>\$68</b>
<b>30 Amp Replacement Fuse</b>	<b>#SY176</b>	<b>\$4</b>
<b>60 Amp Replacement Fuse</b>	<b>#SY177</b>	<b>\$8</b>

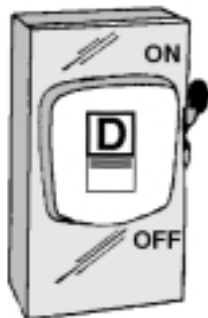

## 400A Disconnect

*Not fused but great value*

Designed to disconnect a battery from a load. Rated 400 amps continuous, 2000 amp surge, and up to 50V.

**#SY222 \$186**

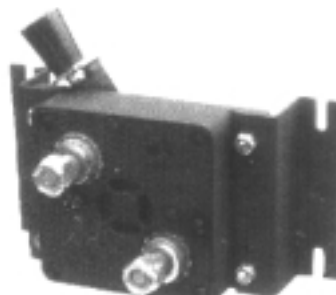

## High Current Battery Disconnect Switch

Use between your battery and the main fuses that protect your loads and charging systems. Handles up to 600 amps continuous and 1000 amp surge. UL listed for marine use. 12-32V. Similar in appearance to SY602, below, but on/off only.

**#SY601 \$149**

## Battery Selection Switch

It's not recommended to connect together two different types of batteries or batteries that are the same type but different ages. Old batteries will act as parasites and bring new batteries down to their condition. You can use this switch to add capacity to your battery bank without shortening the life of your new batteries. You can then supply your load from either battery bank or both. Also acts as a battery disconnect. 250 amps continuous, 360 amps intermittent, works from 6 to 32 volts.

**#SY602 \$39**



## Dual Battery Relay

*Use your car or truck to charge a secondary battery.*

When you're in a remote place, you can use the power in a secondary, deep-cycle battery without worrying about discharging the battery you need to start your vehicle up again.

This relay connects both batteries in parallel when you're driving and automatically disconnects them when you turn the ignition switch off.

**#SC651 \$22.95**

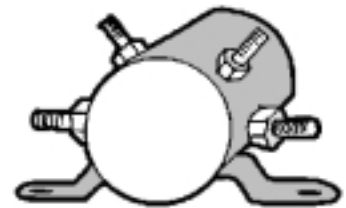

## Photovoltaics FAQ

- Q.** I plan to move soon, and hope to build my dream home. As part of this, solar power is potentially exciting. Unfortunately, last night I printed your FAQs on it, and my wife read it. She keyed on the line that utility power is cheaper right out of the outlet. I'm interested in any studies you have done comparing costs that I can use to justify PV as possible main power source for my home, or just as emergency power. (Scott Kirby)
- A.** There is no way to economically beat cheap, reliable convenient grid electricity if it's available. The things to keep in mind are:
- 1) The utilities are able to provide that electricity to us only because of massive subsidies and tremendous damage to our environment. We pay a dime, but our grandchildren?
  - 2) The cost of electricity is only going to increase. Fossil fuel sources are finite and are only going to become more scarce.
  - 3) Solar and wind sources will not run out of fuel, do not pollute, do not put future generations at risk for our short-term pleasure. You are invulnerable to the rising costs of other electricity sources or even simple line failures.

## Battery Combiners

Battery isolators can cause a voltage drop of about .7 volts that may undercharge the batteries and waste up to 70 watts as heat. They only work with alternator charge current and won't switch. Battery combiners cost more but solve the above problems and let you add in the system solar modules, generators, and inverter/chargers. They parallel the batteries whenever any battery is being charged and automatically disconnect. LED lights when batteries combined.

- 2 Banks 70 Amp #SY655 \$95**
- 3 Banks 70 Amp #SY656 \$140**
- 2 Banks 130 Amp #SY657 \$146**

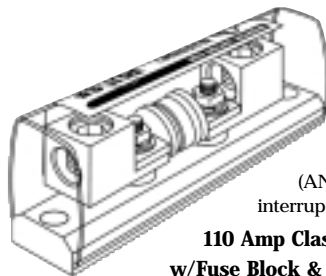

### Class T Fuses

The best fuse to use between battery bank and inverter. Interrupts short circuits in less than 1/120 of a second. Highest interrupting capacity—60,000 amps (ANN fuses have 2500 amps interrupting).

- 110 Amp Class T Fuse #SY235 \$20**
- w/Fuse Block & Cover #SY236 \$53**

- 200 Amp Class T Fuse #SY231 \$20**
- w/Fuse Block & Cover #SY232 \$55**
- 400 Amp Class T Fuse #SY233 \$40**
- w/Fuse Block & Cover #SY234 \$80**



### Trace Circuit Breakers

Safe, handy way to disconnect inverter from the battery bank. Designed specifically for Trace SW and DR inverters. Makes it easy to meet electric codes and pass inspections.

Accommodates second breaker for stacked inverter installations, individual handles let you shut down inverters separately. 125V DC max.

- 175A, up to 2/0 wire #SY1297 \$275**
- 250A, up to 4/0 wire #SY1298 \$329**

**Negative/Ground Bonding Block #SY4024 \$50**  
For solar array input disconnect for a C40 controller.

- 15A Trace DC Circuit Breaker:**
- Mounts on side of 175A or 250A #SY6279 \$39**
- 60A Trace DC Circuit Breaker:**
- Mounts on side of 175A or 250A #SY4025 \$44**

### Indoor Disconnect

For generator distribution, provides up to six 120vac circuits or any combination of 120 or 240vac circuits. 100 amps max.

**#SY1582 \$39**

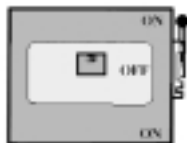

### Manual Transfer Switch

Switch between your inverter and generator safely. Rated 120/240vac. Up to 100 amps.

**#SY1583 \$441**

## Delta Lightning Protection

Lightning and static discharge cause more problems with PV systems than any other cause. Unseen lightning miles away can create high voltage that damages sensitive electronics, inverters, controls and fluorescent ballasts. Our Lightning Protectors divert this high voltage away from your equipment and send it to grounding rods, cold water pipes or buried copper wire. Surge rating 50,000 amps, 5,000 volts. 5 nanosecond response time. For either 12 or 24V systems.

**#SY320 \$48**

## AC Lightning Surge Arrestor

As above, designed for AC side of systems to absorb spikes introduced by lightning.

**#SY1587 \$40**



## Solar Array Combiner w/Lightning Protection

*Build your system to strict U.S. safety code requirements*

The U.S. National Electric Code specifies that PV panels must be wired in such a way that disconnecting a single panel for servicing does not interrupt ground connections to the other panels. Our array combiner solves this problem neatly by functioning as a heavy duty junction box with 6 terminals each for positive, negative and ground wires. Oversized terminal block handles those oversized wires with ease. Metal cabinet has standard conduit knockouts. 48V max.

**#SY1513 \$160**



## Inverter FAQ's

**Q. If I use an inverter, how long will my batteries last? How big a battery bank will I need?**



**A. You need to define the loads that you want to operate and how long you want to run them between battery charging cycles. These questions can be answered using the ever useful formula: WATTS = VOLTS x AMPS, or AMPS = WATTS/VOLTS.**

**Q. How do I install an inverter?**

**A. There is no single answer to this question. Often customers will have an electrician or dealer do the installation. If they have not worked with inverters before, we recommend that you have the installer call us or the factory before doing the installation.**

## DC Compact Fluorescent Lighting

Compact fluorescents can drastically decrease the total cost of a PV system. They cost more at first but compare the difference in efficiency. They can provide the same amount of light as an incandescent and only use 1/4th to 1/6th the power—less solar modules!

	5 watt = 25 watt	
	7 watt = 40 watt	
	10 watt = 50 watt	
	13 watt = 60 watt	
	18 watt = 75 watt	
	22 watt = 100 watt	
	26 watt = 120 watt	



### TFT Ballast/Base Screw-In Adapters

Use a standard Edison base to mount a 12V DC CF light? Here's the adapter to do it. Integral ballast accepts 10 to 18 watt 4-pin quad tubes. A 13 watt gives 900 lumens, 2700 K color temperature, and uses just 1.1 amp. Pictured here with an 18 watt sub-compact fluorescent listed below.

12V	#DC5505	\$36
24V	#DC5506	\$33

### 12V DC One Piece Compact Fluorescents

High efficiency, energy saving DC lights. Integral ballast with bulb and medium screw edison base - just screw into a standard lamp or outlet socket connected to a DC battery. 7 watt uses .58A and gives out 420 lumens, the 11 watt .9A and 650 lumens.

7 watt	#DC7797	\$24
11 watt	#DC7798	\$25

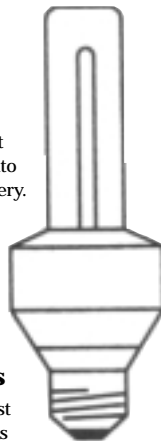

### DC Compact Fluorescents

Versatile bulbs you can use almost anywhere. About the same size as typical incandescents, they even fit in lamp harps. Handy adapters snap over the outside—round or oval white diffusers, R30 or R40 reflector/floodlight. The 11 watt bulb equals a 55 watt incandescent, the 15W equals a 75 watt, and the 18W equals a 100 watt. Use the #DC1674 or #DC5505 ballast/base for 12V or the #DC5506 for 24V systems.

11 watt replacement bulb	#DC5788	\$10.50
15 watt replacement bulb	#DC5789	\$10.50
18 watt replacement bulb	#DC5790	\$10.50
23 watt replacement bulb	#DC5784	\$11
26 watt replacement bulb	#DC5785	\$11
32 watt replacement bulb	#DC5786	\$12



### 12V Compact Fluorescent

Price, quality and appearance

Compact fluorescent adapter with ballast built into attractive base. Uses higher quality, 4-pin DE bulbs and with a slim 17/8" diameter fits almost anywhere. Super efficient and bright. Lights instantly without flicker. Uses standard 4-pin 10, 13 or 18 watt quad bulbs (sold separately). (GROUP A)

12V base	#DC449	\$30
24V base	#DC1332	\$30
10W bulb	#AC376	\$15.25
13W bulb	#AC377	\$15.50
18W bulb, 4.6"	#DC1830	\$17
18W bulb, 7.5"	#AC353	\$16.50
Metal handle	#DC1762	\$10



### High-Output DC Bulbs and Ballasts

Brighter compact fluorescents for DC systems. 4-pin base bulbs made for electronic ballasts won't flicker, cause radio interference, or have a hard time starting in cold weather. And bright! The 32 watt version gives you as much light as a 150 watt incandescent, the 26 watt is like a 120 watt bulb and the 18 watt like a 75 watt bulb. They all use the same ballast and adapter—easy to mix-and-match, experiment or change the brightness in your fixtures or lamps. New "triple-tube configuration". (GROUP D)

12V ballast	#DC1806	\$37
24V ballast	#DC1807	\$37
26 watt bulb, 5.2"	#DC1831	\$18
32 watt bulb, 5.8"	#DC1832	\$19
4-pin flat	#DC522	\$4.50
18/26 flat adapter	#DC528	\$5

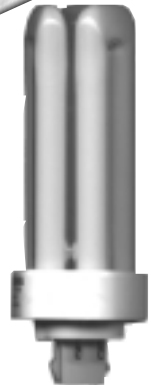

### CF One Piece 28W Quad 12V

High output prewired compact fluorescent - just screw into a socket. Use a 4 pin bulb and get the equivalent of a 140 watt incandescent bulb. Includes medium screw base with 12V DC ballast but not the lamp.

#DC442 \$79

### Compact Fluorescent Flat Adapters

Wire the ballast separately and use these adapters to make your own fixtures or retrofit old ones. Easy to install—just push the two wires into holes in the back of adapter and attach with screws through mounting holes. Small wattage tubes have two pins and larger four pins. 1.5".



5, 7, & 9 Watt tubes	#DC523	GROUP B	\$2.50
13 Watt twin & quad tubes	#DC524	GROUP B	\$2.50
4-pin quad tubes	#DC522	GROUP A	\$4.50
18 Watt flat adapter	#DC528	GROUP A	\$5
26 Watt quad tubes	#DC4196	GROUP A	\$5
4 In-A-Row Flat Adapter, 5-9 Watt	#DC4198	GROUP C	\$5

## Thin-Lite DC Fluorescent Ballasts

Use these high quality ballasts to convert almost any 120V AC fluorescent fixture to 12V DC (24V available for F20 & F40 bulbs). Also for repairing old DC fixtures.

Tube Size	Item #	# Tubes	Type Light	Amps	Price
FC8T9	#DC450	1	22 watt circle (108)	1.6	\$27
F8T5	#DC452	1	8W 12" (111)	0.9	\$25
F8T5	#DC453	2	8W 12" (112)	0.9	\$23
F15T8	#DC454	1	15W 18" (115)	1.3	\$25
F15T8	#DC455	2	15W 18" (116)	2.1	\$25
F13T5	#DC456	1	13W 21" (125)	1.4	\$25
F13T5	#DC457	2	13W 21" (126)	2.1	\$25
F20T12	#DC458	1	20W 24" (151)	1.6	\$21
F20T12	#DC459	2	20W 24" (138)	2.5	\$29
F40	#DC460	1	40W 48" (153)	2.9	\$25
F30T12	#DC461	1	30W 36" (187)	2.1	\$23

## Compact Fluorescent Tubes

Use these tubes to replace used or broken bulbs in compact fluorescent fixtures or with the above ballasts and corresponding sockets. You can retrofit fixtures not intended for compact fluorescents or use with the bulb exposed.

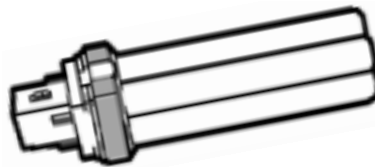

Watts	Code	Length	Replaces	Ballast	Price
5	#AC900	4.5"	25W	C	\$7
7	#AC901	5.5"	40W	B,C	\$6.50
7	#AC373	4.6"	40W	B,C	\$12
9	#AC903	7.5"	50W	C	\$11.50
13	#AC904	8"	60W	B	\$6.50
13Q	#AC907	4.8"	60W	B	\$9.75
18Q *	#AC353	7.5"	75W	A	\$16.50
13	#AC375	6.9"	60W	A,D	\$8.75
10Q *	#AC376	4.6"	50W	A,D	\$19.90
13Q *	#AC377	5.9"	60W	A,D	\$15.50
13 **	#AC378	8"	75W	B	\$24

\*4-pin bulbs \*\*Ott shielded full spectrum \*\*\*full spectrum

Kinds	Type	Configuration	Advantages	Disadvantages	Code #	Ballast
S	2-pin, twin or quad tubes		fit both AC & DC least expensive	flickers and hard to start when cold	#AC900-904	B,D
					#AC907	B,D
SE	4 in row, twin tube	low wattage, electronic, 3.4"	twin tube only longer	5 watt #DC1833	C	
DE	Quad, 4-pin	shorter, electronic	lower cost but longer than TE	10 watt #AC376	A	
				13 watt #AC377	A	
				18 watt #AC353	A	
TE	Triple tube, 4-pin	shorter 4.6, 5.2 5.8" brighter, electronic	higher cost, globe adapters don't fit	18-watt #DC1830	A	
				26-watt #DC1831	A	
				32-watt #DC1832	A	
					A	

## DC Ballasts

Use these ballasts to make compact fluorescent tubes work on 12 or 24V DC. Easy to wire and small—up to 13 watt is only 2.5" x 2" x 1". When ordering 2-pin tubes request DC type. We take out the AC starters and they work much better in DC systems. If you use the 4-pin bulbs, one 18/26 watt ballast will work for two 9, 10, or 13 watt bulbs. One 13 watt ballast will also power two 5 watt 4-pin bulbs. 4-pin bulbs will dim with a rheostat, start at colder temperatures, and last longer. (GROUP D)

12V PL 13 or Quad 13	#DC410	\$27	24V PL 13/15 Watt	#DC422	\$29
12V PL 18/40 Watt	#DC1806	\$37	24V PL 18/40 Watt	#DC1807	\$37

## Ballast Options Demystified

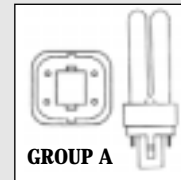

GROUP A

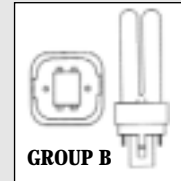

GROUP B

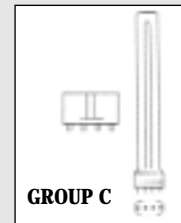

GROUP C

All fluorescent bulbs need a ballast. The same bulb works in 12V DC systems, 24V DC, 120 vac, 230 vac, etc.—just use the right ballast for your line voltage. For DC systems, you have several choices. In most cases the "Group A" 4-pin ballast/adaptor works best.

Designed for 4-pin electronic bulbs, they don't flicker and start right up in cold conditions. The base screws into standard lamp and receptacle

sockets. Just take a normal 120 vac lamp, use one of these adapters with a 4-pin 10, 13, or 18 watt bulb and wire directly into your DC system or outlet. The 4-pin bulb choices are limited however. We don't have full spectrums or globes with 4-pin bases. In this case, use the "Group B" ballast/adaptor for 2-pin bulbs. 2-pin bulbs have AC starters in the base that cause flickering and sometimes prevent lighting. We cut these out for DC systems. Use the "Group C"

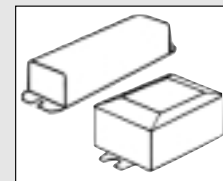

ballast for 4-in-a-row bulbs when you want the shortest (3.4") and lowest power use (5 watts) compact fluorescent. Higher wattage bulbs need a larger ballast that's too large to mount in a base. Use the "Group D" ballasts that look like a silver box and wire separately. Either a flat or screw base adapter holds the bulb. They work with all types of bulbs, just match the wattage.

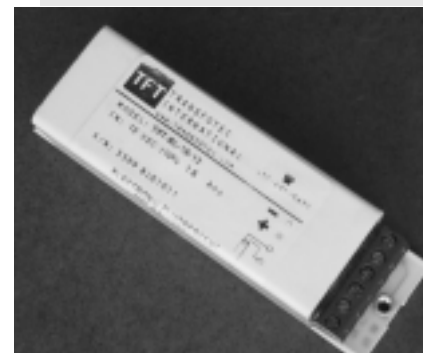

## DC Fluorescent Lighting

More light per watt—from 4-5 times more than incandescents. And DC fluorescents solve one of the major drawbacks to AC fluorescents—that little flicker that irritates eye muscles. That's because DC lights have a cycle rate thousands of times faster than regular AC light. Even sensitive eyes perceive it as steady. Our Thin-Lite brand has a special design that allows them to work over a wide range of voltages. They give light 50% to 100% brighter plus a ballast that lasts much longer than competitive models. UL approved and guaranteed for two years. Our "Low-Cost" and "Night Light" don't match Thin-Lite quality but the much lower price makes them a good option for many situations. All fluorescent fixtures use the same tubes that AC fixtures do—the same type found in most hardware and grocery stores.

### Lumina

*Compact fluorescent light specially designed for solar electric systems*

Most DC fluorescent fixtures are intended for boats and RV's. Lumina kept solar requirements in mind and made their lights with high voltage tolerance (10.5-15V), high temperature operating range (-10 to 50 degree C) and a high efficiency (90%) sine wave ballast that preheats the lamp before operation. This prolongs the life and prevents early tube blackening. Easy to mount, short circuit and reverse polarity protected, flicker-free, filtered against radio interference, 2-year warranty—the perfect fluorescent fixture for alternative energy systems! 350 x 80 x 50 mm.

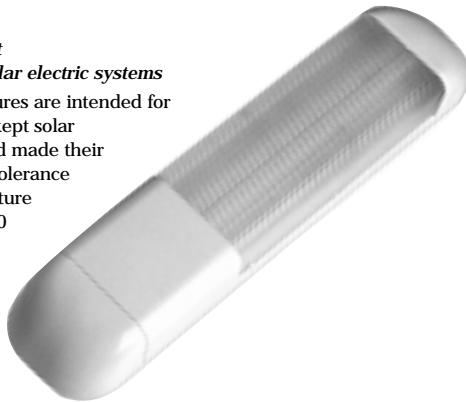

<b>Lumina 12v 18w Indoor Fixture</b>	<b>#DC3382</b>	<b>\$63</b>
<b>Lumina 24v 18w Indoor Fixture</b>	<b>#DC3383</b>	<b>\$63</b>
<b>Lumina 12v 11w Indoor Fixture</b>	<b>#DC3384</b>	<b>\$48</b>
<b>Lumina 24v 11w Indoor Fixture</b>	<b>#DC3385</b>	<b>\$48</b>

### Fluorescent Night Light

Low power use and low cost. For such a low cost light, we get an amazingly low number of returns. Doesn't give much light output but great for keeping you from tripping over things at night, in a closet or other small dark place. 2" W x 13" L x 7/8".



#DC921 \$15

### 12V Compact Fluorescent Drum Fixtures

Neat, clean and elegant way to install the most efficient lighting. Low profile design gives you the most light output from the least amount of space—only 2 1/2" down from your ceiling. White powder-coat housing for maximum reflectance and durability. 8 1/4" diameter.



<b>9 Watt</b>	<b>#DC260</b>	<b>\$66</b>
<b>13 Watt</b>	<b>#DC261</b>	<b>\$72</b>
<b>26 Watt</b>	<b>#DC262</b>	<b>\$110</b>

### Standard Rectangular Fixtures

The most commonly found 12V fluorescent fixture. This Thin-Lite is the most reliable and efficient. 15 watt model uses one F15T8 bulb, produces 880 lumens, and measures 18" x 4" x 1 3/8" deep. 30 watt uses two F15T8 bulbs, gives 1760 lumens, 18" x 5 1/2" x 1 3/8". Both include tubes and switch.

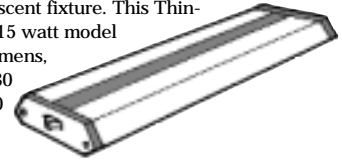

<b>15 Watt</b>	<b>#DC140</b>	<b>\$38</b>
<b>30 Watt</b>	<b>#DC141</b>	<b>\$48</b>

### 12V Low-Cost Fluorescent

Economy lighting with 3-year warranty. 16 watt fluorescent light with low cost but long, 3-year warranty. Vinyl woodgrain trim looks good and rustproof aluminum body switches on/off at one end. Includes two 1/2 amp tubes. 4.5" W x 12.5" L x 1" D. Not nearly as high quality or as much light output as Thin-Lite 15 watt fixture but the lower cost makes them more appropriate for some installations.

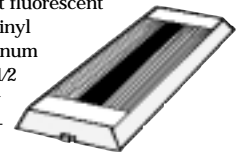

#DC920 \$21



### Easy-Mount AC/DC Light

*Three-way power—AA batteries, 120 vac, or 12V DC*

Use this light anywhere—backpacking with the 8 AA batteries (not included), in a car or solar-powered home, or when you find yourself in a place with grid power. 12" bright 8 watt fluorescent bulb with built-in reflector and three sets of hook and loop pads for easy mounting – take it with you wherever you go!

#DC3017 \$19

### Decorator Fluorescents

*Efficiency with style.*

The same high quality Thin-Lite ballast with a more stylish appearance. They have a gracefully styled diffuser and longer tubes. 8, 15 and 30 watt 2 1/4" x 27/16", 40 watt. 358" x 3 1/2". All but 40 watt include tubes.

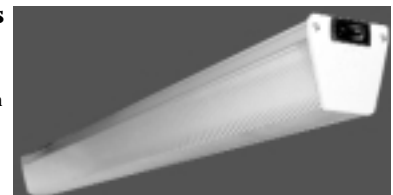

<b>8 Watt, 12V, 123/8"</b>	<b>#DC120</b>	<b>\$34</b>
<b>8 Watt, 24V, 123/8"</b>	<b>#DC5661</b>	<b>\$42</b>
<b>15 Watt, 181/8"</b>	<b>#DC121</b>	<b>\$39</b>
<b>30 Watt, 361/8"</b>	<b>#DC122</b>	<b>\$51</b>

### 12V Strip Lights

The best combination of price and quality. The most light-per-watt in a quality fixture. Does not have diffuser though, and may create a glare in some environments. 8, 15, and 30 watt fixtures have ballast mounted on the end and curved aluminum reflectors. They include a tube but the 20 and 40 watt models do not. The 20 and 40 have the ballasts mounted behind the tube which makes them shorter but wider. 8, 15, and 30 watt are all 2 1/8" x 1 1/4". 8 watt 175/8" long, 15 watt 233/8" and 30 watt 413/8". 20 and 40 watt are 33/8 x 15/8", 24" and 48" long. Thin-Lite.

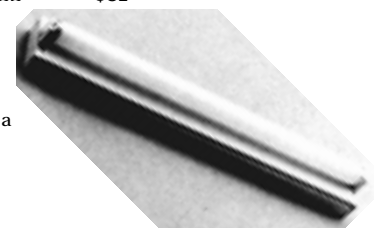

<b>8 Watt</b>	<b>#DC103</b>	<b>\$32</b>
<b>18 Watt</b>	<b>#DC100</b>	<b>\$33</b>
<b>20 Watt, less bulb</b>	<b>#DC101</b>	<b>\$38</b>
<b>30 Watt, less bulb</b>	<b>#DC102</b>	<b>\$40</b>
<b>40 Watt, less bulb</b>	<b>#DC105</b>	<b>\$53</b>

# DC LIGHTING

## Large Area Fixtures

Replace three 60 watt bulbs with one fixture.

The most light for the smallest space. Tubes last 15,000 hours at 3 hours per start. Clear lens lets most of the light out into the room. Easy access for standard wiring and attractive aluminum base. 18 watt. 358" x 31/2" x 101/4", 24 watt 141/2" and 36 watt 181/8".

**18 Watt #DC4237 \$70**  
**24 Watt #DC151 \$69**

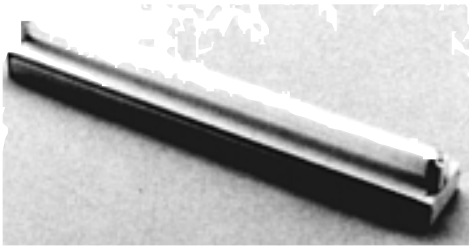

## 12V Circline

Convert table, swag and hanging fixtures to 12V. Just screw into a standard AC lamp or fixture. 22 watt bulb gives as much light as a 60 watt incandescent. Ballast neatly mounted in the center. 9.5" diameter, 1100 lumens, 2 amps.

**#DC191 \$44**

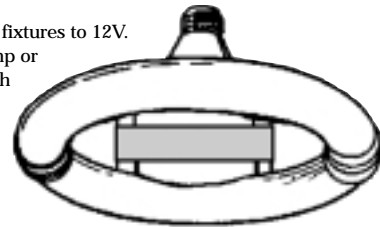

## Electrodex

Wall or Ceiling Fixture

Natural wood base makes this compact fluorescent fixture look great. Corrosion resistant materials and almost indestructible polycarbonate diffuser make it ideal for marine or RV applications. Special reflector and efficient 13 watt bulb give light equal to a 75 watt incandescent and make it ideal for the DC home or cabin. For indoor or outdoor use.

**#DC630 \$92**

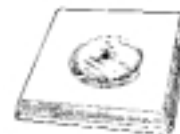
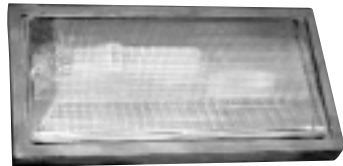

## 12V Circlines

Attractive room lights with energy efficient ballasts. Round 22 watt fixture uses one 9.5" diameter tube and produces 1100 lumens. Square style also 9.5" and 1.8 amps. 32 watt style has attractive, fluted appearance. 13.25" x 2.25".

**#DC142 Fluted \$42**  
**#DC143 Round \$42**  
**#DC144 Square \$68**

## Reflex 12V Compact Fluorescent Flood Light

Also works great as a recessed ceiling fixture. Highly polished reflector makes efficiency even higher than standard compact fluorescents. Mounted in an 8 foot ceiling, just one will light up a 10' x 10' area. Hard wire only—ballast attached to base. Recessed ceiling kit includes a clear lens cover, ceiling fascia ring and gasket. 13 watt.

**Reflex w/attached ballast #DC841 \$66**  
**Recessed Ceiling Kit #DC842 \$16**



## 12V Grow Lights

Start your seedlings early indoors—on 12V! Best quality full-spectrum fluorescent tubes get your plants off to a good start. When starting season is over, just switch to a regular tube and use the fixture for general lighting!

**20 Watt #DC111 \$49**  
**30 Watt #DC112 \$55**  
**40 Watt #DC113 \$62**

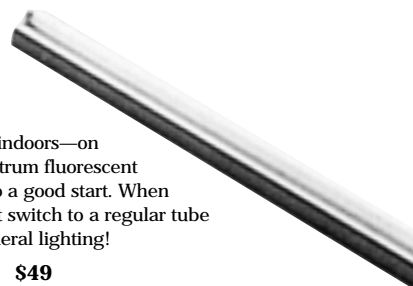

## Quartz Halogen Bulbs

Quartz halogens have a tungsten filament encased in a halogen, gas-filled casing (not glass). They have a nice, warm white light and last 3 - 4 times longer than regular incandescent bulbs. Unlike fluorescents, you can dim them with a DC rheostat. Their lumen output stays constant throughout their life—a big advantage because in a normal bulb, the filament burns and blackens while the light becomes less and less bright. Quartz halogens give twice as much brightness as an equivalent wattage incandescent. Keep them within plus or minus 10% of their rated voltage—too high voltage can cause them to break and too low can darken the glass.

## 12V Quartz Halogen Bulbs

These bulbs look just like a regular incandescent light but inside have the efficient quartz halogen element with its 2000 hour life. They emit the same light spectrum as natural daylight in a steady, warm beam and are at least 30% more efficient than 12V incandescents.

**12V, 10 Watt #DC320 \$12**  
**12V, 20 Watt #DC321 \$12**  
**12V, 35 Watt #DC322 \$12**  
**12V, 50 Watt #DC323 \$12**  
**24V, 20 Watt #DC325 \$15**  
**24V, 50 Watt #DC326 \$15**

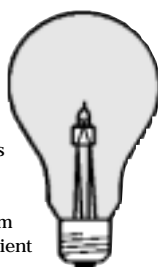

## 12V Clear Halogen Bulbs

More light per watt. Our frosted halogen bulbs work best when you can see the bulb. This clear version has more glare but gives more light. Use in lamps with shades or fixtures with diffusers; they're much brighter.

**10 Watt #DC365 \$15**  
**20 Watt #DC366 \$15**  
**35 Watt #DC367 \$15**



## 12V Halogen Flood Lights

Shine light exactly where you want it with these 12V quartz halogen flood lights. They screw into a standard medium screw base fixture and with 20 watts provide a bright, focused light. Faceted dichronic reflector maximizes efficiency and gives a sharp clean light with excellent color rendition. Elegant brass base looks great.

**Indoor #DC350 \$21**  
**Outdoor #DC349 \$24**





## Osram Quartz Halogen Lamps

The same efficient 5-watt halogen bulbs and swivel goose necks described as Traveling Quartz Halogens above. These have screw-mount bases and three different lengths. Great for a bedside, desk or anywhere you need a bright light and low power use.

4"	#DC600	\$24
12"	#DC601	\$29
20"	#DC602	\$29

## Traveling Quartz Halogen

Whenever, wherever, however you travel—by car, van, boat, or plane, this versatile and highly efficient quartz halogen mobile light brightens up your reading. In your DC home it keeps right on working. The precisely-focused Osram lamp plugs into a DC cigarette plug receptacle and you get brilliant, glare-free halogen performance using only 5 watts. The flexible gooseneck keeps the light exactly where you need it. An 8" lamp with a cigarette plug end.

#DC603 \$24

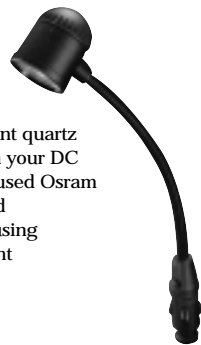

## Power Beam

Light up the night with this hand-held 12V halogen spotlight. 250,000 candle-power, 12' cord with 12V plug, 3 amps.

#DC610 \$16



## DC Incandescent Bulbs

Not nearly as efficient or long-lasting as compact fluorescents or quartz halogens but much less expensive per bulb. Good if you have more power than you need. DC incandescents give about twice as much light per watt as AC incandescents. You can use a 25 watt bulb where you would need 50 watts in an AC system.

12V	15, 25 or 50 Watts	#DC329-31	\$3
12V	75 or 100 Watts	#DC332-3	\$4
24V	25 or 60Watts	#DC334-5	\$6
24V	100 Watts	#DC336	\$13

*"We can not get kerosene nor natural gas in Lichinga. Fuel (diesel and gasoline) is available under a quota system and supplies are frequently interrupted. We would like to set up the place as a functioning demonstration of alternative energy sources."*

— MVK, Mozambique

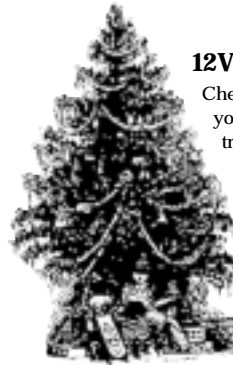

## 12V Christmas Lights

Cheer up your solar home, car, RV, boat or anywhere you can find a 12V battery. Handcrafted Christmas tree lights—each set takes 2 hours to make. High quality and multicolored, will last years. Plug up to three strings into a 3-outlet appliance cord. 28' cord, 32 multi-colored lights. LED version has 18 red, green, and yellow bulbs on a 10' string and uses 1/20th of an amp.

LED #DC3997 \$29

## Humphrey Propane Lamps

You might want a propane light during those long storms in the winter. Or you might want to experiment with methane or hydrogen gas. Watch out for the mantles though that like all mantles contain radioactive thorium. Humphrey with 92 years experience making propane lamps still has the best.

Lamp	#DC950	\$59
Preformed Mantle	#DC3191	\$6
Tie-On Mantles	#DC3192	\$7
Replacement Globe	#DC3185	\$16
Replacement Burner Nose	#DC1687	\$6



## SunPipes

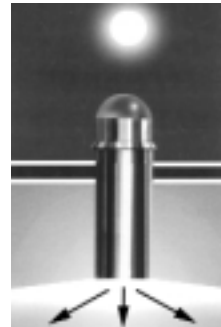

1500 watts of free, fresh light as easy to install as stovepipe. Hollow, super-reflective pipe runs from your roof down to a translucent ceiling fixture that spreads the light down. Natural, full-spectrum light without glare, heat, or uncomfortable hot spots. Less expensive and easier to install than a skylight; also doesn't build up unwanted summer heat, create condensation, sun-fading problems, and won't leak. Install in less than 2.5 hours. Use extensions to go through attics or top floors. Install straight, on an angle, or with optional elbows. 13" kit for up to 240 sq.ft. rooms, 21" for up to 600 sq.ft. Standard dome lets in 52%

of the light, optional replacements 72 or 98%. (98% too intense unless installed in cloudy or shady areas). 5-year warranty.

Basic 13" w/o Pipe	#AC3332	\$195
4' 13" SunPipe Kit	#AC850	\$347
2' 13" SunPipe Kit	#AC3999	\$273
2' Extension	#AC851	\$74
Basic 21"	#AC4004	\$349
4' Extension	#AC852	\$148
45° elbow	#AC4001	\$77
90° Elbow	#AC4002	\$86

## Brass Oil-Fired Lamp

French-made brass lamp uses round wicks to produce 2-3 times the light output of flat-wick lamps. Specially designed chimney means no annoying flicker. Burns kerosene or regular lamp oil. 19" tall.

Oil-fired lamp	#DC1473	\$66
Extra wick	#DC1475	\$4
Spare Burner	#DC5403	\$22
3-Year Kit - 2 chimneys/wicks	#DC5077	\$25
Replacement Chimney	#DC5076	\$7



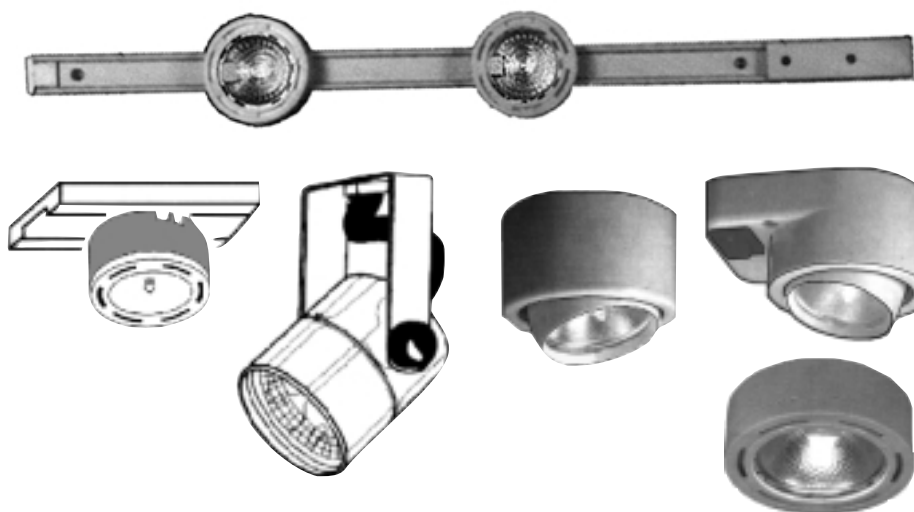

## 12V Track Lighting System

*Halogen "snap & slide" multi-functional lights*

Mount up to three dimmable 20 watt halogen bulbs on each 39" cuttable track, 6 per 6' track. Minipots shine straight down, #DC3054 rotates both horizontal and vertical and #DC3055 uses an MR-11 spot light in pivoting cylinder.

<b>39.75" Track</b>	<b>#DC3051</b>	<b>\$20</b>
<b>72" Track</b>	<b>#DC3052</b>	<b>\$32</b>
<b>Minipot - Flat</b>	<b>#DC3053</b>	<b>\$19</b>
<b>Minipot - Rotating</b>	<b>#DC3054</b>	<b>\$30</b>
<b>Minipot - Spot (no bulb)</b>	<b>#DC3055</b>	<b>\$35</b>
<b>MR11 Bulb for above</b>	<b>#DC3799</b>	<b>\$20</b>
<b>60 Watt Transformer for AC Systems</b>	<b>#IN3067</b>	<b>\$42</b>



## 12V Minipots

*Flush or surface-mount halogen fixtures*

Just the right amount of light in just the right place. 20 watt, energy efficient, long-life halogens in white plastic housing with aluminum reflectors and clear tempered glass diffusers. #DC3056 shines straight, #DC3057 has "eyeball" design to adjust beam in different directions and #DC3058 includes built-in on/off switch. Use AC for 120 vac systems (Black, brass, or chrome finishes cost extra. Minimum order of 6.)

<b>12V Minipot</b>	<b>#DC3056</b>	<b>\$21</b>
<b>"Eyeball"</b>	<b>#DC3057</b>	<b>\$25</b>
<b>with On/Off Switch</b>	<b>#DC3058</b>	<b>\$40</b>

## NiteOwl

The ultimate book light, a reader's favorite companion, a marriage saver—all this and more! Slim enough to double as a book mark, NiteOwl slips between pages to illuminate a reading surface without disturbing others. Extend the pre-curved neck and activate the powerful krypton bulb and reflector system. Choose between cordless AA battery operation, and convenient, lightweight AC and DC power adapters for hours of uninterrupted reading pleasure anywhere. Less than an ounce without the battery pack, AC household adapter includes 6' cord, DC adapter ten foot cord with 12V plug.

<b>NiteOwl Book Light</b>	<b>#SF3550</b>	<b>\$24</b>
<b>NiteOwl DC Adapter</b>	<b>#SF3551</b>	<b>\$17</b>
<b>NiteOwl AC adapter</b>	<b>#SF3552</b>	<b>\$14</b>



## Littlite—The Ultimate Bedside Lamp

The perfect light for reading in bed without bothering anyone nearby who might want to sleep. High intensity 5 watt quartz halogen bulb concentrates light in a tightly controlled area easily aimed exactly where you need it. Also great for any job involving accurate, close or detail work—drawing, computer, on a music stand, by a stereo system. The small hooded end won't get in your way, you have just the right amount of light, and you save energy (only 5 watts!). Includes 18" flexible gooseneck, mounting base and fully adjustable dimmer. Weighted base converts into a movable free standing lamp.

<b>12V Model</b>	
<b>#DC690</b>	<b>\$47</b>
<b>Weighted Base</b>	<b>#AC661</b>
	<b>\$14</b>

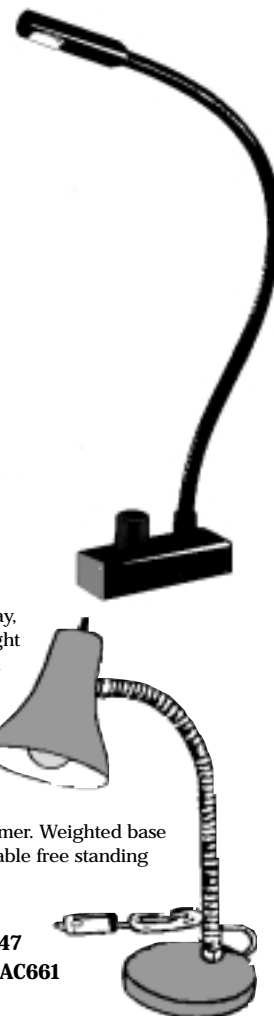

## 12V Desk Lamps

Dependable, high quality desk lamp with quartz halogen bulb. Puts warm, full spectrum light on your work. Adjustable gooseneck, on-off switch, and 12V plug make lamp easy to use. 5.5" round base and 17" high.

<b>#DC620</b>	<b>\$42</b>
---------------	-------------

*"I've purchased two Arco 51 panels a year ago and they work wonderfully. We live atop a hill on an island called Epi, and our solar lights can be seen from neighboring islands 5 miles away. Local people think solar panels are a great idea and affordable as well considering they pay up to \$200 a year for kerosene to light their houses with hurricane lamps."*

— Jim Stahl, Vanuatu, South Pacific

*"I have just returned from Wasolo, Zaire, Africa after having worked there with a protestant mission for about 8 weeks as their physician, it became evident that they were very inefficient in their use of fuels for electricity, having the potential to save about 500 US\$ per month in fuel costs by converting the Operating Room to full time 12 Volt power from Solar Panels and batteries, like our home in Lawrence and Jamaica."*

—Dr. Roger Johnson



## White LED's

### The Next Generation of Super Energy Efficient Lighting

Only two years ago, with white LED's in large quantity, OEM size orders cost so much that residential use wasn't realistic. Now the price is down and the next major evolution in lighting is under way. Most white LED's produce natural spectrum (85 CRI) pure white light and have a 100,000+ hour life. So efficient, it's hard to measure your power use. You can downsize the expensive solar module and battery parts of alternative energy systems.



### White LED DC Bulbs

*Super energy efficient and long-lasting LED's with conventional bulbs and bases.*

LED's last 10 times longer than compact fluorescents and 133 times longer than a typical incandescent. And energy savings are incredible. It would cost \$772.20 to use one hundred 25 watt incandescents for 13 hours a day for one year, compared to only \$30.80 using these light-equivalent LED's—a savings of \$741.40. They only produce 3.4 BTUs/hr. compared to 85 for incandescents—no more heat problems! And they fit in standard receptacles, lamps, recessed cans, track lights—any place you would use a normal bulb.

9 LED's in a A-19 bulb—the same style as a typical incandescent (238" diameter). They look the same, have the same base, and replace a 25 watt incandescent while using less than .9 watts.

**12V DC #DC5808 \$39**

### White LED Mini-Spot

9 white LED's in a R-20 reflector bulb with standard medium Edison base. A great, super efficient spot light with an expected 100,000 hour life. Good for reading if the book isn't too far away from the light. .9 watts.

**12V DC #DC5812 \$42**



### LED Lighting Systems

*Super-efficient 12V LED cluster lamp lasts 100,000 hours*

We now make our popular LED lamp with a combination of colors that blend into a bright, focused, white light (rainbow bulb). They still only use 1.2 watts and last an average of 68 years if used for four hours per day. The incredible efficiency means much smaller and less expensive solar module and battery sizing in photovoltaic systems. Both fit standard Edison type light socket. 12V DC only. Complete systems include solar panel and sealed battery. One hour of sunlight gives almost 1.5 hours of light at night, up to 10 hours of reading!

**Complete System #DC107 \$100**

### Solar LED lamp

A special LED lamp made for renewable energy systems and the 12V DC systems in cars, boats, RV's. A combination of LED colors blend into a bright, focused, white light. They only use 1.2 watts and last an average of 68 years if used for four hours per day. The incredible efficiency means much smaller and less expensive solar module and battery sizing in photovoltaic systems. They fit in Edison type light sockets - just replace standard bulbs and use with a 12V DC power supply. Every hour of direct sunlight gives almost 1.5 hours of light at night, up to 10 hours of reading with an average 6 peak hours of sunshine!

**#DC1414 \$28**



### 12V DC White LED Room/Reading Light

Full spectrum (85 CRI) pure white light, super low power use and long life. 9 pure white light LED's mounted in a standard light bulb base. Less than 1.5 watts, 100,000+ hour life. 12V DC.

**#DC3070 \$40**

### Individual White Light Emitting Diodes

**#DC5206 \$2**



### Bayonet Base White LEDs

Convert your RV or bayonet base fixture to LED technology. RV's frequently use bayonet base incandescent bulbs - a bad choice because the filaments easily break with movement and RV's move around! Use our DC525 adapter and use the same bulb in a standard medium base Edison fixture. 12V DC.

**3 LED #DC7620 \$26**

**6 LED #DC7621 \$42**

### White LED Strip Lights

**Small 6" #DC3755 \$49**

**Medium 12" #DC3756 \$99**

**Large 18" #DC3757 \$139**

### Sunspot

*White LED Outdoor Spotlight*

Perfect for front and back porches, landscaping, outbuildings, walkways—all your outdoor artistic lighting displays! Just one day of solar charging with a typical 75 watt module provides enough power to use this light for more than 65 nights! Wire in our optional mini-Sunrise/Sunset switch and up to 3 of these spots will automatically turn on when it gets dark and turn off in the morning. 6-LED only uses 50 milliamps (35 of a watt). 12-LED uses 120 milliamps (about 1 watt); 18-LED uses 180 milliamps (about 2 1/4 watts).

**6-LED Sunspot #DC3753 \$54.46**

**12-LED Sunspot #DC5965 \$84**

**18-LED Sunspot #DC5966 \$108**

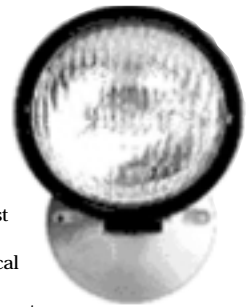

### 2-in-1 Nova LED

*White and red (super bright) LED fixture*

Strong, weather tight light with stainless steel body. Includes a glass lens and single throw, double pole switch. Use the red light to protect your night vision, the white when you need a brighter light. 3 white LED's and 3 red LED's—uses only 60 milliamps.

**#DC5292 \$52**



## Mini-Sunrise/Sunset Switches

Automatically turn small loads (like LED lights) on when it gets dark and off in the morning. The two small sizes are only available as built-in options for the LED fixtures on this page. The large, 10 amp version works with any fixtures and also includes low voltage disconnect and an anodized aluminum body for outdoor and marine environments.

Up to 18 LED's	#DC3758	\$10
Up to 30 LED's	#DC3759	\$24
10 Amp w/IVD	#DC3760	\$56



## Do-It-Yourself White LED's

*Make your own super efficient LED light fixtures*

Each LED configuration mounted on a circuit board with 12V resistor and wire leads—just connect to a 12V battery. Glue in place, cut a hole and mount in sheet rock or paneling, cover with stained glass: infinite artistic lighting possibilities! Our 6-LED version works great to shine on a gate, walkway, or as a bright reading light. Use the "very" bright 12-LED in a small room, tool shed, paint locker, or front porch and the 18 LED in larger spaces

6 LED, 60 mA	#DC5960	\$29
12 LED, 120 mA	#DC5963	\$55
18 LED, 180 mA	#DC5964	\$84



## Economy 12V White LEDs

*Edison, bi- or single-pin bayonet bases*

Easy to install almost anywhere, just choose the correct base. The 6 bright LED's give a good light but a little hard to read by. Perfect for replacing inefficient and easily broken room lights in boats, trailers and RVs. Bumping and jarring doesn't hurt LED's!

Edison Medium Base	#DC5989	\$29
Bi-Pin Base	#DC5990	\$29
Single-Pin Base	#DC5991	\$29

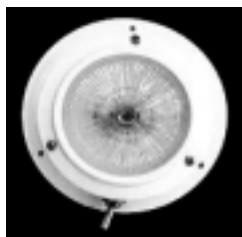

## White 12V LED Light Fixtures

*Brighten up the dark corners of your life without feeling guilty about using too much power*

You can afford to leave these lights burning—the Moon-glow fixture uses 1 LED and just 10 mA, 0.012 watts! Great as a night light, or for entryways and carports. Compact (4 1/2"), installs easily with common hand tools. The Comet uses 3 LED's (30 mA) and the stainless steel 100,000 hour bulb life and not damaged by heat, cold, moisture or vibration. Both have white powder-coated painted aluminum light housing and strong glass lens. These fixtures last for generations!

1-LED "Moonglow"	#DC3724	\$23
3-LED "Comet"	#DC3725	\$39
6-LED "Nova"	#DC3726	\$64.70

## Large White LED Strip Lights

Bright LED's in 3/4" round x 12" poly tubing. Includes clips for mounting or attachment for ganging together. Single strip has 18 LED's and equals a 25 watt incandescent, double strip has 36 LED's and 40 watt equivalency. 24V, includes 120 vac adapter for AC systems.

Single Row	#AC6816	\$84
Double Row	#AC6819	\$149



## LED Mini-Reading Lamp

This portable, self-contained lamp goes with you anywhere and provides 25 hours of reading per charge. 3 bright, white LED's and a flexible gooseneck shines the light exactly where you need it. Simply recharge or run by plugging into a 12V DC outlet or with AC from our "Mini-Transformer". 9", 12V.

#DC3754	\$68
---------	------



## Cabin Light

Adjustable bright 3 LED white light uses only 30 mA! Bright enough to read, efficient enough to leave on all night. Ten lights on at the same time use less than 5 watts. Great for a night light or in a bathroom. 3 LED's. 100,000 hour life.

#DC3870	\$34
---------	------

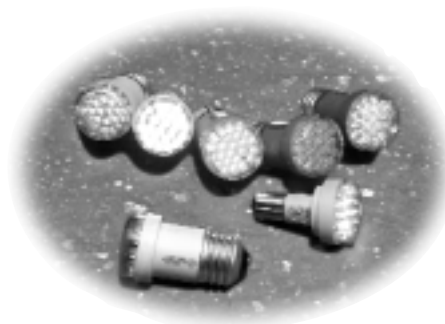

## SolarLED's

Full spectrum (85 CRI) pure white light, super low power use and long life (over 100,000 hours!). Each bulb has a protective lens, and Edison base that screws into standard lamps and fixtures. 12 LED version for "high power" reading and 24 LED version for an area lamp. 1.33" diameter and 2.5" long. 3 year warranty.

12 LED SolarLED	#DC5837	\$69
24 LED SolarLED	#DC5838	\$108

## Custom LED's

We can make LED lights for specific jobs with almost any base and brightness. We need orders of at least 25 pieces though. In addition we have LED pathlight systems in a wide range of colors and spacing that just snap together for almost any length. Other common applications are Exit signs, flashlights, emergency strobes, and outdoor sign lettering.



### Low-Voltage LED Table Lamps

The lowest power consumption per lumen of any light anywhere! Truly the most miserly light available - 10 times more efficient than incandescents and 5 times more efficient than fluorescents. Genuine hand-crafted red oak bases and brass plated swivel necks make these lamps substantial, functional and attractive. Uses high-brightness LEDs sealed inside an acrylic dome - and of course no mantels or bulbs to break. LEDs have a 25 year warranty. Includes a solid oak base with built-in switch, an 18 inch swivel neck and 8' cable with DC plug. Operates from any 12V DC source or from 120 vac with our AC/DC adapter.

<b>20-LED model, 1.65 watts</b>	<b>#DC8728</b>	<b>\$134</b>
<b>42-LED model, 1.65 watts</b>	<b>#DC8780</b>	<b>\$198</b>
<b>90-LED model, 1.65 watts</b>	<b>#DC8729</b>	<b>\$298</b>



### CubeBase 12V LED Table Lamp

Another beautiful, efficient, and practical 90-LED table lamp. This one features a 12" swivel neck with built-in recharge port and off-on switch. It includes a 5 amp/hour built-in sealed battery for about 5 hours of light between charges. Recharged from auto and RV batteries, from an AC chargers or solar module. Uses just 7.35 watts but VERY bright.

**#DC8784    \$321**

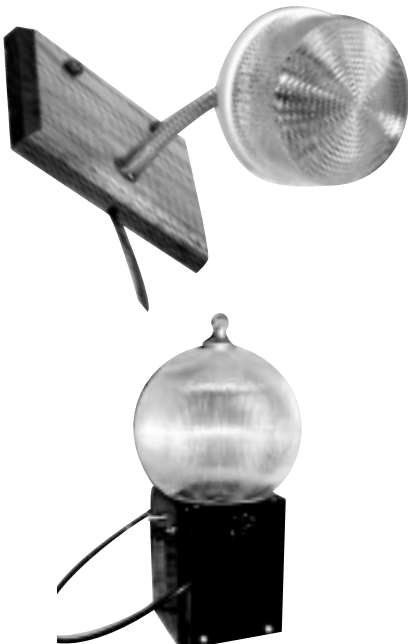

### 12V LED Wall Lights

Beautiful solid oak base wall lamps with 6" flexible brass plated necks. They include a 12' cable with in-line switch and DC plus. Use from any 12V power source or our AC/DC adapter. The 20-LED model uses only 1.65 watts, the 42 LED size 3.43 watts, and the 90 LED 7.35 watts.

<b>w/ 20 LED's</b>	<b>#DC8785</b>	<b>\$111</b>
<b>w/ 42 LED's</b>	<b>#DC8786</b>	<b>\$177</b>
<b>w/ 90 LED's</b>	<b>#DC8787</b>	<b>\$277</b>

### LED Lantern - 90 LED's

*The world's highest quality, most efficient lantern*

That's a big statement - and the world's a big place - but we definitely haven't seen and can't imagine a more efficient lantern this bright. 90 LEDs with a 360 degree beam with low / off / high settings - 30 LEDs on low, 90 on high. And built strong - baked on gloss black enamel steel body and brass hardware with a shatter-resistant acrylic globe and heavy-duty carrying handle. Built-in recharge port and off-on switch. It will operate at least 30 hours between recharges on low, 10 hours on high. The 5 amp/hour rechargeable battery is sealed from leaks and requires no maintenance. Recharge from 120 vac, 12V DC, or a small solar module.

<b>90 LED Lantern</b>	<b>#DC8774</b>	<b>\$333</b>
<b>120 vac charging adapter</b>	<b>#SC8776</b>	<b>\$93</b>
<b>solar charger</b>	<b>#PV2913</b>	<b>\$42</b>



### 12V LED Ceiling Lights

Solid oak base ceiling lamps using the "light of the future" - bright LEDs. They include a 12' cable with in-line switch and DC plus. Use from any 12V power source or our AC/DC adapter. The 20-LED model uses only 1.65 watts, the 42 LED size 3.43 watts, and the 90 LED 7.35 watts.

<b>w/ 20 LED's</b>	<b>#DC8788</b>	<b>\$111</b>
<b>w/ 42 LED's</b>	<b>#DC8789</b>	<b>\$177</b>
<b>w/ 90 LED's</b>	<b>#DC8790</b>	<b>\$277</b>



### 120 vac charging adapter

This AC/DC adapter/charger includes a charger, 8' AC input cable, 8' DC output cable with DC plug and instructions. Use to charge any of the Jetstream built-in 12V batteries or to power any of their other 12V lamps from a regular 120 vac power source.

**#SC8776    \$93**

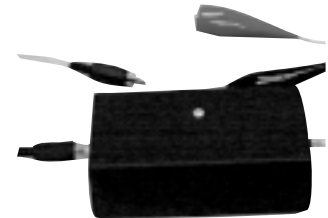

### 12V charging adapter

Battery-to-battery charger. Use to charge Jetstream built-in batteries from another 12V battery. Includes charger, 8' input cable with alligator clips and 8' output cable with DC plug and instructions.

**#SC8777    \$52**



## Solaris Solar Lantern

*Highest quality solar lantern*

During the last 15 years, we've sold almost every solar lantern on the market. None come even close to comparing with this one - the best by far. It brings together new advances in solar and battery technology for some incredible performance. Longest battery run time and cycle life, full spectrum (90 CRI) compact fluorescent light with 5000+ hour life, 40 watt incandescent bulb equivalent. Some of the other features include: low voltage disconnect - turns lamp off when batteries go down to 90% discharge and assures 1000+ cycles, advanced NiMH battery pack (3500 mA) for 1000 usage cycles, up to 6hrs run time (no memory and toxic free); built-in charge/discharge protection; flexible, unbreakable 330mA solar panel, 8.25 by 11.25"; amorphous triple thin film silicon design means charging even under clouds, optional wall plug charging; rugged ABS case, polycarbonate lens - we've drop tested this thing and it just keeps running; tested to work at the bottom of a swimming pool. Keep 80% of their capacity at -30 degrees (lead acid batteries only have 25%, Nicads only 40%); Completely recyclable but no negative environmental problems if thrown away; No memory effect; Lasts as long as 6000 alkaline batteries.

#SF6394 \$148

Replacement Battery Pack #SF6640 \$65

## Nite Stick Portable

### Compact Fluorescent.

Brightly lights up a big room and only uses 7 watts. Use as a table lamp, carry around, or hang from a shelf or ceiling. With a small Powersonic battery you have a light weight system that will provide many hours of light between charges. Rechargeable battery from Phoenix Solar Module. For each day of sun would give you 8 or more hour of light per night. 6' cord has standard SAE (trailer) polarized rubber plug and lighter plug adapter for easy connection.

#DC625 \$62

Powersonic 12V 7 amp Battery #RB149

\$22

Phoenix Solar Panel

#PV6828

\$80



## World Lantern

Super bright light, high quality and efficiency, fold-out Siemens solar module - and a great price! Mirror-like plastic reflectors on top, behind, and below the full spectrum 9 watt compact fluorescent bulb maximize brightness but keep energy use low. The single crystal, made in the USA, Siemens 2.5W/8.7V solar module folds out for the best angle to the sun and then retracts for transport and storage. It's easy to replace both the bulb and 6V 4.0 Ah Yuasa gel cell battery. A great value.

#SF7749 \$98



## Freeplay 2020 Windup Flashlight blue

Never be without light!

The Freeplay 2020

houses two

independent units

within it's 4.8" h x

9.4" l x 4" wide case.

This revolutionary product incorporates the latest in self-powered technology, for those times when you need light immediately, plus it

offers a recharge option that provides an intense beam for everyday use. A fully charged battery provides a shine time of approximately 45 minutes. A full spring wind (60 turns) provides a LED shine time of approximately 10 minutes. The light source for the incandescent is provided by a unique Xenon-filled bulb. The LED's light is from an Indium Gallium Nitride ultra-bright white Light Emitting Diodes. These LED's never need replacing. This flashlight includes an AC/DC adapter for battery recharging and an extra bulb. Also available with a translucent Clear case. 2lbs. 2 ozs.

#SF7467 \$75

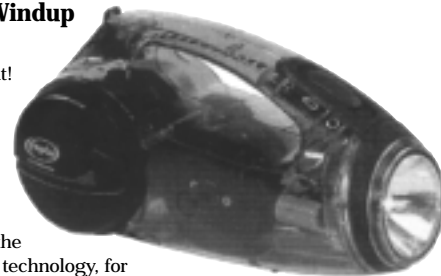

## Lighthawk Rechargeable Lantern

Imagine a lantern that can illuminate a campsite (or your home when the lights go out) without burning any fuel. The Lighthawk gives you bright white light with a built in dimmer.

Rechargeable up to 1000 times. Charge from AC power, or plug into your car or boat and charge from 12 volt DC. Comes with chargers, with an amber diffuser to avoid attracting bugs, and a red diffuser to preserve your night vision and to act as an emergency signal.

#SF4165 \$55



## Lighthawk "Sidekick" Rechargeable Lantern

Area lighting in a compact package. Lighthawk Sidekick delivers light equal to a 25 watt incandescent. Ideal for camping or home power outages. Keep in your car for roadside emergencies. Carrying handle doubles as a hook for hanging in tight places. Uses 4 D batteries.

#SF4167 \$14

## Quantum 2000 LED Flashlight

Not only the brightest LED Flashlight available, but the LED "bulb" will live longer than you!

Made of durable rubber, this versatile flashlight uses either 3 AA alkaline batteries which are supplied with light, or use 4 AA rechargeable Nicads (sold separately). Weatherproof and buoyant, its great for emergency use and the attached wrist strap and accessory capsule make it ideal for many outdoor activities.

#SF6878 \$39



## Nightstar Flashlight

Something truly new - a flashlight that you can't break, and that never runs out of batteries. In fact, you shake it every time you use it. Internal magnetic generator turns shaking motion into stored electricity. Shaking it for 1 minute, gives you 5 minutes of light. Brilliant LED lights 6 foot 1 from 30 feet out and never needs replacement!

<b>Clear</b>	<b>#SF4592</b>	<b>\$85</b>
<b>Yellow</b>	<b>#SF8730</b>	<b>\$85</b>
<b>Ruby</b>	<b>#SF8731</b>	<b>\$85</b>
<b>Emerald</b>	<b>#SF8732</b>	<b>\$85</b>
<b>Amber</b>	<b>#SF8733</b>	<b>\$85</b>
<b>Sapphire</b>	<b>#SF8734</b>	<b>\$85</b>

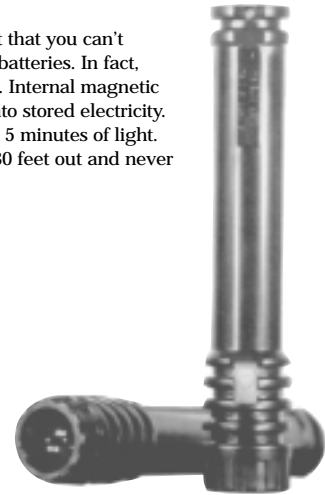

## Eternalight

A new lightsource for the 21st century

If you expect the most from your equipment, here's the most versatile, high-tech flashlight we've ever seen. Unique microprocessor controls with a variety of flashing sequences: S.O.S., dazzler, and strobe. Waterproof to more than 100 feet and even floats. 4 super bright LED's with variable intensity. Ultra-long 30 hours on its brightest setting to more than 700 hours as a soft glow. Lifetime warranty (except included batteries).

#SF8294 \$79



## Solar Flashlight

Battery Charger Combination

How many times have you needed to use a flashlight only to discover the batteries were dead? Never let that happen again! Just keep this solar flashlight in a sunny window. Also charges two AA, C, or D batteries. Built-in solar panel made from NASA highest efficiency space industry "Super Cells". Nicad batteries best but also works with most alkaline and carbon-zinc batteries—extends their life 2-3 times.

#SF505 \$37

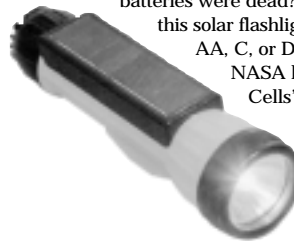

## LEDs -

- Last 100,000 hours
- Use a fraction of typical energy use
- Make batteries last of to 15 x longer
- Natural spectrum, 85 CRI light



## LED Flashlight

30 hours of light with just one set of batteries! You'll have to recharge or replace the included batteries but the white LED's should last long enough for your great grandchildren to still use. Light output is about one-fourth that of a standard flashlight - adequate for most situations. Made of rugged ABS plastic.

#SF7550 \$12

## 3-LED Flashlight

Not as bright as a conventional flashlight but definitely does the job. Three bright LED's clustered together in the middle of a high efficiency reflector. Only 6" long and tapered from 1" to 1.5" but it has a nice grip and feel. You can get up to 20 hours of light with just one set of batteries. Uses two AA's.

#SF8748 \$16

## Lifetime Flashlight Conversions

Convert standard flashlights to LED bulbs - they last 100,000 hours and, since they only use 1/12th the power of standard bulbs, extend your battery life up to 12 times.

<b>2-cell standard amber</b>	<b>#SF905</b>	<b>\$12</b>
<b>2-cell standard red</b>	<b>#SF1759</b>	<b>\$12</b>
<b>2-cell standard white</b>	<b>#SF5842</b>	<b>\$4</b>
<b>MiniMag white</b>	<b>#SF5843</b>	<b>\$5</b>



# FLASHLIGHTS

## “Forever” Flashlight

*Always ready—no batteries!*

Made for the Soviet army in 1956 and still in use today. Dynamo-powered by hand-squeezing—no batteries to run down or recharge. Great for an emergency kit, always ready. Focusable beam, pump handle folds shut for compact storage. Unlike the more common Chinese model, this one has a sturdy frame, glass lens, heavy plastic case, and die-cast handle.



**Flashlight** #SF1708 \$12  
**Replacement Bulb** #SF6264 \$0.50

## Multipurpose Solar Flashlight

*Multipurpose Solar-powered Light*

High quality bike light with both powerful front-facing search light and bright, blinking red LED's facing back.

Mounting brackets fit all types of bicycle frames, adjust for any angle and direction, and special release makes it easy to take with you and use as a flashlight. Compartment for 2 extra AA batteries that will double use time—up to 6 hours between charges. Floats, includes extra bulbs and nylon carrying strap.



#SF3371 \$28



## FlashLED's

*Highest quality, most options, and brightest LED Flashlights*

Uses two AA batteries that last 15-17 times longer than a similar flashlight with standard bulbs. Rugged anodized aluminum housing withstands severe vibration and shock—lifetime warranty. These use white LED's but by special order we can also send for the same price red, orange, blue, yellow, green, or infrared for an extra \$40. 3-LED bulb illuminates a 1m square area at 1.5m.

### 3-LED FlashLED Flashlight

#SF5834 \$59

### 3-LED replacement bulb

#SF5839 \$29

### 6-LED FlashLED Flashlight

#SF5835 \$89

## Lazer Stik

The environmentally friendly solution to chemical lightsticks.

Water proof to 300 feet and even floats!

Super-Bright single LED. Battery lasts 12 hours in steady-on or 30 hours in flashing model. Cone diffuses light for a soft area illumination.

The green version is a great light to hang in a tent, the red preserve night vision.

SF7398 \$13

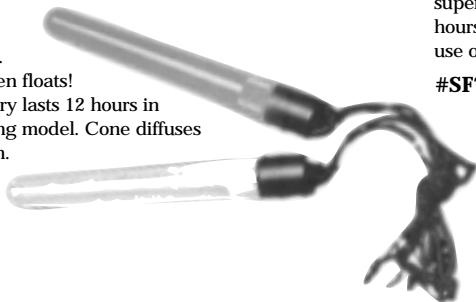

## Stargazer Key Chain Flashlight

Over 58 hours of light on just one battery charge!

Your night vision stays clear with the pure, unfiltered red LED illumination and you still have plenty of light to walk around, read star charts, or find your key hole in the dark. Twist for constant on, push a button for fast on/off. With no fragile filaments, the key chain light is nearly impervious to shock and vibration. The diodes last at least ten times longer than standard incandescent bulbs, batteries 15 to 20 times longer. Lifetime defects warranty. Use our BC300 to recharge.

#SF7605 \$12

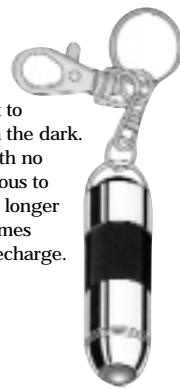

## LED Keyring

*Tiny, bright, 5 hours between charges*

The best light “in a pinch” (with a pinch!). Slightly thicker but shorter than an average key, it takes up about the same amount of room in your pocket. Bright LED doubles as a dim but adequate flashlight always with you.



Gives about five hours of light (1200 door openings) and you can recharge the battery with our Button Battery Chargers.

**Amber** #SF3105 \$12

**White** #SF3224 \$20

## Power-Glow Pen

A pen that writes in the dark? Pretty handy item, especially with a green LED in place of a light bulb. You'll never need to change a bulb, and power consumption is minimal. Take the head off and use it as a penlight, solar recharge the batteries with our BC300.

**Blue** #SF4070 \$12

**Green** #SF6652 \$12

**White** #SF6654 \$12



## Guardian Light

*The Lightest, Brightest, Toughest light in its class!*

Weighs less than 1 ounce. Waterproof to 300 feet. One super-bright LED means 20 hours of constant use, or 150 hours for flashing models on just one battery. Comes with a handy clip for use on hat band, belt or dog collar. Perfect for backpacking or glovebox.

#SF7399 \$13

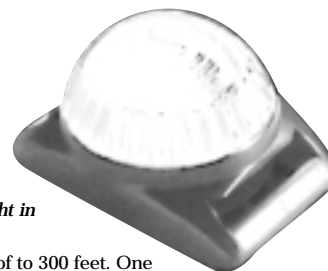

*"Warmest greetings from our small village of Tamatama in the middle of the Venezuelan jungle . . . We are missionaries working with the Guaica Indians and are especially interested in a 12 volt system using Solar panels."*

- WR, Venezuela

## Solar Outdoor Lighting

- Billboards • Streetlights • Sign Lighting
- Parking Lot and Area Lighting

Solar billboards, streetlights, sign lighting, parking lot lights, bus shelter systems and outdoor, commercial lighting. We design, supply, and arrange for installation of solar outdoor lighting on almost any scale. The solar streetlights listed here with 4 hours of average sun give either 6 or 12 hours of light per night. By changing system design, both the hours per night and the number of days the system will work without sun increase. To give a rough idea, we also list some costs for solar billboard systems. Systems vary widely based on required light brightness, hours per day of operation, and amount of sun at the location. Call or write for brochures and more information.

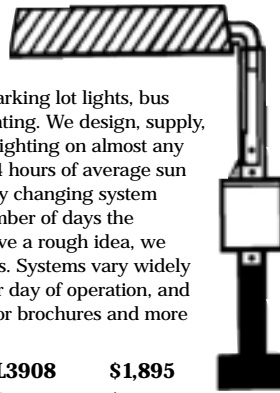

<b>6-hour Streetlight System</b>	<b>#OL3908</b>	<b>\$1,895</b>
<b>12-hour Rural Area Light</b>	<b>#OL3909</b>	<b>\$2,690</b>
<b>10 x 10 Solar Billboard System</b>	<b>#OL3910</b>	<b>\$1,585</b>
<b>10 x 20 Solar Billboard System</b>	<b>#OL3911</b>	<b>\$2,580</b>
<b>10 x 30 Solar Billboard System</b>	<b>#OL3912</b>	<b>\$5,190</b>

## En-R-Lights

Modular—efficient lamp assembly with battery storage and rugged solar panel, mounts on any pole in about 2 hours

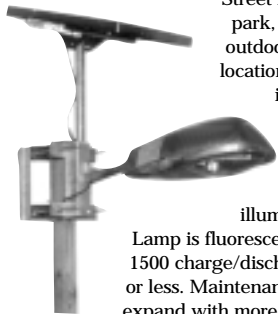

Street lighting off the grid! Now you can light a park, a street intersection, or any other small outdoor area without running grid power to the location. En-R-Light mounts on top of a pole. It incorporates a solar panel, sealed battery, light and a ballast/controller. During the day it captures and stores solar electricity. At night it switches on the street light for up to 12 hours of illumination. Solar panel is rated at 50 watts.

Lamp is fluorescent (or optional sodium). Battery capable of 1500 charge/discharge cycles. Installation is simple, 2 hours or less. Maintenance is minimal, and the unit is easy to expand with more solar or battery capacity. Install multiple units to light an entire street.

<b>En-R-Light Street Light</b>	<b>#OL4637</b>	<b>\$1,525</b>
<b>En-R-Light Area Security Light</b>	<b>#OL4638</b>	<b>\$1,364</b>

## Solar Highway Beacons

Reliability and efficiency breakthrough. Built-in photo sensor connected to automatic rheostat gives this new highway beacon 2-4 times more efficiency than anything previously available. This means less solar and battery storage required—much lower system cost. Includes “lifetime” electronic flasher and halogen bulb that gives twice as much brightness as the same wattage incandescent bulb and lasts 3-4 times longer. Complete systems for any application available.



<b>Head only</b>	<b>#OL111</b>	<b>\$240</b>
<b>Complete System</b>	<b>#SB1000</b>	<b>\$1,670</b>

## Maverick

Solar barrier warning light

The brightness, battery capacity, and recharge capability to replace conventional warning lights with greater performance, dependability, and no maintenance. Cluster LED's last 100,000 hours and are so efficient the 2.4 amp battery will last 3 nights without sun. Visible up to 3000', 360° swivel, meets 6E-5 & ITE specifications.

**#OL109 \$89**



## Frosted S14 LED Bulbs

Delightful colors for hard-to-reach, decorative lighting. Gigantic maintenance and energy savings - these bulbs last 100,000 hours and only use one watt! They replace a 25-30 watt bulb, don't produce heat and don't easily break with jarring like. The perfect solution for many commercial lighting applications. Wholesale and quantity discounts available.



<b>Red</b>	<b>#AC7277</b>	<b>\$32</b>
<b>Amber</b>	<b>#AC7278</b>	<b>\$32</b>
<b>Green</b>	<b>#AC7279</b>	<b>\$44</b>
<b>Blue</b>	<b>#AC7280</b>	<b>\$44</b>
<b>White</b>	<b>#AC7281</b>	<b>\$44</b>

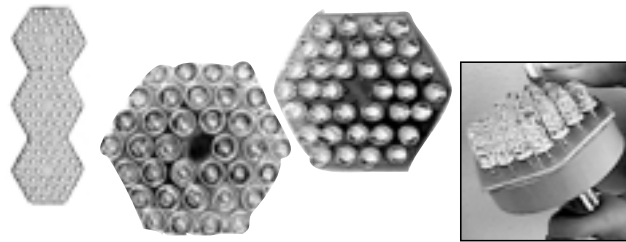

## 36 Cluster LEDs

A big deal in a small package. Interlock these lights in a honey comb design for as much light as you need. Compact and very bright. 360 milliamps.

<b>36 Cluster LEDs</b>	<b>#AC7575</b>	<b>\$220</b>
<b>with diffuser</b>	<b>#AC7576</b>	<b>\$230</b>
<b>with single/bi pin</b>	<b>#AC7577</b>	<b>\$225</b>

## Lighted Safety VestLED

Great for riding a bike on dark streets and for high visibility in hazardous environments (perfect if disco gets popular again!). 16 high intensity red LED's flash 90-100 times per minute and are visible for up to half a mile. Powered by two AA alkaline batteries, it works for 240 continuous hours. Neon orange vest with bright reflective yellow stripes on both back and front.

**#SY5840 \$92**



## A Bright Idea

Lighting in the U.S. creates 39 million annual tons of carbon dioxide emissions. Yet the technology exists to save \$30 billion a year, retire 70-120 large power plants and reduce these emissions by perhaps 35 million tons. That technology is the compact fluorescent light bulb (CFL). CFLs are 4 times more efficient than incandescent bulbs and last 10-13 times longer. At an average electricity cost of 8.3¢ per kilowatt hour, each one pays for itself and saves you \$37.00 in electric bills over its lifetime. That same bulb will prevent 1,500 lbs of CO2 emissions and 20 lbs. of sulphur dioxide pollution from a coal-burning plant; 1/2 a curie of radioactive waste (a large amount) from a nuclear plant; or enough oil from an oil-burning plant to drive your car 1,000 miles.

# OUTDOOR LIGHTING

## Thin-Lite Outdoor Fixture

Weather-proof outdoor light survives harsh conditions and still provides great light. The amber lens won't attract mosquitoes or other insects. 12V 16 watt fluorescent light shines 800 lumens into the darkest night. High quality. Please specify amber or clear lens. 12.5".

#DC160 \$62

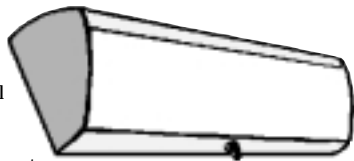

## Solar House Number Light

Help friends and emergency services find your house. Just 1.5 hours of sun gives a full night of illumination. Automatically goes on at night, off in the morning. Bright red 4" numbers easily visible from 500'. Easy to install, no wiring. Just mount on included stake, on mailbox or on the house. Solar panel goes on the light or up to 8' away.

#OL301 \$55



## 12V Compact Fluorescent Outdoor Floodlights

Light up large outdoor areas, signs, yards, and landscaping. Efficient mylar reflector and solid, black finished aluminum housing. Perfect for most outdoor installations—even very wet.

9 watt #DC153 \$95  
39 watt #DC159 \$197

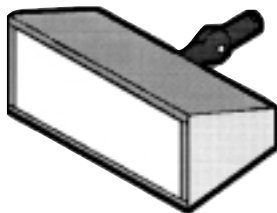

## Nightstar

### Flashing light system

Complete PV powered system with 4-second flash. Great for marking obstructions, buoys, docks, construction, harbors.

#OL110 \$240

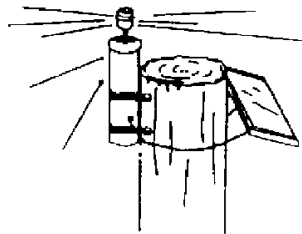

## SensorLight

*New halogen bulb for brighter light and more efficiency*

The price came down on this new motion detector light and the quality went up. Automatically turns on when triggered by heat or motion and turns off when you leave. Adjustable sensitivity control reduces false triggers. Easily mounts in minutes and operates up to 2 weeks without sun. Includes cord to mount solar panel up to 14' away from light. 20 watt halogen lights up a large area.

SensorLight #OL100 \$119  
Replacement Battery #OL4372 \$15  
Replacement Bulb #OL4560 \$11



## Siemens PL Sensor Light

All the benefits of a motion sensing light and solar powered. Automatically turns on when sensor detects heat or motion. Adjustable sensitivity prevents false alarms. Detachable solar panel mounts up to 14 feet away. Battery storage can operate for 2 weeks (intermittently) without solar recharging. 10,000 hour 9 watt compact fluorescent floodlight and replaceable battery.

#DC6166 \$75

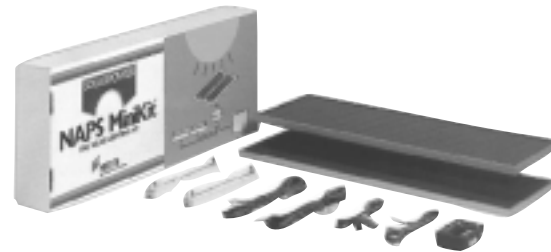
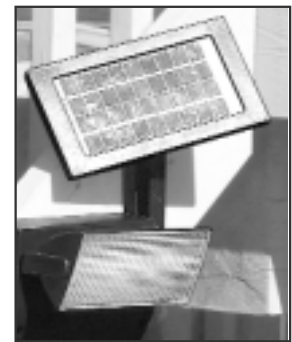

## Solar Lighting Kit

*True plug-n-play operation*

Simple to install with easy-to-follow instructions. The NAPS MiniKit operates 2 lights for up to 3 hours per day. The controller features both voltage regulator and battery protector to enhance battery life. To complete your system, simply add 12 volt lead acid battery (35-75 AH capacity). Kit contains: 2 solar modules (5 watts each); controller; 2 fluorescent lights (8 watts each); all cables, mountings and interconnects; complete instructions.

#DC4717 \$290

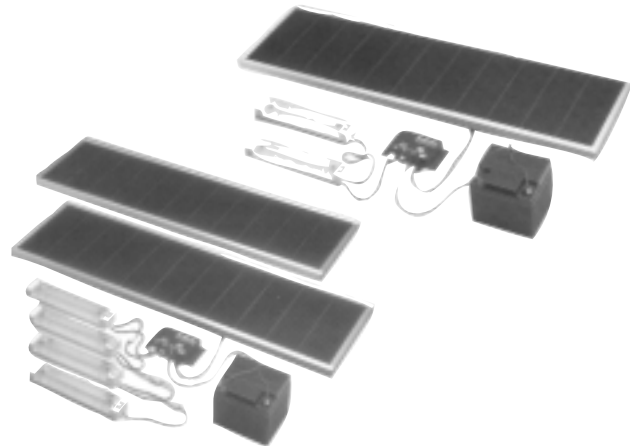

## Uni-Kit Solar Lighting

*Take the guesswork out of your remote lighting needs*

These kits combine an unbreakable Unisolar solar module, a sophisticated charge/load controller and super efficient fluorescent lighting. You supply the 12V deep cycle battery. UniKit 30watt comes with two lights and gives you enough power to run them for 6-8 hours each. The Uni-Kit 60 adds a second solar module and two more light fixtures for even more hours of lighting. All clearly labeled with all the electrical connections needed. 10 year warranty on the solar panel, 1 year on the lights and controller.

#PV8018 30W \$474  
#PV8019 60W \$758



## Retrofitting a typical 7000 sq. ft. office...



**Prevents**  
15 tons of CO<sub>2</sub>  
per year

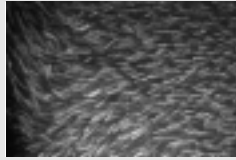

**Prevents**  
250 pounds of SO<sub>2</sub>  
per year



**Prevents**  
110 pounds of NO<sub>x</sub>  
per year

## These carbon dioxide reductions are equivalent to...



**Planting**  
4 acres of Trees



**Removing**  
2 cars from  
the road

## Operating Cost Comparison

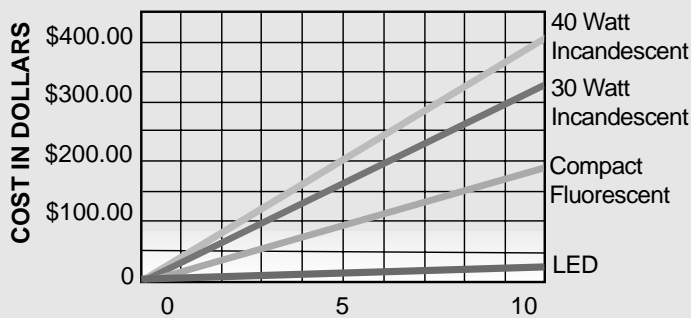

## Years of Operation

	40 Watt Incandescent	30 Watt Incandescent	Compact Fluorescent	LED
Energy Usage	40 Watts	30 Watts	9 Watts	1.89 Watts
Energy Cost/Year	\$35.04	\$26.28	\$9.20	\$1.65
Cost of Bulbs/Year	\$4.00	\$4.00	\$3.50	\$0.00
1 Year Total	\$39.04	\$30.28	\$12.70	\$1.65
5 Year Total	\$195.20	\$151.40	\$83.50	\$8.25
10 Year Total	\$390.40	\$302.80	\$157.00	\$16.50

## Energy Efficiency, Pollution Prevention and Major Cost Savings

Save 20,000 kilowatt hours (kWh) of electricity per year by upgrading 7000 square feet of office space to energy efficient lighting. Experience dramatic reductions in energy costs while reducing emissions of carbon dioxide (CO<sub>2</sub>), sulphur dioxide (SO<sub>2</sub>), and nitrogen oxides (NO<sub>x</sub>), the air pollutants most responsible for climate change, acid rain, and

## Consulting

As a pioneer of commercial LED systems and an engineering partner of Conserv-a-Watt, systems designer for clients like Vectra Bank, MCI, Chevron, Coors, the City of Thornton, and Boulder Valley Schools, we're uniquely positioned to help you sort through today's maze of lighting options. Having designed custom LEDs for everything from Disneyland to New York's Tribeca Hotel and even Hollywood movies, our experts will evaluate your unique requirements and special lighting needs, and recommend the most cost effective and environmentally sound solutions.



## Linear Fluorescents

Retrofit your fixtures or outfit new construction with state-of-the-art energy-efficient ballasts and linear fluorescent tubes. Our new T-8 bulbs replace common four foot, 40-watt tubes yet use only 28 watts—an energy savings of 30%.

## Exit Signs

Since most exit signs operate continuously, converting them to LEDs creates huge savings in both energy and bulb costs. A typical incandescent exit sign needs bulb replacement every two months. Even compact fluorescent signs need changing once a year. But an LED exit sign lasts over 10 years. With typical incandescent labor and bulb adding up to \$35 per year, each LED sign saves over \$350 plus another \$260 in energy costs (based on a 2-watt LED replacing two 20-watt incandescents and energy costs of 10¢ per kWh). That's a total of \$610 per sign. Multiply that by the number of exit signs in your facility and it's hard to see how you can afford not to retrofit.

## Outdoor Lighting

Because outdoor lights are bright and used for hours, they offer endless possibilities for reducing energy bills. We offer cost-saving LED, compact fluorescent and HID exterior lighting. Our Pulse Star ballast, for example, saves 18-22% of the energy used by standard HID fixtures without sacrificing illumination. We also have solar powered systems for remote locations, and sign and billboard systems.

## Compact Fluorescents

Because compact fluorescents use only 25% of the energy needed by incandescents and last 10-50 times longer (while providing the same amount of light), their savings are impressive. Just one bulb over the course of its life saves \$40-\$50. And that doesn't count incandescent replacement costs! We offer complete integrated fixtures and a huge selection of replacement bulbs, including super low cost spiral bulbs for just \$7 each. According to the Union of Concerned Scientists, each compact fluorescent bulb prevents the burning of 300 lbs. of coal. That means you can have a huge impact on the environment and your energy costs with a simple change of light bulbs.

## Full Spectrum Lighting

Many scientists believe that we need full spectrum lighting in order to function at peak performance. Reproducing the rich white light of the sun, full spectrum lighting renders colors more truly and reduces the glare that causes eyestrain, headaches, and stress. Their impact is measurable. Reading is easier and less tiring, errors are reduced, attention spans increase, and work improves in both quality and quantity. Employees become happier and more productive. Customers see better, feel better and shop longer.

## LED Lighting

LEDs quickly outpace the competition when it comes to lower lumen decorative lighting on things like signage and amusement attractions, and lighting in hard-to-reach locations. With such lights usually operating for extended periods, LEDs will deliver impressively lower operating costs. Even better, if left on 24 hours a day, 7 days a week LEDs last up to 11 years. During that lifetime, your fixture would otherwise burn through 128 standard incandescent bulbs, 29 halogens, or 10 compact fluorescents—bulbs you'll never buy again.

## Controls

Turning off unused lights is perhaps the best way to save energy. But all too often people forget to hit the switch. That's why we offer control systems that do it automatically. With our fluorescent dimming and other self-adjusting fixtures and systems, you'll save money without thinking about it!

## Traffic Control

Our sister company, Solar Beacons, Inc., designs and manufactures solar highway warning systems. They also offer beacon replacement lamps, traffic lights, and small barricade lights—all using super efficient, long life LED technology.



## Halogen Flood Light Adapters

Replace just the MR16 bulb/reflector instead of the entire lamp. It doesn't look nearly as nice as the one-piece unit but long-term costs much less and you can also use the 50 watt version. 12V only.

#DC375 \$11



## Replacement Quartz Halogen Bulbs

Use with the halogen adapter listed above. The 5 watt size fits Traveling Quartz Halogens and Littlites. Remember not to touch with your fingers!

12V – 5 Watt #DC370 \$7  
 12V – 17 Watt #DC371 \$7.50  
 12V – 25 Watt #DC372 \$7.50  
 12V – 34 Watt #DC373 \$7.50  
 24V – 25 Watt #DC374 \$8

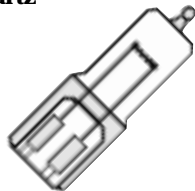

## 12V Bulb Adapter

It's easy to change a variety of fixtures and lamps to 12V with this inexpensive adapter. Auto-brake-light, high intensity bulbs fit one end and the other screws into standard medium base fixtures.

#DC525 \$7



## 12V MR16 Replacement Reflector Bulbs

20 Watt #DC380 \$9  
 50 Watt #DC381 \$10  
 20 Watt w/cover #DC1122 \$13



## MR16 Adapters

Make your own Tram-Style lighting. These adapters give you almost as much versatility as the expensive Tram lighting systems used in restaurants. (We can send you a flyer on \$700+ 5-light systems.) They accept the MR16 reflector bulbs such as our DC380 and 381.

#DC1292 \$3



## Quartz Halogen Adapter

Use this adapter with the replaceable halogen bulbs listed below. You won't have to replace the entire fixture when the bulb burns out—less expensive and more ecological. Great for small spaces—only two inches long. Be careful not to touch the globes with your fingers though because the oil will burn on the glass and decrease the light output. (You can get it off with alcohol if you clean it before you turn the light on again.) Halogens with globes are better for lamps with shades that rest on the globe, and they diffuse the light more.

#DC526 \$11

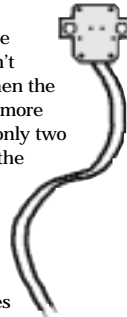

## Programmable Timer

Ideal for security lights, signs, yard lighting, water pumping. Program up to 16 events over seven days and the internal battery will maintain the program for one year without external power. Rated for 8 amps inductive, 16 amps resistive load and easily expanded to 35 or 60 amps (an additional \$67 and \$94 respectively). 6-24 volt (24V needs regulator). One year warranty. 3.9" x 3.8" x 2".

#DC1112 \$85

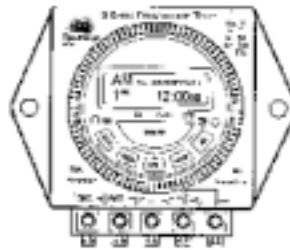

## 12V 20 Amp Timer

Using only a tiny 10 mA, this timer does wonders. It controls 12V pumps, lights, fans, and other appliances that use up to 20 amps. Set up to 3 time cycles each day to run from between 15 minutes and 23.5 hours. Includes self contained 200 hour backup.

12V #DC500 \$97  
 120 Vac 20A #DC4153 \$146  
 230 Vac 50Hz #DC3483 \$175



## Motion Switch

Passive infrared sensor "sees" small temperature changes caused by the motion of people and cars. The sensor triggers a light switch that invites welcome visitors and deters intruders. Great for security systems, commercial and residential lighting. 12V powered, 10 amp switching capability.

#DC512 \$89



## DC Dimmer

98% Efficient, Multiple Uses

Set just the right amount of power for DC appliances, lights, and fans while maintaining 98% efficiency on all settings. Includes fuse, on-off switch and double filtering that protects against voltage surges and prevents interference with radio reception. Miniature size allows easy wall box or panel installation. Optional switch plate mount for standard electrical boxes (add \$6 for standard or \$11 with DC cigarette plug receptacle). Options include auto leveling to maintain specific illumination, temperature range, or other parameters.

4A #SC984 8A #SC985 \$39  
 9.5A #SC986 11A4A #SC987 \$48



## Night Watchman

Automatic on/off, dawn/dusk. Price breakthrough for a powerful dusk to dawn switch. Drives up to 10 amp, 12V. 100% waterproof for outdoor use. Only 1" square and simple to install—just 3 wires.

#DC224 \$46



## Time Delay Switch

Don't worry that someone will forget to turn lights or an appliance off and waste valuable power. Let this time delay switch take care of it for you. Adjust the time from a few seconds up to 10 minutes and each time someone turns the switch on, it will automatically turn off after your preset time. Upper switch lets you temporarily disable the timer. Handles up to a 12 amp load and includes fuse.

#SC220 \$36



## Trace C12 Light Controller

Multiple functions in one inexpensive, outdoor, rainproof enclosure. 3-stage, solid state 12 amp charge control with automatic or manual battery equalization. Automatic low voltage disconnect after 5 minute warning and manual 10 minute extension switch. Auto on at dusk, off at dawn lighting control with adjustable timer. Perfect for small systems, outdoor area and sign lighting, telecommunications. 12V only.

#RG104 \$110



## Ratchet Style Crimping Tool

Easy, secure crimping for between 16 and 8 gauge insulated terminals. It ensures a proper crimp by not opening until it's been fully closed.

#MM8060 \$86



## Die Cast Terminal Crimping Tool

Long, fully insulated 26" handles to assure a solid crimp. Use for wire sizes between 6 gauge through 4/0. Lock button for rotating dies.

#MM8064 \$236



## Wire Strippers

Self adjusting, high quality wire strippers. Strips 18, 16, 14, 12, and 10 gauge wire

#MM806 \$52

## 36" Heavy Duty Wire Cutters

Make cutting heavy wire quick, clean, and easy. The long handles help provide a powerful cutting force on thick wire. Cuts copper cable from 8 gauge to 4/0. (Does not cut steel.)

#MM8062 \$108

## Hand-Held Heavy Duty Wire Cutters

Cut copper cable between 8 and 3/0 gauge with this high quality 8 3/4" hardened steel tool.

#MM8063 \$26

## Compression Terminals

Connect large gauge wire without soldering or special tools. Just cut insulation off the end of your cable, put into the terminal, and tighten with a wrench. Solid brass.

#6 wire	#SC950	\$5
#4 wire	#SC951	\$5
#1/0 wire	#SC952	\$6
#2/0 wire	#SC953	\$8.50
#4/0 wire	#SC954	\$8

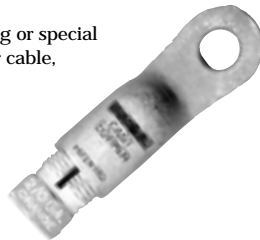

## Battery Terminals

Convert conventional post-type battery to wing-nut connection. Greatly simplifies battery hook-ups in small systems. Just crimp ring terminal on the end of a wire, slip over post and tighten wing nut.

#SC959 \$2



## 8 Gauge to 4/0 Crimping Tool

Make your own battery and inverter cables

Use a hammer or vise with this heavy duty crimping tool and make strong, solderless connections on wire sizes up to 4/0.

<b>Crimping Tool</b>	#SC962	\$29
<b>2/0 Battery Terminals</b>	#SC966	\$0.90
<b>4/0 Battery Terminals</b>	#SC967	\$1.45



## Cordless 12V Planer

Use anywhere without the heavy, large equipment

Powerful 12V (2Ah) battery gives maximum performance and planes up to 140 feet at a depth of 1/64" from a single charge. 2-blade cutting head makes 18,000 cuts per minute for fast and smooth planing. Uses 2" carbide tipped blades. V-groove on base for easy chamfer cutting, electric brake for fast stopping of blades, and low noise at only 69dB for quiet operation. Includes battery, DC charger, planer blade, hex wrench, guide rule and holder, battery cover, dust bag, plastic tool case. No load speed 9,000 RPM, 11-9/16" L, 4.6 lbs. (w/battery) . Makita

#TL8117 \$280



## Mobile Reciprocating Saw

Solar rechargeable and high power for easy cutting in tight areas like between framing studs and in crawl spaces.

Motor mounts vertically instead of horizontally which both makes it easier to get into small spaces as well as letting it sit upright when set down. A quick-change blade clamp accepts blades upside-down for making upward cuts. " Network" 19.2V battery system also powers a drill, hammer-drill, circular saw, and more. Variable speed (0-2, 900 SPM). Includes the saw, high-capacity battery pack, advanced diagnostic charger, carrying case, and operating manual . 19.2 Volt, 2 Amp/hour batteries for more power and longer run time.

#TL8116 \$279



## Flameless Heat Gun

Solid state, powerful heat gun designed for shrink tubing. Dual settings for either 750 or 1100 degrees F. 1200 watts, 120 vac.

#MM8059 \$39

## Quick Connect Battery Terminal

Easily detach cables from battery posts—just twist knob! Makes it easy to move batteries or detach to prevent electrical drain.

#SC3469 \$6

## The Ultimate Multi-Purpose Independence Tool Kit



Imagine this—a human-powered tool that without any other power source could turn a powerful table saw, drill, belt sander or wood lathe, grind grain into flour, sharpen tools, wash and spin dry laundry, pump water, recharge a laptop or cell phone, operate a computer or television—even help replace a solar electric system on cloudy

days. Something from a futuristic science fiction novel? Actually, it's a 19th century technology reinvented for 21st century life styles—a foot-operated push bar flywheel similar to the working parts on an old Singer treadle sewing machine. Faster and easier than bicycle generators and includes variable speed settings—750, 1350, or 1750 rpms. Kit has over 175 pieces, all the precision machined parts needed, the flywheel, chain gear and sprockets for power take-off—everything but the structural wood. It takes about 40 hours of hard work and you'll need a good table saw and router. 8 pages of computer-drawn plans include complete instructions and materials list.

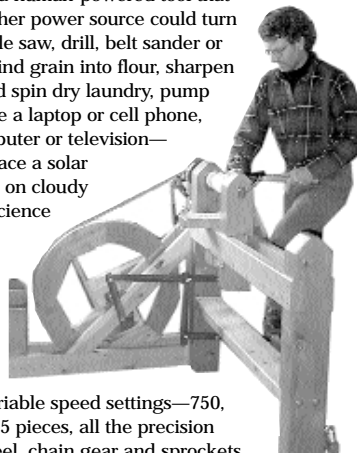

<b>Complete Kit</b>	<b>#TL5500</b>	<b>\$825</b>	<b>Flywheel only</b>	<b>#TL550</b>	<b>\$318</b>
<b>Wood Lathe Kit</b>	<b>#TL5410</b>	<b>\$676</b>	<b>Lathe Plans Only</b>	<b>#TL5962</b>	<b>\$35</b>
<b>Multi-Purpose Independence Tool Plans only</b>				<b>#TL5409</b>	<b>\$30</b>
<b>Saw</b>	<b>#TL7667</b>	<b>\$300</b>	<b>Drill</b>	<b>#TL7668</b>	<b>\$96</b>
<b>Grinder</b>	<b>#TL7669</b>	<b>\$160</b>	<b>Polisher</b>	<b>#TL7670</b>	<b>\$72</b>
<b>Generator</b>	<b>#TL7671</b>	<b>\$360</b>			



## DC Impact Wrench

Run a powerful impact wrench from your car battery or Renewable Energy powered shop. DC Impact uses 12V DC to power an impact wrench that will remove hundreds of lug nuts torqued up to 450 ft-lbs on one charge. Also great for working on farm tools and any remote, mechanical equipment. On board worklight helps with nighttime use. Don't confuse with cheap imitations, this is a commercial quality unit. Recharges from 120volts AC in about 3 hours.



**TL7381 \$1,299**

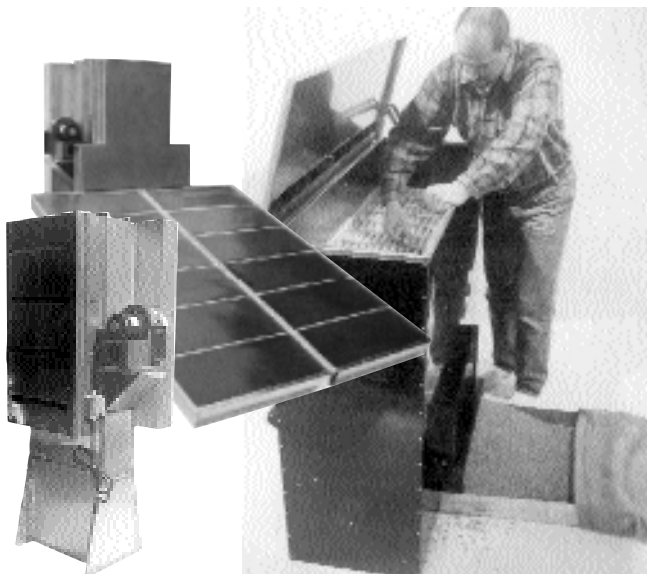

## AirFlo Dehydrator

Large scale, high efficiency dehydrator for coffee, beans, nuts, and grain. Connect a hot air collector system or any heat source and a small PV system; 5 super efficient fans (using 35 watts total) pull the air vertically through the dehydrator, drying crops evenly and quickly while safeguarding against mold. It eliminates the need to rotate crops during the drying process and retains the highest quality due to the optimum drying efficiency. Capacity c. 100 lbs. every 6-8 hours. Stainless steel gates and hardware, FDA approved high density polyethylene interior. Larger, custom models available by request.

**#KT6044 \$3,990**

## Earth Press

*Make your own buildings with locally available materials*

You can quickly make strong and high quality adobe bricks made with these state-of-the-art new block presses. The Twin Axle Trailer-mounted industrial-duty Earth Press II does 10 blocks per minute and has a hopper capacity of 62 bricks. We rate all components for extreme industrial use to withstand years of service. All models have automatic or manual modes, specifically designed hydraulic cooling system, double welded seams, built-in leveling jack and 12V DC electrical systems. They produce blocks 8 x 12 x 4 inches (20 cm x 25 cm x 10 cm). The Earth Press III makes 4 blocks per minute and the Earth Press IV 6-8.



<b>Earth Press II</b>	<b>#TL8012</b>	<b>\$61,000</b>
<b>Earth Press III</b>	<b>#TL8013</b>	<b>\$29,000</b>
<b>Earth Press IV</b>	<b>#TL8014</b>	<b>\$45,000</b>

## Flameless Heat Gun

Solid state, powerful heat gun designed for shrink tubing. Dual settings for either 750 or 1100 degrees F. 1200 watts, 120 vac.

**#MM8059 \$39**





Dallas Love Field Airport System



Wireless' low-power microwave system.



Crystal Clear video and audio may be sent up to 3,000 feet over twisted-pair telephone wire using active line drivers from Network Video Technologies (NVT).



Kalatel's KTB 304E keyboard. The joystick provides 360° of pan and tilt and can be programmed for proportional response.



Digital Video Motion Detector (DVDMD01).

## Mobil Vision

Remote audio and visual surveillance without wires, cables, or external power. Control up to 512 cameras from one building or vehicle-based keyboard controller. Transmit both audio and video up to two miles with this low-power microwave system. Designed to operate in all environments, the Kalatel color cameras automatically switch to infrared in low light conditions, zoom to 22X, and move through a 360 degree pan and tilt. Transmit crystal clear video and audio through a large building complex an additional 3000' with optional line drivers. Record the information on a VCR, initiate alarms, and/or monitor live.

We designed one of these systems for the Dallas Love Field Airport. This system allows the transmission of video and audio from multiple remote camera sites via microwave to a single frequency receiver. Until now, each microwave transmitter, in a geographic area, has required its own corresponding receiver with its own separate frequency. This installation also incorporates a solar/battery power supply that, in combination with the microwave system, eliminates the need for any external physical connection. It is the first solar/battery power supply to use Nickel Metal Hydride batteries in an application of this type.

These systems can save lives, prevent theft, and assure compliance at airports and other commercial sites. Good applications include installations at schools, car dealerships, parks, embassies, malls, office and government buildings, banks, warehouses, parking lots, ranches, and farms.

#RS8172 Call for Quote

## Solar Powered Electric Fencers

Our Parmak electric fencers use the free energy of the sun to charge powerful batteries for maximum shock day or night. Eliminates expensive battery replacement or inconvenient recharging. 6-Volt Solar-Pak model will operate 21 days without sun and will charge up to 25 miles of fence. 12V Magnum model operates up to 3 months without sun, charges up to 25 miles of fence, and shocks through wet weeds and brush. Built-in performance meter tells you exact condition of the fence. One year warranty.

<b>Solar-Pak</b>	<b>#AA130</b>	<b>\$195</b>
<b>Magnum</b>	<b>#AA131</b>	<b>\$375</b>

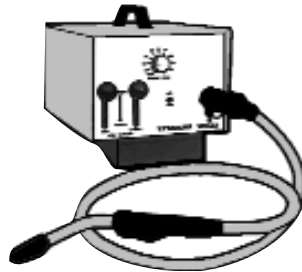

## Portable Welder

Weld 200 amps from 24V!

Lightweight (23 lbs.) portable unit is ideal for welding steel, aluminum, sheet metal, or heavy plate. Output ranges from 60 to over 200 amps. Useable with .030 or .035 self shielding steel wire—no gas bottles required. Comes with wire speed (current) and voltage controls. Includes hook-up cables, wirefeed torch and work clamp with cable. Two year warranty. 11" x 9 1/2" x 20".

#GN150 \$789

## Corn Planter

Easy on your back and knees—no stooping, just push the steel blade into the ground and squeeze the handles. It makes a hole and drops an adjusted number of seeds in one easy step. All wood and steel except for plastic hopper sides and seed track. 35" long, 2 lbs.

#AA3546 \$56

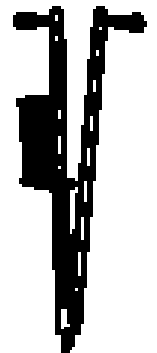

## Wireless Motion Alerts

Announce visitors from 500' away

If you're in the barn, greenhouse or garden, these wireless radio operated systems will let you know when you have company. Set the transmitter model in any direction—it emits an 80 ft. invisible beam and sends a signal up to 500' back to a ringing bell or turns on lights, activates a siren, starts a telephone tape dialer, etc. 120 VAC receiver has on/off switch, 4" x 4" transmitter uses 9V battery. Rubber hose drive alert activates the same signals when a vehicle crosses a 25' 3/8" hose.



<b>Wireless Motion Alert</b>	<b>#AA1128</b>	<b>\$219</b>
<b>Extra Transmitter</b>	<b>#AA1129</b>	<b>\$124</b>
<b>Extra Receiver w/Bell</b>	<b>#AA1130</b>	<b>\$95</b>
<b>Rubber Hose Alert</b>	<b>#AA1131</b>	<b>\$149</b>
<b>Extra Receiver w/Bell</b>	<b>#AA1132</b>	<b>\$95</b>
<b>Extra Transmitter</b>	<b>#AA1133</b>	<b>\$65</b>

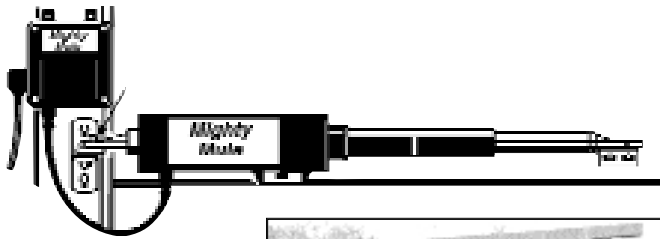

## Solar Gate Opener

Battery powered, solar charged, automatic gate opener becomes a miracle on one of those dark rainy nights when you're coming home late and tired. Easily opens and closes gates up to 16' long and up to 350 pounds. Adaptable for all types of single swing gates and only takes about an hour to install. Includes one transmitter. Commercial versions with custom options also available.



<b>Solar Gate Opener</b>	<b>#AA120</b>	<b>\$595</b>
<b>Solar Panel</b>	<b>#AA121</b>	<b>\$145</b>
<b>Extra Transmitter</b>	<b>#AA122</b>	<b>\$32</b>
<b>Digital Gate Key Pad</b>	<b>#AA123</b>	<b>\$72</b>
<b>Pin Lock</b>	<b>#AA4351</b>	<b>\$18</b>
<b>Electric Lock</b>	<b>#AA33756</b>	<b>\$145</b>

## Aeration and De-Icing Systems

*Aerate fish ponds, septic, unfreeze stock tanks*

Solar air pumps destratify stock tanks, melt ice, make sure animals have water, help ailing septic systems and keep conditions just right for fish. Melt a hole in 2" ice with just one hour of early morning sun! Many kinds of systems available, the best one depends on the amount of water, the ambient temperature, the type of fish for aeration. We list some of the common types here and design and size systems based on your requirements. Anything from an automatic stock tank deicer to aeration of a large lake. The stock tank systems (also good for small ponds) include an outdoor compressor cabinet, air tubing and diffusers. Use the Aeration systems in ponds, lakes or reservoirs for ice removal, improving fish and waterfowl habitats, and lakes. The Solar-Aire I includes two 75 watt solar modules, all needed components and works in ponds up to one surface acre and depths up to 50'. The Solar-Aire II has 4 solar panels and does twice the aeration or ice melting. The Windaire has 6 blades for low torque, low wind speed start up begins working with wind speeds as low as 4 mph. For ponds up to 2 surface acres and depths up to 50'. Use the listed DC compressors to make your own system.

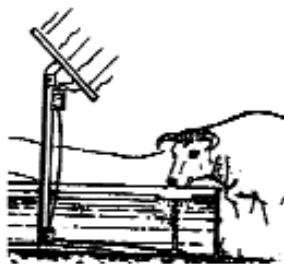

<b>Small Stock Tank</b>	<b>#AA3901</b>	<b>\$150</b>	
<b>Medium Stock Tank</b>	<b>#AA3902</b>	<b>\$184</b>	
<b>Small Aeration</b>	<b>#AA3903</b>	<b>\$1,220</b>	
<b>Medium Aeration</b>	<b>#AA3904</b>	<b>\$1,440</b>	
<b>Solar-Aire I</b>	<b>#AA3905</b>	<b>\$2,955</b>	
<b>Solar-Aire II</b>	<b>#AA3906</b>	<b>\$4,884</b>	
<b>Windaire</b>	<b>#AA3907</b>	<b>\$4,760</b>	
<b>1.8 CFM 4 - 10 psi</b>	<b>Compressor 12V</b>	<b>#WP120</b>	<b>\$160</b>
<b>3.2 CFM 4 - 15 psi</b>	<b>Compressor 12V</b>	<b>#WP121</b>	<b>\$330</b>
<b>0.6 CFM @ 5 psi and .45 CFM @ 15 psi</b>		<b>#WP122</b>	<b>\$93</b>

## LP Stock Tank Heater

The best solution for keeping stock tanks thawed in extreme cold. Connect to propane tank—keeps ice away for weeks on one filling. 13,000 BTU burner housed in a submerged case, heavy steel construction, easy servicing. Fits most sizes and styles of stock tanks. Standard as LP, convertible to natural gas (extra).

**#AA5388 \$318**



## Solar Fire Ant Charmer

- Control fire ants environmentally
- No poisons, chemicals or baits
- No product is more effective or safe to control these pests!

The red imported fire ant was accidentally introduced in Mobile, Alabama from South America in the 1930's. The species spread through the lower United States and continues to expand northward and westward into areas with mild climates and plentiful food. Fire ants attack animals, people, and even electrical devices. They cause failures in air conditioning units and traffic control boxes. Fire ants kill livestock and have also been known to kill humans. The solar ant charmer controls fire ants without poisons by eliminating a major part of the ant colony's defenses. It collects thousands of fire ants in just minutes. Fire ant poisons pollute the Earth and fire ant baits take up to six weeks to become effective. Use it over and over again for years without replacing any batteries, the solar cell does it all!

**#AA3553 \$96**



## SolarMoler

Don't kill or poison the critters! You can still keep your garden healthy - just use the SolarMoler as an underground "keep-out" sound that repels moles, voles, and shrews. And you won't need any wires going across your paths - the built-in solar panel provides power. Just push the stake in the ground and keep a garden up to 7000 square feet safe for plants. Internal NiMH battery charges by day to ensure around the clock operation. 16" stake, 7" diameter.

**#EP6796 \$44**



## Solar Mosquito Repeller

In the history of the world, more people have died from diseases transmitted by mosquitoes than from all the fighting in all the wars. Unfortunately, this solar device won't do much to stop war but it does create a high frequency sound that keeps mosquitoes away! On/off switch, covers 12' radius.



**#ST241 \$7**

## Automatic Hay Feeder Trough

Here's a brilliant way to feed all your animals with one choring per day! Feedbox mounts in the stall, and holds a full feeding or ration (hay or concentrate). Remote solar charged unit trips a pneumatic line to open feedbox at a preset time. Air actuation means no



chance of electrical shock to the animal. Another great feature—control unit can open a series of boxes at the same time. Design is so creative, it's patented.

**Multi-Trough Power System #AA5249 \$700**  
**Reinforced Steel Trough #AA5354 \$500**



## Pasture Pump

*Your animals pump their own water!*

Animals learn the first day you install this pump that they get water by pushing on a lever. Prevents animals from damaging stream banks, springs, and ponds. They also pump from shallow wells—vertical lifts up to 26' and horizontal distances up to 126'. Each pump provides enough water for up to 30 horses or cows. Easy to move from place to place, weighs 22 lbs.

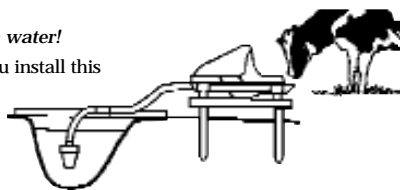

**#WP733 \$349**

## Paulownia Trees bring good luck!



*Example of intercropping: five year old Paulownia Tree*



*Four year old Paulownia Tree*

*In China they believe that planting the Paulownia by their house attracts the Phoenix!*

### The Perfect Sustainable Tree!

Just imagine the difference that could be made if everyone planted one Paulownia tree. An 8 year study done by the International Development Research Centre, established that atmospheric oxygen and relative humidity increased 10-15% as a result of these incredible trees. Also, their ability to grow and thrive in areas that had severe dust, smoke, and sulfur, added to significantly reduced air pollution.

Paulownia trees can become the foundation for ecologically sustainable communities. Fast growing deciduous trees, they provide shade, valuable hardwood, and create ideal microclimates for growing a wide variety of organic food crops.

### Ornamental Benefits:

- Shade for home starting in just 16-18 months
- Beautiful edible lavender flowers

- Fully matured to 30' in just three years
- Gentle scent like Jasmine

### Food Source Benefits:

- Leaves are great for tea and make excellent burritos. Leaves are 18-20% protein, high in nitrogen—excellent animal fodder or fertilizer (mature tree produces 85lbs.)
- Flowers are tasty and beautiful in salads
- Bees love the flowers—excellent source of organic honey
- Trees feed the animals, their waste can feed the trees

### Forestry Benefits:

- Grows 70'-80' in 10-15 years
- Drought resistant, disease resistant
- Hardwood has grain like mahogany
- Hardwood does not warp twist or crack
- Excellent wood for insulation
- Lightweight with excellent weight strength ratio
- Great for furniture, musical instruments, doors, moldings, poles, fencing, paper, wood, wool, & more

- Fire-resistant and water repellent
- Air dries in 30-60 days, kiln dries in 24-48 hours
- Commercially harvested in just 5-7 years
- Regenerates from the stump after harvesting

### Air and Waste Water Control Benefits:

- Significantly reduces waterway contamination and odors
- Increases nitrogen uptake
- Erosion control, windbreak, and screen
- Absorbs dust, smoke, sulfur, and other chemicals.

### Kawakamii

**30' High in 3 years, +5/130° #EP6751 \$29**

### Elongata

**75' High in 10 years, -5/130° #EP6753 \$29**

**Trees are guaranteed**



## Remote Medical Equipment

In remote areas of developing countries, thousands of people die from diseases considered minor in the west. A missing element is early diagnosis—without power, commonly available medical equipment won't work. We list just a few items here. For more details, order our booklet, "Remote Medical and Dental Equipment." - #PI144

### Anaemascan

*"Inexpensive accurate haemoglobin measurement at the bedside."*

A small, easy to use electronic Hb meter. Calibrate with touch-pad controls and large digital read-out. Multi-power options - 120/240v AC (switched) - 12vDC car battery, rechargeable NiCad batteries or direct from a small solar panel. Minimal power consumption and battery life prolonged by an automatic cut-off after one minute (if not in use). Simple design for reliability - resistance to heat and humidity built-in. It uses standard cuvettes - reagents (NaOH & Triton X) are safe and simple to make - primary standards are cheap, easy to prepare and stable for up to 8 months at 4 - 8 degrees centigrade. It uses the alkaline-haematin method but can accommodate the cyanide method - either by changing the interference filter or, more easily, by weakening the blood dilution strength from 1:151 to 1:251.

#MD7936 \$466



### Solmic Solar Powered Mini-Microscope

*A new portable field microscope to strengthen rural Primary Health Care*

A small (13 X 7.5 X 19cm high) instrument weighing only approximately 1Kg. According to the optics selected it has a magnification range up to X1000 (oil). Illumination is provided by a low-consumption 'Ultrabrite' LED with multi-power options, i.e. 120/240v AC mains (switched), 12V DC vehicle battery or 3 high capacity 'AA' NiCad cells giving up to 20 hours of continuous lighting when fully charged. A small solar panel (e.g. 'Portosol') directly powers the LED and when this is switched off, charges the internal batteries. The optical tube has a bayonet mount to facilitate lens changing; this is also spring-loaded to eliminate backlash. Use multi-directional specimen scanning by means of a single 'joystick' mounted at the side of the optical tube. The microscope is mounted at one end of a strong protective case (measuring 8 X 13 X 20 cm), with a lockable lid and carrying handle, into which it can be folded and fully enclosed when not in use or when being transported. This also has space for spare optics and other accessories. The base is fitted with a small female threaded socket to permit fixing it to a small camera tripod for field use. The base unit is hinged at one side to allow access to the specimen carrier and lighting system, and for cleaning. Includes X 10 ocular and X9, X40 and X100 (oil) objectives.

#MD7947 \$466

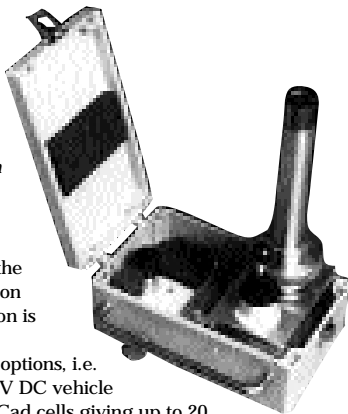

*"Thank you very much for your prompt response and clear answers to my questions. I would like to order the Vaccine Storage Refrigerator. Our mission has several remote rural clinics here in Haiti. Thank you for your emphasis on products that have application in the third world."*

- Paul Eckhoff, MD, La Pointe, Haiti

### Jabric

*Multi-purpose manual centrifuge*

For use in busy out-patient "outreach" clinics in non-electrified health clinics and emergency field situations. This portable hand-turned manual centrifuge works during power failures, in rural Health Centers and Veterinary Stations where neither electricity nor batteries are available. Strongly built, fully enclosed, safe and simple to use. In addition to the standard "Spinductor" safety features, the Jabric includes a lockable lid with observation window and a plastic splash-guard which is removable for cleaning. It is fitted with the 'Spinductor' microhaematocrit disc, with its novel colour-coded and letter-coded bands and 1g/dl interval lines for easy reading. Three interchangeable rotors hold either 20 x 50 mm capillary tubes, 8 x 10 ml capped sample tubes, or 20 x 1.6ml 'Multivette' sample tubes. Speeds up to 6500 rpm, 30 x 25 x 25 cm, 6 kg.

#MD223 \$965

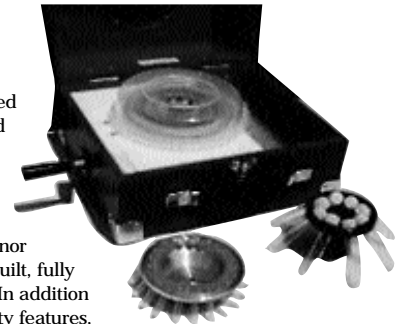

### Saturn Solar Powered Portable Microhaematocrit Centrifuge

"An invaluable field instrument for use in electrified and non-electrified health posts, in "outreach" clinics and in refugee and disaster situations world-wide." A small, compact and fully self-contained instrument needing neither electricity nor vehicle battery. Fitted with the 'Spinductor' disc, it has automatic speed control, a counter-current electric brake, an automatic safety cut-out (if lid is raised during operation), a 'battery low' warning light and a lockable lid with observation window. It has timed runs of 5 minutes duration - shorter runs are controlled by the on/off switch. 7850 rpm - electronically controlled by infra-red sensor and stroboscope on shaft. Besides solar, power with 120/240 vac (switched), 12V DC vehicle battery, 10 Nickel Hydride, high capacity 'C' cells - when fully charged these

give 16 runs at full speed without recharging (enough for processing 320 samples). 20 cm dia x 15 cm high, 3.75 kg.

#MD7948 \$965

### Pima

*A new, inexpensive microhaematocrit reader*

A simple field tool for reading both PCV% and haemoglobin values in centrifuged microcapillary tube blood samples. The small size and simplicity of method makes it easy for rural health personnel and others to understand and use. Just position each sample in front of the reader card by sliding the card sideways to align the top of each sample with the green datum line. You'll be able to instantly read both the PCV% (black lines) and the Hb values (colour bands). The solid hardwood block base unit has a groove to take the card and lines of 3mm deep holes to hold the tubes. Reader-card markings have been carefully adjusted to compensate for the different centrifuge speed to ensure maximum accuracy. Full operating instructions are given on the reverse of the laminated card and include a warning note for those samples with dangerously low Hb values in the lowest red band (0 - 5g/dl).

#MD7946 \$20



## Spindoctor

*Easy, comprehensive blood testing without power*

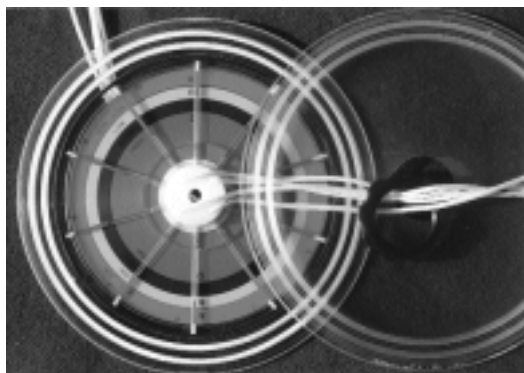

Just tie this mini-centrifuge to a tree or building and it works like a child's toy top. Simple and inexpensive yet capable of saving thousands of lives. Gives accurate blood sample diagnosis of

anaemia, dehydration, and tropical disease even when used by health care workers with little training. "A new approach to anaemia diagnosis at the periphery." It has a durable plastic disc holding 20 x 50 mm capillary tube blood samples. A clear plastic cover-plate locked in place seals the unit during centrifugation. 4 braided nylon strings, each with a 100 Kg breaking strain supply power. 5400 rpm peak speed. Two absorbent cotton bands kept moist with strong chlorine solution (1 tablet + 25 mls water = 10,000 ppm), quickly reveal and trap any blood leakages. Four colour-coded and letter-coded bands enable results to be read immediately in situ by Community Health Workers and other relatively unskilled assistants, without removing or measuring the samples. Get more accurate results using the 1 g/dl lines. Where samples vary in length from the norm (i.e. 45mm including 3mm plug) they can be removed and both Hb and PCV% can be read easily on the new reader card supplied with the kit. The shoulder strap from the zipped carrying case, when passed round a tree or post, provides a ready anchor point. Fully loaded the 'Spindoctor' weighs only 160g. Adequate packing of the red blood cells to give a clear 'buffy coat' is achieved in 4 - 5 minutes without undue physical effort. When correctly used, the 'Spindoctor' can achieve an accuracy of +/- 1.5g/dl. It can also be fitted to the 'Jabric' and 'Saturn' centrifuges. The kit includes a wooden handle, spare strings, cotton liners, neoprene cushion liners, sealant block, white plasticine and chlorine tablets.

#MD222 \$240



## Solar Powered Portable Vaccine Refrigerator

In Zaire these 100 lb. solar-powered refrigerators on pushable carts are launching a mass vaccination program to reduce the area's high rate of infant mortality. Each one meets vaccine storage requirements for a population center of 100,000 people. And it only needs one solar panel! Two hours of sun on a 3 amp panel provides enough energy to run it for one full day. A 100 amp battery stores enough power for one week of operation without sun while only discharging 50 percent. It never needs defrosting and has only one moving part. Virtually indestructible—expect over 20 years of service. Less expensive to operate, more reliable and requires less servicing than kerosene or any other "fuel" powered refrigerator. The large #FV044 weighs more (160 lbs.) but also makes ice that can act as a backup cooling source when no power is available. *Solar module not included.*

#FV44 \$1,595

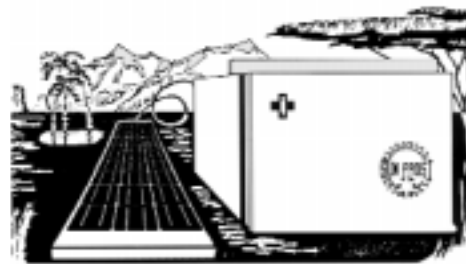

## Medical Cold Chain

### Solar Medical Refrigerators and Freezers

*Highest quality for the most demanding and critical applications.*

The RR-1, designed for both residential and medical use in remote areas, adjusts for either refrigerator or freezer use but primarily used as a deep freezer. Highly insulated polyethylene cabinet with 127 liter internal volume. It uses a single compressor and includes a charge controller. Outside dimensions with export packing 119 cm x 79 cm x 74 cm, 71 Kg. The RR-2 has the same dimensions but two compressors for heavier use and reliability. It also has a battery compartment. The RR-50L has a 50 liter chest-type refrigerator/freezer and is designed for the storage of vaccines and medical supplies. The small internal volume helps save energy by limiting the amount of non-essential items that are sometimes placed in medical refrigerators. Use as 100% refrigerator, 100% freezer, or 50% refrigerator and 50% freezer. Inside dimensions 56 cm x 36 cm tapering down to 42 cm x 34 cm at the bottom, 35.5 cm deep, 38.5 Kg. Includes charge controller and meets WHO performance requirements.



The E-3 model (not solar powered) approved by the World Health Organization for the storage of vaccines in cities and rural areas in which AC power is available only 4 to 10 hours per day, or where power is not available for days. Meets WHO performance requirements, no exceptions. Same dimensions as RR-1, inside volume 100 liters, available in voltages from 100 to 240 vac, 50-60 Hz.

<b>RR-1</b>	<b>#RF6049</b>	<b>\$1,900</b>
<b>RR-2</b>	<b>#RF6050</b>	<b>\$2,544</b>
<b>RR-50L</b>	<b>#RF6053</b>	<b>\$1,830</b>
<b>E-3</b>	<b>#RF6054</b>	<b>\$1,610</b>

**For other portable refrigerators see the Appliances section.**

*"I have just returned from Wasolo, Zaire, Africa after having worked there with a protestant mission for about 8 weeks as their physician, it became evident that they were very inefficient in their use of fuels for electricity, having the potential to save about 500 US\$ per month in fuel costs by converting the Operating Room to full time 12 Volt power from Solar Panels and batteries, like our home in Lawrence and Jamaica." - Dr. Roger Johnson*

## Energy Saving Appliances

You need long-term vision to consider buying the new super energy efficient appliances. They cost more than conventional versions you find at local stores. Justify the higher cost by calculating the energy savings per year. Of course, if you're producing your own power or plan to in the future, the break-even point is much closer or even immediate (smaller inverter, fewer solar modules, etc.). If you add the benefit to the environment and our natural resources, the advantage is always immediate (and some communities now offer big rebates).

### Equator Washer/Dryer

*Now ventless—Washes and dries in the same energy and water efficient machine!*

Save space, water, power, money, time, and work! Time and work because you don't have to transfer clothes from washer to dryer, water and power because of the efficient front-loading design (only uses 9.4 gallons per cu.ft.), space because it takes 40% less room than a typical washer and dryer, money because of the energy savings and not needing to buy a dryer. Winner of numerous awards including the Appliance Manufacturer Award for Excellence in Designs, it uses 115V, 900 watt motor, 650 or 1300 watt heating element. 33" H x 23.5" W x 20.5" D, 176 lbs. EZ1500 and EZ2500 have 10 lb. capacity. EZ3600 has 13 lb. capacity. 1000 RPM spin cycle. Standard 1-year warranty (parts & labor).

All models measure 33" H x 23.5" W. EZ1500 is 20.5" D, EZ2500 is 17.5" D, and EZ3600 is 23.5" D.

<b>EZ1500</b>	<b>#AA670</b>	<b>\$890</b>
<b>EZ2500 (non-venting)</b>	<b>#AA1927</b>	<b>\$945</b>
<b>Caster Kit</b>	<b>#AA3514</b>	<b>\$44</b>
<b>Faucet Adapter</b>	<b>#AA3513</b>	<b>\$18</b>
<b>Extended Warranty – 1 year</b>	<b>#AA3684</b>	<b>\$70</b>
<b>Extended Warranty – 2 year</b>	<b>#AA3685</b>	<b>\$100</b>

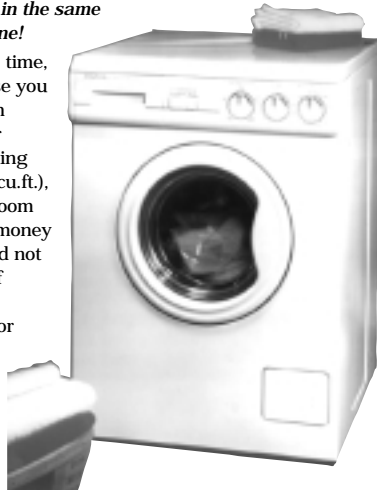

### Equator Energy-Star Washer/Dryer

Another all-in-one washer and dryer from Equator. Like the EZ3600C, this unit features the convenience of one appliance for your whole laundry cycle. Super efficiency and Energy Star rated. It also adds to the EZ3600 features:

- An extra wash option (part of regular wash)
- Improved control panel markings
- Additional button for half load option
- 3 wash/rinse options (hot/cold, warm/cold, cold/cold)

**#AA5699 \$1,090**

### Equator Adapter for Modified Sine-Wave Inverters

As far as we know, none of the super energy efficient washing machines other than Staber will work on modified sine wave inverters. This easy-to-exchange electronic module turns any of the Equators into a modified sine wave machine. Just slide the old module out and return as an exchange.

**#AA6093 \$85**

### Staber 2300

*Super energy and water saving, 117V, runs on small inverter*

The convenience of top-loading with the efficiency of horizontal, tumble-action. 66% less water and 75% less detergent. Asko washing machines are great but require 220V, utility power or a sine wave inverter. The Staber will work on an 800+ watt modified sine wave inverter, a 500 watt Exeltech, or on 117V. They still only use a maximum of 21 gallons per load and as little as 200 watt-hours per load while powering more water through clothes for cleaner laundry. Stainless steel inner and outer tubs. 16+ lb. clothes capacity. 42" H x 27" W x 26" D, 175 lbs.

**#AA699 \$1,284**

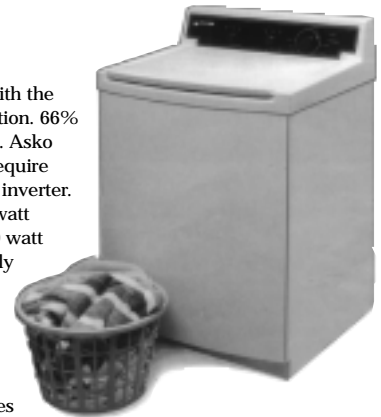

### Asko W600 Clothes Washer

*Save more than \$200 per year in water, electricity and detergent. Askos pay for themselves in about five years.*

New larger capacity—matches any top-loader (15 towels and most king-size comforters). Super Quick Wash cycle will clean better than an old-style agitator and do it in only 34 minutes while using only 5.7 gallons of water and 0.3 (2c) kWh of electricity. The smaller exterior allows for more convenient installations under counters or stacked in closets. Additional wiring unnecessary to accommodate this 220 volt unit because it plugs into the back of an ASKO dryer. Feature differences between models revolve mainly around spin speeds and controls. Higher spin speeds reduce drying time and adjust up to 1000 rpm for the W600, up to 1200 for the W620, 1400 for the W640, and 1600 for the W660. All but the W600 have "delay start", the two high end models let you interrupt a cycle and add an option, "EasyControl," one-touch command for the four most popular programs, and an abundance of special options. 20-year life expectancy, 152-176 lbs., 33 1/2" x 23 1/2" x 24 5/8".

<b>W600</b>	<b>#AA6610</b>	<b>\$1,184</b>
<b>W620</b>	<b>#AA6610</b>	<b>\$1,290</b>
<b>W640</b>	<b>#AA6610</b>	<b>\$1,484</b>
<b>W660</b>	<b>#AA6610</b>	<b>\$1,675</b>
<b>W660 stainless steel</b>	<b>#AA6610</b>	<b>\$2,100</b>

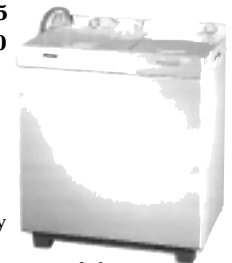

### Danby Twin Tub Washer

Super low power and water use—only 360 watts for the wash and 150 watts for the 1600 RPM adjustable-spin tub extractor (6 watts per minute—you need about 14 minutes for heavy items and only about 5 for light ones. Uses 36 liters of water per load—less than 10 gallons! Quick connect for attaching to sink faucet and holds 11 lbs. of clothes. 115V AC, 33.5" H x 29" W x 18.3" D, 70.4 lbs.

**#AA4566 \$495**

### WonderWash

*Clean clothes in 2 minutes*

Unique pressure system causes hot water to heat trapped air. The air then expands further increasing pressure that forces water and soap at high speed through fabrics. You get a super clean wash with a tiny amount of detergent and without using any electricity. Holds up to 4.8 lbs of clothing and only weighs 6 lbs. Small size (11" x 14") makes it easily portable. We're told it's great as a butter churn, too!

**#AA606 \$54.95**



## Dyna Jet Wringer for Hand Washers

*Simplify hand washing your laundry*

This hand wringer clamps to washtub and features two spring loaded press rollers to extract most of the water from your clothes.

Compatible with the James Hand Washer. More durable than the James Wringer but doesn't squeeze out as much water. Made to last many years even in a commercial application.

**AA5136 \$120**



## James Hand Washer

To most people, washing clothes by hand sounds like a ridiculous amount of work. Actually, with a James Washer, it's not that hard. The secret is letting the clothes soak in hot soapy water for a few hours first. Then just a few minutes of swishing the lever back and forth does a great job. You can wash a normal-size load and the sturdy design assures many years of clean clothes without wasting electricity. Holds 16 gallons, easy bottom drain valve, pine legs. The optional handwringer squeezes out 90% of the water. Stainless steel.

**Washer #AA150 \$315**

**Wringer #AA151 \$149**

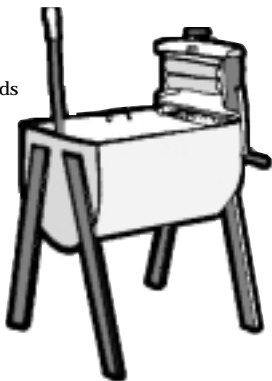

## Speed Queen Wringer Washer

*115 vac*

When Speed Queen stopped making this popular wringer washer 5 years ago, we had many disappointed customers. It gets clothes clean and dry with minimal power use, holds a full 14 lbs. of clothes, and the double-walled porcelain tub keeps water warm longer. Wringer has 8 different positions and instantly releases with safety bar or emergency release. Gas powered model uses 2 HP B & S engine with solid state ignition and operates at just above idle, reducing wear-and-tear and eliminating vibration. 115 and 230 vac models weigh 139 lbs. and use up to 825 watts; gas powered version weighs 229 lbs.

**Standard Model #AA3543 \$695**

**Gasoline-Powered Model #AA3545 \$975**



## Gas Dryers

*Save huge amounts of electricity*

Electric heating—for clothes, air or water—uses ridiculous amounts of power. Completely unrealistic in a renewable energy system, it doesn't make sense in a grid-connected house either. The gas dryers listed here immediately pay for themselves in solar module savings and quickly pay for themselves in AC grid-power savings. 300-400 watts.

**1 Time/1 Auto Cycle: 2 Temps #AA660 \$434**

**3 Time/1 Auto Cycle: 4 Temps #AA661 \$489**

**4 Time/3 Auto Cycle: 4 Temps #AA663 \$525**



## Frigidaire Gas Dryer

*4 temps 3 time/1 auto cycle*

A perfect companion to the Frigidaire Washer (AA5514). Four temperature selections, 3 timed and 1 auto cycle. Tumbling action reverses for more even drying and fewer wrinkles. Large opening, reversible door lets you match the dryer to your laundry room. Stackable with the Frigidaire Washer. Requires 220 vac, 4500 watts. Warranty 2 years.

**#AA4656 \$575**

## Deflect-o

*Free heat from your clothes dryer*

An operating clothes dryer produces enough hot humidified air to keep a 30' x 24' room warm (20,000 BTU's per hour). Just flip a lever on the Deflect-o and this heat goes into your house instead of up the vent. Easy to clean screen stops lint but lets the heat and humidity go through. Easy to install in just a few minutes. Also good as year-round lint trap where outside venting not practical.

**#EP215 \$12**



## Low Suds Detergent

*Specially designed for horizontal axis washing machines*

Horizontal, low water use washing machines work on a different principle than conventional machines and have special detergent needs. Common detergents create too many suds, don't dissolve well, and can damage machines. This new low-sudsing brand was specially formulated for horizontal axis washers. It easily dissolves in either cold or hot water and doesn't harm stainless steel drums. Fragrance and phosphate free, 100% biodegradable and super concentrated. 4-pack (3.6 kg) good for up to 160 washes.

**#AA3348 \$7**

**#AA3357 (4-pack) \$28**

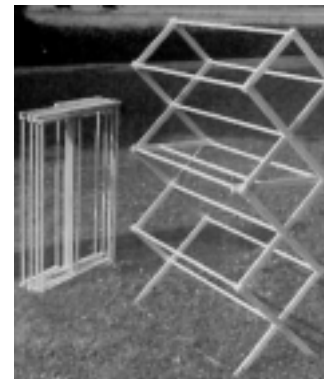

## Accordion Laundry Racks

The average electric clothes dryer uses \$70 of electricity each year—more than the average electric range and almost as much as the total household's lighting (\$75/year). Why not use the sun? It's easier on the clothes, the environment, and your pocketbook! Here in Colorado, our clothes dry inside in just a few hours. Laundry racks fold up into a small space, hold a "clothesline" of laundry, and easily move from space to space—put outside in the sun, bring back in when it rains. All much stronger and durable than the commonly found versions, our regular dryer has wire reinforced stress points and the "Heavy Duty" versions attach the dowels to the frame with screws instead of staples, hardwood frames, and extra struts for added support. The "Wall Mount" doesn't take any floor space and has a strong shelf great for holding detergent and other laundry supplies.

Model	Dimensions	Drying	Item #	Cost
Regular	53" x 18" x 36"	45'	#EP6016	\$42
Small Heavy Duty	60" x 19" x 40"	34'	#EP6081	\$66
Large Heavy Duty	70" x 23" x 48"	40'	#EP6082	\$79
Wall Mount	34" x 29"	16'	#EP6083	\$64

## Outback Oven

Turn your camp stove into a temperature controlled oven! Reduce fuel consumption by a third and have a versatile system of components you'll use every time you cook. All Outback Ovens come with the aluminized fiberglass convection dome, diffuser plate with riser bar, thermometer, reflector collar, mesh storage sack and backcountry baking booklet. Stoves positioned underneath may present a danger—check our website for more info.



**Ultralight #OT5006 \$36**

Cook set pot for a baking pan (up to 8" diameter). 1-2 campers.

**The Plus 8 #OT5007 \$48**

8" Teflon pan w/ nesting lid. Doubles as a frying pan too. 1-2 campers.

**The Plus10 #OT5008 \$55**

10" Teflon pan w/nesting lid. Doubles as a frying pan too. 2-4 campers.

**The Outfitter #OT5009 \$90**

Oven with 12" Teflon pan w/nesting lid, Jaws pot lifter, UTU spatula/knife, and cutting board. Can double as a frying pan. 4-6 campers.

**Outback Evolution/Ultralight Combo #OT5010 \$55**

The Ultralight, w/premium non-stick cookware.

## Hydro-Que Hydrogen BBQ Grill

Hydrogen gas fueled table-top barbecue. For outdoor use only. Includes high quality stainless flow control valve, brass flashback arrestor, and ss bar-burner, laser-drilled for use with hydrogen. Comes with top cover, handles, and heat diffuser.

Does not use lava rocks. Not equipped with low Nox burner. Includes s.s. temperature gauge. Hydro-que™ Model HQ-5

**#AA5511 \$444**

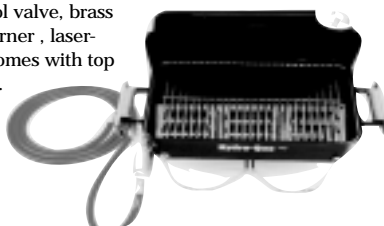

## Sierra Zip Stove

*"The best invention for backpackers since feet."*

Use wood, pinecones, twigs, bark, charcoal, or any solid fuel and quickly generate intense heat output (18,000 BTU/hr.) Works like a blacksmith's forge by blowing air into the fire—uses one AA battery that lasts more than 6 hours of cooking. No propane or gasoline to leak, spill, splash, or explode! 4" x 5" and only weighs 15 oz. Includes new windshield for windy conditions, "Xtra grate" for larger and longer sticks, stainless steel quart pot with frying pan cover that serves as carrying case for the stove. Complete set weighs just 30 oz.



**Complete set #AA142 \$72**

**Stove only #AA143 \$52**

## Eagle Stove

*New Zip Stove like having a portable fire pit*

Over 35,000 BTU/hr.—almost double the output of the Sierra and boils water by the gallon. Ideal for car camping, group cooking, scout outings, evening campfires by the RV, or disaster preparedness. Provides a contained fire where open fires not permitted. Like the Sierra, the Eagle has an adjustable speed fan for forced ventilation. The damper control allows for adjustable heat and fuel conservation. The standard "D" cell power supply provides over 35 hours of cooking time. Even without the fan, the Eagle has a strong natural draft and still works fine. 8 lbs., 12" x 10" x 12" high.



**#AA3018 \$62**

## Backpacker Solar Oven

Only 1 lb. 12 oz. but bakes bread and gets up to 375°. Cooks almost anything—fish, meat, baked potatoes and folds to 4" x 10" x 10". Made from 97% paper products but demonstrated reliability—over 35,000 already sold. Great for backpacking, expeditions, science oriented experimenters, and teachers.

**#AA144 \$39**



## Sunflash Solar Cooker

*Over 3 times more heat than box solar cookers*

Produces 750 BTU/hr. compared to the typical 240 BTU/hr. for box cookers—more useful for tasks like boiling water or sterilizing medical utensils. March U.S. Southwest sun in spring conditions on test brought a quart of water to a boil in one hour and baked a 2 lb. loaf of bread in two hours. Reflective cone concentrates the sun through spherical glass that stores energy for nighttime cooking. Includes 4 quart black pot.

**#AA138 \$425**

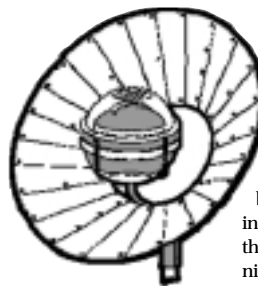

## Village Sun Oven

Bake hundreds of loaves of bread per day, boil countless gallons of water, cook virtually anything quickly and in large volumes, sterilize large quantities of medical instruments. All with solar energy or propane. Generates temperatures over 500° F. With propane will operate night or day, rain or shine, 24 hours/day (2 propane tanks come with each oven). 1 lb. of propane will run oven for 8 hours. Transported size is 5'10" h x 5'1" w x 5'1" l. Operating size with panels folded out is 9'6" h.

**Basic Unit #AA135 \$10,000**

**Transport Trailer #AA136 \$300**

**Propane Back-Up #AA137 \$600**

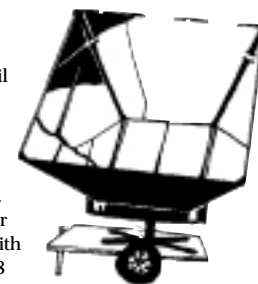

## Sun Oven with Thermometer

Solar ovens save energy, keep your kitchen cooler on hot days, cook better tasting food, and make meals more fun. In remote areas, no need to buy, collect, carry, and store fuel. No burned food, no smoke, no air pollution. Saves trees and soil, safe around children. Commonly reach 350°. Weighs 30 pounds and has an interior oven dimension of 14" x 14" x 10". Electric back-up fits on the glass and heats oven over 400°. Even broils. Uses 500 watts at 117V AC—1/7th the power of a conventional oven. Optional black pot makes cooking fast and easy.

**Global Sun Oven #AA140 \$229**

**3 qt. Black Pot #KT4904 \$9**

**Thermometer #AA147 \$5**

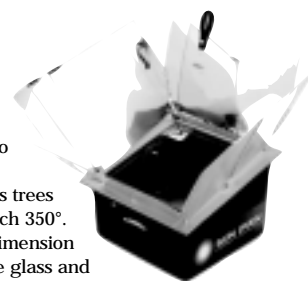

## Sun Toys Solar Cooker

*Cooks like a crock pot, bakes like an oven but weighs only 8 oz!*

This improved version of the "Solar Cookit" withstands rain, has better insulation, and still folds down to a 14" x 14" x 2" flexible packet. Low cost, high quality, extremely useful—everyone should have at least one!

**#AA3549 \$19**

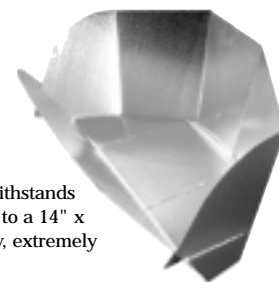

# Rainforest Coffee



**“Beyond Organic” Coffee and Roaster**

Shade-grown, organic, rainforest-friendly, and most likely the best tasting coffee you will ever sip packaged with a Precision Roaster and 2.5 oz. grinder. Includes 4 lbs. of green coffee beans processed with solar thermal and solar electric systems in Costa Rica. This coffee is part of an initiative to trade Green Coffee for Green Technology as well as provide education, telemedicine for healthcare, telebanking to facilitate needed financing, and other services for rural communities in developing countries. The goal is to set up Centers powered by low-cost and environmentally-friendly solar-photovoltaic and renewable-power generation systems. These centers will help empower rural coffee farmers to become an economic engine in their regions, create local jobs and rural prosperity. A primary benefit will be the slowing or reversing of migration by the rural poor to the urban centers of developing countries.

Coffee is the world's second most popular beverage (after water), the second most traded commodity (after oil), and the second biggest cause of rainforest destruction (after cattle ranching). Solar drying means shorter, on-site drying as a lower temperature - 122°F instead of the conventional 158°F. It minimizes deterioration and spoilage from excessive moisture and can save up to 30% of the harvest. It eliminates the need for firewood and helps stop deforestation - 16,000 acres of rainforest are stripped away for this purpose each year. It also eliminates the need for the chemical fertilizer and pesticides that end up further polluting water supplies and rivers. It provides more value to the small farmers because dried beans sell for many times more and permits storage instead of the need to sell within a few days of harvesting - a great poverty-reduction strategy. This creates more jobs in rural areas preventing the increasing and disastrous trend urbanization. Coffee goes stale within 7 days of roasting making it more acidic with a more sour, bitter taste.

#KT6975 \$169

**Precision Coffee Roaster**

The best home coffee-roasting product available at any price. Roasts enough beans to fill a standard 12-cup automatic-drip coffee maker and only takes 9-10 minutes. Roasting just prior to brewing ensures the ultimate flavor. Set the degree of roasting anywhere between light “Cinnamon” and dark, almost burned “Italian”. Uses a heated, forced air process that bounces the beans around inside the clear cylinder - a delightful sight and smell. A red light indicates roasting, a green one the cooling process. It also separates out the coffee chaff that makes a great nutrient for house plants.

#KT8878 \$149

**“Beyond Organic” Green Coffee Beans**

The best, most environmentally friendly green coffee beans for your new roaster. Choose from Costa Rican, Ethiopian, Columbian, Columbian Decaf, Peruvian, Indonesian, or Bolivian. All are solar-dried by small co-ops trying to preserve their local eco-systems and raise the standard of living in their local economies. The Costa Rican processed with a photovoltaic/solar air system.

#KT8879 \$5 per lb.

**Waffles off grid!**

A stove top waffle maker for delicate,crisp waffles with extra deep pockets to capture your favorite toppings. And faster than an electric waffle iron! Long lasting ,heavy cast aluminum with a non-stick coating and cool bakelite handles. 16.5" x 8.5 "x 1.5", baking surface 7.25" x 7.25".

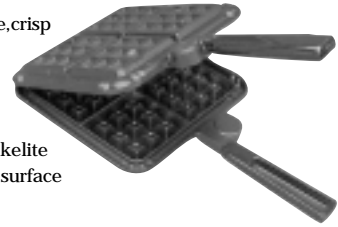

#KT8794 \$39



**Brown Gas Ranges**

Many people want a gas stove to conserve electricity but most gas stoves use an energy-hungry electric starting system. Brown ranges have optional low power use electronic ignitions (+c.\$50) but the models we list here have pilots and require no electricity at all. Conventional appearance and features—non-tilt oven racks, push to turn valves, leg levelers, fiberglass insulation, adjustable door springs, roll out broiler. Almond, white, harvest gold, or black.

Request flyer for more options.

<b>24" Surface Range</b>	<b>#AA824</b>	<b>\$181</b>
<b>30" Surface Range</b>	<b>#AA4654</b>	<b>\$185</b>
<b>Wall Oven</b>	<b>#AA825</b>	<b>\$505</b>
<b>20" Gas Range</b>	<b>#AA820</b>	<b>\$364</b>
<b>24" Gas Range</b>	<b>#AA821</b>	<b>\$414</b>
<b>30" Gas Range</b>	<b>#AA822</b>	<b>\$395</b>
<b>36" Gas Range</b>	<b>#AA823</b>	<b>\$474</b>
<b>30" w/Black Glass Door</b>	<b>#AA3236</b>	<b>\$496</b>

**Premier Gas Ranges**

No glow bars on any Premier Gas Ranges! Light with electronic spark or with a match and save the energy drain - no electricity required. Allows oven and top burners to be lit during power failure. Features universal valves for easy conversion between natural gas and LP gas (propane) without additional parts or special tools. Sealed burners keep spills on the cooktop for easy cleanup. Lifetime warranty. 28 models available - the 4 listed here are gas only, non electric, the others have a 120 vac electronic spark but will also light with a match during power failures.



<b>SAC 100 20" Apartment Model</b>	<b>#AA7379</b>	<b>\$455</b>
<b>SFC 100 30" Standard Burner</b>	<b>#AA7391</b>	<b>\$521</b>
<b>SCC 100 24" Standard Compact Burner</b>	<b>#AA7383</b>	<b>\$521</b>
<b>SLC 100 36" 4-Burner</b>	<b>#AA7413</b>	<b>\$620</b>

## Corona Grain & Corn Mill

Grind wheat, corn, nuts, coffee or seeds without using any electric power. Grind one pound of cereal per minute but for fine flour you need to run through the mill several times. Stone conversion kit makes a fine grind the first time. Easy to change back to metal plates for the advantages of both types.

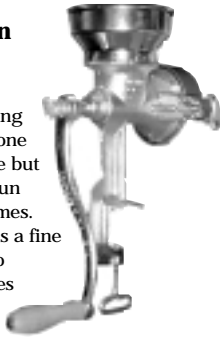

- Corona Mill** #KT126 \$46
- Stone Conversion** #KT127 \$62
- Extra Grinding Plate Set** #KT4690 \$7
- Dehulling Attachment** #KT4691 \$36

## Solar Food Dehydrators

*Dry vegetables, fruits and herbs with just the sun—no power required!*

Use the latest solar technology and enjoy fruits, herbs and vegetables all year long. Fun, easy to use and clean, and no electricity required. The sun's rays penetrate through the transparent cover, vents create a warm current that moves across the stainless steel food tray. Also great for making raisins, fruit roll-ups, and herbs you can add to soups, stews, and dips. Heavy duty stainless steel with stainless steel food trays, it will last for years and years.



- Large Dome (22" x 45")** #KT4921 \$309

## Sunshine Nugget Flour Mill

*The Best, Low-Cost Grain Mill*

High performance in low-cost mill. Quickly converts from stone to iron burrs. (Stone grinds finer but clogs with oily materials; iron not as fine but handles almost anything).

Powder coated aluminum body is corrosion proof, dishwasher-safe and the aluminum never touches your food. 5-cup hopper means less stopping to refill. Special set-back base for bowl to catch flour. Special spring assembly instead of auger for easier cleaning. Removable clamp kit, optional stainless steel burr kit.



- Sunshine Nugget Flour Mill** #KT5345 \$149
- Optional Stainless Steel Burrs** #KT5346 \$60



## Hanging Solar Food Dehydrator

5 sq.ft. of drying area but folds to 3" x 15" x 15". Easy to move and store, almost indestructible polypropylene.

- #KT205 \$49**

## AirFlo Dehydrator

Large scale, high efficiency dehydrator for coffee, beans, nuts, and grain. Connect a hot air collector system or any heat source and a small PV system; super efficient fans (5 using 35 watts total) pull the air vertically through the dehydrator drying crops evenly and quickly while safeguarding against mold. It eliminates the need to rotate crops during the drying process and retains the highest quality due to the optimum drying efficiency. Capacity 100 lbs. every 6-8 hours. Stainless steel gates and hardware, FDA approved high density polyethylene interior. Larger, custom models available by request.

- #KT6044 \$3,990**

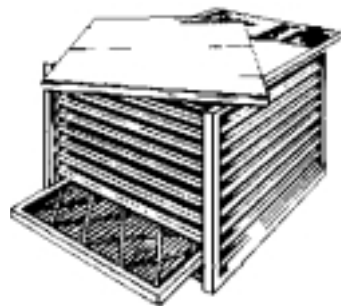

## Excalibur Food Dehydrators

*Save your harvest!*

Dry everything from herbs to jerky. With less than 2 square feet of counter space quickly dehydrate a large amount of fruits or vegetables. Also make jerky, soup mixes and trail foods. Thermostat adjusts from 85° to 145°. 9 tray holds 40 lbs., 4 tray 13 lbs., 5 tray 22 lbs. 5 & 9 tray 17" W x 19" D x 8.5" H or 13" H, 4 tray 13" W x 16" D x 6" H.

- 4 Tray** #KT201 \$128
- 9 Tray** #KT203 \$250
- 5 Tray** #KT202 \$196



## Country Living Mill

Whole grain into flour with minimum effort and maximum control. The Country Living Mill grinds fine or coarse with a simple hand crank—enough for 2 loaves in 15 minutes. Want more flour? Drive the large pulley from a bicycle, or with a 1/2 hp motor like our GN621. Made in the USA, a grain mill your grandchildren will be glad to inherit. Accessories: Power Bar, (#KT4487) increases leverage for tougher grinding. Nut & Bean Auger (#KT4488) for milling nuts, large beans, soft grains and coffee.

- Country Living Mill** #KT4486 \$344
- Power Bar** #KT4487 \$28



## Countertop Dishwasher

Quick, clean dishes without electricity or wet hands. 24 spinning hot water-powered jet sprays wash, rinse and air dry four place settings in just 10 minutes (a typical electric dishwasher takes 45 minutes). Compact, portable and only uses one teaspoon of regular dishwashing detergent. Just connect to any faucet - it's safe for all your dishes including fine china and plasticware. Great for small homes, apartments, offices and dorms.

#AA7660 \$130



## Super-Fast Reading 78 Apple Peeler

Endorsed by history: made since 1878. It doesn't core or slice but with just six turns peels crisp apples and drops them into a bowl—six apples per minute! Cast iron construction ensures long life. Parts which contact the food are nickel plated, so there's never a problem with a metallic taste.

#AA1498 \$80



## Non-Electric Yogurt Incubator

In just a few hours, make delicious all-natural yogurt from cow, soy, or goat milk. No moving parts, lasts a lifetime! 9" H x 8" Diameter, 2 qt., 2 lbs.

#AA3542 \$46



## 3 Leg Cast Iron Pots

*Cook and bake anywhere—with anything from propane gas to a wood fire*

A cooking tool brought to Africa during the middle ages and a traditional part of African culture since that time. The 3 tall legs let you have a fire under the pot while keeping it out of coals. The round belly shape allows even heat distribution while keeping the liquids at the lowest point. Special domed lid for optimal internal heat circulation has a peripheral gutter on the lid for heaping coals. Lifetime warranty, pre-seasoned. Cookbook available.

<b>3 gallon/25 lbs.</b>	<b>#KT4940</b>	<b>\$88</b>
<b>6 gallon/45 lbs.</b>	<b>#KT4941</b>	<b>\$132</b>
<b>10 gallon/75 lbs.</b>	<b>#KT4942</b>	<b>\$189</b>
<b>14gallon/71 lbs.</b>	<b>#KT5343</b>	<b>\$204</b>
<b>25 gallon/157 lbs.</b>	<b>#KT5340</b>	<b>\$321</b>
<b>20 gallon/105 lbs.</b>	<b>#KT5342</b>	<b>\$264</b>
<b>Potjiekos Cook Book</b>	<b>#BK5983</b>	<b>\$22</b>

## Food Strainer

Make tomato paste & juice, fruit & vegetable purees, apple sauce — all without peeling or coring. Strains baby foods and separates juices and pulp from skin and seeds. Fast and easy.

#KT4913 \$64



## Equator Compact Dishwasher

Saves valuable kitchen space, even fits on a countertop yet still holds 8 full place settings. Ideal for small spaces and only uses 4.75 gallons of water in the heavy wash cycle. Built-in water heater. Includes a special faucet adapter that quickly snaps on and off any sink faucet and a drain hose for hooking over a sink edge. 120 vac, 1400 watts, UL listed, white. 46 lbs. 19.5" H x 19.75" W x 19.75" D.

#AA3680 \$350

## The Gamma Seal Lid

*Storage - airtight, watertight, and affordable.*

Gamma Seals snap to a standard 3 1/2, 5 or 7 gallon plastic bucket (12 inch rim), contain heavy duty threaded lid. Allow easy access to stored supplies, seals with two rubber gaskets. Ideal for long term storage of food, supplies, equipment.

#EP4612 \$10



*"Your new summer catalogue was very welcome! My only wish is that it contained several hundred pages in order that I could be occupied with it for a month instead of reading it cover to cover 3 times in 2 days!"*

—Brian Blancher, Honduras



**Wheat Grass Juicer**

One of nature's most complete live foods, wheat grass contains vitamins C, E, the B complex and Provitamin A (Carotene), and more than 100 elements and trace minerals, including calcium, magnesium, potassium and iron. Because the chlorophyll in wheat grass is almost identical to human hemoglobin (the medium by which oxygen is carried to the cells), our bodies are able to easily assimilate these nutrients. Our top-feed Wheat Grass Juicer features a powerful 220-watt motor for maximum juice yield and is also great for juicing leafy greens, berries and soft fruits. Aluminum-free, it features non-toxic nylon and stainless steel juicing components. Easy-to-clean. Use the Flour Mill Attachment and make fresh flour as you need it. 13 1/2" H x 16 1/2" L x 5" W.



#KT7722 \$195



**Steam Juicer/Cooker**

Juice grapes, berries, fruits; steam cook seafood and vegetables—all without any electricity. Simple to use. No squeezing, straining or mess. 8 1/2 quart capacity, heavy stainless steel.

#KT921 \$110

**12V Wet & Dry Vacuum**

Much more suction from this canister vacuum than the small DC car vacuums. A large one gallon dirt capacity and reusable dust cap, (you don't buy new bags), make this a good solution for difficult car and other clean-ups. Heavy duty 12,500 RPM motor and 36" hose, 15" cord, upholstery brush, rug tool for carpet pile, and crevice tool to get those crumbs! 11 amps, 103/4" H x 8 1/2" diameter.

#AA101 \$32

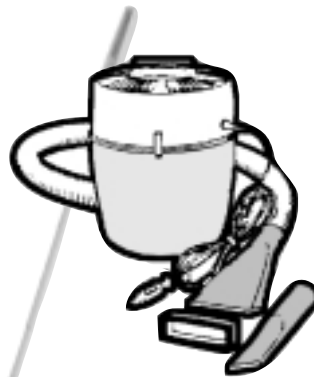

**Hoky Carpet Sweeper**

So small you can store in a tiny space, so quiet you barely know it's there, and yet effective enough to pick up difficult things like cat hair, sand and thread on both carpets and hard surface floors. All without using one watt! The commercial grade N/T models use "Rotorblades" that outlast bristle brushes by as much as 8 times and self-clean. All parts replaceable.

<b>Standard</b>	#AA104	\$43
9.5" Rotorblade	#AA105	\$50
12.5" Rotorblade	#AA106	\$72



**Waring 12V Blender**

More expensive but also larger and more powerful than previously available blenders. 45 oz. pitcher, 15' cord with cigarette lighter plug, chrome plated plastic base, uses up to 11 amps depending on how hard the contents are

#AA116 \$159



**Professional Hand Juicer**

This Citrus Juicer uses rack-and-pinion torque to provide hundreds of pounds of pressure to squeeze juice and nutrients from limes, lemons, oranges and grapefruit. Professional stainless steel construction includes an extractive reamer that prevents rinds from making your juice bitter plus a strainer and 10-oz. cup. With non-skid rubber feet. 19 1/2" H x 7" L x 5 1/2" W. 6 lbs.

#KT7720 \$84

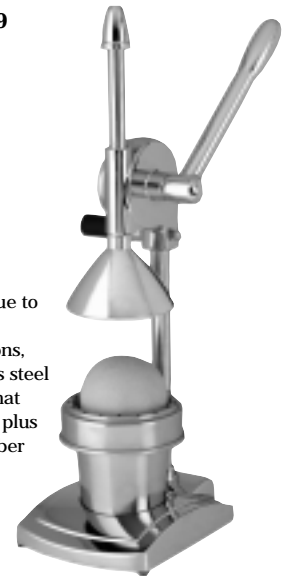

**Treadle Sewing Machines**

*No electricity needed*

A beautiful and dependable tool made for years of daily use. Simple and sturdy design capable of extensive and heavy sewing. Forward/back and tension control, cast iron flywheel, frame, and foot; wood cabinet, two drawers and fold-down thread bin. Some assembly required.

<b>Complete</b>	#AA1957	\$440
<b>Head only</b>	#AA1958	\$200

**12V Coffee Maker**

5 cup capacity with thermostat and tempered glass carafe. 6' 12V cord.  
#AA3040 \$35

# REFRIGERATORS



## Sun Frost

*The ultimate in energy efficient refrigerators... DC or AC*

Three simple factors make Sun Frost the leader in energy efficient refrigeration: 1) They've moved the compressor—and all the heat it generates—out from the bottom and up onto the top of the unit. The heat from a typical refrigerator (since the compressor is on the bottom) rises and constantly creates an electric blanket of air around the refrigerator; 2) The small, well designed compressors, lack of fans and the low percentage run time all contribute to Sun Frost's exceptionally quiet operation. No more listening to the humming and buzzing of a typical large AC refrigerator; 3) The polyurethane insulation is 3 inches thick in the refrigerator walls and up to 6 inches at the freezer top to keep the heat away from your frozen foods. Compare this with your average "energy saver" refrigerator. These factors combine to eliminate the reasons that most average refrigerators seem to be running all the time. Sun Frost's higher initial cost is offset by their incredible efficiency. This makes the idea of a solar refrigerator practical. Conventional AC refrigerators just take too much electricity.

## SolarFridge

Similar to Sun Frost with the compressor mounted on the top and 4" of insulation, the SolarFridge ships much more quickly and has several extra features like an LCD temperature control and display. Other standard features include an ABS inner liner, molded door shelves, stainless steel interior shelves, magnetic door gaskets, a natural wood door handle, adjustable leveling legs, user replaceable door panel, and a refrigerator compartment light. "19 cu. ft." has 12 cu.ft. of refrigerator space and 4 cu.ft. of freezer (calling them "19" instead of "16" seems common in the industry, dimensions are 66" x 35" x 28"), and it uses an average of 60 amps per day at 12V. The "10" cu.ft. is 52" x 24" x 23" with a 6.9 cu.ft. refrigerator and 1.7 cu.ft. freezer. It uses 43 amps per day at 12V. 48Volt models are available an extra charge.

12V SolarFridge 19	#RF5859	\$2,790
24V SolarFridge 19	#RF5919	\$2,790
120 vac SolarFridge 19	#RF5920	\$2,730
12V SolarFridge 10	#RF5918	\$1,780
24V SolarFridge 10	#RF5921	\$1,780
120 vac SolarFridge 10	#RF5922	\$1,750



## Planet DC 11.6 cu.ft. 12/24V DC Refrigerator/Freezer

Planet DC refrigerators have the highest powered DC compressor on the market. Bring food to proper storage temperature in hours rather than days. Modern cabinet fits any kitchen decor. More power, faster cooling, lower price—and ready for immediate shipment. 12 volt uses 68 amp-hours per day, 24 volt uses 34 ah. 150 watts of PV will keep it running year round.

12V DC	#RF4924	\$1,295
24V DC	#RF4925	\$1,295



SUN FROST		Size	*Amp Hours/Day Type	Shipping @ 12V	Crate Dimensions	Weight	
12V	24V					(lbs.)	Cost
#RF16	#RF216	16 cu.ft.	Refrig-Freezer	45	62.5"H x 34.5"W x 27.75"D	300	\$2,655
#RF19	#RF219	19 cu.ft.	Refrig-Freezer	62	66"H x 34.5"W x 27.75"D	320	\$2,800
#RR19	#RR219	19 cu.ft.	Refrig only	30	66"H x 34.5"W x 27.75"D	310	\$2,539
#FF19	#FF219	19 cu.ft.	Freezer only	100	66"H x 34.5"W x 27.75"D	320	\$2,855
#RF12	#RF212	12 cu.ft.	Refrig-Freezer	28	49.3"H x 34.5"W x 27.75"D	230	\$1,979
#RR10	#RR210	10 cu.ft.	Refrig only	15	43.5"H x 34.5"W x 27.75"D	215	\$1,595
#FF10	#FF210	10 cu.ft.	Freezer only	55	43.5"H x 34.5"W x 27.75"D	215	\$1,825
#RF44	#RF244	4 cu.ft.	Refrig-Freezer	13	31.5"H x 34.5"W x 27.75"D	160	\$1,454
#RR44	#RR244	4 cu.ft.	Frig or Freezer	9	31.5"H x 34.5"W x 27.75"D	160	\$1,390
#FV44	#FV244	4 cu.ft.	Vaccine Frig/Frgr	13	31.5"H x 34.5"W x 27.75"D	160	\$1,595
n/a	#RR201	1 cu.ft.	Vaccine Storage	6	28"H x 23"W x 20.5"D	100	\$1,310

\*energy used per 24 hour period at 70° F. Shipped freight collect. Add US\$60 crating charge for 16 and 19 cu.ft. models, US\$50 for 12 cu.ft., US\$45 for 4 and 10 cu.ft., and US\$40 for 1 cu.ft. Add US\$120 (RF3974) for custom colors, and US\$180 (RF3975) for wood finishes.

## Walk-In Solar Power Refrigerators

Large scale refrigerators or freezers built to your specifications. Brushless DC motors, eutectic plates, super high quality and efficiency. This pictured system transports tree seedlings and fits on a standard pick-up truck. Can operate from vehicle or aircraft power, utility grid or generator power, or from photovoltaic and other alternative power sources. It cools 230 cubic feet with 470 peak watt PV array. Internal temperatures stay between 45° to 55° F—a larger PV array required for lower temperatures. Other applications include fish or food storage, eco-tourism, campsites catering to adventure travelers, rural schools, exotic flowers preservation during delivery to an airport, disaster relief and storage of medical and veterinary supplies.

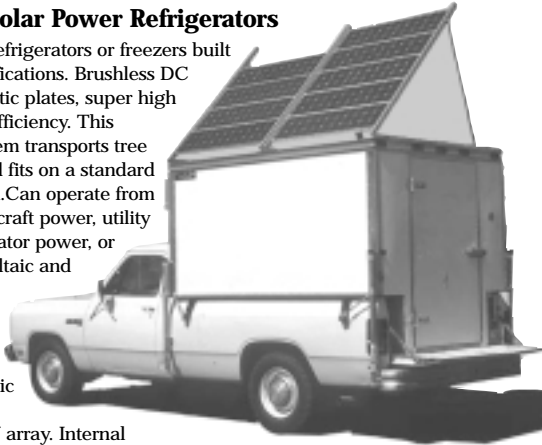

#RF6048 Costs depends on application

## Coldsaver 15.1 cu.ft. Eutectic Freezers

Specifically designed to run from a generator or where power unavailable or unreliable. "Eutectic" glycol tanks store the cold for use when no power is available. You only need 1.5 hours of power each day if room temperature 70 degrees, 3 hours if 80 degrees. Use a generator (small, 2.2 kW enough), grid, wind, or solar power. Thick and dense polyurethane insulation (80–120 mm) keeps the cold in, heat out, and your food frozen for 24–36 before you need power again. And it gets cold (down to -40 degrees F). Uses CFC-free ester oil R404A refrigerant and a Danfoss BD 35f compressor. 10 interior baskets; 15.1 cu.ft based on actual size, 18 cu.ft based on the common practice of adding 20%. 63" x 29" x 35", 396 lbs. 360 watts.

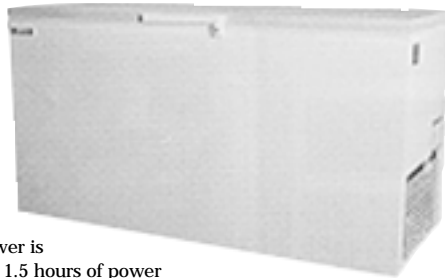

120 vac #RF6055 \$2,800  
12 or 24V DC #RF6056 \$3,400



## Coldsaver 14 cu.ft. Eutectic Refrigerator

Like the freezer above, designed to run from a generator or unreliable power source, this refrigerator only need 1–2 hours of power each day. 13.4 cu.ft based on actual size, 16 cu.ft based on the common practice of adding 20%. 64.6" x 27.9" x 32.3"; 396 lbs. 292 watts.

120 vac #RF6057 \$2,800  
12 or 24V DC #RF6058 \$3,440

## Minus 40 Fridge/Freezer

Portable refrigerators made in Africa for the roughest off-road conditions. Low power consumption, 12 or 24V DC. Powerful enough to make ice and operate as a freezer, stainless steel lined for longest life. Rugged and reliable, battery powered to suit the electrical system of the vehicle/boat/yacht/caravan.

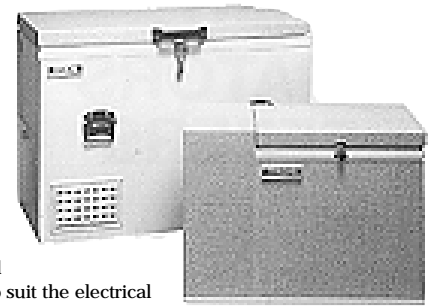

Caravelle 1.41 cu.ft. #RF4613 \$1,550  
Safari 15 gallon, 2 cu.ft #RF4614 \$1,935  
Bushmaster 25 gallon 4.1 cu.ft. #RF4615 \$1,800  
Kalahari 30 gallon 5.4 cu.ft #RF46160 \$2,000

## Nova Kool: Make Your Own DC Refrigerator

Build your own insulated box and use this 12V DC Nova Kool Kit to make your own super efficient refrigerator or freezer. You can make up to a 10 cu.ft. refrigerator, a 4 cu.ft. freezer or combination. Includes pre-charged Danfoss compressor (same unit used in Sun Frost), radiator, fan, electronics on a base, two cold plate evaporators extended on 10' of quick-connect tubing, and external temperature control. 5 amps when running. Depending on size and insulation, it uses as little as 18 amps per day. Fridge Kit won't work as a freezer but will power a refrigerator up to 20 cu.ft. ColdMachine makes up to a 15 cu.ft. freezer and draws 6A at full load. Freezer 15" x 6" x 12", mount compressor up to 15' away. 12V.



Basic Nova Kool Kit #RF191 \$770  
20 cu.ft. Fridge Kit #RF192 \$700  
ColdMachine #RF3835 \$1,244

## Appropriate Technology in Action

Mohammed Bah Abba, Nigeria

Mohammed Bah Abba discovered a way to use inexpensive, locally available materials and make simple refrigeration systems. Easy to make, inexpensive, and requiring no electricity, they still work incredibly well - eggplants stay fresh for 27 days instead of the normal 3, peppers and tomatoes last 21 days or more; and African spinach that normally spoils in just 1 day, lasts for 12. By putting a smaller clay pot inside a larger one with wet sand in between, he found that the natural evaporation creates a refrigeration process with a cost of only 30 cents! We're experimenting to help improve this process and testing a solar powered fan blowing across the top of the pots as well as using a third outside pot filled with water.

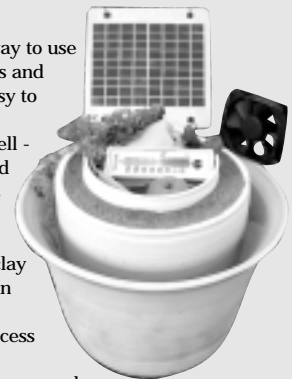

## Solus 5 cu.ft. Refrigerator

Super efficient refrigerator provides both low cost and high efficiency. A proprietary control algorithm optimizes the speed of a Danfoss compressor for maximum efficiency and minimum battery cycling. Operates on either 12 or 24V DC and uses c. 12-16 ah/day at 24V.

#RR5858 \$995



## Koolatron

12V Portable cooler/warmer

Lay flat like an ice box or stand upright like a refrigerator. Double doors for greater efficiency. Miniature thermoelectric module replaces CFC gases, loud motors, and bulky piping coils with no moving parts to wear out or break down. Adjustable shelves, 4 amps, 13 lbs. Holds 42 12-oz. cans. 19.5" L x 13.5" W x 16" H

#RF240 \$159

## Dometic LP, 12V or 117 vac

Portable refrigeration

Looks like an ice chest but holds more and operates from almost any power source. Take with you and switch over to whatever kind of power you find. 1.17 cu.ft. size holds more than six 6-packs and makes ice cubes. Super low power usage—6 gal. of propane per week or only 60 watts/hr of electricity.

#RF1461 \$425



## Engel Portable Refrigerator/Freezers

High Quality! Great Price!

Engel - a world leader in portable compressor freezers now offers 2 new highly efficient models. Small, light and made from rugged plastic, the Engel 15 and Engel 30 are convenient 12 v units that can be used exclusively as refrigerators or freezers. Engel 's unique patented Swing Motor compressor is shock mounted - functions perfectly even when tilted making it ideal for transport in vehicles, boats, and airplanes. Well insulated, the 15 features smaller storage with a large compressor capable of freezing, the 30 provides more space, but runs a smaller compressor that will keep most items frozen.

Environmentally friendly CFC free, uses 12V cigarette lighter plug or 110 volt with adapter. CE - Approved, 12 month warranty.

Engel 15 #RF6817 \$549

Engel 30 #RF6818 \$549



*"Products that spark my imagination. Their website is what you expect in an on-line merchant: descriptions such as you would find in a catalogue and the ability to purchase easily. Many merchants are disappointing in that they forget that you need to see a picture of every product as well as be able to read a description of it."*

— P.L. Moore 8/1/99

## Total Refrigerators and Freezers

A range of chest refrigerators and freezers specifically designed for solar electric systems in remote areas of developing countries. High efficiency, super insulated steel cabinets have three coating for corrosion resistance. A large surface evaporator increases the high cooling efficiency. The lid is fitted for a lock and a plughole makes draining and defrosting easy. A special indicator on the front tells when the power is on, if batteries are too low, if the compressor is running and also shows the thermostat setting - from 1 to 6. Not quite as efficient as Sun Frost but less expensive.

4.9 cu.ft. refrigerator	#RF7819	\$1,072
7.1 cu.ft. refrigerator	#RF7558	\$1,120
10.6 cu.ft. refrigerator	#RF7820	\$1,296
4.9 cu.ft. freezer	#RF7821	\$1,041
7.1 cu.ft. freezer	#RF7822	\$1,194

## Absolute Zero Multi-power source Refrigerator and/or Freezer

The new Zero "Slimline" 2.2 Cu/ft combination refrigerator/freezer has all the features needed in the most rugged environment. Major insulation - 3" on the sides, 5" on the front and back - makes ice quickly and keeps it frozen while the gas or electric thermostat turns power consumption off. Specially designed for mobile use to fit into tight areas such as minivan's, boats and ATV's. Also great for cabins, campers and fishermen. Sturdy carry handles and 3 alternative sources of power -LP gas, 120 vac, or 12V DC. 31" H x 26" W x 19.5" D. 1000 BTU, 1.4A at 120 vac, 13.3 at 12V DC. Africa.

For use as a fridge or freezer. Will easily freeze and make ice. Aluminum inner liner with no exposed piping. Carrying handles Combo gas/electric thermostat Can be used as a refrigerator or freezer. Approved for tropical conditions. Durable Textradek Lid. Push button Ignition. Totally CFC free. Photovoltaic-compatible. Interior Storage Basket. Recessed controls. Built-in levelling legs. Made in South Africa,

#RF7810 \$790



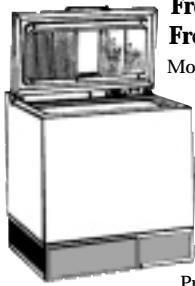

## Frostek 8.25 cu.ft. Gas and Kerosene Freezers

More expensive than the Nordin but better for hot climates. In laboratory tests, this freezer reached -8°F with room temperatures of 80°F and 0° with room temperatures of 90°. Low setting uses 1200 BTU (the same as the maximum for the Nordin) and the high setting for very hot days or climates gives you 50% more cooling capacity and uses 1800 BTU. Exterior thermometer tells you the exact interior conditions without opening the door.

Push-button ignition for matchless starting. New kerosene version is ideal for rural areas where LP gas availability is a problem. Higher maintenance than LP version, but gets colder in hot climates. Easy-to-fill roll-out tank. 38" H x 44" L x 32" D, 220 lbs.

**Propane #RF221 \$1,850**

## Norcold 2-Way Refrigerator/Freezer

Includes door panels, built-in style; LP & 120 vac, 300 watts on DC side @ 52.7/8" H x 23.5 x 24, 6.3 cu ft Also available as a 3-way—adds 12V (\$30 extra).

**#RF3368 \$1,190**



## Propane Refrigerator/Freezers

*Built with over 60 years experience*

In 1925 both the Swedish company, Electrolux and Servel began producing LP-gas refrigerators based on the principles of "ice-from-fire" absorption cooling. Over 2 million units were sold as the Servel name became synonymous with high quality, long lasting LP-gas refrigerators. Distribution stopped as America switched to electric

refrigerators. Now Electrolux through their U.S. company, Dometic offers their experience and innovation in this new Servel unit. Exterior controls include manual ignition, thermostat and fuel selector. Specifications: 7.5 cu.ft. with 1.7 cu.ft. freezer; weight 181 lbs.; consumption 1500 BTU/hr. (c.1.5 gallons of propane/week); colors white and almond (almond called Dometic). Right-hinge door only. Order 120V bolt-on electric kit for back-up electric power. 57.75" H x 24.75" W x 24.75" D. Kerosene-fueled model has 3.7 gal tank that rolls out for easy filling. The Brazilian Consul has smaller freezer (1.1 cu.ft.), larger refrigerator (6.7). 58" H x 23.5" W x 28.8" D. Danby, made in Canada, less expensive because less freight and duty.

<b>Servel</b>	<b>#RF200</b>	<b>\$1,340</b>
<b>Domestic</b>	<b>#RF201</b>	<b>\$1,275</b>
<b>Kerosene</b>	<b>#RF203</b>	<b>\$1,660</b>
<b>Consul</b>	<b>#RF204</b>	<b>\$1,200</b>
<b>Danby</b>	<b>#RF205</b>	<b>\$1,085</b>
<b>Kerosene Burner</b>	<b>#RF6479</b>	<b>\$60</b>
<b>Chimney</b>	<b>#RF6482</b>	<b>\$18</b>
<b>Three Year Parts Kit</b>	<b>#RF6480</b>	<b>\$79</b>

## Servel/Whirlpool Repair Manual

Gas refrigerator maintenance and repair manual for models made between 1933 and 1957. How to install, maintain, adjust burners, and identify problem parts. Extensive list of replacement parts with information on how to order.

**#BK3324 \$12**



## Crystal Cold 12 cu ft LP Freezer

*Largest available size, most dependable*

A good quality freezer you can depend on for years of trouble-free service. 4 cu. ft. larger than chest-type, 3 quick-freeze shelves, holds 3 average locker boxes. Built-in thermometer, magnetic door steel, white steel exterior. Single door, 1-year warranty. 26" D x 38" W x 54" H

**#RF1169 \$2,200**

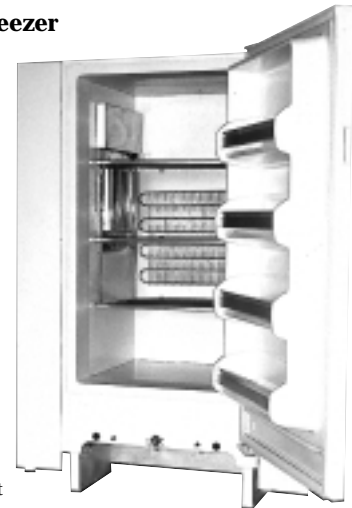

## 10 cu.ft. Euro

A Crystal Cold with the tall and slim European style. Great for fitting into a small footprint without giving up much food storage space. Probably the coldest gas refrigerator ever built - great for really hot locations.

63" H x 23.25" W x 28" D

**#RF7272 \$1,600**

## Crystal Cold 17 cu.ft. Refrigerator/Freezers

*The largest and coldest refrigerator/freezers*

Tested in a 95 degree room, Crystal Cold stayed many degrees colder than other models. This largest model has 13 cu.ft. of refrigerator space and 4 cu.ft. of freezer. Efficient too—the 2100 BTU burners only use 1.5 lbs (.35

gallons) of propane per 24 hour cycle. 65" H x 28" W x 37" D, 275 lbs.

**17 cu.ft. LP #RF5267 \$2,460**

**17 cu.ft. NG #RF5271 \$2,490**



## Crystal Cold 13.3 cu.ft. Propane Refrigerator/Freezer

*High quality, reliable—holds 14 half-gallons of ice cream!*

In kitchens with frequent temperatures over 90°, the freezer in this new LP model still stays below 0°. 60.5" H x 28.25" W x 32.5" D. Textured almond or white exterior (please specify). Casters for easy moving. Reversible doors, rubber coated inside shelves. Also available in natural gas by special order.

**#RF1794 \$2,290**

## Standard Telephone Service Without Wires!

Wireless phone systems extend your telephone service from the termination of an existing phone jack to an almost unlimited distance. We design and supply many kinds of systems for your individual situation—anything from an extension for a barn to a multi-phone system in a remote village. Get an individual cordless phone or up to 30 channel multiplex service. Fax, modem, intercom, and telex capability; portable, mobile, or point-to-point. AC or DC powered equipment. Since terrain and requirements vary so much, it's best to call and discuss what you would like to do. Our Telecommunications booklet could also help. Average power use 1.7 watts on standby and 18 watts while transmitting. FCC approved Telemobile and Telenex approved for use in the US and Canada, less-expensive models don't have FCC approval.



**FCC: Approved for use in the U.S.**

## Telemobile PTEL Systems

*Our best, most versatile system*

Get a data/fax/digital-compatible phone jack up to 50 miles (80 km) from the closest phone line! Your existing telephones (including cordless phones), fax machines and modems plug right in and work normally. Secure unauthorized hand-held and mobile phones can't access your phone lines with extra optional voice scrambling. Compander feature means great audio and full 9600-band G3 fax transmission speeds. Basic system includes: Terminal, remote unit, (2) Yaggi antennas and (2) 15M coax cables (longer lengths available by request). Many options, including pay phone interface and 32-channel selector switch. 12V DC, FCC approved.



- |                     |                |                |
|---------------------|----------------|----------------|
| <b>2 Watt PTEL</b>  | <b>#CP1858</b> | <b>\$3,195</b> |
| <b>10 Watt PTEL</b> | <b>#CP1859</b> | <b>\$3,595</b> |
| <b>25 Watt PTEL</b> | <b>#CP1860</b> | <b>\$4,195</b> |

*"If I went conventional power, with telephone, it would cost me \$85,000. I can't afford this and then pay them every month for the rest of my life."*

—B.K., Pomeroy, WA

# TELEMOBILE INC.



Anything from small neighborhood systems to large village multi-user set-ups with mobile, point-to-point, emergency, business, personal, and pay phones. Combines radio with telephone by interfacing the highest quality analog and digital communication techniques. Interconnects all frequencies and all geographic locations. Prices listed here for general budgeting considerations—please contact us with your specific requirements for an exact quotation. FCC approved.

- |                              |                |                 |
|------------------------------|----------------|-----------------|
| <b>10-15 Watt Multi-Line</b> | <b>#CP1505</b> | <b>\$8,995</b>  |
| <b>25-30 Watt Multi-Line</b> | <b>#CP1506</b> | <b>\$9,195</b>  |
| <b>40 Lines, 8 Channels</b>  | <b>#CP1507</b> | <b>\$32,000</b> |

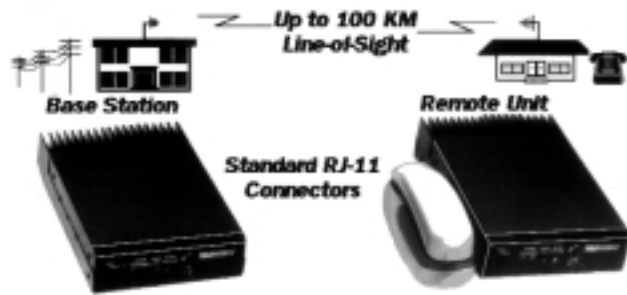

**Start your own remote telephone business**

## Satellite Telephone Systems

Instead of extending a phone line with our cordless phones or using cellular, you can now link directly to a 6,600 lb. satellite in geosynchronous orbit. They provides phone service for all of North America, coastal waters, Central America and most of the Caribbean—and the rest of the world. As easy to use as any standard telephone, it connects you directly with the public telephone network—just dial the number and press a send key. You receive calls on your own 800 number.



### Qualcomm Tri Mode Handset

Clear voice and short message services through three separate technologies - Code Division Multiple Access (CDMA) digital technology, analog (AMPS) for cellular service, and Globalstar for satellite service. Automatically extend communications to areas where cellular or land-line phones are inaccessible due to lack of coverage or incompatible cellular technologies. Features include high contrast illuminated LCD display, built-in speed dial and store frequently called numbers. Specifications: Dimensions: 177mm x 57mm x 48mm Weight: 370 grams

#CP8131 #CP8131 \$1190

### Qualcomm Fixed Satellite Phone

Voice communications for people in offices or residential sites where land-based phone services do not exist. Quick and easy communication systems in remote, hard-to-reach locations, and in under-served urban and rural areas. A Globalstar fixed phone can, for the first time ever, bring a dial tone to areas where traditional telephone services are not economically feasible. The antenna and fixed phone are mounted in a convenient outdoor location with a clear view of the sky and connected to a variety of available indoor phone units using standard telephone cable. The phone supports service of multiple extensions for a single line using standard telephone units including wall, desk, and cordless

models, and answering machines. Data will be available in 2H2000. Includes analog handset. Use grid power, battery or solar panels. 12V, 3 Amp, 3.3 kg, 510(H) x 80(D) x 210(W) mm

<b>Phone</b>	#CP8132	\$2,500
<b>GSP 60 Feet Antenna Cable</b>	#CP8153	\$418
<b>GSP 30 Feet Antenna Cable</b>	#CP8152	\$217
<b>Marine Kit</b>	#CP8151	\$1,782
<b>Privacy Headset and Headset Adapter</b>	#CP8148	\$59
<b>GSP1600 High Capacity Battery</b>	#CP8143	\$109
<b>GSP1600 Travel Charger</b>	#CP8142	\$129
<b>GSP1600 Wall Charter</b>	#CP8141	\$89
<b>GSP1600 Hands Free Car Kit</b>	#CP8140	\$999
<b>Globalstar Cigarette Lighter Adapter</b>	#CP8138	\$89

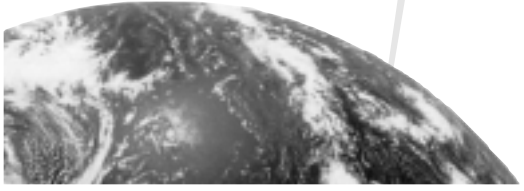

## i-WLL Remote Phone Link

Connect to the Internet without a phone line. This dual-line, all-digital remote phone link delivers data, email and the Internet to your remote PC and allows high-quality voice transmission at the same time. Using a point-to-point spread spectrum telephone system, the I-WLL never needs tuning and assures complete privacy. And because it uses the 2.4 GHz frequency band, there is no FCC license required. Wireless modem rates are consistently between 9.6 and 33.6 kbps. You must have a true line-of-sight connection (approx. 10 miles) between sites. Lightweight portability allows latitude in selecting an optimal installation site.

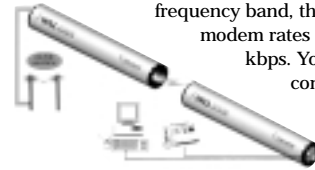

#CM6853 \$4,800

## Karaoke Systems

Portable, remote back-up music for great parties and social events



Stage your own musical extravaganzas or rent the equipment and solar power supplies. Liven up your community or village, then take the show on the road. The less expensive "Singing Machine" has a 7 watt plus 7 watt RMS stereo top loading CD and graphics player with double cassette player as well as built in



speaker system. Includes balance control, automatic vocal changer, audio and two microphone inputs and both video and audio outputs. 120 vac, 26 lbs., 27" L x 15.5" W x 12" D The deluxe Califone adds a public address system, separate volume controls for the two mic inputs (one microphone included), a 15 watt amplifier, two 6" speakers, high speed dubbing, and many extra features. 120 vac, 19 lbs., 17.5" H x 13" W x 7.5" D

<b>Singing Machine</b>	#CM8051	\$395
<b>Califone</b>	#CM8052	\$664

## Portable Audio Systems

The ultimate in portable sound systems

From remote music sets to educational and business seminars to sporting events, this is the equipment you'll need. Only 28 lbs. but still a powerful four channel, 150 watt stereo powered mixer with digital reverb and two, custom full-range speaker cabinets. It operates on either AC or DC power (with the DC-DC converter accessory, CM8055) and accepts Passport Wireless Systems for the ultimate in both flexibility and portability. It packs into a convenient, weather-resistant, portable package and sounds fantastic! Includes 150 watts stereo (75 watts per channel), three mic/ line inputs and one mono/stereo input for CD, Tape or Computer input. System includes one P-51 microphone with cable and stand clip and speaker cables. It sets up in less than five minutes. The P-250 increases to a 250 watts stereo (125 watts per channel), four mic/ line inputs and two mono/stereo inputs for CD, tape, video or computer connections and includes two P-51 microphones (with cables and stand clips) and speaker cables.



<b>P-150</b>	#CM8030	\$550
<b>P-250</b>	#CM8031	\$890
<b>DC power converter</b>	#CM8055	\$125

Just because you're off the grid does not mean you have to be without phone service! In today's society a phone is a necessity. We offer several high quality phone solutions - simply connect our cordless phone base station to any telephone line, and use the handset at a remote location up to 70km away from the phone line!



## FCC approved Remote Phone

*Up to 40km (30 mile) range!*

By far, the longest range FCC certified phone available. This high quality digital phone system offers the longest communication range of any commercially available FCC certified cordless phone - and it is legal to use in the USA! In a rural environment without the external antenna upgrade, expect a range of about a half mile. With the factory external antenna you'll get between 1-2 miles in most conditions, and under true line of sight conditions (with factory external antenna and no obstructions) this phone has been tested at 8+ miles! For the absolute maximum range, a G2 linear amplifier set may be added to deliver a range of up to 30 miles! This long range phone is packed with features such as vibration alert, "walkie-talkie" style full duplex digital 2 way radio between handsets, Caller ID/Caller ID call waiting, music on hold, headset jack, and much more. It is excellent for use inside buildings and the military grade frequency hopping system assures privacy. The standard one line system may be expanded to include as many as 4 lines (requires optional equipment) and up to 36 handsets. We guarantee that this unit is, by far, the longest range FCC certified phone available.

Package Options Standard Package: 1 line 1 handset system, Pro Pak (2-5km) includes factory external antenna with 20M cable, 2nd nimh battery, leather case with swivel belt clip, headset adapter, and music on hold cable, The Pro Pak Level II (15-30km) also adds our revolutionary base station G2 linear amplifier package (see page 177), and the Pro Pak level III (25-40km) additionally includes our G2 handset amplifier for in car use. Other options include additional handset kit (comes with a nimh battery and desktop rapid charger), and additional base station (required for each additional line).

<b>Standard Package</b>	<b>#CM8812</b>	<b>\$479</b>
<b>Pro Pak</b>	<b>#CM8820</b>	<b>\$649</b>
<b>Pro Pak Level II</b>	<b>#CM8959</b>	<b>\$1,149</b>
<b>Pro Pak Level III</b>	<b>#CM8960</b>	<b>\$1,448</b>
<b>Additional Handset Kit</b>	<b>#CM8961</b>	<b>\$239</b>
<b>Additional Base Station</b>	<b>#CM8962</b>	<b>\$249</b>

## Non-FCC: Not approved for use in the U.S.

### The Basic - 258R

*Range up to 70km!*

A great price, high quality, and exceptional performance but without all of the extra bells and whistles. This rugged system offers a user customizable range of up to 70km and has a built in scrambler for voice privacy. A small handset, long battery life, clear sound quality, and a headset jack make this system a top choice for the budget minded. As your communications needs grow the system may be expanded to include as many as 15 handsets (which may communicate with one another in 2 way radio mode) and our popular G2 linear amplifiers (#CM8807) may be added to increase the range. This unit is our most affordable "ultra long range" cordless phone and is backed by ISO9002 manufacturing quality to assure years of reliable service. Base system (2km) includes one handset. The pro pak (15km) adds an external factory antenna with 8M cable, belt clip for the handset, ear microphone, desktop charger for handset, extra battery, and a cigarette cord adapter for in car use. The pro pak Level II (45km) also adds our revolutionary base station G2 linear amplifier package (see page 177), and the pro pak level III (70km) additionally includes our G2 handset amplifier for in car use..



<b>Standard Package</b>	<b>#CM6845</b>	<b>\$549</b>
<b>Pro Pak</b>	<b>#CM8963</b>	<b>\$698</b>
<b>Pro Pak Level II</b>	<b>#CM8964</b>	<b>\$1,198</b>
<b>Pro Pak Level III</b>	<b>#CM8965</b>	<b>\$1,497</b>
<b>Additional Handset kit</b>	<b>#CM8966</b>	<b>\$298</b>

### Data Capable

*Packed with features, range up to 70km!*

The 328RR is the most advanced system we offer at any price. It features a small, light, and durable handset with exceptional battery life and a range of up to 70km (with optional G2 linear amplifier set). It's no surprise the 328RR is our most popular long range phone. A short list of advanced features includes: Caller ID/CID call waiting, vibration alert, military grade voice scrambler, Built-in two-way radio with call transfer capability between handsets, backlit LCD and keypad, battery and signal strength indicators, real time clock, headset jack, 30 number alphanumeric phonebook, customizable ring tones, Handset Smart Switch(tm) - allows for easy scrolling through memory functions, even a speaker phone on the handset! And those are just the handset features!

The system can evolve into a multi-user/multi-line wireless network by simply adding handsets and/or other hardware. Exceptional battery life is attained through the system's advanced power management software. The standard battery delivers an unbelievable 4 hours of talk-time. If you require a sophisticated wireless communication network, or simply the ultimate cordless phone for your personal use, look no further than the revolutionary 328RR. The Standard Package (2km) includes one handset, The Pro Pak (15km) adds an external factory antenna with 8M cable, leather case, ear microphone, desktop charger for handset, extra battery, and a cigarette cord adapter for in car use. The Pro Pak Level II (45km) also adds our revolutionary base station G2 linear amplifier package (see page 177), and the Pro Pak Level III (70km) additionally includes our G2 handset amplifier for in car use.



<b>Standard Package</b>	<b>#CM7151</b>	<b>\$698</b>
<b>Pro Pak</b>	<b>#CM8816</b>	<b>\$989</b>
<b>Pro Pak Level II</b>	<b>#CM8817</b>	<b>\$1,484</b>
<b>Pro Pak Level III</b>	<b>#CM8818</b>	<b>\$1,787</b>
<b>Additional Handset kit</b>	<b>#CM8967</b>	<b>\$349</b>



## SX30 Data Adapter

Check e-mail, send faxes, even power a credit card terminal. This device, which works in conjunction with our 258R and 328RR long range cordless phones, is designed for continuous reliable data transmission. This unit receives the signal from our 258R or 328RR cordless phone base station (much the same way a cordless handset would) and in turn emits a dial tone just like a home/business telephone jack would. It may be used to access the internet, send/receive faxes, and more. After extensive testing under a variety of circumstances, we are confident that the SX30 will fulfill your demanding requirements. Previously a product such as this cost \$4,000 minimum.



The below shows a possible system configuration. Any of the 3 remote sites (the handset, the car, or the house) are able to utilize the same phone line. Data, as well as voice, may be transmitted from either the mobile data link or the fixed site data link. The handset is used for voice only.

**SX30 Fixed Site Kit** #CM8810 \$798  
**SX30 Mobile Kit** #CM8811 \$698

## G2 Linear Amplifiers

*Increase the range of your cordless phone!*

The revolutionary G-2 Base Amplifier will substantially increase the range of the 910R, 258R, or 328RR long range cordless phones. This high quality amplifier raises the transmission power of the long range phone base station from its current maximum of 1W to the equivalent of 14W. Transmission quality is not affected - voice conversations are still crystal clear. Included in the G-2 Base Station Amplifier Package: G-2 Base Station Linear Amplifier with AC power supply, Ultra high performance OMNI directional antenna (3 meters), & 30 meters high performance RG58 antenna cable.

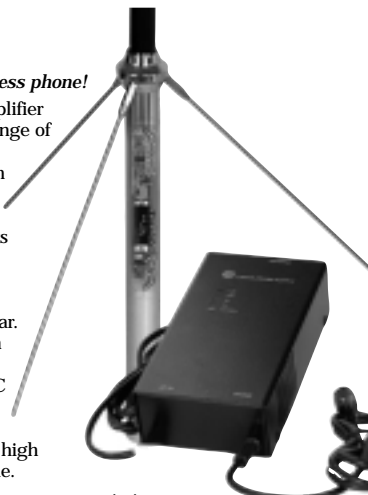

For those who require an even greater transmission range, we offer the 7W G-2 Handset Amplifier (shown to the left). When used in conjunction with the G-2 Base Amplifier, the G-2 Handset Amplifier will increase the range of the 910R phone system up to 40km, and the 258R/328RR system up to 70km (under line of sight conditions). This kit, designed for use in the car, includes an external magnetic mount antenna. The handset battery is automatically charged when connected to the amplifier. The user may conveniently transport the amplifier between vehicles - simply plug it into the cigarette lighter adapter of the desired vehicle. NOTE the G2 amplifiers are offered at a special package price if purchased with the phone system. Get your complete system now, and save!

**G2 Base Station Amplifier** #CM8807 \$689  
**G2 Handset Amplifier** #CM8808 \$499

**SPECIAL! Get both amplifiers for \$799!**

**Item #CM8968**

*if purchased with a phone system.*

## Classroom Wall/Ceiling Projection Screens

The longest life expectancy of any classroom type screen. Matte white surface, tearproof fiberglass, washable, fire retardant, double stitched hems, mildew resistant - made to use frequently and last. Easily attaches to either wall or ceiling.

40" x 40"	#CM8034	\$53
50" x 50"	#CM8035	\$59
60" x 60"	#CM8036	\$67
52" x 70"	#CM8037	\$77
70" x 70"	#CM8038	\$80
84" x 84"	#CM8039	\$175
96" x 96"	#CM8040	\$245
108" x 108"	#CM8041	\$336



## Classroom/Auditorium Tripod Screens

One of the best tripod screens available. Simple design but heavy-gauge components, special leg lock clamps, steel roller, easy adjustments, and built-in keystone eliminator that tilts screen to eliminate distortion. Use the "Lenticular" models in narrow rooms where you can't control the incoming light very well.

50" x 50"	#CM8042	\$188
60" x 60"	#CM8043	\$214
70" x 70"	#CM8044	\$232
84" x 84"	#CM8045	\$362
72" x 96"	#CM8046	\$392
96" x 96"	#CM8047	\$452
50" x 50" Lenticular	#CM8048	\$218
60" x 60" Lenticular	#CM8049	\$240
70" x 70" Lenticular	#CM8050	\$260



## Overhead Projectors

Economical overhead projectors built to withstand rough classroom use. Quality 50-line fresnel lens for distortion-free images. 10" x 10" stage, 30 degree head rotation. Many other model with various features also available. 28" H x 13.5" W x 15" L, 12.5 lbs. 120 or 220 vac

**120 vac** #CM8053 \$172



## Video Projector/Player

Show videos to large groups. The best value per dollar in a video projector. Takes auxiliary inputs from cameras, speakers, separate VCR's—from VHS or other formats. Projects sharp, high contrast images up to 100" diagonal. 350 lines horizontal resolution. Built-in 5-watt amplifier and speaker. 23.1 lbs, 50/60 Hz, 3A, 120V.

#CM946 \$2,985



## Crusader 12V Filmstrip & Slide Projectors

Simple and lightweight projectors great for remote areas. Project single 35mm slides as well as filmstrips. Comes with simple wireform base or optional battery in base compartment for portability (add \$50). 220V also available.

#CM110 \$88

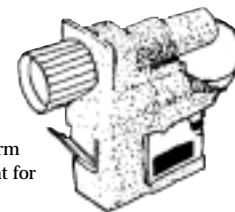

## World-Band (Shortwave) Radio

Tune in to news, entertainment, music and cultural programming from around the world! In this era of satellite TV and the Internet, international radio might seem quaint. In fact, radio transmissions freely cross national boundaries, friendly and hostile alike, and cannot readily be censored or edited. Often, views on events vary considerably from country to country. Why not tune in to a few and draw your own conclusions? Listening conditions vary from day to day but it's rare to be without something interesting to follow. In Colorado we easily receive the BBC, Radio Canada International, Voice of Russia, Radio Deutsche Welle, Radio Netherlands, New Zealand's domestic service, and many others.

## FreePlay® Solar Radio

*Longer play time, less weight, lower cost*

The FreePlay® Solar Radio produces an hour of the highest quality broadcast sound from a simple 30 second wind via the flip-out handle and internal generator. With a built-in solar panel, the radio will operate on both sunlight and spring energy, seamlessly to the user. The radio draws energy from available light and switches automatically to spring energy only when needed.

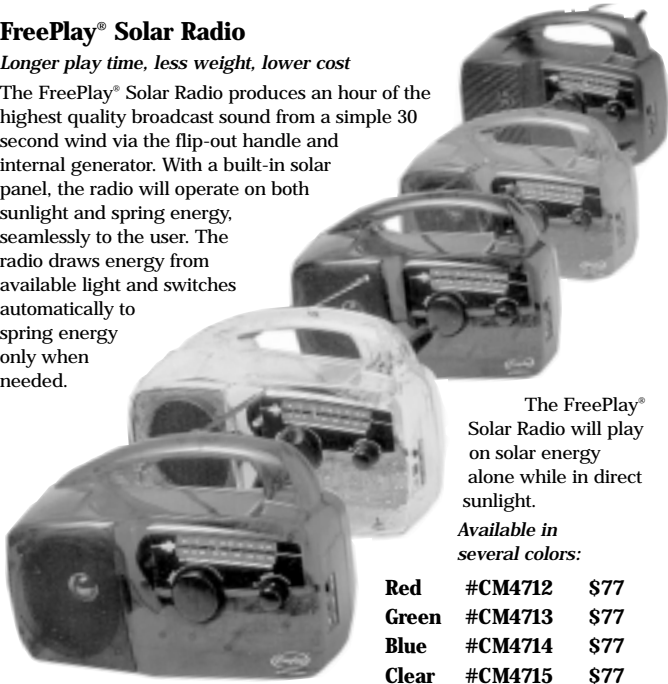

The FreePlay® Solar Radio will play on solar energy alone while in direct sunlight. Available in several colors:

<b>Red</b>	<b>#CM4712</b>	<b>\$77</b>
<b>Green</b>	<b>#CM4713</b>	<b>\$77</b>
<b>Blue</b>	<b>#CM4714</b>	<b>\$77</b>
<b>Clear</b>	<b>#CM4715</b>	<b>\$77</b>

## FreePlay®

*Wind for 60 seconds, play for half an hour*

Requires no power but built-in clockwork generator. Digitally-tuned sets and vacuum-tube oldies are great but when you can't rely on batteries or an external source of power, the FreePlay® has no peer. Ideal for use in rural areas as well as urban ones: you never have to worry about dead batteries during a power outage. Mono FM coverage from 88-108 MHz, AM (MW) from 550-1600 KHz. Shortwave versions: International Band, 6-18 MHz; American Band, 3-12 MHz. 40W x 32H x 18D (cm), 3 KG.



<b>FreePlay® International Band</b>	<b>#CM1447</b>	<b>\$72</b>
<b>FreePlay® American Band</b>	<b>#CM4492</b>	<b>\$100</b>
<b>Portable Shortwave Antenna</b>	<b>#CM3868</b>	<b>\$20</b>

## Soltronix Headset Radio

A light, comfortable headset radio that keeps charging as you jog, work in the garden, watch an outdoor sporting event or even walk around in a sunny room. The super thin NASA spin-off solar cell powers the radio with only 30% of full sunlight and sends extra power into the included NiMH battery. Store on a windowsill when not in use - every hour of light gives you an extra 1-2 hours of radio time up to 18 hours when fully charged. Excellent AM or FM sound with extended bass. Unobtrusive internal antenna and dual headband for comfort and stability. Excellent quality.

**#CM8370 \$39**

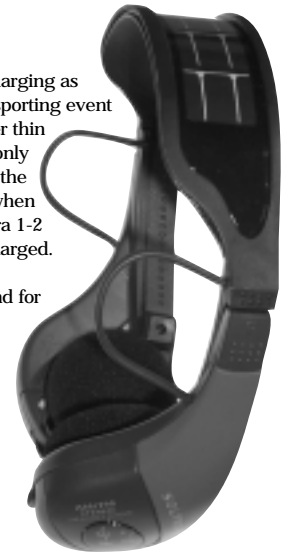

## Freeplay S360 AM/FM Radio

Ending the need to ever think of batteries again, the compact S360 offers versatility, dependability, convenience and exceptional sound quality. The S360 will play

on spring power and can be rewound without interrupting radio reception. The solar panel will fully power the S360 all day in direct sunlight. With its internal power storage system, the S360 will automatically save all available spring and solar energy, giving 15 hours of playtime when fully charged. For additional convenience, the S360 can also be easily recharged through the AC/DC wall adapter.

<b>Clear</b>	<b>#CM6472</b>	<b>\$65</b>
<b>Blue</b>	<b>#CM6473</b>	<b>\$65</b>
<b>Olive Gray</b>	<b>#CM6474</b>	<b>\$65</b>

## FreePlay® – The Second Generation

Radio-only version of the popular FreePlay® hand-crank radio. No shortwave but just 60 winds plays the AM or FM radio for up to one hour. Easy to carry, only 5.5 lbs., the 4" Silverdome speaker sounds great and the antennas get excellent reception. 8" H x 11.5" L x 8" D.

**#CM3033 \$70**



## AM/FM Mono & Stereo/Cassette Players

*Take your music with you when you go outside*

Portable sounds are great. AC/DC stereos let you listen to AM and FM radio or cassettes, and they work on 110 vac household power and on DC battery power.

**AM/FM Stereo w/Dual Cassette Player #CM4173 \$55**



## AC and DC Radio/Dual Cassette/CD

This "boom box" has it all: AM/FM stereo, auto-reverse cassette player/recorder, full-featured CD player. Audio control for maximum bass response. Rugged and splash resistant, perfect for use outdoors. 17 1/16" x 6 1/2" x 9 1/2", 9 lbs. Operates from batteries, AC or DC power. AC adapter included.

**#CM1980 \$349**



**Portable DVD Player**

DVD represents a revolutionary step ahead in portable entertainment. Experience the thrilling sights and sounds of the cinema in your own home, on the road, or in a remote village with no power available. And the DVD-Audio format offers levels of audio quality previously unheard of in a portable system. The world's lightest and thinnest portable DVD-Video player with a built-in DTS®/Dolby Digital® dual decoder and an LCD screen - easy to pack up and play again at your next destination. The included rechargeable battery pack provides up to four hours of continuous playback and can recharge from a solar system. Six channels of audio information, control speaker configuration, delay time, master volume and speaker level control. Hook up to a multi-channel audio system and enjoy the thrilling sounds of a theater anywhere!

#CM7728 \$900

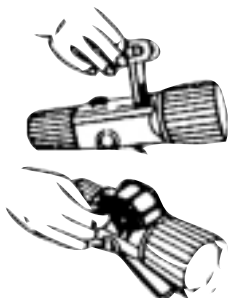

**Illustrator Projector**

Produces the light of a 150 watt line voltage projector with less than 25 watts of power. Special slide inserter allows showing of an unlimited number of slides continuously. Also use vertical format or horizontal format 35mm

filmstrips. Designed for worldwide use with maximum flexibility and portability. Operates at 12V and weighs less than two pounds. Optional power module operates from various voltages and frequencies as found around the world.

**Illustrator Projector** #CM112 \$75

**Optional Power Module** #CM4836 \$34

**Fax Timer**

Powering a fax machine from an inverter system creates a high, unnecessary 24-hour load. This special timer solves the problem—it connects the fax to the power and starts the inverter if necessary when the phone rings, maintains the inverter power for 6 minutes, then disconnects.

#CM3540 \$166



**AC/DC 13" Color TV with VCR**

Video player with 34 button remote, sleep/timer/alarm, record timer, auto head cleaner, on-screen display.

#CM3041 \$560

**AC/DC 13" Color TV with VCR**

Top mount video player, cable ready, 12V & 120 vac cords.

#CM3042 \$400

**AC/DC Starlite 12" Black & White TV**

A quality TV for a great price. Quick start picture tube, extendible telescoping antenna, low power consumption—only about 12 watts! Includes 12V DC car cord. We sometimes substitute different brands (same specs). 16 lbs.

#CM4557 \$100

**Starlite 10" AC/DC Color TV**

Automatic fine tuning, quick start picture tube, receives 2-13 VHF and 14-83 UHF. Includes DC car cord and uses about 60 watts.

#CM204 \$250



**AC/DC 9" Color TV with VCR**

Video recorder, remote control, cable ready, 12V & 120 vac cords.

#CM3043 \$440

**AC/DC Video Player**

11 key remote control, auto head cleaner, digital auto tracking.

#CM3044 \$160

**AC/DC Portable Car/Home CD Player**

Both amplified speakers and stereo headphones, 12V & 120 vac cords, built-in recharging circuit, car cassette adapter.

#CM3322 \$125

**AC/DC 9" Color TV**

Remote control, cable ready, 12V & 120 vac cords, on-screen displays.

#CM3045 \$280

**AC/DC 13" Color TV**

23 button digital remote control, on screen display, earphone jack, 12V & 120 vac cords.

#CM3046 \$320

**Grundig 15" Color TV**

*Multi-System Reception DC 10-30V, AC 90-260V. 50 watts.*

Not only the largest screen size available in 12V but also a true multi-system for worldwide reception. Operates from either 12 or 24V DC and AC voltages between 90-260 50/60 Hz. Set up for direct satellite reception, headphones and computers. Many features such as on-screen display, sleep timer, high tech tuning, and auto stand-by switchover. Includes infrared remote control and a wideband speaker for 4 watts of music power. 24 lbs.

#CM861 \$450



**High Efficiency Linear Power Supply**

Many household items such as notebook computers, answering machines and personal stereos can be run from a battery bank, with the proper power cord, but unfortunately few of them are designed to operate from the 12 or 24V commonly used. Our linear power supplies will drop the voltage down to an appropriate level (adjustable) and will keep it regulated to within 1%, removing potentially harmful voltage spikes. 78% efficient, too. 2A version is a wall plate with standard cigarette lighter socket. 8A version is a hard-wired wall mounted box. 8A version is great for powering 12V compact fluorescent lamps from a 24V battery bank! When ordering, please specify 12 or 24 volt versions.

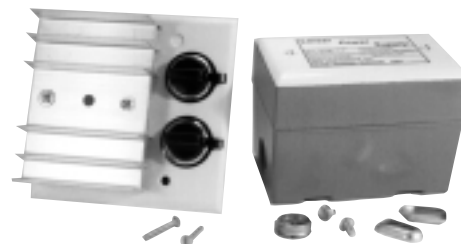

**2 Amp, 12V** #SC518 \$79

**2 Amp, 24V** #SC4830 \$79

**8 Amp, 12V** #SC520 \$175

## SUN-MAR Model Selection

### Self-contained Units

All Sun-Mar self-contained units come with everything needed for installation. Waterless, they require no plumbing. The only installation task is to assemble the 2" or 4" vent stack supplied with the unit - it's quick and easy. Capacity ratings vary with the size of the Bio-Drum, and these ratings can be doubled for short periods. Even so, it is always better to have a good safety margin, and if possible, we suggest you pick a unit with more capacity than you need.



### Excel-NE

#### Our Best Seller

For years, this large-capacity, easy-to-maintain unit has been the right choice for those without power, or those who wish to conserve it. The "chimney effect" of the 4" vent pipe facilitates air-flow and eliminates the need for electricity. Handles a family of 5-7 for cottage use and 2-3 for residential use, with ample capacity for guests. An optional 12 volt fan increases capacity and evaporation for heavy residential use. 1.9 watts. Unit 57 lbs. Shipping, 95 lbs. Unit dimensions: 32"H x 22.5"W x 33"L.

#CT100 \$880

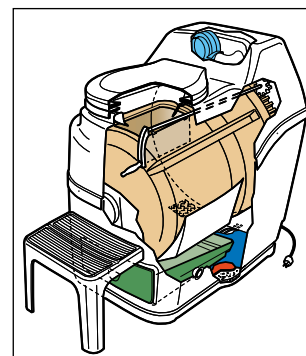

### Excel

#### High Capacity AC with fan and heating element.

Offers the same high-capacity Bio-Drum as the Excel-NE, but evaporating and composting capacity is increased by a thermostatically controlled heating element in the base, and a 110 volt fan in the unit. Easy to maintain; just plug it in, add peat moss and turn the drum as directed. Capacity is 6-8 people for vacation use, and 3-5 people for residential use. 150 watts. Unit, 60 lbs. Shipping 100 lbs. Unit dimensions: 32"H x 22.5"W x 33"L.

#CT101 \$1050



### Compact

#### Elegant low profile AC

Perfect for those with a small home or a private cottage. Engineered to incorporate the Sun-Mar patented Bio-Drum into an elegant rounded design whose looks will complement any bathroom. Capacity is 3-4 people for vacation use and 1-2 people for residential use. 130 watts. Unit, 50 lbs. Shipping, 90 lbs. Unit dimensions: 27.5"H x 22"W x 33"L.

#CT105 \$950

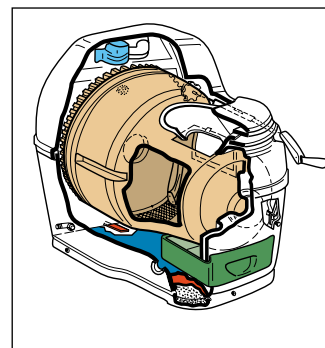

## Also available are Space Saver and Mobile Units

Model	Description	Composting Capacity (#of people)		Unit Pricing
		Weekend / Vacation	Residential/ Continuous	
#CT104 Excel AC/DC	Special dual vented Excel with 2" vent for when 115 volt power is available, and 4" vent (NE) when it's not. Great for those who operate generators over 12 hours a day, or for people who expect to have continuous 110 volt power in future. Variable capacity dependent upon electrical or nonelectrical operation.	5-7	2-4	\$810
#CT1930 Space Saver	Medium capacity, ideal for limited space. 19" width, 28" height and 21" depth. 110 volt electric unit. 75 watts. Unit, 140 lbs. Shipping, 75lbs.	3-4	1-2	\$980
#CT1932 Ecolet Mobile	Special mobile version of the space saver for recreational vehicles. 19" width, 28" height and 21" depth. Unit, 40lbs. Shipping, 75lbs. If and when power is available, unit has a 110 volt 120 watt heater. A second heater is available as an option. Includes 12 volt, 40 watt fan.	3-4	1-2	\$999
#CT1931 Ecolet Mobile (Hull Shaped)	Special mobile version of the space saver for boats. 19" width, 28" height and 21" depth. Unit, 40lbs. Shipping, 75lbs. If and when power is available, unit has a 110 volt, 120 watt heater. A second heater is available as an option. Includes 12 volt, 40 watt fan.	3-4	1-2	\$999

## Model Overview

### Central Composting Toilet Systems: Regular and High Capacity Units

#### Sun-Mar Model Selection

Central composting systems have an elegant 1 pint flush or dry toilet in the bathroom, with the composting unit installed under a building or at the side of a building. For units with 1 pint toilets, installation involves hooking up the water and mounting the toilet in the bathroom, connecting 3" plumbing pipe from the toilet to the composter, and erecting the 2" vent stack supplied with the unit (4" on non-electric

units). If a Dry Toilet is used, the toilet itself must be positioned directly over the composting unit. The Sun-Mar Dry Toilet and Sealand 1 Pint Flush toilets are purchased separately. 12 Volt fans (supplied) should be installed in the vent stack of all non-electric Dry toilet (A/F) units, with all AC/DC units, and with the non-electric version of the Centrex 3000. 12 Volt fans are optional with all other non-electric Central units.



### Centrex 2000 Series

Perfect for medium to heavy seasonal or light residential use, the 2000 series allows for both a longer composting cycle and larger waste volumes. The increased surface area in the evaporating chamber coupled with the larger heating element provides better evaporation on electric units. When used seasonally by up to 6-7 adults, compost will normally only need annual removal each spring. Unlike the 1000 series, the 2000 series have optional A/F (air flow) versions for use with a Sun-Mar Dry toilet, in addition to the regular units designed for use with a 1 pint flush toilet. All 2000 series units 27.5" H x 44.75" W x 26.5" L.

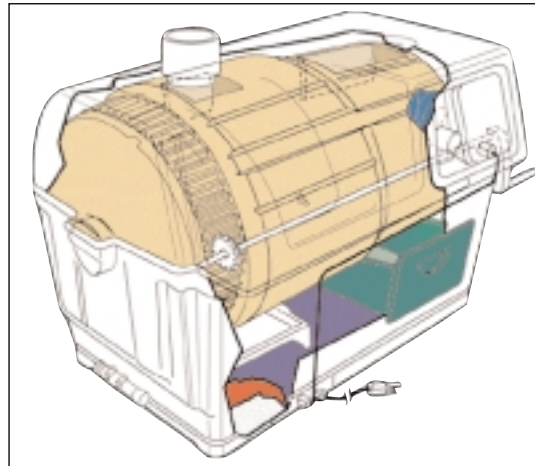

Model	Description	Composting Capacity		Unit Pricing
		Weekend/ Vacation	Residential/ Continuous	
#CT8739 Centrex 2000	The regular version for those with 110 volt electricity. Unit 97 lbs, Shipping 118 lbs	7-9	4-6	\$1,200
#CT8740 Centrex 2000 NE	Non-electric version for those with no continuous 110 volt electricity. Unit 87 lbs, Shipping 108 lbs	6-8	3-5	\$950
#CT8741 Centrex 2000 AC/DC	Dual vented version. Regular electric unit with 4" non-electric vent also added. Unit 97 lbs, Shipping 118 lbs	7-9 or 6-8	4-6 or 3-5	\$1,300
<b>Units for use with Sun- Mar dry toilets (Purchased separately)</b>				
#CT8742 Centrex 2000 A/F	The regular version for those with 110 volt electricity. Unit 103 lbs, Shipping 124 lbs	6-8	4-6	\$1,250
#CT8743 Centrex 2000 A/F NE	Non-electric version for those with no continuous 110 volt electricity. Unit 93 lbs, Shipping 114 lbs	5-7	3-5	\$1,000
#CT8744 Centrex 2000 A/F AC/DC	Dual vented version. Regular electric unit with 4" non-electric vent also added. Unit 108 lbs, Shipping 129 lbs	7-9 or 6-8	4-6 or 3-5	\$1,350

# COMPOSTING TOILETS



## Centrex 1000 Series

The Centrex 1000 was recently re-engineered for better compost flow. In light to medium seasonal use, it typically holds compost for the full season and you only need to empty the tray once each spring. Centrex 1000 electrical units have a 250 watt heater in a sealed compartment under the unit and the standard Sun-Mar 30 Watt turbo fan. The included 2" vent stack ensures odorless operation. Non-electric units normally don't need a 12V fan for the 4" vent stack but the optional 1.9 watt fan increases capacity. A 12V, 1.9 watt fan comes with the AC/DC unit. All 1000 series units have a 1" drain hose which you connect to the 1" drain at the bottom left of the unit. The 1000 series is designed only for use with 1 pint flush toilets (purchased separately). All these models have the same dimensions: 27.5" H x 31.25" W x 26.25" L.

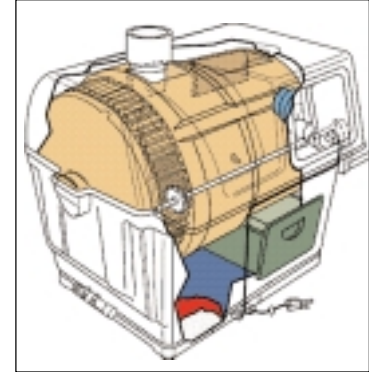

Model	Description	Composting Capacity		Unit Pricing
		Weekend/ Vacation	Residential/ Continuous	
#CT106 Centrex 1000	Regular version for those with 110 volt electricity Unit 50lbs, Shipping 95 lbs.	5-7	N/A	\$1,050
#CT108 Centrex 1000 NE	Non-electric version for those with no continuous 110 volt electricity. Unit 45 lbs, Shipping 90 lbs.	4-6	N/A	\$850
#CT110 Centrex 1000 AC/DC	Dual vented version. Regular electric unit with 4" non-electric vent also added. Unit 50 lbs, Shipping 100 lbs.	5-7 or 4-6	N/A	\$1,150



## Centrex 3000 Series

Designed especially for very heavy cottage, or medium residential use, the Centrex 3000 series (formerly Centrex Plus) has some 40% more composting capacity than the 2000 series. This allows a longer composting cycle, and enables this unit to handle larger waste volumes. The 3000 features a double composting drum. As the drum rotates, waste moves through primary and secondary sections before dropping automatically into the collection chamber at the end of the unit. When used seasonally by up to 8-10 adults, compost will normally only need to be removed annually at the beginning of the following season. The 3000 series is available in A/F (air-flow) versions for use with a Sun-Mar dry toilet, in addition to the regular units designed for use with a 1 pint toilet.

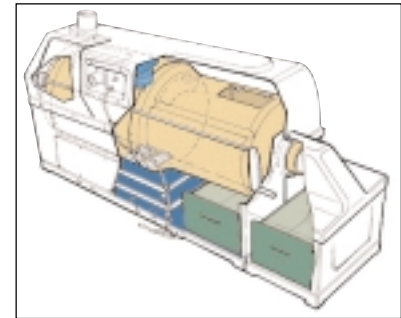

Model	Description	Composting Capacity		Unit Pricing
		Weekend/ Vacation	Residential/ Continuous	
#CT1874 Centrex 3000	The regular version for those with 110 volt electricity. Unit 111 lbs, Shipping 217 lbs	9-11	6-8	\$1,600
#CT1875 Centrex 3000 NE	Non-electric version for those with no continuous 110 volt electricity. Unit 96 lbs, Shipping 202 lbs	6-8	3-5	\$1,420
#CT1879 Centrex 3000 AC/DC	Dual vented version. Regular electric unit with 4" non-electric vent also added. Unit 116 lbs, Shipping 222 lbs.	7-9 or 6-8	4-6 or 3-5	\$1,699
<b>Units for use with Sun- Mar dry toilets (Purchased separately)</b>				
#CT1876 Centrex 3000 A/F	The regular version for those with 110 volt electricity. Unit 116 lbs, Shipping 222 lbs	6-8	4-6	\$1,650
#CT1877 Centrex 3000 A/F NE	Non-electric version for those with no continuous 110 volt electricity. Unit 101 lbs, Shipping 207 lbs	5-7	3-5	\$1,449
#CT2979 Centrex 3000 A/F AC/DC	Dual vented version. Regular electric unit with 4" non-electric vent also added. Unit 121 lbs, Shipping 227 lbs.	7-9 or 6-8	4-6 or 3-5	\$1,749

## Biolet Basic

This model has the standard Biolet features but a handle for manual rather than automatic and mixing. Capacity: four people part-time or three for full-time, residential use. Optional 12V fan and composting bins available to increase capacity. 26" H x 22"W x 30" D

#CT5349 \$949



## Biolet Standard

The original BioLet with a handle to after each use. Includes a heating element, fan and thermostat. Capacity: four people part-time vacation use, three for full-time residential use. Height - 26" (66cm), Width - 22" (55cm), Depth - 29" (74cm). 110V, 250W Adjustable thermostatically controlled heating element 225W and fan motor 25W. 3 year warranty

#CT806 \$1,390



## Biolet UFA

*A new two-piece Biolet composting toilet*

An attractive, standard size toilet with a high capacity, fully automatic composter in the basement. Includes a built in chute for composting organic kitchen waste. Rated for 5-7 people in a residential application, 5-8 with part-time use. The fully insulated composter utilizes a powerful heater for use in unfinished crawl spaces. No stirring or mixing - simply empty the finished compost tray every few months.

#CT8009 \$2,250

## Biolet NE

*Lowest cost non-electric*

The best low cost system for cabins and week-end use. Two separate composting chambers - when the first one fills, it slides to the back for further composting and the second comes to the front. When the second fills, compost in the first will be ready to trench into the soil. The capacity of four people part-time vacation use and three people full-time can be increased with the use of one or more optional composting chambers. Seat height 19.5", 26" H (66cm), 22" W (55cm), 30" D (76cm).



<b>Toilet</b>	#CT804	\$949
<b>Extra containers</b>	#CT801	\$46
<b>12V fan</b>	#CT7690	\$49

## Biolet Deluxe

Automatic mixing, high capacity, normal seat height The fully automatic BioLet Deluxe has pleasing, compact design and a seat height of only 19 1/2". An electric motor rotates two mixing blades inside the composting chamber to assure proper mixing of the compost. This vital function of the composting process activates automatically after each use - no drum to turn, no rake bars to pull, as in other composting toilets. A cover hides the compost from view and opens automatically

when sitting. Completely sealed ABS casing, mixing arms and other important metal components stainless steel. Recommended capacity: five persons for part-time vacation use, three persons for full-time residential use. 26"H x 22" W x 29" L, 120 vac, 290W (Heater 225W, mixer motor 40W and fan motor 25W) Three year limited warranty. Sweden.

#CT805 \$1,425

## Biolet

40% more capacity, NSF approval, automatic mixing Equipped with the same automatic features as the BioLet Deluxe, the XL adds an extra heating element and more capacity. Tested and approved by the National Sanitation Foundation, its design was voted the most user-friendly of all high capacity composting toilets. It needs no water or chemicals and there is no waste water discharge from the unit, necessitating a connection to a sewer or septic tank. Capacity: four people residential, six people cottage (60 days/year). 19.5" seat height, 26"H x 32"L x 26"W, 375 watts 120 vac, 370W (Adjustable thermostatically controlled heating element 305W, mixer motor 40W and fan motor 25W). Three year limited warranty.

#CT807 \$1,495



## The Carousel Composting Toilet System

The Carousel system uses standard piping. Contact your plumber for venting requirements or purchase at your local home center. Note: toilet stool is not included with system.

### Small Carousel

20.87" high, 52" wide. Shipped from Norway. Capacity with heater: 2 people for year-round use. Seasonal usage: 12.

<b>Small Carousel</b>	#CT1657	\$1,255
<b>with fan</b>	#CT3670	\$1,695
<b>with fan &amp; heater</b>	#CT1658	\$1,976

### Medium Carousel

24.8" high, 52" wide. Made in the USA! Capacity with heater: 3 people for year-round use. Seasonal usage: 15.

<b>Medium Carousel</b>	#CT3476	\$2,056
<b>with fan</b>	#CT3671	\$2,325
<b>with fan &amp; heater</b>	#CT3672	\$4,344

### Large Carousel

51.2" high, 52" wide. Made in the USA! Capacity with heater: 5+ people for year-round use (and up to 100 people a day with solar enhancer). Seasonal usage: 32 people.

<b>Large Carousel</b>	#CT1936	\$3,875
<b>with fan</b>	#CT3673	\$4,144
<b>with fan &amp; heater</b>	#CT1935	\$4,425

### Uniseal for 4" Sched 40 PVC #CT6163

connecting exhaust/vent pipe to the top of the Carousel composter

### Uniseal for 6" Sched 40 PVC

#CT6164 \$20

connecting vent/exhaust pipe or a connecting pipe from a commode to the top of the Carousel composter.

### Uniseal 1.5" Leachate Drain Fitting for Sched 40 PVC. #CT6165 \$5

**BioNova Non Electric Composting Toilet #CT5496 \$885**

Call for pricing on larger orders.

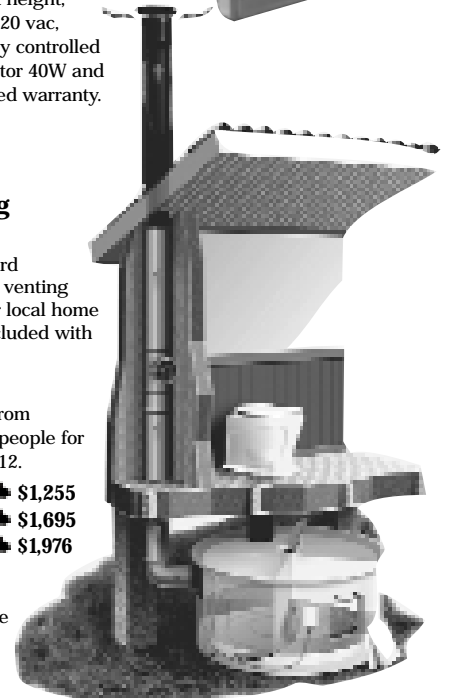

# COMPOSTING TOILETS

## Septic Digester

### Stop sludge build-up

Use for greywater and septic systems, grease traps, drain lines, cesspools or in commercial agro and dairy applications. Solves major problems for any facility with a septic tank including homes and offices. Both aerobic and anaerobic microbes selected for their ability to digest a wide range of complex organisms form a biofilm on the inner walls of drain lines and grease traps reducing the BOD and COD of the wastewater. The bacteria enhances natural forming enzymes that digest grease, oil, fat, and detergents, and other organic material getting rid of the "bad stuff". For less than 50 cents per week, you can keep your waste systems trouble free. Safe for humans, pets, plants and pipes.

2 lbs	#CT7583	\$16
25 lbs	#CT6876	\$200

## Sealand Ceramic One Pint Flush Toilet

### The Ultimate Water Saver



High Profile Small Bowl



Low Profile Small Bowl



High Profile Large Bowl

Perfect for Sun-Mar Centrex and smaller Clivus composting systems. Also great for overloaded septic systems, holding tanks, to upgrade an RV, and to minimize water usage in other situations.

You only need a water supply with 2 GPM—works fine with gravity fed water from a roof tank. Same water surface area, rim wash and full-size seat as conventional toilet but only uses 1 to 2 pints per flush.

Tough vitreous china bowl won't stain, scratch or fade. Easy to clean, simple installation, fits in the same small areas as the uncomfortable plastic toilets. Foot pedal flush controls the amount of water used. Not intended for conventional sewer systems. 1/2" MPT water connection. 2-year warranty, freight collect.

Sealand 910, 15", small bowl	#WS234	\$169
Sealand 911, 10", small bowl	#WS235	\$184
Sealand 510, 15", large bowl	#WS236	\$225

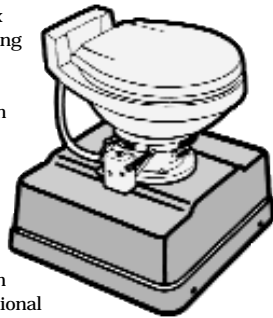

## Urine Diverting Toilets

Solve a key element in waste management. Urine is biologically sterile and a great source nitrogen vital to a healthy greywater system. This toilet separates urine and uses just 3 oz. of water to flush. Build your own composting chamber for solids that will break down into sanitary humus for use as a top-soil enhancer.

Without water this process goes fast. Top Quality porcelain ensures hygiene and great looks.

Single flush	#CT7420	\$572
Double flush	#CT7421	\$673



*"The idea of waste, of something unusable, reveals an incomplete understanding of how things work. Nature admits no waste. Nothing is left over; everything is joined in the spiral of life. Perhaps other cultures know this better than we, for they have no concept of, no word for, waste."*

- Sim Van der Ryn, *The Toilet Papers*

## Toto Low Flush Toilet

An ANSI test of 31 low flush toilets gave Toto the highest scores for best performance—higher than much more expensive models. Looks and works like a quality standard toilet but only uses 1.6 gallons per flush. Vitreous china, smooth, sanitary interior and exterior surfaces, accepts standard toilet seats (not included). Easy to install—simple two piece design, standard ballcock, flush valve, and 12" rough-in. "100% Rim Bowl Washing" keeps the Toto clean longer and makes it easier to clean. A Toto will save the average 4-person family over \$74/year. 1 year warranty, freight collect. 1.6 gallon round. Truck shipping only. 60lbs.



White, Round	#WS210	\$119
White, Elongated	#WS5664	\$174
Bone, Round	#WS211	\$135
Bone, Elongated	#WS5665	\$160



## "Air Flush" Waterless Toilet

*Don't use any water at all!*

For Clivus Multrum or Sun-Mar systems. White, fiberglass stool, polyethylene liner, open front seat and cover, stainless steel collar. Seat 14" above floor. Add \$40 per 2' of chute.

#CT360 \$249

## Storburn Incinerator Toilets

### Pollution-free!

A toilet that works like a self-cleaning oven. Safe, sanitary, self-contained. No electricity, water, holding tanks, or plumbing needed. No moving parts to freeze up. Great for places where you can't have a flush toilet. Use at the cottage, cabin, remote area, or work site. Handles up to 8 people full-time and burns waste to a harmless, sterile mineral ash and water vapor. Up to 60 visits in succession before incineration necessary. Just add a packet of anti-foam and light with piezo ignition (uses 7 lbs. of propane per burn). Guarantee odorless—indoors or out. Pollution-free. 17.75" W x 31.25" D x 53.5" H.

Storburn Propane	#CT601	\$2,650
Storburn Natural Gas	#CT602	\$2,680
1-Story Vent Kit, 115"	#CT603	\$290
Mobile Building Vent, 82"	#CT604	\$240
Anti-Foam 24-pack	#CT605	\$26.50



## Incinolet CF-1

Use electric heat to incinerate human waste. Incinolet reduces waste to a tablespoon of clean ash. Cool to the touch even when operating. Incinerates at the touch of a button. Installs simply—simple vent line and power hookup complete the installation. 120V/1000W. Vent Kits available for direct vent (\$14.95) and vertical (\$29.95). One year warranty Models for home, watercraft, and RV. Draws 15 amps @ 120 vac.

CF-1 (1 person)	#CT4567	\$2,300
Heavy Duty (8 People)	#CT4570	\$2,600
Direct Vent Kit	#CT4841	\$30

## Incinolet CF120 - 110vac

CF120 (1 person)	#CT6136	\$2,200
------------------	---------	---------





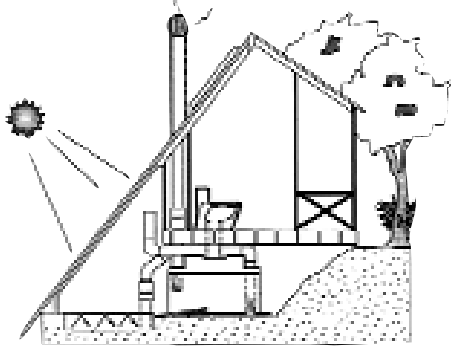

## Large Systems

High capacity composters for parks, villages, campgrounds and industrial sites. We engineer larger systems based on climate, amount of usage, terrain, accessibility, and other factors. We provide different components in different parts of the world—let us know as many details as possible and we'll make recommendations.

## Clivus Multrum 1 Composter

The same state-of-the-art features used for years on large systems now available for single family residences. The original composting toilet company (since 1939) brings its time-tested technology to this new, smaller system. The Multrum 1 fully treats both solids and liquids. It produces two types of high quality fertilizer and you won't notice any odors in the process. Use Multrum 1 for 4-5 people in continuous residential use or for 6-8 people with intermittent vacation use. Clivus first received NSF approval in 1982. Produces 2-3 gallons of compost per person per year. Virtually foolproof with lower maintenance, a larger multrum for longer times before emptying, and nothing mechanical to break down. Use with SeaLand or "Air Flush" toilets. Made from 100% recycled and recyclable plastic. 56" H x 33" W x 65" L.



#CT305      \$2,500

## Garden Composter

A strong, sturdy and attractive composter that works great and "walks its talk"—made from 100% recycled plastic. Quick-access, animal-resistant snap-swing lid with a large door for easy waste disposal and a sliding bottom door for fast, efficient compost removal. Patented venting system speeds composting action. Optional rodent screen keeps burrowing animals out. Includes a complete composting guide. Assembly required but you won't need any tools, it just snaps together. 11 cu. ft. volume, 36" H x 23" W x 23" D. 27 lbs.



**Garden Composter**      #EP7673      \$52  
**Garden Composter w/ rodent screen**      #EP7674      \$55

## Clivus Multrum 2 Composter

Twice the capacity at a fraction of the price. Odorless, cost effective, pollution-preventing sanitation for up to 3 bedroom residences. Reduces bio-mass input by 95%, releases carbon dioxide and water vapor, produces valuable fertilizers. Makes 2-3 gallons of compost per person per year. Includes a solid waste composting chamber and liquid fertilizer storage cradle. Built-in moistening system ensures optimal composting conditions. Made from 100% recycled polyethylene. 66" H x 33" W x 65" L.

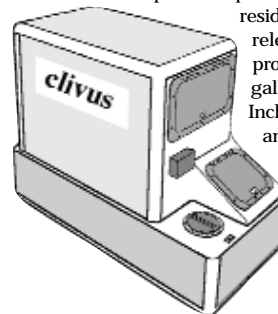

#CT306      \$3,000

## Toilet Tank Water Saver

Can save 12,000 gals/year

Stainless steel and thermo-plastic panels save up to 35% of toilet water use (2-3 gallons each time). Can reduce total household water use by 15%. Adjustable for different types of toilets and fits all tank styles. No tools needed for installation—just push down into place. Much better than bricks or rocks. (The minerals can dissolve and cause havoc with your plumbing.) Doesn't work well with low pressure toilets.



#WS201      \$10

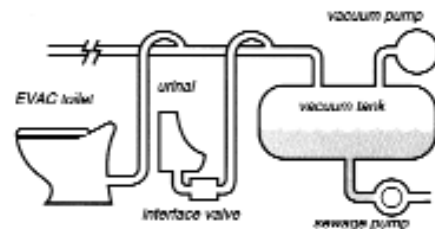

## EVAC Vacuum Toilet System

Only 0.375 gallons per flush—reduces water and sewage use up to 90%

Ideal for composting toilet systems and difficult installations: 20 foot vertical lift capability with small 1 1/2" waste pipe. Run pipe in ceilings, around or over obstructions. Eliminates cost and installation of vent pipe. Separates black from grey water and controls the time and volume of sewage discharge. A single vacuum station services several toilets. Prices vary depending on configuration. Please call or write with your requirements.

## Spinning Composter

Compost up to 85 lbs. of rich fertile soil in as little as 30 days

Effortless composting—with an easy push, just spin this 100% recycled plastic cylinder to mix in vital oxygen and speed decomposition. Instead of adding to a landfill, your food scraps and yard wastes become a rich and useful resource. The removable, wheeled base collects water dripping off the compost pile and you can water plants and gardens with this nutritious by-product. 31" H x 26" L x 21" W. 7 cu. ft. volume. 14 lbs. USA.

#EP7676      \$108



# GREYWATER SYSTEMS

## Greywater Systems

Let's stop wasting our waste!

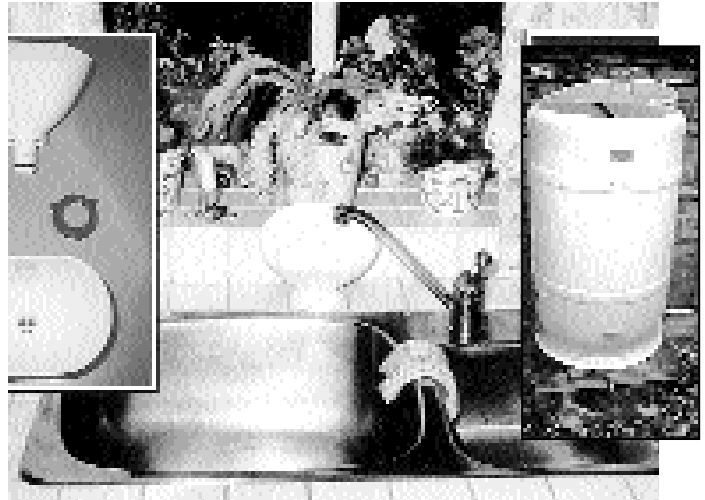

When we mix greywater (water from sinks, washing machines, showers) with blackwater (water from toilets), we take a small amount of pollutants and make a large amount. (Every 3 gallons become about 10.) By diluting the higher concentration of bacteria in blackwater we also greatly slow down the natural decomposition process. And while many water treatment plants are already running at capacity and many underground aquifers are in danger of depletion, an average family of 4 wastes 41,000 gallons of greywater a year that they could use for irrigation. It's crazy. And it's time to stop wasting all the waste and start using greywater systems on a large scale.

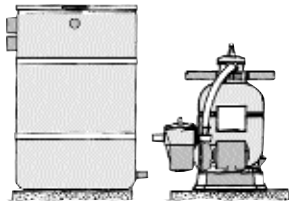

### Earthstar Greywater Systems

Automatic operation, sand filter with backwash cleaning. Simple, high quality, and easy maintenance. When greywater reaches a high level in the 55 gallon tank, a float switch starts a centrifugal pump that begins an irrigation cycle. A simple 5-minute backwash cleaning process every 2 months keeps everything in top shape. And you don't even have to get your hands wet. Comes complete with everything you need to install. Color-coded components make assembly easy in less than an hour. 12 gallon tank good for tight spaces.



With 55 gallon tank #CT125 \$1,065   
 With 12 gallon tank #CT126 \$1,065 

### Sub-Surface Irrigation Packages

Use your greywater to irrigate landscapes  
 Practical when you have at least 300-400 gallons of greywater per day. In many places, sub-surface irrigation is necessary to meet code requirements. It maintains a moist layer at the root zones while maintaining a good balance of air for the best plant growth and strength. Extremely efficient watering method—no evaporation, runoff, overspray, or wet sidewalks. Special emitters prevent root growth into the tubing for 20 years. Internal filter rings prevent soil and sediment clogging. Matches up with and improves previously installed irrigation systems.

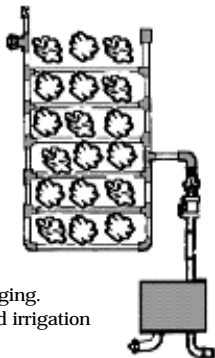

2 Bedroom House Size, 750' #CT130 \$425  
 3 Bedroom House Size, 937' #CT131 \$518  
 Bedroom House Size, 1125' #CT132 \$584  
 Bedroom House Size, 1312' #CT133 \$642

\*Estimates—Systems are customized to site

### 3-Way Valves

Use these three-way valves to make your own greywater system. Used in almost all systems to divert water with contaminants (bleach, paint, dye) to a septic or other processor. Guaranteed never to leak or break; never needs lubrication. Each valve fits two pipe sizes, one on the outside, one on the inside. Rated to 200 psi.

1.5 or 2" #CT121 \$40  
 2 or 2.5" #CT122 \$39

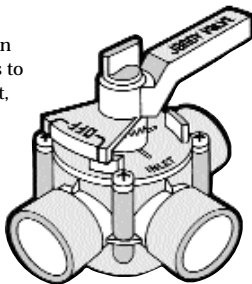

### Envirosink®

#### Greywater Recycling System

Makes saving greywater simple. Installs at your kitchen sink. Basin made from durable ABS plastic. Plumbing to divert the water to a storage tank available locally at a cost of under \$50. Water can irrigate gardens or (with an auxiliary pump) flush your toilet. Only system that allows some catchment of water from kitchen (kitchen sinks are designated as "black water").

#CT4882 \$42

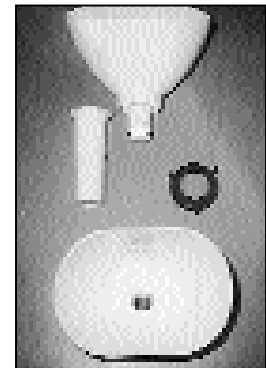

### Spin-Down Sediment Trap Filters

No more expensive cartridges to replace! Just open the ball valve and let the spin action clean your filter out. The clear housing lets you see when there's a build-up and you need to clean the reusable, inner 100 mesh filter. 2" version great for greywater systems - use the standard version first and then the 500 mesh (30 micron) for drip irrigation. Smaller sizes great for waterpumping systems. 100 mesh (152 micron).

3/4" #WC7144 \$68  
 1" #WC7145 \$70  
 1.5" #WC7146 \$84  
 2" #WC7147 \$112  
 2" 500 mesh #WC7148 \$118

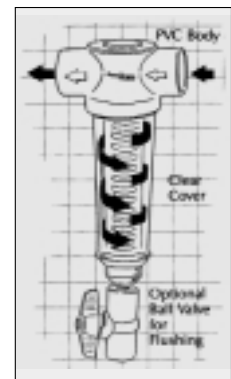

### Double Ells

The key component to the "split drain to mulch basins or mini-leachfields" system (See the "Builder's Greywater Guide"). This ultra-simple, robust system offers automated, subsurface greywater disposal without filtration, pumping, a surge tank, or hardly any maintenance.

It is one of the few systems which is both practical and legal. The area to be irrigated has to be downhill from the house, and laying out the lines must be done with fanatical attention to proper slope. Each system needs at most one 2" double ell, and the other parts you can buy locally.



1.5" Double Ell with Cleanout #WS6429 \$15  
 2" Double Ell with Cleanout #WS6430 \$20

## Bilge Pumps

*Automatically empty a greywater tank*



Built-in float switch activates pump when water fills greywater tank. Computer controlled timing checks for water without on/off cycling. When it detects water, pumps until tank is empty and shuts off. Power use in "monitor" mode is less than .25 amps per day. 500 GPH model has 3/4" port and draws .9 amp. 1100 GPH size has 1" port and 3.3 amp draw. Quiet, long-life, cleanable strainer base. Needs filtered water.

<b>500 GPH, 12V</b>	<b>#CT138</b>	<b>\$76</b>
<b>500 GPH, 24V</b>	<b>#WP4647</b>	<b>\$28</b>
<b>1100 GPH, 12V</b>	<b>#CT139</b>	<b>\$95</b>

## Septic Digester

*Stop sludge build-up*

Use for greywater and septic systems, grease traps, drain lines, cesspools or in commercial agro and dairy applications. Solves major problems for any facility with a septic tank including homes and offices. Both aerobic and anaerobic microbes selected for their ability to digest a wide range of complex organisms form a biofilm on the inner walls of drain lines and grease traps reducing the BOD and COD of the wastewater. The bacteria enhances natural forming enzymes that digest grease, oil, fat, and detergents, and other organic material getting rid of the "bad stuff". For less than 50 cents per week, you can keep your waste systems trouble free. Safe for humans, pets, plants and pipes.

<b>2 lbs</b>	<b>#CT7583</b>	<b>\$16</b>
<b>25 lbs</b>	<b>#CT6876</b>	<b>\$200</b>

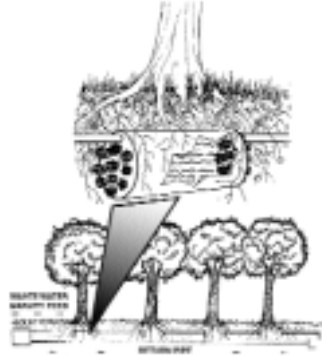

## EcoChamber Greywater Emitters

*Stop wasting your waste water*

Only 33" long by 12" diameter, but buried near a growing tree becomes a super drip irrigation greywater emitter providing up to 50 gallons of water per day. Stores up to 13 gallons when you have more greywater than your trees need. Patented design won't clog from organic material or roots. Decorated redwood bark creates millions of water passageways and enhances bacterial breakdown of organic solids. Low maintenance, easy installation. Proven reliability for over 15 years.

**#CT3199 \$160**

## Dry Well/Sand Filter

Collect and store excess greywater, composting toilet overflow, storm water. Multi-purpose system made from recycled plastic. Stops soil erosion, puddles and contaminated water reaching rivers and lakes. Three interlocking panels with leaching knock-outs. Also great for outside shower drain, sump pump chamber, roof drainage, and floor drains. 24" diameter, 28" high, 49 gallons, up to 16 GPM leaching. Stack or interconnect.

**#CT1636 \$160**

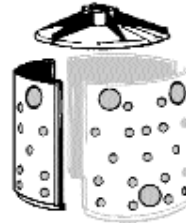

## 1" Flexible PVC

Use this special tubing and make a simple drumless laundry greywater system. Won't kink so you don't have to worry about burning out your washing machine pump. Just move the hose to a new place after each laundry load. The washing machine provides pressure that gets water to your garden or trees. Don't forget to use Oasis laundry soap! (Also great for hooking up hydro-electric systems without extra friction loss.)

**50' #CT136 \$60**

## Greywater Filter

Use old water and save costly leach fields. Filters the wastewater from sinks, showers, washing machines, and all non-toilet sources. So effective a small flower bed can handle the treated greywater. So clean you can use it in a garden. Minimal maintenance, dual alternating filters. 45 gallon polyethylene tank, nylon filters, and optional automatic discharge pumps. 24" L x 18" W x 24" H.

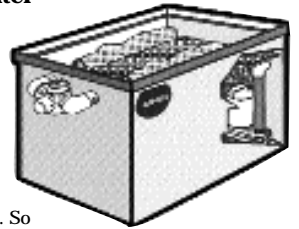

<b>Basic System</b>	<b>#CT384</b>	<b>\$375</b>
<b>AC Pump</b>	<b>#CT385</b>	<b>\$165</b>
<b>DC Pump</b>	<b>#CT386</b>	<b>\$98</b>
<b>Replacement Filters</b>	<b>#CT387</b>	<b>\$8</b>

## Greywater Tank

Most Greywater systems need a tank to temporarily hold water that surges out too fast for the drain hose. Also allows hot water to cool before reaching plants. More expensive than a 55 gallon drum but easier to fit in small spaces. Also approved for potable water storage. 55 gallon 41" L x 27" W x 14" H, 110 gallon same but 29" H. 8" lid opening, 2" vents, specify 3/4", 1 1/4", or 2" drain ports.

<b>55 Gallon</b>	<b>#CT155</b>	<b>\$254</b>
<b>110 Gallon</b>	<b>#CT156</b>	<b>\$288</b>

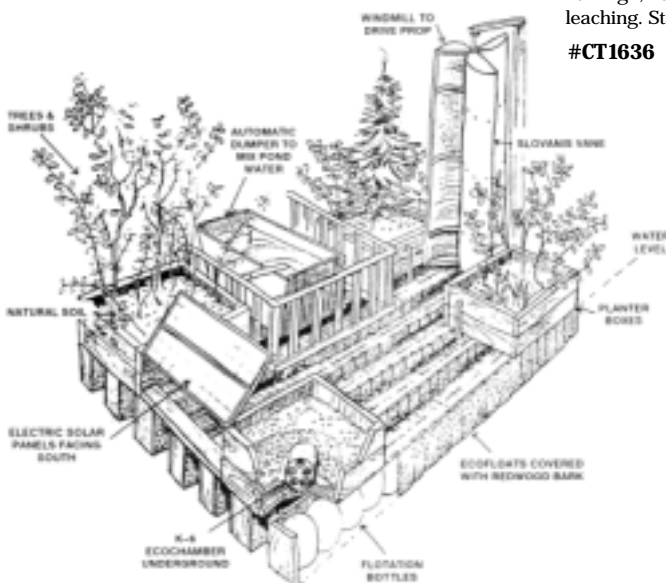

## EcoRaft

*A floating wildlife wetland*

Keep your pond clean and healthy with a wind- and solar-powered EcoRaft, a natural wetland filtering system. Microorganisms on decorticated redwood bark fibers attract larger insects and snails that decontaminate the pond, while trees and shrubs planted on the EcoRaft use up inorganic nutrients in the water. A wind-driven vane and a solar-powered pump stir up the water to speed biological activity, which in turn cleans the water. Each standard 12' x 12' EcoRaft equals about 300 feet of lake shoreline. Requires a minimum pond depth of three feet. Shipped in components, customized to site, price based on configuration and requirements.

**#CT7580 Customized to site**



Post Frame R-4.91



Crawl Space R-16.8

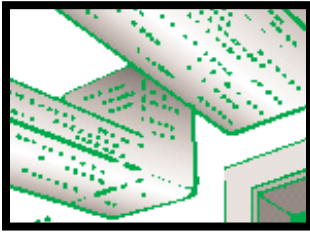

Duct Wrap w/Airspace R-5.6



Basement Walls R-6.13



Garage Door R-4

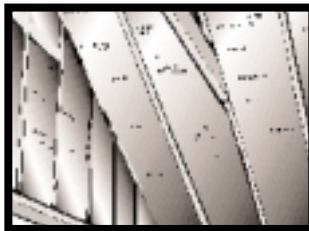

Attic



Spiral Pipe Wrap R-4

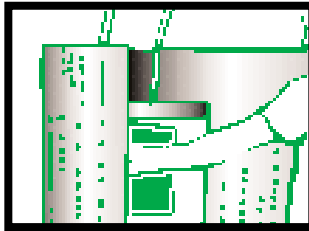

Water Heater Wrap R-4

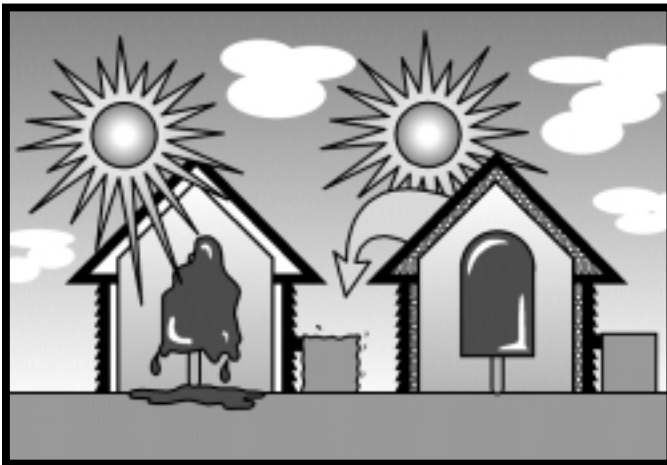

## Reflectix Insulation

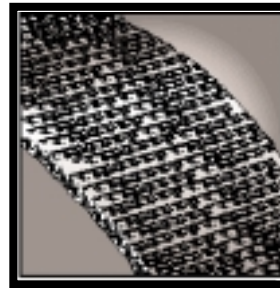

Does your building feel like an oven? Cool it down fast with Reflectix®! Stop radiation, the single biggest source of heat transfer. Often 75% of total heat transfer in buildings occurs through radiation. While mass insulation does little, Reflectix® stops up to 97%. This means huge savings in both heating and cooling costs. Reflectix® is also easy to install—just cut with scissors and staple or tape in place (no gloves necessary).

Perfect for installation in metal buildings or new wood frame structures. Just as good for adding insulation in attics, crawl spaces, walls, and even wrapping hot water heaters, water pipes and ducts.

Other uses include: Garage Doors • Auto Sun Shields • Sleeping Bag and Tent Mats • Survival Blankets • Covering Openings in Animal Shelters • Boot Liners

Other advantages: Clean • Non-toxic • Unaffected by moisture (Moisture reduces the bulk quality of fiberglass and converts it into a heat conductor instead of a heat barrier.) • Class A Fire Rating (No chemical agents needed for fire retardation, no special uniforms or tools needed for installation—work longer and faster in greater comfort.)

Seven layers of foil and bubble but still slim and trim at 5/16" thick.

Although Reflectix® gives the most benefit keeping buildings cool, it also helps to keep them warm during the winter. In a recent test by the University of Nevada, Reflectix® gave almost identical performance in stopping heat to R-19 fiberglass insulation. Optional staple tabs assist installation between studs and joints.



### Description

Description	Item #	Price
16" x 25' Staple Tab Insulation	#ES101	\$18
16" x 50' Staple Tab Insulation	#ES102	\$35
16" x 125' Staple Tab Insulation	#ES103	\$80
16" x 100' Standard Edge Insulation	#ES6507	\$68
24" x 25' Standard Edge Insulation	#ES104	\$28
24" x 50' Standard Edge Insulation	#ES105	\$52
24" x 125' Standard Edge Insulation	#ES106	\$120
48" x 25' Standard Edge Insulation	#ES107	\$55
48" x 50' Standard Edge Insulation	#ES108	\$106
48" x 100' Standard Edge Insulation	#ES6270	\$174
48" x 125' Standard Edge Insulation	#ES109	\$240
2" x 25' Spiral Pipe Wrap	#ES110	\$4
6" x 25' Linear Pipe Wrap	#ES100	\$9
12" x 25' Duct Wrap	#ES111	\$15
2" x 30' Foil Tape	#ES112	\$3
2" x 150' Foil Tape	#ES113	\$9.99

R-value measures conductive heat transfer and not radiant transfer. With 1" air spaces on both sides, Reflectix® has an R-value of 14.3 measuring heat coming in from the roof, 9.8 through walls, and 8.3 measuring heat rising upward.

## Tuff-Glass

The clearest, toughest, multi-purpose insulating film. The most cost effective way to insulate storm windows and doors. An easy and inexpensive way to quickly make a greenhouse or cold frame.

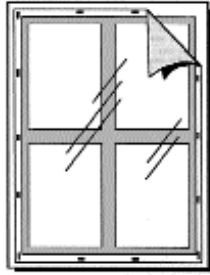

Fast temporary windows you can see through without distortion. Cover tables and furniture, carpets, hundreds of uses. Staple over your windows to lock out drafts. Keeps your house warmer in the winter and cooler in the summer. Pliable, easy to clean, reusable, 3-year warranty (12 mil). Both 8 and 12 mil have ultraviolet ray inhibitors that help block harmful UV rays and prolong the life of the film. So strong a large man can stand on a suspended section without tearing it.

4 mil 36"x 25'	#ES3690	\$20
4 mil 48"x 25'	#ES3691	\$24
4 mil 36" x 183'	#ES208	\$100
4 mil 48" x 138'	#ES209	\$100
8 mil 36"x 25'	#ES3692	\$32
8 mil 48"x 25'	#ES3693	\$40
8 mil 60"x 25'	#ES3694	\$69
8 mil 36" x 183'	#ES210	\$160
8 mil 48" x 138'	#ES211	\$160
12 mil 36"x 15'	#ES3695	\$39
12 mil 48"x 15'	#ES3696	\$52
12 mil 60"x 15'	#ES3697	\$71
12 mil 36" x 183'	#ES201	\$322
12 mil 48" x 138'	#ES203	\$322
12 mil 60" x 110'	#ES205	\$322
12 mil 72" x 106'	#ES207	\$400

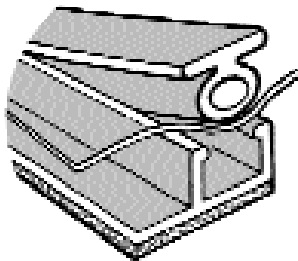

## Tuff-Track

*Do-it-yourself storm windows*

Make all your windows into "dual-pane glass" and eliminate drafts. This two-piece track turns Tuff-Glass into secure but easy to remove storm windows without eliminating visibility. Add insulating value during the winter and easily take down during the summer for extra ventilation.

3/4" x 48", white	#ES212	\$3
24-pack, white	#ES1726	\$60

## Tuff-Shade

A unique vinyl product that offers protection from harmful UV rays, insulates in both summer and winter, and helps protect windows from breaking. It blocks up to 53.5% of heat and 95% of UV rays—saves on air conditioning bills and prevents furniture from fading. The clearest film of this kind, it blocks heat and rays while maintaining the view. Easily applied, remove and reuse as needed. "Privacy" tint lets you see out but prevents view from outside to inside during the day. Use the "Bronze" tint for earth tone colored exteriors and "Gray" for all other colors. 10 mil, 5-year limited warranty.

24" x 7' Gray	#ES3676	\$15
24" x 7' Bronze	#ES3775	\$15
24" x 7' Privacy	#ES3776	\$16
36" x 7' Gray	#ES3677	\$21
36" x 7' Bronze	#ES3777	\$21
36" x 7' Privacy	#ES3778	\$23
48" x 7' Gray	#ES3678	\$28
48" x 7' Bronze	#ES3779	\$28
48" x 7' Privacy	#ES3780	\$31

Also available in bulk rolls for big projects.

36" x 183' Bronze	#ES1923	\$437
48" x 139' Bronze	#ES1924	\$440
36" x 183' Gray	#ES1925	\$437
48" x 139' Gray	#ES1926	\$440
36" x 183' Privacy	#ES3973	\$456
48" x 139' Privacy	#ES3972	\$454

## High Performance Windows Questionnaire

*The world's most energy efficient glass*

Use the same high tech glass installed around the world in museums, banks, and government buildings—affordable for residential applications now because you can buy directly from the manufacturer. The most energy-efficient glass in the world, you can have big windows without unwanted heat loss or gain.

Special "Heat Mirror" technology reflects heat back to its source—outside in summer and inside in winter (similar versions available for passive solar home systems). Glass also impacts comfort, overall design, HVAC design and loads, day lighting, condensation, ultraviolet fading and sound control—choosing the best glazing is one of the most important and far-reaching decisions for every architect and building owner. Available as standard or special complete windows, sliding glass doors, and unique applications. R-values to 7.1, 99.5% UV blocking, U-values to 9.0. Just tell us what you need or request a specification questionnaire.

#HM3493 \$1

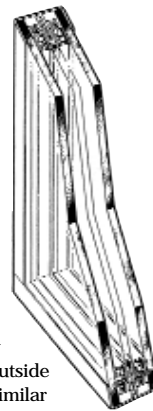

## Radiant Barrier

Flexible, easy-to-install, highly effective. Similar to standard Reflectix but without the bubble air space—most of the radiant protection without the R value. Great when the main concern is keeping a space cooler—reflects up to 97% of all radiant heat. Re-radiates only 3% of heat it comes in close contact with compared to 90% re-radiation of ordinary building materials. Reinforced 99% pure aluminum foil. Easy installation and low price make this an excellent energy saving choice.

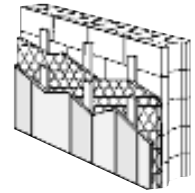

2" x 30' Foil Tape	#ES112	\$3
2" x 150' Foil Tape	#ES113	\$10
48" x 50' Eco Guard RBS Wrap	#ES114	\$40
48" x 125' Eco Guard RBS Wrap	#ES115	\$96

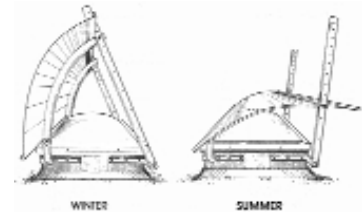

## Sunbender Reflector/Shade

The Sunbender Reflector/Shade is designed to fit any well built, sturdy curb mount skylight. During the heating season, it reflects from 100,000 to 200,000 extra BTU's per square foot of skylight into the building below. In the lowered summer position, it shades the skylight and greatly reduces heat gain, while still allowing light to enter. Built to withstand 30 lbs./sq.ft. of windloading and have a specially constructed fastening scheme to prevent rattling.

6'	#TM5072	\$389
8'	#TM5073	\$449
10'	#TM5074	\$599
12'	#TM5075	\$649

## Super-Therm

*Paint on Insulation!*

A combination of high performance resins that - although a fraction of the thickness - acts as effectively as 6 inches of batt insulation. Two ceramic layers reflect sunlight and radiant heat and a third ceramic compound helps stops heat and/or cold conduction. It cures completely to an extremely tough, non-yellowing water resistant coating that has the flexibility needed to withstand repeated expansions and contractions. Non Flammable with no toxic off-gassing, it reduces surface temperatures by half compared to dark asphalt shingles.



For best results paint both inner and outer surfaces.

#ES8020 \$109

# FANS AND SOLAR COOLING

## Thermofor

### Solar Vent Openers

Open greenhouse windows, sky lights, cold frames, or intake and exhaust vents. No electricity or any other power source required. They work on heat alone. Select a temperature between 55–85° for the window to open. It holds the window just where needed to maintain the desired temperature. Use the "Classic" for greenhouses and cold frames—it will open any hinged window up to 15 pounds a full 15". Strong return spring ensures windows close properly when it gets colder. The "Select" does the same thing up to 12" and works better on windows with screens (cylinder projects less than 2" back into the room—"Classic" 3–4"). The "Regal" has brackets for louvered windows found in RV's, roof vents, and some greenhouses. Add extra thermofors for larger, heavier windows.

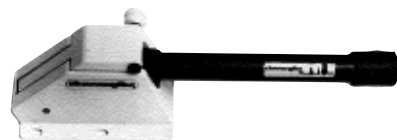

- Classic** #FC115 \$59
- Select** #FC116 \$69
- Regal** #FC117 \$56

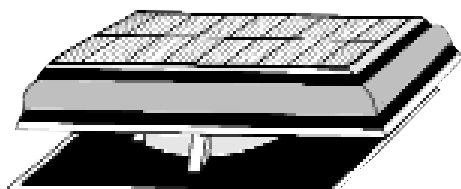

## Solar Jet Fans

Most efficient, highest quality. Only 4 watts on low speed and 6.5 watts on high. Tilts, swivels, and eas to mount. All plastic construction holds up in high humidity areas. Very quiet. Using 3 of these fans only uses 1 amp! 6" blades, 750 CFM. New 5" single speed uses 3 watts, 270 mA, 500 CFM.

- 5"** #FC101 \$39
- 6"** #FC100 \$84



## Sunvent

Extract 680 cu.ft. of air per hour from your RV, attic, boat, outhouse, greenhouse, or other too-hot place. Light shining on the solar cell starts a low-noise motor that regulates a multi-blade fan. Easy to install since no wiring or plugs required. Keeps water and back drafts out. Great for a battery room—the more batteries are likely to gas, the more air draws out. 8 1/2" diameter and requires a 4 3/4" mounting hole. Any wall thickness okay.

- #FC130 \$53**



## SolarTek

Automatic foundation vents. Simple and inexpensive device that prevents frozen pipes, termites, excess moisture, wood decay, molds, mildews, and fungus. It will also keep your home warmer in the winter and cooler in the summer. A bi-metal stainless steel coil automatically opens the vent at 72° and closes at 38°. Easy to install and high quality.

- #EP820 \$19**

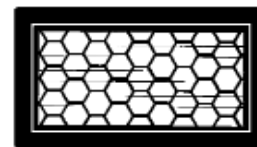

## 800 CFM Solar Roof Fans

Keep cooler in summer, warmer in winter. During summer months attic temperatures reach 150° F. This causes air to expand creating a pressure that forces hot currents down into living areas. Unlike AC powered fans that don't turn on until temperatures reach 104° or more, solar fans start during the early morning hours when the outside air is still cool. Preventative cooling. During winter months ventilation reduces the build-up of moisture. Keeping insulation dry maintains the R-value and keeps the house warmer. It also prevents mildew, cracking plaster, peeling paint, and roof damage. All this and nothing added to your utility bills! 10 watt solar module.

- For shingled, pitched roofs** #FC321 \$388
- For flat roofs** #FC322 \$388

## Solar Attic Gable Fan

Using less than 1 amp, blows over 1000 CFM. Less expensive and more efficient than our other solar vent fans. Smaller, lighter frame but easier to mount. Over 1000 CFM of fresh air ventilation with just one 10 watt solar panel or 12V battery, much more with 24V system. Optional temperature switch prevents fan from coming on during cool weather, adjustable thermostat for greenhouses, double pole/double throw switch reverses polarity to bring outside air in.

- 6"** #FC5992 \$100
- 12"** #FC127 \$140
- 16"** #FC129 \$155

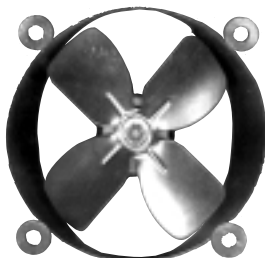

## Solar Attic Fan Kits

Quickly reduce attic temperatures up to 40° with these easy-to-install fan kits. For both AC and DC houses. Also great for greenhouses, storerooms, garages, and room air flow. Automatic operation without controls. 16" kit blows 1000 CFM in full sun and includes 18 watt solar module, 20" of wire, reversible, ball bearing PM motor, 16" three wing aluminum blade in 20" square steel venturi housing. 12" fan kit blows 550 CFM and includes 15 watt panel.

- 12" Fan Kit** #FC112 \$269
- 12" Fan only** #FC109 \$134
- 16" Fan Kit** #FC111 \$374
- 16" Fan only** #FC110 \$139
- Extra Motors** #FC5050 \$80

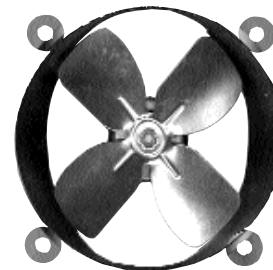

## Solar Powered Outhouse Fan

Fresh air from sunshine! Use your 12V system or a 9 watt solar panel and power this high RPM DC fan. Rubber and plastic covering protects from corrosive fumes. Easily mounts on 4" vent pipe and includes metal rain hood, mounting hardware, and protective rodent/pest screen.

- Fan and Cap only** #FC125 \$75
- With Solar Module** #FC126 \$179

## Vari Fan

42" diameter fan—4 or 5 blades

This fan uses only 0.4 amps—9.6 per 24-hour day! The secret is a special high torque permanent magnet motor. Works on 12 or 24 volts—turns at 80-90 RPM at 12V. Use a rheostat if operating 24V or more—higher voltage is much better for cooling. Made of durable molded ABS plastic, will not dent, scratch, or corrode. Easily painted to match your decor—comes in a matte black finish. Requires a wall switch. Comes with 5 blades but you can change to 4 blades. Motor design makes this fan unable to use a light kit.

#FC4876 \$196



## 44" 12V Ceiling Fan

Plain appearance but good, durable quality. In summer, a little air movement can make a hot room comfortable. This 3-blade, 44 inch fan runs on 12 or 24 volts, moves 11 cubic feet per minute of air at 12V. It draws just 48 watts so a small PV

panel can run it direct (battery pack required for 24 volt operation). Reversible for destratifying—blowing down warm air from the ceiling on cold days.

#FC3569 \$215



## Super Efficient AC Ceiling Fans

Cool things down fast with only .65 amp. Our DC ceiling fans work better for moving warm air down during the winter. Typical high air volume AC fans use too much power. These commercial, UL listed ceiling fans combine low power use with high CFM ratings. White only.

36" 1600 sq.ft., .65 amp, 12,500 CFM, 22 lbs.	#FC220	\$136
48" 2025 sq.ft., .85 amp, 3-speed pull chain	#FC221	\$170
56" 3800 sq.ft., 1 amp, 3-speed pull chain	#FC222	\$240
56" 3800 sq.ft., 1 amp, reversible	#FC223	\$240

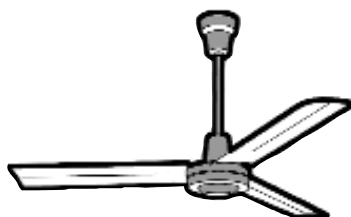

## DC Ceiling Fan

42" oak blades and brass hub

Top quality DC ceiling fan with 5-blades and notched shaft with internal threaded bolt. Uses 18 watts @ 13.5V

#FC6519 \$292

## Enviro-Fan

Water driven ceiling fan—no electricity required

Stop wiping the steam off your bathroom mirror after you shower. This clever product mounts like a standard bathroom exhaust fan, but doesn't use electricity. Instead, water passes through the fan's drive mechanism on the way to your shower head. You can also plumb this fan into the water circuit that fills your toilet tank, so it starts venting after you flush. No matter how you use it, the fan needs at least 30 psi of water pressure and 12 liters per minute of water flow. Needs at least 3 GPM.

#FC4333 \$75



## The Chiller

Natural gas or propane air conditioning—High efficiency without ozone damaging CFC's. Send for free flyer with technical details and specifications.

3 Ton Chiller #FC505 \$4,200

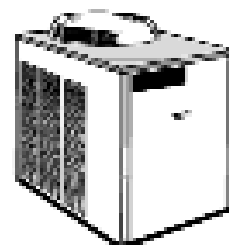

## 12-24 Voltage Doubler

Run fans, motors and pumps at higher RPM. Many ceiling fans, motors and water pumps use 24V. They still work fine in 12V systems but you lose RPM's, which translates into less air movement with a fan and less water with a pump. Our DC ceiling fans work great in the winter for moving warm air down. With this handy new converter, you can also effectively use it for keeping cooler in the summer. The less expensive model is either on or off, the adjustable one lets you fine-tune the speed. Comes mounted on switch plate. 2 amps at 24V.

On-Off only, 2A	#IN1795	\$72
Adjustable, 2A	#IN1796	\$140
On-Off only, 7.5A	#IN6008	\$130
Adjustable, 7.5A	#IN6009	\$225

## Super Efficient Speed Control

Will control up to 3 fans—larger versions and 220V available.

#FC3291 \$36

## DC Variable-Speed Fan Control

All-in-one control provides on/off, full range speed control plus a forward/reverse switch. Adjusts 2 amp fans from ultra slow to full speed. 97% efficient. Mounted on ivory wall plate for easy installation in standard wall box. Includes installation components.

#FC909 \$47

## DC Thermostats

Turn fans on and off as temperatures change. Attic thermostat adjusts to turn fans on between 90-130° F and off after temperature drops. Up to 10 amps at 12 or 24V.

#FC911 \$33



## 12V Windmaker

Low amp draw, high air flow and cooling! With just .3.9 amps, 3670 CFM on the low setting, .08 amps, 2000 CFM. Light weight, quiet, direction-adjustable - this fan has it all! Includes alligator clips for easy connection to a 12V battery.

#FC9117 \$200

## Convair Prestige 900

CFC-free air conditioner uses only 90 watts! Evaporative air conditioners use the cooling power of water to keep your brain cells alert and happy on sweltering days. Portable so you don't have to use a window or make a hole in your wall. 3-speed fan control, oscillating action and attractive pedestal stand. 15 liter (4 gallon) reservoir with built-in level indicator. Cools a room 12-15 sq. meters (120-150 square feet). The drier the air, the better it works (not recommended for humid climates). 1026mm (40 1/4") H (on stand), 615mm (24 1/4") W, 298mm (12") 120 VAC. 3370 BTU/hr.

#FC1417 \$360



## Ecofan Self-Powered Stove Fan

- Increases wood stove's efficiency
- Enhances warm air circulation
- Generates its own energy
- Fan speed automatically varies with temperature
- Ultra-quiet operation

Thermoelectric module powers a 100 CFM fan that circulates warm air throughout a room. No need for an external power source. Fan speed varies automatically with the stove temperature. Ultra quiet, 1-year warranty, made in Canada.

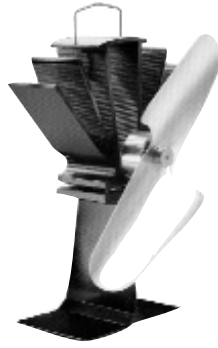

Ecofan #FC4993 \$99

## MiniMax Battery Powered Portable Fan

Lots of cooling in a little package. Folded, it's less than 6" x 6" x 4", unfold for a powerful and efficient DC powered fan that moves a good flow of air at low speed, a torrent on high. With just four D cell alkaline batteries, it runs for up to 500 hours on low speed, up to 70 hours on high. You can also plug into a wall socket with common 6 volt adapter or 6 volt solar cell (neither included). Runs nearly silently with a finger safe blade—it won't cut even at high speed operation. One year warranty.



MiniMax #FC5823 \$17

## Ultimate 12V Fan

A powerful fan that plugs right into a cigarette lighter. 7" fan blade moves a lot of air, yet is soft and finger safe. Includes a suction cup and screw mount bases. Pivot the head up and down or swivel it sideways to aim the air in just the right direction. Perfect as a dashboard fan or in a solar cabin or house. Easy on your batteries, draws just .59 amps. 1 year warranty.



12V Fan #FC5824 \$32

## 12V Air Movement Fans

Small computer fans. Great for moving warm air from a woodstove down long hallways or into cold rooms. Mount close to where you want it warmer or need more air flow. Out of many choices, these are the most efficient. Ours feature ball bearings for long life.

- Micro 1 watts, 11.6 CFM,**  
**2.38" x 2.38" x 1" #FC1170 \$9**  
**Small 6.8 watts, 90 CFM,**  
**4.68" x 4.68" x 1" #FC1171 \$24**  
**Large 7.2 watts, 95 CFM,**  
**4.68" x 4.68" x 1.5" #FC1172 \$28**



## 12V Table Fan

Sits on a table or mounts on a wall. Moves a good amount of air but only draws 1.2 amps on low setting and 2 amps on high. Oscillates or locks into one position with the flick of a switch. It's noisy on the high setting, though. 8" blades.

#FC404 \$38

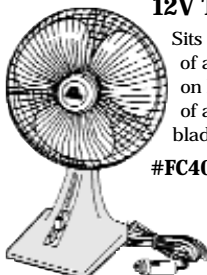

## AutoVent Turbo

No more burning leather seats and stuffy hot cars. The Autovent Turbo is an easy and secure way to ventilate a parked car. A solar powered fan extracts dank air and leaves a cooler fresher interior. Fits over the edge of the front or back window, comes with special fittings to adapt to any car.



#FC6801 \$29

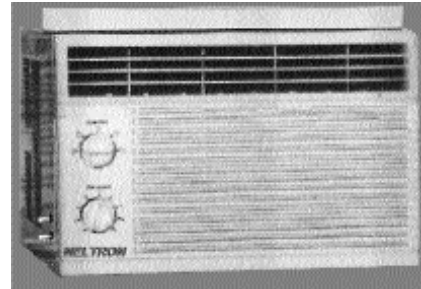

## DC Air Conditioner

Off-The-Grid in a climate too humid for evaporative cooling? Finally an air conditioner that works on DC! 1/2 Ton, 6000 BTUs of real cooling. Wall or window mounting, 2 fans and cooling speeds, an alarm sounds to warn of low battery voltage. Adjustable louvers let you send the air where you need it. 480 watts. 40 amps at 12volts. 24 and 48 volt models also available. 12.25" x 19" x 15.25"

#FC7000 \$1,495

## Global Warming

Greenhouse gases (chlorofluorocarbons, carbon dioxide, methane, nitrous oxide, etc.) let heat in but stop it from going back out—like a windshield in a parked car.

At our current rate of creating these gases by industry, cars and burning fossil fuels, scientists predict a temperature increase of 4–9° F by 2050. (9°F separates today's average temperatures from the last ice age.)

The United Nations Panel on Climate Change recommends that we immediately cut our use of fossil fuels by at least half. To prevent the current rate from increasing, we would have to cut by 60%.

This same panel projects that by 2050 over a million more people will die each year from malaria because of higher mosquito populations due to global warming. Already, mosquitoes bearing yellow and dengue fever are found over 3000' higher than their normal range in South America.

Other predicted results of global warming include expanding deserts, forest fires, heat waves, crop failure, erosion, mud slides, mass extinction of plants and animals, sea level increases causing flooding and damage to coastal aquifers.



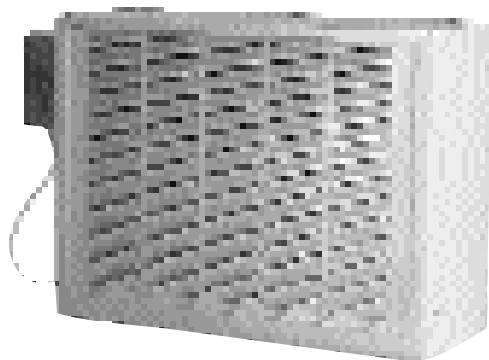

## “Solar Chill”

### Solar-Powered Evaporative Coolers

Solar Chills now come with both “Energy Saving” and “High Performance” models—you can more exactly match the cooler to your application. The new clean out pump and wind up mechanical timer make maintenance a breeze, just turn the lever and the water in the pan pumps out to your favorite plants. The customized control boxes provide a convenient place for optional thermostats, clean out timer, rheostat, pump switch, main switch, and reverse/exhaust switch. Solar panel sold separately.

#### How Solar Chills Work

Like bread and butter, solar power and cooling complement each other—the more intense the sun shines, the more cooling power generates. Each gallon of water evaporated gives almost 16,000 BTU of cooling and you can evaporate 1–7 gallons each hour. You can cool down a 110° room to 75°.

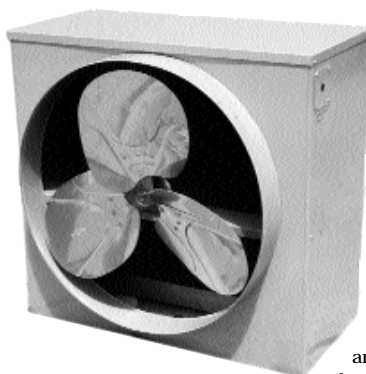

#### What Size Do I Need?

On average, you can multiply the square footage of the space you want to cool times 2 for a required CFM number. (2000 sq.ft. house multiplied by 2 = 4000 CFM evaporative cooler.) In hotter climates, though, use a larger size.

#### Cooling Tips and Strategies:

- Eliminate duct work whenever possible and direct discharge into the cooled space when possible
- Use a thermostat to save unneeded run time
- Blow cool air into living areas and discharge through bedrooms
- Use bleed-off or batch-drain systems to minimize mineral build-ups.
- Dry out pad daily

16"	12V, 20W	1250 CFM	#FC1949	\$700
20"	12V, 41W	2500 CFM	#FC1950	\$748
12"	24V, 68W	1450 CFM	#FC1952	\$658
20"	24V, 69W	2500 CFM	#FC1953	\$748
30" High Performance	24V, 80W	5200 CFM	#FC1954	\$1,115
12"	12V, 18W	850 CFM	#FC3436	\$658
12" High Performance	12V, 31W	1100 CFM	#FC3437	\$683
16" High Performance	12V, 25W	1600 CFM	#FC3438	\$725
20"	12V, 49W	2800 CFM	#FC3439	\$790
16"	24V, 60W	1950 CFM	#FC3440	\$705
22"	12V, 37W	2900 CFM	#FC6035	\$875
22"	24V, 61W	2600 CFM	#FC6036	\$886
22" Energy Saver	12V, 21W	1700 CFM	#FC6037	\$898
22" High Performance	12V, 53W	3500 CFM	#FC6039	\$898
30" Energy Saver	12V, 24W	3200 CFM	#FC6040	\$1,065
30"	12V, 75W	1700 CFM	#FC6041	\$1,065
Variable Speed Rheostat			#FC3435	\$70

## Dual Kool

### World's lowest energy using cooler

Evaporative cooling for RV's, boats, cars, tents and small rooms at a fraction of typical air conditioning energy costs. Cools hot dry air as much as 35°F but uses only 18 or 24 watts at 12V. Connect to DC battery, cigarette lighter receptacle, or solar module. Lightweight and portable—use for camping and backpacking (weighs just 2 lbs./3 for large size). Doubles as a good humidifier. 11–15V DC, 200 CFM/300 CFM, 1.6A/2A, 12" H x 12" L x 9"/15" W. Uses 1–1 1/2 quarts of water per hour (Tri Kool uses 1 1/2–2 quarts). Warranty: 5 years on highest efficiency CelDek pad, 1 year on everything else.

Dual Kool	#FC3432	\$282
Tri Kool	#FC3433	\$328
115V Adapter for Kar Kool	#FC3434	\$22



## Solar Water Heating: A History

Solar water heating has a long, rich history with proven cost-effectiveness and economic viability. In today's world of decreasing energy resources and increasing energy-related pollution, we need to use solar water heating more and more. From the 1st century A.D., almost all of the famous Roman Baths used the sun to help in the heating process. Some, like the Baths of Diocletian served thousands of Romans every day. They used large, south-facing windows, indoor sand to absorb the heat, and simple solar collectors made by filling a pit with broken pottery and covering it with a black floor surface made from lime, ashes, and dark sand. By the 4th century, the heated bath water was recycled and the baths helped heat adjacent rooms. In 1767 a French-Swiss scientist (Horace de Saussure) experimented with a glass covered "Hot Box", one of the first ancestors to modern solar collectors.

Clarence Kemp combined this idea with the common practice of putting black water tanks in the sun and patented the first U.S. commercial solar water heater in 1891. It was called the Climax, sold for \$25, and saved the average homeowner \$9 a year. By 1900, there were over 1600 Climax installations in southern California and more in other states. 1909 saw the first copper "flat plate" collector and by 1920 sales by just one of the manufacturers was topping 1000 systems per year. Estimates of solar water systems installed in Miami, FL between 1935 and 1941 go up to 60,000 and over half the Miami population used solar heated water. Between 1957 and 1967, Israel installed almost 50,000 solar systems on their own land as well as exporting systems to 60 other countries. During a similar time, 40,000 solar systems went up in Australia. By 1969, there were 3.7 million solar water systems in Japan saving 50 million tons of fuel each year. The lure of cheap fossil fuels and more convenience, however, seduced homeowners to electric systems as the solar industry in Japan died out.

In the U.S. during the 1930's and 1940's, gas and electric companies fought back against this non-sellable energy source. Gas companies dropped their prices 75%, offered free installation, discounted prices, and gave easy terms on gas water heaters. Electric companies did much the same and also gave builders special incentives for installing electric water heaters.

The pay-back time for solar increased from 4 to 8 years and most people switched to gas or electric. Ironically, if these people would have looked further than the 8 years and invested the subsequent savings, their heirs would be millionaires today.

Millions of systems in numerous countries for over 100 years prove the effectiveness of solar water heating. History shows solar's popularity going up and down based on competition from gas and electric energy sources. Today, perhaps as no time in solar's long, illustrious history, the competitive advantage far surpasses any other choice.

— Statistics from *The Golden Thread* by Butti & Perlin

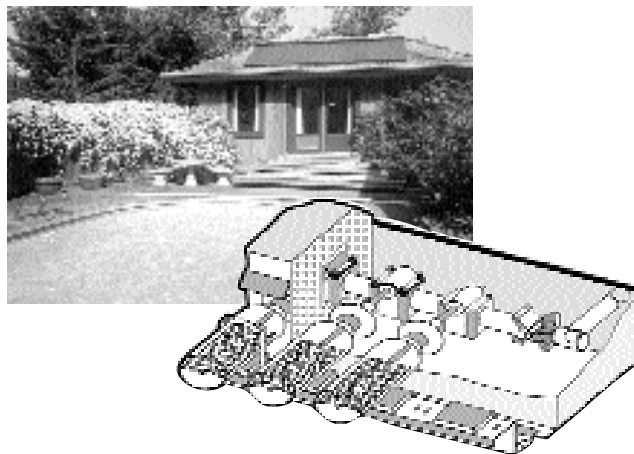

## Thermomax Solar Collectors

*70% of domestic hot water in worst case climates*

When US tax credits stopped, most companies went out of business. New research & development almost completely stopped. In Europe, progress continued and Thermomax emerged as a world leader in solar heating technology. Over 2 million solar tubes are now in daily use at over 60,000 locations in 40+ countries. Thermomax was recently granted internationally recognized ISO 9001 and ISO 9002 accreditations, and has also received nine major international awards. Provides 100% of domestic hot water in good solar areas. Converts twice the energy of a good quality flat plate collector with exceptional performance in cloudy and cold weather. So light and modular one person can install, it pays for itself many times over. (Return on investment generally 5-10%.) Annually saves the equivalent pollution of one automobile. Great for central heating and swimming pools. Small home system includes 20 Thermomax tubes, manifold, roof mount, valves, pump, control, expansion tank with safety relief, control circuits, etc. Medium size has 30 tubes. Please call for design and sizing help. Twenty tube system (small home) 56" x 77", 30 tube (medium home) 78" x 84".

<b>Small Home/Cabin System with low use</b>	<b>#HW1544</b>	<b>\$2,450</b>
<b>Off-Grid Version</b>	<b>#HW1547</b>	<b>\$2,600</b>
<b>Medium Size Home, full time</b>	<b>#HW1548</b>	<b>\$3,120</b>
<b>Off-Grid Version</b>	<b>#HW1549</b>	<b>\$3,470</b>
<b>Replacement Collector Tube</b>	<b>#HW621</b>	<b>\$74</b>
<b>Crating Fee</b>	<b>#HW3347</b>	<b>\$150</b>

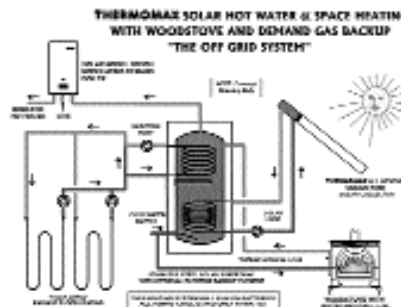
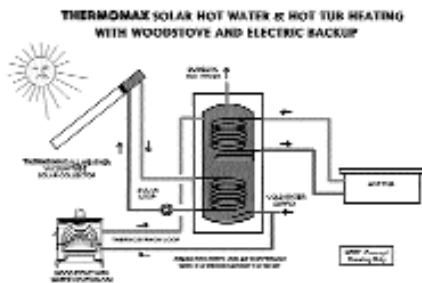
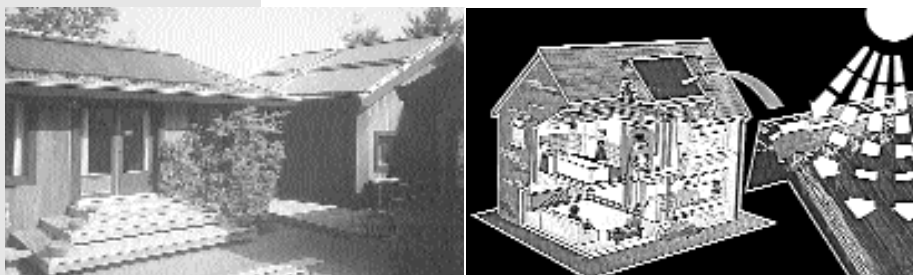

## Sunbather Water Heaters

Eliminate most or all of your water heating costs with this easy-to-install, passive solar batch collector. Sunlight passes through two tempered glass plates then heats a black chrome-coated storage tank. An insulated cabinet and dual glazing keep the water hot. The heated water then goes into a backup water heater or directly to point of use. Mount on ground or roof—no pumps, electricity or moving parts to wear out. Easy to install, just 2 connections—cold water in and hot water out. Best for warm climates, preheating water, summer only in cold places, or when hot water needed only in afternoons & evenings. 40 gallon tank.. 26" x 36" x 78", 150 lbs. Specify if plumbing is on east or west side when ordering.

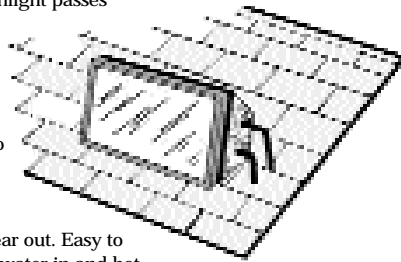

#HW1356 \$1,050

## AquaStat

Turn pumps or fans on or off as temperatures change. Mainly used for solar water or air heating systems, also good for greenhouses and applications when you need a specific temperature range. Models available to control from -30 to 120°. Available with clamp on connection or 8' coils with remote sensor. No power required. Please describe application with order.

#SH3349 \$68

## No-Burst 100

Antifreeze without high toxicity—perfect for protecting your hydronic or solar heating system. Uses Propylene Glycol—safe for systems where there's potential contact with potable water. Use at full strength for -50° F. protection, dilute with 25% water for -35° or 50/50 for -10°. Intended for sealed systems operating at less than 275°. One gallon. Order #SH5323 for a package of test strips to determine concentration of No Burst.

#SH5322 \$19



## Used Liquid Solar Collectors

These maintained and pressure tested solar collectors have low iron tempered glass with copper waterways in an insulated enclosure. Availability varies—call for current specs.

<b>3' x 6' Liquid Collector</b>	<b>#HW3565</b>	<b>\$150</b>
<b>3' x 8' Liquid Collector</b>	<b>#HW3566</b>	<b>\$166</b>
<b>4' x 8' Liquid Collector</b>	<b>#HW3567</b>	<b>\$215</b>
<b>4' x 10' Liquid Collector</b>	<b>#HW3568</b>	<b>\$290</b>

## Solar Heater Control Package

*Installing solar water? We've done the hard part for you!*

Includes mounted controller, sensors, pump, 2 gallon expansion tank, check valve, pressure gauge, drain-fill assembly and separate air vent, pressure relief valve, and 2 sensors. Mounted on a plywood board, pre-plumbed and ready to install! Options available for larger systems.

#HW1722 \$697.40

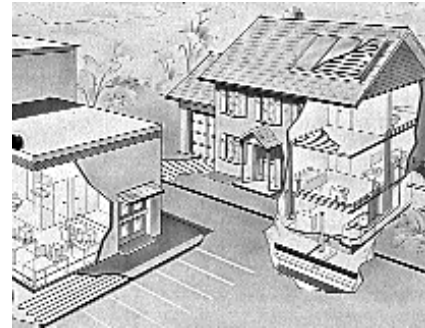

## Solar Thermal Pipe

*Make your own solar collector!*

Very popular in Israel, this is the least expensive quality way to heat your water. (You could also just use black plastic pipe but it won't last long and lots of nasties will get into the water.) This special Kitec collection tube is designed for outdoor water heating and has UV inhibitors, an aluminum oxygen barrier and four layers. The 1/2" holds 1.025 gallons per 100' and needs a 6" diameter to make a loop back. The 5/8" holds 1.54 gallons per 100' and takes 8" to make a turn. Black.

<b>1/2" x 600'</b>	<b>#HW3085</b>	<b>\$480</b>
<b>5/8" x 400'</b>	<b>#HW3086</b>	<b>\$525</b>
<b>Kitec SS Cutting Tool</b>	<b>#SH3088</b>	<b>\$32</b>
<b>Beveling Tool</b>	<b>#SH3087</b>	<b>\$14</b>
<b>1/2" Repair Coupling</b>	<b>#SH3090</b>	<b>\$9</b>
<b>5/8" Repair Coupling</b>	<b>#SH3016</b>	<b>\$12</b>
<b>3-Loop Kitec 1/2" Manifold</b>	<b>#SH2992</b>	<b>\$96</b>
<b>3-Loop Kitec 5/8" Manifold</b>	<b>#SH3096</b>	<b>\$115</b>
<b>1/2" x 1/2" MPT Adapter</b>	<b>#SH3091</b>	<b>\$6</b>
<b>5/8" x 1/2" MPT Adapter</b>	<b>#SH3092</b>	<b>\$7</b>
<b>5/8" x 3/4" MPT Adapter</b>	<b>#SH3015</b>	<b>\$7</b>
<b>1/2" x 1/2" Copper Sweat Adapter</b>	<b>#SH3083</b>	<b>\$7</b>
<b>5/8" x 5/8" Copper Sweat Adapter</b>	<b>#SH3095</b>	<b>\$10</b>
<b>1/2" x 1/2" Copper Sweat Adapter</b>	<b>#SH3093</b>	<b>\$7</b>
<b>5/8" x 5/8" Copper Sweat Adapter</b>	<b>#SH3094</b>	<b>\$10</b>

## Heliotrope Solar Sidebar

**Fully solarize your solar water system.**

Use a small PV module and eliminate freeze-up possibility caused by 115 vac pump/controller error. You no longer need an AC-powered circulation pump, controller or heat exchanger in your solar water heating system! Solar Sidebar installs on the side of any electric water heater, (at the bottom drain connection), and provides a safe, reliable, 12V drain down system. Monitor performance with the digital thermometer and flow rate indicators. Can't freeze up in cold weather. Takes less than 1/3 the normally required power—just the included 10W PV panel. Special monitors make it fun to watch your system as the sun moves across the sky—a flow meter indicates the amount of water moving through your system, and a temperature monitor with LCD displays water temperature in your storage tank and in the water returning from your collectors. (Use with flat plate thermal collectors from 24 to 96 square feet.) Heliotrope has confidence in their controllers: they've made over a half-million of them since 1974 and give a 10-year warranty.

#HW1852 \$1,312



## Aqua Star/Bosch Tankless Water Heaters

Instant energy savings and endless hot water. Ideal to back up a solar water heating system in cloudy weather, the Aqua Star gives a boost to water temperatures, or stands alone to provide all your hot water needs—automatically. Aqua Star uses the best materials, tests each unit 5 times before it leaves the factory, and even has a 15-year full warranty on the heat exchanger. A consumer magazine survey recently ranked Aqua Star first in tankless heaters. Easy to install—just mount on a wall, vent, and light. Bosch recently bought the Aqua Star company and brings new models including one designed for hydronic space heating and improved features like a lower psi minimum of only 15 and a lower flow requirement of only 1/2 GPM. The 125X uses 2 “D” cell batteries that turn the unit off and on with water pressure. This eliminates the standing pilot—no wasted propane or natural gas use! The Aqua Star is limited to one major application at a time.

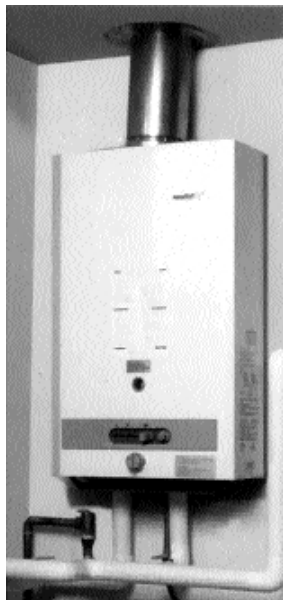

<b>Model 125X</b>	<b>LP</b>	<b>#HW5049</b>	<b>\$699</b>	<b>NG</b>	<b>#HW5531</b>	<b>\$699</b>
<b>Model 38 B</b>	<b>LP</b>	<b>#HW102</b>	<b>\$359</b>	<b>NG</b>	<b>#HW1964</b>	<b>\$359</b>
<b>Model 125 B</b>	<b>LP</b>	<b>#HW105</b>	<b>\$599</b>	<b>NG</b>	<b>#HW1385</b>	<b>\$599</b>
<b>Model 125 B Solar</b>	<b>LP</b>	<b>#HW106</b>	<b>\$649</b>	<b>NG</b>	<b>#HW1386</b>	<b>\$649</b>
<b>Model 125 BL (recirculating)</b>	<b>LP</b>	<b>#HW1962</b>	<b>\$614</b>	<b>NG</b>	<b>#HW1963</b>	<b>\$614</b>

## Aqua Star Sizing Guide

Usage/Appliance	Model 38	Model 125
Venting requirement	3"	5"
One sink (1 GPM)	yes	yes
Two sinks (2 GPM)	no	yes
Shower	1 GPM	3 GPM yes
Two showers (same time)	no	no
Bath tub	no	yes
Washing machine	no	yes
Dishwasher	no	yes
Whirlpool bath	no	yes

## COMPARISON CHART

	AQUASTAR TANKLESS WATER HEATER	TANK WATER HEATER
LIMITLESS HOT WATER	Yes	No
LIFE OF UNIT	20+ years	2-10 years
ENERGY USAGE	Only when you need it	On/off all the time
EFFICIENCY	82% always	80% first year and then decreases as the heater ages
WARRANTY	15 years on heat exchange. 2 years on parts.	5 or 10 year warranty (price options)
LEAKING POTENTIAL	None	Inevitable
ENERGY FACTOR	.69-.80	0.59 (average)

## Tankless Water Heaters

Cut your bills in half with a tankless propane or natural gas water heater. You'll never run out of hot water again! Conventional water heaters keep a tank of water hot night and day—whether you're using it or not. The tankless heater goes on only when you want hot water and since it heats the water so fast, a whole crowd can shower, and the last person will have as much hot water as the first. This efficiency means a tankless water heater can pay for itself in two years. Water heaters are the second biggest user of

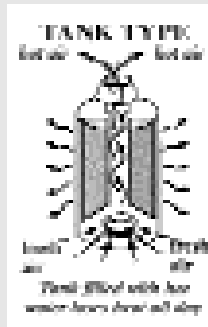

energy in a typical home and one of the most effective places to slash energy costs. You can save hundreds of dollars each year by replacing a tank type water heater with a tankless, on-demand unit. While you have to replace tank-type heaters every few years, tankless heaters last a lifetime—even more savings!

### Conventional Tank Heaters:

- Waste costly fuel by keeping water constantly heated when not needed
- Erratic water temperature—hot turning to warm changing to cold
- 1-2 hour wait for more hot water after tank used
- Average water heater only lasts 5-8 years
- Much higher fuel bills

Model	BTUs	GPM*	GPM**	GPM***	Cost
AS 38	30,000	.95	.75	1.2	\$334
PH-6	43,800	1.2	.8	1.4	\$484
PH-12	89,300	2.3	1.6	2.85	\$895
AS 125	125,000	3.25	2.11	3.8	\$579
PH-24	178,500	4.5	3.2	5.7	\$1,295

\*@70° \*\*@90° \*\*\*@50° temperature rises

## Power Venting

Venting tankless water heaters out walls, horizontally, requires a power vent kit.. 120 vac required.

#HW250 \$295

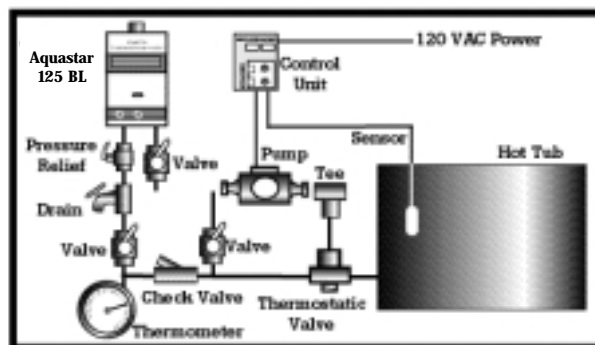

- Up to 20 units together 5,000,000 BTU's
- Automatic water valves
- Saves space
- Electronic ignition, no standing pilot light
- Saves more than 45% on utility costs
- Replaces inefficient boilers
- Computerized safety devices
- Indoor & Outdoor Models
- Save Money with endless Hot water
- Each unit can provide over 200 gallons of hot water every hour
- Outdoor installation for mild climates
- Indoor installation
- Indoor/Outdoor wall hanging
- Endless Hot water
- Space Saving - 60 pounds and 2.2 cubic feet
- Energy Savings - only burns gas when you need hot water
- Safety Controls - computer monitored safety devices
- Quality - the best quality material for durability and long life, unlike storage tanks which are designed to eventually rust and be thrown away.

## Takagi Mobius

Huge evolution in home and commercial tankless water heater technology. A unit that fits in anywhere - from the smallest home to the largest commercial building. Connect up to 20 units together for up to 6000 gallons per hour @ a 100°F rise. With high thermal efficiency, Mobius uses much less fuel than traditional systems, it's quieter, safer and more cost effective than any other water heater on the market today. Use a single Mobius unit, or link multiple units together for unlimited hot water - instantly! Safety features include an overheat cutoff switch, hi-limit and temperature sensor, computer controlled gas valves and freeze protection. The only product of its kind to receive SAQMD (Southern California Air Quality Management District) approval for its low emissions. From single family homes to high-rises, Mobius provides a solution. For large commercial use, such as hotels or industrial plants, Mobius replaces inefficient boilers with customized flow and temperature control. Only the best materials used - all copper and brass water ways, stainless steel burners and rust resistant epoxy powder coating. Built to last!

<b>LP (propane)</b>	<b>HW8799</b>	<b>\$2,100</b>
<b>natural gas</b>	<b>HW8799</b>	<b>\$2,100</b>
<b>remote display/ temperature control</b>	<b>HW8803</b>	<b>\$374</b>
<b>multiple unit controller</b>	<b>HW8804</b>	<b>\$1,196</b>
<b>Exhaust Backflow prevention kit</b>	<b>HW8806</b>	<b>\$49</b>

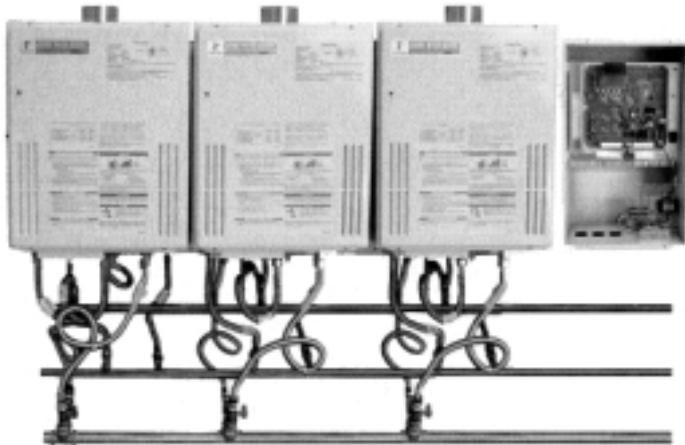

## Takagi TK-1

### Takagi Demand Water Heaters

Need more hot water than the Aquastar 125? The T-K1 fits the bill. Up to 5 gpm of endless hot water. Install indoors or out. Electronic ignition means no wasteful pilot light. Built in power venting solves vertical venting nightmares and uses only 0.8 amp @120vac. Small enough to ship UPS. These two features save you money over the Aquastar 170.

<b>TK-1 NG</b>	<b>#HW6884</b>	<b>\$999</b>
<b>TK-1 LP</b>	<b>#HW6888</b>	<b>\$999</b>
<b>Vent Terminator</b>	<b>#HW6885</b>	<b>\$89</b>
<b>Wall Hanging Kit</b>	<b>#HW6886</b>	<b>\$24</b>



## Paloma Tankless Water Heaters

### Quality and energy-saving demand water heaters

The recent "Asian financial crisis" led to a lower cost for the made-in-Japan Paloma water heaters. AquaStar has more features like automatic thermostat and models for solar-heated water, but Palomas have stronger housing, a more narrow body, and the PH6 is the least expensive demand water heater capable of heating a shower. In cold climates though, the water won't be very hot unless you also use a super low flow showerhead like our #WS3066 Aqua Helix.

<b>PH-6</b>	<b>#HW201</b>	<b>\$484</b>
<b>PH-12</b>	<b>#HW202</b>	<b>\$895</b>
<b>PH-24 (LP)</b>	<b>#HW204</b>	<b>\$1,295</b>
<b>PH-24 (NG)</b>	<b>#HW4347</b>	<b>\$1,295</b>

## Paloma

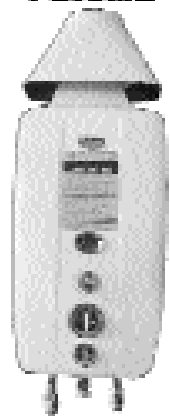



## Chofu Wood Water Heater

This heater combines high-tech manufacturing with elegance of design. Operates just like any wood stove. Made specifically for hot tubs by Chofu, Japan's leading hot bath company. Built to exacting standards of quality and efficiency. The Chofu utilizes a sophisticated water jacket system that surrounds the firebox. Fire is also directed through a baffle chamber for maximum heat exchange, 9 sq. ft. of heat transfer surface. The Chofu heats a 250-gallon tub from 55F to 105F in 3 hours. Made of 20-gauge stainless steel. Circulates water without a pump by thermo-siphon, needs no electricity. Uses 17" wood, 4" chimney pipe. Includes 1-1/2" diameter inlet and outlet pipes and thru-wall hot tub ports for easy hook-up. Drain plug for freeze protection. Secondary combustion at smoke-outlet reduces emissions. 55 lbs., 17 x 18 x 24 inches.

The Chofu can be used to retrofit wood hot tubs, spas, or do-it-yourself tubs. The majority of our customers use a metal or plastic stock tank to make an inexpensive hot tub. Conversion manual available upon request.

NOTE: Both wood-fired and propane heaters include hot tub ports for 1/2" or less tub wall thickness. You must order long-shank thru-port for wood hot tubs.

<b>Chofu Wood Water Heater</b>	<b>#HW350</b>	<b>\$660</b>
<b>Long thru-wall port (for walls more than 1/2")</b>	<b>#HW3655</b>	<b>\$36</b>
<b>S.S. Stove Pipe (24")</b>	<b>#HW6972</b>	<b>\$28</b>

## Chofu LP Outdoor Hot Tub Heater

*Quick and automatic outdoor hot tub heating without electricity*

Circulates water by thermosiphon, needs no pump or electricity. Temperature controlled by a manual set timer, remote control mounts onto tub. 36,000 BTU's heats a 250 gallon tub from 55° F to 105° F in only 2.5 hours. Weather resistant cowl, direct vents without chimney. Includes 1-1/2" diameter inlet and outlet pipes, and thru-wall hot tub ports for easy hook-up. Connects to any hot tub. 18 lbs., 17x14"x9". Freeze drain necessary for use in cold climates.



<b>Heater</b>	<b>#HW6973</b>	<b>\$632</b>
<b>Freeze Drain</b>	<b>#HW6974</b>	<b>\$40</b>
<b>Long thru-wall port</b>	<b>#HW6972</b>	<b>\$28</b>

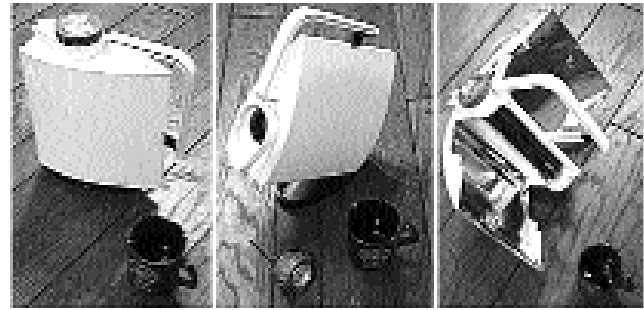

## Solar Thermos

*Boiling water in minutes*

Using the same advanced technology as the new solar thermal systems, our Solar Thermos solar water boiler and thermos jug provides enough boiling hot water for two cups of tea. Just slide out the stainless steel parabolic wings, point toward the sun and heat water even on overcast days. Includes thermometer, adjustable stand to get the best solar angle, carrying handle, and pour spout. Slides and folds into a compact 10" x 11.5" x 4" and only weighs 2 lbs.

**#HW8290 \$120**

## Sunda 3

Pre-heat incoming cold water to 25c during winter months and up to 92c in summer months. The Sunda 3 system comes in sets of 4 evacuated tubes.

Each tube has an inner stainless steel flask tested to 10 bar pressure. The surface area of that flask is coated with a selective coating using a sputtering method. The manifold at the top of the 4 tubes allows incoming water at mains pressure to enter each flask through a 12 mm tube, which runs the whole length of the flask. As a tap/ faucet is opened the incoming cold water travels down the 4 12 mm internal pipes to the bottom and pushes the heated hot water from the top, out through the manifold to where hot water is required at mains pressure. To extend the volume of water in the 4 tubes, a temperature mixing valve is set at about 30c. In Britain our incoming cold water for 6 months of the year is around 5-6c 42f as it takes at least 3 months of direct sunshine hitting the ground before the ground 2 meters down starts to warm up. In the summer time from end of may to October the incoming water temperature is about 12c - 54f

**#HW7811 \$2,000**



## Store heat during the day and keep warm at night

If you live in a cold place with good sun, you can accomplish passive solar heating marvels with Sun-Lite water tubes. Mount behind a sunny window for heat gain during the day that slowly dissipates back into your house at night. Or make an "active" system in your attic by adding a blower, glazing, and moveable shutter. Also great for greenhouses. Add dyes to color the space and increase solar absorption up to 35%. Largest size great for aquaculture, greywater systems, or water storage.

**#SH401 \$89**

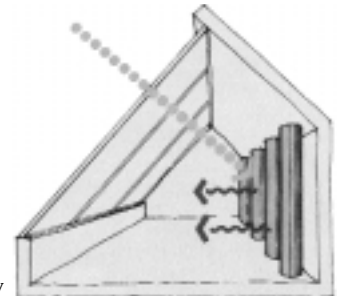

## Nippa Sauna Stoves

### Woodburning or gas saunas

For over 2000 years, saunas have been a way of life in Finland. Finns brought this tradition to America in 1638 when they settled in Delaware and started making these Sauna Stoves in 1930. All Nippa wood burning Sauna Stoves have cast grates and doors, a scoop-type ash pan, 6" flue, and hold 125-150 lbs. of rock. The 18" model heats rooms up to 8' x 8', the 22" heats rooms 8' x 12', and the 24" heats rooms 12' x 15'.



A \$175 Firing Extension option lets you put wood in the stove from outside the sauna room. An \$125 water tank option heats water very quickly and works great when you don't have a nearby shower. The gas stoves have an automatic thermostat and extension for drawing combustion air from outside the sauna room. Specify natural gas or propane or wood.

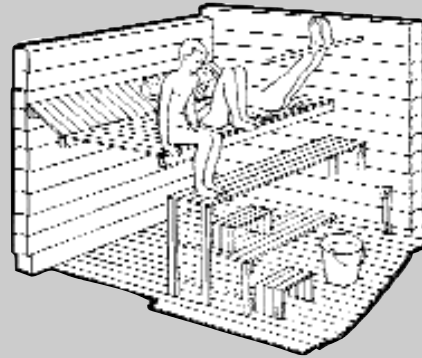

<b>18" Wood</b>	<b>#HW370</b>	<b>\$555</b>
<b>22" Wood</b>	<b>#HW371</b>	<b>\$630</b>
<b>22" Wood with Extension</b>	<b>#HW6521</b>	<b>\$815</b>
<b>24" Wood</b>	<b>#HW372</b>	<b>\$698</b>
<b>24" Wood with Extension</b>	<b>#HW6522</b>	<b>\$883</b>
<b>Firing Extension</b>	<b>#HW375</b>	<b>\$100</b>
<b>Water Jacket</b>	<b>#HW376</b>	<b>\$95</b>
<b>18" Gas</b>	<b>#HW373</b>	<b>\$1,150</b>
<b>22" Gas</b>	<b>#HW374</b>	<b>\$1,250</b>

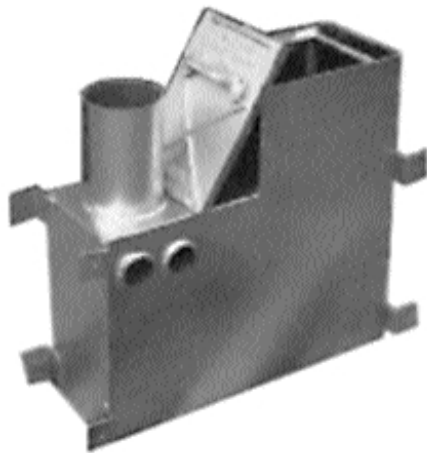

## "Scuba" & "Snorkel" Wood-Fired Hot Tub Stoves

A Snorkel stove raises the temperature of a 5' diameter, 4' deep hot tub 33° per hour. An 85,000 BTU gas heater only does 20°/hour and a 12kW electric heater only 9°/hour. Your hot tub will be ready in just 1-2 hours (Scuba takes twice as long). As easy to operate as a fireplace or woodstove. No need for the complicated pumps, motors, and plumbing in gas and electric systems. Snorkels are more efficient and faster heating than our Chofu heater but also take up more space in the hot tub. In general, the Chofu is better for small hot tubs (350 gallons or less) and the Snorkel is better for larger tubs.

<b>Scuba Wood-Fired Hot Tub Stove</b>	<b>#HW360</b>	<b>\$490</b>
<b>Snorkel Wood-Fired Hot Tub Stove</b>	<b>#HW361</b>	<b>\$680</b>

## Woodfired Water Heaters

Abundant hot water from a wood stove. Heat your house and hot water at the same time! Enough hot water for domestic use or hydronic in-the-floor space heating. Built to last a lifetime from heavy rolled steel. Thermostat and big fire box permits large fillings of wood for 12 to 15 hours of controlled heat.

**#HW5095 \$795**



## Woodfired Water Heater w/Stainless Steel Water Coils:

95,000 BTU for space heating 78,000 BTU's for Hot water single coil, recovery time for Domestic Hot Water.

**#HW5096 \$850**



## Woodfired Water Heater/Furnace

Woodfired Forced Air Furnace For Air Heating!

Could outfit with DHW coil, HW5103, 105,000 Btu's for space heating. EPA Approved

**#HW5097 \$920**

## Woodfired Water Heater/Boiler

137,000 BTU for Hot Water, three coils, two sides, one on top, for fast recovery time, needed for Hydronic heating systems. Can be hooked directly into existing boiler system. EPA Approved

**#HW5098 \$1,250**

## The Sauna

*History, Health and How-To*

All you ever wanted to know about the history and benefits of the sauna. Includes step by step instructions for building two styles of sauna. 197 pages, soft cover.

**#BK1865 \$20**



# WOODSTOVES

## Wood Cookstoves

### Camping and emergency wood heating and cookstoves

Inexpensive cooking, baking, water and space heating—in the woods, during a power outage, or to keep in store for possible emergencies. Light and portable but airtight efficiency, strong and durable design. The special air cooled bottom almost impossible to burn through—the entire stove guaranteed against burn-through for three years. Intended for outdoor use. Made from galvanized steel and approved by the US Forest Service.

### The Sidekick

The most packable size—13" x 10" x 22" and weighs only 18 lbs. but a full accessory kit (14 lbs.) including a 3 gallon water tank, large shelf and four 4" x 20" pipe sections fit inside.

**Sidekick** #WA5932 \$159  
**Sidekick Accessories** #WA5996 \$84

### Wrangler

Heats a large tent, cooks for a small group, holds a fire for 6–8 hours yet only weighs 26 lbs. 16" x 13" x 26". An 18 lb. optional accessory kit fits inside and includes a 6 gallon water tank, extra large shelf and four 5" x 24" pipe sections

**Wrangler** #WA5936 \$209  
**Wrangler Accessories** #WA5997 \$111

### Little Amigo

A light weight (12 lb) stove, small shelf, and 5' of 4" pipe

#WA6176 \$129

## Chuckwagon Warming Oven

Hangs on the side of a stove or goes right on top for the best baking. Air pocket bottom prevents scorching. 12" x 9" x 5", 5 lbs.

**Chuckwagon** #WA5938 \$72

## Combo Cookstove w/Oven

Includes the Wrangler stove, an 18 lb. 13" x 18" x 13" chimney oven, 5 gallon water tank, two shelves, and 6' of pipe. The oven breaks down into a small package but gets up to 500° and can even cook a turkey. 59.5 lbs. total.

**Combo** #WA5937 \$540  
**Chimney Oven only** #WA5998 \$219



**Combo cookstove with oven**

# WOODSTOVE ACCESSORIES

## Non-Electric Woodstove Fan

Not a misprint; our handcrafted Free-Breeze piston fan (14" diameter) uses no electricity or fuel other than the hot air from your woodstove—just set it on stovetop, and it spins! Steel, copper and wood construction. Your choice of black, grey or blue (please specify).

#FC3258

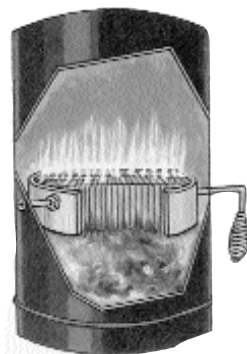

## Miracle Heat

### Stovepipe catalytic combustors

Burn the smoke that normally goes up the chimney and reduce creosote and pollutants by as much as 80%. Increases heat output by up to 30%. Use less firewood and dramatically increase "burn time" from each load of wood. Install horizontally or vertically.

**6"** #WA122 \$164  
**8"** #WA123 \$188

## Vacu-Stack Chimney Stack

Prevent downdraft and back-puffing from your woodstove or fireplace while providing protection from snow, rain, animals, and debris. Stainless steel chimney cap with special spherical design creates a venturi effect that increases chimney draft and protects the flue against flow reversal regardless of wind direction. Deflects wind around the Vacu-Stack even when it blows downward. Proven effective in thousands of installations.

For Masonry & Round Class-A Pipe		For Double- & Triple-Wall Air-Cooled Chimneys	
6"	#WA130	6"	#WA136
7"	#WA131	7"	#WA137
8"	#WA132	8"	#WA138
10"	#WA133	9"	#WA140
6" x 10"	#WA134	10"	#WA139
Masonry Adapters (specify size)		#WA135	

## Flamex Gloves

### For the perfect fire in your woodstove or fireplace

With these fire gloves you reach right into your woodstove or fireplace, pick up burning logs, and arrange them into the best burning locations. 100% heavy weight leather, lined with insulating felt, and with a big 5.5" gauntlet, they give maximum protection without the bulky stiffness of many similar gloves—flexible even after repeated heat exposure.

#WA100 \$29





## Decentralize your Space Heating

The average U.S. home uses 57.3% of its annual energy budget for space heating—much more in colder climates and during the winter. Heating with electricity, of course, wastes the most energy. Solar hydronic, sunspaces and solar closets work the best but could cost too much and be impractical for retrofitting or if you're renting. While gas or oil central furnaces offer more general efficiency, they often heat rooms that no one uses, greatly lowering their over-all efficiency. Zone heaters give extremely high efficiency and heat only the spaces you need heated.



### Vented vs. Unvented Gas Heaters: which is best for you?

Vented heaters cost more but use outside air for combustion, reducing cold drafts and preserving fresh indoor air. Unvented heaters are more efficient and easier to install, but they consume oxygen from your indoor air. All of our unvented models have a safety feature which turns the heater off if indoor oxygen levels drop below safe levels. Unvented heaters less than 10,000 BTU are approved for sleeping rooms, under 5,000 are approved for bathrooms. Larger sizes not recommended for sleeping rooms.



### Eco-Therm Direct Vent

Decentralize your heating for huge energy savings. No electricity required. Only heat the rooms you use—up to an 800 sq.ft. space. Uses outside air for combustion and vents directly out a wall. Doesn't create drafts and easy to install—no need for vent pipe or holes in your roof. Built-in thermostat and Piezo ignitor—no need for matches. Enameled long-life heat exchanger and stainless steel burner.

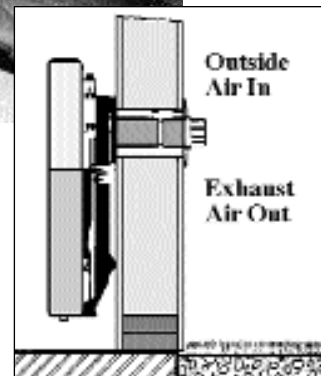

#### Features:

- Enameled long-life heat exchanger • Piezo ignitor—no need for a match
- Built-in thermostat • Safety thermocouple • No electricity required
- Modulating gas valve • Stainless steel burner

## DIRECT VENT HEATERS

### Cozy Direct Vent Wall Furnaces

*More heating capacity for larger spaces*

No electricity required but enough heating capacity for more than a 2000 square foot home. Easily mounts on any outside wall and takes a minimum of space. Draws combustion air from outside and includes a complete out-the-wall vent assembly. Thermostat mounts on separate wall for less cycling. Louvered cabinet design maximizes airflow to provide even temperatures from floor to ceiling.

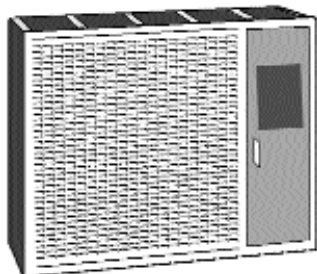

BTU's	Fuel	Item #	Price	Shipping Wt
15,000 BTU	LP	#SH390	\$612	70 lbs
	NG	#SH393	\$618	70 lbs
25,000 BTU	LP	#SH391	\$742	115 lbs
	NG	#SH394	\$748	115 lbs
33,000 BTU	LP	#SH392	\$798	115 lbs
	NG	#SH395	\$798	115 lbs
Adjustable "Night" Thermostat		#SH396	\$89	

Cat installation →

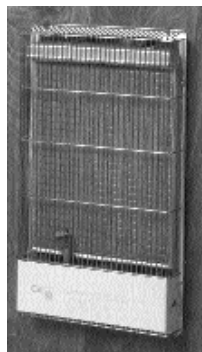
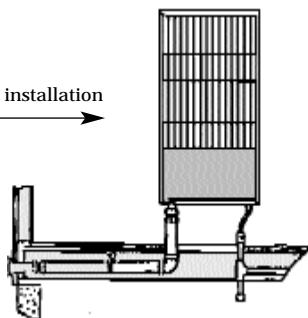

### The Cat Vented Catalytic Heater

Catalytic heaters directly warm people and objects before heating air. This saves tremendous amounts of energy—you don't have to heat the air that rises to the highest points of our ceiling first. This cuts heating bills up to 40%. Just set the wall thermostat and the electronic ignition (110 vac or 12 volt DC) turns the heat on and off automatically. With a woodstove, the CAT makes efficient heat for cold back bedrooms or bathrooms, or keeps you from freezing while you get the fire started. Super efficient. Only uses 30 watt hours per night. Flame-free and AGA approved. DC 6000 BTU, AC 5,200 BTU.

DC Model	#SH300	\$438
AC Model	#SH301	\$463

BTU's	Fuel	Item #	Price	Shipping Wt
5,600 BTU	LP	#SH241	\$449	33 lbs
	NG	#SH243	\$420	33 lbs
8,400 BTU	LP	#SH242	\$522	42 lbs
	NG	#SH244	\$499	42 lbs
14,000 BTU	LP	#SH240	\$469	52 lbs
	NG	#SH245	\$538	52 lbs

	SH240/245	SH242/244	SH241/243
Input BTU/hr (max)	14,000	8,400	5,600
Output BTU/hr (max)	10,690	6,400	4,200
Input BTU/hr (min)	6,000	3,800	2,312
Output BTU/hr (min)	4,286	2,890	1,734
Direct Vent flue size	43/4"	39/16"	39/16"
Max wall thickness	12"	12"	12"
Min clearances Floor: 4-3/4" Side Wall: 4" Rear: 0" Ceiling: 36"			

## Solar Showers

*Hot water anywhere!*

Just fill with water, hang in the sun, and take a nice warm shower. Portable, lightweight, and folds compactly for easy storage. Heats water to 110° with three hours of sunshine on a 70° day. 5 gallon size holds enough water for 4-5 showers. Heavy duty 5 gallon much more durable. 8 gallon doubles as a storage tank. 6 gallon Safari includes a strong shoulder strap and adjustable buckle. Special insulator prevents heat loss through the back, faster and hotter heating. Solo great for backpacking, only 3.5 oz. Inflatable enclosure less than 4 lbs.

### Heavy-Duty 5 Gallon

#HW704	\$15	
8 Gallon	#HW701	\$34
Enclosure	#HW702	\$32
6 Gallon Safari	#HW705	\$32
3 Liter Solo	#HW706	\$12



## 12V Bedwarmers

Better than electric blankets, bedwarmers fit the mattress and provide quick, even, efficient heat. Automatically adjusts for changes in room temperature. Direct current doesn't have the electro-magnetic problems associated with AC power. Uses 5-7 amps. 2-year warranty.

Bunk 24" x 60"	#SH100	\$75
Twin 36" x 60"	#SH101	\$72.40
Three-Quarter 46" x 60"	#SH102	\$79
Full 54" x 60"	#SH103	\$91.90
Queen 60" x 60"	#SH104	\$103.70
Seat/Back 18" x 20"	#SH108	\$64.70

## Super SunShower

*5-, 15- and 25-minute adjustable solar showers*

Continuous hot water for luxurious outdoor showers or large groups—just connect your garden hose. 7.5' solar collector tube, hot/cold mixing valve on included stand. 5 gallon size lasts 5-6 minutes. Guaranteed against freezing.

5 Gallon	#HW766	\$240
10 Gallon add-on	#HW767	\$145

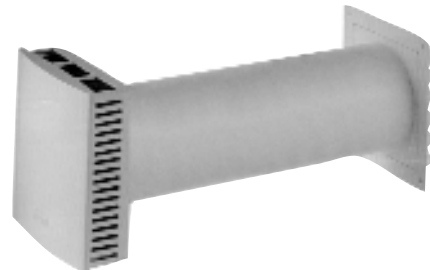
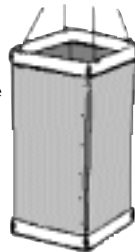

## Midnight Sun Heater

"Thermophotovoltaics"—quite a mouthful. Simply stated, it's PV that makes power from infrared radiation - heat. Combine that panel with a gas heater and you can heat the room while making electricity. Midnight Sun uses LP gas, produces 25,000 BTU of heat and 100 watts of power. Charge a 12 volt battery at 8 amps while heating the room. In 12 hours, you've burned 3 gallons of LP while putting 100 amp-hours into storage. Made from stainless steel, brass, and aluminum—looks great in your living room.

#SH6374 \$2,850

## Air Supply Ventilator

*Breathe a little easier!*

Well-insulated, energy efficient homes normally don't supply enough intake air for gas appliances and woodstoves. This causes sluggish draft, backdrafting, lingering odors, sweating windows, smoky fireplaces, and generally poor performance. This easy-to-install Air Supply Ventilator ensures venting performance as well as fresher indoor air. It solves problems from dampness, molds, dangerous contaminant build-ups. Included filter quickly washes and takes out dust particles larger than 10 microns. Long-life optional pollen filter takes out 90% of pollutants over 5 microns. Electrically charged High Tec filters particles over 1/2 micron and removes hydrocarbons from car exhausts, asbestos—even viruses and bacteria.

Air Supply Ventilator	#AP3034	\$59
Replacement Dust Filter	#AP3035	\$3
Storm Shield (for high wind areas)	#AP3038	\$45
High Tec Filter	#AP3037	\$16
Pollen Filter	#AP3036	\$8

*"Thank you so much for helping all of us down here in Mexico! You always seem to come through on what we order."*

*- Mike Imus, NTM Mexico*

## Solar Forced Air Heaters

A single 2' x 4' heating panel equipped with the standard 50 cfm, 110 vac 40 watt fan warms an average room (12' x 15') by about 10-15 degrees per hour - about a 35 to 45 degrees during sunny midday heating. By constantly solar heating a room during the day, you'll lower your heating costs by 50% or more. (Well-insulated spaces stay hotter and retain heat for a longer period of time.) Compare the \$1.50 per month or less to operate one of these, to an electric 1300 Watt space heater that consumes \$20 to \$25 per month. By coupling an additional solar heating panel, the output temperatures will raise by an additional 30 degrees F or more. Lightweight, unbreakable, and easy to set up and use. Mount outdoors or indoors



inside a large window. Two 3" flexible air ducts mount on the back of the 2-1/2" thick box, extract cold air and return warm air back into the space.

Includes a clear polycarbonate plastic insert with two vent holes to place in windows for sending air from outside to inside. Most installations easy to do yourself. A smaller 12V, 5 watt fan powers the 2' X 2' forced air heat collector. (Power by optional solar electric panels, a rechargeable battery, or 120 vac house current.) Raise the temperature inside your RV, boat, tent, or camper by 40 to 50 degrees or more during sunny, midday heating periods. Higher altitudes or near-snow use increase temperature gains.

#SH8426 2' x 4' \$360

#SH8427 2' x 2' \$196

## Sun Mate

Mount on a south wall and heat 150 sq.ft.

Channels cool air through an absorber plate that heats and circulates it back into a room. Built-in thermostat regulates temperature and turns the blower on and off. Easy to install and efficient—only uses 14 watts! 4" x 24" x 48", 30 lbs. Add \$35 for crating.

#SH550 \$430



## 24V DC Telestats

Solar thermal/irrigation/hydronics—with only DC!

In the past, doing a solar thermal, hydronic, or timed irrigation system meant getting an inverter and greatly lowering efficiency. Our new valves with 24V DC actuators called telestats make up a completely DC "zone valve". Chrome plated brass suitable for closed systems or potable water, available in 1/2", 3/4", and 1" sizes with solder or threaded pipe connectors. Optionally available as angled bodies like radiator valves.

**3/4" NPT angle RA2000 valve body and ABNR telestat 24V DC, 3 watt, Cv = 2.7 (good for 1 -> 5 GPM typically)**

#SH3009 \$129

**3/4" NPT straight RA2000 valve body and ABNR telestat 24V DC, 3 watt, Cv = 2.7 (good for 1 -> 5 GPM typically)**

#SH3011 \$142

**3/4" NPT straight RA2000 valve body and ABNR telestat 24V DC, 3 watt, Cv = 5.9 (good for 3 -> 8 GPM typically)**

#SH3012 \$166

**1" NPT straight VMT valve body and ABNV-NC telestat 24V DC, 3 watt, Cv = 9.4 (good for 7 -> 14 GPM)**

#SH3013 \$215

## Solar Heating + Ventilation Cooling

A new type of affordable all-year solar system for both heating and ventilating your home! A revolutionary air-type solar system that supplements both your heating and cooling, taking a healthy bite out of your winter fuel and summer electricity bills. The patented AutoVent™ Control, a two-valve, four-port air-handler, selects from four operating modes - Recirculation Solar Heating, Direct Solar Heating, Ventilation Cooling, and Cool Air Conservation. You get efficient solar heating in cold weather, whole-room ventilation in warm weather, and cool air conservation in hot weather (this automates the house-shutting strategy used by conservation-minded homeowners).



The AutoVent control senses inside and outside temperature and adapts automatically. Compatible with A/C, the system ventilates on demand in comfortable weather, but conserves cool air in hot weather, while positively protecting the collector. The system's Transorber™ Selective Matrix™ Solar Absorber has 55 times the surface area of a flat plate absorber, providing 72% ASHRAE efficiency. Two models save up to 55/70 gallons of heating oil, or up to 120/150 kWh of electricity per year. The all-in-one module installs through window or wall, leaving your roof intact. Use multiple modules for larger requirements. Comes with quiet 14 Watt AC fan, available with PV panel and DC fan for off-grid (O/G) operation. The collector and connecting manifold are shipped separately, assembled by user, then mounted. Brackets are included.

PC20 (46 x 64, 20.4 ft.) #SH6386 \$1,190

O/G #SH7205 \$1,465

PC25 (46 x 80, 25.5 ft.) #SH7204 \$1,400

O/G #SH7206 \$1,684

## Solar Hot-Air Panels

### Air Collectors

Simple and reliable, solar air collector systems give a quick cost payback in energy savings

while providing years of safe, clean, solar heated warmth. Depending on climate and building construction, a 4' x 8' solar air collector provides 25 to 50% of the heat needed for a 400 to 800 sq. ft. space. Use insulated flex duct to bring cold air from the floor up to the collectors and your system doubles as a destratifying ceiling fan. Use a separate blower, control and ducting system for each 32 to 64 sq. ft. of collector area. Packaged kits include one or two 4' x 8' collectors, blowers, backdraft dampers, line voltage thermostats, and snap disc controllers. Installation kit includes 50' of 6" insulated flex duct, 2 roof jacks, cold and hot air boots, grill, register, galvanized weatherproofing and elbows. Mounting kits have all the hardware necessary for roof mounting (specify pitch and location).



**Air Collector Mounting Kit** #SH3572 \$132

**Air Collector 362 CFM Blowers** #SH3573 \$148

**Air Collector 488 CFM Blowers** #SH3574 \$164

**Air Collector 176 CFM 12V Blowers** #SH3575 \$76

**Sun Aire 4' x 8' Collector** #SH3561 \$520

**Sun Aire 4' x 12' Collector** #SH3562 \$836

**Air Collector Kit w/Blower & Controls** #SH3563 \$624

**Dual Air Collector Kit** #SH3564 \$825

**Air Collector Installation Kit** #SH3571 \$190

Installation kit includes 50' of 6" insulated flex duct, 2 roof jacks, cold and hot air boots, grill, register, galvanized weatherproofing and elbows.

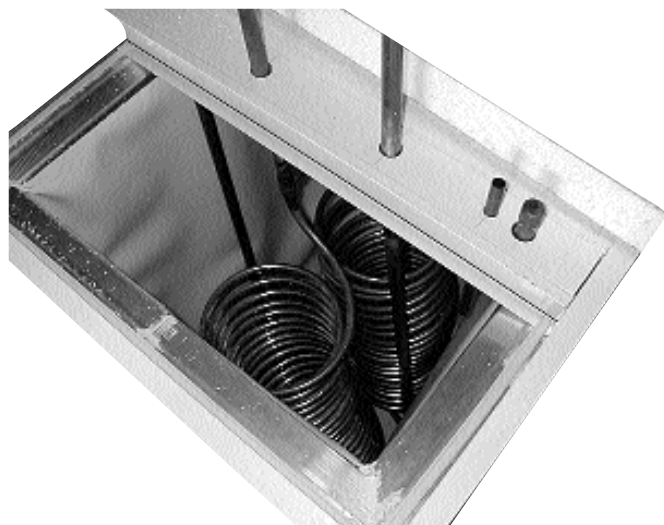

## Integrated Solar Water Heating Systems

Rather than trying to assemble a complete system from components, you can save many head aches, assure the best quality and reliability with these convenient, ready to install systems. Designed and tested by engineers, they come with everything you need. Choose with standard AC pumps and controllers or with a PV panel and DC pump. AC retrofit kits run off house current and include a SRS Water Storage tank, a new Independent Energy™ GL-30 controller sensors, necessary tubing, [2] 4' x 10' collectors and an AC pump(s).

AC 120 gal	2-4x8'	#HW8478	\$3972
AC 120 gal	2-4x10'	#HW8479	\$4,370
AC 210 gal	3-4x8'	#HW8480	\$5,240
AC 210 gal	3-4x10'	#HW8481	\$5,836
AC 320 gal	5-4x8'	#HW8482	\$7,673
AC 320 gal	5-4x10'	#HW8483	\$8,667
AC 425 gal	7-4x8'	#HW8484	\$10,587
AC 425 gal	7-4x10'	#HW8485	\$11,980
AC 640 gal	10-4x8'	#HW8486	\$14,055
AC 640 gal	10-4x10'	#HW8487	\$16,044
DC 120 gal	2-4x8'	#HW8488	\$4,688
DC 120 gal	2-4x10'	#HW8489	\$5,085
DC 210 gal	3-4x8'	#HW8490	\$5,955
DC 210 gal	3-4x10'	#HW8491	\$6,552
DC 320 gal	5-4x8'	#HW8492	\$8,389
DC 320 gal	5-4x10'	#HW8493	\$9,383
DC 425 gal	7-4x8'	#HW8494	\$12,027
DC 425 gal	7-4x10'	#HW8495	\$13,419
DC 640 gal	10-4x8'	#HW8496	\$15,495
DC 640 gal	10-4x10'	#HW8497	\$17,484

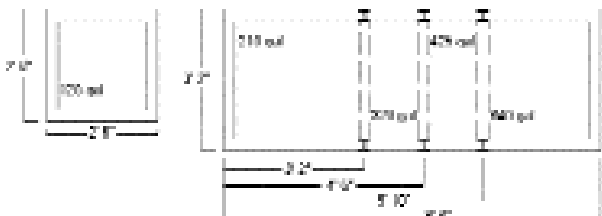

## Six Rivers Solar Storage Tanks

Designed by engineers with 21 years of solar installation and solar servicing experience, these tanks and systems were tested and refined in real world applications for more than 15 years. These ruggedly designed tanks form the core of our modern "Drainback" solar water systems and will provide decades of dependable service. With a variety of standard sizes and the capability to construct custom tanks, these components make ideal replacement tanks for converting older systems to drainback technologies or original equipment for new systems as shown above. Use the 120-gallon model for most typical homes, the larger models for large homes and commercial/institutional use as well as integral radiant floor heating systems. Super high quality tanks backed up with a limited 20-year warranty.

120 gal	Single Coil Heat Exchange Tank	#HW8467	\$1,641
120 gal	Twin Coil Heat Exchange Tank	#HW8468	\$1,973
210 gal	Single Coil Heat Exchange Tank	#HW8469	\$1,994
210 gal	Twin Coil Heat Exchange Tank	#HW8471	\$2,326
320 gal	Single Coil Heat Exchange Tank	#HW8472	\$2,592
320 gal	Twin Coil Heat Exchange Tank	#HW8473	\$2,924
425 gal	Single Coil Heat Exchange Tank	#HW8474	\$3,471
425 gal	Twin Coil Heat Exchange Tank	#HW8475	\$3,803
640 gal	Single Coil Heat Exchange Tank	#HW8476	\$4,174
640 gal	Twin Coil Heat Exchange Tank	#HW8477	\$4,506

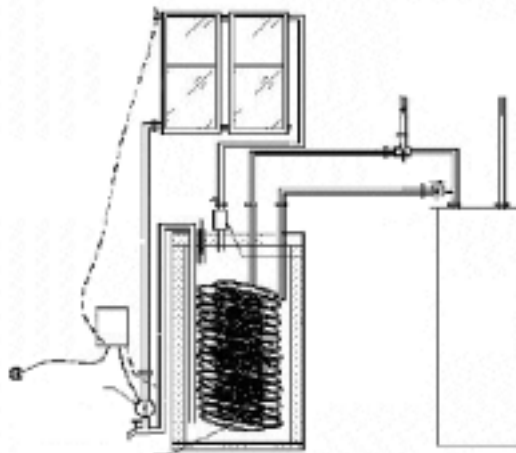

## Photoelectric Smoke Detectors

1 hour faster, less false alarms and no radioactive material!

Most home smoke alarms contain americium 241--a highly toxic radioactive material that causes cancer if inhaled or ingested and takes thousands of years to decay. These detectors work much better without radioactive parts. They detect smoke from smoldering fires up to an hour faster while staying less sensitive to humidity & cooking smoke--less annoying false alarms.

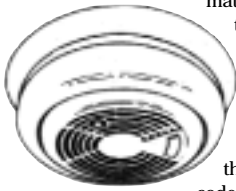

Hardwire the 120V AC and 12V models or just mount the 9V model. 120V w/ back-up required for building codes in many places.

**120V w/9V Back-Up** #WA910 \$59  
**9V** #WA907 \$32

## Trifield Meters

Find the "hot spots" in your home, office or community--then take steps to avoid long term exposure to high electromagnetic pollution. Trifield meters monitor the levels of electrical, magnetic and microwave radiation. Two scales measure extra low frequency fields (ELF), a second measures ELF/VLF, and another Radiowave/Microwave radiation. Takes measurements in all three axis directions while giving a true total field reading. Indicates if "safe", "borderline" or "high" range.



**Meter** #EP940 \$195  
**Meter rental** #EP941 \$25

## AIM Carbon Monoxide Detector

Protect yourself and your family from fatal carbon monoxide poisoning. The self-powered AIM carbon monoxide detector uses an electrochemical sensor and features a digital display with unique memory capabilities. Levels of CO instantly display with a push of the test button, use historical data to detect the peak, and fluctuating levels of CO exposure. Automatic daily self-testing assures reliability of the sensing mechanism. Approved by the IAS, the principal regulating agency in the US for residential and commercial gas appliances.

#EP6712 \$45



## Microwave Leakage Detector

Avoid dangerous microwave radiation which has been shown to cause birth defects, cancer, pacemaker interference and other ailments with this simple hand held device. Unit gives digital readings of amount of leakage and sounds alarm when above danger threshold. Uses 9v battery, not included.

#EP947 \$66



## Home Composter

Install anywhere and easily recycle your organic kitchen waste into a wonderful fertilizer! Fast, odorless, and convenient, the Home Composter transforms messy food scraps into a nutrient-rich, organic peat moss fertilizer and some "compost tea". Designed to fit in a cabinet space the size of a dishwasher but just as easy to put in a laundry room, basement, garage, or outside on a porch or backyard. Also good for boats, RV's, cabins, and office lunch rooms. Easy to operate--just add the supplied "compost sure" and "microbe mix", warm water and kitchen scraps--you're ready for regular use. A small fan vents like a conventional dryer and assures quick evaporation with no odor. Does not require electricity for outside use but composting rates slow with colder temperatures. Sized for 6 people full time use, 20+ in an office lunch room.



#EP6893 \$360

## Kitchen Compost Crock

*Attractive compost holder with carbon filter*

You won't want to hide this one under the sink! A fully glazed ceramic looks beautiful and prevents stains and odor absorption. The 1.25 gallon interior holds a week's worth of scraps and a lid with an activated carbon filter traps odors and lets air circulate to prevent rotting. A removable stainless steel handle makes carrying easy. Dishwasher safe, replacement filters available in a set of 4. 13 3/4" H x 7 1/2" W x 7" D with lid. 6 lbs. USA.

**Compost Crock** #KT7879 \$40  
**4 Replacement filters** #KT7880 \$8



## Portable Pest Repeller

Take effective pest protection with you. Just add a 9-volt battery and make this lightweight repeller completely portable. It uses 2 separate frequencies to rid up to 750 sq. ft. outdoors, 1,500 sq. ft. inside of either mice and bats or spiders and many other insects (not mosquitoes). Ideal for patios, picnics, camp sites, boats, attics, and places with no electrical outlets. Includes 120 vac power cord for plug-in use where outlets exist. 4 3/4" H x 5 3/4" W x 2" D. USA.

#AA7761 \$30



## Most Powerful Pest Repeller

Match the button to your pest and say goodbye to unwanted guests! This state-



of-the-art, most powerful repeller available, emits a combination of sonic and ultrasonic frequencies from dual speakers. Repels mice, fleas, many insects and spiders, bats, squirrels, and raccoons. Just push any one of five buttons for three quiet and two audible settings, chase pests from up to 5,000 sq. ft. of indoor space. The louder settings disturb pets and people but work great for remote applications like keeping an infrequently used cabin in good shape while you're gone. 4.5" x 9" x 3.25". 2.2 lbs.

**Transonic ESP** #AA7748 \$90



## Deodorant Stone

Save both your body and the earth from harsh perfumes, propellants and harmful chemicals. Over 300% more effective than commercial deodorants and used daily lasts at least a year. 100% natural minerals and when you're done, it's gone—no plastic or metal to throw away.

**Stone w/Travel Pouch #EP302 \$12**



## Razor Saver

Common and simple, but actually a razor blade represents some remarkable technology. Days of a strap and straight razor aren't that far in the past. It's a shame to have to throw them away so quickly. In fact, they're only disposable because you can't resharpen them. And now you can! Just insert a razor head and draw the old blade across the Razor Saver - it will be like new. Get 50 or more shaves from any regular or disposable razor blade, men's or women's, single or double. You'll use 75% less razors each year. 5 3/4" L x 2 1/4" W. Imported.

**#EP7681 \$12**

## Sun UV Watch

*Don't Get Burned by the Sun!*

Excessive UV radiation leads to premature wrinkling, sun burn or even skin cancer. This watch has a unique UV sensor that tells you when you have had too much sun. Program in your skin type and which sunscreen you applied. The UV sensor tracks sunlight intensity and tells you when to cover up. Watch includes timer, alarm, date and time. Water resistant, too.

**#EP7118 \$89**



## Solid Bar Shampoo

*Made the old-fashioned way—by hand!*

100% natural, no preservatives, no animal products.

Works great: the thick lather smells great, and it lasts as long as a 24 oz. bottle of most shampoos. Another alternative to chemicals and plastic! There's no sodium laurel sulfate or DEA in this shampoo!



This shampoo will not strip the natural oils from your hair so most people do not need a conditioner. Great for permed or colored hair, and hair with natural curl. Tea tree formula also has hemp and almond oil. It's great for serious dandruff problems, even psoriasis. The damaged hair formula adds vitamin E, aloe vera, and almond oil to promote healing and restoration of your hair. "A Natural Traveler"

(shown) is designed to carry our shampoo. It is the ultimate in convenience and intended for people on the go, who value simplicity, quality and the preservation of our environment. 100% recycled plastic—no messy liquids to spill—dries bar between uses. Use our all-pine Shampoo Shelf for your home to extend the life of the bar.

**Original Bar Shampoo #EP300 \$6**

**Original Bar Shampoo – 6 pk. #EP3498 \$34**

**Tea Tree Formula #EP3667 \$6**

**Damaged Hair Formula #EP3668 \$6**

**"Shampoo Shelf" #EP301 \$10**

**w/Original Bar #EP301 \$10**

**"A Natural Traveler" #EP5663 \$14**

**w/Original Bar #EP5663 \$14**

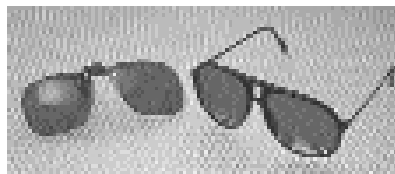

## Ott Full Spectrum Sunglasses

*"World's greatest sunglasses"*

Eliminate glare, distortion, & harmful UV. Many sunglasses distort images and visual acuity. Cheap versions actually dilate your eyes and let in more harmful radiation than you would get without sunglasses. Ott Full Spectrum glasses meet ANSI standards for UV protection but still let in the beneficial, full-spectrum light. Black frames, Ott Gray lenses, aviator style, ten-year warranty.

**Aviator #AC421 \$21**

**Clip-Ons #AC422 \$21**



## Solar Alarm Clock

Our new Solar Powered alarm clock needs less light than your indoor plants and will work for up to 8 months in total darkness - never again worry about waking up in time for that important appointment! It charges with either natural or artificial light and the environmentally friendly alkaline batteries contain no cadmium, nickel, or mercury. Attractive compact design, perfect for travelling.

**Black #ST6809 \$26**

**White #ST6810 \$26**

## Nuwick 120-Hour Candle

Moveable, reusable, non-toxic light source—also good for heating and cooking! Fail-safe source of lighting, heating and cooking all in one. The main Nuwick innovation is the wick—completely independent, moveable, reusable, non-toxic, and waterproof. It "floats" on top of the wax. Each one burns 25–40 hours. To increase heat or light just add more wicks. Ideal for camping and hiking, blackouts, emergency situations, or just a 120-hour romantic atmosphere! Includes 6 moveable wicks, 14 oz. slow burning wax, tweezers, and matches. Great for pocket or backpack.

**#EP901 \$12.50**



## A Summary of the World

If we could shrink the Earth's population to a village of precisely 100 people...with all existing human ratios remaining the same, it would look like this:

- There would be 57 Asians, 21 Europeans, 14 from the Western Hemisphere (North and South), and 8 Africans.
- 51 would be female; 49 would be male.
- 70 would be nonwhite; 30 white.
- 70 would be non-Christian; 30 Christian.
- 50% of the entire world's wealth would be in the hands of only 6 people and all 6 would be citizens of the U.S.
- 80 would live in substandard housing.
- 70 would be unable to read.
- 50 would suffer from malnutrition.
- 1 would be near death, 1 would be near birth
- Only 1 would have a college education.



## Pedal Pick-up

*Easy hauling without fossil fuels*

This pedal-powered workbike has a chromoly frame with black powder-coat finish, heavy-duty steel axles, and a rear axle differential for outstanding maneuverability. The bed has aluminum side posts and railings, a removable gate and 12 square foot capacity. Other features include 48-spoke alloy hubs and rims, a 21-speed drivetrain with indexed shifting, a powerful rear hydraulic brake with an innovative "floating disc" to prevent brake drag. Options include expanded aluminum sides, dual halogen headlight system (low/high), running lights, turn signals and brake lights, shovel and rake racks that hold four long-handled tools, and custom cargo beds. 140 lbs.

#EV8170 \$2,800

## Speed Controls

MOSFET electronic motor controllers with high frequency switching provide smooth, silent and efficient speed and torque control. High quality, simple installation.

24V 175A\* #EV502 \$590

\* Other speed controls available—call us for specs, pricing and availability.

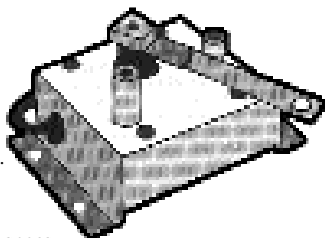

## Optima "Yellow Tops"

*The best battery for EV's!*

Superior power, longer life, double the cycles. Get up to 2500 cycles with a 30% discharge, 350 with a 100% discharge. 50 amp size 10" L x 6.8" W x 7.8" H, 42.9 lbs.

50 Amp #RB6112 \$177

90 Amp #RB6113 \$260



## QuikStix Workbook

10 Electric vehicle designs—a builder's "erector set". Build everything from your bed to a portable home to an electric vehicle with components you can recycle yourself thousands of times. A revolution in building design and construction—inexpensive, amazingly versatile and easy. Anyone can use these simple methods and design, save hundreds of dollars, and build things to their exact specifications. Explains and shows how to make furniture, modular shelters, greenhouses, many kinds of electric vehicles, a mini-tractor, wind generator, solar concentrator, and much more. Appropriate technology at its best.

#BK166 \$20



## Express Power Pack

Electrify your bicycle! Express Power Pack attaches like a saddle bag, straddling the rear wheel and driving it by friction when you press a trigger. Pedal lightly and travel 7 to 8 miles at 11 to 12 mph on a single charge. Pedal harder and travel faster and farther. Batteries recharge in 6 to 8 hours and last up to 2 years of everyday riding. Fits almost any bicycle (not recommended for extremely knobby mountain bike tires)

Weight 27 lbs. High tension steel frame. Complete the installation of your ETC express power pack with the mounting rack and trigger. Mounts behind the seat, straddling the rear wheel. Makes the power unit easily removable.

ETC Express Complete #EV5439 \$384

Power Pack only #EV5440 \$300

Rack & Trigger only #EV5441 \$56



## USProDrive Mountain Bicycle

*Power! Performance! Excitement!*

That's the beauty of the USPD Mountain Bicycle. With its fully integrated direct-drive power system, you're able to go off the beaten path like never before. Direct-drive for maximum propulsion, efficiency and performance in rain, snow and mud. Allows all-electric propulsion power, rider-powered pedaling, combination of pedal power and electric power. Free-wheeling feature eliminates drag and friction when pedaling or coasting with motor "off". Powerful 24 volt DC brushless motor, state-of-the-art electronic pulse-width modulation (PWM) motor controller. Speeds up to 18 mph.

#EV5446 \$999

## USProDrive Conversion Kit

Everything you need to convert your bike to electric: powerful 24 volt DC brushless motor, state-of-the-art electronic pulse-width modulation (PWM) controller, handlebar-mounted thumb throttle with variable speed control, 1 amp charger.

#EV5447 \$595





## Stop Paying Rent!

Stop paying rent without mortgaging your next 30 years. Shelter is an area where all people experience a common ground—everyone needs a place to stay warm and dry. However, the United Nations estimates over one billion homeless people worldwide. Fortunately, as the descriptions and books in this section demonstrate, we have more choices. For example, instead of paying \$600 a month rent, why not stay at a friend's or camp out for 3–4 months? You could use the \$2400 you would save to buy a Yurt. Then find some land you could use for low or no cost. In 2 years you could save \$14,400—enough to buy some nice land and move your portable Yurt. 10 years of saving the \$600 a month rent yields \$72,000, over \$100,000 if reinvested at 10%!



### Pacific Domes

A home that combines the sacred geometry of R. Buckminster Fuller with a choice of progressively designed covers. Easy to assemble, completely water repellent, set up for a woodstove, great windows for natural lighting, lots of screens

for summer, optional winter liners. A suspended sky chair adds a nice touch. Super durable—easily withstands high winds, safe in earth quakes, no problem with heavy snow loads. All this and unassembled it still fits in the trunk of your car!

Call or write for color pamphlet.

12' Dome	#HM6068	\$2,200
16' Dome	#HM6069	\$2,600
20' Dome	#HM6070	\$4,300
24' Dome	#HM6071	\$5,300
30' Dome	#HM6072	\$6,600
36' Dome	#HM6073	\$9,300

### Yurts

An "architectural wonder" in use for centuries in extreme climates

Nomadic people in the Far East have used Yurts for hundreds of years. They combine unparalleled strength, spaciousness, and portability. Easy to transport and construct by only two people, they will keep you warm, dry and comfortable with warm lighting. Tension bands transfer roof loads onto the yurt's walls and a lattice structure maximizes the strength-to-weight ratios. A skylight provides excellent ventilation and you can easily vent a stove pipe. Send for detailed information.

16' Standard Yurt	#HM101	\$3,900	
20' Standard Yurt	#HM102	\$5,315	
24' Standard Yurt	#HM6032	\$5,890	
30' Standard Yurt	#HM6033	\$7,500	



### Solar Gro-Domes

*Inexpensive greenhouse you can set up in 30 minutes without tools*

Extremely strong but free-standing and light weight—pick up and put on top of established plants, move to another site when plants are well-established. Super strong translucent covering is completely waterproof but still breathes. The Bubble Domes add an additional band of poles and create the maximum interior space with the minimum footprint.

8' diameter, 7' 4" high	#HM1628	\$475
11' diameter, 6' 4" high	#HM1629	\$595
14' diameter, 7' high	#HM1630	\$650
18' diameter, 9' high	#HM1631	\$750

20' diameter, 10' high

#HM1632 \$875

10' Bubble Dome 8.5' high

#HM1633 \$560

14' Bubble Dome 11' high

#HM1634 \$865

20' Bubble Dome 15' high

#HM1635 \$1,350

Light House 14' Shelter #HM6157 \$595

### Ultimate Hammock

*It feels like smooth cotton but it's made from recycled soda bottles!*

The hand-crafted polyester rope used to make this extraordinary

hammock doesn't just have an environmental benefit - it's much better than cotton because it won't rot or suffer UV radiation damage. It holds an amazing 450 lbs., two or three people! Strong white oak ends are finished with natural linseed oil. Hanging hardware included. 14'L (ring to ring) x 5'W. 12 lbs. USA.

#EP7845 \$146







**Tipis**

Authentic and functional home, mountain retreat, backyard expedition, or playroom encampment. The eminently practical home of the American Plains Indian. Warm in winter, cool in summer, able to withstand the roughest weather, moveable and easy to set up. All within a conical space where "the spirit can soar". Patterned after the 3-pole Sioux design with Cheyenne-style smoke flaps, these tipis use the finest

treated canvas with buffalo hide sewn around the door opening and other high-stress areas. Complete packages include tipi cover, poles, door cover, wooden stakes, lacing pins, all necessary ropes and liner. 5-year warranty.

<b>12' Cover</b>	<b>#HM113</b>	<b>\$324</b>	
<b>12' Complete</b>	<b>#HM114</b>	<b>\$695</b>	
<b>16' Cover</b>	<b>#HM115</b>	<b>\$466</b>	
<b>16' Complete</b>	<b>#HM116</b>	<b>\$998</b>	



**Sky Lodge Tipis**

An innovation on the traditional Sioux tipi design and an ideal environment for many uses in the art of living. Easy to assemble and portable, they're water resistant, handle snow loads and winds, and set up for a wood stove. They include a portable fire pit, skylight and removable round window for natural lighting, screens for ventilation, and optional liners. 12' (HM8686) \$1205

<b>14' #HM8687</b>	<b>\$1,505</b>	<b>16' #HM8688</b>	<b>\$1,675</b>
<b>18' #HM8689</b>	<b>\$1,830</b>	<b>20' #HM8690</b>	<b>\$2,065</b>
<b>22' #HM8691</b>	<b>\$2,380</b>	<b>24' #HM8692</b>	<b>\$2,650</b>
<b>28' #HM8693</b>	<b>\$3,250</b>		

**Optional portable fire pit #HM8745 \$150**



**Platform Pitched Wall Tents**

Strong, durable tents built to last with 13 oz. formaldehyde free marine "Sunforger" fabric. Front and rear door openings, walls grommet and lace at corners to allow

side wall roll-up. Natural cream color, water repellent and mildew retardant fabrics. Comes with tent cover, storage bag, all guy and corner ropes. Options include rain fly, bug net screens, upright and ridge pole sets. 1 year materials and 5 year workmanship warranty.

<b>10' x 12'</b>	<b>#HM7175</b>	<b>\$461</b>
<b>12' x 14'</b>	<b>#HM7176</b>	<b>\$516</b>
<b>14' x 16'</b>	<b>#HM7183</b>	<b>\$656</b>
<b>16' x 20'</b>	<b>#HM7185</b>	<b>\$806</b>

**Outfitter's Wall Tents**

Heavily reinforced wall tents designed for compact transportation without sacrificing roominess. Tapered overlaps for secure privacy and cold weather enclosure. Sidewall height of 4'6" and ridge height of 7'6" on all tent sizes. Door flaps tie back in four positions. Options include heavier weight, different fabric types, flame retardancy, sod cloth, stove pipe outlet, mosquito net windows, rain fly, floor cover, upright and ridge poles, and a variety of colors.E

<b>8' x 10'</b>	<b>#HM7187</b>	<b>\$249</b>
<b>10' x 12"</b>	<b>#HM7189</b>	<b>\$310</b>
<b>12' x 14'</b>	<b>#HM7190</b>	<b>\$351</b>
<b>14' x 16'</b>	<b>#HM7191</b>	<b>\$387</b>



**Opendor Drop Screen**

Make any door a screen door instantly! Can't open doors to let in fresh air because there's no screen? Don't want the hassle and expense of installing permanent screen doors? Try this. In just seconds, our Opendor Drop Screen attaches to pre-applied velcro strips to completely cover open door frames and turn them into screened openings! Its fine mesh lets cool breezes in, while a weighted bottom keeps bugs out. And it opens instantly for comings and goings. Superior quality mesh won't run or tear. Fits all standard 80" x 36" door frames. Folds compactly for easy storage. 1 lb. USA.

**#EP7890 \$32**

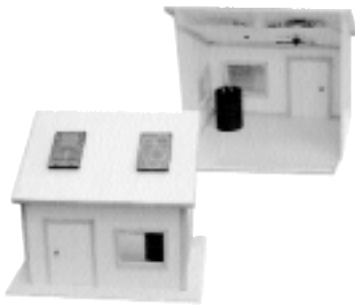

## Solar-Electric House Kit

*Make your own appropriate technology model house*

Use cardboard, micro straw bales, mini adobe bricks, foam board, or your favorite building material. This kit supplies the rest—a working solar module, bright LED red light with dome cover, ceiling fan that works off the PV, solar thermal module and tubing (use a black-painted paper towel tube for the storage tank).

Comprehensive instructions

include directions for solar orientation, roof overhangs, and assembly techniques. A wonderful starting point demonstrations, education or experimentation.

#ST3861 \$35

## Solar Cool Cap

This baseball cap has a built-in sun-powered evaporative cooling system that can keep you cool on the hottest days. Works great and gets attention!

White only.

#ST103 \$15



## Our Most Practical Solar Energy Kit

Learn the difference between wiring in parallel and series to increase voltage or current—the most common question when installing both solar modules and batteries. Use the 8 mini-panels to make a solar circuit, an electrical circuit or a larger solar module.

Powers the included motor and fan.

a small radio, calculator, 1.5V cassette player, or recharges NiCads.

#ST214 \$22

## Sunpower House

Working model of a passive solar house. Exceptional learning tool. Expand your students', children's and your own understanding of energy costs and ways to improve efficiency.

11" x 11" x 8" model complete with detailed Teacher's Guide including activities in basic science, solar energy and energy conservation.

#ST909 \$43



## Solar Worksheet:

*Macintosh program for PV design & sizing*

Enter in your AC & DC loads or pull down the typical appliance power uses from the menu. Enter inverter efficiency, click your location on a map and this program recommends the number of solar modules and batteries you will need. Change the loads or usage time and quickly discover how much the changes cost. Needs 4+ megs/memory.

#PV315 \$15

## Solar Insolation Meter

Measure your sun power. Precision readings of diffuse solar radiation. Illustrates the changes from hour to hour and season to season. Calibrated in BTUs/hr/sq.ft. and watts.

#ST520 \$85

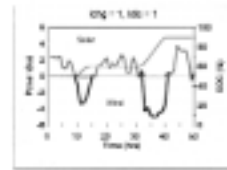

## Energy System Engineering

*Expert optimization of off-grid energy systems*

Sustainable Village includes free design & sizing for normal residential and smaller systems. Engineering analysis for the best system in commercial and hybrid

applications can take a considerable amount of time and resources though. We now have on staff an engineering PhD (Dennis Barley) with years of experience in designing hybrid wind/PV/battery/engine power systems. He's written a book with software called Hybrid Power Design Handbook (\$300 but only recommended for people with engineering backgrounds) and can analyze the unique resources and requirements in your planned off-grid electrical system. This in-depth report answers questions including the most economical combination of alternative power sources, the best trade-off between buying batteries vs. buying fuel for a back-up generator, the kind of performance to expect, both the short and long term costs. Dennis takes into consideration hour-to-hour weather patterns, seasonal cycles, component costs, fuel cost, battery cycle-life, terrain, and financing. His report includes easy-to-understand charts, graphs and text. Please request our free "Project Data Submittal Form".

<b>Within U.S.</b>	<b>#PS3490</b>	<b>\$225</b>
<b>Outside of U.S.</b>	<b>#PS3491</b>	<b>\$275</b>
<b>Project Data Submittal Form</b>	<b>#PS3492</b>	<b>Free</b>

## PC-Solar

*Easy solar shading calculations*

Great software for Windows 3.1—just the tool for planning wall placement, roof overhangs, solar panels, skylights, greenhouses and trees. Just define the basic shape and features of the surface in question and PC-Solar creates a wireframe representation. The real magic shines as it draws shadows the way they will appear throughout the day, month or year. Track the movement of the sun with animation. Don't like what you see? Change the configuration of the wall or roofline around until you do! Export images into other CAD, publishing or graphics applications. 3.5" floppy.

#PV1452 \$50

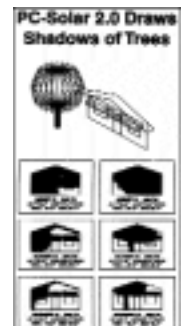

## Solar Pathfinder

Quickly evaluate solar potential. One quick siting gives accurate, easily recorded solar site information for the entire year. Shows energy lost due to each shadow casting object and a fast comparison to other sites. Since shading just one cell in a PV module reduces output up to 80%, a Pathfinder can more than pay for itself. Also great to evaluate passive space heating, domestic hot water, swimming pool heating, and just learning more about the sun.

<b>Hand-Held Model</b>	<b>#PV903</b>	<b>\$190</b>
<b>w/Tripod &amp; Metal Case</b>	<b>#PV904</b>	<b>\$280</b>

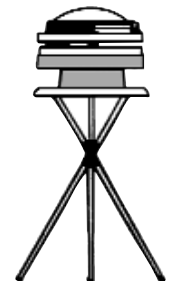

## Composting Toilets and Greywater

### The Composting Toilet Book

Written by David Del Porto, one of the world's few experts on this topic and member of the NSF wastewater treatment development committee.

Described as "the definitive book on ecological engineering and composting toilets." 200 pages.

#BK3478 \$30



### Sustainable Sewerage

Guidelines for community schemes

Outlines techniques for affordable and effective sewer systems in developing areas. Ways to modify conventional designs, optimize local resources. Financial & technical aspects. 112 pages.

#BK170 \$19.50



### Sewage Solutions: Answering The Call of Nature

Not waste, sewage contains rich nutrients soil and plants love.

Recycle sewage waste using natural processes. Helps with choices regarding small-scale sewage treatment. Authors Nick Grant, Mark Moodie and Chris Weedon deliver a wealth of experience with a British perspective. 189 pages.

#BK1764 \$14.95

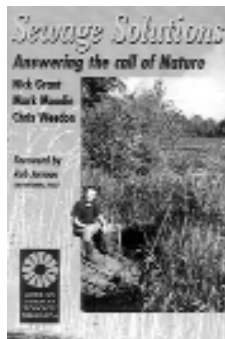

### Future Fertility

Discover how to use urine and manure to safely fertilise our farmlands and replenish minerals and organic matter that our soils are lacking. 1995, 164 pgs.

#BK3282 \$18.50

### How To Shit In The Woods

The basic information everyone should know. Chock-full of practical tips which are useful in a variety of situations and the great sense of humor makes learning fun. Written by a woman, lots of extra information for women in the wild. Easy to read and leads to an ecologically sound conclusion to having a bowel movement. 2nd edition covers health concerns, feedback from 1st edition, and much more. Kathleen Meyer. 128 pages.

#BK3675 \$7



### The Humanure Handbook

A guide to composting human manure

Though filled with humor and great jokes, this book includes a wealth of good, hard data on dealing with human waste safely and effectively. Sections on pathogens and chemistry are interspersed with cartoons and humorous "tips". Essential information for recycling human waste safely without creating more environmental pollution. A great book. Author Joe Jenkins tells us that those who don't like the book can always recycle it as toilet paper: We'll take his word for it! "Anyone who cares about the earth and wants to stop being part of our modern throw-away society should read this book." 198 pages.

#BK1411 \$19



### Branched Drain Greywater Systems

An inexpensive and easy to install greywater system, inherently simple and surprisingly easy to use. A supplement to Create An Oasis With Greywater, this book gives detailed plans and specific systems for the reliable, sanitary and low-maintenance distribution of household greywater to downhill plants without filtration or pumping. No more reason to procrastinate!

#BK7354 \$14.95



### Building Professional's Greywater Guide

Complete installation manual. Intended for contractors and plumbers but extremely useful for anyone considering or building a greywater system. Considers both the legal and practical concerns, includes and annotates the new California greywater law, diagrams. Addendum for "Greywater Information" below. 45 pages.

#BK390 \$14.95

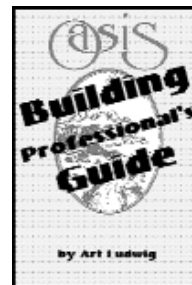

### Greywater Information Booklet

Describes the compelling ecological and economic advantages of recycling household greywater for landscape irrigation and explains how to design, build and operate 20 systems ranging from "dishpan dump" to micro-processor controlled drip irrigation. New updated and expanded booklet, over twice the info of first version. 47 pages.

#BK320 \$14.95



### The Septic System Owner's Manual

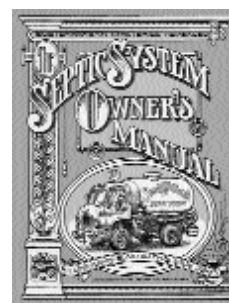

Although we have 25 million septic systems in the United States and about 400,000 new systems each year, they remain a mystery for most people. With entertaining text and humorous graphics, this book explains how they work,

how they should be treated (what should and should not go down the drain), how they should be maintained and what to do if things go wrong. Not an engineering treatise but a great basic manual for the average homeowner. Also covers composting toilet systems, designs for simple greywater systems and some of the typical alternatives to the standard, gravity-fed septic system. An excellent chapter on small town system upgrades and a fascinating chapter on the history of waste disposal.

#BK7602 \$14.95

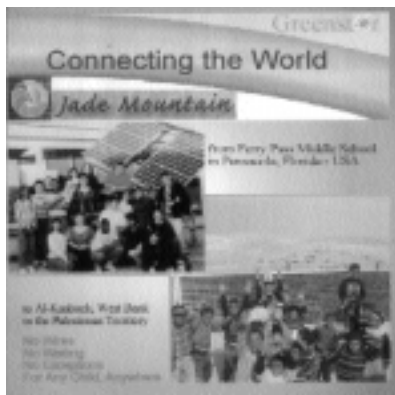

**The Voice of Swift River From the Blue Mountains of Jamaica - CD**

One of our partners, Greenstar offers this powerful mix of mento band, kumina drums, gospel, revival and nyabingi performed live by the people of this ancient place. Greenstar works with people who live in remote, traditional villages around the world to produce unique artwork and music; giving expression to the voice, the vision, the history, language and culture of these villages. Using solar power, satellite communications and computers, Greenstar trains community members in e-commerce to enable local artisans to sell their products around the world. A significant portion of the income from sales of this music goes directly to the Swift River Re-Development Association to improve health, education, energy and communications for the village, its children and families.

#CM8008 \$14

**Appropriate Technology**

**Gaviotas**

*A village to reinvent the world*

Appropriate technology exciting adventure story—and true! Not only inspiring but numerous practical project descriptions like making a low-cost teeter-totter well pump and solar heated cottonseed oil pressure cookers. This group of AT pioneers in Colombia were so successful with their sustainable efforts, an ancient rainforest unexpectedly regenerated. Amazing what's possible—we're on the right path! Hardcover, 240 pages.

#BK3665 \$23

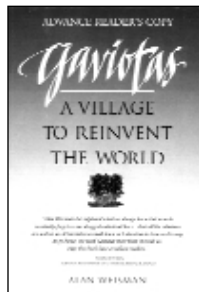

**Renewable Energy Dictionary**

Defines and translates 1000+ AT terms into English, French, Spanish. Thoroughly cross-referenced and illustrated dictionary gives excellent definitions and translations. Separate sections for English, French, and Spanish. Inspiring summary of what's possible and available. Extensive bibliography. Five pages of conversion tables. Invaluable reference aid. 484 pages.

#BK843 \$29.75

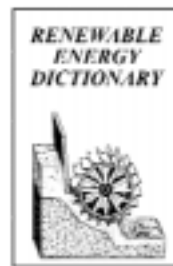

**Off-Grid Electricity in Rural Areas**

Organizing village scale rural electrification projects - strategies for grass roots participation instead of the problem-ridden "top-down" approach. A must read for any participant in larger scale sustainability projects, whether in the USA or abroad. Technical Working Paper from the IT press culled form projects in Sri Lanka and Zimbabwe. 36 pages

#BK7419 \$22.50



**When Aid is No Help:**

*How projects fail and how they could succeed*

The global aid effort is failing in its most crucial task: helping the neediest. This book describes why well-intentioned work fails and suggests ways to change the \$50 billion a year aid effort to become more appropriate to the needs of its recipients. Good chapter of guidelines on how to organize and plan an effective program in a developing country.

#BK115 \$19.50

**Village Technology Handbook**

One of the best resources for development workers and do-it-yourselfers. Written to bridge the technical information gap that keeps the world's villages from learning from each other's experience. Includes information from numerous sources. Covers well-digging, pumps, tools for agriculture, sanitation, food storage, how to make hand washing machines, evaporative food coolers and much more. Easy to read and use construction plans. 430 pages.

#BK359 \$28



**Pocket Ref**

Almost every conversion factor and bit of technical data you could ever imagine wanting to know. 544 pages packed into a pocket sized 3.2" x 5.4" book you can easily take with you anywhere. The BTU's in a gallon of propane or a kilowatt-hour, wire and lumber sizing, area and zip codes, mixing ratios, wind and water formulas, exchange rates, maps, charts, it goes on and on. Author: Thomas J. Glover, ©1995-96, 544 pages.

#BK999 \$10



**The Appropriate Technology Library**

*Translate your ideas into action!*

An AT Library for your laptop. The most comprehensive, practical, and economical Appropriate Technology reference collection ever compiled. Over 150,000 pages from over 1050 books and documents on Mac and PC compatible CD-ROMs or Microfiche for under 50 cents a book. Covers a full range of information. Here are just a few of the topics included:

- Agricultural Tools and Techniques
- Water Supply Systems
- Workshop Tools and Equipment
- Solar / Wind / Water / Biomass Power
- Health Care
- Small Industry & Management
- Forestry
- Disaster Relief / Preparedness
- Transportation
- Non-formal Education

**CD-ROM Library** #BK6912 \$495  
**Microfich Library** #BK800 \$895  
**Portable Microfiche Reader** #BK802 \$440

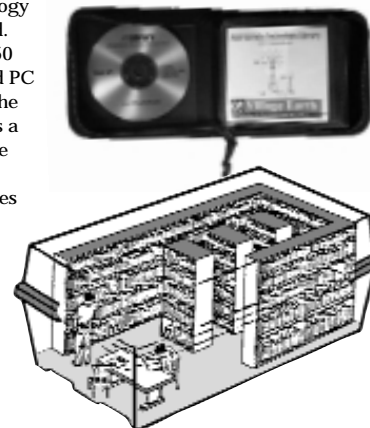

**Appropriate Technology CD-ROM**

Want to build a bridge, design a cookstove to save fuel, survey a field for irrigation, replant a forest, install a water system, or pursue any other small-scale technology project? Invaluable, practical resource on small-scale technologies. Reviews 1150 of the most useful appropriate technology books and gives complete ordering information. Highly recommended for anyone working in a developing country.

#BK1772 \$28



**Make Your Own**

**Living on Less**

Affordable food, fuel, and shelter

Updated version of Mother Earth News' classic manifesto on "back-to-the-land" lifestyles. From electric cars and straw bale building to foraging and raising livestock, this one covers it all.

#BK3585 \$20



**Passport to World Band Radio**

Tune into voices from home, or from around the world with the aid of your shortwave radio and Passport to World Band Radio. Contains up-to-date program schedules and frequencies for most international broadcasters, peeks behind the scenes, equipment reviews by Larry Magne, and much, much more. 150+ pages. Makes a great companion to our BayGen Freeplay radio.

#BK1787 \$20

**Passport to Web Radio**

Listen to radio through your computer? It's not hard to do. Broadcasts from around the world are available on the Web. With the right software, you can listen to an eclectic mix of programs in many languages. This guide tells you how, gives you an idea of what's out there, even lists broadcasts by country. Clearly and entertainingly written.

#BK5205 \$19.95



**Appropriate Paper-Based Technology**

New desk, lamp, rocking chair, picture frame? How about a doll house, puppet, toy car, or building blocks? Solar oven, fruit dryer, bowl, box, or basket? Tricycle or wheelchair? This book shows how to use paper and cardboard to make all these and more. Attractive, results prove rugged and long-lasting. During the last few years, this new paper technology spread like wildfire through Africa. It can enliven and bring smiles everywhere. Many illustrations and color photos. 155 pages.

#BK1296 \$19

**The Smart Kitchen**

Whether you own or rent your kitchen space, the ideas in this book make it more user- and eco-friendly. Not at all glossy, but it offers a wealth of info based on the author's 10+ years of experience operating a demonstration kitchen. New edition offers 30 extra recycling ideas and expanded resources section. 134 pages. Goldbeck.

#BK1733 \$16.95

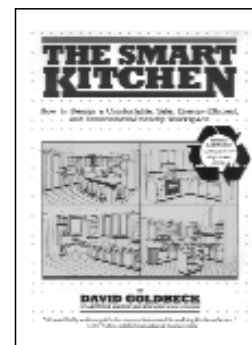

**Planet Earth Home**

*The complete reference book for self-sufficient homes*

Compilation of the entire world's knowledge and technology for new self-sufficient home designs. Organized as a reference work covering virtually all related technologies such as solar, photovoltaic, wind, greenhouses, and more. Includes a plan for constructing a family of four completely self-sufficient home designed to provide both food and power and can be located anywhere. 603-page hardbound book with over 70 illustrations and 14 blueprint reductions.

#BK7559 \$85

**There Are No Electrons**

Do you know how electricity works? Want to? Read this book and learn about volts, amps, watts, resistance—all that stuff that us techie types like to talk about while everybody else scratches their heads. So much fun to read, you won't even notice you're learning stuff. And if you already "know" about all this, you'll enjoy it even more—just be prepared to rethink everything. Highest recommendation.

#BK5104 \$16

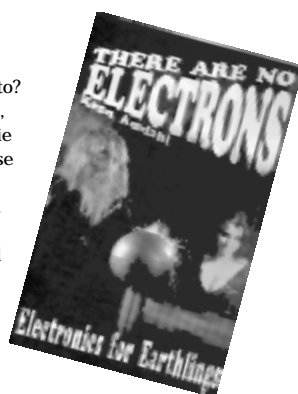

**Ammonia Absorption Cooling**

Ammonia absorption cooling has been around for a long time, but most appliance people don't know anything about it. The local company that refurbishes LP refrigerators and freezers for us wrote a nice little book on the subject. It'll help you understand how they work, what can go wrong, and what to do when they need repair.

#BK5563 \$6

**Basic Blacksmithing**

Learn to make or repair tools and other metal products. Basic and advanced rural blacksmithing techniques and step-by-step instructions on how to make a range of tools and useful items from scrap metal. Builds on traditional techniques and describes how to set up your own workshop by making a bellows, hearth and anvil. Amazing and inspiring what you can do with locally available materials. Hundreds of diagrams, 127 pages.

#BK113 \$26



## The Blacksmithing Instructors' Guide

Sixteen lesson plans with teaching advice. Designed to help skilled blacksmiths train others in forge techniques. Uses easily obtainable equipment and scrap metal to produce tools like hoes, sickles, hammers and axes. Outlines a comprehensive approach to teaching with illustrated lesson plans and key points to emphasize at each demonstration stage. 70 pages.

#BK137 \$36



## The Canning, Freezing, Curing, & Smoking of Meat, Fish, & Game

If you hunt, fish, or raise livestock—here's a great intro to meat preservation. Chapters on butchering, freezing, canning, drying, and preserving. Smoke ham, make jerky—very comprehensive and clear discussion on the techniques. Shows how to build a smokehouse, how to pack meat into jars for canning, proper techniques for freezing. Concludes with recipes to help you start using your preserved meats.

#BK5151 \$12.95



## Metal Casting

*AT in the small foundry*

Step-by-step instructions on how to make equipment for a small-scale non-ferrous casting shop from local materials. Detailed information on moulding techniques, design pattern making, core and core mixtures, the use of wax, repair and welding, cleaning, metal preparation and melting. 192 pages.

#BK141 \$26

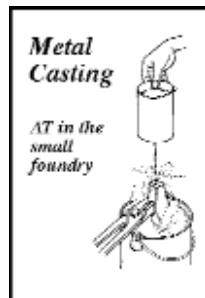

## Improved Wood

### Waste & charcoal burning stoves

Help solve the many problems of traditional stoves. The latest alternatives for saving fuel, conserving heat output, decreasing required attention, etc.

#BK365 \$29

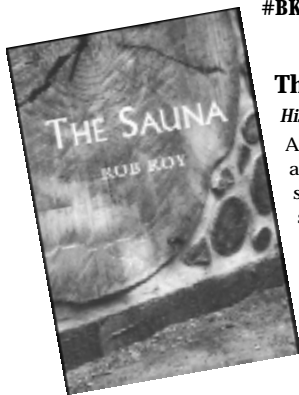

## The Sauna

*History, Health and How-To*

All you ever wanted to know about the history and benefits of the sauna. Includes step by step instructions for building two styles of sauna. 197 pages, soft cover.

#BK1865 \$20

## Ecology & Environment

### Island Technology

Sustainable fishing, forestry, and mining

From an island point of view, a critical look at the effects of Western technology and proposals for better approaches. Covers a wide range of topics from agriculture and forestry to banking, communications, and health. 384 pages.

#BK326 \$32



### Save Money With Energy Efficient CD-Rom

*A breakthrough in energy savings*

Lower your energy consumption and maintenance costs while improving the lighting quality of your business. CD-ROM informs and entertains. Quick and easy interactive training. Multimedia PC, Windows 3.1 required.

#BK1880 \$50

### Who Owns the Sun?

Existing solar technologies combined with local management present remedies for our energy gluttony. Find out what the coal, petrochemical, nuclear, banking, and transportation industries don't want you to know! 330 pages, hardcover. Berman & O'Connor.

#BK1864 \$34

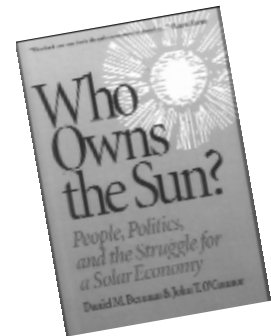

### Sustainable Cities

Leading experts from a wide range of fields present concepts and strategies for ecological city design. How urban development and the environment can coexist in a successful partnership that will result in better air quality, cleaner water, more nutritious food, less commuting time, quieter and more nature-oriented surroundings, a richer community life, less urban stress, and improved health for the people who live and work in cities. A good, important book! 350+ pages.

#BK6679 \$25

### Clean & Green

A wonderful little book crammed with formulae for making your own non-toxic, household cleaners, waxes and polishes. Effective? Yes! These "recipes" save money too: Make your own! Ideal for anyone who suffers from sensitivity to chemicals. Berthold-Boyd, 162 pages.

#BK1734 \$8.95



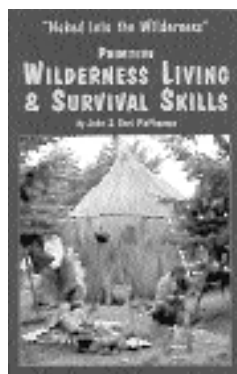
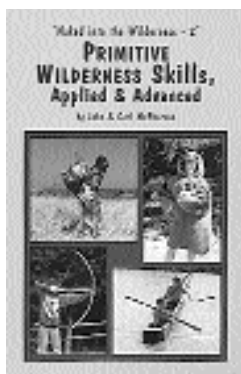

**Naked Into The Wilderness**

Could you walk into the wilderness with nothing, build a fire and a shelter, and keep yourself fed? Prehistoric people did that for millennia. It's how they made their living. John and Geri

McPherson have spent years learning to use those skills. Their books can teach you how, too. If you ever wondered how to make a fire with two sticks—here's where you can learn. Book 1 has chapters on primitive fire, shelter, clothing, trapping, hunting, butchering—all the important skills for wilderness survival. Book 2 takes those skills and shows you how to apply them in a real setting.

**Primitive Wilderness Living & Survival Skills**

**(Book 1) #BK4571 \$25**

**Primitive Wilderness Skills, Applied & Advanced**

**(Book 2) #BK4572 \$25**

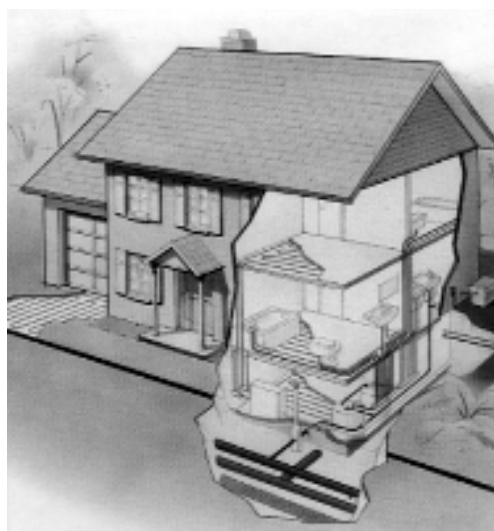

**Hydronic Radiant Heating**

*A practical guide for the non-engineer installer*

If you're dealing with hydronic heating on any level—considering, designing, maintaining, installing professionally or as a do-it-yourself project—you will love this book. Although it includes all the complicated, technical information, a great writing style makes fast learning fun and entertaining. 215 pages

**#BK5968 \$20**

**How Come?**

*Hydronic heating questions we've been asking for 100 years*

In a question-and-answer format, almost everything about hot water heating (but not solar). Find an answer quickly! Gravity hot-water heat comes first and includes many of the basic principles that make all the other hydronic heating systems work. Next, find Indirect Hot Water Heating, go on to Diverter Tee Hot Water Heating, Loop Hot Water Heating and ways you can make these simple systems better. A big chapter on Radiant-Floor Hot Water Heating and finally Condensate Hot Water heating. All in all, one hundred years worth of hydronic heating questions (over 600 of them!) answered in a plain-English way. 185 pages and dozens of easy-to-follow illustrations.

**#BK5979 \$20**

**The Lost Art of Steam Heating**

Everything you ever wanted to know about steam heating in one easy-to-understand book. From the history of how steam first came to the US to details on how it works and how to install and maintain. What to do—and what not to do. Details like how and why systems work better when the pressure is kept low. One chapter explains two dozen of the most common vapor/vacuum steam systems from the turn of the century to the 1930s. Hundreds of drawings and photographs. 296 pages.

**#BK5978 \$35**

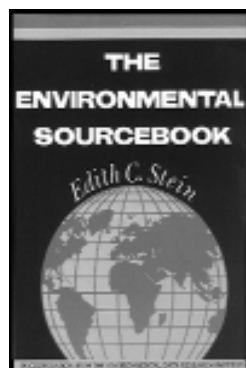

**Environmental Sourcebook**

Comprehensive guide to the environmental movement. Invaluable source of information on environmental issues—energy, agriculture, solid waste, endangered lands, oceans, population, etc. Lists groups, grant foundations and a wide range of environmental books and periodicals. 264 pages.

**#BK205 \$17**

**Village Wisdom / Future Cities**

Based on a conference held in the traditional village of Yoff, Senegal, January 8 through 12 of 1996 This book is for everyone concerned about the future of our communities and the health of our environment, including practitioners, teachers and students of architecture, design, planning, appropriate Technology, social sciences, environmental activism and contemporary and traditional Africa. 232 pages, softcover

**#BK6678 \$15.95**

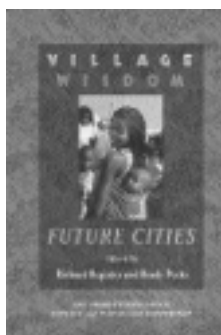

**Hydronic Heating**

**Hydronic Heating Manual**

Hydronic heating—the most comfortable way to heat your home. This book explains and simplifies designing your own system using Kitec tubing. Size a system to your local conditions using regional climate tables. Also gives construction details. A must-have if you're serious about using hydronic heat.

**#BK4804 \$9**



**Solar Water Heating**

*A do-it-yourself guide*

How to make solar panels. How to connect, mount and install them. How to make a controller for a pumped system. Details on plumbing, wood preserving and soldering.

**#BK146 \$12**



## Remote Medical

### Where There Is No Doctor

*A Village Health Care Manual*

Over 2 million copies in print in over 50 languages. More than a book on first aid, this covers everything from diarrhea to tuberculosis, from helpful and harmful home remedies to the cautious use of certain modern medicines. Using simple language and hundreds of drawings; how to prevent, recognize and treat common illnesses. 512 newly revised pages.

**English #BK651 \$17**  
**Spanish #BK1728 \$17**

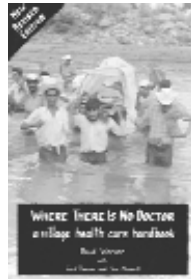

### Where Women Have No Doctor

Women's health needs don't change in the absence of a doctor. Book details ways to maintain health and treat conditions specific to women. Developed by community health workers with worldwide experience.

**#BK4588 \$20**

### A Book for Midwives

Susan Klein's massive, 519-page book is ideal for caregivers, midwives and aid workers concerned about the health of pregnant women and their babies, and can also be used to help others learn the skills. Clear language and numerous drawings.

**English #BK1665 \$22**  
**Spanish #BK1730 \$22**



### The Wordless Travel Book

Point at pictures to communicate! We can't guarantee results every time, but it's a great idea and attractively done. When you need something but don't know the language, just show the picture! Handy, pocket-sized book.

**#BK1294 \$5**

### Where There Is No Dentist

Shows people how to care for their teeth and gums, how to prevent almost all tooth and gum problems. Emphasis on sharing this knowledge in the home, community and school. Detailed and well-illustrated information on using dental equipment, placing fillings, taking out teeth, and more. 208 pages.

**English #BK652 \$8.95**



### Helping Health Workers Learn

Indispensable resource for anyone involved in teaching about health. With great illustrations shows how to make health education fun and effective. Focuses on a people-centered approach presenting strategies for effective community involvement through participatory education. 640 pages.

**English #BK653 \$20**  
**Spanish #BK1729 \$20**

### Staying Healthy In Asia, Africa, and Latin America

A complete health guide to traveling and living in less developed regions of the world. Basic enough for the short-term traveler yet complete enough for someone living full-time in a developing country. Big sections on both prevention and guidelines in case of illness.

**#BK655 \$12**



### Family First Aid

*Owies, boo-boos and all the things that really happen*

Covers everything from head lice to stubbed toes. No rare stuff, but plenty on "ordinary owies", including The Average Tummy Ache. 60 pages. By The Nursing Staff at Lucille Salter Packard Children's Hospital.

**#BK3658 \$12.50**

### The Doctors Book of Home Remedies

*Thousands of tips and techniques to heal everyday health problems.*

Guide to over 2300 health remedies you can use at or away from home. A compilation from hundreds of doctors and health professionals asked to make practical suggestions for both common and uncommon ailments. A comprehensive health guide we highly recommend and use whenever a health question arises. Written in an easy to understand style and organized for quick reference. 676 pages.

**Book I #BK1150 \$27.95**  
**Book II #BK6369 \$27.95**



### Community Assessment

Guidelines for rural health care workers. Identify the causes of ill health and provide more effective and less costly health interventions. Based on a multi-disciplinary approach, a discussion of water and sanitation, food preparation and nutrition, community resources. Great for busy health care workers, community medicine courses, and anyone looking for information about the causes of health problems in developing countries. 144 pages.

**#BK376 \$18**

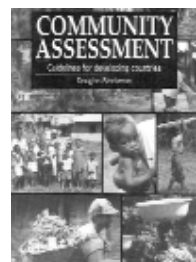

### Making Health-Care Equipment

Ideas for design alternatives in developing countries where it's too expensive/difficult to import medical equipment.

Easy-to-follow instructions for making hospital furniture, wheelchair, centrifuge, water still, incubator, calipers, and other laboratory, physiotherapy, orthopedic, and maternity equipment. 80 pages.

**#BK107 \$18.50**



**Medical & Hygiene Textile Production**

How to make gauze, bandages, sanitary towels, and diapers from cotton or wool. All the methods described can be done by hand or with the use of small mechanically driven equipment. Takes the process from raw material processing to the packaging and labeling of finished products. 56 pages.

#BK132 \$14



**Hydraulic Ram Pumps**

Use water to pump water—no other power required! Step-by-step instructions on designing, making, installing and operating a water pumping system that requires no external power other than water falling to the site. A time-tested technology that uses the pressure of water falling to lift a percentage of the water up 100's of feet. 144 pages.

#BK138 \$26

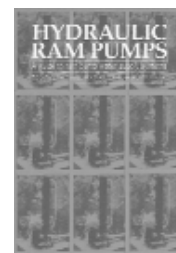

**Australian Tea Tree Oil First Aid Hand Book**

Used for centuries by Australian natives, tea tree oil has gone global. It's an extract from the leaves of an Australian tree. Book describes its effectiveness against skin infections, as a topical treatment for dental and mouth ailments and as an inhalant therapy for several respiratory conditions. Explains how the oil is to be mixed, discusses appropriate dosages for many medical conditions. Numerous anecdotal reports of successful treatments.

#BK4995 \$3

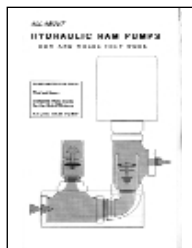

**All About Hydraulic Ram Pumps**

Pump water without external power? Sounds suspicious, but ram pumps have done just that for decades. Here's a book that tells how they work. Describes how rams use falling water to lift water to high elevations. Refers to specific models, with details on installation and design.

#BK5148 \$9.95

**Water**

**Freshwater Fish Pond Culture & Management**

Comprehensive guide for planning, constructing, and maintaining a small-scale warm water fish pond. Fully illustrated, valuable reference manual. 196 pages.

#BK845 \$22



**Safe to Drink? The Quality of Your Water**

Can we trust our tap water? What exactly is in it, and why? If you don't like it, what can you do about it? Are filters or bottled water better? What about getting your own supply? Answers for these common questions and more, with the help of diagrams and tables. 157 pages.

#BK1768 \$14.95

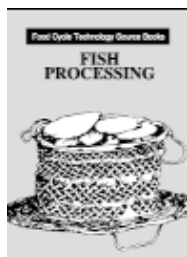
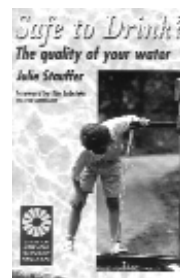

**Fish Processing**

*Food cycle technology sourcebook*

Describes traditional methods and examines improved techniques through case studies and examples of equipment that can be constructed locally. 68 pages.

#BK136 \$16

**The Home Water Supply**

*How to find, filter, store, and conserve water*

Deals with all major water supply problems. Shows how to locate water and move it. Outlines different purification methods and provides plans for storing and distributing water to your home. Also gives tips on water conservation. Thorough and easy to understand. 236 pages.

#BK307 \$19



**Understanding Solar Stills**

In-depth information on the construction, maintenance, and uses of solar stills. McCracken & Gordes, 45 pages.

#BK3595 \$12



**Don't Drink the Water**

*(Without Reading This Book)*

A comprehensive, illustrated guide to the state of public drinking water; examines regulations, health risks, contaminants, treatment systems & more. "...the most up-to-date & readable work I've seen on the subject of contamination of our drinking water & how to protect yourself from it. Read the advice on these pages & act on it!" — Dr. Andrew Weil, MD. 112 pages.

#BK3059 \$12

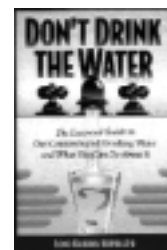

**Solar Still Manual**

Build your own, inexpensive, 3 gallon/day solar still! Plans, operating instructions and design considerations are covered in an easily-understood manner. Breslin & Clark, 36 pages.

#BK1742 \$10



**Hand-Pump Maintenance**

*In the context of community well projects*

Introduction to hand pump types and maintenance. Details on specific models and installations. Concise and to-the-point. Emphasizes developing nations and community well installations

#BK4623 \$12

## Water-Pumping Devices

*A handbook for users and choosers*

Starts at the beginning defining and designing your water usage requirements and goes through types of pumps, powering, installing, even making simple models. Great section on human- and animal-powered pumps and also includes solar, wind, hydro, and biomass powered systems. Numerous diagrams and charts, 254 pages, surprisingly complete, the best water pumping book we've seen.

#BK3752 \$38

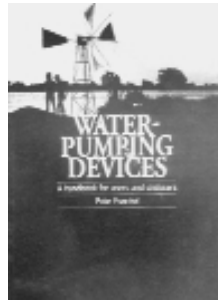

## The Water Heater Workbook

In the US alone, we throw away 655 water heaters every hour (5.7 million per year). With the tips in this easy-to-follow book, you can help your water heater last 20 years—an average water heater now only lasts 5-8 years. Explains how they work, how to prevent failure, how to upgrade, and how to select and install a new heater.

#BK335 \$20

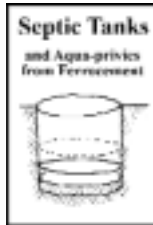

## Septic Tanks

Build your own septic tank from ferrocement. Step-by-step construction details in non-technical language. Compares and recommends different options for different situations. Explains basics of how waste treatment systems work. 98 pages.

#BK119 \$16

## Hand Dug Wells

*Water with limited money & materials*

General principals of ground water storage, preparatory work and actual construction of hand dug wells. Details standard and alternative methods and equipment. Information on low-cost manual, animal-powered, motor, and wind-powered pumping systems. Complete instructions and illustrations.

#BK842 \$29

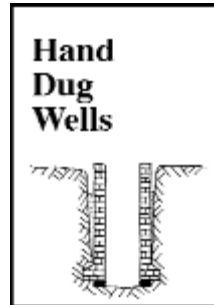

## Water Supplies for Rural Communities

How to implement a successful village water supply project. A lack of sufficient clean water is clearly related to poverty and a lack of self-reliance. This book describes using community participation and the use of appropriate technology to provide this most basic element. Human aspects of water projects, not nuts & bolts; describes projects in Nepal, Malawi, Kenya, and the Pacific. Written for missionaries and community redevelopment workers. 56 pages.

#BK116 \$15

## Rainwater Harvesting

The collection of rainfall and runoff in rural areas. Clearly illustrated details for building rainwater catchment and water storage tanks with locally available materials. Oriented for people in developing countries but excellent information for anyone needing more water. Great hope for the thousands of scattered, small communities in semi-arid countries not served by centralized water. Case studies of work in Africa, India and Southeast Asia. 216 pages.

#BK117 \$22



## Rainwater Collection for the Mechanically Challenged

Great primer for not only Rainwater Harvesting but all aspects of water management—from a cistern to the kitchen sink. Topics include calculating gallons of rainwater collected from a given roof size, choosing a cistern, water purification, pressure pumps and tanks, and the basic plumbing and electrical skills needed to put it all together. Written in a down-home style with lots of clear (often humorous) illustrations. Highly recommended! 50 pages.

#BK3118 \$17.95

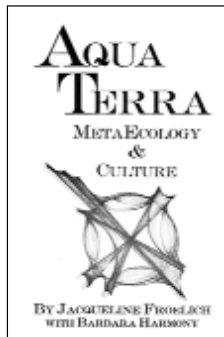

## AquaTerra: MetaEcology & Culture

*Reverence for water*

Eclectic collection of essays and investigations into water technologies. Everything from dowsing to waste water treatment to hydrogen fuel to ecological spirituality. From Lao Tsu to John Todd. Inspiring and informative. Jacqueline Froelich with Barbara Harmony, 1995. 159 pages.

#BK3280 \$10

## We All Live Downstream

*A guide to waste treatment that stops water pollution*

Clear and strong statement describing the mistake of mixing water and human waste, the dire ecological consequences, and numerous alternatives. Compares different composting toilet systems but misses Sun-Mar and Sustainable Village.

#BK3281 \$7.95

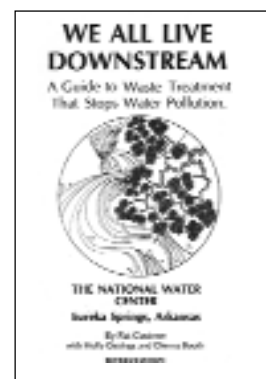

## Rainwater Catchment Systems for Domestic Supply

Learn to design, construct, and implement a rainwater catchment system from numerous examples around the world. This book focuses on the implementation of roof and ground catchment systems for either total or supplementary household water systems. Covers all aspects of design including sizing, gutters, materials, construction techniques, training operation and maintenance. Many drawings, photos and step-by-step instructions on several household rainwater tanks.

#BK6713 \$25

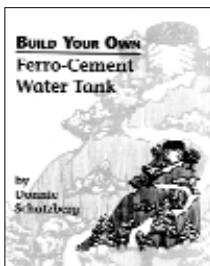

## Build Your Own Ferro-Cement Water Tank

During the last 24 years, the author has built more than 70 of these inexpensive and extremely strong water storage tanks. They are still holding water without a leak and will last longer than we will. Suggests uses, gives detailed instructions, and material lists. 58 pages.

#BK310 \$14

## Hydro and Wind Power

### Building a Domestic Windpump

Make your own water pumping wind machine from inexpensive, recycled materials. Includes information on site selection as well as step-by-step instructions. The design works best for pumping 200 gallons per day or less with 10' of head. Possible to use with higher heads of water but would need stronger components. 50 pages.

#BK3479 \$23



### Micro-Hydropower Sourcebook:

*A practical guide to design and implementation in developing countries*

Detailed reference manual and guide for planning, designing and implementing a micro-hydropower system. Includes cost-effective examples of systems installed within the constraints of developing countries. 286 pages.

#BK370 \$27



### Hydro Plans

Build your own hydroelectric system from an old oil drum. Good, detailed instructions. DC generator and parts kit also available.

#HY501 \$10

### Going with the Flow: Small Scale Water Power

For those considering a small (less than 100kW) water power scheme. Detailed information on site assessment and flow measurement, system design, costs and payback, turnkey systems, installation, safety, wiring, planning, and maintenance. Also useful for general interest—history of water power, general principles, components, selling power to the grid, case studies and glossary. Bill Langely, 128 pages.

#BK3008 \$15

### Motors as Generators for Micro-Hydropower

Practical handbook for using induction motors to make micro-hydro systems in remote locations. Written from the practical experiences of engineers and technicians designing and installing small systems for isolated houses and villages in a number of countries. 84 pages.

#BK371 \$12

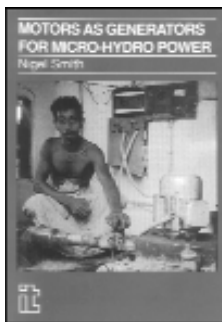

### Water Current Turbines



Inexpensively pump water from a river using the force of the river itself. Includes manufacturing drawings and information on low-cost components like bicycle parts. Includes many real-life experiences and

economic assessments. 114 pages.

#BK372 \$14.97

### Windpumps

*A guide for development workers*

Comprehensive look into every aspect of wind-powered water pumping—history, economics, how to size and choose the best system, installation, operation, and maintenance. Huge source of practical information. 156 pages.

#BK105 \$31

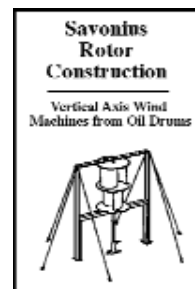

### Savonius Rotor Construction

Build a wind generator from oil drums. Step-by-step instruction manual for building either a two-stage wind machine for water pumping or a three-stage rotor for charging batteries. Simple construction using hand tools and commonly available materials. Fully illustrated.

#BK844 \$14.95

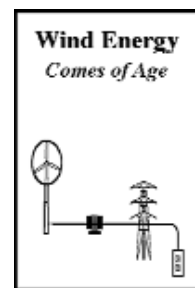

### Wind Energy

*Comes of age*

Details the history of wind power and its usage in the US and abroad. Focuses on current technology while also discussing the political, environmental, and economic factors involved. Filled with technical data, maps and organizational lists. An excellent reference source—essential for anyone working with wind energy. 536 pages.

#BK204 \$120



### Wind Power for Home and Business

*Renewable energy for the 1990s and beyond*

Complete reference on small wind generators. 90 illustrations, maps, 432 pages.

#BK155 \$35

**Solar Electric**

**The Solar Electric Independent Home Book**

Great book for understanding, sizing and installing a solar electric system. Many pages of diagrams that show at a quick glance how the various components fit together. Also chapters on mounting, controllers, batteries, inverters, and maintenance. We especially like the chapter called "Safe, Safer, Code." 182 pages.



**#BK555 \$20**

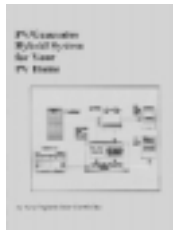
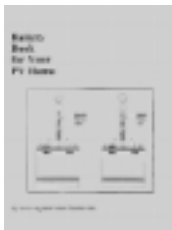

**PV Home Series Booklets**

Detailed information booklets full of diagrams and instructions. They average 25 pages.

**Battery Book for your PV Home #BK556 \$8**  
**PV/Generator Hybrid System #BK557 \$9.50**



**Photovoltaics**

A complete manual for PV design and installation. Full of useful data: solar insolation, maintenance schedule and trouble-shooting guides. Topics include system components, system loads, system sizing and installation. Easy to understand and yet probably the most complete educational guide to solar electric systems available. In fact, the only publication that complete PV novices could follow and actually both design and install a solar electric system by themselves. 173 pages, 55 pages of charts & graphs.

**#BK340 \$60**

**From Space To Earth:**

*The Story of Solar Electricity*

"For those of us who grew up with the space program, solar cells have always been there - on satellites. The story of how photovoltaics came to be goes back nearly 100 years, though. As with any good history, it's filled with colorful people, intrigue, and politics. From Space To Earth reads like a good thriller. Author John Perlin spent years researching this book. He got his hands on laboratory notes, personal correspondence, and unpublished papers. He declassified documents; and conducted innumerable interviews with individuals throughout the world who devoted their lives to photovoltaics. The history of PV is a quiet success story. You'll be gratified to learn how this elegant power source has gained worldwide acceptance."



**#BK6489 \$32**



**The Fuel Savers**

Complete kit of solar ideas. Analyzes the different solar energy ideas you can use in your living area. Recommends many inexpensive and easy-to-do energy saving techniques. A great step-by-step guide for improving the solar potential of your home and reducing the need for fossil fuels.

**#BK1141 \$5**

**Wiring 12 Volts For Ample Power**

Hard to find wiring details, general schematics and troubleshooting information. Includes history of electronics from 600 BC to the modern age, DC electricity, DC magnetics, wiring practices, and much more. Smead & Ishihara.

**#BK202 \$20**



**Practical Photovoltaics**

Understandable guide to design, theory and future of solar cells. Combines technical discussion and practical advice including step-by-step instructions for assembling a solar array. 200 pages.

CoEvolution Quarterly calls this book, "The easiest, most complete education of the subject available."

**#BK101 \$18**

**Independent Energy Guide**

*Electrical Power for Home, Boat & RV*

Review of all available options for producing, storing and using electrical power on land and sea. Photovoltaics, small wind and water powered generators, alternators, portable generators, batteries, inverters, system controls, energy-efficient appliances, and much more. 256 pages.

**#BK3112 \$20**

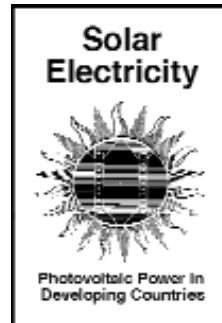
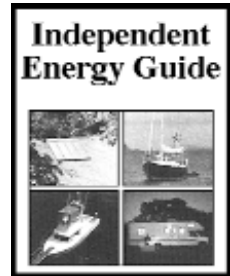

**Solar-Powered Electricity**

Photovoltaic Power in Developing Countries

A survey and description of use in developing countries. Comprehensive testimony on the value of solar electricity in remote areas. Lighting in the South Pacific, water pumping in Mali, solar refrigerators in India,

rural electrification in Indonesia. Also describes many other kinds of applications like water treatment, telecommunications and unusual applications like aircraft warning lights and navigation buoys. A great deal of hard-to-find information we haven't seen in any other books. 87 pages.

**#BK110 \$29.50**

**Solar 2 CD-ROM**

"Solar 2", produced by Home Power Magazine (HP), is about Solar Energy and how to capture and use it for home, village, recreational and business use. Renewable energy is experiencing increasing popularity as people discover this enabling technology and apply it here in the U.S. and abroad. The CD contains the largest body of knowledge about practical applications of solar power; the first 42 issues/3900+ pages of HP magazine. This on CD-ROM offers an easy to navigate, searchable front-end to the information at an attractive price. It also saves over 15 lbs of paper with the associated printing and distribution impacts.

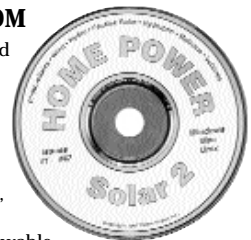

**Solar 2 CD-ROM \$29**  
**Issues 1 through 42 #PV4639**  
**Solar 3 CD-ROM \$29**  
**Issues 43 through 60 #PV4846**

## Solar Cooking

### Solar Box Cooker Guide and Plans

Basic plans and instructions for making solar cookers. How to make an efficient cooking device in just a few hours using locally available materials such as cardboard or wood, glue and glass. Detailed plans tells how to make and use. Leaders' Guide gives information on teaching and promoting solar cooking.

**Basic Plans #BK331 \$9**  
**Leaders' Guide #BK332 \$10**



### Cooking with the Sun

Detailed, simple instructions on building a solar oven that can reach over 425° and a solar hot plate that gets over 600°. Includes 100 solar recipes keyed with graphics indicating the best sun position and whether to use the oven or hot plate. 122 pages.

**#BK333 \$9.95**

### Morning Hill Solar Cookery Book

Great source of recipes for solar-cooked healthy, hearty, and tasty vegetarian fare. Includes cooking techniques and tips for both solar and conventional cookery.

**#BK7573 \$15**



### Amazing Sun Fun Activities

Introduce kids to the basics of solar energy with this handy booklet. Clear text and cartoons guide them through 10 simple hands-on experiments, including a pizza box solar cooker. Also great for teachers! Daley, 32 pages.

**#BK1736 \$12.95**

### Cocinas Solares

En los países pobres, el 85% de la energía consumida se emplea para cocinar. Según un informe de la FAO, cerca de 1.500 millones de personas no disponen de combustible necesario para calentar los alimentos o pasteurizar el agua. Este práctico manual enseña, paso a paso, cómo construir y usar una "caja" o cocina solar, capaz de alcanzar y mantener temperaturas superiores a 100 °C, con la cual se puede cocinar una gran variedad de alimentos sin otra energía que la procedente del Sol, así como pasteurizar el agua de consumo, evitando multitud de enfermedades causadas por contaminación bacteriana. 96 páginas.



**#BK4970 \$15**

### Cooking with Sunshine

*"The Lazy Cook's Guide to Solar Cuisine"*

Solar cookers are a practical and enjoyable way to reduce your energy dependence. Here's how you can start using one. Learn about equipment and cooking methods. Tells you when and where you can efficiently use a solar cooker. Complete directions for building your own, and lots of great recipes, too.

**#BK5004 \$14**



### The Expanding World of Solar Box Cookers

The definitive book on solar box cookers. Technical enough for the most experienced box cooker builder, but also easy enough for beginners. Emphasizes cooker use in developing countries and focuses on using available resources inexpensively. Demonstrates how to design and build your own box cooker, includes four cardboard cooker plan sets.

**#BK180 \$15**



## Renewable Energy

### Solar Electric Systems for Africa

*The best, most practical, do-it-yourself PV book*

We love this book. Written for people in remote places without handy hardware stores, it includes hundreds of wonderful graphics and charts that make it simple and easy to design, install, trouble-shoot, and maintain solar electric systems. Great cost-saving ideas like how to make your own mounting structures and manual solar trackers. Not code-oriented but extremely practical.

**#BK144 \$26**

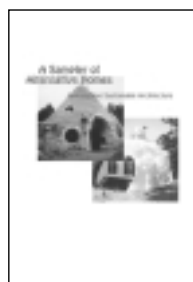

### A Sampler of Alternative Energy Homes

There's more than one way to build a house. This video shows creative alternatives to conventional lumber and plywood. Adobe, straw bale, cordwood, and more are all documented in this professional quality video. Videographer Kelly Hart brings his personal experience since he himself is living in a house made of sandbags. Two hours of fascinating, challenging concepts.

**#V04594 \$30**

### Renewable Energy Videos

A close look behind the advertising into the dynamics of actual systems. See answers to the most common questions filmed on-site in dramatic color. A great index lists questions with the corresponding time on the tape they're described. If you're considering a renewable energy system, this is the best, fun and easy way to learn the fundamental information.



**Residential Microhydro Power #V03102 \$39**

**Residential Solar Electricity #V03103 \$39**

**Residential Wind Power #V03104 \$39**

**Solar Water Pumping #V03198 \$39.95**

### Storage Batteries for Renewable Energy Systems

Newest addition to the "Renewable Energy With The Experts" series. Narrated by Richard Perez from Home Power Magazine. Excellent overview of batteries in a renewable energy system. Touches on other components like inverters, meters, and controllers as well. We highly recommend this to anyone considering building their own power system!

**#V04756 \$39**



## Alternative Transportation

### QuikStix Workbook

10 Electric vehicle designs—a builder's "erector set". Build everything from your bed to a portable home to an electric vehicle with components you can recycle yourself thousands of times. A revolution in building design and construction—inexpensive, amazingly versatile and easy. Anyone can use these simple methods and designs, save hundreds of dollars, and build things to their exact specifications. Explains and shows how to make furniture, modular shelters, greenhouses, many kinds of electric vehicles, a mini-tractor, wind generator, solar concentrator, and much more. Appropriate technology at its best.

#BK166 \$20



### New Electric Vehicles

*A clean and quiet revolution*

Completely comprehensive overview covering solar cars, electric conversions, human-powered vehicles, building your own, maintenance, bikes, boats, and planes. Wonderful pictures and entertaining text by venerable AT writer Michael Hackleman. Produced six miles from the grid with power from PV and wind, Exeltech and Trace inverters (it took 424 kWh). Essential—everyone should have this book. 272 pages.

#BK1492 \$24.50

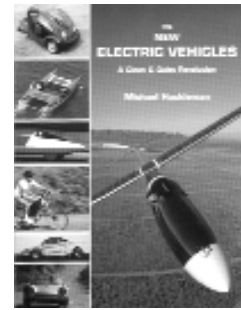

### Build Your Own Electric Vehicle

One of the best books on building your own EV. A comprehensive textbook on EV conversion including information on all major components. Details the major procedures from start to finish. 310 pages.

#BK915 \$19.95



### The Design and Manufacture of Animal Drawn Carts

Describes commonly used kinds of carts and suggests improvements. 122 pages.

#BK135 \$19.50

### Convert It

The definitive hands-on EV conversion manual. A synthesis of 28 years electric vehicle experience. Systematically goes through the conversion process step-by-step with instructions for producing a practical and reliable electric vehicle. Good chapter on getting started by choosing the appropriate donor car. 3rd edition, 1993, 128 pages.

#BK911 \$25



### Low-Cost Load-Carrying Devices

Design and manufacture of basic transport technologies. Solve the most common transport problems in remote areas—off the road movement of small loads over short distances. Good illustrations of design details and guidelines for making wheelbarrows, handcarts, carriers for bicycles, panniers for animals, animal-drawn sledges, and carrying aids like shoulder poles and backframes. 192 pages.

#BK139 \$29.50

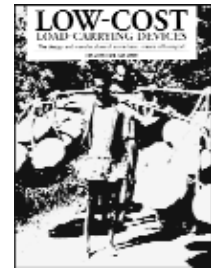

### Earth Roads

*Construction and Maintenance*

Practical manual describing how inexperienced people can design and build roads with a usage of up to 50 vehicles per day. Covers drainage, road planning, the actual construction, and subsequent maintenance. 134 pages.

#BK140 \$18

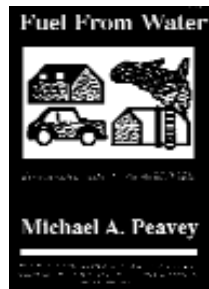

### Fuel From Water

How to make, store and use hydrogen. Plans for making your own electrolyzer and modifying engines to run on hydrogen. Detailed information on basic theory, applications and safety. The basic source and reference book for anyone interested in this most promising alternative to fossil fuels. 244 pages.

#BK591 \$25

### Electrical Vehicle Structures & Components

A survey of the technology used in battery-powered vehicles. The latest trends in EV battery technology, electric motors and structural materials—the benefits and drawbacks of each type. Comprehensive descriptions and component analysis based on environmental impact. 75 pages.

#BK905 \$16



### Pedal Power Plans

Keep yourself in shape while you charge your battery system. Generate up to 125 watts of power. Designed for ten-speed 27" bicycle but you can easily modify for other sizes, exercise bikes and children's bicycles.

#PP101 \$18



**From the Fryer to the Fuel Tank**

With a minimal investment and a willingness to get your hands greasy, make diesel fuel from waste vegetable oil. Biodiesel burns dramatically cleaner than petrodiesel and costs far less. Authors Joshua and Kaia Tickell have toured the country in their biodiesel powered “Veggie Van” and have taught their technique to thousands. Their book tells you how, in clear and entertaining fashion.

#BK4818      \$24.95

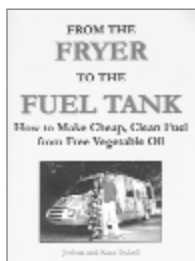

**A Chinese Biogas Manual**

Build your own biogas system for cooking, lighting and producing power. China has over seven million biogas pits in operation. They act as a combination waste disposal, recycling center and fertilizer production, while providing a high quality fuel for cooking, lighting and power. One cubic meter of biogas will light a 60–100 watt bulb for 6 hours, cook 3 meals for a family of 6, generate 1.25 kW of electricity, run a 3-ton truck for 2.8 km, or a 1 HP motor for 2 hours. Complete details for making a biogas system in a variety of situations and soil types. 135 pages.

#BK841      \$21

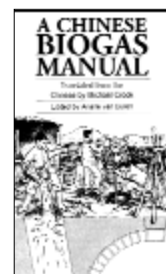

**Farm Motors**

Beginning with a fascinating introduction to “the animal as motor”, this complete guide, presents the origins and mechanical principles of farm motors. Using the mechanics of the horse as the springboard, Farm Motors goes on to present an accessible and fully illustrated tutorial on energy and its sources, the law of transformation of energy, prime movers vs electrical motors, and much more. Also includes clear explanations on the mechanics of the most popular types of farm motors including waterwheels, tidal machiness, and windmills; steam engines; internal combustion engines; and current electricity, along with information on their construction. Originally published in 1908, 222 pages.

#BK7479      \$13



**Three Cubic Meter Biogas Plant**

*A construction manual*

Step-by-step instructions for making a low-cost, reliable, and low maintenance continuous feed methane digester. Proven design used in thousands of systems in India.

#BK3593      \$12

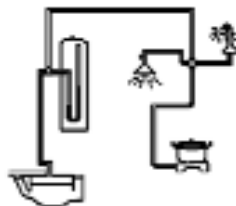

**Power Plants:**

*Biofuels made simple*

Biofuels represent a significant, under-utilized resource. From agricultural produce to farm slurry, landfill gas to gasohol, biofuels play an increasing role. Sustainable energy sources such as these can help replace fossil fuels and nuclear power sources. Brian Horne analyzes different techniques and their environmental impact, and presents this complex topic in an understandable form. 62 pages.

#BK1777      \$16



**Handcart Handbook**

Give your draft horses a rest with a well-designed and versatile handcart. With inexpensive components and some time, you can make the same handcart you see advertised for hundreds of dollars. Detailed instructions for building and using a standard handcart plus many variations - human and animal harnesses, a bicycle attachment, a sled, even your own taxicab. Handcarts are especially useful for hauling in remote areas and diverse landscapes, or as a portable kiosk. 48 pages.

#BK7579      \$4.50

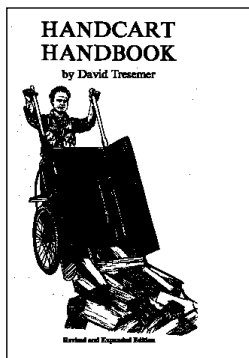

**Alternative Building**

**Passive Solar House Basics**

Great info for siting, designing, building—even living in—a passive solar house. Great diagrams and floor plans make the described principles easy to understand and apply. By Peter van Dresser who in 1958 built one of the two oldest solar heated houses in the US. 1995. 136 pages.

#BK3393      \$11



**Biogas**

**Biogas**

*A complete handbook*

How to build a biogas system that will transform animal and crop wastes into a clean, high-grade fuel while producing a great fertilizer. Compares author's experience in Nepal to systems in India and China. For both domestic and community systems. 187 pages.

#BK850      \$28



**Biogas Systems in India**

Potential fuel and fertilizer source assessment. Detailed and thoughtful analysis of resource, economic and social aspects. Includes computer simulation.

#BK3592      \$29

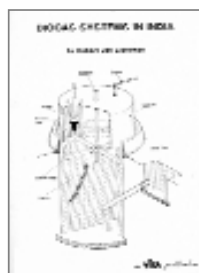

**The Passive Solar House**

*Using solar design to heat & cool your home*

Full of valuable, constructive advice with a comprehensive look at the ten key principles of solar design. Useful for any architectural style or building method. Detailed work sheets and clear drawings. ©1997. 211 pages.

#BK3064      \$24.95

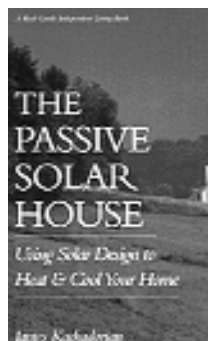

## Adobe: Build It Yourself

*"Unquestionably the best how-to-do-it book on all aspects of adobe construction"*

From planning to countertops, comprehensive information about every step in adobe home building. McHenry, 1985, 158 pages.

#BK3396 \$22.95



## The Natural Builder

Easy to read reference guides full of detailed, concise information and tips needed to build naturally.

**Volume 1** explores various forms of earthen architecture including traditional unstabilized adobe, semi-stabilized adobe, fully stabilized adobe, pressed block adobe, poured adobe, monolithic adobe ("cob"), cast earth, rammed earth, fired ceramic adobe ("geltaftan"), burnt adobe, sod bricks and "superadobe". Soil analysis, engineering tests and other critical elements of building with earth are covered in this volume.

#BK7296 \$20

**Volume 2** is dedicated to the use of sculptural adobe, known as English cob, to create residential buildings. Written specifically to help a cob builder receive a building permit. All aspects of building with cob covering.

#BK7297 \$20

**Volume 3** provides a detailed understanding on plastering adobe, cob, straw-bale, earthship and light clay homes with natural earthen, gypsum, lime and kaolin clay plasters, alis and casein paints. Loaded with plaster formulas, plastering and preparation tips.

#BK7298 \$20



## Adobe and Rammed Earth Buildings: Design & Construction

Expanded sequel to Adobe: Build It Yourself. Numerous diagrams and photographs, in-depth design considerations, detailed information on building codes—essential book for anyone serious about building with adobe. Like having a pro by your side! McHenry, 1984, 217 pages.

#BK3395 \$27.50

## Prescriptions for a Healthy House-

*A Practical Guide for Architects, Builders, and Homeowners*

Take the mystery out of healthy house building. A great walk-through book for the owner/architect/builder team. Goes through the construction process, explains where and why standard building practices become healthful, what to do differently, and how to maintain alternative materials and expertise. Exceptional information on how to design interior and exterior space and select construction materials that enhance and promote physical well-being. Soft-Cover. 259 Pages.

#BK7345 \$30

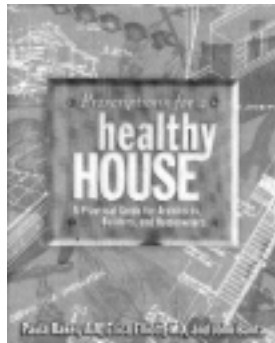

## New Compact House Designs

An overview of 27 house designs, 1,250 square feet or less. Small houses require less energy to operate and consume smaller amounts of raw materials. The houses featured here vary in design from Bauhaus-inspired and postmodernist to traditional and rustic. 188 pages.

#BK1409 \$24

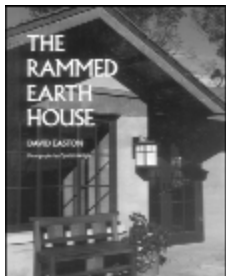

## The Rammed Earth House

*Rediscovering the most ancient building material*

Excellent guide to using indigenous resources as building materials. Rammed earth homes mix three readily available materials (earth, water and a little cement) that pack around wooden frames to form solid, energy efficient structures. Complete information about this building process and many helpful hints. 224 pages.

#BK1157 \$30

## Build a Classic Timber-Framed House

Today's timber-framed home-building easily becomes an ultra expensive affair requiring exotic tools. Here's advice on how to do it affordably using local materials and common hand tools. 202 pages.

#BK1410 \$19.95



## Timber Frame Construction

*All About Post-and-Beam Building*

By the author of Build a Classic Timber-Framed House, this book specifically deals with post-and-beam structures and includes plans for a small Shaker-inspired shed that you can build as your first project. Many photos and clear drawings. 204 pages.

#BK1408 16.95

## The Homestead Builder

Written in 1850 to help new US immigrants build their own shelter. Just as useful today. Tells you how to put up a cabin, a barn, a simple house using local materials. Emphasizes economical construction and simplicity. Includes sections on log, frame, stone, and adobe building materials. Great antidote for "castle fever".

#BK5383 \$12.95



## Build Your Own Low-Cost Log Home

The basic book for log house building. All construction techniques and professional tips on simplifying the work. 208 pages.

#BK366 \$17



## Building With Papercrete and Paper Adobe

A revolutionary new way to build your own home for next to nothing—and do some major recycling at the same time! Affordable housing that also benefits the environment: win-win! This book tells it all with easy-to-understand text, helpful photos, and resource information. Let's do it!

#BK5967 \$22



**Treehouses**

How to design, build, and enjoy a treehouse. Imagine your own Swiss Family Robinson adventure! Also includes great stories and photos of amazing treehouses. 128 pages

#BK5999 \$19.95

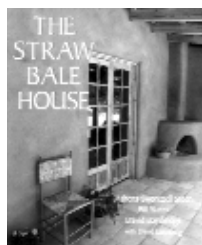

**The Straw Bale House**

Includes 16 full-color straw bale house pictures, 40 illustrations, 280 B&W photos, floor plans. Step-by-step, chaff-to-home discussion of techniques and materials. Wall and

roof types, flooring, plastering methods, and the fundamentals of passive solar design. Hundreds of photos and illustrations. A beautiful book. 300 pages.

#BK149 \$30

**Timber Reduced Energy Efficient Homes**

Building or remodeling a home? You need this book! Real life building experience with realistic building materials cost analysis. Building homes that look and work better, last longer. Cost comparisons for adobe, tires, frame, passive solar. Numerous drawings and photos. 127 pages.

#BK1295 \$18



**Shelter**

1000 photos of houses around the world in this reprinted classic. Ideas for designers, detailed plans for builders, inspiration for dreamers. Caves, huts, barns, yurts, domes, stud-frame building plans, mortise and tenon, tree houses. Materials section includes wood, adobe, rammed earth, sod, plaster, stone, canvas, reed, bamboo. 176 pages.



#BK350 \$20

**How to Build Your Elegant Home with Straw Bales**

90 minute video on every phase of straw bale construction: design, foundations, wall prep and raising, stucco prep and application. Includes an excellent 60 page manual. Enough to go from not knowing anything about bale building to constructing a house.

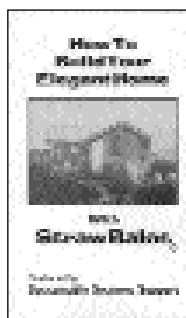

**Video & Manual** #V0102 \$44.95  
**Video** #V0103 \$33  
**Manual** #BK153 \$15

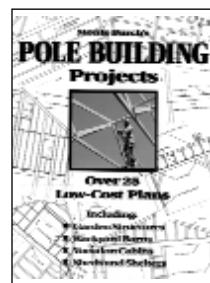

**Pole Building Projects**

Over 25 low-cost plans Garden structures, backyard barns, vacation cabins, sheds, and shelters, pole building construction saves time, labor, and money. Good for many sites not suitable for other types of

construction. Covers every aspect of construction. 208 pages.

#BK305 \$18.95

**Build It With Bales**

Updated and expanded version of Straw-Bale Primer. Complete step-by-step guide for building with straw—from start to finish. Focuses on main points of actual construction. The best book to keep with you during each stage of a straw bale project. 79 pages.



#BK362 \$29.95

**Straw-Bale Construction**

*The Elegant Solution*

30 minute inspiring video on straw bale construction. Great for showing building inspectors, interested but skeptical people.

#V0101 \$33



**Straw Bale Video Series**

*Help with code approval*

Vol. 1 - Visit a novice, weekend workshop and learn design considerations, construction techniques and finishing details of a straw bale home. 73 minutes.

Vol. 2 - What does a straw bale home look like? Tour modern straw-bale homes, learn from experiences of others. 60 minutes.

Vol. 3 - Are straw bale homes durable and fire resistant? Documents code guidelines and testing in NM, AZ and CA. Includes printed copy of NM straw bale building requirements. 40 minutes.

**Volume 1** #V0105 \$30  
**Volume 2** #V01703 \$29.95  
**Volume 3** #V01704 \$38.95

**Earth Construction:**

*A comprehensive guide*

Almost everything you could want to know about the world's oldest and most widespread building material. Comprehensive description of traditional and modern solutions to the various problems and potentials. Essential reading for anyone involved in an earth construction project at any level. 372 pages.

#BK125 \$49



**Buildings of Earth and Straw**

*Structural design for rammed earth and straw bale architecture*

Impress your building inspector and your bank's lending officers. This book details all the structural considerations and test results relating to codes for rammed earth and straw bale building techniques.

#BK3587 \$25

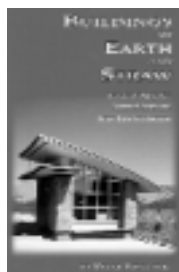

**How to Make Low-Cost Building Blocks**

A user's manual for building in remote areas. Straightforward and illustrated methods for building with earth blocks—from plans and soil testing to completed buildings. Includes structure plans, detailed material lists, techniques—everything you need to know!

#BK114 \$12.50



## Storey's Basic Country Skills

Its a common dream - get a piece of land, build a house, and declare your independence! This book is a great resource to help you literally from the ground up. Chapters on building shelter, gardening, livestock and creating your own power. 544 pages of well illustrated, practical advice for living a more self-sufficient, satisfying life.

#BK6465 \$30

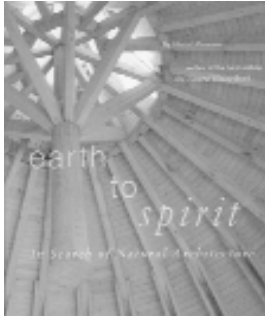
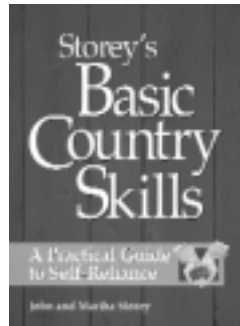

## Earth to Spirit

The author of *The Natural House Book* returns, with wonderful examples of buildings heeding ancient wisdom of ecology, health and spiritual awareness, and how they integrate wisdom of the past with today's technology. Beautifully illustrated. David Pearson, 1994. 159 pages.

#BK3394 \$17.95

## Out of the Woods

*Ecological designs for timber frame DIY construction*

We could just about say, "essential" for anyone building their own home. Evaluates the positive elements and drawbacks of almost every possible design feature. The ecological pros and cons of building materials, how to get from a rough idea to the finished plans, and build the most environmentally friendly home possible. 124 pages, 192 full color plans and photographs.

#BK147 \$29

## Energy-Efficient and Environmental Landscaping

Cut your utilities bills 30% & create a natural, healthy yard. Strategic landscaping that saves from \$200 to \$700 a year. How to use outdoor plants, fences and landforms to cut home energy use heating bills by 30%, air-conditioning by 50-75%, outdoor watering costs by 80%. This could create environmental savings equivalent to closing 23 large power plants or taking 26 million cars off the road. Details plant placement and selection for both regional climates and particular microclimates. 240 pages.

#BK368 \$18

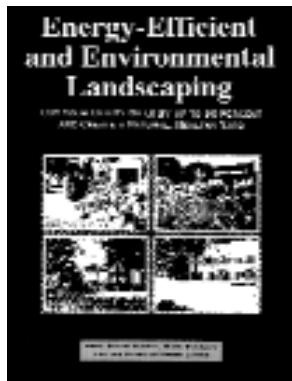

## The \$50 & Up Underground House Book

How to build a home from between \$50 to \$15,000. The author himself started with a \$50 version and added a \$500 addition in 1975 where he still lives and works promoting his book. Also tells how to build root cellars and greenhouses, deal with building codes, solve drainage problems, and get the maximum light, air and views.

#BK354 \$16.95

## Sheds

Upgrade your back yard building projects. Everything from Irish garden sheds, potting, pool, and play sheds to elegant Japanese style. Includes plans for 14 different styles with step-by-step instructions. 152 pages.

#BK6000 \$19.95

## The Tire House Book

Used tires are a big waste headache—piled up in landfills and tire dumps around the world. Now enterprising builders are using them as a basis for building houses. This book is an overview of how some are doing it. Examples are from New Mexico, but there's information you can apply anywhere.

#BK4019 \$15



## Building Stone Walls

Make a stone wall that looks good and lasts almost forever. Also includes information on using stone for runoff control and stream diversion. Many handy tips and illustrations for designing and selecting the best materials and tools. 108 pages.

#BK1407 \$11.95

## Building With Stone

The art and craft of creating stone structures and projects. Detailed instructions on building walls, fireplaces, dams, barns, and repairing old stone structures. 192 pages.

#BK306 \$17.95

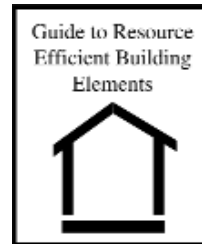

## Guide to Resource Efficient Building Elements

*Directory of recycled alternative building products*  
Complete reference on what's available and where. Over 400 sources and text on efficient building, design, job-site recycling, resource management, and selection. Essential reference for homeowners, builders, designers, governments. 111 pages.

#BK560 \$25

## The Cob Builders Handbook

*You can hand-sculpt your own home*

Cob building is easy, affordable, comfortable, and long-lasting but doesn't have anything to do with corn cobs. Building cobs consist of earth, sand and straw bricks used for thick, load-bearing walls. Fifty thousand in-use-today cob buildings built in England during the 18th & 19th centuries attest to this building method's practical durability. The Handbook covers all the necessary basics on design, foundations, floors, windows, roofs, as well as making and using cobs.

#BK3586 \$24





**Appropriate Building Materials**

*Standard reference for low cost building in remote areas*

Easy to access solutions for almost any low-cost housing construction problem. Fundamental information on all important building materials followed by numerous practical examples from all parts of the world. Incredible amount of knowledge, diagrams and photographs packed into 430 pages.

**#BK112 \$29.50**

**Classic House Plans for City and Farm**

Written at the turn of the century by architect S.B.Reed, this book reflects the attention to detail and pride in construction of an era when homes were built to last. Here are dozens of designs selected by the author for their practicality, comfort and economy. Ranges from simple one room cottages to elegant multilevel Victorians. Each design is accompanied by several detailed floor plans plus useful instructions on building. Includes measurements, materials and estimated cost (a whopping \$1,100 for a three-story home in 1878). Village and Country Residences provides inspiration and time honored council on building the beautiful, reliable home of your dreams in the very same style as the stately original. 243 pages.

**#BK7480 \$13**



**Earthship Vol. 1, 2, and 3**

A home you can build yourself that costs nothing to heat or cool and grow your own vegetables year round! No utility bills! Made from free recycled tires and aluminum cans! If this sounds hard to believe, order Clark Curtis' video or Dennis Weaver's 28 minute documentary video showing his own Earthship and see for yourself. Vol. 1 shows and tells how to build your own Earthship. Includes photographs and floor plans. (230 pages.) Vol. 2 details interior systems inside an Earthship—waste water, bathtubs, stairways, lighting, cabinets, as well as info on building permits and codes. (257 pages). More ideas in Vol. 3 including a solar composting toilet.



- The Earthship Documentary (Dennis Weaver)** #V0302 \$28
- The Earthship Documentary (Clark Curtis)** #V04593 \$29
- Earthship Vol. 1** #BK301 \$29.95
- Earthship Vol. 2** #BK303 \$29.95
- Earthship Vol. 3** #BK304 \$27

**Rustic Retreats—A Build it Yourself Guide**

Get out of town! A rural retreat doesn't have to be exotic, or large, or expensive. How about a river raft with a small cabin on it? A tree house? Small log cabin? This book tells you how to build them all. Starts with basic techniques, describes ways to fabricate doors, windows and other necessary components. Materials lists and measured drawings for each structure. Even if you're just looking for design ideas, this is a great place to find them!

**#BK5093 \$19.95**

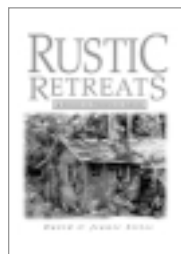

**Gardening, Farming, & Forestry**



**The Xeriscape Flower Gardener**

*A water-wise guide for the Rocky Mountain region*

Create beautiful, low maintenance, and environmentally sound landscaping and gardens. Profiles and compares a long list of flowers, shrubs, and grasses. Full color pictures, charts, and design diagrams—beautiful and important book. Knopf, 1991, 182 pages.

**#BK3397 \$17**

**Saving Seeds**

Seed catalogs jam your mailbox each spring. But how would you like to cut your dependence on them? Gardeners who know how to save seeds are prepared to keep their gardens going indefinitely. This book shows you how and why you can harvest and preserve seeds. Vegetables or flowers—tells you what varieties to select. Includes a list of seed sources to get you started.

**#BK5149 \$12.95**

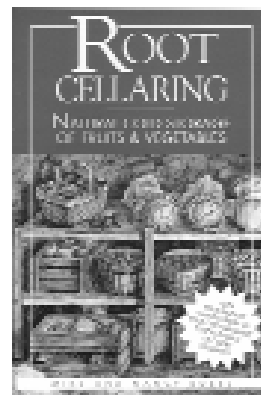

**Root Cellaring**

Root cellars are an old fashioned way of storing your garden's produce without using any power. Using simple insulation and moderating temperatures by digging into the ground, you can keep root vegetables fresh for months. Book describes multiple strategies for building a root cellar. Explains how to maintain temperature and humidity to maximize storage time. Also discusses the best varieties of vegetables for long term storage.

**#BK5150 \$14.95**

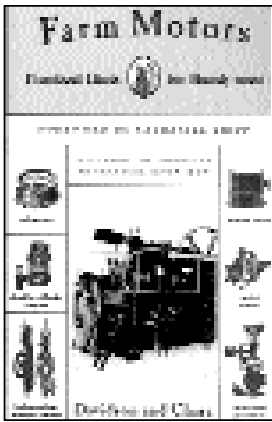

**Farm Motors**

Beginning with a fascinating introduction to "the animal as motor", this complete guide, presents the origins and mechanical principles of farm motors. Using the mechanics of the horse as the springboard, Farm Motors goes on to present an accessible and fully illustrated tutorial on energy and its sources, the law of transformation of energy, prime movers vs electrical motors, and much more. Also includes clear explanations on the mechanics of the most popular types of farm motors including waterwheels, tidal machiness, and windmills; steam engines; internal combustion engines; and current electricity, along with information on their construction. Originally published in 1908, 222 pages.

#BK7479 \$13



**Fences, Gates, and Bridges and How to Make Them**

Written at the turn of the century, this functional pocket manual is loaded with instructions on how to build a wide variety of devices for all regions. Includes over 300 illustrations! 192 pgs.

BK6768 \$13

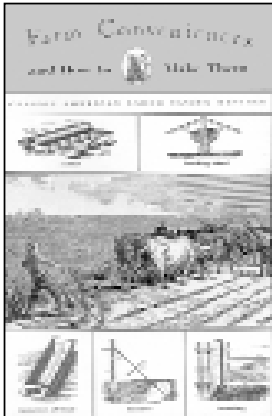

**Farm Conveniences**

Your great grandfather probably knew how to do the things described in this book. Back when the country was young and people grew their own food and made their own clothes, you couldn't walk to the store and buy much. So you made it yourself. Chicken nests, hay racks, horse driven bone-crushers—it's all here. Lots of great ideas if you're planning on getting more self-sufficient.

#BK5384 \$12.95



**Farm Machinery**

*Practical Hints for Handy-men*

A classic of American know-how, this classic guide presents the principles of mechanics as well as step by step instruction on how to build or repair all types of farm machinery, practical enough to use even on todays modern farms.

#BK6737 \$12.95

**Farm Appliances and How to Make Them**

A classic of American ingenuity, this book will take you back to a time when self sufficient farmers devised these clever labor saving devices out of necessity. This pricelss guide contains the most innovative approaches to building appliances, wells, irrigation equipment and land levelers. 200 illustrations 192 pps.

#BK6770 \$12.95



**Farm Blacksmithing**

The complete, no-nonsense guide originally published at the turn of the century. Dispenses invaluable instruction on all the essential skills of the blacksmiths craft. Author J.M. Drew begins with basics including how to set up shop, selecting materials and tools, practice projects such as door hooks, staples and chains. He then goes on to give a complete tutelage on all the techniques any good blacksmith must master - from welding to tempering tools to shoeing farm horses. The best part is that this book is the lightest thing the novice blacksmith needs to pick up! 98 pages.

BK7470 \$13

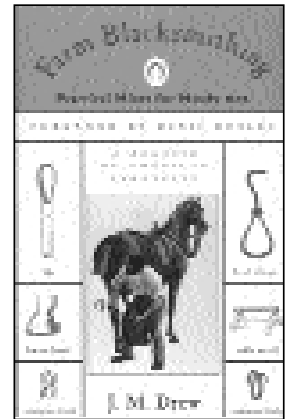

**Handy Farm Devices and How to Make Them**

Originally published in 1909, much of this information is nearly a lost art in this era of store-bought, ready-made products. Many illustrated projects for the farm or home, as well as formulas and good advice make this fascinating reading, even for today's urbanite. Originally sold for ten cents; our price is unfortunately, somewhat higher today! 288 pages.

#BK1415 \$12.95

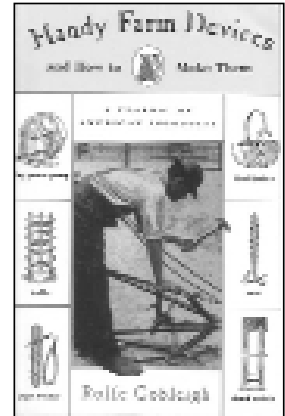

**Solar Gardening**

Grow vegetables year round while you increase your yield. Excellent guide to extending the growing season for almost any type of vegetable. Dramatically increase the annual yield without using harmful fossil fuels. How to build solar equipment for maximizing solar heating during cold months and minimizing scorching during the summer. Helps select crops that thrive during different times of the year. 267 pages.

#BK337 \$25

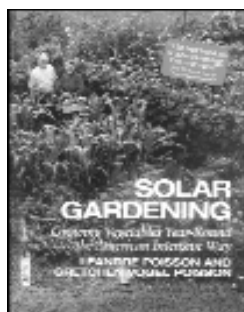

**Forest Gardening**

*Cultivating an edible landscape*

Work with rather than against nature for high productivity with minimal maintenance. Transform a small cottage garden into a diverse and inviting habitat for songbirds, butterflies, and other wildlife. The more people that read and work with this book, the better our world will become.

#BK3588 \$18



**Fences for Pasture and Garden**

Want to build a fence? Keeping something out, or keeping it in? Or just because one would look so nice? Here's the book that will help you decide what to use and how to put it up. Electric, woven wire, rail—all the major styles are here. Learn how to set posts, stretch wire—all the basic skills needed to make a fence strong.

#BK4917 \$15

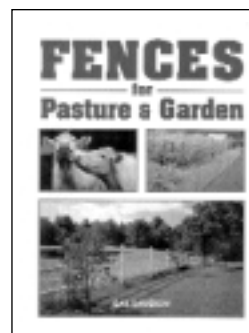

**Agroecology**

The scientific basis of sustainable agriculture. Classic text on basic ecological principles of how to study, design and manage agroecosystems, create productivity while conserving natural resources. 428 pages.

#BK327 \$38

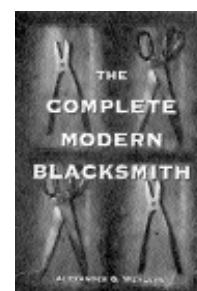
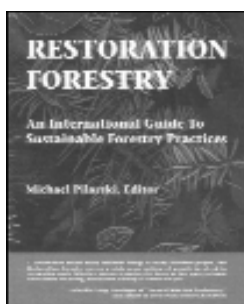

**Restoration Forestry**

International, comprehensive guide to sustainable forestry practices. 50 articles, 2400 references, 528 pages—an invaluable teaching and information reference manual for ecological forestry and sustainable development projects worldwide. Describes ecological forest management and gives actual results from restoration projects in many countries. This is a wonderful book, we highly recommend it. 528 pages.

#BK148 \$27

**Chicken Tractor**

The gardener's guide to happy hens and healthy soil. Chickens belong in your garden! A chicken tractor is a bottomless shelter, moved around where you need help most. Chickens eat pests, weed, seed, and fertilize the soil. Emphasizes humane treatment of animals. 230 pages.

#BK1866 \$20

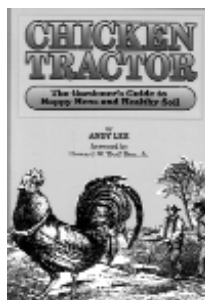

**The Complete Metalsmith**

Almost everything about working with metal—easy reference to a huge variety of techniques and procedures, charts, conversion tables, and hard-to-find technical details. Good beginning level yet a great resource for experienced hands as well. 208 pages.

#BK6001 \$14.95

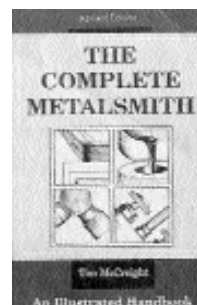

**You Can Farm**

A powerful, heartfelt description of how a small-scale farm can succeed. Joel Salatin is one of the nation's top practitioners of direct marketing. From their farm in Virginia's Shenandoah Valley, Joel and his family generate a healthy income by selling meat, produce, firewood and many other products to a large base of customers. They do all of this without large machinery, without accepting subsidies—entirely on their own terms. This book will help you decide if you have what it takes to do the same.

#BK4693 \$34.95

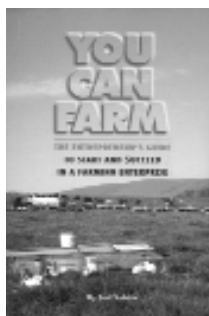

**Building Small Barns, Sheds, and Shelters**

You've bought a little piece of land and would like to start farming it on a small scale. Now you need some storage. A barn for hay, livestock shelters for your critters. It's all here—how to design, size and build them. Explains techniques and materials. Specific ideas for rabbits, poultry and swine. Build a smokehouse and a root cellar. Clear directions and diagrams.

#BK5152 \$14.95



**The Complete Modern Blacksmith**

Design, forge, and fix your own tools, hardware, kitchen accessories—this comprehensive 304 page resource gives all the essential information. Combines three previously published books, Making of Tools, Modern Blacksmith, and Recycling, Use, and Repair of Tools.

#BK6002 \$19.95

S50 & Up Underground House Book.....	186	Battery Adapter.....	72	Complete Modern Blacksmith.....	189	Ecology & Environment.....	174
& Amp Meters.....	92	Battery Boxes.....	87	Compost Crock.....	165	EcoRaft.....	147
120V DC Inverter.....	79	Battery Cables.....	87	Composting Toilet Book.....	171	Efficient Speed Control.....	151
12V Bedwarmers.....	162	Battery Capacity Meter.....	93	Compression Terminals.....	87, 116	EI-SID.....	26
12V Bulb Adapter.....	115	Battery Chargers.....	86	Congo Submersible.....	20	Electric Faucet Combo.....	21
12V Christmas Lights.....	103	Battery Combiners.....	98	Consulting.....	113	Electric Fencers.....	118
12V Circline.....	102	Battery Enclosure.....	87	Convair Prestige.....	151	Electrical Vehicle Structures.....	182
12V Compact Fluorescent.....	99	Battery Recharging Station.....	6	Convert It.....	182	Electrodex.....	102
12V DC One Piece.....	99	Battery Reconditioner.....	87	Cooking with Sunshine.....	181	Electrolyzer.....	47
12V Desk Lamps.....	104	Battery Selection Switch.....	97	Cooking with the Sun.....	181	Electrolyzers.....	47
12V Grow Lights.....	102	Battery Terminals.....	87	Corn Planter.....	118	Electronic Converter.....	81
12V LED Wall Lights.....	107	Battery Tester.....	71, 72	Corona Grain & Corn Mill.....	127	Elongata.....	120
12V Planer.....	116	BatterySAVER.....	70	Countertop Dishwasher.....	128	En-R-Lights.....	111
12V Quartz Halogen Bulbs.....	102	Bayonette Base White LEDs.....	105	Country Living Mill.....	127	EN-R-PAK.....	62
12V Track Lighting System.....	104	Bergey Wind.....	52	Cozy Direct Vent Wall Furnaces.....	161	Energy Saving Appliances.....	123
3 Leg Cast Iron Pots.....	128	Beyond Organic.....	126	Crimping Tool.....	87, 116	Energy System Engineering.....	170
3-Way Valves.....	146	Bilge Pumps.....	147	Crusader 12V Filmstrip.....	137	Energy-Efficient and Environmental Landscaping.....	186
6/12V Modules.....	61	Biogas A complete handbook.....	183	Crystal Cold.....	133	EnerMaxer III.....	90
A Book for Midwives.....	176	Biogas Systems in India.....	183	Custom Hydro Systems.....	49	Engel.....	132
Absolute Zero.....	132	Biolet.....	143	Custom LED's.....	106	Enviro-Fan.....	151
AC Converter.....	25	Biolet Basic.....	143	Cyst Filter.....	34	Environmental Sourcebook.....	175
AC to DC Converters.....	81	Blacksmithing Instructors' Guide.....	174	Daily Water Requirements.....	19	EnviroSink®.....	146
AC/DC Light.....	101	Blender.....	129	Damping Line.....	25	Equator Compact Dishwasher.....	128
Accordion Laundry Racks.....	124	Blumat Outdoor Kits.....	45	Danby Twin Tub Washer.....	123	Equator Washer/Dryer.....	123
Adobe and Rammed Earth Buildings.....	184	Blumat Plant Saver.....	45	Dankoff Solar Water Pumps.....	22	Eternalight.....	109
Adobe: Build It Yourself.....	184	Bowjon Wind Generator.....	30	DC.....	54	Eutetic Freezers.....	131
Aeration and De-Icing Systems.....	119	Bowjon Wind-Powered Water-Lift Systems.....	30	DC Ballasts.....	100	Eutetic Refrigerator.....	131
Aerobic 07.....	42	BP Panels.....	61	DC Ceiling Fan.....	151	EVAC.....	145
Aeromax.....	87	Branched Drain Greywater.....	171	DC Dimmer.....	94, 115	Excallbur Food Dehydrators.....	127
AeroVironment.....	29	Brass Oil-Fired Lamp.....	103	DC Dual Fuel Generators.....	53	Exceltech.....	78
Agroecology.....	189	Brown Gas Ranges.....	126	DC Generators.....	54	Exceltech Inverters.....	78
Air 403.....	50	Build a Classic Timber-Framed House.....	184	DC Impact Wrench.....	117	Exit Signs.....	114
Air Compressor.....	30	Build It With Bales.....	185	DC Incandescent Bulbs.....	103	Expanding World of Solar Box Cookers.....	181
Air Flush.....	144	Build Your Own Electric Vehicle.....	182	DC Load Center.....	97	Expedition Filter.....	39
Air Heaters.....	163	Build Your Own Ferro-Cement Water Tank.....	46, 178	DC Thermostats.....	151	Explorer Purifier.....	38
Air Supply Ventilator.....	162	Build Your Own Low-Cost Log Home.....	184	DC to DC Converters.....	81	Express Power Pack.....	167
Air Tower Kits.....	52	Building a Domestic Windpump.....	179	DC Variable-Speed Fan Control.....	151	Exstream Microfilters.....	34
AirFlo Dehydrator.....	117, 127	Building Small Barns, Sheds, and Shelters.....	189	DC/Air Conditioner.....	152	Extension Cords.....	94
Airwell Distiller.....	43	Building Stone Walls.....	186	Decorator Fluorescents.....	101	EZ-Wire System.....	51
Aladdin Hand-Powered Generator.....	69	Building With Papercrete and Paper Adobe.....	184	Deflect-o.....	124	Family First Aid.....	176
Alarm Clock.....	166	Building With Stone.....	186	Deka.....	83	Family SoSaver.....	43
All About Hydraulic Ram Pumps.....	177	Buildings of Earth and Straw.....	185	Dempster Hand Pumps.....	28	FAQ's—Hydro Electric.....	48
Amazing Sun Fun Activities.....	181	Button Battery Charger.....	70	Deodorant Stone.....	166	Farm Appliances and How to Make Them.....	188
Amazon 4 GPM.....	20	BZ Charge Controller.....	88	Deschutes.....	34	Farm Blacksmithing.....	188
Ammeters.....	93	Cabin Light.....	106	Design and Manufacture of Animal Drawn Carts.....	182	Farm Conveniences.....	188
Ammonia Absorption Cooling.....	173	Cabin Power Center.....	62	Diesel Generators.....	53	Farm Machinery.....	188
Ampair Pacific.....	52	Cable.....	95	Digital Amp Meter.....	93	Farm Motors.....	183, 188
Anaemascan.....	121	Camp Filter.....	39	Digital Meter.....	90	Fax Timer.....	139
Answering Machines.....	81	Canning, Freezing, Curing, & Smoking of Meat, Fish, & Game.....	174	Digital Voltmeter.....	93	Faxguard.....	80
Apple Peeler.....	128	Car-cord Inverter.....	79	Diodes.....	95	FCC approved Remote Phone.....	136
Appropriate Building Materials.....	187	Carbon Filter.....	35	Disconnect.....	97	Fences for Pasture and Garden.....	189
Appropriate Paper-Based Technology.....	173	Carbon Monoxide Detector.....	165	Do-It-Yourself White LED's.....	106	Fences, Gates, and Bridges and How to Make Them.....	188
Appropriate Technology Library.....	172	Carousel Composting Toilet System.....	143	Doctors Book of Home Remedies.....	176	Fish Processing.....	177
Appropriate Technology Water Pumping Station.....	10	Cat Vented Catalytic Heater.....	161	Domes.....	168	Flameless Heat Gun.....	117
Aqua D-2000.....	43	CD Player.....	139	Domestic.....	132	Flamex Gloves.....	160
Aqua Helix.....	44	Cedar Hot Tubs.....	32	Don't Drink the Water.....	177	FlashLED's.....	110
Aqua Star/Bosch.....	156	Ceiling Fan.....	151	Double Ells.....	146	Flat Adapters.....	99
AquaClean.....	43	Cell Phone Charger.....	68	Double Outlet.....	94	Flexcharge.....	88
Aquair Submersible Generator.....	49	Centrex.....	142	Double-Bubbler.....	47	Flexible PVC.....	49
AquaMate.....	42	Check Valve/Gauge.....	28	Doulton Berkefeld Gravity Filters.....	40	Float Switches.....	31
Aquasolar Fountain Pump.....	27	Chicken Tractor.....	189	Downpipe Filter Collectors.....	46	Floating Suction Filters.....	46
AquaStat.....	155	Chiller.....	151	Drum Fixtures.....	101	Floatron Solar.....	42
AquaTerra.....	178	Chinese Biogas Manual.....	183	Drip Water Filter/Cooler.....	40	Flowlight Booster Pump.....	23
ASE - Advanced Solar Encapsalant.....	57	Chofu.....	158	Dry Run Switch.....	31	Fluorescent Night Light.....	101
Asko W600 Clothes Washer.....	123	Circlines.....	102	Dry Well/Sand Filter.....	147	Food Strainer.....	128
AstroPower Single Crystal Modules.....	57	Circuit Breakers.....	98	Dual Battery Relay.....	97	Foot Pump.....	28
ATC Fuse Box.....	97	Class T Fuses.....	98	Dual Kool.....	153	Forest Gardening.....	189
Atex Soldering Irons.....	95	Classic House Plans for City and Farm.....	187	Dual-Battery Controllers.....	89	Forever Flashlight.....	110
Attic Gable Fan.....	150	Clean & Green.....	174	Duplex Submersible.....	18	Fountain Pumps.....	27
Australian Tea Tree Oil.....	177	CleanSource.....	18	Dyna Jet Wringer.....	124	FreePlay Solar Radio.....	138
Automatic Demand Pump.....	21	Clear Halogen Bulbs.....	102	E-Meter.....	92	Freshwater Fish Pond Culture & Management.....	177
Automatic Faucet Control.....	45	Clivus Multrum.....	145	e-Still.....	43	Frigidaire Gas Dryer.....	124
Automatic Hay Feeder.....	120	Cob Builders Handbook.....	186	Eagle Stove.....	125	From Space To Earth.....	180
Automatic Pump Stop.....	31	Cocinas Solares.....	181	Earth Construction.....	185	From the Fryer to the Fuel Tank.....	183
Automatic Voltage Switchers.....	80	Coffee Beans.....	126	Earth Massage Low Flow Showerhead.....	44	Frostek.....	133
AutoVent Turbo.....	152	Coffee Maker.....	129	Earth Press.....	117	Fuel From Water.....	47, 182
Back-Up Sump Pump System.....	20	Coffee Roaster.....	126	Earth Roads.....	182	Fuel Savers.....	180
Backpacker Solar Oven.....	125	Coldsaver.....	131	Earth to Spirit.....	186	Fuse & Breaker Boxes.....	97
BactaCell Kit.....	34	Collapsible Water Container.....	33	Earthship Vol. 1, 2, and 3.....	187	Gamma Seal Lid.....	128
Ballast Options Demystified.....	100	Color TV.....	139	Earthstar Greywater.....	146	Garden Composter.....	145
Bamboo Water Falls.....	27	Combi Filter.....	39	Eco-Therm.....	161	Gas Dryers.....	124
Barrel Strainer.....	31	Community Assessment.....	176	EcoChamber.....	147	Gaviotas.....	172
Basic Blacksmithing.....	173	Compact Fluorescent Tubes.....	100	Ecofan.....	152		
Bathtub Faucet Filter.....	41	Complete Metalsmith.....	189				

Gel One.....	83	Kitchen Faucet Aerator.....	45	Nickle Metal Hydride.....	71	Powersonic Nicads.....	72
GenMate.....	54	Kolaps-A-Tanks.....	33	Night Watchman.....	115	PowerStar.....	79
Ginny.....	31	Koolatron.....	132	Nightstar.....	112	Practical Photovoltaics.....	180
GM/Ovonic.....	83	Kyocera Solar.....	60	Nightstar Flashlight.....	109	Practical Solar Energy Kit.....	170
Going with the Flow: Small Scale Water Power.....	179	Laminates.....	64	NIMH Batteries.....	71	Premier Gas Ranges.....	126
Gravi-Chek.....	29	Laptop Flight Adapter.....	68	NIMH Cordless Phone Batteries.....	71	Prescriptions for a Healthy House.....	184
Great American Rain Barrels.....	46	Large Area Fixtures.....	102	Nippa Sauna Stoves.....	159	Pressure Pumps.....	21
Greywater Filter.....	147	Lazer Stik.....	110	Nite Stick Portable Compact Fluorescent.....	108	Pressure Switch.....	31
Greywater Guide.....	171	LED Ceiling Lights.....	107	NiteOwl.....	104	Pressure Tanks.....	31
Greywater Information.....	171	LED Flashlight.....	109	No-Burst 100.....	155	Prioritizer.....	54
Grundfos Solar Pumps.....	26	LED Keyring.....	110	Notebook Battery.....	68	Prochargers.....	56
Guardian.....	20	LED Lantern.....	107	Notebook Chargers.....	68	Programmable Timer.....	115
Guardian Light.....	110	LED Light Fixtures.....	106	Nova Kool.....	131	Projection Screens.....	137
Guide to Resource Efficient Building Elements.....	186	LED Lighting Systems.....	105	Nova LED.....	105	Propane Refrigerator/Freezers.....	133
Guzzler Hand Water Pumps.....	28	LED Strip Lights.....	105, 106	Nuwick.....	166	Prostar.....	88
H2O 2U.....	35	LED Table Lamps.....	107	O-SO PURE.....	36	Pulse Charge Controllers.....	96
Halogen Bulbs.....	115	Lester Battery Chargers.....	85	Off-Grid Electricity.....	172	Pump Jack.....	29
Halogen Flood Light Adapters.....	115	Library Service.....	14	OmniMeter+.....	93	PUR Scout.....	38
Halogen Flood Lights.....	102	Lifetime Flashlight Conversions.....	109	Optima.....	83	PUR Ultimate.....	37
Hand Dug Wells.....	178	Light Controller.....	115	Optima "Yellow Tops".....	167	Pura BigBoy.....	36
Hand Juicer.....	129	Lighthawk.....	108	Osram Quartz Halogen Lamps.....	103	Pura Household.....	35
Hand Wheel Pump.....	29	Lightning Protection.....	98	Out of the Woods.....	186	PureAC Grid Filters.....	80
Hand-Pump Maintenance.....	177	Linear Amplifiers.....	137	Outback Oven.....	125	PureTap.....	35
Handcart Handbook.....	183	Linear Current Boosters.....	31	Outdoor Floodlights.....	112	PV Home Series.....	180
Handheld Massage Shower Filter.....	41	Linear Fluorescents.....	113	Outfitter's Wall Tents.....	169	PV to Battery Wire.....	95
Handy Farm Devices and How to Make Them.....	188	Linear Power Supply.....	139	OutHouse Fan.....	150	Qualcomm.....	135
Hanging Solar Food Dehydrator.....	127	Littlite.....	104	Outlets & Switches.....	94	Quantum 2000 LED Flashlight.....	109
Harris Hydroelectric.....	49	Living on Less.....	173	Overhead Projectors.....	137	Quick Convec.....	87
Heat Gun.....	116	Lost Art of Steam Heating.....	175	Ozone Systems.....	33	QuikStix Workbook.....	167, 182
Heliotrope Solar Sidebar.....	155	Low Suds Detergent.....	124	Pacific Domes.....	168	Radiant Barrier.....	149
Helping Health Workers Learn.....	176	Low Voltage Disconnects.....	94	Paloma.....	157	Rainwater Catchment Systems.....	46, 178
High Lifter.....	29	Low-Cost Fluorescent.....	101	Passive Solar House.....	183	Rainwater Collection for the Mechanically Challenged.....	46, 178
High Performance Windows.....	149	Low-Cost Load-Carrying Devices.....	182	Passive Solar House Basics.....	183	Rainwater Harvesting.....	46, 178
High-Low Shower.....	45	LP Stock Tank Heater.....	119	Passport to Web Radio.....	173	Rammed Earth House.....	184
High-Output DC Bulbs and Ballasts.....	99	Lumina.....	101	Passport to World Band Radio.....	173	Rancher.....	30
Hiker Microfilter.....	38	Lyncom.....	90	Pasture Pump.....	120	Razor Saver.....	166
Hoky Carpet Sweeper.....	129	Make Your Own.....	173	Paulownia Trees.....	120	Receptacles.....	95
Home Composter.....	165	Making Health-Care Equipment.....	176	PC-Solar.....	170	Reciprocating Saw.....	116
Home Power Systems.....	61	Marine Power System.....	62	Pedal Pick-up.....	167	Rectangular Fixtures.....	101
Home Water Analysis Kit.....	42	Marine Solar Electric Systems.....	61	Pedal Power Plans.....	182	Reflectix Insulation.....	148
Home Water Supply.....	177	Maverick.....	111	Pelton Wheel Turbines.....	48	Reflex 12V.....	102
Homestead Builder.....	184	Medical & Hygiene Textile Production.....	177	PEPower CD Battery.....	69	Remote Medical Equipment.....	121
Hot Water Pumps.....	26	Medical Cold Chain.....	122	Percentage Gauge.....	92	Renewable Energy Dictionary.....	172
How Come?.....	175	Metal Casting.....	174	Pest Repeller.....	165	Renewable Energy Videos.....	181
How to Build Your Elegant Home with Straw Bales.....	185	Meter Lights.....	93	Phoenix.....	57	Replacement Filters.....	36
How to Make Low-Cost Building Blocks.....	185	Meter Wire.....	95	Photovoltaics.....	55, 180	Residential Microhydro Power.....	181
Human Power Generator.....	54	Micro Solar Hydrogen.....	47	Photowatt.....	57	Residential Solar Electricity.....	181
Humanure Handbook.....	171	Micro-Hydropower Sourcebook.....	179	Pima.....	121	Residential Wind Power.....	181
Humphrey Propane Lamps.....	103	Micro-manufacturing Solar Electric Components.....	6	Planet DC.....	130	Restoration Forestry.....	189
HydraDrills.....	31	Microfich Library.....	172	Planet Earth Home.....	173	Rio Vita Shower Filter.....	41
Hydraulic Ram Pumps.....	177	Microster Water Turbines.....	48	Platform Pitched Wall Tents.....	169	Roof Fans.....	150
Hydro Plans.....	179	Microwave Leakage Detector.....	165	Plugs.....	95	Root Cellaring.....	187
Hydro-Que.....	47, 125	Midi D.....	43	Pocket Ref.....	172	Rustic Retreats.....	187
Hydrocaps.....	87	Midnight Sun Heater.....	162	Pole Building Projects.....	185	RV Power System.....	62
Hydronic Heating Manual.....	175	Mini DC Motors.....	54	Polyethylene 100" Roll.....	25	Safe to Drink?.....	177
Hydronic Radiant Heating.....	175	Mini Filter.....	39	Polyethylene Storage Tanks.....	32	Safety Switches.....	97
i-WLL.....	135	Mini-Panels.....	59	Pond and Fountain Clarifier.....	27	Safety VestLED.....	111
IBE 2V Industrial Cells.....	84	Mini-Reading Lamp.....	106	Pony Pump.....	20	Sampler of Alternative Energy Homes.....	181
IBE Battery Chargers.....	85	MiniMag.....	109	Portable Audio Systems.....	135	Satellite Telephone Systems.....	135
Ice House Business.....	14	MiniMax.....	152	Portable DVD Player.....	139	Saturn.....	121
Improved Wood Waste & Charcoal Burning Stoves.....	174	Minipots.....	104	Portable Irrigation Tanks.....	33	Save Money.....	174
Incinole.....	144	Minus 40 Fridge/Freezer.....	131	Portable Microfiche Reader.....	172	Save-the-Rain Diverter.....	46
Incredible Showerhead.....	44	Miracle Heat.....	160	Portable Mini Filter.....	40	Saving Seeds.....	187
Independent Energy Guide.....	180	Mission Drip Filter.....	40	Portable Power Generators.....	63	Saving Water.....	44
Individual Cells.....	59	Mobil Vision.....	118	Portable Sine Wave Inverters.....	78	Savonius Rotor Construction.....	179
Individual White Light Emitting Diodes.....	105	Mobile Music.....	15	Portable Vaccine Refrigerator.....	122	Screen.....	169
Inline Surge Protectors.....	80	Module Interconnect.....	94	Portable Welder.....	118	Scuba.....	159
Installation Kits.....	18	Morning Hill Solar Cookery Book.....	181	PortaWattz Power Pac.....	62	Sealand.....	144
Intake Filter.....	31	Mosquito Repeller.....	119	Portawattz.....	79	Sediment Filter.....	35
Inverter Cables.....	95	Motion Switch.....	115	Positive Pump.....	30	Sediment Trap Filters.....	146
Island Technology.....	174	Motors as Generators.....	179	Power Beam.....	103	Sensor Light.....	112
Jabric.....	121	Movement Fans.....	152	Power Booster.....	69	SensorLight.....	112
James Hand Washer.....	124	MPPT Charge Controllers.....	91	Power Centers.....	96	Septic Digester.....	144
Kant Freeze Hand Pump.....	28	MR16 Adapters.....	115	Power Control Center.....	18	Septic System Owner's Manual.....	171
Karaoke Systems.....	135	Multi-Purpose Independence Tool Kit.....	117	Power Converter for Answering Machines.....	80	Septic Tanks.....	178
Katadyn Drip Filter.....	40	Multi-Voltage 12V.....	81	Power Jack.....	59	Servel/Whirlpool Repair Manual.....	133
Katadyn Industrial Filters.....	33	Multimeter.....	92	Power Plants.....	183	Sewage Solutions: Answering The Call of Nature.....	171
Katadyn Portable.....	39	Multiple Battery Charger.....	70	Power Twin Pump.....	21	Sewing Shop.....	12
Katadyn Siphon Filter.....	39	Multipurpose Solar Flashlight.....	110	Power Venting.....	156	Shampoo.....	166
Kawakamil.....	120	Naked Into The Wilderness.....	175	Power Zone Portable Power System.....	62	Sheds.....	186
Kestrel.....	53	Nautilus.....	21	Power-Glow Pen.....	110	Shelter.....	185
Kilowatt Hour Meter.....	93	New Compact House Designs.....	184	PowerPal Low-Head Micro-Hydro.....	49	Shower-Cleen.....	41
		New Electric Vehicles.....	182	PowerPro Inverters.....	79	Shower-For-Two.....	44
		Niagara Portable.....	20	PowerPulse.....	72	Shower/Bath Adapter.....	41
		Nicad Charger.....	70	Powersonic.....	83		
				Powersonic Chargers.....	85		

Shurflo Sub Rebuild Kit.....31	Spraydius.....45	Transfer Switch.....98	Windmaker.....151
Shurflo SubPump.....17	Sprite Economy Dechlorinator.....41	Travel Adapters.....81	Windpumps.....179
Shurflo Surface Pumps.....20	Staber 2300.....123	Travel Kit.....81	Wire Cutters.....116
Shurflo Turbo.....21	Stainless Steel Burrs.....127	Traveling Quartz Halogen.....103	Wire Strippers.....116
SID-Servo I.....26	Standing Seam Roofing Panels.....64	Treadle Sewing Machines.....129	Wireless Motion Alerts.....118
Siemens.....56	Stargazer Key Chain.....110	Treehouses.....185	Wiring 12 Volts For Ample Power.....180
Sierra Zip Stove.....125	Staying Healthy.....176	Tri-Metric Meter.....92	WonderWash.....123
Simple Pumps.....28	StayPut Fastening Kits.....55	Trifold Meters.....165	Wood Cookstoves.....160
Sine Wave.....74	Steam Engine.....54	Tripod Screens.....137	Wood Lathe Kit.....117
Sling Pumps.....20	Steam Juicer/Cooker.....129	Trojan L-16.....82	Wood Saver.....44
Smart Adapter.....68	Storage Batteries for Renewable Energy Systems.....181	TrueCharge.....85	Wood Shop.....8
Smart Kitchen.....173	Storburn.....144	TSP 1000™.....22	Woodfired Water Heater/Boiler.....159
Smoke Detectors.....165	Storey's Basic Country Skills.....186	Tuff-Glass.....149	Woodfired Water Heaters.....159
Snorkel.....159	Stormwater Catch Basin.....46	Tuff-Shade.....149	Woodstove Fan.....160
Soap-Up Saver.....45	Straw Bale House.....185	Tuff-Track.....149	World Lantern.....108
Solttech.....29	Straw Bale Video Series.....185	Turbo Pumps.....21	Wrangler.....160
Solar 2 CD-ROM.....180	Straw-Bale Construction.....185	TurboShower.....41	Xeriscape Flower Gardener.....187
Solar Array Junction Box.....96	Stream Engines.....48	TV.....139	Yogurt Incubator.....128
Solar Attic Fan Kits.....150	Strip Lights.....101	Ultimate 12V Fan.....152	You Can Farm.....189
Solar Box Cooker Guide.....181	Sub-Surface.....146	Ultraviolet Water Filter.....36	Yukon.....34
Solar Centrifugal.....22	Submersible Pump Wire.....95	Underground Storage Tank.....32	Yurts.....168
Solar Chill.....153	SubPump Controller.....17	Understanding Solar Stills.....177	Zomeworks Universal Trackers.....67
Solar Cool Cap.....170	Sun Catcher.....69	Uni-Kit Solar Lighting.....112	
Solar Electric Independent Home Book.....180	Sun Frost.....130	Uni-Solar.....64	
Solar Electric Systems for Africa.....181	Sun Mate.....163	Uni-Solar Modules.....55	
Solar Fire Ant Charder.....119	Sun Oven.....125	UniRac.....66	
Solar Flashlight.....109	Sun Toys Solar Cooker.....125	Unit Liner.....32	
Solar Food Dehydrators.....127	Sun-Mar.....140	United Solar Marine Modules.....55	
Solar Force Piston Pump.....24	Sunbather.....155	Universal Adapter.....94	
Solar Gardening.....189	Sunbender.....149	Universal Battery Eliminator.....81	
Solar Gate Opener.....119	Sunda.....158	Urine Diverting Toilets.....144	
Solar Gro-Domes.....168	Sunflash Solar Cooker.....125	Used Liquid Solar Collectors.....155	
Solar Guard.....89	Sungari.....34	USProDrive Conversion Kit.....167	
Solar Heater Control Package.....155	Sunglasses.....166	USProDrive Mountain Bicycle.....167	
Solar Highway Beacons.....111	Sunmotor M3 Floating Pump.....20	UV *AddOn*.....36	
Solar Hot-Air Panels.....163	SunPipes.....103	UV Watch.....166	
Solar House Number Light.....112	Sunpower House.....170	UX-Series.....76	
Solar Hydrogen Chronicles.....47	SunRise Submersible.....25	Vaccine Storage.....130	
Solar Insolation Meter.....170	Sunrise/Sunset Switches.....106	Vacu-Stack.....160	
Solar Installation and Maintenance Business.....5	Sunshine Nugget Flour Mill.....127	Vacuum.....129	
Solar Island Fountain Pump.....27	Sunspot.....105	Vari Fan.....151	
Solar Jet Fans.....150	Sunvent.....150	Vented vs. Unvented Gas Heaters.....161	
Solar Laundromat.....13	Sunwater Solar Distillers.....43	Video Player.....139	
Solar LED lamp.....105	Sunwatt Solar Charger.....70	Video Projector/Player.....137	
Solar Lighting Kit.....112	Super Efficient AC Ceiling Fans.....151	Video Theater.....4	
Solar Outdoor Lighting.....111	Super-Therm.....149	Village Dehydrator.....10	
Solar Pathfinder.....170	Surette.....84	Village Grinder.....7	
Solar Power: A Historical Perspective.....64	Survivor Reverse Osmosis Systems.....38	Village Sun Oven.....125	
Solar Pump Kit.....27	Sustainable Cities.....174	Village Technology Handbook.....172	
Solar Showers.....162	Sustainable Sewerage.....171	Village Water Shop.....9	
Solar Slowpump.....23	Syphoon.....46	Village Wisdom.....175	
Solar Still Manual.....177	Table Fan.....152	VirusStat Kit.....34	
Solar Storage Tanks.....164	Takagi.....157	Voice of Swift River.....172	
Solar Submersible.....19	Tapworks.....43	Voltage Doubler.....151	
Solar Thermal Pipe.....155	Telemobile.....134	Voltage Stabilizers.....80	
Solar Trackers.....67	Telephone Service.....4	Voyageur Purifier.....38	
Solar Trailer.....61	Telestats.....163	Waffles Off Grid!.....126	
Solar Water.....164	TFT Ballast/Base.....99	Walk-In Solar Power Refrigerators.....131	
Solar Water Heating.....175	The Expedition.....68	Warming Oven.....160	
Solar Water Heating: A History.....154	The Sauna.....159	Water Current Turbines.....179	
Solar Water Pumping.....181	The Sidekick.....160	Water Distillers.....43	
Solar Water Pumping Glossary.....24	The Wordless Travel Book.....176	Water Heater Workbook.....178	
Solar Worksheet.....170	There Are No Electrons.....173	Water Pipe.....17	
Solar-Electric House Kit.....170	Thermofor.....150	Water Purification Systems Compared.....37	
Solar-Powered Electricity.....180	Thermomax.....154	Water Store Franchise.....35	
Solaram Surface Pump.....23	Thin Film Solar.....59	Water Supplies for Rural Communities.....178	
SolarBoost 50.....91	Thin-Lite DC Fluorescent Ballasts.....100	Water Wheel.....49	
Solarex.....58	Thin-Lite Outdoor Fixture.....112	Water-Pumping Devices.....178	
SolarFridge.....130	Three Cubic Meter Biogas Plant.....183	Watercheck Water Tests.....42	
Solargizer.....72	Timber Frame Construction.....184	Watts Up?.....93	
Solargizer Solar Chargers.....72	Timber Reduced Energy Efficient Homes.....185	We All Live Downstream.....178	
Solaris Solar Lantern.....108	Time Delay Switch.....115	Well Bucket.....28	
SolarJack Quad Submersible.....18	Timer.....115	Well Drilling, Pump Installation Service.....13	
SolarLED's.....106	Tipis.....169	What is Appropriate Technology?.....3	
SolarMoler.....119	Tire House Book.....186	Wheat Grass Juicer.....129	
SolarTek.....150	Toilet Tank Water Saver.....145	When Aid is No Help.....172	
SolarVerter.....59	Toto.....144	Where There Is No Dentist.....176	
Solmic Solar powered mini-microscope.....121	Tower Kits.....51	Where There Is No Doctor.....176	
SolSaver.....43	Towers.....30	Where Women Have No Doctor.....176	
Soltronix Headset Radio.....138	Trace "Tiger" Series.....76	Whisper 175.....51	
Solus.....132	Trace Charge Controllers.....90	White LED DC Bulbs.....105	
Speed Controls.....167	Trace DR-Series.....75	Who Owns the Sun?.....174	
Speed Queen Wringer Washer.....124	Trace Power Modules.....77	Wind Energy.....179	
Spindoctor.....122	Trace PS2512.....74	Wind Power for Home and Business.....179	
Spinning Composter.....145	Transfer Pumps.....29	Wind Speed Indicator.....53	
Sports Bottle.....39, 40		Wind Totalizer.....53	