

**[Home](#)-immediately access 800+ free online publications. [Download](#) CD3WD (680 Megabytes) and distribute it to the 3rd World. CD3WD is a 3rd World Development private-sector initiative, mastered by Software Developer [Alex Weir](#) and hosted by [GNUveau\\_Networks](#) (From globally distributed organizations, to supercomputers, to a small home server, if it's Linux, we know it.)**

---

**[home.cd3wd.ar.cn.de.en.es.fr.id.it.ph.po.ru.sw](#)**

**VITA**

**RENEWABLE ENERGY DICTIONARY**

**DICCIONARIO DE ENERGIA RENOVABLE**

**DICTIONNAIRE DE L'ENERGIE RENOUVELABLE**

**This publication was made possible, in part,  
through the generous support of  
the United States Agency  
for International Development  
and the United Nations Education,  
Scientific and Cultural Organization**

**VITA**

**1600 Wilson Boulevard, Suite 500  
Arlington, Virginia 22209 USA  
Tel: 703/276-1800 \* Fax: 703/243-1865  
Internet: [pr-info@vita.org](mailto:pr-info@vita.org)**

Copyright [C] 1982 Volunteers in Technical Assistance

All rights reserved. No part of this publication may be reproduced or transmitted in any form or by any means, electronic or mechanical, including photocopy, recording, or any information storage and retrieval system without the written permission of the publisher.

Manufactured in the United States of America.

Designed by Margaret Crouch.

Published by

VITA

1600 Wilson Boulevard, Suite 500

Arlington, Virginia 22209 USA

10 9 8 7 6 5 4 3 2 1

Library of Congress Cataloging in Publication Data

Renewable energy dictionary

Bibliography: p. 479

1. Renewable energy sources--Dictionaries. 2. Power (Mechanics)--Dictionaries. I. Volunteers in Technical Assistance.

TJ163.16.R48 1982 333.79 82-50309

ISBN 0-86619-161-5

## PREFACE

Soon after beginning a major program in renewable energy in 1979, VITA (Volunteers in Technical Assistance) found that many of the technical terms commonly used in renewable energy literature were not understood by many of the laypeople for whom the information was meant. VITA also realized that it was no easy task to find definitions for many of these terms. There were specialized glossaries for the various areas of renewable energy, but there was no one source devoted to defining renewable energy terminology. The Renewable Energy Dictionary is designed to meet this need. This encyclopedic dictionary is comprised of up-to-date and authoritative definitions of terms used in renewable energy. Definitions are presented in the clearest and most concise language possible without detracting from their technical accuracy. They are thoroughly cross-referenced for ease of use. The terms that were selected for this dictionary are primarily those not commonly

defined in their renewable energy context in conventional dictionaries. Some of the terms are now considered to be archaic. Mostly related to wind energy, they are included because of their usefulness in developing an overall understanding of the field.

VITA's 22 years in international development and technology transfer have brought a sensitivity to the need in developing countries for technical materials in languages other than English. This dictionary is translated into French and Spanish in an effort to help meet this need.

In addition to 1,000 entries in each language, many with illustrations, the dictionary includes comprehensive conversion tables and a bibliography.

Our research indicates that this is the only published reference work of its kind available. We feel it is a significant resource for those working with renewable energy technologies and concepts.

## ACKNOWLEDGEMENTS

No work of this scope and magnitude could be completed without the assistance and

contributions of many individuals. Along with Dr. William Sorsby, our primary contributor, we wish to acknowledge the invaluable contributions made by VITA Volunteers who gave their time freely to make this book a reality. Our deepest thanks go out to: Dr. Sam Baldwin, Thomas J. Beckman, Richard A. Boettcher, Jean-Claude Bruffaerts, Jerome E. Dobroski, George S. Erskine, H. Speer Ezzard, Hal Finkelstein, Dr. Peter B. Hammond, Robert W. Hawthorn, James L. Hogan, and Dr. Norbert J. Kreidl. We also wish to thank the following members of VITA's technical staff for their reviews, contributions, and constant support: John M. Downey, Alan Wyatt, Dr. Gary L. Garriott, Stephen H. Hirsch, Fred Hopman, William R. Breslin, Dr. William A . Gross, Richard J. Fera, O. Christopher Ahrens, Balla Sidibe, and Hector Reyes, and research assistant Vandana Malhotra. Special thanks go to artist Christopher P. Schmidt for the excellent illustrations. Finally, we acknowledge the editorial and production contributions of Kristine Stroad Ament, Julie Badger, Margaret Crouch, Bonnie Duley, Gregory James, and David Jarmul, who put the whole thing together.

## TRANSLATIONS

This dictionary was translated into French and Spanish by Berlitz International Translation Service.

<Select this link for French> <Select this link for Spanish>

## ENGLISH

## INGLES

## ANGLAIS

## HOW TO USE THIS DICTIONARY

This dictionary is thoroughly cross-referenced for ease of use and to provide for the most thorough understanding of each term.

The terms are organized alphabetically in each language. Each term is printed in bold type and capital letters. The term is followed by a parenthetical classification reference. Some terms have more than one reference, which helps to clarify the ways in which they can be used. These references are defined at the beginning of each language section. Some words within the definition are also in capital letters. These are words that are defined elsewhere in the

dictionary. Subsequent use of these words within the same definition is in lower case letters.

At the end of each definition are translations of the term itself into French and Spanish. The preferred usage is listed first, with secondary or less common usages following. The preferred term is the one that appears in the other language section.

For example:

Defined

Term References elsewhere

ABSORPTANCE (sol) (meas). The ratio between the SOLAR RADIATION absorbed by a surface and the total amount of solar radiation that strikes it.

F - absorptance; coefficient d'absorption

S - coeficiente de absorcion

Spanish

French (preferred term first)

Second reference

This is a measurement (meas) term used in the field of solar (sol) energy. The term "Solar Radiation" is defined in the "S" section of the dictionary. The primary translation of this term into French is "absorptance," though in

some French documents, the term "coefficient d'absorption" may be found. The translation of this term into Spanish is "coeficiente de absorcion."

#### DEFINITION OF ABBREVIATIONS

agri Relating to agriculture.

alc Alcohol production or alcohol fuels.

ani Relating to animal power.

arc Archaic. Terms that are outdated but are still useful.

auto Relating to internal combustion engines or automobiles.

bio Relating to the field of biological science or a biological substance.

biocon Relating to bioconversion. Includes methane and woodfuel.

chem Relating to the field of chemical science or a chemical substance.

constr Relating to construction methods, materials, and structures.



**elec** Relating to the production and use of electricity.

**fos** Relating to fossil fuels.

**gen** General terms, which may apply to various areas of energy, particularly renewable energy technologies.

**geo** Geothermal power concepts and applications.

**heat** Relating to heating or the use of heat for space heating and to produce other forms of energy.

**hydr** Relating to water and the application of water power. Also closed hydraulic systems, which may use fluids other than water.

**impl** Implement. Tools, utensils, or devices that work in conjunction with other equipment.

**meas** Measuring instruments, scales, or types of measurement.

**ocean** Methods or devices for extracting energy from the ocean.

**prod** Relating to producer gas.

**refrig** Relating to refrigerants or methods of

refrigeration.

sol Relating to the field of solar energy.

wind Relating to wind power or other aspects of air movement.

A

ABSORBENT (refrig). The less VOLATILE of the two working FLUIDS used in an absorption cooling device.

F - absorbant

S - absorbente

ABSORBENT OIL (refrig). A type of oil used in an absorption cooling device.

F - huile absorbante

S - aceite absorbente

ABSORBER PLATE (sol). A dark surface that absorbs SOLAR RADIATION and converts it into heat; a component of a FLAT-PLATE SOLAR COLLECTOR.

F - plaque d'absorption

S - placa de absorcion

ABSORPTANCE (sol) (meas). The ratio between the SOLAR RADIATION absorbed by a surface and the total amount of solar radiation that strikes it.

F - taux d'absorptivite

S - coeficiente de absorcion

**ABSORPTION AIR CONDITIONER (sol)**. An air conditioner designed to use a **SOLAR HEATED** liquid. Such a system provides space cooling through use of **ABSORBER PLATES, VOLATILE FLUIDS, HEAT EXCHANGERS, and CONDENSERS**.

F - climatiseur a absorption

S - aire acondicionado por absorcion

**ABSORPTION REFRIGERATION (refrig)**. A cooling system that uses heated liquid to activate the chilling process.

F - refrigeration par absorption

S - refrigeracion por absorcion

**AC (elec)**. Abbreviation for **ALTERNATING CURRENT**.

F - CA

S - C.A.

**ACCELERATOR (impl)**. A mechanism that controls the speed of a vehicle or other device.

F - accélérateur

S - acelerador

**ACCUMULATION (gen) (elec)**. The action of collecting or gathering. In electricity, the charging of a **BATTERY** or the storage of electric **POWER**.

F - accumulation

S - acumulacion

**ACCUMULATOR (gen)**. A **CELL, SOLAR POND, THERMAL MASS, or other device** to store **ENERGY**.

F - accumulateur

S - acumulador

## AC-DC

AC-DC (elec). Pertaining to a device that will operate on either ALTERNATING CURRENT or DIRECT CURRENT.

F - CA-CC

S - CA-CC

ACETATE (chem) (sol). A compound composed of the SALTS of ACETIC ACID or the acetylation products of acetic acid, such as CELLULOSE acetate. Certain acetates can be used as GLAZING on SOLAR COLLECTORS.

F - acetate

S - acetato

ACETIC ACID (chem). An important raw material in the chemical industry. It is a by-product of the DESTRUCTIVE DISTILLATION of wood. It can also be obtained by oxidizing ALCOHOL. The chemical make-up of acetic acid is [CH.sub.3]COOH.

F - acide acetique

S - acido acetico

ACID (bio) (biocon). A compound that dissociates or separates in a water solution to provide hydrogen ions. Acid forms a SALT when mixed with ALKALI, and is important in ANAEROBIC DIGESTION and FERMENTATION.

F - acide

S - acido

ACID DIGESTION (biocon). The "first phase" of BIOGAS production, in which complex molecules are broken down into smaller ones.

F - digestion acide

S - digestion de acido

ACID HYDROLYSIS (chem) (alc). A chemical process that uses ACID to convert STARCH to sugar. This is the "first phase" in ETHANOL production.

F - hydrolysatation acide

S - hidrolisis de acido

ACROMETER (gen) (meas). An instrument used to measure the density of gases.

F - acrometre

S - acrometro

ACTINOMETER (sol) (meas). An instrument used to measure DIRECT RADIATION from the sun.

F - actinometre

S - actinometro

ACTIVE DRIED YEAST (alc). YEAST that has been dried, but in which the yeast cells still can be activated.

F - levure seche active

**S - levadura activa secada**

**ACTIVE SOLAR HEATING (sol)**. Warming an interior space with heat collected mechanically through **SOLAR COLLECTORS**.

The collection and distribution of this warm air requires additional external **ENERGY** to operate pumps, motors, valves, etc.

**F - chauffage solaire actif**

**S - calefaccion solar activa**

**AIR BRAKES**

**ADAPTED SEED (biocon)**. **INOCULUM** used during the **START-UP** of a **BIOGAS DIGESTER** that has been obtained from another digester with similar **FEEDSTOCK** composition and operating under similar conditions.

**F - germe adapte**

**S - semilla adaptada**

**ADOBE (constr) (sol)**. Sun-dried brick of clay and straw. Also the clay and soil used for making such bricks.

Adobe is high in **THERMAL MASS** and is useful in low-cost building construction.

**F - adobe**

**S - adobe**

**ADSORPTION (chem)**. The process through which carbonaceous materials are able to compress and hold on their surfaces large quantities of gas. Also, the physical adhesion of molecules to the surfaces of solids without

causing a chemical reaction.

F - adsorption

S - adsorcion

AEOLIAN (wind). (See: EOLIAN)

F - eolien, - ienne

S - eolico

AEROBIC (bio). Pertaining to micro-organisms that require FREE OXYGEN to live.

F - aerobie

S - aerobio

AEROBIC BACTERIA (bio) (biocon). BACTERIA living on FREE OXYGEN that is derived from the air. Aerobic bacteria break down ORGANIC MATTER during COMPOSTING.

F - bacterias aerobias

S - bacteria aerobia

AEROBIC DECOMPOSITION (biocon). (See: AEROBIC BACTERIA)

F - decomposition aerobie

S - descomposicion aerobia

AFFORESTATION (gen). Forest crops established by purposeful planting on land previously not used for tree crops.

F - boisement

S - conversion en bosque

AFTERBURNER (gen). An air pollution abatement device that

removes undesirable organic gases through incineration.

F - postcombustion

S - quemador auxiliar

AIR BRAKES (wind) (arc). Longitudinal SHUTTERS that are sometimes incorporated in PATENT SAILS to reduce the speed of SAIL rotation in strong winds.

F - freins d'ailes

S - frenos de aire

AIR DIFFUSER

AIR DIFFUSER (gen). A device that delivers air into a room to mix with the room air.

F - diffuseur d'air

S - difusor de aire

AIRFOIL (wind). A curved surface designed to create aerodynamic LIFT forces when air flows around it.

F - voilure d'aile

S - plano aerodinamico

<FIGURE>

10p06.gif (207x600)





### **airfoil**

**AIR-GAS RATIO (chem)**. The ratio of the air volume to the gas volume. It can be adjusted to change the character of combustion.

F - rapport air-gaz

S - relacion de aire-gas

**AIR HEATING SYSTEM (sol)**. A SOLAR HEATING system, which heats air in a SOLAR COLLECTOR and uses the heated air as the HEAT-TRANSFER MEDIUM to the rest of the system.

F - chauffage d'air, systeme de

S - sistema de calefaccion del aire

**AIR-TYPE COLLECTOR (sol)**. A SOLAR COLLECTOR designed to use air as its HEAT-TRANSFER MEDIUM.

F - capteur a air

S - colector solar tipo aire

**AIR VELOCITY (wind)**. (See: WIND VELOCITY)

F - vitesse d'ecoulement de l'air

S - velocidad del aire

ALBEDO (sol) (meas). The ratio of the amount of light reflected by a surface to the light falling onto it.

F - albedo

S - albedo

ALCOHOL (chem). A class of compounds composed of carbon, hydrogen, and oxygen, which occurs widely in nature and is used in solvents, antifreezes, chemical manufacture, and as a fuel. Alcohol commonly is obtained by FERMENTATION. (See also: BUTYL ALCOHOL, ETHYL ALCOHOL, and METHYL ALCOHOL)

F - alcool

S - alcohol

ALKALINE BATTERY

ALCOHOL CONDENSER (alc). (See: CONDENSER)

F - condenseur d'alcool

S - condensador de alcohol

ALCOHOL STILL (alc). (See: STILL)

F - alambic de distillation

S - alambique de alcohol

<FIGURE>

10p07.gif (486x486)

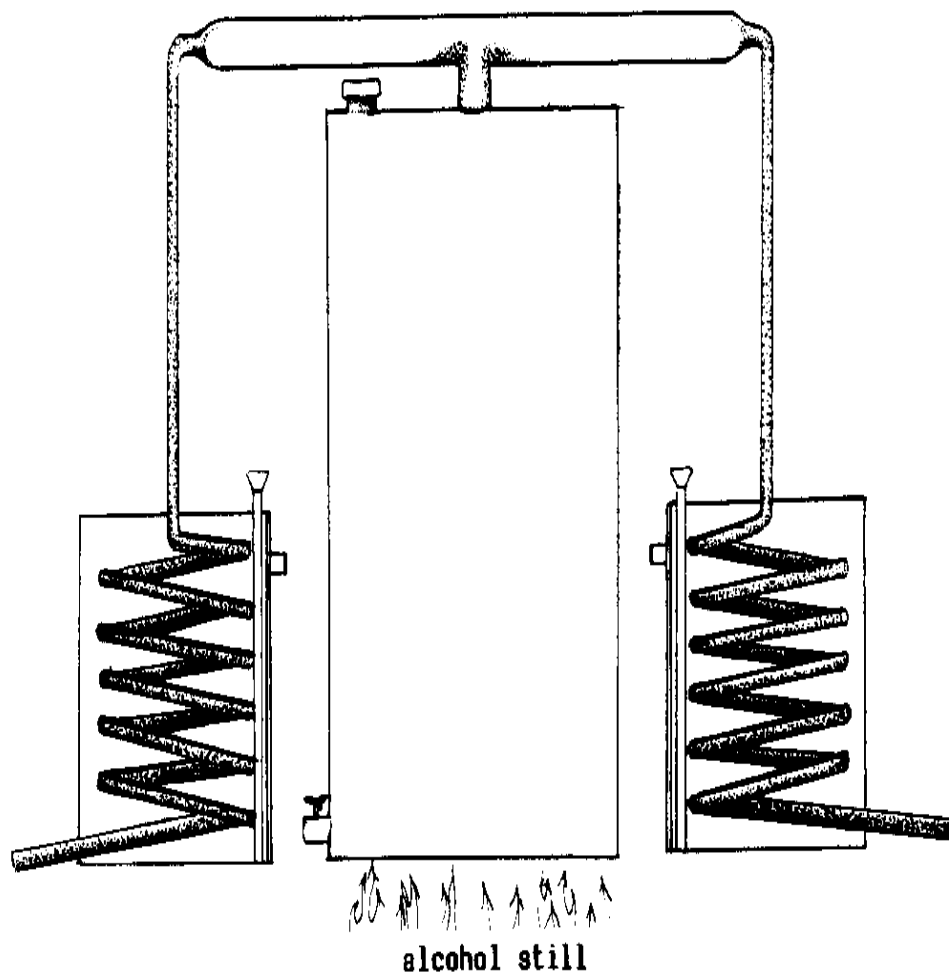

ALCOHOL VAPOR (alc). ALCOHOL in its gaseous state.

F - vapeur d'alcool

S - vapor de alcohol

ALGAE (bio) (biocon) (gen). Fresh and saltwater aquatic plants, usually microscopic in size, but including seaweed.

They are valuable in waste treatment, as a protein source for humans, as animal feed, and as a FEEDSTOCK for BIOGAS DIGESTERS.

F - algues

S - algas

ALKALI (chem) (biocon). Any of various BASES, which neutralize ACIDS to form SALTS. Bases are important in maintaining the chemical balance in a BIOGAS DIGESTER.

F - alcali

S - alcali

ALKALINE BATTERY (elec). A BATTERY that uses sodium or potassium hydroxide as an electrolyte, and nickel-oxide flakes and powdered iron or nickel-cadmium for its active plates.

F - accumulateur alcalin

S - pila alcalina

## ALKANE

ALKANE (chem). A general name for hydrocarbons of the METHANE series.

F - paraffine

S - alcano

ALTERNATING CURRENT (elec). An electric current that periodically reverses its direction. Generally abbreviated as ac.

F - courant alternatif  
S - courriente continua

ALTERNATIVE COMBUSTION ENGINES (auto). Alternatives to the spark ignition and the diesel combustion engines. Among the more developed designs are the GAS TURBINE and STIRLING ENGINES.

F - substituts aux moteurs a combustion  
S - motores de combustion alterna

ALTERNATIVE ENERGY SOURCES (gen). Sources of ENERGY different from those generally employed by a user. The term usually refers to RENEWABLE ENERGY sources such as SOLAR ENERGY, WIND ENERGY, GEOTHERMAL POWER, HYDROPOWER, etc. The use of alternative energy sources is attractive because of the [1] high price and limited availability of petroleum-based fuels; [2] the pollution that is associated with the burning of FOSSIL FUELS; and [3] the expense and dangers of nuclear power.

F - sources d'energie de substitution  
S - fuentes alternas de energia

ALTERNATOR (elec). A GENERATOR that changes mechanical ENERGY into electrical energy (ALTERNATING CURRENT) by the rotation of its ROTOR. Alternators are used in motor vehicles to recharge and minimize the drain on the BATTERY. They are also commonly adapted to be driven by WINDMILLS or by STEAM TURBINES and WATER TURBINES.

F - alternateur  
S - alternador

**ALUMINIZED MYLAR (constr) (sol).** A very strong, thin sheet of plastic material coated with aluminum. Used as a reflective surface for SOLAR COOKERS.

F - Mylar aluminise

S - Milar aluminizado

**AMBIENT (gen).** Referring to undisturbed environmental surroundings, particularly to air and temperature.

F - ambiant

S - ambiente

**ANAEROBES (bio).** (See: ANAEROBIC BACTERIA)

F - anaerobies

S - anaerobes

**ANAEROBIC (bio).** Pertaining to micro-organisms that can live in an airless environment.

F - anaerobie

S - anaerobio

**ANCHOR**

**ANAEROBIC BACTERIA (bio) (biocon).** BACTERIA, known as ANAEROBES, that can live in an airless environment by obtaining oxygen through the DECOMPOSITION of compounds.

F - bacterias anaerobies

S - bacteria anaerobia

**ANAEROBIC DIGESTER (biocon).** (See: BIOGAS DIGESTER)

F - digesteur anaerobie

S - digestor anaerobio

ANAEROBIC DIGESTION (bio) (biocon). The DECOMPOSITION of ORGANIC MATTER by ANAEROBIC BACTERIA. This process involves ACID-forming BACTERIA and METHANE-forming bacteria.

F - digestion anaerobie

S - digestion anaerobia

ANAEROBIC FERMENTATION (bio) (biocon). (See: ANAEROBIC DIGESTION)

F - fermentation anaerobie

S - fermentacion anaerobia

ANAEROBIC ORGANISMS (bio) (biocon). (See: ANAEROBIC BACTERIA)

F - organismes anaerobies

S - organismos anaerobios

ANCHOR (wind) (impl). A rod or stake driven into the ground, to which GUY WIRES for a WINDMILL TOWER are attached.

F - ancrage

S - ancla

<FIGURE>

10p09.gif (317x317)

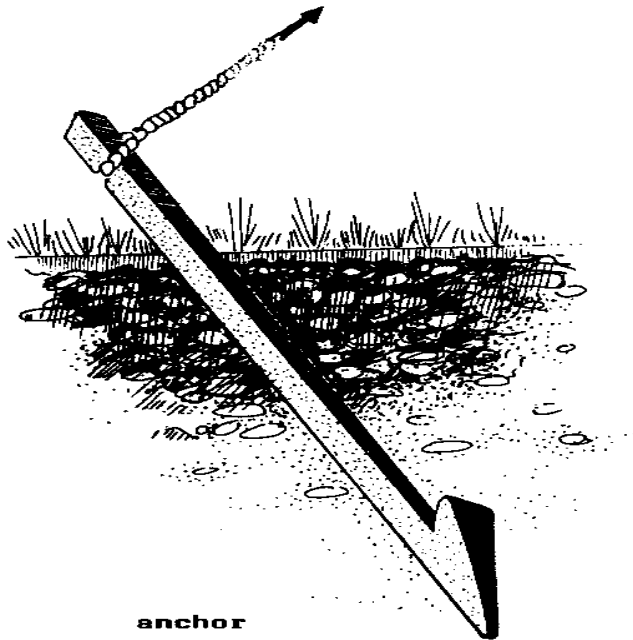

## ANDIRON

**ANDIRON** (impl). Raised metal bars placed on a fireplace hearth to support firewood for burning. Andirons allow air to pass under the burning wood for more **EFFICIENT** combustion.

F - chenets

S - morillo

**ANEMOMETER** (wind) (meas). An instrument for measuring **WIND** **SPEED**.

F - anenometre

S - anemometro



**ANGLE OF ATTACK (wind)**. The angle between the **CHORD** of an **AIRFOIL** and the wind. It is considered in **WINDMILL ROTOR** design.

F - angle d'attaque

S - angulo de ataque

<FIGURE>

10p10.gif (150x437)

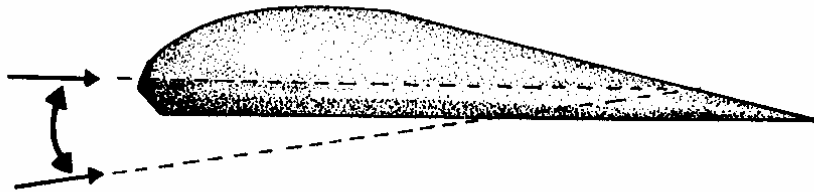

**angle of attack**

**ANGLE OF INCIDENCE (sol)**. (See: **INCIDENT ANGLE**)

F - angle incident

S - angulo de incidencia

**ANGLE OF REFLECTION (sol)**. (See: **INCIDENT ANGLE**)

F - angle de reflexion

S - angulo de reflexion

**ANHYDROUS (alc) (biocon)**. Free from moisture. The term applies to oxides, **SALTS**, and other substances that do not contain water.

F - anhydre

S - anhidro

ANHYDROUS ALCOHOL (alc). ALCOHOL that is almost completely free from water. Alcohol must be ANHYDROUS to be mixed with gasoline to form GASAOL. Alcohol and water cannot be separated beyond 199.99 PROOF. At that CONCENTRATION, they form an AZEOTROPE and vaporize at the same temperature.

F - alcool anhydre

S - alcohol etilico anhidro

ANIMAL-DRAWN (ani). (See: ANIMAL-POWERED)

F - animal de trait

S - traccion animal

ASH BOX

ANIMAL-POWERED (ani). Driven or impelled by animals.

F - traction animale

S - impulsado por animales

ANIMAL WASTE CONVERSION (biocon). The process of directly burning or obtaining ENERGY PRODUCTS from animal wastes.

F - conversion des dechets animaux

S - conversion de los desechos animales

ANNUAL LOAD FRACTION (sol) (meas). That portion of annual heating that is supplied to a building by SOLAR ENERGY.

F - part de la charge annuelle

S - fraccion de la carga anual

ANNULAR SAIL (wind) (arc). A ring-like SAIL with radial SHUTTERS.

F - aile annulaire

S - aspa circular

ANTICLOCK SAIL (wind) (arc). A SAIL ROTOR that runs counterclockwise when observed from the front of the WINDMILL.

F - aile a rotation positive

S - aspa sinistrorsa

AQUATIC BIOMASS (biocon). BIOMASS grown in fresh or saltwater, including ALGAE, seaweed, etc.

F - biomasse aquatique

S - biomasa acuatica

AQUEDUCT (hydr). A CHANNEL or trough built to convey water For irrigation, to operate a HYDROPOWER plant, or for household use. The water in aqueducts generally flows by means of gravity, although pumps may also be used.

F - aqueduc

S - acueducto

AQUIFER (hydr). Any geological formation containing water, especially one that supplies the water for wells, springs, etc.

**F - aquifere**

**S - acuifera**

**ARTICULATED WINDMILL (wind) (arc).** A WINDMILL constructed to provide maximum EFFICIENCY in winds of various speeds and from different directions.

**F - eolienne articulee**

**S - molino de viento articulado**

**ASH BOX (heat).** A removable box below the GRATE in a WOOD STOVE or a PRODUCER GAS GENERATOR that collects ash residue from combustion.

**F - cendrier**

**S - caja de cenizas**

**ASYNCHRONOUS GENERATOR**

**ASYNCHRONOUS GENERATOR (elec) (wind).** An electrical GENERATOR that produces ALTERNATING CURRENT, matching an existing POWER source so the two sources can be combined to power one LOAD. These generators are often used with WINDMILLS to provide power to buildings that already receive power from an electric utility.

**F - generateur asynchrone**

**S - generador asincronico**

**ATMOSPHERIC PRESSURE (gen).** The pressure exerted by the Earth's atmosphere at any given point, generally measured on a scale based on the pressure of air at sea

level.

F - pression atmosferique

S - presion atmosferica

ATRIUM (sol). An unroofed, partially roofed, or fully roofed courtyard or room in a dwelling, which allows sunlight to reach adjoining rooms. It is often used for PASSIVE SOLAR HEATING.

F - atrium

S - atrio

ATTENUATION (alc). The fall in SPECIFIC GRAVITY of the WORT during FERMENTATION. This is caused by the weakening of BACTERIA or FUNGI in a CULTURE.

F - attenuation

S - atenuacion

AUGER (impl) (alc). A rotating, screw-type device that moves material through a tube. In ALCOHOL production, it is used to transfer grains from storage to the grinding site, and from the grinding site to the COOKER.

F - vrille d'alimentation

S - barrena

AUTOMATIC DAMPER (impl). A device that automatically maintains the FLOW of hot or cold air into a room.

F - registre automatique

S - regulador de tiro automatico

AUTOMATIC TRACKING (sol). The use of a device that allows

SOLAR COLLECTORS to "track" or follow the sun during the day without manual adjustment.

F - poursuite automatique

S - aparato de seguimiento automatico

AUXILIARY GENERATOR (gen) (elec). A small, engine-driven GENERATOR that supplements a RENEWABLE ENERGY POWER source.

F - generateur auxiliaire

S - generador auxiliar

AVAILABLE ENERGY (gen) (meas). That part of the total ENERGY produced by a system that can be applied usefully. EFFICIENCY is a measure of available energy.

F - energie disponible

S - energia disponible

AZEOTROPE

AVERAGE WIND SPEED (wind) (meas). The most common WIND VELOCITY over a specified period of time.

F - vitesse moyenne du vent

S - velocidad promedio del viento

AXIS (gen). An imaginary line passing through the center of a body, about which the body rotates. (Plural: axes)

F - axe de rotation

S - axis

AXLE (gen). A supporting member that carries a wheel. It

either rotates with the wheel to transmit mechanical POWER, or allows the wheel to rotate freely on it.

F - essieu

S - eje

AZEOTROPE (chem) (alc). The chemical term for two liquids that, at a certain CONCENTRATION, boil at the same temperature. For example, ETHANOL and water cannot be separated further than 199.9 PROOF because at this concentration they form an azeotrope and vaporize together.

F - azeotrope

S - azeotrope

B

BABO'S LAW (biocon). A law stating that the VAPOR PRESSURE of a liquid is lowered when a non-VOLATILE substance is dissolved in it. The pressure is lowered by an amount proportional to the CONCENTRATION of the solution.

F - loi de von Babo

S - ley de Babo

BACKPUFFING (gen). The emission of smoke through cooking holes or other openings in a wood-burning or CHARCOAL stove. It occurs when poor DRAFT in the CHIMNEY causes air to pass back down into the stove.

F - retour de fumee

S - contracorriente de humo

**BACK STAYS** (wind) (arc). Support bars across the back of the **SAILS** of a **WINDMILL**.

F - galhaubans

S - soporte posterior

**BACK WATERING** (hydr). The braking effect caused by the immersion in water of the lowest **BLADES** of an **OVERSHOT WATER WHEEL**.

F - frein d'immersion

S - remanso

**BACTERIA** (bio). Any of numerous single-celled micro-organisms occurring in a wide variety of forms, existing either as free-living organisms or as parasites, having a wide range of biochemical properties. Bacteria are necessary for **DIGESTION** and **FERMENTATION**. (Singular: bacterium)

F - bacterias

S - bacteria

**BACTERIAL DECOMPOSITION** (biocon). The chemical breakdown of **ORGANIC MATTER** by micro-organisms.

F - decomposition bacterienne

S - descomposicion bacteriana

**BAFFLE** (gen). A metal plate or other artificial obstruction used to check or deflect the **FLOW** of **FLUIDS**.

F - deflecteur

S - desviador



**BAGASSE (biocon)**. The fibrous residue remaining after the extraction of the juice from sugar cane. It may be used as a fuel.

F - bagasse

S - bagazo

**BANCO (biocon)**. (See: LORENA STOVE)

F - banco

S - banco

## **BASES**

**BANKI TURBINE (hydr)**. A WATER TURBINE with curved BLADES, GUIDE VANES, and a hallow interior. Water passing through it propels the RUNNER both on entering and leaving. This turbine operates well under a wide HEAD range and FLOW rates.

F - turbine de Banki

S - turbina de Banki

<FIGURE>

10p15.gif (486x486)

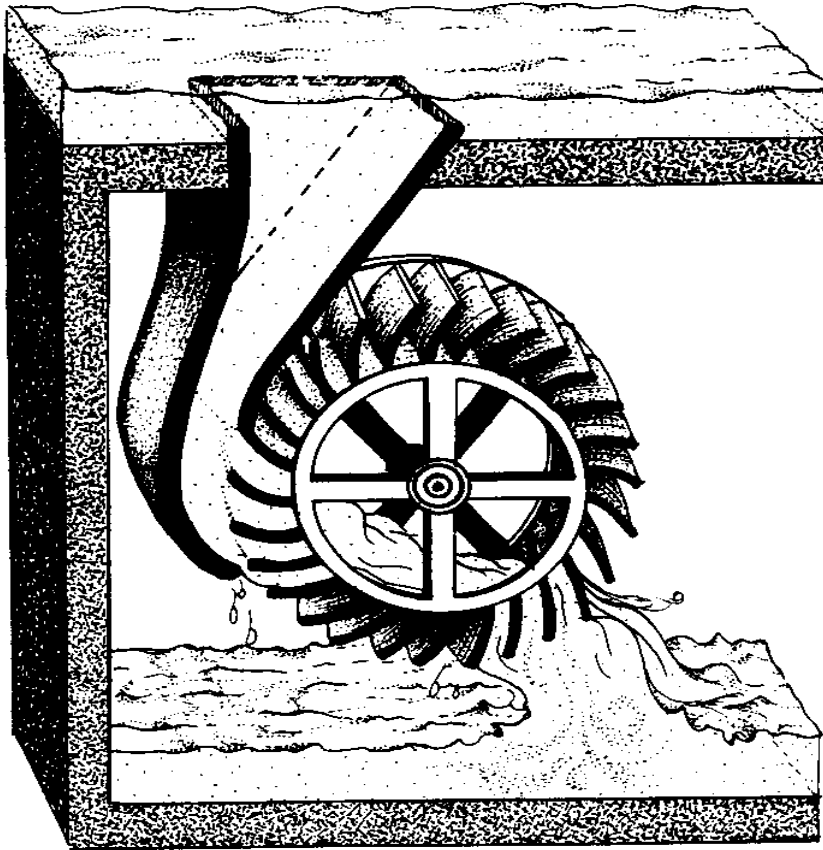

**Banki turbine**

**BAROMETER** (meas). A device used to measure **ATMOSPHERIC PRESSURE**.

F - barometre

S - barometro

**BASES** (alc) (chem). Compounds that dissociate in water solution to form **HYDROXYL** ions. Bases react with **ACIDS**

to form SALTS, and can be used to maintain the proper pH (POTENTIAL HYDROGEN) balance in an ALCOHOL STILL.

F - bases

S - bases

## BATCH DIGESTION

BATCH DIGESTION (biocon). A process of BIOGAS production in which the material to be digested is loaded into the DIGESTER at the start of the process. A SEED may also be added at this time. The digester is then sealed and the contents left to FERMENT. At completion, the digested SLUDGE is removed and the tank reloaded. Daily gas production varies during the process. It is slow at the start, increases, and finally declines toward the end of the DIGESTION cycle.

F - digestion a charge initiale

S - digestion por tandas

BATCH DISTILLATION (alc). A batch DISTILLATION process of ALCOHOL production in which the material to be distilled is loaded into a STILL at the start of the process.

The entire volume is heated and left to distill.

At completion, the distilled MASH is removed and the still reloaded. Daily alcohol production varies during the process. It is slow at the start, increases, and finally declines toward the end of the distillation cycle.

F - distillation a charge initiale

S - destilacion intermitente

**BATCH FEED (gen)**. A **DIGESTER** or **STILL** in which **ORGANIC MATTER** is loaded, allowed to generate gas or **FERMENT**, and then removed. The digester or still then is cleaned and prepared for a fresh load of **BIOMASS**.

F - alimentation initiale unique

S - alimentacion por tandas

**BATCH-LOADING DIGESTER (biocon)**. (See: **BATCH FEED**)

F - digesteur a chargement unique

S - digestor de carga intermitente

**BATCH PROCESSING (biocon)**. (See: **BATCH FEED**)

F - traitement de charges uniques

S - elaboracion por tandas

**BATTERY (elec)**. A group of two or more **CELLS** or **ACCUMULATORS** electrically connected in series or parallel.

Batteries are used to store electrical **ENERGY**.

F - batterie

S - bateria

**BATTERY CUT-OUT (wind) (impl)**. An automatic switch that disconnects a **BATTERY** during its charge if the voltage of the wind charger falls below or rises above that of the battery, within certain limits. A battery cut-out is a battery protection device.

F - coupe-circuit de batterie

S - interruptor de bateria

**BEARING (gen)**. A machine part that supports and guides a shaft, pivot, or wheel that slides, rotates, or oscillates in or on it.

F - palier

S - cojinete

<FIGURE>

10p17.gif (256x256)

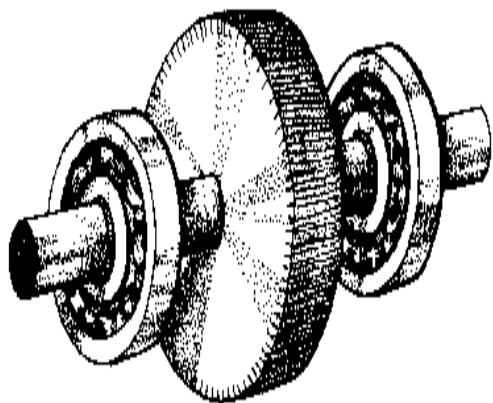

bearings

**BERM**

**BEARING ANGLE (sol)**. (See: SOLAR AZIMUTH)

F - azimut

S - marcacion

**BEAUFORT SCALE (meas) (wind)**. A scale of WIND VELOCITIES

ranging from 0 to 12 as follows:

## WIND VELOCITY

Code Number (mph) Description

- 0 less than 1 calm
- 1 1-3 light air
- 2 4-7 light breeze
- 3 8-12 gentle breeze
- 4 13-18 moderate breeze
- 5 19-24 fresh breeze
- 6 25-31 strong breeze
- 7 32-38 moderate gale; near gale
- 8 39-46 gale
- 9 47-54 strong gale
- 10 55-63 whole gale (or storm)
- 11 64-74 violent storm
- 12 over 74 hurricane

F - Beaufort, echelle de

S - escala de Beaufort

BEER COLUMN (alc). (See: STRIPPING COLUMN)

F - colonne a biere

S - columna de cerveza

BERM (constr). A manmade mound or small hill of earth

built up against a house to stop the INFILTRATION of hot or cold air.

F - banquette

S - monticulo

#### BEVEL GEAR

BEVEL GEAR (gen). One of a pair of gears used to connect two shafts whose AXES intersect.

F - engrenage conique

S - engranaje biselado

BICYCLE ADAPTER (gen) (impl). A device that can be attached to a bicycle to supply POWER to pump water, generate electricity, etc.

F - adaptateur de bicyclette

S - adaptador de bicicleta

BICYCLE GENERATOR (elec). A small GENERATOR that produces DIRECT CURRENT (dc) electricity through PEDAL POWER.

F - generateur a pedaliar

S - generador accionado por bicicleta

BIOCONVERSION (chem) (gen). The conversion of ORGANIC WASTE into ENERGY PRODUCTS through the action of micro-organisms. Chemically, this is the reduction of complex organic compounds into simpler, more stable forms.

F - bioconversion

S - bioconversion

**BIOGAS (biocon)**. The gaseous mixture produced during **ANAEROBIC DIGESTION**, composed chiefly of **METHANE** and carbon dioxide.

F - bio-gaz

S - biogas

**BIOGAS DIGESTER (biocon)**. An airtight vessel in which **ANAEROBIC DIGESTION** takes place and from which **METHANE** may be drawn off.

F - digesteur de bio-gaz

S - digestor de biogas

<FIGURE>

10p18.gif (540x540)



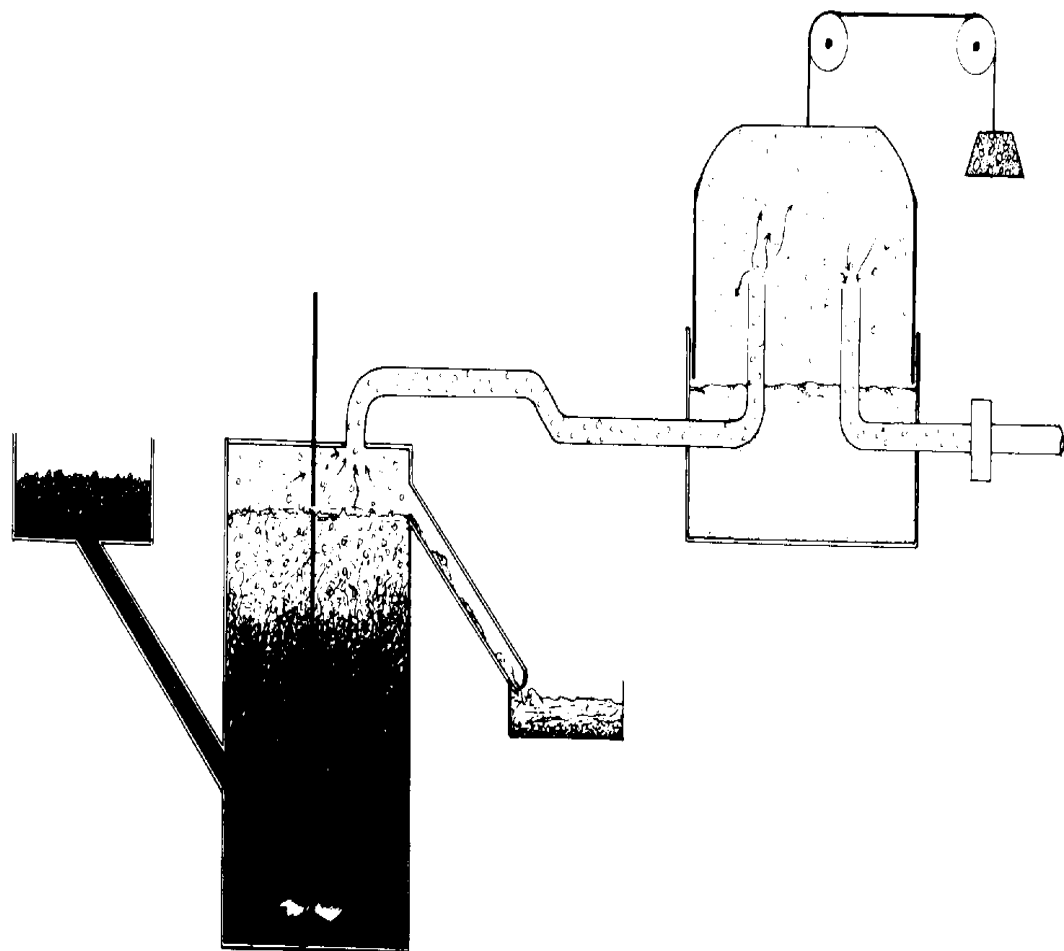

**biogas digester**

**BITUMEN**

**BIOGAS GENERATOR (biocon). (See: BIOGAS DIGESTER)**

**F - generateur de bio-gaz**

S - generador de biogas

BIOGAS PLANT (biocon). (See: BIOGAS DIGESTER)

F - reacteur de bio-gaz

S - planta de biogas

BIOLOGICAL ENERGY CONVERSION (biocon). The use of BIOMASS to convert one form of ENERGY into another.

F - conversion biologique de l'energie

S - conversion biologica de energia

BIOMASS (bio). Plants and plant materials, trees, crop residues, wood and bark residues, and animal manures.

Any ORGANIC MATTER that can be used in BIOCONVERSION processes.

F - biomasse

S - biomasa

BIOMASS ENERGY (biocon). The ENERGY that is released from BIOMASS when it is eaten, burned, or otherwise used as or converted into fuel.

F - energie de la biomasse

S - energia de biomasa

BIOMASS FEEDSTOCK (biocon). The ORGANIC MATTER used to produce ENERGY PRODUCTS through BIOCONVERSION.

F - biomasse d'alimentation

S - alimento seco de la biomasa

**BIOMASS FUELS (biocon)**. Fuels, such as **METHANE**, produced from **BIOMASS**.

F - combustibles de la biomasse

S - combustibles de biomasa

**BIOMASS YIELD (biocon) (meas)**. The amount of **BIOMASS** that can be produced in a given area. It usually is expressed in weight units per area measurement per unit of time.

F - production de biomasse

S - produccion de biomasa

**BIOMONITORING (biocon (meas))**. A pollution-control method in which living organisms are used to test the **EFFLUENT** from a **DIGESTER** to determine whether it is safe to discharge the effluent into a body of water. It may also be used to test the quality of waters downstream from a digester discharge point.

F - controle biologique

S - biocontrol

**BITUMEN (fos)**. Any naturally-occurring hydrocarbon, especially solid hydrocarbons such as asphalt, wax, pitch, and Gilsonite.

F - bitume

S - bitumen

**BLACKBODY**

**BLACKBODY (sol)**. A surface that completely absorbs all

SOLAR RADIATION that strikes it.

F - corps noir

S - cuerpo negro

BLADE (hydr) (impl) (wind). [1] The curved surface of certain types of WATER TURBINES (i.e., CROSS-FLOW TURBINES). Water striking the blades causes the turbine to rotate. Some turbines, such as the PELTON WHEEL, have cups instead of blades. [2] A single, extended surface of a WINDMILL ROTOR.

F - [1] aube; [2] pale

S - [1] paleta; [2] aspa

BLADE ANGLE [1] (wind). The angle of a CHORD of a WINDMILL BLADE with the ROTOR plane of rotation. [2] (hydr). The INCIDENT ANGLE of a TURBINE BLADE.

F - [1] angle de pale; [2] angle d'aube

S - [1] angulo del aspa; [2] angulo de la paleta

BORE HOLE (gen). A deep, vertical hole in the earth. Usually used to describe a well.

F - trou de sondage

S - pozo de sondeo

BRACE SOLAR STEAM COOKER (sol). (See: INSULATED STEAM COOKER)

F - rechaud a vapeur solaire Brace

S - portahornillo de vapor solar Brace

<FIGURE>

10p20.gif (540x540)

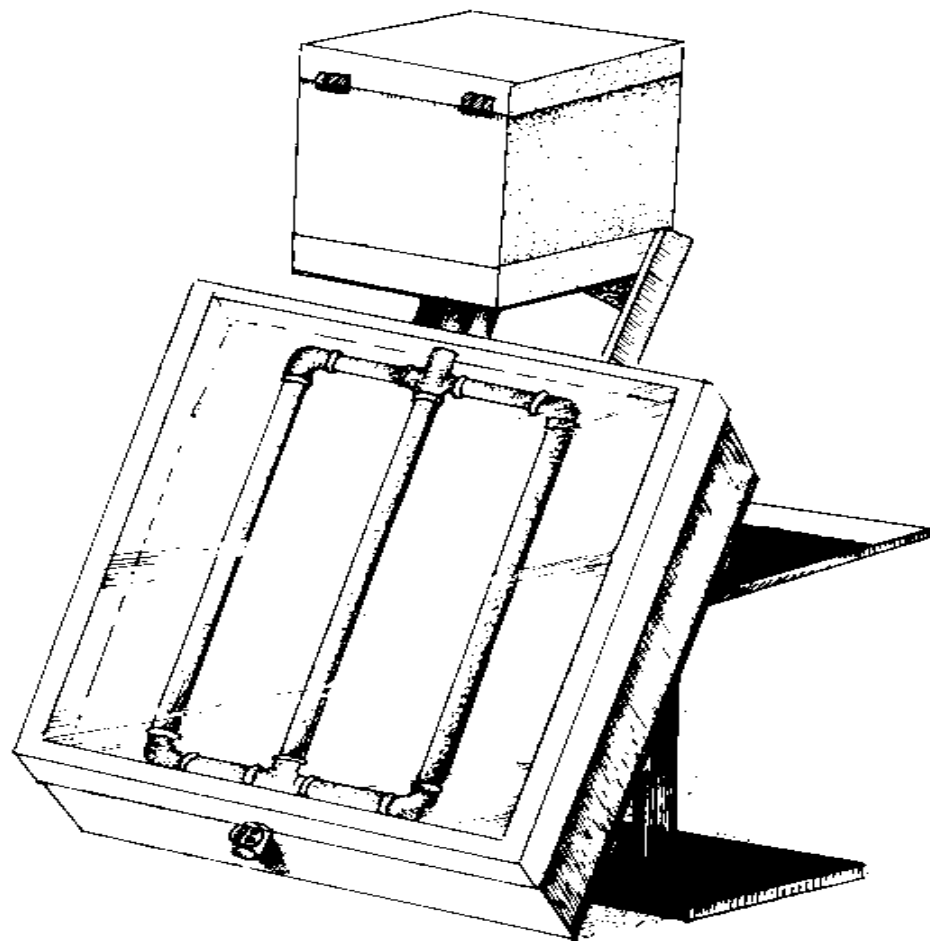

**Brace solar steam cooker**

**BREAST WHEEL**

**BRAKE (gen)**. A device used to slow or stop motion, especially by contact friction.

F - frein

S - freno

**BRAZING (gen)**. A process by which two pieces of metal are joined using a nonferrous alloy with a lower melting point than either of the two metals being joined.

F - brasage

S - soldadura con laton

**BREAST BEAM (wind) (arc)**. The main lateral beam below the WIND SHAFT.

F - poutrelle maitresse

S - viga de costado

**BREAST WHEEL (hydr)**. A sophisticated type of WATER WHEEL into which water enters below the top of the wheel and is kept in the BUCKETS until being discharged at or near the lowest point on the wheel. Breast wheels generally operate best with HEADS amounting to less than the diameter of the wheel. High breast wheels (where the water enters above the center shaft) can approach 65 percent ENERGY CONVERSION EFFICIENCY. (Syn: breast-shot wheel)

F - roue de poitrine

S - rueda de costado

<FIGURE>

10p21.gif (486x486)

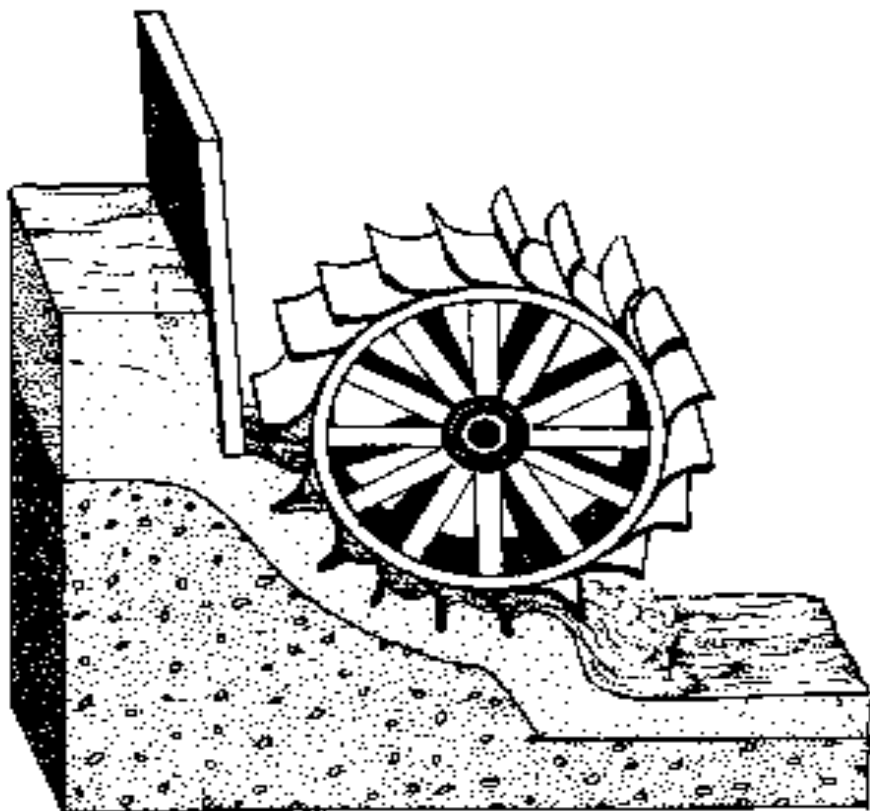

breast wheel

## BREEZE

**BREEZE** (wind). In general, any light to moderate wind.  
(See also: BEAUFORT SCALE)

F - brise

S - brisa

BREWER'S DRIED GRAIN (alc). (See: DISTILLER'S GRAIN).

F - grains secs de brasserie

S - grano seco de destilacion

BREWING MASH (alc). Crushed or ground FEEDSTOCK mixed with warm water in preparation for FERMENTATION during the production of ETHANOL.

F - mout de brassage

S - mosto

BRINE (refrig). A heavy SALT solution used in REFRIGERATION.

F - saumure

S - salmuera

BRIQUETTE (fos). A type of fuel that has been finely ground and compressed in pressure molds. It is usually made from low-grade coal, coke, CHARCOAL, or BIOMASS, and is mixed with a binder such as STARCH, tar, cement, pitch, or asphalt.

F - briquette

S - briqueta

BRITISH THERMAL UNIT (heat) (meas). The amount of heat required to raise the temperature of one pound of water one degree FAHRENHEIT under stated conditions of temperature and pressure. It is a standard unit for measuring quantity of HEAT ENERGY. Generally abbreviated as BTU.



F - British thermal unit  
S - unidad termica britanica

BUBBLE CAP (alc). A perforated cap on the plates of a DISTILLATION COLUMN, used to ensure that the vapor and condensed liquid mix thoroughly.

F - cloche de barbotage  
S - casquete de burbujeo

BUBBLE CHAMBER (biocon). A safety device attached to a BIOGAS DIGESTER to ensure that the gas is free of air, since an air and gas mixture would be explosive. The gas is "bubbled" through a container of water before being used or stored. If LIMEWATER is used instead of water, the bubble chamber can also be used to SCRUB the gas. In addition, the bubble chamber serves as a SPARK ARRESTER.

F - chambre a bulles  
S - camara de burbujas

BUCKET (hydr). Cup-shaped containers or BLADES attached to a WATER WHEEL.

F - auget  
S - cangilon

BUTYL ALCOHOL

<FIGURE>

10p23.gif (486x486)

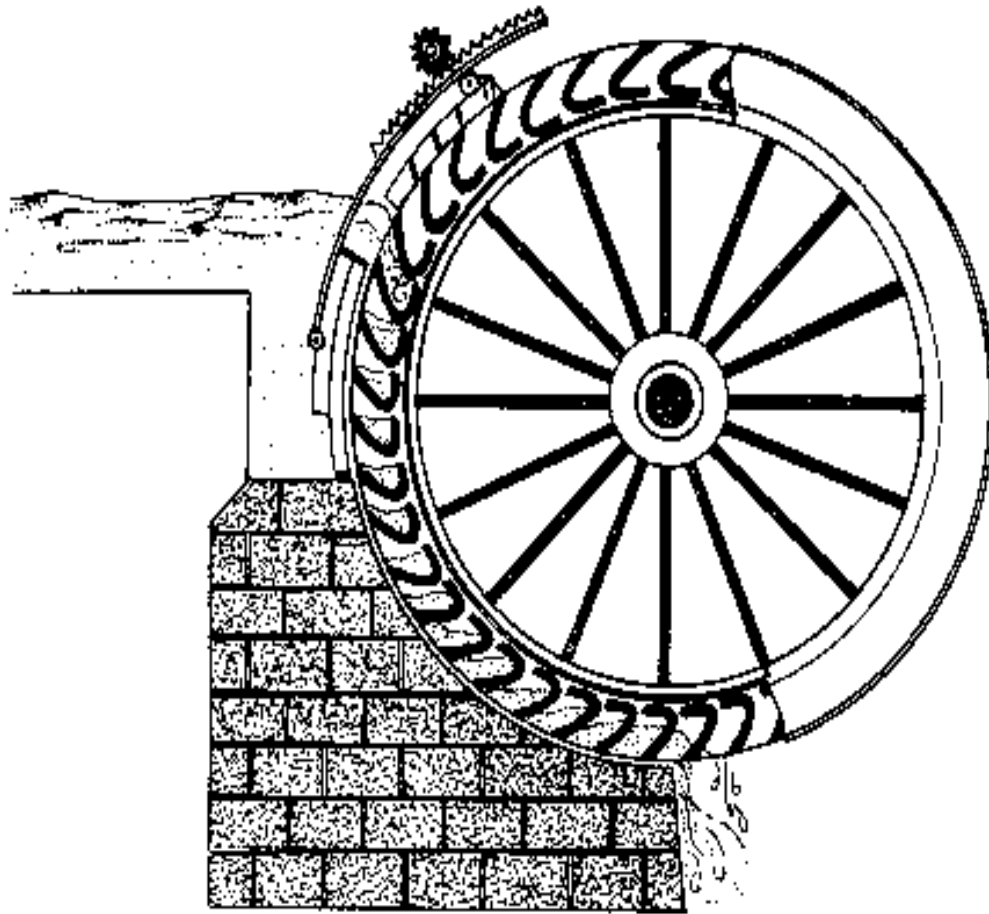

buckets on a breast wheel

**BUCKET ANGLE (hydr)**. The **INCIDENT ANGLE** of **BUCKETS** on a **WATER WHEEL**.

F - angle d'auget

S - angulo de los cangilones

**BUCKET CHAIN (hydr)**. A chain loop with **BUCKETS** attached to

it at regular intervals. The chain runs over sprocket wheels. As each bucket passes by a water source, water fills the bucket, providing POWER and propelling the chain further along.

F - noria a godets

S - transportador de cangilones

BUFFER CAPACITY (biocon) (chem). The capacity of a solution to resist pH (POTENTIAL HYDROGEN) changes when small amounts of ACID or ALKALI are added. In the case of DIGESTED SLUDGE, the ammonium and bicarbonate ions are mainly responsible for buffering.

F - pouvoir tampon

S - capacidad amortiguadora

BUTANOL (alc). (See: BUTYL ALCOHOL).

F - butanol

S - butanol

BUTYL ALCOHOL (alc) (chem). An ALCOHOL obtained by the FERMENTATION of sugar or cornstarch. The chemical equivalent of butyl alcohol is  $[C_{4}H_{9}OH]$ . (Syn: butanol)

F - alcool butylique

S - alcohol butilico

C

C (meas). Abbreviation for CELSIUS.

F - C

S - C

CALCIUM HYDROXIDE (biocon) (chem). A solution that is often used in BUBBLE CHAMBERS to SCRUB BIOGAS. It is commonly known as LIMEWATER.

F - hydrate de calcium

S - hidroxido de calcio

CALORIE (gen). The amount of heat required to raise the temperature of one gram of water one degree CELSIUS at ATMOSPHERIC PRESSURE.

F - calorie [1]

S - caloria

CAM (gen). An eccentric projection on a revolving shaft, shaped to produce variable or reciprocating motion in another contacted or engaged part.

F - came

S - leva

CANAL (gen) (hydr). An artificial watercourse uniting rivers, lakes, or seas for purposes of inland navigation, irrigation, or conveyance of water to a HYDROPOWER device.

F - canal

S - canal

CANISTER (wind) (arc). A piece of metal placed at the outer end of a ROTOR SPAR to hold the SAIL in place.

F - douille

S - chapa de fijacion

CAP (wind) (arc). The revolving top of a TOWER MILL or SMOCK MILL.

F - calotte

S - cumbrera

CAPACITY FACTOR (elec) (meas). The total KILOWATT HOURS of ENERGY consumed divided by the total KILOWATTS produced by an electricity-generating plant. Generally calculated on an annual basis.

F - facteur de capacite

S - factor de capacidad

CAPACITY OF THE WIND (wind) (meas). The total amount of dirt and dust particles of a given kind that can be sustained per unit volume of air by a wind of a given velocity.

F - capacite du vent

S - capacidad del viento

CELLULASE

CARBOHYDRATE (alc) (chem). Sugars, STARCHES, CELLULOSE, and other similar compounds containing carbon, hydrogen, and oxygen only. Carbohydrates are excellent FEEDSTOCK for an ALCOHOL STILL.

F - hydrates de carbone

S - carbohidrato

**CARBON-TO-NITROGEN RATIO (biocon)**. The proportion of carbon to nitrogen in the material being placed in a BIOGAS DIGESTER. This ratio is important for maintaining biogas production. 25:1 is the optimal C/N ratio.

**Nitrogen Carbon-Nitrogen  
Material Content Ratio**

Cow dung 1.7% 25 to 1  
Poultry manure 6.3% No carbon  
Grass 4.0% 12 to 1  
Sheep manure 3.75% No carbon  
Urine 15-18% 8 to 1  
Wheat straw 0.3% 128 to 1  
Potato tops 1.5% 25 to 1  
Tomato 3.3% 128 to 1

F - rapport carbone-azote  
S - proporcion de carbon a nitrogeno

**CARBURETOR (auto)**. A device for mixing and controlling the amount of air and fuel supplied to a gasoline engine.

F - carburateur  
S - carburador

**CASING (sol)**. The framework housing the components of a FLAT-PLATE COLLECTOR. It is generally made of metal and lined with material for THERMAL insulation. Inlet and outlet openings are provided.

**F - enveloppe**

**S - envoltura**

**CATCHMENT APRON (hydr)**. A projecting slope on the downstream side of a SLUICE or dam, which is provided to withstand the force of falling water.

**F - pente de captage**

**S - plataforma colectora**

**CELL (elec)**. A device that generates electricity, traditionally consisting of two plates or conducting surfaces placed in an electrolytic FLUID.

**F - element**

**S - celula**

**CELLULASE (bio) (alc)**. Any of several ENZYMES found in FUNGI, BACTERIA, and lower animals that cause CELLULOSE to break down in water. These enzymes are needed for ALCOHOL DISTILLATION.

**F - cellulase**

**S - celulase**

**CELLULOSE**

**CELLULOSE (chem) (alc)**. The main POLYSACCHARIDE in living plants. Cellulose forms the skeletal structure of plant cell walls and can be HYDROLYZED to form GLUCOSE.

**F - cellulose**

**S - celulosa**

**CELLULOSIC BIOMASS (biocon)**. BIOMASS that contains vegetable matter.

F - biomasse cellulosique

S - biomasa celulosica

**CELSIUS (meas)**. The international temperature scale in which water freezes at 0 [degrees] and boils at 100 [degrees]. To convert from degrees Celsius to degrees FAHRENHEIT, multiply the temperature in degrees Celsius by 9/5 (or 1.8) and add 32. To convert from degrees Fahrenheit to degrees Celsius, subtract 32 from the Fahrenheit temperature and then multiply by 5/9. Abbreviated as C. (Syn: centigrade)

F - Celsius

S - Celsio

**CENTIGRADE (meas)**. (See: CELSIUS).

F - centigrade

S - centigrado

**CENTRIFUGAL FORCE (gen)**. The inertial force repelling a body away from the center of the curvature of a curved path along which it is moving, or away from the AXIS around which it rotates. The opposite of CENTRIPETAL FORCE.

F - force centrifuge

S - centrifuga, fuerza



**CENTRIPETAL FORCE** (gen). A force attracting a body toward the center of the curvature of a curved path along which it is moving, or toward the **AXIS** around which it rotates. The apposite of **CENTRIFUGAL FORCE**.

F - force centripete

S - centripeta , fuerza

**CHALK ADOBE** (constr). A method of making **ADOBE** bricks in which chalk is added to the clay, straw, and water.

Chalk adobe is useful as a **THERMAL MASS**.

F - adobe a la chaux

S - mezcla de adobe y creta

**CHANNEL** (hydr). The bed of a stream or waterway. (See also: **CANAL**)

F - chenal [1]

S - cauce

**CHARCOAL** (fos) (gen). A dark-colored or black porous form of **CARBON** made from vegetable or animal substances.

Charcoal commonly is made by charring wood in a **KILN** or **RETORT** from which air is partially excluded. It is used for **FUEL**, and in various mechanical, artistic, and chemical processes. By using **DISTILLATION** and retorts to produce charcoal, several valuable products can be collected that would otherwise be lost, including **COMBUSTIBLE GASES**, **CREOSOTE OIL**, **METHANOL**, soluble tar, and combustible pitch.

F - charbon de bois

S - carbon

CHIMNEY CAP

CHARCOAL GAS (prod). (See: PRODUCER GAS)

F - gaz de charbon de bois

S - gas de carbon

CHIMNEY (constr). A vertical passage or FLUE through which smoke and gases escape from a stove or fireplace.

F - cheminee

S - chimenea

CHIMNEY CAP (constr). A cone, usually made of sheet metal, placed pointed end up slightly above the top of a CHIMNEY. It prevents rain and debris from falling into the chimney.

F - mitre

S - sombreroete de chimenea

<FIGURE>

10p27.gif (486x486)

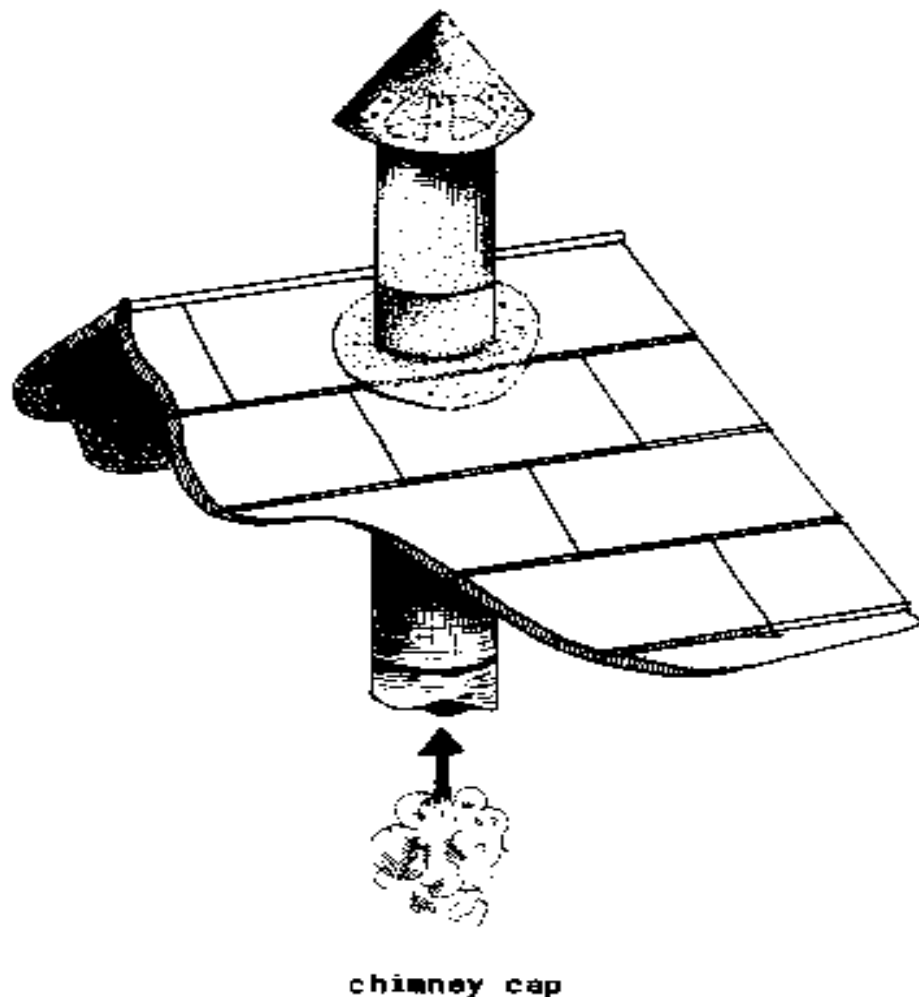

## CHINESE-TYPE DIGESTER

CHINESE-TYPE DIGESTER (biocon). A BIOGAS DIGESTER that is primarily designed to produce fertilizer. Usually a FIXED-DOME DIGESTER.

F - digesteur type chinois

S - digestor de tipo chino

<FIGURE>

10p28.gif (486x486)

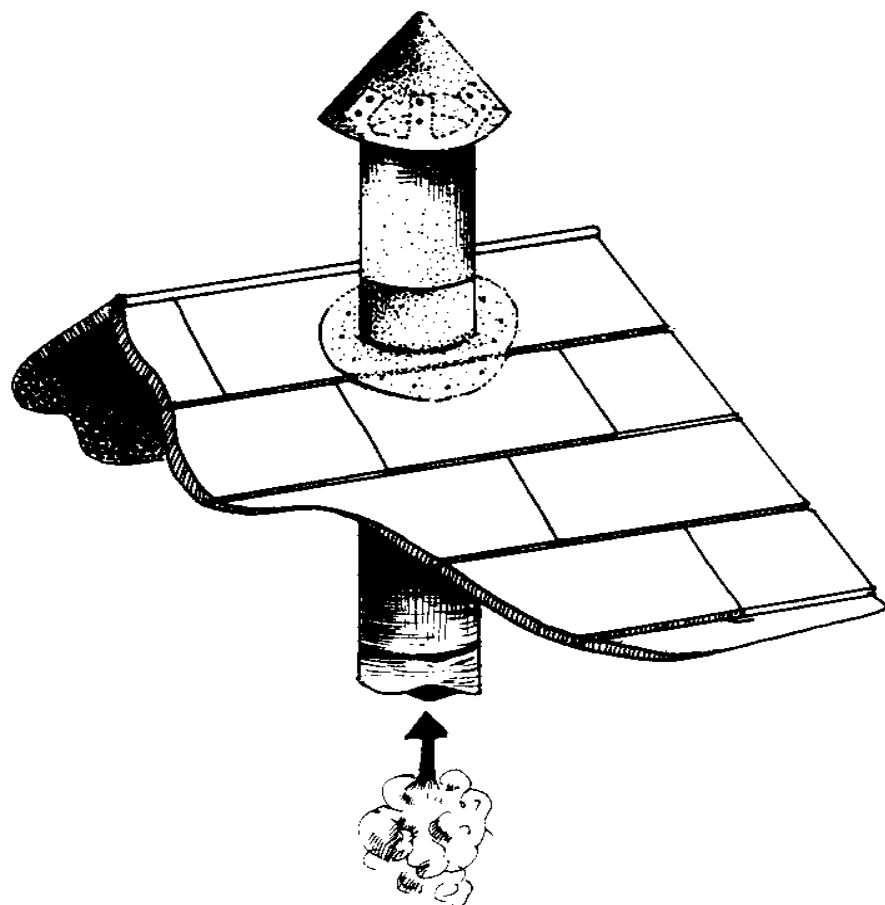

chimney cap

CHORD (wind). The distance from the LEADING EDGE to the TRAILING EDGE of an AIRFOIL. The term refers to WINDMILL

**BLADE design.**

**F - profondeur de l'aile**

**S - profundidad del aspa**

**CHULA (biocon).** A small, wood-burning stove, usually made of mud, clay, brick, or metal. The term is widely used in South Asia.

**F - chula**

**S - chula**

**CIRCULAR FOCUSING COLLECTOR (sol).** (See: COMPOUND PARABOLIC COLLECTOR)

**F - capteur circulaire a concentration**

**S - colector circular de enfoque**

**CISTERN (hydr).** An artificial reservoir or watertight tank for storing water or other liquids.

**F - citerne**

**S - cisterna**

**CLAMPS (wind) (arc).** Wooden splints bolted to the sides of the STOCKS, locking the SAIL assembly in the POLL END.

**F - eclisses**

**S - prensas**

**COLLECTOR**

**CLEARNESS INDEX (sol) (meas).** A SOLAR ENERGY concept introduced to express the ratio of a particular hour, day, or month's SOLAR RADIATION on a horizontal surface

to the EXTRATERRESTRIAL SOLAR RADIATION on that same surface for the same period of time. It is useful in calculating DIFFUSE RADIATION and RADIATION falling on a tilted surface.

F - indice de clarte

S - indice de claridad

CLERESTORY (sol). A vertical window that is placed high in a wall near the eaves for light, HEAT GAIN, and ventilation.

F - lanterneau

S - claraboya

CLOSED-LOOP SYSTEM (sol). A SOLAR HEATING system in which distilled water, antifreeze, and/or corrosion inhibitors are circulated through the COLLECTORS and storage tanks in a closed loop. Heat picked up from the collectors by the circulating FLUIDS is transferred to the water in the storage tanks through the closed loop or other HEAT EXCHANGERS.

F - circuit ferme, systeme de

S - sistema de ciclo cerrado

C/N (biocon). (See: CARBON TO NITROGEN RATIO)

F - C/N

S - C/N

COAL GASIFICATION (prod). The combustion of coal to form a gas suitable for use as a fuel. This is usually done in a PRODUCER GAS GENERATOR.

F - gazeification du charbon

S - gasificacion del carbon

COB ADOBE (constr). A type of ADOBE in which corn cobs are added to clay, water, and straw. Adobe bricks are reinforced by this addition of cobs during the brick-making process. Cob adobe is a useful THERMAL MASS.

F - adobe a la rafle de mais

S - mezcla de paja, arcilla, agua y mazorcas

COLLECTION (sol). The act of trapping SOLAR RADIATION.

F - captation

S - captacion

COLLECTOR (sol). A device to trap SOLAR RADIATION and convert it into usable heat. The term collector frequently refers to an insulated frame containing a panel made from an ABSORBER PLATE and GLAZING. More broadly, a well-designed building with windows facing the equator may also be considered a collector, as can other solar devices that capture SOLAR RADIATION in the form of heat.

F - capteur

S - colector

#### COLLECTOR EFFICIENCY

COLLECTOR EFFICIENCY (sol) (meas). The ratio of SOLAR ENERGY absorbed by a COLLECTOR to the RADIANT ENERGY

falling on the collector.

F - rendement d'un collecteur

S - eficiencia del colector

COLLECTOR/HEAT-EXCHANGER CORRECTION FACTOR (sol) (meas).

An index that indicates how much useful SOLAR ENERGY is lost during the exchange of heat from the COLLECTOR to the storage tank in LIQUID-BASED SOLAR HEATING SYSTEMS.

F - coefficient de correction capteur-echangeur de chaleur

S - factor de correccion del colector/termopermutador

COLLECTOR-HEAT REMOVAL EFFICIENCY FACTOR (sol) (meas). The ratio of actual useful HEAT GAIN of a FLAT-PLATE SOLAR COLLECTOR to the heat gain if the entire COLLECTOR PLATE were at the same temperature as the inlet FLUID.

F - coefficient de rendement capteur-echangeur de chaleur

S - factor de eficiencia del colector-termoextractor

COLLECTOR PLATE (sol). A metal sheet in a SOLAR COLLECTOR whose primary function is to absorb as much as possible of the SOLAR RADIATION reaching it through the GLAZING, while losing as little heat as possible as it transfers the retained heat to the HEAT TRANSFER MEDIUM.

F - plaque collectrice

S - placa colector

COLLECTOR TILT ANGLE (sol) (meas). The angle between the plane of the horizon and the surface of a SOLAR COLLECTOR,



generally used to maximize the COLLECTION of SOLAR RADIATION.

F - inclinasion d'un capteur

S - angulo de inclinacion del colector

COMBUSTIBLE GAS (biocon) (prod). Gas that will burn. This includes BIOGAS, PRODUCER GAS, and other VOLATILE FLUIDS.

F - gaz combustible

S - gas combustible

COMBUSTION CHAMBER (heat). The place in a stove where fuel is burned.

F - chambre de combustion

S - camara de combustion

COMBUSTION ZONE (prod). The section in a PRODUCER GAS GENERATOR in which the FEEDSTOCK is burned.

F - zone de combustion

S - zona de combustion

COMMON SAIL (wind) (arc). A WINDMILL SAIL that is covered with a canvas cloth.

F - aile de moulin

S - aspa comun

CONING

COMPOSTED SLUDGE (biocon). SLUDGE that has been rendered relatively PATHOGEN-free through COMPOSTING. It generally

can be used safely as fertilizer.

F - boues compostees

S - composte de lodos cloacales

COMPOSTING (biocon). AEROBIC DECOMPOSITION of ORGANIC MATTER. The resulting material is used as a fertilizer.

F - compostage

S - composte

COMPOUND PARABOLIC COLLECTOR (sol). A type of SOLAR COLLECTOR using parabolic REFLECTORS.

F - capteur parabolique compose

S - colector parabolico compuesto

CONCENTRATING COLLECTOR (sol). A SOLAR COLLECTOR that uses REFLECTORS to concentrate DIRECT RADIATION from the sun onto a narrow ABSORBER PLATE to produce intense heat.

F - capteur a concentration [1]

S - colector concentrador

CONCENTRATING PHOTOVOLTAIC ARRAY (sol). A series of lenses or mirrors used to concentrate SOLAR RADIATION onto PHOTOVOLTAIC CELLS, which convert the sunlight into electricity. The concentrated sunlight increases the output of each cell, thus reducing the total number of cells required to produce a given amount of electricity.

(See also: PHOTOVOLTAIC ARRAY)

F - groupe photovoltaique de concentration

S - conjunto concentrador fotovoltaico

**CONCENTRATING THERMAL COLLECTOR (sol). (See: CONCENTRATING COLLECTOR)**

**F - capteur thermique a concentration**

**S - colector termico concentrador**

**CONCENTRATION (gen). The amount of a substance contained in a FLUID per unit volume.**

**F - concentration**

**S - concentracion**

**CONDENSER (gen) (impl). A device used to change a vapor into a liquid. This can be done either by exposing to air a tube that contains vapor, or by passing the tube through a WATER JACKET.**

**F - condenseur**

**S - condensador**

**CONDUCTION (heat). Heat transfer from direct contact between a hot body and a cold body.**

**F - conduction**

**S - conduccion**

**CONING (wind). The practice of tilting up the WIND SHAFT of a WIND MACHINE at a small angle.**

**F - fuseler**

**S - movimiento de la pala**

**CONTINUOUS DIGESTION**

CONTINUOUS DIGESTION (biocon). The continuous feeding of BIOMASS into a BIOGAS DIGESTER, with the removal of an equivalent volume of EFFLUENT. The process is usually started with the addition of a SEED. It may take several DETENTION TIMES before the process becomes steady. For many purposes, this is a more EFFICIENT and convenient process than BATCH DIGESTION. Processes involving daily addition and removal are more properly described as semi-continuous.

F - digestion en continu

S - digestion continua

CONTINUOUS FLOW DIGESTER (biocon). A DIGESTER into which BIOMASS may be loaded and gas and EFFLUENT recovered without discontinuing digestion.

F - digesteur a flux continu

S - digestor de circulacion continua

CONTINUOUS PROCESSING (biocon). (See: CONTINUOUS DIGESTION)

F - traitement en continu

S - proceso continuo

CONTINUOUS STILL (alc). An ALCOHOL STILL into which MASH may be loaded and ALCOHOL recovered without discontinuing alcohol production.

F - alambic a distillation continue

S - alambique continuo

CONTROLLED BURNING ATMOSPHERE (fos). An atmosphere in which oil or natural gas is burned with just enough oxygen

to prevent all the carbon from being consumed. The recovered carbon may be used as a fuel.

F - atmosphere a combustion controlee

S - atmosfera de combustion controlada

CONVECTION (heat). The transfer of heat between one location or surface and another by the motion of a heat-carrying FLUID. Also, the transfer of heat within a fluid by movements within the fluid.

F - convection

S - conveccion

CONVECTION AIR COOLER (refrig). A non-electric cooler that depends on the natural circulation of air.

F - refroidisseur par convection d'air

S - enfriador de aire por conveccion

CONVERSION PROCESS (gen). A process through which ENERGY is converted from one form to another, such as RADIANT ENERGY into heat or electric energy.

F - conversion

S - proceso de conversion

COOKER (alc). A heated tank with an AGITATOR that heats the MASH as part of the ALCOHOL production process.

F - chaudiere de cuisson

S - caldera de coccion

CROSS-FLOW TURBINE

**COOKING (alc)**. A heating and stirring process that breaks down **STARCH** granules, thus making the starch available for the liquefaction and **SACCHARIFICATION** steps of the **ALCOHOL** manufacturing process.

F - cuisson

S - coccion

**COOK STOVE (biocon)**. An apparatus in which fuel is burned to produce heat for cooking.

F - cuisiniere

S - estufa

**CO-PRODUCT (alc)**. Substances resulting from the production of **ETHANOL** by **FERMENTATION**.

F - coproduit

S - coproducto

**CORRUGATED METAL SOLAR COLLECTOR (sol)**. A type of **SOLAR COLLECTOR** that uses a corrugated metal as its **ABSORBER PLATE**. The metal is usually painted with **FLAT BLACK PAINT**.

F - capteur solaire en tole ondulee

S - colector solar de metal corrugado

**COVER (sol)**. (See: **GLAZING**)

F - revetement

S - revestimiento

**COVER PLATE (sol)**. The transparent material placed over a

COLLECTOR-ABSORBER PLATE so that heat loss to the atmosphere is reduced and a greater fraction of the SOLAR RADIATION is collected as useable heat.

F - plaque de couverture

S - placa revestidora

CREOSOTE OIL (gen). A by-product from CHARCOAL production by DISTILLATION. It may be used as a preservative to protect wood from termites, moisture, etc.

F - huile de creosote

S - aceite de creosota

CRETAN SAIL WINDMILL (wind). (See: CRETAN WINDMILL)

F - moulin a ailes cretois

S - molino de viento con aspas cretananas

<FIGURE>

10p34.gif (540x353)

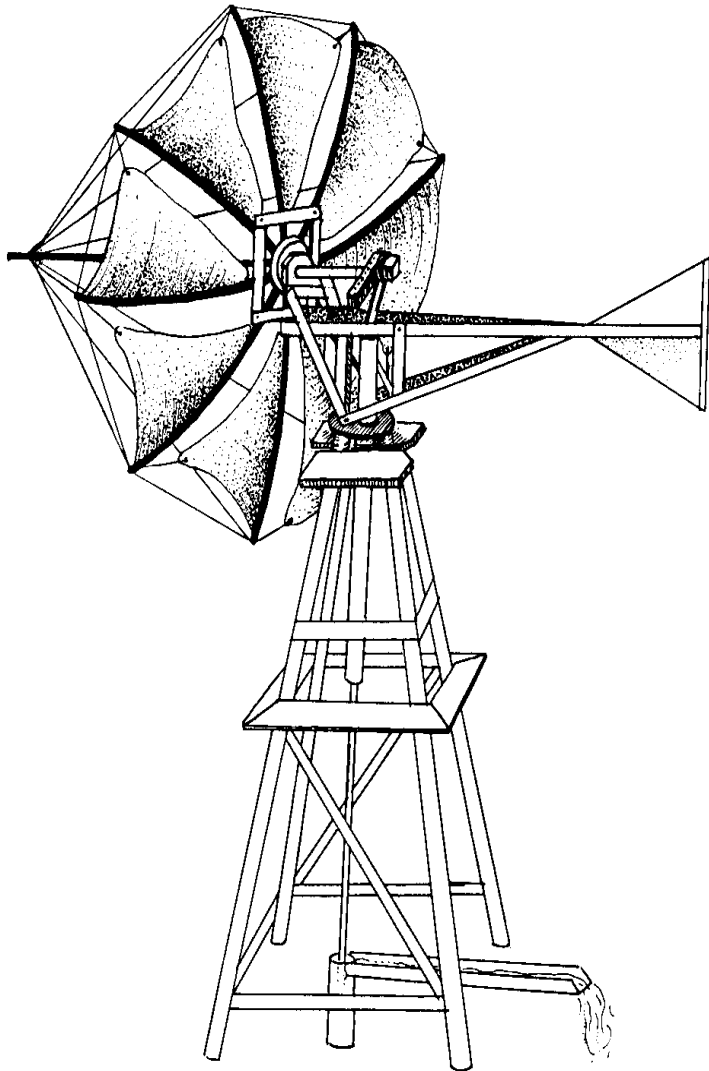

Cretan sail windmill

**CRETAN WINDMILL (wind)**. A type of **HORIZONTAL AXIS SAIL ROTOR WINDMILL** generally having four fixed, triangular **SAILS**. Cretan windmills are used primarily for low-lift water pumping.



F - moulin a vent cretois  
S - molino de viento cretano

CROSS (wind) (arc). A cruciform iron support for the sail assembly, used as an alternative to the POLL END.

F - croix  
S - aspa de hierro

CROSS-FLOW TURBINE (hydr). (See: BANKI TURBINE)

F - turbine a ecoulement radial  
S - turbina con rodete de tambor

#### CROSSWIND

CROSSWIND (wind). Winds blowing crosswise to the direction of the wind stream.

F - vent de travers  
S - viento de costado

CULTURE (bio). A preparation containing micro-organisms that are growing on a medium.

F - bouillon de culture  
S - cultivo

#### CUP ANEMOMETER

CUP ANEMOMETER (wind) (meas). An ANEMOMETER with three or four cups that rotate with the wind to measure wind speed.

**F - anemometre a coquilles**

**S - anemometro de tazas**

**<FIGURE>**

**10p35.gif (486x486)**

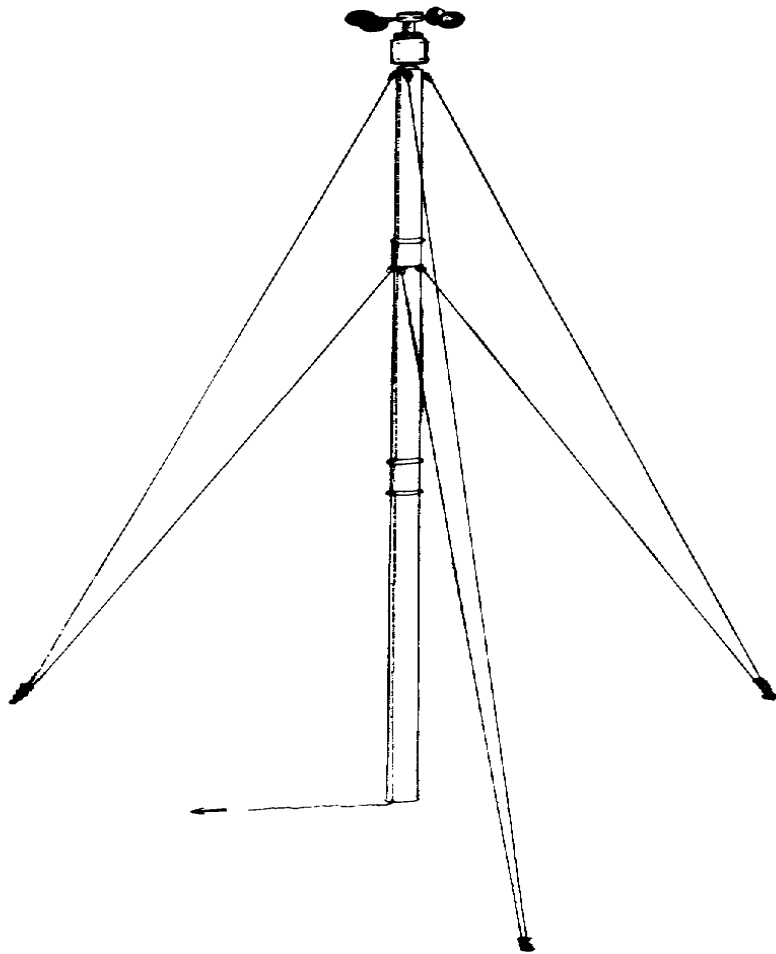

**cup anemometer**

**CUPS**

**CUPS (hydr). Bowl shaped BLADES found on PELTON WHEELS and other types of IMPULSE TURBINES.**

**F - godets**

**S - tazas**

**<FIGURE>**

**10p36.gif (486x486)**

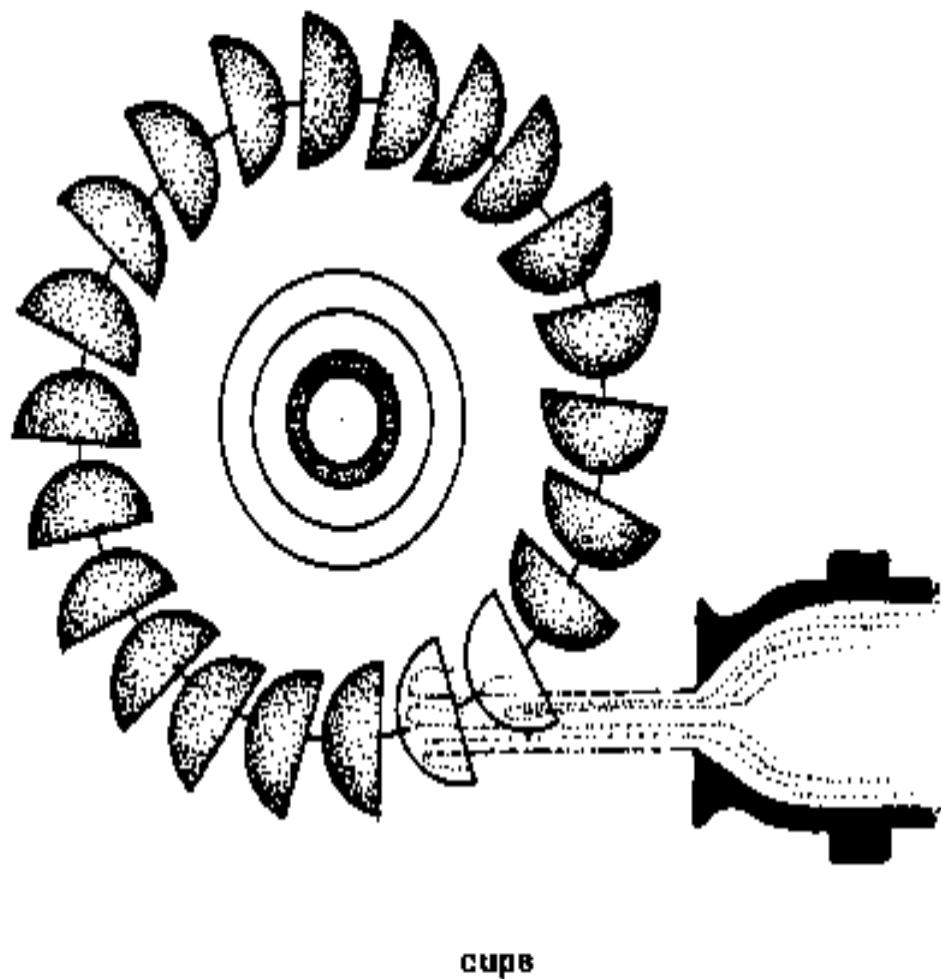

**CURB** (wind) (arc). In **SMOCK MILLS** and **TOWER MILLS**, the circular timber rim or wall plate supporting the revolving cap.

**F** - chemin de glissement

**S** - apoyo circular

**CURRENT** (elec). The **FLOW** of electrons through a conductor.

F - courant  
S - corriente

CUT-IN SPEED (wind). The WIND VELOCITY at which a WIND MACHINE is activated.

F - vitesse d'enclenchement  
S - velocidad de accionamiento

CUT-OUT SPEED (wind). The WIND VELOCITY at which a WIND MACHINE turns out of the wind. (See also: BATTERY CUT-OUT)

F - vitesse de disjonction  
S - velocidad de interrupcion

CYLINDER (hydr). In hydraulic systems, a short, hollow metal tube containing a piston, piston rod, and end seals, and fitted with a system to allow the entrance and exit of FLUIDS.

F - cylindre  
S - cilindro  
D

DAM (hydr). A structure that detains the FLOW of water in an open CHANNEL or watercourse. POWER dams raise the level of streams or rivers to create or concentrate HEAD for power purposes.

F - barrage  
S - represa

&lt;FIGURE&gt;

10p37.gif (486x486)

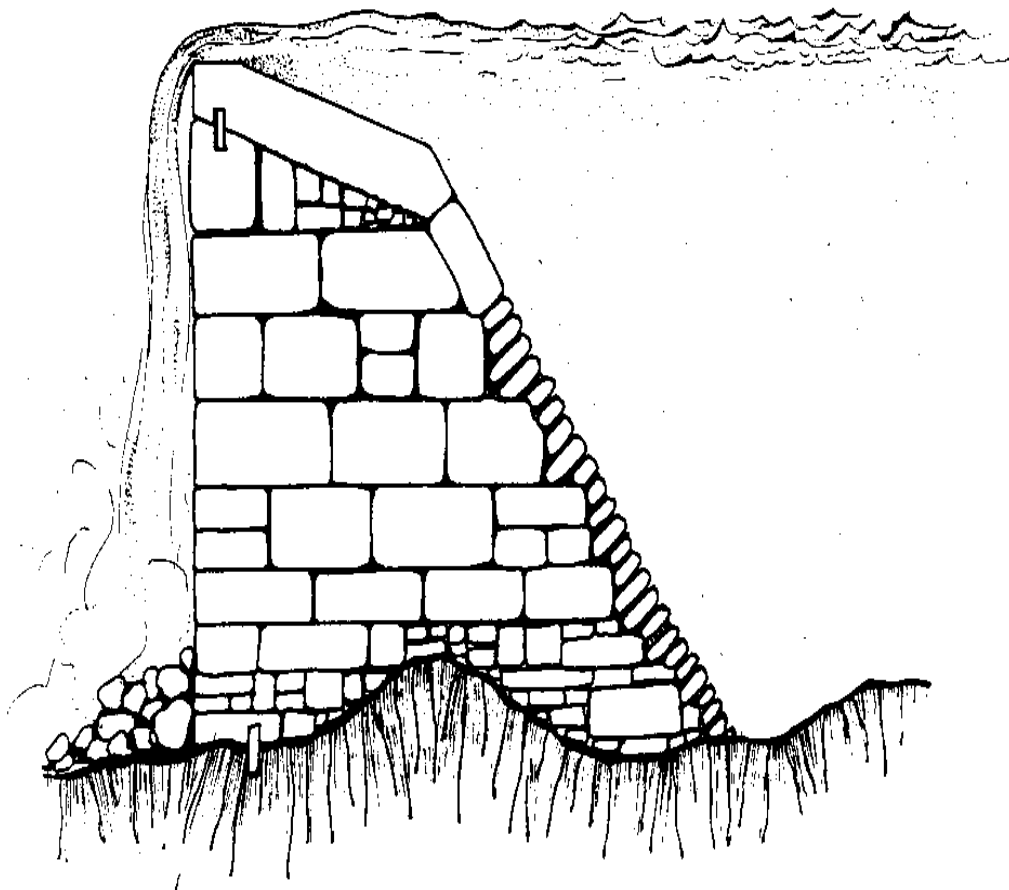

stone dam

**DAMPER** (heat). A movable plate or other device for regulating the air-FLOW and burning rate in a stove. It is often located either inside the stove or in the FLUE

**pipe.**

**F - registre**

**S - regulador de tiro**

**<FIGURE>**

**10p38.gif (486x486)**

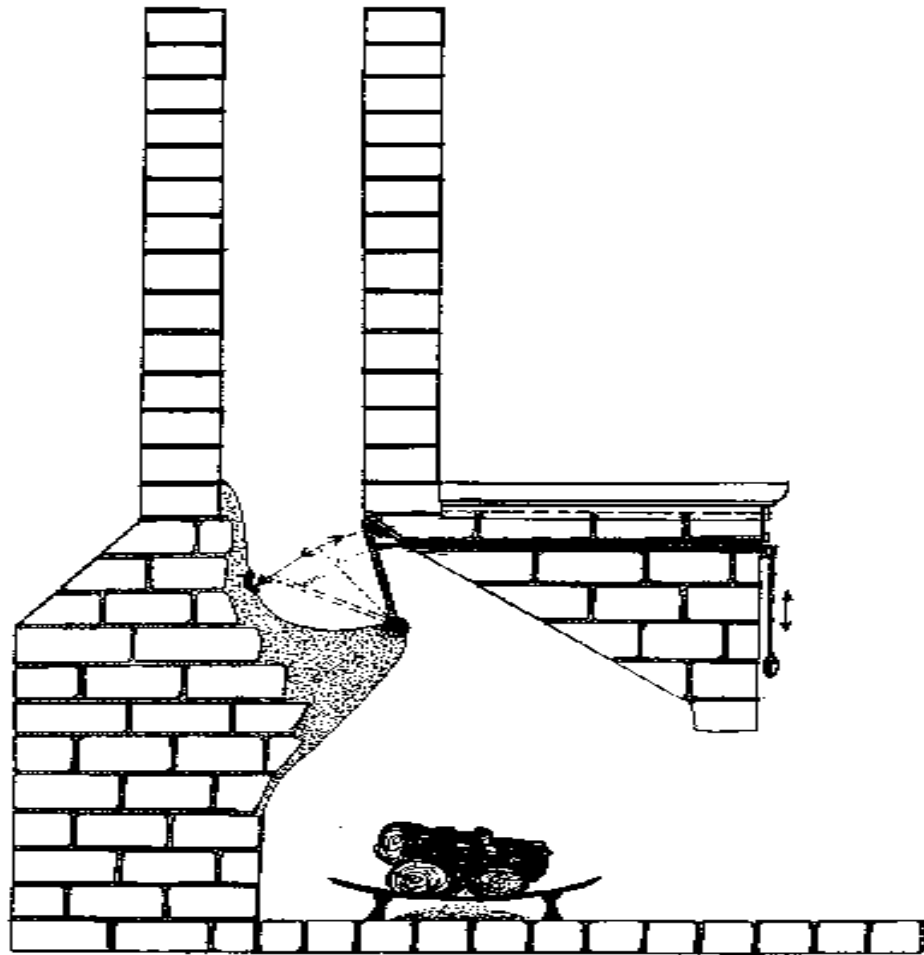

damper in a fireplace

DARRIEUS ROTOR WINDMILL (wind). A VERTICAL AXIS WIND MACHINE that has long, thin, loop-shaped BLADES connected at the top and bottom of the WIND SHAFT.

F - eolienne a rotor de Darrieus

S - molino de viento de rotor Darrieus

<FIGURE>



10p39.gif (393x393)

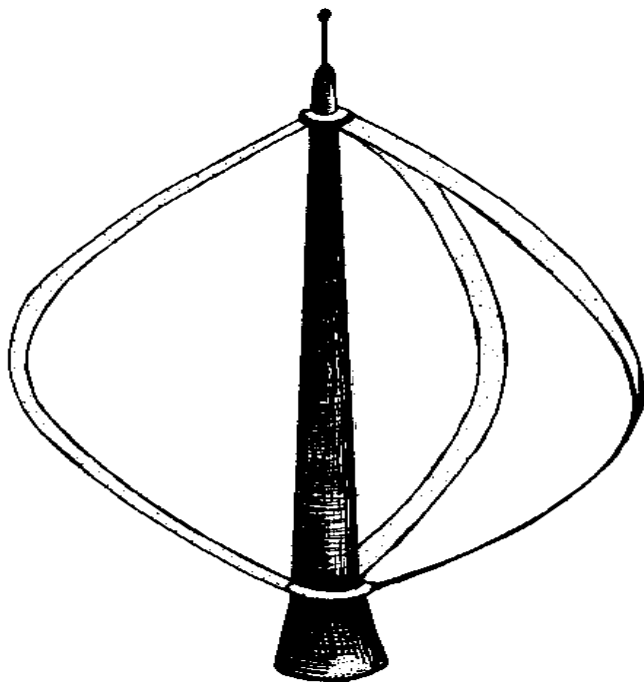

**Darrieus rotor**

DC (elec). Abbreviation for DIRECT CURRENT.

F - CC

S - C.C.

DDG (alc). Abbreviation for DISTILLER'S DRIED GRAINS.

(See: DISTILLER'S GRAINS)

F - GSB

S - G.S.D.

**DEADMAN**

DDGS (alc). Abbreviation for DISTILLER'S DRIED GRAINS and SOLUBLES. (See: DISTILLER'S GRAIN)

F - G.S.B.S.

S - G.S.D.S.

DEAD AIR SPACE (constr) (sol). An empty area within the walls of a building in which the air remains motionless and acts as insulation. Dead air space may be included in a SOLAR COLLECTOR between the ABSORBER PLATE and the GLAZING, between glazings, and in the CASING.

F - espace d'air inerte

S - espacio de aire no renovado

DEAD CURB (wind) (arc). A ledge supporting the CAP of a WINDMILL without the interposition of WHEELS or ROLLERS.

F - chemin dormant

S - reborde

DEADMAN (wind). A log or a mass of concrete or steel buried in the ground, to which GUY WIRES for supporting towers and poles are attached.

F - point fixe d'amarage

S - macizo de anclaje

<FIGURE>

10p40.gif (393x393)

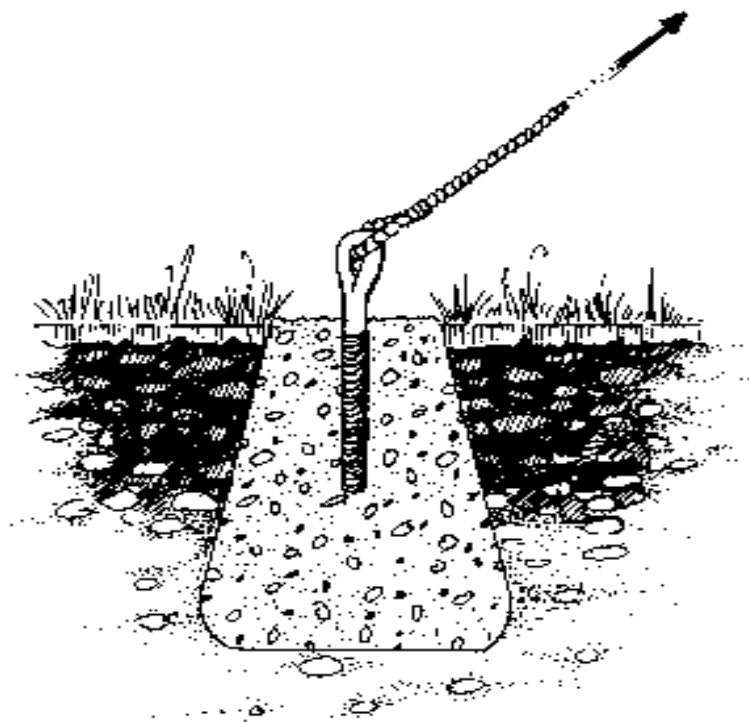

deadman

## DECOMPOSITION

DECOMPOSITION (bio) (chem). Decay of ORGANIC MATTER due to the action of BACTERIA. Also the separation of a substance into its component parts by chemical action.

F - decomposition

S - descomposicion

DEEP CYCLE BATTERY (elec) (wind). A BATTERY that can be fully charged and discharged without shortening its

life. They are often used with WIND GENERATORS.

F - batterie a cycle profond

S - bateria de gran ciclo

DEGREE DAY COOLING (gen) (meas). A measurement used to evaluate the summer cooling requirements of a given location. Each degree that the daily temperature is above 75 [degrees] F (24 [degrees] C), one cooling degree day is counted.

F - degre-jour de refroidissement

S - enfriamiento de grado-dia

DEGREE DAY HEATING (gen) (meas). A measurement used to determine the winter heating requirements of a given location. Each degree that the daily temperature is below 65 [degrees] F (19 [degrees] C) is a heating degree day.

F - degre-jour de chauffage

S - calefaccion de grado-dia

DIGESTED SLURRY

DEHYDRATION (gen). The removal of moisture from a substance.

F - deshydratation

S - deshidratacion

DENATURE (alc). The process of adding a substance, often METHANOL, to ETHANOL to make it unfit for human consumption.

F - denaturer

S - desnaturalizar

**DEPHLEGMATOR (alc). (See: ALCOHOL STILL)**

**F - deflegmateur**

**S - desflegmador**

**DESIGN HEAT LOAD (heat) (meas). The total heat loss from a building during the most severe winter conditions the building is likely to experience.**

**F - charge thermique nominale**

**S - carga de calefaccion prevista**

**DESSICANT (gen). A substance with an affinity for water, used for drying purposes.**

**F - dessicatif**

**S - desecante**

**DESTRUCTIVE DISTILLATION (alc) (gen). The heating, DECOMPOSITION, and subsequent DISTILLATION of FLUIDS from ORGANIC MATTER (e.g., METHANOL production from wood).**

**F - distillation destructive**

**S - destilacion destructora**

**DETENTION TIME (biocon) (meas). The amount of time that incoming material is retained in a BIOGAS DIGESTER.**

**F - temps de retention**

**S - periodo de detencion**

**DIFFUSED RADIATION (sol). Indirect, scattered sunlight, which casts no shadow. It is the opposite of DIRECT**

**RADIATION.**

F - rayonnement diffus

S - radiacion difusa

**DIFFUSION (chem).** The process by which a substance of a greater **CONCENTRATION** mixes with a substance of a lesser concentration to produce a uniform mixture.

F - diffusion

S - difusion

**DIGESTED SLUDGE (biocon).** The residue remaining after **DIGESTION**. Digested sludge contains some **UNDIGESTED SOLIDS** and stabilized **ORGANIC MATTER**.

F - boues digerees

S - sedimento digerido

**DIGESTED SLURRY (biocon).** (See: **DIGESTED SLUDGE**)

F - boue digeree

S - fango digerido

**DIGESTER**

**DIGESTER (biocon).** The tank in which **ANAEROBIC DIGESTION** takes place.

F - digesteur

S - digestor

**DIGESTER TANK (bio).** The reservoir area in a **BIOGAS DIGESTER** in which **DIGESTION** of **ORGANIC MATTER** takes place. It usually has some gas holding capacity, and

provides For the collection and removal of SCUM and SLUDGE.

F - reservoir digesteur

S - tanque digestor

DIGESTION (biocon). The process by which ORGANIC MATTER is decomposed by the action of ANAEROBIC BACTERIA, producing METHANE and high-grade fertilizer.

F - digestion

S - digestion

DILUTION RATE (biocon) (meas). The frequency with which water is added to a BIOGAS DIGESTER.

F - taux de dilution

S - tasa de dilucion

DIRECT CONVERSION (sol). The transformation of sunlight to electricity without an intervening thermodynamic cycle.

F - conversion directe

S - conversion directa

DIRECT CURRENT (elec). A continuous, one-directional FLOW of electricity, such as that from a BATTERY. Commonly abbreviated as dc.

F - courant continu

S - corriente continua

DIRECT GAIN SYSTEM (sol). (See: DIRECT SOLAR GAIN)

F - gain direct, systeme de

S - sistema de ganancia directa

DIRECT METHODS OF SOLAR HEATING (sol). SOLAR HEATING techniques in which SOLAR RADIATION enters a building through windows and SKYLIGHTS and is trapped inside to warm a room.

F - chauffage solaire direct

S - metodos directos de calefaccion solar

DIRECT RADIATION (sol). Sunlight that has traveled a straight path from the sun. It is the opposite of DIFFUSED RADIATION.

F - rayonnement direct

S - radiacion directa

DIRECT SOLAR ENERGY (sol). ENERGY acquired From conversion of DIRECT RADIATION.

F - energie solaire directe

S - energia solar directa

DOUBLE-GLAZING

DIRECT SOLAR GAIN (sol). A PASSIVE SOLAR HEATING system in which SOLAR RADIATION passes through and warms a room in a dwelling before being stored in THERMAL MASS for longterm heating.

F - apport solaire direct

S - ganancia solar directa

DISCHARGE PIPE (hydr) (biocon). [1] The pipe through which



water exits from a WATER TURBINE. [2] The outlet for EFFLUENT from a BIOGAS DIGESTER.

F - [1] tube de decharge; [2] tuyau d'evacuation

S - tubo de descarga

DISTILLATE (alc). The portion of a liquid that is removed from a solid or semisolid as a vapor and CONDENSED during the DISTILLATION process. ETHANOL is a distillate of FERMENTED MASH. (See also: SOLAR DISTILLATE)

F - distillat

S - destilado

DISTILLATION (alc). An evaporation and recondensation process by which liquids are separated into various fractions according to their boiling points. ETHANOL is separated by distillation from MASH and water.

F - distillation

S - destilacion

DISTILLATION COLUMN (alc). (See: STILL COLUMN)

F - colonne de distillation

S - columna de destilacion

DISTILLER'S DRIED GRAIN (DDG) (alc). (See: DISTILLER'S GRAIN)

F - grains secs de brasserie (GSB)

S - grano seco de destilacion (GSD)

**DISTILLER'S GRAIN (alc)**. A by-product of ETHANOL production. Once ethanol has been driven from the MASH in an ALCOHOL STILL, the remaining solids are known as distiller's grain. When dried, these grains can be used as high protein animal feed. The dried distiller's grain commonly is abbreviated as DDG. (Syn: BREWER'S DRIED GRAIN)

F - grains de distillerie

S - grano de destilacion

**DISTILLER'S MASH (alc)**. (See: SPENT MASH)

F - mout de distillateur

S - mezcla de destilacion

**DOUBLE CHAMBER (biocon)**. A type of BIOGAS DIGESTER in which the GASHOLDER is separate from the DIGESTER TANK.

F - chambre double

S - camara doble

**DOUBLE-GLAZING (sol)**. [1] A cover for a SOLAR COLLECTOR that is made from two layers of GLAZING materials. [2] Double-glass windows designed to serve as insulation for buildings.

F - [1] vitre double; [2] double vitrage

S - vidriado doble

**DOUBLE-SHUTTERED**

**DOUBLE-SHUTTERED (wind) (arc)**. PATENT SAILS or SPRING SAILS fitted with SHUTTERS on both sides of the WHIP.

F - double volets, a  
S - doble postigo

DOWNCOMER (alc) (impl). A component of an ALCOHOL STILL.  
When water is separated from ALCOHOL during DISTILLATION,  
the water falls toward the bottom of the STILL  
COLUMN through a pipe called a downcomer.

F - deversoir  
S - tubo de descenso

DOWNDRAFT (gen) (prod). [1] A type of PRODUCER GAS GENERATOR  
in which air and gas FLOWS from the top of the COMBUSTION  
ZONE down through to the bottom. [2] KILNS or  
other types of ovens and stoves in which CONVECTION or  
combustion air flows down through the device.

F - [1] tirage en bas; [2] tirage inverse  
S - corriente descendiente

DOWNWIND (wind). On the side opposite the WIND DIRECTION.

F - sous le vent  
S - con el viento

<FIGURE>

10p44.gif (393x393)

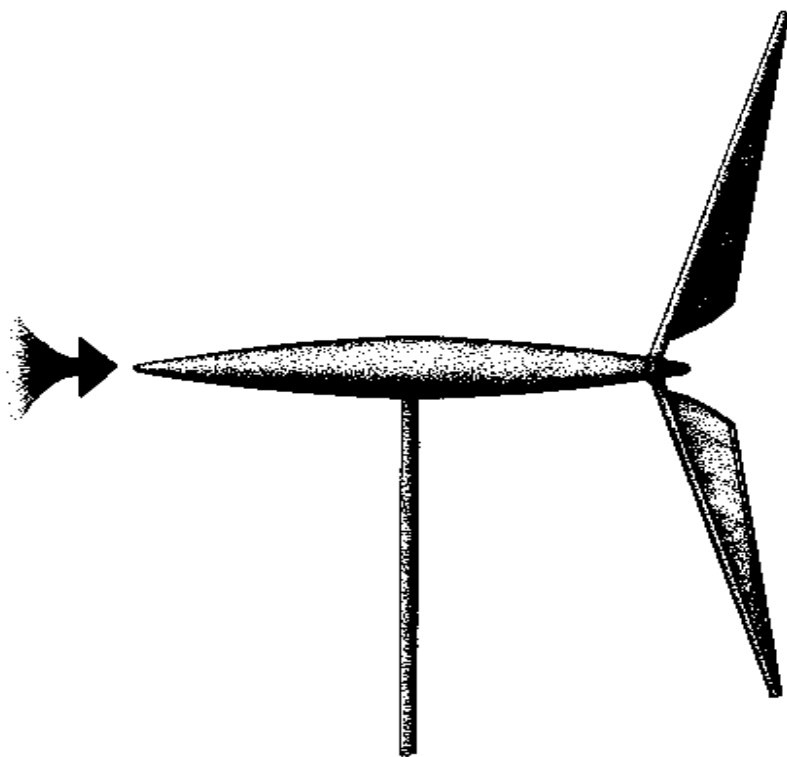

rotor placed downwind

## DRYING BED

**DRAFT** (heat). The **FLOW** of air through a **KILN**, stove, oven, fireplace, **PRODUCER GAS GENERATOR**, etc. Draft affects both temperature and rate of combustion.

**F** - tirage

**S** - tiro de aire

**DRAG** (wind). An aerodynamic force that retards the motion of lift-type **ROTOR** blades, or that causes **BLADE** motion in **DRAG-TYPE WIND MACHINES**.

**F** - trainee

S - resistencia aerodinamica

DRAG-TYPE SYSTEM (wind). WIND MACHINES that are actuated by aerodynamic DRAG in a WIND STREAM (e.g., SAVONIUS ROTOR).

F - type a trainee, systeme du

S - sistema del tipo de arrastre

DRAG-TYPE WIND MACHINE (wind). A WIND MACHINE that rotates by being pushed by the wind instead of by being driven by LIFT forces. This is generally a slow-moving device.

F - eolienne a trainee

S - aerogenerador del tipo de arrastre

DRAIN DOWN SOLAR COLLECTOR (sol). A SOLAR COLLECTOR that will automatically drain itself to protect against freezing.

F - capteur solaire a evacuation automatique

S - colector solar con drenaje

DRY BIOMASS (gen). Moisture-free BIOMASS. It is valuable because it can be conveniently stored for long periods of time. (See also: DRY ORGANIC WASTE)

F - biomasse seche

S - biomasa seca

DRY-BULB TEMPERATURE (meas). The temperature of air as indicated by a standard thermometer, as contrasted with WET-BULB TEMPERATURE that depends on atmospheric humidity.

This measure of AMBIENT temperature is used in designing PASSIVE SOLAR HEATING and SOLAR COOLING systems.

F - temperature au thermometre sec

S - temperatura de bola seca

DRY DIGESTION (biocon). DIGESTION in which more than 10 percent of the SLURRY is solid material.

F - digestion seche

S - digestion seca

DRYING BED (biocon). An area prepared for drying EFFLUENT after it has been removed from a METHANE DIGESTER. Dried effluent can be used as fertilizer or as animal feed.

F - lit de sechage

S - lecho secador

DRY ORGANIC WASTE

DRY ORGANIC WASTE (gen). ORGANIC WASTE that is free from moisture. This type of waste can be stored for long periods before being used as a fuel or fertilizer. (See also: DRY BIOMASS)

F - dechets organiques secs

S - desperdicios organicos secos

DRY SLURRY (biocon). SLURRY that is more than 10 percent solid material.

F - boue seche

S - fango seco

DRY STEAM (geo). An ENERGY source obtained when hot water boils in an underground reservoir. As the steam rises, some of it condenses on surrounding rock. The uncondensed steam that reaches the surface is called dry steam, and may be tapped and used in STEAM TURBINES.

F - vapeur seche

S - vapor seco

DUAL-FUEL ENGINE (auto) (gen). A gasoline or diesel engine equipped to operate on an alternative fuel, either alternately or in combination (e.g., gasoline-BIOGAS, diesel-biogás, gasoline-WOOD GAS, diesel-wood gas).

F - moteur polycarburant

S - motor a doble combustible

DYNAPOD

DUNG (bio). Manure, usually without urine. Dried dung can be burned directly as a fuel or used as a fertilizer.

F - fumier

S - estiercol

DUNG GAS (biocon). (See: BIOGAS)

F - gaz de fumier

S - gas de estiercol

DYNAMO (elec). A device for converting mechanical ENERGY into electrical energy by electromagnetic induction.

Dynamos are often adapted to be driven by WINDMILLS.

(See also: ALTERNATOR)

F - dynamo

S - dinamo

DYNAPOD (gen) (impl). A pedal-operated POWER source. It is used to drive a variety of machines and devices.

F - dynapod

S - dynapod

<FIGURE>

10p46.gif (540x540)



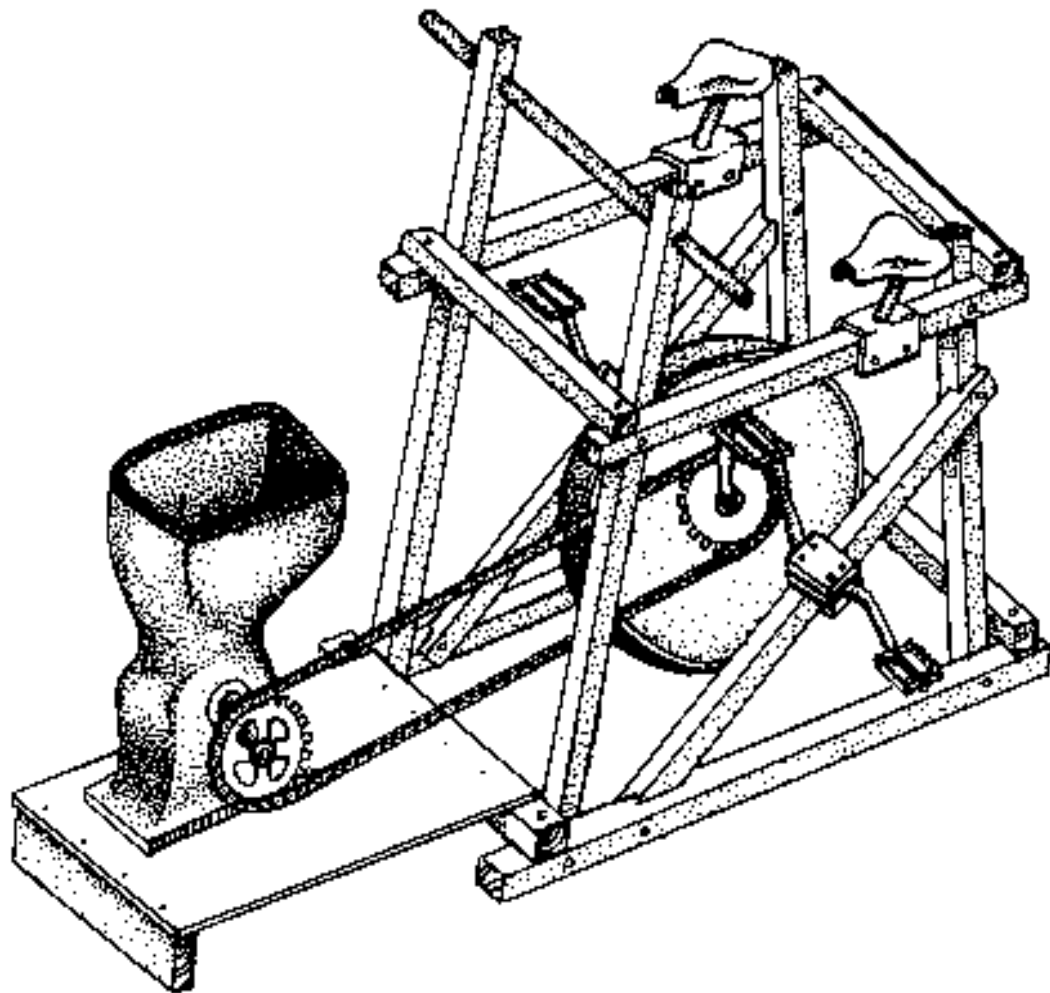

**dynapod with chain drive and grinder**

## **E**

**EARTH KILN (heat)**. A relatively inefficient KILN made by mounding earth over the materials to be burned. Used in

traditional CHARCOAL production.

F - meule a charbon de bois

S - horno de tierra

<FIGURE>

10p48a.gif (486x486)

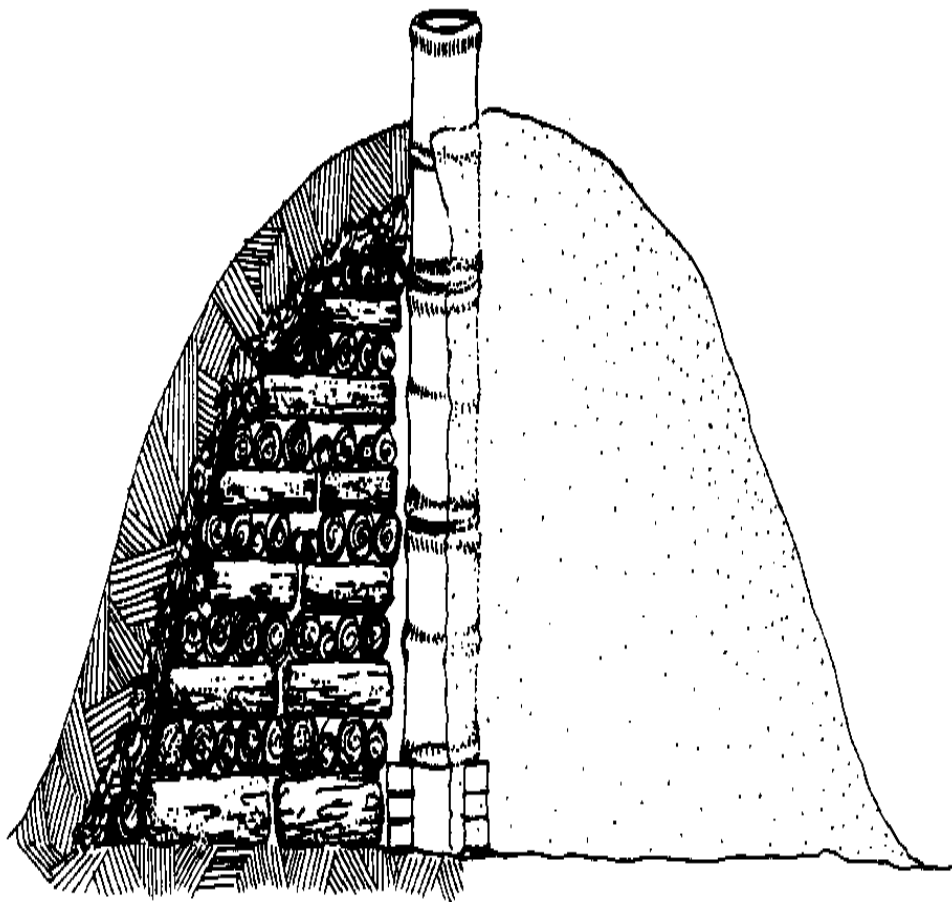

earth kiln (cutaway view)

**ECCENTRIC WHEEL (gen)**. A wheel in which the axle is not at the center point, but slightly off-center.

F - roue excentrique

S - rueda excentrica

<FIGURE>

10p48b.gif (317x317)

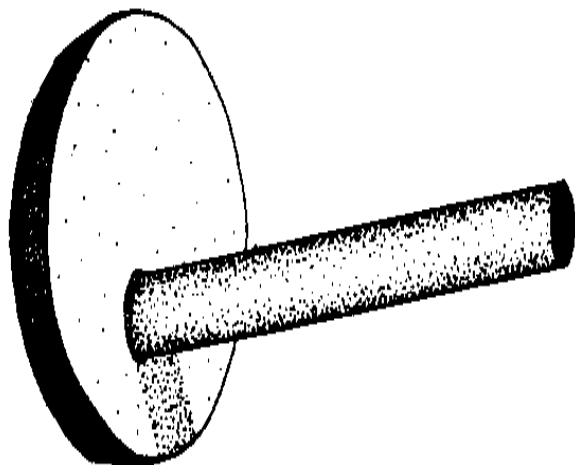

eccentric wheel with axle

**ECONOMIZER (heat)**. A **HEAT EXCHANGER** that recovers heat from **FLUE** gases and uses it to heat feedwater or combustion air.

F - economiseur

S - economizador

**ENERGY CONSUMPTION**

**EFFECTIVENESS (heat) (meas)**. The ratio of actual heat transfer in a **HEAT EXCHANGER** to the maximum possible heat transfer.

F - efficacite

S - eficacia

**EFFICIENCY (gen)**. The ratio of the **ENERGY** output to the energy input. Efficiency is usually expressed as a percentage.

F - rendement

S - eficiencia

**EFFLUENT (biocon)**. [1] **SLURRY** that has been removed from a **BIOGAS PLANT**. [2] Liquid sewage after having passed through any stage in its purification.

F - effluent

S - efluente

**EMISSIVITY (sol)**. The ratio of **RADIANT ENERGY** emitted by a body to that emitted by a perfect **BLACKBODY**. A perfect blackbody has an emissivity of one; a perfect **REFLECTOR**, an emissivity of zero.

F - emissivite

S - emisividad

**EMITTANCE (sol) (meas)**. A rating of the ability of a material to give off heat as **RADIANT ENERGY**.

F - emittance

S - emitancia

**ENERGY (gen)**. The capacity of a body to do work; **POWER** in action.

F - energie

S - energia

**ENERGY CAPABILITY OF AN ELECTRICITY-PRODUCING DEVICE (gen)**  
(meas). The maximum amount of electricity that an electricity-producing device may produce under the best conditions during a given period. ENERGY capability is determined by the mechanical EFFICIENCY of the device.

F - capacite energetique d'un dispositif produisant du courant

S - capacidad energetica de un aparato productor de electricidad

**ENERGY CONSERVATION (gen)**. Practices and measures that increase the EFFICIENCY with which ENERGY is used or produced.

F - conservation de l'energie

S - conservacion de energia

**ENERGY CONSUMPTION (gen)**. The amount of ENERGY consumed in the form in which it is obtained by the user. This term excludes electrical generation and distribution losses. It also is called net energy consumption.

F - consommation d'energie

S - consumo de energia

**ENERGY CONVERSION**

**ENERGY CONVERSION (gen)**. The act of changing ENERGY from one form to another (e.g., WIND ENERGY to mechanical energy) .

**ENERGY CONVERSION OF PRACTICAL, RENEWABLE  
ENERGY SYSTEMS - Maximum Efficiency**

**Wind Generator 40%**

**Mechanical Water Turbine 68-93% Electrical**

**Steam Power Plant 40%**

**Mechanical Windmill 20-30% Mechanical**

**Waterwheel 70-85%**

**Solar Flat Collector 40-60% Thermal**

**Concentrator 80-90% (Heat)**

**Chemical Wood Combustion Burner Thermal**

**85% maximum (Heat)**

**Chemical Battery 80% (Storage) Electrical**

**Chemical Biogas Digester 40-60% Chemical**

**F - conversion de l'energie**

**S - conversion de energia**

**ENERGY PATTERN FACTOR (wind). The ratio of the available ENERGY in all of the winds in a particular location over a certain period of time to the energy that would be available if the WIND SPEED over that period of time were constant at the mean wind speed over that period of time.**

**F - coefficient de diagramme energetique**

**S - factor energetico del viento**

**ENERGY PRODUCTS (gen).** Fuels that can be used to produce ENERGY. Also, the by-products that result when fuels are produced.

**F - combustibles energetiques**

**S - productos energeticos**

**ENERGY STORAGE (gen) (meas).** The ability to convert ENERGY into other forms, such as heat or a chemical reaction, so that it can be retrieved for later use. Also the development, design, construction, and operation of devices for storing energy until needed. The technology includes devices such as batteries, pumped storage for hydroelectric generation and compressed gas.

**F - stockage de l'energie**

**S - almacenamiento de energia**

**ENHANCEMENT (sol).** Increasing the amount of sunlight transmitted through the GLAZING in a SOLAR COLLECTOR through the use of a REFLECTOR.

**F - reinforcement**

**S - intensificacion**

**EQUINOX**

**RENEWABLE ENERGY STORAGE**



**Storage****Storage Efficien- Major Loss (\*) (\*\*)****Medium cy (%) Characteristics A B****SOLAR Water 75-90 Leaks (therma] 2 1  
(Heat) & physical)****Earth varies Leaks (thermal) 1 1****Rock 60-80 Leaks (thermal) 2 2****Salt Hy- 75-95 Material Break- 3 3  
drates down****WIND/WATER Pumped 50-70 Evaporation 1 2  
(Mechanical) Water Friction****Compressed 40-50 Leaks 2 2****Air (com- Friction  
pressed)****WIND/WATER Battery 70-85 Internal 3 3  
(Electrical) Discharge****METHANE Tank Leaks 1 2****Tank (com- 50-60 3 3  
pressed)****ALCOHOL Tank Leaks  
Evaporation 1 1****(\*) A Relative Cost 1. Negligible**

## 2. Intermediate

(\*\*) B Degree of Mechanical Complexity 3. Considerable

**ENZYMATIC HYDROLYSIS (alc)**. The use of **ENZYMES** to convert **STARCH** into simple sugars. This is a stage in the production of **ETHANOL**.

F - saccharification enzymatique

S - hidrolisis enzimica

**ENZYMES (chem) (alc)**. Organic substances that are produced in the cells of living organisms, and which cause specific chemical changes. Enzymes are produced by **BACTERIA** or **FUNGI** and are used in the liquefaction and **SACCHARIFICATION** steps of **ALCOHOL** production.

F - enzymes

S - enzimas

**EOLIAN (wind)**. Of, relating to, formed by, or deposited by the wind or air currents. (Syn: Aeolian)

F - eolien, eolienne

S - eolico

**EQUINOX (sol)**. Either of two times of year when the sun passes over the celestial equator and when the length of day and night are almost equal.

F - equinoxe

S - equinoccio

## **ETHANOL**

**ETHANOL (alc)**. A Flammable organic compound ( $C[H.sub.3]C[H.sub.2]OH$ ) formed during sugar **FERMENTATION**. It is also called ethyl alcohol, **GRAIN ALCOHOL**, or simply **ALCOHOL**.

F - ethanol

S - etanol

**ETHYL ALCOHOL (alc)**. (See: **ETHANOL**)

F - alcool ethylique

S - alcohol etilico

**EUTECTIC SALTS (heat)**. Heat storing salts that melt at a relatively low temperature. They absorb large quantities of heat when they do melt. Heat is released when the salts freeze.

F - eutectiques

S - sales eutecticos

**EVACUATED TUBE COLLECTOR (sol)**. A **SOLAR COLLECTOR** that uses a vacuum to insulate the **ABSORBER PLATE**. This **COLLECTOR** is highly **EFFICIENT** but very expensive.

F - capteur a tube vide

S - colector con tubo vaciado

**EVAPORATIVE COOLING (refrig)**. The exchange of heat from air to a water spray or wet surface through a reversible **THERMODYNAMIC** process. Air passing through the water is cooled as the water evaporates. The process can be reversed by condensing the vapor on a cool surface.

F - refroidissement par evaporation

S - enfriamiento evaporante

EXCESS AIR (heat). Air that passes through a COMBUSTION ZONE in excess of the quantity theoretically required for complete combustion.

F - exces d'air

S - aire excesivo

EXTRATERRESTRIAL SOLAR RADIATION (sol) (meas). The amount of SOLAR RADIATION that would strike a surface if that surface were outside the Earth's atmosphere. (See also: CLEARNESS INDEX)

F - rayonnement solaire extraterrestre

S - radiacion solar extraterrestre

F

F (meas). Abbreviation for FAHRENHEIT.

F - F

S - F

FAHRENHEIT (meas). The temperature scale in which water freezes at 32 [degrees] F and boils at 212 [degrees] F. Temperatures of the Fahrenheit scale can be converted to equivalent temperatures on the CELSIUS or Centigrade scale by first subtracting 32 [degrees] from the Fahrenheit temperature, then multiplying the result by 5/9 according to the formula:

$(F - 32) \times 5/9 = C.$

F - Fahrenheit

**S - Fahrenheit**

**FALL WIND (wind)**. A strong, cold, downhill wind.

**F - vent catabatique**

**S - racha de viento**

**FANTAIL (wind) (arc)**. A small, secondary ROTOR set at a right angle to the main ROTOR of a WINDMILL to provide the motive POWER to turn the CAP to face the wind.

**F - gouvernail**

**S - timon**

**FARM WINDMILL (wind)**. A multi-BLADED WINDMILL that is based on an Early American design and is used primarily for water pumping.

**F - eolienne de ferme**

**S - molino de viento rural**

<FIGURE>

10p54.gif (486x317)

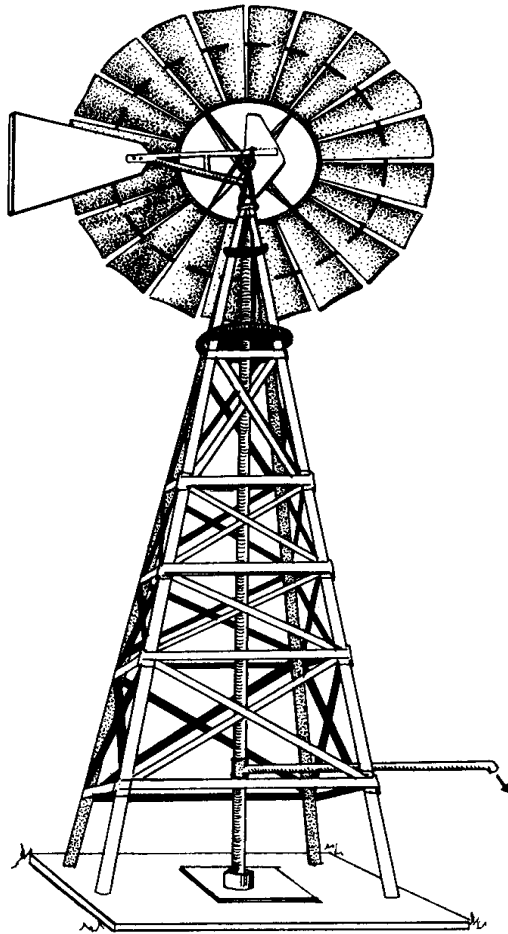

fara windmill

**FEATHER** (wind). Turning the **SAILS** or the **ROTOR** of a **WIND MACHINE** out of the wind to protect the device from damage from high **WIND VELOCITIES**.

**F** - mettre en drapeau

**S** - poner en bandolera

**FEATHERING MECHANISM** (wind) (impl). A mechanism on a

WINDMILL that automatically turns the BLADES out of the wind when winds are too strong. This slows the windmill, protecting it from damage in high winds.

F - mecanisme de mise en drapeau

S - mecanismo de puesta en bandolera

FEED (gen). See: FEEDSTOCK)

F - alimentation

S - alimento

FEEDSTOCK (gen). The raw ORGANIC MATTER, such as grain, fruit, DUNG, or other BIOMASS, used as the INFLUENT in the FERMENTATION or DIGESTION processes.

F - charge d'alimentation

S - materia prima organica

FARM WINDMILL

FIRE BRICK

FENESTRATION (sol). An opening in a building that admits light and/or air.

F - fenestration

S - ventanaje

FERMENT (biocon). A transformation or DECOMPOSITION of ORGANIC MATTER by the catalytic effect of ENZYMATIC action. To cause or undergo the action of FERMENTATION.

F - fermenter

S - fermentar

**FERMENTABLE SUGAR (alc). (See: MONOSACCHARIDE)**

**F - sucre fermentable**

**S - azucar fermentable**

**FERMENTATION (alc) (chem). [1] A biological sequence of ENZYMATIC reactions that convert sugars to carbon dioxide and ALCOHOL in the absence of FREE OXYGEN. The term generally refers to metabolism in the absence of oxygen.**

**[2] The process by which YEAST changes sugar to ALCOHOL in the absence of air. [3] The process of chemical change in ORGANIC MATTER brought about by living organisms.**

**F - fermentation**

**S - fermentacion**

**FERMENTATION PERIOD (gen) (meas). The length of time required for a substance to FERMENT.**

**F - duree de fermentation**

**S - periodo de fermentacion**

**FERMENTATION TANK (alc). The container in which FERMENTATION takes place in an ETHANOL production operation.**

**F - cuve de fermentation**

**S - tanque de fermentacion**

**FERMENTER (gen). (See: FERMENTATION TANK)**

**F - fermenteur**

**S - fermentador**



**FETCH AREA (wind)**. The geographic area over which the wind passes shortly before reaching a **WIND MACHINE**. It is considered in the selection of a site for a wind-powered device.

F - portee du vent  
S - extension expuesta

**FIRE BACK (constr)**. A metal plate set in a **CHIMNEY** to control the back **DRAFT** of flames.

F - contre-feu  
S - respaldo refractario

**FIREBOX (gen)**. The area in a stove, oven, or **PRODUCER GAS GENERATOR** in which combustion occurs.

F - chambre de combustion  
S - caja refractaria

**FIRE BRICK (constr)**. A type of brick with a high melting point that is used to line **FLUES**, **CHIMNEYS**, furnaces, and fireplaces.

F - brique refractaire  
S - ladrillo refractario

**FIXED-DOME DIGESTER**

**FIXED-DOME DIGESTER (biocon)**. A **BIOGAS DIGESTER** in which the gasholder is an integral part of the digester, rather than a **FLOATING GAS CAP**. This type of digester is usually used to produce fertilizer. **METHANE** is considered

a by-product.

F - digesteur a dome fixe

S - digestor de sombreroete fiyo

FLAT BLACK PAINT (sol). A nonglossy black paint with a relatively high ABSORPTANCE.

F - peinture noire mate

S - pintura negra uniforme

FLAT-PLATE SOLAR COLLECTOR (sol). A device that uses an ABSORBER PLATE to COLLECT SOLAR RADIATION without assistance of devices to concentrate the sun's rays.

F - capteur solaire a panneau plan

S - colector solar de placa lisa

FLOAT (hydr). The BUCKET of a WATER WHEEL.

F - aube

S - paleta [1]

FLOATING GAS CAP (biocon). A lid over a BIOGAS DIGESTER that rises or falls with the production of METHANE.

F - cloche a gaz flottante

S - sombreroete movable

<FIGURE>

10p56.gif (540x540)

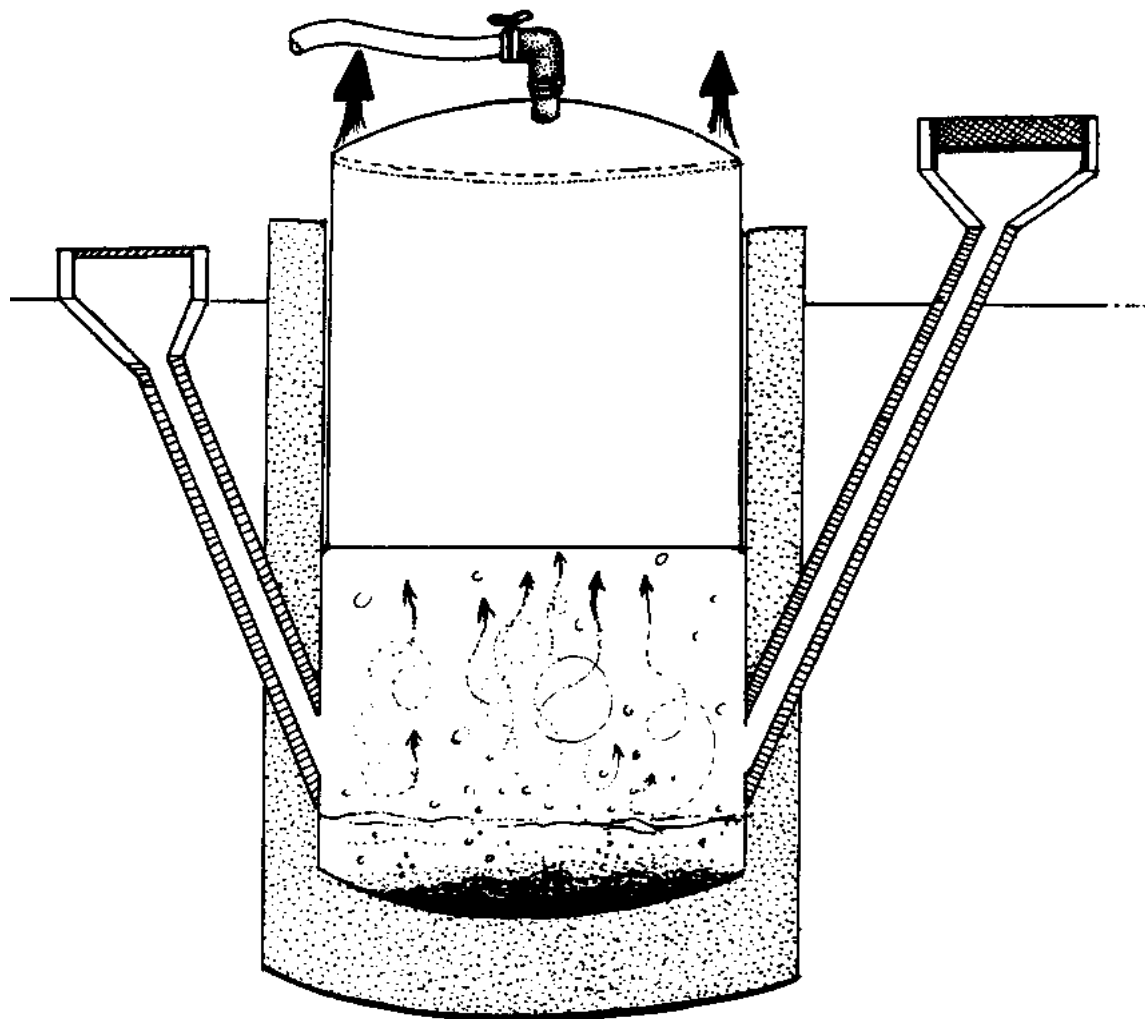

floating gas cap

## FOCUSING COLLECTOR

FLOW (gen). The volume of a substance passing a point per unit time (e.g., meters per second, gallons per hour, etc.)

F - debit  
S - flujo

**FLOW DESIGN (hydr) (meas)**. The FLOW rate at which a TURBINE is designed to operate.

F - debit nominal  
S - diseno de flujo

**FLUE (const)**. A passageway in a CHIMNEY that vents gases produced during combustion. The flue opening can be regulated to control the DRAFT in the oven or stove, thus changing the rate of combustion.

F - carneau  
S - conducto de humos

**FLUE GAS DRYING (heat)**. THERMAL drying using gases in a FLUE as the source of heat.

F - sechage au gaz de carneau  
S - secado por gases del conducto

**FLUID (gen)**. Any substance that FLOWS, such as a liquid or gas. Fluids differ from solids in that they cannot resist changes in their shape when acted upon by a force.

F - fluide  
S - fluido

**FLUIDIZED BED GASSIFIER (prod)**. A type of PRODUCER GAS GENERATOR in which air FLOWS upward through a bed of

suitably-sized fuel particles fast enough to buoy the particles and give them an appearance of great agitation. The fuel particles generally are small. This type of combustion reduces the sulphur-dioxide emissions when coal is burned.

F - gazogene a lit fluidise

S - gasificador en lecho fluidizado

FLUME (hydr). [1] A HEAD RACE in the form of a trough or CHANNEL that carries water to a WATER WHEEL. [2] A waterway, usually made of wood and often supported on a trestle, that conveys water to be used for POWER, transportation, etc.

F - [1] coursier; [2] canal d'amenee

S - canaleta

FLYWHEEL (gen) (impl). A rotating element attached to the shaft of a machine to maintain uniform angular velocity and revolutions per minute.

F - volant

S - volante

FOCUSING COLLECTOR (sol). A type of SOLAR COLLECTOR that focuses the sun's rays on a single point.

F - capteur a concentration [2]

S - colector enfocante

FOLD-UP REFLECTOR

FOLD-UP REFLECTOR (sol). A portable type of folding mirror

used in SOLAR COOKERS to reflect sunlight.

F - reflecteur pliant

S - reflector plegable

FOOT-POUND (gen) (meas). The amount of ENERGY required to lift one pound of a substance one foot.

F - pied-livre

S - libra-pie

FORCED CONVECTION (heat). The use of a pump or blower to control the FLOW of heat into a heated FLUID (e.g. circulating warm air in a room or dwelling with a pump or blower).

F - convection forcee

S - conveccion forzada

FOSSIL FUELS (fos). Nonrenewable, naturally-occurring fuels from ORGANIC MATTER. These include coal, crude oil, and natural gas.

F - combustibles fossiles

S - combustibles fosiles

FRACTIONATING COLUMN (alc). A vertical tube or column attached to an ALCOHOL STILL that is usually filled with packing or intersected with plates. An internal REFLUX results in a separation between the high and low boiling fractions inside the column. Those with the lowest boiling point DISTILL out. (See also: DISTILLATION COLUMN)

F - colonne de fractionnement

S - columna de fraccionar  
FRESNEL LENS

FRANCIS TURBINE (hydr). A WATER TURBINE that operates on a low or medium HEAD and is often installed in large HYDROELECTRIC plants. Water enters the turbine radially and leaves axially.

F - turbine de Francis

S - turbina Francis

<FIGURE>

10p58.gif (486x486)

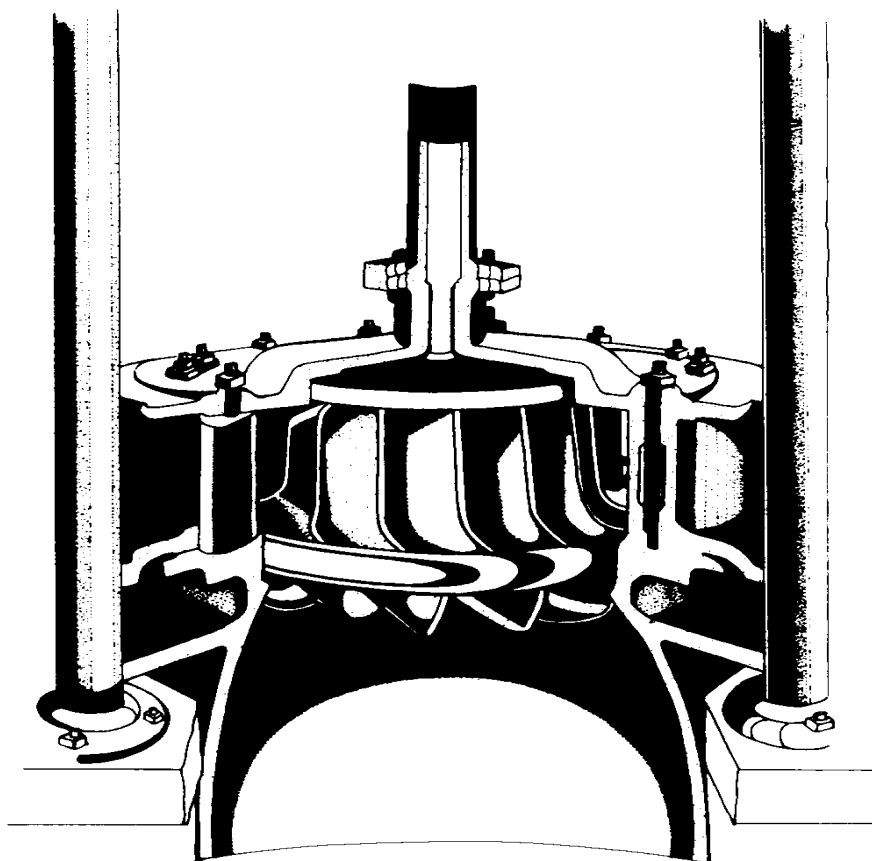

**Francis turbine (cutaway view)**

**FREE OXYGEN (bio).** Oxygen in the atmosphere, which can be extracted at no cost. Conversely, oxygen extracted at a cost would cause the substance from which the oxygen molecules were taken to **DECOMPOSE**.

**F - oxygene libre**

**S - oxigeno libre**



FRESNEL COLLECTOR (sol). A type of SOLAR COLLECTOR consisting of a concentric series of rings with reflecting surfaces. These rings focus SOLAR RADIATION onto an ABSORBER PLATE.

F - capteur a lentille de Fresnel

S - colector Fresnel

FRESNEL LENS (sol). A type of lens built up from a number of narrow concentric segments. It is used in SOLAR CONCENTRATORS.

F - lentille de Fresnel

S - lente de Fresnel

<FIGURE>

10p59.gif (486x486)

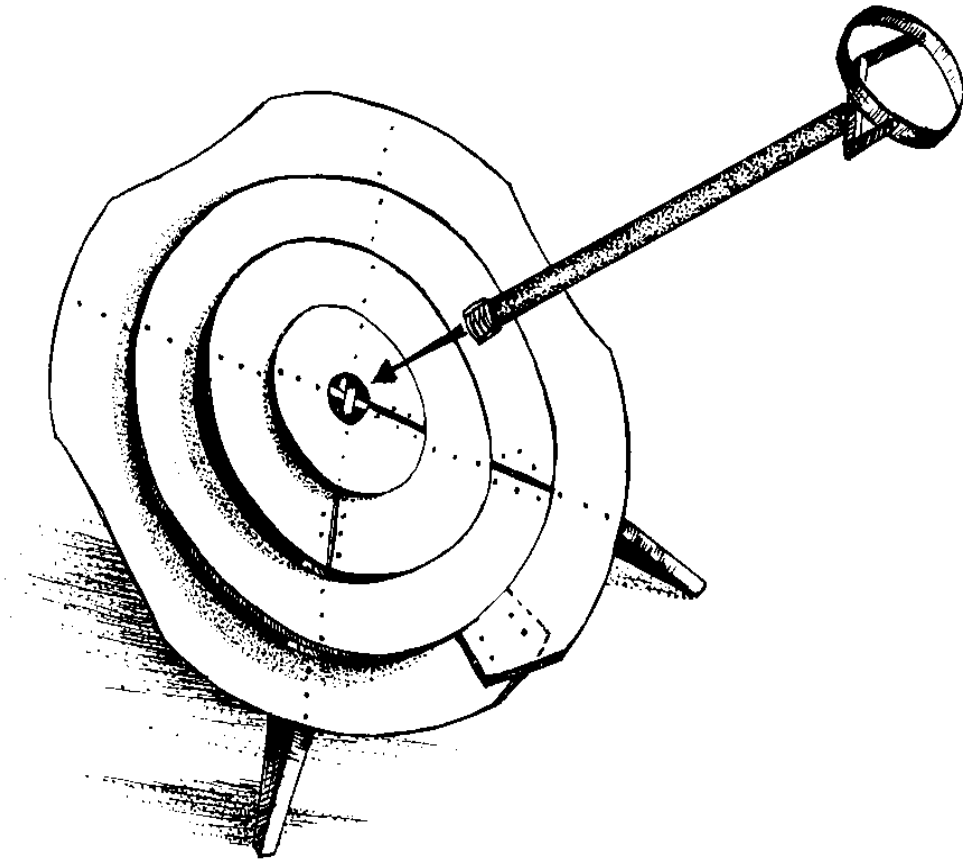

Fresnel lens solar cooker

## FRICITION

FRICITION (gen). Surface resistance to relative motion, which slows down movement and causes heat.

F - frottement

S - friccion

FRICITION HEAD (hydr). HEAD or ENERGY lost due to FRICITION

created by the contact between a moving stream of water and the conduit through which it is moving. In pipes, the friction head is also caused by bends in the pipelines, changes in the pipe diameter, valves, and couplings.

F - perte frictionnelle

S - perdida de carga por rozamiento

FRUCTOSE(alc) (chem). A FERMENTABLE sugar commonly found in fruit. Fructose can be used as a FEEDSTOCK in ETHANOL production.

F - fructose

S - fructosa

FUEL EFFICIENCY (heat) (meas). The ratio of heat produced by a fuel for doing work to the available heat of the fuel. Fuel EFFICIENCY is determined by the nonheat-forming materials in the fuel and the nonwork-producing heat that is developed by the fuel.

F - rendement du combustible

S - eficiencia del combustible

FUELWOOD (heat). Any type of wood that can be used to fuel a fire.

F - bois de chauffe

S - lena

FULL SAIL (wind) (arc). A COMMON SAIL with the cloth fully

**spread.**

**F - aile deployee**

**S - aspa completamente estirada**

**FUNGUS (bio).** One of numerous plants in the division of Thallophyta characterized by a lack of chlorophyll, including YEAST, molds, and mushrooms. Fungi do not require FREE OXYGEN to survive. (Plural: fungi)

**F - champignon**

**S - hongo**

**FURLING (wind).** Rolling up and tying back SAILS of a WINDMILL to keep the ROTOR from turning.

**F - ferlage**

**S - aferramiento**

**FURLING SPEED (wind).** (See: CUT-OUT SPEED)

**F - vitesse de ferlage**

**S - velocidad maxima admisible**

**G**

**GASAHOL (alc).** A gasoline substitute or supplement derived from 10 percent ETHANOL and 90 percent unleaded gasoline. (Syn: gasohol)

**F - carburol**

**S - gasohol**

**GAS CAP (biocon).** (See: GASHOLDER)

**F - cloche a gaz**

S - tapa de gas

GAS DIGESTION (biocon). The second stage of BIOGAS generation, during which METHANE ( $[CH_4]$ ) is produced.

F - digestion de gaz

S - digestion de gas

GASHOLDER (biocon). (1) A container for holding the BIOGAS produced in a DIGESTER. The size of the holder depends on the rates of gas production and gas use. (See also: FLOATING GAS CAP)

F - gazometre

S - gasometro

GASIFICATION (prod). The conversion of wood or coal to COMBUSTIBLE GAS without leaving a combustible residue.

F - gazeification

S - gasificacion

GASIFIER (prod). A special type of furnace in which the air supply to the COMBUSTION ZONE is carefully metered. This promotes the production of COMBUSTIBLE GASES as wood or coal are burned.

F - gazogene

S - gasificador

GAS PRODUCTION RATE (biocon) (meas). The quantity of METHANE generated per unit of time. It generally is expressed as cubic feet/day or cubic meters/day. The

figure should be quoted under standard conditions of temperature and pressure.

F - taux de production du gaz

S - tasa de produccion de gas

**GAS SCRUBBER (gen). (See: SCRUBBING)**

F - epurateur de gaz

S - lavagases

**GAS STORAGE CAPACITY (biocon).** The maximum amount of **METHANE** that a **BIOGAS DIGESTER** is able to store. The amount generally is expressed in cubic feet or cubic meters.

F - capacite de stockage de gaz

S - capacidad de almacenamiento de gas

**GAS TURBINE**

**GAS TURBINE (auto).** An **ALTERNATIVE COMBUSTION ENGINE** in which a gas, under pressure or formed by combustion, is directed against the **BLADES** of a **TURBINE**. The **ENERGY** in the expanding gas is thereby converted into useful mechanical energy.

F - turbine a gaz

S - turbina de gas

**GEAR RATIO (gen) (meas).** The number of revolutions required of one gear to turn another gear, which generally is of a different size.

F - demultiplication

S - relacion de los engranajes

GENERATOR (elec) (impl). A device that converts mechanical ENERGY into electrical energy.

F - generateur

S - generador

GENGAS (prod). (See: PRODUCER GAS)

F - gaz pauvre de gazogene

S - gengas

GEOPRESSURED RESERVOIR (geo). A GEOTHERMAL RESERVOIR consisting of porous sands that contain water or BRINE at high temperatures and pressure.

F - reservoir sous geopression

S - tanque de presion geotermica

GEOTHERMAL (geo). Of or relating to the heat of the Earth's interior.

F - geothermique

S - geotermico

GEOTHERMAL FIELD (geo). A geographical region with known GEOTHERMAL POWER sources that might be tapped to produce ENERGY.

F - zone geothermique

S - zona geotermica

GEOTHERMAL POWER (geo). ENERGY obtained from GEOTHERMAL

sources. Geothermal power is tapped in three ways: by using hot water, steam, or DRY STEAM. Each may be used to drive a TURBINE.

F - energie geothermique

S - energia geotermica

GEOTHERMAL RESERVOIR (geo). A water reserve created near a HOT DRY ROCK RESERVOIR to develop a potential GEOTHERMAL POWER site.

F - reservoir geothermique

S - tanque geotermico

GEOTHERMAL STEAM (geo). Steam drawn from sources within the Earth.

F - vapeur geothermique

S - vapor geotermico

GEYSER (geo). Natural steam or hot water spouts in active GEOTHERMAL regions.

F - geyser

S - geiser

GRAVITY CONVECTION

GIN POLE (wind). A long board or pipe used to improve the leverage in lifting a TOWER for a WINDMILL.

F - fleche de levage

S - mastil grua

GLAZING (impl) (sol). A transparent sheet that admits sunlight



to a SOLAR COLLECTOR and then inhibits the escape of heat. Commonly used glazing materials include ACETATE, acrylic, fiber-reinforced plastics, and glass.

F - vitrification

S - vidrioado

GLOBAL RADIATION (sol). The combination of DIFFUSED RADIATION, DIRECT RADIATION, and REFLECTED RADIATION. (See: SOLAR RADIATION)

F - rayonnement global

S - radiacion global

GLUCOSE (chem) (alc). The most common sugar, which is derived from STARCH during the ETHANOL production process.

F - glucose

S - glucosa

GOBAR GAS (biocon). (See: BIOGAS)

F - bio-gaz

S - gas gobar

GOVERNOR (gen) (impl). A device that regulates the speed of an engine or other device under varying conditions of load and pressure. Also a device for regulating the FLOW or pressure of a FLUID passing through a device.

F - regulateur

S - regulador

**GRAIN ALCOHOL (alc). ETHANOL made from grain by DISTILLATION.**

**F - alcool de grains**

**S - alcohol de granos**

**GRAM CALORIE (gen). The amount of ENERGY required to raise one gram of water one degree CELSIUS.**

**F - calorie [2]**

**S - caloria-gramo**

**GRAMLAXMI GAS (biocon). (See: BIOGAS)**

**F - bio-gaz**

**S - gas gramlaxmi**

**GRATE (impl) (heat). A frame of metal bars that holds fuel above the floor of a firebox. It usually is used in a boiler, GASIFIER, fireplace, or stove.**

**F - grille**

**S - parilla**

**GRAVITY CONVECTION heat). (See: NATURAL CONVECTION)**

**F - convection par pesanteur**

**S - conveccion por gravedad**

**GUIDE VANES**

**GUIDE VANES (hydr) (impl). Surfaces that direct water to the appropriate parts of TURBINE BLADES or BUCKETS so as to increase POWER output.**

**F - aubes directrices**

S - alabe director

GUSSET (constr) (wind). A triangular metal brace for reinforcing a corner or angle. It is commonly used in TOWER construction.

F - gousset

S - esquinero

GUST (wind). A sudden, brief increase in WIND VELOCITY that is then followed by calmer air.

F - rafale

S - rafaga

GUYED TOWER (impl) (wind). A WINDMILL TOWER that is supported by GUY WIRES.

F - pylone haubanne

S - torre atirantada

<FIGURE>

10p64.gif (393x393)

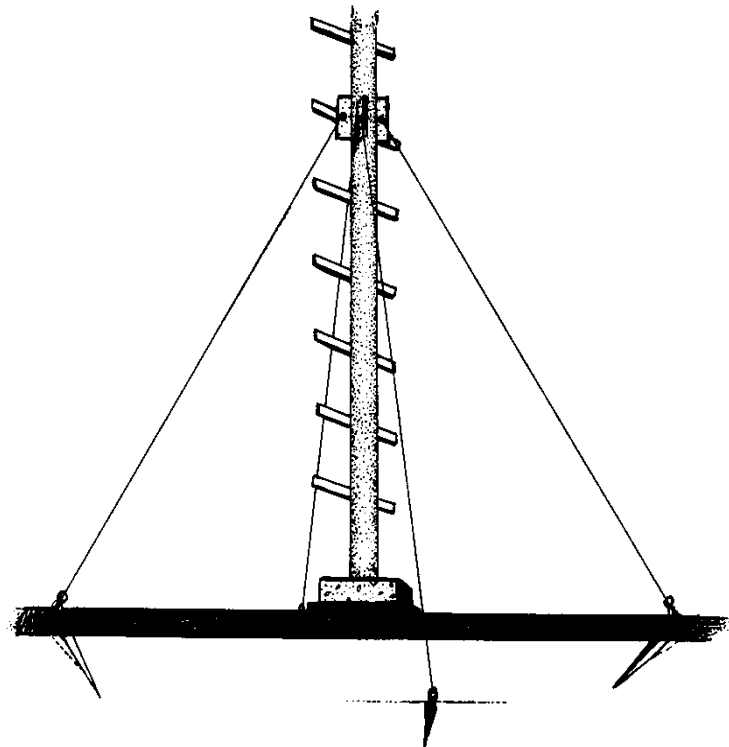

guyed tower with anchors

**GUY WIRE** (wind) (impl). A cable that stabilizes a structure and keeps it in position. For example, wires attached to a **WINDMILL TOWER** so that it cannot move or shake from the force of the wind.

F - hauban

S - retenida de alambre

H

**HARNESS** (ani). The gear or tackle, other than a **YOKE**, used on draft animals to pull a vehicle or drive an implement. It differs from a yoke, which joins together draft

**animals.**

**F - harnais**

**S - arnes**

**<FIGURE>**

**10p65.gif (486x486)**

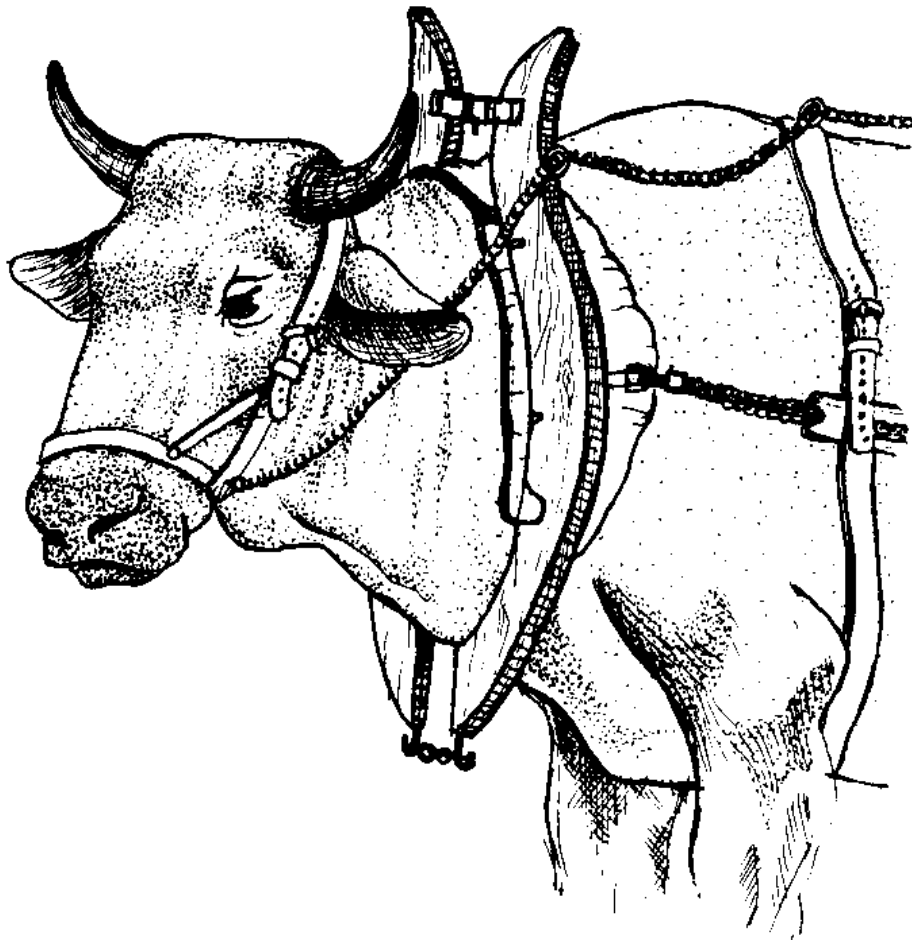

**harness and collar**

HEAD (hydr) (meas). [1] The vertical distance from the point where water enters an intake to the point where the water leaves a HYDROPOWER device. It is generally measured in feet or meters. The product of the head times the FLOW is a measurement of potential POWER. [2] The vertical distance a liquid must be pumped from its source to its point of use or storage.

**F - chute d'eau [1]-[2]**

**S - altura**

**<FIGURE>**

**10p66.gif (600x600)**

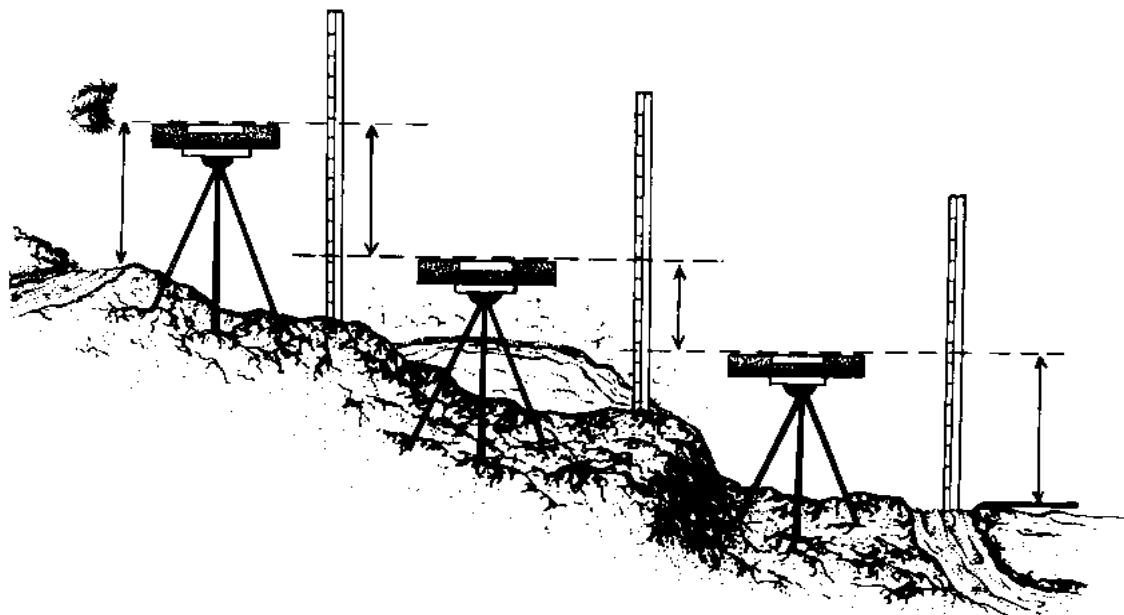

head measurement techniques

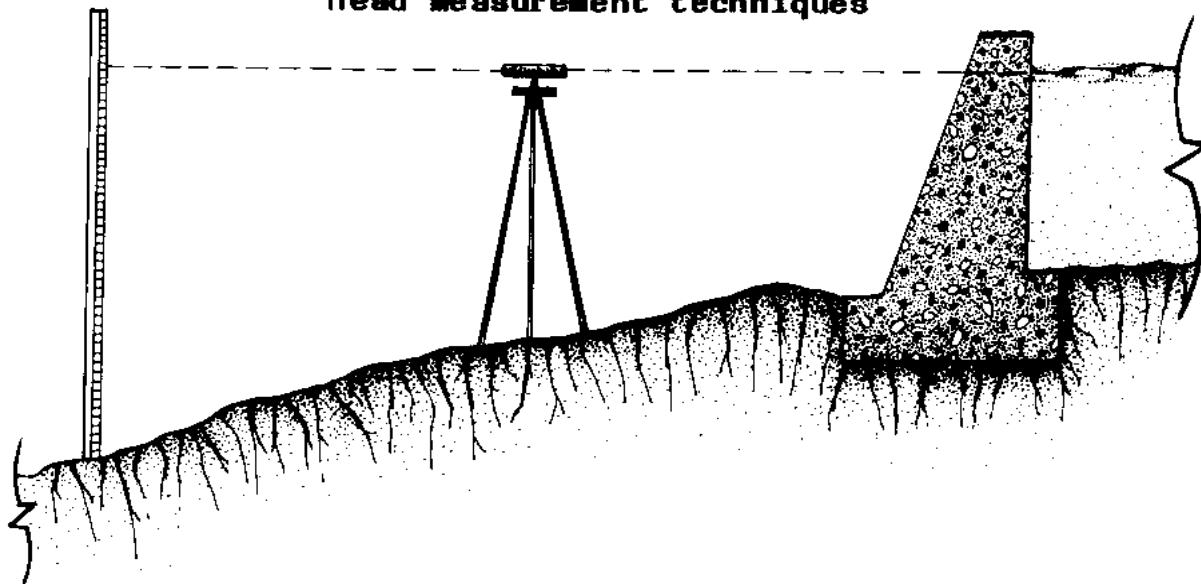

**HEADER (sol)**. The pipe that runs across the top of an **ABSORBER PLATE** to gather or distribute **HEAT TRANSFER**



FLUID from or to the grid pipes that run across the absorber surface. Some headers run along the bottom of the absorber plate.

F - entree-sortie

S - tubo colector

## HEADRACE

HEADRACE (hydr). A CANAL or conduit that feeds water into a mill, WATER WHEEL, or TURBINE.

F - bief d'amont

S - canal de llegada

HEAD WATER (hydr). The water upstream of a DAM or a HYDROPOWER plant.

F - eau d'amont

S - aguas arriba

HEAT CAPACITY (heat) (meas). The amount of heat required to raise by one degree the temperature of a unit mass of a substance.

F - capacite thermique

S - capacidad calorifica

HEAT ENERGY (heat). ENERGY in the form of heat.

F - energie thermique

S - energia calorifica

HEAT TRANSFER FLUID

**HEAT EXCHANGER (heat) (impl).** A device, such as a coiled copper tube immersed in a tank of water which is used to transfer heat from one FLUID to another through a separating wall. A CONDENSER is one type of heat exchanger.

F - échangeur de chaleur

S - termopermutador

**HEAT GAIN (heat).** The increase of heat in a space resulting from DIRECT RADIATION and from the heat given off by such other sources as THERMAL MASS, a stove, a fireplace, humans, or animals.

F - apport de chaleur

S - ganancia calorífica

**HEATING VALUE (heat) (meas).** The amount of heat produced by the complete combustion of a specific amount of fuel. This is a measure of FUEL EFFICIENCY.

F - pouvoir calorifique

S - valor calorífico

**HEAT LOSS (heat).** An unwanted decrease in the amount of heat contained in a space. Heat is usually lost through CONVECTION.

F - perte de chaleur

S - pérdida calorífica

**HEAT PUMP (heat) (impl).** A mechanical device that transfers heat from a heat source to a HEAT SINK. This process

causes the source to cool and the sink to become warmer.

F - pompe a chaleur

S - bomba calorifica

HEAT RATE TRANSFER COEFFICIENT (heat) (meas). The rate at which heat is transferred per hour, per unit surface, per degree of temperature difference.

F - coefficient de transmission de chaleur

S - coeficiente de transferencia del consumo calorifico

HEAT-REFLECTIVE GLASS (sol). A type of glass designed to reflect SOLAR RADIATION.

F - verre a pouvoir reflechissant thermique

S - vidrio reflector de calor

HEAT SINK (sol). A body that is capable of accepting and storing heat. It therefore may also act as a heat source.

F - puits de chaleur

S - sumidor de calor

HEAT TAX (heat). Referring to the HEAT ENERGY that becomes unavailable for further use whenever ENERGY is converted from one form to another.

F - chaleur perdue

S - gravamen calorifico

**HEAT TRANSFER FLUID (sol). (See: HEAT TRANSFER MEDIUM)**

**F - fluide caloporteur**

**S - fluido de termotransferencia**

**HEAT TRANSFER MEDIUM**

**HEAT TRANSFER MEDIUM (sol). The FLUID that is heated in a SOLAR COLLECTOR for conducting heat to another place or substance.**

**F - caloporteur**

**S - medio de termotransferencia**

**HELICAL SAIL WINDMILL (wind). The name for a particular type of HORIZONTAL-AXIS, SAIL ROTOR WINDMILL. It usually is used for low-lift water pumping.**

**F - eolienne a ailes helicoidales**

**S - molino con aspas helicoidales**

**HELIO-ELECTRICAL PROCESS (sol). A process by which PHOTOVOLTAIC MODULES convert SOLAR ENERGY into electricity.**

**F - processus helioelectrique**

**S - proceso helioelectrico**

**HELIOSTAT (sol) (impl). A solar-focusing instrument consisting of a mirror mounted on an AXIS that is moved by clockwork. The heliostat reflects sunbeams in one direction, usually to a central ABSORBER located in a TOWER.**

**F - heliostat**

**S - heliostato**

HELIO THERMAL (sol). [1] A process that uses SOLAR RADIATION to produce heat. [2] A device that absorbs RADIATION on a blackened surface and converts it into heat.

F - heliothermique

S - helio termico

HELIO THERMAL PROCESS (sol). A process by which SOLAR ENERGY is used to provide THERMAL ENERGY for space heating, space cooling, and domestic water heating.

F - processus heliothermique

S - proceso helio termico

HELIO THERMOMETER (sol) (meas). An instrument that measures heat from the sun.

F - heliothermometre

S - helio termometro

HELIO TROPIC (sol) (impl). Turning toward light. It describes devices that TRACK the sun, following its movement across the sky.

F - heliotropique

S - heliotropico

HORIZONTAL AIR MILL (wind) (arc). (See: HORIZONTAL-AXIS WINDMILL)

F - moulin a vent a arbre horizontal

S - molino de aire horizontal

HORIZONTAL AXIS SAIL ROTOR (wind). A WIND MACHINE with cloth sails in which the WIND SHAFT is situated on a horizontal plane.

F - eolienne a ailes en toile sur axe horizontal

S - rotor de eje horizontal

HUMUS

HORIZONTAL AXIS WINDMILL (wind). A WINDMILL driven by a ROTOR on a horizontal WIND SHAFT.

F - eolienne a arbre horizontal

S - molino de eje horizontal

HORIZONTAL WATERMILL (hydr). A WATERMILL driven by a horizontal wheel mounted on a vertical shaft. (Syn: Greek Mill; Norse Mill)

F - moulin a eau horizontal

S - molino hidraulico horizontal

HORIZONTAL WATER WHEEL (hydr). (See: HORIZONTAL WATERMILL)

F - roue hydraulique horizontale

S - rueda hidraulica horizontal

HORSEPOWER (gen). A unit of POWER equal to 33,000 FOOT POUNDS per minute, 550 foot pounds per second, or 746 WATTS.

F - cheval-vapeur

S - potencia util

HOT DRY ROCK (geo) A system for using GEOTHERMAL POWER. A

hole is drilled and the deep rock cracked. This may be done hydraulically, as is done in conventional oil fields, or with explosives. Water is injected into the fractured rock, allowed to heat, and then withdrawn as steam for use as an ENERGY source.

F - roche chaude et seche

S - roca seca caliente

HOT WATER RESERVOIR (geo). (See: GEOTHERMAL RESERVOIR)

F - reservoir d'eau chaude

S - tanque de agua caliente

HOUR ANGLE (sol) (meas). The angular displacement of the sun east or west of the local meridian due to the rotation of the Earth on its AXIS at 15 [degrees] per hour (morning [+] afternoon [-]).

F - angle horaire

S - angulo hora

HUB EXTENSION (wind). A piece of pipe that sticks out from the front of the hub of a ROTOR on a WINDMILL. It provides a place to attach GUY WIRES to strengthen the BLADES or SAILS.

F - rallonge de moyeu

S - extension del cubo

HUMIDIFIER (gen). A mechanical means for increasing the relative humidity in an enclosed area by injecting water vapor into the air.

F - humidificateur

S - humidificador

HUMUS (biocon). Well-decomposed organic soil material consisting of the residues from plant and animal matter together with the cell substances of soil organisms and various inorganic materials.

F - humus

S - humus

HYBRID GENERATOR

HYBRID GENERATOR (biocon). A two-stage BIOGAS DIGESTER design consisting of a larger batch-fed, ACID-producing, cold phase, and a smaller CONTINUOUS-FEED, METHANE-producing, heated phase. Alternatively, any digester that separates acid and methane production.

F - generateur hybride

S - generador hibrido

HYBRID POWER SYSTEM (gen). A system, such as one might find within a home, that derives its heating, lighting, and other ENERGY from several interconnected sources. One or more of these sources generally would come from RENEWABLE ENERGY.

F - energie heterogene, systeme d'

S - sistema de energia hibrida

HYBRID SOLAR ENERGY SYSTEM (sol). A heating or cooling system that uses both ACTIVE SOLAR HEATING and PASSIVE



SOLAR HEATING methods in its design. At least one of the system's significant THERMAL ENERGY FLOWS is by natural means, and at least one is by forced means.

F - energie solaire heterogene, systeme d'

S - sistema de energia solar hibrida

HYDRATE (chem). A solid material resulting from the combination under pressure of a gas with water.

F - hydrate

S - hidrato

HYDRAULIC RAM (hydr) (impl). A water pump that uses the ENERGY of descending water to raise a part of the water to a height greater than that of the source. It requires no other power than the energy from the descending water.

F - belier hydraulique

S - ariete hidraulico

<FIGURE>

10p70.gif (600x600)

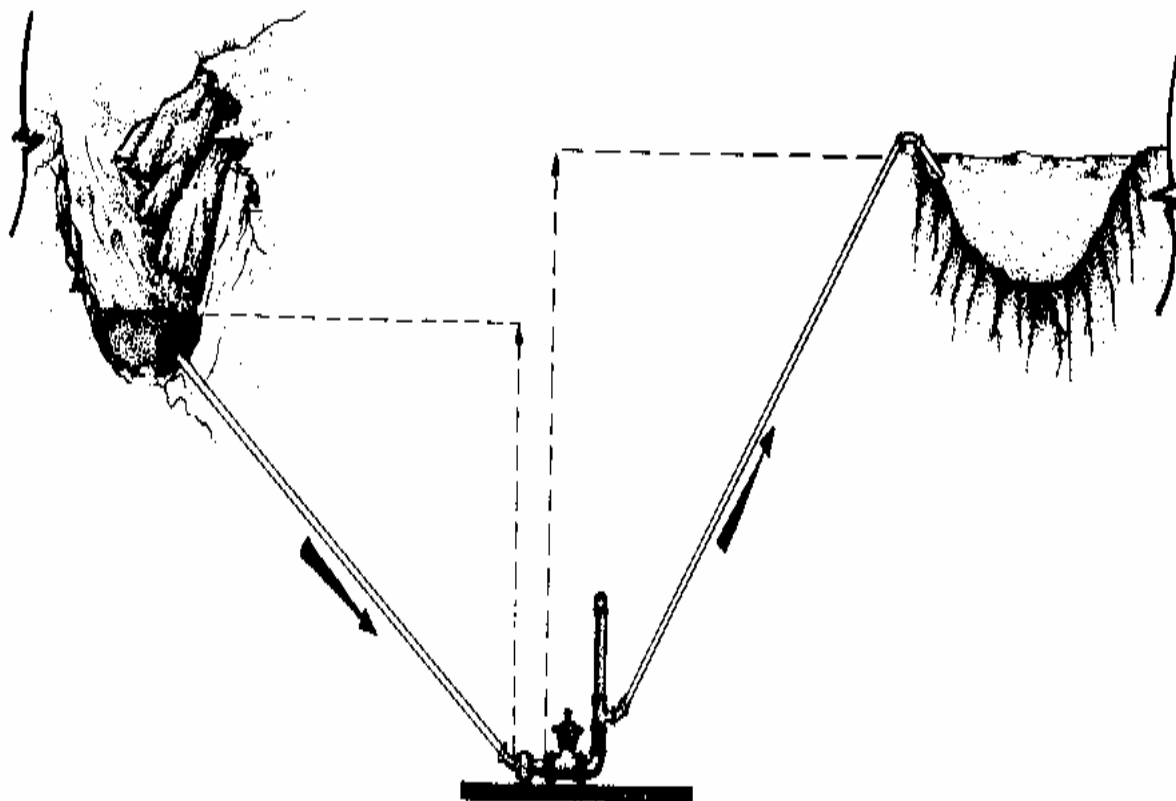

hydraulic ram

**HYDROXYL**

**HYDRAULIC RETENTION TIME (biocon) (meas) . The number of**

days an average volume of SLURRY remains in a BIOGAS DIGESTER.

F - duree de retention hydraulique

S - periodo de retention hidraulica

HYDROELECTRIC (hydr). Relative to a system in which the potential ENERGY of falling water is harnessed by releasing it from DAMS or through a PENSTOCK downward through WATER TURBINES.

F - hydro-electrique

S - hidroelectrico

HYDROLOGIC CYCLE (hydr). The cycle in which water passes through different states. It begins as atmospheric water vapor. It then becomes a liquid through precipitation. Next it flows along the ground surface, where it is useful as an energy source. Finally, it returns to its original form through evaporation and transpiration.

F - cycle hydrologique

S - ciclo hidrológico

HYDROLOGY (hydr). The science of water systems on or beneath the Earth's surface.

F - hydrologie

S - hidrologia

HYDROLYSIS (alc) (chem). The chemical process that breaks complex organic molecules into simple molecules. For example, STARCH and CELLULOSE can be hydrolyzed by ACIDS

or ENZYMES to produce simple sugars, which can be FERMENTED to form ETHANOL.

F - hydrolyse

S - hidrolisis

HYDROMETER (impl) (meas). An instrument used to determine the density or SPECIFIC GRAVITY of FLUIDS.

F - hydrometre

S - hidrometro

HYDROPOWER (hydr). POWER produced by falling water. The term is used to identify a type of electricity-generating station or any energy output in which the main mover is driven by FLOWing water.

F - puissance hydraulique

S - potencia hidraulica

HYDROPOWER SYSTEM (hydr). A system in which the potential ENERGY of FLOWing water is used to create electricity or to mechanically drive machines, by impounding it behind DAMS and then diverting it through a CHANNEL to a WATER TURBINE.

F - systeme de puissance hydraulique

S - sistema de potencia hidraulica

<FIGURE>

10p72.gif (600x600)

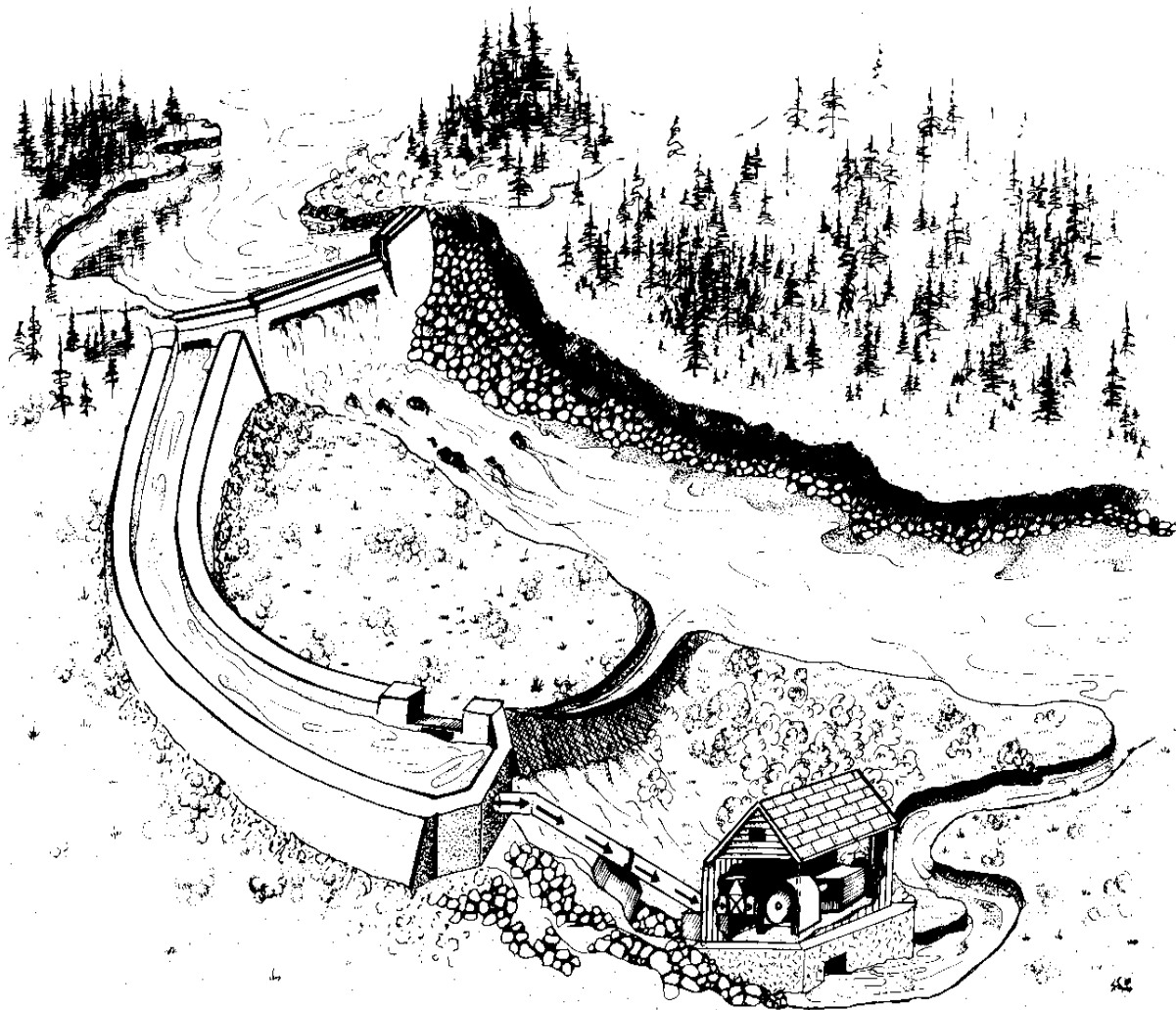

hydropower system

**HYDROXYL (biocon)**. A monovalent group consisting of a hydrogen atom and an oxygen atom linked together. Most

**BASES** contain hydroxyl groups. (See also: **BASE**)

**F** - hydroxyle

**S** - hidroxilo

**HYDROPOWER SYSTEM**

**HYGROMETER**

**HYGROMETER** (impl) (meas) (sol). A device for measuring the humidity of the air. It is used in designing **SOLAR HEATING** and **SOLAR COOLING** systems.

**F** - hygrometre

**S** - higrometro

**I**

**IMPERMEABLE DRY ROCK** (geo). Rock systems in **GEOHERMAL** regions where the heat is contained almost entirely in impermeable rock.

**F** - roche seche impermeable

**S** - roca seca impermeable

**IMPULSE TURBINE** (hydr). A **TURBINE** driven by high velocity **JETS** of water or steam that are produced by forcing the water or steam through a nozzle.

**F** - turbine a action

**S** - turbina de impulsion

<FIGURE>

10p74.gif (486x486)

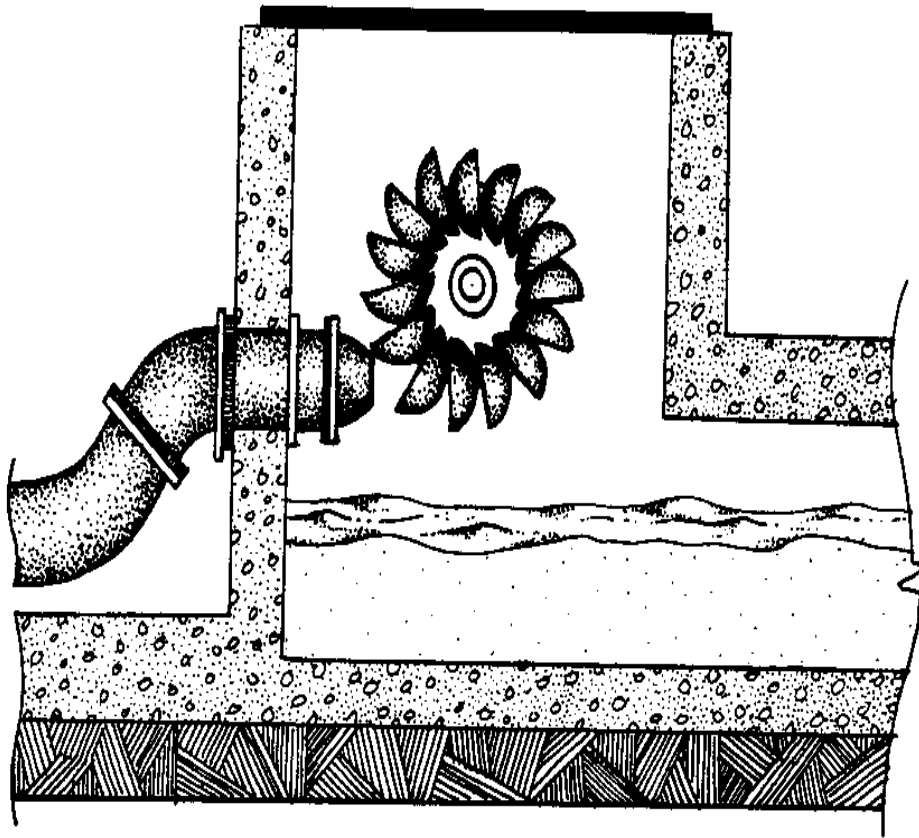

impulse turbine (cutaway view)

INCIDENT ANGLE (sol) (hydr). [1] The angle between the sun's rays and a line perpendicular (normal) to the irradiated surface. The incident angle determines both the intensity of the DIRECT RADIATION component striking the surface and the ability of the surface to reflect,

transmit, or ABSORB the sun's rays. [2] In the case of HYDROPOWER devices, the angle between the water intake and a line perpendicular to the BUCKETS.

F - angle d'incidence

S - angulo incidente

INCIDENT RADIATION (sol) (meas). The quantity of RADIANT ENERGY striking a surface per unit time and unit area.

F - rayonnement incident

S - radiacion de incidencia

INDIRECT SOLAR ENERGY

INDIAN-TYPE DIGESTER (biocon). A BIOGAS DIGESTER primarily designed to produce METHANE. These digesters usually have FLOATING GAS CAPS.

F - digesteur type indien

S - digestor de tipo indio

<FIGURE>

10p75.gif (486x486)



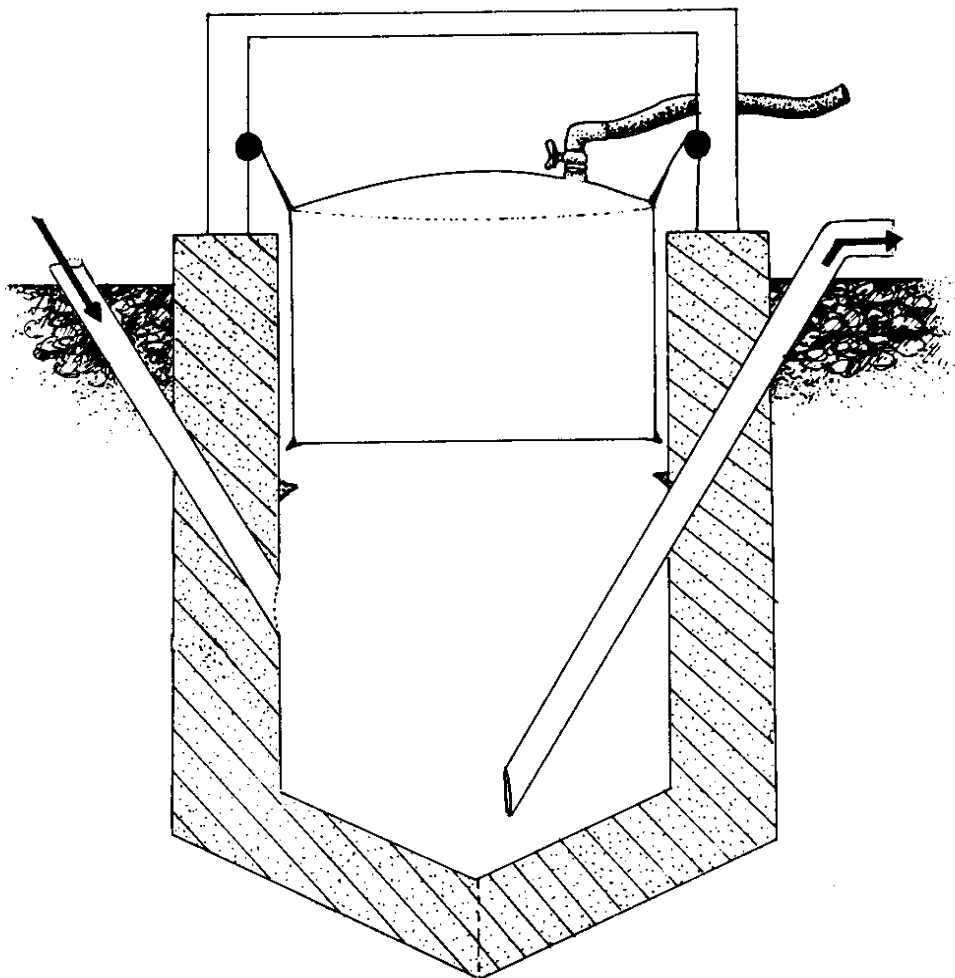

Indian-type digester

**INDIRECT CONVERSION (sol)**. The indirect use of **SOLAR ENERGY** from such sources as solar-produced winds, thermal currents in air and water, and wave action.

**F** - conversion indirecte

**S** - conversion indirecta

**INDIRECT SOLAR ENERGY (sol)**. A system in which **SOLAR**

ENERGY is COLLECTED and used through mechanical means.

F - energie solaire indirecte

S - energia solar indirecta

INDIRECT SOLAR GAIN

INDIRECT SOLAR GAIN (sol) . A PASSIVE SOLAR HEATING system in which heat is stored between the COLLECTING and the distributing surfaces (e.g., TROMBE WALL) .

F - apport solaire indirect

S - ganancia solar indirecta

INDIRECT SOLAR HEATING (sol) . A method of solar heating in which SOLAR RADIATION is COLLECTED in FLAT PLATE or CONCENTRATING COLLECTORS that are mounted on a roof, a wall, or apart from a building. Pumps or fans are used to circulate HEAT TRANSFER FLUIDS through the collectors and then back to a heat storage medium.

F - chauffage solaire indirect

S - calefaccion solar indirecta

INDUCTION MOTOR (elec) (wind) . A common type of motor, which, when modified slightly and driven by the rotary action of a WINDMILL or TURBINE, provides ALTERNATING CURRENT (ac) .

F - moteur a induction

S - motor de induccion

INFILTRATION (heat) . The unchecked movement of outdoor air into a building through cracks around windows and doors

or in walls, roofs, and floors. Infiltration generally refers to cold air during the winter and hot air during the summer.

F - infiltration

S - infiltracion

INFLUENT (biocon). BIOMASS mixed with water for use in a BIOGAS DIGESTER.

F - affluent

S - influente

INFRARED RADIATION (sol). Electromagnetic RADIATION from the sun or a warm body that has wavelengths longer than the red end of the visible spectrum. Infrared radiation is experienced as heat.

F - radiation infrarouge

S - radiacion infraroja

INOCULATION (biocon). Adding a SEED of ANAEROBIC BACTERIA to a BIOGAS GENERATOR.

F - inoculation

S - inoculacion

INOCULUM (biocon). A sample of partially DIGESTED SLURRY, and its associated BACTERIA, that is added at the start of DIGESTION to a BIOGAS DIGESTER. It provides sufficient micro-organisms for the digestion process to proceed at a satisfactory rate. Without this seeding, there

generally is a prolonged wait before a digester begins producing gas. (Syn: seed)

F - inoculum

S - inoculum

ISOLATED SOLAR GAIN

INSOLATION (sol). The rate at which ENERGY from the sun reaches the Earth's surface. Insolation generally is measured in BTU/square feet (meters)/day.

F - insolation

S - insolacion

INSULATED STEAM COOKER (sol). A small, insulated cooking box in which steam acts as the heating agent. Water heated to steam by a SOLAR COLLECTOR flows into the box, condenses, and drips back into the COLLECTOR.

F - rechaud a vapeur isole

S - cocinilla aislada de vapor

INTEGRATED HEATING (sol). A method of SOLAR HEATING in which SOLAR RADIATION is intercepted and absorbed by a massive exterior wall or roof pond, which usually doubles as a heat storage container. Heat flows to the rooms by CONDUCTION, or natural CONVECTION. This is a form of PASSIVE SOLAR HEATING.

F - chauffage integre

S - calefaccion solar integrada

INTEGRATED SYSTEM (biocon). A system in which the outputs

of one activity are used as inputs in other related activities. For example, a BIOGAS system in which the EFFLUENT is used as a nutrient to enrich an aquaculture environment. In exchange, BIOMASS from the aquaculture may be used as INFLUENT to the DIGESTER.

F - systeme integre

S - sistema integrado

INVERTER (elec) (wind). A device that converts DIRECT CURRENT (dc) to ALTERNATING CURRENT (ac). It often is used with WIND GENERATORS.

F - onduteur

S - invertidor

IRRIGATION WHEEL (hydr). (See: NORIA)

F - roue hydraulique d'irrigation

S - rueda de irrigacion

ISOLATED SOLAR GAIN (sol). A PASSIVE SOLAR HEATING system in which heat is collected in one area to be used in another. (See also: SOLAR GREENHOUSE)

F - apport solaire isole

S - ganancia solar aislada

J

JACKET (prod) (impl). An enclosure around a PRODUCER GAS GENERATOR through which cooling liquid flows. (See also: WATER JACKET)

F - chemise d'eau

S - cubierta

JET (auto) (hydro). A nozzle of a specific size that limits the FLOW of water to a TURBINE or the flow of fuel in a CARBURETOR.

F - gicleur

S - lanza

JET STREAM (wind). Strong winds concentrated in a relatively narrow, shallow stream in the upper troposphere.

F - jet-stream

S - manga de aire

JIB SAILS (wind) (arc). Triangular COMMON SAILS, set on radiating SPARS.

F- clinfoc

S- aspas triangulares

JOULE (meas). A unit of ENERGY or work equal to one WATT per second or 0.737 foot pounds.

F- Joule

S- Joule

JOULE'S LAW (gen) (heat). The law stating that: [1] The rate at which heat is produced by a steady current in any part of an electric circuit is jointly proportional to the resistance and to the square of the current. [2] The internal ENERGY of an ideal gas depends only on its

temperature regardless of volume and pressure.

F - loi de Joule

S - ley de Joule

JUMPER (elec). A length of wire, usually with clips on each end, for making temporary electrical connections.

F - fil volant

S - puente

K

KAPLAN TURBINE (hydr). A propeller-type of WATER TURBINE with variable pitch BLADES that adjust automatically in accordance with the HEAD.

F - turbine de Kaplan

S - turbina Kaplan

<FIGURE>

10p79.gif (540x540)

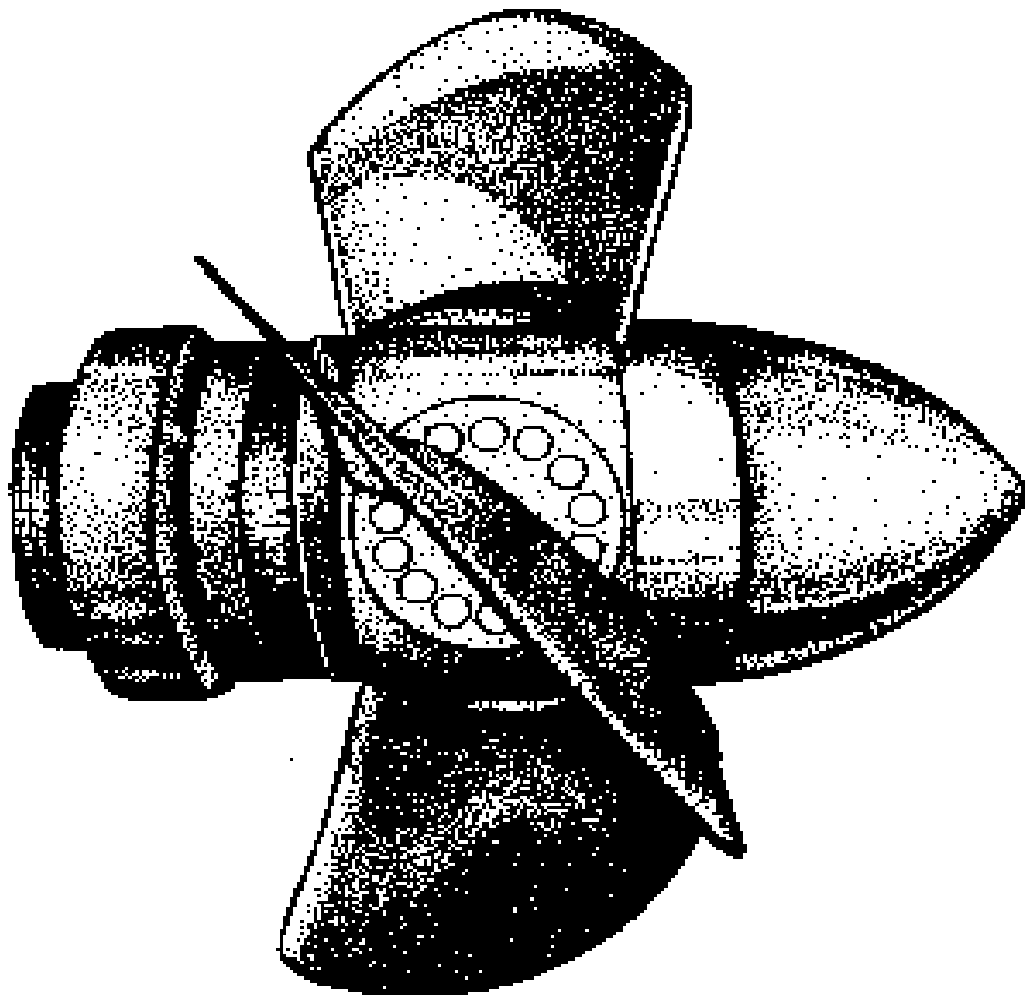

**Kaplan turbine**

**KENAF** (biocon). An annual East Indian plant, which may be used effectively in  **BIOGAS** production.

**F** - kenaf

**S** - hibiscus cannabinus



**KILN (heat)**. A high temperature oven, furnace, or heated enclosure used to process a substance by burning, firing, or drying. Kilns often are described by the direction that air passes through them (i.e., UPDRAFT or DOWNDRAFT).

F - four

S - horno

**KILOWATT (elec)**. A unit of POWER equal to 1,000 WATTS or to ENERGY consumption at a rate of 1,000 JOULES per second. It is usually used as a measure of electrical energy. Commonly abbreviated as kW.

F - kilowatt

S - kilovatios

**KILOWATT HOUR**

**KILOWATT HOUR (elec) (meas)**. A unit of POWER consumption equal to the amount of power multiplied by the amount of time the power is used. A 100-watt light bulb burning for 10 hours uses one kilowatt-hour of power.

F - kilowattheure

S - kilovatio-hora

**KINETIC ENERGY (gen)**. The ENERGY that a body possesses by virtue of its motion.

F - energie cinetique

S - energia cinetica

**KNOT (wind)**. A measure of **WIND SPEED** equal to one nautical mile per hour. One knot equals 1.15 miles per hour.

F - noeud

S - nudo

L

**LANGLEY (sol) (meas)**. A unit of **SOLAR RADIATION** intensity, equal to 1.0 gram **CALORIE** per square centimeter.

F - langley

S - langley

**LATITUDE (gen) (meas)**. An angular position north or south of the equator, measured in degrees along a meridian of a point.

F - latitude

S - latitud

**LEADING EDGE (wind)**. The vertical edge of a **WINDMILL BLADE** that lies on the side towards which the blade moves. The opposite edge is called the **TRAILING EDGE**.

F - arete avant

S - borde anterior

**LIFE-CYCLE COSTING (gen) (meas)**. A method for estimating the comparative costs of **ALTERNATIVE ENERGY** or other systems. Life-cycle costing takes into consideration such long-term costs as **ENERGY** consumption, maintenance,

and repair.

F - evaluation du cycle de vie

S - calculo del coste de la vida util

LIFT (wind). The aerodynamic force that "pulls" the BLADES of a WINDMILL and causes them to rotate.

F - portance

S - impulsion

LIFT COEFFICIENT (wind) (meas). The ratio of LIFT forces to FLOW forces.

F - coefficient de portance

S - coeficiente de impulsión

LIFT-TYPE DEVICES (wind). WIND MACHINES that provide aerodynamic LIFT in a wind stream.

F - eoliennes a portance

S - aparatos impulsores

LIME (chem). A white powder composed of calcium oxide that forms a highly ALKALINE solution when mixed with water.

It is used in various ways, including as a means to increase the pH (POTENTIAL HYDROGEN) of MASH in ALCOHOL STILLs or BIOGAS DIGESTERS.

F - chaux

S - cal

LIME KILN (chem). A KILN used to make LIME from coral or limestone.

F - four a chaux  
S - horno de cal  
LIMEWATER

LIMEWATER (biocon) (chem). A CALCIUM HYDROXIDE solution often used as a gas SCRUBBER.

F - eau de chaux  
S - agua de cal

LINED FIREBOX (gen). A firebox fitted with special insulating material.

F - chambre de combustion garnie  
S - caja de fuego revestida

LIQUID-BASED SOLAR HEATING SYSTEM (sol). A SOLAR HEATING system in which a liquid HEAT TRANSFER MEDIUM is heated in SOLAR COLLECTORS. The liquid generally is either water or an antifreeze solution.

F - chauffage solaire a liquide, systeme de  
S - sistema de energia solar a base de liquidos

LIQUID SLURRY (biocon). SLURRY comprising less than 10 percent solid material.

F - boue liquide  
S - fango liquido

LIQUID-TYPE COLLECTOR (sol). (See: LIQUID-BASED SOLAR HEATING SYSTEM)

F - capteur a liquide

S - colector de tipo liquido

LIVE CURB (wind) (arc). The circular timber rim or wall plate supporting a WINDMILL CAP that revolves on ROLLERS or WHEELS.

F - chemin de roulement

S - soporte movil

LOAD (elec) (meas). The output of one or several electric machines or transformers. Load also denotes the POWER carried by a particular circuit.

F - charge

S - carga

LOADING RATE (biocon) (meas). The amount of BIOMASS added to a DIGESTER over a specific period of time.

F - taux de charge

S - velocidad de carga

LOLLY AXIS (wind). (See: YAW AXIS)

F - axe de lacet

S - eje de relingar

LORENA STOVE (biocon). An inexpensive, yet efficient, cook stove made of a sand, clay, and water mixture known as "lorena."

F - cuisiniere lorena

S - estufa lorena

&lt;FIGURE&gt;

10p83.gif (486x486)

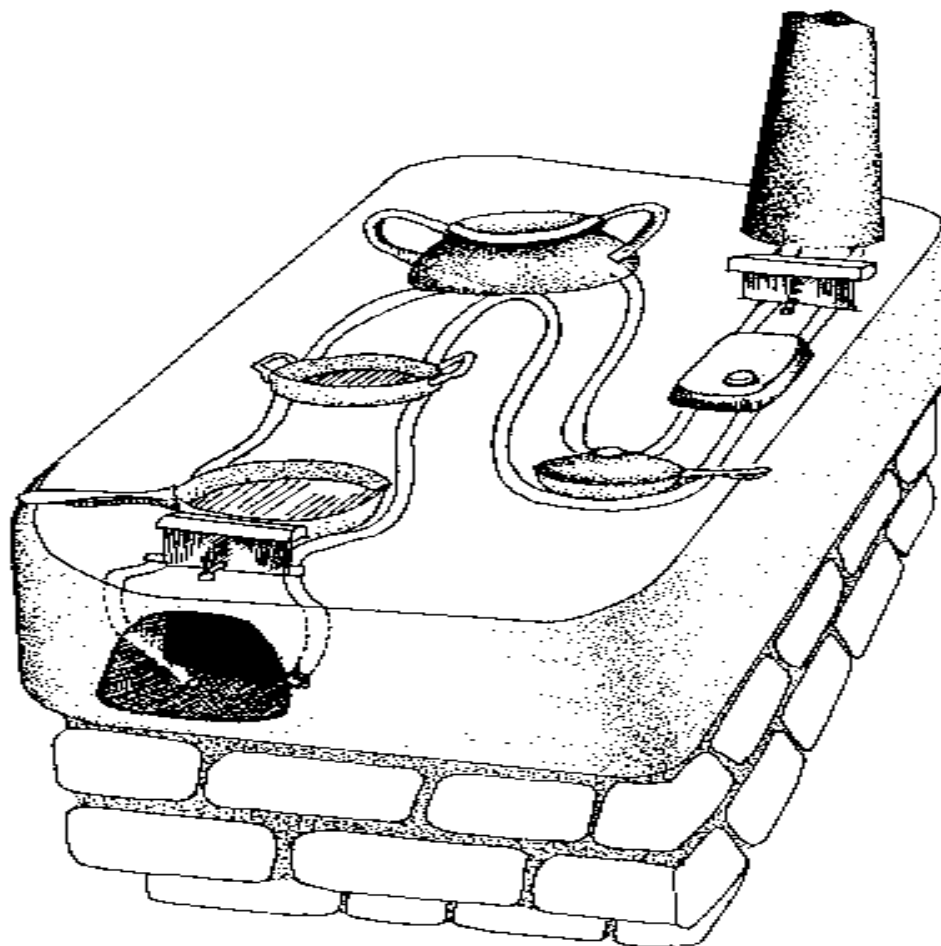

lorena stove

LOW HEAD TURBINE (hydr). A WATER TURBINE that is designed to function with a low HEAD.

F - turbine pour chutes faibles

S - turbina de poco desnivel

LUFF

LUFF (wind). To turn the BLADES of a WINDMILL into the wind so they will rotate.

F - lofer

S - cenir el viento

M

MAGNESITE BRICK (constr) (sol). A masonry brick to which magnesium or similar material has been added to darken the color of the brick and increase its THERMAL CONDUCTIVITY and ABSORPTANCE.

F - brique a la magnesite

S - ladrillo de magnesita

MAGNETO (elec). A small, permanent-magnet, electric GENERATOR capable of producing periodic high voltage impulses.

F - magneto

S - magneto

MAGNOUS EFFECT (wind). An effect whereby a spinning CYLINDER exposed to the wind produces a horizontal force.

This effect has been used to enable experimental WIND MACHINES to POWER small boats.

F - effet magnus

S - efecto de fuerza horizontal

**MALT (alc)**. Sprouted grain that contains **ENZYMES** to convert **STARCH** to sugar. Special varieties of barley are frequently used to produce malt.

F - malt

S - malta

**MANOMETER (biocon) (meas)**. A device used to measure gas pressure. It may be used to monitor gas pressure in a **BIOGAS DIGESTER**.

F - manometre

S - manometro

**MANTLE (biocon) (impl)**. A cloth **MEMBRANE** in which gases are collected and burned to create light through incandescence.

F - manchon a incandescence

S - manteleta

**MARSH GAS (biocon)**. **METHANE**. Decaying **ORGANIC MATTER** at the bottom of a marsh or pond will produce bubbles of methane gas when stirred.

F - gaz des marais

S - gas de los pantanos

**MASH (alc)**. A mixture of water and crushed grains or other **FEEDSTOCKS** that can be **FERMENTED** to produce **ETHANOL**.

F - mout

S - mezcla



**MASH COMPOSITION (alc)**. The materials making up the MASH in an ALCOHOL STILL.

F - composition du mout

S - malta empastada

**METHANE**

**MASONITE (constr)**. Trademark name for a thin board made of compressed wood fibers. It is useful as a backing for SOLAR REFLECTORS.

F - masonite

S - masonite

**MAXIMUM FLOW RATE (hydr) (meas)**. The maximum amount of water that can FLOW past a point during a given period of time. This measurement is used to evaluate the HYDROPOWER potential of a site.

F - debit maximum

S - velocidad maxima de flujo

**MEADOW MILL (hydr)**. A small, untended WATERMILL used for drainage.

F - moulinet de campagne

S - molino de pradera

**MECHANICAL ADVANTAGE (gen) (meas)**. The factor by which a machine multiplies any applied force.

F - effet mecanique

**S - rendimiento mecanico**

**MECHANICAL TURBULENCE (wind).** Erratic air movement caused by such obstructions as trees or buildings.

**F - turbulence mecanique**

**S - turbulencia mecanica**

**MEGAWATT (elec) (meas).** One million WATTS.

**F - megawatt**

**S - megavatio**

**MEMBRANE (alc).** A sheet polymer or thin biological tissue capable of separating liquid solutions. Membranes are sometimes used in the ALCOHOL DISTILLATION process.

**F - membrane**

**S - membrana**

**MERIDIONAL WIND (wind).** The wind or wind component along the local meridian.

**F - vent meridien**

**S - viento meridional**

**MESOPHYLLIC BACTERIA (biocon).** BACTERIA that thrive best at temperatures of 70-104 [degrees] F (21-40 [degrees] C) and are useful in producing BIOGAS.

**F - bacteries mesophyliennes**

**S - bacteria mesofilica**

**METHANATION (biocon).** A process of converting to METHANE

the carbon monoxide and carbon dioxide present in synthetic gas.

F - methanisation

S - metanacion

**METHANE** (biocon) (chem). An odorless, colorless gas (C[H.sub.4]), nearly insoluble in water, which burns with a pale, faintly luminous flame to produce water and carbon dioxide (or carbon monoxide if oxygen is deficient).

(See also: MARSH GAS) (Syn: BIOGAS)

F - methane

S - metano

**METHANE CONVERSION**

**METHANE CONVERSION** (biocon). The production of **METHANE** through **BIOCONVERSION**.

F - conversion du methane

S - conversion de metano

**METHANE DIGESTER** (biocon). A device that converts **BIOMASS** into **METHANE** and Fertilizer through biological activity.

(See also: BIOGAS DIGESTER)

F - digesteur au methane

S - digestor de metano

**METHANE GAS** (biocon) (chem). (See: **METHANE**)

F - gaz de methane

S - gas de metano

**METHANE GENERATION (biocon). (See: BIOGAS DIGESTER)**

**F - production du methane**

**S - produccion de metano**

**METHANE PLANT (biocon). (See: BIOGAS DIGESTER; METHANE)**

**F - generateur a methane**

**S - instalacion de metano**

**METHANOGENIC BACTERIA (bio) (biocon). BACTERIA that generate METHANE (i.e., those that are responsible for the "second step" of DIGESTION). (See also: ANAEROBIC DIGESTION)**

**F - bacteries methanogenes**

**S - bacteria metanogenica**

**METHANOL (alc). A light, VOLATILE, flammable, poisonous liquid ALCOHOL (C[H.sub.3]OH) formed in the DESTRUCTIVE DISTILLATION of wood or made synthetically. METHANOL is used especially as a solvent, antifreeze, or DENATURANT for ETHANOL, and in the synthesis of other chemicals. It is also used increasingly as a fuel. (Syn: methyl alcohol or wood alcohol)**

**F - methanol**

**S - metanol**

**METHYL ALCOHOL (alc). (See: METHANOL)**

**F - alcool methylique**

**S - alcohol metilico**

**MICROFLORA MICRO-ORGANISMS (bio) (biocon). The microscopic organisms, chiefly BACTERIA in this context, that are responsible for ANAEROBIC DIGESTION.**

**F - micro-organismes de la flore microbienne**

**S - microorganismos de microflora**

**MICROHYDRO (hydr). Small-scale, water-powered systems that may be used to produce mechanical POWER or less than 100 KILOWATTS of electricity. They commonly are used for homes, farms, or small industries.**

**F - microcentrales hydrauliques**

**S - microhidro**

**<FIGURE>**

**10p87.gif (600x600)**

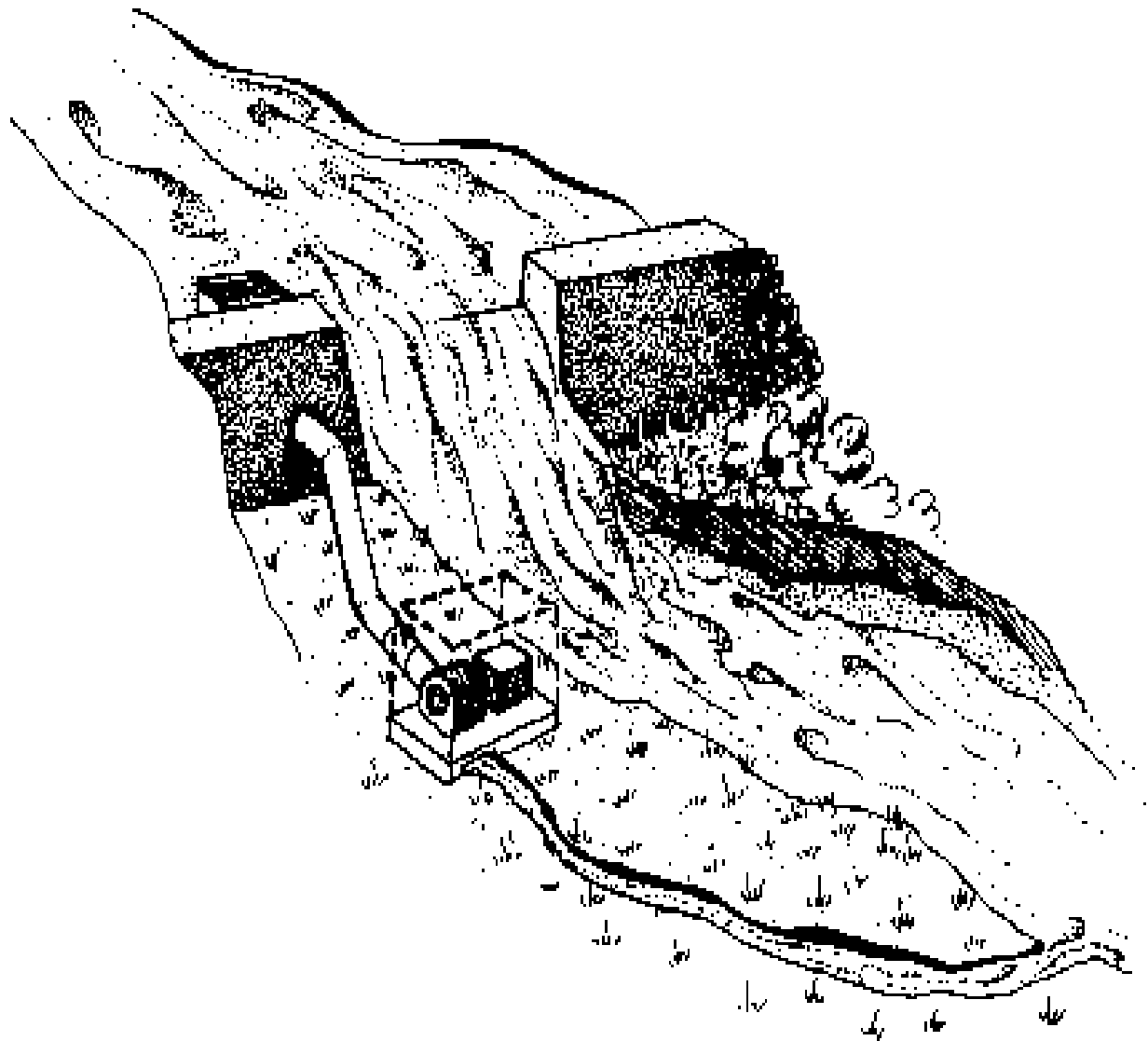

**microhydro power system**

**MIXING TANK**

**MILL (gen) (hydr) (wind). A device to grind grain and**

cereals. Also used colloquially to describe a WINDMILL, WATER WHEEL, or WATER MILL.

F - moulin

S - molino

MILL RACE (hydr). A CHANNEL that carries water to a WATER WHEEL.

F - bief de moulin

S - caz

MINIHYDRO (hydr). HYDROPOWER units that produce 100-1000 KILOWATTS.

F - minicentrales hydrauliques

S - minihidro

MINIMUM FLOW RATE (hydr) (meas). The least amount of water that will FLOW past a given point at any time. This measurement is used to help evaluate the HYDROPOWER potential of a site.

F - debit minimum

S - velocidad minime de flujo

MISCIBLE (chem). Capable of being mixed in any proportion.

F - miscible

S - miscible

MIXING TANK (biocon) (impl). A chamber in which BIOMASS is mixed with water to form SLURRY for a BIOGAS DIGESTER.

F - reservoir de melange

S - cuba de mezcla

## MOLECULAR SIEVE

MOLECULAR SIEVE (alc). A STILL COLUMN that separates molecules by selectively ADSORPING them on the basis of size.

F - tamis moleculaire

S - criba por accion molecular

MONOSACCHARIDE (alc). SUGAR derived from STARCH and CELLULOSE that can be converted to ETHANOL.

F - monosaccharide

S - monosacarido

MOUNTAIN AND VALLEY WINDS (wind). A system of daily winds prevailing in calm, clear weather along the width of a valley. The winds blow uphill and upvalley by day and downhill and downvalley by night.

F - vents des monts et des vallees

S - vientos de las montanas y aldeas

MULTIBLADE WINDMILL (wind). A WINDMILL that has a large number of BLADES. It generally is used to pump water.

F - eolienne a ailes multiples

S - molino de multiaspas

MULTIVANE WINDMILL (wind). A WINDMILL having more than one TAIL.



F - eolienne a empennages multiples  
S - molino de multiples puntas  
N

NACELLE (wind). The portion of a wind electric conversion machine that houses the electricity generating equipment.

F - carter  
S - barquilla

NATURAL CONVECTION (heat). The natural CONVECTION of heat through the FLUID in a body that occurs when warm, less dense fluid rises and cold, dense fluid sinks under the influence of gravity. (Syn: gravity convection)

F - convection naturelle  
S - conveccion natural

NET AREA (sol) (meas). The area of the opening of a SOLAR COLLECTOR, through which SOLAR RADIATION may pass.

F - fenetre d'entree  
S - superficie neta

NET ENERGY CONSUMPTION (gen) (meas). (See: ENERGY CONSUMPTION)

F - consommation nette d'energie  
S - consumo neto de energia

NIGHT SKY RADIATION (sol). A method of cooling through RADIANT ENERGY exchange. Relatively warm surfaces are

exposed directly to the colder night sky to which they radiate the heat they collected during the day.

F - rayonnement diffus nocturne

S - radiacion del cielo nocturno

NIGHT SOIL (bio). Human excreta with or without flush water, which may be used as FEEDSTOCK for a BIOGAS DIGESTER.

F - vidanges

S - defecaciones humanas

NOCTURNAL RADIATION (sol). (See: NIGHT SKY RADIATION)

F - rayonnement nocturne

S - radiaciones nocturnas

NORIA (hydr) (arc). A vertical WATER WHEEL that is turned by water current. Containers attached to its rim LIFT water for irrigation.

F - noria

S - noria

O

OCEAN THERMAL GRADIENTS (oceans). The temperature difference between deep and surface water in the ocean. These temperature variations may be used as an ALTERNATIVE ENERGY SOURCE.

F - gradients de temperature oceaniques

S - termogradientes oceanicos

OCEAN THERMAL POWER (ocean). ENERGY acquired from differences

in temperatures at different depths in the ocean.

F - energie thermique des mers

S - termopotencia oceanica

OCEAN TIDAL POWER (ocean). The production of electricity by harnessing ocean tidal movements through the use of adjustable-BLADE WATER TURBINES or other devices.

F - energie maremotrice

S - energia oceanica

OFFSHORE WINDS (wind). Winds blowing seaward from the coast.

F - vents de terre

S - vientos terrales

OHM'S LAW (elec). The law stating that for any circuit the electric current is proportional to the voltage and inversely proportional to the resistance.

F - loi d'ohm

S - ley de ohmio

ONSHORE WINDS (wind). Winds blowing shoreward from the sea.

F - vents du large

S - vientos del mar

OPERATING FLOW (hydr) (meas). The FLOW rate needed by a HYDROPOWER device to operate at its rated LOAD level.

F - debit nominal

**S - flujo de operacion**

**ORGANIC MATTER (gen)**. Materials of animal or vegetable origin.

**F - matieres organiques**

**S - materia organica**

**ORGANIC WASTE (bio)**. Residues derived from living organisms. Organic wastes may be used as **FEEDSTOCK** for **BIOGAS DIGESTERS**. (See also: **BIOMASS**)

**F - dechets organiques**

**S - desperdicios organicos**

**OVERSHOT WATER WHEEL**

**ORIENTATION (sol)**. The arrangement of windows on a building or solar device along a given **AXIS** to face in a direction best suited to absorb **SOLAR RADIATION**. This is an essential element in planning **PASSIVE SOLAR HEATING** systems for homes and other buildings.

**F - exposition**

**S - orientacion**

**OSMOSIS (gen)**. The process by which a solvent is **DIFFUSED** through a semipermeable **MEMBRANE** into a more **CONCENTRATED** solution.

**F - osmose**

**S - osmosis**

**OVERFLOW WEIR (hydr)**. (See: **WEIR**)

F - deversoir de trop-plein

S - vertedero de superficie

OVERSHOT WATER WHEEL (hydr). A WATER WHEEL powered by a HEADRACE that discharges over the outer circumference of the wheel. (Syn: overshot gravity wheel)

F - roue en dessus

S - rueda hidraulica de admision superior

<FIGURE>

10p91.gif (486x486)

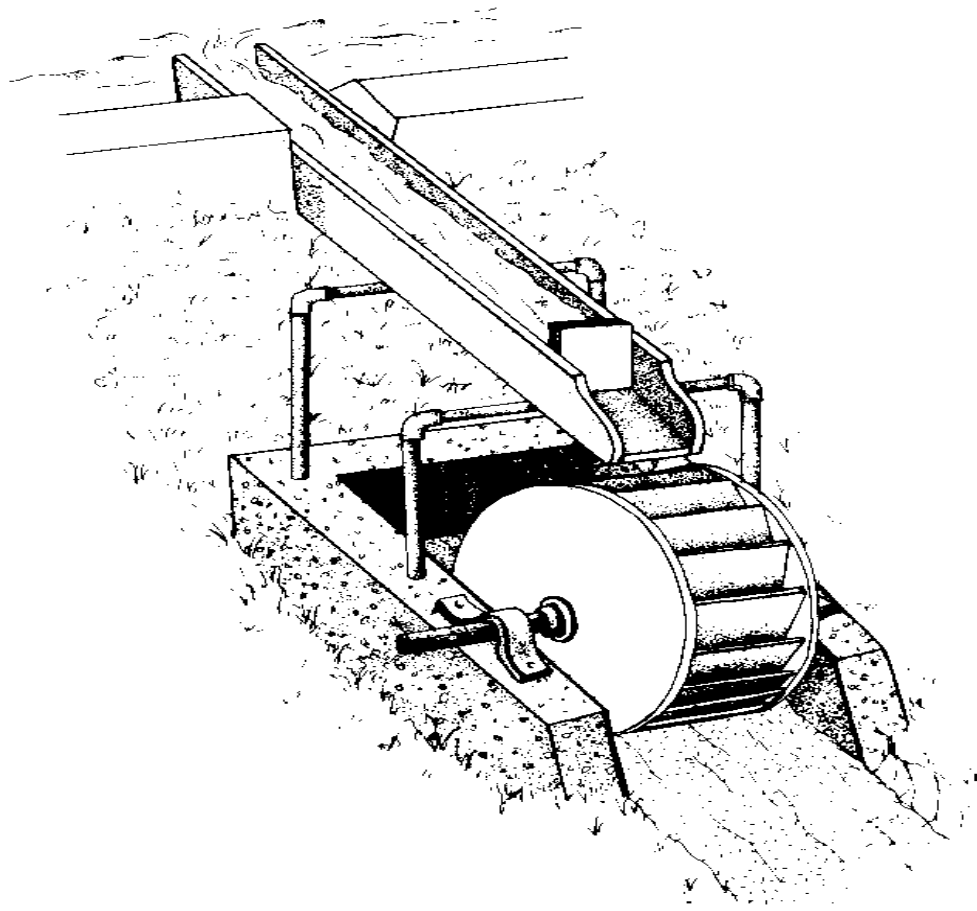

**overshot water wheel system**

P

**PACKED COLUMN (alc)**. A type of **STILL COLUMN** or pipe that is used in **ALCOHOL DISTILLATION**. It is filled with such material as metal filings, plastic, or glass beads. Packed columns increase **ALCOHOL** yields by providing continuous redistillation of the **ALCOHOL VAPOR** as it moves up the still column.

F - colonne garnie  
S - columna compacta

PANEMONE (wind). A VERTICAL-AXIS WIND MACHINE, generally a DRAG-TYPE WIND MACHINE, that can react to winds from any direction.

F - panemone  
S - molino de eje vertical

PARABOLA (sol). The geometrically-curved shape used in the design of SOLAR COOKERS to focus sunlight on a single point. A parabola is based on a family of quadratic curves.

F - parabole  
S - parabola

PARABOLIC CONCENTRATING COOKER (sol). A SOLAR COOKER that uses a PARABOLIC DISH to focus sunlight.

F - cuisEUR solaire a miroir concave  
S - cocina parabolica concentrante

PARABOLIC DISH (sol). A SOLAR ENERGY device shaped like a dish or bowl, with the characteristics of a PARABOLA. It focuses sunlight on a point or a very small area.

F - parabolique solaire  
S - plato parabolico

PARABOLIC MIRROR (sol). A device with a large, shiny, curved surface that focuses SOLAR RADIATION on a

specific point, such as a cooking vessel, for heating or boiling.

F - miroir parabolique

S - espejo parabolico

PASCAL'S LAW (gen). The law stating that pressure applied to a confined FLUID at any point is transmitted throughout the fluid in all directions. The pressure acts upon every part of the confining vessel at right angles to its interior surfaces, acting equally upon equal areas.

F - loi de Pascal

S - ley de Pascal

PASSIVE SOLAR DESIGN (sol). An architectural design that makes use of the structural elements of a building to heat or cool spaces in the building.

F - systeme solaire passif

S - diseno solar pasivo

PELTON WHEEL

PASSIVE SOLAR HEATING (sol). The SOLAR HEATING of a building by use of architectural design, without the aid of mechanical equipment.

F - chauffage solaire passif

S - calefaccion solar pasiva

PATENT SAIL (wind) (arc). A SAIL fitted with SHUTTERS that are controlled automatically.



F - aile a volets

S - aspa patente

PATHOGENIC ORGANISM (bio). (See: PATHOGENS)

F - organisme pathogene

S - organismos patogenicos

PATHOGENS (bio). Harmful micro-organisms, such as BACTERIA and viruses. Pathogens may be found in human, animal, and other wastes, and help spread disease.

F - microbes pathogenes

S - patogenos

PEAK WATT (sol) (meas) (elec). Unit used for the performance rating of PHOTOVOLTAIC CONVERTERS. A system rated at one peak watt will deliver one WATT at the specified working voltage under peak SOLAR IRRADIATION.

F - watt-crete

S - vatio maximo

PEAT (bio) (biocon). Partially decomposed ORGANIC MATTER formed in marshes and swamps. Dried peat is useful as a fuel.

F - tourbe

S - turba

PEBBLE BED (sol). A large bin of uniformly-sized pebbles that is used to store heat in SOLAR HEATING or SOLAR COOLING systems. A pebble bed is one type of HEAT SINK.

F - lit de galets  
S - lecho de gravilla

PEDAL POWER (gen). Mechanical or electrical POWER generated by the use of a bicycle-gearing apparatus. Pedal power may be used for buffing, lathing, grinding grain or meat, operating a potter's wheel, driving a small GENERATOR, turning a sharpening stone, operating a corn sheller, and other applications.

F - energie par pedaliere  
S - potencia generada por pedal

PEDAL-POWER UNIT (impl). (See: PEDAL POWER; DYNAPOD)

F - appareil a entrainement par pedales  
S - unidad de potencia-pedal

PELTON WHEEL (hydr). An IMPULSE WATER TURBINE in which the pressure of the water supply is concentrated through a few stationary nozzles. The JETS of water strike the BUCKETS, which are mounted on the RUNNER. Pelton wheels usually are limited to installations with HEADS that exceed 500 feet, or about 160 meters. (Syn: Pelton turbine)

F - roue Pelton  
S - rueda Pelton

<FIGURE>

10p94a.gif (486x486)

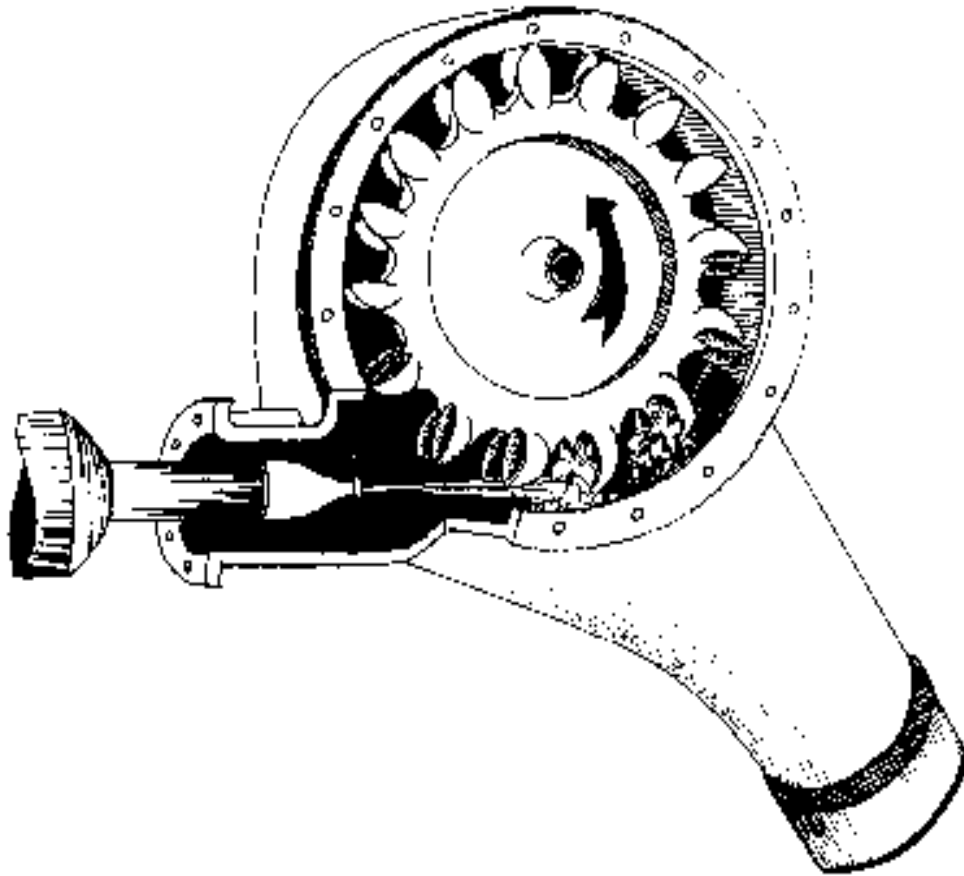

**Pelton wheel**

## **PENSTOCK**

**PENSTOCK (hydr)**. A water conduit from a DAM to a TURBINE or WATER WHEEL. (See also: CHANNEL)

**F** - conduite forcee

**S** - paradera de caz

<FIGURE>

10p94b.gif (486x486)

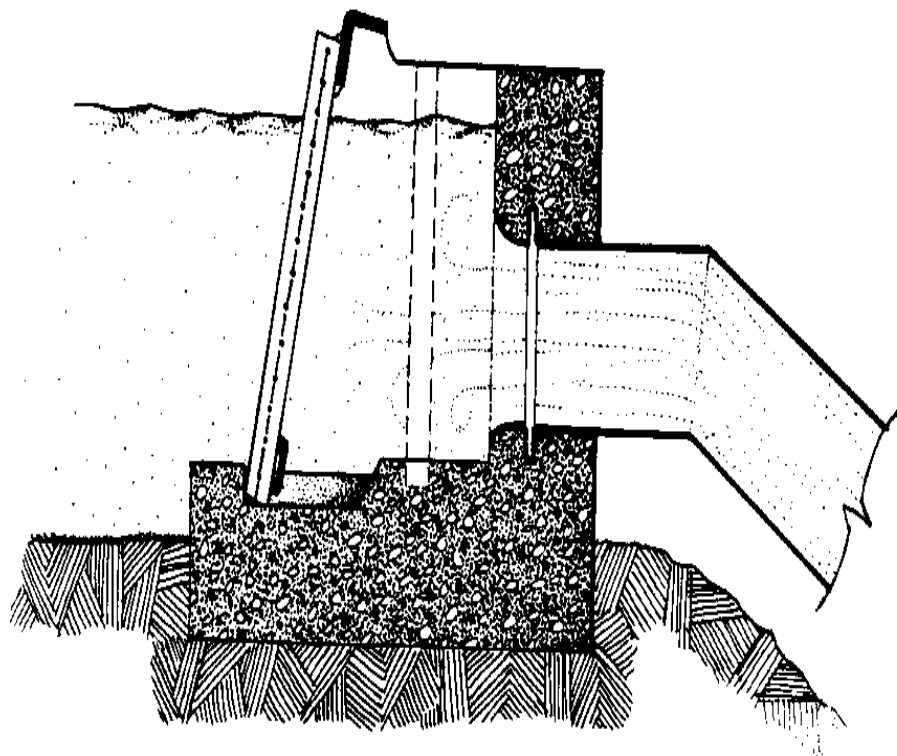

penstock intake (cutaway view)

## PHOTOVOLTAIC CELL

pH (chem) (meas). Potential hydrogen. The symbol that

denotes a measurement of the effective hydrogen ion CONCENTRATION. On a scale of 0 to 14, 7 represents neutrality. Numbers less than 7 indicate increasing ACIDITY. Numbers greater than 7 indicate increasing ALKALINITY of a solution.

F - pH

S - pH

PHOTOMETER (sol) (meas). A device that measures the intensity of light.

F - photometre

S - fotometro

PHOTOVOLTAIC ARRAY (sol). A number of PHOTOVOLTAIC MODULES that are electrically connected in a series and/or in parallel so as to provide the desired POWER and voltage. The modules are mounted on a sturdy framework that generally faces the equator. The array may be tailored to the requirements of a particular application and location. Such an array is valuable because it can generate electricity from sunlight without the use of moving mechanical parts.

F - chapelet de photopiles

S - conjunto fotovoltaico

<FIGURE>

10p95.gif (437x437)

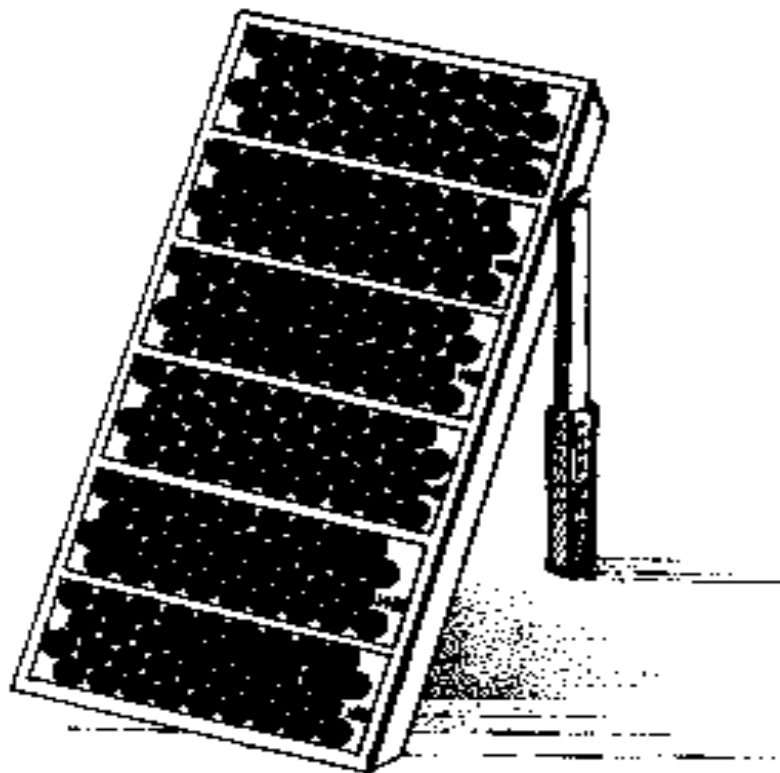

**photovoltaic array**

**PHOTOVOLTAIC CELL (sol)**. A **SOLAR ENERGY** device that changes light into electrical **ENERGY**. The cell is a small square or circular wafer made of treated **SILICON** or other semiconductor material.

**F** - cellule photovoltaique

**S** - celula fotovoltaica

**PHOTOVOLTAIC CONVERTER**

**PHOTOVOLTAIC CONVERTER (sol)**. (See: **PHOTOVOLTAIC CELL**)

F - convertisseur photovoltaique

S - convertidor fotovoltaico

PHOTOVOLTAIC MODULE (sol). The basic building block of a PHOTOVOLTAIC ARRAY, which consists of a number of interconnected SOLAR CELLS.

F - module photovoltaique

S - modulo fotovoltaico

PHOTOVOLTAIC PANEL (sol). (Syn: PHOTOVOLTAIC MODULE)

F - panneau photovoltaique

S - panel fotovoltaico

PHOTOVOLTAIC PROCESS (sol). A process by which light rays are converted directly into electrical ENERGY.

F - conversion photovoltaique

S - proceso fotovoltaico

PITCH (wind) (meas). The angle between the BLADE surface and the ANGLE OF ATTACK in a WINDMILL.

F - pas

S - paso

PITCH-BACK WATER WHEEL (hydr). An OVERSHOT WATER WHEEL in which the trough carrying water to the wheel is modified to discharge onto the near side of the wheel, thus reversing the normal direction of rotation.

F - roue hydraulique a jet inverse

S - rueda hidraulica de engranaje

PIT KILN (heat). A KILN made from a hole that is dug in the ground.

F - four en terre

S - horno de foso

PLUG FLOW GENERATOR (biocon) (impl). A BIOGAS DIGESTER with no mechanical agitation through which the SLURRY passes along in more or less discrete "plugs," creating a cycle of "first in-first out." The EFFLUENT is then theoretically composed only of older slurry. The plug flow design differs from traditional designs, in which all slurry is purposely mixed together in a single pit or tank.

F - generateur a effet bouchon

S - generador de flujo

POLL ENDS (arc) (wind). (See: CANISTER)

F - bouts de mats

S - puntas

POLYSACCHARIDE (chem). (See: STARCH)

F - polysaccharide

S - polisacarido

POLYURETHANE FOAM (constr). A very lightweight plastic or other synthetic insulating material.

F - mousse de polyurethane

S - espuma de poliuretano



**POUNDS PER SQUARE INCH**

**POLYVINYL ACETATE (chem) (sol)**. A clear plastic made of **CELLULOSE ACETATE** and used as **GLAZING** on **SOLAR COLLECTORS**.

**F - acetate de polyvinyle**

**S - acetato de polivinilo**

**PONCELET WHEEL (hydr)**. An **UNDERSHOT WATER WHEEL** made with curved metal **BLADES**.

**F - roue Poncelet**

**S - rueda hidraulica Poncelet**

**<FIGURE>**

**10p97.gif (437x437)**

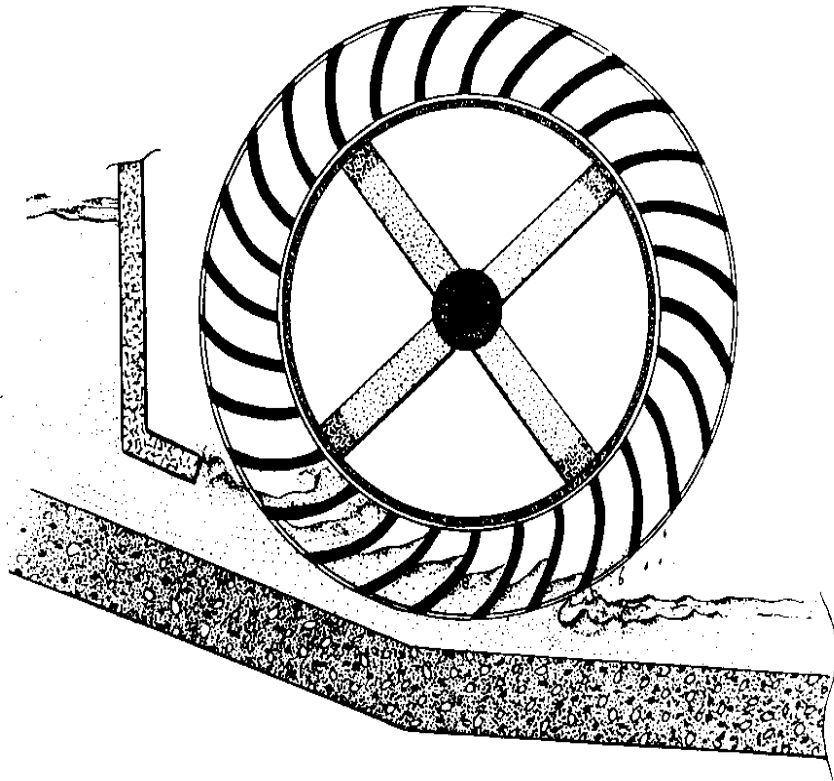

Poncelet wheel

POST MILL (wind) (arc). This is the earliest type of European WINDMILL. The body of the windmill is balanced on a large post and trestle. The entire body revolves to turn the BLADES into the wind.

F - moulin pivot

S - molino de poste

<FIGURE>

10p98.gif (437x437)

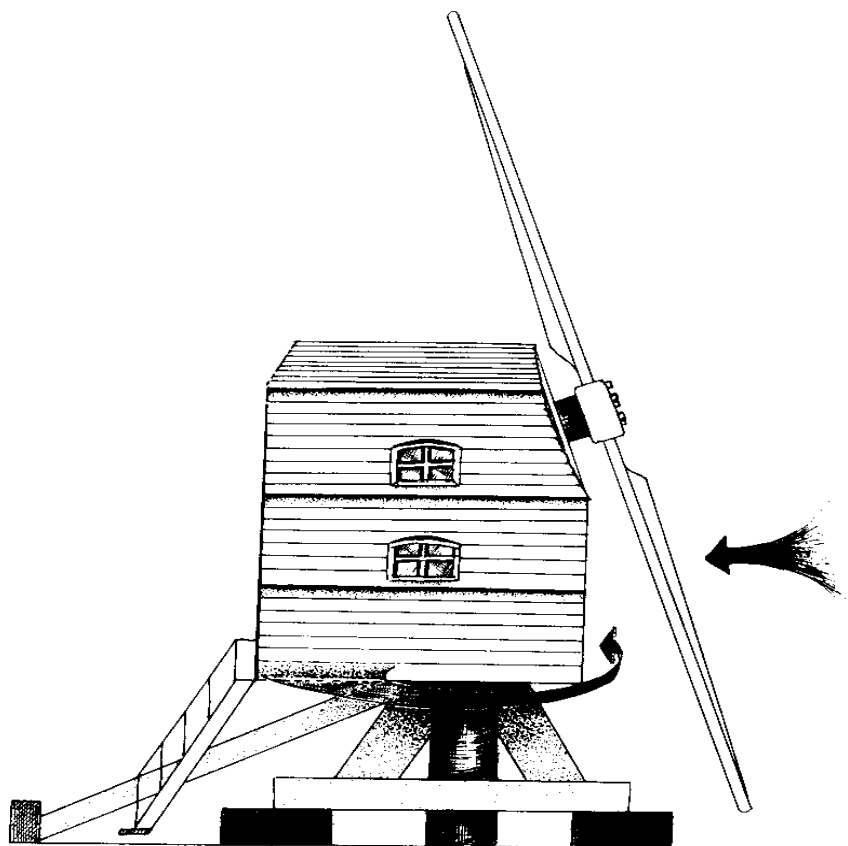

post mill

POTENTIAL HYDROGEN (chem) (meas). (See: pH)

F - potentiel d'hydrogene

S - potencial de hidrogeno

POUNDS PER SQUARE INCH (meas). A measurement of gas pressure.

Commonly abbreviated as psi.

F - livres par pouce carre

S - libras/[pulgada.sup.2]

## POWER

POWER (gen). The rate at which ENERGY is consumed or produced.

F - puissance

S - potencia

POWER COEFFICIENT (wind) (meas). The ratio of the POWER extracted by a WIND MACHINE ROTOR to the power available in a wind stream.

F - coefficient de puissance

S - coeficiente de potencia

POWER DENSITY (wind) (meas). The amount of POWER per unit of a cross-sectional area of a wind stream.

F - puissance volumique

S - densidad de potencia

## PRODUCER GAS

PRECULTURE (alc). A method for reducing the time and increasing the EFFICIENCY of FERMENTATION. The preculture process involves CONCENTRATING the ALCOHOL-producing YEAST before introducing it into the FERMENTATION TANK.

F - preculture

S - precultivo

PREPARED ORGANIC WASTE (biocon). BIOMASS mixed with water for use in a BIOGAS DIGESTER. (Syn: SLURRY)

F - dechets organiques prepares

S - desperdicio organico preparado

PREVAILING WIND (wind). The direction from which the wind blows most often. This is an important consideration in selecting a site for a WINDMILL.

F - vent dominant

S - viento dominante

PRODUCER GAS (prod). A combination of COMBUSTIBLE GASES created through the combustion of wood or coal in a controlled-air environment. Producer gas may be used to drive gasoline or diesel engines.

F - gaz de gazogene

S - gas pobre

PRODUCER GAS GENERATOR

PRODUCER GAS GENERATOR (gen). A furnace in which COMBUSTIBLE GASES are produced for use as a fuel.

F - gazogene

S - generador de gas pobre

<FIGURE>

10p99.gif (486x486)

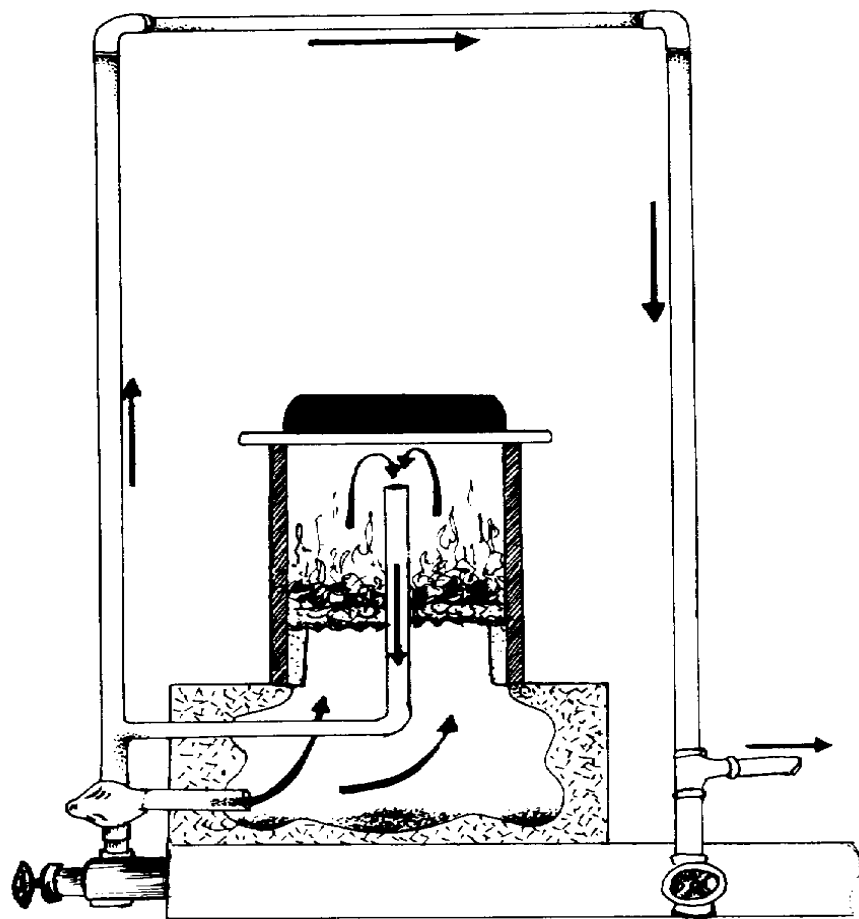

**producer gas generator (cutaway view)**

**PROOF** (alc) (meas). A unit measurement of the strength of **ALCOHOL**. The proof is twice the percentage of the alcohol in the liquid. Alcohol that is 90 proof contains 45 percent alcohol. (See also: **PROOF-GALLON**)

**F** - degree en alcool

**S** - graduacion normal

PROOF-GALLON (alc) (meas). A standard U.S. gallon of a mixture that is 50 percent ALCOHOL and 50 percent water (i.e., that is 100 proof). An alcohol/water mixture that contains a different ratio of each may be translated into proof-gallons by moving the decimal point of the proof two places to the left and multiplying by the total number of gallons of the mixture.

F - proof-gallon

S - proof-gallon

PSI (meas). Abbreviation for POUNDS PER SQUARE INCH.

F - psi

S - lb/[pulg.sup.2]

PYRANOMETER (meas) (sol). A device that measures total GLOBAL RADIATION.

F - pyranometre

S - piranometro

PYROHELIOMETER (meas) (sol). An instrument that measures SOLAR RADIATION from the sun, or from a small portion of the sky that surrounds the sun.

F - pyroheliometre

S - piroheliometro

PYROLYSIS (chem). The DECOMPOSITION of a substance subjected to very high heat.

F - pyrolyse

S - pirolisis

## Q

QUAD (meas). One quadrillion BTUs. It is expressed as either [10.sup.15] or 1,000,000,000,000,000 BTus. A quad is used to measure any large unit of energy such as wood, gasoline, coal, etc. For example, a quad can be used to describe the amount of THERMAL ENERGY that is potentially available from burning a certain acreage of trees in WOODSTOVES.

F - quad

S - cuad

QUARTERING (wind). The action of turning a WINDMILL broadside to the WIND.

F - larguage

S - venteo

R

RACE (hydr). An AQUEDUCT or CHANNEL that carries water to and from the place where it is used to drive a HYDROPOWER device.

F - chenal

S - canal de trabajo

RADIAL FLOW (hydr). A type of HYDROPOWER device in which the water flows out radially from the power shaft. (See also: FRANCIS TURBINE)

F - ecoulement radial



S - flujo radial

RADIANT ENERGY (sol). ENERGY in the form of electromagnetic waves that travels outward in all directions from its source.

F - energie rayonnante

S - energia radiante

RADIANT PANELS (sol). SOLAR COLLECTORS with integral passages for the FLOW of HEAT TRANSFER FLUID. Heat from the fluid is conducted into a room or building by THERMAL RADIATION.

F - panneaux rayonnants

S - paneles radiantes

RADIATION (sol). Electromagnetic waves that directly transport ENERGY through space. Sunlight is a form of radiation.

F - rayonnement

S - radiacion

RATED POWER CAPACITY (wind) (meas). The expected POWER output of a WIND MACHINE. It is equal to either the maximum power of the machine or to an output at some WIND SPEED less than the maximum speed, but at which GOVERNING controls start to reduce the power.

F - puissance nominale

S - capacidad de potencia tasada

**RATED WIND SPEED (meas) (wind).** The WIND SPEED at which a WIND MACHINE delivers its RATED POWER CAPACITY.

F - vitesse nominale du vent

S - velocidad eolica tasada

**RATE LIMITING STEP (biocon).** Whichever stage in the ANAERIOBIC process that is slowest. Since each step in the digestion process requires the preceeding one to be completed before it can begin, the overall gas production rate is limited by the slowest step.

F - stage limitant la cadence

S - etapa de velocidad limitadora

**RECTIFIER**

**RAW SLUDGE (biocon).** Fresh, undried, uncomposted EFFLUENT from a DIGESTER. Also residue in the same condition from the bottom of a digester.

F - boues brutes

S - cienos sin tratar

**RAYLEIGH DISTRIBUTION (wind).** Standard WIND SPEED DISTRIBUTION that is useful in wind site analysis. It is a probability density function that allows one to model the wind speed distribution based on a single input parameter. (See also: WEIBULL DISTRIBUTION)

F - distribution de Rayleigh

S - distribucion de Rayleigh

REACTION TURBINE (hydr). A WATER TURBINE that uses the mass or weight of water hitting the RUNNER as opposed to being driven by the velocity of the water.

F - turbine a reaction

S - turbina a reaccion

REACTION WATER WHEEL (hydr). A WATER WHEEL that uses the mass or weight of water falling onto it rather than the FLOW.

F - roue hydraulique a reaction

S - rueda hidraulica reactiva

RECIPROCATING ENGINE (hydr). A device that converts the potential ENERGY in a FLUID to mechanical energy by expanding the FLUID against a piston.

F - moteur a pistons

S - maquina alternativa

RECIPROCATING PUMP (wind). A type of water pump commonly used with WINDMILLS. Motion and pressure are applied to the water by a piston moving up and down in a CYLINDER. The piston is powered by the WINDMILL.

F - pompe alternative

S - bomba aspirante e impelente

RECLAIMED OIL (heat). (See: USED OIL)

F - huile de recuperation

S - aceite recuperado

**RECOVERED ENERGY (gen)**. Heat or other **ENERGY** that normally would be lost during a process, but instead is captured and reused. For example, **FLUE** gases may be used for drying purposes.

F - energie recuperee

S - energia recobrada

**RECTIFIER [1] (alc) (impl)**. A second column on an **ALCOHOL STILL** that is used to further remove water from the **ALCOHOL VAPOR**, thus increasing the **PROOF** of the alcohol. This increase in **CONCENTRATION** is achieved by the repeated interaction of the rising vapor with the liquid **DISTILLATE**. [2] (elec). A device that converts **ALTERNATING CURRENT (ac)** into **DIRECT CURRENT (dc)**.

F - [1] colonne de rectification; [2] redresseur

S - [1] rectificadora; [2] rectificador

**RECTIFYING COLUMN**

**RECTIFYING COLUMN (alc) (impl)**. [See: **RECTIFIER (alc)**]

F - colonne de rectification

S - columna de rectificar

**REDUCING SUGAR (alc)**. (See: **MONOSACCHARIDE**)

F - sucre reducteur

S - azucar reductora

**REEFING (wind)**. Rolling and tying down a portion of a **WINDMILL SAIL** to reduce the area exposed to the wind.

F - prendre les ris

S - recoger las velas

REFLECTANCE (sol). The ratio of RADIATION reflected from a surface to that incident on the surface. [See also: REFLECTIVITY (2)].

F - facteur de reflexion

S - reflectancia

REFLECTED RADIATION (sol). SOLAR RADIATION that has been reflected from such surfaces as the ground or buildings, and which ultimately becomes INCIDENT RADIATION.

F - rayonnement reflechi

S - radiacion reflejada

REFLECTIVITY (sol) (meas). [1] The ability to reflect SOLAR RADIATION, which is possessed to some degree by all materials. It is called the ALBEDO in atmospheric references. [2] The ratio of RADIANT ENERGY reflected by a body to that falling upon it.

F - pouvoir reflecteur

S - reflectividad

REFLECTOMETER (sol) (meas). A PHOTOMETER or other electronic device that measures REFLECTANCE or RADIANT ENERGY.

F - reflectometre

S - reflectometro

REFLECTOR (sol). A device that can be used to reflect and

**focus SOLAR RADIATION.**

**F - reflecteur**

**S - reflector**

**REFLECTOR BACKING (sol).** The material used on the rear part of a SOLAR REFLECTOR. (See also: MASONITE)

**F - renfort de reflecteur**

**S - revestimiento reflector**

**REFLECTOR COOKER (sol).** (See: REFLECTOR-TYPE SOLAR COOKER)

**F - cuiseur a reflecteur**

**S - hornillo reflector**

**RETURN TIME**

**REFLECTOR-TYPE SOLAR COOKER (sol).** A SOLAR COOKER in which a REFLECTOR concentrates the sun's rays on a cooking device.

**F - cuiseur solaire a reflecteur**

**S - hornillo solar reflector**

**REFLUX (alc).** Liquid ALCOHOL that is condensed in a DISTILLATION COLUMN, and then reintroduced into the column to increase its CONCENTRATION.

**F - reflux**

**S - reflujo**

**REFRIGERANT (refrig).** A VOLATILE substance that can be used as a working FLUID in a cooling system.

**F - refrigerant**

**S - refrigerante**

**REFRIGERATION (refrig)**. The act or process of making or keeping something cool or cold. It especially applies to the use of artificial means for cooling.

**F - refrigeration**

**S - refrigeracion**

**RENEWABLE ENERGY (gen)**. ENERGY produced from regenerative or virtually inexhaustible resources such as BIOMASS, SOLAR RADIATION, the wind, water, or heat from the Earth's interior.

**F - energie renouvelable**

**S - energia renovable**

**RENEWABLE RESOURCES (gen)**. (See: RENEWABLE ENERGY)

**F - ressources renouvelables**

**S - recursos renovables**

**RESISTANCE VALUE (constr) (meas)**. A rating of a substance's thermal resistance to summer HEAT GAIN or winter heat loss. It is used as a measure of insulation efficiency. (Syn: R-VALUE) (See also: U-VALUE)

**F - resistance thermique**

**S - valor de resistencia**

**RETORT (alc) (gen)**. [1] A vessel in which substances are subjected to heat for the purpose of DISTILLATION or DECOMPOSITION. A retort is distinguished from a STILL in

that it is more often used for the treatment of solid or semisolid substances. [2] A closed container used in CHARCOAL production in which COMBUSTIBLE GASES are captured and made into liquids, generally through CONDENSATION.

F - cornue

S - retorta

RETROFITTING (sol). The installation of SOLAR HEATING or SOLAR COOLING systems in existing structures.

F - readaptation

S - modificacion retroactiva

RETURN TIME (wind) (meas). The length of time during which low winds prevent a WINDMILL from reaching its CUT-IN SPEED or START-UP SPEED. The "down time" or time period when the wind is too low to enable a WINDMILL to reach its cut-in speed or start-up speed.

F - temps mort

S - tiempo de restablecimiento

REYNOLDS' NUMBER

REYNOLDS' NUMBER (meas) (sol) (wind). The ratio of material forces to VISCOUS forces in any FLUID FLOW. The Reynolds' number is determined through the following equation:  $(PVD)/U$  where:

P ( $\rho$ ) = density

V = velocity

D = length of flow distance



U ( $\mu$ ) = viscosity.

F - nombre de Reynolds

S - numero de Reynolds

RICE HUSK STOVE (biocon). A stove designed to use rice husks as its primary fuel.

F - poele a paille de riz

S - estufa de cascaras de arroz

RIGGING (wind) (impl). Collectively, all the ropes and cords used to support the mast of the WINDMILL, and to FURL or unfurl the SAILS.

F - haubanage

S - cordaje

RIPARIAN RIGHTS (hydr). The right of a landowner to the water on or bordering his or her property, including the right to prevent diversion or misuse of upstream water.

F - droits de riverainete

S - derechos riberenos

RISER (alc). A tube that penetrates a plate in a STILL COLUMN, allowing ALCOHOL VAPORS to move up the column. A perforated cap or cup is placed on top of each riser to distribute the vapor into the column section and to prevent water from dripping into the riser.

F - colonne montante

S - tubo de subida

RIVER GENERATOR (elec) (hydr). A HYDROELECTRIC GENERATOR that gets its power from a river or other FLOWING water.

F - generateur riverain

S - generador fluvial

ROCKBED (sol). A heat storage container filled with rocks or pebbles that is used in SOLAR HEATING and SOLAR COOLING systems.

F - lit de pierres

S - fondo de roca

ROCKBED COOLING SYSTEM (sol). A passive air-conditioning system that circulates a building's air through a bed of rocks that has cooled during the night or early morning.

F - refroidissement par lit de pierres, systeme de

S - sistema de enfriamiento con lecho de roca

R-VALUE

ROCKER ARM (wind) (impl). A support mechanism that rotates on a shaft at one end while moving up and down at the other. It is used to convert the rotating motion of a WINDMILL to an up-and-down motion, usually for pumping.

F - culbuteur

S - balancin

ROLLER REEFING SAIL (wind) (arc). A ROTOR BLADE that is fitted with canvas strips (SAILS) wound on ROLLERS. The rollers are used for REEFING the sails.

F - aile a rouleaux de prise de ris

S - aspa con rodillos

ROLLERS (wind) (arc). BEARINGS between the CURB and the CAP of a TOWER MILL or SMOCK MILL. The rollers allow the top of the MILL to turn into the wind.

F - rouleaux

S - rodillos

ROTOR (wind). The assembly of SAILS or BLADES that rotate about an AXIS created by the WIND SHAFT of a WINDMILL.

F - rotor

S - rotor

ROTOR SHAFT (wind). (See: WIND SHAFT)

F - arbre de rotor

S - eje del rotor

RUNG (hydr) (wind). [1] The BLADES of a WATER WHEEL. [2] The transverse iron rods that hold the SAIL CLOTHS in a WINDMILL.

F - [1] palette; [2] barreau

S - paleta

RUNNER (hydr). The TURBINE wheel.

F - roue de turbine

S - rueda movil

<FIGURE>

10p107.gif (486x486)

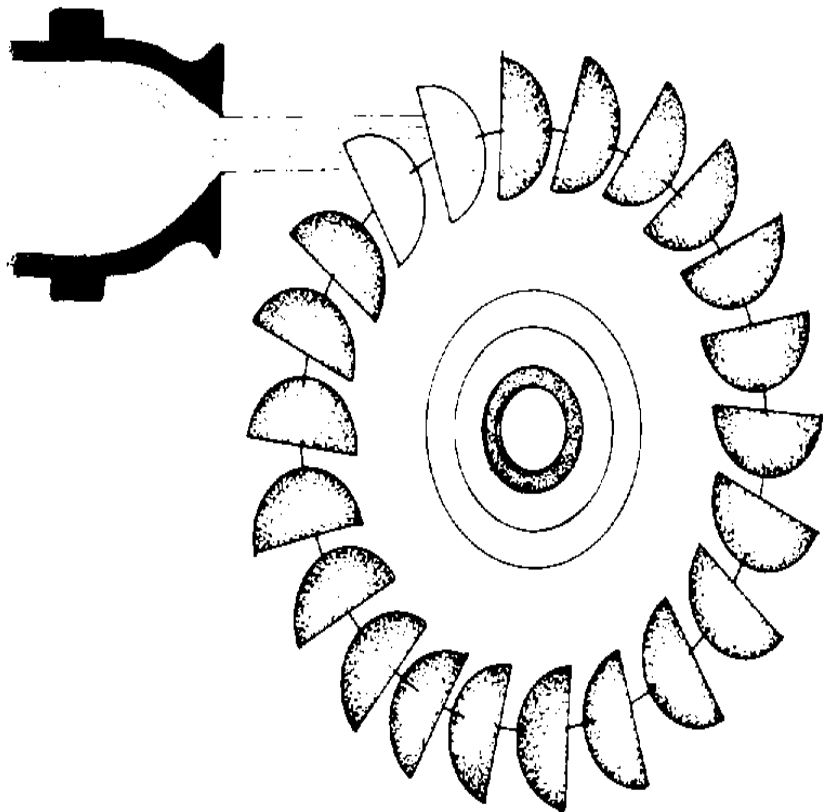

runner with cups

R-VALUE (meas). (See: RESISTANCE VALUE)

F - resistance thermique

S - valor R

S

**SACCHARIFICATION (alc)**. A conversion process using **ACIDS**, **BASES**, or **ENZYMES** in which **CARBOHYDRATES** are broken down into **FERMENTABLE SUGARS**. (See also: **FERMENTATION**)

F - saccharification

S - sacarificacion

**SAIL (wind)**. A piece of cloth attached between each of the **SPARS** of a **WINDMILL** for the purpose of catching the wind. Also used to define windmill sails collectively.

F - aile

S - vela

**SAIL BACK (wind) (arc)**. A single **SPAR** that replaces the **STOCK** and **WHIP** in **WINDMILLS** that are fitted with iron crosses instead of **POLL ENDS**.

F - bras d'aile

S - barra del aspa

**SAILCLOTH (wind)**. Very strong cotton or canvas that may be used for **SAILS** on **WINDMILLS**.

F - toile a voile

S - lona

**SAILWING WINDMILL (wind)**. A **WINDMILL** that has a small number of cloth **SAILS**. Sailwing windmills are usually simple designs, and are most commonly used for water pumping.

F - moulin a volants

S - molino de viento con vela de lona

SALT (chem). A product formed by the neutralization of an ACID by a BASE.

F - sel

S - sal

SANITATION/DIGESTER SYSTEM (biocon). A BIOGAS system that combines METHANE production with facilities to dispose of human excreta. This also is an effective way to eliminate dangerous PATHOGENS.

F - systeme sanitaire/digesteur

S - sistema de saneamiento/digestor

SAVONIUS ROTOR (wind). A WIND MACHINE with a VERTICAL AXIS, often made from split oil drums. It is a DRAG-TYPE device with relatively low EFFICIENCY, but with high starting TORQUE.

F - rotor de Savonius

S - rotor Savonius

<FIGURE>

10p109.gif (600x600)

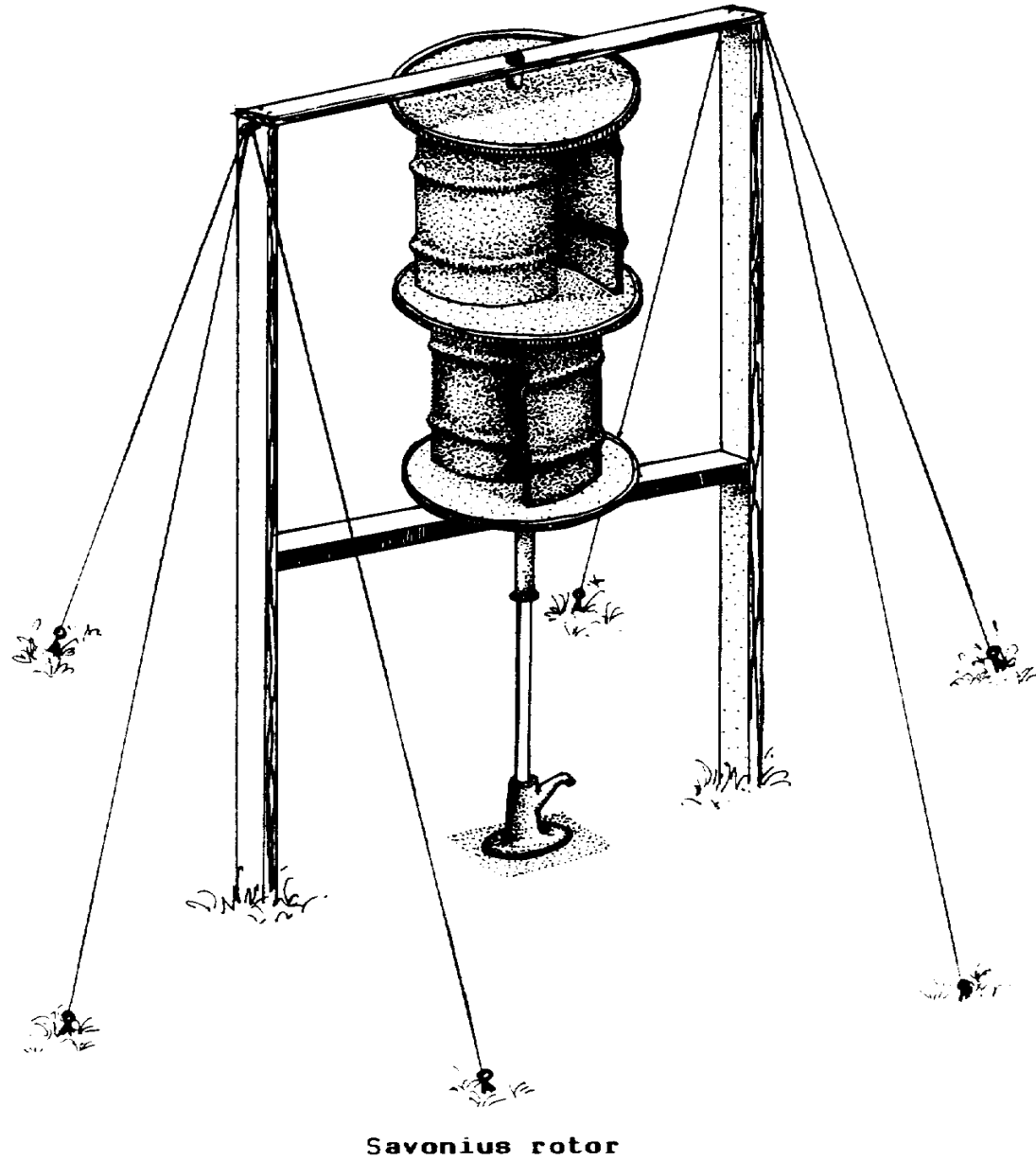

**Savonius rotor**

**SCOOP WHEEL**

**SAWDUST STOVE (biocon). A stove designed to use sawdust as its primary fuel.**

**F - poele a sciure de bois**

**S - estufa de aserrin**

**<FIGURE>**

**10p110.gif (486x486)**



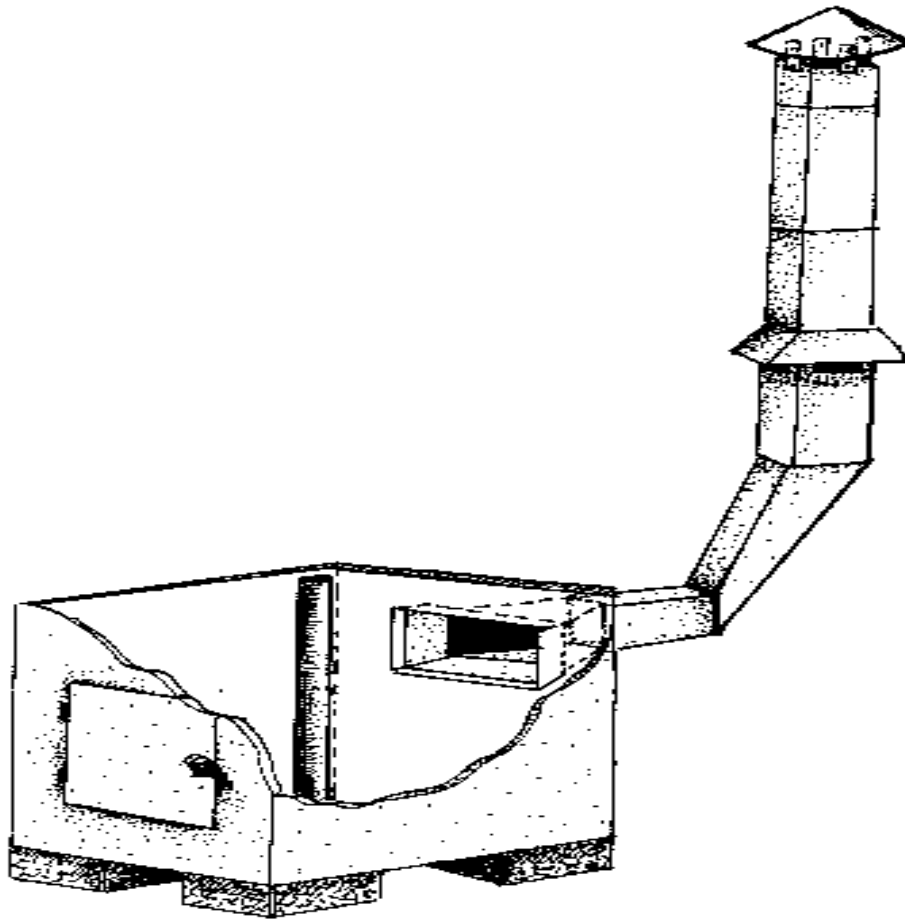

sandust burning stove (cutaway view)

SCOOP WHEEL (wind) (arc). A vertical, cast-iron wheel with wooden BLADES or scoops that lift water from one level to another. Scoop wheels usually are driven by WINDMILLS.

F - roue a godets

S - rueda de cangilones

**SCRUBBING**

SCRUBBING (biocon). [1] Removing unwanted gases from BIOGAS or PRODUCER GAS. [2] The process of removing an undesirable, and usually corrosive, component or components from a COMBUSTIBLE GAS mixture. This is done by passing the mixture upwards and counter to a stream of liquid that is capable of selectively ADSORBING the undesirable components. Gases can also be scrubbed by passing them through iron filings.

F - epuration

S - proceso de lavado

**SHADING COEFFICIENT**

SCUM (biocon). In BIOGAS DIGESTION, a mixture of coarse, fibrous material floating on the surface of the SLURRY. The accumulation of scum may inhibit METHANE production.

F - ecume

S - nata espumosa

SCUM CONTROL DEVICE (biocon) (impl). A mechanism, usually some type of STIRRING device, that is used to break up the layer of SCUM that rises to the surface in a BIOGAS DIGESTER.

F - dispositif pour le controle de l'ecume

S - aparato controlador de la nata

SECOND LAW OF THERMODYNAMICS (gen). The law stating that ENERGY FLOWS from a higher CONCENTRATION to a lower

concentration.

F - seconde loi de la thermodynamique

S - segunda ley termodinamica

SEED (biocon). (See: INOCULUM)

F - germe

S - semilla

SELECTIVE SURFACE (sol). A specially adapted surface coating for a COLLECTOR that has high SOLAR RADIATION ABSORPTANCE and low THERMAL EMITTANCE. It is used on the surface of ABSORBER PLATES to increase collector EFFICIENCY.

F - vitrage selectif

S - superficie selectiva

SELF-SUPPORTING TOWER (wind). A TOWER, usually made of steel, which supports a WINDMILL without the use of GUY WIRES.

F - pylone autoporteur

S - torre autoportante

SENSIBLE HEAT (heat). That heat, which, when added or subtracted, results only in a temperature change (as opposed to a chemical or other reaction).

F - chaleur sensible

S - calefaccion termosensible

SENSIBLE HEAT STORAGE (heat). A heat storage medium in

which the addition or removal of heat results only in a temperature change (as opposed to a chemical or other reaction). The storage medium often consists of water or gravel.

F - stockage de chaleur sensible

S - almacenaje termosensible

SHADING COEFFICIENT (sol) (meas). A method for determining reductions in solar HEAT GAIN caused by certain kinds of GLAZING. It is determined by dividing the solar heat gain through a sheet of glazing under specific conditions by the solar gain through a single-color DOUBLE-GLAZING under the same conditions. The lower the number, the greater the reduction in solar heat gain.

F - coefficient de vitrage

S - coeficiente de sombra

SHEAR

SHEAR (wind). Variations in horizontal WIND SPEED due to the distance of the wind from the ground. The higher the wind is above the ground, the faster it moves because of the reduced friction.

F - cisaillement

S - gradiente transversal de la velocidad del viento

SHOT CURB (wind) (arc). (See: LIVE CURB)

F - chemin de roulement

S - reborde movil

SHROUD (wind) (arc) (hydr). [1] A structure used to concentrate or deflect a stream of wind. [2] A deep rim partially enclosing the BUCKETS in OVERSHOT WATER WHEELS or BREAST WHEELS.

F - [1] carenage; [2] bache

S - refuerzo

SHROUDED WINDMILL (wind) (arc). A WINDMILL with a funnel-like structure around the outside edge of the SWEPT AREA that forces wind from a larger area to pass through the BLADES.

F - eolienne carenee

S - molino de viento reforzado

SHUTTERS (wind) (arc). Pivoting slats that are used instead of SAILCLOTH in SPRING SAILS and PATENT SAILS.

F - volets

S - hojas basculantes

SIEVE PLATE (alc). A component of an ALCOHOL STILL COLUMN. It is one of a series of perforated plates that is used to promote the contact of liquid with vapor in the column.

F - plateau perfore

S - placa perforada

SILICON SOLAR CELL (sol). A SOLAR CELL made with the crystalline element SILICON as part of its conductor.

F - cellule solaire a la silicone

S - celula solar de silicio

SILVICULTURAL BIOMASS (biocon). BIOMASS from trees.

F - biomasse de sylviculture

S - biomasa de silvicultura

SINGLE-AXIS TRACKING COLLECTOR (sol). A SOLAR COLLECTOR that follows the path of the sun on only one AXIS.

F - capteur a poursuite du soleil autour d'un seul axe

S - colector de seguimiento monoaxial

SINGLE SHUTTERED (wind) (arc). A SAIL having SHUTTERS on only one side of the WHIP.

F - a obturation simple

S - aspa de monohoja

SMOCK MILL

SITE SELECTION (gen). The process of locating the best available site to build or place a WIND MACHINE, HYDROPOWER device, or SOLAR POWER device.

F - choix du site

S - seleccion del emplazamiento

SKY DOME (sol). The sky above the horizon in all directions, as seen from a particular area.

F - dome du ciel

S - domo aereo

SKYLIGHT (sol). A roof opening that is covered with

**GLAZING** and that allows sunlight to enter a house or room.

**F - lucarne**

**S - tragaluz**

**SKYSCRAPERS** (wind) (arc). (See: AIR BRAKES)

**F - freins a vent**

**S - rascacielos**

**SLOPE** (hydr) (meas). A CHANNEL FLOW calculation equal to the number of feet a surface "drops" or inclines downward per 1,000 feet of horizontal distance; also expressed in meters of drop per kilometer.

**F - pente**

**S - pendiente**

**SLUDGE** (biocon). Solid material that collects at the bottom of a DIGESTER.

**F - boues**

**S - sedimentos**

**SLUDGE GAS** (biocon). An alternative name used for BIOGAS, particularly when the gas is produced by sewage.

**F - gaz de vidange**

**S - gas de lodo**

**SLUICE** (hydr). A manmade CHANNEL or waterway to conduct water to a HYDROPOWER device. It generally has one or more adjustable gates to regulate the FLOW of water.

**F - canal a vannes**

S - esclusa

SLUICEWAY (hydr). (See: SLUICE)

F - chenal d'ecluse

S - saetin

SLURRY (biocon). The semisolid material in a BIOGAS DIGESTER consisting of BIOMASS mixed with water.

F - boue

S - fango

SMOCK MILL (wind) (arc). The timber-framed counterpart to the TOWER MILL. The smock mill frame generally is covered with boarding to protect it from the weather.

F - moulin a calotte pivotante

S - molino a la holandesa

SMOKE CHAMBER

SMOKE CHAMBER (heat). The section in a fireplace FLUE that is directly above the DAMPER.

F - conduite de fumee

S - camara de humo

SODIUM CARBONATE (biocon). A BASE used to control pH (POTENTIAL HYDROGEN). It is useful in maintaining the pH balance in a BIOGAS DIGESTER, and to a somewhat lesser degree in ALCOHOL STILLs.

F - carbonate de sodium

S - carbonato de sodio



**SOLAR ABSORBER (sol)**. A sheet of material, usually copper, aluminum, or steel that forms the surface of a SOLAR COLLECTOR. It collects and retains SOLAR RADIATION, which is passed to a HEAT TRANSFER MEDIUM.

F - absorbeur solaire

S - absorbente solar

**SOLAR ABSORPTION (sol)**. The absorption of SOLAR RADIATION by a material.

F - absorption solaire

S - absorcion solar

**SOLAR ALTITUDE (sol)**. The sun's angle above the horizon, as measured in a vertical plane.

F- hauteur du soleil

S- altura solar

**SOLAR ARCHITECTURE (sol)**. (See: PASSIVE SOLAR DESIGN)

F - architecture solaire

S - arquitectura solar

**SOLAR ARRAY (sol)**. A group of SOLAR COLLECTORS or PHOTOVOLTAIC MODULES.

F - panneau solaire

S - conjunto solar

**SOLAR AZIMUTH (sol)**. The horizontal angle between the sun and due south in the northern hemisphere, or between the sun and due north in the southern hemisphere. (Syn:

bearing angle)

F - azimut du soleil

S - azimut solar

SOLAR BATTERY (sol). A BATTERY that is charged through PHOTOVOLTAIC CELLS.

F - pile solaire

S - bateria solar

SOLAR CABINET DRYER (sol). (See: SOLAR CROP DRYER)

F - chambre de sechage solaire

S - secador solar de gabinete

SOLAR CELL (sol). (See: PHOTOVOLTAIC CELL)

F - cellule solaire

S - celula solar

SOLAR DECLINATION

SOLAR COATING (sol). FLAT BLACK PAINT or some other ABSORPTIVE substance that is applied to the ABSORBER PLATE of a SOLAR COLLECTOR to help it absorb, rather than reflect, sunlight.

F - couche antireflet

S - revestimiento solar

SOLAR COLLECTOR (sol). A device that gathers and accumulates SOLAR RADIATION to produce heat. Nearly all solar collectors have a layer of GLAZING on top to trap heat that has passed into the collector. Beneath the glazing

is a solar ABSORBER PLATE, which transfers heat to a HEAT TRANSFER MEDIUM. The medium may be air, water, an antifreeze solution, or other substance(s).

F - capteur solaire

S - colector de radiacion solar

SOLAR COLLECTOR CONNECTIONS (sol). Inlets and outlets leading to and from SOLAR COLLECTORS and connecting the collectors with related apparatus. In the case of water tanks that run water through collectors, there will be an outlet near the bottom of the tank and an inlet near the top of the tank. Likewise, there will be an inlet near the bottom of the collector and an outlet near the top of the collector.

F - raccordements pour capteurs

S - conexiones del colector solar

SOLAR COLLECTOR EFFICIENCY (sol) (meas). The total SOLAR RADIATION that is incident on a COLLECTOR during a specific time period.

F - rendement radiatif

S - rendimiento del colector solar

SOLAR CONCENTRATOR (sol). The part of a SOLAR COLLECTOR that focuses sunlight onto an ABSORBER surface.

F - concentrateur solaire

S - concentrador solar

SOLAR COOKER (sol). A general term for the many types of

**SOLAR-POWERED** cooking devices.

**F** - cuiseur solaire

**S** - cocina por calor solar

**SOLAR COOLING** (sol). A **SOLAR SYSTEM** used to lower the temperature in a room or a device.

**F** - refroidissement solaire

**S** - enfriamiento solar

**SOLAR CROP DRYER** (sol). An apparatus that uses **SOLAR RADIATION** to dry rice, grain, fruit, vegetables, or other foods.

**F** - sechoir solaire pour récoltes

**S** - secador solar para alimentos

**SOLAR CROP DRYER** (sol). An apparatus that uses **SOLAR RADIATION** to dry rice, grain, fruit, vegetables, or other foods.

**F** - sechoir solaire pour récoltes

**S** - secador solar para alimentos

**SOLAR DECLINATION** (sol). The angle of the sun north or south of the equatorial plane. It is plus if north of the plane, and minus if south of the plane.

**F** - declinaison solaire

**S** - declinacion solar

**SOLAR DISH**

**SOLAR DISH** (sol). (See: **PARABOLIC DISH**)

F - miroir solaire  
S - reflector parabolico

SOLAR DISTILLATE (sol). The product resulting from SOLAR DISTILLATION.

F - distillat solaire  
S - destilado solar

SOLAR DISTILLATION (sol). A process in which SOLAR ENERGY is trapped and used to evaporate impure or salty water. The water vapor CONDENSES as distilled water that can be used for drinking or for other uses.

F - distillation solaire  
S - destilacion solar

SOLAR DRYER (sol). Any device that uses SOLAR RADIATION to remove moisture from a substance. (See also: SOLAR CROP DRYER)

F - sechoir solaire  
S - secador solar

SOLAR DRYING (sol). (See: SOLAR DRYER)

F - sechage par energie solaire  
S - secado por energia solar

SOLAR ELECTRICITY (sol). Electricity that is produced from SOLAR ENERGY sources. (See also: PHOTOVOLTAIC PROCESS; PHOTOVOLTAIC CELL)

F - electricite solaire

**S - electricidad solar**

**SOLAR ENERGY (sol)**. The electromagnetic **RADIATION** generated by the sun. Solar energy may be converted to useful forms of **ENERGY** through the **PHOTOVOLTAIC PROCESS**, **THERMAL CONVERSION**, or through high temperature concentrators and **COLLECTORS**. Solar energy initially is usually captured in the form of heat, and is therefore best used for a variety of heating purposes. This may be done through the use of **SOLAR COLLECTORS** and **SOLAR COOKERS**. **SOLAR RADIATION** may also be converted directly into electrical energy through the use of **PHOTOVOLTAIC CELLS**.

**F - energie solaire**

**S - energia solar**

**SOLAR EYEBALL (sol)**. A type of **SOLAR CONCENTRATING COLLECTOR** that uses a **FRESNEL LENS** to focus **SOLAR RADIATION** on a **PHOTOVOLTAIC CELL**.

**F - bulbe solaire**

**S - foco solar**

**SOLAR FURNACE (sol)**. A **SOLAR CONCENTRATOR** used to produce very high temperatures. Also a solar device used to obtain high temperatures by focusing the sun's rays onto a small receiver.

**F - four solaire**

**S - horno solar**

**SOLAR IRRADIANCE**

SOLAR GAIN (sol). The part of a building's heat supply, or an additional load for cooling, that is provided by SOLAR RADIATION that strikes the building or passes into it through windows.

it through windows.

F - apport solaire

S - ganancia por la energia solar

SOLAR GRAIN DRYER (sol). (See: SOLAR CROP DRYER)

F - sechoir solaire pour cereales

S - secador solar de granos

SOLAR GREENHOUSE (sol). Specific greenhouse designs that take into account basic principles of PASSIVE SOLAR HEATING. Increasingly, solar greenhouses are being attached to dwellings. Excess heat from the greenhouse passes into the dwelling through air CONVECTION and THERMAL CONDUCTANCE from a mutual wall.

F - serre solaire

S - invernadero solar

<FIGURE>

10p117.gif (486x486)

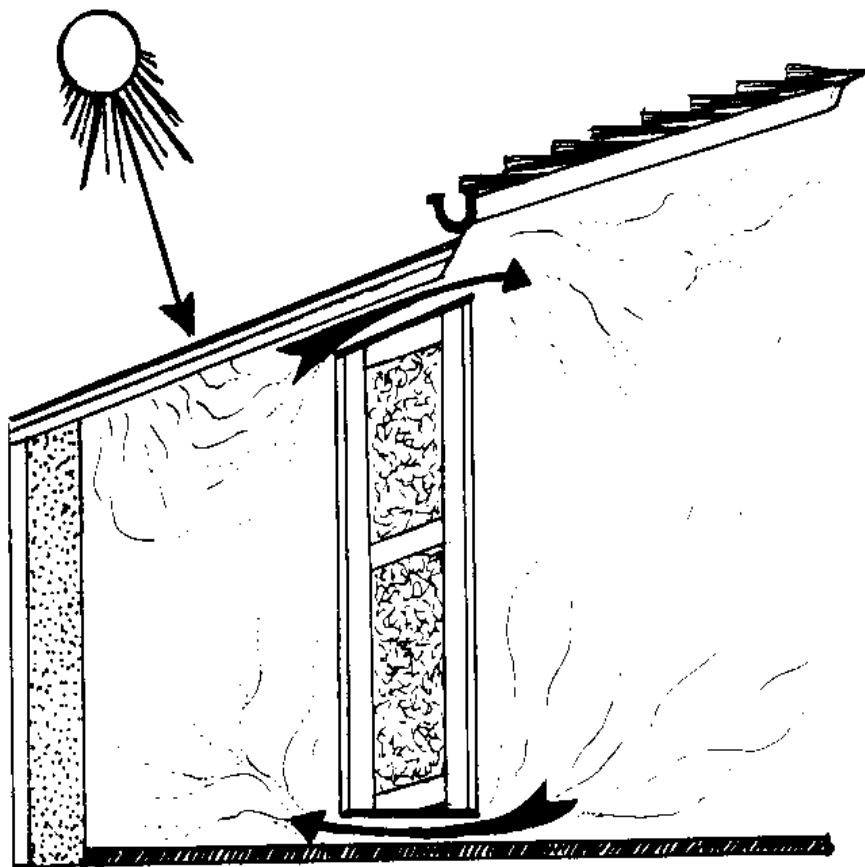

**solar greenhouse**

**SOLAR HEATING (sol)**. The use of a SOLAR SYSTEM to raise the temperature in a room or a device.

F - chauffage solaire

S - calefaccion solar

**SOLAR IRRADIANCE (sol)**. The total amount of SOLAR RADIATION striking a given area.



F - irradiation solaire

S - irradiancia solar

## SOLAR OVEN

SOLAR OVEN (sol). An oven that relies on SOLAR RADIATION as its source of ENERGY.

F - four solaire

S - horno solar

SOLAR POND (sol). A shallow body of salt water with a black or dark bottom. When incident SOLAR RADIATION penetrates the water, some of it is absorbed by the water. However, a large proportion of the radiation reaches the bottom of the pond. There it is absorbed, heating the bottom surface. The bottom surface in turn heats the water next to it, which then can be used as an ENERGY source through the use of HEAT EXCHANGERS. The pond's salinity should increase with its depth.

F - bassin solaire

S - charca solar

SOLAR POSITION (sol). The location of the sun in the sky during the EQUINOXES, based on the latitude of the observer. Solar position is determined by the value of the SOLAR ALTITUDE and the SOLAR AZIMUTH.

F - position du soleil

S - posicion solar

SOLAR POWER (sol). The rate at which SOLAR ENERGY falls on

an area. The area is usually given in terms of the whole Earth.

F - puissance solaire

S - potencia solar

SOLAR PUMP (sol). A pump that operates on SOLAR ENERGY, either by a PHOTOVOLTAIC process or by a thermal system in which a FLUID heated by the sun drives a TURBINE or piston that powers the pump.

F - pompe solaire

S - bomba solar

SOLAR RADIATION (sol). RADIANT ENERGY received from the sun, from both direct exposure and diffuse or reflected sunlight.

F - rayonnement solaire

S - radiacion solar

SOLAR REFLECTOR (sol). A device that reflects SOLAR RADIATION.

F - reflecteur solaire

S - reflector solar

SOLAR REFRIGERATION (sol). A process in which SOLAR RADIATION is used to provide HEAT ENERGY to activate a cooling process.

F - refrigeration solaire

S - refrigeracion solar

SOLAR SALT (sol). SALT obtained by SOLAR DISTILLATION of salt water.

F - sel solaire

S - sal solar

SOLAR SYSTEM

SOLAR SHOWER (sol). A shower bath that uses a SOLAR WATER HEATER to provide hot water.

F - douche solaire

S - ducha solar

SOLAR SITE SELECTOR (sol) (meas). A circular transparency, similar to a map, that is used to determine solar positions and calculate shading.

F - dispositif de selection de l'emplacement solaire

S - selector del emplazamiento solar

SOLAR SPACE HEATER (sol). A SOLAR HEATING system that heats FLUID on a black metal surface that is under GLAZING. The heated fluid may be circulated during the day and stored at night.

F - appareil de chauffage solaire individuel

S - calentador espacial solar

SOLAR SPECTRUM (sol). The total distribution of electromagnetic RADIATION emitted from the sun. It is usually listed minus those wavelengths that are absorbed by the atmosphere. On Earth, this amounts to about 420 trillion KILOWATT HOURS of SOLAR POWER annually.

**F - spectre solaire**

**S - espectro solar**

**SOLAR STEAM COOKER (sol). (See: INSULATED STEAM COOKER)**

**F - autoclave solaire**

**S - horno de vapor solar**

**SOLAR STILL (sol). A device used for SOLAR DISTILLATION.**

**F - alambic solaire**

**S - alambique solar**

**<FIGURE>**

**10p119.gif (486x486)**

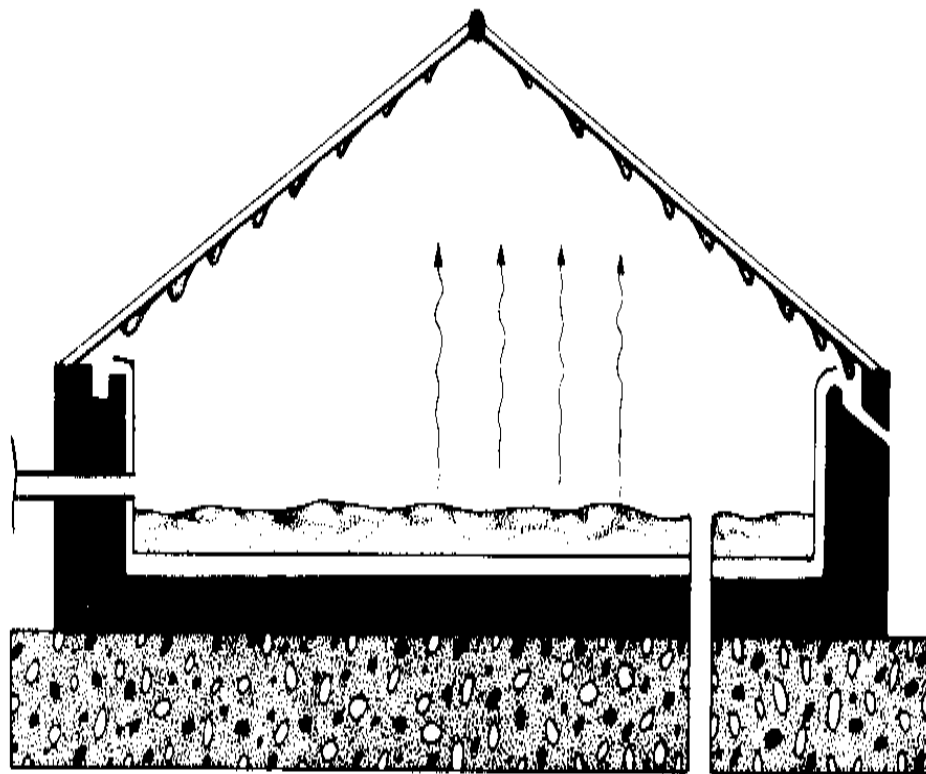

solar still

**SOLAR SYSTEM (sol).** Any heating, cooling, or POWER system that uses ENERGY generated by the sun.

F - système solaire

S - sistema solar

**SOLAR WATER HEATER**

**SOLAR WATER HEATER (sol).** A water heater that depends on

**RADIANT ENERGY** from the sun as its source of power.

**F** - chauffage-eau solaire

**S** - calentador de agua solar

<FIGURE>

10p120.gif (437x437)

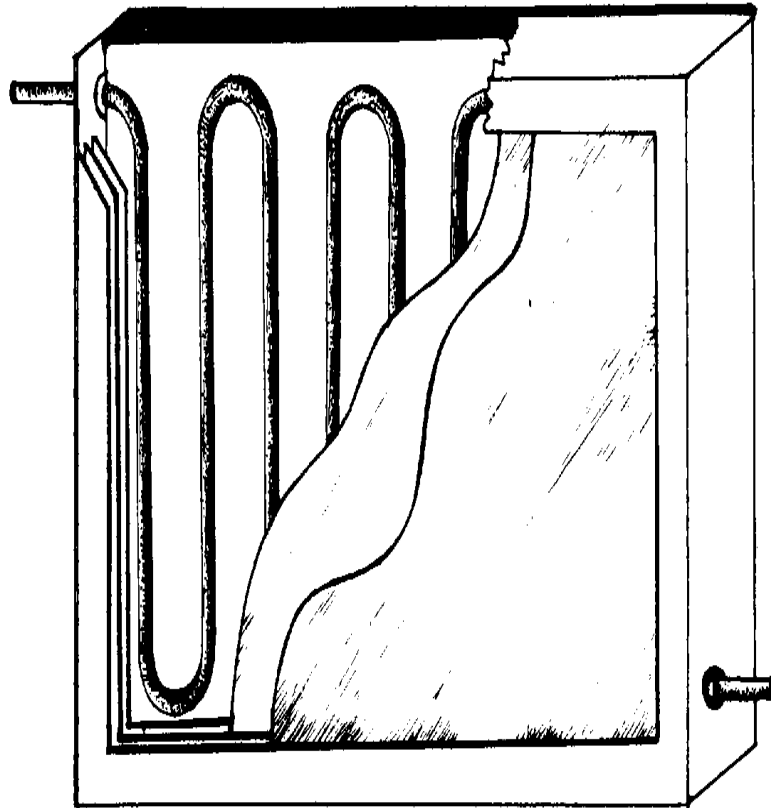

**flat-plate solar water heater (cutaway view)**

**SOLIDITY (wind) (meas)**. The ratio of the **BLADE** surface

area to the SWEPT AREA of a ROTOR.

F - coefficient de solidite

S - solidez

SOLIDS RETENTION TIME (biocon) (meas). (See: DETENTION TIME)

F - temps de retention des solides

S - periodo de retencion de los solidos

SOLID WASTE (biocon). Waste material in a solid state, such as is found in households, commercial activities, municipal plants, etc. Many solid wastes are useful in BIOCONVERSION processes.

F - dechets solides

S - desperdicios solidos

SOLUBILIZATION (biocon). The first of three stages in the ANAEROBIC DIGESTION of ORGANIC MATTER, in which the complex proteins, CARBOHYDRATES, CELLULOSE, fats, and oils are dissolved by ENZYMES. This HYDROLYSIS transforms the complex compounds into simple amino ACIDS, simple sugars, fatty acids, and glycerol. The simple compounds are rendered into a form that is dissolved easily and can pass through the cell walls of the acid-forming BACTERIA to be FERMENTED.

F - solubilisation

S - solubilizacion

SPARK ARRESTER (impl). Screening, steel wool, or other

porous substance(s) that is placed in the distribution pipes from a BIOGAS DIGESTER or PRODUCER GAS GENERATOR. They prevent a spark or flame from passing back up the pipe and causing an explosion.

F - pare-etincelle

S - parachispas

SQUARE WAVE

SPARS (wind). The frames extending from the WIND SHAFT of a WIND MACHINE to support the SAILS.

F - bras [1]

S - [1] largueros; [2] varillaje

SPECIFIC GRAVITY (gen). The ratio of the weight of a given volume of a substance to an equal volume of air or water at a given temperature and pressure. The specific gravity, which may be measured by a HYDROMETER, indicates the CONCENTRATION of a substance in a solution.

(See also: PROOF).

F - densite

S - gravedad especifica

SPECIFIC SPEED (hydr) (meas). The speed at which a given type of RUNNER in a TURBINE would operate if it were reduced proportionately in size to produce one HORSE-POWER under a one-foot (30.48 centimeter) HEAD. This speed or velocity is expressed in revolutions per minute. It is used to determine the proper type of turbine to install at a HYDROELECTRIC POWER PLANT under



given conditions.

F - vitesse spécifique

S - velocidad específica

SPENT MASH (alc). The semisolid MASH, without the ALCOHOL, following FERMENTATION and DISTILLATION.

F - residu de distillation

S - vinazas

SPENT SLURRY (biocon). (See: EFFLUENT)

F - boue epuisee

S - fango usado

SPILLWAY (hydr). A passage over or around a CHANNEL or DAM through which excess water may escape.

F - deversoir

S - vertedero

SPILLWAY APRON (hydr). (See: SPILLWAY)

F - chenal du deversoir

S - paramento del vertedero

SPILLWAY CHANNEL (hydr). (See: SPILLWAY)

F - canal du deversoir

S - canal vertedor

SPRING SAIL (wind) (arc). A WINDMILL BLADE fitted with SHUTTERS that are controlled by springs.

F - aile a ressorts

S - aspa de resorte

SQUARE WAVE (wind). A type of ALTERNATING CURRENT (ac), produced by low-cost, solid-state INVERTERS, which may be used for most, but not all, ac appliances.

F - onde rectangulaire

S - onda cuadrada

S-ROTOR

S-ROTOR (wind). see: SAVONIUS ROTOR)

F - rotor de Savonius

S - rotor S

STACK (constr). A CHIMNEY or other passageway designed to vent smoke from a stove, oven, furnace, etc.

F - corps de cheminee

S - canon

STACK EFFECT (heat). The impulse of a heated gas to rise through a vertical passage, such as a CHIMNEY.

F - effet de cheminee

S - efecto de humero

STACK GAS (heat). Gases resulting from combustion, which pass up a CHIMNEY.

F - gaz de cheminee

S - gases de la chimenea

STAGNATION (sol). The condition that may be reached in a

SOLAR COLLECTOR when the sun is shining on the device and no FLUID is flowing through it. The resulting high temperatures may damage the COLLECTOR.

F - stagnation

S - estancacion

STARCH (alc) (chem). A white, tasteless, solid CARBOHYDRATE ( $[C.sub.6][H.sub.10][O.sub.5]$ ). Starch is a major component of many agricultural crops, such as potatoes, grains, etc., that are used to produce GLUCOSE.

F - amidon

S - almidon

START-UP (biocon). The process of adding INOCULUM to a BIOGAS DIGESTER so that the digester will begin to function.

F - mise en marche

S - puesta en marcha

START-UP SPEED (wind) (meas). The WIND VELOCITY at which a WIND MACHINE begins to rotate.

F - vitesse de mise en marche

S - velocidad de puesta en marcha

STATIC HEAD (hydr). The vertical height from the surface of a body of water to the water outlet of the DISCHARGE PIPE of a TURBINE.

F - hauteur d'elevation

S - altura de elevacion

STATIONARY PEDAL POWER UNIT (gen). (See: PEDAL POWER)

F - appareil stationnaire d'entraînement par pedales

S - unidad de rendimiento del pedal inmovil

STEAM ENGINE (geo) (auto). An engine in which the mechanical force of steam is used as a motive POWER to drive machinery, etc.

F - moteur A vapeur

S - motor de vapor de agua

STOCK

STEAM GAS (geo). Superheated steam that is used as an ENERGY source. Steam gas is usually obtained from GEOTHERMAL sources.

F - vapeur surchauffee

S - gas de agua

STEAM TURBINE (gen) (geo). A TURBINE that is driven by expanding steam or gas rather than by the velocity or weight of water.

F - turbine a vapeur

S - turbina de vapor

STILL (gen) (alc). [1] An apparatus for DISTILLATION that consists primarily of a closed vessel in which the solution to be distilled is heated. It also includes mechanisms to condense the vapor that is produced. [2] An ALCOHOL distillation unit that consists of a container to heat MASH, a DISTILLATION COLUMN to separate the

water from the alcohol, and a CONDENSER to convert ALCOHOL VAPORS into liquid.

F - alambic

S - alambique

STILLAGE (alc). A mixture of non-FERMENTABLE SOLID WASTES and water that remains in a STILL after the ALCOHOL is removed by DISTILLATION. Stillage may be used as an animal feed.

F - residus de distillation non-fermentable

S - residuos

STILL CAP (alc). (See: BUBBLE CAP)

F - calotte de barbotage

S - casquete de alambique

STILL COLUMN(alc) (impl). A component of an ALCOHOL STILL that is used to separate ALCOHOL from the MASH and water. The still column consists of SIEVE PLATES, BUBBLE CAPS, and a DOWNCOMER.

F - colonne de distillation

S - columna de alambique

STIRLING ENGINE (auto). An external combustion engine in which air is alternately heated and cooled to drive a piston up and down. Hydrogen is used instead of air in some newer models. The Stirling engine may in some cases be nonpolluting and more efficient than the internal combustion engine.

F - moteur de Stirling

S - motor Stirling

STIRRING (biocon). Agitating or mixing the SLURRY in a BIOGAS DIGESTER. Stirring helps prevent SCUM buildup and promotes METHANE production.

F - vaguage

S - agitacion

STOCK (wind) (arc). [1] A bar that is used to support a WINDMILL SAIL. [2] A tapered SPAR that passes through the POLL END of a windmill, supporting a pair of sails. (Syn: sailstock)

F - fut

S - barra

STORAGE

STORAGE (gen). (See: ENERGY STORAGE)

F - stockage

S - almacenado

STORAGE CAPACITY (gen). The total amount of ENERGY that a system is capable of holding for use at a later time.

(See also: ENERGY STORAGE)

F - capacite de stockage

S - capacidad de almacenado

STRATIFICATION (sol). In SOLAR HEATING, temperature variations

that occur in a substance or an area. The highest temperatures are found higher up and cooler temperatures are found lower down.

F - stratification

S - estratificacion

STRIKING GEAR (wind) (arc). The mechanism used with PATENT SAILS to apply pressure to SHUTTERS. It consists of a striking rod that passes through the length of the WIND SHAFT. The rod is operated by an endless chain upon which weights are hung. The number of weights is determined by the force of the wind.

F - embrayage

S - engranaje de contacto

STRIPPING COLUMN (alc). The section of the STILL COLUMN in which the ALCOHOL CONCENTRATION in the DISTILLATE is increased and the starting solution is decreased. (Syn: beer column)

F - colonne a desessencier

S - columna de destilacion

SUBMERGED WEIR (hydr). An underwater obstruction that diverts water into a CHANNEL.

F - barrage immerge

S - vertedero sumergido

SUBSTRATE (bio) (biocon). [1] The particular FEEDSTOCK component that is used by bacteria to promote their

growth and metabolism. The component often is one particular compound. [2] ORGANIC MATTER that is used to generate METHANE in a BIOGAS DIGESTER. (See: SLURRY)

F - substrat

S - subestrato

SUCROSE (alc) (chem). A FERMENTABLE SUGAR ([C.sub.12][H.sub.22][O.sub.11]) that is commonly found in nature.

F - sucrose

S - sucrosa

SUCTION ANEMOMETER (wind) (meas). A device that measures WIND VELOCITY according to the degree of exhaust caused when the wind is blown through or across a tube.

F - anemometre a aspiration

S - anemometro de succion

SUN BASKET

SULFURIC ACID (alc) (chem). A strong ACID that is used to increase the acidity, and thus lower the pH (POTENTIAL HYDROGEN), in an ALCOHOL STILL.

F - acide sulfurique

S - acido sulfurico

SUN ANGLE CALCULATOR (sol) (meas). A set of transparent curves and overlays that tells where the sun is in the sky and that gives other SOLAR ALTITUDES. (See: SOLAR SITE SELECTOR)

F - calculateur d'angle solaire



S - calculador del angulo solar

SUN BASKET (sol). A SOLAR COOKER in the shape of a deep PARABOLA. This cooker may be a woven basket lined with a reflective material.

F - panier solaire

S - cesto solar

<FIGURE>

10p125.gif (486x486)

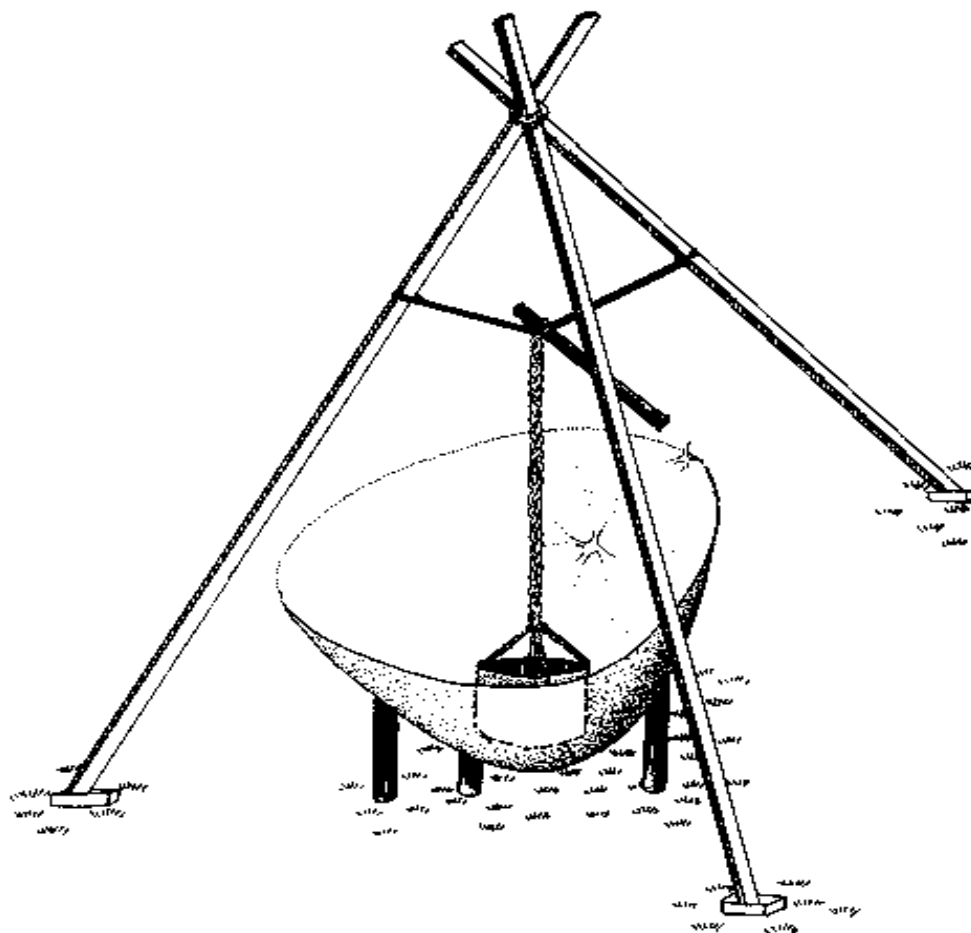

sun basket

## SUN EFFECT

SUN EFFECT (sol) (meas). The amount of heat from the sun that tends to heat an enclosed space.

F - effet solaire

S - efecto solar

SUN-TEMPERING (sol). A heating system that involves a significant daytime SOLAR GAIN and an effective distribution system, but which generally lacks a STORAGE function.

F - dispositif de repartition de l'energie solaire  
S - atemperacion solar

SUN-TRACKING DEVICE (sol) (impl). A device attached to a SOLAR COLLECTOR that automatically turns the face of the collector towards the sun.

F - dispositif de poursuite du soleil  
S - dispositivo de seguimiento solar

SUPERNATANT (biocon). The liquid portion of the SLURRY that floats above the SLUDGE in a BIOGAS DIGESTER.

F - fraction surnageante  
S - sobrenatantil

SWASH PLATE (wind). A disk set obliquely on a rotating AXIS. It acts as a CAM to convert rotational movement into up-and-down movement.

F - plateau oscillant  
S - plato oscilante

SWEEP (wind) (arc). (See: SAIL)

F - balayage  
S - barrer

SWEPT AREA (wind) (meas). The area in a plane that is perpendicular to the wind through which a WINDMILL's

**BLADES** pass. The area is defined by the circumference of the circle formed by the rotating blades, and is one factor in determining the amount of WIND POWER available from the wind.

F - zone balayee

S - area barrida

**SWING POT** (wind) (arc). A pivoting bearing that is sometimes used to support the WIND SHAFT of a WINDMILL.

F - palier pivotant

S - cojinete pivotante

**SWORD POINT** (wind) (arc). The amount that a SAILCLOTH is rolled up or REEFED to reduce its exposure to the wind.

This term refers to the pointed end on a reefed SAIL.

(See also: REEFING)

F - prise de ris

S - punto de recogida

**SYNCHRONOUS INVERTER** (elec) (wind). An electronic device that can be used with a WIND GENERATOR, to convert DIRECT CURRENT (dc) to ALTERNATING CURRENT (ac), but which must be powered by another ac source.

F - inverseur synchrone

S - convertidor sincronico

T

**TABOR SURFACE** (sol). A black nickel SELECTIVE SURFACE coating that typically absorbs 90 percent of the incoming

SOLAR RADIATION but which radiates only about 10 percent as much radiation as would be emitted by a coat of FLAT BLACK PAINT.

F - surface de tabor

S - superficie tabor

TAIL (wind). A flat piece of sheet metal that is attached to the extension of the WINDSHAFT of a WINDMILL. The plane of the tail is normally perpendicular to the wind so the tail may intercept changes in wind direction and turn the ROTOR around to face the wind. (Syn: vane)

F - empennage

S - punta del aspa

TAIL POLE (wind) (arc). The projecting SPAR used to turn a WINDMILL that is not equipped with automatic WINDING gear.

F - barre de queue

S - saliente del aspa

TAILRACE (hydr). The discharging CHANNEL of a HYDROPOWER system. It is that section of a RACE that is downstream of a hydropower device.

F - bief d'aval

S - canal de descarga

TAILWATER (hydr). Water passing back into a discharging CHANNEL after being applied to a HYDROPOWER device.

F - eau d'aval

S - agua de descarga

TAILWATER LEVEL (hydr) (meas). The depth of the TAILWATER as measured at a reference point on its surface.

F - niveau de l'eau d'aval

S - nivel de la descarga

TAILWINDED (wind). The condition when a WINDMILL is caught by a sudden change in wind direction, which exerts pressure on the wrong side of the SAIL assembly.

F - a vent arriere

S - con viento de cola

THERMAL (gen). Having to do with the use or production of heat. Also any reaction caused by heat.

F - thermique

S - termico

THERMAL ADMITTANCE (heat) (meas). The total amount of BTUs that a square foot (929 square centimeters) of a surface will admit in one hour.

F - admittance thermique

S - admision termica

THERMAL COLLECTOR

THERMAL COLLECTOR (sol). (See: COLLECTOR)

F - capteur thermique

S - colector termico

**THERMAL CONDUCTANCE** (heat) (meas). The amount of heat that will pass through a given amount of material in a given amount of time, and with a unit temperature difference maintained between the surfaces of the material under uniform and steady conditions.

F - conductance thermique

S - termoconductancia

**THERMAL CONDUCTION** (heat). Heat transfer by direct contact from one substance to another of a lower temperature.

F - transmission de chaleur

S - termotransmision

**THERMAL CONDUCTIVITY** (heat) (meas). The ability of a material to conduct heat. It is commonly measured in units of **THERMAL CONDUCTANCE**.

F - conductivite thermique

S - termoconductibilidad

**THERMAL EFFICIENCY** (heat) (meas). A percentage that indicates the available heat that is converted to useful purposes. Thermal efficiency is used to evaluate wood-conserving stoves and numerous other devices.

F - rendement thermique

S - termorendimiento

**THERMAL ENERGY** (heat). **ENERGY** from heat.

F - energie thermique

**S - termoenergia**

**THERMAL LAG (meas)**. The time required for the temperature of an area to reach that of an adjacent area, either by heating or cooling. For example, the time required for indoor air temperature to reach the cooler outside air temperature when there is no additional heat added to the house; or the time required for the inside surface of a **TROMBE WALL** to reach the temperature of the outside surface, which is exposed to the sun.

**F - retard thermique**

**S - retardo termico**

**THERMAL MASS (gen)**. Material or mass of sufficient size and density to store heat. Thermal mass walls are often used in buildings that use **PASSIVE SOLAR HEATING** techniques and **NIGHT SKY RADIATION**. (See also: **TROMBE WALL**)

**F - masse thermique**

**S - masa termica**

**THERMAL POWER (gen)**. Any type of **ENERGY** generated or developed through the use of **HEAT ENERGY**.

**F - puissance thermique**

**S - termopotencia**

**TIDAL POWER**

**THERMAL WINDS (wind)**. Winds that are caused by the heating of the ground by **SOLAR RADIATION**.



F - vents thermiques

S - vientos termicos

**THERMOCOUPLE** (meas) (impl). A device used to measure temperature.

It is based on the principle that an electrical current is produced when two dissimilar wires are joined together and the junction is heated. Thermocouples are often used to measure temperatures at different levels in BIOGAS DIGESTERS, WOOD STOVES, KILNS, or other devices where use of a conventional thermometer would be difficult.

F - thermocouple

S - termopar

**THERMOPHILLIC BACTERIA** (biocon). BACTERIA that grow best in a temperature range between 122-131 [degrees] F (50-55 [degrees] C).

F - bacterias thermophiles

S - bacteria termofilica

**THERMOSYPHON** (sol). A CLOSED LOOP SYSTEM in which water automatically circulates between a SOLAR COLLECTOR and a water storage tank above it. A solar collector based on the THERMOSYPHON PRINCIPLE uses the natural difference in density between the warmer and cooler portions of a liquid.

F - thermosiphon

S - termosifon

**THERMOSYPHON CIRCULATION** (sol). (See: THERMOSYPHON

**PRINCIPLE)**

F - circulation de thermosiphon

S - circulacion por termosifon

**THERMOSYPHON EFFECT (sol). (See: THERMOSYPHON)**

F - effet thermosiphon

S - efecto de termosifon

**THERMOSYPHON PRINCIPLE (gen) (sol).** The tendency of heated liquids to rise. In a SOLAR WATER HEATER, this principle is used to lift water from a SOLAR COLLECTOR to a storage tank above it without the use of a pump.

F - principe du thermosiphon

S - principio de termosifon

**THIN STILLAGE (biocon).** The water soluble fraction of FERMENTED MASH plus the mash water.

F - residu dilue de distillation

S - residuos liquidos

**TIDAL ENERGY (ocean).** The KINETIC ENERGY existing in the tides by virtue of the moving mass of water.

F - energie des marees

S - energia mareal

**TIDAL POWER (ocean).** Mechanical POWER generated by the rise and fall of ocean tides, which may be converted into electricity.

F - puissance maremotrice

S - fuerza mareal

**TILT ANGLE**

**TILT ANGLE (sol)**. The angle at which a SOLAR COLLECTOR is tilted upward from the horizon for maximum solar exposure and maximum heat collection.

F - angle d'inclination

S - angulo de inclinacion

**TIME LAG (sol) (meas)**. (See: THERMAL LAG)

F - retard

S - tiempo de retardo

**TIP SPEED (wind) (meas)**. The speed of the outer end or tip of a BLADE of a WINDMILL ROTOR. This speed may be faster than the rotation rate of the WIND SHAFT, and may be faster or slower than the actual WIND SPEED.

F - vitesse peripherique

S - velocidad de giro de las aspas

**TIP SPEED RATIO (wind) (meas)**. The quotient of the TIP SPEED and the actual WIND SPEED.

F - quotient de vitesse peripherique

S - relacion de las velocidades de giro

**TORQUE (gen)**. Any force that acts to produce rotation. The measured ability of a rotating part, such as a gear or shaft.

F - couple

S - par

**TOTAL ENERGY HOUSE (gen)**. A house that is heated, cooled, and receives its cooking and lighting **POWER**, completely from **ALTERNATIVE ENERGY SOURCES**.

F - maison a energie integrale

S - casa energetica total

**TOTAL SOLIDS (biocon) (meas)**. The proportion in weight of solids in a sample of **SLURRY** or other **EFFLUENT** (e.g. **MASH**).

F - fraction solide

S - solidos totales

**TOWER (wind)**. The main supporting structure of a **WIND MACHINE**. Towers are usually made of wood or steel, and are suitably braced to withstand the stress to which they are subjected.

F - pylone

S - torre

**TOWER MILL (wind) (arc)**. A **WINDMILL** made of masonry or brickwork, and usually fitted with a **REVOLVING CAP**.

F - eolienne sur pylone

S - molino de torre

**TOXIN (bio) (biocon)**. A material that inhibits the growth and metabolism of or kills micro-organisms, often by interfering with the normal chemical or biochemical processes. A toxin may cause a **BIOGAS DIGESTER** to stop

producing gas.

F - toxine

S - toxina

TREADLE POWER

TRACKED PHOTOVOLTAIC ARRAY (sol). A PHOTOVOLTAIC ARRAY that follows the path of the sun across the sky.

F - dispositif photovoltaïque a poursuite solaire

S - conjunto fotovoltaico de seguimiento

TRACKING (sol). Referring to adjustments that cause a SOLAR COOKER or a SOLAR COLLECTOR to "track" or follow the sun's path across the sky. Tracking is done either automatically or manually.

F - poursuite du soleil

S - seguimiento

TRACKING CONTROL (sol) (impl). (See: AUTOMATIC TRACKING)

F - controle de la poursuite

S - control del seguimiento

TRAILING EDGE (wind). The edge of a WINDMILL BLADE that lies on the side opposite the direction of rotation.

F - arete arriere

S - borde posterior

TRANSDUCER (gen). A device that converts ENERGY from one form into another (e.g., PHOTOVOLTAIC CELL).

F - transducteur

S - transductor

TRANSFER MEDIUM (sol). A substance that carries heat From a SOLAR COLLECTOR to a storage area or from a storage area to be warmed in a collector. Transfer mediums are usually either air, water, or antifreeze solutions.

F - agent de transfert

S - medio de transferencia

TRANSMITTANCE (sol) (meas). The ratio of the RADIANT ENERGY transmitted through a substance to the total radiant energy falling on its surface. Transmittance is always affected by the thickness and composition of the substance, as well as by the INCIDENT ANGLE.

F - facteur de transmission

S - transmision

TRASH RACK (hydr). A protective "screen" made of vertical bars that catches leaves, grass, and debris, keeping clear the intake of a HYDROPOWER device.

F - grille pare-bois

S - parrilla colector

TREADLE MECHANISM (gen). (See: TREADLE POWER)

F - mecanisme a pedale

S - mecanismo de pedal

TREADLE POWER (gen). A use of foot POWER in which an up-and-down motion of the foot on a pedal produces a

rotating motion on a machine.

F - puissance de pedale

S - energia producida por pedal

#### TREATED EFFLUENT

TREATED EFFLUENT (biocon). Discharge from a BIOGAS DIGESTER that has been rendered harmless by reducing the number of PATHOGENS in it. The treatment often consists of either drying or COMPOSTING the EFFLUENT.

F - effluent traite

S - efluente tratado

TROMBE WALL (constr) (heat) (sol). A masonry wall located directly inside windows that face the equator. The wall functions simultaneously as a structural element of the building and as a SOLAR COLLECTOR and HEAT STORAGE unit. (See also: THERMAL MASS)

F - mur de trombe

S - pared de trombe

<FIGURE>

10p132.gif (587x587)

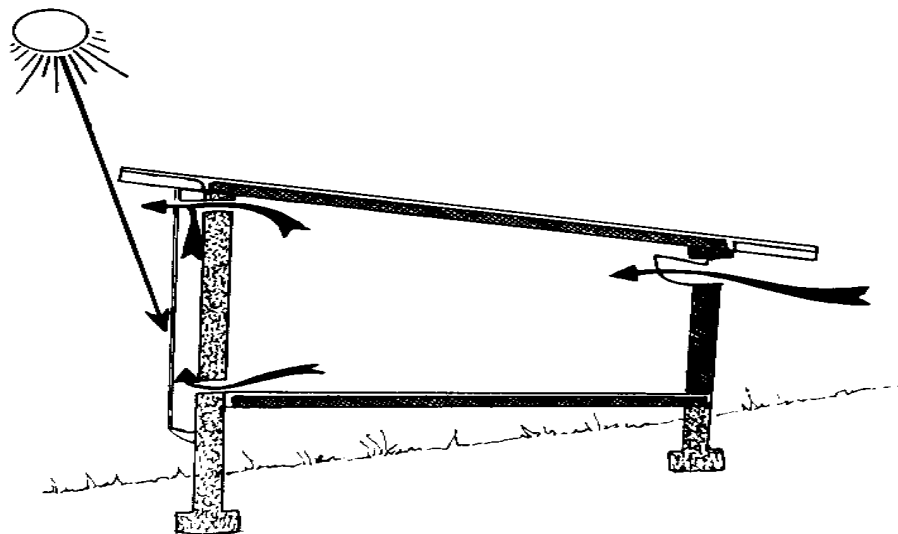

trombe wall - summer

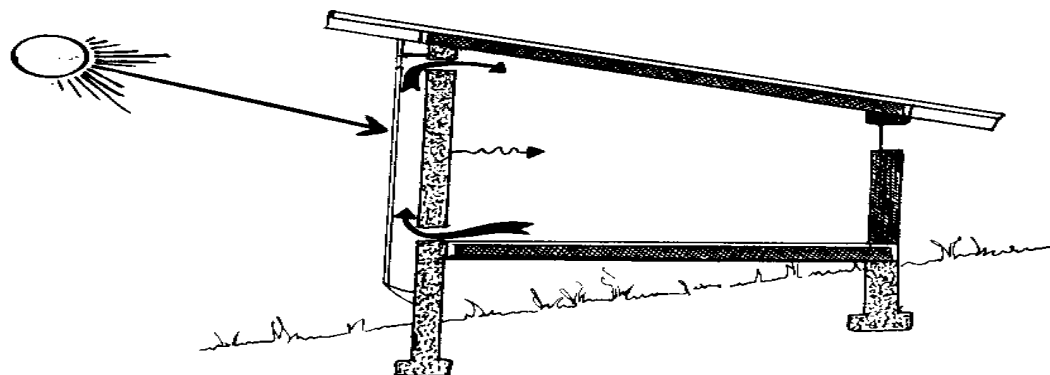

trombe wall - winter

**TRUNION** (impl) (wind). A pin or pivot that is mounted on **BEARINGS** to rotate or turn something. It usually is used



as a WINDMILL component. (See also: TURNTABLE)

F - tourillon

S - munon

TURBULENCE

TUBE-IN-PLATE ABSORBER (sol). A metal ABSORBER PLATE with passages through which HEAT TRANSFER FLUID flows.

F - absorbeur a tubes internes

S - absorbedor con placa de tubos

TUBE-TYPE COLLECTOR (sol). A COLLECTOR in which the TRANSFER MEDIUM FLOWS through metal tubes fastened to an ABSORBER PLATE.

F - capteur a tubes solidaires

S - colector con tubos

TURBINE (gen). A device that converts the ENERGY in a stream of FLUID into mechanical energy. By passing the stream through a system of fixed and/or moving BLADES, a drive shaft is rotated.

F - turbine

S - turbina

TURBINE WHEEL (hydr). The part of a WATER TURBINE that is attached to a drive shaft, and which holds the BLADES or CUPS that cause the wheel to rotate when struck by a stream of steam or water. The wheel rotates the shaft to produce mechanical or electrical POWER. (Syn: RUNNER)

F - roue de turbine

S - rueda turbina

TURBULENCE (wind). Irregular motion and GUSTS in the WIND SPEED. (See also: MECHANICAL TURBULENCE)

F - turbulence

S - turbulencia

TURGO IMPULSE TURBINE

TURGO IMPULSE TURBINE (hydr). An improved version of the PELTON WHEEL in which the JET is set at an angle to the face of the RUNNER. Water strikes the front of the BUCKETS and discharges at the opposite side.

F - turbine a impulsion turgo

S - turbina de impulsion turgo

<FIGURE>

10p134.gif (437x540)

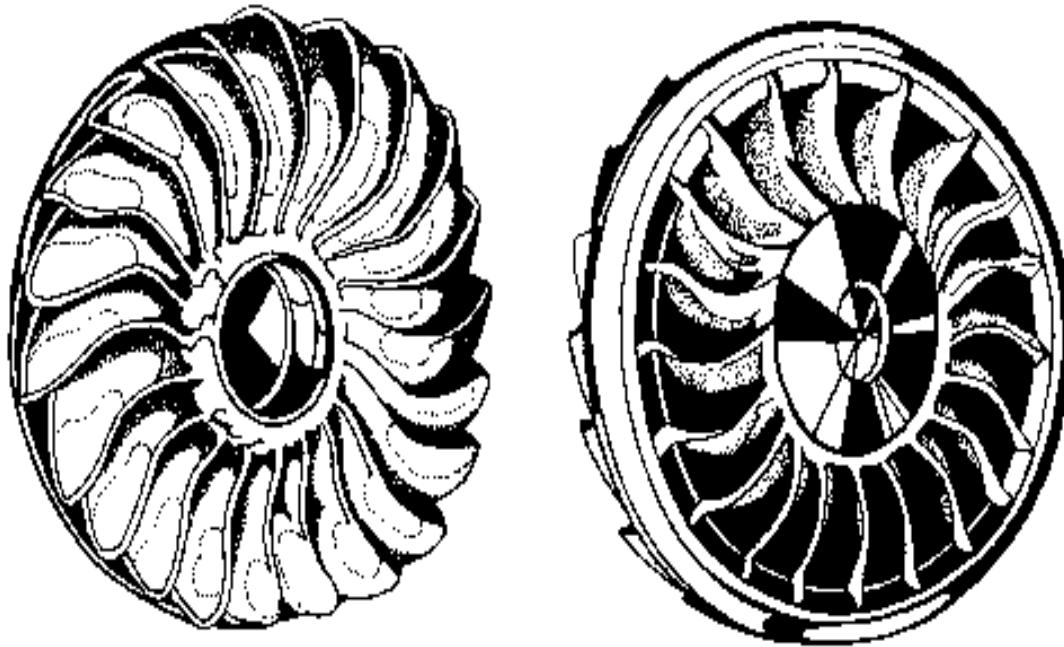

turgo impulse turbine (two side views)

TURNAROUND EFFICIENCY (gen) (meas). The resulting EFFICIENCY when ENERGY is converted from one form to another and then changed back again into its original form or state.

F - rendement aller-retour

S - eficiencia resultante

TURNTABLE (wind). A rotating platform on which the ROTOR, ROTOR SHAFT, and TAIL of a WINDMILL may move to orient

the BLADES or SAILS into the wind.

F - plaque tournante

S - plataforma giratoria

U

ULTRA-VIOLET RADIATION (sol). Electromagnetic RADIATION, usually from the sun, that consists of wavelengths that are shorter than the violet end of the visible spectrum.

F - rayons ultra-violet

S - radiacion ultravioleta

UNDERSHOT WATER WHEEL (hydr). A WATER WHEEL driven by water that strikes the underside of the wheel.

F - roue en dessous

S - rueda hidraulica de admision inferior

<FIGURE>

10p135.gif (353x486)

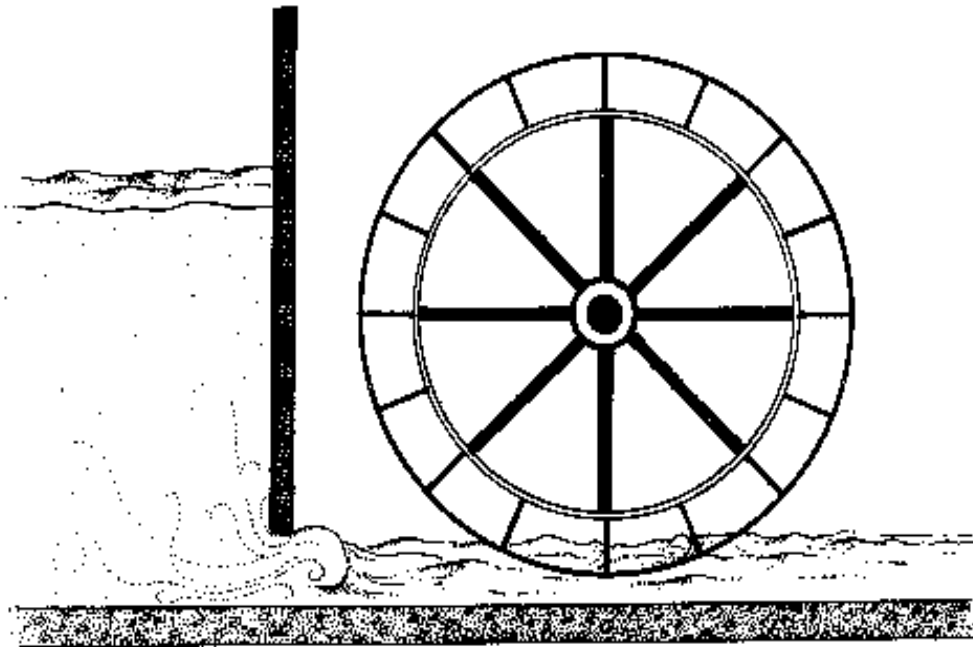

undershot water wheel

UNDIGESTED SOLIDS (biocon). Heterogenous BIOMASS, contained in either the SLURRY or EFFLUENT, which has not DECOMPOSED in a BIOGAS DIGESTER.

F - solides non-digeres

S - solidos sin digerir

UNGLAZED COLLECTOR (sol). A COLLECTOR without a cover.

F - capteur non-vitre

S - colector no vidriado

UPDRAFT (prod) (gen). [1] Referring to a PRODUCER GAS GENERATOR in which the air-gas mixture flows upward to

the engine. [2] Any cooking or heating device (e.g., a KILN) in which air for CONVECTION or combustion flows upward through the device.

F - tirage vers le haut

S - corriente aerea ascendente

UPLONG

UPLONG (wind) (arc). A longitudinal bar in the BACKSTAY of a SAIL.

F - barre longitudinale

S - varilla longitudinal

UPWIND (wind). [1] On the same side as the direction from which the wind is blowing (i.e. , in the path of the oncoming wind). [2] A type of WINDMILL in which the ROTOR remains between the oncoming wind and the TOWER.

F - vent de proue

S - viento contrario

<FIGURE>

10p136.gif (353x353)

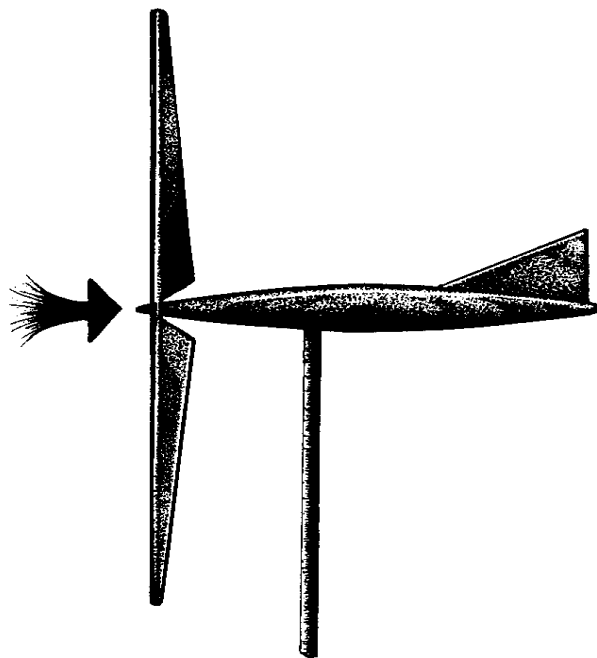

rotor placed upwind

USED OIL (heat). Automotive or other lubrication oil, which is "used up" or no longer useful for its original purpose. If mixed with water at a ratio of five to one, and then dripped onto a heated metal sheet, used oil will burst into flames. This makes it useful as a fuel.

(Syn: waste oil)

F - huile epuisee

S - aceite usado

**U-VALUE**

**USEFUL ENERGY GAIN (sol)**. The ENERGY absorbed by a SOLAR

COLLECTOR that is not lost to the surrounding atmosphere and which may be used for space or water heating.

F - gain energetique utile

S - ganancia de energia util

USEFUL SOLAR HEAT (sol). Heat delivered by a SOLAR COLLECTOR that can be applied for cooking, heating, or other purposes.

F - chaleur solaire utile

S - calor solar util

USEFUL WATER CAPACITY (hydr) (meas). The volume of water that a reservoir can hold and usefully exploit, and which lies between the lowest and highest levels normally contained in the reservoir.

F - capacite utile en eau

S - capacidad aprovechable de agua

U-VALUE (heat) (meas). The amount of heat that FLOWS in or out of a substance under constant conditions, in one hour, when there is a one degree difference in temperature between the air inside and outside the building.

U-value is the inverse of RESISTANCE-VALUE.

F - valeur U

S - valor U

V

VACUUM DISTILLATION (gen). DISTILLATION under reduced pressure. This lowers the boiling point of the distilled



material so that it will not crack or decompose.

F - distillation sous vide

S - vacuodestilacion

VALVE ASSEMBLY (gen). The assembled parts of a valve.

F - garniture de soupape

S - montaje de valvula

VANE [1] (hydr) (See: GUIDE VANE); [2] (wind) (See: TAIL)

F - aube

S - aspa

VAPOR LOCK (auto). A blockage in a fuel line that is caused when the fuel vaporizes.

F - tampon de vapeur

S - obstruccion por vapor

VAPOR PRESSURE (chem) (meas). The pressure of a vapor while in contact with its solid or liquid form. This is also referred to as saturated vapor pressure. The pressure rises with any increase in temperature.

F - tension de vapeur

S - presion del vapor

VERTICAL-AXIS WATER WHEEL (hydr). A WATER WHEEL that drives a vertical axis instead of the more common horizontal axis

F - roue hydraulique a axe vertical

S - rueda hidraulica de eje vertical

**VERTICAL-AXIS WIND MACHINE (wind)**. A **WIND MACHINE** in which the **WINDSHAFT** is on a vertical axis. This type of device may accept wind from any direction. (See also: **DARRIEUS ROTOR**; **SAVONIUS ROTOR**)

F - eolienne axe vertical

S - generador eolico de eje vertical

**VIOLET CELL (sol)**. A type of **SILICON SOLAR CELL** that is more effective than conventional **PHOTOVOLTAIC CELLS** in converting sunlight to electricity from the violet and **ULTRA-VIOLET** range of the light spectrum.

F - cellule violette

S - celula violeta

**VISCOSITY (chem)**. The resistance to **FLOW** or change of shape due to molecular cohesion and internal friction in **FLUIDS**. Viscosity varies inversely with temperature.

F - viscosite

S - viscosidad

#### **VOLATILE ACIDS**

**VOLATILE (gen) (refrig)**. [1] Easily burned, unstable, or explosive. [2] Liquids that are readily evaporated at a relatively low temperature.

F - volatile

S - volatil

**VOLATILE ACIDS (biocon). Fatty ACIDS of a low molecular weight. These acids are very SOLUBLE.**

**F - acides volatiles**

**S - acidos volatiles**

**W - X**

**WASTE CONVERSION TO ENERGY (biocon). (See: BIOCONVERSION)**

**F - conversion des dechets en energie**

**S - conversion energetica de desperdicios**

**WASTE HEAT (heat). Heat that is left after useful ENERGY generation.**

**F - chaleur perdue [1]**

**S - calor perdido**

**WATER-AIR HEAT EXCHANGER (heat). A HEAT EXCHANGER in which FLUIDS may either be heated or cooled by water or air.**

**F - échangeur de chaleur eau/air**

**S - termopermutador de agua-aire**

**WATER BED (sol). Shallow plastic bags that are filled with water and placed on roofs of homes or buildings. In cooler climates, the bags collect SOLAR ENERGY during the day, and radiate heat to the building during the day and radiate this heat to the sky at night, thus cooling the building. In warmer climates, panels are placed over the bags during the day and removed at night so the bags can draw off heat from the building and keep it cool.**

F - lit d'eau  
S - lecho de agua

WATER CHUTE (hydr). A steep CHANNEL by which water descends in force. Water chutes are used to create or increase the HEAD for a HYDROPOWER system.

F - chute d'eau  
S - caida de agua

WATER HYACINTHS (biocon). A type of water plant with a high carbon content, which makes it very useful as FEEDSTOCK for BIOGAS production.

F - eichornia  
S - jacinto de agua

WATER JACKET (auto) (prod). A casing or compartment containing water that is placed around all or part of a device to keep it cool, as around the cylinders or cylinder head of an internal combustion engine.

F - chemise a eau  
S - envuelta de agua

WATER MILL (hydr). A MILL driven by a WATER WHEEL.

F - moulin hydraulique  
S - molino hidraulico

WATERPOWER (hydr). The ENERGY in water as derived from its weight or momentum, and which may be used to drive machinery, generate electricity, or for other purposes.

(Syn: HYDROPOWER)

F - energie hydraulique

S - energia hidraulica

W.E.C.S. OR WECS

WATER PUMPING WINDMILLS (wind). (See: WIND-POWERED PUMP)

F - eoliennes de pompage

S - molinos de viento con bombas hidraulicas

WATER SEAL (biocon). The part of a GASHOLDER designed to prevent the METHANE from mixing with air and becoming potentially explosive. It generally is created by submerging a portion of the holder in water.

F - joint hydraulique

S - junta hidraulica

WATERSHED (hydr). [1] the divide or crestline dividing two drainage areas. [2] The area draining into a river, stream etc.

F - [1] ligne de partage des eaux; [2] bassin hydrographique

S - divisoria de aguas

WATER TURBINE (hydr). A device that converts the ENERGY of falling water into rotating mechanical energy. Water turbines are usually smaller than WATER WHEELS and operate at the higher speeds required to generate electricity.

F - turbine hydraulique

S - turbina hidraulica

WATER WHEEL (hydr). A wheel with BUCKETS or BLADES that allow it to be turned by the weight or velocity of falling water or by water moving underneath it.

F - roue hydraulique

S - rueda hidraulica

WATT (elec) (meas). The unit rate at which work is done in an electrical circuit. One watt equals one JOULE of work per second.

F - watt

S - vatio

WAVE POWER (ocean). The production of electricity by harnessing ocean wave movements through the use of specialized TURBINES or other devices.

F - energie des vagues

S - energia de las olas

WEATHERED SAILS (wind) (arc). SAILS with variable pitch from the inner to the outer edge.

F - ailes a airage

S - velas inclinadas

WEATHER STRIPPING (gen). Narrow strips of rubber, felt, metal or other material that are used to conserve ENERGY by preventing air INFILTRATION around doors or windows.

F - bourrelets d'etancheite

S - moldura

W.E.C.S. or WECS (wind). (See: WIND ENERGY CONVERSION SYSTEM)

F - S.C.E.E. ou SCEE

S - S.C.E.E. o SCEE

WEIBULL DISTRIBUTION

WEIBULL DISTRIBUTION (wind) (meas). A probability density function that allows one to model the WIND SPEED DISTRIBUTION for a given site, based on certain input parameters.

A mathematical application of the Weibull probability density function gives the wind speed distribution.

The Weibull distribution is a two-parameter function, whereas the RAYLEIGH DISTRIBUTION is a simplified Weibull that only uses one parameter. (See also: RAYLEIGH DISTRIBUTION)

F - distribution de Weibull

S - distribucion de Weibull

WEIR (hydr). An obstruction placed across a stream to divert the water to make it FLOW through a desired CHANNEL, which may be a notch or opening in the weir itself. A weir also is that part of a dam, embankment, CANAL, etc. that contains gates, and over which surplus water flows. A calibrated rod can be placed before the opening in a weir to measure flow. Weirs are sometimes set up exclusively as flow-measuring devices. (Syn: waterweir)

18/10/2011

<b> VITA

**F - deversoir**

**S - presa de aforo**

**<FIGURE>**

**10p142.gif (600x600)**



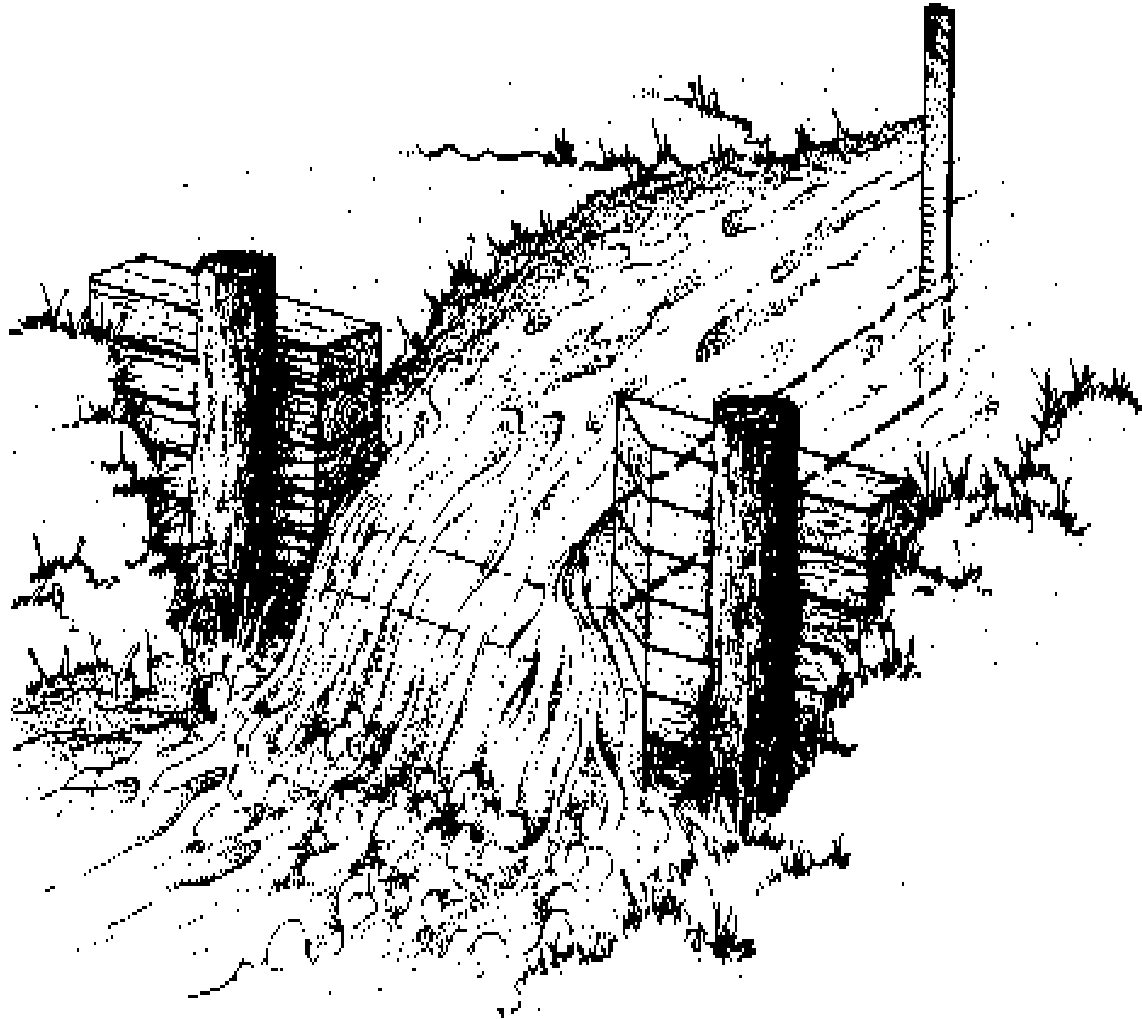

WBT

**WET-BULB TEMPERATURE** (meas). A measure of the relative humidity in a room. It is taken by a special thermometer

whose bulb is kept wet.

F - temperature de bulbe humide

S - temperatura de bola humeda

WIND ELECTRIC SYSTEM

WET SLURRY (biocon). (See: LIQUID SLURRY)

F - boue humide

S - fango mojado

WET STEAM (geo). Underground water that is hotter than the boiling point, but which remains liquid because of high surrounding pressures. Reservoirs of this superheated water may be tapped, producing a mixture of water and steam that flows to the surface and which may provide power for a TURBINE or other machinery.

F - vapeur humide

S - vapor saturado

WHEELS (wind) (arc). (See: ROLLERS)

F - roues

S - muelas

WHIP (wind) (arc). The principal longitudinal frame for the individual WINDMILL SAIL. It is strapped and bolted to the face of the BLADE.

F - bras [2]

S - varillaje

WIND CONCENTRATOR (wind). A device or structure that is

used to concentrate a wind stream.

F - concentrateur du vent

S - concentrador de viento

<FIGURE>

10p143.gif (317x317)

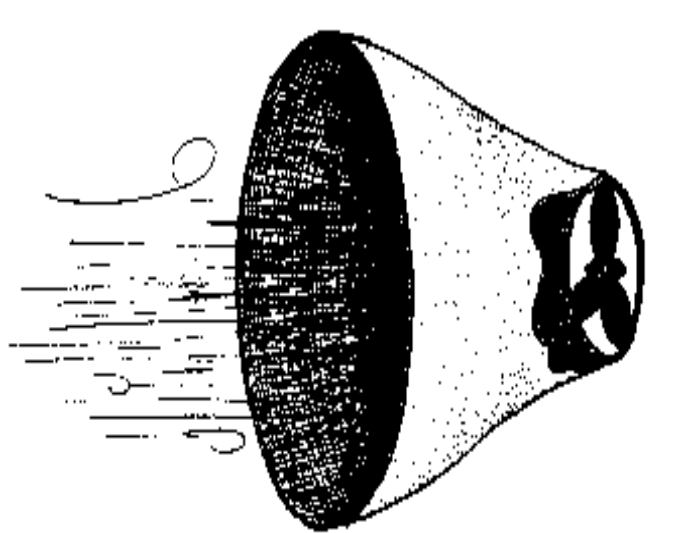

wind concentrator

WIND DIRECTION (wind). The forward course along which the wind is blowing.

F - direction du vent

S - direccion del viento

WIND ELECTRIC SYSTEM (wind). A system in which a WINDMILL

is used to generate electricity. A windmill can either be used with an ALTERNATOR or DYNAMO to provide electricity, which is either stored in batteries or used directly to run appliances.

F - electricite eolienne, systeme de

S - sistema electrogeno eolico

WIND ENERGY

WIND ENERGY (wind). ENERGY that is tapped from the natural movement of the air. Wind energy is considered a form of SOLAR ENERGY because wind is caused by variations in the amount of heat that the sun sends to different parts of the earth. It may be converted into electrical or mechanical POWER through the use of a WIND MACHINE.

F - energie du vent

S - energia eolica

WIND ENERGY CONVERSION SYSTEM (wind). The conversion of WIND ENERGY into electrical, mechanical, or thermal energy through the use of WIND MACHINES. Commonly abbreviated as W.E.C.S. or WECS.

F - conversion de l'energie eolienne, systeme de

S - sistema de conversion de la energia eolica

WIND FURNACE (wind). A WIND MACHINE that converts WIND POWER into HEAT ENERGY.

F - four eolien

S - horno eolico

**WIND GAUGE (wind) (meas). Any instrument that measures  
WIND VELOCITY. (Syn: ANEMOMETER)**

**F - indicateur de vent**

**S - anemometro**

**WIND GENERATOR (wind). A type of WINDMILL that extracts  
ENERGY from the wind to produce electricity by driving a  
GENERATOR. It generally has two or three narrow BLADES  
that turn at a high speed, often using gearing to  
multiply the number of revolutions per minute up to a  
range required by the generator.**

**F - eolienne generatrice**

**S - generador eolico**

**<FIGURE>**

**10p144.gif (353x353)**

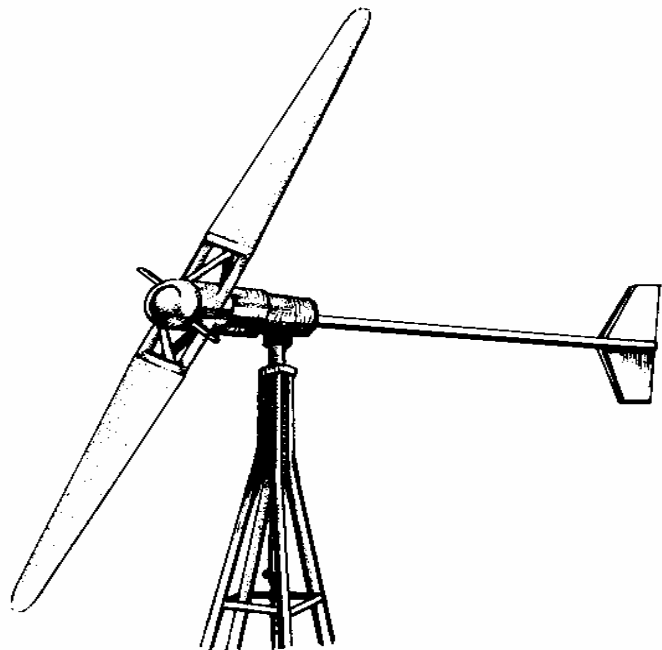

wind generator

## WIND LOAD RATING

WINDING (wind) (arc). The action of turning the WINDMILL CAP into the WIND. This is done either automatically or manually. (Pronounced to rhyme with finding.)

F - virer

S - venteamiento

<FIGURE>

10p145.gif (486x285)

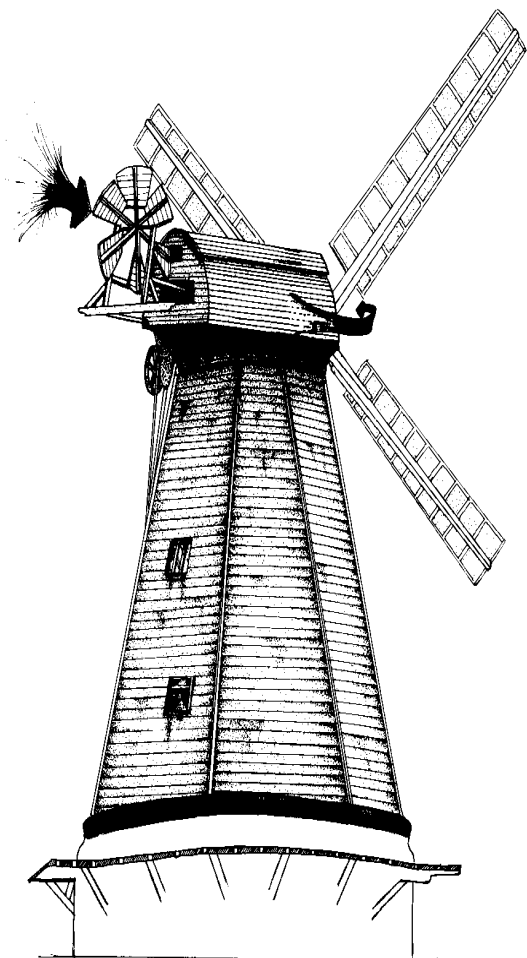

winding mechanism

**WIND LOAD RATING (wind) (meas)**. A specification used to indicate the resistance of a **WINDMILL TOWER** to the force of the wind.

**F** - puissance eolienne nominale

**S** - clasificador de la carga eolica

**WIND MACHINE**

**WIND MACHINE** (wind). Any of several types of wind-driven devices that are used to extract useful POWER from the wind.

F - eolienne

S - maquina eolica

**WIND MEASUREMENT** (wind). (See: BEAUFORT SCALE)

F - mesure du vent

S - medicion eolica

**WINDMILL** (wind). In a strictly technical sense, only those wind-powered MACHINES that drive MILLS to grind grain. However, the term is generally used to describe WIND MACHINES of all kinds. A windmill is powered by wind pressure, and usually has a slowly turning ROTOR with two or more BLADES attached to it. The blades are turned by the wind, thus rotating the rotor and the WIND SHAFT. In this way, WIND ENERGY is converted to mechanical energy. Some typical windmill applications include water pumping, milling or threshing, and electricity generation.

F - moulin a vent, eolienne

S - molino de viento

**WIND POWER** (wind) (meas). Power available from the wind that can be used by various types of WIND MACHINES. It can be expressed as:  $P = E(.5) [DAV.sup.3]$ , where:

A = SWEEPED AREA in square meters

V = WIND VELOCITY in meters/sec



P = power in KILOWATTS

D = air density in kilograms/cubic meters

E = EFFICIENCY of the device expressed as a percentage

F - puissance du vent

S - potencia eolica

WIND-POWERED PUMP (wind). A water-lifting device driven by a WIND MACHINE.

F - pompe a energie eolienne

S - bomba de aeromotor

WIND ROSE (wind) (meas). A two-dimensional graph that shows monthly or yearly mean WIND SPEEDS as well as a distribution of wind speeds. It usually indicates the speed and the percentage of time that the wind blows from eight to 16 different directions.

F - rose des vents

S - rosa de los vientos

WIND ROTOR (wind). (See: ROTOR)

F - rotor d'eolienne

S - rotor eolico

WIND SHAFT (wind). The metal rod attached to and turned by the ROTOR to provide mechanical POWER.

F - arbre d'eolienne

S - eje eolico

WIND SPEED (wind). (See: WIND VELOCITY; BEAUFORT SCALE)

F - vitesse du vent  
S - caudal del viento  
WORT

WIND SPEED DISTRIBUTION (wind) (meas). A two-dimensional graph that shows the total time or the percentage of time that the wind blows at each WIND SPEED at a particular location. It differs from a WIND ROSE in that it can give a grand total of wind speeds, regardless of their directions.

F - distribution des vitesses du vent  
S - distribucion del canal del viento

WIND TURBINE (wind). (See: WIND MACHINE)

F - turbine A vent  
S - turbina eolica

WIND VELOCITY (wind) (meas). The speed of air movement measured in miles per hour or meters per second. The amount of POWER available from the wind depends in part on the WIND SPEED or velocity. It is a peculiarity of WIND POWER that the ENERGY available increases as the cube of the wind velocity. Wind velocity may be measured by an ANEMOMETER.

F - vitesse du vent  
S - velocidad del viento

WINKLER PROCESS (prod). A FLUIDIZED BED GASIFIER process, which produces a low or medium BTU gas from a wide

variety of coals.

F - procede de Winkler

S - proceso de Winkler

WOOD ALCOHOL (alc). (See: METHANOL)

F - alcool de bois

S - alcohol metilico

WOOD GAS (prod). (See: PRODUCER GAS)

F - gaz de bois

S - gas metilico

WOOD STOVE (biocon). A stove that uses wood and most wood residues as fuel.

F - poele a bois

S - estufa de lena

WORM (alc) (impl) (wind) (arc). [1] A type of CONDENSER used in ALCOHOL STILLs. It is a coiled metal tube that leads from the still to a container holding cool water. It increases the rate of CONDENSATION and therefore the purity of the alcohol produced. [2] A cylindrical gear that supports a helical thread. It frequently is used in WINDMILL WINDING gears.

F - [1] serpentin; [2] vis sans fin

S - tornillo sin fin

WORT (alc). The liquid portion of MASH that has not yet been inoculated with YEAST. It is a brewing term that

describes the mash when it is between the BREWING MASH stage and the FERMENTATION period.

F - avoi

S - mosto no fermentado

Y

YAW AXIS (wind). The vertical axis about which a HORIZONTAL AXIS WINDMILL rotates to align itself with the wind.

F - axe de lacet

S - eje vertical

YEAST (alc) (bio). A single-celled micro-organism that can change simple sugars into ETHANOL and carbon dioxide by FERMENTATION. Yeasts are one type of FUNGI.

F - levure

S - levadura

YOKE (ani) (impl). A contrivance that joins together a pair of draft animals, especially oxen, and which generally consists of a crosspiece with bow-shaped pieces that fit over the shoulders of the animals.

F - joug

S - yugo

<FIGURE>

10p148.gif (486x486)

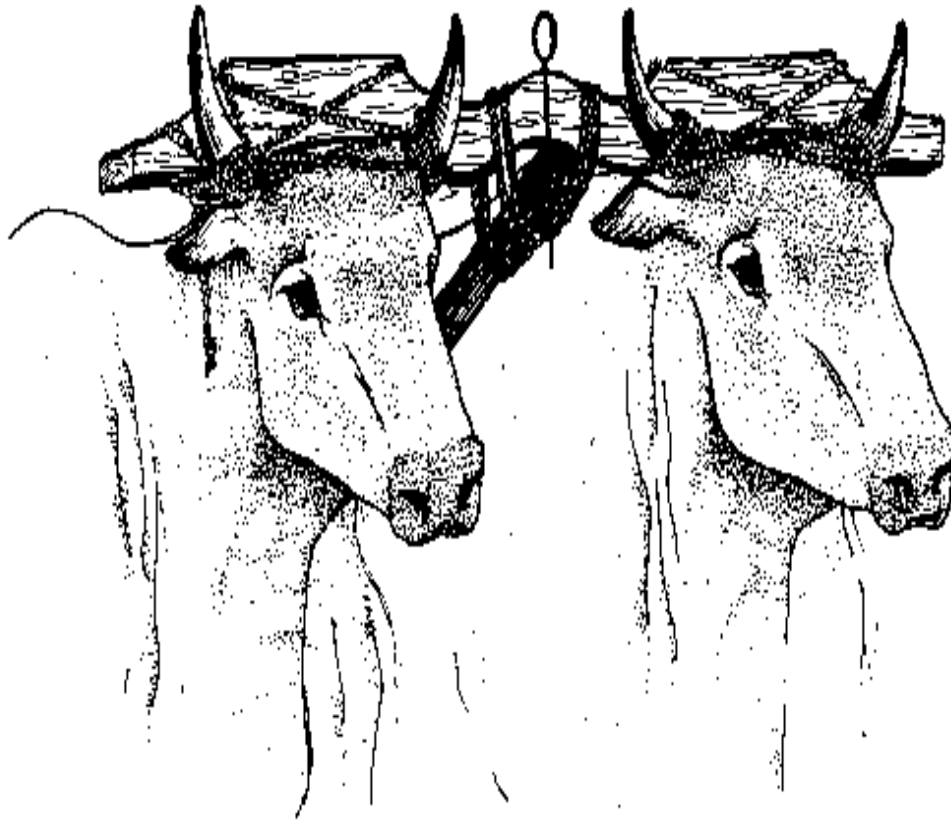

yoke

Z

**ZERO TILL (agri)**. An **ENERGY-CONSERVING** method of agriculture that requires little or no plowing or turning of the soil.

**F - labourage nul**

**S - cero arado**

ZONAL WIND (wind). Winds that blow approximately along the local parallel of the LATITUDE.

F - vent zonal

S - viento zonal

ZONE HEAT (heat). A central heating system in which different temperatures may be maintained in two or more of the areas being heated.

F - chauffage par zone

## CONVERSION TABLES

### MULTIPLY BY TO OBTAIN

acres 43,560 square feet

acres 4,047 square meters

acres 1.562 X [10.sup.-3] square miles

acres 0.004047 square kilometers

acres 4840 square yards

atmospheres 76.0 cms of mercury

atmospheres 29.92 inches of mercury

stmospheres 10,333 kgs/square meter

atmospheres 14.70 pounds/square inch

British thermal units 0.2530 kilogram-calories

B.t.u. 777.5 foot-pounds

B.t.u. 3.927 X [10.sup.-4] horsepower-hours

B.t.u. 1,054 joules

B.t.u. 107.5 kilogram-meters  
B.t.u. 2.928 X [10.sup.-4] kilowatt-hours  
B.t.u./min. 0.02356 horsepower  
B.t.u./min. 0.01757 kilowatts  
B.t.u./min. 17.57 watts  
calories 0.003968 B.t.u.  
calories 3.08596 foot-pounds  
calories 1.1622 X [10.sup.-6] kilowatt-hours  
centimeters 0.3937 inches  
centimeters 0.01 meters  
centimeters of mercury 0.1934 pounds/square inch  
centimeters/second 1.969 feet/minute  
centimeters/second 0.036 kilometer/hour  
centimeters/second 0.6 meters/minute  
centimeters/second 0.02237 miles/hour  
cubic centimeters [10.sup.-6] cubic meters  
cubic centimeters 6.102 X [10.sup.-2] cubic inches  
cubic centimeters 3.531 X [10.sup.-5] cubic feet  
cubic centimeters 1.308 X [10.sup.-6] cubic yards  
cubic feet 1,728 cubic inches  
cubic feet 0.02832 cubic meters  
cubic feet 2.832 X [10.sup.4] cubic centimeters  
cubic feet 7.481 gallons  
cubic feet 28.32 liters  
cubic feet/minute 472.0 cubic cms/second  
cubic feet/minute 0.1247 gallons/second  
cubic feet/minute 0.4720 liters/second  
cubic feet/minute 62.4 pounds water/min  
cubic inches 5.787 X [10.sup.-4] cubic feet

cubic inches 1.639 X [10.sup.-5] cubic meters  
cubic inches 2.143 X [10.sup.-5] cubic yards  
cubic meters 35.31 cubic feet  
cubic meters 264.2 gallons  
cubic meters [10.sup.3] liters  
cubic yards 7.646 X [10.sup.5] cubic centimeters  
cubic yards 27.0 cubic feet  
cubic yards 46,656 cubic inches  
cubic yards 0.7646 cubic meters  
cubic yards 202.0 gallons  
cubic yards 764.6 liters  
cubic yards/min. 0.45 cubic feet/second

**MULTIPLY BY TO OBTAIN**

cubic yards/min. 3.367 gallons/second  
cubic yards/min. 12.74 liters/second  
degrees (angle) 60 minutes  
degrees (angle) 0.01745 radians  
degrees (angle) 3,600 seconds  
dynes 1.020 X [10.sup.-3] grams  
dynes 2.248 X [10.sup.-6] pounds  
ergs 9.486 X [10.sup.11] B.t.u.  
ergs 1 dyne-centimeters  
ergs 7.376 X [10.sup.-8] foot-pounds  
ergs [10.sup.-7] joules  
ergs 2.390 X [10.sup.-11] kilogram-calories  
ergs 1.020 X [10.sup.-8] kilogram-meters  
ergs/second 1.341 X [10.sup.-10] horsepower



ergs/second [10.sup.-10] kilowatts  
feet 30.48 centimeters  
feet 0.3048 meters  
feet/second 18.29 meters/minute  
foot-pounds 1.286 X [10.sup.-3] B.t.u.  
foot-pounds 1.356 X [10.sup.7] ergs  
foot-pounds 5.050 X [10.sup.-7] horsepower-hours  
foot-pounds 3.241 X [10.sup.-4] kilogram-calories  
foot-pounds 0.1383 kilogram-meters  
foot-pounds 3.766 X [10.sup.-7] kilowatt-hours  
foot-pounds/minute 1.286 X [10.sup.-3] B.t.u./minute  
foot-pounds/minute 0.01667 foot-pounds/second  
foot-pounds/minute 3.241 X [10.sup.-4] kg-calories/min  
foot-pounds/minute 2.260 X [10.sup.-5] kilowatts  
foot-pounds/second 7.172 X [10.sup.-2] B.t.u./minute  
foot-pounds/second 1.818 X [10.sup.-3] horsepower  
foot-pounds/second 1.945 X [10.sup.-2] kg-calories/min  
foot-pounds/second 1.356 X [10.sup.-3] kilowatts  
gallons 0.1337 cubic feet  
gallons 231 cubic inches  
gallons 3.785 X [10.sup.-3] cubic meters  
gallons 3.785 liters  
gallons/minute 2.228 X [10.sup.-3] cubic feet/second  
gallona/minute 0.06308 liters/second  
grams [10.sup.-3] kilograms  
grams [10.sup.3] milligrams  
grams 0.03527 ounces  
grams 0.03215 troy ounces  
grams/cubic centimeter 62.43 pounds/cubic feet

grams centimeters 9.297 X [10.sup.-8] B.t.u.  
horsepower 42.44 B.t.u./minute  
horsepower 33,000 foot-pounds/minute  
horsepower 550 foot-pounds/second  
horsepower 10.70 kg-calories/min  
harsepower 0.7457 kilowatts  
horsepower 745.7 watts  
horsepower 1.014 horsepower(metric)  
horsepower-hours 2547 B.t.u.  
horsepower-hours 1.98 X [10.sup.6] foot-pounds  
horsepower-hours 641.7 kilogram-calories  
horsepower-hours 2.737 X [10.sup.5] kilogram-meters  
horsepower-hours 0.7457 kilowatt-hours  
horsepower-hours 2.684 X [10.sup.6] joules  
inches 2.540 centimeters  
inches 254.0 millimeters

#### MULTIPLY BY TO OBTAIN

inches of mercury 0.03342 atmospheres  
inches of mercury 1.133 feet of water  
inches of mercury 345.3 kgs/sq meter  
inches of mercury 70.73 pounds/sq foot  
inches of mercury 0.4912 pounds/sq inch  
inches of water 0.002458 atmospheres  
inches of water 0.07355 inches of mercury  
inches of water 25.40 kgs/square meter  
inches of water 0.5781 ounces/square inch  
inches of water 5.204 pounds/square foot

inches of water 0.03613 pounds/square inch  
joules 0.0009458 B.t.u.  
joules 0.73756 foot-pounds  
joules 0.0002778 watt-hours  
joules 1.0 watt-seconds  
kilograms 980,665 dynes  
kilograms [10.sup.3] grams  
kilograms 2.2046 pounds  
kilograms 1.102 X [10.sup.-3] short tons  
kilogram-calories 3.968 B.t.u.  
kilogram-calories 3,086 foot-pounds  
kilogram-calories 1.558 X [10.sup.-3] horsepower-hours  
kilogram-calories 4,183 joules  
kilogram-calories 426.6 kilogram-meters  
kilogram-calories/min. 51.43 foot-pounds/second  
kilogram-calories/min. 0.09351 horsepower  
kilogram-calories/min. 0.06972 kilowatts  
kilograms/hectare .893 pounds/acre  
kilometers [10.sup.5] centimeters  
kilometers 0.6214 miles  
kilometers 3,281 feet  
kilometers 1,000 meters  
kilometers 1093.6 yards  
kilometers/hour 27.78 centimeter/sec  
kilometers/hour 54.68 feet/minute  
kilometers/hour 0.9113 feet/second  
kilometers/hour 0.5396 knots/hour  
kilometers/hour 16.67 meters/hour  
kilometers/hour 0.6214 miles/hour

kilowatts 56.92 B.t.u./minute  
kilowatts 4.425 X [10.sup.4] foot-pounds/minute  
kilowatts 737.6 foot-pounds/second  
kilowatts 1.341 horsepower  
kilowatts 14.34 kg-calories/min  
kilowatts [10.sup.3] watts  
kilowatts-hours 3,412 B.t.u.  
kilowatts-hours 2.655 X [10.sup.6] foot-pounds  
kilowatts-hours 1.341 horsepower-hours  
kilowatts-hours 3.6 X [10.sup.6] joules  
kilowatts-hours 860.5 kilogram-calories  
kilowatts-hours 3.671 X [10.sup.5] kilogram-meters  
meters 100 centimeters  
meters 3.2808 feet  
meters 39.37 inches  
meters [10.sup.-3] kilometers  
meters [10.sup.3] millimeters  
meters 1.0936 yards  
meter-kilograms 9.807 X [10.sup.7] centimeter-dynes

**MULTIPLY BY TO OBTAIN**

meter-kilograms [10.sup.5] centimeter-grams  
meter-kilograms 7.233 pound-feet  
meters/minute 1.667 centimeters/second  
meters/minute 3.281 feet/minute  
meters/minute 0.05468 feet/second  
meters/minute 0.06 kilometers/hour  
meters/minute 0.03728 miles/hour

meters/second 196.8 feet/minute  
meters/second 3.281 feet/second  
meters/second 3.6 kilometers/hour  
meters/second 0.06 kilometers/minute  
meters/second 2.237 miles/hour  
meters/second 0.03728 miles/minute  
miles 1.609 X [10.sup.5] centimeters  
miles 5,280 feet  
miles 1.6093 kilometers  
miles 1,760 yards  
miles/min 88.0 feet/second  
miles/min 1.6093 kilometers/minute  
miles/min 0.8684 knots/minute  
ounces 8.0 drams  
ounces 437.5 grains  
ounces 28.35 grams  
ounces 0.625 pounds  
ounces/square inch 0.0625 pounds/square inch  
pints (dry) 33.60 cubic inches  
pints (liquid) 28.87 cubic inches  
pounds 444,823 dynes  
pounds 7,000 grains  
pounds 453.6 grams  
pounds 0.45 kilograms  
pounds of water 0.01602 cubic feet  
pounds of water 27.68 cubic inches  
pounds of water 0.1198 gallons  
pounds of water/min. 2.669 X [10.sup.-4] cubic feet/second  
pounds/cubic foot 0.01602 grams/cubic cms.

pounds/cubic foot 16.02 kgs/cubic meter  
pounds/cubic foot 5.787 X [10.sup.-4] pounds/cubic inch  
pounds/square foot 4.882 kgs/sq meter  
pounds/square foot 6.944 X [10.sup.-3] pounds/square inch  
pounds/square inch 0.06304 atmospheres  
pounds/square inch 703.1 kgs/square meter  
pounds/square inch 144.0 pounds/square foot  
quarts (dry) 67.20 cubic inches  
quarts (liquid) 57.75 cubic inches  
quadrants (angle) 90 degrees  
quadrants (angle) 5,400 minutes  
quadrants (angle) 1.571 radians  
radians 57.30 degrees  
radians 3,438 minutes  
radians/second 57.30 degrees/second  
radians/second 0.1592 revolutions/second  
revolutions 360.0 degrees  
revolutions 4.0 quadrants  
revolutions 6.283 radians  
revolutions/minute 6.0 degrees/second  
square centimeters 1.076 X [10.sup.-3] square feet  
square centimeters 0.1550 square inches  
square centimeters [10.sup.-6] square meters

**MULTIPLY BY TO OBTAIN**

square centimeters 100 square millimeters  
square feet 2.296 X [10.sup.-5] acres  
square feet 929.0 square centimeters

square feet 144.0 square inches  
square feet 0.09290 square meters  
square feet 3.587 X [10.sup.-8] square miles  
square feet 0.1111 square yards  
square inches 6.452 square centimeters  
square inches 645.2 square millimeters  
square meters 2.471 X [10.sup.-4] acres  
square meters 10.764 square feet  
square meters 3.861 X [10.sup.-7] square miles  
square meters 1.196 square yards  
square miles 640.0 acres  
square miles 2.7878 X [10.sup.7] square feet  
square miles 2.590 square kilometers  
square miles 3.098 X [10.sup.6] square yards  
square yards 2.066 X [10.sup.-4] acres  
square yards 9.0 square feet  
square yards 0.8361 square meters  
square yards 3.228 X [10.sup.-7] square miles  
temp (degs C) + 237 1.0 abs temp (degs K)  
temp (degs C) + 17.8 1.8 temp (degs F)  
temp (degs F) - 32 5/9 temp (degs C)  
tons (long) 1,016 kilograms  
tons (long) 2,240 pounds  
tons (metric) [10.sup.3] kilograms  
tons (metric) 2,205 pounds  
tons (short) 907.2 kilograms  
tons (short) 2,000 pounds  
tons (short)/sq. foot 9,765 kgs/square meter  
tons (short)/sq. foot 13.89 pounds/square inch

tons (short)/sq. inch 1.406 X [10.sup.6] kgs/square meter  
tons (short)/sq. inch 2,000 pounds/square inch  
yards 0.9144 meters

## BIBLIOGRAPHY

Abbott, Ira H. and A. E. Von Doenhoff. Theory of Wing Sections. New York: Dover Publications, Inc., 1949.

Abelson, Phillip H., ed. Energy: Use, Conservation and Supply. Washington, D.C.: American Association for the Advancement of Science, 1974.

A Glossary of Energy Terms in Appropriate Technology. Norman, Oklahoma: Science and Public Policy Program, University of Oklahoma, 1975.

Angrist, Stanley W., ed. Direct Energy Conversion (3rd. ed.). Boston, Massachusetts: Allyn and Bacon, Inc., 1976.

Anderson, Bruce and Michael Riordan, The Solar Home Book; Heating, Cooling and Designing with the Sun. Harrisville, New Hampshire: Cheshire Books, 1976.

Anderson, Russell E., Biological Paths to Self-Reliance. Environmental Engineering Service. New York: Von



Nostrand Reinhold Company, 1979.

Application of Solar Technology to Today's Energy Needs.  
Washington, D.C.: United States Department of Energy.  
1978.

Backus, Charles E. Solar Cells. Institute of Electrical  
and Electronic Engineers. New York: Wiley-Interscience,  
1976.

Beedell, Suzanne. Windmills. New York: Charles Scribner's  
Sons, 1975.

Bente, Paul F. Bio-Energy Directory. Washington, D.C.:  
Bio-Energy Council, 1980.

Block, C. and W. Jezewski. Illustrated Automobile Dictionary  
in Six Languages. Boston, Massachusetts: Kluwer-Boston,  
Inc., 1978.

Beeckman, W. B. Elsevier's Wood Dictionary (vol. 3:  
Research, Manufacture, Utilization). New York: Elsevier-North  
Holland Publishing Co., 1968.

Clark, Wilson. Energy Survival: The Alternative to  
Extinction. New York: Doubleday and Co., Inc., 1975.

Clason, W. E. Elsevier's Dictionary of Measurement and  
Control. New York: Elsevier-North Holland Publishing

Co., 1977.

Clean Fuels from Biomass and Wastes, Symposium II, January 1977. Chicago: Institute of Gas Technology, 1977.

Coe, Gigi. Present Value: Constructing a Substantial Future. Friends of the Earth. San Francisco, California: State of California Office of Appropriate Technology. 1979.

Clegg, Peter D. and Ralph Wolfe. Home Energy for the Eighties. Charlotte, Vermont: Garden Way Publishing Co., 1979.

Collazo, Javier L., ed., Encyclopedic Dictionary of Technical Terms (3 vols.). New York: McGraw-Hill Books, Inc., 1980.

Congdon, R. J. Introduction to Appropriate Technology. Emmaus, Pennsylvania: Rodale Books, Inc., 1977.

Crawley, Gerald M. Energy. New York: Macmillan Publishing Co., Inc., 1975.

Dancy, Rev. Harold K. Manual on Building Construction. London: Intermediate Technology Publications, 1977.

Daniels, Farrington. Direct Use of the Sun's Energy. New York: Ballantine Books, Division of Random House, Inc.,

1964.

Darrow, Ken and Rick Pam. *Appropriate Technology Sourcebook (2 vols.)*. Stanford, California: Volunteers in Asia, 1976.

Davis, C. V. and K. E. Sorenson. *Handbook of Applied Hydraulics*. New York: McGraw-Hill Books, Inc., 1968.

Duffie, John A. and William A. Beckman. *Solar Energy Thermal Processes*. New York: Wiley-Interscience, 1974.

Earl, Derek E. *Forest Energy and Economic Development*. New York: Oxford University Press, 1975.

Eccli, Sandy, ed. *Alternative Sources of Energy: Practical Technology and Philosophy for a Decentralized Society*. New York: Seabury Press, Inc., 1974.

*Energy Alternatives: A Comparative Analysis*. Norman Oklahoma: The Science and Public Policy Program, University of Oklahoma, 1975.

*Energy Audit Workbook*. Washington, D.C.: United States Department of Energy, 1979.

*Energy Information Data Base: Subject Thesaurus*. Washington, D.C.: Technical Information Center, United States Department of Energy, 1979.

**Energy Microthesaurus. Springfield, Virginia: National Technical Information Service, 1976.**

**Fact Sheet #18--Alternative Energy Sources: A Glossary of Terms. Washington D.C.: United States Department of Energy, 1981.**

**Fisher, R. and B. Yanda. The Food and Heat Producing Greenhouse: Design, Construction and Operation. Santa Fe, New Mexico: John Muir Publications, 1979.**

**Fraenkel, Peter. Food from Windmills. London: Intermediate Technology Publications, 1977.**

**Fraenkel, Peter. The Power Guide: A Catalogue of Small-Scale Power Equipment. London: Intermediate Technology Publications, 1979.**

**Freeman, Christina and Leo Pyle. Methane Generation by Anaerobic Digestion: An Annotated Bibliography. London: Intermediate Technology Publications, 1977.**

**Freese, Stanley. Windmills and Millwrighting. North Pomfret, Vermont: David and Charles, Inc., 1971.**

**Fry, L. John. Practical Building of Methane Power Plants for Rural Energy Independence. Santa Barbara, California: L. J. Fry, 1974.**

Fuel From Farms--A Guide to Small-Scale Ethanol Production. Solar Energy Data Bank. Golden, Colorado: SoIar Energy Research Institute, United States Department of Energy, 1980.

Golding, E. W. The Generation of Electricity by Wind Power. New York: John Wiley and Sons, Inc., 1977.

Gray, T. J. and O. K. Gashus. Tidal Power. New York: Plenum Publishing Corp., 1972.

Hackleman, Michael and David House. Wind and Windspinners. Sangus, California: Earthmind, 1974.

Handbook of Homemade Power. The Mother Earth News Staff, New York: Bantam Books Inc., 1974.

Hand, Jackson. Solar Heating and Cooling. New York: Harper and Row Publishers, Inc., 1978.

Havens, David. The Woodburner's Handbook. Brunswick, Maine: Harpswell Press, 1975.

Hays, Denis. Energy for Development: Third World Options. World Watch Institute. New York: Unipub, 1977.

House, D. The Compleat Biogas Handbook, Aurora, Oregon: At Home Everywhere, 1978.

Hunt, V. Daniel. *Energy Dictionary*. New York: Von Nostrand Reinhold Company, 1979.

Jequier, Nicolas and Gerard Blanc. *Appropriate Technology Directory*. Paris: Development Center of the Organization for Economic Co-operation and Development, 1979.

Klass, D. L. *Energy from Biomass and Wastes: 1979 Update*. Chicago: Institute for Gas Technology, 1980.

Kondo, K. *Elsevier's Dictionary of Automobile Engineering*. New York: Elsevier-North Holland Publishing Co., 1977.

Lee, Kaiman. *Encyclopedia of Energy-Efficient Building Design: 391 Practical Case Studies (2 vols.)*. Newtonville, Massachusetts: Environmental Design and Research Center, 1977.

Lee, Kaiman and Jaqueline Masloff. *Kaiman's Encyclopedia of Energy Topics (2 vols.)*. Newtonville, Massachusetts: Environmental Design and Research Center, 1979.

Leckie, Jim et. al. *Other Homes and Garbage*. San Francisco, California: Sierra Publications, 1975.

Loftness, Robert L. *Energy Handbook*. New York: Von Nostrand Reinhold Company, 1978.

Mages, Loren J. Electric Generating Systems. Indianapolis, Indiana: Theodore Audel, 1970.

Mantell, C. L. Batteries and Energy Systems. New York: McGraw-Hill Books, Inc., 1970.

Mazria, Edward. The Passive Solar Energy Book: Expanded Professional Edition. Emmaus, Pennsylvania: Rodale Books, Inc., 1979.

McCullagh, James, ed. Pedal Power: In Work, Leisure, and Transportation. Emmaus, Pennsylvania: Rodale Books, Inc., 1977.

McGuigan, Dermot. Harnessing Water Power for Home Energy. Charlotte, Vermont: Garden Way Publishing, Inc., 1978.

Merrill, Richard and Thomas Gage, eds. Energy Primer: Updated and Revised Version. New York: Dell Publishing Company, 1974.

Meynell, Peter-John. Methane: Planning a Digester. New York: Schocken Books, Inc., 1978.

Mole, W. M. International Glossary of Hydrology. World Meteorological Organization and the United Nations Education, Scientific and Cultural Organization, New York: Unipub, 1974.

Neville, Richard C. Solar Energy Conversion. New York: Elsevier-North Holland Publishing Co., 1978.

Pachauri, R. K. Energy and Economic Development in India. New York: Praeger Publishers, 1977.

Parker, Sybil. Encyclopedia of Energy (2nd. ed.). New York: McGraw-Hill Book Co., 1980.

Park, Jack. Simplified Wind Power Systems for Experimenters (2nd. ed.). Sylmar, California: Helion, 1975.

Park, Jack. The Wind Power Book. Palo Alto, California: Cheshire Books, 1980.

Putnam, P. C. Power from the Wind. New York: Von Nostrand Reinhold Company, 1974.

Proceedings of the United Nation Conference on New Sources of Energy, New York, New York: Unipub, 1961.

Reed, T. B. and R. M. Lerner. Methanol: A Versatile Fuel for Immediate Use. Washington, D.C.: American Association for the Advancement of Science, 1973.

Reynolds, John. Windmills and Watermills. New York: Praeger Publishers, 1970.



Ross M. H. and R. H. Williams. **Our Energy: Regaining Control.** New York: McGraw-Hill Book Co., 1980.

Sachs, Peter. **Wind Forces in Engineering (2nd. ed.).** Elmsford, New York: Pergamon Press, Inc. 1972.

Schlegel, H. G. **Microbial Energy Conversion.** Elmsford, New York: Pergamon Press, Inc.

Shefter, Y. **Wind Powered Machines.** Springfield, Virginia: National Technical Information Service, 1974.

Shelton, Jay and Andrew Shapiro. **The Woodburner's Encyclopedia.** Waitsfield, Vermont: Vermont Crossroads Press, 1976.

Stafford, D. A. **Methane Production from Waste Organic Matter.** Boca Raton, Florida: CRC Press, 1977.

Stoner, Carol H. **Producing Your Own Power: How to Make Nature's Energy Sources Work for You.** Emmaus, Pennsylvania: Rodale Press, Inc. 1974.

Sullivan, F. P. and N. C. McNerney. **Energy Reference Handbook (3rd. ed.).** Rockville, Maryland: Government Institutes, Inc.

Tweney, C. F. and L. E. C. Hughes, eds. **Chamber's Technical Dictionary (3rd. ed., revised, with supplement).** New

York: Macmillan Publishing Co., Inc., 1958.

Todd, David Keith, ed. Water Encyclopedia. Syosset, New York: Water Information Center, 1970.

Van Buren, Ariane and Leo Pyle, eds. A Chinese Biogas Manual. Translated from Chinese by Michael Crook, London: Intermediate Technology Publications, 1979.

Veziroglu, T. Nejat, ed. Alternative Energy Sources: Proceedings--Miami International Conference on Alternative Energy Sources. Washington, D.C.: Hemisphere Publishing Corp., 1978.

VITA Construction Manual and Technical Bulletin Series, Washington, D.C.: Volunteers in Technical Assistance, Inc.

Vivian, John. Wood Heat: New and Improved Edition. Emmaus, Pennsylvania: Rodale Press, Inc., 1978.

Water Pumping Windmill Designs: A Hand Book. Bombay, India. Tata Research Institute, 1981.

Watt, Simon. Chinese Chain and Washer Pumps. London: Intermediate Technology Publications, 1977.

Wood and Energy. Washington, D.C.: United States Department of Energy, 1980.

Wood Conserving Cookstoves: A Design Guide. Washington, D.C.: Volunteers in Technical Assistance and Intermediate Technology Development Group, 1979.

Yule, John-David, ed. Phaidon Concise Encyclopedia of Science and Technology. Oxford: Phaidon Press, Ltd., 1978.

=====  
=====