

Candidate Name \_\_\_\_\_

Centre Number	Candidate Number

**International General Certificate of Secondary Education**  
**CAMBRIDGE INTERNATIONAL EXAMINATIONS**  
**AGRICULTURE**  
**PAPER 2**

**0600/2**

**OCTOBER/NOVEMBER SESSION 2002**

1 hour

Candidates answer on the question paper.  
No additional materials are required.

**TIME** 1 hour

**INSTRUCTIONS TO CANDIDATES**

Write your name, Centre number and candidate number in the spaces at the top of this page.

Answer **all** questions.

Write your answers in the spaces provided on the question paper.

**INFORMATION FOR CANDIDATES**

The intended number of marks is given in brackets [ ] at the end of each question or part question.

FOR EXAMINER'S USE	
1	
2	
3	
4	
5	
6	
<b>TOTAL</b>	

---

**This question paper consists of 12 printed pages.**



1 (a) Fig. 1.1 shows a soil profile.

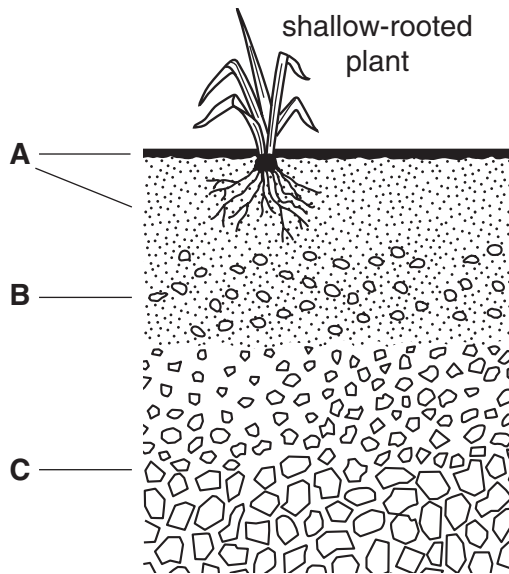

Fig. 1.1

(i) Name layer **B**. .....[1]

(ii) Explain how the layer **C** could be broken up by  
the action of plants; .....  
.....  
the action of chemicals from the atmosphere. ....  
.....  
.....[3]

(b) Fig. 1.2 shows pie charts that illustrate the components of two soil types.

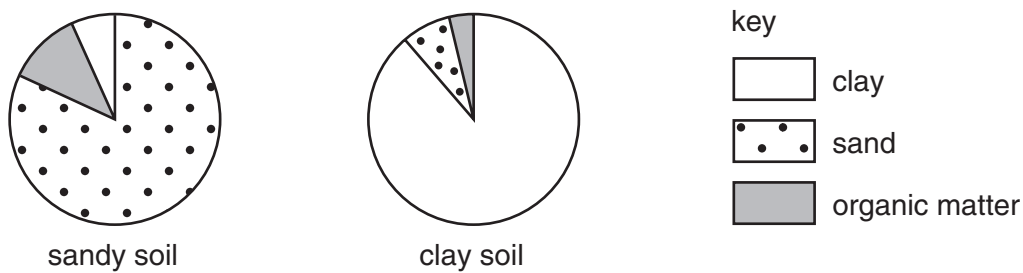
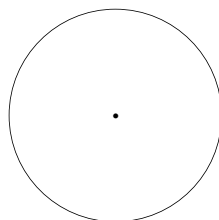

Fig. 1.2

Using the same key, fill in the pie chart below to represent a loam soil type.



[2]

(c) Fig. 1.3 shows an experiment to investigate the effect of adding lime to clay and farmyard manure.

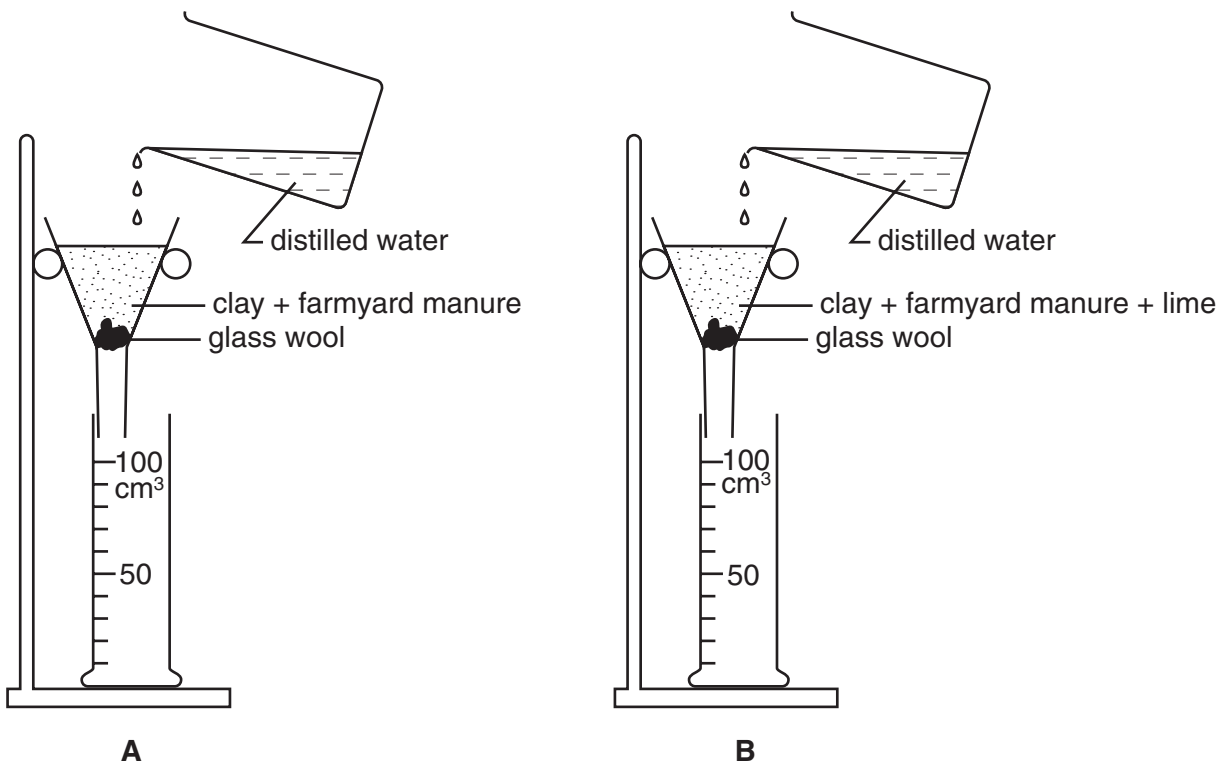

Fig. 1.3

The water in the beakers is slowly poured on to the soil samples and left for 30 minutes.

Suggest which cylinder, **A** or **B**, would have: (i) more water and (ii) water with the higher pH. Give reasons for your answers.

(i) more water

cylinder .....

reason.....

.....[2]

(ii) water with the higher pH

cylinder .....

reason.....

.....[2]

[Total : 10]

2 Fig. 2.1 shows two plants; **P** is a grass and **Q** is a legume.

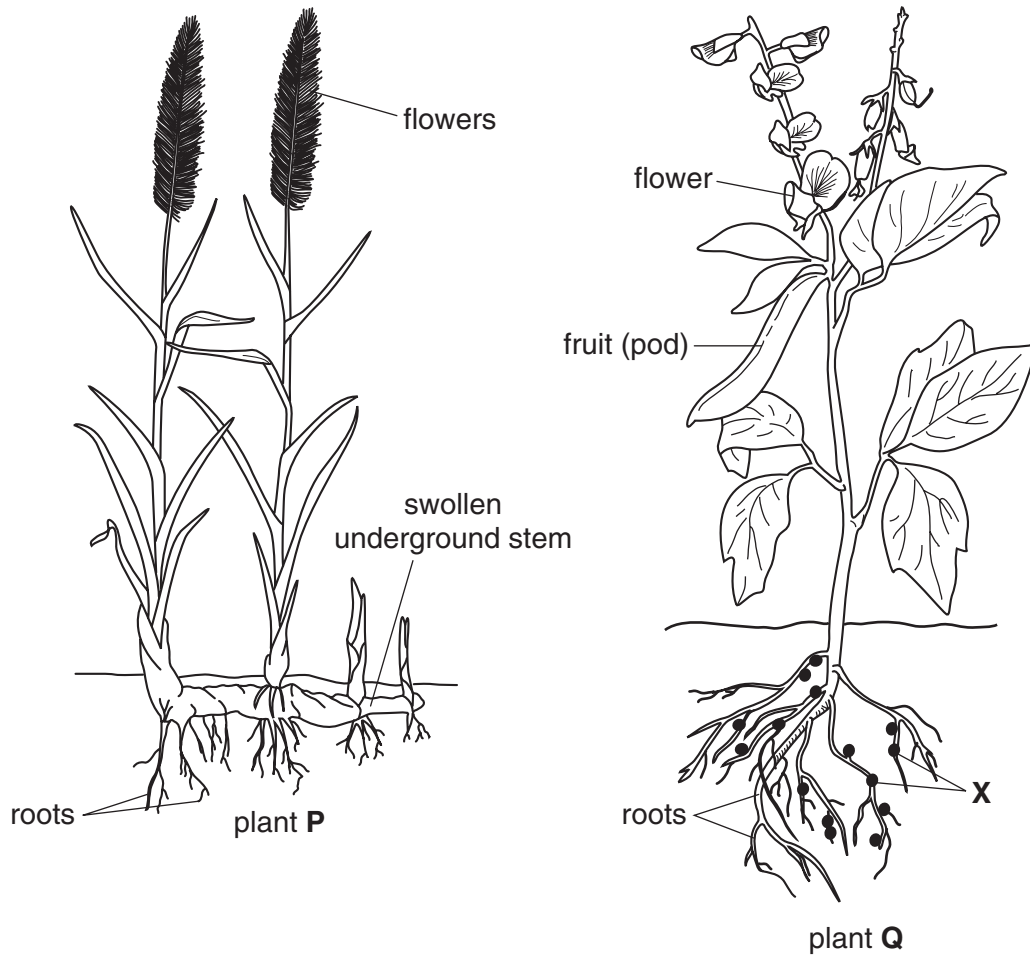

Fig. 2.1

(a) (i) Which of these plants is pollinated by insects? .....[1]

(ii) State two features of insect-pollinated flowers.

1. ....

.....

2. ....

.....

.....[2]

(iii) State **one** function of the swollen underground stem in plant **P**.

.....

.....[1]

(iv) Name the structures labelled **X** in plant **Q**.

.....[1]

(v) What is contained within the structure **X**?

.....[1]

(b) (i) Name the process of water loss from leaves. ....[1]

(ii) Which plant would you expect to lose more water, **P** or **Q**? .....

Give a reason for your answer. ....

.....[2]

(c) Some of the leaves in plants **P** and **Q** show a white powder on their undersides after rain. They then turn brown and die.

(i) What type of organism could cause this condition? .....[1]

(ii) Describe how the spread of these organisms could be controlled.

.....

.....

.....[1]

(d) Plants **P** and **Q** were grown in a garden plot in which the weeds were **not** controlled.

Suggest which plant, **P** or **Q**, you would expect to grow better in these conditions. ....

Give a reason for your answer.

.....

.....

.....[2]

[Total : 13]

3 (a) (i) Name two hand tools that can be used for turning over the soil.

..... *and* .....[2]

(ii) State **one** safety precaution to be observed when using hand tools in the garden plot.

.....  
.....[1]

(iii) State two reasons for turning over the soil.

1. ....  
2. ....[2]

(b) List three things to consider when deciding where to make a garden plot.

1. ....  
2. ....  
3. ....[3]

(c) Name a cereal crop. ....

(i) Explain how you would recognise when this crop is ready for harvesting.

.....  
.....  
.....[2]

(ii) Describe how this crop is harvested.

.....  
.....  
.....[2]

(iii) State two problems that can occur during the storage of this crop and explain how these problems can be prevented.

*problem 1* .....

*prevention* .....

*problem 2* .....

*prevention* .....

.....[2]

[Total : 14]

4 (a) Table 4.1 lists food groups and their use in animals.

**Table 4.1**

food group	use in the animal
carbohydrate	energy production
protein	.....
.....	energy storage
vitamins	health
minerals	health

(i) Complete the missing details in Table 4.1. [2]

(ii) State **one** essential part of an animal's diet not listed in Table 4.1.  
.....[1]

(iii) Name the process that animals carry out to release the energy from digested food.  
.....[1]

(iv) What do animals use the mineral calcium for? .....  
.....[1]

(v) What do plants use the mineral magnesium for? .....  
.....[1]

(b) Describe how plants make glucose (carbohydrate).  
.....  
.....  
.....  
.....  
.....  
.....[4]

(c) Different parts of plants are used for different animal rations.

(i) Explain why animals needing a maintenance ration are fed a high proportion of tubers e.g. potatoes or cassava.

.....  
.....[1]

(ii) Explain why animals needing a production ration are fed a high proportion of grain e.g. maize or millet.

.....  
.....[1]

[Total : 12]

5 (a) Fig. 5.1 shows a poultry house and run.

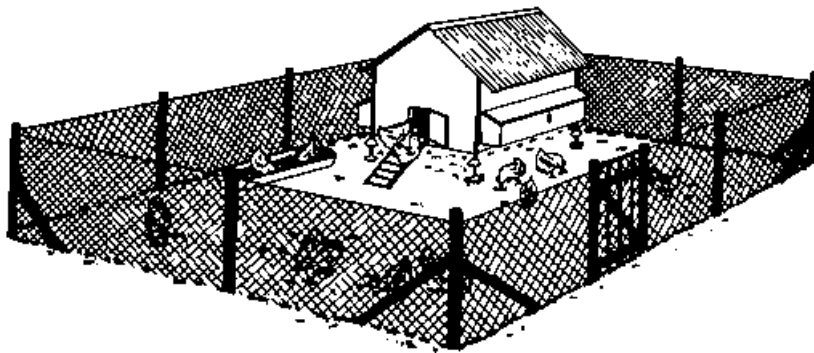

Fig. 5.1

(i) State two advantages of using corrugated iron instead of thatch for the roof of the house.

1. ....  
.....  
2. ....  
.....[2]

(ii) Suggest why the house is **not** in a good position in this run.

.....  
.....[1]



(iii) State two advantages of dividing the run.

- 1. ....  
.....
- 2. ....  
.....[2]

(b) Fig. 5.2 shows a poultry house with a wire floor built over a pond.



Fig. 5.2

The pond is used for fish farming.  
The poultry droppings fall into the water.

State **one** advantage and **one** disadvantage of this system of animal management.

- advantage* .....
- .....
- disadvantage* .....
- .....[2]

(c) Both chickens and turkeys provide meat and eggs, yet very few farmers keep turkeys.

Suggest a reason to explain this fact.

- .....
- .....[1]

[Total : 8]

6 (a) Fig. 6.1 shows the male reproductive system of a farm animal.

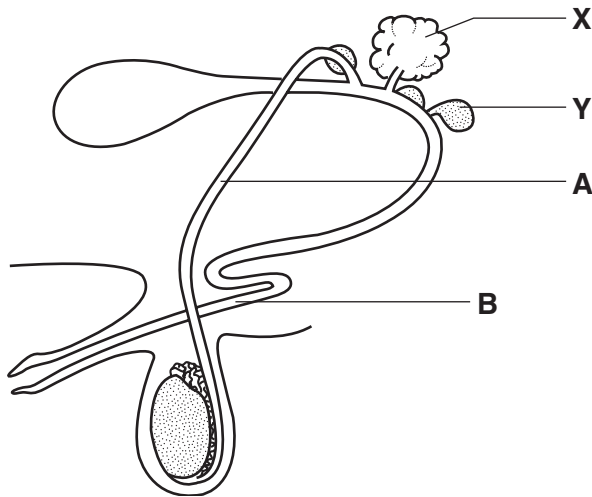

Fig. 6.1

(i) Name the parts labelled **A** and **B**.

**A** .....

**B** .....

[2]

(ii) State a function of the fluids produced by the glands **X** and **Y**.

.....[1]

(b) At the birth of a farm animal, certain tasks should be carried out.

State a task that should be carried out by the farmer

just before birth; .....

just after birth. ....[2]

(c) Explain the importance of colostrum to the young animal.

.....

.....[1]

(d) Weaning young early is a practice sometimes used for farm animals that are bred for meat.

Suggest an effect this would have for

the young; .....

.....

the mother. ....

.....[2]

- (e) Table 6.1 shows the population changes in a herd of goats over four years. Two kids, one male, one female, are born every year to each breeding female. After six months, the male kids are eaten and the female kids join the breeding herd.

**Table 6.1**

year	breeding males	breeding females	male kids	female kids	total herd
2001 – January	2	8			10
2001 – July	2	8	8	8	26
2002 – January	2	16			18
2002 – July	2	16	16	16	50
2003 – January	4	32			36
2003 – July	4	...	...	...	...
2004 – January	4	...			...

- (i) Complete Table 6.1 to show how many females are used for breeding in 2004. [1]

- (ii) The carrying capacity of the goats' pasture is 18 goats per hectare. The total pasture available to the goats is 5 hectares.

In which year will the pasture first be overgrazed? .....

Show your working.

[2]

- (iii) State two effects on the pasture of overgrazing.

1. ....  
.....

2. ....  
.....[2]

[Total : 13]

---

*Copyright Acknowledgements:*

Question 5                    M W Dickson. Tilapia. MacMillan.

Cambridge International Examinations has made every effort to trace copyright holders, but if we have inadvertently overlooked any we will be pleased to make the necessary arrangements at the first opportunity.