



# IBM InfoPrint Color 100 Print Media Guide





# IBM InfoPrint Color 100 Print Media Guide

### **First Edition (August 1998)**

The following paragraph does not apply to any other country where such provisions are inconsistent with local law.

INTERNATIONAL BUSINESS MACHINES CORPORATION PROVIDES THIS PUBLICATION "AS IS" WITHOUT WARRANTY OF ANY KIND, EITHER EXPRESS OR IMPLIED, INCLUDING, BUT NOT LIMITED TO THE IMPLIED WARRANTIES OF MERCHANTABILITY OR FITNESS FOR A PARTICULAR PURPOSE. Some states do not allow disclaimers of express or implied warranties in certain transactions, therefore, this statement may not apply to you.

Order publications through your IBM representative or the IBM branch office serving your locality. Publications are not stocked at the address given below.

The IBM Printing Systems Company welcomes your comments. A form for readers' comments is provided at the back of this publication. If the form has been removed, you may send your comments to the following address:

IBM Printing Systems Company  
Information Development  
Department H7FE, Building 003G  
P.O. Box 1900  
Boulder, CO 80301-9191  
U.S.A

If you prefer to send comments electronically, use one of the following methods:

Internet: [print\\_pubs@vnet.ibm.com](mailto:print_pubs@vnet.ibm.com)

Fax: 1-800-524-1519

Visit our home page at <http://www.printers.ibm.com/>.

When you send information to IBM, you grant a nonexclusive right to use or distribute the information in any way IBM believes appropriate without incurring any obligation to you.

© **Copyright International Business Machines Corporation 1998 All rights reserved.**

Note to U.S. Government Users – Documentation related to restricted rights – Use, duplication or disclosure is subject to restrictions set forth in GSA ADP Schedule Contract with IBM Corp.

<b>IBM InfoPrint Color 100 Print Media Guide</b>	<b>1</b>
<b>Purpose of this manual</b>	<b>3</b>
<b>Requesting a Print Medium Test</b>	<b>5</b>
Importance of Print Medium Testing .....	5
Procedures.....	5
Test Results, Medium Performance Rating and Script .....	9
Rush Testing .....	9
<b>Basic Paper Types and Their Properties</b>	<b>11</b>
Basic paper types.....	11
Uncoated paper .....	11
Coated paper .....	12
Speciality paper .....	12
Paper properties.....	13
<b>Guidelines for Print Medium Quality Inspection</b>	<b>15</b>
Check Paper Quality .....	15
Guidelines for Print Medium Storage and Handling .....	16
Splicing.....	17
Roll inspection.....	17
Paper Waste During Printing and Waste Reduction (PES code 3.10).....	18
Start of a Print Job .....	18
Auto Mode .....	18
Manual Mode.....	18
Finishing the Print Job .....	18
Changing the Paper Roll.....	18
Operator Skills .....	19
Paper Quality .....	19
Environment.....	19
<b>Artifact Samples</b>	<b>21</b>
Low-density cloudiness .....	22
High-density cloudiness .....	22
High-frequency cloudiness.....	23
Periodic low-density bands .....	23
Weak cloudiness .....	24
Low-density speckles.....	24
Low-density spots .....	25
Gloss too low.....	25
GEM hot offset .....	26
Worm like streaks.....	26
Wrinkling in the PRS .....	27
Micro-blistering from the fuser.....	27
Non-uniform transfer quality across the web.....	28
<b>Description of paper-dependent parameters</b>	<b>29</b>
<b>List of IBM Recommended Print Media for InfoPrint Color 100</b>	<b>33</b>



---

# IBM InfoPrint Color 100 Print Media Guide





---

## Purpose of this manual

- A guide to have print medium tested through a certified agency
- To provide information on basic paper quality requirements for the InfoPrint Color 100 Printer.
- To provide information on proper paper handling and storage
- To provide information about how paper is tested at the certified agency.
- To provide information on the basic paper types and properties.
- To assist in understanding the media limitations of InfoPrint Color 100 Printer.
- To provide Artifact Samples to assist in print quality troubleshooting.



---

# Requesting a Print Medium Test

---

## Importance of Print Medium Testing

InfoPrint Color 100 Print Medium testing is needed to adjust and optimize a set of control parameters to obtain the best print quality.

Using a tested and supported print medium offers you the following advantages:

- Stable print quality
- Minimum quantity of wasted paper
- Minimum printing problems, such as paper jams
- Minimum contamination of the InfoPrint Color 100 print engine; thereby reducing machine intervention and frequency of service.

---

## Procedures

1. Before considering a print medium test, request the latest InfoPrint Color 100 Print Media List from your account representative. Or check the IBM web site at <http://www.printers.ibm.com/manuals.html> for the latest list. Make sure that there is not a similar stock on this list before you initiate a request for a test.
2. Make sure there is full support from the Medium Manufacturer.
3. Contact IBM certified Medium Test Agencies  
For US region contact RIT (Lisa Ford, Tel: 716-475-5593, Fax: 716-475-5250, Email: LM-FASP@RIT.EDU).

For EMEA regions, contact Pira (Mike Chamberlain, Tel: 44-1372-802000, Fax: 44-1372-802238/46, E-mail: [paper@pira.co.uk](mailto:paper@pira.co.uk) or [printing@pira.co.uk](mailto:printing@pira.co.uk))

4. The test will cost the medium manufacturer or the customer about \$240/hour. It usually takes about 2.5 - 3 hours for one medium test. The turn around time is about 2 to 6 months depending on the agencies current work load. A paper may also be tested on an emergency basis with a shorter turn around time for a cost premium.
5. Paper Test Agencies will request certain information from the medium manufacturer through two different forms as a pre-requisite for testing. The following is a sample of these forms:

**Note:** Current InfoPrint Color 100 print medium testing will be executed on the InfoColor 70, the InfoColor 70 script will then be converted into an InfoPrint Color 100 script.

**Form 1: Substrate Qualification Data Collection Worksheet**

Product Name:	
Manufacture:	
<b>Company Contact</b>	
Name:	
Title:	
Address:	
City:	
State:	
Country:	
Postal Code:	
Telephone Number:	
Fax Number:	
Email:	
<b>Paper Classification</b>	<b>X</b>
Uncoated Super Calandered	
Uncoated Calandered	
Uncoated Uncalandered	
Uncoated Pigmented	
Matte Coated	
Satin Coated	
Glossy Coated	
Single-sided Cast Coated	
Recycled Coated	
Latex Impregnated Paper	
Film	
Others (Please specify)	
<b>Material Properties (Fill-in or attach documentation)</b>	
Grammage (GSM)	
Caliper(micron)	
Brightness (ISO%)	
Opacity(%)	

Smoothness (PPS micron/Sheffield units)	
Moisture Content (% AH)	
Certificate of Non-toxicity (Please Attach)	
Guarantee Splice Free	
<b>Marketing Contact:</b>	
Name:	
Title:	
Address:	
City:	
State:	
Country:	
Postal Code:	
Telephone Number:	
Fax Number:	
Email:	
<b>Technical Contact:</b>	
Name:	
Title:	
Address:	
City:	
State:	
Country:	
Postal Code:	
Telephone Number:	
Fax Number:	
Email:	
Distribution List (Please attach)	

**Form 2: Specifications for Print Media Qualification on the InfoPrint Color 100 Print Engine**

<b>Roll Dimensions</b>		
Description	Dimension (USA)	Dimension (EU)
Inner Core Diameter	3" -0/+0.02	75mm ±.5
	6" -0/+0.02	150mm ±.5
Maximum Roll Diameter	19.7"	500mm
Typical Roll Diameter	15.75"	400mm
Maximum Roll Weight	188 lbs	85 kg
Roll Width	19.7" - 20"	500mm - 508mm

**Roll Specifications**

The paper must be free from splices, tears, dents, holes and other physical defects. The paper should be flush with the core and must not slide axially over the core.

**Paper Weight**

60 to 250GSM are specification limits for InfoPrint Color 100 engine.

**Temperature Resistance**

The paper must withstand prolonged (1 hour minimum) heating to 100°C and heating to 200°C for 5 seconds without physical or chemical degradation. Under these conditions, the paper should not release any toxic substances.

**Demonstrated Paper Properties**

The following data must be submitted for each substrate to be tested.

- Weight (grams/m<sup>2</sup>)
- Caliper (micron)
- Brightness (ISO%)
- Opacity (%)
- Smoothness (pps/sheffield units)
- Moisture Content (%AH)

A certificate of non-toxicity is required. This must contain the following statement: "The print medium will not release toxic gasses when heated up to 200°C during 5 seconds and during prolonged heating at 100°C."

**Note:** The above properties can be tested at the Agencies for a fee.

---

## Test Results, Medium Performance Rating and Script

Once the print medium is tested, the performance of the medium is reviewed. All the information of the paper and scripts will be shared information.

The tested print medium will be rated at 1A, 1B, 2, 3 performance level. These performance levels are defined as follows:

- 1A – Good print quality is easy to obtain and rather stable without any finishing or stacking problems.
- 1B – Good print quality is not very easy to obtain. It requires close monitoring to maintain good and stable print quality. No finishing or stacking problems.
- 2 – Minor print quality problems and/or finishing problems.
- 3 – Severe print quality and finishing problems.

IBM has chosen to support 1A level media only. IBM allows customer to use 1B level media and a select few others at their own risk. IBM provides these scripts to its customers through IBM Service Engineers. They can update the InfoPrint Color 100 with the latest print medium scripts upon your request.

---

## Rush Testing

In a situation where paper needs to be tested in a short period of time, paper test agencies may offer testing on rush basis for a surcharge. IBM may also offer medium testing under some limitations. To qualify for testing at IBM, you need to contact your account manager. Your account manager will need to petition the marketing organization for an evaluation and approval. IBM marketing will evaluate the following key areas:

1. Does IBM already provide support for a similar stock?
2. Does this print medium open a new market for InfoPrint Color 100 print business?
3. Does this new print media bring additional IBM sales opportunities?

If you are approved for testing at IBM, you will need to submit the same pre-requisite medium information and prepare a medium sample (3 rolls) just as you would do for certified agencies. The turn around time at IBM is usually about 3 to 6 weeks depending on work load.





# Basic Paper Types and Their Properties

## Basic paper types

In order to understand fully what requirements have to be met by the paper, it is important that you know how paper types are distinguished:

Paper types	Uncoated paper	Uncalendered
		calendered
		Supercalendered
	Coated paper	Matt
		Satin
		Glossy
		High-gloss
	Speciality paper	Embossed
		Watermarked
		Recycled
		Tinted & Colored
		Translucent
		Parchment

## Uncoated paper

Paper, the surface of which is not covered with an additional coating. It is only composed of pulp, containing cellulose fibers, fillers, binders, pigments, etc.. The various types of uncoated paper are listed in the table below.

Uncoated paper types	Description
Uncalendered paper	Paper which was not submitted to the calendering process. See below.
Calendered paper	During the calendering process the paper passes through a number of calendering rolls made of steel, in order to make it more compact and smoother by increasing influences of temperature and pressure on the paper.
Supercalendered paper	During the supercalendering process the paper passes through a number of calendering rolls made alternately of steel and cotton, in order to make it even more compact and smoother.

## Coated paper

Paper, the surface of which is covered with a coating, in order to alter the surface properties of the original paper such as smoothness, gloss and water resistance.

Gloss property	Description
Matte coated paper	Coated paper, which was not submitted to the calendering process, or which passed through only one pair of calendars.
Satin coated paper	Coated paper, which was submitted to the calendering process.
Glossy and high-gloss coated paper	Coated paper, which was submitted to the supercalendering process.

Depending on the production method, coated papers can also be divided as follows:

Coated paper type	Description
Machine coated paper	Coating is applied by means of a dosing roll and the excess coating is removed with a scraper. The gloss is achieved by calendering. The coating thickness is variable on the scale of the paper's relief.
Cast coated paper	The gloss of the coated paper is obtained by passing the paper over a very smooth chromium roll. This results in very high-gloss coated paper. The coating thickness is uniform.

## Speciality paper

Paper, which has special properties, intended for special purpose use.

Feature	Description
Embossed paper	Paper with an amount of relief which is produced by pressing it between a rotary embosser, i.e. a metal roll having a embossing pattern.
Recycled paper	Paper that is made of pulp containing fibers of paper that has already been used and to which new fibers are added. Sometimes all fibers are recycled.
Tinted and Colored paper	Paper that is made of pulp containing an amount of colored pigments. Colored paper has a more saturated color than tinted paper.

Feature	Description
Watermarked paper	With a roll similar to an embosser, paper, that is still very wet in the paper machine, is processed. This causes thickness variations that creates different transparency levels.
Translucent paper	Paper which is highly transparent due to a special way of crushing the fibers.

---

## Paper properties

Paper property	Description
Weight	In grams per square meter ( $\text{g/m}^2$ ).
Caliper	Thickness of the paper expressed in $\mu\text{m}$ .
Absolute moisture content	The absolute moisture content is the ratio between the total amount of water in the paper and the weight of the paper (including fibers, fillers, binders and water).
Relative moisture content	The relative moisture content equals the relative humidity of the surrounding air, in equilibrium with the paper.
Smoothness	A paper property characterized by the roughness value, i.e. the size of tips and valleys on the paper's surface measured in PPS $\mu\text{m}$ , Bendtsen, Bekk, or sheffield.
Brightness	Total amount of visible light reflected by the paper. Adequate paper brightness is necessary to provide high-contrast images.
Bulk	The thickness of paper, in terms of the number of pages per inch for a given basis weight.
Formation	The formation of paper depends on the structure of cellulose fibers, which, in turn, depends on the construction of the paper machine and the composition of the pulp.
Opacity	Opacity is the opposite of transparency. The lower the opacity, the more you can see through the paper. Thin papers usually have a lower opacity.
Gloss	The amount of incident light under a certain angle that the paper reflects with the same angle.



---

## Guidelines for Print Medium Quality Inspection

---

### Check Paper Quality

1. Compare the manufacturer's Packaging and Reel Formation information with the Paper Roll specifications listed in the following table.

<b>Roll Dimensions</b>		
Description	Dimension (USA)	Dimension (EU)
Inner Core Diameter	3" -0/+ .02	75mm ±.5
	6" -0/+ .02	150mm ±.5
Maximum Roll Diameter	19.7"	500mm
Typical Roll Diameter	15.75"	400mm
Maximum Roll Weight	188 lbs	85 kg
Roll Width	19.7" - 20"	500mm - 508mm

<b>Roll Specifications</b>
----------------------------

The paper must be free from splices, tears, dents, holes and other physical defects. The paper should be flush with the core and must not slide axially over the core.
--

2. Paper Formation  
Good paper formation is very important to obtaining good print and finish quality. A paper with poor formation quality produces a high degree of uneven print, mottling, and release of fibers. Non-uniform texture affects the uniformity of resistivity, causing uneven toner transfer to the paper.
3. Moisture content  
Moisture content should be consistent from roll to roll and also within a roll. Uneven moisture content can cause unstable print quality. Too high a moisture content can cause wrinkling (especially with thin paper), curling, and poor print quality. See "Artifact Samples" on page 21.
4. Surface smoothness  
A smooth paper surface greatly improves print quality because the contact area between the paper and the imaging drum is more uniform.

## Guidelines for Print Medium Storage and Handling

- Print Medium for the InfoPrint Color 100 needs to be wrapped moisture tight on a continuous basis (including unused partial roll).
- Print Medium for InfoPrint Color 100 needs to be stored on a wood shelf, moisture tight, for 48 hours or longer to allow the paper to reach equilibrium with the printing room environment prior to printing.
- The moisture content of the print medium (especially paper) for the InfoPrint Color 100 should not be allowed to vary. The variation needs to be within  $\pm 0.1\%$ . If the moisture content varies outside of this range within the roll or from roll to roll, the paper conditioning script may not work consistently.

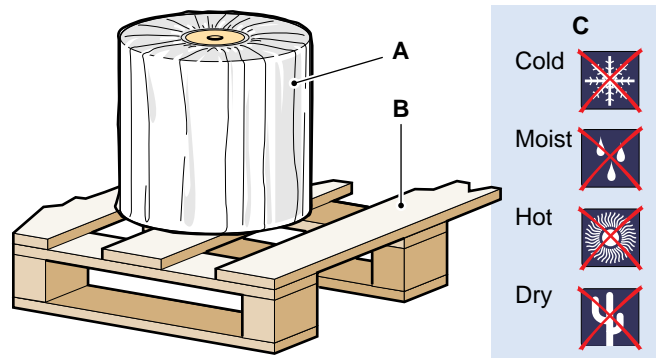

Precaution	Reason
Store the rolls in their original package in the printer room for 48 hours or longer, depending on the difference between the ambient temperature and that of the roll. (A)	During long term storage the paper roll needs to retain the moisture content as shipped from the paper mill. If the paper roll is at a different temperature from that of the print room while printing, the paper can lose or absorb moisture, causing print quality problems.
Store rolls on a pallet, not on a cold or warm surface. (B)	A roll containing warmer or colder areas cannot be conditioned uniformly in the paper supply (PRS) of the InfoPrint Color 100.
Store rolls under normal ambient conditions. Avoid extreme temperature and moisture conditions. (C)	If the rolls are stored under extreme conditions, the paper-dependent parameters will not match the paper properties.
Remove the roll from the paper supply of the machine after printing and wrap the roll in its original package.	Over night the outer windings of a paper roll may attract or lose a substantial amount of moisture.

## Splicing

Always make sure that no adhesive substance is left near the splice on either side of the web.

Apply an additional single-sided tape over the exposed edge if you are making a splice between two different print media, as shown in the table below. This will minimize jams and broken splices.

Print medium in paper supply	Print medium in engine
label stock	any medium
film	any medium
any medium	film
stiff material (250 g/m <sup>2</sup> paper)	any medium

## Roll inspection

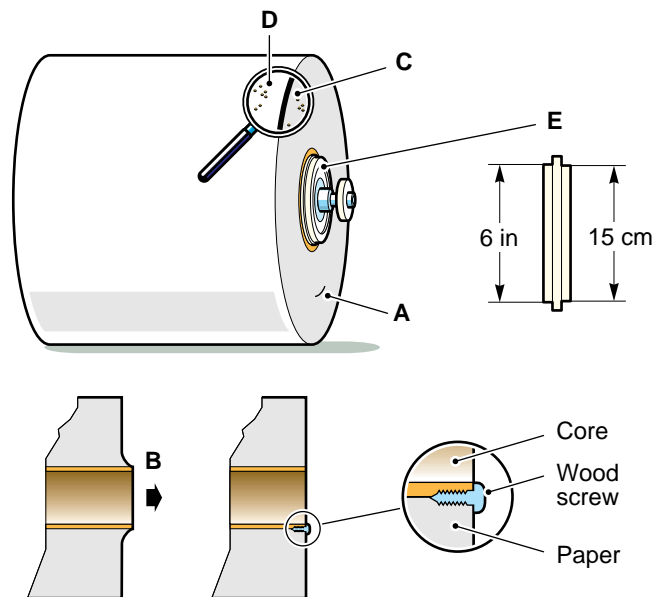

1. Check whether the roll is guaranteed splice free. (A)
  - a. If there is a factory splice. Stop printing as soon as the splice lies within a few millimeters of the outer windings.
  - b. Cut the paper at the splice table and unwind the roll until you can remove the factory splice.
  - c. Then splice the paper together again using the standard splicing procedure.
2. Check whether the paper is wound around the core tightly to prevent the web from shifting left/right. (B)
  - a. If the paper is not tightly wound around the core a wood screw can be used as a “first-aid solution” to secure the paper to the core. See illustration above.
  - b. If this situation occurs, contact your paper supplier and report a quality issue.
3. Check for dust on roll sides and surface.
 

**Note:** Do Not put the brake onto the roll before you have removed any dust.

  - a. Remove dust from the sides of the roll using either an adhesive rubber roller or a vacuum cleaner. (C)
  - b. Remove dust from the roll surface by removing the first winding of paper. (D)

- c. If dust appears on the paper surface of the entire roll, contact your paper supplier.
4. Verify that the paper axle mounting flanges are mounted correctly for the current paper roll inner core diameter. (E)

---

## Paper Waste During Printing and Waste Reduction (PES code 3.10)

Paper waste is one of the biggest concerns to the press industry. To reduce the amount of paper waste to minimum levels, you must first understand the causes of paper waste in the InfoPrint Color 100. This section explains where paper waste occurs when printing with the InfoPrint Color 100 and how to minimize it.

### Start of a Print Job

Whenever you send a job to print, the printer will always respond by cutting one blank sheet (size varies). The printer will then stop and wait for the fuser to reach its set point.

#### Auto Mode

1. Paper conditioning

At normal start-up or sitting for a length of time, you will need to run a minimum of 33 A4 equivalent size blanks to get the paper conditioning system to reach its required criteria. Some paper types may take a longer time (more blanks), depending on the weight and quality of paper. The Gloss Enhancement Module (GEM) also requires additional time to warm up. It can take 20 to 25 blank sheets minimum of about A4 size (depending on parameters set) to get the GEM to warm from 30°C to 100°C during a typical first run in the morning. The GEM starts to warm up at the same time the PRS begins to condition the paper.

Usually it takes a little longer to get paper conditioned when you start the machine and print the first job of the day. Or right after you have changed to a different paper. This is because the machine has not yet determined the conditioning temperature needed for your specific environment, specific paper and the initial values to be used.

2. Starting the image

Once the paper has reached the proper condition, and the GEM is at the correct temperature, the printer will begin to image. After imaging starts, the printer will cut 25 A4 equivalent blank sheets, plus two blank sheets of the current job size before your job will appear at the cutter.

#### Manual Mode

In Manual print mode the number of blanks sheets can be either reduced or increased, depending on the quality of the material, the experience of the operator, the quality requirements for the print job, and other factors.

### Finishing the Print Job

1. At the end of the last job, the printer will cut 4 A4 equivalent blank sheets, (dependent on the White length size).
2. Between jobs, if the 1st and 2nd jobs are both simplex<sup>1</sup>, (or both duplex<sup>2</sup>) the printer will output 4 A4 equivalent blank sheets the size of the second job. If you switch between duplex and simplex, the printer will output 11 A4 equivalent blank sheets the size of the next job.  
In the situation that the 2nd job has not been completely loaded to the print heads the number of blank sheets will be increased.

### Changing the Paper Roll

1. Paper left over from a previous roll also contributes to paper waste. The Operator needs to replace

---

1. Must be printing from the same tower (either X or Y).

2. Must have image data on both sides of paper for both jobs. If a duplex job does not have an image on one side it is treated as a simplex job.



the paper roll when receiving the "Paper Low" alarm. Close to the end of the paper roll, the paper tension is not very stable. This condition can cause a print quality problem. The Operator must avoid running the end of the paper through the printer. Running the end of the paper through the printer can cause damage to sensitive parts, taking the printer down for several hours while the damage is repaired.

2. When a new roll is spliced in, the splice must be completely driven through the printer before starting (or resuming) a print job. The engine will stop driving the paper out at about one meter past the splice. This can be controlled by the operator or by changing the splice\_delay value in the params.set file. If needed, ask your IBM Customer Engineer to change this value.

## Operator Skills

Operator inexperience can cause additional unusable prints and/or blank sheets due to (but not limited to):

1. Out of specification densities.
2. Out of specification registration.
3. Dirty corona wires causing print defects.
4. Starting to print before the printer is conditioned to the correct temperature and humidity.
5. Reloading the conditioning script when a new roll of the same media is mounted.
6. The GEM is switched On and Off during printing.
7. The job is sent to print before the heating drum reaches its standby temperature.
8. The job is sent to print in the non-GEM mode before the GEM has cooled.

## Paper Quality

Paper Quality can be affected by improper manufacturing, handling, or storage. This can cause unstable conditioning and registration, contributing to the number of unusable prints or blank sheets. You should always protect stored paper in moisture tight packaging. Do not use the paper before it reaches the same temperature as the print room.

## Environment

In a humid print room environment, paper can easily become curled, wavy, or even wrinkled depending on its thickness. These conditions can be minimized by reducing the fusing temperature, GEM temperature, or possibly the U2 value.



---

## Artifact Samples

There are a number of common artifacts that can be corrected by optimizing parameters. See the section “Description of paper-dependent parameters” on page 29 for additional information on machine/paper parameters.

The following artifact samples (and the suggested actions) should not be used until the following items have been addressed.

1. Has periodic maintenance/cleaning been performed?
2. Has the new medium been acclimated (at least 48 hours)?
3. Is current print quality, on a known paper, good?

If you answered No, to any of the above questions Do Not proceed until the machine is clean, functioning properly and the new medium has been acclimated.

Artifact	Page No.
Low-density cloudiness	22
High-density cloudiness	22
High-frequency cloudiness	23
Periodic low-density bands	23
Weak cloudiness	24
Low-density speckles	24
Low-density spots	25
Gloss too low	25
GEM hot offset	26
Worm like streaks	26
Wrinkling in the PRS	27
Micro-blistering from the fuser	27
Non-uniform transfer quality across the web	28

**Note:** This book is being distributed in both hard copy and online versions. If you are using the online version to print a copy, be aware that your choice of paper and the print quality of the printer that you use to print it on can affect the appearance of the artifact samples. Use a known paper, that has excellent print quality characteristics on a printer that does not have any print quality problems.

## Low-density cloudiness

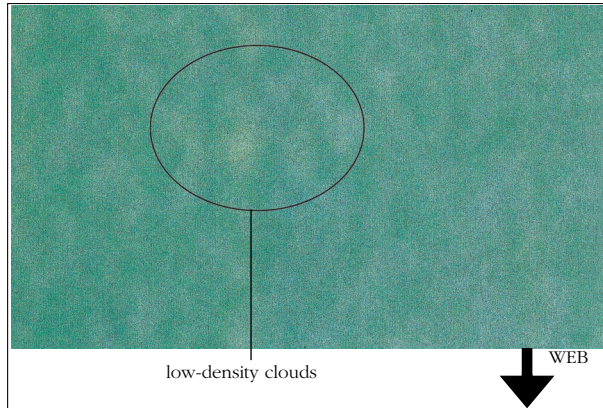

Description	Cause	Solution
Light clouds of 0.5 to 1cm in diameter in a darker surrounding. They have a reduced density and occur against a background of normal density. They are not clearly edged.	Transfer currents too low.	Increase transfer currents in steps of 20%.

## High-density cloudiness

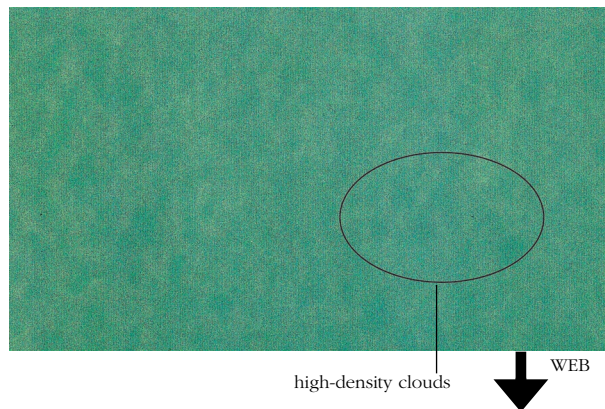

Description	Cause	Solution
Dark clouds of 0.1 to 0.5cm in diameter in a lighter surrounding, equivalent to the mottle structure of the paper. They have a normal density and appear against a background of reduced density. They are clearly edged.	Transfer currents too high.	Decrease transfer currents in steps of 20%.

## High-frequency cloudiness

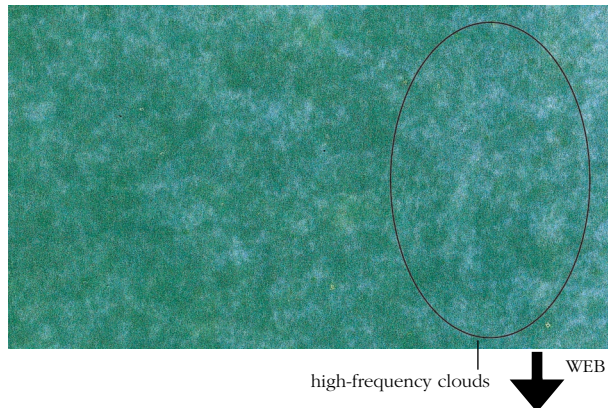

Description	Cause	Solution
Irregular low-density clouds, especially occurring at the borders of the web.	Duplex currents too high.	Decrease positive duplex currents in steps of $20\mu\text{A}$ and negative duplex currents in steps of $10\mu\text{A}$ .

## Periodic low-density bands

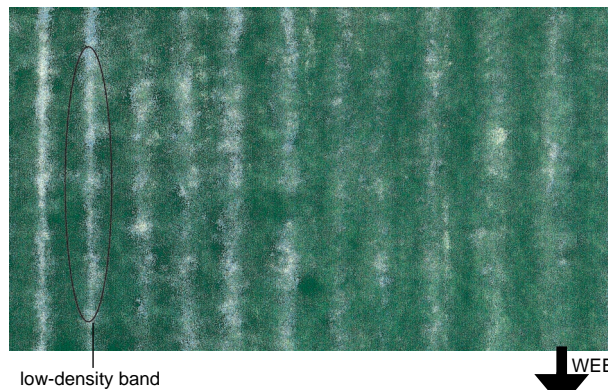

Description	Cause	Solution
Low-density bands along the web, appearing in duo-color planes over the whole web width. They do not occur in mono-color planes.	Duplex currents too low.	Increase the positive duplex currents in steps of $10\mu\text{A}$ and the negative duplex currents in steps of $5\mu\text{A}$ .

## Weak cloudiness



Description	Cause	Solution
Small amount of cloudiness. It is not easy to determine what type of cloudiness it is.	Transfer current too high or too low.  Duplex currents too high or too low.	Decrease or increase the transfer current in steps of 10 $\mu$ A.  Decrease or increase the duplex current in steps of 10 $\mu$ A (positive) and 5 $\mu$ A (negative).

## Low-density speckles

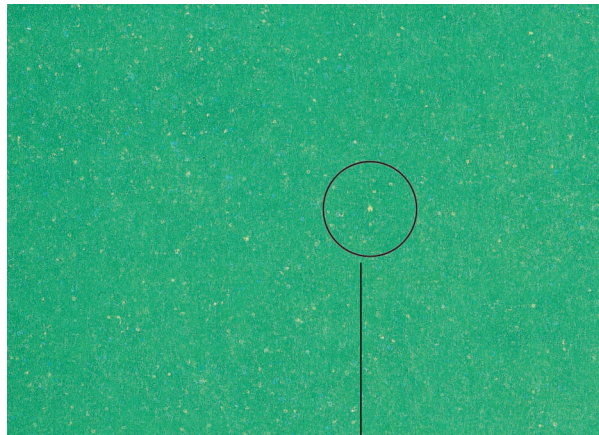

Description	Cause	Solution
Tiny round speckles ranging from 1 to 2mm in diameter with reduced density and sharply outlined.	Transfer currents too high.	First, reduce IPS/U2.N2 in steps of 20V. Decrease transfer currents in steps of 10 $\mu$ A. Increasing duplex currents may also be desirable but not always necessary.



## Low-density spots

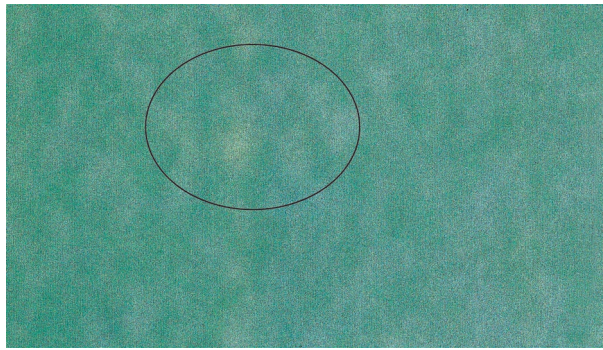

Description	Cause	Solution
Spots having an irregular shape and not sharply outlined.	Paper surface too rough.	Owing to the cause, this artifact cannot be eliminated.

## Gloss too low



Description	Cause	Solution
The gloss is visibly too low.	Temperature set points IFX/T5.N22 and IFX/T6.N22 are too low.	Increase temperature set points IFX/T5.N22 and IFX/T6.N22 of both roll pairs in steps of 2°C.
		If IFX/T5.N22 and IFX/T6.N22 are too high, GEM hot offset will appear. Therefore, decrease temperature set points IFX/T5.N22 and IFX/T6.N22 again by 2°C until the lines disappear (see "GEM hot offset" on page 26).

## GEM hot offset

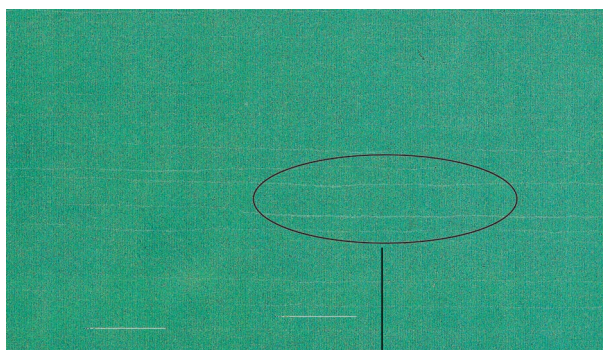

hot offset line



Description	Cause	Solution
When looking at the gloss of the image, recurrent very narrow lines, similar to scratches or cracks across the web, are visible.	Temperature set points IFX/T5.N22 and IFX/T6.N22 are too high.	Decrease temperature set points IFX/T5.N22 and IFX/T6.N22 of both roll pairs in steps of 2°C until the offset lines disappear.

## Worm like streaks

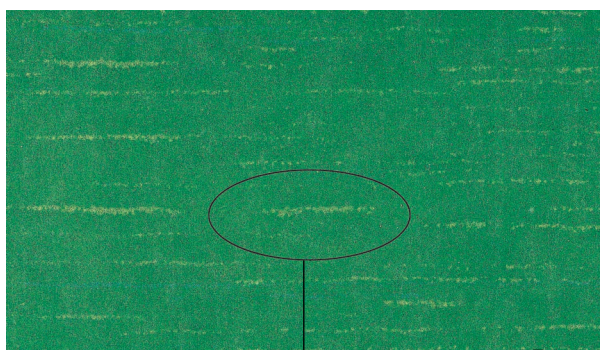

wormlike streak



Description	Cause	Solution
Tiny snakes, especially visible in duo-colors and on papers weighing more than 150 g/m <sup>2</sup> .	Erase voltage is too high.	Consult your service technician to reduce the erase voltage.
	IPS/U2.N2 is too high (if erase voltage was correct).	To eliminate the worms completely, reduce IPS/U2.N2 in steps of 20 to 40V (depending on the quantity and severity of the worms). Then, transfer currents must always be decreased.



## Wrinkling in the PRS

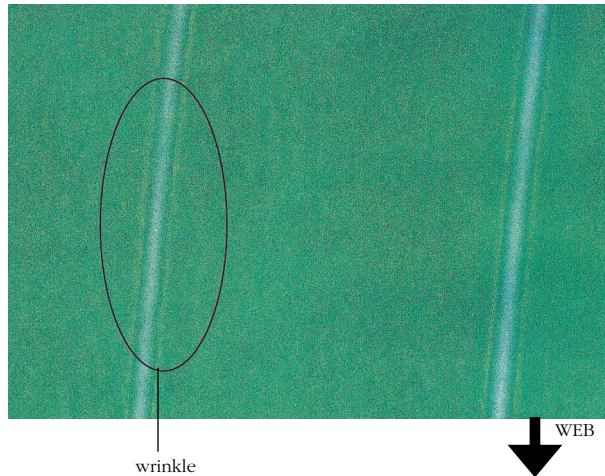

Description	Cause	Solution
Bent and slanted wrinkles across the whole web on print media weighing less than 100 g/m <sup>2</sup> . Since the wrinkles occur before the paper is printed, weak transfer occurs in and around the wrinkles.	Pre-heating roll temperature is too high, causing temperature shock.	Decrease paper conductivity set point IPS/U2.N2 in steps of 20V, so that the pre-heater's temperature decreases. Transfer currents must also be decreased.

## Micro-blistering from the fuser



Description	Cause	Solution
Tiny craters are visible (you can see the underlying toner) and tangible (the printed surface is rough and the tops of the craters can be rubbed away). Sometimes, only the underlying toner and small glossy dots are visible.	Due to the high temperature of the paper traveling through the fuser; excess moisture in the paper erupts like tiny volcanos, especially in high coverage areas.	Reduce IFX/T3.N2 in steps of 5°C until the artifact disappears.

## Non-uniform transfer quality across the web

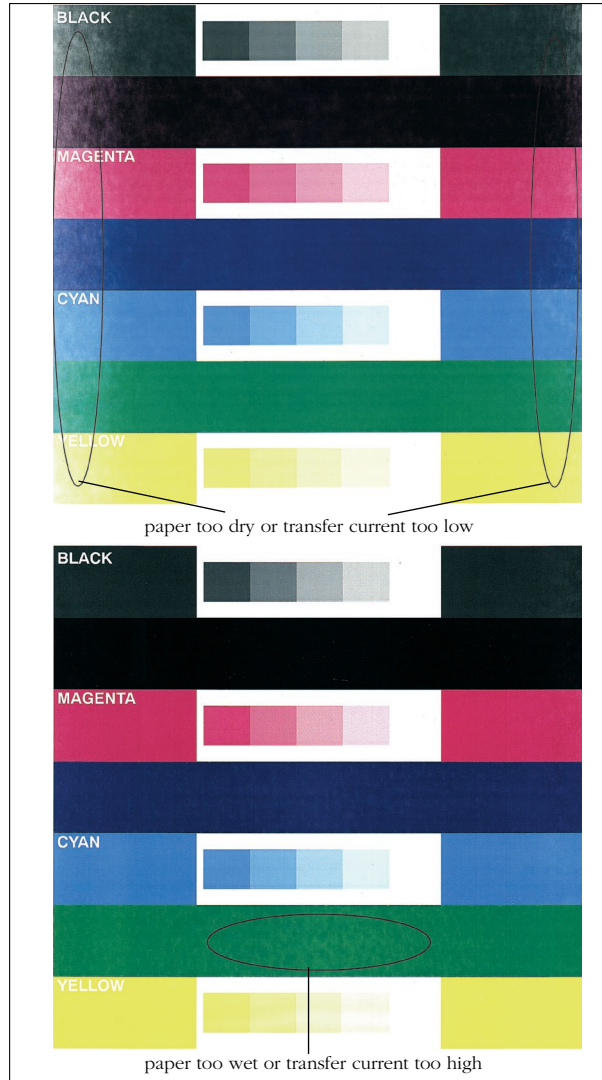

Description	Cause	Solution
<p>Either transfer quality is good in the center of the web, and poor at the border, or vice versa. The image will always be clouded either in the center (high-density clouds because of transfer current too high) or at the border (low-density clouds because of transfer current too low).</p>	<p>Moisture content of the paper too high.</p>	<p>Due to the limited drying capacity of the pre-heater, this artifact cannot be eliminated.</p>
	<p>Inappropriate storage of paper reels (more moisture towards the edges).</p>	<p>Paper reel cannot be used. To prevent this problem, wrap each reel in a moisture-tight package.</p>

# Description of paper-dependent parameters

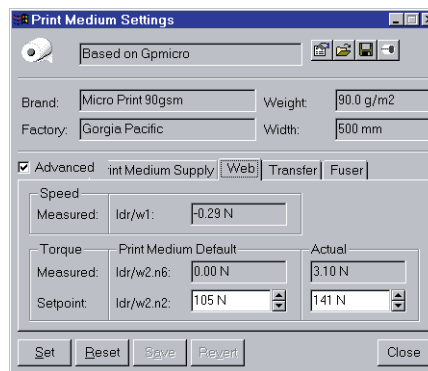
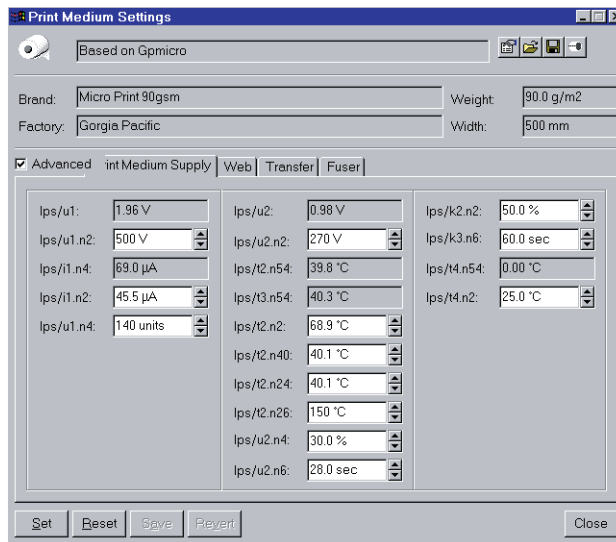
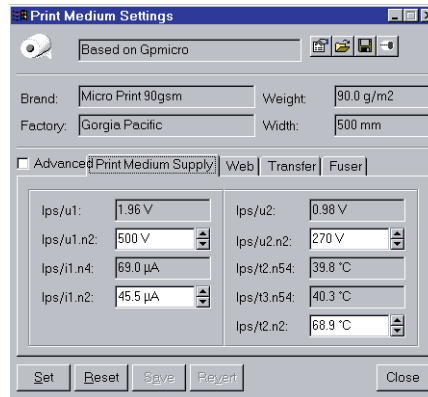

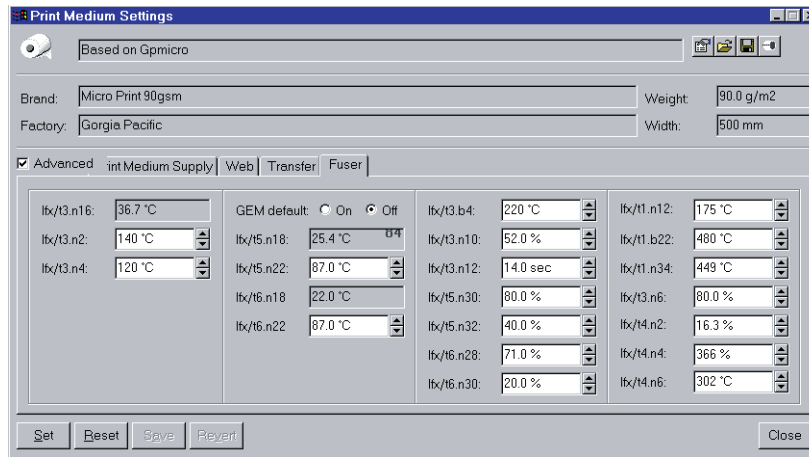
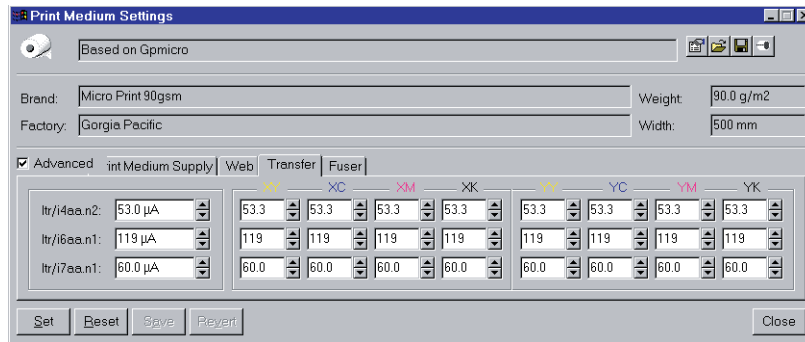

The table below briefly describes the paper-dependent parameters that can be found in XPOSE.

Parameter	Description
ICN/T9.N8	Current duty cycle valve PRS cooling
IDR/W2.N2	Current setpoint torque measurement
IFX/T1.B22	Power cut off temperature level fusing system
IFX/T1.N12	Setpoint temp. of FIX heat. el. (standby mode)
IFX/T1.N34	Maximum warmup element temperature
IFX/T3.B4	Alarm level high temperature of medium
IFX/T3.N10	FIX P-control parameter
IFX/T3.N12	FIX I-control parameter
IFX/T3.N2	Setpoint temperature of medium without GEM
IFX/T3.N4	Setpoint temperature of medium with GEM
IFX/T3.N6	D coefficient T1=f(T3)
IFX/T4.N2	A coef. T1=f(T4)
IFX/T4.N4	B coef. T1=f(T4)
IFX/T4.N6	D coef. T1=f(T4)
IFX/T5.N22	Setpoint temp. upper rollers running mode

Parameter	Description
IFX/T5.N30	I preset duty cycle upper rollers (temp 20 C)
IFX/T5.N32	I preset duty cycle upper rollers (temp 100 C)
IFX/T6.N22	Setpoint temp. lower rollers running mode
IFX/T6.N28	I preset duty cycle lower rollers (temp 20 C)
IFX/T6.N30	I preset duty cycle lower rollers (temp 100 C)
IFX/T7.N4	Default setting activation GEM
IFX/T8.N2	Setpoint preheating roll temperature during ru
IFX/T8.N4	Setpoint preheating roll temperature (standby)
IPS/I1.N2	Limiting charge current
IPS/K2.N2	Initial setpoint duty cycle dryer 1
IPS/K3.N6	Setpoint time web startup
IPS/T2.N2	Initial setpoint temperature dryer 1
IPS/T2.N24	Minimum temperature dryer 1 run mode
IPS/T2.N26	Maximum temperature dryer 1 run mode
IPS/T2.N34	PRS I/PRS II control strategy selector
IPS/T2.N40	PRS-standby temperature
IPS/T4.N10	I factor medium temp control PRS cooling
IPS/T4.N14	Correction coefficient far potential control
IPS/T4.N2	Setpoint medium temperature control T4
IPS/T4.N8	P factor medium temp control PRS cooling
IPS/U1.N2	Setpoint near charge potential control
IPS/U1.N4	Parameter I regulation
IPS/U2.N2	Setpoint far charge potential control
IPS/U2.N4	Proportional factor far charge potential loop
IPS/U2.N6	Integration factor far charge potential loop
ITR/I4XQ.N2	Setpoint transfer current X1
ITR/I4XS.N2	Setpoint transfer current X3
ITR/I4XR.N2	Setpoint transfer current X2
ITR/I4XT.N2	Setpoint transfer current X4
ITR/I4XP.N2	Setpoint transfer current X0
ITR/I4YQ.N2	Setpoint transfer current Y1
ITR/I4YS.N2	Setpoint transfer current Y3
ITR/I4YR.N2	Setpoint transfer current Y2
ITR/I4YT.N2	Setpoint transfer current Y4
ITR/I4YP.N2	Setpoint transfer current Y0
ITR/I6XQ.N1	Setpoint positive duplex current X1

<b>Parameter</b>	<b>Description</b>
ITR/I6XS.N1	Setpoint positive duplex current X3
ITR/I6XR.N1	Setpoint positive duplex current X2
ITR/I6XT.N1	Setpoint positive duplex current X4
ITR/I6XP.N1	Setpoint positive duplex current X0
ITR/I6YQ.N1	Setpoint positive duplex current Y1
ITR/I6YS.N1	Setpoint positive duplex current Y3
ITR/I6YR.N1	Setpoint positive duplex current Y2
ITR/I6YT.N1	Setpoint positive duplex current Y4
ITR/I6YP.N1	Setpoint positive duplex current Y0
ITR/I7XQ.N1	Setpoint negative duplex current X1
ITR/I7XS.N1	Setpoint negative duplex current X3
ITR/I7XR.N1	Setpoint negative duplex current X2
ITR/I7XT.N1	Setpoint negative duplex current X4
ITR/I7XP.N1	Setpoint negative duplex current X0
ITR/I7YQ.N1	Setpoint negative duplex current Y1
ITR/I7YS.N1	Setpoint negative duplex current Y3
ITR/I7YR.N1	Setpoint negative duplex current Y2
ITR/I7YT.N1	Setpoint negative duplex current Y4
ITR/I7YP.N1	Setpoint negative duplex current Y0

## List of IBM Recommended Print Media for InfoPrint Color 100

### Important Notes:

1. Select the medium based on your application needs. Be sure you understand the meaning of the Performance Rating before making any decision.
2. Except as noted all scripts are translated from InfoColor 70 scripts. Some scripts may require additional tweaking of the control parameters to achieve desired print quality.
3. Make sure paper is stored properly at all times.
4. Request splice free material from your paper distributor.

Please visit <http://www.printers.ibm.com/manuals.html> for the latest list.

### Uncoated Paper

Paper Script Location: Media\Paper\

Brand Name	Weight (g/m <sup>2</sup> )	Type/Description	Manufacturer/Distributor	Script Name	Performance Rating	Comment
DigiSmooth 60	60	Calendered	Enso / Tervakoski 973-635-3530 US	Factory\Uncoated\ DIGISM60	1A	
Mitsubishi II	60	Uncoated	Mitsubishi Japan	IBM\JAPAN\JM60G	1A	Contact IBM Japan for more information
NopaColor Digi 60	60	Uncoated	Nordland Papier (UPM- Kymmene) 914-332-4444 US	Factory\Uncoated\ NOCOD060	1A	
Compat Clearbrite 17#	63	Translucent uncal- endered	Nationwide Papers 800-323-1003 US	IBM\NATIONWD\ NW63CB	1A	
Mitsubishi I	64	Contact IBM Japan for more information	Mitsubishi Japan	IBM\JAPAN\JM64G	1A	Contact IBM Japan for more information
Westminster Trade Book	66	Calendered with vellum finish	Georgia Pacific	IBM\GPACIFIC\ GP66WMTB	1A	
Digital Publishing Text	66	Calendered	Georgia Pacific 800-386-8118 US	IBM\GPACIFIC\ GP66MCDI	1A	
Springhill Incentive 100 DP 50#	74	Calendered, 100% Recycled	International Paper 814-870-6282 US	IBM\INTPAPER\ SPIDP074	1A	

Brand Name	Weight (g/m2)	Type/Description	Manufacturer/Distributor	Script Name	Performance Rating	Comment
4CC 80	80	Calendered	Enso / Tervakoski 973-635-3530 US	Factory\Uncoated\ 4CCN080	1A	
Digisuperior 80	80	Calendered	Enso Group	IBM\ENSODISUP0 80	1A	
Hokuetsu	80	Contact IBM Japan for more information	Hokuetsu Japan	IBM\JAPAN\JH80G	1A	Contact IBM Japan for more information
Lenza-Top-Recycling	80	Calendered, 100% Recycled	Lenzing Papier AG 43-7672-701-3465 Austria	IBM\LENZING\ LENTRO80	1A	Rough surface. Use at your own risk.
Lenza-Top-Recycling- Super	80	Calendered, 100% Recycled	Lenzing Papier AG 43-7672-701-3465 Austria	IBM\LENZING\ LENTRO80	1A	Rough surface. Use at your own risk.
NopaColor Digi 80	80	Super-calender	Nordland Papier (UPM- Kymmene) 914-332-4444 US	Factory\Uncoated\ NOCOD080	1A	
Springhill Opaque Smooth 60#	89	Calendered	International Paper	IBM\INTPAPER\ SPHOS089	1A	
Hamermill Accent Opaque Luster White 60#	89	Calendered	International Paper 814-870-6282 US	IBM\INTPAPER\ HMAOW089	1A	
Brazil Chamex Premium 90	90	Calendered, wood- free	Champion, Brazil	IBM\CHAMPION\ CHMEX090	1A	
Microprint DCP	90	Calendered	Georgia Pacific 800-386-8118 US	IBM\GPACIFIC\ GP90MDCP	1A	
Rolltek Opaque Text 60#	90	Not calendered	Rollsource 612-331-2900 US	IBM\ROLLTEK\ RT90-OPQ	1A	
MultiCopy 90	90	Calendered	Stora Kabel	IBM\STORA\ STMLC090	1A	
Lightening Laser 24#	90	Calendered	Union Camp 757-569-5131 US	IBM\UNCAMP\ UCLL090	1A	
IvoLaser 95	95	Calendered	Steinbach Intermills 978-834-0002 US	Factory\Uncoated\ IVOL095	1A	
DCP 100	100	Uncoated	Clairefontaine	Factory\Uncoated\ DCP100	1A	



Brand Name	Weight (g/m2)	Type/Description	Manufacturer/Distributor	Script Name	Performance Rating	Comment
4CC 100	100	Calendered	Enso / Tervakoski 973-635-3530 US	Factory\Uncoated\ 4CCN100	1A	
Galilei Opal 100	100	Calendered	Metsä-Serla 358-1046-45346 Finland	Factory\Uncoated\ MSGO100	1A	
MoDo Ebene Satin/Data-copy Digital 100	100	Calendered	MoDo Paper PSM	IBM\MODO\ MOEBS100	1A	
NopaColor Digi 100	100	Super-calender	Nordland Papier (UPM-Kymmene) 914-332-4444 US	Factory\Uncoated\ NOCOD100	1A	
Aussedat Rey/Zanders Imaging Natura 100	100	Calendered	Zanders	Factory\Uncoated\ ARZIN100	1B	
Beckett Expression Text Snow Smooth 70#	104	Calendered	International Paper 814-870-6282 US	IBM\INTPAPER\ BKETS104	1A	
Recycled Super Smooth 70# Text	104	Not calendered, Recycled	Nationwide Papers	IBM\NATIONWD\ NW104RSS	1A	
Hokuetsu	105	Contact IBM Japan for more information	Hokuetsu Japan	IBM\JAPAN\JH105G	1A	Contact IBM Japan for more information
IvoLaser 105	105	Calendered	Steinbach Intermills 978-834-0002 US	Factory\Uncoated\ IVOL105	1A	
Mitsubishi	106	Contact IBM Japan for more information	Mitsubishi Japan	IBM\JAPAN\JM106G	1A	Contact IBM Japan for more information
Lenza-Plakat	110	Not calendered	Lenzing Papier AG 43-7672-701-3465 Austria	IBM\LENZING\ LENPL110	1A	Rough surface. Use at your own risk.
Finch Fine 118	118	Calendered	Finch, Pruyn & Co., Inc. 518-793-2541 US	Factory\Uncoated\ FPCFF118	3	Use at your own risk.
Solar White Classic Crest 80# Text	118	Calendered	Neenah 800-558-5061 US	IBM\NEENAH\ NNSW118	1A	
Lightening DCP 73#	118	Calendered	Union Camp 757-569-5131 US	IBM\UNCAMP\ UCLD118	1A	
Microprint DCP	120	Calendered	Georgia Pacific 800-386-8118 US	IBM\GPACIFIC\ GP120MDC	1A	

Brand Name	Weight (g/m2)	Type/Description	Manufacturer/Distributor	Script Name	Performance Rating	Comment
Galilei Opal 120	120	Calendered	Metsä-Serla 358-1046-45346 Finland	Factory\Uncoated\ MSGO120	1A	
Color Copy R 120	120	Calendered	Neusiedler	Factory\Uncoated\ COCOR120	1A	
NopaColor Digi 120	120	Super-calender	Nordland Papier (UPM- Kymmene) 914-332-4444 US	Factory\Uncoated\ NOCOD120	1A	
DCP 130	130	Calendered	Clairefontaine	Factory\Uncoated\ DCP130	1A	
4CC 130	130	Calendered	Enso / Tervakoski 973-635-3530 US	Factory\Uncoated\ 4CCN130	1A	
IvoLaser 135	135	Calendered	Steinbach Intermills 978-834-0002 US	Factory\Uncoated\ IVOL135	1A	
Book Design Smooth 150	150	Calendered	Klippan AB 46-478-10600 Sweden	Factory\Uncoated\ KLIBD150	1A	
NopaColor Digi 150	150	Super-calender	Nordland Papier (UPM- Kymmene) 914-332-4444 US	Factory\Uncoated\ NOCOD150	1A	
Finch Fine Reply Card 155	155	Calendered	Finch, Pruyn & Co., Inc. 518-793-2541 US	Factory\Uncoated\ FPCFF155	3	Use at your own risk.
DCP 160	160	Calendered	Clairefontaine	Factory\Uncoated\ DCP160	1A	
4CC 160	160	Calendered	Enso / Tervakoski 973-635-3530 US	Factory\Uncoated\ 4CCN160	1A	
High Tech Special 160	160	Calendered	Klippan AB 46-478-10600 Sweden	Factory\Uncoated\ KLIHT160	1A	
Galilei Opal 160	160	Calendered	Metsä-Serla 358-1046-45346 Finland	Factory\Uncoated\ MSGO160	1A	
Color Copy R 160	160	Calendered	Neusiedler	Factory\Uncoated\ COCOR160	1A	

Brand Name	Weight (g/m2)	Type/Description	Manufacturer/Distributor	Script Name	Performance Rating	Comment
IvoLaser 160	160	Calendered	Steinbach Intermills 978-834-0002 US	Factory\Uncoated\ IVOL160	1A	
110 Index	163	Super-calender, 9pt Recycled	Dunsirn Industries 800-593-1588 US	IBM\DUNSIRN\ DI163IN	1A	
Microprint DCP 100# Text	163	Calendered	Georgia Pacific 800-386-8118 US	IBM\GPACIFIC\ GP163MDC	1A	
NopaColor Digi 170	170	Super-calender	Nordland Papier (UPM- Kymmene) 914-332-4444 US	Factory\Uncoated\ NOCOD170	1A	
Solar White Classic Crest 65#cvr	176	Calendered	Neenah 800-558-5061 US	IBM\NEENAH\ NNSW176	1A	
DCP 190	190	Calendered	Clairefontaine	Factory\Uncoated\ DCP190	1A	
4CC 190	190	Calendered	Enso / Tervakoski 973-635-3530 US	Factory\Uncoated\ 4CCN190	1A	
NopaColor Digi 190	190	Super-calender	Nordland Papier (UPM- Kymmene) 914-332-4444 US	Factory\Uncoated\ NOCOD190	1A	
IvoLaser 190	190	Calendered	Steinbach Intermills 978-834-0002 US	Factory\Uncoated\ IVOL190	1A	
DataCopy Digital 200	200	Calendered	MoDo Paper PSM 46-660-421000 Sweden	Factory\Uncoated\ DACOD200	1A	
Color Copy R 200	200	Calendered	Neusiedler	Factory\Uncoated\ COCOR200	1A	
4CC 220	220	Calendered	Enso / Tervakoski 973-635-3530 US	Factory\Uncoated\ 4CCN220	1A	
IvoLaser 240	240	Calendered	Steinbach Intermills 978-834-0002 US	Factory\Uncoated\ IVOL240	1A	
4CC 250	250	Calendered	Enso / Tervakoski 973-635-3530 US	Factory\Uncoated\ 4CCN250	1B	

<b>Brand Name</b>	<b>Weight (g/m2)</b>	<b>Type/Description</b>	<b>Manufacturer/Distributor</b>	<b>Script Name</b>	<b>Performance Rating</b>	<b>Comment</b>
DataCopy Digital 250	250	Calendered	MoDo Paper PSM 46-660-421000 Sweden	Factory\Uncoated\ DACOD250	1A	
Color Copy R 250	250	Calendered	Neusiedler	Factory\Uncoated\ COCOR250	1A	

## Coated Paper

Paper Script Location: Media\Paper\

Brand Name	Weight (g/m2)	Type/Description	Manufacturer/Distributor	Script Name	Performance Rating	Comment
Hanno'Art Tecgloss 80	80	Glossy Coated	Sappi Europe	Factory\Coated_G\ HAGLO080	1B	
Hanno'Art Tecsilks 80	80	Matte Coated	Sappi Europe	Factory\Coated_M\ HASIL080	1B	
60# Semi-gloss CS2 Web	90	Gloss, Web Enamel	Dunsirn Industries 800-593-1588 US	IBM\DUNSIRN\ DI90SGL	1A	
4CC Art 90	90	Glossy Coated	Enso / Oulu Mills 973-635-3530 US	Factory\Coated_G\ DIGIA090	1A	
4CC Silk 90	90	Satin Coated	Enso / Oulu Mills 973-635-3530 US	Factory\Coated_S\ DIGIS090	1B	
Hanno'Art Tecgloss 90	90	Glossy Coated	Sappi Europe	Factory\Coated_G\ HAGLO090	1B	
Hanno'Art Tecsilks 90	90	Matte Coated	Sappi Europe	Factory\Coated_M\ HASIL090	1B	
Lazulis Brillant 90	90	Glossy Coated	Smurfit Condat	Factory\Coated_G\ LAZBR090	1A	
4CC Art 100	100	Glossy Coated	Enso / Oulu Mills 973-635-3530 US	Factory\Coated_G\ DIGIA100	1A	
4CC Silk 100	100	Satin Coated	Enso / Oulu Mills 973-635-3530 US	Factory\Coated_S\ DIGIS100	1B	
DataCopy Option 100	100	Matte Coated	MoDo Paper PSM 46-660-421000 Sweden	Factory\Coated_M\ DACOP100	1A	
Hanno'Art Tecgloss 100	100	Glossy Coated	Sappi Europe	Factory\Coated_G\ HAGLO100	1B	
Hanno'Art Tecsilks 100	100	Matte Coated	Sappi Europe	Factory\Coated_M\ HASIL100	1B	
Lazulis Brillant 100	100	Glossy Coated	Smurfit Condat	Factory\Coated_G\ LAZBR100	1A	

Brand Name	Weight (g/m2)	Type/Description	Manufacturer/Distributor	Script Name	Performance Rating	Comment
Champion Courtland Matte	105	Matte Coated	Champion	IBM\CHAMPION\ CH105CM	1A	
70# Semi-gloss CS2 Web	105	Gloss, Web Enamel	Dunsirn Industries 800-593-1588 US	IBM\DUNSIRN\ DI105SGL	1A	
4CC Art 115	115	Glossy Coated	Enso / Oulu Mills 973-635-3530 US	Factory\Coated_G\ DIGIA115	1A	
4CC Silk 115	115	Satin Coated	Enso / Oulu Mills 973-635-3530 US	Factory\Coated_S\ DIGIS115	1B	
Royal Digital Gloss 115	115	Glossy Coated	KNP Leykam 32-897-19645 Belgium	Factory\Coated_G\ RDGLS115	1A	
Royal Digital Silk 115	115	Satin Coated	KNP Leykam 32-897-19645 Belgium	Factory\Coated_S\ RDSIL115	1A	
Hanno'Art Tecgloss 115	115	Glossy Coated	Sappi Europe	Factory\Coated_G\ HAGLO115	1B	
Hanno'Art Tecsilks 115	115	Matte Coated	Sappi Europe	Factory\Coated_M\ HASIL115	1B	
Lazulis Brillant 115	115	Glossy Coated	Smurfit Condat	Factory\Coated_G\ LAZBR115	1A	
Aussedat Rey/Zanders Imaging Gloss 115	115	Glossy Coated	Zanders	Factory\Coated_G\ ARZIG115	1A	
Aussedat Rey/Zanders Imaging Matt 115	115	Matte Coated	Zanders	Factory\Coated_M\ ARZIM115	1A	
Champion Influence White	118	Glossy Coated	Champion	IBM\CHAMPION\ CH118IW	1A	
Champion Preference White	118	Glossy Coated	Champion	IBM\CHAMPION\ CH118PW	1A	
Champion Influence Soft Gloss 118GSM	118	Glossy Coated	Champion 203-358-6931 US	IBM\CHAMPION\ CH118ISG	1A	
Golden Web Gloss 80# Text	118	Glossy Coated	Nationwide Papers 800-323-1003 US	IBM\NATIONWD\ NW118GW	1A	

Brand Name	Weight (g/m2)	Type/Description	Manufacturer/Distributor	Script Name	Performance Rating	Comment
Rolltek Matte Text	118	Matte Coated	Rollsource	IBM\ROLLTEK\ RT118MTT	1A	
Rolltek Gloss Text	118	Glossy Coated	Rollsource 612-331-2900 US	IBM\ROLLTEK\ RT118GLT	1A	
Lustro Web Gloss 80# Text	118	Glossy Coated	S.D. Warren 303-721-7383 US	IBM\SDWARREN\ WA118LWG	1A	
Champion Courtland Gloss	120	Glossy Coated	Champion	IBM\CHAMPION\ CH120CG	1A	
NopaCoat 120	120	Glossy Coated	Kymenne Nordland/ Russell-Field	IBM\NORDLAND\ NOPAC120	1A	
DataCopy Option 120	120	Matte Coated	MoDo Paper PSM 46-660-421000 Sweden	Factory\Coated_M\ DACOP120	1A	
4CC Art 130	130	Glossy Coated	Enso / Oulu Mills 973-635-3530 US	Factory\Coated_G\ DIGIA130	1A	
4CC Silk 130	130	Satin Coated	Enso / Oulu Mills 973-635-3530 US	Factory\Coated_S\ DIGIS130	1B	
DigiMagic/Magic Gloss 86# Text	130	Glossy Coated	Enso Group 973-635-3530 US	IBM\ENSO\ MG130G	1A	
Galilei Art Gloss 130	130	Glossy Coated	Metsä-Serla 358-1046-45346 Finland	Factory\Coated_G\ MSGAG130	1B	
Galilei Art Silk 130	130	Satin Coated	Metsä-Serla 358-1046-45346 Finland	Factory\Coated_S\ MSGAS130	1B	
MoDo Silverblade Matte 130	130	Matte Coated	MoDo Paper PSM	IBM\MODO\ MOSIM130	1A	
Silverblade Gloss 130	130	Glossy Coated	MoDo Paper Silverdalen	Factory\Coated_G\ SILGL130	1A	
Royal Digital Gloss 135	135	Glossy Coated	KNP Leykam 32-897-19645 Belgium	Factory\Coated_G\ RDGLS135	1A	
Royal Digital Silk 135	135	Satin Coated	KNP Leykam 32-897-19645 Belgium	Factory\Coated_S\ RDSIL135	1A	

Brand Name	Weight (g/m2)	Type/Description	Manufacturer/Distributor	Script Name	Performance Rating	Comment
DataCopy Option 135	135	Matte Coated	MoDo Paper PSM 46-660-421000 Sweden	Factory\Coated_M\ DACOP135	1A	
Satin Matte 135	135	Matte Coated	Russel-Field 800-323-1947 US	IBM\RSLFIELD\ SATMT135	1A	
Satin Gloss 135	135	Glossy Coated	Russell-Field	IBM\RSLFIELD\ SATGL135	1A	
Hanno'Art Tecgloss 135	135	Glossy Coated	Sappi Europe	Factory\Coated_G\ HAGLO135	1B	
Hanno'Art Tecsilks 135	135	Matte Coated	Sappi Europe	Factory\Coated_M\ HASIL135	1B	
Lazulis Brillant 135	135	Glossy Coated	Smurfit Condat	Factory\Coated_G\ LAZBR135	1A	
Aussedat Rey/Zanders Imaging Gloss 135	135	Glossy Coated	Zanders	Factory\Coated_G\ ARZIG135	1A	
Aussedat Rey/Zanders Imaging Matt 135	135	Matte Coated	Zanders	Factory\Coated_M\ ARZIM135	1A	
Rolltek Gloss Text	148	Glossy Coated	Rollsource	IBM\ROLLTEK\ RT148GLT	1A	
Lustro Web Dull 100# Text	148	Dull Coated	S.D. Warren	IBM\SDWARREN\ WA148LWD	1A	
4CC Art 150	150	Glossy Coated	Enso / Oulu Mills 973-635-3530 US	Factory\Coated_G\ DIGIA150	1A	
4CC Silk 150	150	Satin Coated	Enso / Oulu Mills 973-635-3530 US	Factory\Coated_S\ DIGIS150	1B	
Digimatt/Matte Art	150	Matte Coated	Enso Group	IBM\ENSOMA150G	1A	
Royal Digital Gloss 150	150	Glossy Coated	KNP Leykam 32-897-19645 Belgium	Factory\Coated_G\ RDGLS150	1A	
Royal Digital Silk 150	150	Satin Coated	KNP Leykam 32-897-19645 Belgium	Factory\Coated_S\ RDSIL150	1A	
Galilei Art Silk 150	150	Satin Coated	Metsä-Serla 358-1046-45346 Finland	Factory\Coated_S\ MSGAS150	1B	



Brand Name	Weight (g/m2)	Type/Description	Manufacturer/Distributor	Script Name	Performance Rating	Comment
DataCopy Option 150	150	Matte Coated	MoDo Paper PSM 46-660-421000 Sweden	Factory\Coated_M\ DACOP150	1A	
Silverblade Gloss 150	150	Glossy Coated	MoDo Paper Silverdalen	Factory\Coated_G\ SILGL150	1A	
Lazulis Brillant 150	150	Glossy Coated	Smurfit Condat	Factory\Coated_G\ LAZBR150	1A	
Aussedat Rey/Zanders Imaging Gloss 150	150	Glossy Coated	Zanders	Factory\Coated_G\ ARZIG150	1A	
Aussedat Rey/Zanders Imaging Matt 150	150	Matte Coated	Zanders	Factory\Coated_M\ ARZIM150	1A	
Rolltek Gloss Cover	162	Glossy Coated	Rollsource 612-331-2900 US	IBM\ROLLTEK\ RT162GLC	1A	
Colorprint Castcote 110# Text	163	Cast Coated	Nationwide Papers 800-323-1003 US	IBM\NATIONWD\ NW163CC	1A	
4CC Art 170	170	Glossy Coated	Enso / Oulu Mills 973-635-3530 US	Factory\Coated_G\ DIGIA170	1A	
4CC Silk 170	170	Satin Coated	Enso / Oulu Mills 973-635-3530 US	Factory\Coated_S\ DIGIS170	1B	
Sweprint Digital 170	170	Matte Coated	Klippan AB 46-478-10600 Sweden	Factory\Coated_M\ KLISD170	1B	
Royal Digital Gloss 170	170	Glossy Coated	KNP Leykam 32-897-19645 Belgium	Factory\Coated_G\ RDGLS170	1A	
Royal Digital Silk 170	170	Satin Coated	KNP Leykam 32-897-19645 Belgium	Factory\Coated_S\ RDSIL170	1A	
Galilei Art Gloss 170	170	Glossy Coated	Metsä-Serla 358-1046-45346 Finland	Factory\Coated_G\ MSGAG170	1B	
Galilei Art Silk 170	170	Satin Coated	Metsä-Serla 358-1046-45346 Finland	Factory\Coated_S\ MSGAS170	1B	
DataCopy Option 170	170	Matte Coated	MoDo Paper PSM 46-660-421000 Sweden	Factory\Coated_M\ DACOP170	1A	

Brand Name	Weight (g/m2)	Type/Description	Manufacturer/Distributor	Script Name	Performance Rating	Comment
Silverblade Gloss 170	170	Glossy Coated	MoDo Paper Silverdalen	Factory\Coated_G\ SILGL170	1A	
Lazulis Brillant 170	170	Glossy Coated	Smurfit Condat	Factory\Coated_G\ LAZBR170	1A	
Rolltek Matte Cover 7pt.	176	Matte Coated	Rollsource	IBM\ROLLTEK\ RT176MTC	1A	
Royal Digital Gloss 200	200	Glossy Coated	KNP Leykam 32-897-19645 Belgium	Factory\Coated_G\ RDGLS200	1A	
Royal Digital Silk 200	200	Satin Coated	KNP Leykam 32-897-19645 Belgium	Factory\Coated_S\ RDSIL200	1A	
DataCopy Option 200	200	Matte Coated	MoDo Paper PSM 46-660-421000 Sweden	Factory\Coated_M\ DACOP200	1A	
Silverblade Gloss 200	200	Glossy Coated	MoDo Paper Silverdalen	Factory\Coated_G\ SILGL200	1A	
Lazulis Brillant 200	200	Glossy Coated	Smurfit Condat	Factory\Coated_G\ LAZBR200	1A	
Aussedat Rey/Zanders Imaging Gloss 200	200	Glossy Coated	Zanders	Factory\Coated_G\ ARZIG200	1A	
Rolltek Gloss Cover 80#	216	Glossy Coated	Rollsource	IBM\ROLLTEK\ RT216GLC	1A	
Lazulis Brillant 225	225	Glossy Coated	Smurfit Condat	Factory\Coated_G\ LAZBR225	1A	
Silverblade Gloss 240	240	Glossy Coated	MoDo Paper Silverdalen	Factory\Coated_G\ SILGL240	1B	
DataCopy Option 250	250	Matte Coated	MoDo Paper PSM 46-660-421000 Sweden	Factory\Coated_M\ DACOP250	1A	

## Specialty Paper

Paper Script Location: Media\Paper\

Brand Name	Weight (g/m2)	Type/Description	Manufacturer/Distributor	Script Name	Performance Rating	Comment
Aussedat Rey/Zanders Imaging Supergloss 80	80	Single-side	Zanders	Special\SUGLO080	1A	
Classic Laid 90	90	Creamy Color Water Marked Paper with Parchment Surface	Neenah 800-558-5061 US	IBM\NEENAH\NNCLD090	1A	
DigiTerreus 100	100	Embossed	Enso 201-635-3530 US	Special\DITER100	1B	
Pretex Manual 120	120	Latex Impregnated	Papierfabrik Lahnstein	Special\PRETE120	1B	
IvoLaser Antique 135	135	Tinted Paper	Steinbach Intermills 978-834-0002 US	Special\VOA135	1A	
IvoLaser Antique TM 135	135	Embossed	Steinbach Intermills 978-834-0002 US	Special\VOAT135	1A	
Aussedat Rey/Zanders Imaging Supergloss 135	135	Cast coated	Zanders	Special\SUGLO135	1A	
Aussedat Rey/Zanders Imaging Supergloss 180	180	Cast coated	Zanders	Special\SUGLO180	1A	
IvoLaser Antique 190	190	Tinted Paper	Steinbach Intermills 978-834-0002 US	Special\VOA190	1A	
IvoLaser Antique TM 190	190	Embossed	Steinbach Intermills 978-834-0002 US	Special\VOAT190	1A	
IvoLaser TM 190	190	Embossed	Steinbach Intermills 978-834-0002 US	Special\VOT190	1A	
ImagEase 212 Chrome	212	1-side Gloss Coated, Latex Saturated	Rexam/Russell-Field	IBM\REXAM\RXIME212	1A	
IvoLaser TM 240	240	Embossed	Steinbach Intermills 978-834-0002 US	Special\VOT240	1A	

<b>Brand Name</b>	<b>Weight (g/m2)</b>	<b>Type/Description</b>	<b>Manufacturer/Distributor</b>	<b>Script Name</b>	<b>Performance Rating</b>	<b>Comment</b>
Copy Fantasy CTM 1500 113gsm	113	Heat Transfer Paper	Messerli	Special\COPFAN15	3	Use at your own risk.
Photo-TransÆ SC		Heat Transfer Paper	Wyndstone 800-395-8870 US	IBM\WSTONE\ WSPHOTSC	3	Use at your own risk. Needs low fusing. Image quality is moderate for fabric.

## Label Materials

Paper Script Location: Media\Label\

Brand Name	Weight (g/m2)	Type/Description	Manufacturer/Distributor	Script Name	Performance Rating	Comment
Fasson Vellum DI-CP			Avery Dennison	Factory\FASVEL	1A	
Fasson MC White DI-CP			Avery Dennison	Factory\FASMCW	1A	
Fasson High Gloss White DI-CP			Avery Dennison	Factory\FASHGW	1A	
Fasson MC White DI-CP w/ scored backing			Avery Dennison	Factory\FASMCWS	1A	
Durakote Label White 75μ			Hanita Coatings	Factory\DKLW	2	Use at your own risk.
Durakote Label Matte Clear 75μ			Hanita Coatings	Factory\DKLMC	2	Use at your own risk.
Durakote Label Super Clear 75μ			Hanita Coatings	Factory\DKLSC	2	Use at your own risk.
White 2 mil Vinyl Thermal Transfer Film Label 3690E		2mil face, 1mil adhesive, 3.2mil paper liner	3M 800-328-1681 US	IBM\3M\3M3690E	1A	
5mil Gloss White Acrylate Thermal Transfer Film Label 3921		5mil face, 1mil adhesive, 4.6mil paper liner	3M	IBM\3M\3M3921	1A	
1.5mil Gloss Clear Polyester Press Printable Film Label 7753		1.5mil face, 0.7mil adhesive, 1.5mil polyester film liner	3M	IBM\3M\3M7753	1A	
Matte White 7mil Teslin™ Polyolefin Laser Imageable Label 7841		7mil face, 0.8mil adhesive, 3.2mil paper liner	3M	IBM\3M\3M7841	1A	
Fasson Digital Print Media High Gloss 7250/10112	50# MF liner	Coated Paper Label, Permanent Adhesive	Avery Dennison 800-443-9380 US	IBM\FASSON\FS7250	1A	
Fasson Digital Print Media Uncoated 7251/10111	50# MF liner	Uncoated Paper Label, Permanent Adhesive	Avery Dennison	BM\FASSON\FS7251	1A	

Brand Name	Weight (g/m2)	Type/Description	Manufacturer/Distributor	Script Name	Performance Rating	Comment
Fasson Digital Print Media 3.4 mil White Flex Vinyl 7252/73180	78# liner	Vinyle Label, Per- menant Adhesive	Avery Dennison	IBMFASSON\ FS7252	1A	
Classic Plus 41405	50# liner	4 mil Vinyl Aggres- sive, 1 mil Perma- nent acrylic adhesive, 3.0 mil paper liner	Flexcon 508-885-8420 US	IBMFLEXCON\ FL41405	1A	

## PET Film

Paper Script Location: Media\Film\

Brand Name	Weight (g/m <sup>2</sup> )	Type/Description	Manufacturer/Distributor	Script Name	Performance Rating	Comment
DigiPrint XE/CL 100	100μ	PET	Folex	Factory\FOLXECL	1A	
DigiPrint XE/WO 130	130μ	PET	Folex	Factory\FOLXEWO	1A	
DigiPrint XE/MA 90	90μ	PET	Folex	Factory\FOLXEMA	1A	
Durakote White 75μ	75μ	PET	Hanita Coatings	Factory\DKW075	2	Use at your own risk.
Durakote White 100μ	100μ	PET	Hanita Coatings	Factory\DKW100	1A	
Durakote White 125μ	125μ	PET	Hanita Coatings	Factory\DKW125	1A	
Durakote Clear 120μ	120μ	PET	Hanita Coatings	Factory\DKC120	1A	
Durakote Super Clear 110μ	110μ	PET	Hanita Coatings	Factory\DKSC110	1B	
XEWHI503 White Opaque Film 75μ	75μ	PET	Lanco Systems	LANWH075	1B	
XEWHI504 White Opaque Film 100μ	100μ	PET	Lanco Systems	Factory\LANWH100	1A	
XEMAT503 Matt Film 75μ	75μ	PET	Lanco Systems	Factory\LANMATT	1A	
XETRA504 Transparent Film		PET	Lanco Systems	Factory\LANTRANS	1A	
Amoartes DM		PET	Messerli	Factory\AMOADM	1A	
Amoartes K		PET	Messerli	Factory\AMOAK	1A	
Amoartes WM-O		PET	Messerli	Factory\AMOAWMO	2	Use at your own risk.





---

# Readers' Comments – We'd Like to Hear from You

IBM InfoPrint Color 100  
Print Media Guide  
Form Number G544-5648-00

Overall, how satisfied are you with the information in this book?

	Very Satisfied	Satisfied	Neutral	Dissatisfied	Very Dissatisfied
Overall satisfaction	<input type="checkbox"/>	<input type="checkbox"/>	<input type="checkbox"/>	<input type="checkbox"/>	<input type="checkbox"/>

How satisfied are you that the information in this book is:

	Very Satisfied	Satisfied	Neutral	Dissatisfied	Very Dissatisfied
Accurate	<input type="checkbox"/>	<input type="checkbox"/>	<input type="checkbox"/>	<input type="checkbox"/>	<input type="checkbox"/>
Complete	<input type="checkbox"/>	<input type="checkbox"/>	<input type="checkbox"/>	<input type="checkbox"/>	<input type="checkbox"/>
Easy to find	<input type="checkbox"/>	<input type="checkbox"/>	<input type="checkbox"/>	<input type="checkbox"/>	<input type="checkbox"/>
Easy to understand	<input type="checkbox"/>	<input type="checkbox"/>	<input type="checkbox"/>	<input type="checkbox"/>	<input type="checkbox"/>
Well organized	<input type="checkbox"/>	<input type="checkbox"/>	<input type="checkbox"/>	<input type="checkbox"/>	<input type="checkbox"/>
Applicable to your tasks	<input type="checkbox"/>	<input type="checkbox"/>	<input type="checkbox"/>	<input type="checkbox"/>	<input type="checkbox"/>

Please tell us how we can improve this book:

Thank you for your responses. May we contact you?  Yes  No

When you send comments to IBM, you grant IBM nonexclusive right to use or distribute your comments in any way it believes appropriate without incurring any obligation to you.

---

Name

---

Address

---

Company or Organization

---

Phone No.



Fold and Tape

Please do not staple

Fold and Tape



NO POSTAGE  
NECESSARY  
IF MAILED IN THE  
UNITED STATES

# BUSINESS REPLY MAIL

FIRST CLASS MAIL PERMIT NO. 40 ARMONK, NEW YORK

POSTAGE WILL BE PAID BY ADDRESSEE

IBM CORPORATION  
Department H7FE Building 003G  
IBM Printing Systems Company  
Information Development  
PO Box 1900  
Boulder CO USA  
80301-9191

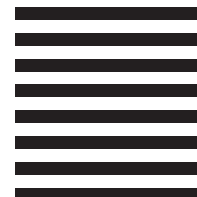

Fold and Tape

Please do not staple

Fold and Tape





G544-5648-00



24L4219

