

Infoprint Manager for Windows



# Configuring PSF Direct for the 3172 Communications Controller



Infoprint Manager for Windows



# Configuring PSF Direct for the 3172 Communications Controller

**Note**

Before using this information and the product it supports, be sure to read the general information in "Notices" on page 71.

**Third Edition (September 2002)**

This publication is one of a set of publications that replaces *Infoprint Manager for Windows NT and Windows 2000: Configuring PSF Direct for Infoprint Manager*. The set includes:

- *Infoprint Manager for Windows NT and Windows 2000: Configuring PSF Direct for the 37xx Communications Controller*
- *Infoprint Manager for Windows: Configuring PSF Direct for the 3172 Communications Controller*
- *Infoprint Manager for Windows NT and Windows 2000: Configuring PSF Direct for the 3174 Communications Controller*
- *Infoprint Manager for Windows NT and Windows 2000: Configuring PSF Direct for an iSeries System*

This edition applies to IBM Infoprint Manager for Windows Version 2 Release 1 and to all subsequent releases and modifications until otherwise indicated in new editions or technical newsletters. Be sure to use the correct edition for the level of the product.

Order publications through your IBM representative or the IBM branch office that serves your locality. Publications are not stocked at the address given below.

IBM Printing Systems welcomes your comments. You may send your comments to the following address:

INFORMATION DEVELOPMENT  
IBM PRINTING SYSTEMS  
DEPARTMENT H7FE, BUILDING 003G  
PO BOX 1900  
BOULDER, CO 80301-9191

If you prefer to send comments electronically, use one of the following methods:

- Internet: [printpub@us.ibm.com](mailto:printpub@us.ibm.com)
- Fax: 1-800-524-1519 within U.S.; 1-303-924-6873 outside U.S

**Internet**

Visit our home page at <http://www.ibm.com/printers>.

When you send information to IBM, you grant IBM a nonexclusive right to use or distribute the information in any way it believes appropriate without incurring any obligation to you.

© Copyright International Business Machines Corporation 2000, 2002. All rights reserved.

US Government Users Restricted Rights – Use, duplication or disclosure restricted by GSA ADP Schedule Contract with IBM Corp.

---

# Contents

**Figures . . . . . v**

**Tables . . . . . vii**

## **Chapter 1. Overview of PSF Direct and Communication Server for Windows NT® 1**

What is PSF Direct? . . . . . 1  
What is IBM SecureWay Communications Server for Windows NT? . . . . . 2  
What are the Available Network Connections? . . . . . 2

## **Chapter 2. Understanding PSF Direct Configuration Requirements . . . . . 5**

Application View of an SNA Network . . . . . 5  
Network Internals View of an SNA Network . . . . . 7  
Key Configuration Parameter Interrelationships. . . . . 8

## **Chapter 3. Preconfiguration Tasks . . . 11**

Defining Devices for IBM SecureWay Communications Server and Infoprint Windows NT. 11  
Defining a Local MAC Address for a Windows NT Server . . . . . 11  
Deciding Whether to Define a Dependent or an Independent LU . . . . . 12  
Configuring an LU 6.2 Partner LU on Your Infoprint Windows NT Server . . . . . 12

## **Chapter 4. Local 3172 Token-Ring Configuration . . . . . 13**

Local 3172 Host Configuration . . . . . 14  
    Specifying the JES2 Initialization Statement. . . . . 14  
    Configuring the Host PSF Printer . . . . . 14  
    Specifying the VTAM Start Option List (ATCSTRxx) . . . . . 17  
    Specifying the VTAM Configuration List (ATCCONnn). . . . . 18  
    Specifying the VTAM Application Program Major Node and Application Program. . . . . 19  
    Specifying the VTAM Mode Table and Entry . . . . . 19  
    Specifying the VTAM Switched Major Node . . . . . 20  
    Specifying the VTAM External Communication Adapter (XCA) Major Node . . . . . 24  
Specifying Communications Server for NT Configuration Profiles . . . . . 25  
    Accessing the Communications Server for NT Profiles . . . . . 26  
    Local 3172 Node Setup . . . . . 27

Local 3172 Device Configuration . . . . . 31  
Enabling SNA API Clients for Local 3172 . . . . . 36  
Local 3172 Peer Connections Configuration. . . . . 38  
Partner LU 6.2 Configuration for Local 3172 . . . . . 43  
Local LU 6.2 Configuration for Local 3172 . . . . . 46  
Mode Configuration for Local 3172 . . . . . 49  
Transaction Program Configuration for Local 3172. . . . . 52  
Local 3172 Token-Ring Configuration Work Sheets 56  
    Local 3172 Token-Ring Configuration Work Sheet Example . . . . . 56  
    Local 3172 Token-Ring Configuration Blank Work Sheet . . . . . 57

## **Chapter 5. Starting an IBM SecureWay Communications Server for Windows NT Configuration . . . . . 59**

## **Chapter 6. Configuring PSF Direct . . . 61**

Creating and Configuring an Infoprint PSF Direct Destination (Printer) . . . . . 62  
    Using the Infoprint Manager Administration GUI 62  
    Using the Infoprint Manager Management Console. . . . . 62  
Defining the PSF Direct Host Receiver . . . . . 62  
Starting a PSF Direct Host Receiver . . . . . 63  
Stopping a PSF Direct Host Receiver . . . . . 64  
Displaying the Status of a PSF Direct Destination on the Windows NT System . . . . . 64  
    Using the Infoprint Manager Management Console. . . . . 64  
    Using the psfstat Command . . . . . 65  
Displaying the Status of a PSF Direct Destination on the Host System . . . . . 66  
Using One Infoprint Actual Destination to Print Data from Multiple Sources . . . . . 66  
    Switching between Data Sources . . . . . 66  
    Sharing an Infoprint Actual Destination: An Example . . . . . 68  
    Displaying the Status of a Shared Infoprint Actual Destination . . . . . 70

## **Notices . . . . . 71**

Licenses . . . . . 71  
Trademarks . . . . . 71

## **Index . . . . . 73**



# Figures

1. Printing with PSF Direct . . . . .	1	39. Communications Server SNA Node Configuration Window: Devices. . . . .	31
2. Local 37xx Configuration: Simplified View . . . . .	3	40. Device Type Window . . . . .	31
3. Remote 37xx Configuration: Simplified View . . . . .	3	41. Define a LAN Device Notebook: Basic Tab . . . . .	32
4. Local 3172 Configuration: Simplified View . . . . .	3	42. Define a LAN Device Notebook: Advanced Tab . . . . .	33
5. Local 3174 Configuration: Simplified View . . . . .	3	43. Define a LAN Device Notebook: Performance Tab . . . . .	34
6. Remote 3174 Configuration: Simplified View . . . . .	4	44. Define a LAN Device Notebook: Reactivation Tab . . . . .	35
7. Local or Remote iSeries Configuration: Simplified View . . . . .	4	45. Communications Server SNA Node Configuration Window: SNA API Clients . . . . .	36
8. SNA Network: Application View . . . . .	5	46. SNA Clients Window . . . . .	37
9. Application View with Configuration Parameters . . . . .	6	47. Communications Server SNA Node Configuration Window: Peer Connections . . . . .	38
10. SNA Network: Network Internals View for a Local 3172 Communications Controller. . . . .	7	48. Define a LAN Connection Notebook: Basic Tab . . . . .	39
11. Logical Unit Names . . . . .	8	49. Define a LAN Connection Notebook: Advanced Tab . . . . .	40
12. Local Address of Logical Unit. . . . .	9	50. Define a LAN Connection Notebook: Adjacent Node Tab . . . . .	41
13. Session Characteristics . . . . .	9	51. Define a LAN Connection Notebook: Reactivation Tab . . . . .	42
14. Physical Unit and Control Point Names . . . . .	10	52. Communications Server SNA Node Configuration Window: Partner LU 6.2 LUs. . . . .	43
15. Network Addresses for Local 3172 Configuration . . . . .	10	53. Define a Partner LU 6.2 Notebook: Basic Tab . . . . .	44
16. Local 3172 Token-Ring Configuration . . . . .	13	54. Define a Partner LU 6.2 Notebook: Advanced Tab . . . . .	45
17. JES2 Initialization Statement Example . . . . .	14	55. Communications Server SNA Node Configuration Window: Local LU 6.2 LUs . . . . .	46
18. Host PSF Printer Guidelines . . . . .	15	56. Define a Local LU 6.2 Notebook: Basic Tab . . . . .	47
19. JES2 External Writer Procedure Example . . . . .	17	57. Define a Local LU 6.2 Notebook: Advanced Tab . . . . .	48
20. VTAM Start Option List (ATCSTRxx) Guidelines . . . . .	17	58. Communications Server SNA Node Configuration Window: Modes . . . . .	49
21. VTAM Start Option List (ATCSTRxx) Example . . . . .	18	59. Define a Mode Notebook: Basic Tab . . . . .	50
22. VTAM Configuration List (ATCCONnn) Guidelines . . . . .	18	60. Define a Mode Notebook: Advanced Tab . . . . .	51
23. VTAM Configuration List (ATCCONnn) Example . . . . .	18	61. Communications Server SNA Node Configuration Window: Transaction Programs . . . . .	52
24. VTAM Application Program Major Node and Application Program Guidelines . . . . .	19	62. Define a Transaction Program Notebook: Basic Tab . . . . .	53
25. VTAM Application Program Major Node and Application Program Example . . . . .	19	63. Define a Transaction Program Notebook: Advanced Tab . . . . .	54
26. VTAM Mode Table and Entry Guidelines . . . . .	19	64. SNA LU 6.2 Session in a PSF Direct Configuration . . . . .	61
27. VTAM Mode Table and Entry Example . . . . .	20	65. PSF Direct Host Receiver . . . . .	61
28. VTAM Switched Major Node Guidelines: Calling Link Station. . . . .	20	66. Printer and Receiver Status Example . . . . .	65
29. VTAM Switched Major Node Guidelines: Listening Link Station . . . . .	21	67. PRINTDEV Statement for PSF for OS/390 Example . . . . .	68
30. VTAM Switched Major Node Example with CPNAME . . . . .	24	68. PRINTDEV Statement for PSF/VSE Example . . . . .	68
31. VTAM Switched Major Node Example with IDBLK and IDNUM. . . . .	24	69. Configuration for PSF for iSeries Example . . . . .	69
32. VTAM XCA Major Node Guidelines . . . . .	24	70. Shared Printer Status . . . . .	70
33. VTAM XCA Major Node Example . . . . .	25		
34. Choose a Configuration Scenario Window . . . . .	26		
35. Communications Server SNA Node Configuration Window: Node . . . . .	27		
36. Define the Node Notebook: Basic Tab . . . . .	28		
37. Define the Node Notebook: Advanced Tab . . . . .	29		
38. Define the Node Notebook: DLU Requester Tab . . . . .	30		





---

## Tables

1.	Windows NT and AIX Parameters for LAN Device Performance. . . . .	35	3.	Local 3172 Token-Ring Configuration Blank Work Sheet. . . . .	57
2.	Local 3172 Token-Ring Configuration Work Sheet Example . . . . .	56	4.	PSF Direct Host Receiver Values Example	63
			5.	Time Limit Parameters. . . . .	68



---

# Chapter 1. Overview of PSF Direct and Communication Server for Windows NT<sup>®</sup>

This chapter contains an overview of the components you need to configure Print Services Facility<sup>™</sup> Direct (PSF Direct) on Systems Network Architecture (SNA) networks. It contains the following subtopics:

- “What is PSF Direct?”
- “What is IBM SecureWay Communications Server for Windows NT?” on page 2
- “What are the Available Network Connections?” on page 2

---

## What is PSF Direct?

PSF Direct provides a direct connection between a host system and a printer defined to IBM<sup>®</sup> Infoprint<sup>®</sup> Manager for Windows NT and Windows<sup>®</sup> 2000. The host system can be an OS/390<sup>®</sup>, VSE, VM, or Operating System/400<sup>®</sup> (OS/400<sup>®</sup>) system. PSF Direct gives you control of key print processes from your host system console. An Infoprint physical printer appears to be directly attached to your host system. Jobs print without delay because they are not spooled by the Windows NT workstation. Because the host system controls the print process, it returns job-completion and error messages to the host system.

PSF Direct uses Communication Server LU 6.2 protocols to communicate between the host system and the Windows NT system. Then PSF Direct uses one of several protocols to communicate between the Windows NT system and the printer:

- Transmission Control Protocol/Internet Protocol (TCP/IP)
- Channel
- Parallel/Serial

These protocols provide you with access to TCP/IP, channel, or parallel/serial printers that otherwise you might not be able to attach from the host system.

To use PSF Direct, you need the IBM SecureWay<sup>®</sup> Communications Server product to communicate between the host system and NT. You create printer definitions on the host system so that print jobs can be directed to the NT printer. Then, you define the printer to the Infoprint server on NT.

After you install PSF Direct, you send the job to the printer, using normal print-submission processes. Because PSF Direct is a direct pipeline to the printer, you need to end the PSF Direct session before you can use the printer to print from another host system or from IBM Infoprint Manager for Windows NT.

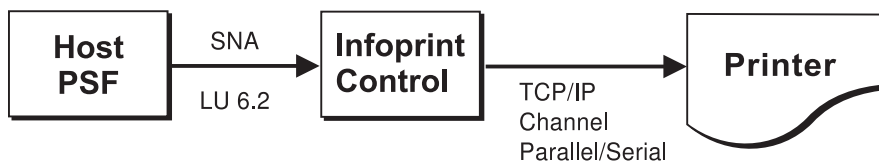

Figure 1. Printing with PSF Direct

---

## What is IBM SecureWay Communications Server for Windows NT?

You need the IBM SecureWay Communications Server for Windows NT to configure and to use PSF Direct. IBM SecureWay Communications Server is an implementation of SNA for the NT operating system running on the NT workstation. It enables an NT workstation to communicate with other nodes in an SNA network.

PSF Direct requires IBM SecureWay Communications Server for Windows NT system software Version 6, Release 01, with maintenance that includes the following authorized program analysis report (APAR) fixes:

- APAR JR13453
- APAR JR14098
- APAR JR13599

Note that the second APAR (JR13599) is necessary only if you will be creating more than one Communications Server profile for dependent LUs.

Infoprint Manager for Windows NT allows you to create a PSF Direct host receiver whether or not you have completed the IBM SecureWay Communications Server node configuration. Therefore, it does not matter whether you install Infoprint Manager or Communications Server first.

To install IBM SecureWay Communications Server from the CD-ROM:

1. Select the **Install Products** icon that appears on the main window.
2. Choose a **Server** install.
3. From the Communications Server Installation window, select only the **Communications Server for Windows NT** option to use the PSF Direct function.

Once you have completed the installation, create shortcuts for both the SNA Node Configuration interface and the Communications Server Node Operations interface, so that you can easily invoke them from your desktop. (The default path for the SNA Node Configuration interface is C:\IBMCS\pcscfg.exe. The default path for the Communications Server Node Operations interface is C:\IBMCS\pcsnops.exe. In both paths, C is the drive where you installed IBM SecureWay Communications Server for Windows NT.)

---

## What are the Available Network Connections?

This document includes detailed examples and guidelines for several common SNA configurations. The diagrams in this section illustrate the network configurations, with references to more detailed information.

**Note:** These diagrams, and the other illustrations in this book, show token-ring configurations. Similar Ethernet configurations are also possible.

- Local 37xx configuration (Figure 2). This configuration is described in *Infoprint Manager for Windows NT and Windows 2000: Configuring PSF Direct for the 37xx Communications Controller*.

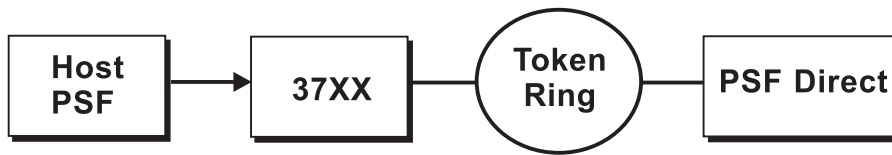

Figure 2. Local 37xx Configuration: Simplified View

- Remote 37xx configuration (Figure 3). This configuration is described in *Infoprint Manager for Windows NT and Windows 2000: Configuring PSF Direct for the 37xx Communications Controller*.

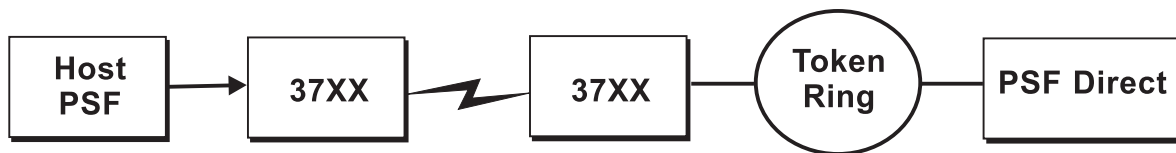

Figure 3. Remote 37xx Configuration: Simplified View

- Local 3172 configuration (Figure 4). This configuration is described in Chapter 4, "Local 3172 Token-Ring Configuration" on page 13.



Figure 4. Local 3172 Configuration: Simplified View

- Local 3174 configuration (Figure 5). This configuration is described in *Infoprint Manager for Windows NT and Windows 2000: Configuring PSF Direct for the 3174 Communications Controller*.

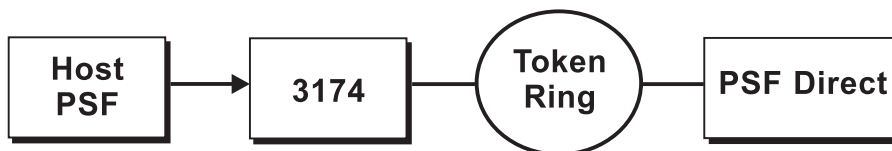

Figure 5. Local 3174 Configuration: Simplified View

- Remote 3174 configuration (Figure 6). This configuration is described in *Infoprint Manager for Windows NT and Windows 2000: Configuring PSF Direct for the 3174 Communications Controller*.

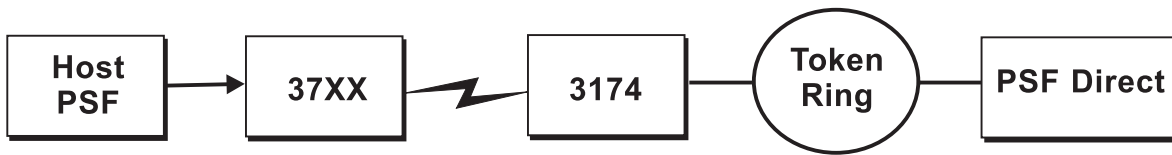

Figure 6. Remote 3174 Configuration: Simplified View

- Local or remote iSeries™ configuration (Figure 7). These configurations are described in *Infoprint Manager for Windows NT and Windows 2000: Configuring PSF Direct for an iSeries System*.



Figure 7. Local or Remote iSeries Configuration: Simplified View

---

## Chapter 2. Understanding PSF Direct Configuration Requirements

An SNA network provides powerful communication capabilities to applications without requiring that the applications be aware of the equipment and transmission facilities that comprise the network. So, an SNA application like PSF Direct can communicate using an SDLC telecommunications link between two continents or a token-ring LAN in a single room.

To configure an SNA application, one normally need only identify the communication partner and the guidelines for exchanging data.

To configure an SNA network, you must describe the internal components of the network and details of their operation.

Considering two views of an SNA network, an application view and a network internals view, aids in understanding PSF Direct configuration requirements. An overview of the key configuration parameter interrelationships when defining logical unit (LU) names follows.

---

### Application View of an SNA Network

An SNA network provides two access points for communication and a logical connection between the two access points. In SNA terminology, the access points are **logical units (LUs)**. The connection between them is a **session**. A **mode** describes a session's characteristics, or guidelines for exchanging data.

The application view displayed in Figure 8 illustrates the interface that SNA provides to applications, such as the host PSF program and the PSF Direct component of Infoprint Manager. These applications are isolated from details of the internal components of the SNA network.

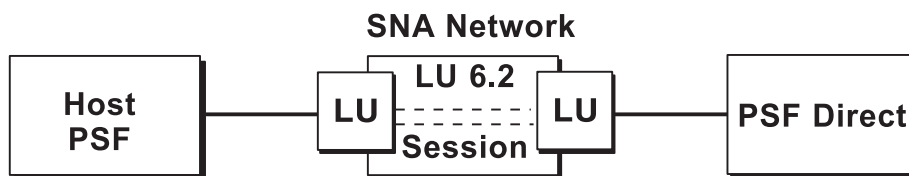

Figure 8. SNA Network: Application View

As the application view suggests, only a few values are required to configure the host PSF program and PSF Direct so they can communicate. Figure 9 on page 6 displays the values used by both applications. Note that each configuration parameter refers to a logical unit or mode provided by the SNA network.

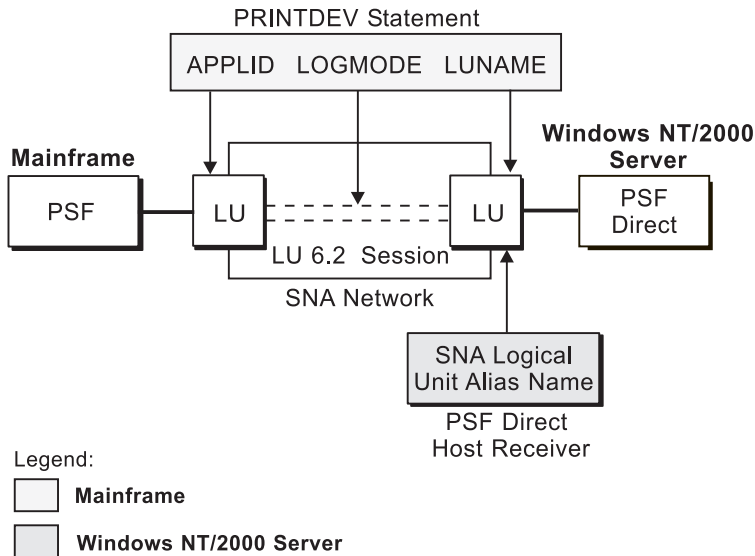

Figure 9. Application View with Configuration Parameters

Host PSF **PRINTDEV** statement parameters:

**APPLID**

Specifies the name of the logical unit that the host PSF program uses.

**LUNAME**

Specifies the name of the logical unit that PSF Direct uses.

**LOGMODE**

Specifies the session characteristics for communication between the two logical units.

Individual modes, or mode entries, are grouped into a table that contains several modes. **LOGMODE** identifies a mode entry. You identify the mode table through the SNA network definitions for the logical unit that PSF Direct uses.

PSF Direct host receiver parameters:

**Local LU alias**

Specifies the local ID that points to the logical unit that PSF Direct uses on the Windows NT server. For an independent LU, you define this parameter on the **Basic** tab of the Define a Local LU 6.2 notebook. For a dependent LU, it is the same as the LU name.

Because there may be several PSF Direct host receivers on an NT workstation and several NT workstations in an SNA network, each PSF Direct host receiver must have a unique logical unit name.



---

## Network Internals View of an SNA Network

While the application view illustrates the relationship of an SNA network to the applications that use it, the network internals view aids in understanding the components of an SNA network and how they must be configured.

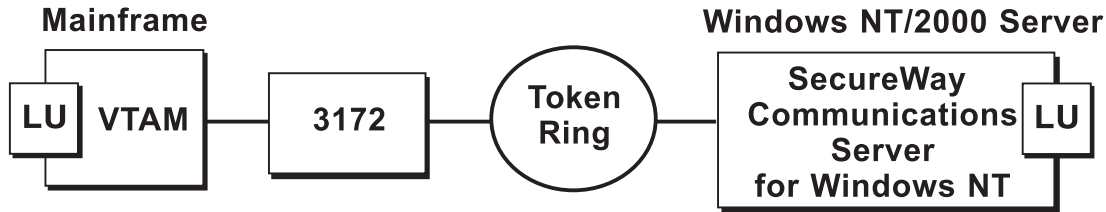

Figure 10. SNA Network: Network Internals View for a Local 3172 Communications Controller

The network internals views illustrate that many components comprise an SNA network. Most of the components have detailed configuration requirements.

First, however, it is important to understand that several network components have configuration parameters whose values are related to configuration parameters for other network components. You must configure these interrelated parameters consistently to make end-to-end communication possible.

“Key Configuration Parameter Interrelationships” on page 8 contains several figures. They illustrate some of the key interrelationships among configuration parameters for SNA network components.

## Key Configuration Parameter Interrelationships

Figure 11 illustrates the interrelationships required when defining logical unit (LU) names.

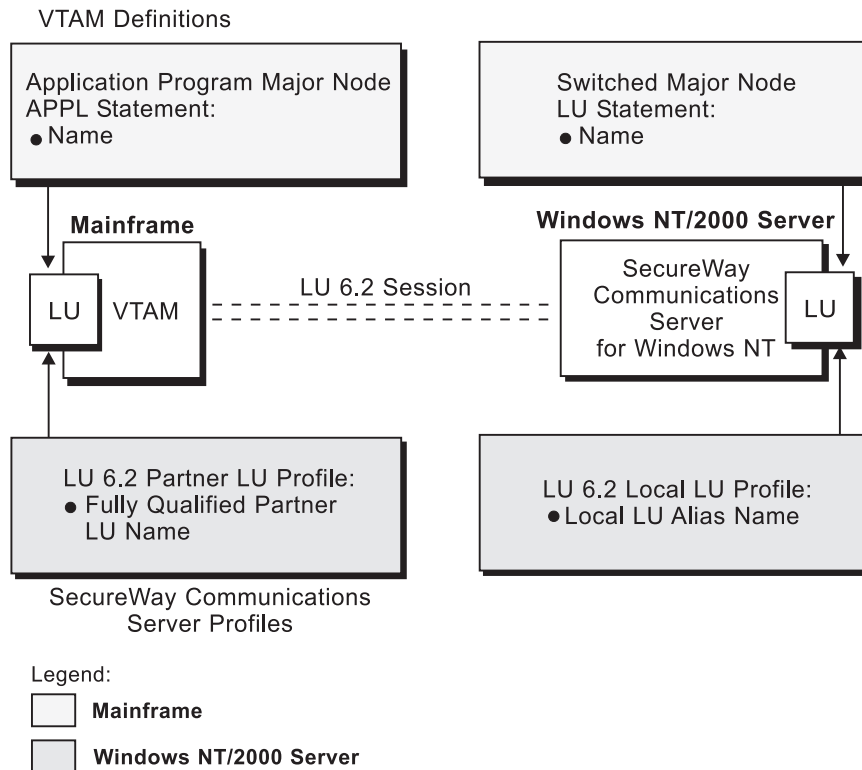

Figure 11. Logical Unit Names

Figure 12 illustrates the interrelationships required when defining the local address of the logical unit provided by SecureWay Communications Server for NT.

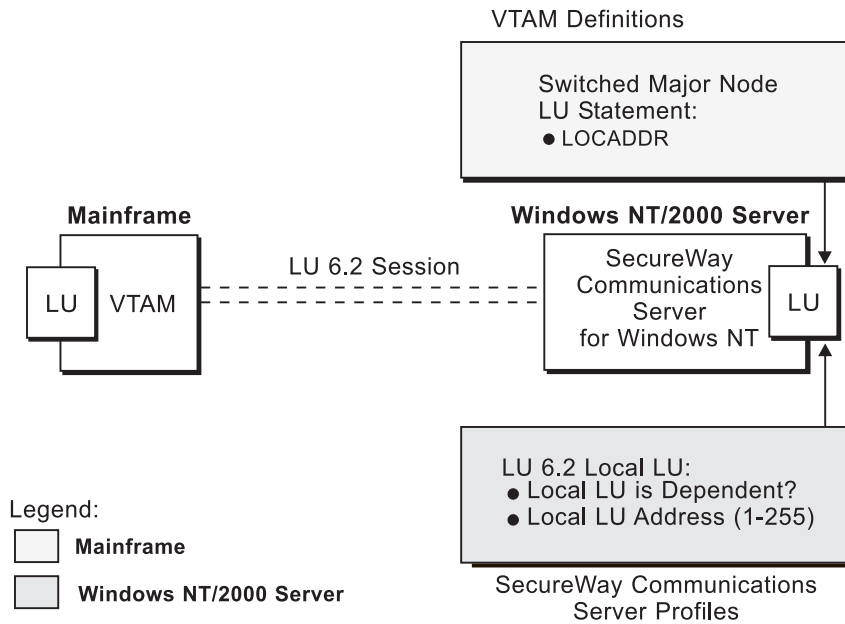

Figure 12. Local Address of Logical Unit

Figure 13 illustrates the interrelationships required when defining session characteristics.

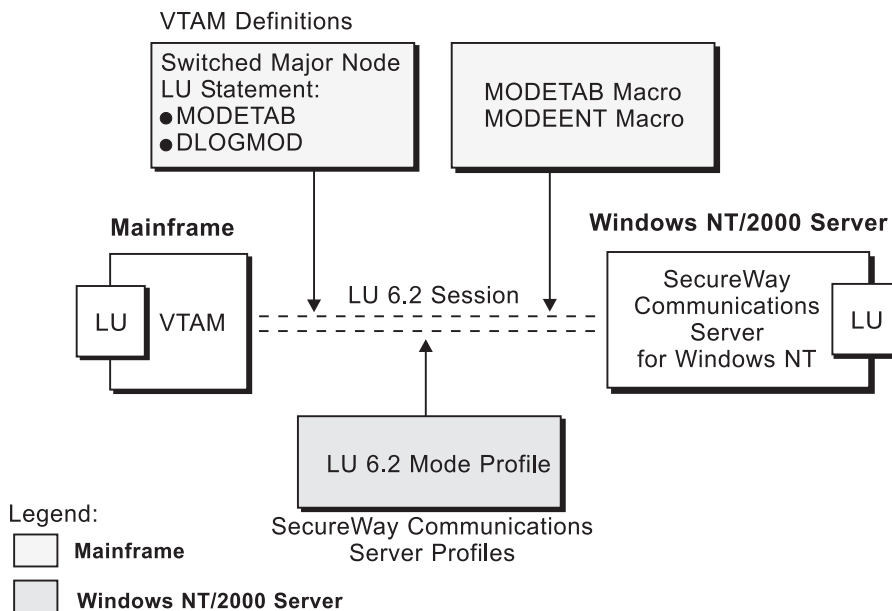

Figure 13. Session Characteristics

Figure 14 illustrates the interrelationships required when defining the names of the physical unit (PU) and control point (CP) provided by SecureWay Communications Server for NT.

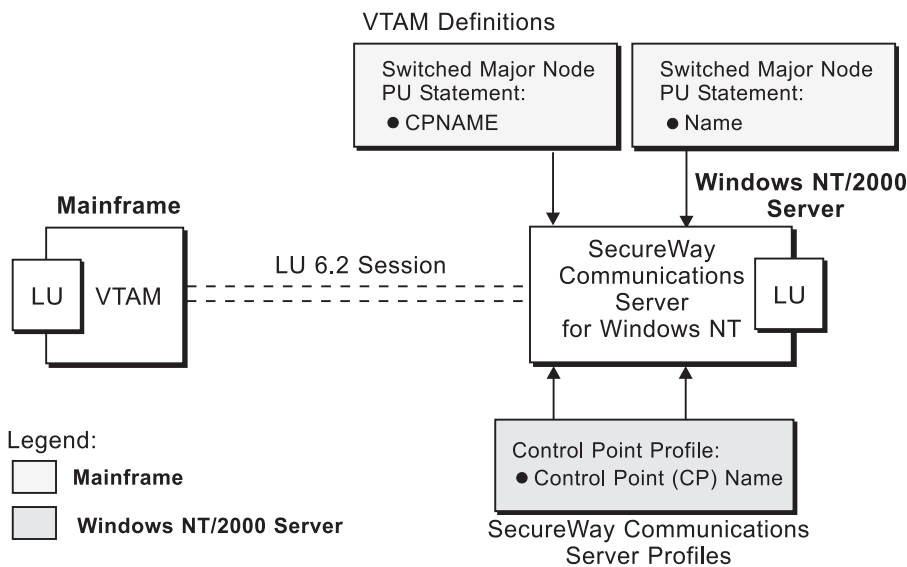

Figure 14. Physical Unit and Control Point Names

Figure 15 illustrates the interrelationships required when defining the network addresses used in the local 3172 configuration.

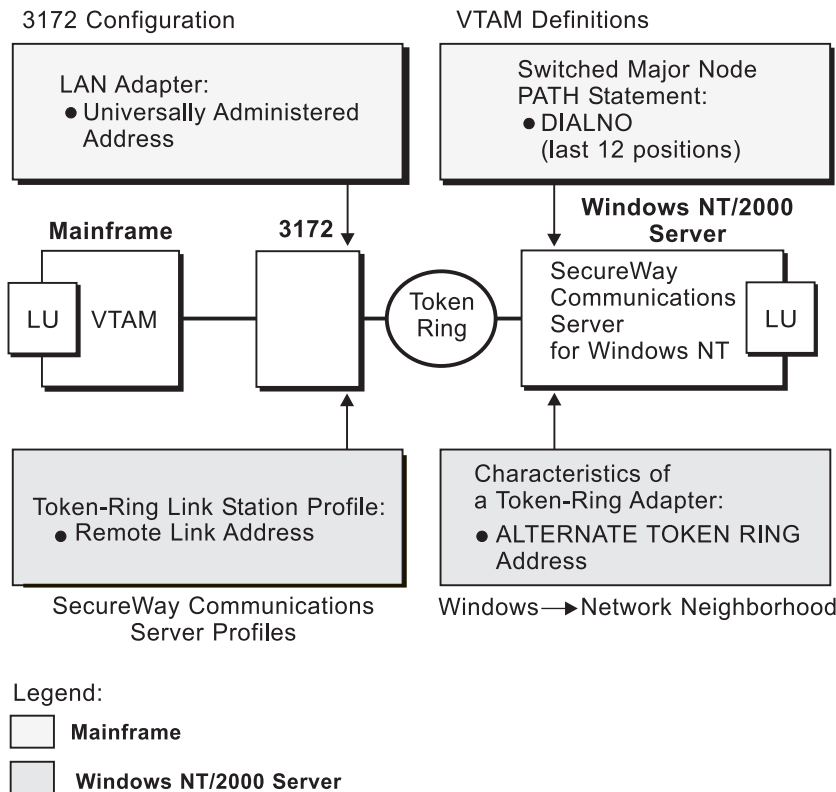

Figure 15. Network Addresses for Local 3172 Configuration

---

## Chapter 3. Preconfiguration Tasks

Before configuration, perform the following tasks:

- “Defining Devices for IBM SecureWay Communications Server and Infoprint Windows NT”
- “Defining a Local MAC Address for a Windows NT Server”
- “Deciding Whether to Define a Dependent or an Independent LU” on page 12
- “Configuring an LU 6.2 Partner LU on Your Infoprint Windows NT Server” on page 12

---

### Defining Devices for IBM SecureWay Communications Server and Infoprint Windows NT

You must define devices for both Communications Server and Infoprint Manager for Windows NT and Windows 2000, so that the token-ring or Ethernet card can carry the SNA data from the PSF host program. Usually, a device must be made available once. It then remains available, even after Windows NT shuts down and restarts. For each configuration example, you accomplish this task through device configuration, the second of the IBM SecureWay Communications Server for NT configuration profiles in each example.

---

### Defining a Local MAC Address for a Windows NT Server

A token-ring or Ethernet address, often called a **medium access control (MAC) address**, has 12 hexadecimal digits, for example, 10005AC8B0EA. Each device in a network must have a unique address. To facilitate unique addressing, every manufacturer assigns a distinct address called a **universal MAC address** to each network adapter. By default, an adapter in a Windows NT server uses the address that the manufacturer assigned when the adapter was made. However, Windows NT systems allow you to define an **alternate network address**, also called a **local MAC address**.

In some configurations, an alternate network address is necessary. For example:

- If the **DIALNO** operand is included in a Virtual Telecommunications Access Method (VTAM<sup>®</sup>) switched major node **PATH** statement, an alternate network address is generally required. The **DIALNO** operand accepts only digits in the 0–9 range; however, most universal MAC addresses (assigned by the manufacturer) include at least one digit in the A–F range. In these instances, you must use an alternate network address that does not contain any digits in the A–F range.

Generally, the first four digits of alternate network addresses must be 4000.

To assign an alternate network address to an adapter in a Windows NT server, you must refer to the operating system online help. Different levels of the operating systems can vary.

For example, if you want to assign an alternate network address to a token-ring adapter on a Microsoft<sup>®</sup> Windows NT Version 4.00.1381 system, use the following procedure:

1. Specify the **My Computer-->Control Panel-->Network** path.

2. Select the **Adapters** tab.
3. Highlight the token-ring adapter and click the **Properties...** button.
4. From the IBM Auto 16/4 Token-Ring Adapter Card Setup pop-up, specify the local MAC address in the **Network Address** field.
5. Shut down and reboot your Infoprint Windows NT server so the new address can take effect.

---

## Deciding Whether to Define a Dependent or an Independent LU

You will usually add an LU 6.2 Local LU profile for each logical unit used by PSF Direct, whether the logical unit is dependent or independent. Whenever possible, you should define an independent LU, because they are easier to manage. With a dependent LU, you must assign a session ID and track its network addressable unit (NAU) address.

A dependent LU requires you to perform the following tasks from the Communications Server SNA Node Configuration window:

1. Click the plus sign (+) next to **Host Resources** to access **Host Connections**.
2. Highlight **Host Connections** and select the **Create** option.
3. Fill in all the values in the Define a LAN Connection notebook, then specify **OK**.
4. At the Do you wish to create and assign new LUs to this connection? pop-up dialog, specify **YES**.
5. Fill in the Host LU Definition window, specifying an **LU name** value.

An independent LU requires you to perform the following tasks from the Communications Server SNA Node Configuration window:

1. Select and define **Peer Connections**, while leaving **Host Resources** empty.
2. Select the **Local LU 6.2 LUs** option under the **CPI-C and APPC** heading.
3. Specify the values on the **Basic** tab of the Define a Local LU 6.2 notebook, leaving the **Dependent LU** box unchecked.
4. Specify the values on the **Advanced** tab of the Define a Local LU 6.2 notebook.

---

## Configuring an LU 6.2 Partner LU on Your Infoprint Windows NT Server

You must configure an LU 6.2 Partner LU profile for each logical unit used by a host PSF program. Some IBM SecureWay Communications Server for NT documentation indicates that an LU 6.2 Partner LU profile is not required if the local LU is an independent logical unit. However, because the logical unit used by the host PSF program does not support parallel sessions, IBM SecureWay Communications Server for NT requires an LU 6.2 profile in all PSF Direct configurations.

---

## Chapter 4. Local 3172 Token-Ring Configuration

Figure 16 shows a local 3172 token-ring configuration.

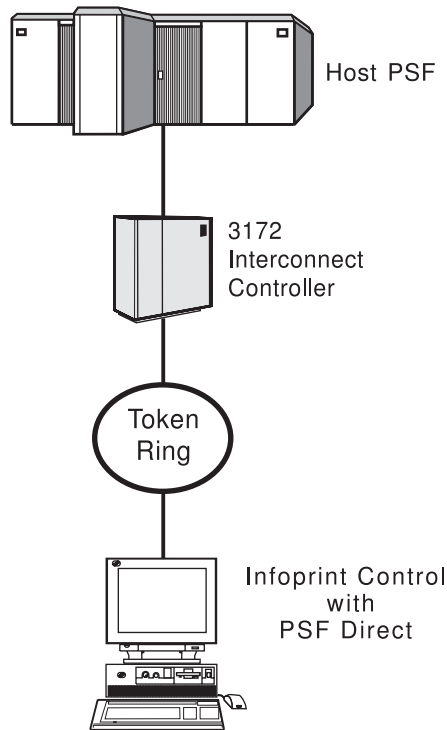

Figure 16. Local 3172 Token-Ring Configuration

This chapter describes how to create a local 3172 token-ring configuration. It contains guidelines and examples for the following tasks:

- “Local 3172 Host Configuration” on page 14
  - “Specifying the JES2 Initialization Statement” on page 14
  - “Configuring the Host PSF Printer” on page 14
  - “Specifying the VTAM Start Option List (ATCSTRxx)” on page 17
  - “Specifying the VTAM Configuration List (ATCCONnn)” on page 18
  - “Specifying the VTAM Application Program Major Node and Application Program” on page 19
  - “Specifying the VTAM Mode Table and Entry” on page 19
  - “Specifying the VTAM Switched Major Node” on page 20
  - “Specifying the VTAM External Communication Adapter (XCA) Major Node” on page 24
- “Specifying Communications Server for NT Configuration Profiles” on page 25
  - “Accessing the Communications Server for NT Profiles” on page 26
  - “Local 3172 Node Setup” on page 27
  - “Local 3172 Device Configuration” on page 31
  - “Enabling SNA API Clients for Local 3172” on page 36
  - “Local 3172 Peer Connections Configuration” on page 38

- “Partner LU 6.2 Configuration for Local 3172” on page 43
- “Local LU 6.2 Configuration for Local 3172” on page 46
- “Mode Configuration for Local 3172” on page 49
- “Transaction Program Configuration for Local 3172” on page 52

**Note:** Before performing this configuration, review Chapter 3, “Preconfiguration Tasks” on page 11.

At the end of the chapter, there are two configuration work sheets. The first work sheet (Table 2 on page 56) is filled out with the values from the examples. The second work sheet (Table 3 on page 57) is blank for your own values.

---

## Local 3172 Host Configuration

This section provides guidelines and examples for the following tasks:

- “Specifying the JES2 Initialization Statement”
- “Configuring the Host PSF Printer”
- “Specifying the VTAM Start Option List (ATCSTRxx)” on page 17
- “Specifying the VTAM Configuration List (ATCCONnn)” on page 18
- “Specifying the VTAM Application Program Major Node and Application Program” on page 19
- “Specifying the VTAM Mode Table and Entry” on page 19
- “Specifying the VTAM Switched Major Node” on page 20
- “Specifying the VTAM External Communication Adapter (XCA) Major Node” on page 24

For each task, this section shows the pertinent parameters. It describes which of these require you to specify *variable\_names* and which require a specific name or number, such as **MODETAB=MODEIBM** or **FMPROF=X'13'**. An underlined value (such as WCONNECT) indicates that the value is a system default.

### Specifying the JES2 Initialization Statement

Define the host PSF printer as you would any other Systems Network Architecture (SNA)-attached printer. For example, on an OS/390 system you must provide either JES2 or JES3 initialization statements.

Figure 17 shows an example.

```
PRT618 CLASS=Y,MARKS=YES,START=NO,MODE=FSS,FSS=WTRES600, X
PRMODE=(LINE,PAGE),UCS=0
```

Figure 17. JES2 Initialization Statement Example

### Configuring the Host PSF Printer

The manner in which a host PSF printer is configured depends on the operating system. You will use one of the following statements:

- Print Services Facility (PSF) for OS/390 **PRINTDEV** statement
- PSF/VSE **PRINTDEV** statement
- Parameters in the PSF/VM **OPTIONS PDM** file



On each operating system, PSF supports specification of both the application program ID (**APPLID**) and the logical unit name (**LUNAME**).

```
.  
. .  
.  
APPLID=appl_prog  
LUNAME=lu_name  
.  
.  
.
```

Figure 18. Host PSF Printer Guidelines

On some operating systems, PSF also supports other configuration parameters. The following text describes these parameters (listed in order of importance) and notes whether they are required or optional:

**APPLID (required)**

Specifies the application program that is the SNA logical unit provided by Virtual Telecommunications Access Method (VTAM) and used by PSF. The **APPLID** value must match:

- An **APPL** statement name in a VTAM application program major node
- The second part of the **Partner LU name** field on the **Basic** tab of the Define a Partner LU 6.2 notebook (Figure 53 on page 44)

**LUNAME (required)**

Specifies the SNA logical unit with which PSF tries to initiate a session. The **LUNAME** value must match:

- An **LU** statement name in a VTAM switched major node
- The **Local LU name** field on the **Basic** tab of the Define a Local LU 6.2 notebook (Figure 56 on page 47)

**LOGMODE (optional)**

Specifies the VTAM logon mode table entry that defines characteristics of the session between the logical units identified by the **APPLID** and **LUNAME** parameters. The **LOGMODE** parameter identifies an entry within a logon mode table. The **MODETAB** operand on the VTAM switched major node **LU** statement identifies the logon mode table. If you omit the **LOGMODE** parameter, the **DLOGMOD** operand on the VTAM switched major node **LU** statement identifies the entry within the logon mode table.

Note that if the logical unit identified by the **LUNAME** parameter is a cross-domain resource, you must not use the **LOGMODE** parameter.

**SETUP (optional)**

Specify **SETUP=FORMS** to cause the Job Entry Subsystem (JES) to issue forms setup messages to the operator.

By default, JES issues forms setup messages to the operator for channel-attached printers, but does not issue forms setup messages to the operator for SNA-attached printers.

**MGMTMODE ={IMMED | OUTAVAIL | DIALIN} (optional)**

Determines how the host PSF program and PSF Direct initiate communication.

**IMMED**

Causes the host PSF program to initiate communication when it starts.

**OUTAVAIL**

Causes the host PSF program to initiate communication when there is available output to print.

**DIALIN**

Causes the host PSF program to initiate communication only after a switched line becomes available. The switched line can become available either when VTAM dials out or when the remote node dials in.

Note that if you specify **DIALIN**:

- Do not use the **LOGMODE** parameter.
- Include the **LOGAPPL** operand on the VTAM switched major node **LU** statement.
- Ensure that the **LOGAPPL** operand on the VTAM switched major node **LU** statement matches the **APPLID** value.

**FAILURE={WCONNECT | STOP} (optional)**

Specifies whether or not the host PSF program re-attempts communication after a printer or communication failure. If you do not specify a value for the **FAILURE** parameter, it defaults to **WCONNECT**.

**WCONNECT**

Specifies that the host PSF program attempts to communicate again.

**STOP** Specifies that the operator must restart the host PSF program.

**DISCINTV (optional)**

Specifies the interval (in seconds) that the host PSF program waits for output to become available to print. If no output becomes available, the host PSF program ends communication with the printer.

Specify 0 to cause the host PSF program to maintain communication indefinitely. If you do not specify a value for **DISCINTV**, it defaults to 0.

Figure 19 on page 17 shows an example of a single **PRTDEV** statement for a device named PRT618. Note that if an installation has multiple printers defined for receiving PSF Direct jobs, you must define a separate **PRTDEV** statement for each printer.

```

//WTRES600 PROC
//*
//STEP01 EXEC PGM=APSPPIEP,REGION=4096K
//*
//STEPLIB DD DSN=SYSTEM.PSF.V220.LINKLIB,DISP=SHR
//*
//JOBHDR OUTPUT PAGEDEF=A06462, /* JOB HEADER PAGEDEF */
// FORMDEF=A10110 /* JOB HEADER FORMDEF */
//JOBTLR OUTPUT PAGEDEF=A06462, /* JOB TRAILER PAGEDEF */
// FORMDEF=A10110 /* JOB TRAILER FORMDEF */
//DSHDR OUTPUT PAGEDEF=A06462, /* DATA SET HEADER PAGEDEF*/
// FORMDEF=A10110 /* DATA SET HEADER FORMDEF*/
//MSGDS OUTPUT PAGEDEF=A06462, /* MESSAGE DATASET PAGEDEF*/
// FORMDEF=A10110 /* MESSAGE DATASET FORMDEF*/
//*
//FONT01 DD DSN=SYS1.FONTLIB,DISP=SHR
//OLAY01 DD DSN=SYS1.OVERLIB,DISP=SHR
//PSEG01 DD DSN=SYS1.PSEGLIB,DISP=SHR
//FDEF01 DD DSN=SYS1.FDEFLIB,DISP=SHR
//PDEF01 DD DSN=SYS1.PDEFLIB,DISP=SHR
//*
//PRT618 PRINTDEV FONTDD=*.FONT01, /* FONT LIBRARY DD */
// OVLydd=*.OLAY01, /* OVERLAY LIBRARY DD */
// PSEGDD=*.PSEG01, /* SEGMENT LIBRARY DD */
// PDEFDD=*.OLAY01, /* PAGEDEF LIBRARY DD */
// FDEFDD=*.OLAY01, /* FORMDEF LIBRARY DD */
// JOBHDR=*.JOBHDR, /* JOB HEADER DD */
// JOBTLR=*.JOBTLR, /* JOB TRAILER DD */
// DSHDR=*.DSHDR, /* DATA SET HEADER DD */
// MESSAGE=*.MSGDS, /* MESSAGE DATA DD */
// PAGEDEF=A06462, /* DEFAULT PAGEDEF */
// FORMDEF=A10110, /* DEFAULT FORMDEF */
// CHARS=(GT10,GC15,GB10,GR10,), /* DEFAULT FONT SET*/
// PIMSG=YES, /* ACCUMULATE DATA SET MESSAGES */
// SETUP=FORMS, /* ISSUE FORMS SETUP MESSAGES */
// MGMTMODE=OUTAVAIL, /* START WHEN OUTPUT AVAILABLE */
// DISCINTV=60, /* DISCONNECT INTERVAL -- SECS */
// LOGMODE=IBM3820T, /* LOGON MODE TABLE ENTRY */
// APPLID=FSAES618, /* APPLICATION PGM NAME */
// LUNAME=PSFDC4LU /* LOGICAL UNIT NAME */
//PRT618 ENDCNTL

```

Figure 19. JES2 External Writer Procedure Example

## Specifying the VTAM Start Option List (ATCSTRxx)

You must specify the values illustrated in Figure 20 and described below.

```

CONFIG=nn,          ATCCON MEMBER OF VTAMLST      X
NETID=network_id,  NETWORK IDENTIFIER          X
SSCPID=nn,         SSCP IDENTIFIER             X
.
.
.

```

Figure 20. VTAM Start Option List (ATCSTRxx) Guidelines

### CONFIG

Specifies the **ATCCON***nn* member to use.

### NETID

Specifies the network identifier for the host system. The first part of the

**Partner LU name** field on the **Basic** tab of the Define a Partner LU 6.2 notebook (Figure 53 on page 44) must match the **NETID** value.

### SSCPID

Specifies the system services control point (SSCP) at the host. The SSCPID is a decimal integer from 0 to 65535.

The SSCP, normally VTAM, provides several network management functions. They include managing dependent logical units and accepting Network Management Vector Transports, such as alerts. Alerts often include information about devices that are unavailable or require corrective action.

To configure a PSF Direct host receiver to send alerts to this SSCP, the least significant portion of the **SNA System Services Control Point ID** value defined for the PSF Direct host receiver must be the hexadecimal equivalent of the SSCPID value. (For information about configuring the host receiver, see “Defining the PSF Direct Host Receiver” on page 62.) The **SNA System Services Control Point ID** must be in the form **05xxxxxxxxxx**, where *x* is a hexadecimal digit.

For example, to configure a PSF Direct host receiver to send alerts to an SSCP with an **SSCPID** value of 283 , the host receiver’s **SNA System Services Control Point ID** value must be 05000000011B.

Figure 21 shows an example.

```
CONFIG=00,      ATCCON MEMBER OF VTAMLST      X
NETID=USIBMBQ, NETWORK IDENTIFIER      X
SSCPID=1,       SSCP IDENTIFIER        X
.
.
.
```

Figure 21. VTAM Start Option List (ATCSTRxx) Example

## Specifying the VTAM Configuration List (ATCCONnn)

The VTAM configuration list indicates the application program major nodes that should become available when VTAM starts. Include the application program major node that contains the application program that PSF uses.

```
appl_prog_major_node,      X
.
.
.
```

Figure 22. VTAM Configuration List (ATCCONnn) Guidelines

Figure 23 shows an example.

```
PSFAPPLS,      X
.
.
.
```

Figure 23. VTAM Configuration List (ATCCONnn) Example

## Specifying the VTAM Application Program Major Node and Application Program

The pertinent operands for the VTAM application program major node and application program are illustrated in Figure 24 and described below.

```

appl_prog_major_node, VBUILD TYPE=APPL           X
appl_prog,           APPL AUTH=ACQ,EAS=1,SONSCIP=YES X
.
.
.

```

Figure 24. VTAM Application Program Major Node and Application Program Guidelines

The host PSF program does not support application programs that use **APPC=YES** or **PARSESS=YES**. The default value for both **APPC** and **PARSESS** is **NO**.

Figure 25 shows an example.

```

PSFAPPLS,  VBUILD TYPE=APPL           X
FSAES618,  APPL AUTH=ACQ,EAS=1,SONSCIP=YES X
.
.
.

```

Figure 25. VTAM Application Program Major Node and Application Program Example

## Specifying the VTAM Mode Table and Entry

The operands for the VTAM mode table are illustrated in Figure 26 and described below.

```

table_name  MODETAB           X
entry_name  MODEENT LOGMODE=IBM3820T,FMPROF=X'13',TSPROF=X'07', X
.
.
.
|           PRIPROT=X'B0',SECPROT=X'B0',COMPROT=X'D0B1'           X
|           PSERVIC=X'06020000000000000000000000000000'         X
|           PSNDPAC=X'10',SRCVPAC=X'10',SSNDPAC=X'00'           X
|           RUSIZES=X'8787'                                     X

```

Figure 26. VTAM Mode Table and Entry Guidelines

### PSNDPAC

Specifies the primary send pacing count. This value influences performance and can be adjusted as desired. A value of X'10' produces good throughput in most configurations.

### SRCVPAC

Specifies the secondary receive pacing count. This value influences performance and can be adjusted as desired. A value of X'10' produces good throughput in most configurations.

### RUSIZES

Specifies the maximum request unit (RU) sizes from the primary and secondary logical units. The RU sizes influence performance and can be adjusted as desired. A value of X'8787' means 1024 bytes for both RU sizes and produces good throughput in most configurations.

The **RUSIZES** specification influences other configuration parameters. These include:

- The **Maximum RU size** field on the **Advanced** tab of the Define a Mode notebook (Figure 60 on page 51)
- The **MAXSTL** operand in the IBM Network Control Program (NCP) **LINE** statement

Figure 27 shows an example.

```

MODEIBM      MODETAB      X
IBM3820T    MODEENT    LOGMODE=IBM3820T,FMPROF=X'13',TSPROF=X'07', X
.
.
.
|              PRIPROT=X'B0',SECPROT=X'B0',COMPROT=X'D0B1' X
|              PSERVIC=X'0602000000000000000000002000' X
|              PSNDPAC=X'10',SRCVPAC=X'10',SSNDPAC=X'00' X
|              RUSIZES=X'8787'

```

Figure 27. VTAM Mode Table and Entry Example

## Specifying the VTAM Switched Major Node

A different set of statements and values is required depending on whether:

- A *calling* Communications Server for NT link station initiates a link connection with a 37xx communication controller.
- A *listening* Communications Server for NT link station waits for the 37xx communication controller to initiate a link connection.

A calling Communications Server link station requires the statements and values shown in Figure 28.

```

.
.
.
node_name VBUILD TYPE=SWNET
*
pu_name  PU      ADDR=nn,          ADDRESS REQUIRED, BUT IGNORED X
          CPNAME=cp_name,        CONTROL POINT NAME          X
          IDBLK=nnn,            BLOCK ID                     X
          IDNUM=nnnnn,         PHYSICAL UNIT ID            X
.
.
.
          MAXOUT=7,           LINK LEVEL WINDOW           X
          MODETAB=mode_table, LOGON MODE TABLE           X
          DLOGMOD=mode_entry, LOGON MODE TABLE ENTRY           X
          VPACING=0,          NO PACING TO BOUNDARY NODE
*
lu_name  LU      LOCADDR=nn,      INDEPENDENT LU

```

Figure 28. VTAM Switched Major Node Guidelines: Calling Link Station

A listening Communications Server link station requires the statements and values shown in Figure 29 on page 21.

```

.
.
.
node_name VBUILD TYPE=SWNET,MAXGRP=1,MAXNO=1
*
pu_name  PU      ADDR=nn,           ADDRESS REQUIRED, BUT IGNORED  X
          CPNAME=cp_name,      CONTROL POINT NAME           X
          IDBLK=nnn,          BLOCK ID                      X
          IDNUM=nnnnn,        PHYSICAL UNIT ID             X
.
.
.
          MAXOUT=7,          LINK LEVEL WINDOW            X
          MODETAB=mode_table, LOGON MODE TABLE           X
          DLOGMOD=mode_entry, LOGON MODE TABLE ENTRY           X
          VPACING=0,          NO PACING TO BOUNDARY NODE
*
path_name PATH  DIALNO=xx044000nnnnnnnn,
          GRPNM=ncp_group,
*
lu_name      LU   LOCADDR=nn,      INDEPENDENT LU

```

Figure 29. VTAM Switched Major Node Guidelines: Listening Link Station

The following describes the pertinent operands on the **VBUILD** statement:

**TYPE** Specify **SWNET** to indicate that the node is a switched major node.

**MAXGRP**

Specifies the number of unique path groups (**GROUP** names) that are defined in the **GRPNM** operand of all **PATH** statements within the switched major node. There is one unique path group in the switched major node guideline presented in Figure 29.

**MAXNO**

Specifies the number of unique token-ring addresses that are defined in the **DIALNO** operand of all **PATH** statements within the switched major node. There is one unique token-ring address in the switched major node guideline presented in Figure 29.

The following describes the pertinent operands on the **PU** statement.

**Note:** The **DLOGMOD**, **MODETAB**, and **VPACING** operands are **LU** operands, but are included here on the **PU** statement. VTAM definitions support a “sift-down effect” that allows you to code an operand on a higher-level statement so you do not need to code it on each lower-level statement for which the same value is desired. There is only one logical unit in the guideline presented here, so the sift-down effect is for demonstration only. If the **DLOGMOD**, **MODETAB**, and **VPACING** operands are specified on the **PU** statement, they do not have to be specified on any of the **LU** statements.

**ADDR**

Specifies the address of the physical unit. Note that this operand is required, but ignored.

**CPNAME (optional)**

Identifies the control point (CP). The value specified for **CPNAME** must match the second part of the **Fully qualified CP name** field on the **Basic** tab of the Define the Node notebook (Figure 36 on page 28). By convention, the **CPNAME** value usually matches the **PU** name.

Either the **CPNAME** operand or both the **IDBLK** and the **IDNUM** operands are required. **CPNAME** can only be used with PU type 2.1 nodes, such as Communications Server for NT.

**IDBLK (optional)**

Specifies a 3–digit hexadecimal string that identifies the product type in a SNA network. The combined values of the **IDBLK** and **IDNUM** operands must match the **Local Node ID** value on the **Basic** tab of the Define the Node notebook (Figure 36 on page 28).

Either the **CPNAME** operand or both the **IDBLK** and the **IDNUM** operands are required.

**IDNUM (optional)**

Specifies a 5–digit hexadecimal string that identifies a physical unit. The combined values of the **IDBLK** and **IDNUM** operands must match the **Local Node ID** value on the **Basic** tab of the Define the Node notebook (Figure 36 on page 28).

Either the **CPNAME** operand or both the **IDBLK** and the **IDNUM** operands are required.

**MAXDATA (optional)**

Specifies the maximum amount of data (in bytes) that the physical unit can receive in one path information unit (PIU). This amount includes the transmission header (TH) and the request/response header (RH).

Note that **MAXDATA** is ignored for type 2.1 nodes, such as Communications Server for NT, that are attached through an NCP with peripheral node type 2.1 support. The type 2.1 node indicates the maximum path information unit (PIU) size when the connection is established. The value that SNA Server/6000 supplies can be configured using the **Maximum PIU size** field on the **Advanced** tab of the Define a LAN Device notebook (Figure 42 on page 33).

**MAXOUT**

Specifies the maximum number of PIUs that are sent to the physical unit before waiting for a response from that physical unit. For optimum performance, the **MAXOUT** value must be equal to, or greater than, the **Receive window count** field in the **Advanced** tab of the Define a LAN Device notebook (Figure 42 on page 33). The **Receive window count** field specifies how many frames are received by the link station before Communications Server for NT sends an acknowledgement.

**MAXPATH (optional)**

Specifies the number of dial-out paths to the physical unit. Figure 29 on page 21 shows one dial-out path.

**MODETAB**

Specifies the name of the logon mode table that contains entries that describe session characteristics.

**DLOGMOD**

Specifies the name of the logon mode table entry that describes session characteristics.

**VPACING**

Determines how VTAM paces the flow of the data from VTAM to the boundary node to which the logical unit is connected. In this configuration, the boundary node is the communication controller. A value of zero means



that no pacing is performed for sessions with the logical unit, or that the largest possible pacing is used if the session is adaptively paced.

The following describes the pertinent operands on the **PATH** statement:

**DIALNO=xx044000nnnnnnnnn (optional)**

This parameter value has three parts:

- xx** Specifies the token-ring interface coupler (TIC) number in the communication controller.
- 04** Specifies the service access point (SAP). This value must always be 04.

**4000nnnnnnnnn**

Specifies the token-ring address of the token-ring adapter in the NT workstation. Although token-ring addresses include twelve hexadecimal digits, the VTAM **DIALNO** operand only accepts digits in the range 0-9. Therefore, an alternate token-ring address that contains only digits in the range 0-9 must be assigned to the token-ring adapter in the NT workstation.

**GRPNM**

Refers to a logical **GROUP** statement in the NCP definitions.

The following describes the pertinent operands on the **LU** statement:

**LOCADDR**

**LOCADDR=0** specifies that this logical unit is an independent logical unit. An SSCP-LU session does not have to be established prior to an LU-LU session with an independent logical unit. For independent logical units, do *not* select **Dependent LU** on the **Basic** tab of the Define a Local LU 6.2 notebook (Figure 56 on page 47).

**SSCPFM (optional)**

The **SSCPFM** operand indicates the type of request units (RUs) that the logical unit supports over its SSCP-LU session. The guidelines illustrated for both the calling link station and the listening link station use an independent logical unit. Therefore, the **SSCPFM** operand is not specified. If you require a dependent logical unit, specify **SSCPFM=USSCS**.

Figure 30 on page 24 and Figure 31 on page 24 show examples for a calling link station.

```

.
.
.
PSFDC4SW  VBUILD TYPE=SWNET
*
DEVTESTB  PU      ADDR=04,          ADDRESS REQUIRED, BUT IGNORED X
           CPNAME=DEVTESTB,        CONTROL POINT NAME          X
.
.
.
           MAXDATA=1033,           MAXIMUM PIU SIZE            X
           MODETAB=MODEIBM,        LOGON MODE TABLE           X
           DLOGMOD=IBM3820T,       LOGON MODE TABLE ENTRY     X
           VPACING=0,              NO PACING TO BOUNDARY MODE
*
           PATH  DIALNO=400059550067, TOKEN-RING ADAPTER ADDRESS X
           GRPNM=PSFDC461          NO PACING TO BOUNDARY NODE
*
PSFDC4LU  LU      LOCADDR=0,        INDEPENDENT LU

```

Figure 30. VTAM Switched Major Node Example with CPNAME

```

.
.
.
PSFDC4SW  VBUILD TYPE=SWNET
*
DEVTESTB  PU      ADDR=04,          ADDRESS REQUIRED, BUT IGNORED X
           IDBLK=05D,              BLOCK ID                     X
           IDNUM=00000,            PHYSICAL UNIT ID             X
.
.
.
           MAXDATA=1033,           MAXIMUM PIU SIZE            X
           MODETAB=MODEIBM,        LOGON MODE TABLE           X
           DLOGMOD=IBM3820T,       LOGON MODE TABLE ENTRY     X
           VPACING=0,              NO PACING TO BOUNDARY MODE
*
           PATH  DIALNO=400059550067, TOKEN-RING ADAPTER ADDRESS X
           GRPNM=PSFDC461          NO PACING TO BOUNDARY NODE
*
PSFDC4LU  LU      LOCADDR=0,        INDEPENDENT LU

```

Figure 31. VTAM Switched Major Node Example with IDBLK and IDNUM

## Specifying the VTAM External Communication Adapter (XCA) Major Node

The keywords and values for the 3172 establishment controller definitions are illustrated in Figure 32 and described below.

```

node_name  VBUILD  TYPE=XCA
port_name  PORT    ADAPNO=n,    X
           CUADDR=nnn, X
           MEDIUM=RING
group_name GROUP   DIAL=YES
line_name  LINE    CALL=INOUT
pu_name    PU

```

Figure 32. VTAM XCA Major Node Guidelines

The following describes the pertinent operands on the **VBUILD** statement:

**TYPE** Specify **XCA** to indicate that the node is an External Communication Adapter major node.

The following describes the pertinent operands on the **PORT** statement:

**ADAPNO**

Specifies the adapter number in the 3172 interconnect controller.

**CUADDR**

Defines the 3-digit hexadecimal channel control unit address that is used for the attached local area network (LAN).

**MEDIUM**

Specify **RING** for a token-ring network.

The following describes the pertinent operands on the **GROUP** statement:

**DIAL** Specify **YES** to indicate that the lines in the group require switched line control protocols.

The following describes the pertinent operands on the **LINE** statement:

**CALL** Specifies whether the link station in the 3172 interconnect controller should call out to the remote link station, or whether the remote link station should call into the 3172 interconnect controller link station. Specify **CALL=INOUT**, which enables either calling or listening link stations to be configured in SecureWay Communication Server for Windows NT.

Figure 33 shows an example.

```
PSFDC4XA  VBUILD  TYPE=XCA
*
PSFDC4P1  PORT    ADAPNO=3,   X
                CUADDR=5FF,  X
                TIMER=60,    X
                MEDIUM=RING
*
PSFDC4G1  GROUP   DIAL=YES
*
PSFDC4LI  LINE    CALL=INOUT
*
PSFDC4P1  PU
```

Figure 33. VTAM XCA Major Node Example

---

## Specifying Communications Server for NT Configuration Profiles

This section contains instructions and guidelines for configuring the Communications Server for NT profiles. It includes the following tasks:

- “Accessing the Communications Server for NT Profiles” on page 26
- “Local 3172 Node Setup” on page 27
- “Local 3172 Device Configuration” on page 31
- “Enabling SNA API Clients for Local 3172” on page 36
- “Local 3172 Peer Connections Configuration” on page 38
- “Partner LU 6.2 Configuration for Local 3172” on page 43
- “Local LU 6.2 Configuration for Local 3172” on page 46

- “Mode Configuration for Local 3172” on page 49
- “Transaction Program Configuration for Local 3172” on page 52

## Accessing the Communications Server for NT Profiles

Use the following procedure to access the IBM SecureWay Communications Server for NT applications that are described in “What is IBM SecureWay Communications Server for Windows NT?” on page 2.

Note that this procedure assumes that you have dragged the icons for **SNA Node Configuration** and **SNA Node Operations** to your desktop after they were created at installation.

1. From your NT desktop view, double-click the **SNA Node Configuration** icon that resides on your desktop:

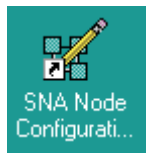

2. At the Welcome to Communications Server Configuration! pop-up window, select the **New** button for a new configuration) and click the **Next>** button. Communications Server creates an *xxx.acg* file (where *xxx* represents the file name you select in this window. This *xxx.acg* file resides in the C:\IBMCS\private directory, where C is the drive where you installed IBM SecureWay Communications Server for NT. For users migrating from PSF Direct on an OS/2® operating system, this *xxx.acg* file is the equivalent of the OS/2 Communications Manager Communications Server *xxx.ndf* file.

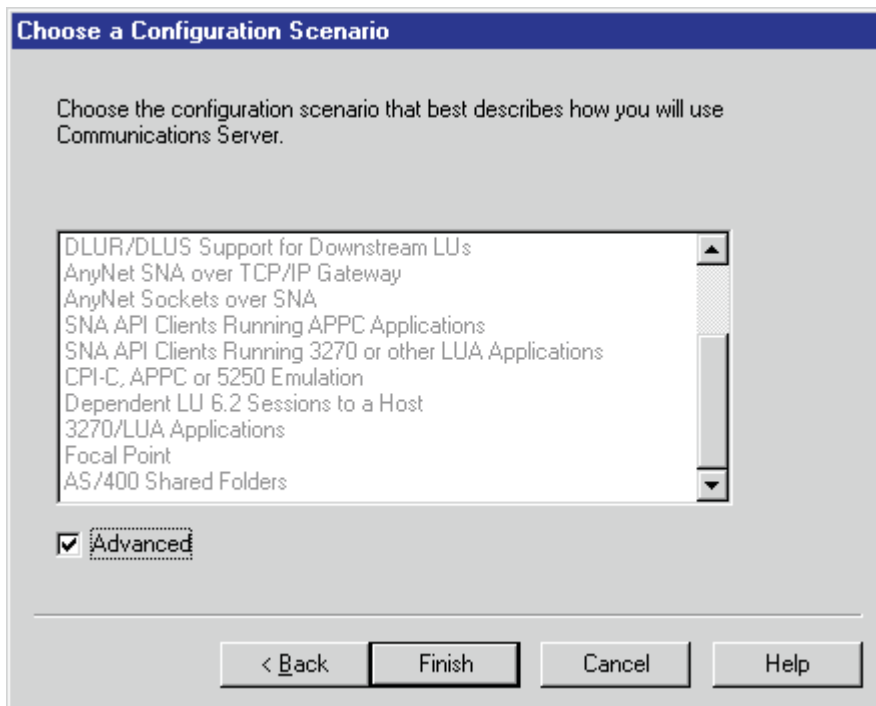

Figure 34. Choose a Configuration Scenario Window

3. In the Choose a Configuration Scenario window (Figure 34 on page 26), check the **Advanced** box, which causes the display to turn gray. Click the **Finish** button.
4. From the Communications Server SNA Node Configuration window (Figure 35), you are ready to begin configuring your system for PSF Direct.

## Local 3172 Node Setup

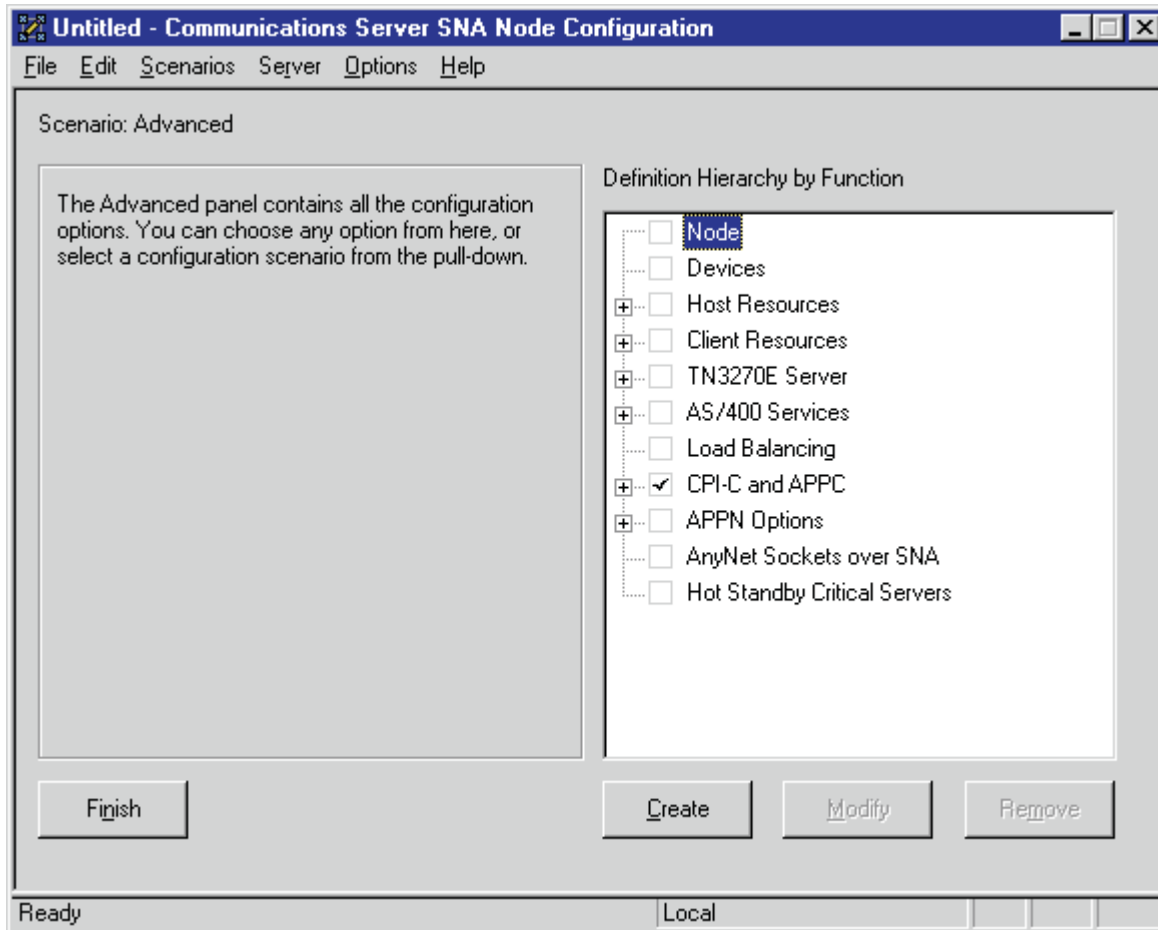

Figure 35. Communications Server SNA Node Configuration Window: Node

In the Communications Server SNA Node Configuration window (Figure 35), right-click the **Node** box and select the **Create** option. The Define the Node notebook opens at the **Basic** tab.

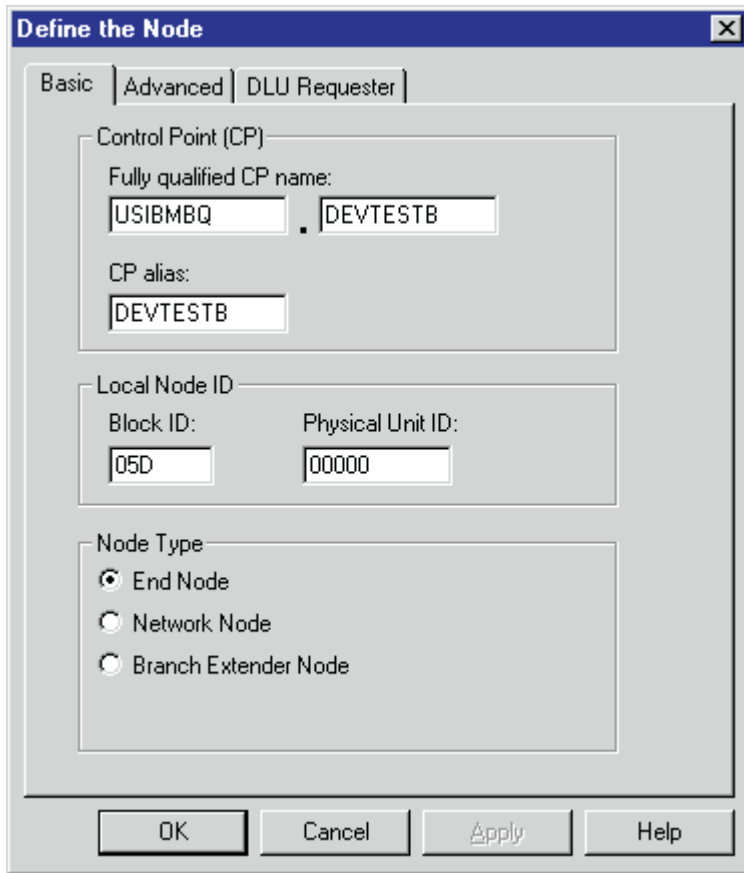

Figure 36. Define the Node Notebook: Basic Tab

On the **Basic** tab (Figure 36), specify values for the following parameters:

**Fully qualified Control Point (CP) name**

Specifies the name of the component that manages the resources of that node. If the **CPNAME** operand is used in the VTAM switched major node **PU** statement (see “Specifying the VTAM Switched Major Node” on page 20), then the second part of this value must match the value of the **CPNAME** operand. By convention, the **CPNAME** is usually the same as the **PU** name.

**CP alias**

Specifies an alternative name for the CP. Local applications can use this name, instead of the **Fully qualified Control Point (CP) name**, to refer to the local CP.

**Local Node ID**

Specifies both the **Block ID** and the **Physical Unit ID**. The **Block ID** is a 3-digit hexadecimal string that identifies the product type in an SNA network. The **Physical Unit ID** is a 5-digit hexadecimal string that identifies a physical unit (PU).

If the **IDBLK** and **IDNUM** operands are used in the VTAM switched major node **PU** statement (see “Specifying the VTAM Switched Major Node” on page 20), then the **Local Node ID** value must match the combined values of the **IDBLK** and **IDNUM** operands. The **IDBLK** operand is normally 071 for Communications Server for NT.

If you are migrating from an AIX<sup>®</sup> operating system, **Local Node ID** matches the **XID Node ID** parameter.

### Node Type

Specifies the type of node. Take the default value, **End node**.

If you are migrating from an AIX operating system, **Node Type** matches the **Control Point Type** parameter.

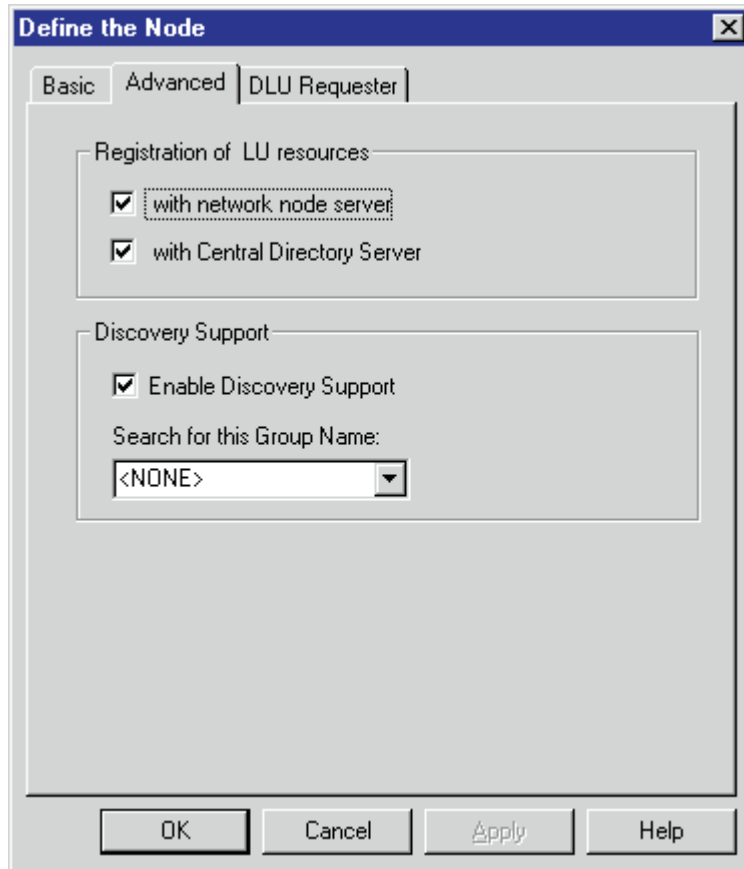

Figure 37. Define the Node Notebook: Advanced Tab

On the **Advanced** tab (Figure 37), specify values for the following parameters:

#### Registration of LU resources

Specifies that directory information about the local logical units (LUs) 6.2 is sent to the server. As the example shows, check both the **Network node server** and the **Central Directory Server**.

#### Discovery Support

Specifies a LAN address resolution protocol that can be used to find another node that matches given search values. Adjust the search parameter to search for APPN<sup>®</sup> network nodes, nodes that provide SNA boundary function, or AS/400s. Select the check box to enable discovery support.

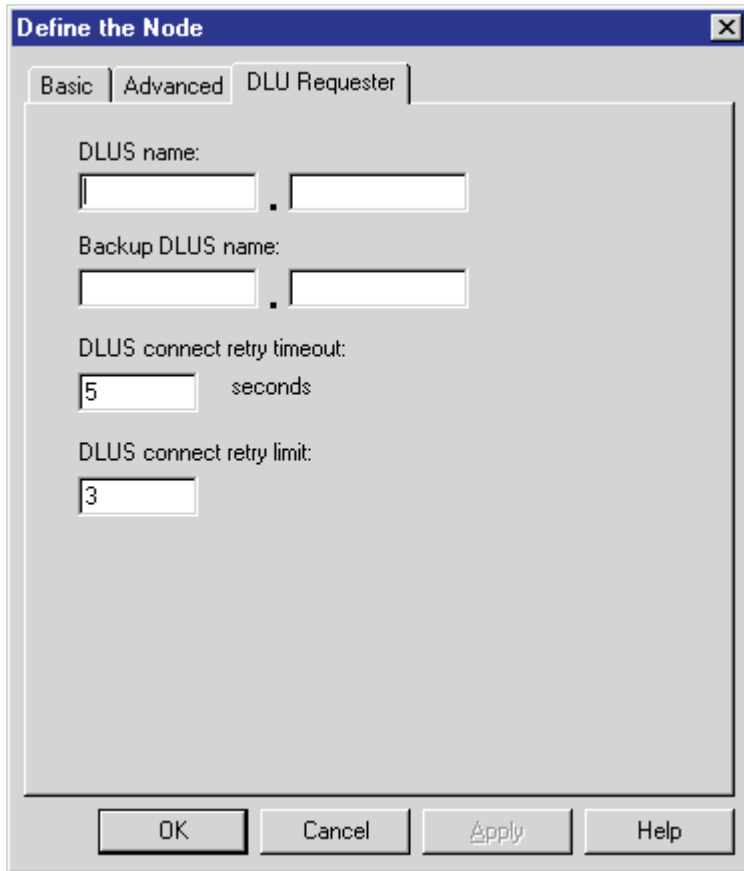

Figure 38. Define the Node Notebook: DLU Requester Tab

On the **DLU Requester** tab (Figure 38), accept the default values for the following parameters:

**DLUS connect retry timeout**

Specifies the time between attempts to reconnect a dependent logical unit server (DLUS). This parameter is based on the **DLUS connect retry limit** parameter. Take the default of 5.

**DLUS connect retry limit**

Specifies the maximum number of attempts to reconnect a DLUS without receiving an acknowledgment in the time set by the **DLUS connect retry timeout** parameter. Take the default of 3.

Click **OK** to save these configuration settings.



## Local 3172 Device Configuration

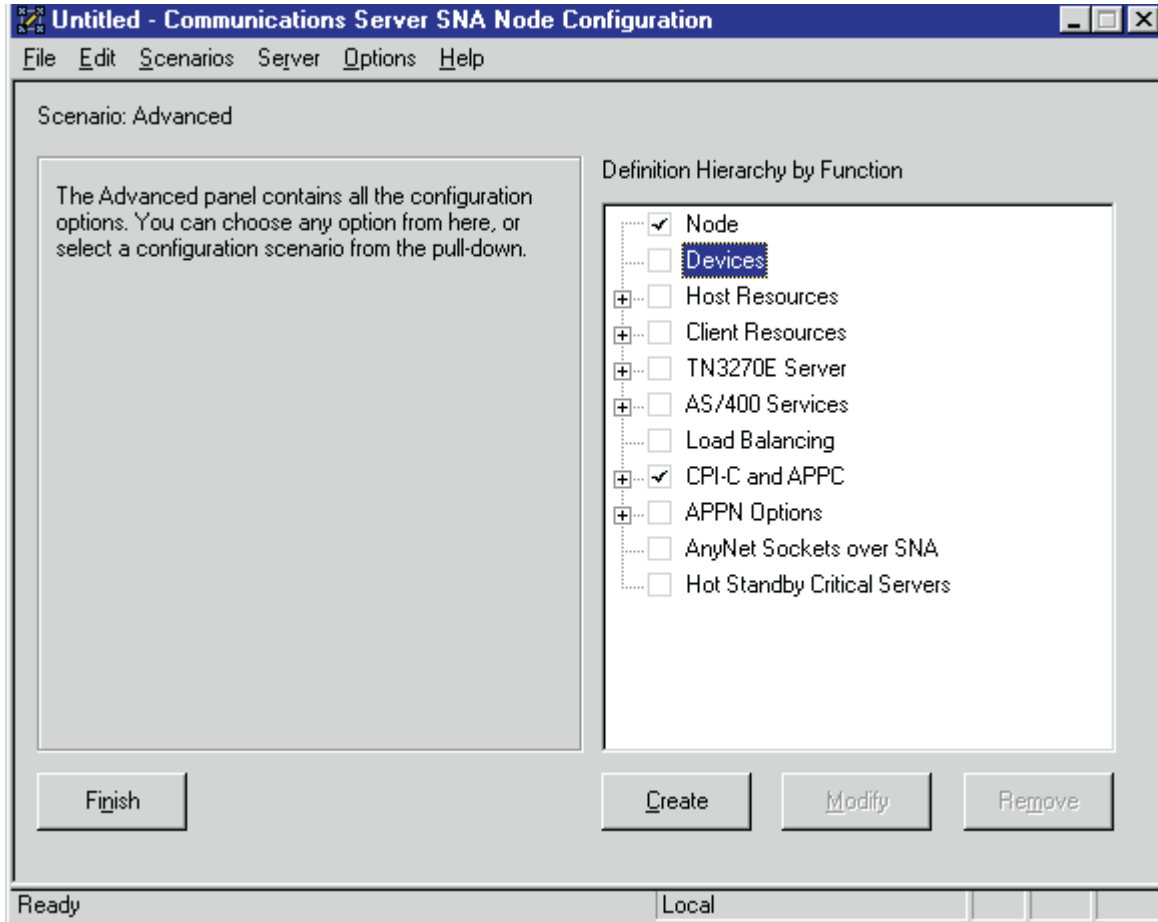

Figure 39. Communications Server SNA Node Configuration Window: Devices

In the Communications Server SNA Node Configuration window (Figure 39), right-click the **Devices** box and select the **Create** option. The Device Type pop-up window (Figure 40) opens.

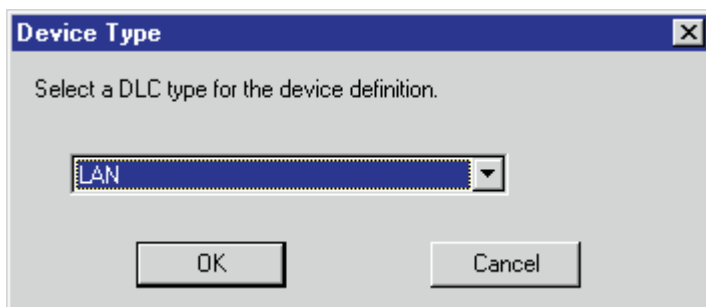

Figure 40. Device Type Window

Select **LAN** as your data link control (DLC) type. A DLC is a set of rules that nodes on a data link (such as an SDLC link or a token ring) use to accomplish an orderly exchange of information.

Click **OK** to save this configuration setting.

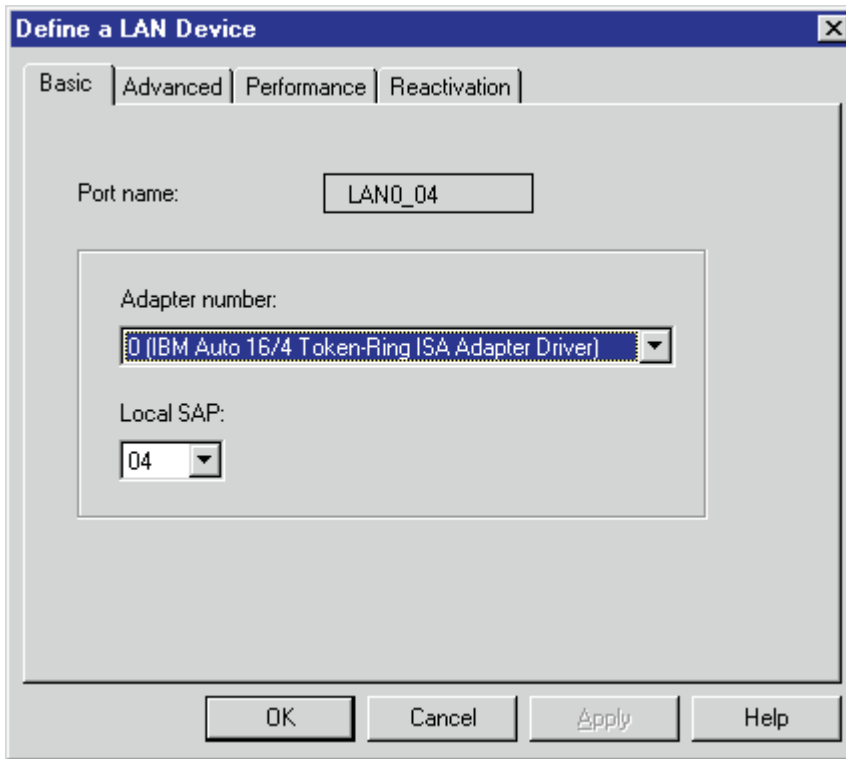

Figure 41. Define a LAN Device Notebook: Basic Tab

On the **Basic** tab of the Define a LAN Device notebook (Figure 41), supply the following values:

**Port name**

Specifies the port name of the physical connection to the link hardware. This value consists of the word **LAN**, the adapter number, and the local SAP number, with an underscore between the adapter number and the local SAP number. Accept the value that is displayed.

**Adapter number**

Specifies a value from 0 to 7 that uniquely identifies this adapter. You may have both token-ring and ethernet adapters defined at your installation. Ensure that you select the proper token-ring LAN adapter.

**Local SAP**

Specifies the local service access point (SAP) number of the local port as a hexadecimal value from 04 through FC. Note that this number must be a multiple of four. Take the default of 04.

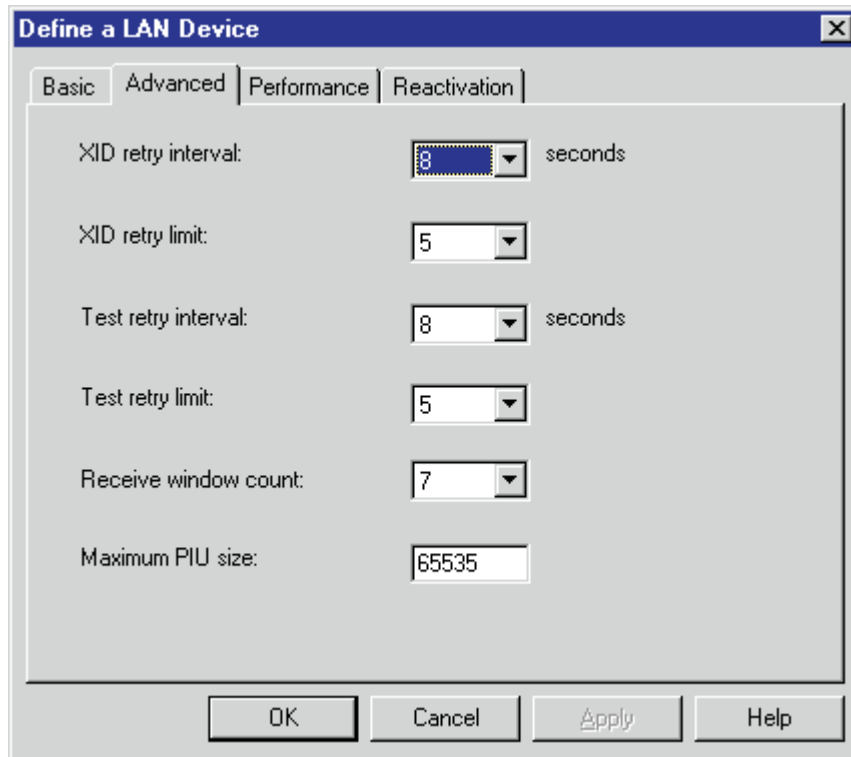

Figure 42. Define a LAN Device Notebook: Advanced Tab

On the **Advanced** tab (Figure 42), supply the following values:

**XID retry interval**

Specifies the time the link station waits for a reply to a previous **XID** command before resending that command. Specify 8. If the link station is a calling link station, this value causes it to try to establish a link connection with the local 3172 communication controller every 8 seconds, until a link connection can be established.

If you are migrating from an AIX operating system to a Windows NT operating system, this parameter replaces the **Response Timeout** parameter from the **Token-Ring SNA DLC** profile.

**XID retry limit**

Specifies the maximum number of times an **XID** command will be retransmitted before Communications Server for NT presumes that the link is broken and stops retrying. Specify 5. The previous parameter defines the interval between the attempts.

If you are migrating from an AIX operating system to a Windows NT operating system, this parameter replaces the **XID Retransmit count** parameter from the **Token-Ring SNA DLC** profile.

**Test retry interval**

Specifies the time between attempts to find the adjacent link station on the LAN. This parameter is needed to establish communication with the network and does not necessarily relate to VTAM or the PSF host system. The number of times an **XID** is sent is based on the configured **XID retry limit**.

### Test retry limit

Specifies the number of times Communications Server attempts to find the adjacent link station on the LAN. Specify a value from 3 to 30.

### Receive window count

Specifies a value that should be equal to the **MAXOUT** value in the VTAM switched major node **PU** statement. The **Receive window count** defines the size of the link-level window. It specifies the maximum number of frames to receive before sending a link-level acknowledgement. The VTAM **PU MAXOUT** value indicates the number of frames the local 3172 communication controller sends before waiting for a link-level acknowledgement. If the **MAXOUT** operand is less than the **Receive window count** field, extremely poor throughput can result. The default **MAXOUT** value is 1. The default **Receive window count** value is 8. You must adjust these defaults to produce acceptable throughput.

### Maximum PIU size

Specifies a value between 99 and 65535 bytes that represents the maximum number of bytes in the data buffer that SNA sessions use for this link. If the **Maximum PIU size** exceeds the frame size supported by your local device driver, the value will be reduced to match the frame size.

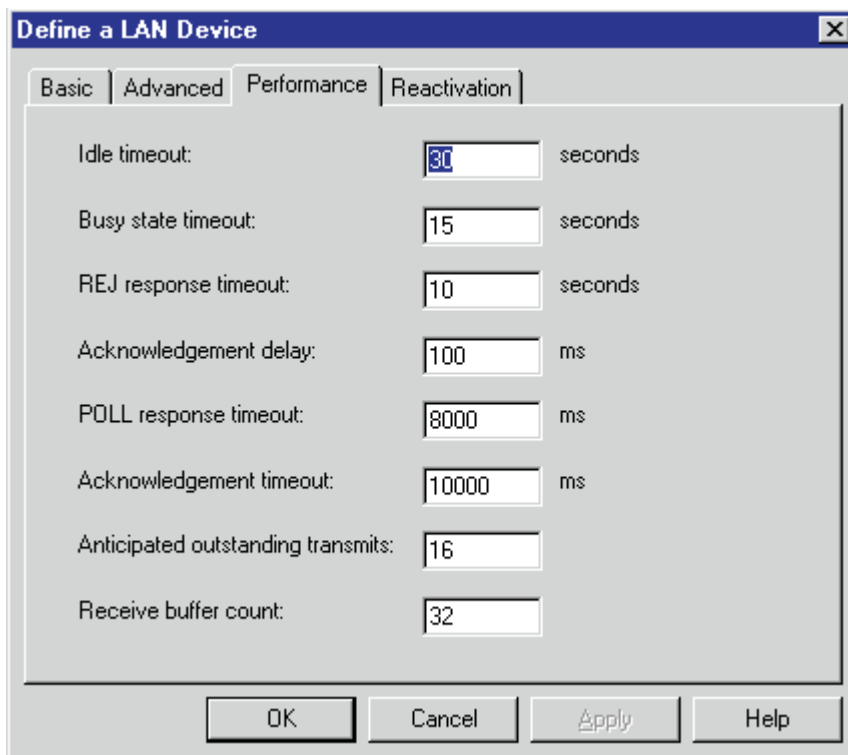

Figure 43. Define a LAN Device Notebook: Performance Tab

On the **Performance** tab (Figure 43), accept the default values.

If you are migrating from an AIX operating system to a Windows NT operating system, see Table 1 on page 35 for a map of the parameters on the **Performance** tab to the corresponding AIX values.

Table 1. Windows NT and AIX Parameters for LAN Device Performance

Windows NT Parameter	AIX Parameter
Idle timeout	Inactivity time-out
Busy state timeout	n/a
Acknowledgement delay	n/a
Acknowledgement timeout	Acknowledgement timeout
POLL response timeout	n/a
Anticipated outstanding transmits	Transmit window count
Receive buffer count	n/a

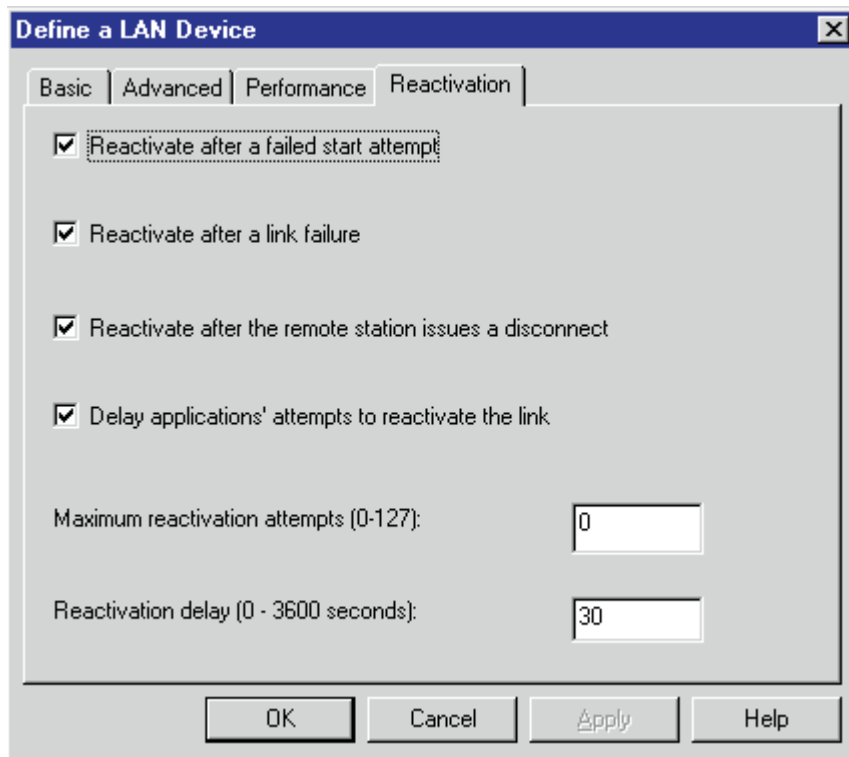

Figure 44. Define a LAN Device Notebook: Reactivation Tab

On the **Reactivation** tab (Figure 44), accept the default values.

Click **OK** to save these configuration settings.

## Enabling SNA API Clients for Local 3172

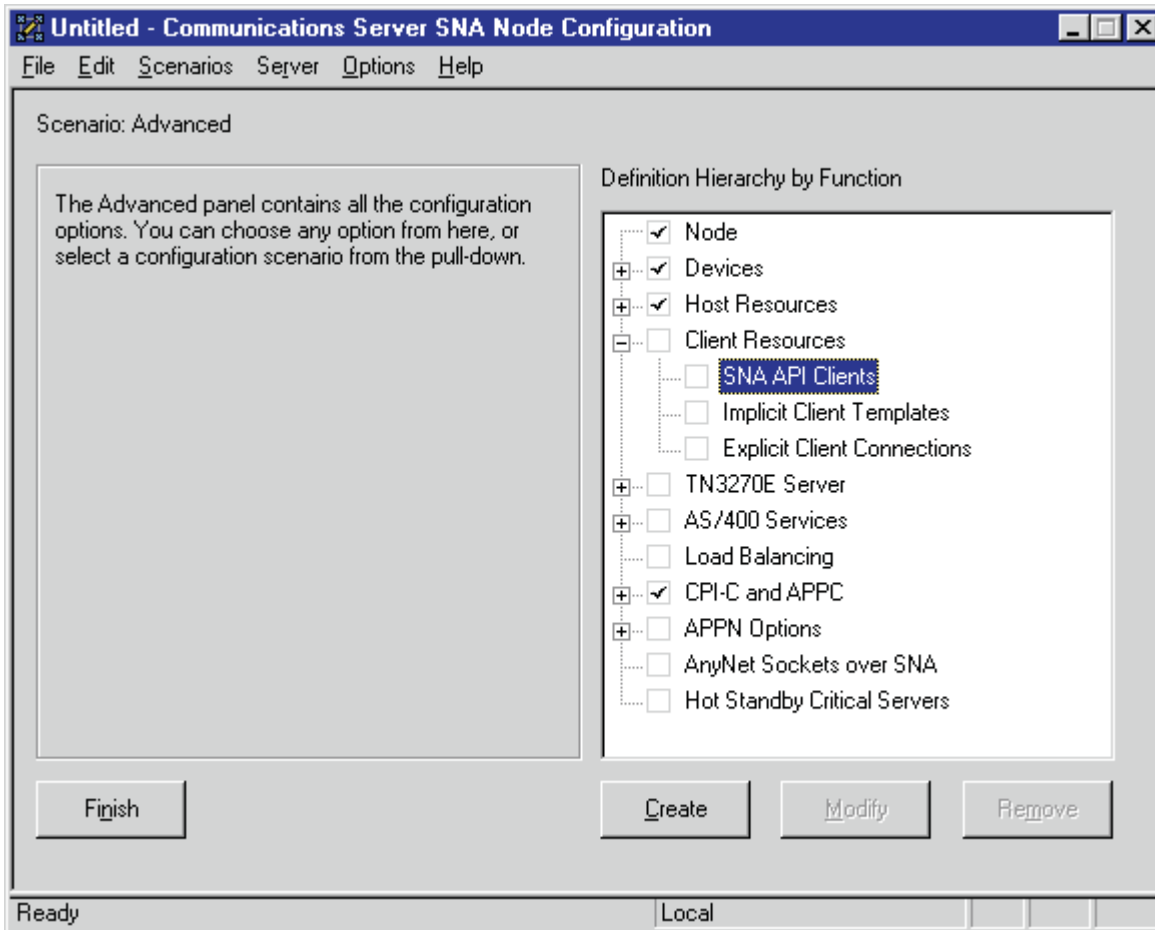

Figure 45. Communications Server SNA Node Configuration Window: SNA API Clients

In the Communications Server SNA Node Configuration window (Figure 45), right-click the **Client Resources** box, then the **SNA API Clients** box. The SNA Clients window opens.

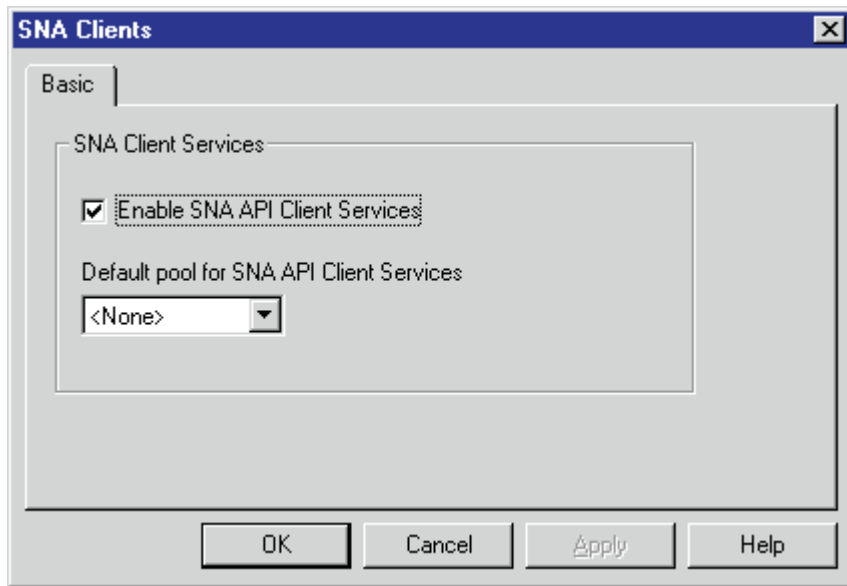

Figure 46. SNA Clients Window

In the SNA Clients window (Figure 46), check the **Enable SNA API Client Services** box.

Click **OK** to save these specifications to the *xxx.acg* file.

## Local 3172 Peer Connections Configuration

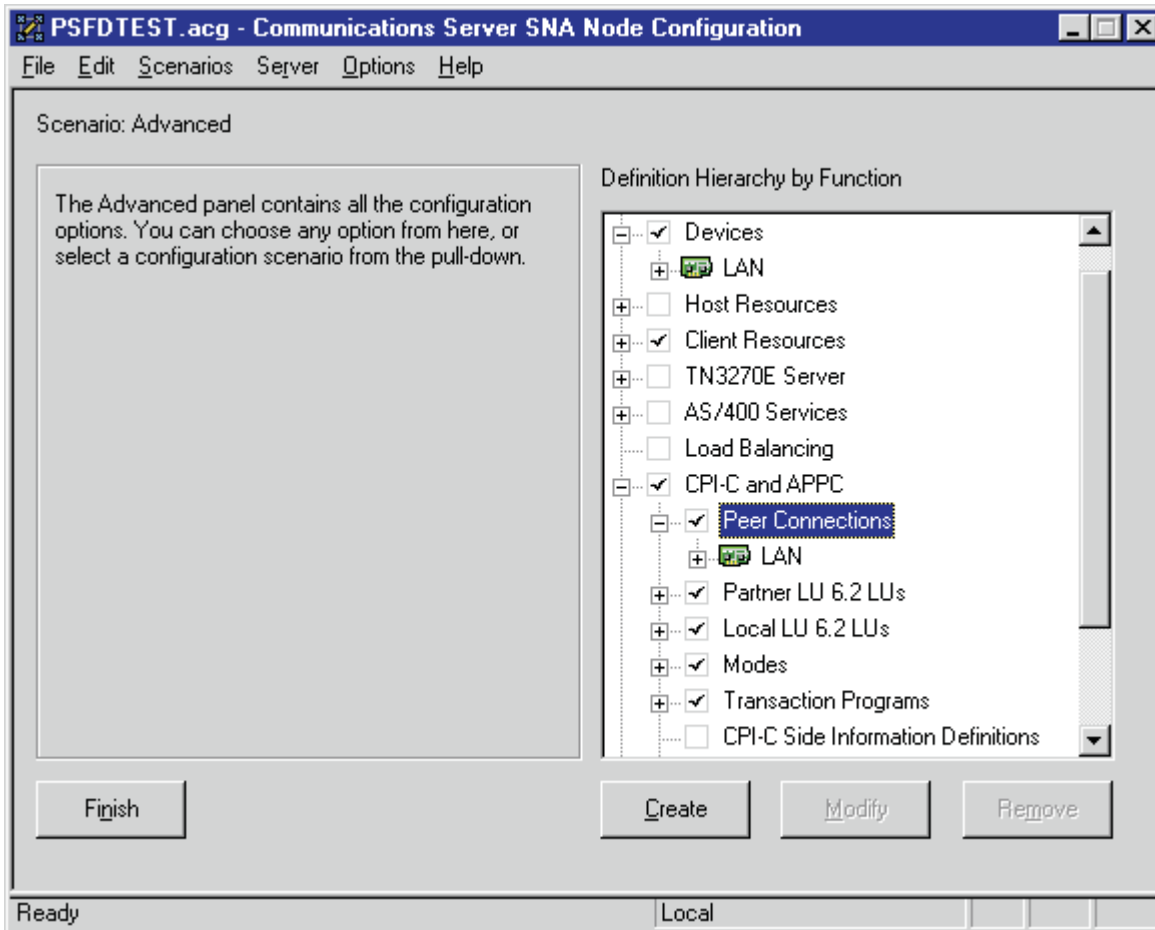

Figure 47. Communications Server SNA Node Configuration Window: Peer Connections

In the Communications Server SNA Node Configuration window (Figure 47), right-click the **CPI-C and APPC** box, then the **Peer Connections** box. Select the **Create** option. The Define a LAN Connection notebook opens at the **Basic** tab.



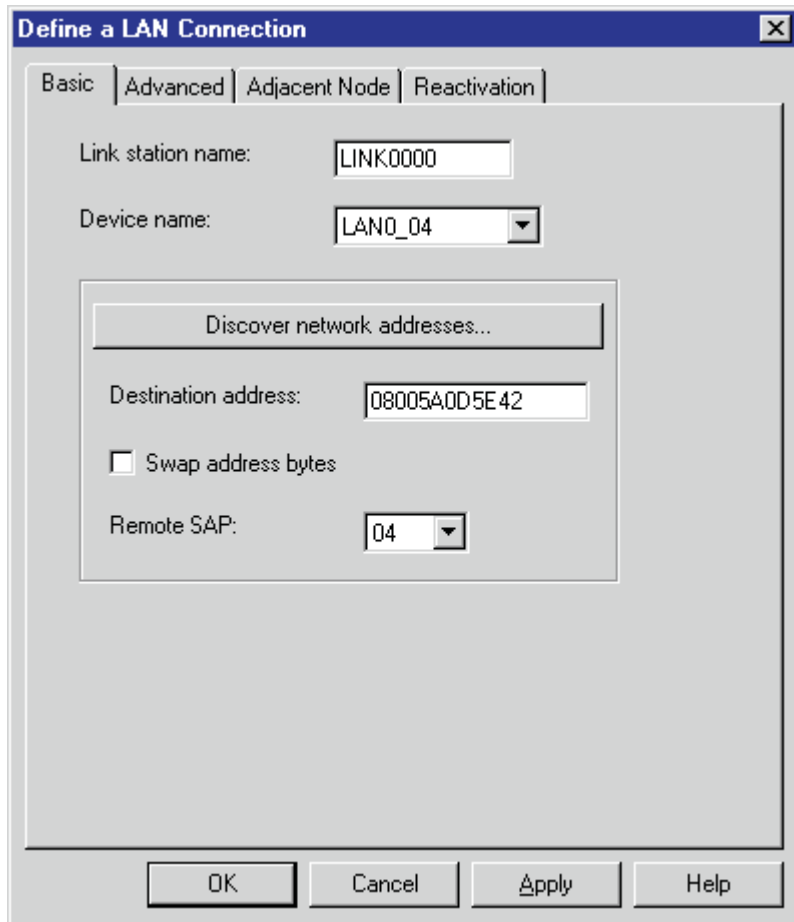

Figure 48. Define a LAN Connection Notebook: Basic Tab

On the **Basic** tab (Figure 48), supply the following values:

**Link station name**

Specifies a 1- to 8-byte character string that is used to identify a connection. The contents of this field will vary, depending on the number of links at your installation.

**Device name**

Specifies the name of the port associated with this link station. This value must match the **Port name** value specified on the **Basic** tab of the Define a LAN Device notebook (Figure 41 on page 32).

**Destination address**

Specifies a 12-character hexadecimal string that specifies the address to activate a connection to the destination. This value must be specified so the NT system can search for and call the PSF host program.

**Swap address bytes**

Check this field to bit-swap the address in the **Destination address** field. You may need to select this check box if the next link in the network is an Ethernet link. If not, you can use the default (unchecked).

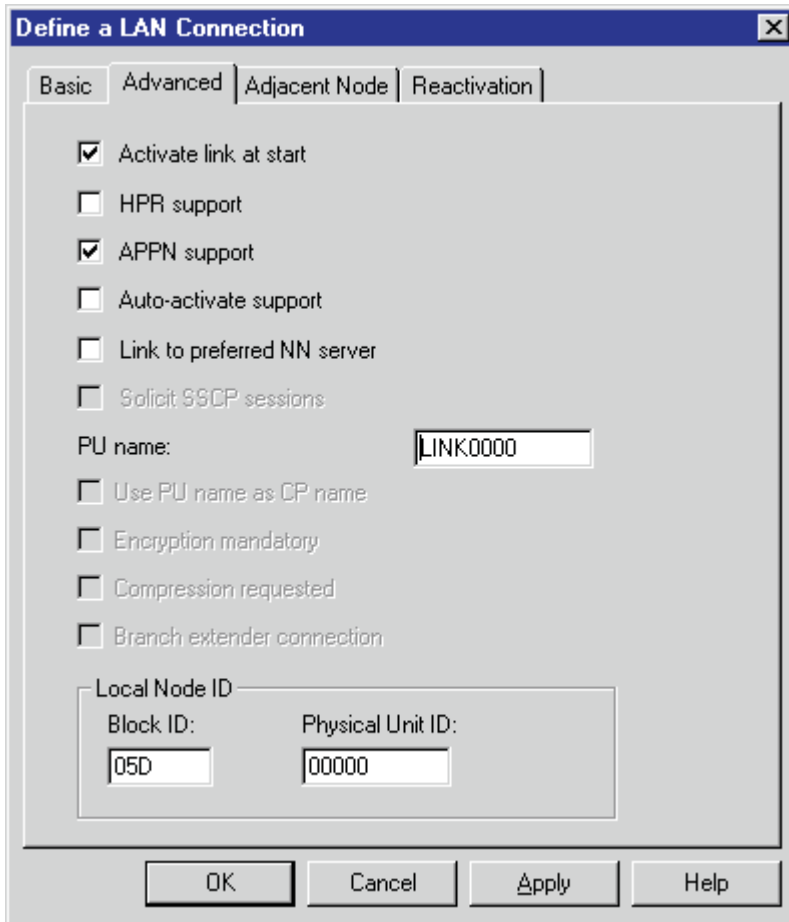

Figure 49. Define a LAN Connection Notebook: Advanced Tab

On the **Advanced** tab (Figure 49), supply the following values:

**Activate link at start**

Specifies that you will use the link reactivation values specified in the port (device) link reactivation definition. Ensure that you select this check box.

**APPN support**

Specifies whether this connection supports CP-CP sessions. Select the check box to specify APPN support.

**PU name**

Specifies the physical unit (PU) name. This is the name of the component that manages and monitors the resources (such as attached links and adjacent link station) associated with a node. The default PU name is automatically created. You can change this definition.

**Block ID**

Identifies the product type in an SNA network.

**Physical Unit ID**

Identifies the physical unit (PU) or component that manages and monitors the resources (such as attached links and adjacent link stations that are associated with a node.

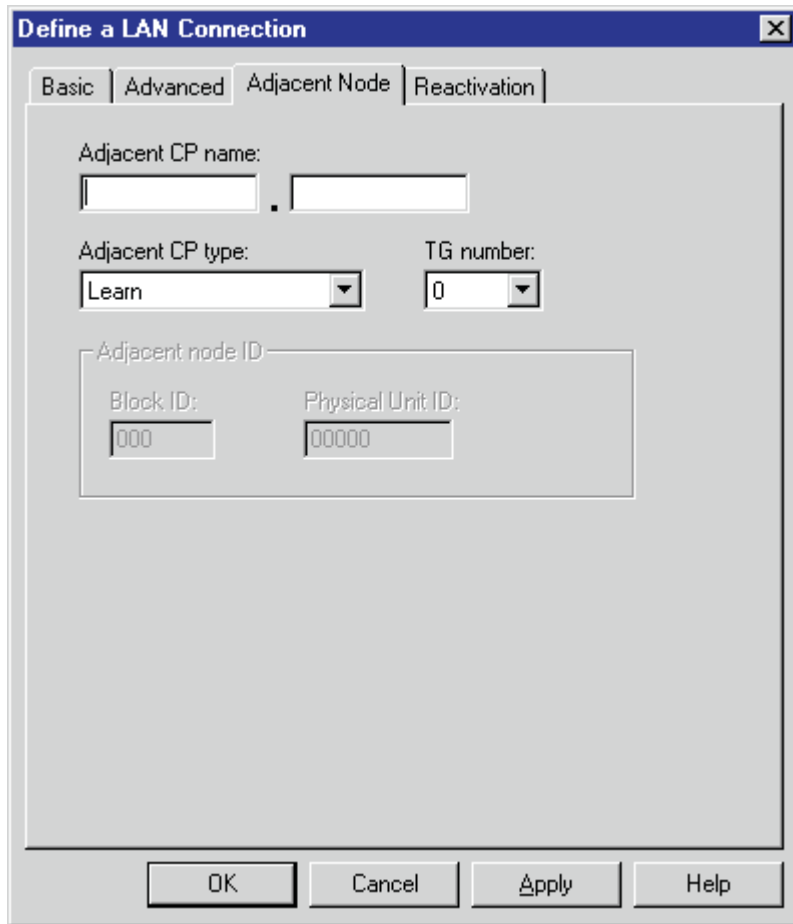

Figure 50. Define a LAN Connection Notebook: Adjacent Node Tab

On the **Adjacent Node** tab (Figure 50), accept the default values.

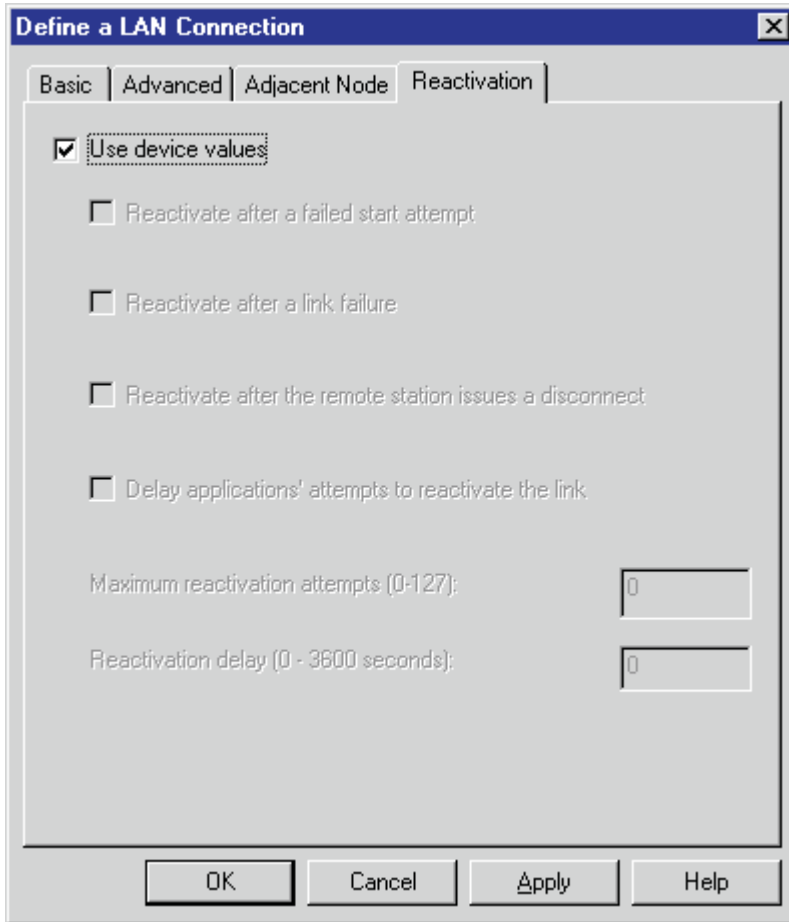

Figure 51. Define a LAN Connection Notebook: Reactivation Tab

On the **Reactivation** tab (Figure 51), accept the default values.

Note that after you select **OK**, a pop-up window appears asking:  
Do you want to automatically route all APPC sessions over this connection?

You must reply yes before the configuration is accepted.

## Partner LU 6.2 Configuration for Local 3172

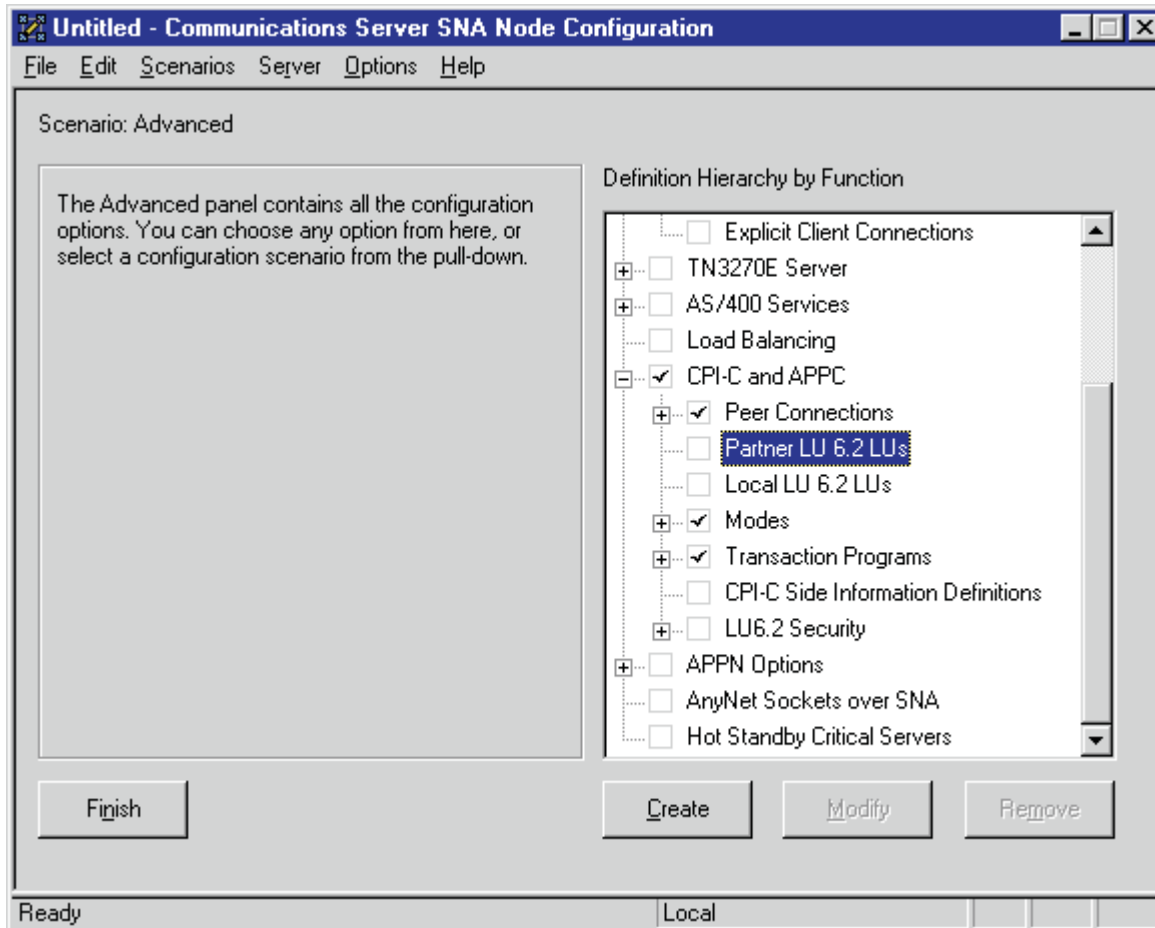

Figure 52. Communications Server SNA Node Configuration Window: Partner LU 6.2 LUs

In the Communications Server SNA Node Configuration window (Figure 52), right-click the **CPI-C and APPC** box, then the **Partner LU 6.2 LUs** box. Select the **Create** option. The Define a Partner LU 6.2 notebook opens at the **Basic** tab.

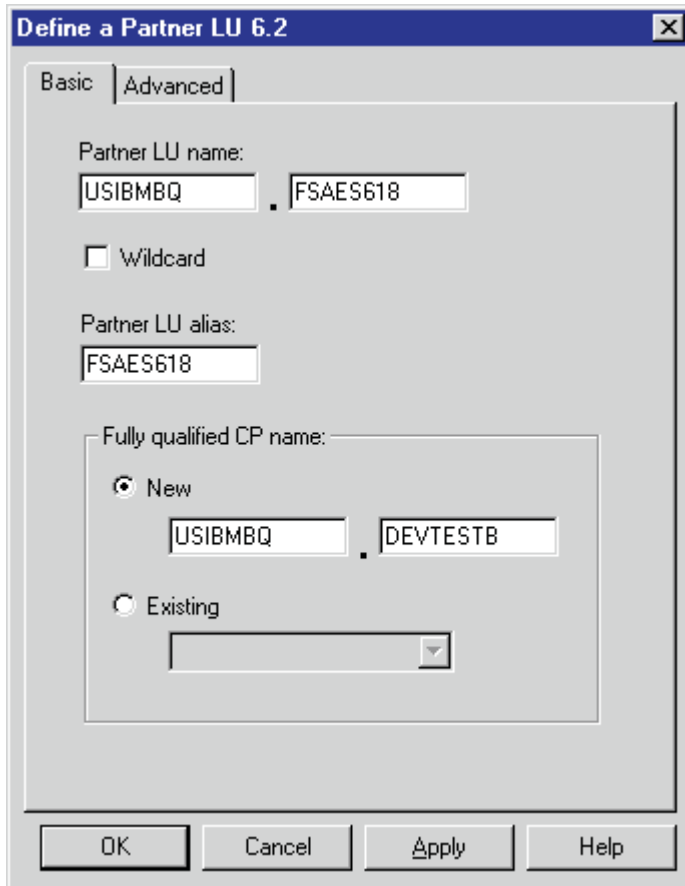

Figure 53. Define a Partner LU 6.2 Notebook: Basic Tab

On the **Basic** tab (Figure 53), supply the following values:

**Partner LU name**

Specifies the network identifier of the network in which the host PSF program resides (followed by a period), and the logical unit name used by the host PSF program. The network identifier portion must match the **NETID** value in the VTAM start option list (ATCSTRxx) (see “Specifying the VTAM Start Option List (ATCSTRxx)” on page 17). The logical unit name portion must match the **APPLID** parameter in one of these places:

- The PSF for OS/390 **PRINTDEV** statement
- The PSF/VSE **PRINTDEV** statement
- the PSF/VM **OPTIONS PDM** file

That **APPLID** parameter on the PSF host system must also match an **APPL** statement in a VTAM application program major node. (Do not check the **Wildcard** check box.)

**Partner LU alias**

Specifies the alternate name for the partner LU. Local applications can use this name, instead of the fully qualified LU name, to refer to the partner LU. While you can choose any meaningful value, IBM recommends specifying the second qualifier of the **Partner LU name**.

**Fully qualified CP name**

Select: **New** to enter the fully qualified CP name of the partner LU’s

owning control point. Communications Server for NT requires this field. Infoprint Manager uses this field as the target for any alerts sent by the PSF Direct program.

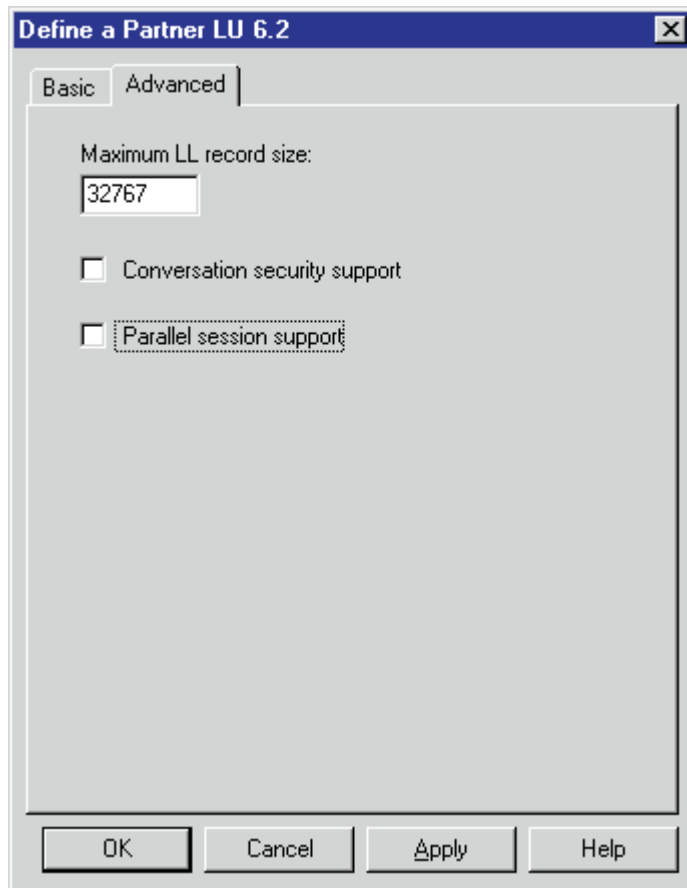

Figure 54. Define a Partner LU 6.2 Notebook: Advanced Tab

On the **Advanced** tab (Figure 54), supply the following values:

**Maximum LL record size**

Specifies a value between 0 and 32767 as the maximum size of the logical record in the data stream for basic conversations. Specify the default (32767), because the PSF host program and the PSF Direct host receiver should both be able to handle the full range.

**Conversation security support**

Specifies that the partner logical unit (LU) is authorized to validate the user identifiers for the local LUs. Select the check box to specify conversation security support if you have matching support on the host PSF program. If not, leave this box unchecked.

**Parallel session support**

Specifies whether the partner LU supports two or more currently active sessions between the same two LUs by using different pairs of network addresses or session identifiers. Because neither PSF Direct nor the PSF host programs support two sessions with the same partner LU, do not select this check box.

Click **OK** to save these specifications to the *xxx.acg* file.

## Local LU 6.2 Configuration for Local 3172

### Dependent or Independent LU?

This procedure configures an *independent* LU. You cannot use it to configure a *dependent* LU. If you require dependent LUs, see “Deciding Whether to Define a Dependent or an Independent LU” on page 12.

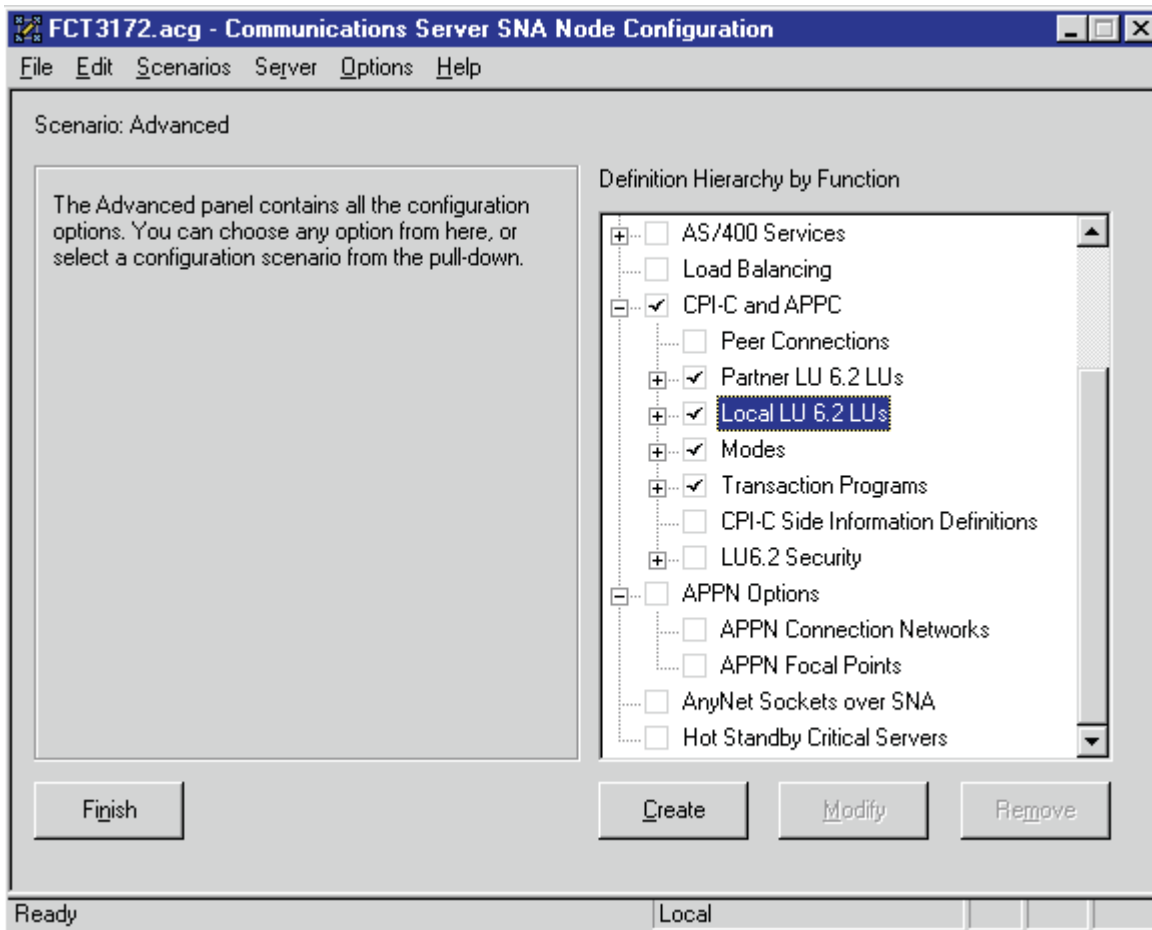

Figure 55. Communications Server SNA Node Configuration Window: Local LU 6.2 LUs

In the Communications Server SNA Node Configuration window (Figure 55), right-click the **CPI-C and APPC** box, then the **Local LU 6.2 LUs** box. Select the **Create** option. The Define a Local LU 6.2 notebook opens at the **Basic** tab.



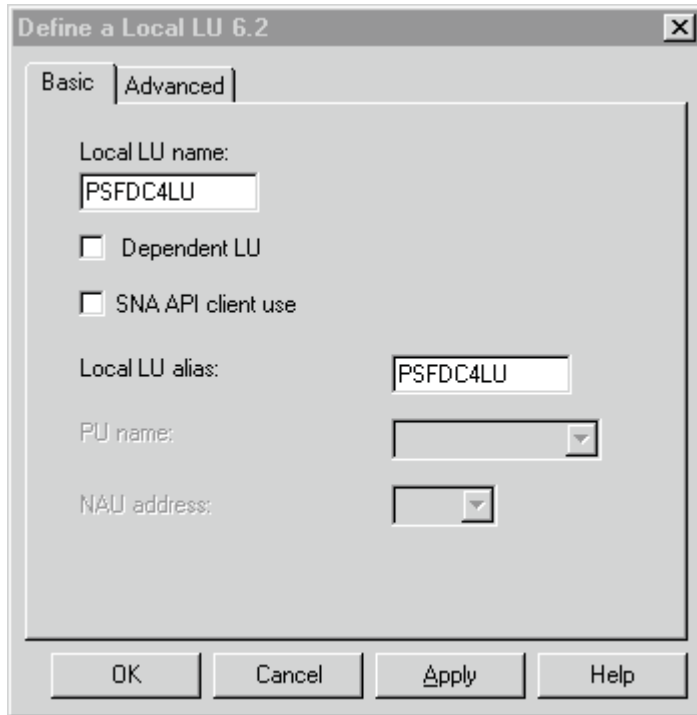

Figure 56. Define a Local LU 6.2 Notebook: Basic Tab

On the **Basic** tab (Figure 56), supply the following values:

**Local LU name**

Specifies a 1- to 8-byte character string that identifies your workstation and gives transaction programs access to the network. This name must match the partner LU that you have defined at the host PSF program.

**Local LU alias**

Specifies the name for the local LU that is used by Infoprint Manager when configuring the PSF Direct host receiver.

**Dependent LU**

Specifies whether this LU requires assistance from a system services control point (SSCP) in order to initiate an LU-LU session. When this check box is selected, the LU must be specified as dependent on the host PSF program. Because this procedure is for an independent LU, do not check the box.

**SNA API client use**

Because this LU will be used by a server-based transaction program (TP), do not check this box.

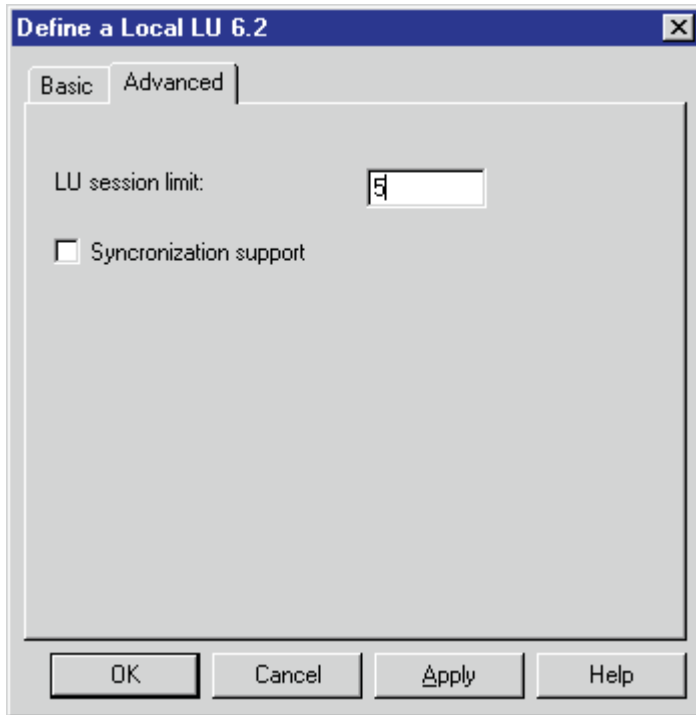

Figure 57. Define a Local LU 6.2 Notebook: Advanced Tab

On the **Advanced** tab (Figure 57), supply the following values:

**LU session limit**

Specifies the maximum number of sessions that the LU supports as a value between 0 and 65535. Specify 5.

**Note:** The application program supports only one LU session at a time, but the SNA session can support more.

**Synchronization support**

Select this check box if another application is supplying synchronization point management (DB/2, for example). In this instance, do not select it.

Click **OK** to save these specifications to the *xxx.acg* file.

## Mode Configuration for Local 3172

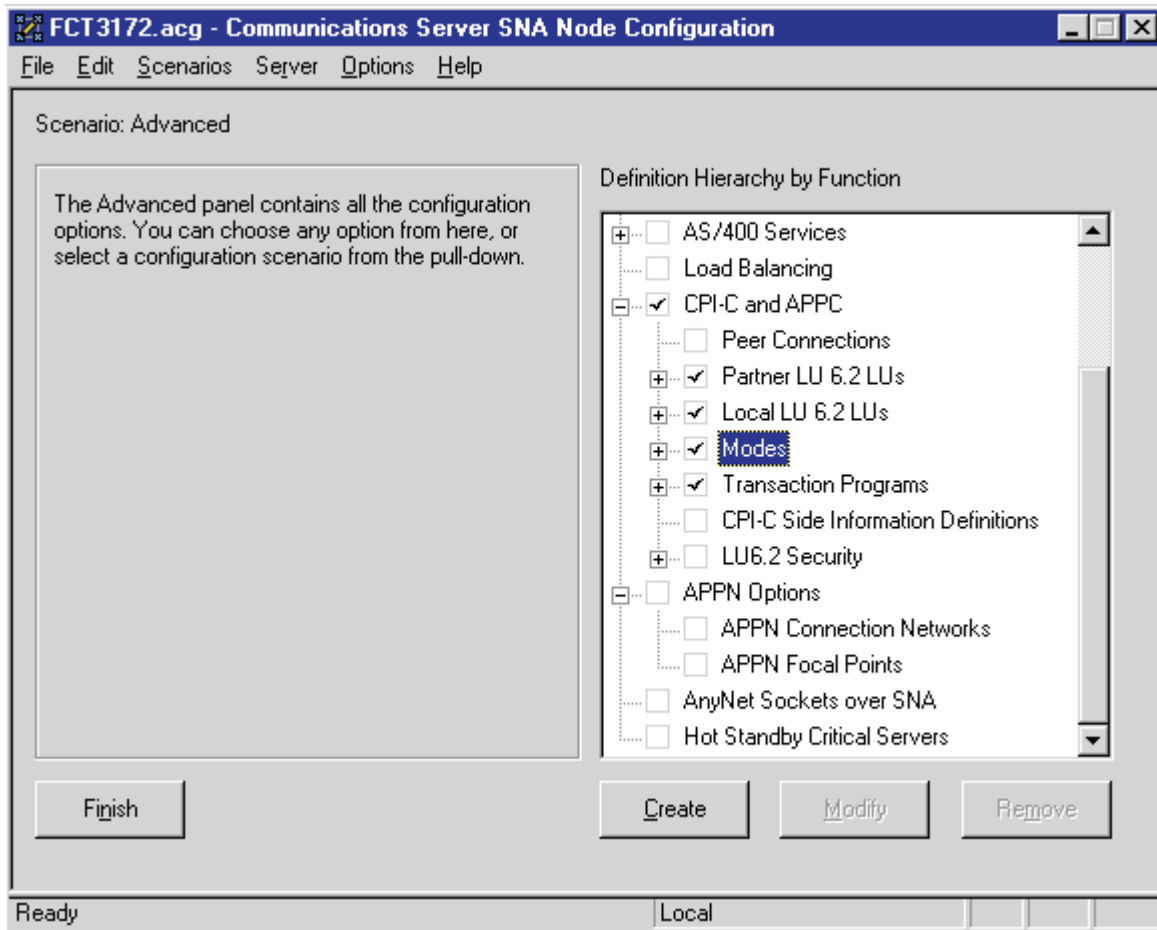

Figure 58. Communications Server SNA Node Configuration Window: Modes

In the Communications Server SNA Node Configuration window (Figure 58), right-click the **CPI-C and APPC** box, then the **Modes** box. Select the **Create** option. The Define a Mode notebook opens at the **Basic** tab.

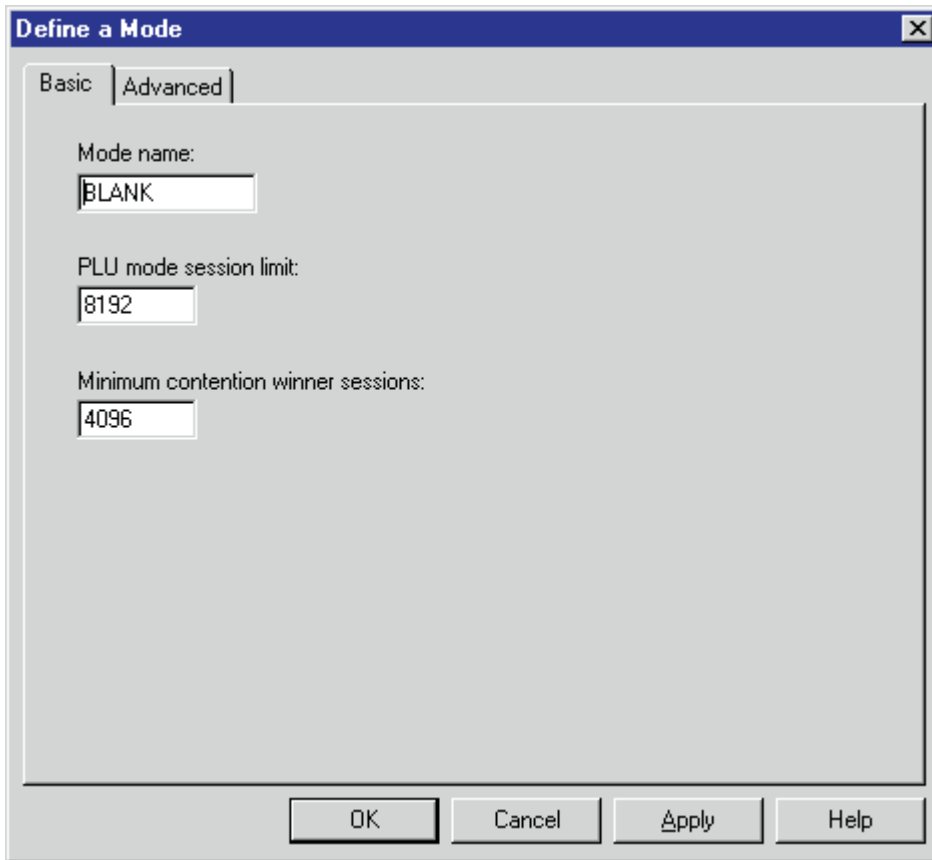

Figure 59. Define a Mode Notebook: Basic Tab

On the **Basic** tab (Figure 59), supply the following values:

**Mode name**

Specifies the characteristics for the session that will be allocated for the conversation. The initiator uses this value. The **Mode name** in the **BLANK** profile is 8 spaces.

**PLU mode session limit**

Specifies a value between 0 and 32767 as the primary logical unit (PLU) mode session limit, or maximum number of concurrently active LU-LU sessions that a particular LU can support. Take the default.

**Minimum contention winner sessions**

Specifies a value between 0 and 32767 as the minimum number of sessions that a local LU using this mode can activate to win a contention with a partner. Take the default.

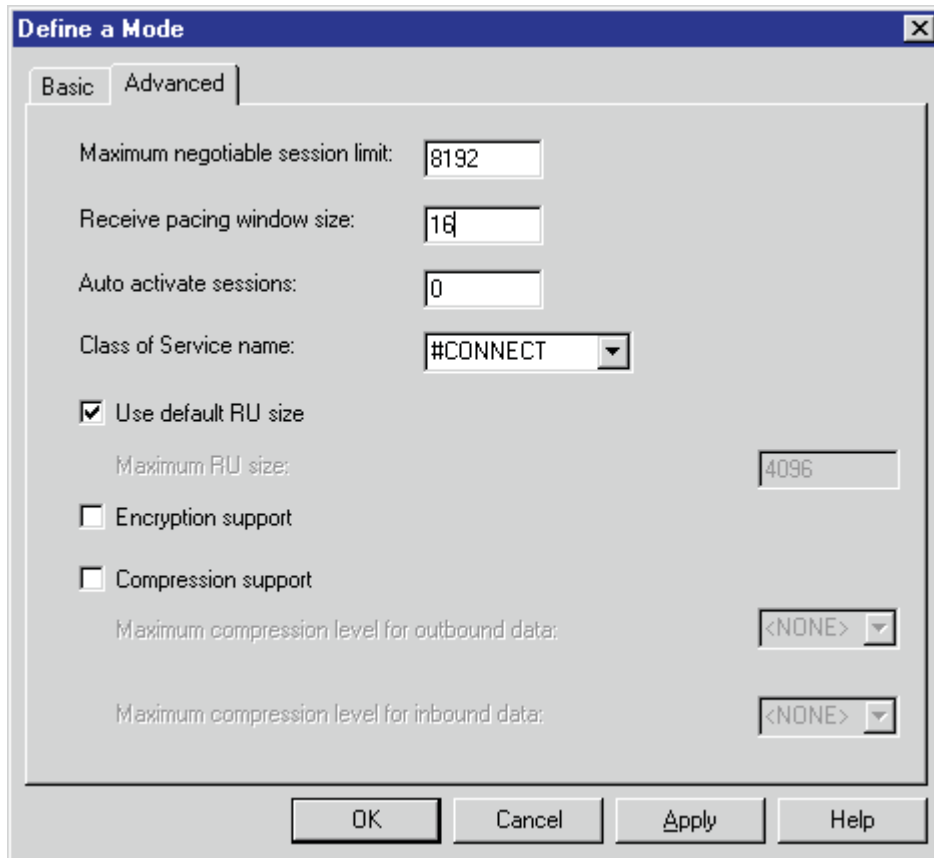

Figure 60. Define a Mode Notebook: Advanced Tab

On the **Advanced** tab (Figure 60), supply the following values:

**Maximum negotiable session limit**

Specifies a value between 0 and 32767 as the maximum number of sessions allowed in this mode between any local logical unit (LU) and partner LU. Take the default.

**Receive pacing window size**

Specifies the secondary receive pacing count. The lesser of this parameter's value and the **SRCVPAC** value in the VTAM **MODEENT** statement is used. (See "Specifying the VTAM Mode Table and Entry" on page 19.) A value of 16 produces good throughput in most configurations. This parameter influences performance and can be adjusted as desired.

**Auto activate sessions**

Specifies a value between 0 and 32767 as the number of parallel LU 6.2 sessions to automatically start when an initial session starts using this mode. Specify 0 so that no parallel sessions can start automatically for this application.

**Class of Service name**

Specifies the name of a set of transport network characteristics. Select the default: **#CONNECT** .

**Use default RU size**

Instructs the node to use the default maximum size for the request/response unit (RU) sent and received on the sessions. Do not select the check box.

### Maximum RU size

Set this value to 1024, if it does not automatically specify that value when you remove the check from the **Use default RU size** parameter above.

Click **OK** to save these specifications to the *xxx.acg* file.

## Transaction Program Configuration for Local 3172

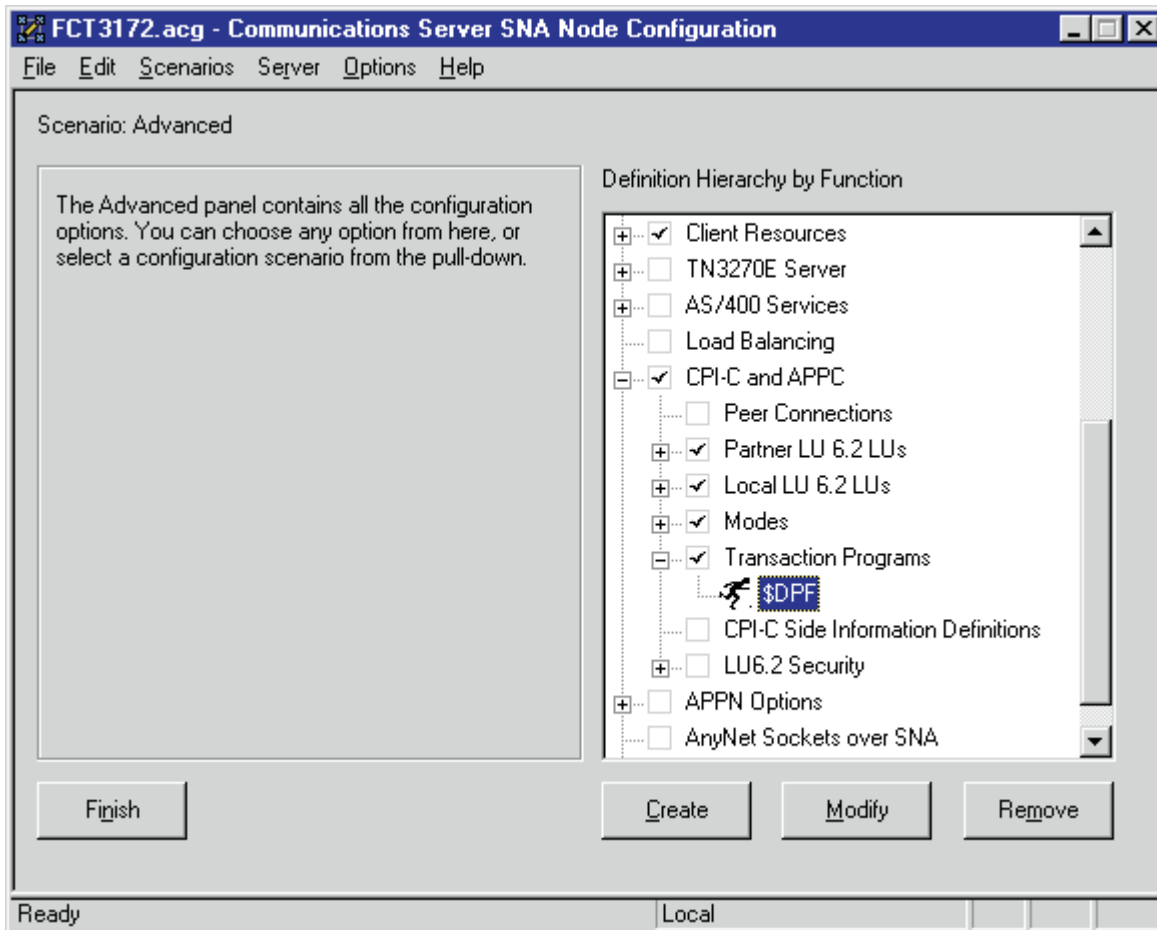

Figure 61. Communications Server SNA Node Configuration Window: Transaction Programs

In the Communications Server SNA Node Configuration window (Figure 61), right-click the **CPI-C and APPC** box, then the **Transaction Programs** box. Select the **Create** option. The Define a Transaction Program notebook opens at the **Basic** tab.

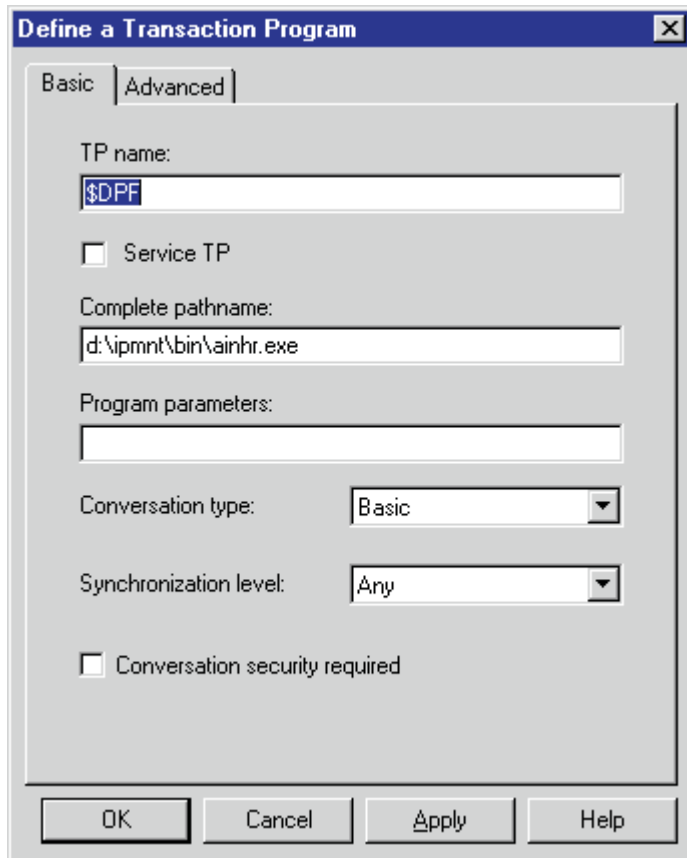

Figure 62. Define a Transaction Program Notebook: Basic Tab

On the **Basic** tab (Figure 62), supply the following values:

**TP name**

Specifies a 1- to 64-byte character string for the program that uses the advanced program-to-program communications (APPC) system to communicate with a partner application program at the partner node. Enter **\$DPF**. If you are migrating from an AIX operating system to a Windows NT operating system, note that this value changes from a binary 30F0F0F0 to a non-binary **\$DPF**. Ensure that the **Service TP** check box is unchecked because it indicates a non-binary value.

**Complete pathname**

Specifies an 1- to 255-byte character string that describes the location of the program to run. The location can include the drive, the directory, the subdirectory, and the file name. In this example, `d:\ipmnt\bin\ainhr.exe` specifies the location where Infoprint Manager for NT is installed on your system.

**Conversation type**

Specifies the conversation type allowed to start the transaction programs (TPs) that use an LU 6.2 session. Select **Basic**.

**Synchronization level**

Specifies the level allowed on allocation requests that start the local and remote transaction programs (TPs). Select **Any**.

**Conversation security required**

Allows controlled access to system resources through security parameters.

If this check box is selected, conversation security information is required to start the TP. Incoming allocation requests for this TP without the conversation security information will be rejected. Do not check this box.

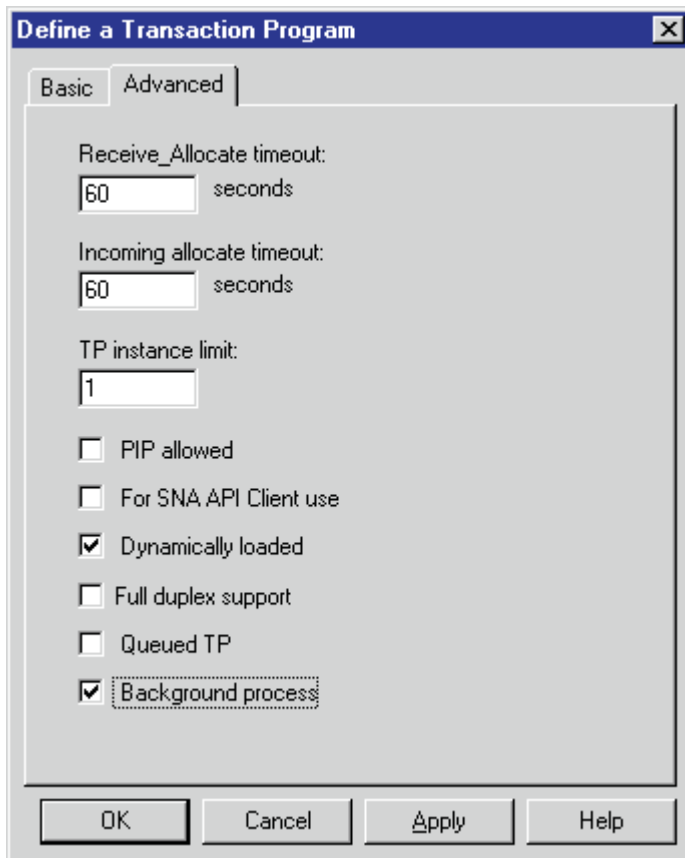

Figure 63. Define a Transaction Program Notebook: Advanced Tab

On the **Advanced** tab (Figure 63), supply the following values:

**Receive\_Allocate timeout**

Specifies a value between 0 and 65535 seconds that identifies the time that a **Receive\_Allocate** verb will be queued while waiting for an **Attach**. Specify 60.

**Incoming allocate timeout**

Specifies a value between 0 and 65535 seconds that identifies the time that an incoming **Attach** will be queued waiting for a **Receive\_Allocate**. Specify 60.

**TP instance limit**

Specifies a value between 0 and 65535 seconds that identifies the maximum number of concurrently active TP instances. Specify at least 1 (or the number of LUs that you have defined). 0 means no limit.

**Dynamically loaded**

Specifies whether the transaction program (TP) can be dynamically started by an allocation request received on a conversation. Select the check box to dynamically load the TP.



**Background process**

Specifies that the program will run in the background. Only 32-bit programs can multitask in the Windows NT environment. Select the check box to use the background process.

**Note:** Ensure that **Dynamically loaded** and **Background process** (the two items checked in Figure 63 on page 54) are the only items checked. If you specify other options, this transaction program will not work.

Click **OK** to save these specifications to the *xxx.acg* file.

Once you have completed creating this configuration, go to Chapter 5, "Starting an IBM SecureWay Communications Server for Windows NT Configuration" on page 59.

## Local 3172 Token-Ring Configuration Work Sheets

Use the following work sheets to configure PSF Direct on both the host PSF and Infoprint Manager for NT:

- Use Table 2 to see how Communications Server for NT configuration settings relate to other configuration settings.
- Use Table 3 on page 57 to record your own Communications Server for NT values.

### Local 3172 Token-Ring Configuration Work Sheet Example

Table 2. Local 3172 Token-Ring Configuration Work Sheet Example

Communication Server	Value	Infoprint Manager	VTAM	3172
Define the Node: Fully-qualified CP name	DEVTESTB		PU <i>name</i> PU CPNAME	
Define the Node: Local Node ID	05D00000		PU IDBLK PU IDNUM	
Define a LAN Device: Receive window count	7		PU MAXOUT	
Define a LAN Device: Maximum PIU size	65535			
Define a LAN Connection: Destination address	08005A0D5E42			Universal MAC address
Define a Partner LU 6.2: Partner LU name	USIBMBQ.FSAES618	APPLID	ATCSTRxx NETID APPL <i>name</i>	
Define a Local LU 6.2: Local LU name	PSFDC4LU	LUNAME	LU <i>name</i>	
Define a Local LU 6.2: Dependent LU	Not selected (address 0)		LU LOCADDR	
Define a Mode: Mode name	BLANK			
Define a Mode: Receive pacing window size	16		MODEENT SRCVPAC	
Define a Mode: Maximum RU size	1024		MODEENT RUSIZES	

## Local 3172 Token-Ring Configuration Blank Work Sheet

Table 3. Local 3172 Token-Ring Configuration Blank Work Sheet

Communication Server	Value	Infoprint Manager	VTAM	3172
Define the Node: Fully-qualified CP name			PU <i>name</i> PU CPNAME	
Define the Node: Local Node ID			PU IDBLK PU IDNUM	
Define a LAN Device: Receive window count			PU MAXOUT	
Define a LAN Device: Maximum PIU size				
Define a LAN Connection: Destination address				Universal MAC address
Define a Partner LU 6.2: Partner LU name		APPLID	ATCSTRxx NETID APPL <i>name</i>	
Define a Local LU 6.2: Local LU name		LUNAME	LU <i>name</i>	
Define a Local LU 6.2: Dependent LU			LU LOCADDR	
Define a Mode: Mode name				
Define a Mode: Receive pacing window size			MODEENT SRCVPAC	
Define a Mode: Maximum RU size			MODEENT RUSIZES	



---

## Chapter 5. Starting an IBM SecureWay Communications Server for Windows NT Configuration

Use the following procedure to start all IBM SecureWay Communications Server for Windows NT configurations:

1. From your NT desktop view, double-click the **SNA Node Operations** icon that resides on your desktop:



2. From the Communications Server Node Operations window, click the plus (+) sign next to **Connections**.
3. If your configuration is an independent LU, highlight **Peer Connections**. If it is a dependent LU, highlight **Host Connections**.
4. From the window's main menu, select **Operations-->Start Node**.
5. From the **Open** pop-up window, select the *xxx.acg* file that represents the configuration you wish to start and click **Open**.

From the right pane of the Communications Server Node Operations window, a lightning bolt icon labeled **Linkxxxx** appears. (xxxx represents the number of links on your system.) When the lightning bolt icon turns completely yellow, the link is active. PSF Direct is ready to receive jobs from the host PSF system. If the lightning bolt turns completely red, the link has failed. You need to review your configuration on both the Infoprint Manager Windows NT server and the PSF host program.



---

## Chapter 6. Configuring PSF Direct

PSF Direct acts as a communication protocol converter. It exchanges data with a host PSF program using an SNA LU 6.2 session and relays the data to an Infoprint actual destination.

From an application perspective, the entire SNA network can be viewed as a black box with two access points that are called **logical units** (LUs). An LU 6.2 session runs through the network and connects the two logical units (Figure 64).

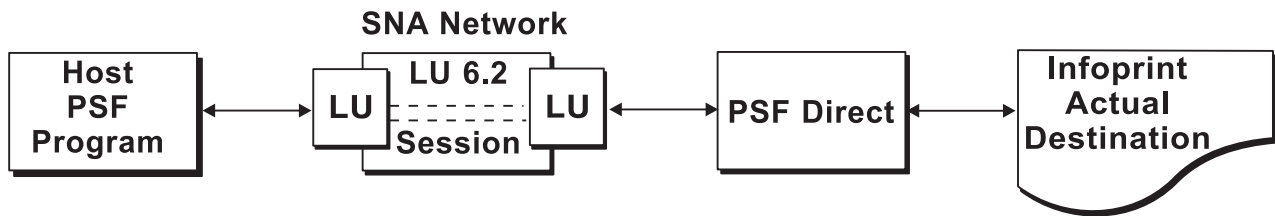

Figure 64. SNA LU 6.2 Session in a PSF Direct Configuration

When you configure a PSF Direct Receiver, you associate a logical unit with an Infoprint actual destination (Figure 65).

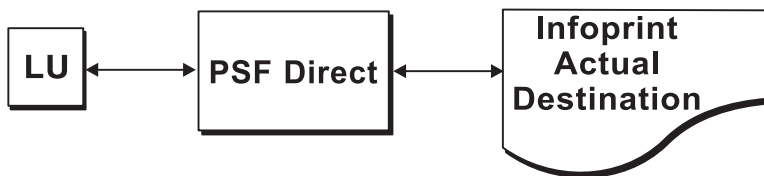

Figure 65. PSF Direct Host Receiver

This chapter contains the following topics:

- “Creating and Configuring an Infoprint PSF Direct Destination (Printer)” on page 62
- “Defining the PSF Direct Host Receiver” on page 62
- “Starting a PSF Direct Host Receiver” on page 63
- “Stopping a PSF Direct Host Receiver” on page 64
- “Displaying the Status of a PSF Direct Destination on the Windows NT System” on page 64
- “Displaying the Status of a PSF Direct Destination on the Host System” on page 66
- “Using One Infoprint Actual Destination to Print Data from Multiple Sources” on page 66

---

## Creating and Configuring an Infoprint PSF Direct Destination (Printer)

Before creating an actual destination (printer) to send jobs from PSF Direct, you should determine the type of configuration. Refer to *Infoprint Manager for Windows NT and Windows 2000: Getting Started*, G544–5717. When you create an Infoprint actual destination, Infoprint adds the functions that allow Infoprint to communicate with the printer. These include a subdirectory and files in the \var\psf directory.

You can create and configure the Infoprint PSF Direct destination in two ways:

- “Using the Infoprint Manager Administration GUI”
- “Using the Infoprint Manager Management Console”

### Using the Infoprint Manager Administration GUI

If you will be using the PSF Direct destination to print data from a PC, you must use the Infoprint Manager Administration GUI to create an actual destination. Use the **Printer-->Create-->PSF** menu to access the Create Printer wizard. Refer to the online help in the Infoprint Manager Administration GUI.

To configure the PSF Direct destination after you create it, you can use the Infoprint Manager Administration GUI. Select the actual destination (printer) you want to configure, then use the **Printer-->Properties** menu to open the Printer Properties notebook. Refer to the online help in the Infoprint Manager Administration GUI.

### Using the Infoprint Manager Management Console

If you will be using the PSF Direct destination to print data from PSF host systems only, you can use the Infoprint Manager Management Console to create an actual destination. First, ensure that the Infoprint Windows NT server is running. Then use the **Edit-->New-->Destination** path and select from the range of potential PSF Direct destinations provided. For more information on configuring this destination, see the related Infoprint Manager Management Console help.

To communicate with an Infoprint actual destination, PSF Direct uses the functions that Infoprint created when you added the printer. However, PSF Direct does not accept data from the Infoprint queue that was created for the printer. Instead, PSF Direct uses an SNA LU 6.2 session that you created through IBM SecureWay Communications Server for NT to obtain print data from a host PSF program.

When you add a PSF Direct receiver, you must indicate which Infoprint actual destination the host receiver should use. This procedure is described in “Defining the PSF Direct Host Receiver”.

---

## Defining the PSF Direct Host Receiver

IBM recommends setting up the PSF Direct Receiver and managing your PSF Direct operations from the Management Console for Infoprint Manager Server... window. You can then use this window to track server events.

To set up a PSF Direct Receiver, use the following procedure:

1. Open the Management Console for Infoprint Manager Server... window. Then use the **Edit-->PSF Direct Receiver Management...** menu to access the PSF Direct Receiver Manager window.
2. Click on the **Add** button.



3. From the **Add PSF Direct Receiver** pop-up menu, specify a value in the **SNA LUNAME** field. This value must match the SNA Logical Unit name defined through the Secure Way Communication Server configuration.
4. Click on the drop-down menu next to the **Target Destination** field. Highlight the Infoprint logical or actual destination to which you want to default for this PSF Direct Receiver.  
This list consists of all the logical and actual destinations that have been defined in the Infoprint Manager Administration GUI.
5. Allow both numeric values in the **SNA System Services Control Point ID** field and the **NMVT Subsystem name** field to default.
6. Specify a numeric value from 0 to 9999 (in seconds) for the **Inactivity limit** field.  
Setting this value to the system default of 9999 causes the PSF Direct receivers to wait indefinitely if the printer is not available. For more information about the **Inactivity limit** field, see “Automatically Stopping a PSF Direct Host Receiver” on page 67.
7. Specify a numeric value from 0 to 9999 (in seconds) for the **Printer busy limit** field.  
Setting this value to the system default of 9999 causes the PSF Direct receivers to wait indefinitely if the printer is not available. For more information on setting this field, see “Controlling the Wait Period for a PSF Direct Host Receiver” on page 67.
8. Once you are satisfied with the fields on the **Add PSF Direct Receiver** pop-up menu, click on the **OK** button.
9. Infoprint adds a PSF Direct Receiver to the main pane, with a red marker. STOPPED displays in the **Status** column.
10. Within a minute or two, the marker for the PSF Direct Receiver that you just created will change from red to green. RUNNING will display in the **Status** column. At this point, you can submit jobs from the OS/390 host system for printing directly on Infoprint Manager printers.

Table 4 shows an example of configuration values for a PSF Direct host receiver.

*Table 4. PSF Direct Host Receiver Values Example*

<b>SNA Logical Unit Name</b>	MVS1
<b>Target Destination</b> (actual destination)	4000wb
<b>Inactivity limit</b> (seconds)	9999
<b>Device busy limit</b> (seconds)	9999
<b>SNA System Services Control Point ID</b>	050000000000
<b>NMVT Subsystem Name</b>	NMVT

---

## Starting a PSF Direct Host Receiver

IBM SecureWay Communications Server for NT starts a PSF Direct receiver automatically when a host PSF program causes an SNA LU 6.2 session to be established and allocates an SNA conversation on that session. As a result, a host system operator indirectly causes a PSF Direct host receiver to be run by starting a host PSF program that establishes a SNA LU 6.2 session.

The operator on the Infoprint Manager Windows NT server does not need to do anything to start a PSF Direct host receiver, as long as IBM SecureWay Communications Server for NT is active on the Windows NT server.

---

## Stopping a PSF Direct Host Receiver

A PSF Direct host receiver can be stopped in several ways:

- The host system operator can end the host PSF program that communicates with the PSF Direct host receiver. When the host PSF program ends the SNA conversation with the PSF Direct host receiver, the PSF Direct host receiver automatically ends.
- The host PSF program's **Disconnect Interval** parameter can be exceeded.  
If the host PSF program is waiting for new print files and none become available within the period specified by the **Disconnect Interval** parameter, the host PSF program ends the SNA session with the PSF Direct host receiver. The PSF Direct host receiver then ends.
- The PSF Direct host receiver **Inactivity Limit** can be exceeded.  
If the PSF Direct host receiver is waiting for data from the host PSF program and no data arrives within the period specified by the **Inactivity Limit** value, the PSF Direct host receiver UNBINDs the SNA session with the host system.  
The **Inactivity Limit** defaults to infinite (9999 seconds). It should only be used in some configurations where a printer is shared.
- If an operator at the Windows NT system stops IBM SecureWay Communications Server for NT, all SNA sessions end, causing all PSF Direct host receivers to end. An operator can also use IBM SecureWay Communications Server for NT to stop an individual SNA session. If a PSF Direct host receiver is using the session, that PSF Direct host receiver ends.

For information about stopping a PSF Direct host receiver that is working with a shared Infoprint actual destination, see "Manually Stopping a PSF Direct Host Receiver" on page 66 and "Automatically Stopping a PSF Direct Host Receiver" on page 67.

---

## Displaying the Status of a PSF Direct Destination on the Windows NT System

Infoprint provides two methods for users to display the status of a PSF Direct host receiver:

- "Using the Infoprint Manager Management Console"
- "Using the psfstat Command" on page 65

### Using the Infoprint Manager Management Console

The Infoprint Manager Management Console allows you to view the status of Infoprint actual destinations and PSF Direct Receivers. If you click on **PSF Direct Host Receivers** in the left pane, the PSF Direct Host Receivers view shows up in the right pane. If you are not using the Management Console for Infoprint Manager Server... window to track server events, this is the easiest method to display PSF Direct status. However, if you are using the Management Console for Infoprint Manager Server... window to track server events, you should use the **psfstat** command to display status.

Note that if you click **destinations** in the left pane of the Management Console for Infoprint Manager Server... window, Infoprint displays the status of all your actual destinations.

## Using the psfstat Command

The **psfstat** command displays information about the status of Infoprint actual destinations and PSF Direct receivers. It tells you whether each Infoprint printer is receiving data from either the Infoprint Manager Windows NT server or from a PSF Direct receiver. The **psfstat** command provides the source of the display provided by the Infoprint Manager Management Console.

If you specify **psfstat** from a command prompt window, the results are similar to Figure 66.

Printer	Attachment	Data	Printer status	Active	Waiting
3287	channel	IPDS	--	--	--
4000wa	TCP/IP	IPDS	intervention	[Queue]	--
4000wb	TCP/IP	IPDS	ok	PSFOS41	[Queue],PSFMVS
ps14	direct	PS	ok	[Queue]	--

LU name	Printer	Attachment	Data	Printer status	Receiver status
PSFMVS	4000wb	TCP/IP	IPDS	ok	sess/prtr_busy
PSFOS41	4000wb	TCP/IP	IPDS	ok	sess/prtr_conn
PSFVSE1	4000wb	TCP/IP	IPDS	ok	idle

Figure 66. Printer and Receiver Status Example

Figure 66 indicates that:

- Printer 3827 is not active.
- Printer 4000wa is printing data from Infoprint Manager ([Queue]). The printer requires operator intervention.
- Printer 4000wb is printing data from a PSF Direct receiver that uses the SNA logical unit name (**LUNAME**) PSFOS41. Additional data is also available on the Infoprint actual destination and from a PSF Direct receiver that uses the SNA **LUNAME** PSFMVS. The order of the waiting data sources does not indicate which source will access the printer next.
- Printer ps14 is printing data from Infoprint Manager.
- Receiver PSFMVS is in session with the host system and is waiting for printer 4000wb.
- Receiver PSFOS41 is in session with the host system and is connected to printer 4000wb.
- Receiver PSFVSE1 is in session with the host system and is idle, but connected to printer 4000wb.

Note that you can use the **psfstat** command to display information about any Infoprint actual destination, not just those are used by PSF Direct host receivers. For the syntax of the **psfstat** command, refer to the *Infoprint Manager: Reference*, S544–5475.

---

## Displaying the Status of a PSF Direct Destination on the Host System

A host system operator can display the status of any printer managed by the host PSF program, including printers that are attached by PSF Direct. For example, an OS/390 operator can use the JES2 \$DU command to display printer status.

---

## Using One Infoprint Actual Destination to Print Data from Multiple Sources

One Infoprint actual destination can print data from more than one host PSF program and from the IBM Infoprint Windows NT server. At any time, however, the Infoprint actual destination can only be dedicated to printing data from a single source: one host PSF program or the IBM Infoprint Windows NT server.

This section describes how to configure and manage the switching of an Infoprint actual destination between data sources. It contains the following topics:

- “Switching between Data Sources”
- “Sharing an Infoprint Actual Destination: An Example” on page 68
- “Displaying the Status of a Shared Infoprint Actual Destination” on page 70

### Switching between Data Sources

Switching an Infoprint actual destination between data sources requires two steps:

1. The process using the Infoprint actual destination must end, whether that process is a PSF Direct host receiver or a print process from the IBM Infoprint Windows NT server. When this process ends, the Infoprint actual destination becomes available to another program. See the following topics:
  - “Manually Stopping a PSF Direct Host Receiver”
  - “Automatically Stopping a PSF Direct Host Receiver” on page 67
  - “Automatically Stopping Printing from the IBM Infoprint Windows NT Server” on page 67
2. A PSF Direct host receiver or Infoprint process that prints from the IBM Infoprint Windows NT server must wait for other programs to stop using the Infoprint actual destination. See the following topics:
  - “Controlling the Wait Period for a PSF Direct Host Receiver” on page 67
  - “Controlling the Wait Period for Printing from an IBM Infoprint Windows NT Server” on page 67

### Manually Stopping a PSF Direct Host Receiver

A host system operator can end a PSF Direct host receiver by ending the host PSF program that communicates with the host receiver. For example, an OS/390 host operator can delete all jobs from the printer by using the \$PPRT<sub>nnn</sub> JES2 command; or the operator can cancel the JES writer procedure.

To end the IBM Infoprint Windows NT server process manually from Infoprint, refer to the **pdshutdown** command as described in the *Infoprint Manager: Reference*, S544–5475. If you merely disable the printer through the **pddisable** command, the Infoprint processes are not stopped, and the PSF Direct host receiver cannot establish a session.

For more detail about shutting down a PSF Direct host receiver, see “Stopping a PSF Direct Host Receiver” on page 64.

### **Automatically Stopping a PSF Direct Host Receiver**

Most host PSF programs have a Disconnect Interval configuration parameter, such as the **DISCINTV** parameter of the **PRINTDEV** statement in PSF for OS/390. This parameter causes the host PSF program to end the SNA session with a PSF Direct host receiver if there is no data to print for the specified period. Ending the SNA session with the host receiver causes the host receiver to end.

Some host PSF programs, such as PSF for iSeries, do not offer a Disconnect Interval configuration parameter. To enable PSF Direct host receivers to be automatically ended when they communicate with these host PSF programs, the PSF Direct host receiver configuration panel includes an **Inactivity limit** parameter. The PSF Direct host receiver **Inactivity limit** parameter causes a host receiver to end if it waits for data from the host system for the specified period.

Using the host PSF program's Disconnect Interval, if it is available, is preferable to using the PSF Direct host receiver **Inactivity limit** parameter.

### **Automatically Stopping Printing from the IBM Infoprint Windows NT Server**

Each Infoprint actual destination has an actual destination attribute called the **printer-release-timer** attribute. This attribute causes Infoprint to stop printing from the IBM Infoprint Windows NT Server if it has completed the Infoprint spool data and the specified interval elapses with no new Infoprint data.

### **Controlling the Wait Period for a PSF Direct Host Receiver**

The PSF Direct host receiver **Device busy limit** parameter controls how long a host receiver waits for an Infoprint actual destination to become available. The **Device busy limit** parameter has a default value of 120 seconds. If an Infoprint actual destination is used to print from several sources, increase the **Device busy limit** parameter to 9999. This value means that the host receiver should wait indefinitely.

While a PSF Direct host receiver is waiting for an Infoprint actual destination to become available, the SNA session with the host system is maintained but no application data is exchanged.

### **Controlling the Wait Period for Printing from an IBM Infoprint Windows NT Server**

By default, the Infoprint program that prints from the IBM Infoprint Windows NT Server waits indefinitely for an Infoprint actual destination to become available. There is no configuration attribute that controls how long the program waits.

Table 5 on page 68 summarizes the time limits for Infoprint printing.

Table 5. Time Limit Parameters

For Device	Function	Option	User Interface	Default Value
PSF Direct Host Receiver	Wait for printer	<b>Device Busy Limit</b> field.	PSF Direct Receiver Manager window of Infoprint Manager Management Console	120 seconds
PSF Direct Host Receiver	End program, making printer available	<b>DISCINTV</b>	Host PSF configuration program	0 seconds (infinite)
PSF Direct Host Receiver	End program, making printer available	<b>Inactivity limit</b> field	PSF Direct Receiver Manager window of Infoprint Manager Management Console	9999 seconds (infinite)
IBM Infoprint Windows NT Server	Wait for printer	none	none	infinite
IBM Infoprint Windows NT Server	End program, making printer available	<b>printer-release-timer</b> attribute	On the Infoprint Manager Administration GUI, the <b>PSF Configuration</b> tab of the Printer Properties notebook	9999 seconds (infinite)

## Sharing an Infoprint Actual Destination: An Example

The example in this section illustrates how to share an Infoprint actual destination between two or more host PSF programs using PSF Direct. The actual destination can also print data from the IBM Infoprint Windows NT Server. The configuration parameters cause the printer to be switched automatically.

This section consists of the following topics:

- “Configuring the Host PSF Programs”
- “Infoprint Actual Destination: PSF Tuning Options” on page 69

### Configuring the Host PSF Programs

For two or more host PSF programs to share an Infoprint actual destination, they must be configured in similar ways, like the examples in Figure 67, Figure 68, and Figure 69 on page 69. Note that the complete configurations would contain more parameters.

```
//PRT833 PRINTDEV
:
//          DISCINTV=60,      /* DISCONNECT INTERVAL -- SECS */
:
//          LUNAME=PSFDC4LU  /* LOGICAL UNIT NAME          */
// PRT833  ENDCNTL
```

Figure 67. PRINTDEV Statement for PSF for OS/390 Example

```
PRT1000 PRINTDEV
:
:          DISCINTV=60,      DISCONNECT INTERVAL -- SECONDS
:
:          LUNAME=PSFDC5LU  LOGICAL UNIT NAME
PRT1000  ENDCNTL
```

Figure 68. PRINTDEV Statement for PSF/VSE Example

*APPC device description:*

```
5769SS1 V4R4M0 990521
Device description . . . . . : DEVD          PRTNT3
:
Local location . . . . . : LCLLOCNAME    BLDOS44
:
```

*PSF Direct Receiver Manager window:*

Inactivity limit: 60

Figure 69. Configuration for PSF for iSeries Example

Although all three host PSF programs use different LUs, they must have the same disconnect interval. Setting **DISCINTV** to 60 seconds for both PSF for OS/390 and PSF/VSE causes each host PSF program to end if all spool data from the printer is completed and no additional data becomes available for 60 seconds. When the host PSF program ends, the PSF Direct host receiver ends, and the Infoprint actual destination becomes available to other programs. If additional host data becomes available for the Infoprint actual destination, the host PSF program starts again and waits, if necessary, for the printer to become available.

Because the **DISCINTV** is not valid for PSF for iSeries, you must set the **Inactivity limit** in the PSF Direct Receiver Manager window of Infoprint Manager Management Console to 60 seconds instead.

### Infoprint Actual Destination: PSF Tuning Options

To allow Infoprint to share the printer with two or more host PSFs, you must adjust the Infoprint actual destination's PSF tuning options. Use the **Printer Properties** notebook in the Infoprint Manager Administration GUI.

Select the actual destination (printer) you want to configure. Then use the **Printer-->Properties** menu to open the Printer Properties notebook. Select the **Tuning** tab and tune the options described in this section.

- The **Release time (sec)** field specifies the number of seconds that Infoprint waits between jobs before giving up control of an actual destination. (This field is equivalent to the **destination-release-timer** attribute.) Setting this value to 60 seconds causes the Infoprint program that prints from the IBM Infoprint Windows NT server to end if it has printed the files in the printer's queue. No additional files become available for 60 seconds. When the program ends, the Infoprint actual destination becomes available to other programs, such as PSF Direct receivers.

If additional files are added to the printer's queue on the IBM Infoprint Windows NT server, the Infoprint program that prints from the server starts again. It waits, if necessary, for the printer to become available.

- Accepting the default **intervention-timer** attribute value of 9999 causes the PSF Direct host receivers that use this printer to issue printer intervention messages on the Windows NT system. It does not cause the host receivers to report intervention conditions to the host PSF program.

If you use an **intervention-timer** value of 3600 instead, the PSF Direct receivers notify the host PSF program if an intervention condition is not addressed within an hour. The host PSF program issues an operator message and ends the SNA session with the PSF Direct receiver. The **intervention-timer** also causes the PSF program that prints from the IBM Infoprint Windows NT server to end if an intervention condition is not addressed within an hour.



- For continuous-forms printers, set the **Non-process-runout timer** field at a lower value than the **Release-time (sec)** attribute. For example, if the **destination-release-timer** attribute value is 60 seconds, reduce the **non-process-runout-timer** attribute value to 30 seconds.

Finally, you must configure the PSF Direct host receivers for each host that will share the printer. This process is described in “Defining the PSF Direct Host Receiver” on page 62.

## Displaying the Status of a Shared Infoprint Actual Destination

The **psfstat** command displays information about the status of Infoprint actual destinations and PSF Direct receivers. The information that **psfstat** displays about an Infoprint actual destination includes:

- The program that currently controls the printer
- A list of the programs waiting to gain control of the printer

For example, **psfstat** might display information like Figure 70.

Printer	Attachment	Data	Printer status	Active	Waiting
4000wb	TCP/IP	IPDS	intervention	MVS1	[Queue],OS4001

LU name	Printer	Attachment	Data	Printer status	Receiver status
MVS1	4000wb	TCP/IP	IPDS	intervention	sess/prtr_conn
OS4001	4000wb	TCP/IP	IPDS	intervention	sess/prtr_busy

Figure 70. Shared Printer Status

Figure 70 shows that the printer is currently dedicated to printing data from the OS/390 spool. The IBM Infoprint Windows NT server ([Queue]) and the OS/400 spool also contain data that is waiting to print.

When the OS/390 host system releases the printer, the printer will print data either from the IBM Infoprint Windows NT server or the OS/400 spool. The order in which the two waiting sources are listed does not imply that the IBM Infoprint Windows NT server has been waiting longer or that it will acquire the printer next.

Figure 70 also indicates that the printer requires intervention.

For more information about the **psfstat** command, see “Displaying the Status of a PSF Direct Destination on the Windows NT System” on page 64 and the *Infoprint Manager: Reference*, S544–5475.



---

## Notices

---

### Licenses

References in this publication to products or services of IBM do not suggest or imply that IBM will make them available in all countries where IBM does business or that only products or services of IBM may be used. Noninfringing equivalents may be substituted, but the user must verify that such substitutes, unless expressly designated by IBM, work correctly. No license, expressed or implied, to patents or copyrights of IBM is granted by furnishing this document. You can send license inquiries, in writing, to the IBM Director of Licensing, IBM Corporation, 500 Columbus Avenue, Thornwood, NY 10594, USA.

Licensees of this program who wish to have information about it for the purpose of enabling: (1) the exchange of information between independently created programs and other programs (including this one) and (2) the mutual use of the information, which has been exchanged, should contact: IBM Corporation, Printing Systems Legal Department, Mail Drop 002S, Boulder, Colorado 80301 USA. Such information may be available, subject to appropriate terms and conditions, including in some cases, payment of a fee.

---

### Trademarks

The following terms are trademarks or registered trademarks of International Business Machines Corporation in the United States or other countries:

- AIX<sup>®</sup>
- APPN<sup>®</sup>
- IBM<sup>®</sup>
- Infoprint<sup>®</sup>
- iSeries
- Operating System/2<sup>®</sup>
- Operating System/400<sup>®</sup>
- OS/2<sup>®</sup>
- OS/390<sup>®</sup>
- OS/400<sup>®</sup>
- Print Services Facility<sup>®</sup>
- SecureWay<sup>®</sup>
- VTAM<sup>®</sup>

Microsoft<sup>®</sup>, Windows<sup>®</sup>, and Windows NT<sup>®</sup> are registered trademarks of Microsoft Corporation.

Other company, product, and service names may be trademarks or service marks of others.



# Index

## Special characters

- .acg file 26
- \$DU command 66
- \$PPRT command 66

## Numerics

- 3172 configuration
  - illustration 13
  - network addresses 10
  - network internals view 7
  - simplified view 3
- 3172 establishment controller 24
- 3174 configuration, local
  - simplified view 3
- 3174 configuration, remote
  - simplified view 4
- 37xx configuration
  - simplified view 3

## A

- Activate link at start check box, Define a LAN Connection notebook 40
- actual destinations
  - configuring 62
  - continuous-forms 70
  - creating 62
  - sharing 66
    - continuous-forms 70
    - example 68
    - status 64, 70
    - stopping 67
- ADAPNO parameter, PORT statement 25
- Adapter number field, Define a LAN Device notebook 32
- ADDR parameter, PU statement 21
- alternate token-ring address
  - Windows NT server 11
- APARs required for Communications Server for Windows NT 2
- API clients, SNA 36
- application program, VTAM 19
- APPLID parameter, PRINTDEV statement 6, 15
- APPN support check box, Define a LAN Connection notebook 40
- ATCCONxx (VTAM configuration list) 18
- ATCSTRxx (VTAM start option list) 17
- Auto activate sessions field, Define a Mode notebook 51

## B

- Background process check box, Define a Transaction Program notebook 55
- blank work sheet 57

- Block ID field, Define a LAN Connection notebook 40

## C

- CALL parameter, LINE statement 25
- calling link station 20
- Class of Service name field, Define a Mode notebook 51
- clients, SNA API 36
- commands, JES2
  - \$DU 66
  - \$PPRT 66
- commands, OS/390
  - \$DU 66
  - \$PPRT 66
- commands, Windows NT
  - pddisable 66
  - pdshutdown 66
  - psfstat 65, 70
- communication protocols
  - channel 1
    - Communication Server LU 6.2 1
    - host to Windows NT 1
    - printer to Windows NT 1
    - serial 1
    - TCP/IP 1
    - Windows NT to host 1
    - Windows NT to printer 1
- Communications Server for Windows NT, IBM SecureWay
  - accessing profiles 26
  - APARs 2
  - defining devices 11
  - description 2
  - Device profile 31
  - installation 2
  - Local LU 6.2 profile 46
  - Mode profile 49
  - Node Setup profile 27
  - Partner LU 6.2 profile 43
  - Peer Connections profile 38
  - starting 59
  - Transaction Program profile 52
  - version required 2
- Communications Server Node Operations interface
  - shortcut 2
- Complete pathname field, Define a Transaction Program notebook 53
- CONFIG parameter, VTAM start option list 17
- configuration list, VTAM 18
- continuous-forms printers
  - non-process-runout-timer attribute 70
  - sharing 70
- control point (CP) name interrelationships 10

- Conversation security required check box, Define a Transaction Program notebook 53
- Conversation security support check box, Define a Partner LU 6.2 notebook 45
- Conversation type field, Define a Transaction Program notebook 53
- correspondences 56
  - local LU address 9
  - LU names 8
  - mode 9
  - network addresses
    - 3172 configuration 10
    - PU name and CP name 10
    - session characteristics 9
- CP (control point) name interrelationships 10
- CP alias field, Define a Node notebook 28
- CPNAME parameter, PU statement 21
- Create Printer wizard 62
- CUADDR parameter, PORT statement 25

## D

- Define a LAN Connection notebook
  - Activate link at start check box 40
  - APPN support check box 40
  - Block ID field 40
  - Destination address field 39
  - Device name field 39
  - Link station name field 39
  - Physical Unit ID field 40
  - PU name field 40
  - Swap address bytes check box 39
- Define a LAN Device notebook
  - Adapter number field 32
  - Local SAP field 32
  - Maximum PIU size field 34
  - Port name field 32
  - Receive window count field 34
  - Test retry interval field 33
  - Test retry limit field 34
  - XID retry interval field 33
  - XID retry limit field 33
- Define a Local LU 6.2 notebook
  - Dependent LU check box 47
  - Local LU alias field 6, 47
  - Local LU name field 47
  - LU session limit field 48
  - SNA API client use check box 47
  - Synchronization support check box 48
- Define a Mode notebook
  - Auto activate sessions field 51
  - Class of Service name field 51
  - Maximum negotiable session limit field 51
  - Maximum RU size field 52

- Define a Mode notebook (*continued*)
  - Minimum contention winner sessions field 50
  - Mode name field 50
  - PLU mode session limit field 50
  - Receive pacing window size field 51
  - Use default RU size check box 51
- Define a Node notebook
  - CP alias field 28
  - Discovery Support field 29
  - DLUS connect retry limit field 30
  - DLUS connect retry timeout field 30
  - Fully qualified control point (CP) name field 28
  - Local node ID field 28
  - Node Type field 29
  - Registration of LU resources field 29
- Define a Partner LU 6.2 notebook
  - Conversation security support check box 45
  - Fully qualified CP name field 44
  - Maximum LL record size field 45
  - Parallel session support check box 45
  - Partner LU alias field 44
  - Partner LU name field 44
- Define a Transaction Program notebook
  - Background process check box 53
  - Complete pathname field 53
  - Conversation security required check box 53
  - Conversation type field 53
  - Dynamically loaded check box 54
  - Incoming allocate timeout field 54
  - Receive\_Allocate timeout field 54
  - Synchronization level field 53
  - TP instance limit field 54
  - TP name field 53
- definition
  - LU 5
  - mode 5
  - session 5
- dependent LU
  - when to define 12
- Dependent LU check box, Define a Local LU 6.2 notebook 47
- description
  - Communications Server for NT 2
  - PSF Direct 1
- Destination address field, Define a LAN Connection notebook 39
- destination-release-timer attribute 69
- destinations, actual
  - configuring 62
  - continuous-forms 70
  - creating 62
  - sharing 66
    - continuous-forms 70
    - example 68
    - status 64, 70
    - stopping 67
- Device busy limit parameter 63
- Device name field, Define a LAN Connection notebook 39
- Device profile 31
- DIAL parameter, GROUP statement 25
- DIALNO parameter, PATH statement 23

- DIALNO parameter, PATH statement (*continued*)
  - alternate network address required 11
- DISCINTV parameter, PRINTDEV statement 16
  - examples for sharing printer 68
- Discovery Support field, Define a Node notebook 29
- displaying status
  - actual destination 64
  - printer 64
  - PSF direct host receiver 64
- DLOGMOD parameter, PU statement 22
- DLUS connect retry limit field, Define a Node notebook 30
- DLUS connect retry timeout field, Define a Node notebook 30
- Dynamically loaded check box, Define a Transaction Program notebook 54

**E**

- establishment controller, 3172 24
- example, work sheet 56

**F**

- FAILURE parameter, PRINTDEV statement 16
- Fully qualified control point (CP) name field, Define a Node notebook 28
- Fully qualified CP name field, Define a Partner LU 6.2 notebook 44

**G**

- GROUP statement
  - DIAL parameter 25
- GRPNM parameter, PATH statement 23

**H**

- host PSF printer
  - configuring 14
  - defining 14
- host PSF program
  - specifying LU 6
- host receiver, PSF Direct
  - configuring 62
  - defining 62
  - Device busy limit parameter 63
  - Inactivity limit parameter 63
  - NMVT Subsystem Name parameter 63
  - SNA Logical Unit Name parameter 63
  - SNA System Services Control Point ID parameter 63
  - specifying local LU alias 6
  - starting 63
  - status 64
  - stopping 64, 66, 67
  - Target Destination parameter 63
  - wait period 67

- host systems
  - communication protocols 1
  - PSF running on
    - specifying LU 6
  - supporting PSF Direct 1

**I**

- IBM Printing Systems web page ii
- IBM SecureWay Communications Server for Windows NT
  - accessing profiles 26
  - APARs 2
  - defining devices 11
  - description 2
  - Device profile 31
  - installation 2
  - Local LU 6.2 profile 46
  - Mode profile 49
  - Node Setup profile 27
  - Partner LU 6.2 profile 43
  - Peer Connections profile 38
  - starting 59
  - Transaction Program profile 52
  - version required 2
- IDBLK parameter, PU statement 22
- IDNUM parameter, PU statement 22
- Inactivity limit parameter 63
- Incoming allocate timeout field, Define a Transaction Program notebook 54
- independent LU
  - when to define 12
- Infoprint actual destinations
  - configuring 62
  - continuous-forms 70
  - creating 62
  - sharing 66
    - continuous-forms 70
    - example 68
    - status 64, 70
    - stopping 67
- Infoprint Manager Administration GUI
  - configuring actual destination 62
  - Create Printer wizard 62
  - creating actual destination 62
  - Printer Properties notebook 62
    - Intervention timer field 69
    - Release time (sec) field 69
- Infoprint Manager Management Console
  - configuring actual destination 62
  - creating actual destination 62
  - displaying printer status 64
  - displaying PSF Direct host receiver status 64
- installing Communications Server for Windows NT 2
- Internet, information on
  - IBM Printing Systems ii
- interrelationships 56
  - local LU address 9
  - LU names 8
  - mode 9
  - network addresses
    - 3172 configuration 10
  - PU name and CP name 10
  - session characteristics 9

Intervention timer field, Printer Properties notebook 69  
intervention-timer attribute 69  
iSeries configuration  
simplified view 4

## J

JES internal writer procedure 14  
JES2 commands  
\$DU 66  
\$PPRT 66  
JES2 initialization statement 14

## L

licenses 71  
LINE statement  
CALL parameter 25  
link station  
calling 20  
listening 20  
Link station name field, Define a LAN Connection notebook 39  
listening link station 20  
LOCADDR parameter, LU statement 23  
local 3172 configuration  
illustration 13  
network addresses 10  
network internals view 7  
simplified view 3  
local 3174 configuration  
simplified view 3  
local 37xx configuration  
simplified view 3  
local iSeries configuration  
simplified view 4  
local LU  
address  
interrelationships 9  
alias  
specifying 6  
dependent or independent? 12  
name  
interrelationships 8  
specifying 6  
Local LU 6.2 profile 46  
Local LU alias field, Define a Local LU 6.2 notebook 6, 47  
Local LU name field, Define a Local LU 6.2 notebook 47  
local MAC address  
Windows NT server 11  
Local node ID field, Define a Node notebook 28  
local OS/400 configuration  
simplified view 4  
Local SAP field, Define a LAN Device notebook 32  
logical unit (LU)  
address  
interrelationships 9  
alias  
specifying for PSF direct 6  
definition 5  
illustration 61

logical unit (LU) (*continued*)  
local  
dependent or independent? 12  
matching address 9  
matching name 8  
specifying alias 6  
specifying name 6  
name  
interrelationships 8  
specifying for host PSF program 6  
specifying for PSF direct 6  
partner  
matching name 8  
specifying name 6  
LOGMODE parameter, PRINTDEV statement 6, 15  
LU (logical unit)  
address  
interrelationships 9  
alias  
specifying for PSF Direct 6  
definition 5  
illustration 61  
local  
dependent or independent? 12  
matching address 9  
matching name 8  
specifying alias 6  
specifying name 6  
name  
interrelationships 8  
specifying for host PSF program 6  
specifying for PSF Direct 6  
partner  
matching name 8  
specifying name 6  
LU session limit field, Define a Local LU 6.2 notebook 48  
LU statement  
LOCADDR parameter 23  
SSCPFM parameter 23  
LUNAME parameter, PRINTDEV statement 6, 15

## M

MAC address, local  
Windows NT server 11  
MAC address, universal  
Windows NT server 11  
mainframes  
communication protocols 1  
PSF running on  
specifying LU 6  
supporting PSF Direct 1  
major node, VTAM application program 19  
major node, VTAM switched 20  
major node, VTAM XCA 24  
matches 56  
local LU address 9  
LU names 8  
mode 9  
network addresses  
3172 configuration 10

matches (*continued*)  
PU name and CP name 10  
session characteristics 9  
MAXDATA parameter, PU statement 22  
MAXGRP parameter, VBUILD statement 21  
Maximum LL record size field, Define a Partner LU 6.2 notebook 45  
Maximum negotiable session limit field, Define a Mode notebook 51  
Maximum PIU size field, Define a LAN Device notebook 34  
Maximum RU size field, Define a Mode notebook 52  
MAXNO parameter, VBUILD statement 21  
MAXOUT parameter, PU statement 22  
MAXPATH parameter, PU statement 22  
MEDIUM parameter, PORT statement 25  
MGMTMODE parameter, PRINTDEV statement 15  
Minimum contention winner sessions field, Define a Mode notebook 50  
Mode name field, Define a Mode notebook 50  
Mode profile 49  
mode table, VTAM 19  
mode, SNA  
interrelationships 9  
specifying 6  
MODEENT statement  
PSNDPAC parameter 19  
RUSIZES parameter 19  
SRCVPAC parameter 19  
MODETAB parameter, PU statement 22  
MODETAB statement 19  
multiple data sources, printing on one printer 66  
example 68

## N

NETID parameter, VTAM start option list 17  
network address  
3172 configuration  
interrelationships 10  
alternate 11  
Windows NT server 11  
network, SNA  
access points 5  
application view 5  
configuration parameters 6  
configurations 2  
definition 5  
internals view 7  
LUs 5  
mode 5  
session 5  
NMVT Subsystem Name parameter 63  
Node Setup profile 27  
Node Type field, Define a Node notebook 29  
Non-process-runout timer field, Printer Properties notebook 70  
non-process-runout-timer attribute 70

## O

- OS/390 commands
  - \$DU 66
  - \$PPRT 66
- OS/400 configuration
  - simplified view 4
- overview
  - Communications Server for Windows NT 2
  - PSF Direct 1

## P

- Parallel session support check box, Define a Partner LU 6.2 notebook 45
- parallel sessions 12
- partner LU
  - name
    - interrelationships 8
    - specifying 6
    - required 12
- Partner LU 6.2 profile 43
- Partner LU alias field, Define a Partner LU 6.2 notebook 44
- Partner LU name field, Define a Partner LU 6.2 notebook 44
- PATH statement
  - DIALNO parameter 23
    - alternate network address required 11
    - GRPNM parameter 23
- pddisable command 66
- pdshutdown command 66
- Peer Connections profile 38
- physical unit (PU) name
  - interrelationships 10
- Physical Unit ID field, Define a LAN Connection notebook 40
- PLU mode session limit field, Define a Mode notebook 50
- Port name field, Define a LAN Device notebook 32
- PORT statement
  - ADAPNO parameter 25
  - CUADDR parameter 25
  - MEDIUM parameter 25
- preconfiguration 11
- Print Services Facility (PSF)
  - specifying LU 6
- PRINTDEV statement
  - APPLID parameter 6, 15
  - DISCINV parameter 16
    - examples for sharing printer 68
  - FAILURE parameter 16
  - LOGMODE parameter 6, 15
  - LUNAME parameter 6, 15
  - MGMTMODE parameter 15
  - SETUP parameter 15
- Printer Properties notebook 62
  - Intervention timer field 69
  - Non-process-runout timer field 70
  - Release time (sec) field 69
- printers
  - communication protocols 1
  - configuring host PSF 14
  - printers (*continued*)
    - configuring Infoprint 62
    - continuous-forms 70
    - creating Infoprint 62
    - defining host PSF 14
    - sharing 66
      - continuous-forms 70
        - example 68
      - status 64, 70
      - stopping 67
      - submitting job 1
- profiles, Communications Server for Windows NT
  - accessing 26
  - Device 31
  - Local LU 6.2 46
  - Mode 49
  - Node Setup 27
  - Partner LU 6.2 43
  - Peer Connections 38
  - Transaction Program 52
- protocols
  - channel 1
  - Communication Server LU 6.2 1
    - host to Windows NT 1
    - serial 1
    - TCP/IP 1
    - Windows NT to host 1
- PSF (Print Services Facility)
  - specifying LU 6
- PSF Direct
  - configuring 61
  - description 1
  - host systems 1
  - licenses 71
  - preconfiguration 11
  - specifying LU 6
- PSF Direct host receiver
  - configuring 62
  - defining 62
  - Device busy limit parameter 63
  - Inactivity limit parameter 63
  - NMVT Subsystem Name parameter 63
  - SNA Logical Unit Name parameter 63
  - SNA System Services Control Point ID parameter 63
  - specifying local LU alias 6
  - starting 63
  - status 64
  - stopping 64, 66, 67
  - Target Destination parameter 63
  - wait period 67
- psfstat command 65, 70
- PSNDPAC parameter, MODEENT statement 19
- PU (physical unit) name
  - interrelationships 10
- PU name field, Define a LAN Connection notebook 40
- PU statement
  - ADDR parameter 21
  - CPNAME parameter 21
  - DLOGMOD parameter 22
  - IDBLK parameter 22
  - IDNUM parameter 22

## PU statement (*continued*)

- MAXDATA parameter 22
- MAXOUT parameter 22
- MAXPATH parameter 22
- MODETAB parameter 22
- VPACING parameter 22

## R

- Receive pacing window size field, Define a Mode notebook 51
- Receive window count field, Define a LAN Device notebook 34
- Receive\_Allocate timeout field, Define a Transaction Program notebook 54
- Registration of LU resources field, Define a Node notebook 29
- Release time (sec) field, Printer Properties notebook 69
- remote 3174 configuration
  - simplified view 4
- remote 37xx configuration
  - simplified view 3
- remote iSeries configuration
  - simplified view 4
- remote OS/400 configuration
  - simplified view 4
- RUSIZES parameter, MODEENT statement 19

## S

- SecureWay Communications Server for Windows NT
  - accessing profiles 26
  - APARs 2
  - defining devices 11
  - description 2
  - Device profile 31
  - installation 2
  - Local LU 6.2 profile 46
  - Mode profile 49
  - Node Setup profile 27
  - Partner LU 6.2 profile 43
  - Peer Connections profile 38
  - starting 59
  - Transaction Program profile 52
  - version required 2
- session, SNA
  - definition 5
  - illustration 61
  - interrelationships 9
  - parallel not supported 12
  - specifying mode 6
- SETUP parameter, PRINTDEV statement 15
- sharing printers 66
  - example 68
- shortcuts
  - Communications Server Node Operations interface 2
  - SNA Node Configuration interface 2
- SNA (Systems Network Architecture)
  - API clients 36
  - mode
    - definition 5



- SNA (Systems Network Architecture)
  - (*continued*)
  - mode (*continued*)
    - interrelationships 9
  - network
    - access points 5
    - application view 5
    - configuration parameters 6
    - configurations 2
    - internals view 7
    - LUs 5
    - mode 5
    - session 5
  - session
    - definition 5
    - illustration 61
    - interrelationships 9
    - parallel not supported 12
- SNA API client use check box, Define a
  - Local LU 6.2 notebook 47
- SNA Logical Unit Name parameter 63
- SNA Node Configuration interface
  - shortcut 2
- SNA System Services Control Point ID
  - parameter 63
- SRCVPAC parameter, MODEENT
  - statement 19
- SSCPFM parameter, LU statement 23
- SSCPID parameter, VTAM start option
  - list 18
- start option list, VTAM 17
- starting Communications Server for
  - Windows NT 59
- starting PSF Direct host receiver 63
- status, displaying
  - actual destination 64
  - printer 64
  - PSF direct host receiver 64
- stopping PSF Direct host receiver 64
  - automatically 67
  - manually 66
- Swap address bytes check box, Define a
  - LAN Connection notebook 39
- switched major node, VTAM 20
- switching printers between data
  - sources 66
  - example 68
- Synchronization level field, Define a
  - Transaction Program notebook 53
- Synchronization support check box,
  - Define a Local LU 6.2 notebook 48
- Systems Network Architecture (SNA)
  - API clients 36
  - mode
    - definition 5
    - interrelationships 9
  - network
    - access points 5
    - application view 5
    - configuration parameters 6
    - configurations 2
    - internals view 7
    - LUs 5
    - mode 5
    - session 5
  - session
    - definition 5

- Systems Network Architecture (SNA)
  - (*continued*)
  - session (*continued*)
    - illustration 61
    - interrelationships 9
    - parallel not supported 12

## T

- Target Destination parameter 63
- Test retry interval field, Define a LAN
  - Device notebook 33
- Test retry limit field, Define a LAN
  - Device notebook 34
- token-ring address
  - 3172 configuration
    - interrelationships 10
    - alternate 11
    - Windows NT server 11
- TP instance limit field, Define a
  - Transaction Program notebook 54
- TP name field, Define a Transaction
  - Program notebook 53
- trademarks 71
- Transaction Program profile 52
- TYPE parameter, VBUILD statement 21, 25

## U

- universal MAC address
  - Windows NT server 11
- Use default RU size check box, Define a
  - Mode notebook 51

## V

- VBUILD statement
  - MAXGRP parameter 21
  - MAXNO parameter 21
  - TYPE parameter 21, 25
- Virtual Telecommunications Access
  - Method (VTAM)
    - application program 19
    - configuration list 18
    - mode table 19
    - start option list 17
    - switched major node 20
    - XCA major node 24
- VPACING parameter, PU statement 22
- VTAM (Virtual Telecommunications
  - Access Method)
    - application program 19
    - configuration list 18
    - mode table 19
    - start option list 17
    - switched major node 20
    - XCA major node 24

## W

- wait period
  - PSF direct host receiver 67
  - Windows NT server 67

- web pages
  - IBM Printing Systems ii
- Windows NT
  - communication protocols 1
- Windows NT commands
  - pddisable 66
  - pdshutdown 66
  - psfstat 65, 70
- work sheets
  - blank 57
  - example 56

## X

- XCA major node, VTAM 24
- XID retry interval field, Define a LAN
  - Device notebook 33
- XID retry limit field, Define a LAN
  - Device notebook 33









Printed in U.S.A.