

IBM DB2 10.1  
for Linux, UNIX, and Windows

*Troubleshooting and Tuning Database  
Performance*





IBM DB2 10.1  
for Linux, UNIX, and Windows

*Troubleshooting and Tuning Database  
Performance*



**Note**

Before using this information and the product it supports, read the general information under Appendix B, "Notices," on page 725.

**Edition Notice**

This document contains proprietary information of IBM. It is provided under a license agreement and is protected by copyright law. The information contained in this publication does not include any product warranties, and any statements provided in this manual should not be interpreted as such.

You can order IBM publications online or through your local IBM representative.

- To order publications online, go to the IBM Publications Center at <http://www.ibm.com/shop/publications/order>
- To find your local IBM representative, go to the IBM Directory of Worldwide Contacts at <http://www.ibm.com/planetwide/>

To order DB2 publications from DB2 Marketing and Sales in the United States or Canada, call 1-800-IBM-4YOU (426-4968).

When you send information to IBM, you grant IBM a nonexclusive right to use or distribute the information in any way it believes appropriate without incurring any obligation to you.

© Copyright IBM Corporation 2006, 2012.

US Government Users Restricted Rights – Use, duplication or disclosure restricted by GSA ADP Schedule Contract with IBM Corp.

# Contents

<b>About this book.</b> . . . . .	<b>vii</b>
How this book is structured. . . . .	vii

## **Part 1. Performance overview . . . . 1**

### **Chapter 1. Performance tuning tools and methodology . . . . . 5**

Benchmark testing . . . . .	5
Benchmark preparation . . . . .	6
Benchmark test creation . . . . .	7
Benchmark test execution . . . . .	8
Benchmark test analysis example . . . . .	9

### **Chapter 2. Performance monitoring tools and methodology. . . . . 11**

Operational monitoring of system performance . . . . .	11
Basic set of system performance monitor elements . . . . .	12
Abnormal values in monitoring data . . . . .	16
The governor utility . . . . .	16
Starting the governor . . . . .	17
The governor daemon . . . . .	18
The governor configuration file. . . . .	18
Governor rule clauses . . . . .	21
Governor log files . . . . .	26
Stopping the governor. . . . .	29

### **Chapter 3. Factors affecting performance . . . . . 31**

System architecture. . . . .	31
DB2 architecture and process overview . . . . .	31
The DB2 process model . . . . .	32
Database agents . . . . .	38
Configuring for good performance . . . . .	47
Instance configuration . . . . .	54
Table space design . . . . .	55
Disk-storage performance factors . . . . .	55
Table space impact on query optimization . . . . .	55
Database design . . . . .	57
Tables . . . . .	57
Indexes. . . . .	62
Partitioning and clustering . . . . .	76
Federated databases . . . . .	83
Resource utilization. . . . .	83
Memory allocation . . . . .	83
Self-tuning memory overview . . . . .	91
Buffer pool management . . . . .	98
Database deactivation behavior in first-user connection scenarios . . . . .	116
Tuning sort performance. . . . .	116
Data organization . . . . .	118
Table reorganization . . . . .	119
Index reorganization . . . . .	129

Determining when to reorganize tables and indexes . . . . .	133
Costs of table and index reorganization. . . . .	137
Reducing the need to reorganize tables and indexes . . . . .	138
Automatic reorganization . . . . .	139
Scenario: ExampleBANK reclaiming table and index space . . . . .	142
Application design . . . . .	147
Application processes, concurrency, and recovery . . . . .	147
Concurrency issues . . . . .	149
Writing and tuning queries for optimal performance. . . . .	161
Improving insert performance . . . . .	181
Efficient SELECT statements . . . . .	182
Guidelines for restricting SELECT statements . . . . .	183
Specifying row blocking to reduce overhead . . . . .	186
Data sampling in queries . . . . .	187
Parallel processing for applications . . . . .	188
Lock management. . . . .	190
Locks and concurrency control . . . . .	190
Lock granularity . . . . .	191
Lock attributes . . . . .	192
Factors that affect locking . . . . .	193
Lock type compatibility . . . . .	195
Next-key locking . . . . .	195
Lock modes and access plans for standard tables . . . . .	196
Lock modes for MDC and ITC tables and RID index scans . . . . .	200
Lock modes for MDC block index scans . . . . .	204
Locking behavior on partitioned tables . . . . .	208
Lock conversion . . . . .	209
Lock waits and timeouts . . . . .	210
Deadlocks . . . . .	211
Query optimization . . . . .	213
The SQL and XQuery compiler process. . . . .	213
Data-access methods . . . . .	235
Predicate processing for queries . . . . .	245
Joins . . . . .	248
Effects of sorting and grouping on query optimization. . . . .	263
Optimization strategies . . . . .	265
Improving query optimization with materialized query tables . . . . .	275
Explain facility . . . . .	277
Optimizing query access plans . . . . .	326
Statistical views . . . . .	402
Catalog statistics . . . . .	413
Minimizing RUNSTATS impact . . . . .	458
Data compression and performance . . . . .	459
Reducing logging overhead to improve DML performance. . . . .	461
Inline LOBs improve performance . . . . .	461

## Chapter 4. Establishing a performance tuning strategy. . . . . 463

The Design Advisor . . . . .	463
Using the Design Advisor . . . . .	466
Defining a workload for the Design Advisor . . . . .	467
Using the Design Advisor to convert from a single-partition to a multi-partition database . . . . .	468
Design Advisor limitations and restrictions . . . . .	468

## Part 2. Techniques for troubleshooting problems. . . . . 471

### Chapter 5. Tools for troubleshooting 475

Checking archive log files with the db2cklog tool . . . . .	475
Overview of the db2dart tool . . . . .	477
Comparison of INSPECT and db2dart . . . . .	478
Analyzing db2diag log files using db2diag tool . . . . .	480
Displaying and altering the global registry (UNIX) using db2greg . . . . .	484
Identifying the version and service level of your product . . . . .	485
Mimicking databases using db2look . . . . .	485
Listing DB2 database products installed on your system (Linux and UNIX) . . . . .	489
Monitoring and troubleshooting using db2pd command . . . . .	490
Collecting environment information with the db2support command . . . . .	504
Validating your DB2 copy . . . . .	509
Basic trace diagnostics . . . . .	509
DB2 traces . . . . .	510
DRDA trace files . . . . .	513
JDBC trace . . . . .	521
CLI trace files . . . . .	521
Platform-specific tools . . . . .	535
Diagnostic tools (Windows) . . . . .	535
Diagnostic tools (Linux and UNIX) . . . . .	535

### Chapter 6. Troubleshooting DB2 database . . . . . 539

Collecting data for DB2 . . . . .	539
Collecting data for data movement problems . . . . .	540
Collecting data for DAS and instance management problems . . . . .	540
Collecting diagnostic data for specific performance problems . . . . .	541
Analyzing data for DB2 . . . . .	544
Recovering from sustained traps . . . . .	544
Identifying db2diag log entries for a load operation . . . . .	545
Troubleshooting administrative task scheduler . . . . .	549
Operation fails because database is currently in use . . . . .	550
Troubleshooting compression . . . . .	551
Data compression dictionary is not automatically created . . . . .	551
Row compression not reducing disk storage space for temporary tables . . . . .	552
Data replication process cannot decompress a compressed row image . . . . .	553
Troubleshooting global variable problems . . . . .	555

Troubleshooting inconsistencies . . . . .	557
Troubleshooting data inconsistencies . . . . .	557
Troubleshooting index to data inconsistencies . . . . .	558
Troubleshooting a database in an inconsistent state . . . . .	558
Troubleshooting installation of DB2 database systems . . . . .	559
Collecting data for installation problems . . . . .	560
Analyzing data for installation problems . . . . .	561
Gathering diagnostic information for instance creation problems . . . . .	562
Known problems and solutions . . . . .	562
Troubleshooting license issues . . . . .	564
Analyzing DB2 license compliance reports . . . . .	564
Diagnosing and resolving locking problems . . . . .	566
Diagnosing a lock wait problem . . . . .	567
Diagnosing a deadlock problem . . . . .	570
Diagnosing a lock timeout problem . . . . .	573
Diagnosing a lock escalation problem . . . . .	576
Troubleshooting SQL performance . . . . .	579
Individual SQL queries run well, but performance decreases when running multiple queries . . . . .	579
Performance overview . . . . .	581
Tuning sort performance . . . . .	583
Minimizing RUNSTATS impact . . . . .	585
Data compression and performance . . . . .	585
Troubleshooting optimization . . . . .	587
Troubleshooting optimization guidelines and profiles . . . . .	587
Troubleshooting partitioned database environments . . . . .	589
FCM problems related to 127.0.0.2 (Linux and UNIX) . . . . .	589
Creating a database partition on an encrypted file system (AIX) . . . . .	589
Troubleshooting table states during data redistribution . . . . .	590
Troubleshooting scripts . . . . .	592
Recompile the static section to collect section actuals after applying Fix Pack 1 . . . . .	592
Troubleshooting storage key support . . . . .	592

### Chapter 7. Troubleshooting the DB2 pureScale Feature . . . . . 595

How to diagnose a problem with the DB2 pureScale Feature . . . . .	595
Manual trace and log file collection . . . . .	597
Installation, instance creation and rollback . . . . .	598
The DB2 Setup wizard does not launch . . . . .	598
Collecting diagnostic data for installation and instance-creation problems . . . . .	598
Creating instance resources returns an error . . . . .	600
Investigating Tivoli SA MP states with DB2 commands . . . . .	601
Creating instance resources hangs the installation . . . . .	602
Frequently asked questions about DB2 pureScale Feature host validation problems . . . . .	604
Frequently asked questions about installation, instance creation, and rollback problems with the DB2 pureScale Feature . . . . .	607

Frequently asked questions about DB2 cluster file system problems . . . . .	608
Frequently asked questions about RSCT peer domain problems . . . . .	609
Frequently asked questions about response file installation problems with the DB2 pureScale Feature . . . . .	609
Frequently asked questions about DB2 pureScale Feature licensing problems . . . . .	610
Post-installation . . . . .	611
The instance does not start . . . . .	611
Frequently asked questions about post-installation problems . . . . .	621
Host or member issues . . . . .	622
Summary of instance status information from the <b>db2instance -list</b> command . . . . .	623
Troubleshooting options for the <b>db2cluster</b> command . . . . .	649
Repairing the cluster manager resource model . . . . .	649
Repairing the cluster manager domain . . . . .	649
Setting the unhealthy host response . . . . .	651
Uninstallation . . . . .	652
Cleaning up an incomplete DB2 pureScale instance drop . . . . .	652
Cleaning up an IBM Reliable Scalable Cluster Technology peer domain . . . . .	653
Frequently asked questions about uninstallation problems with the DB2 pureScale Feature . . . . .	653
<b>Chapter 8. Troubleshooting DB2 Text Search . . . . .</b>	<b>655</b>
Using the DB2 trace facility for text search operations . . . . .	655
Logging and tracing for the DB2 Text Search server . . . . .	655
Monitoring queues for DB2 Text Search index updates . . . . .	656
Troubleshooting hints and tips for DB2 Text Search . . . . .	658
<b>Chapter 9. Learning more about troubleshooting . . . . .</b>	<b>661</b>
Learning more . . . . .	661
Diagnostic data directory path. . . . .	662
Administration notification log . . . . .	667
DB2 diagnostic (db2diag) log files . . . . .	670
Combining DB2 database and OS diagnostics . . . . .	675

db2cos (callout script) output files . . . . .	679
Dump files . . . . .	680
First occurrence data capture information . . . . .	681
Internal return codes . . . . .	693
Introduction to messages . . . . .	695
Platform-specific error log information . . . . .	697
Trap files . . . . .	701

<b>Chapter 10. Searching knowledge bases . . . . .</b>	<b>703</b>
How to search effectively for known problems . . . . .	703
Troubleshooting resources . . . . .	703

<b>Chapter 11. Getting DB2 product fixes . . . . .</b>	<b>705</b>
Getting fixes. . . . .	705
Fix packs, interim fix packs and test fixes . . . . .	705
Applying test fixes . . . . .	707

<b>Chapter 12. Support . . . . .</b>	<b>709</b>
Contacting IBM Software Support . . . . .	709
Exchanging information with IBM . . . . .	709
Subscribing to Support updates . . . . .	711

---

## Part 3. Appendixes . . . . . 713

<b>Appendix A. Overview of the DB2 technical information . . . . .</b>	<b>715</b>
DB2 technical library in hardcopy or PDF format . . . . .	715
Displaying SQL state help from the command line processor . . . . .	718
Accessing different versions of the DB2 Information Center . . . . .	718
Updating the DB2 Information Center installed on your computer or intranet server . . . . .	718
Manually updating the DB2 Information Center installed on your computer or intranet server . . . . .	720
DB2 tutorials . . . . .	721
DB2 troubleshooting information . . . . .	722
Terms and conditions. . . . .	722

<b>Appendix B. Notices . . . . .</b>	<b>725</b>
--------------------------------------	------------

<b>Index . . . . .</b>	<b>729</b>
------------------------	------------





---

## About this book

This guide provides information about tuning database performance and solving problems with DB2® database clients and servers.

It helps you to:

- Develop a performance monitoring and tuning strategy
- Develop a troubleshooting strategy for day-to-day operations
- Adjust the configuration of the database server
- Make changes to the applications that use the database server
- Identify problems and errors in a concise manner
- Solve problems based on their symptoms
- Learn about available diagnostic tools

### Who should use this book?

This guide is intended for customers, users, system administrators, database administrators (DBAs), communication specialists, application developers, and technical support representatives who are interested in tuning database performance and troubleshooting problems with DB2 database clients and servers. To use it, you should be familiar with:

- Communications, relational database, and local area network (LAN) concepts
- Hardware and software requirements and options
- The overall configuration of your network
- Application programs and other facilities that run on your network
- Basic DB2 database administrative tasks
- The information on installation and early tasks described in the *Quick Beginnings* guides for the products you have installed.

---

## How this book is structured

To assist you in performance monitoring and tuning of the database system, the information provided here contains the necessary background material to understand the factors affecting database performance and instructions to help you tune the performance of your system. To help you understand, isolate, and resolve problems with your DB2 database software, the troubleshooting and support information contains instructions for using the problem determination resources that are provided with your DB2 database products.

### Part 1. Tuning database performance

As a database administrator, you might encounter a situation in which users anecdotally report that their database applications are running slow. The information provided here describes how to develop a performance monitoring strategy to obtain objective assessments of database system performance in comparison with historical results, how to adjust the configuration of the database server, and how to make changes to the applications that use the database server; all with the goal of improving the database system performance without increasing processing costs and without degrading service to users.

- Chapter 1, “Performance tuning tools and methodology,” describes how to design and implement a benchmark testing program to help you improve performance.
- Chapter 2, “Performance monitoring tools and methodology,” provides information about the importance of an operational monitoring strategy that collects key system performance data on a periodic basis.
- Chapter 3, “Factors affecting performance,” contains information about the various factors that can affect database system performance. Some of these factors can be tuned or reconfigured.
- Chapter 4, “Establishing a performance tuning strategy,” describes the DB2 Design Advisor tool that can help you significantly improve your workload performance.

## **Part 2. Troubleshooting a problem**

To assist you to resolve a problem on your own, the information contained in this section describes how to identify the source of a problem, how to gather diagnostic information, where to get fixes, and which knowledge bases to search for additional information. If you must contact IBM Software Support, there is information here that describes how to contact support and what diagnostic information the service technicians require to help you address a problem.

- Chapter 5, “Tools for troubleshooting,” describes the troubleshooting tools that can be used to help in the systematic approach to solving a problem. The goal is to determine why something does not work as expected and how to resolve the problem.
- Chapter 6, “Troubleshooting DB2 database,” provides information about various known problems that can arise and how to troubleshoot them.
- Chapter 7, “Troubleshooting DB2 Connect™,” provides information about various known problems that can arise and how to troubleshoot them.
- Chapter 8, “Searching knowledge bases,” provides information about how to find solutions to problems by searching IBM knowledge bases. This chapter describes how to optimize your results by using available resources, support tools, and search methods.
- Chapter 9, “Getting DB2 product fixes,” presents information about obtaining a product fix that might already be available to resolve your problem. You can get fixes by following the steps outlined here.
- Chapter 10, “Learning more about troubleshooting,” describes how the following topics can help you acquire the conceptual information that you require to effectively troubleshoot problems with DB2 database server.
- Chapter 11, “Contacting IBM Software Support,” provides information about how to contact IBM Software Support and what information they will require from you to assist you in resolving product defects and database problems.

## **Part 3. Appendixes**

- Appendix A, “Overview of the DB2 technical information”
- Appendix B, “Notices”

---

## Part 1. Performance overview

*Performance* refers to the way that a computer system behaves in response to a particular workload. Performance is measured in terms of system response time, throughput, and resource utilization.

Performance is also affected by:

- The resources that are available on the system
- How well those resources are used and shared

In general, you will want to tune your system to improve its cost-benefit ratio.

Specific goals could include:

- Processing larger, or more demanding, workloads without increasing processing costs
- Obtaining faster system response times, or higher throughput, without increasing processing costs
- Reducing processing costs without degrading service to users

Some benefits of performance tuning, such as a more efficient use of resources and the ability to add more users to the system, are tangible. Other benefits, such as greater user satisfaction because of quicker response times, are intangible.

### Performance tuning guidelines

Keep the following guidelines in mind when developing an overall approach to performance tuning.

- **Remember the law of diminishing returns:** The greatest performance benefits usually come from your initial efforts.
- **Do not tune just for the sake of tuning:** Tune to relieve identified constraints. Tuning resources that are not the primary cause of performance problems can actually make subsequent tuning work more difficult.
- **Consider the whole system:** You cannot tune one parameter or resource in isolation. Before you make an adjustment, consider how the change will affect the system as a whole. Performance tuning requires trade-offs among various system resources. For example, you might increase buffer pool sizes to achieve improved I/O performance, but larger buffer pools require more memory, and that might degrade other aspects of performance.
- **Change one parameter at a time:** Do not change more than one factor at a time. Even if you are sure that all the changes will be beneficial, you will have no way of assessing the contribution of each change.
- **Measure and configure by levels:** Tune one level of your system at a time. System levels include:
  - Hardware
  - Operating system
  - Application server and requester
  - Database manager
  - SQL and XQuery statements
  - Application programs

- **Check for hardware as well as software problems:** Some performance problems can be corrected by applying service to your hardware, your software, or both. Do not spend excessive time monitoring and tuning your system before applying service to the hardware or software.
- **Understand the problem before you upgrade your hardware:** Even if it seems that additional storage or processor power could immediately improve performance, take the time to understand where your bottlenecks are. You might spend money on additional disk storage, only to find that you do not have the processing power or the channels to exploit it.
- **Put fallback procedures in place before you start tuning:** If tuning efforts result in unexpected performance degradation, the changes made should be reversed before you attempt an alternative approach. Save your original settings so that you can easily undo changes that you do not want to keep.

## Developing a performance improvement process

The performance improvement process is an iterative approach to monitoring and tuning aspects of performance. Depending on the results of this performance monitoring, you will adjust the configuration of the database server and make changes to the applications that use the database server.

Base your performance monitoring and tuning decisions on your knowledge of the kinds of applications that use the data and on your understanding of patterns of data access. Different kinds of applications have different performance requirements.

Any performance improvement process includes the following fundamental steps:

1. Define the performance objectives.
2. Establish performance indicators for the major constraints in the system.
3. Develop and execute a performance monitoring plan.
4. Continually analyze monitoring results to determine which resources require tuning.
5. Make one adjustment at a time.

If, at some point, you can no longer improve performance by tuning the database server or applications, it might be time to upgrade the hardware.

## Performance information that users can provide

The first sign that your system requires tuning might be complaints from users. If you do not have enough time to set performance objectives and to monitor and tune in a comprehensive manner, you can address performance issues by listening to your users. Start by asking a few simple questions, such as the following:

- What do you mean by “slow response”? Is it 10% slower than you expect it to be, or tens of times slower?
- When did you notice the problem? Is it recent, or has it always been there?
- Do other users have the same problem? Are these users one or two individuals or a whole group?
- If a group of users is experiencing the same problem, are these users connected to the same local area network?
- Does the problem seem to be related to a specific type of transaction or application program?

- Do you notice any pattern of occurrence? For example, does the problem occur at a specific time of day, or is it continuous?

### **Performance tuning limits**

The benefits of performance tuning are limited. When considering how much time and money should be spent on improving system performance, be sure to assess the degree to which the investment of additional time and money will help the users of the system.

Tuning can often improve performance if the system is encountering response time or throughput problems. However, there is a point beyond which additional tuning cannot help. At this point, consider revising your goals and expectations. For more significant performance improvements, you might need to add more disk storage, faster CPUs, additional CPUs, more main memory, faster communication links, or a combination of these.



---

# Chapter 1. Performance tuning tools and methodology

---

## Benchmark testing

Benchmark testing is a normal part of the application development life cycle. It is a team effort that involves both application developers and database administrators (DBAs).

Benchmark testing is performed against a system to determine current performance and can be used to improve application performance. If the application code has been written as efficiently as possible, additional performance gains might be realized by tuning database and database manager configuration parameters.

Different types of benchmark tests are used to discover specific kinds of information. For example:

- An *infrastructure benchmark* determines the throughput capabilities of the database manager under certain limited laboratory conditions.
- An *application benchmark* determines the throughput capabilities of the database manager under conditions that more closely reflect a production environment.

Benchmark testing to tune configuration parameters is based upon controlled conditions. Such testing involves repeatedly running SQL from your application and changing the system configuration (and perhaps the SQL) until the application runs as efficiently as possible.

The same approach can be used to tune other factors that affect performance, such as indexes, table space configuration, and hardware configuration, to name a few.

Benchmark testing helps you to understand how the database manager responds to different conditions. You can create scenarios that test deadlock handling, utility performance, different methods of loading data, transaction rate characteristics as more users are added, and even the effect on the application of using a new release of the database product.

Benchmark tests are based on a repeatable environment so that the same test run under the same conditions will yield results that you can legitimately compare. You might begin by running the test application in a normal environment. As you narrow down a performance problem, you can develop specialized test cases that limit the scope of the function that you are testing. The specialized test cases need not emulate an entire application to obtain valuable information. Start with simple measurements, and increase the complexity only if necessary.

Characteristics of good benchmarks include:

- The tests are repeatable
- Each iteration of a test starts in the same system state
- No other functions or applications are unintentionally active in the system
- The hardware and software used for benchmark testing match your production environment

Note that started applications use memory even when they are idle. This increases the probability that paging will skew the results of the benchmark and violates the repeatability criterion.

## Benchmark preparation

There are certain prerequisites that must be satisfied before performance benchmark testing can be initiated.

Before you start performance benchmark testing:

- Complete both the logical and physical design of the database against which your application will run
- Create tables, views, and indexes
- Normalize tables, bind application packages, and populate tables with realistic data; ensure that appropriate statistics are available
- Plan to run against a production-size database, so that the application can test representative memory requirements; if this is not possible, try to ensure that the proportions of available system resources to data in the test and production systems are the same (for example, if the test system has 10% of the data, use 10% of the processor time and 10% of the memory that is available to the production system)
- Place database objects in their final disk locations, size log files, determine the location of work files and backup images, and test backup procedures
- Check packages to ensure that performance options, such as row blocking, are enabled when possible

Although the practical limits of an application might be revealed during benchmark testing, the purpose of the benchmark is to measure performance, not to detect defects.

Your benchmark testing program should run in an accurate representation of the final production environment. Ideally, it should run on the same server model with the same memory and disk configurations. This is especially important if the application will ultimately serve large numbers of users and process large amounts of data. The operating system and any communications or storage facilities used directly by the benchmark testing program should also have been tuned previously.

SQL statements to be benchmark tested should be either representative SQL or worst-case SQL, as described in the following list.

### Representative SQL

Representative SQL includes those statements that are executed during typical operations of the application that is being benchmark tested. Which statements are selected depends on the nature of the application. For example, a data-entry application might test an INSERT statement, whereas a banking transaction might test a FETCH, an UPDATE, and several INSERT statements.

### Worst-case SQL

Statements falling under this category include:

- Statements that are executed frequently
- Statements that are processing high volumes of data
- Statements that are time-critical. For example, statements in an application that runs to retrieve and update customer information while the customer is waiting on the telephone.
- Statements with a large number of joins, or the most complex statements in the application. For example, statements in a banking application that produces summaries of monthly activity for all of a customer's accounts.



A common table might list the customer's address and account numbers; however, several other tables must be joined to process and integrate all of the necessary account transaction information.

- Statements that have a poor access path, such as one that is not supported by an available index
- Statements that have a long execution time
- Statements that are executed only at application initialization time, but that have disproportionately large resource requirements. For example, statements in an application that generates a list of account work that must be processed during the day. When the application starts, the first major SQL statement causes a seven-way join, which creates a very large list of all the accounts for which this application user is responsible. This statement might only run a few times each day, but it takes several minutes to run if it has not been tuned properly.

## Benchmark test creation

You will need to consider a variety of factors when designing and implementing a benchmark testing program.

Because the main purpose of the testing program is to simulate a user application, the overall structure of the program will vary. You might use the entire application as the benchmark and simply introduce a means for timing the SQL statements that are to be analyzed. For large or complex applications, it might be more practical to include only blocks that contain the important statements. To test the performance of specific SQL statements, you can include only those statements in the benchmark testing program, along with the necessary CONNECT, PREPARE, OPEN, and other statements, as well as a timing mechanism.

Another factor to consider is the type of benchmark to use. One option is to run a set of SQL statements repeatedly over a certain time interval. The number of statements executed over this time interval is a measure of the throughput for the application. Another option is to simply determine the time required to execute individual SQL statements.

For all benchmark testing, you need a reliable and appropriate way to measure elapsed time. To simulate an application in which individual SQL statements execute in isolation, measuring the time to PREPARE, EXECUTE, or OPEN, FETCH, or CLOSE for each statement might be best. For other applications, measuring the transaction time from the first SQL statement to the COMMIT statement might be more appropriate.

Although the elapsed time for each query is an important factor in performance analysis, it might not necessarily reveal bottlenecks. For example, information on CPU usage, locking, and buffer pool I/O might show that the application is I/O bound and not using the CPU at full capacity. A benchmark testing program should enable you to obtain this kind of data for a more detailed analysis, if needed.

Not all applications send the entire set of rows retrieved from a query to some output device. For example, the result set might be input for another application. Formatting data for screen output usually has a high CPU cost and might not reflect user needs. To provide an accurate simulation, a benchmark testing program should reflect the specific row handling activities of the application. If rows are sent to an output device, inefficient formatting could consume the majority of CPU time and misrepresent the actual performance of the SQL statement itself.

Although it is very easy to use, the DB2 command line processor (CLP) is not suited to benchmarking because of the processing overhead that it adds. A benchmark tool (**db2batch**) is provided in the `bin` subdirectory of your instance `sqllib` directory. This tool can read SQL statements from either a flat file or from standard input, dynamically prepare and execute the statements, and return a result set. It also enables you to control the number of rows that are returned to **db2batch** and the number of rows that are displayed. You can specify the level of performance-related information that is returned, including elapsed time, processor time, buffer pool usage, locking, and other statistics collected from the database monitor. If you are timing a set of SQL statements, **db2batch** also summarizes the performance results and provides both arithmetic and geometric means.

By wrapping **db2batch** invocations in a Perl or Korn shell script, you can easily simulate a multiuser environment. Ensure that connection attributes, such as the isolation level, are the same by selecting the appropriate **db2batch** options.

Note that in partitioned database environments, **db2batch** is suitable only for measuring elapsed time; other information that is returned pertains only to activity on the coordinator database partition.

You can write a driver program to help you with your benchmark testing. On Linux or UNIX systems, a driver program can be written using shell programs. A driver program can execute the benchmark program, pass the appropriate parameters, drive the test through multiple iterations, restore the environment to a consistent state, set up the next test with new parameter values, and collect and consolidate the test results. Driver programs can be flexible enough to run an entire set of benchmark tests, analyze the results, and provide a report of the best parameter values for a given test.

## Benchmark test execution

In the most common type of benchmark testing, you choose a configuration parameter and run the test with different values for that parameter until the maximum benefit is achieved.

A single test should include repeated execution of the application (for example, five or ten iterations) with the same parameter value. This enables you to obtain a more reliable average performance value against which to compare the results from other parameter values.

The first run, called a warmup run, should be considered separately from subsequent runs, which are called normal runs. The warmup run includes some startup activities, such as initializing the buffer pool, and consequently, takes somewhat longer to complete than normal runs. The information from a warmup run is not statistically valid. When calculating averages for a specific set of parameter values, use only the results from normal runs. It is often a good idea to drop the high and low values before calculating averages.

For the greatest consistency between runs, ensure that the buffer pool returns to a known state before each new run. Testing can cause the buffer pool to become loaded with data, which can make subsequent runs faster because less disk I/O is required. The buffer pool contents can be forced out by reading other irrelevant data into the buffer pool, or by de-allocating the buffer pool when all database connections are temporarily removed.

After you complete testing with a single set of parameter values, you can change the value of one parameter. Between each iteration, perform the following tasks to restore the benchmark environment to its original state:

- If the catalog statistics were updated for the test, ensure that the same values for the statistics are used for every iteration.
- The test data must be consistent if it is being updated during testing. This can be done by:
  - Using the restore utility to restore the entire database. The backup copy of the database contains its previous state, ready for the next test.
  - Using the import or load utility to restore an exported copy of the data. This method enables you to restore only the data that has been affected. The reorg and runstats utilities should be run against the tables and indexes that contain this data.

In summary, follow these steps to benchmark test a database application:

**Step 1** Leave the DB2 registry, database and database manager configuration parameters, and buffer pools at their standard recommended values, which can include:

- Values that are known to be required for proper and error-free application execution
- Values that provided performance improvements during prior tuning
- Values that were suggested by the **AUTOCONFIGURE** command
- Default values; however, these might not be appropriate:
  - For parameters that are significant to the workload and to the objectives of the test
  - For log sizes, which should be determined during unit and system testing of your application
  - For any parameters that must be changed to enable your application to run

Run your set of iterations for this initial case and calculate the average elapsed time, throughput, or processor time. The results should be as consistent as possible, ideally differing by no more than a few percentage points from run to run. Performance measurements that vary significantly from run to run can make tuning very difficult.

**Step 2** Select one and only one method or tuning parameter to be tested, and change its value.

**Step 3** Run another set of iterations and calculate the average elapsed time or processor time.

**Step 4** Depending on the results of the benchmark test, do one of the following:

- If performance improves, change the value of the same parameter and return to Step 3. Keep changing this parameter until the maximum benefit is shown.
- If performance degrades or remains unchanged, return the parameter to its previous value, return to Step 2, and select a new parameter. Repeat this procedure until all parameters have been tested.

## Benchmark test analysis example

Output from a benchmark testing program should include an identifier for each test, iteration numbers, statement numbers, and the elapsed times for each execution.

Note that the data in these sample reports is shown for illustrative purposes only. It does not represent actual measured results.

A summary of benchmark testing results might look like the following:

Test Numbr	Iter. Numbr	Stmt Numbr	Timing (hh:mm:ss.ss)	SQL Statement
002	05	01	00:00:01.34	CONNECT TO SAMPLE
002	05	10	00:02:08.15	OPEN cursor_01
002	05	15	00:00:00.24	FETCH cursor_01
002	05	15	00:00:00.23	FETCH cursor_01
002	05	15	00:00:00.28	FETCH cursor_01
002	05	15	00:00:00.21	FETCH cursor_01
002	05	15	00:00:00.20	FETCH cursor_01
002	05	15	00:00:00.22	FETCH cursor_01
002	05	15	00:00:00.22	FETCH cursor_01
002	05	20	00:00:00.84	CLOSE cursor_01
002	05	99	00:00:00.03	CONNECT RESET

Figure 1. Sample Benchmark Testing Results

Analysis shows that the CONNECT (statement 01) took 1.34 seconds to complete, the OPEN CURSOR (statement 10) took 2 minutes and 8.15 seconds, the FETCH (statement 15) returned seven rows, with the longest delay being 0.28 seconds, the CLOSE CURSOR (statement 20) took 0.84 seconds, and the CONNECT RESET (statement 99) took 0.03 seconds to complete.

If your program can output data in a delimited ASCII format, the data could later be imported into a database table or a spreadsheet for further statistical analysis.

A summary benchmark report might look like the following:

PARAMETER	VALUES FOR EACH BENCHMARK TEST				
TEST NUMBER	001	002	003	004	005
locklist	63	63	63	63	63
maxappl	8	8	8	8	8
applheapsz	48	48	48	48	48
dbheap	128	128	128	128	128
sortheap	256	256	256	256	256
maxlocks	22	22	22	22	22
stmthead	1024	1024	1024	1024	1024
SQL STMT	AVERAGE TIMINGS (seconds)				
01	01.34	01.34	01.35	01.35	01.36
10	02.15	02.00	01.55	01.24	01.00
15	00.22	00.22	00.22	00.22	00.22
20	00.84	00.84	00.84	00.84	00.84
99	00.03	00.03	00.03	00.03	00.03

Figure 2. Sample Benchmark Timings Report

---

## Chapter 2. Performance monitoring tools and methodology

---

### Operational monitoring of system performance

Operational monitoring refers to collecting key system performance metrics at periodic intervals over time. This information gives you critical data to refine that initial configuration to be more tailored to your requirements, and also prepares you to address new problems that might appear on their own or following software upgrades, increases in data or user volumes, or new application deployments.

#### Operational monitoring considerations

An operational monitoring strategy needs to address several considerations.

Operational monitoring needs to be very light weight (not consuming much of the system it is measuring) and generic (keeping a broad “eye” out for potential problems that could appear anywhere in the system).

Because you plan regular collection of operational metrics throughout the life of the system, it is important to have a way to manage all that data. For many of the possible uses you have for your data, such as long-term trending of performance, you want to be able to do comparisons between arbitrary collections of data that are potentially many months apart. The DB2 product itself facilitates this kind of data management very well. Analysis and comparison of monitoring data becomes very straightforward, and you already have a robust infrastructure in place for long-term data storage and organization.

A DB2 database (“DB2”) system provides some excellent sources of monitoring data. The primary ones are snapshot monitors and, in DB2 Version 9.5 and later, workload management (WLM) table functions for data aggregation. Both of these focus on summary data, where tools like counters, timers, and histograms maintain running totals of activity in the system. By sampling these monitor elements over time, you can derive the average activity that has taken place between the start and end times, which can be very informative.

There is no reason to limit yourself to just metrics that the DB2 product provides. In fact, data outside of the DB2 software is more than just a nice-to-have. Contextual information is key for performance problem determination. The users, the application, the operating system, the storage subsystem, and the network – all of these can provide valuable information about system performance. Including metrics from outside of the DB2 database software is an important part of producing a complete overall picture of system performance.

The trend in recent releases of the DB2 database product has been to make more and more monitoring data available through SQL interfaces. This makes management of monitoring data with DB2 very straightforward, because you can easily redirect the data from the administration views, for example, right back into DB2 tables. For deeper dives, activity event monitor data can also be written to DB2 tables, providing similar benefits. With the vast majority of our monitoring data so easy to store in DB2, a small investment to store system metrics (such as CPU utilization from `vmstat`) in DB2 is manageable as well.

## Types of data to collect for operational monitoring

Several types of data are useful to collect for ongoing operational monitoring.

- A basic set of DB2 system performance monitoring metrics.
- DB2 configuration information

Taking regular copies of database and database manager configuration, DB2 registry variables, and the schema definition helps provide a history of any changes that have been made, and can help to explain changes that arise in monitoring data.

- Overall system load

If CPU or I/O utilization is allowed to approach saturation, this can create a system bottleneck that might be difficult to detect using just DB2 snapshots. As a result, the best practice is to regularly monitor system load with **vmstat** and **iostat** (and possibly **netstat** for network issues) on Linux and UNIX, and **perfmon** on Windows. You can also use the administrative views, such as `ENV_GET_SYSTEM_RESOURCES`, to retrieve operating system, CPU, memory, and other information related to the system. Typically you look for changes in what is normal for your system, rather than for specific one-size-fits-all values.

- Throughput and response time measured at the business logic level

An application view of performance, measured above DB2, at the business logic level, has the advantage of being most relevant to the end user, plus it typically includes everything that could create a bottleneck, such as presentation logic, application servers, web servers, multiple network layers, and so on. This data can be vital to the process of setting or verifying a service level agreement (SLA).

The DB2 system performance monitoring elements and system load data are compact enough that even if they are collected every five to fifteen minutes, the total data volume over time is irrelevant in most systems. Likewise, the overhead of collecting this data is typically in the one to three percent range of additional CPU consumption, which is a small price to pay for a continuous history of important system metrics. Configuration information typically changes relatively rarely, so collecting this once a day is usually frequent enough to be useful without creating an excessive amount of data.

## Basic set of system performance monitor elements

11 metrics of system performance provide a good basic set to use in an on-going operational monitoring effort.

There are hundreds of metrics to choose from, but collecting all of them can be counter-productive due to the sheer volume of data produced. You want metrics that are:

- Easy to collect – You do not want to use complex or expensive tools for everyday monitoring, and you do not want the act of monitoring to significantly burden the system.
- Easy to understand – You do not want to look up the meaning of the metric each time you see it.
- Relevant to your system – Not all metrics provide meaningful information in all environments.
- Sensitive, but not too sensitive – A change in the metric should indicate a real change in the system; the metric should not fluctuate on its own.

This starter set includes 11 metrics:

1. The number of transactions executed:

TOTAL\_COMMITS

This provides an excellent base level measurement of system activity.

2. Buffer pool hit ratios, measured separately for data, index, XML storage object, and temporary data:

**Note:** The information that follows discusses buffer pools in environments other than DB2 pureScale® environments. Buffer pools work differently in DB2 pureScale environments. For more information, see “Buffer pool monitoring in a DB2 pureScale environment”, in the *Database Monitoring Guide and Reference*.

- Data pages:  $(\text{pool\_data\_lbp\_pages\_found} - \text{pool\_async\_data\_lbp\_pages\_found} - \text{pool\_temp\_data\_l\_reads}) / \text{pool\_data\_l\_reads} \times 100$
- Index pages:  $((\text{pool\_index\_lbp\_pages\_found} - \text{pool\_async\_index\_lbp\_pages\_found} - \text{pool\_temp\_index\_l\_reads}) / \text{pool\_index\_l\_reads}) \times 100$
- XML storage object (XDA) pages:  $((\text{pool\_xda\_gbp\_l\_reads} - \text{pool\_xda\_gbp\_p\_reads}) / \text{pool\_xda\_gbp\_l\_reads}) \times 100$
- Temporary data pages:  $((\text{pool\_temp\_data\_l\_reads} - \text{pool\_temp\_data\_p\_reads}) / \text{pool\_temp\_data\_l\_reads}) \times 100$
- Temporary index pages:  $((\text{pool\_temp\_index\_l\_reads} - \text{pool\_temp\_index\_p\_reads}) / \text{pool\_temp\_index\_l\_reads}) \times 100$

Buffer pool hit ratios are one of the most fundamental metrics, and give an important overall measure of how effectively the system is exploiting memory to avoid disk I/O. Hit ratios of 80-85% or better for data and 90-95% or better for indexes are generally considered good for an OLTP environment, and of course these ratios can be calculated for individual buffer pools using data from the buffer pool snapshot.

**Note:** The formulas shown for hit ratios for data and index pages exclude any read activity by prefetchers.

Although these metrics are generally useful, for systems such as data warehouses that frequently perform large table scans, data hit ratios are often irretrievably low, because data is read into the buffer pool and then not used again before being evicted to make room for other data.

3. Buffer pool physical reads and writes per transaction:

**Note:** The information that follows discusses buffer pools in environments other than DB2 pureScale environments. Buffer pools work differently in DB2 pureScale environments. For more information, see “Buffer pool monitoring in a DB2 pureScale environment”, in the *Database Monitoring Guide and Reference*.

$$\frac{(\text{POOL\_DATA\_P\_READS} + \text{POOL\_INDEX\_P\_READS} + \text{POOL\_XDA\_P\_READS} + \text{POOL\_TEMP\_DATA\_P\_READS} + \text{POOL\_TEMP\_INDEX\_P\_READS})}{\text{TOTAL\_COMMITTS}}$$
$$\frac{(\text{POOL\_DATA\_WRITES} + \text{POOL\_INDEX\_WRITES} + \text{POOL\_XDA\_WRITES})}{\text{TOTAL\_COMMITTS}}$$

These metrics are closely related to buffer pool hit ratios, but have a slightly different purpose. Although you can consider target values for hit ratios, there are no possible targets for reads and writes per transaction. Why bother with these calculations? Because disk I/O is such a major factor in database performance, it is useful to have multiple ways of looking at it. As well, these

calculations include writes, whereas hit ratios only deal with reads. Lastly, in isolation, it is difficult to know, for example, whether a 94% index hit ratio is worth trying to improve. If there are only 100 logical index reads per hour, and 94 of them are in the buffer pool, working to keep those last 6 from turning into physical reads is not a good use of time. However, if a 94% index hit ratio were accompanied by a statistic that each transaction did twenty physical reads (which can be further broken down by data and index, regular and temporary), the buffer pool hit ratios might well deserve some investigation.

The metrics are not just physical reads and writes, but are normalized per transaction. This trend is followed through many of the metrics. The purpose is to decouple metrics from the length of time data was collected, and from whether the system was very busy or less busy at that time. In general, this helps ensure that similar values for metrics are obtained, regardless of how and when monitoring data is collected. Some amount of consistency in the timing and duration of data collection is a good thing; however, normalization reduces it from being critical to being a good idea.

4. The ratio of database rows read to rows selected:

`ROWS_READ / ROWS_RETURNED`

This calculation gives an indication of the average number of rows that are read from database tables to find the rows that qualify. Low numbers are an indication of efficiency in locating data, and generally show that indexes are being used effectively. For example, this number can be very high in the case where the system does many table scans, and millions of rows have to be inspected to determine if they qualify for the result set. Alternatively, this statistic can be very low in the case of access to a table through a fully-qualified unique index. Index-only access plans (where no rows need to be read from the table) do not cause `ROWS_READ` to increase.

In an OLTP environment, this metric is generally no higher than 2 or 3, indicating that most access is through indexes instead of table scans. This metric is a simple way to monitor plan stability over time – an unexpected increase is often an indication that an index is no longer being used and should be investigated.

5. The amount of time spent sorting per transaction:

`TOTAL_SORT_TIME / TOTAL_COMMITS`

This is an efficient way to handle sort statistics, because any extra time due to spilled sorts automatically gets included here. That said, you might also want to collect `TOTAL_SORTS` and `SORT_OVERFLOWS` for ease of analysis, especially if your system has a history of sorting issues.

6. The amount of lock wait time accumulated per thousand transactions:

`1000 * LOCK_WAIT_TIME / TOTAL_COMMITS`

Excessive lock wait time often translates into poor response time, so it is important to monitor. The value is normalized to one thousand transactions because lock wait time on a single transaction is typically quite low. Scaling up to one thousand transactions provides measurements that are easier to handle.

7. The number of deadlocks and lock timeouts per thousand transactions:

`1000 * (DEADLOCKS + LOCK_TIMEOUTS) / TOTAL_COMMITS`

Although deadlocks are comparatively rare in most production systems, lock timeouts can be more common. The application usually has to handle them in



a similar way: re-executing the transaction from the beginning. Monitoring the rate at which this happens helps avoid the case where many deadlocks or lock timeouts drive significant extra load on the system without the DBA being aware.

8. The number of dirty steal triggers per thousand transactions:

$$1000 * POOL\_DRTY\_PG\_STEAL\_CLNS / TOTAL\_COMMITTS$$

A “dirty steal” is the least preferred way to trigger buffer pool cleaning. Essentially, the processing of an SQL statement that is in need of a new buffer pool page is interrupted while updates on the victim page are written to disk. If dirty steals are allowed to happen frequently, they can have a significant affect on throughput and response time.

9. The number of package cache inserts per thousand transactions:

$$1000 * PKG\_CACHE\_INSERTS / TOTAL\_COMMITTS$$

Package cache insertions are part of normal execution of the system; however, in large numbers, they can represent a significant consumer of CPU time. In many well-designed systems, after the system is running at steady-state, very few package cache inserts occur, because the system is using or reusing static SQL or previously prepared dynamic SQL statements. In systems with a high traffic of ad hoc dynamic SQL statements, SQL compilation and package cache inserts are unavoidable. However, this metric is intended to watch for a third type of situation, one in which applications unintentionally cause package cache churn by not reusing prepared statements, or by not using parameter markers in their frequently executed SQL.

10. The time an agent waits for log records to be flushed to disk:

$$\frac{LOG\_WRITE\_TIME}{TOTAL\_COMMITTS}$$

The transaction log has significant potential to be a system bottleneck, whether due to high levels of activity, or to improper configuration, or other causes. By monitoring log activity, you can detect problems both from the DB2 side (meaning an increase in number of log requests driven by the application) and from the system side (often due to a decrease in log subsystem performance caused by hardware or configuration problems).

11. In partitioned database environments, the number of fast communication manager (FCM) buffers sent and received between partitions:

$$FCM\_SENDS\_TOTAL, FCM\_RECVS\_TOTAL$$

These give the rate of flow of data between different partitions in the cluster, and in particular, whether the flow is balanced. Significant differences in the numbers of buffers received from different partitions might indicate a skew in the amount of data that has been hashed to each partition.

## Cross-partition monitoring in partitioned database environments

Almost all of the individual monitoring element values mentioned previously are reported on a per-partition basis.

In general, you expect most monitoring statistics to be fairly uniform across all partitions in the same DB2 partition group. Significant differences might indicate data skew. Sample cross-partition comparisons to track include:

- Logical and physical buffer pool reads for data, indexes, and temporary tables
- Rows read, at the partition level and for large tables

- Sort time and sort overflows
- FCM buffer sends and receives
- CPU and I/O utilization

## Abnormal values in monitoring data

Being able to identify abnormal values is key to interpreting system performance monitoring data when troubleshooting performance problems.

A monitor element provides a clue to the nature of a performance problem when its value is worse than normal, that is, the value is abnormal. Generally, a worse value is one that is higher than expected, for example higher lock wait time. However, an abnormal value can also be lower than expected, such as lower buffer pool hit ratio. Depending on the situation, you can use one or more methods to determine if a value is worse than normal.

One approach is to rely on industry rules of thumb or best practices. For example, a rule of thumb is that buffer pool hit ratios of 80-85% or better for data are generally considered good for an OLTP environment. Note that this rule of thumb applies to OLTP environments and would not serve as a useful guide for data warehouses where data hit ratios are often much lower due to the nature of the system.

Another approach is to compare current values to baseline values collected previously. This approach is often most definitive and relies on having an adequate operational monitoring strategy to collect and store key performance metrics during normal conditions. For example, you might notice that your current buffer pool hit ratio is 85%. This would be considered normal according to industry norms but abnormal when compared to the 99% value recorded before the performance problem was reported.

A final approach is to compare current values with current values on a comparable system. For example, a current buffer pool hit ratio of 85% would be considered abnormal if comparable systems have a buffer pool ratio of 99%.

---

## The governor utility

The governor monitors the behavior of applications that run against a database and can change that behavior, depending on the rules that you specify in the governor configuration file.

**Important:** With the new strategic DB2 workload manager features introduced in DB2 Version 9.5, the DB2 governor utility has been deprecated in Version 9.7 and might be removed in a future release. For more information about the deprecation of the governor utility, see “DB2 Governor and Query Patroller have been deprecated”. To learn more about DB2 workload manager and how it replaces the governor utility, see “Introduction to DB2 workload manager concepts” and “Frequently asked questions about DB2 workload manager”.

A governor instance consists of a frontend utility and one or more daemons. Each instance of the governor is specific to an instance of the database manager. By default, when you start the governor, a governor daemon starts on each database partition of a partitioned database. However, you can specify that a daemon be started on a single database partition that you want to monitor.

The governor manages application transactions according to rules in the governor configuration file. For example, applying a rule might reveal that an application is using too much of a particular resource. The rule would also specify the action to take, such as changing the priority of the application, or forcing it to disconnect from the database.

If the action associated with a rule changes the priority of the application, the governor changes the priority of agents on the database partition where the resource violation occurred. In a partitioned database, if the application is forced to disconnect from the database, the action occurs even if the daemon that detected the violation is running on the coordinator node of the application.

The governor logs any actions that it takes.

**Note:** When the governor is active, its snapshot requests might affect database manager performance. To improve performance, increase the governor wake-up interval to reduce its CPU usage.

## Starting the governor

The governor utility monitors applications that are connected to a database, and changes the behavior of those applications according to rules that you specify in a governor configuration file for that database.

### Before you begin

Before you start the governor, you must create a governor configuration file.

To start the governor, you must have SYSADM or SYSCTRL authorization.

### About this task

**Important:** With the workload management features introduced in DB2 Version 9.5, the DB2 governor utility was deprecated in Version 9.7 and might be removed in a future release. It is not supported in DB2 pureScale environments. For more information, see “DB2 Governor and Query Patroller have been deprecated” at <http://publib.boulder.ibm.com/infocenter/db2luw/v9r7/topic/com.ibm.db2.luw.wn.doc/doc/i0054901.html>.

### Procedure

- To start the governor, use the **db2gov** command, specifying the following required parameters:

**START** *database-name*

The database name that you specify must match the name of the database in the governor configuration file.

*config-file*

The name of the governor configuration file for this database. If the file is not in the default location, which is the `sqlib` directory, you must include the file path as well as the file name.

*log-file*

The base name of the log file for this governor. For a partitioned database, the database partition number is added for each database partition on which a daemon is running for this instance of the governor.

- To start the governor on a single database partition of a partitioned database, specify the **dbpartitionnum** option.  
For example, to start the governor on database partition 3 of a database named SALES, using a configuration file named salescfg and a log file called saleslog, enter the following command:  

```
db2gov start sales dbpartitionnum 3 salescfg saleslog
```
- To start the governor on all database partitions, enter the following command:  

```
db2gov start sales salescfg saleslog
```

## The governor daemon

The governor daemon collects information about applications that run against a database.

The governor daemon runs the following task loop whenever it starts.

1. The daemon checks whether its governor configuration file has changed or has not yet been read. If either condition is true, the daemon reads the rules in the file. This allows you to change the behavior of the governor daemon while it is running.
2. The daemon requests snapshot information about resource use statistics for each application and agent that is working on the database.
3. The daemon checks the statistics for each application against the rules in the governor configuration file. If a rule applies, the governor performs the specified action. The governor compares accumulated information with values that are defined in the configuration file. This means that if the configuration file is updated with new values that an application might have already breached, the rules concerning that breach are applied to the application during the next governor interval.
4. The daemon writes a record in the governor log file for any action that it takes.

When the governor finishes its tasks, it sleeps for an interval that is specified in the configuration file. When that interval elapses, the governor wakes up and begins the task loop again.

If the governor encounters an error or stop signal, it performs cleanup processing before stopping. Using a list of applications whose priorities have been set, cleanup processing resets all application agent priorities. It then resets the priorities of any agents that are no longer working on an application. This ensures that agents do not remain running with non-default priorities after the governor ends. If an error occurs, the governor writes a message to the administration notification log, indicating that it ended abnormally.

The governor cannot be used to adjust agent priorities if the value of the **agentpri** database manager configuration parameter is not the system default.

Although the governor daemon is not a database application, and therefore does not maintain a connection to the database, it does have an instance attachment. Because it can issue snapshot requests, the governor daemon can detect when the database manager ends.

## The governor configuration file

The governor configuration file contains rules governing applications that run against a database.

The governor evaluates each rule and takes specified actions when a rule evaluates to true.

The governor configuration file contains general clauses that identify the database to be monitored (required), the interval at which account records containing CPU usage statistics are written, and the sleep interval for governor daemons. The configuration file might also contain one or more optional application monitoring rule statements. The following guidelines apply to both general clauses and rule statements:

- Delimit general comments with braces ({ }).
- In most cases, specify values using uppercase, lowercase, or mixed case characters. The exception is application name (specified following the `app|name` clause), which is case sensitive.
- Terminate each general clause or rule statement with a semicolon (;).

If a rule needs to be updated, edit the configuration file without stopping the governor. Each governor daemon detects that the file has changed, and rereads it.

In a partitioned database environment, the governor configuration file must be created in a directory that is mounted across all database partitions so that the governor daemon on each database partition can read the same configuration file.

## General clauses

The following clauses cannot be specified more than once in a governor configuration file.

### **dbname**

The name or alias of the database to be monitored. This clause is required.

### **account *n***

The interval, in minutes, after which account records containing CPU usage statistics for each connection are written. This option is not available on Windows operating systems. On some platforms, CPU statistics are not available from the snapshot monitor. If this is the case, the account clause is ignored.

If a short session occurs entirely within the account interval, no log record is written. When log records are written, they contain CPU statistics that reflect CPU usage since the previous log record for the connection. If the governor is stopped and then restarted, CPU usage might be reflected in two log records; these can be identified through the application IDs in the log records.

### **interval *n***

The interval, in seconds, after which the daemon wakes up. If you do not specify this clause, the default value of 120 seconds is used.

## Rule clauses

Rule statements specify how applications are to be governed, and are assembled from smaller components called rule clauses. If used, rule clauses must appear in a specific order in the rule statement, as follows:

1. **desc**: A comment about the rule, enclosed by single or double quotation marks
2. **time**: The time at which the rule is evaluated

3. **authid:** One or more authorization IDs under which the application executes statements
4. **applname:** The name of the executable or object file that connects to the database. This name is case sensitive. If the application name contains spaces, the name must be enclosed by double quotation marks.
5. **setlimit:** Limits that the governor checks; for example, CPU time, number of rows returned, or idle time. On some platforms, CPU statistics are not available from the snapshot monitor. If this is the case, the setlimit clause is ignored.
6. **action:** The action that is to be taken when a limit is reached. If no action is specified, the governor reduces the priority of agents working for the application by 10 when a limit is reached. Actions that can be taken against an application include reducing its agent priority, forcing it to disconnect from the database, or setting scheduling options for its operations.

Combine the rule clauses to form a rule statement, using a specific clause no more than once in each rule statement.

```
desc "Allow no UOW to run for more than an hour"
setlimit uowtime 3600 action force;
```

If more than one rule applies to an application, all are applied. Usually, the action that is associated with the first limit encountered is the action that is applied first. An exception occurs if you specify a value of -1 for a rule clause: A subsequently specified value for the same clause can only override the previously specified value; other clauses in the previous rule statement are still operative.

For example, one rule statement uses the `rowsel 100000` and `uowtime 3600` clauses to specify that the priority of an application is decreased if its elapsed time is greater than 1 hour or if it selects more than 100 000 rows. A subsequent rule uses the `uowtime -1` clause to specify that the same application can have unlimited elapsed time. In this case, if the application runs for more than 1 hour, its priority is not changed. That is, `uowtime -1` overrides `uowtime 3600`. However, if it selects more than 100 000 rows, its priority is lowered because `rowsel 100000` still applies.

## Order of rule application

The governor processes rules from the top of the configuration file to the bottom. However, if the `setlimit` clause in a particular rule statement is more relaxed than the same clause in a preceding rule statement, the more restrictive rule applies. In the following example, ADMIN continues to be limited to 5000 rows, because the first rule is more restrictive.

```
desc "Force anyone who selects 5000 or more rows."
setlimit rowsel 5000 action force;

desc "Allow user admin to select more rows."
authid admin setlimit rowsel 10000 action force;
```

To ensure that a less restrictive rule overrides a more restrictive previous rule, specify -1 to clear the previous rule before applying the new one. For example, in the following configuration file, the initial rule limits all users to 5000 rows. The second rule clears this limit for ADMIN, and the third rule resets the limit for ADMIN to 10000 rows.

```
desc "Force anyone who selects 5000 or more rows."
setlimit rowsel 5000 action force;

desc "Clear the rowsel limit for admin."
```

```

authid admin setlimit rowsel -1;

desc "Now set the higher rowsel limit for admin"
authid admin setlimit rowsel 10000 action force;

Example of a governor configuration file

{ The database name is SAMPLE; do accounting every 30 minutes;
  wake up once a second. }
dbname sample; account 30; interval 1;

desc "CPU restrictions apply to everyone 24 hours a day."
setlimit cpu 600 rowsel 1000000 rowsread 5000000;

desc "Allow no UOW to run for more than an hour."
setlimit uowtime 3600 action force;

desc 'Slow down a subset of applications.'
applname jointA, jointB, jointC, quryA
setlimit cpu 3 locks 1000 rowsel 500 rowsread 5000;

desc "Have the governor prioritize these 6 long apps in 1 class."
applname longq1, longq2, longq3, longq4, longq5, longq6
setlimit cpu -1
action schedule class;

desc "Schedule all applications run by the planning department."
authid planid1, planid2, planid3, planid4, planid5
setlimit cpu -1
action schedule;

desc "Schedule all CPU hogs in one class, which will control consumption."
setlimit cpu 3600
action schedule class;

desc "Slow down the use of the DB2 CLP by the novice user."
authid novice
applname db2bp.exe
setlimit cpu 5 locks 100 rowsel 250;

desc "During the day, do not let anyone run for more than 10 seconds."
time 8:30 17:00 setlimit cpu 10 action force;

desc "Allow users doing performance tuning to run some of
their applications during the lunch hour."
time 12:00 13:00 authid ming, geoffrey, john, bill
applname tpcc1, tpcc2, tpcA, tpcG
setlimit cpu 600 rowsel 120000 action force;

desc "Increase the priority of an important application so it always
completes quickly."
applname Vlapp setlimit cpu 1 locks 1 rowsel 1 action priority -20;

desc "Some people, such as the database administrator (and others),
should not be limited. Because this is the last specification
in the file, it will override what came before."
authid gene, hershel, janet setlimit cpu -1 locks -1 rowsel -1 uowtime -1;

```

## Governor rule clauses

Each rule in the governor configuration file is made up of clauses that specify the conditions for applying the rule and the action that results if the rule evaluates to true.

The rule clauses must be specified in the order shown.

## Optional beginning clauses

- desc** Specifies a description for the rule. The description must be enclosed by either single or double quotation marks.
- time** Specifies the time period during which the rule is to be evaluated. The time period must be specified in the following format: `time hh:mm hh:mm`; for example, `time 8:00 18:00`. If this clause is not specified, the rule is evaluated 24 hours a day.
- authid** Specifies one or more authorization IDs under which the application is executing. Multiple authorization IDs must be separated by a comma (,); for example: `authid gene, michael, james`. If this clause is not specified, the rule applies to all authorization IDs.
- applname** Specifies the name of the executable or object file that is connected to the database. Multiple application names must be separated by a comma (,); for example: `applname db2bp, batch, geneprog`. If this clause is not specified, the rule applies to all application names.

### Note:

1. Application names are case sensitive.
2. The database manager truncates all application names to 20 characters. You should ensure that the application that you want to govern is uniquely identified by the first 20 characters of its application name. Application names specified in the governor configuration file are truncated to 20 characters to match their internal representation.

## Limit clauses

### setlimit

Specifies one or more limits for the governor to check. The limits must be -1 or greater than 0 (for example, `cpu -1 locks 1000 rowsse1 10000`). At least one limit must be specified, and any limit that is not specified in a rule statement is not limited by that rule. The governor can check the following limits:

- cpu *n*** Specifies the number of CPU seconds that can be consumed by an application. If you specify -1, the application's CPU usage is not limited.
- idle *n*** Specifies the number of idle seconds that are allowed for a connection. If you specify -1, the connection's idle time is not limited.

**Note:** Some database utilities, such as backup and restore, establish a connection to the database and then perform work through engine dispatchable units (EDUs) that are not visible to the governor. These database connections appear to be idle and might exceed the idle time limit. To prevent the governor from taking action against these utilities, specify -1 for them through the authorization ID that invoked them. For example, to prevent the governor from taking action against utilities that are running under authorization ID DB2SYS, specify `authid DB2SYS setlimit idle -1`.



**locks** *n*

Specifies the number of locks that an application can hold. If you specify -1, the number of locks held by the application is not limited.

**rowsread** *n*

Specifies the number of rows that an application can select. If you specify -1, the number of rows the application can select is not limited. The maximum value that can be specified is 4 294 967 298.

**Note:** This limit is not the same as `rowsse1`. The difference is that `rowsread` is the number of rows that must be read to return the result set. This number includes engine reads of the catalog tables and can be reduced when indexes are used.

**rowsse1** *n*

Specifies the number of rows that can be returned to an application. This value is non-zero only at the coordinator database partition. If you specify -1, the number of rows that can be returned is not limited. The maximum value that can be specified is 4 294 967 298.

**uowtime** *n*

Specifies the number of seconds that can elapse from the time that a unit of work (UOW) first becomes active. If you specify -1, the elapsed time is not limited.

**Note:** If you used the `sqlmon` API to deactivate the unit of work monitor switch or the timestamp monitor switch, this will affect the ability of the governor to govern applications based on the unit of work elapsed time. The governor uses the monitor to collect information about the system. If a unit of work (UOW) of the application has been started before the Governor starts, then the Governor will not govern that UOW.

## Action clauses

**action** Specifies the action that is to be taken if one or more specified limits is exceeded. If a limit is exceeded and the `action` clause is not specified, the governor reduces the priority of agents working for the application by 10.

**force** Specifies that the agent servicing the application is to be forced. (The **FORCE APPLICATION** command terminates the coordinator agent.)

**Note:** In partitioned database environments, the `force` action is only carried out when the governor daemon is running on the application's coordinator database partition. Therefore, if a governor daemon is running on database partition A and a limit is exceeded for some application whose coordinator database partition is database partition B, the `force` action is skipped.

**nice** *n* Specifies a change to the relative priority of agents working for the application. Valid values range from -20 to +20 on Linux and UNIX, and from -1 to 6 on Windows platforms.

- On Linux and UNIX, the **agentpri** database manager configuration parameter must be set to the default value; otherwise, it overrides the `nice` value.

- On Windows platforms, the **agentpri** database manager configuration parameter and the `nice` value can be used together.

You can use the governor to control the priority of applications that run in the default user service superclass, `SYSDEFAULTUSERCLASS`. If you use the governor to lower the priority of an application that runs in this service superclass, the agent disassociates itself from its outbound correlator (if it is associated with one) and sets its relative priority according to the agent priority specified by the governor. You cannot use the governor to alter the priority of agents in user-defined service superclasses and subclasses. Instead, you must use the agent priority setting for the service superclass or subclass to control applications that run in these service classes. You can, however, use the governor to force connections in any service class.

**Note:** On AIX® systems, the instance owner must have the `CAP_NUMA_ATTACH` capability to raise the relative priority of agents working for the application. To grant this capability, logon as root and run the following command:

```
chuser capabilities=CAP_NUMA_ATTACH,CAP_PROPAGATE <userid>
```

On Solaris 10 or higher, the instance owner must have the `proc_priocntl` privilege to be able to raise the relative priority of agents working for the application. To grant this privilege, logon as root and run the following command:

```
usermod -K defaultpriv=basic,proc_priocntl db2user
```

In this example, `proc_priocntl` is added to the default privilege set of user `db2user`.

Moreover, when DB2 is running in a non-global zone of Solaris, the `proc_priocntl` privilege must be added to the zone's limit privilege set. To grant this privilege to the zone, logon as root and run the following command:

```
global# zonecfg -z db2zone
zonecfg:db2zone> set limitpriv="default,proc_priocntl"
```

In this example, `proc_priocntl` is added to the limit privilege set of zone `db2zone`.

On Solaris 9, there is no facility for DB2 to raise the relative priority of agents. Upgrade to Solaris 10 or higher to use the `ACTION NICE` clause of DB2 governor.

### **schedule [class]**

Scheduling improves the priorities of agents working on applications. The goal is to minimize the average response time while maintaining fairness across all applications.

The governor chooses the top applications for scheduling on the basis of the following criteria:

- The application holding the greatest number of locks (an attempt to reduce the number of lock waits)
- The oldest application

- The application with the shortest estimated remaining run time (an attempt to allow as many short-lived statements as possible to complete during the interval)

The top three applications in each criterion are given higher priorities than all other applications. That is, the top application in each criterion group is given the highest priority, the next highest application is given the second highest priority, and the third-highest application is given the third highest priority. If a single application is ranked in the top three for more than one criterion, it is given the appropriate priority for the criterion in which it ranked highest, and the next highest application is given the next highest priority for the other criteria. For example, if application A holds the most locks but has the third shortest estimated remaining run time, it is given the highest priority for the first criterion. The fourth ranked application with the shortest estimated remaining run time is given the third highest priority for that criterion.

The applications that are selected by this governor rule are divided up into three classes. For each class, the governor chooses nine applications, which are the top three applications from each class, based on the criteria described previously. If you specify the `class` option, all applications that are selected by this rule are considered to be a single class, and nine applications are chosen and given higher priorities as described previously.

If an application is selected in more than one governor rule, it is governed by the last rule in which it is selected.

**Note:** If you used the `sqlmon` API to deactivate the statement switch, this will affect the ability of the governor to govern applications based on the statement elapsed time. The governor uses the monitor to collect information about the system. If you turn off the switches in the database manager configuration file, they are turned off for the entire instance, and the governor no longer receives this information.

The schedule action can:

- Ensure that applications in different groups get time, without all applications splitting time evenly. For example, if 14 applications (three short, five medium, and six long) are running at the same time, they might all have poor response times because they are splitting the CPU. The database administrator can set up two groups, medium-length applications and long-length applications. Using priorities, the governor permits all the short applications to run, and ensures that at most three medium and three long applications run simultaneously. To achieve this, the governor configuration file contains one rule for medium-length applications, and another rule for long applications.

The following example shows a portion of a governor configuration file that illustrates this point:

```
desc "Group together medium applications in 1 schedule class."
applname medq1, medq2, medq3, medq4, medq5
setlimit cpu -1
action schedule class;
```

```
desc "Group together long applications in 1 schedule class."
applname longq1, longq2, longq3, longq4, longq5, longq6
setlimit cpu -1
action schedule class;
```

- Ensure that each of several user groups (for example, organizational departments) gets equal prioritization. If one group is running a large number of applications, the administrator can ensure that other groups are still able to obtain reasonable response times for their applications. For example, in a case involving three departments (Finance, Inventory, and Planning), all the Finance users could be put into one group, all the Inventory users could be put into a second group, and all the Planning users could be put into a third group. The processing power would be split more or less evenly among the three departments.

The following example shows a portion of a governor configuration file that illustrates this point:

```
desc "Group together Finance department users."
authid tom, dick, harry, mo, larry, curly
setlimit cpu -1
action schedule class;
```

```
desc "Group together Inventory department users."
authid pat, chris, jack, jill
setlimit cpu -1
action schedule class;
```

```
desc "Group together Planning department users."
authid tara, dianne, henrietta, maureen, linda, candy
setlimit cpu -1
action schedule class;
```

- Let the governor schedule all applications.  
If the `class` option is not specified, the governor creates its own classes based on how many active applications fall under the `schedule` action, and puts applications into different classes based on the query compiler's cost estimate for the query the application is running. The administrator can choose to have all applications scheduled by not qualifying which applications are chosen; that is, by not specifying `applname`, `authid`, or `setlimit` clauses.

## Governor log files

Whenever a governor daemon performs an action, it writes a record to its log file.

Actions include the following:

- Starting or stopping the governor
- Reading the governor configuration file
- Changing an application's priority
- Forcing an application
- Encountering an error or warning

Each governor daemon has a separate log file, which prevents file-locking bottlenecks that might result when many governor daemons try to write to the same file simultaneously. To query the governor log files, use the **db2govlg** command.

The log files are stored in the `log` subdirectory of the `sql11b` directory, except on Windows operating systems, where the log subdirectory is located under the Common Application Data directory that Windows operating systems use to host application log files. You provide the base name for the log file when you start the governor with the `db2gov` command. Ensure that the log file name contains the database name to distinguish log files on each database partition that is governed. To ensure that the file name is unique for each governor in a partitioned database environment, the number of the database partition on which the governor daemon runs is automatically appended to the log file name.

## Log file record format

Each record in the log file has the following format:

```
Date Time DBPartitionNum RecType Message
```

The format of the *Date* and *Time* fields is *yyyy-mm-dd-hh.mm.ss*. You can merge the log files for each database partition by sorting on this field. The *DBPartitionNum* field contains the number of the database partition on which the governor is running.

The *RecType* field contains different values, depending on the type of record being written to the log. The values that can be recorded are:

- ACCOUNT: the application accounting statistics
- ERROR: an error occurred
- FORCE: an application was forced
- NICE: the priority of an application was changed
- READCFG: the governor read the configuration file
- SCHEDGRP: a change in agent priorities occurred
- START: the governor was started
- STOP: the governor was stopped
- WARNING: a warning occurred

Some of these values are described in more detail in the following list.

### ACCOUNT

An ACCOUNT record is written in the following situations:

- The value of the `agent_usr_cpu_time` or `agent_sys_cpu_time` monitor element for an application has changed since the last ACCOUNT record was written for this application.
- An application is no longer active.

The ACCOUNT record has the following format:

```
<auth_id> <appl_id> <applname> <connect_time> <agent_usr_cpu_delta>  
<agent_sys_cpu_delta>
```

### ERROR

An ERROR record is written when the governor daemon needs to shut down.

### FORCE

A FORCE record is written when the governor forces an application, based on rules in the governor configuration file. The FORCE record has the following format:

```
<appl_name> <auth_id> <appl_id> <coord_partition> <cfg_line>  
<restriction_exceeded>
```

where:

*coord\_partition*

Specifies the number of the application's coordinator database partition.

*cfg\_line*

Specifies the line number in the governor configuration file where the rule causing the application to be forced is located.

*restriction\_exceeded*

Provides details about how the rule was violated. Valid values are:

- CPU: the total application USR CPU plus SYS CPU time, in seconds
- Locks: the total number of locks held by the application
- Rowssel: the total number of rows selected by the application
- Rowsread: the total number of rows read by the application
- Idle: the amount of time during which the application was idle
- ET: the elapsed time since the application's current unit of work started (the uowtime setlimit was exceeded)

**NICE** A NICE record is written when the governor changes the priority of an application, based on rules in the governor configuration file. The NICE record has the following format:

```
<appl_name> <auth_id> <appl_id> <nice_value> <cfg_line>  
<restriction_exceeded>
```

where:

*nice\_value*

Specifies the increment or decrement that will be made to the priority value for the application's agent process.

*cfg\_line*

Specifies the line number in the governor configuration file where the rule causing the application's priority to be changed is located.

*restriction\_exceeded*

Provides details about how the rule was violated. Valid values are:

- CPU: the total application USR CPU plus SYS CPU time, in seconds
- Locks: the total number of locks held by the application
- Rowssel: the total number of rows selected by the application
- Rowsread: the total number of rows read by the application
- Idle: the amount of time during which the application was idle
- ET: the elapsed time since the application's current unit of work started (the uowtime setlimit was exceeded)

## **SCHEDGRP**

A SCHEDGRP record is written when an application is added to a scheduling group or an application is moved from one scheduling group to another. The SCHEDGRP record has the following format:

```
<appl_name> <auth_id> <appl_id> <cfg_line> <restriction_exceeded>
```

where:

*cfg\_line*

Specifies the line number in the governor configuration file where the rule causing the application to be scheduled is located.

*restriction\_exceeded*

Provides details about how the rule was violated. Valid values are:

- CPU: the total application USR CPU plus SYS CPU time, in seconds
- Locks: the total number of locks held by the application
- Rowsel: the total number of rows selected by the application
- Rowsread: the total number of rows read by the application
- Idle: the amount of time during which the application was idle
- ET: the elapsed time since the application's current unit of work started (the `uowtime setlimit` was exceeded)

## START

A START record is written when the governor starts. The START record has the following format:

Database = <database\_name>

**STOP** A STOP record is written when the governor stops. It has the following format:

Database = <database\_name>

## WARNING

A WARNING record is written in the following situations:

- The `sqlfrce` API was called to force an application, but it returned a positive SQLCODE.
- A snapshot call returned a positive SQLCODE that was not 1611 (SQL1611W).
- A snapshot call returned a negative SQLCODE that was not -1224 (SQL1224N) or -1032 (SQL1032N). These return codes occur when a previously active instance has been stopped.
- On Linux and UNIX, an attempt to install a signal handler has failed.

Because standard values are written, you can query the log files for different types of actions. The *Message* field provides other nonstandard information that depends on the type of record. For example, a FORCE or NICE record includes application information in the *Message* field, whereas an ERROR record includes an error message.

A governor log file might look like the following example:

```
2007-12-11-14.54.52  0 START      Database = TQTEST
2007-12-11-14.54.52  0 READCFG    Config = /u/db2instance/sqllib/tqtest.cfg
2007-12-11-14.54.53  0 ERROR      SQLMON Error: SQLCode = -1032
2007-12-11-14.54.54  0 ERROR      SQLMONSZ Error: SQLCode = -1032
```

## Stopping the governor

The governor utility monitors applications that are connected to a database, and changes the behavior of those applications according to rules that you specify in a governor configuration file for that database.

### Before you begin

To stop the governor, you must have SYSADM or SYSCTRL authorization.

## About this task

**Important:** With the workload management features introduced in DB2 Version 9.5, the DB2 governor utility was deprecated in Version 9.7 and might be removed in a future release. It is not supported in DB2 pureScale environments. For more information, see “DB2 Governor and Query Patroller have been deprecated” at <http://publib.boulder.ibm.com/infocenter/db2luw/v9r7/topic/com.ibm.db2.luw.wn.doc/doc/i0054901.html>.

## Procedure

To stop the governor, use the **db2gov** command, specifying the **STOP** parameter.

## Example

For example, to stop the governor on all database partitions of the SALES database, enter the following command:

```
db2gov STOP sales
```

To stop the governor on only database partition 3, enter the following command:

```
db2gov START sales nodenum 3
```



# Chapter 3. Factors affecting performance

## System architecture

### DB2 architecture and process overview

On the client side, local or remote applications are linked with the DB2 client library. Local clients communicate using shared memory and semaphores; remote clients use a protocol, such as named pipes (NPIPE) or TCP/IP. On the server side, activity is controlled by engine dispatchable units (EDUs).

Figure 3 shows a general overview of the DB2 architecture and processes.

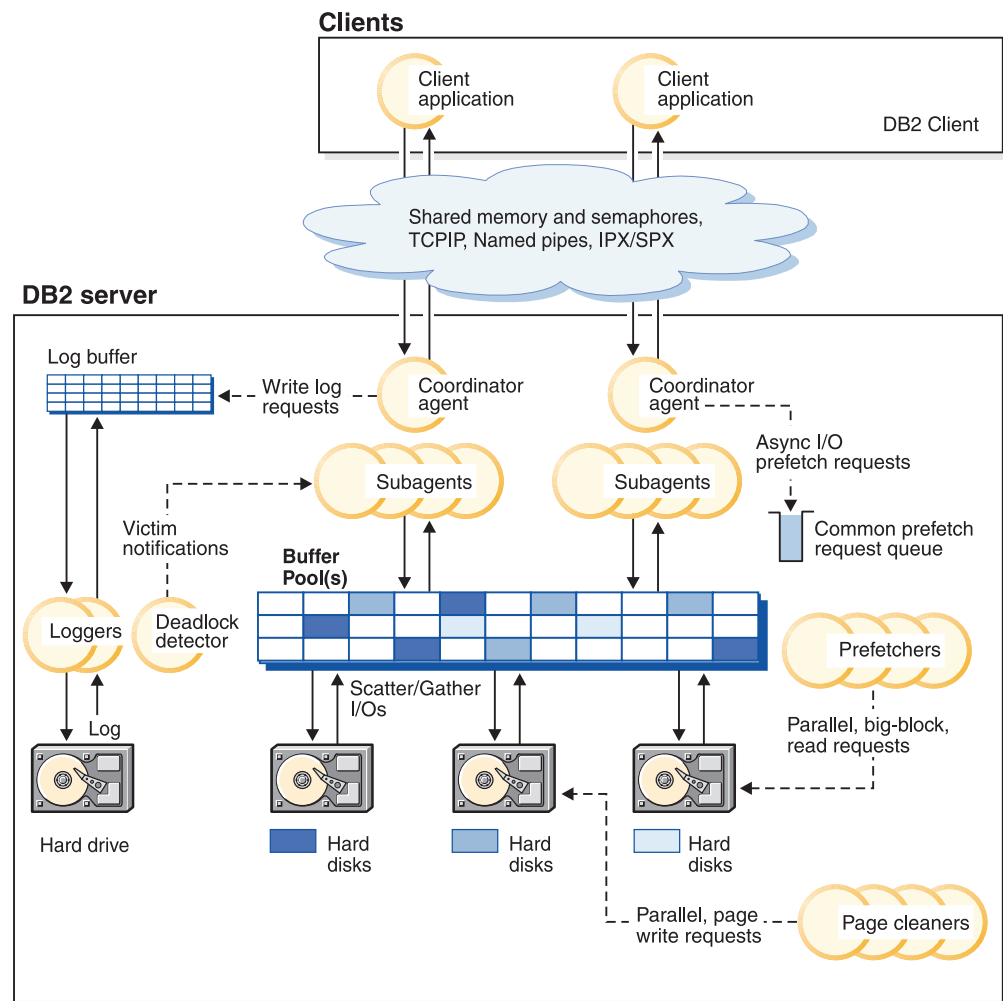

Figure 3. Client connections and database server components

EDUs are shown as circles or groups of circles.

EDUs are implemented as threads on all platforms. DB2 agents are the most common type of EDU. These agents perform most of the SQL and XQuery processing on behalf of applications. Prefetchers and page cleaners are other common EDUs.

A set of subagents might be assigned to process client application requests. Multiple subagents can be assigned if the machine on which the server resides has multiple processors or is part of a partitioned database environment. For example, in a symmetric multiprocessing (SMP) environment, multiple SMP subagents can exploit multiple processors.

All agents and subagents are managed by a pooling algorithm that minimizes the creation and destruction of EDUs.

Buffer pools are areas of database server memory where pages of user data, index data, and catalog data are temporarily moved and can be modified. Buffer pools are a key determinant of database performance, because data can be accessed much faster from memory than from disk.

The configuration of buffer pools, as well as prefetcher and page cleaner EDUs, controls how quickly data can be accessed by applications.

- *Prefetchers* retrieve data from disk and move it into a buffer pool before applications need the data. For example, applications that need to scan through large volumes of data would have to wait for data to be moved from disk into a buffer pool if there were no data prefetchers. Agents of the application send asynchronous read-ahead requests to a common prefetch queue. As prefetchers become available, they implement those requests by using big-block or scatter-read input operations to bring the requested pages from disk into the buffer pool. If you have multiple disks for data storage, the data can be striped across those disks. Striping enables the prefetchers to use multiple disks to retrieve data simultaneously.
- *Page cleaners* move data from a buffer pool back to disk. Page cleaners are background EDUs that are independent of the application agents. They look for pages that have been modified, and write those changed pages out to disk. Page cleaners ensure that there is room in the buffer pool for pages that are being retrieved by prefetchers.

Without the independent prefetchers and page cleaner EDUs, the application agents would have to do all of the reading and writing of data between a buffer pool and disk storage.

## The DB2 process model

Knowledge of the DB2 process model helps you to understand how the database manager and its associated components interact. This knowledge can help you to troubleshoot problems that might arise.

The process model that is used by all DB2 database servers facilitates communication between database servers and clients. It also ensures that database applications are isolated from resources, such as database control blocks and critical database files.

The DB2 database server must perform many different tasks, such as processing database application requests or ensuring that log records are written out to disk. Each task is typically performed by a separate *engine dispatchable unit* (EDU).

There are many advantages to using a multithreaded architecture for the DB2 database server. A new thread requires less memory and fewer operating system resources than a process, because some operating system resources can be shared among all threads within the same process. Moreover, on some platforms, the context switch time for threads is less than that for processes, which can improve performance. Using a threaded model on all platforms makes the DB2 database server easier to configure, because it is simpler to allocate more EDUs when needed, and it is possible to dynamically allocate memory that must be shared by multiple EDUs.

For each database accessed, separate EDUs are started to deal with various database tasks such as prefetching, communication, and logging. Database agents are a special class of EDU that are created to handle application requests for a database.

In general, you can rely on the DB2 database server to manage the set of EDUs. However, there are DB2 tools that look at the EDUs. For example, you can use the **db2pd** command with the **-edus** option to list all EDU threads that are active.

Each client application connection has a single coordinator agent that operates on a database. A *coordinator agent* works on behalf of an application, and communicates to other agents by using private memory, interprocess communication (IPC), or remote communication protocols, as needed.

While in a DB2 pureScale instance, these processes are used to monitor the health of DB2 members and/or cluster caching facilities (CFs) running on the host, as well as to distribute the cluster state to all DB2 members and CFs in the instance.

The DB2 architecture provides a firewall so that applications run in a different address space than the DB2 database server (Figure 4 on page 34). The firewall protects the database and the database manager from applications, stored procedures, and user-defined functions (UDFs). The firewall maintains the integrity of the data in the databases, because it prevents application programming errors from overwriting internal buffers or database manager files. The firewall also improves reliability, because application errors cannot crash the database manager.

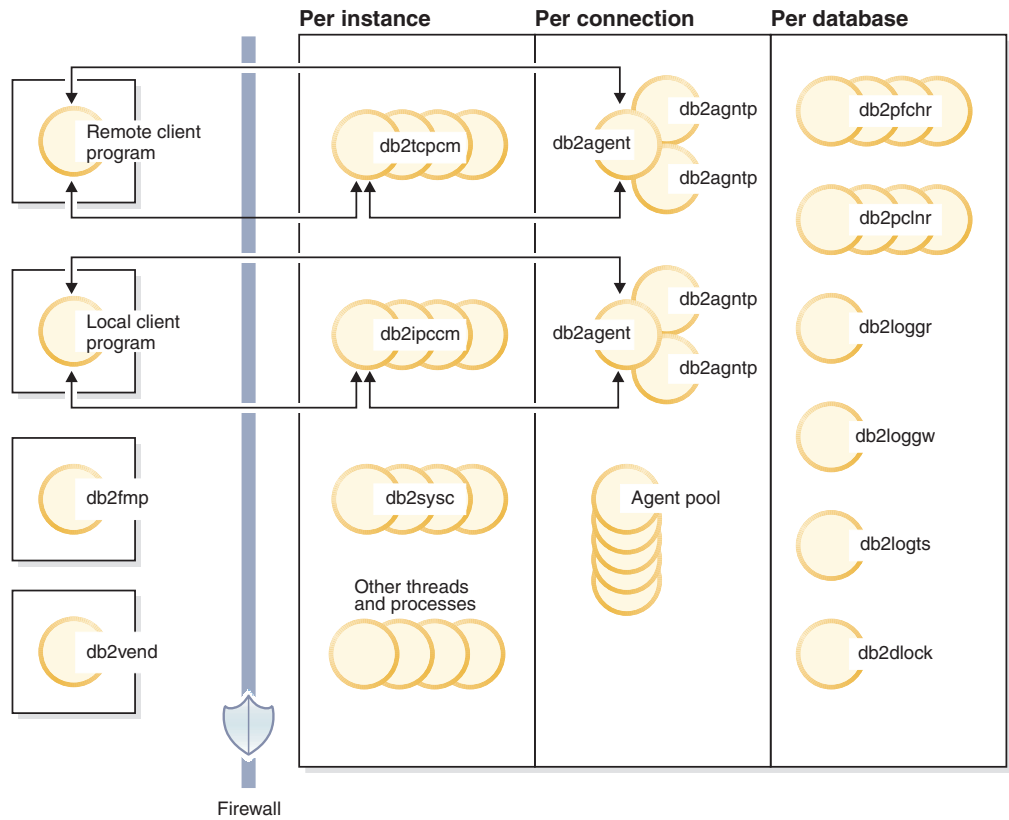

Figure 4. Process model for DB2 database systems

## Client programs

Client programs can be remote or local, running on the same machine as the database server. Client programs make first contact with a database through a communication listener.

## Listeners

Communication listeners start when the DB2 database server starts. There is a listener for each configured communications protocol, and an interprocess communications (IPC) listener (**db2ipccm**) for local client programs. Listeners include:

- **db2ipccm**, for local client connections
- **db2tccm**, for TCP/IP connections
- **db2tcpdm**, for TCP/IP discovery tool requests

## Agents

All connection requests from local or remote client programs (applications) are allocated a corresponding coordinator agent (**db2agent**). When the coordinator agent is created, it performs all database requests on behalf of the application.

In partitioned database environments, or systems on which *intraquery parallelism* is enabled, the coordinator agent distributes database requests to subagents (**db2agntp** and **db2agnts**). Subagents that are associated with an application but that are currently idle are named **db2agnta**.

A coordinator agent might be:

- Connected to the database with an alias; for example, **db2agent (DATA1)** is connected to the database alias DATA1.
- Attached to an instance; for example, **db2agent (user1)** is attached to the instance user1.

The DB2 database server instantiates other types of agents, such as independent coordinator agents or subcoordinator agents, to execute specific operations. For example, the independent coordinator agent **db2agnti** is used to run event monitors, and the subcoordinator agent **db2agnsc** is used to parallelize database restart operations after an abnormal shutdown.

A gateway agent (**db2agentg**) is an agent associated to a remote database. It provides indirect connectivity that allows clients to access the host database.

Idle agents reside in an agent pool. These agents are available for requests from coordinator agents that operate on behalf of client programs, or from subagents that operate on behalf of existing coordinator agents. Having an appropriately sized idle agent pool can improve performance when there are significant application workloads. In this case, idle agents can be used as soon as they are required, and there is no need to allocate a new agent for each application connection, which involves creating a thread and allocating and initializing memory and other resources. The DB2 database server automatically manages the size of the idle agent pool.

A pooled agent can be associated to a remote database or a local database. An agent pooled on a remote database is referred to as a pooled gateway agent (**db2agntgp**). An agent pooled on a local database is referred to as a pooled database agent (**db2agentdp**).

### **db2fmp**

The fenced mode process is responsible for executing fenced stored procedures and user-defined functions outside of the firewall. The **db2fmp** process is always a separate process, but might be multithreaded, depending on the types of routines that it executes.

### **db2vend**

The **db2vend** process is a process to execute vendor code on behalf of an EDU; for example, to execute a user exit program for log archiving (UNIX only).

## **Database EDUs**

The following list includes some of the important EDUs that are used by each database:

- **db2pfchr**, for buffer pool prefetchers
- **db2pc1nr**, for buffer pool page cleaners
- **db2loggr**, for manipulating log files to handle transaction processing and recovery
- **db2loggw**, for writing log records to the log files
- **db2logts**, for tracking which table spaces have log records in which log files. This information is recorded in the DB2TSCG.HIS file in the database directory.

- **db2dlock**, for deadlock detection. In a partitioned database environment, an additional thread (**db2glock**) is used to coordinate the information that is collected by the **db2dlock** EDU on each partition; **db2glock** runs only on the catalog partition. In a DB2 pureScale environment, a **db2glock** EDU is used to coordinate the information that is collected by the **db2dlock** EDU on each member. A **db2glock** EDU is started on each member, but only one is active.
- **db2stmm**, for the self-tuning memory management feature
- **db2taskd**, for the distribution of background database tasks. These tasks are executed by threads called **db2taskp**.
- **db2fw**, the event monitor fast writer; which is used for high volume, parallel writing of event monitor data to tables, files, or pipes
- **db2hadrp**, the high availability disaster recovery (HADR) primary server thread
- **db2hadrs**, the HADR standby server thread
- **db2lfr**, for log file readers that process individual log files
- **db2loggr**, for manipulating log files to handle transaction processing and recovery
- **db2loggw**, for writing log records to the log files
- **db2logmgr**, for the log manager. Manages log files for a recoverable database.
- **db2logts**, for tracking which table spaces have log records in which log files. This information is recorded in the DB2TSCHG.HIS file in the database directory.
- **db2used**, for updating object usage
- **db2pcsd**, for autonomic cleanup of the package cache
- **db2pchr**, for buffer pool prefetchers
- **db2pc1nr**, for buffer pool page cleaners
- **db2redom**, for the redo master. During recovery, it processes redo log records and assigns log records to redo workers for processing.
- **db2redow**, for the redo workers. During recovery, it processes redo log records at the request of the redo master.
- **db2shred**, for processing individual log records within log pages
- **db2stmm**, for the self-tuning memory management feature
- **db2taskd**, for the distribution of background database tasks. These tasks are executed by threads called **db2taskp**.
- **db2w1md**, for automatic collection of workload management statistics
- Event monitor threads are identified as follows:
  - db2evm%1%2 (%3)
    - where %1 can be:
      - g - global file event monitor
      - gp - global piped event monitor
      - l - local file event monitor
      - lp - local piped event monitor
      - t - table event monitor
    - and %2 can be:
      - i - coordinator
      - p - not coordinator
    - and %3 is the event monitor name
- Backup and restore threads are identified as follows:

- `db2bm.%1.%2` (backup and restore buffer manipulator) and `db2med.%1.%2` (backup and restore media controller), where:
  - `%1` is the EDU ID of the agent that controls the backup or restore session
  - `%2` is a sequential value that is used to distinguish among (possibly many) threads that belong to a particular backup or restore session

For example: `db2bm.13579.2` identifies the second `db2bm` thread that is controlled by the `db2agent` thread with EDU ID 13579.

- The following database EDUs are used for locking in a DB2 pureScale environment:
  - `db2LLMn1`, to process information sent by the global lock manager; there are two of these EDUs on each member, one for the primary CF, and another for the secondary CF
  - `db2LLMn2`, to process information sent by the global lock manager for a special type of lock that is used during database activation and deactivation processing; there are two of these EDUs on each member, one for the primary CF, and another for the secondary CF
  - `db2LLMng`, to ensure that the locks held by this member are released in a timely manner when other members are waiting for these locks
  - `db2LLMr1`, to process the release of locks to the global lock manager
  - `db2LLMrc`, for processing that occurs during database recovery operations and during CF recovery

## Database server threads and processes

The system controller (`db2sysc` on UNIX and `db2syscs.exe` on Windows operating systems) must exist if the database server is to function. The following threads and processes carry out various tasks:

- `db2acd`, an autonomic computing daemon that hosts the health monitor, automatic maintenance utilities, and the administrative task scheduler. This process was formerly known as `db2hmon`.
- `db2aiiothr`, manages asynchronous I/O requests for a database partition (UNIX only)
- `db2alarm`, notifies EDUs when their requested timer expires (UNIX only)
- `db2disp`, the client connection concentrator dispatcher
- `db2fcms`, the fast communications manager sender daemon
- `db2fcmr`, the fast communications manager receiver daemon
- `db2fmd`, the fault monitor daemon
- `db2licc`, manages installed DB2 licenses
- `db2panic`, the panic agent, which handles urgent requests after agent limits are reached
- `db2pdbc`, the parallel system controller, which handles parallel requests from remote database partitions (used only in a partitioned database environment)
- `db2resync`, the resync agent that scans the global resync list
- `db2sysc`, the main system controller EDU; it handles critical DB2 server events
- `db2sysc` (idle), the DB2 idle processes, which enable the restart light of a guest member on a host quickly and without competing with the resident member for resources.
- `db2thc1n`, recycles resources when an EDU terminates (UNIX only)
- `db2wdog`, the watchdog on UNIX and Linux operating systems that handles abnormal terminations

- **db2w1mt**, the WLM dispatcher scheduling thread
- **db2w1mtm**, the WLM dispatcher timer thread

## Database agents

When an application accesses a database, several processes or threads begin to perform the various application tasks. These tasks include logging, communication, and prefetching. Database agents are threads within the database manager that are used to service application requests. In Version 9.5, agents are run as threads on all platforms.

The maximum number of application connections is controlled by the **max\_connections** database manager configuration parameter. The work of each application connection is coordinated by a single worker agent. A *worker agent* carries out application requests but has no permanent attachment to any particular application. *Coordinator agents* exhibit the longest association with an application, because they remain attached to it until the application disconnects. The only exception to this rule occurs when the engine concentrator is enabled, in which case a coordinator agent can terminate that association at transaction boundaries (COMMIT or ROLLBACK).

There are three types of worker agents:

- Idle agents

This is the simplest form of worker agent. It does not have an outbound connection, and it does not have a local database connection or an instance attachment.

- Active coordinator agents

Each database connection from a client application has a single active agent that coordinates its work on the database. After the coordinator agent is created, it performs all database requests on behalf of its application, and communicates to other agents using interprocess communication (IPC) or remote communication protocols. Each agent operates with its own private memory and shares database manager and database global resources, such as the buffer pool, with other agents. When a transaction completes, the active coordinator agent might become an inactive agent. When a client disconnects from a database or detaches from an instance, its coordinator agent will be:

- An active coordinator agent if other connections are waiting
- Freed and marked as idle if no connections are waiting, and the maximum number of pool agents is being automatically managed or has not been reached
- Terminated and its storage freed if no connections are waiting, and the maximum number of pool agents has been reached

- Subagents

The coordinator agent distributes database requests to subagents, and these subagents perform the requests for the application. After the coordinator agent is created, it handles all database requests on behalf of its application by coordinating the subagents that perform requests against the database. In DB2 Version 9.5, subagents can also exist in nonpartitioned environments and in environments where intraquery parallelism is not enabled.

Agents that are not performing work for any application and that are waiting to be assigned are considered to be idle agents and reside in an *agent pool*. These agents are available for requests from coordinator agents operating on behalf of client



programs, or for subagents operating on behalf of existing coordinator agents. The number of available agents depends on the value of the **num\_poolagents** database manager configuration parameter.

If no idle agents exist when an agent is required, a new agent is created dynamically. Because creating a new agent requires a certain amount of overhead, CONNECT and ATTACH performance is better if an idle agent can be activated for a client.

When a subagent is performing work for an application, it is associated with that application. After it completes the assigned work, it can be placed in the agent pool, but it remains associated with the original application. When the application requests additional work, the database manager first checks the idle pool for associated agents before it creates a new agent.

### Database agent management

Most applications establish a one-to-one relationship between the number of connected applications and the number of application requests that can be processed by the database server. Your environment, however, might require a many-to-one relationship between the number of connected applications and the number of application requests that can be processed.

Two database manager configuration parameters control these factors separately:

- The **max\_connections** parameter specifies the maximum number of connected applications
- The **max\_coordagents** parameter specifies the maximum number of application requests that can be processed concurrently

The connection concentrator is enabled when the value of **max\_connections** is greater than the value of **max\_coordagents**. Because each active coordinating agent requires global database resource overhead, the greater the number of these agents, the greater the chance that the upper limits of available global resources will be reached. To prevent this from occurring, set the value of **max\_connections** to be higher than the value of **max\_coordagents**, or set both parameters to AUTOMATIC.

There are two specific scenarios in which setting these parameters to AUTOMATIC is a good idea:

- If you are confident that your system can handle all of the connections that might be needed, but you want to limit the amount of global resources that are used (by limiting the number of coordinating agents), set **max\_connections** to AUTOMATIC. When **max\_connections** is greater than **max\_coordagents**, the connection concentrator is enabled.
- If you do not want to limit the maximum number of connections or coordinating agents, but you know that your system requires or would benefit from a many-to-one relationship between the number of connected applications and the number of application requests that are processed, set both parameters to AUTOMATIC. When both parameters are set to AUTOMATIC, the database manager uses the values that you specify as an ideal ratio of connections to coordinating agents. Note that both of these parameters can be configured with a starting value and an AUTOMATIC setting. For example, the following command associates both a value of 200 and AUTOMATIC with the **max\_coordagents** parameter:  
`update dbm config using max_coordagents 200 automatic.`

## Example

Consider the following scenario:

- The **max\_connections** parameter is set to AUTOMATIC and has a current value of 300
- The **max\_coordagents** parameter is set to AUTOMATIC and has a current value of 100

The ratio of **max\_connections** to **max\_coordagents** is 300:100. The database manager creates new coordinating agents as connections come in, and connection concentration is applied only when needed. These settings result in the following actions:

- Connections 1 to 100 create new coordinating agents
- Connections 101 to 300 do not create new coordinating agents; they share the 100 agents that have been created already
- Connections 301 to 400 create new coordinating agents
- Connections 401 to 600 do not create new coordinating agents; they share the 200 agents that have been created already
- and so on...

In this example, it is assumed that the connected applications are driving enough work to warrant creation of new coordinating agents at each step. After some period of time, if the connected applications are no longer driving sufficient amounts of work, coordinating agents will become inactive and might be terminated.

If the number of connections is reduced, but the amount of work being driven by the remaining connections is high, the number of coordinating agents might not be reduced right away. The **max\_connections** and **max\_coordagents** parameters do not directly affect agent pooling or agent termination. Normal agent termination rules still apply, meaning that the connections to coordinating agents ratio might not correspond exactly to the values that you specified. Agents might return to the agent pool to be reused before they are terminated.

If finer granularity of control is needed, specify a simpler ratio. For example, the ratio of 300:100 from the previous example can be expressed as 3:1. If **max\_connections** is set to 3 (AUTOMATIC) and **max\_coordagents** is set to 1 (AUTOMATIC), one coordinating agent can be created for every three connections.

## Client-server processing model

Both local and remote application processes can work with the same database. A remote application is one that initiates a database action from a machine that is remote from the machine on which the database server resides. Local applications are directly attached to the database at the server machine.

How client connections are managed depends on whether the connection concentrator is on or off. The connection concentrator is on whenever the value of the **max\_connections** database manager configuration parameter is larger than the value of the **max\_coordagents** configuration parameter.

- If the connection concentrator is off, each client application is assigned a unique engine dispatchable unit (EDU) called a *coordinator agent* that coordinates the processing for that application and communicates with it.
- If the connection concentrator is on, each coordinator agent can manage many client connections, one at a time, and might coordinate the other worker agents

to do this work. For internet applications with many relatively transient connections, or applications with many relatively small transactions, the connection concentrator improves performance by allowing many more client applications to be connected concurrently. It also reduces system resource use for each connection.

In Figure 5, each circle in the DB2 server represents an EDU that is implemented using operating system threads.

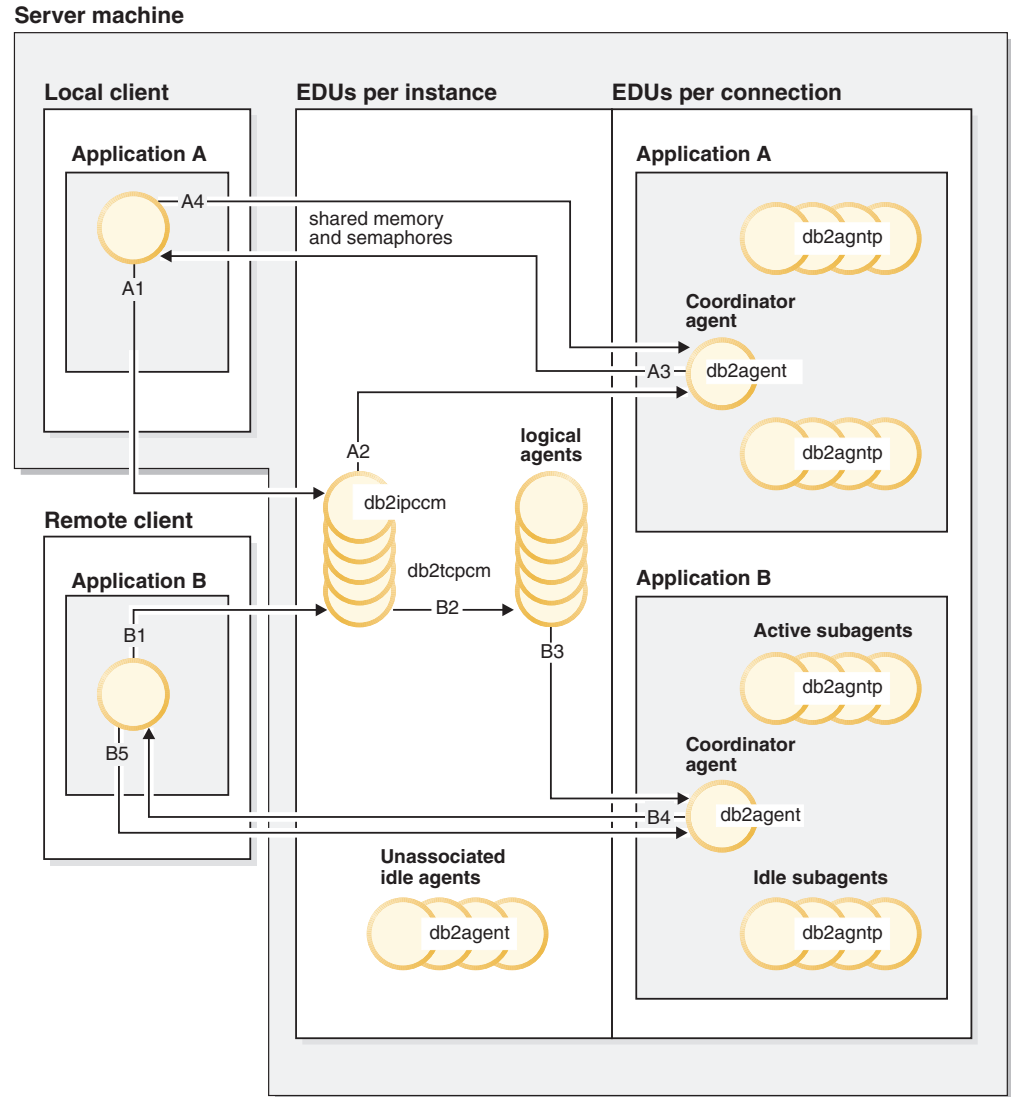

Figure 5. Client-server processing model overview

- At A1, a local client establishes communications through db2ipccm.
- At A2, db2ipccm works with a db2agent EDU, which becomes the coordinator agent for application requests from the local client.
- At A3, the coordinator agent contacts the client application to establish shared memory communications between the client application and the coordinator.
- At A4, the application at the local client connects to the database.

- At B1, a remote client establishes communications through db2tpcm. If another communications protocol was chosen, the appropriate communications manager is used.
- At B2, db2tpcm works with a db2agent EDU, which becomes the coordinator agent for the application and passes the connection to this agent.
- At B4, the coordinator agent contacts the remote client application.
- At B5, the remote client application connects to the database.

Note also that:

- Worker agents carry out application requests. There are four types of worker agents: active coordinator agents, active subagents, associated subagents, and idle agents.
- Each client connection is linked to an active coordinator agent.
- In a partitioned database environment, or an environment in which intra-partition parallelism is enabled, the coordinator agents distribute database requests to subagents (db2agntp).
- There is an agent pool (db2agent) where idle agents wait for new work.
- Other EDUs manage client connections, logs, two-phase commit operations, backup and restore operations, and other tasks.

Figure 6 on page 43 shows additional EDUs that are part of the server machine environment. Each active database has its own shared pool of prefetchers (db2pfchr) and page cleaners (db2pclnr), and its own logger (db2loggr) and deadlock detector (db2dlock).

Server machine

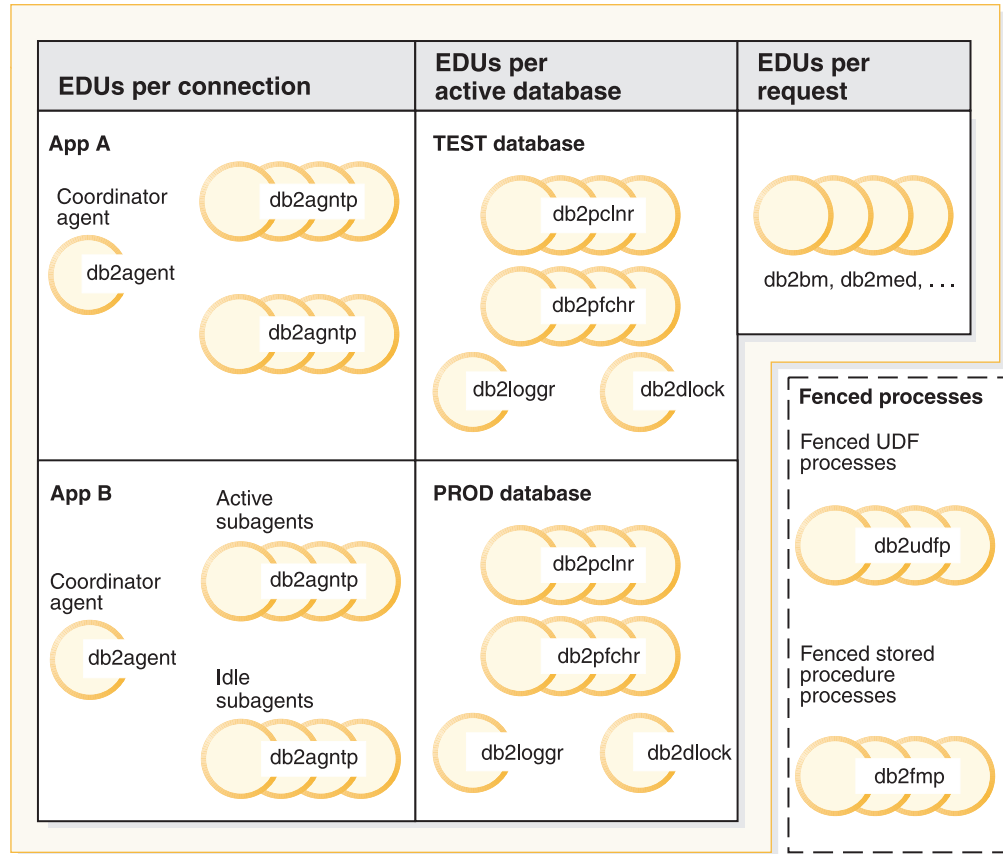

Figure 6. EDUs in the database server

Fenced user-defined functions (UDFs) and stored procedures, which are not shown in the figure, are managed to minimize costs that are associated with their creation and destruction. The default value of the **keepfenced** database manager configuration parameter is YES, which keeps the stored procedure process available for reuse at the next procedure call.

**Note:** Unfenced UDFs and stored procedures run directly in an agent's address space for better performance. However, because they have unrestricted access to the agent's address space, they must be rigorously tested before being used.

Figure 7 on page 44 shows the similarities and differences between the single database partition processing model and the multiple database partition processing model.

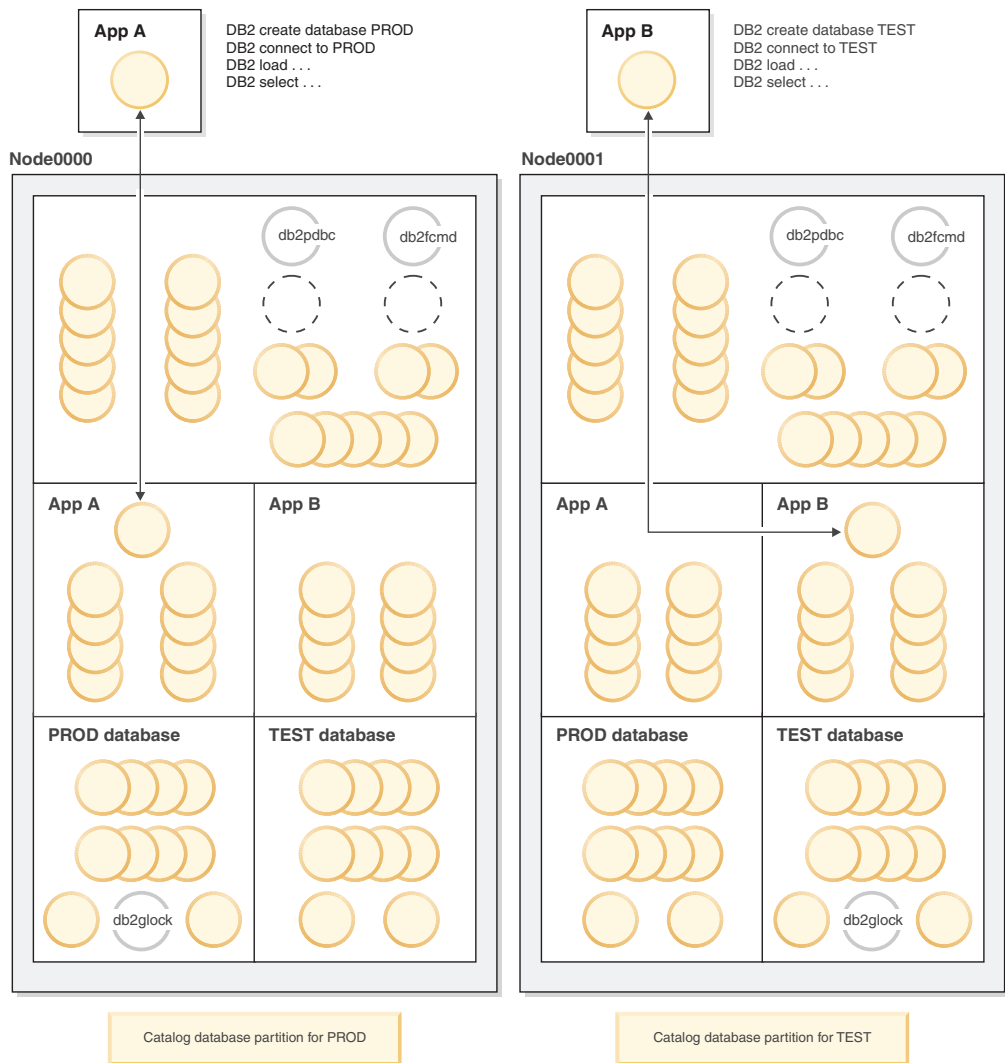

Figure 7. Process model for multiple database partitions

In a multiple database partition environment, the database partition on which the **CREATE DATABASE** command was issued is called the *catalog database partition*. It is on this database partition that the system catalog tables are stored. The system catalog is a repository of all of the information about objects in the database.

As shown in Figure 7, because Application A creates the PROD database on Node0000, the catalog for the PROD database is also created on this database partition. Similarly, because Application B creates the TEST database on Node0001, the catalog for the TEST database is created on this database partition. It is a good idea to create your databases on different database partitions to balance the extra activity that is associated with the catalog for each database across the database partitions in your environment.

There are additional EDUs (`db2pdbc` and `db2fcmd`) that are associated with the instance, and these are found on each database partition in a multiple database partition environment. These EDUs are needed to coordinate requests across database partitions and to enable the fast communication manager (FCM).

There is an additional EDU (db2glock) that is associated with the catalog database partition. This EDU controls global deadlocks across the database partitions on which the active database is located.

Each connect request from an application is represented by a connection that is associated with a coordinator agent. The *coordinator agent* is the agent that communicates with the application, receiving requests and sending replies. It can satisfy a request itself or coordinate multiple subagents to work on the request. The database partition on which the coordinator agent resides is called the *coordinator database partition* of that application.

Parts of the database requests from an application are sent by the coordinator database partition to subagents at the other database partitions. All of the results are consolidated at the coordinator database partition before being sent back to the application.

Any number of database partitions can be configured to run on the same machine. This is known as a *multiple logical partition* configuration. Such a configuration is very useful on large symmetric multiprocessor (SMP) machines with very large main memory. In this environment, communications between database partitions can be optimized to use shared memory and semaphores.

### **Connection-concentrator improvements for client connections**

The connection concentrator improves the performance of applications that have frequent but relatively transient connections by enabling many concurrent client connections to be processed efficiently. It also reduces memory use during each connection and decreases the number of context switches.

The connection concentrator is enabled when the value of the **max\_connections** database manager configuration parameter is greater than the value of the **max\_coordagents** configuration parameter.

In an environment that requires many simultaneous user connections, you can enable the connection concentrator for more efficient use of system resources. This feature incorporates advantages that were formerly found only in DB2 Connect connection pooling. After the first connection, the connection concentrator reduces the time that is required to connect to a host. When disconnection from a host is requested, the inbound connection is dropped, but the outbound connection to the host is kept within a pool. When a new connection request is received, the database manager attempts to reuse an existing outbound connection from the pool.

For best performance of applications that use connection pooling or the connection concentrator, tune the parameters that control the size of the block of data that is cached. For more information, see the DB2 Connect product documentation.

### **Examples**

- Consider a single-partition database to which, on average, 1000 users are connected simultaneously. At times, the number of connected users might be higher. The number of concurrent transactions can be as high as 200, but it is never higher than 250. Transactions are short.

For this workload, you could set the following database manager configuration parameters:

- Set **max\_coordagents** to 250 to support the maximum number of concurrent transactions.

- Set **max\_connections** to AUTOMATIC with a value of 1000 to ensure support for any number of connections; in this example, any value greater than 250 will ensure that the connection concentrator is enabled.
- Leave **num\_poolagents** at the default value, which should ensure that database agents are available to service incoming client requests, and that little overhead will result from the creation of new agents.
- Consider a single-partition database to which, on average, 1000 users are connected simultaneously. At times, the number of connected users might reach 2000. An average of 500 users are expected to be executing work at any given time. The number of concurrent transactions is approximately 250. Five hundred coordinating agents would generally be too many; for 1000 connected users, 250 coordinating agents should suffice.

For this workload, you could update the database manager configuration as follows:

```
update dbm cfg using max_connections 1000 automatic
update dbm cfg using max_coordagents 250 automatic
```

This means that as the number of connections beyond 1000 increases, additional coordinating agents will be created as needed, with a maximum to be determined by the total number of connections. As the workload increases, the database manager attempts to maintain a relatively stable ratio of connections to coordinating agents.

- Suppose that you do not want to enable the connection concentrator, but you do want to limit the number of connected users. To limit the number of simultaneously connected users to 250, for example, you could set the following database manager configuration parameters:
  - Set **max\_coordagents** to 250.
  - Set **max\_connections** to 250.
- Suppose that you do not want to enable the connection concentrator, and you do not want to limit the number of connected users. You could update the database manager configuration as follows:

```
update dbm cfg using max_connections automatic
update dbm cfg using max_coordagents automatic
```

## Agents in a partitioned database

In a partitioned database environment, or an environment in which intra-partition parallelism has been enabled, each database partition has its own pool of agents from which subagents are drawn.

Because of this pool, subagents do not have to be created and destroyed each time one is needed or has finished its work. The subagents can remain as associated agents in the pool and can be used by the database manager for new requests from the application with which they are associated or from new applications.

The impact on both performance and memory consumption within the system is strongly related to how your agent pool is tuned. The database manager configuration parameter for agent pool size (**num\_poolagents**) affects the total number of agents and subagents that can be kept associated with applications on a database partition. If the pool size is too small and the pool is full, a subagent disassociates itself from the application it is working on and terminates. Because subagents must be constantly created and reassociated with applications, performance suffers.



By default, **num\_poolagents** is set to AUTOMATIC with a value of 100, and the database manager automatically manages the number of idle agents to pool.

If the value of **num\_poolagents** is manually set too low, one application could fill the pool with associated subagents. Then, when another application requires a new subagent and has no subagents in its agent pool, it will recycle inactive subagents from the agent pools of other applications. This behavior ensures that resources are fully utilized.

If the value of **num\_poolagents** is manually set too high, associated subagents might sit unused in the pool for long periods of time, using database manager resources that are not available for other tasks.

When the connection concentrator is enabled, the value of **num\_poolagents** does not necessarily reflect the exact number of agents that might be idle in the pool at any one time. Agents might be needed temporarily to handle higher workload activity.

In addition to database agents, other asynchronous database manager activities run as their own process or thread, including:

- Database I/O servers or I/O prefetchers
- Database asynchronous page cleaners
- Database loggers
- Database deadlock detectors
- Communication and IPC listeners
- Table space container rebalancers

---

## Configuring for good performance

Some types of DB2 deployment, such as the InfoSphere® Balanced Warehouse® (BW), or those within SAP systems, have configurations that are highly specified.

In the BW case, hardware factors, such as the number of CPUs, the ratio of memory to CPU, the number and configuration of disks, and versions are pre-specified, based on thorough testing to determine the optimal configuration. In the SAP case, hardware configuration is not as precisely specified; however, there are a great many sample configurations available. In addition, SAP best practice provides recommended DB2 configuration settings. If you are using a DB2 deployment for a system that provides well-tested configuration guidelines, you should generally take advantage of the guidelines in place of more general rules-of-thumb.

Consider a proposed system for which you do not already have a detailed hardware configuration. Your goal is to identify a few key configuration decisions that get the system well on its way to good performance. This step typically occurs before the system is up and running, so you might have limited knowledge of how it will actually behave. In a way, you have to make a “best guess,” based on your knowledge of what the system will be doing.

### Hardware configuration

CPU capacity is one of the main independent variables in configuring a system for performance. Because all other hardware configuration typically flows from it, it is not easy to predict how much CPU capacity is required for a given workload. In business intelligence (BI) environments, 200-300 GB of active raw data per

processor core is a reasonable estimate. For other environments, a sound approach is to gauge the amount of CPU required, based on one or more existing DB2 systems. For example, if the new system needs to handle 50% more users, each running SQL that is at least as complex as that on an existing system, it would be reasonable to assume that 50% more CPU capacity is required. Likewise, other factors that predict a change in CPU usage, such as different throughput requirements or changes in the use of triggers or referential integrity, should be taken into account as well.

After you have the best idea of CPU requirements (derived from available information), other aspects of hardware configuration start to fall into place. Although you must consider the required system disk capacity in gigabytes or terabytes, the most important factors regarding performance are the capacity in I/Os per second (IOPS), or in megabytes per second of data transfer. In practical terms, this is determined by the number of individual disks involved.

Why is that the case? The evolution of CPUs over the past decade has seen incredible increases in speed, whereas the evolution of disks has been more in terms of their capacity and cost. There have been improvements in disk seek time and transfer rate, but they haven't kept pace with CPU speeds. So to achieve the aggregate performance needed with modern systems, using multiple disks is more important than ever, especially for systems that will drive a significant amount of random disk I/O. Often, the temptation is to use close to the minimum number of disks that can contain the total amount of data in the system, but this generally leads to very poor performance.

In the case of RAID storage, or for individually addressable drives, a rule-of-thumb is to configure at least ten to twenty disks per processor core. For storage servers, a similar number is recommended; however, in this case, a bit of extra caution is warranted. Allocation of space on storage servers is often done more with an eye to capacity rather than throughput. It is a very good idea to understand the physical layout of database storage, to ensure that the inadvertent overlap of logically separate storage does not occur. For example, a reasonable allocation for a 4-way system might be eight arrays of eight drives each. However, if all eight arrays share the same eight underlying physical drives, the throughput of the configuration would be drastically reduced, compared to eight arrays spread over 64 physical drives.

It is good practice to set aside some dedicated (unshared) disk for the DB2 transaction logs. This is because the I/O characteristics of the logs are very different from DB2 containers, for example, and the competition between log I/O and other types of I/O can result in a logging bottleneck, especially in systems with a high degree of write activity.

In general, a RAID-1 pair of disks can provide enough logging throughput for up to 400 reasonably write-intensive DB2 transactions per second. Greater throughput rates, or high-volume logging (for example, during bulk inserts), requires greater log throughput, which can be provided by additional disks in a RAID-10 configuration, connected to the system through a write-caching disk controller.

Because CPUs and disks effectively operate on different time scales – nanoseconds versus microseconds – you need to decouple them to enable reasonable processing performance. This is where memory comes into play. In a database system, the main purpose of memory is to avoid I/O, and so up to a point, the more memory a system has, the better it can perform. Fortunately, memory costs have dropped significantly over the last several years, and systems with tens to hundreds of

gigabytes (GB) of RAM are not uncommon. In general, four to eight gigabytes per processor core should be adequate for most applications.

## AIX configuration

There are relatively few AIX parameters that need to be changed to achieve good performance. Again, if there are specific settings already in place for your system (for example, a BW or SAP configuration), those should take precedence over the following general guidelines.

- The VMO parameter **LRU\_FILE\_REPAGE** should be set to 0. This parameter controls whether AIX victimizes computational pages or file system cache pages. In addition, **minperm** should be set to 3. These are both default values in AIX 6.1.
- The AIO parameter **maxservers** can be initially left at the default value of ten per CPU. After the system is active, **maxservers** is tuned as follows:
  1. Collect the output of the `ps -elfk | grep aio` command and determine if all asynchronous I/O (AIO) kernel processes (aioservers) are consuming the same amount of CPU time.
  2. If they are, **maxservers** might be set too low. Increase **maxservers** by 10%, and repeat step 1.
  3. If some aioservers are using less CPU time than others, the system has at least as many of them as it needs. If more than 10% of aioservers are using less CPU, reduce **maxservers** by 10% and repeat step 1.
- The AIO parameter **maxreqs** should be set to  $\text{MAX}(\text{NUM\_IOCLEANERS} \times 256, 4096)$ . This parameter controls the maximum number of outstanding AIO requests.
- The hdisk parameter **queue\_depth** should be based on the number of physical disks in the array. For example, for IBM disks, the default value for **queue\_depth** is 3, and the recommended value would be  $3 \times \text{number-of-devices}$ . This parameter controls the number of queuable disk requests.
- The disk adapter parameter **num\_cmd\_elems** should be set to the sum of **queue\_depth** for all devices connected to the adapter. This parameter controls the number of requests that can be queued to the adapter.

## Solaris and HP-UX configuration

For DB2 running on Solaris or HP-UX, the **db2osconf** utility is available to check and recommend kernel parameters based on the system size. The **db2osconf** utility allows you to specify the kernel parameters based on memory and CPU, or with a general scaling factor that compares the current system configuration to an expected future configuration. A good approach is to use a scaling factor of 2 or higher if running large systems, such as SAP applications. In general, **db2osconf** gives you a good initial starting point to configure Solaris and HP-UX, but it does not deliver the optimal value, because it cannot consider current and future workloads.

## Linux configuration

The DB2 database manager automatically updates key Linux kernel parameters to satisfy the requirements of a wide variety of configurations.

For more information see “Kernel parameter requirements ( Linux )” in *Installing DB2 Servers*

## Partitioned database environments

The decision to use partitioned database environments is not generally made based purely on data volume, but more on the basis of the workload. As a general guideline, most partitioned database environments are in the area of data warehousing and business intelligence. The partitioned database environment is highly recommended for large complex query environments, because its shared-nothing architecture allows for outstanding scalability. For smaller data marts (up to about 300 GB), which are unlikely to grow rapidly, a DB2 Enterprise Server Edition configuration is often a good choice. However, large or fast-growing BI environments benefit greatly from a partitioned database environment.

A typical partitioned database system usually has one processor core per data partition. For example, a system with  $n$  processor cores would likely have the catalog on partition 0, and have  $n$  additional data partitions. If the catalog partition will be heavily used (for example, to hold single partition dimension tables), it might be allocated a processor core as well. If the system will support very many concurrent active users, two cores per partition might be required.

In terms of a general guide, you should plan on about 250 GB of active raw data per partition.

The InfoSphere Balanced Warehouse documentation contains in-depth information regarding partitioned database configuration best practices. This documentation contains useful information for non-Balanced Warehouse deployments as well.

## Choice of code page and collation

As well as affecting database behavior, choice of code page or code set and collating sequence can have a strong impact on performance. The use of Unicode has become very widespread because it allows you to represent a greater variety of character strings in your database than has been the case with traditional single-byte code pages. Unicode is the default for new databases in DB2 Version 9.5. However, because Unicode code sets use multiple bytes to represent some individual characters, there can be increased disk and memory requirements. For example, the UTF-8 code set, which is one of the most common Unicode code sets, uses from one to four bytes per character. An average string expansion factor due to migration from a single-byte code set to UTF-8 is very difficult to estimate because it depends on how frequently multibyte characters are used. For typical North American content, there is usually no expansion. For most western European languages, the use of accented characters typically introduces an expansion of around 10%.

On top of this, the use of Unicode can cause extra CPU consumption relative to single-byte code pages. First, if expansion occurs, the longer strings require more work to manipulate. Second, and more significantly, the algorithms used by the more sophisticated Unicode collating sequences, such as locale-sensitive UCA-based collations, can be much more expensive than the typical SYSTEM collation used with single-byte code pages. This increased expense is due to the complexity of sorting Unicode strings in a culturally-correct way. Operations that are impacted include sorting, string comparisons, LIKE processing, and index creation.

If Unicode is required to properly represent your data, choose the collating sequence with care.

- If the database will contain data in multiple languages, and correct sort order of that data is of paramount importance, use one of the locale-sensitive UCA-based collations. Depending on the data and the application, this could have a performance overhead of 1.5 to 3 times more, relative to the IDENTITY sequence.
- There are both normalized and non-normalized varieties of locale-sensitive UCA-based collations. Normalized collations have the attribute NO specified and provide additional checks to handle malformed characters. Non-normalized collations have the attribute NX specified and do not provide any such checking. Unless the handling of malformed characters is an issue, use the non-normalized version, because there is a performance benefit in avoiding the normalization code. That said, even non-normalized locale-sensitive UCA-based collations are very expensive.
- If a database is being moved from a single-byte environment to a Unicode environment, but does not have rigorous requirements about hosting a variety of languages (most deployments will be in this category), language aware collation might be appropriate. *Language aware collations* (for example, SYSTEM\_819\_BE) take advantage of the fact that many Unicode databases contain data in only one language. They use the same lookup table-based collation algorithm as single-byte collations such as SYSTEM\_819, and so are very efficient. As a general rule, if the collation behavior in the original single-byte database was acceptable, then as long as the language content does not change significantly following the move to Unicode, culturally aware collation should be considered. This can provide very large performance benefits relative to culturally correct collation.

## Physical database design

- In general, file-based database managed storage (DMS) regular table spaces give better performance than system managed storage (SMS) regular table spaces. SMS is often used for temporary table spaces, especially when the temporary tables are very small; however, the performance advantage of SMS in this case is shrinking over time.
- In the past, DMS raw device table spaces had a fairly substantial performance advantage over DMS file table spaces; however, with the introduction of direct I/O (now defaulted through the NO FILE SYSTEM CACHING clause in the CREATE TABLESPACE and the ALTER TABLESPACE statements), DMS file table spaces provide virtually the same performance as DMS raw device table spaces.

**Important:** Regular table spaces that use System Managed Space (SMS) are deprecated and might be removed in a future release. Catalog table spaces, and temporary table spaces that use System Managed Space are not deprecated but it is recommended that Database Managed Spaces (DMS) or Automatic Storage table spaces (AMS) be used instead.

## Initial DB2 configuration settings

The DB2 configuration advisor, also known as the **AUTOCONFIGURE** command, takes basic system guidelines that you provide, and determines a good starting set of DB2 configuration values. The **AUTOCONFIGURE** command can provide real improvements over the default configuration settings, and is recommended as a way to obtain initial configuration values. Some additional fine-tuning of the recommendations generated by the **AUTOCONFIGURE** command is often required, based on the characteristics of the system.

Here are some suggestions for using the **AUTOCONFIGURE** command:

- Even though, starting in DB2 Version 9.1, the **AUTOCONFIGURE** command is run automatically at database creation time, it is still a good idea to run the **AUTOCONFIGURE** command explicitly. This is because you then have the ability to specify keyword/value pairs that help customize the results for your system.
- Run (or rerun) the **AUTOCONFIGURE** command after the database is populated with an appropriate amount of active data. This provides the tool with more information about the nature of the database. The amount of data that you use to populate the database is important, because it can affect such things as buffer pool size calculations, for example. Too much or too little data makes these calculations less accurate.
- Try different values for important **AUTOCONFIGURE** command keywords, such as **mem\_percent**, **tpm**, and **num\_stmts** to get an idea of which, and to what degree, configuration values are affected by these changes.
- If you are experimenting with different keywords and values, use the **APPLY NONE** option. This gives you a chance to compare the recommendations with the current settings.
- Specify values for all keywords, because the defaults might not suit your system. For example, **mem\_percent** defaults to 25%, which is too low for a dedicated DB2 server; 85% is the recommended value in this case.

## DB2 autonomics and automatic parameters

Recent releases of DB2 database products have significantly increased the number of parameters that are either automatically set at instance or database startup time, or that are dynamically tuned during operation. For most systems, automatic settings provide better performance than all but the very carefully hand-tuned systems. This is particularly due to the DB2 self-tuning memory manager (STMM), which dynamically tunes total database memory allocation as well as four of the main memory consumers in a DB2 system: the buffer pools, the lock list, the package cache, and the sort heap.

Because these parameters apply on a partition-by-partition basis, using the STMM in a partitioned database environment should be done with some caution. On partitioned database systems, the STMM continuously measures memory requirements on a single partition (automatically chosen by the DB2 system, but that choice can be overridden), and 'pushes out' heap size updates to all partitions on which the STMM is enabled. Because the same values are used on all partitions, the STMM works best in partitioned database environments where the amounts of data, the memory requirements, and the general levels of activity are very uniform across partitions. If a small number of partitions have skewed data volumes or different memory requirements, the STMM should be disabled on those partitions, and allowed to tune the more uniform ones. For example, the STMM should generally be disabled on the catalog partition.

For partitioned database environments with skewed data distribution, where continuous cross-cluster memory tuning is not advised, the STMM can be used selectively and temporarily during a 'tuning phase' to help determine good manual heap settings:

- Enable the STMM on one 'typical' partition. Other partitions continue to have the STMM disabled.
- After memory settings have stabilized, disable the STMM and manually 'harden' the affected parameters at their tuned values.

- Deploy the tuned values on other database partitions with similar data volumes and memory requirements (for example, partitions in the same partition group).
- Repeat the process if there are multiple disjointed sets of database partitions containing similar volumes and types of data and performing similar roles in the system.

The configuration advisor generally chooses to enable autonomic settings where applicable. This includes automatic statistics updates from the **RUNSTATS** command (very useful), but excludes automatic reorganization and automatic backup. These can be very useful as well, but need to be configured according to your environment and schedule for best results. Automatic statistics profiling should remain disabled by default. It has quite high overhead and is intended to be used temporarily under controlled conditions and with complex statements.

## Explicit configuration settings

Some parameters do not have automatic settings, and are not set by the configuration advisor. These need to be dealt with explicitly. Only parameters that have performance implications are considered here.

- **logpath** or **newlogpath** determines the location of the transaction log. Even the configuration advisor cannot decide for you where the logs should go. As mentioned previously, the most important point is that they should not share disk devices with other DB2 objects, such as table spaces, or be allowed to remain in the default location, which is under the database path. Ideally, transaction logs should be placed on dedicated storage with sufficient throughput capacity to ensure that a bottleneck will not be created.
- **logbufsz** determines the size of the transaction logger internal buffer, in 4-KB pages. The default value of only eight pages is far too small for good performance in a production environment. The configuration advisor always increases it, but possibly not enough, depending on the input parameters. A value of 256-1000 pages is a good general range, and represents only a very small total amount of memory in the overall scheme of a database server.
- **mincommit** controls *group commit*, which causes a DB2 system to try to batch together *n* committing transactions. With the current transaction logger design, this is rarely the desired behavior. Leave **mincommit** at the default value of 1.
- **buffpage** determines the number of pages allocated to each buffer pool that is defined with a size of -1. The best practice is to ignore **buffpage**, and either explicitly set the size of buffer pools that have an entry in SYSCAT.BUFFERPOOLS, or let the STMM tune buffer pool sizes automatically.
- **diagpath** determines the location of various useful DB2 diagnostic files. It generally has little impact on performance, except possibly in a partitioned database environment. The default location of **diagpath** on all partitions is typically on a shared, NFS-mounted path. The best practice is to override **diagpath** to a local, non-NFS directory for each partition. This prevents all partitions from trying to update the same file with diagnostic messages. Instead, these are kept local to each partition, and contention is greatly reduced.
- **DB2\_PARALLEL\_IO** is not a configuration parameter, but a DB2 registry variable. It is very common for DB2 systems to use storage consisting of arrays of disks, which are presented to the operating system as a single device, or to use file systems that span multiple devices. The consequence is that by default, a DB2 database system makes only one prefetch request at a time to a table space container. This is done with the understanding that multiple requests to a single device are serialized anyway. But if a container resides on an array of disks, there is an opportunity to dispatch multiple prefetch requests to it

simultaneously, without serialization. This is where **DB2\_PARALLEL\_IO** comes in. It tells the DB2 system that prefetch requests can be issued to a single container in parallel. The simplest setting is **DB2\_PARALLEL\_IO=\*** (meaning that all containers reside on multiple – assumed in this case to be seven – disks), but other settings also control the degree of parallelism and which table spaces are affected. For example, if you know that your containers reside on a RAID-5 array of four disks, you might set **DB2\_PARALLEL\_IO** to **\*:3**. Whether or not particular values benefit performance also depends on the extent size, the RAID segment size, and how many containers use the same set of disks.

## Considerations for SAP and other ISV environments

If you are running a DB2 database server for an ISV application such as SAP, some best practice guidelines that take into account the specific application might be available. The most straightforward mechanism is the DB2 registry variable **DB2\_WORKLOAD**, which can be set to a value that enables aggregated registry variables to be optimized for specific environments and workloads. Valid settings for **DB2\_WORKLOAD** include: 1C, CM, COGNOS\_CS, FILENET\_CM, MAXIMO, MDM, SAP, TPM, WAS, WC, and WP .

Other recommendations and best practices might apply, such as the choice of a code page or code set and collating sequence, because they must be set to a predetermined value. Refer to the application vendor's documentation for details.

For many ISV applications, such as SAP Business One, the **AUTOCONFIGURE** command can be successfully used to define the initial configuration. However, it should not be used in SAP NetWeaver installations, because an initial set of DB2 configuration parameters is applied during SAP installation. In addition, SAP has a powerful alternative best practices approach (SAP Notes) that describes the preferred DB2 parameter settings; for example, SAP Note 1086130 - DB6: DB2 9.5 Standard Parameter Settings.

Pay special attention to SAP applications when using partitioned database environments. SAP uses partitioned database environment mainly in its SAP NetWeaver Business Intelligence (Business Warehouse) product. The recommended layout has the DB2 system catalog, the dimension and master tables, plus the SAP base tables on Partition 0. This leads to a different workload on this partition compared to other partitioned database environments. Because the SAP application server runs on this partition, up to eight processors might be assigned to just this partition. As the SAP BW workload becomes more highly parallelized, with many short queries running concurrently, the number of partitions for SAP BI is typically smaller than for other applications. In other words, more than one CPU per data partition is required.

---

## Instance configuration

When you start a new DB2 instance, there are a number of steps that you can follow to establish a basic configuration.

- You can use the Configuration Advisor to obtain recommendations for the initial values of the buffer pool size, database configuration parameters, and database manager configuration parameters. To use the Configuration Advisor, specify the **AUTOCONFIGURE** command for an existing database, or specify the **AUTOCONFIGURE** parameter on the **CREATE DATABASE** command. You can display the recommended values or apply them by using the **APPLY** parameter on the **CREATE DATABASE** command. The recommendations are based on input that you provide and system information that the advisor gathers.



- Consult the summary tables (see “Configuration parameters summary”) that list and briefly describe each configuration parameter that is available to the database manager or a database. These summary tables contain a column that indicates whether tuning a particular parameter is likely to produce a high, medium, low, or no performance change. Use these tables to find the parameters that might help you to realize the largest performance improvements in your environment.
- Use the **ACTIVATE DATABASE** command to activate a database and starts up all necessary database services, so that the database is available for connection and use by any application. In a partitioned database environment, this command activates the database on all database partitions and avoids the startup time that is required to initialize the database when the first application connects.

---

## Table space design

### Disk-storage performance factors

Hardware characteristics, such as disk-storage configuration, can strongly influence the performance of your system.

Performance can be affected by one or more of the following aspects of disk-storage configuration:

- Division of storage

How well you divide a limited amount of storage between indexes and data and among table spaces determines to a large degree how the system will perform in different situations.

- Distribution of disk I/O

How well you balance the demand for disk I/O across several devices and controllers can affect the speed with which the database manager is able to retrieve data from disk.

- Disk subsystem core performance metrics

The number of disk operations per second, or the capacity in megabytes transferred per second, has a very strong impact on the performance of the overall system.

### Table space impact on query optimization

Certain characteristics of your table spaces can affect the access plans that are chosen by the query compiler.

These characteristics include:

- Container characteristics

Container characteristics can have a significant impact on the I/O cost that is associated with query execution. When it selects an access plan, the query optimizer considers these I/O costs, including any cost differences when accessing data from different table spaces. Two columns in the SYSCAT.TABLESPACES catalog view are used by the optimizer to help estimate the I/O costs of accessing data from a table space:

- **OVERHEAD** provides an estimate of the time (in milliseconds) that is required by the container before any data is read into memory. This overhead activity includes the container's I/O controller overhead as well as the disk latency time, which includes the disk seek time.

You can use the following formula to estimate the overhead cost:

$$\text{OVERHEAD} = \text{average seek time in milliseconds} \\ + (0.5 * \text{rotational latency})$$

where:

- 0.5 represents the average overhead of one half rotation
- Rotational latency (in milliseconds) is calculated for each full rotation, as follows:

$$(1 / \text{RPM}) * 60 * 1000$$

where:

- You divide by rotations per minute to get minutes per rotation
- You multiply by 60 seconds per minute
- You multiply by 1000 milliseconds per second

For example, assume that a disk performs 7200 rotations per minute. Using the rotational-latency formula:

$$(1 / 7200) * 60 * 1000 = 8.328 \text{ milliseconds}$$

This value can be used to estimate the overhead as follows, assuming an average seek time of 11 milliseconds:

$$\text{OVERHEAD} = 11 + (0.5 * 8.328) \\ = 15.164$$

- TRANSFERRATE provides an estimate of the time (in milliseconds) that is required to read one page of data into memory.

If each table space container is a single physical disk, you can use the following formula to estimate the transfer cost in milliseconds per page:

$$\text{TRANSFERRATE} = (1 / \text{spec\_rate}) * 1000 / 1024000 * \text{page\_size}$$

where:

- You divide by *spec\_rate*, which represents the disk specification for the transfer rate (in megabytes per second), to get seconds per megabyte
- You multiply by 1000 milliseconds per second
- You divide by 1 024 000 bytes per megabyte
- You multiply by the page size (in bytes); for example, 4096 bytes for a 4-KB page

For example, suppose that the specification rate for a disk is 3 megabytes per second. Then:

$$\text{TRANSFERRATE} = (1 / 3) * 1000 / 1024000 * 4096 \\ = 1.333248$$

or about 1.3 milliseconds per page.

If the table space containers are not single physical disks, but are arrays of disks (such as RAID), you must take additional considerations into account when estimating the TRANSFERRATE.

If the array is relatively small, you can multiply the *spec\_rate* by the number of disks, assuming that the bottleneck is at the disk level. However, if the array is large, the bottleneck might not be at the disk level, but at one of the other I/O subsystem components, such as disk controllers, I/O busses, or the system bus. In this case, you cannot assume that the I/O throughput capacity is the product of the *spec\_rate* and the number of disks. Instead, you must measure the actual I/O rate (in megabytes) during a sequential scan. For example, a sequential scan resulting from `select count(*) from big_table` could be several megabytes in size. In this case, divide the result by the

number of containers that make up the table space in which `BIG_TABLE` resides. Use this result as a substitute for `spec_rate` in the formula given previously. For example, a measured sequential I/O rate of 100 megabytes while scanning a table in a four-container table space would imply 25 megabytes per container, or a `TRANSFERRATE` of  $(1 / 25) * 1000 / 1\,024\,000 * 4096 = 0.16$  milliseconds per page.

Containers that are assigned to a table space might reside on different physical disks. For best results, all physical disks that are used for a given table space should have the same `OVERHEAD` and `TRANSFERRATE` characteristics. If these characteristics are not the same, you should use average values when setting `OVERHEAD` and `TRANSFERRATE`.

You can obtain media-specific values for these columns from hardware specifications or through experimentation. These values can be specified on the `CREATE TABLESPACE` and `ALTER TABLESPACE` statements.

- Prefetching

When considering the I/O cost of accessing data in a table space, the optimizer also considers the potential impact that prefetching data and index pages from disk can have on query performance. Prefetching can reduce the overhead that is associated with reading data into the buffer pool.

The optimizer uses information from the `PREFETCHSIZE` and `EXTENTSIZE` columns of the `SYSCAT.TABLESPACES` catalog view to estimate the amount of prefetching that will occur.

- `EXTENTSIZE` can only be set when creating a table space. An extent size of 4 or 8 pages is usually sufficient.
- `PREFETCHSIZE` can be set when you create or alter a table space. The default prefetch size is determined by the value of the `dft_prefetch_sz` database configuration parameter. Review the recommendations for sizing this parameter and make changes as needed, or set it to `AUTOMATIC`.

After making changes to your table spaces, consider executing the `runstats` utility to collect the latest statistics about indexes and to ensure that the query optimizer chooses the best possible data-access plans before rebinding your applications.

---

## Database design

### Tables

#### Table and index management for standard tables

In standard tables, data is logically organized as a list of data pages. These data pages are logically grouped together based on the extent size of the table space.

For example, if the extent size is four, pages zero to three are part of the first extent, pages four to seven are part of the second extent, and so on.

The number of records contained within each data page can vary, based on the size of the data page and the size of the records. Most pages contain only user records. However, a small number of pages include special internal records that are used by the data server to manage the table. For example, in a standard table, there is a free space control record (FSCR) on every 500th data page (Figure 8 on page 58). These records map the free space that is available for new records on each of the following 500 data pages (until the next FSCR).

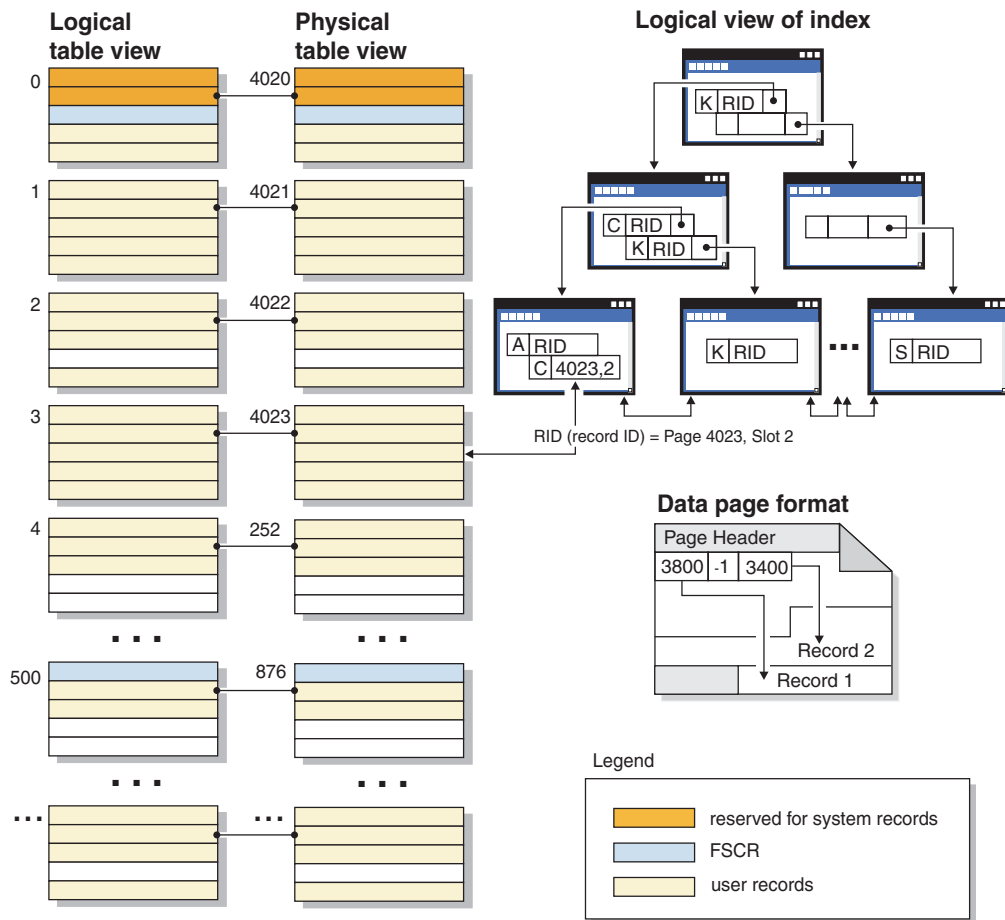

Figure 8. Logical table, record, and index structure for standard tables

Logically, index pages are organized as a B-tree that can efficiently locate table records that have a specific key value. The number of entities on an index page is not fixed, but depends on the size of the key. For tables in database managed space (DMS) table spaces, record identifiers (RIDs) in the index pages use table space-relative page numbers, not object-relative page numbers. This enables an index scan to directly access the data pages without requiring an extent map page (EMP) for mapping.

Each data page has the same format. A page begins with a page header; this is followed by a slot directory. Each entry in the slot directory corresponds to a different record on the page. An entry in the slot directory represents the byte-offset on the data page where a record begins. Entries of -1 correspond to deleted records.

### Record identifiers and pages

Record identifiers consist of a page number followed by a slot number (Figure 9 on page 59). Index records contain an additional field called the ridFlag. The ridFlag stores information about the status of keys in the index, such as whether they have been marked deleted. After the index is used to identify a RID, the RID is used to identify the correct data page and slot number on that page. After a record is assigned a RID, the RID does not change until the table is reorganized.

## Data page and RID format

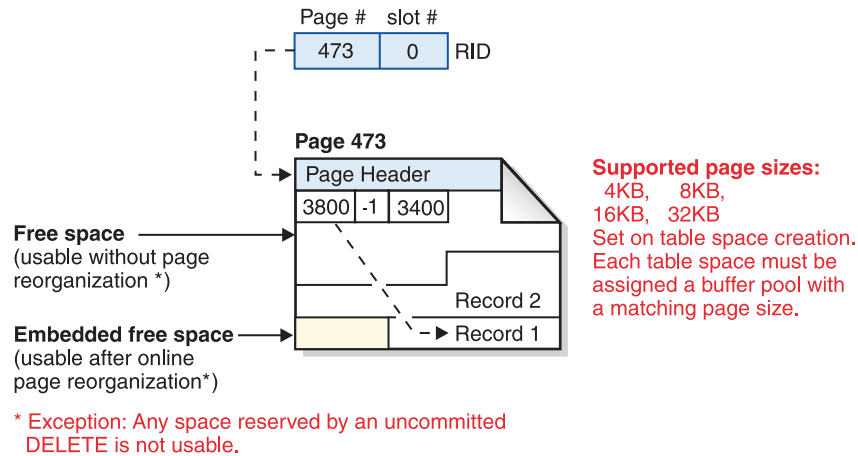

Figure 9. Data page and record ID (RID) format

When a table page is reorganized, embedded free space that is left on the page after a record is physically deleted is converted to usable free space.

The DB2 data server supports different page sizes. Use larger page sizes for workloads that tend to access rows sequentially. For example, sequential access is commonly used for decision support applications, or when temporary tables are being used extensively. Use smaller page sizes for workloads that tend to access rows randomly. For example, random access is often used in online transaction processing (OLTP) environments.

## Index management in standard tables

DB2 indexes use an optimized B-tree implementation that is based on an efficient and high concurrency index management method using write-ahead logging. A B-tree index is arranged as a balanced hierarchy of pages that minimizes access time by realigning data keys as items are inserted or deleted.

The optimized B-tree implementation has bidirectional pointers on the leaf pages that allow a single index to support scans in either forward or reverse direction. Index pages are usually split in half, except at the high-key page where a 90/10 split is used, meaning that the highest ten percent of index keys are placed on a new page. This type of index page split is useful for workloads in which insert operations are often completed with new high-key values.

Deleted index keys are removed from an index page only if there is an X lock on the table. If keys cannot be removed immediately, they are marked deleted and physically removed later.

If you enabled online index defragmentation by specifying a positive value for MINPCTUSED when the index was created, index leaf pages can be merged online. MINPCTUSED represents the minimum percentage of used space on an index leaf page. If the amount of used space on an index page falls below this value after a key is removed, the database manager attempts to merge the remaining keys with those of a neighboring page. If there is sufficient room, the merge is performed and an index leaf page is deleted. Because online defragmentation occurs only when keys are removed from an index page, this does not occur if keys are merely marked deleted, but have not been physically

removed from the page. Online index defragmentation can improve space reuse, but if the MINPCTUSED value is too high, the time that is needed for a merge increases, and a successful merge becomes less likely. The recommended value for MINPCTUSED is fifty percent or less.

The INCLUDE clause of the CREATE INDEX statement lets you specify one or more columns (beyond the key columns) for the index leaf pages. These include columns, which are not involved in ordering operations against the index B-tree, can increase the number of queries that are eligible for index-only access. However, they can also increase index space requirements and, possibly, index maintenance costs if the included columns are updated frequently. The maintenance cost of updating include columns is less than the cost of updating key columns, but more than the cost of updating columns that are not part of an index.

### **Table and index management for MDC and ITC tables**

Table and index organization for multidimensional (MDC) and insert time clustering (ITC) tables is based on the same logical structures as standard table organization.

Like standard tables, MDC and ITC tables are organized into pages that contain rows of data divided into columns. The rows on each page are identified by record IDs (RIDs). However, the pages for MDC and ITC tables are grouped into extent-sized blocks. For example, Figure 10 on page 61, shows a table with an extent size of four. The first four pages, numbered 0 through 3, represent the first block in the table. The next four pages, numbered 4 through 7, represent the second block in the table.

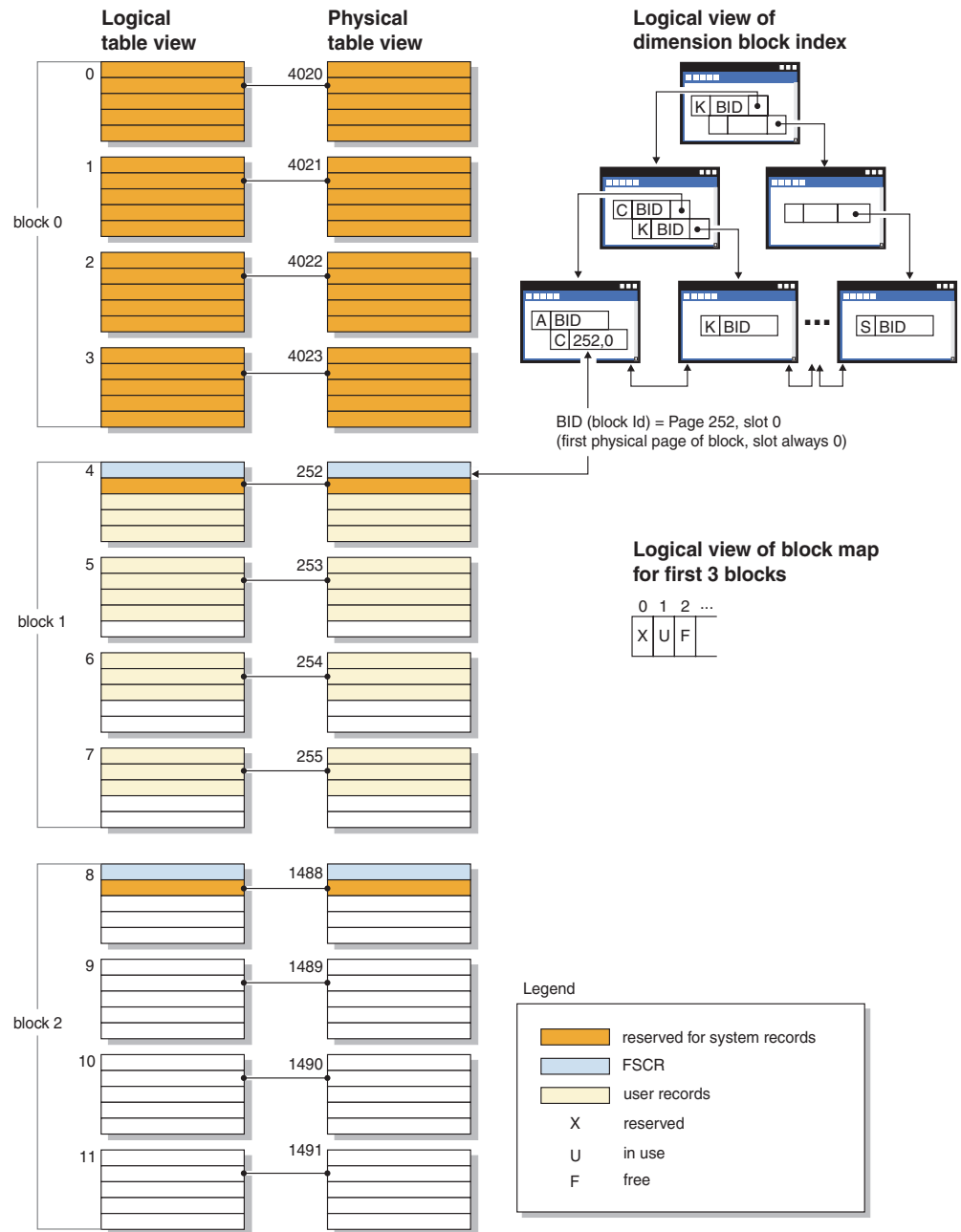

Figure 10. Logical table, record, and index structure for MDC and ITC tables

The first block contains special internal records, including the free space control record (FSCR), that are used by the DB2 server to manage the table. In subsequent blocks, the first page contains the FSCR. An FSCR maps the free space for new records that exists on each page of the block. This available free space is used when inserting records into the table.

As the name implies, MDC tables cluster data on more than one dimension. Each dimension is determined by a column or set of columns that you specify in the ORGANIZE BY DIMENSIONS clause of the CREATE TABLE statement. When you create an MDC table, the following two indexes are created automatically:

- A dimension-block index, which contains pointers to each occupied block for a single dimension

- A composite-block index, which contains all dimension key columns, and which is used to maintain clustering during insert and update activity

The optimizer considers access plans that use dimension-block indexes when it determines the most efficient access plan for a particular query. When queries have predicates on dimension values, the optimizer can use the dimension-block index to identify—and fetch from—the extents that contain these values. Because extents are physically contiguous pages on disk, this minimizes I/O and leads to better performance.

You can also create specific RID indexes if analysis of data access plans indicates that such indexes would improve query performance.

As the name implies, ITC tables cluster data based on row insert time. The differences between MDC and ITC tables are:

- block indexes are not used for any data access,
- only a single composite block index is created for the table, and that index consists of a virtual dimension, and
- the index is never chosen by the optimizer for plans because the column it contains cannot be referenced by any SQL statement.

MDC and ITC tables can have their empty blocks released to the tablespace.

## Indexes

### Index structure

The database manager uses a B+ tree structure for index storage.

A B+ tree has several levels, as shown in Figure 11 on page 63; “rid” refers to a record ID (RID).



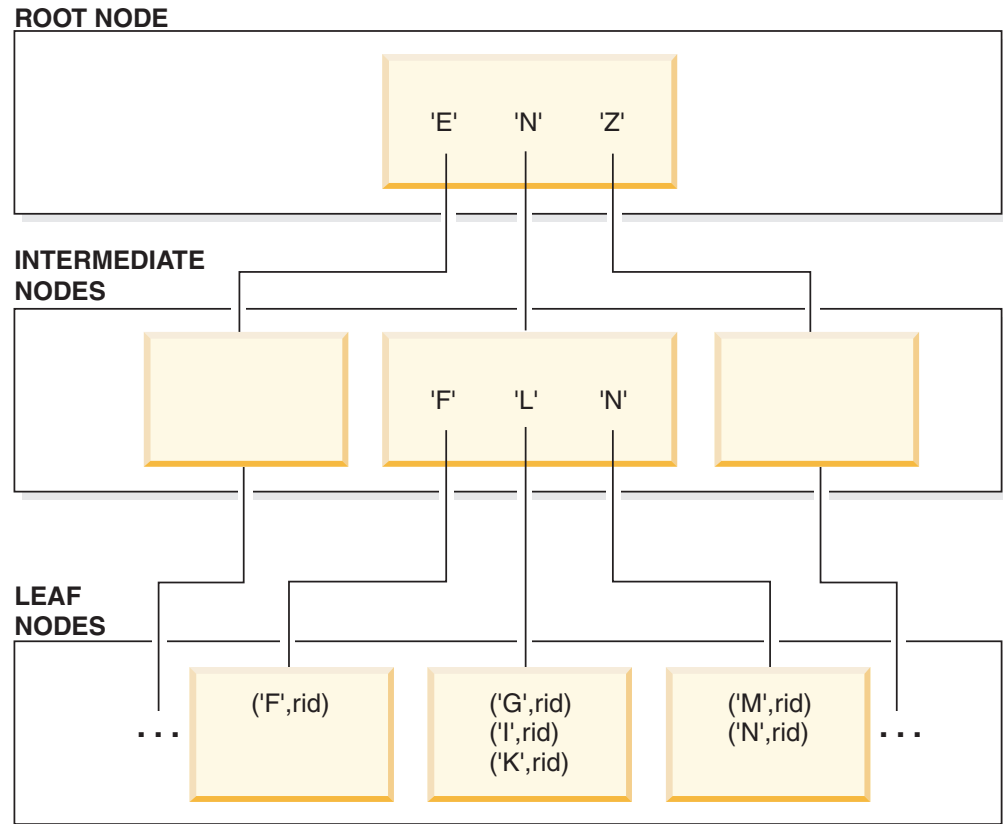

Figure 11. Structure of a B+ Tree Index

The top level is known as the *root node*. The bottom level consists of *leaf nodes* that store index key values with pointers to the table rows that contain the corresponding data. Levels between the root and leaf node levels are known as *intermediate nodes*.

When it looks for a particular index key value, the index manager searches the index tree, starting at the root node. The root node contains one key for each (intermediate) node in the next level. The value of each of these keys is the largest existing key value for the corresponding node at the next level. For example, suppose that an index has three levels, as shown in the figure. To find a particular index key value, the index manager searches the root node for the first key value that is greater than or equal to the search key value. The root node key points to a specific intermediate node. The index manager follows this procedure through each intermediate node until it finds the leaf node that contains the index key that it needs.

Suppose that the key being looked for in Figure 11 is "I". The first key in the root node that is greater than or equal to "I" is "N", which points to the middle node at the next level. The first key in that intermediate node that is greater than or equal to "I" is "L", which, in turn, points to a specific leaf node on which the index key for "I" and its corresponding RID can be found. The RID identifies the corresponding row in the base table.

The leaf node level can also contain pointers to previous leaf nodes. These pointers enable the index manager to scan across leaf nodes in either direction to retrieve a

range of values after it finds one value in the range. The ability to scan in either direction is possible only if the index was created with the `ALLOW REVERSE SCANS` option.

In the case of a multidimensional clustering (MDC) or insert time clustering (ITC) table, a block index is created automatically for each clustering dimension that you specify for the table. A composite block index is also created; this index contains a key part for each column that is involved in any dimension of the table. Such indexes contain pointers to block IDs (BIDs) instead of RIDs, and provide data-access improvements.

A one-byte *ridFlag*, stored for each RID on the leaf page of an index, is used to mark the RID as logically deleted, so that it can be physically removed later. After an update or delete operation commits, the keys that are marked as deleted can be removed. For each variable-length column in the index, two additional bytes store the actual length of the column value.

## Index cleanup and maintenance

After you create an index, performance might degrade with time unless you keep the index compact and organized.

The following recommendations help you keep indexes as small and efficient as possible:

- Enable online index defragmentation.  
Create indexes with the `MINPCTUSED` clause. Drop and recreate existing indexes, if necessary.
- Perform frequent commits, or acquire table-level X locks, either explicitly or through lock escalation, if frequent commits are not possible.  
Index keys that are marked deleted can be physically removed from the table after a commit. X locks on tables enable the deleted keys to be physically removed when they are marked deleted.
- Use the **REORGCHK** command to help determine when to reorganize indexes or tables, and when to use the **REORG INDEXES** command with the **CLEANUP** parameter.  
To allow read and write access to the index during reorganization, use the **REORG INDEXES** command with the **ALLOW WRITE ACCESS** option.  
With DB2 Version 9.7 Fix Pack 1 and later releases, issue the **REORG INDEXES** command with the **ON DATA PARTITION** parameter on a data partitioned table to reorganize the partitioned indexes of the specified partition. During index reorganization, the unaffected partitions remain read and write accessible access is restricted only to the affected partition.
- If the objective is to reclaim space, use the **REORG INDEXES** command with the **CLEANUP** and **RECLAIM EXTENTS** parameters. The **CLEANUP** parameter maximizes the amount of reclaimable space.  
The `RECLAIMABLE_SPACE` output of the `ADMIN_GET_INDEX_INFO` function shows how much space is reclaimable, in kilobytes.

Index keys that are marked deleted are cleaned up:

- During subsequent insert, update, or delete activity  
During key insertion, keys that are marked deleted and that are known to have been committed are cleaned up if that might avoid the need to perform a page split and prevent the index from increasing in size.

During key deletion, when all keys on a page have been marked deleted, an attempt is made to find another index page where all the keys are marked deleted and all those deletions have committed. If such a page is found, it is deleted from the index tree. If there is an X lock on the table when a key is deleted, the key is physically deleted instead of just being marked deleted. During physical deletion, any deleted keys on the same page are also removed if they are marked deleted and known to be committed.

- When you execute the **REORG INDEXES** command with the **CLEANUP** parameter:  
The **CLEANUP PAGES** option searches for and frees index pages on which all keys are marked deleted and known to be committed.  
The **CLEANUP ALL** option frees not only index pages on which all keys are marked deleted and known to be committed, but it also removes record identifiers (RIDs) that are marked deleted and known to be committed from pages that contain some non-deleted RIDs. This option also tries to merge adjacent leaf pages if doing so results in a merged leaf page that has at least PCTFREE free space. The PCTFREE value is defined when an index is created. The default PCTFREE value is 10 percent. If two pages can be merged, one of the pages is freed.

For data partitioned tables, it is recommended that you invoke the **RUNSTATS** command after an asynchronous index cleanup has completed. To determine whether there are detached data partitions in the table, query the STATUS field in the SYSCAT.DATAPARTITIONS catalog view and look for the value 'L' (logically detached), 'D' (detached partition having detach dependent tables such as a materialized query tables) or 'I' (index cleanup).

- When an index is rebuilt (or, in the case of data partitioned indexes, when an index partition is rebuilt)  
Utilities that rebuild indexes include the following:
  - **REORG INDEXES** with the default **REBUILD** parameter
  - **REORG TABLE** without the **INPLACE** or **RECLAIM EXTENTS** parameter
  - **IMPORT** with the **REPLACE** parameter
  - **LOAD** with the **INDEXING MODE REBUILD** parameter

### Asynchronous index cleanup

Asynchronous index cleanup (AIC) is the deferred cleanup of indexes following operations that invalidate index entries. Depending on the type of index, the entries can be record identifiers (RIDs) or block identifiers (BIDs). Invalid index entries are removed by index cleaners, which operate asynchronously in the background.

AIC accelerates the process of detaching a data partition from a partitioned table, and is initiated if the partitioned table contains one or more nonpartitioned indexes. In this case, AIC removes all nonpartitioned index entries that refer to the detached data partition, and any pseudo-deleted entries. After all of the indexes have been cleaned, the identifier that is associated with the detached data partition is removed from the system catalog. In DB2 Version 9.7 Fix Pack 1 and later releases, AIC is initiated by an asynchronous partition detach task.

Prior to DB2 Version 9.7 Fix Pack 1, if the partitioned table has dependent materialized query tables (MQTs), AIC is not initiated until after a SET INTEGRITY statement is executed.

Normal table access is maintained while AIC is in progress. Queries accessing the indexes ignore any invalid entries that have not yet been cleaned.

In most cases, one cleaner is started for each nonpartitioned index that is associated with the partitioned table. An internal task distribution daemon is responsible for distributing the AIC tasks to the appropriate table partitions and assigning database agents. The distribution daemon and cleaner agents are internal system applications that appear in **LIST APPLICATIONS** command output with the application names **db2taskd** and **db2aic**, respectively. To prevent accidental disruption, system applications cannot be forced. The distribution daemon remains online as long as the database is active. The cleaners remain active until cleaning has been completed. If the database is deactivated while cleaning is in progress, AIC resumes when you reactivate the database.

## AIC impact on performance

AIC incurs minimal performance impact.

An instantaneous row lock test is required to determine whether a pseudo-deleted entry has been committed. However, because the lock is never acquired, concurrency is unaffected.

Each cleaner acquires a minimal table space lock (IX) and a table lock (IS). These locks are released if a cleaner determines that other applications are waiting for locks. If this occurs, the cleaner suspends processing for 5 minutes.

Cleaners are integrated with the utility throttling facility. By default, each cleaner has a utility impact priority of 50. You can change the priority by using the **SET UTIL\_IMPACT\_PRIORITY** command or the db2UtilityControl API.

## Monitoring AIC

You can monitor AIC with the **LIST UTILITIES** command. Each index cleaner appears as a separate utility in the output. The following is an example of output from the **LIST UTILITIES SHOW DETAIL** command:

```

ID                               = 2
Type                             = ASYNCHRONOUS INDEX CLEANUP
Database Name                    = WSDB
Partition Number                 = 0
Description                      = Table: USER1.SALES, Index: USER1.I2
Start Time                      = 12/15/2005 11:15:01.967939
State                            = Executing
Invocation Type                  = Automatic
Throttling:
  Priority                        = 50
Progress Monitoring:
  Total Work                     = 5 pages
  Completed Work                 = 0 pages
  Start Time                    = 12/15/2005 11:15:01.979033

ID                               = 1
Type                             = ASYNCHRONOUS INDEX CLEANUP
Database Name                    = WSDB
Partition Number                 = 0
Description                      = Table: USER1.SALES, Index: USER1.I1
Start Time                      = 12/15/2005 11:15:01.978554
State                            = Executing
Invocation Type                  = Automatic
Throttling:
  Priority                        = 50
Progress Monitoring:

```

Total Work	= 5 pages
Completed Work	= 0 pages
Start Time	= 12/15/2005 11:15:01.980524

In this case, there are two cleaners operating on the USERS1.SALES table. One cleaner is processing index I1, and the other is processing index I2. The progress monitoring section shows the estimated total number of index pages that need cleaning and the current number of clean index pages.

The State field indicates the current state of a cleaner. The normal state is Executing, but the cleaner might be in Waiting state if it is waiting to be assigned to an available database agent or if the cleaner is temporarily suspended because of lock contention.

Note that different tasks on different database partitions can have the same utility ID, because each database partition assigns IDs to tasks that are running on that database partition only.

### **Asynchronous index cleanup for MDC tables**

You can enhance the performance of a rollout deletion—an efficient method for deleting qualifying blocks of data from multidimensional clustering (MDC) tables—by using asynchronous index cleanup (AIC). AIC is the deferred cleanup of indexes following operations that invalidate index entries.

Indexes are cleaned up synchronously during a standard rollout deletion. When a table contains many record ID (RID) indexes, a significant amount of time is spent removing the index keys that reference the table rows that are being deleted. You can speed up the rollout by specifying that these indexes are to be cleaned up after the deletion operation commits.

To take advantage of AIC for MDC tables, you must explicitly enable the *deferred index cleanup rollout* mechanism. There are two methods of specifying a deferred rollout: setting the **DB2\_MDC\_ROLLOUT** registry variable to DEFER or issuing the SET CURRENT MDC ROLLOUT MODE statement. During a deferred index cleanup rollout operation, blocks are marked as rolled out without an update to the RID indexes until after the transaction commits. Block identifier (BID) indexes are cleaned up during the delete operation because they do not require row-level processing.

AIC rollout is invoked when a rollout deletion commits or, if the database was shut down, when the table is first accessed following database restart. While AIC is in progress, queries against the indexes are successful, including those that access the index that is being cleaned up.

There is one coordinating cleaner per MDC table. Index cleanup for multiple rollouts is consolidated within the cleaner, which spawns a cleanup agent for each RID index. Cleanup agents update the RID indexes in parallel. Cleaners are also integrated with the utility throttling facility. By default, each cleaner has a utility impact priority of 50 (acceptable values are between 1 and 100, with 0 indicating no throttling). You can change this priority by using the **SET UTIL\_IMPACT\_PRIORITY** command or the db2UtilityControl API.

**Note:** In DB2 Version 9.7 and later releases, deferred cleanup rollout is not supported on a data partitioned MDC table with partitioned RID indexes. Only the NONE and IMMEDIATE modes are supported. The cleanup rollout type will be

IMMEDIATE if the **DB2\_MDC\_ROLLOUT** registry variable is set to DEFER, or if the CURRENT MDC ROLLOUT MODE special register is set to DEFERRED to override the **DB2\_MDC\_ROLLOUT** setting.

If only nonpartitioned RID indexes exist on the MDC table, deferred index cleanup rollout is supported. The MDC block indexes can be partitioned or nonpartitioned.

### Monitoring the progress of deferred index cleanup rollout operation

Because the rolled-out blocks on an MDC table are not reusable until after the cleanup is complete, it is useful to monitor the progress of a deferred index cleanup rollout operation. Use the **LIST UTILITIES** command to display a utility monitor entry for each index being cleaned up. You can also retrieve the total number of MDC table blocks in the database that are pending asynchronous cleanup following a rollout deletion (BLOCKS\_PENDING\_CLEANUP) by using the ADMIN\_GET\_TAB\_INFO table function or the **GET SNAPSHOT** command.

In the following sample output for the **LIST UTILITIES SHOW DETAIL** command, progress is indicated by the number of pages in each index that have been cleaned up. Each phase represents one RID index.

```

ID = 2
Type = MDC ROLLOUT INDEX CLEANUP
Database Name = WSDB
Partition Number = 0
Description = TABLE.<schema_name>.<table_name>
Start Time = 06/12/2006 08:56:33.390158
State = Executing
Invocation Type = Automatic
Throttling:
  Priority = 50
Progress Monitoring:
  Estimated Percentage Complete = 83
  Phase Number = 1
    Description = <schema_name>.<index_name>
    Total Work = 13 pages
    Completed Work = 13 pages
    Start Time = 06/12/2006 08:56:33.391566
  Phase Number = 2
    Description = <schema_name>.<index_name>
    Total Work = 13 pages
    Completed Work = 13 pages
    Start Time = 06/12/2006 08:56:33.391577
  Phase Number = 3
    Description = <schema_name>.<index_name>
    Total Work = 9 pages
    Completed Work = 3 pages
    Start Time = 06/12/2006 08:56:33.391587

```

### Online index defragmentation

Online index defragmentation is enabled by the user-definable threshold, MINPCTUSED, for the minimum amount of used space on an index leaf page.

When an index key is deleted from a leaf page and this threshold is exceeded, the neighboring index leaf pages are checked to determine whether two leaf pages can be merged. If there is sufficient space on a page, and the merging of two neighboring pages is possible, the merge occurs immediately. The resulting empty index leaf page is then deleted.

The MINPCTUSED clause cannot be altered by the ALTER INDEX statement. If existing indexes require the ability to be merged via online index defragmentation,

they must be dropped and then recreated with the CREATE INDEX statement specifying the MINPCTUSED clause. When enabling online index defragmentation, to increase the likelihood that pages can be merged when neighboring pages are checked, MINPCTUSED should be set to a value less than 50. A value of zero, which is the default, disables online defragmentation. Whether MINPCTFREE is set or not, the ability to perform a REORG CLEANUP on that index is not affected. Setting MINPCTFREE to a low value, 1-50, might reduce the work left for REORG CLEANUP to do as more page merging is performed automatically at run time.

Index nonleaf pages are not merged during online index defragmentation. However, empty nonleaf pages are deleted and made available for reuse by other indexes on the same table. To free deleted pages for other objects in a database managed space (DMS) storage model there are two reorganization options, REBUILD or RECLAIM EXTENTS. For system managed space (SMS) storage model only REORG REBUILD is allowed. RECLAIM EXTENTS moves pages to create full extents of deleted pages and then frees them. REBUILD rebuilds the index from scratch making the index as small as possible respecting PCTFREE.

Only REBUILD addresses the number of levels in an index. If reducing the number of levels in an index is a concern perform a reorganization with the REBUILD option.

When there is an X lock on a table, keys are physically removed from a page during key deletion. In this case, online index defragmentation is effective. However, if there is no X lock on the table during key deletion, keys are marked deleted but are not physically removed from the index page, and index defragmentation is not attempted.

To defragment indexes regardless of the value of MINPCTUSED, invoke the REORG INDEXES command with the CLEANUP ALL option. The whole index is checked, and whenever possible two neighboring leaf pages are merged. This merge is possible if at least PCTFREE free space is left on the merged page. PCTFREE can be specified at index creation time; the default value is 10 (percent).

## Using relational indexes to improve performance

Indexes can be used to improve performance when accessing table data. Relational indexes are used when accessing relational data, and indexes over XML data are used when accessing XML data.

Although the query optimizer decides whether to use a relational index to access relational table data, it is up to you to decide which indexes might improve performance and to create those indexes. The only exceptions to this are the dimension block indexes and the composite block index that are created automatically for each dimension when you create a multidimensional clustering (MDC) table.

Execute the runstats utility to collect new index statistics after you create a relational index or after you change the prefetch size. You should execute the runstats utility at regular intervals to keep the statistics current; without up-to-date statistics about indexes, the optimizer cannot determine the best data-access plan for queries.

To determine whether a relational index is used in a specific package, use the explain facility. To get advice about relational indexes that could be exploited by one or more SQL statements, use the **db2adv is** command to launch the Design Advisor.

IBM® InfoSphere Optim™ Query Workload Tuner provides tools for improving the performance of single SQL statements and the performance of groups of SQL statements, which are called query workloads. For more information about this product, see the product overview page at <http://www.ibm.com/software/data/optim/query-workload-tuner-db2-luw/index.html>. In Version 3.1.1 or later, you can also use the Workload Design Advisor to perform many operations that were available in the DB2 Design Advisor wizard. For more information see the documentation for the Workload Design Advisor at <http://publib.boulder.ibm.com/infocenter/dstudio/v3r1/topic/com.ibm.datatools.qrytune.workloadtunedb2luw.doc/topics/genrecsdsgn.html>.

### **Advantages of a relational index over no index**

If no index on a table exists, a table scan must be performed for each table that is referenced in an SQL query. The larger the table, the longer such a scan will take, because a table scan requires that each row be accessed sequentially. Although a table scan might be more efficient for a complex query that requires most of the rows in a table, an index scan can access table rows more efficiently for a query that returns only some table rows.

The optimizer chooses an index scan if the relational index columns are referenced in the SELECT statement and if the optimizer estimates that an index scan will be faster than a table scan. Index files are generally smaller and require less time to read than an entire table, especially when the table is large. Moreover, it might not be necessary to scan an entire index. Any predicates that are applied to the index will reduce the number of rows that must be read from data pages.

If an ordering requirement on the output can be matched with an index column, scanning the index in column order will enable the rows to be retrieved in the correct order without the need for a sort operation. Note that the existence of a relational index on the table being queried does not guarantee an ordered result set. Only an ORDER BY clause ensures the order of a result set.

A relational index can also contain include columns, which are non-indexed columns in an indexed row. Such columns can make it possible for the optimizer to retrieve required information from the index alone, without having to access the table itself.

### **Disadvantages of a relational index over no index**

Although indexes can reduce access time significantly, they can also have adverse effects on performance. Before you create indexes, consider the effects of multiple indexes on disk space and processing time. Choose indexes carefully to address the needs of your application programs.

- Each index requires storage space. The exact amount depends on the size of the table and the size and number of columns in the relational index.
- Each insert or delete operation against a table requires additional updating of each index on that table. This is also true for each update operation that changes the value of an index key.
- Each relational index represents another potential access plan for the optimizer to consider, which increases query compilation time.

### **Relational index planning tips**

A well-designed index can make it easier for queries to access relational data.



Use the Design Advisor (**db2adv** command) to find the best indexes for a specific query or for the set of queries that defines a workload. This tool can make performance-enhancing recommendations, such as include columns or indexes that are enabled for reverse scans.

The following guidelines can also help you to create useful relational indexes.

- Retrieving data efficiently
  - To improve data retrieval, add *include columns* to unique indexes. Good candidates are columns that:
    - Are accessed frequently and would benefit from index-only access
    - Are not required to limit the range of index scans
    - Do not affect the ordering or uniqueness of the index key

For example:

```
create unique index idx on employee (workdept) include (lastname)
```

Specifying LASTNAME as an include column rather than part of the index key means that LASTNAME is stored only on the leaf pages of the index.

- Create relational indexes on columns that are used in the WHERE clauses of frequently run queries.

In the following example, the WHERE clause will likely benefit from an index on WORKDEPT, unless the WORKDEPT column contains many duplicate values.

```
where workdept='A01' or workdept='E21'
```

- Create relational indexes with a compound key that names each column referenced in a query. When an index is specified in this way, relational data can be retrieved from the index only, which is more efficient than accessing the table.

For example, consider the following query:

```
select lastname
  from employee
 where workdept in ('A00','D11','D21')
```

If a relational index is defined on the WORKDEPT and LASTNAME columns of the EMPLOYEE table, the query might be processed more efficiently by scanning the index rather than the entire table. Because the predicate references WORKDEPT, this column should be the first key column of the relational index.

- Searching tables efficiently

Decide between ascending and descending key order, depending on the order that will be used most often. Although values can be searched in reverse direction if you specify the ALLOW REVERSE SCANS option on the CREATE INDEX statement, scans in the specified index order perform slightly better than reverse scans.
- Accessing larger tables efficiently

Use relational indexes to optimize frequent queries against tables with more than a few data pages, as recorded in the NPAGES column of the SYSCAT.TABLES catalog view. You should:

  - Create an index on any column that you will use to join tables.
  - Create an index on any column that you will be searching for specific values on a regular basis.

- Improving the performance of update or delete operations

- To improve the performance of such operations against a parent table, create relational indexes on foreign keys.
- To improve the performance of such operations against REFRESH IMMEDIATE and INCREMENTAL materialized query tables (MQTs), create unique relational indexes on the implied unique key of the MQT, which is composed of the columns in the GROUP BY clause of the MQT definition.

- Improving join performance

If you have more than one choice for the first key column in a multiple-column relational index, use the column that is most often specified with an equijoin predicate (*expression1 = expression2*) or the column with the greatest number of distinct values as the first key column.

- Sorting

- For fast sort operations, create relational indexes on columns that are frequently used to sort the relational data.
- To avoid some sorts, use the CREATE INDEX statement to define primary keys and unique keys whenever possible.
- Create a relational index to order the rows in whatever sequence is required by a frequently run query. Ordering is required by the DISTINCT, GROUP BY, and ORDER BY clauses.

The following example uses the DISTINCT clause:

```
select distinct workdept
from employee
```

The database manager can use an index that is defined on the WORKDEPT column to eliminate duplicate values. The same index could also be used to group values, as in the following example that uses a GROUP BY clause:

```
select workdept, average(salary)
from employee
group by workdept
```

- Keeping newly inserted rows clustered and avoiding page splits

Define a clustering index, which should significantly reduce the need to reorganize the table. Use the PCTFREE option on the CREATE TABLE statement to specify how much free space should be left on each page so that rows can be inserted appropriately. You can also specify the pagefreespace file type modifier on the **LOAD** command.

- Saving index maintenance costs and storage space

- Avoid creating indexes that are partial keys of other existing indexes. For example, if there is an index on columns A, B, and C, another index on columns A and B is generally not useful.
- Do not create arbitrary indexes on many columns. Unnecessary indexes not only waste space, but also cause lengthy prepare times.
  - For online transaction processing (OLTP) environments, create one or two indexes per table.
  - For read-only query environments, you might create more than five indexes per table.

**Note:** For workloads involving many ad-hoc queries with many different predicates where index gap cardinality is small and the selectivity of non index gaps after the index gap is small, it is likely more appropriate to create a few large composite indexes for a table, as opposed to many smaller indexes.

- For mixed query and OLTP environments, between two and five indexes per table is likely appropriate.
- Enabling online index defragmentation
  - Use the MINPCTUSED option when you create relational indexes. MINPCTUSED enables online index defragmentation; it specifies the minimum amount of space that must be in use on an index leaf page.

## Relational index performance tips

There are a number of actions that you can take to ensure that your relational indexes perform well.

- Specify a large utility heap
  - If you expect a lot of update activity against the table on which a relational index is being created or reorganized, consider configuring a large utility heap (**util\_heap\_sz** database configuration parameter), which will help to speed up these operations.
- To avoid sort overflows in a symmetric multiprocessor (SMP) environment, increase the value of the **sheaphres** database manager configuration parameter
- Create separate table spaces for relational indexes
  - You can create index table spaces on faster physical devices, or assign index table spaces to a different buffer pool, which might keep the index pages in the buffer longer because they do not compete with data pages.
  - If you use a different table space for indexes, you can optimize the configuration of that table space for indexes. Because indexes are usually smaller than tables and are spread over fewer containers, indexes often have smaller extent sizes. The query optimizer considers the speed of the device that contains a table space when it chooses an access plan.
- Ensure a high degree of clustering
  - If your SQL statement requires ordering of the result (for example, if it contains an ORDER BY, GROUP BY, or DISTINCT clause), the optimizer might not choose an available index if:
    - Index clustering is poor. For information about the degree of clustering in a specific index, query the CLUSTERRATIO and CLUSTERFACTOR columns of the SYSCAT.INDEXES catalog view.
    - The table is so small that it is cheaper to scan the table and to sort the result set in memory.
    - There are competing indexes for accessing the table.
  - A clustering index attempts to maintain a particular order of the data, improving the CLUSTERRATIO or CLUSTERFACTOR statistics that are collected by the runstats utility. After you create a clustering index, perform an offline table reorg operation. In general, a table can only be clustered on one index. Build additional indexes after you build the clustering index.
  - A table's PCTFREE value determines the amount of space on a page that is to remain empty for future data insertions, so that this inserted data can be clustered appropriately. If you do not specify a PCTFREE value for a table, reorganization eliminates all extra space.
  - Except in the case of range-clustered tables, data clustering is not maintained during update operations. That is, if you update a record so that its key value in the clustering index changes, the record is not necessarily moved to a new page to maintain the clustering order. To maintain clustering, delete the record and then insert an updated version of the record, instead of using an update operation.
- Keep table and index statistics up-to-date

After you create a new relational index, execute the runstats utility to collect index statistics. These statistics help the optimizer to determine whether using the index can improve data-access performance.

- Enable online index defragmentation

Online index defragmentation is enabled if MINPCTUSED for the relational index is set to a value that is greater than zero. Online index defragmentation enables indexes to be compacted through the merging of index leaf pages when the amount of free space on a page falls below the specified MINPCTUSED value.

- Reorganize relational indexes as necessary

To get the best performance from your indexes, consider reorganizing them periodically, because updates to tables can cause index page prefetching to become less effective.

To reorganize an index, either drop it and recreate it, or use the reorg utility.

To reduce the need for frequent reorganization, specify an appropriate PCTFREE value on the CREATE INDEX statement to leave sufficient free space on each index leaf page as it is being created. During future activity, records can be inserted into the index with less likelihood of index page splitting, which decreases page contiguity and, therefore, the efficiency of index page prefetching. The PCTFREE value that is specified when you create a relational index is preserved when the index is reorganized.

- Analyze explain information about relational index use

Periodically issue EXPLAIN statements against your most frequently used queries and verify that each of your relational indexes is being used at least once. If an index is not being used by any query, consider dropping that index.

Explain information also lets you determine whether a large table being scanned is processed as the inner table of a nested-loop join. If it is, an index on the join-predicate column is either missing or considered to be ineffective for applying the join predicate.

- Declare tables that vary widely in size as “volatile”

A *volatile table* is a table whose cardinality at run time can vary greatly. For this kind of table, the optimizer might generate an access plan that favors a table scan instead of an index scan.

Use the ALTER TABLE statement with the VOLATILE clause to declare such a table as volatile. The optimizer will use an index scan instead of a table scan against such tables, regardless of statistics, if:

- All referenced columns are part of the index
- The index can apply a predicate during the index scan

In the case of typed tables, the ALTER TABLE...VOLATILE statement is supported only for the root table of a typed table hierarchy.

### **Using CURRENT MEMBER default value in a DB2 pureScale environment to improve contention issues**

In a DB2 pureScale environment, you can set the default value for a column to the CURRENT MEMBER special register. This member information can then be used to range partition a table or an index, and therefore reduce database contention.

The following scenarios outline some of the situations where creating a new index using a CURRENT MEMBER column improves database contention issues. Once this new index is created, the DB2 pureScale cluster can make use of the member number information to reduce the amount of active sharing between members

when referencing the table index. This resource reduction can improve the speed and overall performance of the DB2 pureScale environment.

### **Inserts with unique and increasing sequence values or timestamps**

One row in the table can be used to store an ever-increasing value sequence (for example, purchase order numbers). These values can be generated automatically as an identity column, or programmatically through an external application. However, when these inserts occur with a significant frequency, contention issues may result, slowing down user queries.

To improve query performance, you can create a new CURRENT MEMBER column, and then index that data in conjunction with the column that stores the sequence.

1. Add the new column to store the member number:

```
ALTER TABLE ordernumber
  ADD COLUMN curmem SMALLINT DEFAULT CURRENT MEMBER IMPLICITLY HIDDEN
```

2. Create (or drop and re-create) the index on the sequence column (seqnumber in this example), adding the new column to the index:

```
CREATE INDEX seqindex
  ON ordernumber (curmem, seqnumber)
```

A similar approach can be taken with database designs where the sequence is a series of timestamp values. The index for the timestamp column would use the PAGE SPLIT HIGH option, and include the new CURRENT MEMBER column as well.

### **Indexes with only a few unique values**

Some tables may have columns with only a few different values, relative to the number of rows in the table. This is another case where adding a CURRENT MEMBER column can be beneficial.

To improve the database performance in this case:

1. Add the new column to store the member number:

```
ALTER TABLE customerinfo
  ADD COLUMN curmem SMALLINT DEFAULT CURRENT MEMBER IMPLICITLY HIDDEN
```

2. Create (or drop and re-create) the index on the one or more columns with the few different values (for example, zipcode and country):

```
CREATE INDEX lowvaridx
  ON customerinfo (zipcode, country, curmem)
```

In all these cases, index compression will likely reduce the size of the index on the new CURRENT MEMBER values.

To reduce the impact on existing SQL statements, use the IMPLICITLY HIDDEN option in the CREATE TABLE or ALTER TABLE command to hide the new column. This hidden column option ensures that the member information is only available to explicit SQL statement references.

## Partitioning and clustering

### Index behavior on partitioned tables

Indexes on partitioned tables operate similarly to indexes on nonpartitioned tables. However, indexes on partitioned tables are stored using a different storage model, depending on whether the indexes are partitioned or nonpartitioned.

Although the indexes for a regular nonpartitioned table all reside in a shared index object, a *nonpartitioned index* on a partitioned table is created in its own index object in a single table space, even if the data partitions span multiple table spaces. Both database managed space (DMS) and system managed space (SMS) table spaces support the use of indexes in a different location than the table data. Each nonpartitioned index can be placed in its own table space, including large table spaces. Each index table space must use the same storage mechanism as the data partitions, either DMS or SMS. Indexes in large table spaces can contain up to 2<sup>29</sup> pages. All of the table spaces must be in the same database partition group.

A *partitioned index* uses an index organization scheme in which index data is divided across multiple *index partitions*, according to the partitioning scheme of the table. Each index partition refers only to table rows in the corresponding data partition. All index partitions for a specific data partition reside in the same index object.

Starting in DB2 Version 9.7 Fix Pack 1, user-created indexes over XML data on XML columns in partitioned tables can be either partitioned or nonpartitioned. The default is partitioned. System-generated XML region indexes are always partitioned, and system-generated column path indexes are always nonpartitioned. In DB2 V9.7, indexes over XML data are nonpartitioned.

Benefits of a nonpartitioned index include:

- The ability to define different table space characteristics for each index (for example, different page sizes might help to ensure better space utilization)
- Indexes can be reorganized independently of one another
- Improved performance of drop index operations
- Reduced I/O contention, which helps to provide more efficient concurrent access to the index data
- When individual indexes are dropped, space becomes immediately available to the system without the need for index reorganization

Benefits of a partitioned index include:

- Improved data roll-in and roll-out performance
- Less contention on index pages, because the index is partitioned
- An index B-tree structure for each index partition, which can result in the following benefits:
  - Improved insert, update, delete, and scan performance because the B-tree for an index partition normally contains fewer levels than an index that references all data in the table
  - Improved scan performance and concurrency when partition elimination is in effect. Although partition elimination can be used for both partitioned and nonpartitioned index scans, it is more effective for partitioned index scans because each index partition contains keys for only the corresponding data partition. This configuration can result in having to scan fewer keys and fewer index pages than a similar query over a nonpartitioned index.

Although a nonpartitioned index always preserves order on the index columns, a partitioned index might lose some order across partitions in certain scenarios; for example, if the partitioning columns do not match the index columns, and more than one partition is to be accessed.

During online index creation, concurrent read and write access to the table is permitted. After an online index is built, changes that were made to the table during index creation are applied to the new index. Write access to the table is blocked until index creation completes and the transaction commits. For partitioned indexes, each data partition is quiesced to read-only access *only* while changes that were made to that data partition (during the creation of the index partition) are applied.

Partitioned index support becomes particularly beneficial when you are rolling data in using the ALTER TABLE...ATTACH PARTITION statement. If nonpartitioned indexes exist (not including the XML columns path index, if the table has XML data), issue a SET INTEGRITY statement after partition attachment. This statement is necessary for nonpartitioned index maintenance, range validation, constraints checking, and materialized query table (MQT) maintenance. Nonpartitioned index maintenance can be time-consuming and require large amounts of log space. Use partitioned indexes to avoid this maintenance cost.

If there are nonpartitioned indexes (except XML columns path indexes) on the table to maintain after an attach operation, the SET INTEGRITY...ALL IMMEDIATE UNCHECKED statement behaves as though it were a SET INTEGRITY...IMMEDIATE CHECKED statement. All integrity processing, nonpartitioned index maintenance, and table state transitions are performed as though a SET INTEGRITY...IMMEDIATE CHECKED statement was issued.

The Figure 12 diagram shows two nonpartitioned indexes on a partitioned table, with each index in a separate table space.

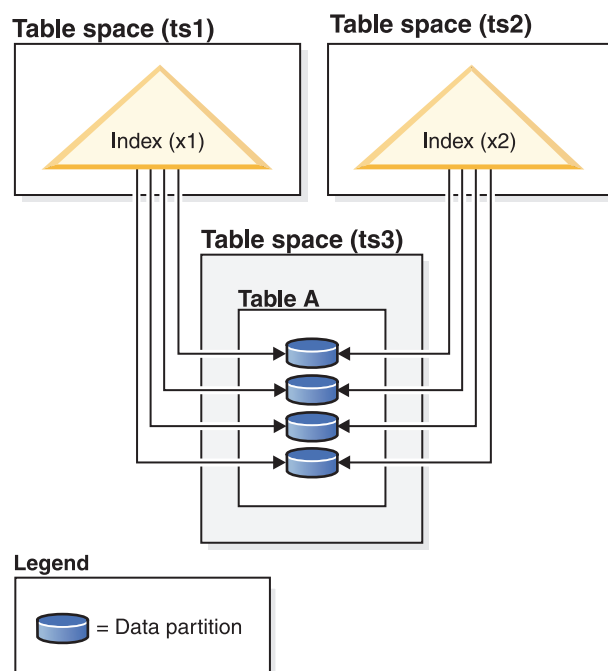

Figure 12. Nonpartitioned indexes on a partitioned table

The Figure 13 diagram shows a partitioned index on a partitioned table that spans two database partitions and resides in a single table space.

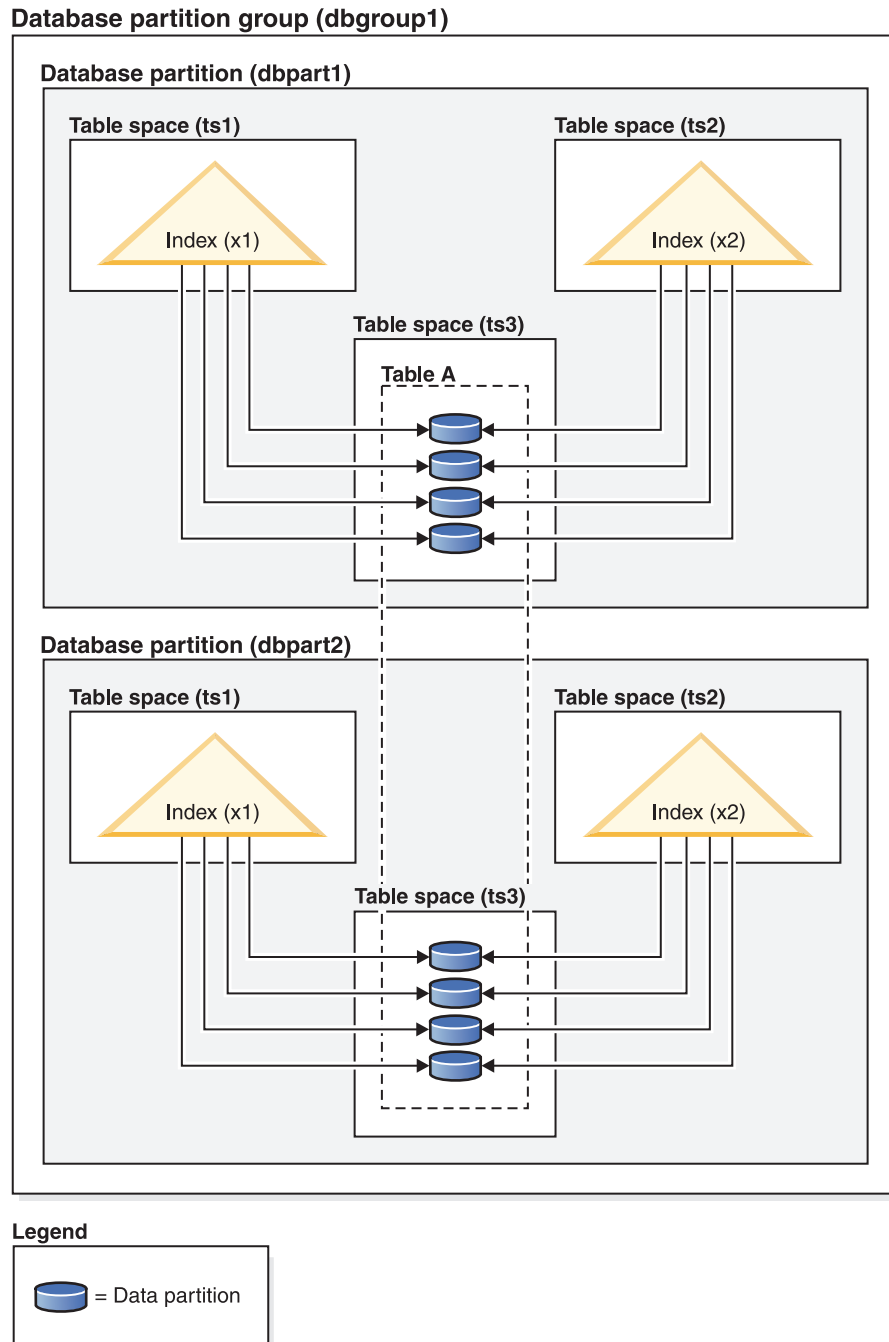

Figure 13. Nonpartitioned index on a table that is both distributed and partitioned

The Figure 14 on page 79 diagram shows a mix of partitioned and nonpartitioned indexes on a partitioned table.



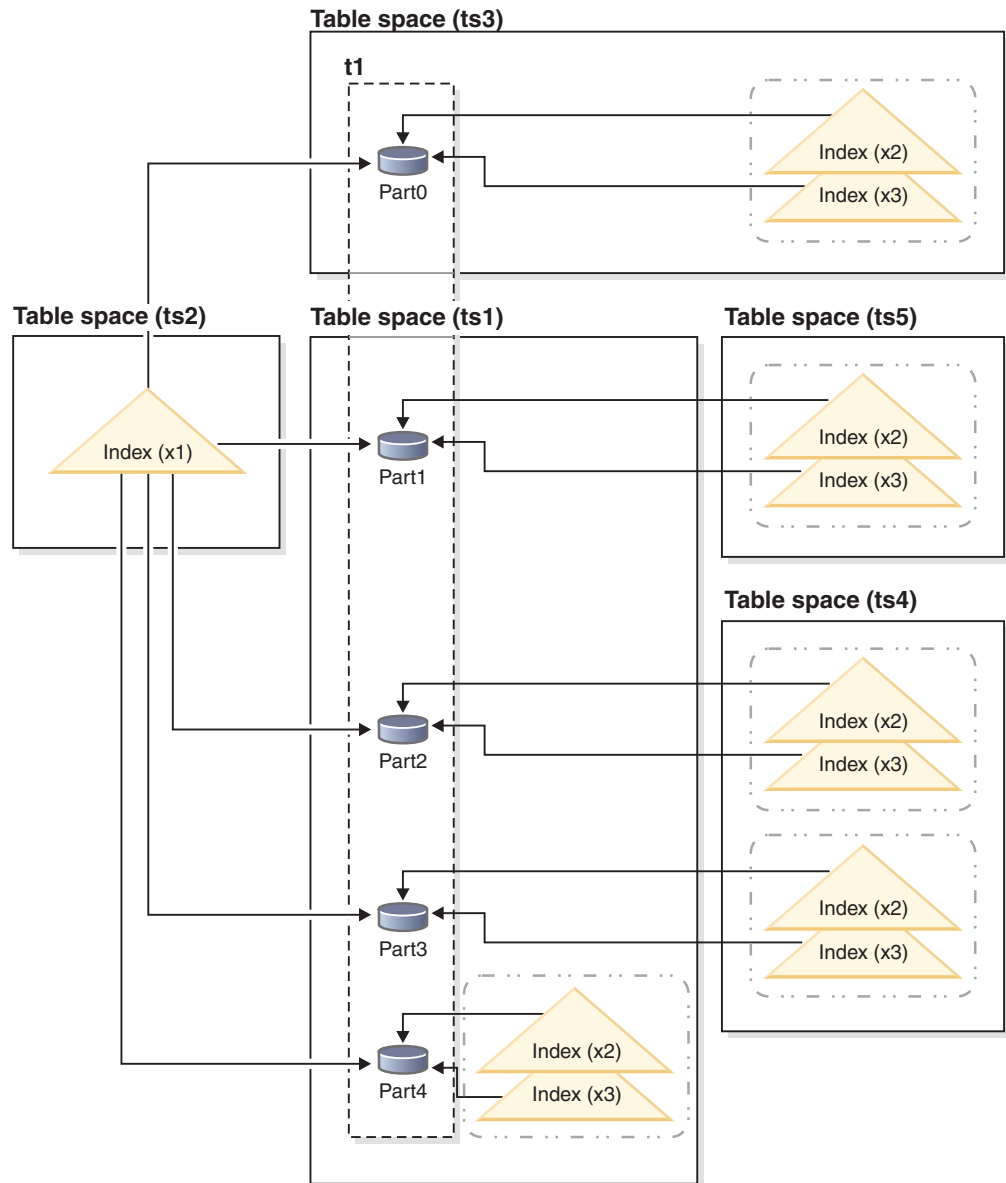

Figure 14. Partitioned and nonpartitioned indexes on a partitioned table

The nonpartitioned index X1 refers to rows in all of the data partitions. By contrast, the partitioned indexes X2 and X3 refer only to rows in the data partition with which they are associated. Table space TS3 also shows the index partitions sharing the table space of the data partitions with which they are associated. This configuration is the default for partitioned indexes.

You can override the default location for nonpartitioned and partitioned indexes, although the way that you do this is different for each. With nonpartitioned indexes, you can specify a table space when you create the index; for partitioned indexes, you need to determine the table spaces in which the index partitions are stored when you create the table.

### Nonpartitioned indexes

To override the index location for nonpartitioned indexes, use the IN clause on the CREATE INDEX statement to specify an alternative table space location for the index. You can place different indexes in different

table spaces, as required. If you create a partitioned table without specifying where to place its nonpartitioned indexes, and you then create an index by using a CREATE INDEX statement that does not specify a table space, the index is created in the table space of the first attached or visible data partition. Each of the following three possible cases is evaluated in order, starting with case 1, to determine where the index is to be created. This evaluation to determine table space placement for the index stops when a matching case is found.

**Case 1:**

When an index table space is specified in the CREATE INDEX...IN *tblspace* statement, use the specified table space for this index.

**Case 2:**

When an index table space is specified in the CREATE TABLE...INDEX IN *tblspace* statement, use the specified table space for this index.

**Case 3:**

When no table space is specified, choose the table space that is used by the first attached or visible data partition.

### **Partitioned indexes**

By default, index partitions are placed in the same table space as the data partitions that they reference. To override this default behavior, you must use the INDEX IN clause for each data partition that you define by using the CREATE TABLE statement. In other words, if you plan to use partitioned indexes for a partitioned table, you must anticipate where you want the index partitions to be stored when you create the table. If you try to use the INDEX IN clause when creating a partitioned index, you receive an error message.

*Example 1:* Given partitioned table SALES (a int, b int, c int), create a unique index A\_IDX.

```
create unique index a_idx on sales (a)
```

Because the table SALES is partitioned, index a\_idx is also created as a partitioned index.

*Example 2:* Create index B\_IDX.

```
create index b_idx on sales (b)
```

*Example 3:* To override the default location for the index partitions in a partitioned index, use the INDEX IN clause for each partition that you define when creating the partitioned table. In the example that follows, indexes for the table Z are created in table space TS3.

```
create table z (a int, b int)
  partition by range (a) (starting from (1)
  ending at (100) index in ts3)
```

```
create index c_idx on z (a) partitioned
```

### **Clustering of nonpartitioned indexes on partitioned tables**

Clustering indexes offer the same benefits for partitioned tables as they do for regular tables. However, care must be taken with the table partitioning key definitions when choosing a clustering index.

You can create a clustering index on a partitioned table using any clustering key. The database server attempts to use the clustering index to cluster data locally within each data partition. During a clustered insert operation, an index lookup is performed to find a suitable record identifier (RID). This RID is used as a starting point in the table when looking for space in which to insert the record. To achieve optimal clustering with good performance, there should be a correlation between the index columns and the table partitioning key columns. One way to ensure such correlation is to prefix the index columns with the table partitioning key columns, as shown in the following example:

```
partition by range (month, region)
create index...(month, region, department) cluster
```

Although the database server does not enforce this correlation, there is an expectation that all keys in the index will be grouped together by partition IDs to achieve good clustering. For example, suppose that a table is partitioned on QUARTER and a clustering index is defined on DATE. There is a relationship between QUARTER and DATE, and optimal clustering of the data with good performance can be achieved because all keys of any data partition are grouped together within the index. Figure 15 on page 82 shows that optimal scan performance is achieved only when clustering correlates with the table partitioning key.

### Clustering with the partitioning key as prefix (correlated)

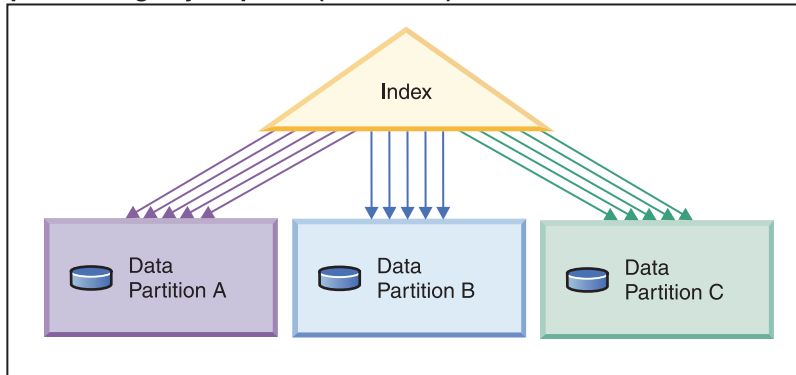

### Clustering does not match partitioning key (locally clustered)

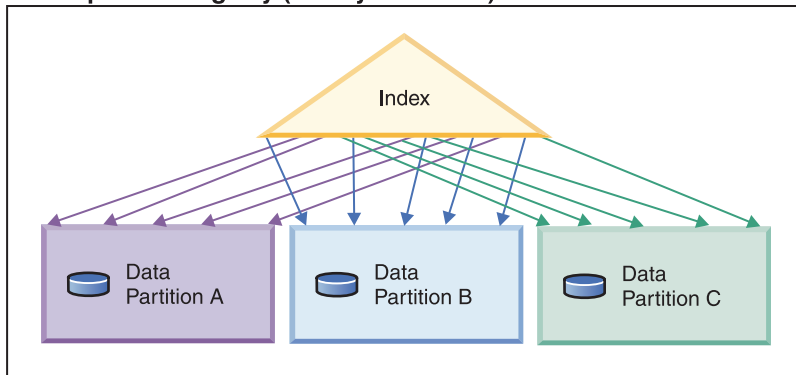

### No clustering

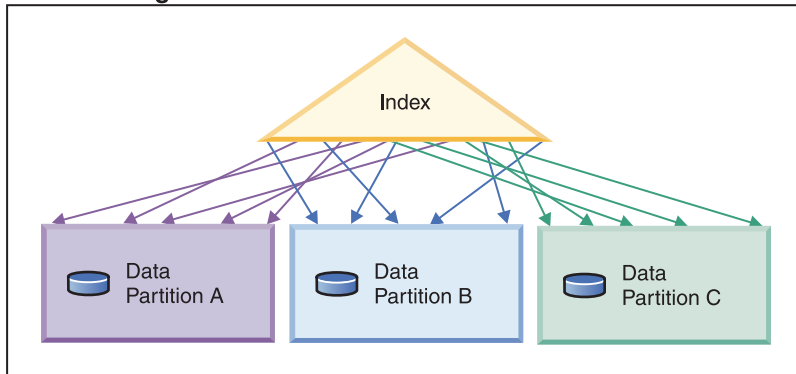

#### Legend

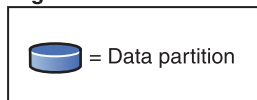

Figure 15. The possible effects of a clustered index on a partitioned table.

Benefits of clustering include:

- Rows are in key order within each data partition.
- Clustering indexes improve the performance of scans that traverse the table in key order, because the scanner fetches the first row of the first page, then each row in that same page before moving on to the next page. This means that only one page of the table needs to be in the buffer pool at any given time. In

contrast, if the table is not clustered, rows are likely fetched from different pages. Unless the buffer pool can hold the entire table, most pages will likely be fetched more than once, greatly slowing down the scan.

If the clustering key is not correlated with the table partitioning key, but the data is locally clustered, you can still achieve the full benefit of the clustered index if there is enough space in the buffer pool to hold one page of each data partition. This is because each fetched row from a particular data partition is near the row that was previously fetched from that same partition (see the second example in Figure 15 on page 82).

## Federated databases

### Server options that affect federated databases

A federated database system is composed of a DB2 data server (the federated database) and one or more data sources. You identify the data sources to the federated database when you issue CREATE SERVER statements. You can also specify server options that refine and control various aspects of federated system operation.

You must install the distributed join installation option and set the **federated** database manager configuration parameter to YES before you can create servers and specify server options. To change server options later, use the ALTER SERVER statement.

The server option values that you specify on the CREATE SERVER statement affect query pushdown analysis, global optimization, and other aspects of federated database operations. For example, you can specify performance statistics as server option values. The *cpu\_ratio* option specifies the relative speeds of the processors at the data source and the federated server, and the *io\_ratio* option specifies the relative rates of the data I/O divides at the data source and the federated server.

Server option values are written to the system catalog (SYSCAT.SERVEROPTIONS), and the optimizer uses this information when it develops access plans for the data source. If a statistic changes (for example, when a data source processor is upgraded), use the ALTER SERVER statement to update the catalog with the new value.

---

## Resource utilization

### Memory allocation

Memory allocation and deallocation occurs at various times. Memory might be allocated to a particular memory area when a specific event occurs (for example, when an application connects), or it might be reallocated in response to a configuration change.

Figure 16 on page 84 shows the different memory areas that the database manager allocates for various uses and the configuration parameters that enable you to control the size of these memory areas. Note that in a partitioned database environment, each database partition has its own database manager shared memory set.

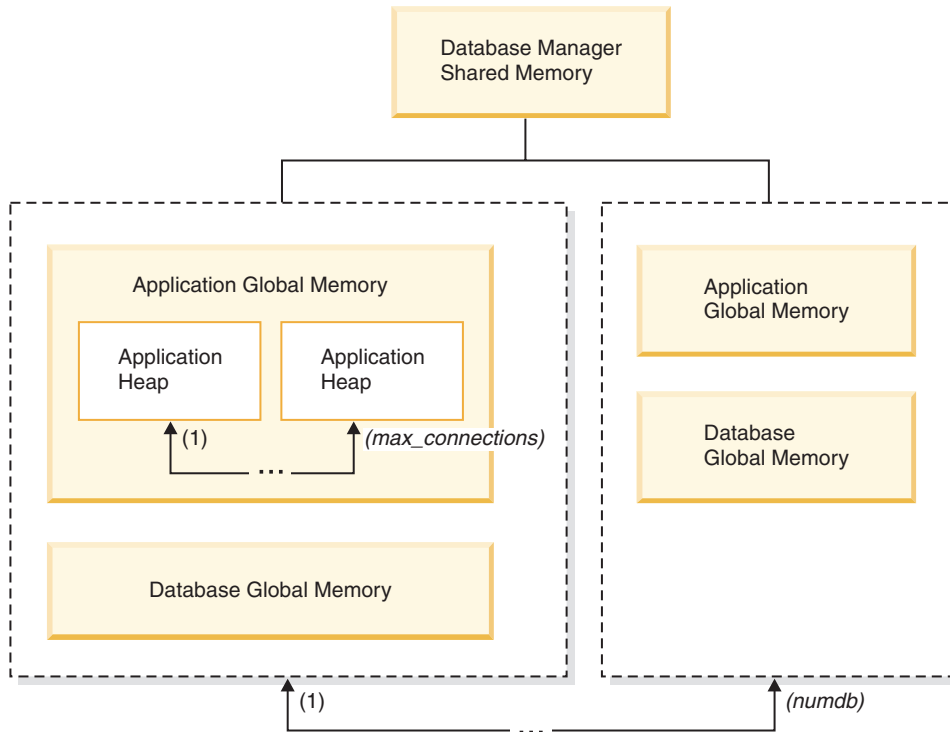

Figure 16. Types of memory allocated by the database manager

Memory is allocated by the database manager whenever one of the following events occurs:

**When the database manager starts (db2start)**

*Database manager shared memory* (also known as *instance shared memory*) remains allocated until the database manager stops (**db2stop**). This area contains information that the database manager uses to manage activity across all database connections. DB2 automatically controls the size of the database manager shared memory.

**When a database is activated or connected to for the first time**

*Database global memory* is used across all applications that connect to the database. The size of the database global memory is specified by the **database\_memory** database configuration parameter. By default, this parameter is set to automatic, allowing DB2 to calculate the initial amount of memory allocated for the database and to automatically configure the database memory size during run time based on the needs of the database.

The following memory areas can be dynamically adjusted:

- Buffer pools (using the ALTER BUFFERPOOL statement)
- Database heap (including log buffers)
- Utility heap
- Package cache
- Catalog cache
- Lock list

The **sortheap**, **sheapthres\_shr**, and **sheapthres** configuration parameters are also dynamically updatable. The only restriction is that **sheapthres** cannot be dynamically changed from 0 to a value that is greater than zero, or vice versa.

Shared sort operations are performed by default, and the amount of database shared memory that can be used by sort memory consumers at any one time is determined by the value of the **sheapthres\_shr** database configuration parameter. Private sort operations are performed only if intra-partition parallelism, database partitioning, and the connection concentrator are all disabled, and the **sheapthres** database manager configuration parameter is set to a non-zero value.

#### **When an application connects to a database**

Each application has its own *application heap*, part of the *application global memory*. You can limit the amount of memory that any one application can allocate by using the **applheapsz** database configuration parameter, or limit overall application memory consumption by using the **appl\_memory** database configuration parameter.

#### **When an agent is created**

*Agent private memory* is allocated for an agent when that agent is assigned as the result of a connect request or a new SQL request in a partitioned database environment. Agent private memory contains memory that is used only by this specific agent. If private sort operations have been enabled, the private sort heap is allocated from agent private memory.

The following configuration parameters limit the amount of memory that is allocated for each type of memory area. Note that in a partitioned database environment, this memory is allocated on each database partition.

**numdb** This database manager configuration parameter specifies the maximum number of concurrent active databases that different applications can use. Because each database has its own global memory area, the amount of memory that can be allocated increases if you increase the value of this parameter.

#### **maxappls**

This database configuration parameter specifies the maximum number of applications that can simultaneously connect to a specific database. The value of this parameter affects the amount of memory that can be allocated for both agent private memory and application global memory for that database.

#### **max\_connections**

This database manager configuration parameter limits the number of database connections or instance attachments that can access the data server at any one time.

#### **max\_coordagents**

This database manager configuration parameter limits the number of database manager coordinating agents that can exist simultaneously across all active databases in an instance (and per database partition in a partitioned database environment). Together with **maxappls** and **max\_connections**, this parameter limits the amount of memory that is allocated for agent private memory and application global memory.

You can use the memory tracker, invoked by the **db2mtrk** command, to view the current allocation of memory within the instance. You can also use the **ADMIN\_GET\_MEM\_USAGE** table function to determine the total memory consumption for the entire instance or for just a single database partition. Use the **MON\_GET\_MEMORY\_SET** and **MON\_GET\_MEMORY\_POOL** table functions to examine the current memory usage at the instance, database, or application level.

On UNIX and Linux operating systems, although the **ipcs** command can be used to list all the shared memory segments, it does not accurately reflect the amount of resources consumed. You can use the **db2mtrk** command as an alternative to **ipcs**.

## Memory sets overview

The DB2 memory manager groups memory allocations from the operating system into *memory sets*.

The memory in a given memory set shares common attributes, such as the general purpose for which the memory is used, its expected volatility, and what, if any constraints there might be on its growth. For example, buffer pools are allocated from the database memory set, and are allocated as long as the database is active. Statement heaps are allocated from the application memory set on behalf of specific SQL preparation requests from an application, and last only as long as the statement compilation operation.

Within each memory set, specific areas of memory get assigned for purposes that are generally related to the specific memory set type. For example, certain types of database-level processing use memory from the database memory set; memory required for the fast communications manager is allocated from the FCM memory set.

Table 1 lists the different types of memory sets.

*Table 1. Memory sets*

Memory set type*	Description	Scope of memory allocated from this set
DBMS	Database memory manager set. Most memory in this set is used for basic infrastructure purposes, including communication services that are not specific to a database. This memory set does not require any configuration, although user-configurable memory from this set include the monitor heap size ( <b>mon_heap_sz</b> ) and the audit buffer size ( <b>audit_buf_sz</b> ).	Instance
FMP	Fenced mode process memory set. Memory allocated from this set is used for communications between agents and fenced mode processes. Memory allocations from this set can be configured with the <b>DB2_FMP_COMM_HEAPSZ</b> registry variable and the <b>as1heapsz</b> configuration parameter.	Instance
PRIVATE	Memory allocated from this set is used for general purposes, including basic infrastructure and diagnostics support. With the exception of systems that use the private sort model, where the <b>sheapthres</b> configuration parameter is set to a value other than 0, the private memory set does not require any configuration.	Instance



Table 1. Memory sets (continued)

Memory set type*	Description	Scope of memory allocated from this set
DATABASE	Database memory set. Memory allocated from this set is generally used for processing that is specific to a single database, but not specific to an application. Examples of memory allocated from this set includes the buffer pools, database heap, locklist, utility heap, package cache, catalog cache, and the shared sort heap. This set can be configured through the <b>database_memory</b> database configuration parameter. You can also use the self-tuning memory manager (STMM) to tune this memory area.	Database
APPLICATION	Application memory set. Memory allocated from this set is generally used for application-specific processing. Memory allocated from this set includes application, statistics and statement heaps, and a non-configurable shared work area. This set can be configured through the <b>appl_memory</b> database configuration parameter.	Database
FCM	Fast communication manager memory set. Memory allocated from this set is used exclusively by the fast communications manager. Memory from this set can be configured with the <b>fcm_num_buffers</b> and the <b>fcm_num_channels</b> database manager configuration parameters.	Host
* The names shown in the first column are the names returned for the <b>memory_set_type</b> monitor element.		

### Database manager shared memory

Database manager shared memory is organized into several different memory areas. Configuration parameters enable you to control the sizes of these areas.

Figure 17 on page 88 shows how database manager shared memory is allocated.

### Database manager shared memory (including FCM)



### Database global memory (database\_memory)

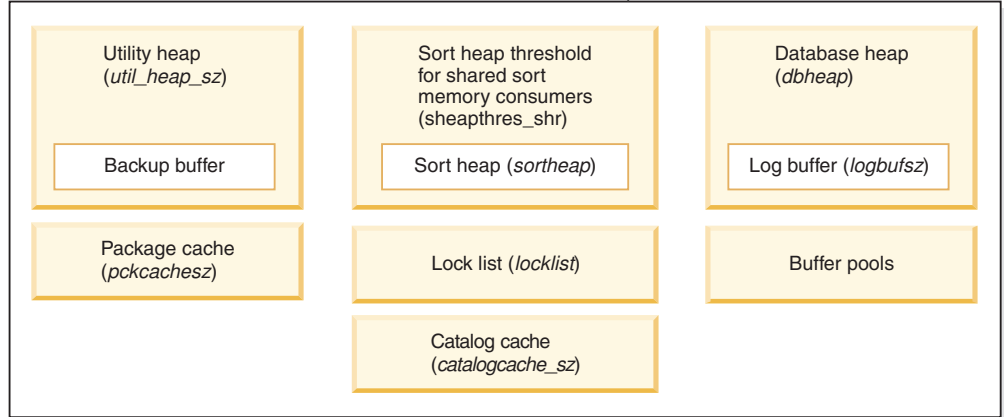

### Application global memory (appl\_memory)

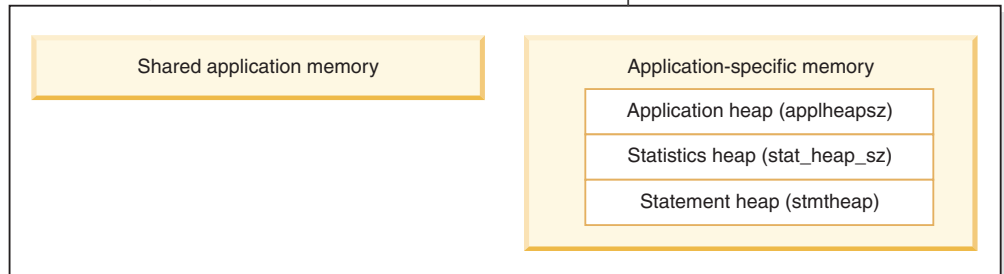

### Agent private memory

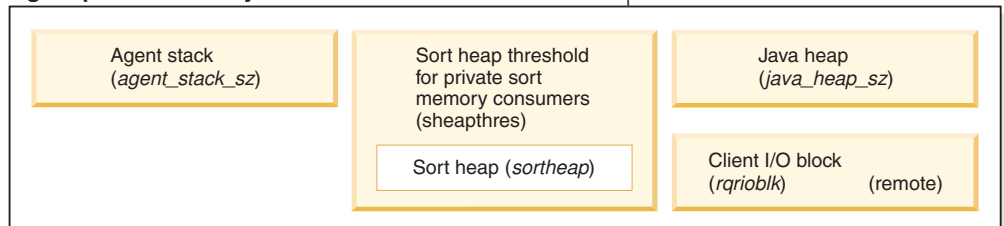

### Agent/Application shared memory

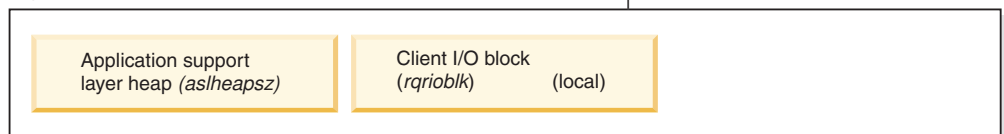

Note: Box size does not indicate relative size of memory.

Figure 17. How memory is used by the database manager

### Database Manager Shared Memory

Database Manager Shared Memory is affected by the following configuration parameters:

- The **audit\_buf\_sz** configuration parameter determines the size of the buffer used in database auditing activities.

- The **mon\_heap\_sz** configuration parameter determines the size of the memory area used for database system monitoring data.
- For partitioned database systems, the Fast Communications Manager (FCM) requires substantial memory space, especially if the value of **fc\_num\_buffers** is large. The FCM memory requirements are allocated from the FCM Buffer Pool.

#### Database global memory

Database global memory is affected by the size of the buffer pools and by the following database configuration parameters:

- **catalogcache\_sz**
- **database\_memory**
- **dbheap**
- **locklist**
- **pckcachesz**
- **sheapthres\_shr**
- **util\_heap\_sz**

#### Application global memory

Application global memory can be controlled by the **appl\_memory** configuration parameter. The following database configuration parameters can be used to limit the amount of memory that any one application can consume:

- **applheapsz**
- **stat\_heap\_sz**
- **stmtheap**

#### Agent private memory

Each agent requires its own private memory region. The data server creates as many agents as it needs and in accordance with configured memory resources. You can control the maximum number of coordinator agents using the **max\_coordagents** database manager configuration parameter. The maximum size of each agent's private memory region is determined by the values of the following configuration parameters:

- **agent\_stack\_sz**
- **sheapthres** and **sortheap**

#### Agent/Application shared memory

The total number of agent/application shared memory segments for local clients is limited by the lesser of the following two values:

- The total value of the **maxappls** database configuration parameter for all active databases
- The value of the **max\_coordagents** database configuration parameter

**Note:** In configurations where engine concentration is enabled (**max\_connections** > **max\_coordagents**), application memory consumption is limited by **max\_connections**.

Agent/Application shared memory is also affected by the following database configuration parameters:

- **aslheapsz**
- **rqrioblk**

## The FCM buffer pool and memory requirements

In a partitioned database system, the fast communication manager (FCM) buffer shared memory is allocated from the database manager shared memory.

This is shown in Figure 18.

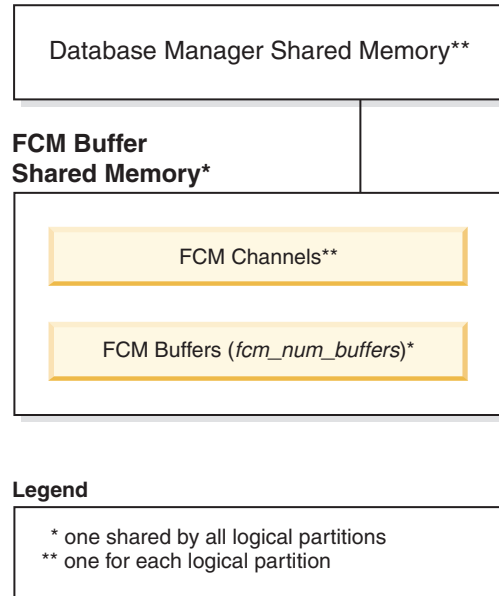

Figure 18. The FCM buffer pool when multiple logical partitions are used

The number of FCM buffers for each database partition is controlled by the **fcm\_num\_buffers** database manager configuration parameter. By default, this parameter is set to automatic. To tune this parameter manually, use data from the **buff\_free** and **buff\_free\_bottom** system monitor elements.

The number of FCM channels for each database partition is controlled by the **fcm\_num\_channels** database manager configuration parameter. By default, this parameter is set to automatic. To tune this parameter manually, use data from the **ch\_free** and **ch\_free\_bottom** system monitor elements.

The DB2 database manager can automatically manage FCM memory resources by allocating more FCM buffers and channels as needed. This leads to improved performance and prevents “out of FCM resource” runtime errors. On the Linux operating system, the database manager can preallocate a larger amount of system memory for FCM buffers and channels, up to a maximum default amount of 4 GB. Memory space is impacted only when additional FCM buffers or channels are required. To enable this behavior, set the **FCM\_MAXIMIZE\_SET\_SIZE** option of the **DB2\_FCM\_SETTINGS** registry variable to YES (or TRUE). YES is the default value.

### Guidelines for tuning parameters that affect memory usage

When tuning memory manually (that is, when not using the self-tuning memory manager), benchmark tests provide the best information about setting appropriate values for memory parameters.

In benchmark testing, representative and worst-case SQL statements are run against the server, and the values of memory parameters are changed until a point

of diminishing returns for performance is found. This is the point at which additional memory allocation provides no further performance value to the application.

The upper memory allocation limits for several parameters might be beyond the scope of existing hardware and operating systems. These limits allow for future growth. It is good practice to not set memory parameters at their highest values unless those values can be justified. This applies even to systems that have plenty of available memory. The idea is to prevent the database manager from quickly taking up all of the available memory on a system. Moreover, managing large amounts of memory incurs additional overhead.

For most configuration parameters, memory is committed as it is required, and the parameter settings determine the maximum size of a particular memory heap. For buffer pools and the following configuration parameters, however, all of the specified memory is allocated:

- **aslheapsz**
- **fcm\_num\_buffers**
- **fcm\_num\_channels**
- **locklist**

For valid parameter ranges, refer to the detailed information about each parameter.

## Self-tuning memory overview

Self-tuning memory simplifies the task of memory configuration by automatically setting values for memory configuration parameters and sizing buffer pools. When enabled, the memory tuner dynamically distributes available memory resources among the following memory consumers: buffer pools, locking memory, package cache, and sort memory.

Self-tuning memory is enabled through the **self\_tuning\_mem** database configuration parameter.

The following memory-related database configuration parameters can be automatically tuned:

- **database\_memory** - Database shared memory size
- **locklist** - Maximum storage for lock list
- **maxlocks** - Maximum percent of lock list before escalation
- **pckcachesz** - Package cache size
- **sheapthres\_shr** - Sort heap threshold for shared sorts
- **sortheap** - Sort heap size

### Self-tuning memory

Starting in DB2 Version 9, a memory-tuning feature simplifies the task of memory configuration by automatically setting values for several memory configuration parameters. When enabled, the memory tuner dynamically distributes available memory resources among the following memory consumers: buffer pools, locking memory, package cache, and sort memory.

The tuner works within the memory limits that are defined by the **database\_memory** configuration parameter. The value of this parameter can be automatically tuned as well. When self-tuning is enabled (when the value of **database\_memory** has been set to AUTOMATIC), the tuner determines the overall

memory requirements for the database and increases or decreases the amount of memory allocated for database shared memory, depending on current database requirements. For example, if current database requirements are high and there is sufficient free memory on the system, more memory is allocated for database shared memory. If the database memory requirements decrease, or if the amount of free memory on the system becomes too low, some database shared memory is released.

If the **database\_memory** configuration parameter is not set to **AUTOMATIC**, the database uses the amount of memory that has been specified for this parameter, distributing it across the memory consumers as required. You can specify the amount of memory in one of two ways: by setting **database\_memory** to some numeric value or by setting it to **COMPUTED**. In the latter case, the total amount of memory is based on the sum of the initial values of the database memory heaps at database startup time.

You can also enable the memory consumers for self tuning as follows:

- For buffer pools, use the **ALTER BUFFERPOOL** or the **CREATE BUFFERPOOL** statement (specifying the **AUTOMATIC** keyword)
- For locking memory, use the **locklist** or the **maxlocks** database configuration parameter (specifying a value of **AUTOMATIC**)
- For the package cache, use the **pckcachesz** database configuration parameter (specifying a value of **AUTOMATIC**)
- For sort memory, use the **sheapthres\_shr** or the **sortheap** database configuration parameter (specifying a value of **AUTOMATIC**)

Changes resulting from self-tuning operations are recorded in memory tuning log files that are located in the **stmmlog** subdirectory. These log files contain summaries of the resource demands from each memory consumer during specific tuning intervals, which are determined by timestamps in the log entries.

If little memory is available, the performance benefits of self tuning will be limited. Because tuning decisions are based on database workload, workloads with rapidly changing memory requirements limit the effectiveness of the self-tuning memory manager (STMM). If the memory characteristics of your workload are constantly changing, the STMM will tune less frequently and under shifting target conditions. In this scenario, the STMM will not achieve absolute convergence, but will try instead to maintain a memory configuration that is tuned to the current workload.

## Enabling self-tuning memory

Self-tuning memory simplifies the task of memory configuration by automatically setting values for memory configuration parameters and sizing buffer pools.

### About this task

When enabled, the memory tuner dynamically distributes available memory resources between several memory consumers, including buffer pools, locking memory, package cache, and sort memory.

### Procedure

1. Enable self-tuning memory for the database by setting the **self\_tuning\_mem** database configuration parameter to **ON** using the **UPDATE DATABASE CONFIGURATION** command or the **db2CfgSet** API.

2. To enable the self tuning of memory areas that are controlled by memory configuration parameters, set the relevant configuration parameters to `AUTOMATIC` using the `UPDATE DATABASE CONFIGURATION` command or the `db2CfgSet` API.
3. To enable the self tuning of a buffer pool, set the buffer pool size to `AUTOMATIC` using the `CREATE BUFFERPOOL` statement or the `ALTER BUFFERPOOL` statement. In a partitioned database environment, that buffer pool should not have any entries in `SYSCAT.BUFFERPOOLDBPARTITIONS`.

## Results

### Note:

1. Because self-tuned memory is distributed between different memory consumers, at least two memory areas must be concurrently enabled for self tuning at any given time; for example, locking memory and database shared memory. The memory tuner actively tunes memory on the system (the value of the `self_tuning_mem` database configuration parameter is `ON`) when one of the following conditions is true:
  - One configuration parameter or buffer pool size is set to `AUTOMATIC`, and the `database_memory` database configuration parameter is set to either a numeric value or to `AUTOMATIC`
  - Any two of `locklist`, `sheapthres_shr`, `pckcachesz`, or buffer pool size is set to `AUTOMATIC`
  - The `sortheap` database configuration parameter is set to `AUTOMATIC`
2. The value of the `locklist` database configuration parameter is tuned together with the `maxlocks` database configuration parameter. Disabling self tuning of the `locklist` parameter automatically disables self tuning of the `maxlocks` parameter, and enabling self tuning of the `locklist` parameter automatically enables self tuning of the `maxlocks` parameter.
3. Automatic tuning of `sortheap` or the `sheapthres_shr` database configuration parameter is allowed only when the database manager configuration parameter `sheapthres` is set to `0`.
4. The value of `sortheap` is tuned together with `sheapthres_shr`. Disabling self tuning of the `sortheap` parameter automatically disables self tuning of the `sheapthres_shr` parameter, and enabling self tuning of the `sheapthres_shr` parameter automatically enables self tuning of the `sortheap` parameter.
5. Self-tuning memory runs only on the high availability disaster recovery (HADR) primary server. When self-tuning memory is activated on an HADR system, it will never run on the secondary server, and it runs on the primary server only if the configuration is set properly. If the HADR database roles are switched, self-tuning memory operations will also switch so that they run on the new primary server. After the primary database starts, or the standby database converts to a primary database through takeover, the self-tuning memory manager (STMM) engine dispatchable unit (EDU) might not start until the first client connects.

## Disabling self-tuning memory

Self-tuning memory can be disabled for the entire database or for one or more configuration parameters or buffer pools.

### About this task

If self-tuning memory is disabled for the entire database, the memory configuration parameters and buffer pools that are set to `AUTOMATIC` remain

enabled for automatic tuning; however, the memory areas remain at their current size.

## Procedure

1. Disable self-tuning memory for the database by setting the **self\_tuning\_mem** database configuration parameter to OFF using the **UPDATE DATABASE CONFIGURATION** command or the db2CfgSet API.
2. To disable the self tuning of memory areas that are controlled by memory configuration parameters, set the relevant configuration parameters to MANUAL or specify numeric parameter values using the **UPDATE DATABASE CONFIGURATION** command or the db2CfgSet API.
3. To disable the self tuning of a buffer pool, set the buffer pool size to a specific value using the ALTER BUFFERPOOL statement.

## Results

### Note:

- In some cases, a memory configuration parameter can be enabled for self tuning only if another related memory configuration parameter is also enabled. This means that, for example, disabling self-tuning memory for the **locklist** or the **sortheap** database configuration parameter disables self-tuning memory for the **maxlocks** or the **sheapthres\_shr** database configuration parameter, respectively.

## Determining which memory consumers are enabled for self tuning

You can view the self-tuning memory settings that are controlled by configuration parameters or that apply to buffer pools.

### About this task

It is important to note that responsiveness of the memory tuner is limited by the time required to resize a memory consumer. For example, reducing the size of a buffer pool can be a lengthy process, and the performance benefits of trading buffer pool memory for sort memory might not be immediately realized.

## Procedure

- To view the settings for configuration parameters, use one of the following methods:
  - Use the **GET DATABASE CONFIGURATION** command, specifying the **SHOW DETAIL** parameter.

The memory consumers that can be enabled for self tuning are grouped together in the output as follows:

Description	Parameter	Current Value	Delayed Value
Self tuning memory	(SELF_TUNING_MEM)	ON (Active)	ON
Size of database shared memory (4KB)	(DATABASE_MEMORY)	AUTOMATIC(37200)	AUTOMATIC(37200)
Max storage for lock list (4KB)	(LOCKLIST)	AUTOMATIC(7456)	AUTOMATIC(7456)
Percent. of lock lists per application	(MAXLOCKS)	AUTOMATIC(98)	AUTOMATIC(98)
Package cache size (4KB)	(PCKCACHESZ)	AUTOMATIC(5600)	AUTOMATIC(5600)
Sort heap thres for shared sorts (4KB)	(SHEAPTHRES_SHR)	AUTOMATIC(5000)	AUTOMATIC(5000)
Sort list heap (4KB)	(SORTHEAP)	AUTOMATIC(256)	AUTOMATIC(256)

- Use the db2CfgGet API.

The following values are returned:

SQLF_OFF	0
SQLF_ON_ACTIVE	2
SQLF_ON_INACTIVE	3



SQLF\_ON\_ACTIVE indicates that self tuning is both enabled and active, whereas SQLF\_ON\_INACTIVE indicates that self tuning is enabled but currently inactive.

- To view the self-tuning settings for buffer pools, use one of the following methods:
  - To retrieve a list of the buffer pools that are enabled for self tuning from the command line, use the following query:

```
SELECT BPNAME, NPAGES FROM SYSCAT.BUFFERPOOLS
```

When self tuning is enabled for a buffer pool, the NPAGES field in the SYSCAT.BUFFERPOOLS view for that particular buffer pool is set to -2. When self tuning is disabled, the NPAGES field is set to the current size of the buffer pool.

- To determine the current size of buffer pools that are enabled for self tuning, use the **GET SNAPSHOT** command and examine the current size of the buffer pools (the value of the **bp\_cur\_buffsz** monitor element):

```
GET SNAPSHOT FOR BUFFERPOOLS ON database-alias
```

An ALTER BUFFERPOOL statement that specifies the size of a buffer pool on a particular database partition creates an exception entry (or updates an existing entry) for that buffer pool in the SYSCAT.BUFFERPOOLDBPARTITIONS catalog view. If an exception entry for a buffer pool exists, that buffer pool does not participate in self-tuning operations when the default buffer pool size is set to AUTOMATIC.

### Self-tuning memory in partitioned database environments

When using the self-tuning memory feature in partitioned database environments, there are a few factors that determine whether the feature will tune the system appropriately.

When self-tuning memory is enabled for partitioned databases, a single database partition is designated as the tuning partition, and all memory tuning decisions are based on the memory and workload characteristics of that database partition. After tuning decisions on that partition are made, the memory adjustments are distributed to the other database partitions to ensure that all database partitions maintain similar configurations.

The single tuning partition model assumes that the feature will be used only when all of the database partitions have similar memory requirements. Use the following guidelines when determining whether to enable self-tuning memory on your partitioned database.

### Cases where self-tuning memory for partitioned databases is recommended

When all database partitions have similar memory requirements and are running on similar hardware, self-tuning memory can be enabled without any modifications. These types of environments share the following characteristics:

- All database partitions are on identical hardware, and there is an even distribution of multiple logical database partitions to multiple physical database partitions
- There is a perfect or near-perfect distribution of data
- Workloads are distributed evenly across database partitions, meaning that no database partition has higher memory requirements for one or more heaps than any of the others

In such an environment, if all database partitions are configured equally, self-tuning memory will properly configure the system.

### **Cases where self-tuning memory for partitioned databases is recommended with qualification**

In cases where most of the database partitions in an environment have similar memory requirements and are running on similar hardware, it is possible to use self-tuning memory as long as some care is taken with the initial configuration. These systems might have one set of database partitions for data, and a much smaller set of coordinator partitions and catalog partitions. In such environments, it can be beneficial to configure the coordinator partitions and catalog partitions differently than the database partitions that contain data.

Self-tuning memory should be enabled on all of the database partitions that contain data, and one of these database partitions should be designated as the tuning partition. And because the coordinator and catalog partitions might be configured differently, self-tuning memory should be disabled on those partitions. To disable self-tuning memory on the coordinator and catalog partitions, set the `self_tuning_mem` database configuration parameter on these partitions to OFF.

### **Cases where self-tuning memory for partitioned databases is not recommended**

If the memory requirements of each database partition are different, or if different database partitions are running on significantly different hardware, it is good practice to disable the self-tuning memory feature. You can disable the feature by setting the `self_tuning_mem` database configuration parameter to OFF on all partitions.

### **Comparing the memory requirements of different database partitions**

The best way to determine whether the memory requirements of different database partitions are sufficiently similar is to consult the snapshot monitor. If the following snapshot elements are similar on all database partitions (differing by no more than 20%), the memory requirements of the database partitions can be considered sufficiently similar.

Collect the following data by issuing the command: `get snapshot for database on <dbname>`

```
Locks held currently           = 0
Lock waits                     = 0
Time database waited on locks (ms) = 0
Lock list memory in use (Bytes) = 4968
Lock escalations              = 0
Exclusive lock escalations     = 0

Total Shared Sort heap allocated = 0
Shared Sort heap high water mark = 0
Post threshold sorts (shared memory) = 0
Sort overflows                 = 0

Package cache lookups          = 13
Package cache inserts          = 1
Package cache overflows        = 0
Package cache high water mark (Bytes) = 655360

Number of hash joins           = 0
Number of hash loops           = 0
```

```

Number of hash join overflows           = 0
Number of small hash join overflows     = 0
Post threshold hash joins (shared memory) = 0

Number of OLAP functions                 = 0
Number of OLAP function overflows       = 0
Active OLAP functions                    = 0

```

Collect the following data by issuing the command: get snapshot for bufferpools on <dbname>

```

Buffer pool data logical reads          = 0
Buffer pool data physical reads        = 0
Buffer pool index logical reads         = 0
Buffer pool index physical reads        = 0
Total buffer pool read time (milliseconds) = 0
Total buffer pool write time (milliseconds)= 0

```

### Using self-tuning memory in partitioned database environments

When self-tuning memory is enabled in partitioned database environments, there is a single database partition (known as the *tuning partition*) that monitors the memory configuration and propagates any configuration changes to all other database partitions to maintain a consistent configuration across all the participating database partitions.

The tuning partition is selected on the basis of several characteristics, such as the number of database partitions in the partition group and the number of buffer pools.

- To determine which database partition is currently specified as the tuning partition, call the **ADMIN\_CMD** procedure as follows:  
CALL SYSPROC.ADMIN\_CMD('get stmm tuning dbpartitionnum')
- To change the tuning partition, call the **ADMIN\_CMD** procedure as follows:  
CALL SYSPROC.ADMIN\_CMD('update stmm tuning dbpartitionnum <partitionnum>')

The tuning partition is updated asynchronously or at the next database startup. To have the memory tuner automatically select the tuning partition, enter -1 for the *partitionnum* value.

### Starting the memory tuner in partitioned database environments

In a partitioned database environment, the memory tuner will start only if the database is activated by an explicit **ACTIVATE DATABASE** command, because self-tuning memory requires that all partitions be active.

### Disabling self-tuning memory for a specific database partition

- To disable self-tuning memory for a subset of database partitions, set the **self\_tuning\_mem** database configuration parameter to OFF for those database partitions.
- To disable self-tuning memory for a subset of the memory consumers that are controlled by configuration parameters on a specific database partition, set the value of the relevant configuration parameter or the buffer pool size to MANUAL or to some specific value on that database partition. It is recommended that self-tuning memory configuration parameter values be consistent across all running partitions.
- To disable self-tuning memory for a particular buffer pool on a specific database partition, issue the ALTER BUFFERPOOL statement, specifying a size value and the partition on which self-tuning memory is to be disabled.

An ALTER BUFFERPOOL statement that specifies the size of a buffer pool on a particular database partition will create an exception entry (or update an existing entry) for that buffer pool in the SYSCAT.BUFFERPOOLDBPARTITIONS catalog view. If an exception entry for a buffer pool exists, that buffer pool will not participate in self-tuning operations when the default buffer pool size is set to AUTOMATIC. To remove an exception entry so that a buffer pool can be enabled for self tuning:

1. Disable self tuning for this buffer pool by issuing an ALTER BUFFERPOOL statement, setting the buffer pool size to a specific value.
2. Issue another ALTER BUFFERPOOL statement to set the size of the buffer pool on this database partition to the default.
3. Enable self tuning for this buffer pool by issuing another ALTER BUFFERPOOL statement, setting the buffer pool size to AUTOMATIC.

### **Enabling self-tuning memory in nonuniform environments**

Ideally, data should be distributed evenly across all database partitions, and the workload that is run on each partition should have similar memory requirements. If the data distribution is skewed, so that one or more of your database partitions contain significantly more or less data than other database partitions, these anomalous database partitions should not be enabled for self tuning. The same is true if the memory requirements are skewed across the database partitions, which can happen, for example, if resource-intensive sorts are only performed on one partition, or if some database partitions are associated with different hardware and more available memory than others. Self tuning memory can still be enabled on some database partitions in this type of environment. To take advantage of self-tuning memory in environments with skew, identify a set of database partitions that have similar data and memory requirements and enable them for self tuning. Memory in the remaining partitions should be configured manually.

## **Buffer pool management**

A buffer pool provides working memory and cache for database pages.

Buffer pools improve database system performance by allowing data to be accessed from memory instead of from disk. Because most page data manipulation takes place in buffer pools, configuring buffer pools is the single most important tuning area.

When an application accesses a table row, the database manager looks for the page containing that row in the buffer pool. If the page cannot be found there, the database manager reads the page from disk and places it in the buffer pool. The data can then be used to process the query.

Memory is allocated for buffer pools when a database is activated. The first application to connect might cause an implicit database activation. Buffer pools can be created, re-sized, or dropped while the database manager is running. The ALTER BUFFERPOOL statement can be used to increase the size of a buffer pool. By default, and if sufficient memory is available, the buffer pool is re-sized as soon as the statement executes. If sufficient memory is unavailable when the statement executes, memory is allocated when the database reactivates. If you decrease the size of the buffer pool, memory is deallocated when the transaction commits. Buffer pool memory is freed when the database deactivates.

To ensure that an appropriate buffer pool is available in all circumstances, DB2 creates small system buffer pools, one with each of the following page sizes: 4 KB,

8 KB, 16 KB, and 32 KB. The size of each buffer pool is 16 pages. These buffer pools are hidden; they are not in the system catalog or in the buffer pool system files. You cannot use or alter them directly, but DB2 uses these buffer pools in the following circumstances:

- When a specified buffer pool is not started because it was created using the DEFERRED keyword, or when a buffer pool of the required page size is inactive because insufficient memory is available to create it  
A message is written to the administration notification log. If necessary, table spaces are remapped to a system buffer pool. Performance might be drastically reduced.
- When buffer pools cannot be brought up during a database connection attempt  
This problem is likely to have a serious cause, such as an out-of-memory condition. Although DB2 will continue to be fully functional because of the system buffer pools, performance will degrade drastically. You should address this problem immediately. You will receive a warning when this occurs, and a message is written to the administration notification log.

When you create a buffer pool, the page size will be the one specified when the database was created, unless you explicitly specify a different page size. Because pages can be read into a buffer pool only if the table space page size is the same as the buffer pool page size, the page size of your table spaces should determine the page size that you specify for buffer pools. You cannot alter the page size of a buffer pool after you create it.

The memory tracker, which you can invoke by issuing the **db2mtrk** command, enables you to view the amount of database memory that has been allocated to buffer pools. You can also use the **GET SNAPSHOT** command and examine the current size of the buffer pools (the value of the **bp\_cur\_buffsz** monitor element).

The buffer pool priority for activities can be controlled as part of the larger set of workload management functionality provided by the DB2 workload manager. For more information, see “Introduction to DB2 workload manager concepts” and “Buffer pool priority of service classes”.

## Buffer pool management of data pages

Buffer pool pages can be either in-use or not, and dirty or clean.

- *In-use pages* are pages that are currently being read or updated. If a page is being updated, it can only be accessed by the updater. However, if the page is not being updated, there can be numerous concurrent readers.
- *Dirty pages* contain data that has been changed but not yet written to disk.

Pages remain in the buffer pool until the database shuts down, the space occupied by a page is required for another page, or the page is explicitly purged from the buffer pool, for example, as part of dropping an object. The following criteria determine which page is removed when another page requires its space:

- How recently was the page referenced?
- What is the probability that the page will be referenced again?
- What type of data does the page contain?
- Was the page changed in memory but not written out to disk?

You can use the FLUSH BUFFERPOOLS statement to reduce the recovery window of a database in the event of a crash or before database operations such as online backups. For more information, see the FLUSH BUFFERPOOLS statement.

Changed pages are always written out to disk before being overwritten. Changed pages that are written out to disk are not automatically removed from the buffer pool unless the space is needed.

### Page-cleaner agents

In a well-tuned system, it is usually the page-cleaner agents that write changed or dirty pages to disk. Page-cleaner agents perform I/O as background processes and allow applications to run faster because their agents can perform actual transaction work. Page-cleaner agents are sometimes referred to as *asynchronous page cleaners* or *asynchronous buffer writers*, because they are not coordinated with the work of other agents and work only when required.

To improve performance for update-intensive workloads, you might want to enable *proactive page cleaning*, whereby page cleaners behave more proactively in choosing which dirty pages get written out at any given point in time. This is particularly true if snapshots reveal that there are a significant number of synchronous data-page or index-page writes in relation to the number of asynchronous data-page or index-page writes.

Figure 19 illustrates how the work of managing the buffer pool can be shared between page-cleaner agents and database agents.

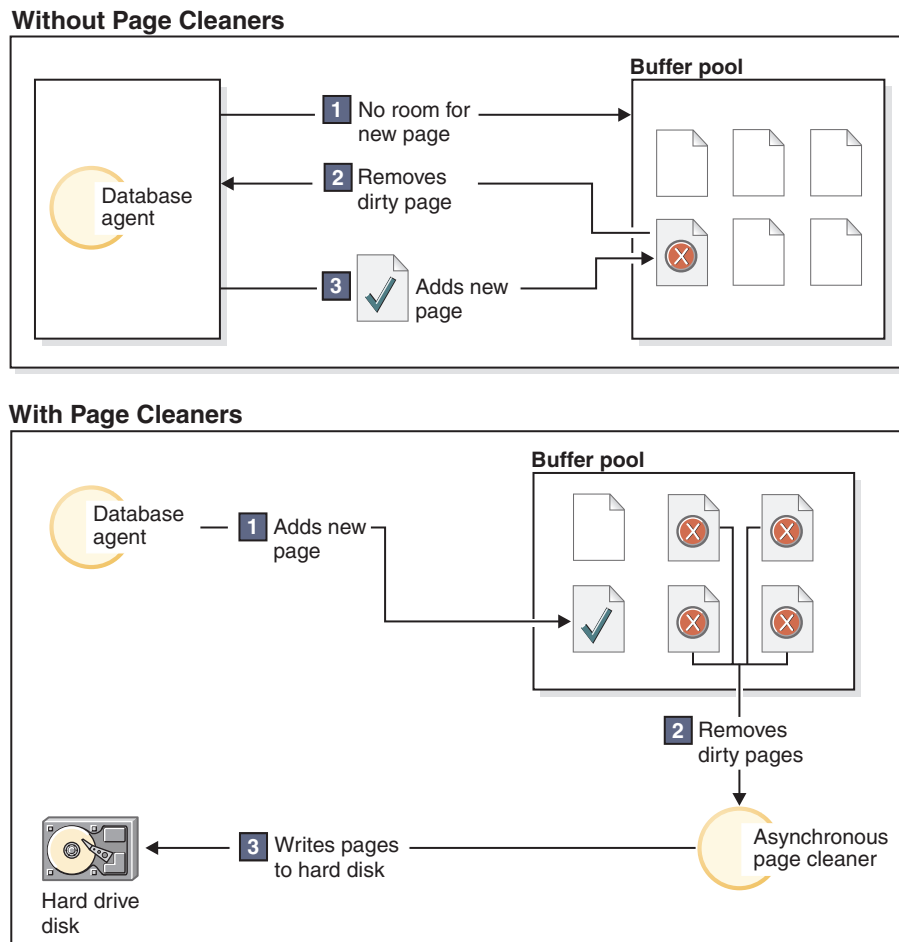

Figure 19. Asynchronous page cleaning. Dirty pages are written out to disk.

## Page cleaning and fast recovery

Database recovery after a system crash is faster if more pages have been written to disk, because the database manager can rebuild more of the buffer pool from disk than by replaying transactions from the database log files.

The size of the log that must be read during recovery is the difference between the location of the following records in the log:

- The most recently written log record
- The log record that describes the oldest change to data in the buffer pool

Page cleaners write dirty pages to disk in such a manner that the size of the log that would need to be replayed during recovery never exceeds the following:

$$\text{logfilsiz} * \text{softmax} / 100 \text{ (in 4-KB pages)}$$

where:

- **logfilsiz** represents the size of the log files
- **softmax** represents the percentage of log files that are to be recovered following a database crash; for example, if the value of **softmax** is 250, then 2.5 log files will contain the changes that need to be recovered if a crash occurs

To minimize log read time during recovery, use the database system monitor to track the number of times that page cleaning is performed. The **pool\_1sn\_gap\_clns** (buffer pool log space cleaners triggered) monitor element provides this information if you have not enabled proactive page cleaning for your database. If you have enabled proactive page cleaning, this condition should not occur, and the value of **pool\_1sn\_gap\_clns** is 0.

The **log\_held\_by\_dirty\_pages** monitor element can be used to determine whether the page cleaners are not cleaning enough pages to meet the recovery criteria set by the user. If **log\_held\_by\_dirty\_pages** is consistently and significantly greater than **logfilsiz \* softmax**, then either more page cleaners are required, or **softmax** needs to be adjusted.

## Management of multiple database buffer pools

Although each database requires at least one buffer pool, you can create several buffer pools, each of a different size or with a different page size, for a single database that has table spaces of more than one page size.

You can use the ALTER BUFFERPOOL statement to resize a buffer pool.

A new database has a default buffer pool called IBMDEFAULTBP, with a default page size that is based on the page size that was specified at database creation time. The default page size is stored as an informational database configuration parameter called **pagesize**. When you create a table space with the default page size, and if you do not assign it to a specific buffer pool, the table space is assigned to the default buffer pool. You can resize the default buffer pool and change its attributes, but you cannot drop it.

## Page sizes for buffer pools

After you create or upgrade a database, you can create additional buffer pools. If you create a database with an 8-KB page size as the default, the default buffer pool is created with the default page size (in this case, 8 KB). Alternatively, you can create a buffer pool with an 8-KB page size, as well as one or more table spaces

with the same page size. This method does not require that you change the 4-KB default page size when you create the database. You cannot assign a table space to a buffer pool that uses a different page size.

**Note:** If you create a table space with a page size greater than 4 KB (such as 8 KB, 16 KB, or 32 KB), you need to assign it to a buffer pool that uses the same page size. If this buffer pool is currently not active, DB2 attempts to assign the table space temporarily to another active buffer pool that uses the same page size, if one exists, or to one of the default system buffer pools that DB2 creates when the first client connects to the database. When the database is activated again, and the originally specified buffer pool is active, DB2 assigns the table space to that buffer pool.

If, when you create a buffer pool with the CREATE BUFFERPOOL statement, you do not specify a size, the buffer pool size is set to AUTOMATIC and is managed by DB2. To change the bufferpool size later, use the ALTER BUFFERPOOL statement.

In a partitioned database environment, each buffer pool for a database has the same default definition on all database partitions, unless it was specified otherwise in the CREATE BUFFERPOOL statement, or the bufferpool size for a particular database partition was changed by the ALTER BUFFERPOOL statement.

### **Advantages of large buffer pools**

Large buffer pools provide the following advantages:

- They enable frequently requested data pages to be kept in the buffer pool, which allows quicker access. Fewer I/O operations can reduce I/O contention, thereby providing better response time and reducing the processor resource needed for I/O operations.
- They provide the opportunity to achieve higher transaction rates with the same response time.
- They prevent I/O contention for frequently used disk storage devices, such as those that store the catalog tables and frequently referenced user tables and indexes. Sorts required by queries also benefit from reduced I/O contention on the disk storage devices that contain temporary table spaces.

### **Advantages of many buffer pools**

Use only a single buffer pool if any of the following conditions apply to your system:

- The total buffer pool space is less than 10 000 4-KB pages
- Persons with the application knowledge to perform specialized tuning are not available
- You are working on a test system

In all other circumstances, and for the following reasons, consider using more than one buffer pool:

- Temporary table spaces can be assigned to a separate buffer pool to provide better performance for queries (especially sort-intensive queries) that require temporary storage.
- If data must be accessed repeatedly and quickly by many short update-transaction applications, consider assigning the table space that contains



the data to a separate buffer pool. If this buffer pool is sized appropriately, its pages have a better chance of being found, contributing to a lower response time and a lower transaction cost.

- You can isolate data into separate buffer pools to favor certain applications, data, and indexes. For example, you might want to put tables and indexes that are updated frequently into a buffer pool that is separate from those tables and indexes that are frequently queried but infrequently updated.
- You can use smaller buffer pools for data that is accessed by seldom-used applications, especially applications that require very random access into a very large table. In such cases, data need not be kept in the buffer pool for longer than a single query. It is better to keep a small buffer pool for this type of data, and to free the extra memory for other buffer pools.

After separating your data into different buffer pools, good and relatively inexpensive performance diagnosis data can be produced from statistics and accounting traces.

The self-tuning memory manager (STMM) is ideal for tuning systems that have multiple buffer pools.

### **Buffer pool memory allocation at startup**

When you create a buffer pool or alter a buffer pool, the total memory that is required by all buffer pools must be available to the database manager so that all of the buffer pools can be allocated when the database starts. If you create or alter buffer pools while the database manager is online, additional memory should be available in database global memory. If you specify the DEFERRED keyword when you create a new buffer pool or increase the size of an existing buffer pool, and the required memory is unavailable, the database manager executes the changes the next time the database is activated.

If this memory is not available when the database starts, the database manager uses only the system buffer pools (one for each page size) with a minimal size of 16 pages, and a warning is returned. The database continues in this state until its configuration is changed and the database can be fully restarted. Although performance might be suboptimal, you can connect to the database, re-configure the buffer pool sizes, or perform other critical tasks. When these tasks are complete, restart the database. Do not operate the database for an extended time in this state.

To avoid starting the database with system buffer pools only, use the **DB2\_OVERRIDE\_BPF** registry variable to optimize use of the available memory.

### **Proactive page cleaning**

Starting in DB2 Version 8.1.4, there is an alternate method of configuring page cleaning in your system. With this approach, page cleaners behave more proactively in choosing which dirty pages get written out at any given point in time.

This proactive page cleaning method differs from the default page cleaning method in two major ways:

- Page cleaners no longer respond to the value of the **chnpggs\_thresh** database configuration parameter.

When the number of good victim pages drops below an acceptable value, page cleaners search the entire buffer pool, writing out potential victim pages and informing the agents of the location of these pages.

- Page cleaners no longer respond to log sequence number (LSN) gap triggers issued by the logger.

When the amount of log space between the log record that updated the oldest page in the buffer pool and the current log position exceeds that allowed by the **softmax** database configuration parameter, the database is said to be experiencing an *LSN gap*.

Under the default page cleaning method, a logger that detects an LSN gap triggers the page cleaners to write out all the pages that are contributing to the LSN gap; that is, the page cleaners write out those pages that are older than what is allowed by the value of **softmax**. Page cleaners alternate between idleness and bursts of activity writing large numbers of pages. This can result in saturation of the I/O subsystem, which then affects other agents that are reading or writing pages. Moreover, by the time that an LSN gap is detected, the page cleaners might not be able to clean fast enough, and DB2 might run out of log space.

The proactive page cleaning method modulates this behavior by distributing the same number of writes over a longer period of time. The page cleaners do this by cleaning not only the pages that are contributing to an LSN gap, but also pages that are likely to contribute to an impending LSN gap, based on the current level of activity.

To use the new page cleaning method, set the **DB2\_USE\_ALTERNATE\_PAGE\_CLEANING** registry variable to on.

## Improving update performance

When an agent updates a page, the database manager uses a protocol to minimize the I/O that is required by the transaction and to ensure recoverability.

This protocol includes the following steps:

1. The page that is to be updated is pinned and latched with an exclusive lock. A log record is written to the log buffer, describing how to undo and redo the change. As part of this action, a log sequence number (LSN) is obtained and stored in the header of the page that is being updated.
2. The update is applied to the page.
3. The page is unlatched. The page is considered to be “dirty”, because changes to the page have not yet been written to disk.
4. The log buffer is updated. Both data in the log buffer and the dirty data page are written to disk.

For better performance, these I/O operations are delayed until there is a lull in system load, or until they are necessary to ensure recoverability or to limit recovery time. More specifically, a dirty page is written to disk when:

- Another agent chooses it as a victim
- A page cleaner works on the page. This can occur when:
  - Another agent chooses the page as a victim
  - The **chngpgs\_thresh** database configuration parameter value is exceeded, causing asynchronous page cleaners to wake up and write changed pages to disk. If proactive page cleaning is enabled for the database, this value is irrelevant and does not trigger page cleaning.
  - The **softmax** database configuration parameter value is exceeded, causing asynchronous page cleaners to wake up and write changed pages to disk. If

proactive page cleaning is enabled for the database, and the number of page cleaners has been properly configured for the database, this value should never be exceeded.

- The number of clean pages drops too low. Page cleaners only react to this condition under proactive page cleaning.
- A dirty page currently contributes to, or is expected to contribute to an LSN gap condition. Page cleaners only react to this condition under proactive page cleaning.
- The page is part of a table that was defined with the NOT LOGGED INITIALLY clause, and the update is followed by a COMMIT statement. When the COMMIT statement executes, all changed pages are flushed to disk to ensure recoverability.

### Formulas for calculating buffer pool hit ratios

Buffer pool hit ratios reflect the extent to which data needed for queries is found in memory, as opposed to having to be read in from external storage. You can calculate hit rates and ratios with formulas that are based on buffer pool monitor elements.

### Local buffer pools

Table 2. Formulas for local buffer pool hit ratios. The formulas shown express the hit ratios as a percentage.

Type of page	Formula for calculating buffer pool hit ratio
Data pages	$(\text{pool\_data\_lbp\_pages\_found} - \text{pool\_async\_data\_lbp\_pages\_found} - \text{pool\_temp\_data\_l\_reads}) / (\text{pool\_data\_l\_reads}) \times 100$
Index pages	$((\text{pool\_index\_lbp\_pages\_found} - \text{pool\_async\_index\_lbp\_pages\_found} - \text{pool\_temp\_index\_l\_reads}) / \text{pool\_index\_l\_reads}) \times 100$
Temporary data pages	$((\text{pool\_temp\_data\_l\_reads} - \text{pool\_temp\_data\_p\_reads}) / \text{pool\_temp\_data\_l\_reads}) \times 100$
Temporary index pages	$((\text{pool\_temp\_index\_l\_reads} - \text{pool\_temp\_index\_p\_reads}) / \text{pool\_temp\_index\_l\_reads}) \times 100$
XML storage object (XDA) pages	$((\text{pool\_xda\_gbp\_l\_reads} - \text{pool\_xda\_gbp\_p\_reads}) / \text{pool\_xda\_gbp\_l\_reads}) \times 100$
Overall hit ratio	$((\text{pool\_data\_lbp\_pages\_found} + \text{pool\_index\_lbp\_pages\_found} + \text{pool\_xda\_lbp\_pages\_found} - \text{pool\_async\_data\_lbp\_pages\_found} - \text{pool\_async\_index\_lbp\_pages\_found} - \text{pool\_async\_xda\_lbp\_pages\_found}) / (\text{pool\_data\_l\_reads} + \text{pool\_index\_l\_reads} + \text{pool\_xda\_l\_reads} + \text{pool\_temp\_data\_l\_reads} + \text{pool\_temp\_xda\_l\_reads} + \text{pool\_temp\_index\_l\_reads})) \times 100$

### Local buffer pools ( environments)

When calculating LBP hit ratios in a environment, the GBP-independent data page hit ratios must also be taken into consideration. When a data page is requested by a , the LBP is examined first. If the page is found in the LBP, then the **pool\_data\_lbp\_pages\_found** monitor element increments. If the page is not found in the LBP, it is read directly from disk, and the **pool\_data\_p\_reads** monitor element increments. However, the **pool\_data\_lbp\_pages\_found** monitor counter also increments when a GBP-dependent page is found in local buffer pool. The new monitor element **pool\_data\_gbp\_indep\_pages\_found\_in\_lbp** is the only way to distinguish between page access counts in these cases.

Table 3. Formulas for GBP-independent (LBP) hit ratios. The formulas shown express the hit ratios as a percentage.

Type of page	Formula for calculating buffer pool hit ratio
Data pages	$(\text{pool\_data\_gbp\_indep\_pages\_found\_in\_lbp} / (\text{pool\_data\_gbp\_indep\_pages\_found\_in\_lbp} + \text{pool\_data\_p\_reads} + \text{pool\_temp\_data\_p\_reads} - \text{pool\_data\_gbp\_p\_reads})) \times 100$

Table 3. Formulas for GBP-independent (LBP) hit ratios (continued). The formulas shown express the hit ratios as a percentage.

Type of page	Formula for calculating buffer pool hit ratio
Index pages	$(\text{pool\_index\_gbp\_indep\_pages\_found\_in\_lbp} / (\text{pool\_index\_gbp\_indep\_pages\_found\_in\_lbp} + \text{pool\_index\_p\_reads} + \text{pool\_temp\_index\_p\_reads} - \text{pool\_index\_gbp\_p\_reads})) \times 100$
XML storage object (XDA) pages	$(\text{pool\_xda\_gbp\_indep\_pages\_found\_in\_lbp} / (\text{pool\_xda\_gbp\_indep\_pages\_found\_in\_lbp} + \text{pool\_xda\_p\_reads} + \text{pool\_temp\_xda\_p\_reads} - \text{pool\_xda\_gbp\_p\_reads})) \times 100$

For GBP-independent pages, tuning the LBP size will affect the hit ratio. For certain type of operations which are independent of the GBP, like temporary page access or NOT LOGGED INITIALLY operations, you will want to monitor the GBP-independent page hit ratio.

Alternatively, to calculate the local buffer pool hit ratio for a GBP-dependent page agent, you can use the following formulas.

Table 4. Formulas for GBP-dependent (LBP) hit ratios. The formulas shown express the hit ratios as a percentage.

Type of page	Formula for calculating buffer pool hit ratio
Data pages	$((\text{pool\_data\_lbp\_pages\_found} - \text{pool\_data\_gbp\_indep\_pages\_found\_in\_lbp}) / (\text{pool\_data\_l\_reads} - \text{pool\_data\_gbp\_indep\_pages\_found\_in\_lbp} - (\text{pool\_data\_p\_reads} - \text{pool\_data\_gbp\_p\_reads}))) \times 100$
Index pages	$((\text{pool\_index\_lbp\_pages\_found} - \text{pool\_index\_gbp\_indep\_pages\_found\_in\_lbp}) / (\text{pool\_index\_l\_reads} - \text{pool\_index\_gbp\_indep\_pages\_found\_in\_lbp} - (\text{pool\_index\_p\_reads} - \text{pool\_index\_gbp\_p\_reads}))) \times 100$
XML storage object (XDA) pages	$((\text{pool\_xda\_lbp\_pages\_found} - \text{pool\_xda\_gbp\_indep\_pages\_found\_in\_lbp}) / (\text{pool\_xda\_l\_reads} - \text{pool\_xda\_gbp\_indep\_pages\_found\_in\_lbp} - (\text{pool\_xda\_p\_reads} - \text{pool\_xda\_gbp\_p\_reads}))) \times 100$

You will need to compare both the LBP hit ratio and the GBP hit ratio to decide how to tune both buffer pools, or to validate the results after tuning the GBP and the LBPs.

### Group buffer pools ( environments)

The formulas used to calculate group buffer pool hit ratios in a environment are different from formulas for hit ratios used in other environments. This difference is because of how the group buffer pool in the works with the local buffer pools in each to retrieve pages of data. The following formulas, which are based on buffer pool monitor elements, can be used to calculate hit ratios for data, index, and XML storage object pages, for both the local and group buffer pools.

Table 5. Formulas for group buffer pool (GBP) hit ratios. The formulas shown express the hit ratios as a percentage.

Type of page	Formula for calculating buffer pool hit ratio
Data pages	$(\text{pool\_data\_gbp\_l\_reads} - \text{pool\_data\_gbp\_p\_reads}) / \text{pool\_data\_gbp\_l\_reads} \times 100$
Index pages	$(\text{pool\_index\_gbp\_l\_reads} - \text{pool\_index\_gbp\_p\_reads}) / \text{pool\_index\_gbp\_l\_reads} \times 100$
XML storage object (XDA) pages	$(\text{pool\_xda\_gbp\_l\_reads} - \text{pool\_xda\_gbp\_p\_reads}) / \text{pool\_xda\_gbp\_l\_reads} \times 100$
Overall hit ratio	$((\text{pool\_data\_gbp\_l\_reads} + \text{pool\_index\_gbp\_l\_reads} + \text{pool\_xda\_gbp\_l\_reads} - \text{pool\_data\_gbp\_p\_reads} - \text{pool\_index\_gbp\_p\_reads} - \text{pool\_xda\_gbp\_p\_reads}) / (\text{pool\_data\_gbp\_l\_reads} + \text{pool\_index\_gbp\_l\_reads} + \text{pool\_xda\_gbp\_l\_reads})) \times 100$

In addition to the preceding formulas for calculating buffer pool hit ratios, you can also use the following formulas to show what percentage of the time pages that are prefetched are found in the GBP:

**Prefetches for data pages**

$$\frac{(\text{pool\_async\_data\_gbp\_l\_reads} - \text{pool\_async\_data\_gbp\_p\_reads})}{\text{pool\_async\_data\_gbp\_l\_reads}} \times 100$$

**Prefetches for index pages**

$$\frac{(\text{pool\_async\_index\_gbp\_l\_reads} - \text{pool\_async\_index\_gbp\_p\_reads})}{\text{pool\_async\_index\_gbp\_l\_reads}} \times 100$$

**Prefetches for XML storage object (XDA) pages**

$$\frac{(\text{pool\_async\_xda\_gbp\_l\_reads} - \text{pool\_async\_xda\_gbp\_p\_reads})}{\text{pool\_async\_xda\_gbp\_l\_reads}} \times 100$$

**Prefetching data into the buffer pool**

*Prefetching* pages means that one or more pages are retrieved from disk in the expectation that they will be required by an application.

Prefetching index and data pages into the buffer pool can help to improve performance by reducing I/O wait times. In addition, parallel I/O enhances prefetching efficiency.

There are three categories of prefetching:

- *Sequential prefetching* reads consecutive pages into the buffer pool before the pages are required by the application.
- *Readahead prefetching* looks ahead in the index to determine the exact pages that ISCAN-FETCH and index scan operations access, and prefetches them.
- *List prefetching* (sometimes called *list sequential prefetching*) prefetches a set of nonconsecutive data pages efficiently.

*Smart data prefetching* is an approach where either sequential detection or readahead prefetching is used, depending on the degree of data clustering. Sequential detection prefetching is used when the data pages are stored sequentially, and readahead prefetching is used when the data pages are badly clustered. Smart data prefetching enables the database system to capitalize on the potential performance benefits of data stored in sequential pages, while also enabling badly clustered data to be prefetched efficiently. Since badly clustered data is no longer as detrimental to query performance, this reduces the need for an expensive operation like a table reorganization.

*Smart index prefetching* is an approach where either sequential detection or readahead prefetching is used, depending on the density of the indexes. Sequential detection prefetching is used when indexes are stored sequentially, and readahead prefetching is used when the indexes have a low density. Smart index prefetching enables the database system to capitalize on the potential performance benefits of indexes stored sequentially, while also enabling low density indexes to be prefetched efficiently. Smart index prefetching reduces the need for an expensive operation like an index reorganization.

Smart data and index prefetching support only applies to index scan operations and does not support XML, extended, and Text Search text indexes. Smart data prefetching cannot be used during scans of global range-clustered table indexes, since they are logical indexes and not physical. Also, for smart data prefetching, if the ISCAN-FETCH scans a global range partitioned index, data readahead prefetching is not used. If index predicates are evaluated during the index scan for

smart data prefetching, and the optimizer determines that not many rows qualify for that index scan, readahead prefetching is disabled. Smart index prefetching also cannot be used for range-clustered table indexes

**Note:** The optimizer determines the type of data or index prefetching that should be enabled for an ISCAN-FETCH or index scan operation. The following are the types of prefetching techniques for smart data and smart index prefetching:

- Sequential detection prefetching
- Readahead prefetching
- Sequential,Readahead prefetching

For this technique both sequential and readahead prefetching is enabled, which is the default. In this technique, sequential detection prefetching is initially used until a threshold of non-prefetched pages is reached or, in some cases, if the MAXPAGES estimate made by the optimizer is exceeded. When the threshold of non-prefetched pages is reached or if the MAXPAGES estimate is exceeded, readahead prefetching is enabled.

However, in some cases the optimizer might not select any prefetching technique if the index scan is on a fully qualified key, the index is unique, and the optimizer's estimated number of pages for the index scan (MAXPAGES) is less than or equal to one. In this case, the MAXPAGES estimate is likely to be reliable, and no prefetching is required.

Prefetching data pages is different than a database manager agent read, which is used when one or a few consecutive pages are retrieved, but only one page of data is transferred to an application.

## **Prefetching and intra-partition parallelism**

Prefetching has an important influence on the performance of intra-partition parallelism, which uses multiple subagents when scanning an index or a table. Such parallel scans result in larger data consumption rates which, in turn, require higher prefetch rates.

The cost of inadequate prefetching is higher for parallel scans than for serial scans. If prefetching does not occur during a serial scan, the query runs more slowly because the agent waits for I/O. If prefetching does not occur during a parallel scan, all subagents might need to wait while one subagent waits for I/O.

Because of its importance in this context, prefetching under intra-partition parallelism is performed more aggressively; the sequential detection mechanism tolerates larger gaps between adjacent pages, so that the pages can be considered sequential. The width of these gaps increases with the number of subagents involved in the scan.

### **Sequential prefetching:**

Reading several consecutive pages into the buffer pool using a single I/O operation can greatly reduce your application overhead.

Prefetching starts when the database manager determines that sequential I/O is appropriate and that prefetching might improve performance. In cases such as table scans and table sorts, the database manager chooses the appropriate type of prefetching. The following example, which probably requires a table scan, would be a good candidate for sequential prefetching:

```
SELECT NAME FROM EMPLOYEE
```

With smart data and smart index prefetching, both sequential and readahead prefetching is enabled, which is the default. Sequential detection prefetching is initially used until a threshold of non-prefetched pages is reached or, in some cases, if the MAXPAGES estimate made by the optimizer is exceeded. When the threshold of non-prefetched pages is reached or if the MAXPAGES estimate is exceeded, readahead prefetching is enabled.

### Sequential detection

Sometimes, it is not immediately apparent that sequential prefetching will improve performance. In such cases, the database manager can monitor I/O and activate prefetching if sequential page reading is occurring. This type of sequential prefetching, known as *sequential detection*, applies to both index and data pages. Use the **seqdetect** database configuration parameter to control whether the database manager performs sequential detection or readahead prefetching.

For example, if sequential detection is enabled, the following SQL statement might benefit from sequential prefetching:

```
SELECT NAME FROM EMPLOYEE
WHERE EMPNO BETWEEN 100 AND 3000
```

In this example, the optimizer might have started to scan the table using an index on the EMPNO column. If the table is highly clustered with respect to this index, the data page reads will be almost sequential, and prefetching might improve performance. Similarly, if many index pages must be examined, and the database manager detects that sequential page reading of the index pages is occurring, index page prefetching is likely.

### Implications of the PREFETCHSIZE option for table spaces

The PREFETCHSIZE clause on either the CREATE TABLESPACE or the ALTER TABLESPACE statement lets you specify the number of prefetched pages that will be read from the table space when data prefetching is being performed. The value that you specify (or 'AUTOMATIC') is stored in the PREFETCHSIZE column of the SYSCAT.TABLESPACES catalog view.

It is good practice to explicitly set the PREFETCHSIZE value as a multiple of the number of table space containers, the number of physical disks under each container (if a RAID device is used), and the EXTENTSIZE value (the number of pages that the database manager writes to a container before it uses a different container) for your table space. For example, if the extent size is 16 pages and the table space has two containers, you might set the prefetch size to 32 pages. If there are five physical disks per container, you might set the prefetch size to 160 pages.

The database manager monitors buffer pool usage to ensure that prefetching does not remove pages from the buffer pool if another unit of work needs them. To avoid problems, the database manager can limit the number of prefetched pages to be fewer than what was specified for the table space.

The prefetch size can have significant performance implications, particularly for large table scans. Use the database system monitor and other system monitor tools to help tune the prefetch size for your table spaces. You can gather information about whether:

- There are I/O waits for your query, using monitoring tools that are available for your operating system
- Prefetching is occurring, by looking at the **pool\_async\_data\_reads** (buffer pool asynchronous data reads) data element provided by the database system monitor

If there are I/O waits while a query is prefetching data, you can increase the value of PREFETCHSIZE. If the prefetcher is not the cause of these I/O waits, increasing the PREFETCHSIZE value will not improve the performance of your query.

In all types of prefetching, multiple I/O operations might be performed in parallel if the prefetch size is a multiple of the extent size for the table space, and the extents are in separate containers. For better performance, configure the containers to use separate physical devices.

### **Readahead prefetching:**

Readahead prefetching looks ahead in the index to determine the exact data pages and index leaf pages that ISCAN-FETCH and index scan operations will access, and prefetches them.

While readahead prefetching provides all the data and index pages needed during the index scan (and no pages that are not needed), it also requires additional resources to locate those pages. For highly sequential data and indexes, sequential detection prefetching will normally out-perform readahead prefetching.

With smart data and smart index prefetching, both sequential and readahead prefetching is enabled, which is the default. Sequential detection prefetching is initially used until a threshold of non-prefetched pages is reached or, in some cases, if the MAXPAGES estimate made by the optimizer is exceeded. When the threshold of non-prefetched pages is reached or if the MAXPAGES estimate is exceeded, readahead prefetching is enabled.

Use the **seqdetect** database configuration parameter to control whether the database manager performs readahead or sequential detection prefetching

### **Restrictions**

If index predicates must be evaluated during an index scan, and the optimizer determines that the index predicates for a particular index scan have a compound selectivity rate below 90% (not many rows qualify), data readahead prefetching is disabled for that index scan. Note that this is a compound selectivity taking into account all index predicates for that particular index scan. If the query optimizer enables readahead prefetching for lower predicate selectivities it might cause many unnecessary pages to be prefetched.

Data readahead prefetching is also disabled while scanning a non-partitioned index on a range-partitioned table to prevent a prefetch request from containing page references from multiple partitions.

For smart data and smart index prefetching, which can use readahead prefetching, these prefetching techniques apply only to index scan operations and do not support XML, extended, and Text Search text indexes.

### **Block-based buffer pools for improved sequential prefetching:**



Prefetching pages from disk is expensive because of I/O overhead. Throughput can be significantly improved if processing overlaps with I/O.

Most platforms provide high performance primitives that read contiguous pages from disk into noncontiguous portions of memory. These primitives are usually called *scattered read* or *vectored I/O*. On some platforms, performance of these primitives cannot compete with doing I/O in large block sizes.

By default, buffer pools are page-based, which means that contiguous pages on disk are prefetched into noncontiguous pages in memory. Sequential prefetching can be enhanced if contiguous pages can be read from disk into contiguous pages within a buffer pool.

You can create block-based buffer pools for this purpose. A block-based buffer pool consists of both a page area and a block area. The page area is required for nonsequential prefetching workloads. The block area consist of blocks; each block contains a specified number of contiguous pages, which is referred to as the *block size*.

The optimal use of a block-based buffer pool depends on the specified block size. The block size is the granularity at which I/O servers doing sequential prefetching consider doing block-based I/O. The extent is the granularity at which table spaces are striped across containers. Because multiple table spaces with different extent sizes can be bound to a buffer pool defined with the same block size, consider how the extent size and the block size will interact for efficient use of buffer pool memory. Buffer pool memory can be wasted if:

- The extent size, which determines the prefetch request size, is smaller than the block size specified for the buffer pool
- Some pages in the prefetch request are already present in the page area of the buffer pool

The I/O server allows some wasted pages in each buffer pool block, but if too many pages would be wasted, the I/O server does non-block-based prefetching into the page area of the buffer pool, resulting in suboptimal performance.

For optimal performance, bind table spaces of the same extent size to a buffer pool whose block size equals the table space extent size. Good performance can be achieved if the extent size is larger than the block size, but not if the extent size is smaller than the block size.

To create block-based buffer pools, use the CREATE BUFFERPOOL or ALTER BUFFERPOOL statement.

**Note:** Block-based buffer pools are intended for sequential prefetching. If your applications do not use sequential prefetching, the block area of the buffer pool is wasted.

### **List prefetching:**

*List prefetching* (or *list sequential prefetching*) is a way to access data pages efficiently, even when those pages are not contiguous.

List prefetching can be used in conjunction with either single or multiple index access.

If the optimizer uses an index to access rows, it can defer reading the data pages until all of the row identifiers (RIDs) have been obtained from the index. For example, the optimizer could perform an index scan to determine the rows and data pages to retrieve.

```
INDEX IX1:  NAME  ASC,
           DEPT  ASC,
           MGR   DESC,
           SALARY DESC,
           YEARS ASC
```

And then use the following search criteria:

```
WHERE NAME BETWEEN 'A' and 'I'
```

If the data is not clustered according to this index, list prefetching includes a step that sorts the list of RIDs that were obtained from the index scan.

### **I/O server configuration for prefetching and parallelism:**

To enable prefetching, the database manager starts separate threads of control, known as *I/O servers*, to read data pages.

As a result, query processing is divided into two parallel activities: data processing (CPU) and data page I/O. The I/O servers wait for prefetch requests from the CPU activity. These prefetch requests contain a description of the I/O that is needed to satisfy the query.

Configuring enough I/O servers (with the **num\_ioservers** database configuration parameter) can greatly enhance the performance of queries that can benefit from prefetching. To maximize the opportunity for parallel I/O, set **num\_ioservers** to at least the number of physical disks in the database.

It is better to overestimate than to underestimate the number of I/O servers. If you specify extra I/O servers, these servers are not used, and their memory pages are paged out with no impact on performance. Each I/O server process is numbered. The database manager always uses the lowest numbered process, and as a result, some of the higher numbered processes might never be used.

To estimate the number of I/O servers that you might need, consider the following:

- The number of database agents that could be writing prefetch requests to the I/O server queue concurrently
- The highest degree to which the I/O servers can work in parallel

Consider setting the value of **num\_ioservers** to **AUTOMATIC** so that the database manager can choose intelligent values based on the system configuration.

*Illustration of prefetching with parallel I/O:*

I/O servers are used to prefetch data into a buffer pool.

This process is shown in Figure 20 on page 113.

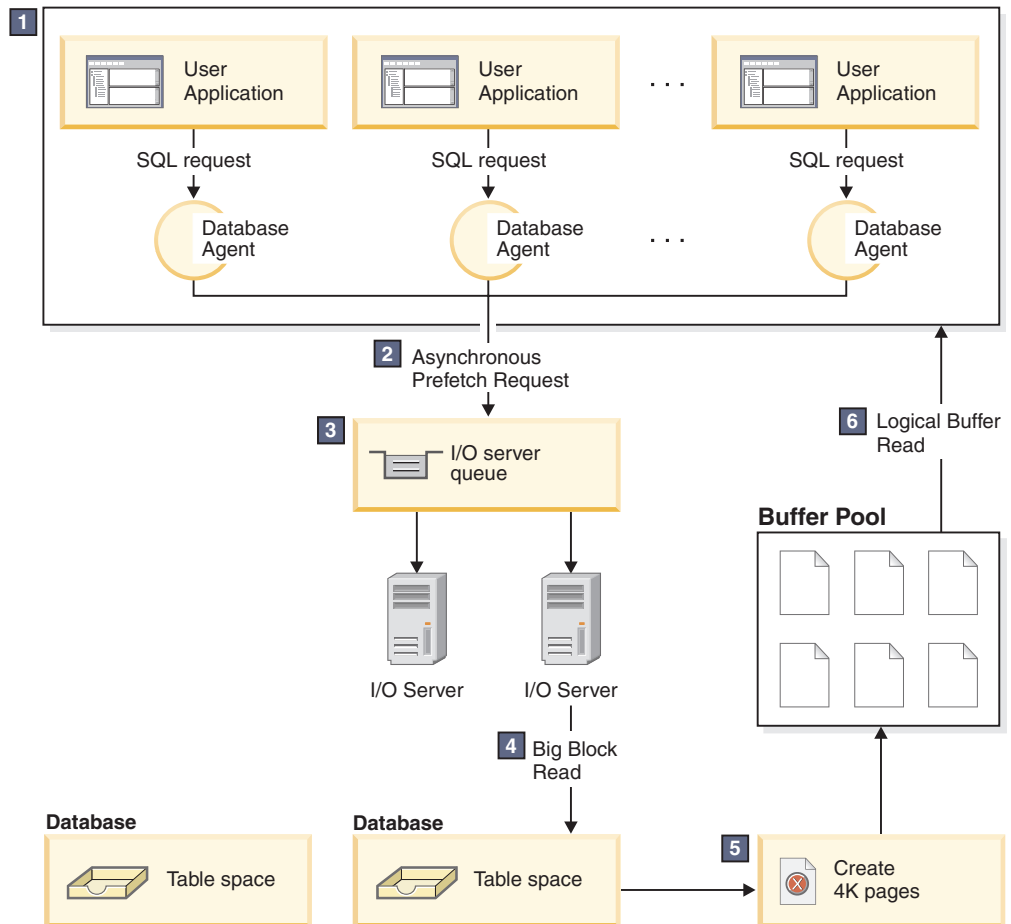

Figure 20. Prefetching data using I/O servers

- 1** The user application passes the request to the database agent that has been assigned to the user application by the database manager.
- 2, 3** The database agent determines that prefetching should be used to obtain the data that is required to satisfy the request, and writes a prefetch request to the I/O server queue.
- 4, 5** The first available I/O server reads the prefetch request from the queue and then reads the data from the table space into the buffer pool. The number of I/O servers that can simultaneously fetch data from a table space depends on the number of prefetch requests in the queue and the number of I/O servers specified by the `num_ioservers` database configuration parameter.
- 6** The database agent performs the necessary operations on the data pages in the buffer pool and returns the result to the user application.

*Parallel I/O management:*

If multiple containers exist for a table space, the database manager can initiate *parallel I/O*, whereby the database manager uses multiple I/O servers to process the I/O requirements of a single query.

Each I/O server processes the I/O workload for a separate container, so that several containers can be read in parallel. Parallel I/O can result in significant improvements in I/O throughput.

Although a separate I/O server can handle the workload for each container, the actual number of I/O servers that can perform parallel I/O is limited to the number of physical devices over which the requested data is spread. For this reason, you need as many I/O servers as physical devices.

Parallel I/O is initiated differently in the following cases:

- For *sequential prefetching*, parallel I/O is initiated when the prefetch size is a multiple of the extent size for a table space. Each prefetch request is divided into smaller requests along extent boundaries. These small requests are then assigned to different I/O servers.
- For *readahead prefetching*, each list of data pages is divided into smaller lists according to extent boundaries. These small lists are then assigned to different I/O servers.
- For *list prefetching*, each list of pages is divided into smaller lists according to the container in which the data pages are stored. These small lists are then assigned to different I/O servers.
- For *database or table space backup and restore*, the number of parallel I/O requests is equal to the backup buffer size divided by the extent size, up to a maximum value that is equal to the number of containers.
- For *database or table space restore*, the parallel I/O requests are initiated and divided the same way as what is done for sequential prefetching. The data is not restored into a buffer pool; it moves directly from the restore buffer to disk.
- When you *load* data, you can specify the level of I/O parallelism with the `DISK_PARALLELISM` command option. If you do not specify this option, the database manager uses a default value that is based on the cumulative number of table space containers for all table spaces that are associated with the table.

For optimal parallel I/O performance, ensure that:

- There are enough I/O servers. Specify slightly more I/O servers than the number of containers that are used for all table spaces within the database.
- The extent size and the prefetch size are appropriate for the table space. To prevent overuse of the buffer pool, the prefetch size should not be too large. An ideal size is a multiple of the extent size, the number of physical disks under each container (if a RAID device is used), and the number of table space containers. The extent size should be fairly small, with a good value being in the range of 8 to 32 pages.
- The containers reside on separate physical drives.
- All containers are the same size to ensure a consistent degree of parallelism.

If one or more containers are smaller than the others, they reduce the potential for optimized parallel prefetching. Consider the following examples:

- After a smaller container is filled, additional data is stored in the remaining containers, causing the containers to become unbalanced. Unbalanced containers reduce the performance of parallel prefetching, because the number of containers from which data can be prefetched might be less than the total number of containers.
- If a smaller container is added at a later date and the data is rebalanced, the smaller container will contain less data than the other containers. Its small amount of data relative to the other containers will not optimize parallel prefetching.

- If one container is larger and all of the other containers fill up, the larger container is the only container to store additional data. The database manager cannot use parallel prefetching to access this additional data.
- There is adequate I/O capacity when using intra-partition parallelism. On SMP machines, intra-partition parallelism can reduce the elapsed time for a query by running the query on multiple processors. Sufficient I/O capacity is required to keep each processor busy. Additional physical drives are usually required to provide that I/O capacity.

The prefetch size must be larger for prefetching to occur at higher rates, and to use I/O capacity effectively.

The number of physical drives required depends on the speed and capacity of the drives and the I/O bus, and on the speed of the processors.

#### Configuring IOCP (AIX):

Configuring I/O completion ports (IOCPs) on AIX servers is not required for the installation of DB2 for Linux, UNIX, and Windows software. However, this configuration step is recommended for performance purposes. You need to perform these steps on each host you want to participate in the DB2 instance.

#### Before you begin

Installing DB2 software by running the **db2setup** command enables IOCP and sets the status of the IOCP port to “Available”.

#### Procedure

1. Enter the **lslpp** command to check whether the IOCP module is installed on your system.

```
$ lslpp -l bos.iocp.rte
```

The resulting output should be similar to the following example:

Fileset	Level	State	Description
Path: /usr/lib/objrepos bos.iocp.rte	5.3.9.0	APPLIED	I/O Completion Ports API
Path: /etc/objrepos bos.iocp.rte	5.3.0.50	COMMITTED	I/O Completion Ports API

2. Enter the **lsdev** command to check whether the status of the IOCP port is Available.

```
$ lsdev -Cc iocp
```

The resulting output should match the following example:

```
iocp0 Available I/O Completion Ports
```

If the IOCP port status is Defined, change the status to Available.

- a. Log in to the server as root and issue the following command:
 

```
# smitty iocp
```
- b. Select **Change / Show Characteristics of I/O Completion Ports**.
- c. Change the configured state at system restart from Defined to Available. For this change to take effect, either perform a system reboot or issue the **cfgmgr** command.
- d. Enter the **lsdev** command again to confirm that the status of the IOCP port has changed to Available.

## Database deactivation behavior in first-user connection scenarios

A database is activated when a user first connects to it. In a single-partition environment, the database is loaded into memory and remains in this state until the last user disconnects. The same behavior applies to multi-partition environments, where any first-user connection activates the database on both local and catalog partitions for that database.

When the last user disconnects, the database shuts down on both local and any remote partitions where this user is the last active user connection for the database. This activation and deactivation of the database based on first connection and last disconnection is known as *implicit activation*. Activation is initiated by the first user connection, and the activation remains in effect until the user executes a `CONNECT RESET` (or until the user terminates or drops the connection), which results in the database being implicitly deactivated.

The process of loading a database into memory is very involved. It encompasses initialization of all database components, including buffer pools, and is the type of processing that should be minimized, particularly in performance-sensitive environments. This behavior is of particular importance in multi-partition environments, where queries that are issued from one database partition reach other partitions that contain part of the target data set. Those database partitions are activated or deactivated, depending on the connect and disconnect behavior of the user applications. When a user issues a query that reaches a database partition for the first time, the query assumes the cost of first activating that partition. When that user disconnects, the database is deactivated unless other connections were previously established against that remote partition. If the next incoming query needs to access that remote partition, the database on that partition will first have to be activated. This cost is accrued for each activation and deactivation of the database (or database partition, where applicable).

The only exception to this behavior occurs if the user chooses to explicitly activate the database by issuing the **ACTIVATE DATABASE** command. After this command completes successfully, the database remains in memory, even if the last user disconnects. This applies to both single- and multi-partition environments. To deactivate such a database, issue the **DEACTIVATE DATABASE** command. Both commands are global in scope, meaning that they will activate or deactivate the database on all database partitions, if applicable. Given the processing-intensive nature of loading a database into memory, consider explicitly activating databases by using the **ACTIVATE DATABASE** command, rather than relying on implicit activation through database connections.

## Tuning sort performance

Because queries often require sorted or grouped results, proper configuration of the sort heap is crucial to good query performance.

Sorting is required when:

- No index that satisfies a requested order exists (for example, a `SELECT` statement that uses the `ORDER BY` clause)
- An index exists, but sorting would be more efficient than using the index
- An index is created
- An index is dropped, which causes index page numbers to be sorted

## Elements that affect sorting

The following factors affect sort performance:

- Settings for the following configuration parameters:
  - Sort heap size (**sortheap**), which specifies the amount of memory to be used for each sort
  - Sort heap threshold (**sheapthres**) and the sort heap threshold for shared sorts (**sheapthres\_shr**), which control the total amount of memory that is available for sorting across the instance
- The number of statements in a workload that require a large amount of sorting
- The presence or absence of indexes that might help avoid unnecessary sorting
- The use of application logic that does not minimize the need for sorting
- Parallel sorting, which improves sort performance, but which can only occur if the statement uses intra-partition parallelism
- Whether or not the sort is *overflowed*. If the sorted data cannot fit into the sort heap, which is a block of memory that is allocated each time a sort is performed, the data overflows into a temporary table that is owned by the database.
- Whether or not the results of the sort are *pipelined*. If sorted data can return directly without requiring a temporary table to store the sorted list, it is a piped sort. In a piped sort, the sort heap is not freed until the application closes the cursor that is associated with the sort. A piped sort can continue to use up memory until the cursor is closed.

Although a sort can be performed entirely in sort memory, this might cause excessive page swapping. In this case, you lose the advantage of a large sort heap. For this reason, you should use an operating system monitor to track changes in system paging whenever you adjust the sorting configuration parameters.

## Techniques for managing sort performance

Identify particular applications and statements where sorting is a significant performance problem:

1. Set up event monitors at the application and statement level to help you identify applications with the longest total sort time.
2. Within each of these applications, find the statements with the longest *total sort time*.  
You can also search through the explain tables to identify queries that have sort operations.
3. Use these statements as input to the Design Advisor, which will identify and can create indexes to reduce the need for sorting.

You can use the self-tuning memory manager (STMM) to automatically and dynamically allocate and deallocate memory resources required for sorting. To use this feature:

- Enable self-tuning memory for the database by setting the **self\_tuning\_mem** configuration parameter to ON.
- Set the **sortheap** and **sheapthres\_shr** configuration parameters to AUTOMATIC.
- Set the **sheapthres** configuration parameter to 0.

You can also use the database system monitor and benchmarking techniques to help set the **sortheap**, **sheapthres\_shr**, and **sheapthres** configuration parameters. For each database manager and for each database:

1. Set up and run a representative workload.
2. For each applicable database, collect average values for the following performance variables over the benchmark workload period:
  - Total sort heap in use (the value of the **sort\_heap\_allocated** monitor element)
  - Active sorts and active hash joins (the values of the **active\_sorts** and **active\_hash\_joins** monitor elements)
3. Set **sortheap** to the average *total sort heap in use* for each database.

**Note:** If long keys are used for sorts, you might need to increase the value of the **sortheap** configuration parameter.

4. Set the **sheapthres**. To estimate an appropriate size:
  - a. Determine which database in the instance has the largest **sortheap** value.
  - b. Determine the average size of the sort heap for this database.  
If this is too difficult to determine, use 80% of the maximum sort heap.
  - c. Set **sheapthres** to the average number of active sorts, times the average size of the sort heap computed previously. This is a recommended initial setting. You can then use benchmark techniques to refine this value.

IBM InfoSphere Optim Query Workload Tuner provides tools for improving the performance of single SQL statements and the performance of groups of SQL statements, which are called query workloads. For more information about this product, see the product overview page at <http://www.ibm.com/software/data/optim/query-workload-tuner-db2-luw/index.html>. In Version 3.1.1 or later, you can also use the Workload Design Advisor to perform many operations that were available in the DB2 Design Advisor wizard. For more information see the documentation for the Workload Design Advisor at <http://publib.boulder.ibm.com/infocenter/dstudio/v3r1/topic/com.ibm.datatools.qrytune.workloadtunedb2luw.doc/topics/genrecsdsgn.html>.

---

## Data organization

Over time, data in your tables can become fragmented, increasing the size of tables and indexes as records become distributed over more and more data pages. This can increase the number of pages that need to be read during query execution. Reorganization of tables and indexes compacts your data, reclaiming wasted space and improving data access.

### Procedure

The steps to perform an index or table reorganization are as follows:

1. Determine whether you need to reorganize any tables or indexes.
2. Choose a reorganization method.
3. Perform the reorganization of identified objects.
4. Optional: Monitor the progress of reorganization.
5. Determine whether or not the reorganization was successful. For offline table reorganization and any index reorganization, the operation is synchronous, and the outcome is apparent upon completion of the operation. For online table reorganization, the operation is asynchronous, and details are available from the history file.
6. Collect statistics on reorganized objects.
7. Rebind applications that access reorganized objects.



## Table reorganization

After many changes to table data, logically sequential data might reside on nonsequential data pages, so that the database manager might need to perform additional read operations to access data. Also, if many rows have been deleted, additional read operations are also required. In this case, you might consider reorganizing the table to match the index and to reclaim space.

You can also reorganize the system catalog tables.

Because reorganizing a table usually takes more time than updating statistics, you could execute the **RUNSTATS** command to refresh the current statistics for your data, and then rebind your applications. If refreshed statistics do not improve performance, reorganization might help.

The following factors can indicate a need for table reorganization:

- There has been a high volume of insert, update, and delete activity against tables that are accessed by queries.
- There have been significant changes in the performance of queries that use an index with a high cluster ratio.
- Executing the **RUNSTATS** command to refresh table statistics does not improve performance.
- Output from the **REORGCHK** command indicates a need for table reorganization.

**Note:** With DB2 V9.7 Fix Pack 1 and later releases, higher data availability for a data partitioned table with only partitioned indexes (except system-generated XML path indexes) is achieved by reorganizing data for a specific data partition. Partition-level reorganization performs a table reorganization on a specified data partition while the remaining data partitions of the table remain accessible. The output from the **REORGCHK** command for a partitioned table contains statistics and recommendations for performing partition-level reorganizations.

**REORG TABLE** commands and **REORG INDEXES ALL** commands can be issued on a data partitioned table to concurrently reorganize different data partitions or partitioned indexes on a partition. When concurrently reorganizing data partitions or the partitioned indexes on a partition, users can access the unaffected partitions but cannot access the affected partitions. All the following criteria must be met to issue REORG commands that operate concurrently on the same table:

- Each REORG command must specify a different partition with the **ON DATA PARTITION** clause.
- Each REORG command must use the **ALLOW NO ACCESS** mode to restrict access to the data partitions.
- The partitioned table must have only partitioned indexes if issuing **REORG TABLE** commands. No nonpartitioned indexes (except system-generated XML path indexes) can be defined on the table.

In IBM Data Studio Version 3.1 or later, you can use the task assistant for reorganizing tables. Task assistants can guide you through the process of setting options, reviewing the automatically generated commands to perform the task, and running these commands. For more details, see *Administering databases with task assistants*.

### Choosing a table reorganization method

There are two approaches to table reorganization: *classic reorganization* (offline) and *inplace reorganization* (online).

Offline reorganization is the default behavior. To specify an online reorganization operation, use the `INPLACE` option on the **REORG TABLE** command.

An alternative approach to inplace reorganization, using online table move stored procedures, is also available. See “Moving tables online by using the `ADMIN_MOVE_TABLE` procedure”.

Each approach has its advantages and drawbacks, which are summarized in the following sections. When choosing a reorganization method, consider which approach offers advantages that align with your priorities. For example, if recoverability in case of failure is more important than performance, online reorganization might be preferable.

### **Advantages of offline reorganization**

This approach offers:

- The fastest table reorganization operations, especially if large object (LOB) or long field data is not included
- Perfectly clustered tables and indexes upon completion
- Indexes that are automatically rebuilt after a table has been reorganized; there is no separate step for rebuilding indexes
- The use of a temporary table space for building a shadow copy; this reduces the space requirements for the table space that contains the target table or index
- The use of an index other than the clustering index to re-cluster the data

### **Disadvantages of offline reorganization**

This approach is characterized by:

- Limited table access; read access only during the sort and build phase of a reorg operation
- A large space requirement for the shadow copy of the table that is being reorganized
- Less control over the reorg process; an offline reorg operation cannot be paused and restarted

### **Advantages of online reorganization**

This approach offers:

- Full table access, except during the truncation phase of a reorg operation
- More control over the reorg process, which runs asynchronously in the background, and which can be paused, resumed, or stopped; for example, you can pause an in-progress reorg operation if a large number of update or delete operations are running against the table
- A recoverable process in the event of a failure
- A reduced requirement for working storage, because a table is processed incrementally
- Immediate benefits of reorganization, even before a reorg operation completes

### **Disadvantages of online reorganization**

This approach is characterized by:

- Imperfect data or index clustering, depending on the type of transactions that access the table during a reorg operation
- Poorer performance than an offline reorg operation
- Potentially high logging requirements, depending on the number of rows being moved, the number of indexes that are defined on the table, and the size of those indexes
- A potential need for subsequent index reorganization, because indexes are maintained, not rebuilt

Table 6. Comparison of online and offline reorganization

Characteristic	Offline reorganization	Online reorganization
Performance	Fast	Slow
Clustering factor of data at completion	Good	Not perfectly clustered
Concurrency (access to the table)	Ranges from no access to read-only	Ranges from read-only to full access
Data storage space requirement	Significant	Not significant
Logging storage space requirement	Not significant	Could be significant
User control (ability to pause, restart process)	Less control	More control
Recoverability	Not recoverable	Recoverable
Index rebuilding	Done	Not done
Supported for all types of tables	Yes	No
Ability to specify an index other than the clustering index	Yes	No
Use of a temporary table space	Yes	No

Table 7. Table types that are supported for online and offline reorganization

Table type	Offline reorganization supported	Online reorganization supported
Multidimensional clustering tables (MDC)	Yes <sup>1</sup>	No
Insert time clustering tables (ITC)	Yes <sup>1</sup>	No
Range-clustered tables (RCT)	No <sup>2</sup>	No
Append mode tables	No	No <sup>3</sup>
Tables with long field or large object (LOB) data	Yes <sup>4</sup>	No
System catalog tables: SYSIBM.SYSDBAUTH, SYSIBM.SYSROUTINEAUTH, SYSIBM.SYSSEQUENCES, SYSIBM.SYSTABLES	Yes	No

Table 7. Table types that are supported for online and offline reorganization (continued)

Table type	Offline reorganization supported	Online reorganization supported
<b>Notes:</b> <ol style="list-style-type: none"> <li>1. Because clustering is automatically maintained through MDC block indexes, reorganization of an MDC table involves space reclamation only. No indexes can be specified. Similarly, for ITC tables, you cannot specify a reorganization using a clustering index.</li> <li>2. The range area of an RCT always remains clustered.</li> <li>3. Online reorganization can be performed after append mode is disabled.</li> <li>4. Reorganizing long field or large object (LOB) data can take a significant amount of time, and does not improve query performance; it should only be done for space reclamation.</li> </ol>		

## Monitoring the progress of table reorganization

Information about the progress of a current table reorg operation is written to the history file. The history file contains a record for each reorganization event. To view this file, execute the **LIST HISTORY** command against the database that contains the table being reorganized.

You can also use table snapshots to monitor the progress of table reorg operations. Table reorganization monitoring data is recorded, regardless of the setting for the database system monitor table switch.

If an error occurs, an SQLCA message is written to the history file. In the case of an inplace table reorg operation, the status is recorded as PAUSED.

## Classic (offline) table reorganization

Classic table reorganization uses a shadow copy approach, building a full copy of the table that is being reorganized.

There are four phases in a classic or offline table reorganization operation:

1. SORT - During this phase, if an index was specified on the **REORG TABLE** command, or a clustering index was defined on the table, the rows of the table are first sorted according to that index. If the INDEXSCAN option is specified, an index scan is used to sort the table; otherwise, a table scan sort is used. This phase applies only to a clustering table reorg operation. Space reclaiming reorg operations begin at the build phase.
2. BUILD - During this phase, a reorganized copy of the entire table is built, either in its table space or in a temporary table space that was specified on the **REORG TABLE** command.
3. REPLACE - During this phase, the original table object is replaced by a copy from the temporary table space, or a pointer is created to the newly built object within the table space of the table that is being reorganized.
4. RECREATE ALL INDEXES - During this phase, all indexes that were defined on the table are recreated.

You can monitor the progress of the table reorg operation and identify the current phase using the snapshot monitor or snapshot administrative views.

The locking conditions are more restrictive in offline mode than in online mode. Read access to the table is available while the copy is being built. However,

exclusive access to the table is required when the original table is being replaced by the reorganized copy, or when indexes are being rebuilt.

An IX table space lock is required during the entire table reorg process. During the build phase, a U lock is acquired and held on the table. A U lock allows the lock owner to update the data in the table. Although no other application can update the data, read access is permitted. The U lock is upgraded to a Z lock after the replace phase starts. During this phase, no other applications can access the data. This lock is held until the table reorg operation completes.

A number of files are created by the offline reorganization process. These files are stored in your database directory. Their names are prefixed with the table space and object IDs; for example, 0030002.R0R is the state file for a table reorg operation whose table space ID is 3 and table ID is 2.

The following list shows the temporary files that are created in a system managed space (SMS) table space during an offline table reorg operation:

- .DTR - Data shadow copy file
- .LFR - Long field file
- .LAR - Long field allocation file
- .RLB - LOB data file
- .RBA - LOB allocation file
- .BMR - Block object file for multidimensional clustering (MDC) and insert time clustering (ITC) tables

The following temporary file is created during an index reorg operation:

- .IN1 - Shadow copy file

The following list shows the temporary files that are created in the system temporary table space during the sort phase:

- .TDA - Data file
- .TIX - Index file
- .TLF - Long field file
- .TLA - Long field allocation file
- .TLB - LOB file
- .TBA - LOB allocation file
- .TBM - Block object file

The files that are associated with the reorganization process should not be manually removed from your system.

### **Reorganizing tables offline:**

Reorganizing tables offline is the fastest way to defragment your tables. Reorganization reduces the amount of space that is required for a table and improves data access and query performance.

### **Before you begin**

You must have SYSADM, SYSCTRL, SYSMOINT, DBADM, or SQLADM authority, or CONTROL privilege on the table that is to be reorganized. You must also have a database connection to reorganize a table.

## About this task

After you have identified the tables that require reorganization, you can run the reorg utility against those tables and, optionally, against any indexes that are defined on those tables.

### Procedure

1. To reorganize a table using the **REORG TABLE** command, simply specify the name of the table. For example:

```
reorg table employee
```

You can reorganize a table using a specific temporary table space. For example:

```
reorg table employee use mytemp
```

You can reorganize a table and have the rows reordered according to a specific index. For example:

```
reorg table employee index myindex
```

2. To reorganize a table using an SQL CALL statement, specify the **REORG TABLE** command with the ADMIN\_CMD procedure. For example:

```
call sysproc.admin_cmd ('reorg table employee')
```

3. To reorganize a table using the administrative application programming interface, call the db2Reorg API.

### What to do next

After reorganizing a table, collect statistics on that table so that the optimizer has the most accurate data for evaluating query access plans.

### Recovery of an offline table reorganization:

An offline table reorganization is an all-or-nothing process until the beginning of the replace phase. If your system crashes during the sort or build phase, the reorg operation is rolled back and will not be redone during crash recovery.

If your system crashes after the beginning of the replace phase, the reorg operation must complete, because all of the reorganization work has been done and the original table might no longer be available. During crash recovery, the temporary file for the reorganized table object is required, but not the temporary table space that is used for the sort. Recovery will restart the replace phase from the beginning, and all of the data in the copy object is required for recovery. There is a difference between system managed space (SMS) and database managed space (DMS) table spaces in this case: the reorganized table object in SMS must be copied from one object to the other, but the reorganized table object in DMS is simply pointed to, and the original table is dropped, if the reorganization was done in the same table space. Indexes are not rebuilt, but are marked invalid during crash recovery, and the database will follow the usual rules to determine when they are rebuilt, either at database restart or upon first index access.

If a crash occurs during the index rebuild phase, nothing is redone because the new table object already exists. Indexes are handled as described previously.

During rollforward recovery, the reorg operation is redone if the old version of the table is on disk. The rollforward utility uses the record IDs (RIDs) that are logged during the build phase to reapply the operations that created the reorganized table, repeating the build and replace phases. Indexes are handled as described

previously. A temporary table space is required for a copy of the reorganized object only if a temporary table space was used originally. During rollforward recovery, multiple reorg operations can be redone concurrently (parallel recovery).

### **Improving the performance of offline table reorganization:**

The performance of an offline table reorganization is largely determined by the characteristics of the database environment.

There is almost no difference in performance between a reorg operation that is running in ALLOW NO ACCESS mode and one that is running in ALLOW READ ACCESS mode. The difference is that during a reorg operation in ALLOW READ ACCESS mode, the utility might have to wait for other applications to complete their scans and release their locks before replacing the table. The table is unavailable during the index rebuild phase of a reorg operation that is running in either mode.

### **Tips for improving performance**

- If there is enough space to do so, use the same table space for both the original table and the reorganized copy of the table, instead of using a temporary table space. This saves the time that is needed to copy the reorganized table from the temporary table space.
- Consider dropping unnecessary indexes before reorganizing a table so that fewer indexes need to be maintained during the reorg operation.
- Ensure that the prefetch size of the table spaces on which the reorganized table resides is set properly.
- Tune the **sortheap** and **sheapthres** database configuration parameters to control the space that is available for sorts. Because each processor will perform a private sort, the value of **sheapthres** should be at least **sortheap** x *number-of-processors*.
- Adjust the number of page cleaners to ensure that dirty index pages in the buffer pool are cleaned as soon as possible.

### **Inplace (online) table reorganization**

Inplace table reorganization enables you to reorganize a table while you have full access to its data. The cost of this uninterrupted access to the data is a slower table reorg operation.

**Restriction:** Inplace (online) reorganization is not supported in DB2 pureScale environments. Any attempts to perform an inplace reorganization in DB2 pureScale environments will fail with SQL1419N.

During an inplace or online table reorg operation, portions of a table are reorganized sequentially. Data is not copied to a temporary table space; instead, rows are moved within the existing table object to reestablish clustering, reclaim free space, and eliminate overflow rows.

There are four main phases in an online table reorg operation:

1. **SELECT  $n$  pages**

During this phase, the database manager selects a range of  $n$  pages, where  $n$  is the size of an extent with a minimum of 32 sequential pages for reorg processing.

2. **Vacate the range**

The reorg utility moves all rows within this range to free pages in the table. Each row that is moved leaves behind a reorg table pointer (RP) record that contains the record ID (RID) of the row's new location. The row is placed on a free page in the table as a reorg table overflow (RO) record that contains the data. After the utility has finished moving a set of rows, it waits until all applications that are accessing data in the table are finished. These "old scanners" use old RIDs when accessing the table data. Any table access that starts during this waiting period (a "new scanner") uses new RIDs to access the data. After all of the old scanners have completed, the reorg utility cleans up the moved rows, deleting RP records and converting RO records into regular records.

3. Fill the range

After all rows in a specific range have been vacated, they are written back in a reorganized format, sorted according to any indexes that were used, and obeying any PCTFREE restrictions that were defined. When all of the pages in the range have been rewritten, the next *n* sequential pages in the table are selected, and the process is repeated.

4. Truncate the table

By default, when all pages in the table have been reorganized, the table is truncated to reclaim space. If the NOTRUNCATE option has been specified, the reorganized table is not truncated.

### Files created during an online table reorg operation

During an online table reorg operation, an .0LR state file is created for each database partition. This binary file has a name whose format is xxxxyyyy.0LR, where *xxxx* is the table space ID and *yyyy* is the object ID in hexadecimal format. This file contains the following information that is required to resume an online reorg operation from the paused state:

- The type of reorg operation
- The life log sequence number (LSN) of the table being reorganized
- The next range to be vacated
- Whether the reorg operation is clustering the data or just reclaiming space
- The ID of the index that is being used to cluster the data

A checksum is performed on the .0LR file. If the file becomes corrupted, causing checksum errors, or if the table LSN does not match the life LSN, a new reorg operation is initiated, and a new state file is created.

If the .0LR state file is deleted, the reorg process cannot resume, SQL2219N is returned, and a new reorg operation must be initiated.

The files that are associated with the reorganization process should not be manually removed from your system.

### Reorganizing tables online:

An online or inplace table reorganization allows users to access a table while it is being reorganized.



## Before you begin

You must have SYSADM, SYSCTRL, SYSMAINT, DBADM, or SQLADM authority, or CONTROL privilege on the table that is to be reorganized. You must also have a database connection to reorganize a table.

## About this task

After you have identified the tables that require reorganization, you can run the reorg utility against those tables and, optionally, against any indexes that are defined on those tables.

## Procedure

- To reorganize a table online using the **REORG TABLE** command, specify the name of the table and the **INPLACE** parameter. For example:  

```
reorg table employee inplace
```
- To reorganize a table online using an SQL CALL statement, specify the **REORG TABLE** command with the ADMIN\_CMD procedure. For example:  

```
call sysproc.admin_cmd ('reorg table employee inplace')
```
- To reorganize a table online using the administrative application programming interface, call the db2Reorg API.

## What to do next

After reorganizing a table, collect statistics on that table so that the optimizer has the most accurate data for evaluating query access plans.

## Recovery of an online table reorganization:

The failure of an online table reorganization is often due to processing errors, such as disk full or logging errors. If an online table reorganization fails, an SQLCA message is written to the history file.

If a failure occurs during run time, the online table reorg operation is paused and then rolled back during crash recovery. You can subsequently resume the reorg operation by specifying the **RESUME** parameter on the **REORG TABLE** command. Because the process is fully logged, online table reorganization is guaranteed to be recoverable.

Under some circumstances, an online table reorg operation might exceed the limit that is set by the value of the **num\_log\_span** database configuration parameter. In this case, the database manager forces the reorg utility and puts it into PAUSE state. In snapshot monitor output, the state of the reorg utility appears as PAUSED.

The online table reorg pause is interrupt-driven, which means that it can be triggered either by a user (using the **PAUSE** parameter on the **REORG TABLE** command, or the **FORCE APPLICATION** command) or by the database manager in certain circumstances; for example, in the event of a system crash.

If one or more database partitions in a partitioned database environment encounters an error, the SQLCODE that is returned is the one from the first database partition that reports an error.

## Pausing and restarting an online table reorganization:

An online table reorganization that is in progress can be paused and restarted by the user.

### Before you begin

You must have SYSADM, SYSCTRL, SYSMAINT, DBADM, or SQLADM authority, or CONTROL privilege on the table whose online reorganization is to be paused or restarted. You must also have a database connection to pause or restart an online table reorganization.

### Procedure

1. To pause an online table reorganization using the **REORG TABLE** command, specify the name of the table, the **INPLACE** parameter, and the **PAUSE** parameter. For example:

```
reorg table employee inplace pause
```

2. To restart a paused online table reorganization, specify the **RESUME** parameter. For example:

```
reorg table employee inplace resume
```

When an online table reorg operation is paused, you cannot begin a new reorganization of that table. You must either resume or stop the paused operation before beginning a new reorganization process.

Following a **RESUME** request, the reorganization process respects whatever truncation option is specified on the current **RESUME** request. For example, if the **NOTTRUNCATE** parameter is not specified on the current **RESUME** request, a **NOTTRUNCATE** parameter specified on the original **REORG TABLE** command, or with any previous **RESUME** requests, is ignored.

A table reorg operation cannot resume after a restore and rollforward operation.

### Locking and concurrency considerations for online table reorganization:

One of the most important aspects of online table reorganization—because it is so crucial to application concurrency—is how locking is controlled.

An online table reorg operation can hold the following locks:

- To ensure write access to table spaces, an IX lock is acquired on the table spaces that are affected by the reorg operation.
- A table lock is acquired and held during the entire reorg operation. The level of locking is dependent on the access mode that is in effect during reorganization:
  - If ALLOW WRITE ACCESS was specified, an IS table lock is acquired.
  - If ALLOW READ ACCESS was specified, an S table lock is acquired.
- An S lock on the table is requested during the truncation phase. Until the S lock is acquired, rows can be inserted by concurrent transactions. These inserted rows might not be seen by the reorg utility, and could prevent the table from being truncated. After the S table lock is acquired, rows that prevent the table from being truncated are moved to compact the table. After the table is compacted, it is truncated, but only after all transactions that are accessing the table at the time the truncation point is determined have completed.
- A row lock might be acquired, depending on the type of table lock:
  - If an S lock is held on the table, there is no need for individual row-level S locks, and further locking is unnecessary.
  - If an IS lock is held on the table, an NS row lock is acquired before the row is moved, and then released after the move is complete.

- Certain internal locks might also be acquired during an online table reorg operation.

Locking has an impact on the performance of both online table reorg operations and concurrent user applications. You can use lock snapshot data to help you to understand the locking activity that occurs during online table reorganizations.

### Monitoring a table reorganization

You can use the **GET SNAPSHOT** command, the `SNAPTAB_REORG` administrative view, or the `SNAP_GET_TAB_REORG` table function to obtain information about the status of your table reorganization operations.

#### Procedure

- To access information about reorganization operations using SQL, use the `SNAPTAB_REORG` administrative view. For example, the following query returns details about table reorganization operations on all database partitions for the currently connected database. If no tables have been reorganized, no rows are returned.

```
select
  substr(tabname, 1, 15) as tab_name,
  substr(tabschema, 1, 15) as tab_schema,
  reorg_phase,
  substr(reorg_type, 1, 20) as reorg_type,
  reorg_status,
  reorg_completion,
  dbpartitionnum
from sysibmadm.snaptab_reorg
order by dbpartitionnum
```

- To access information about reorganization operations using the snapshot monitor, use the **GET SNAPSHOT FOR TABLES** command and examine the values of the table reorganization monitor elements.

#### Results

Because offline table reorg operations are synchronous, errors are returned to the caller of the utility (an application or the command line processor). And because online table reorg operations are asynchronous, error messages in this case are not returned to the CLP. To view SQL error messages that are returned during an online table reorg operation, use the **LIST HISTORY REORG** command.

An online table reorg operation runs in the background as the `db2Reorg` process. This process continues running even if the calling application terminates its database connection.

## Index reorganization

As tables are updated, index performance can degrade.

The degradation can occur in the following ways:

- Leaf pages become fragmented. When leaf pages are fragmented, I/O costs increase because more leaf pages must be read to fetch table pages.
- The physical index page order no longer matches the sequence of keys on those pages, resulting in low density indexes. When leaf pages have a low density, sequential prefetching is inefficient and the number of I/O waits increases. However, if smart index prefetching is enabled, the query optimizer switches to readahead prefetching if low density indexes exist. This helps reduce the negative impact that low density indexes have on performance.

- The index develops too many levels. In this case, the index should be reorganized.

Index reorganization requires:

- SYSADM, SYSMAINT, SYSCTRL, DBADM, or SQLADM authority, or CONTROL privilege on the table and its indexes
- When the REBUILD option with the ALLOW READ or WRITE ACCESS options are chosen, an amount of free space in the table space where the indexes are stored is required. This space must be equal to the current size of the indexes. Consider placing indexes in a large table space when you issue the **CREATE TABLE** statement.
- Additional log space. The index reorg utility logs its activities.

If you specify the MINPCTUSED option on the CREATE INDEX statement, the database server automatically merges index leaf pages if a key is deleted and the free space becomes less than the specified value. This process is called *online index defragmentation*.

To restore index clustering, free up space, and reduce leaf levels, you can use one of the following methods:

- Drop and recreate the index.
- Use the **REORG TABLE** command with options that allow you to reorganize the table and rebuild its indexes offline.
- Use the **REORG INDEXES** command with the REBUILD option to reorganize indexes online or offline. You might choose online reorganization in a production environment, because it allows users to read from or write to the table while its indexes are being rebuilt.

If your primary objective is to free up space, consider using the CLEANUP and RECLAIM EXTENTS options of the **REORG** command. See the related links for more details.

In IBM Data Studio Version 3.1 or later, you can use the task assistant for reorganizing indexes. Task assistants can guide you through the process of setting options, reviewing the automatically generated commands to perform the task, and running these commands. For more details, see Administering databases with task assistants.

With DB2 V9.7 Fix Pack 1 and later releases, using the **REORG INDEXES ALL** command on a data partitioned table and specifying a partition with the ON DATA PARTITION clause reorganizes the partitioned indexes for single data partition. During index reorganization, the unaffected partitions remain read and write accessible access is restricted only to the affected partition.

**REORG TABLE** commands and **REORG INDEXES ALL** commands can be issued on a data partitioned table to concurrently reorganize different data partitions or partitioned indexes on a partition. When concurrently reorganizing data partitions or the partitioned indexes on a partition, users can access the unaffected partitions. All the following criteria must be met to issue REORG commands that operate concurrently on the same table:

- Each REORG command must specify a different partition with the **ON DATA PARTITION** clause.
- Each REORG command must use the ALLOW NO ACCESS mode to restrict access to the data partitions.

- The partitioned table must have only partitioned indexes if issuing **REORG TABLE** commands. No nonpartitioned indexes (except system-generated XML path indexes) can be defined on the table.

**Note:** The output from the **REORGCHK** command contains statistics and recommendations for reorganizing indexes. For a partitioned table, the output contains statistics and recommendations for reorganizing partitioned and nonpartitioned indexes. Alternatively, if the objective is to reclaim space, the **RECLAIMABLE\_SPACE** output of the **ADMIN\_GET\_INDEX\_INFO** function shows how much space is reclaimable. Use the **REORG INDEXES** command with the **RECLAIM EXTENTS** option to free this reclaimable space.

## Online index reorganization

When you use the **REORG INDEXES** command with the **ALLOW WRITE ACCESS** and **REBUILD** options, all indexes on the specified table are rebuilt while read or write access to the table continues. During reorganization, any changes to the underlying table that would affect the indexes are logged. The reorg operation processes these logged changes while rebuilding the indexes.

Changes to the underlying table that would affect the indexes are also written to an internal memory buffer, if such space is available for use. The internal buffer is a designated memory area that is allocated on demand from the utility heap. The use of a memory buffer space enables the index reorg utility to process the changes by reading directly from memory first, and then reading through the logs, if necessary, but at a much later time. The allocated memory is freed after the reorg operation completes.

Online index reorganization in **ALLOW WRITE ACCESS** mode (with or without the **CLEANUP** option) is supported for spatial indexes or multidimensional clustering (MDC) and insert time clustering (ITC) tables.

**Restriction:** Online reorganization with the **REBUILD** option is not supported in DB2 pureScale environments. Any attempts to perform an online reorganization with the **REBUILD** option in DB2 pureScale environments will fail with SQL1419N.

## Locking and concurrency considerations for online index reorganization

In this topic, online index reorganization applies to an index reorganization that is run with the **ALLOW READ ACCESS** or **ALLOW WRITE ACCESS** parameters.

These options allow you to access the table while its indexes are being reorganized. During online index reorganization with the **REBUILD** option, new indexes are built as additional copies while the original indexes remain intact. Concurrent transactions use the original indexes while the new indexes are created. At the end of the reorganization operation, the original indexes are replaced by the new indexes. Transactions that are committed in the meantime are reflected in the new indexes after the replacement of the original indexes. If the reorganization operation fails and the transaction is rolled back, the original indexes remain intact. During online index reorganization with the **CLEANUP** and **RECLAIM EXTENTS** options, space is reclaimed and made available for use for all objects in the table space.

An online index reorganization operation can hold the following locks:

- To ensure access to table spaces, an IX-lock is acquired on the table spaces affected by the reorganization operation. This includes table spaces that hold the table, as well as partition, and index objects.

- To prevent the affected table from being altered during reorganization, an X alter table lock is acquired.
- A table lock is acquired and held throughout the reorganization operation. The type of lock depends on the table type, access mode, and reorganization option:
  - For nonpartitioned tables:
    - If **ALLOW READ ACCESS** is specified, a U-lock is acquired on the table.
    - If **ALLOW WRITE ACCESS** is specified, an IN-lock is acquired on the table.
    - If **CLEANUP** is specified, an S-lock is acquired on the table for READ access, and IX-lock for WRITE access.
  - For partitioned tables, reorganization with **ALLOW READ ACCESS** or **ALLOW WRITE ACCESS** is supported at partition level only:
    - If **ALLOW READ ACCESS** is specified, a U-lock is acquired on the partition.
    - If **ALLOW WRITE ACCESS** is specified, an IS-lock is acquired on the partition.
    - If **CLEANUP** is specified, an S-lock is acquired on the partition for READ access, and an IX-lock for WRITE access.
    - An IS-lock is acquired on the table regardless of which access mode or option is specified.
- An exclusive Z-lock on the table or partition is requested at the end of index reorganization. If a partitioned table contains nonpartitioned indexes, then the Z-lock is acquired on the table as well as the partition. This lock suspends table and partition access to allow for the replacement of the original indexes by the new indexes. This lock is held until transactions that are committed during reorganization are reflected in the new indexes.
- The IS table lock and NS row lock are acquired on the system catalog table SYSIBM.SYSTABLES.
- For a partition level reorganization, IS table lock and NS row lock are also acquired on the system catalog table SYSIBM.SYSDATAPARTITIONS.
- Certain internal locks might also be acquired during an online index reorganization operation.
- Online index reorganization might have impact on concurrency if the reorganization operation fails. For example, the reorganization might fail due to insufficient memory, lack of disk space, or a lock timeout. The reorganization transaction performs certain updates before ending. To perform updates, reorganization must wait on existing transaction to be committed. This delay might block other transactions in the process. Starting in DB2 Version 9.7 Fix Pack 1, reorganization requests a special drain lock on the index object. Reorganization operations wait for existing transactions to finish; however, new requests to access the index object are allowed.

## Monitoring an index reorganization operation

### About this task

You can use the **db2pd** command to monitor the progress of reorganization operations on a database.

### Procedure

Issue the **db2pd** command with the **-reorgs index** parameter:

```
db2pd -reorgs index
```

## Results

The following is an example of output obtained using the **db2pd** command with the **-reorgs index** parameter, which reports the index reorganization progress for a range-partitioned table with two partitions.

**Note:** The first output reports the Index Reorg Stats of the non-partitioned indexes. The following outputs report the Index Reorg Stats of the partitioned indexes on each partition; the index reorganization statistics of only one partition is reported in each output.

```
Index Reorg Stats:
Retrieval Time: 02/08/2010 23:04:21
TbspaceID: -6      TableID: -32768
Schema: TEST1    TableName: BIGRPT
Access: Allow none
Status: Completed
Start Time: 02/08/2010 23:03:55   End Time: 02/08/2010 23:04:04
Total Duration: 00:00:08
Prev Index Duration: -
Cur Index Start: -
Cur Index: 0          Max Index: 2          Index ID: 0
Cur Phase: 0          ( - )      Max Phase: 0
Cur Count: 0          Max Count: 0
Total Row Count: 750000

Retrieval Time: 02/08/2010 23:04:21
TbspaceID: 2      TableID: 5
Schema: TEST1    TableName: BIGRPT
PartitionID: 0   MaxPartition: 2
Access: Allow none
Status: Completed
Start Time: 02/08/2010 23:04:04   End Time: 02/08/2010 23:04:08
Total Duration: 00:00:04
Prev Index Duration: -
Cur Index Start: -
Cur Index: 0          Max Index: 2          Index ID: 0
Cur Phase: 0          ( - )      Max Phase: 0
Cur Count: 0          Max Count: 0
Total Row Count: 375000

Retrieval Time: 02/08/2010 23:04:21
TbspaceID: 2      TableID: 6
Schema: TEST1    TableName: BIGRPT
PartitionID: 1   MaxPartition: 2
Access: Allow none
Status: Completed
Start Time: 02/08/2010 23:04:08   End Time: 02/08/2010 23:04:12
Total Duration: 00:00:04
Prev Index Duration: -
Cur Index Start: -
Cur Index: 0          Max Index: 2          Index ID: 0
Cur Phase: 0          ( - )      Max Phase: 0
Cur Count: 0          Max Count: 0
Total Row Count: 375000
```

## Determining when to reorganize tables and indexes

After many changes to table data, logically sequential data might be on nonsequential physical data pages, especially if many update operations created overflow records. When the data is organized in this way, the database manager must perform additional read operations to access required data. Additional read operations are also required if many rows are deleted.

## About this task

Table reorganization defragments data, eliminating wasted space. It also reorders the rows to incorporate overflow records, improving data access and, ultimately, query performance. You can specify that the data can be reordered according to a particular index, so that queries can access the data with a minimal number of read operations.

Many changes to table data can cause index performance to degrade. Index leaf pages can become fragmented or badly clustered, and the index could develop more levels than necessary for optimal performance. All of these issues cause more I/Os and can degrade performance.

Any one of the following factors indicate that you might reorganize a table or index:

- A high volume of insert, update, and delete activity against a table since the table was last reorganized
- Significant changes in the performance of queries that use an index with a high cluster ratio
- Executing the **RUNSTATS** command to refresh statistical information does not improve performance
- Output from the **REORGCHK** command suggests that performance can be improved by reorganizing a table or its indexes

In some cases, the **REORGCHK** utility will always recommend table reorganization, even after a table **REORG** operation has been performed. For example, using a 32-KB page size with an average record length of 15 bytes and a maximum of 253 records per page means that each page has  $32\,700 - (15 \times 253) = 28\,905$  unusable bytes. This means that approximately 88% of the page is free space. You can analyze **REORGCHK** utility recommendations and assess the potential benefits against the costs of performing a reorganization.

- If reclaiming space is your primary concern, the **REORG** command with the **CLEANUP** and **RECLAIM EXTENTS** options can be used.

The **RECLAIMABLE\_SPACE** output of the **ADMIN\_GET\_INDEX\_INFO** and **ADMIN\_GET\_TAB\_INFO** functions show how much space, in kilobytes, is available for reclaim. If you issue the **REORG** command with the **CLEANUP** option before running the **ADMIN\_GET\_INDEX\_INFO** and **ADMIN\_GET\_TAB\_INFO** functions, the output of the functions shows the maximum space available for reclamation. Use this information to determine when a **REORG** with **RECLAIM EXTENTS** would help reduce the size of your tables and indexes.

The **REORGCHK** command returns statistical information about data organization and can advise you about whether particular tables or indexes need to be reorganized. When space reclaim is your only concern, the **RECLAIMABLE\_SPACE** output of the **ADMIN\_GET\_INDEX\_INFO** and **ADMIN\_GET\_TAB\_INFO** functions outline how much space is available for reclaim. However, running specific queries against the **SYSSTAT** views at regular intervals or at specific times can build a history that helps you identify trends that have potentially significant performance implications.

To determine whether there is a need to reorganize your tables or indexes, query the **SYSSTAT** views and monitor the following statistics:

- Overflow of rows

Query the **OVERFLOW** column in the **SYSSTAT.TABLES** view to monitor the overflow value. The value represents the number of rows that do not fit on their original pages. Row data can overflow when variable length columns cause the



record length to expand to the point that a row no longer fits into its assigned location on the data page. Length changes can also occur if a column is added to the table. In this case, a pointer is kept at the original location in the row and the actual value is stored in another location that is indicated by the pointer. This can impact performance because the database manager must follow the pointer to find the contents of the column. This two-step process increases the processing time and might also increase the number of I/Os that are required. Reorganizing the table data will eliminate any row overflows.

- Fetch statistics

Query the following columns in the SYSSTAT.INDEXES catalog view to determine the effectiveness of the prefetchers when the table is accessed in index order. These statistics characterize the average performance of the prefetchers against the underlying table.

- The AVERAGE\_SEQUENCE\_FETCH\_PAGES column stores the average number of pages that can be accessed in sequence. Pages that can be accessed in sequence are eligible for prefetching. A small number indicates that the prefetchers are not as effective as they could be, because they cannot read in the full number of pages that is specified by the PREFETCHSIZE value for the table space. A large number indicates that the prefetchers are performing effectively. For a clustered index and table, this number should approach the value of NPAGES, the number of pages that contain rows.
- The AVERAGE\_RANDOM\_FETCH\_PAGES column stores the average number of random table pages that are fetched between sequential page accesses when fetching table rows using an index. The prefetchers ignore small numbers of random pages when most pages are in sequence, and continue to prefetch to the configured prefetch size. As the table becomes more disorganized, the number of random fetch pages increases. Disorganization is usually caused by insertions that occur out of sequence, either at the end of the table or in overflow pages, and query performance is impacted when an index is used to access a range of values.
- The AVERAGE\_SEQUENCE\_FETCH\_GAP column stores the average gap between table page sequences when fetching table rows using an index. Detected through a scan of index leaf pages, each gap represents the average number of table pages that must be randomly fetched between sequences of table pages. This occurs when many pages are accessed randomly, which interrupts the prefetchers. A large number indicates that the table is disorganized or poorly clustered to the index.

- Number of index leaf pages containing record identifiers (RIDs) that are marked deleted but not yet removed

RIDs are not usually physically deleted when they are marked deleted. This means that useful space might be occupied by these logically deleted RIDs. To retrieve the number of leaf pages on which every RID is marked deleted, query the NUM\_EMPTY\_LEAFS column of the SYSSTAT.INDEXES view. For leaf pages on which not all RIDs are marked deleted, the total number of logically deleted RIDs is stored in the NUMRIDS\_DELETED column.

Use this information to estimate how much space might be reclaimed by invoking the **REORG INDEXES** command with the CLEANUP ALL option. To reclaim only the space in pages on which all RIDs are marked deleted, invoke the **REORG INDEXES** command with the CLEANUP PAGES option.

- Cluster-ratio and cluster-factor statistics for indexes

In general, only one of the indexes for a table can have a high degree of clustering. A cluster-ratio statistic is stored in the CLUSTERRATIO column of the SYSCAT.INDEXES catalog view. This value, between 0 and 100, represents the

degree of data clustering in the index. If you collect detailed index statistics, a finer cluster-factor statistic between 0 and 1 is stored in the CLUSTERFACTOR column instead, and the value of CLUSTERRATIO is -1. Only one of these two clustering statistics can be recorded in the SYSCAT.INDEXES catalog view. To compare CLUSTERFACTOR values with CLUSTERRATIO values, multiply the CLUSTERFACTOR value by 100 to obtain a percentage value.

Index scans that are not index-only access might perform better with higher density of indexes. A low density leads to more I/O for this type of scan, because a data page is less likely to remain in the buffer pool until it is accessed again. Increasing the buffer size might improve the performance of low density indexes. Also, if smart index prefetching is enabled, it can also improve the performance of low density indexes which reduces the need to perform the **REORG** command on indexes. Smart index prefetching achieves this by switching from sequential detection prefetching to read ahead prefetching whenever low density indexes exist.

If table data was initially clustered on a certain index, and the clustering statistics indicate that the data is now poorly clustered on that same index, you might want to reorganize the table to re-cluster the data. Also, if smart data prefetching is enabled, it can improve the performance of poorly clustered data which reduces the need to perform the **REORG** command on tables. Smart data prefetching achieves this by switching from sequential detection prefetching to read ahead prefetching whenever badly clustered data pages exist.

- Number of leaf pages

Query the NLEAF column in the SYSCAT.INDEXES view to determine the number of leaf pages that are occupied by an index. This number tells you how many index page I/Os are needed for a complete scan of the index.

Ideally, an index should occupy as little space as possible to reduce the number of I/Os that are required for an index scan. Random update activity can cause page splits that increase the size of an index. During a table **REORG** operation, each index can be rebuilt with the least amount of space.

By default, ten percent of free space is left on each index page when an index is built. To increase the free space amount, specify the PCTFREE option when you create the index. The specified PCTFREE value is used whenever you reorganize the index. A free space value that is greater than ten percent might reduce the frequency of index reorganization, because the extra space can accommodate additional index insertions.

- Number of empty data pages

To calculate the number of empty pages in a table, query the FPAGES and NPAGES columns in the SYSCAT.TABLES view and then subtract the NPAGES value (the number of pages that contain rows) from the FPAGES value (the total number of pages in use). Empty pages can occur when entire ranges of rows are deleted.

As the number of empty pages increases, so does the need for table reorganization. Reorganizing a table reclaims empty pages and reduces the amount of space that a table uses. In addition, because empty pages are read into the buffer pool during a table scan, reclaiming unused pages can improve scan performance.

If the total number of in-use pages (FPAGES) in a table is less than or equal to (NPARTITIONS \* 1 extent size), table reorganization is not recommended. NPARTITIONS represents the number of data partitions if the table is a partitioned table; otherwise, its value is 1. In a partitioned database

environment, table reorganization is not recommended if  $FPAGES \leq (\text{the number of database partitions in a database partition group of the table}) * (NPARTITIONS * 1 \text{ extent size})$ .

Before reorganizing tables or indexes, consider the trade-off between the cost of increasingly degraded query performance and the cost of table or index reorganization, which includes processing time, elapsed time, and reduced concurrency.

## Costs of table and index reorganization

Performing a table reorganization or an index reorganization with the **REBUILD** option incurs a certain amount of overhead that must be considered when deciding whether to reorganize an object.

The costs of reorganizing tables and reorganizing indexes with the **REBUILD** option include:

- Processing time of the executing utility
- Reduced concurrency (because of locking) while running the reorg utility.
- Extra storage requirements.
  - Offline table reorganization requires more storage space to hold a shadow copy of the table.
  - Online or inplace table reorganization requires more log space.
  - Offline index reorganization requires less log space and does not involve a shadow copy.
  - Online index reorganization requires more log space and more storage space to hold a shadow copy of the index.

In some cases, a reorganized table might be larger than the original table. A table might grow after reorganization in the following situations:

- In a clustering reorg table operation in which an index is used to determine the order of the rows, more space might be required if the table records are of a variable length, because some pages in the reorganized table might contain fewer rows than in the original table.
- The amount of free space left on each page (represented by the PCTFREE value) might have increased since the last reorganization.

## Space requirements for an offline table reorganization

Because offline reorganization uses a shadow copy approach, you need enough additional storage to accommodate another copy of the table. The shadow copy is built either in the table space in which the original table resides or in a user-specified temporary table space.

Additional temporary table space storage might be required for sort processing if a table scan sort is used. The additional space required might be as large as the size of the table being reorganized. If the clustering index is of system managed space (SMS) type or unique database managed space (DMS) type, the recreation of this index does not require a sort. Instead, this index is rebuilt by scanning the newly reorganized data. Any other indexes that are recreated will require a sort, potentially involving temporary space up to the size of the table being reorganized.

Offline table reorg operations generate few control log records, and therefore consume a relatively small amount of log space. If the reorg utility does not use an

index, only table data log records are created. If an index is specified, or if there is a clustering index on the table, record IDs (RIDs) are logged in the order in which they are placed into the new version of the table. Each RID log record holds a maximum of 8000 RIDs, with each RID consuming 4 bytes. This can contribute to log space problems during an offline table reorg operation. Note that RIDs are only logged if the database is recoverable.

## Log space requirements for an online table reorganization

The log space that is required for an online table reorg operation is typically larger than what is required for an offline table reorg. The amount of space that is required is determined by the number of rows being reorganized, the number of indexes, the size of the index keys, and how poorly organized the table is at the outset. It is a good idea to establish a typical benchmark for log space consumption associated with your tables.

Every row in a table is likely moved twice during an online table reorg operation. For each index, each table row must update the index key to reflect the new location, and after all accesses to the old location have completed, the index key is updated again to remove references to the old RID. When the row is moved back, updates to the index key are performed again. All of this activity is logged to make online table reorganization fully recoverable. There is a minimum of two data log records (each including the row data) and four index log records (each including the key data) for each row (assuming one index). Clustering indexes, in particular, are prone to filling up the index pages, causing index splits and merges which must also be logged.

Because the online table reorg utility issues frequent internal COMMIT statements, it usually does not hold a large number of active logs. An exception can occur during the truncation phase, when the utility requests an S table lock. If the utility cannot acquire the lock, it waits, and other transactions might quickly fill up the logs in the meantime.

## Reducing the need to reorganize tables and indexes

You can use different strategies to reduce the need for (and the costs associated with) table and index reorganization.

### Reducing the need to reorganize tables

To reduce the need for table reorganization:

- Use multi-partition tables.
- Create multidimensional clustering (MDC) tables. For MDC tables, clustering is maintained on the columns that you specify with the ORGANIZE BY DIMENSIONS clause of the CREATE TABLE statement. However, the reorgchk utility might still recommend reorganization of an MDC table if it determines that there are too many unused blocks or that blocks should be compacted.
- Create insert time clustering (ITC) tables. For ITC tables, if you have a cyclical access pattern, for example you delete all data that was inserted at similar times, you can release that space back to the system. In such cases, you can reduce the need for a table reorganization with the REORG RECLAIM EXTENTS command that frees space.
- Enable the APPEND mode on your tables. If the index key values for new rows are always new high key values, for example, the clustering attribute of the table

will attempt to place them at the end of the table. In this case, enabling the APPEND mode might be a better choice than using a clustering index.

To further reduce the need for table reorganization, perform these tasks after you create a table:

- Alter the table to specify the percentage of each page that is to be left as free space during a load or a table reorganization operation (PCTFREE)
- Create a clustering index, specifying the PCTFREE option
- Sort the data before loading it into the table

After you have performed these tasks, the clustering index and the PCTFREE setting on the table help to preserve the original sorted order. If there is enough space on the table pages, new data can be inserted on the correct pages to maintain the clustering characteristics of the index. However, as more data is inserted and the table pages become full, records are appended to the end of the table, which gradually becomes unclustered.

If you perform a table reorg operation or a sort and load operation after you create a clustering index, the index attempts to maintain the order of the data, which improves the CLUSTERRATIO or CLUSTERFACTOR statistics that are collected by the runstats utility.

**Note:** If readahead prefetching is enabled it helps reduce the need to reorganize tables even if formula F4 of the **REORGCHK** command states otherwise.

## Reducing the need to rebuild indexes

To reduce the need to rebuild indexes with index reorganization:

- Create indexes specifying the PCTFREE or the LEVEL2 PCTFREE option.
- Create indexes with the MINPCTUSED option. Alternatively, consider using the CLEANUP ALL option of the REORG INDEXES command to merge leaf pages.
- Use the RECLAIM EXTENTS option of the REORG INDEXES command to release space back to the table space in an online fashion. This operation provides space reclaim without the need for a full rebuild of the indexes.

**Note:** If readahead prefetching is enabled it helps reduce the need to rebuild indexes with index reorganization, even if formula F4 of the **REORGCHK** command states otherwise.

## Automatic reorganization

After many changes to table data, the table and its indexes can become fragmented. Logically sequential data might reside on nonsequential pages, forcing the database manager to perform additional read operations to access data.

The statistical information that is collected by the **RUNSTATS** utility shows the distribution of data within a table. Analysis of these statistics can indicate when and what type of reorganization is necessary.

The automatic reorganization process determines the need for table or index reorganization by using formulas that are part of the **REORGCHK** utility. It periodically evaluates tables and indexes that have had their statistics updated to see whether reorganization is required, and schedules such operations whenever they are necessary.

The automatic reorganization feature can be enabled or disabled through the **auto\_reorg**, **auto\_tbl\_maint**, and **auto\_maint** database configuration parameters.

In a partitioned database environment, the initiation of automatic reorganization is done on the catalog database partition, and these configuration parameters need to be enabled only on that partition. The **REORG** operation, however, runs on all of the database partitions on which the target tables reside.

If you are unsure about when and how to reorganize your tables and indexes, you can incorporate automatic reorganization as part of your overall database maintenance plan.

You can also reorganize multidimensional clustering (MDC) and insert time clustering (ITC) tables to reclaim space. The freeing of extents from MDC and ITC tables is only supported for tables in DMS table spaces. Freeing extents from your MDC and ITC tables can be done in an online fashion using the **RECLAIM EXTENTS** option of the **REORG** command.

You can also schedule automatic space reclamation from your indexes. With the **RECLAIM EXTENTS** option of the **REORG** command, space is released back to the table space in an online fashion. This operation provides space reclamation without the need for a full rebuild of the indexes. The **REBUILD** option of the **REORG** command also reclaims space.

## Automatic reorganization on data partitioned tables

For DB2 Version 9.7 Fix Pack 1 and earlier releases, automatic reorganization supports reorganization of a data partitioned table for the entire table. For DB2 V9.7 Fix Pack 1 and later releases, automatic reorganization supports reorganizing data partitions of a partitioned table and reorganizing the partitioned indexes on a data partition of a partitioned table.

To avoid placing an entire data partitioned table into **ALLOW NO ACCESS** mode, automatic reorganization performs **REORG INDEXES ALL** operations at the data partition level on partitioned indexes that need to be reorganized. Automatic reorganization performs **REORG INDEX** operations on any nonpartitioned index that needs to be reorganized.

Automatic reorganization performs the following **REORG TABLE** operations on data partitioned tables:

- If any nonpartitioned indexes (except system-generated XML path indexes) are defined on the table and there is only one partition that needs to be reorganized, automatic reorganization performs a **REORG TABLE** operation with the **ON DATA PARTITION** clause to specify the partition that needs to be reorganized. Otherwise, automatic reorganization performs a **REORG TABLE** on the entire table without the **ON DATA PARTITION** clause.
- If no nonpartitioned indexes (except system-generated XML path indexes) are defined on the table, automatic reorganization performs a **REORG TABLE** operation with the **ON DATA PARTITION** clause on each partition that needs to be reorganized.

## Automatic reorganization on volatile tables

You can enable automatic index reorganization for volatile tables. The automatic reorganization process determines whether index reorganization is required for

volatile tables and schedules a REORG INDEX CLEANUP. Index reorganization is performed periodically on volatile tables and releases space that can be reused by the indexes defined on these tables.

Statistics cannot be collected in volatile tables because they are updated frequently. To determine what indexes need to be reorganized, automatic reorganization uses the numInxPseudoEmptyPagesForVolatile attribute instead of statistics. This attribute in the AUTO\_REORG policy indicates how many empty index pages with pseudo deleted keys an index must have in order to trigger index reorganization.

To enable automatic index reorganization in volatile tables, the **DB2\_WORKLOAD** registry variable must be set to *SAP*, automatic reorganization must be enabled, and the numInxPseudoEmptyPagesForVolatile attribute must be set.

## Enabling automatic table and index reorganization

Use automatic table and index reorganization so that you don't have to worry about when and how to reorganize your data.

### About this task

Having well-organized table and index data is critical to efficient data access and optimal workload performance. After many insert, update, and delete operations, logically sequential table data might reside on nonsequential data pages, so that the database manager must perform additional read operations to access data. Additional read operations are also required when accessing data in a table from which a significant number of rows have been deleted. You can enable the DB2 server to reorganize the system catalog tables as well as user tables.

### Procedure

To enable your database for automatic reorganization, set each of the following configuration parameters to ON:

- **auto\_maint**
- **auto\_tbl\_maint**
- **auto\_reorg**

## Enabling automatic index reorganization in volatile tables

You can enable automatic reorganization to perform index reorganization in volatile tables.

### About this task

If you enable automatic index reorganization in volatile tables, automatic reorg checks at every refresh interval whether the indexes on volatile tables require reorganization and schedules the necessary operation using the **REORG** command.

### Procedure

To enable automatic index reorganization in volatile tables, perform the following steps:

1. Set the **DB2\_WORKLOAD** registry variable to *SAP*. The following example shows how to set this variable using the **db2set** command:

```
db2set DB2_WORKLOAD=SAP
```

Restart the database so that this setting takes effect.

2. Set the **auto\_reorg** database configuration parameter to ON. The following example shows how to set this database configuration parameter using the DB2 CLP command line interface:

```
UPDATE DB CFG FOR SAMPLE USING auto_reorg ON
```

Ensure that the **auto\_maint** and **auto\_tbl\_maint** database configuration parameters are also set to ON. By the default, **auto\_maint** and **auto\_tbl\_maint** are set to ON.

3. Set the **numInxPseudoEmptyPagesForVolatileTables** attribute in the AUTO\_REORG policy by calling the AUTOMAINT\_SET\_POLICY or AUTOMAINT\_SET\_POLICYFILE procedure. This attribute indicates the minimum number of empty index pages with pseudo deleted keys required to perform the index reorganization. The following example shows how to set this attribute:

```
CALL SYSPROC.AUTOMAINT_SET_POLICY
('AUTO_REORG',
 BLOB(' <?xml version="1.0" encoding="UTF-8"?>
<DB2AutoReorgPolicy
xmlns="http://www.ibm.com/xmlns/prod/db2/autonomic/config" >

  <ReorgOptions dictionaryOption="Keep" indexReorgMode="Online"
    useSystemTempTableSpace="false" numInxPseudoEmptyPagesForVolatileTables="20" />

  <ReorgTableScope maxOfflineReorgTableSize="0">
    <FilterClause>TABSCHEMA NOT LIKE 'SYS%'/</FilterClause>
  </ReorgTableScope>
</DB2AutoReorgPolicy>')
)
```

You can monitor the values for the PSEUDO\_EMPTY\_PAGES, EMPTY\_PAGES\_DELETED, and EMPTY\_PAGES\_REUSED column by querying the MON\_GET\_INDEX table function to help you determine an appropriate value for the **numInxPseudoEmptyPagesForVolatileTables** attribute.

## Scenario: ExampleBANK reclaiming table and index space

This scenario presents ExampleBANK, a banking institution with a large customer base spanning many branches, as an organization wanting to reclaim table and index space.

ExampleBANK reclaims table and index space to ensure that the size of their tables and indexes is consistently managed without rendering them unavailable to users at any time. Organizations that handle large amounts of constantly changing data, like ExampleBANK, need a way to manage their table and index size. Reclaiming table and index space helps achieve this objective.

### Scenario: ExampleBANK reclaiming table and index space - Space management policies

The database administrator at ExampleBANK, Olivia, struggled for years to effectively manage the size of databases.

During the normal course of business operation, batch deletes are done on tables to get rid of data that is no longer required. The tables and associated indexes have free unused space that cannot be used by any other object in the same table space after the batch deletes are complete. ExampleBank has a space management policy in place to free this unused space. Each month Olivia takes the affected databases offline so the tables and indexes can be reorganized. The reorganization of the objects frees the space. To minimize downtime, the work is done during off-peak hours.



This table and index space management policy takes time and manual intervention. Also, because Olivia takes the database offline to complete this task, the affected tables and indexes are not available to users during the reorganization.

Olivia is told about new command and statement parameters to reclaim space from tables and indexes. A new way to manage the space needed for tables and indexes is presented.

### Scenario: ExampleBANK reclaiming table and index space - Creating an insert time clustering table

Insert time clustering (ITC) tables can help Olivia, and ExampleBANK, manage database size more effectively without manual intervention or database downtime.

Olivia creates an insert time clustering table as a test (the ORGANIZE BY INSERT TIME clause ensures that the table is created as an ITC table):

```
DB2 CREATE TABLE T1(c1 int, c2 char(100), ...) IN TABLESPACE1 ORGANIZE BY INSERT TIME;
DB2 CREATE INDEX INX1 ON T1(C1);
```

### Scenario: ExampleBANK reclaiming table and index space - Evaluating the effectiveness of reclaiming space from a table

Time passes and normal operations are performed on the ITC table.

At some point a batch delete is performed on this table, and large portions of the object become empty. Olivia wants to make this trapped space available to other objects in TABLESPACE1. Olivia can evaluate the effectiveness of space reclaim by using the ADMIN\_GET\_TAB\_INFO\_V97 function. This function can collect information about the physical space occupied by the data portion of the table T1.

Olivia collects the value of the current space taken by the data of table T1:

```
SELECT DATA_OBJECT_L_SIZE,DATA_OBJECT_P_SIZE,RECLAIMABLE_SPACE
FROM TABLE (SYSPROC.ADMIN_GET_TAB_INFO_V97('OLIVIA', 'T1'))
```

DATA_OBJECT_L_SIZE	DATA_OBJECT_P_SIZE	RECLAIMABLE_SPACE
6500354	10242064	2560025

1 record(s) selected.

Using the **REORG** command, Olivia then releases the reclaimable space now empty after the batch delete process back to the system while allowing users access to the table:

```
REORG TABLE T1 RECLAIM EXTENTS
```

Olivia then repeats the command to determine how much space was released to the table space:

```
SELECT DATA_OBJECT_L_SIZE,DATA_OBJECT_P_SIZE,RECLAIMABLE_SPACE
FROM TABLE (SYSPROC.ADMIN_GET_TAB_INFO_V97('OLIVIA', 'T1'))
```

DATA_OBJECT_L_SIZE	DATA_OBJECT_P_SIZE	RECLAIMABLE_SPACE
6500354	7682039	0

1 record(s) selected.

The result is 2,560,025 KB of space reclaimed that was once taken by data.

## Scenario: ExampleBANK reclaiming table and index space - Evaluating the effectiveness of reclaiming space from an index

Olivia notes the space reclaimed from the data portion of the table T1 after a batch delete. Olivia knows that there is some cleanup left to be done in the indexes for this table.

Reclaiming index space can recover space occupied by indexes while the same indexes are still available for use by users.

As with reclaiming space from the table, the space in question is reclaimed back to the table space for reuse by other objects.

Olivia uses the ADMIN\_GET\_INDEX\_INFO function to see how much space can be reclaimed:

```
SELECT SUBSTR(INDNAME,1,10) AS INDNAME, IID, INDEX_OBJECT_L_SIZE, INDEX_OBJECT_P_SIZE,
       RECLAIMABLE_SPACE FROM TABLE(SYSPROC.ADMIN_GET_INDEX_INFO('', 'OLIVIA', 'T1'))
       AS INDEXINFO WHERE INDNAME='INX1'
```

INDNAME	IID	INDEX_OBJECT_L_SIZE	INDEX_OBJECT_P_SIZE	RECLAIMABLE_SPACE
INX1	3	1106752	1106752	846592

1 record(s) selected.

Olivia uses the **REORG** command with the new parameters added for reclaiming index space to finish the cleanup in the index:

```
REORG INDEXES ALL FOR TABLE T1 ALLOW WRITE ACCESS CLEANUP ALL RECLAIM EXTENTS
```

Olivia then repeats the command to determine how much space was released to the table space:

```
SELECT SUBSTR(INDNAME,1,10) AS INDNAME, IID, INDEX_OBJECT_L_SIZE, INDEX_OBJECT_P_SIZE,
       RECLAIMABLE_SPACE FROM TABLE(SYSPROC.ADMIN_GET_INDEX_INFO('', 'OLIVIA', 'T1'))
       AS INDEXINFO WHERE INDNAME='INX1'
```

INDNAME	IID	INDEX_OBJECT_L_SIZE	INDEX_OBJECT_P_SIZE	RECLAIMABLE_SPACE
INX1	3	259776	259776	0

1 record(s) selected.

The result is an estimated 846,592 KB of space reclaimed. If the physical size after space is reclaimed is subtracted from the original physical size, Olivia notes that the actual space reclaimed is 846,976 KB.

## Scenario: ExampleBANK reclaiming table and index space - Converting an existing table to an insert time clustering table

Olivia sees the benefit of using insert time clustering tables. Olivia now wants to use this solution on existing tables in the production database. This change is accomplished by using the online table move utility.

Olivia has a table that exists on a system with the following schema. In this scenario, assume that the table actually has a column which is useful for placing data in approximate insert time order (C4).

```
CREATE TABLE EXMP.T1 (C1 INT, C2 CHAR(50), C3 BIGINT, C4 DATE) IN TABLESPACE1
```

```
CREATE INDEX INX1 ON EXMP.T1(C4)
```

Olivia now creates the target table for the conversion:

```
DB2 CREATE TABLE EXMP.NEWT1(C1 INT, C2 CHAR(50), C3 BIGINT, C4 DATE)
  IN TABLESPACE1 ORGANIZE BY INSERT TIME
```

The schema is identical to the original table but by using the ORGANIZE BY INSERT TIME keywords, Olivia ensures that this table is clustered by time.

Olivia uses the online table move stored procedure to perform the conversion.

Since a clustering index exists on column C4, it gives Olivia a good approximation of insert time ordering. For tables that do not have such a column, the space reclamation benefits of moving to an insert time clustering table is not apparent for some time. This benefit is not immediately apparent because newer data is grouped together with older data.

```
DB2 CALL SYSPROC.ADMIN_MOVE_TABLE('EXMP', 'T1', 'NEWT1', NULL, 'MOVE')
```

EXMP.T1 is now in a time clustering table format. It is ready to have extents reclaimed after subsequent batch deletions.

### Scenario: ExampleBANK reclaiming table and index space - General index maintenance

Olivia notes that, for some indexes and tables, space consumption and behavior are not closely tracked. Periodically, a script can check whether any space in the affected table spaces can be cleaned up and reclaimed.

Olivia uses the **REORGCHK** command to determine whether an index cleanup would be beneficial:

```
REORGCHK ON TABLE USER1.TBL1;
```

```
Doing RUNSTATS ....
```

Table statistics:

```
F1: 100 * OVERFLOW / CARD < 5
F2: 100 * (Effective Space Utilization of Data Pages) > 70
F3: 100 * (Required Pages / Total Pages) > 80
```

SCHEMA.NAME	CARD	OV	NP	FP ACTBLK	TSIZE	F1	F2	F3	REORG
Table: USER1.TBL1	3400	0	201	295	-	775200	0	67	70 -**

Index statistics:

```
F4: CLUSTERRATIO or normalized CLUSTERFACTOR > 80
F5: 100 * (Space used on leaf pages / Space available on non-empty leaf pages) >
  MIN(50, (100 - PCTFREE))
F6: (100 - PCTFREE) * (Amount of space available in an index with one less level /
  Amount of space required for all keys) < 100
F7: 100 * (Number of pseudo-deleted RIDs / Total number of RIDs) < 20
F8: 100 * (Number of pseudo-empty leaf pages / Total number of leaf pages) < 20
```

SCHEMA.NAME	INDCARD	LEAF	ELEAF	LVLS	NDEL	KEYS	LEAF_RECSIZE
Table: USER1.TBL1							
Index: USER1.TBL1_INX1	3400	244	0	3	1595	2882	205

(continued)

NLEAF_RECSIZE	LEAF_PAGE_OVERHEAD	NLEAF_PAGE_OVERHEAD	PCT_PAGES_SAVED	F4	F5	F6

205 132 132 0 100 64 9

-----  
(continued)  
F7 F8 REORG  
-----

31 0 ---\*-  
-----

CLUSTERRATIO or normalized CLUSTERFACTOR (F4) will indicate REORG is necessary for indexes that are not in the same sequence as the base table. When multiple indexes are defined on a table, one or more indexes may be flagged as needing REORG. Specify the most important index for REORG sequencing.

Tables defined using the ORGANIZE BY clause and the corresponding dimension indexes have a '\*' suffix to their names. The cardinality of a dimension index is equal to the Active blocks statistic of the table.

Formula F7 in the output shows that, for the TBL1\_INX1 index, an index cleanup using the **REORG** command would be beneficial. Olivia issues the command to clean up the indexes:

```
REORG INDEXES ALL FOR TABLE USER1.TBL1 ALLOW WRITE ACCESS CLEANUP;
```

To determine how much space can be reclaimed now that the **REORG INDEXES CLEANUP** command freed up space, Olivia uses the ADMIN\_GET\_INDEX\_INFO routine:

```
SELECT RECLAIMABLE_SPACE  
FROM TABLE(sysproc.admin_get_index_info('T','USER1', 'TBL1'))  
AS t";
```

```
RECLAIMABLE_SPACE  
-----  
14736
```

1 record(s) selected.

If Olivia considers this value, in KB, to be significant, she can run the **REORG INDEX RECLAIM EXTENTS** command:

```
REORG INDEXES ALL FOR TABLE USER1.TBL1 ALLOW WRITE ACCESS RECLAIM EXTENTS;
```

Olivia can schedule this work at regular intervals to ensure that the indexes in question do not hold more space than required. This regularly scheduled work does not prohibit others from using the indexes in question.

### Scenario: ExampleBANK reclaiming table and index space - AUTO\_REORG policy

Olivia can opt to automatically manage index reorganization in place of performing manual checks.

In the samples directory SQLLIB/samples/automaintcfg, Olivia finds a file called DB2AutoReorgPolicySample.xml. In this file, Olivia notes the following line:

```
<ReorgOptions dictionaryOption="Keep" indexReorgMode="Offline"  
useSystemTempTableSpace="false" />
```

Olivia decides that the reclaimExtentsSizeForIndexObjects threshold must exceed 51,200 KB (50 MB) before any automatic reorganization with the RECLAIM EXTENTS

option is run. Olivia copies DB2AutoReorgPolicySample.xml to a file called autoreorg\_policy.xml and changes the line in the sample to the following value:

```
<ReorgOptions dictionaryOption="Keep" indexReorgMode="Online"
  useSystemTempTableSpace="false" indexReclaimExtents="51200" />
```

Olivia then sets the policy:

```
cp $HOME/autoreorg_policy.xml $HOME/sql11ib/tmp/.
db2 "call sysproc.automaint_set_policyfile( 'AUTO_REORG', 'autoreorg_policy.xml')"
```

As a final step, Olivia ensures that AUTO REORG is enabled. For more details, see the related tasks.

Now that the policy is defined and AUTO REORG is enabled, automatic reorganization starts when the reclaimExtentsSizeForIndexObjects threshold exceeds 51,200 KB (50 MB).

---

## Application design

Database application design is one of the factors that affect application performance. Review this section for details about application design considerations that can help you to maximize the performance of database applications.

### Application processes, concurrency, and recovery

All SQL programs execute as part of an *application process* or agent. An application process involves the execution of one or more programs, and is the unit to which the database manager allocates resources and locks. Different application processes might involve the execution of different programs, or different executions of the same program.

More than one application process can request access to the same data at the same time. *Locking* is the mechanism that is used to maintain data integrity under such conditions, preventing, for example, two application processes from updating the same row of data simultaneously.

The database manager acquires locks to prevent uncommitted changes made by one application process from being accidentally perceived by any other process. The database manager releases all locks it has acquired and retained on behalf of an application process when that process ends. However, an application process can explicitly request that locks be released sooner. This is done using a *commit* operation, which releases locks that were acquired during a unit of work and also commits database changes that were made during the unit of work.

A *unit of work* (UOW) is a recoverable sequence of operations within an application process. A unit of work is initiated when an application process starts, or when the previous UOW ends because of something other than the termination of the application process. A unit of work ends with a commit operation, a rollback operation, or the end of an application process. A commit or rollback operation affects only the database changes that were made within the UOW that is ending.

The database manager provides a means of backing out of uncommitted changes that were made by an application process. This might be necessary in the event of a failure on the part of an application process, or in the case of a deadlock or lock timeout situation. An application process can explicitly request that its database changes be cancelled. This is done using a *rollback* operation.

As long as these changes remain uncommitted, other application processes are unable to see them, and the changes can be rolled back. This is not true, however, if the prevailing isolation level is uncommitted read (UR). After they are committed, these database changes are accessible to other application processes and can no longer be rolled back.

Both DB2 call level interface (CLI) and embedded SQL allow for a connection mode called *concurrent transactions*, which supports multiple connections, each of which is an independent transaction. An application can have multiple concurrent connections to the same database.

Locks that are acquired by the database manager on behalf of an application process are held until the end of a UOW, except when the isolation level is cursor stability (CS, in which the lock is released as the cursor moves from row to row) or uncommitted read (UR).

An application process is never prevented from performing operations because of its own locks. However, if an application uses concurrent transactions, the locks from one transaction might affect the operation of a concurrent transaction.

The initiation and the termination of a UOW define *points of consistency* within an application process. For example, a banking transaction might involve the transfer of funds from one account to another. Such a transaction would require that these funds be subtracted from the first account, and then added to the second account. Following the subtraction step, the data is inconsistent. Only after the funds have been added to the second account is consistency reestablished. When both steps are complete, the commit operation can be used to end the UOW, thereby making the changes available to other application processes. If a failure occurs before the UOW ends, the database manager will roll back any uncommitted changes to restore data consistency.

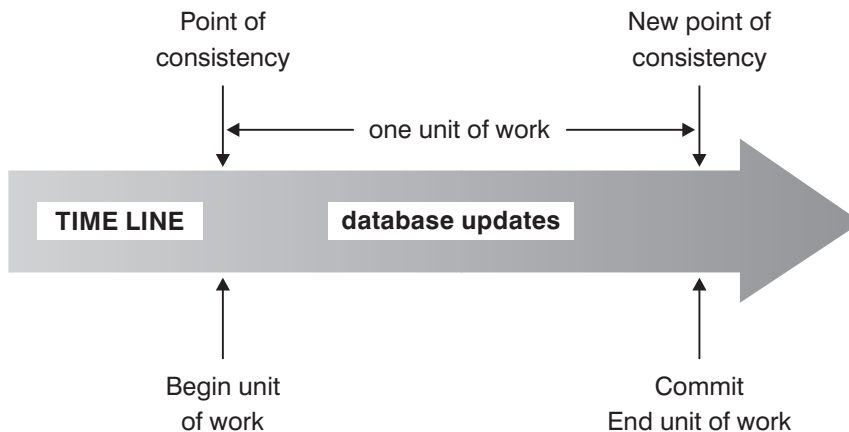

Figure 21. Unit of work with a COMMIT statement

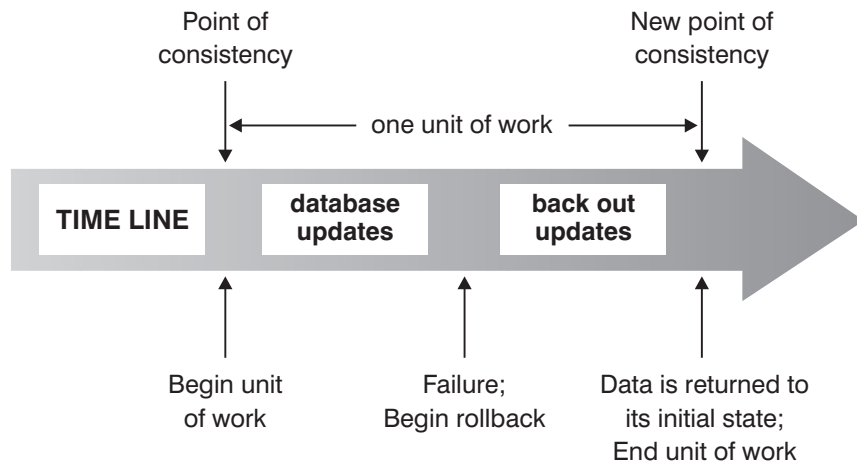

Figure 22. Unit of work with a ROLLBACK statement

## Concurrency issues

Because many users access and change data in a relational database, the database manager must allow users to make these changes while ensuring that data integrity is preserved.

*Concurrency* refers to the sharing of resources by multiple interactive users or application programs at the same time. The database manager controls this access to prevent undesirable effects, such as:

- **Lost updates.** Two applications, A and B, might both read the same row and calculate new values for one of the columns based on the data that these applications read. If A updates the row and then B also updates the row, A's update is lost.
- **Access to uncommitted data.** Application A might update a value, and B might read that value before it is committed. Then, if A backs out of that update, the calculations performed by B might be based on invalid data.
- **Non-repeatable reads.** Application A might read a row before processing other requests. In the meantime, B modifies or deletes the row and commits the change. Later, if A attempts to read the original row again, it sees the modified row or discovers that the original row has been deleted.
- **Phantom reads.** Application A might execute a query that reads a set of rows based on some search criterion. Application B inserts new data or updates existing data that would satisfy application A's query. Application A executes its query again, within the same unit of work, and some additional ("phantom") values are returned.

Concurrency is not an issue for global temporary tables, because they are available only to the application that declares or creates them.

## Concurrency control in federated database systems

A *federated database system* supports applications and users submitting SQL statements that reference two or more database management systems (DBMSs) in a single statement. To reference such data sources (each consisting of a DBMS and data), the DB2 server uses nicknames. *Nicknames* are aliases for objects in other

DBMSs. In a federated system, the DB2 server relies on the concurrency control protocols of the database manager that hosts the requested data.

A DB2 federated system provides *location transparency* for database objects. For example, if information about tables and views is moved, references to that information (through nicknames) can be updated without changing the applications that request this information. When an application accesses data through nicknames, the DB2 server relies on concurrency control protocols at the data source to ensure that isolation levels are enforced. Although the DB2 server tries to match the isolation level that is requested at the data source with a logical equivalent, results can vary, depending on data source capabilities.

## Isolation levels

The *isolation level* that is associated with an application process determines the degree to which the data that is being accessed by that process is locked or isolated from other concurrently executing processes. The isolation level is in effect for the duration of a unit of work.

The isolation level of an application process therefore specifies:

- The degree to which rows that are read or updated by the application are available to other concurrently executing application processes
- The degree to which the update activity of other concurrently executing application processes can affect the application

The isolation level for static SQL statements is specified as an attribute of a package and applies to the application processes that use that package. The isolation level is specified during the program preparation process by setting the ISOLATION bind or precompile option. For dynamic SQL statements, the default isolation level is the isolation level that was specified for the package preparing the statement. Use the SET CURRENT ISOLATION statement to specify a different isolation level for dynamic SQL statements that are issued within a session. For more information, see “CURRENT ISOLATION special register”. For both static SQL statements and dynamic SQL statements, the *isolation-clause* in a *select-statement* overrides both the special register (if set) and the bind option value. For more information, see “Select-statement”.

Isolation levels are enforced by locks, and the type of lock that is used limits or prevents access to the data by concurrent application processes. Declared temporary tables and their rows cannot be locked because they are only accessible to the application that declared them.

The database manager supports three general categories of locks:

### Share (S)

Under an S lock, concurrent application processes are limited to read-only operations on the data.

### Update (U)

Under a U lock, concurrent application processes are limited to read-only operations on the data, if these processes have not declared that they might update a row. The database manager assumes that the process currently looking at a row might update it.

### Exclusive (X)

Under an X lock, concurrent application processes are prevented from



accessing the data in any way. This does not apply to application processes with an isolation level of uncommitted read (UR), which can read but not modify the data.

Regardless of the isolation level, the database manager places exclusive locks on every row that is inserted, updated, or deleted. Thus, all isolation levels ensure that any row that is changed by an application process during a unit of work is not changed by any other application process until the unit of work is complete.

The database manager supports four isolation levels.

- “Repeatable read (RR)”
- “Read stability (RS)” on page 152
- “Cursor stability (CS)” on page 152
- “Uncommitted read (UR)” on page 153

**Note:** Some host database servers support the *no commit (NC)* isolation level. On other database servers, this isolation level behaves like the uncommitted read isolation level.

A detailed description of each isolation level follows, in decreasing order of performance impact, but in increasing order of the care that is required when accessing or updating data.

### **Repeatable read (RR)**

The *repeatable read* isolation level locks all the rows that an application references during a unit of work (UOW). If an application issues a SELECT statement twice within the same unit of work, the same result is returned each time. Under RR, lost updates, access to uncommitted data, non-repeatable reads, and phantom reads are not possible.

Under RR, an application can retrieve and operate on the rows as many times as necessary until the UOW completes. However, no other application can update, delete, or insert a row that would affect the result set until the UOW completes. Applications running under the RR isolation level cannot see the uncommitted changes of other applications. This isolation level ensures that all returned data remains unchanged until the time the application sees the data, even when temporary tables or row blocking is used.

Every referenced row is locked, not just the rows that are retrieved. For example, if you scan 10 000 rows and apply predicates to them, locks are held on all 10 000 rows, even if, say, only 10 rows qualify. Another application cannot insert or update a row that would be added to the list of rows referenced by a query if that query were to be executed again. This prevents phantom reads.

Because RR can acquire a considerable number of locks, this number might exceed limits specified by the **locklist** and **maxlocks** database configuration parameters. To avoid lock escalation, the optimizer might elect to acquire a single table-level lock for an index scan, if it appears that lock escalation is likely. If you do not want table-level locking, use the read stability isolation level.

While evaluating referential constraints, the DB2 server might occasionally upgrade the isolation level used on scans of the foreign table to RR, regardless of the isolation level that was previously set by the user. This results in additional locks being held until commit time, which increases the likelihood of a deadlock or a

lock timeout. To avoid these problems, create an index that contains only the foreign key columns, which the referential integrity scan can use instead.

### **Read stability (RS)**

The *read stability* isolation level locks only those rows that an application retrieves during a unit of work. RS ensures that any qualifying row read during a UOW cannot be changed by other application processes until the UOW completes, and that any change to a row made by another application process cannot be read until the change is committed by that process. Under RS, access to uncommitted data and non-repeatable reads are not possible. However, phantom reads are possible. Phantom reads might also be introduced by concurrent updates to rows where the old value did not satisfy the search condition of the original application but the new updated value does.

For example, a phantom row can occur in the following situation:

1. Application process P1 reads the set of rows *n* that satisfy some search condition.
2. Application process P2 then inserts one or more rows that satisfy the search condition and commits those new inserts.
3. P1 reads the set of rows again with the same search condition and obtains both the original rows and the rows inserted by P2.

In a DB2 pureScale environment, an application running at this isolation level might reject a previously committed row value if the row is updated concurrently on a different member. To override this behavior, specify the `WAIT_FOR_OUTCOME` option.

This isolation level ensures that all returned data remains unchanged until the time the application sees the data, even when temporary tables or row blocking is used.

The RS isolation level provides both a high degree of concurrency and a stable view of the data. To that end, the optimizer ensures that table-level locks are not obtained until lock escalation occurs.

The RS isolation level is suitable for an application that:

- Operates in a concurrent environment
- Requires qualifying rows to remain stable for the duration of a unit of work
- Does not issue the same query more than once during a unit of work, or does not require the same result set when a query is issued more than once during a unit of work

### **Cursor stability (CS)**

The *cursor stability* isolation level locks any row being accessed during a transaction while the cursor is positioned on that row. This lock remains in effect until the next row is fetched or the transaction terminates. However, if any data in the row was changed, the lock is held until the change is committed.

Under this isolation level, no other application can update or delete a row while an updatable cursor is positioned on that row. Under CS, access to the uncommitted data of other applications is not possible. However, non-repeatable reads and phantom reads are possible.

CS is the default isolation level. It is suitable when you want maximum concurrency and need to see only committed data.

In a DB2 pureScale environment, an application running at this isolation level may return or reject a previously committed row value if the row is concurrently updated on a different member. The `WAIT FOR OUTCOME` option of the concurrent access resolution setting can be used to override this behavior.

**Note:** Under the *currently committed* semantics introduced in Version 9.7, only committed data is returned, as was the case previously, but now readers do not wait for updaters to release row locks. Instead, readers return data that is based on the currently committed version; that is, data prior to the start of the write operation.

## Uncommitted read (UR)

The *uncommitted read* isolation level allows an application to access the uncommitted changes of other transactions. Moreover, UR does not prevent another application from accessing a row that is being read, unless that application is attempting to alter or drop the table.

Under UR, access to uncommitted data, non-repeatable reads, and phantom reads are possible. This isolation level is suitable if you run queries against read-only tables, or if you issue `SELECT` statements only, and seeing data that has not been committed by other applications is not a problem.

UR works differently for read-only and updatable cursors.

- Read-only cursors can access most of the uncommitted changes of other transactions.
- Tables, views, and indexes that are being created or dropped by other transactions are not available while the transaction is processing. Any other changes by other transactions can be read before they are committed or rolled back. Updatable cursors operating under UR behave as though the isolation level were CS.

If an uncommitted read application uses ambiguous cursors, it might use the CS isolation level when it runs. The ambiguous cursors can be escalated to CS if the value of the `BLOCKING` option on the `PREP` or `BIND` command is `UNAMBIG` (the default). To prevent this escalation:

- Modify the cursors in the application program to be unambiguous. Change the `SELECT` statements to include the `FOR READ ONLY` clause.
- Let the cursors in the application program remain ambiguous, but precompile the program or bind it with the `BLOCKING ALL` and `STATICREADONLY YES` options to enable the ambiguous cursors to be treated as read-only when the program runs.

## Comparison of isolation levels

Table 8 summarizes the supported isolation levels.

*Table 8. Comparison of isolation levels*

	UR	CS	RS	RR
Can an application see uncommitted changes made by other application processes?	Yes	No	No	No

Table 8. Comparison of isolation levels (continued)

	UR	CS	RS	RR
Can an application update uncommitted changes made by other application processes?	No	No	No	No
Can the re-execution of a statement be affected by other application processes? <sup>1</sup>	Yes	Yes	Yes	No <sup>2</sup>
Can updated rows be updated by other application processes? <sup>3</sup>	No	No	No	No
Can updated rows be read by other application processes that are running at an isolation level other than UR?	No	No	No	No
Can updated rows be read by other application processes that are running at the UR isolation level?	Yes	Yes	Yes	Yes
Can accessed rows be updated by other application processes? <sup>4</sup>	Yes	Yes	No	No
Can accessed rows be read by other application processes?	Yes	Yes	Yes	Yes
Can the current row be updated or deleted by other application processes? <sup>5</sup>	Yes/No <sup>6</sup>	Yes/No <sup>6</sup>	No	No

**Note:**

1. An example of the *phantom read phenomenon* is as follows: Unit of work UW1 reads the set of  $n$  rows that satisfies some search condition. Unit of work UW2 inserts one or more rows that satisfy the same search condition and then commits. If UW1 subsequently repeats its read with the same search condition, it sees a different result set: the rows that were read originally plus the rows that were inserted by UW2.
2. If your label-based access control (LBAC) credentials change between reads, results for the second read might be different because you have access to different rows.
3. The isolation level offers no protection to the application if the application is both reading from and writing to a table. For example, an application opens a cursor on a table and then performs an insert, update, or delete operation on the same table. The application might see inconsistent data when more rows are fetched from the open cursor.
4. An example of the *non-repeatable read phenomenon* is as follows: Unit of work UW1 reads a row. Unit of work UW2 modifies that row and commits. If UW1 subsequently reads that row again, it might see a different value.
5. An example of the *dirty read phenomenon* is as follows: Unit of work UW1 modifies a row. Unit of work UW2 reads that row before UW1 commits. If UW1 subsequently rolls the changes back, UW2 has read nonexistent data.
6. Under UR or CS, if the cursor is not updatable, the current row can be updated or deleted by other application processes in some cases. For example, buffering might cause the current row at the client to be different from the current row at the server. Moreover, when using currently committed semantics under CS, a row that is being read might have uncommitted updates pending. In this case, the currently committed version of the row is always returned to the application.

## Summary of isolation levels

Table 9 on page 155 lists the concurrency issues that are associated with different isolation levels.

Table 9. Summary of isolation levels

Isolation level	Access to uncommitted data	Non-repeatable reads	Phantom reads
Repeatable read (RR)	Not possible	Not possible	Not possible
Read stability (RS)	Not possible	Not possible	Possible
Cursor stability (CS)	Not possible	Possible	Possible
Uncommitted read (UR)	Possible	Possible	Possible

The isolation level affects not only the degree of isolation among applications but also the performance characteristics of an individual application, because the processing and memory resources that are required to obtain and free locks vary with the isolation level. The potential for deadlocks also varies with the isolation level. Table 10 provides a simple heuristic to help you choose an initial isolation level for your application.

Table 10. Guidelines for choosing an isolation level

Application type	High data stability required	High data stability not required
Read-write transactions	RS	CS
Read-only transactions	RR or RS	UR

## Specifying the isolation level

Because the isolation level determines how data is isolated from other processes while the data is being accessed, you should select an isolation level that balances the requirements of concurrency and data integrity.

### About this task

The isolation level that you specify is in effect for the duration of the unit of work (UOW). The following heuristics are used to determine which isolation level will be used when compiling an SQL or XQuery statement:

- For static SQL:
  - If an *isolation-clause* is specified in the statement, the value of that clause is used.
  - If an *isolation-clause* is not specified in the statement, the isolation level that was specified for the package when the package was bound to the database is used.
- For dynamic SQL:
  - If an *isolation-clause* is specified in the statement, the value of that clause is used.
  - If an *isolation-clause* is not specified in the statement, and a SET CURRENT ISOLATION statement has been issued within the current session, the value of the CURRENT ISOLATION special register is used.
  - If an *isolation-clause* is not specified in the statement, and a SET CURRENT ISOLATION statement has not been issued within the current session, the isolation level that was specified for the package when the package was bound to the database is used.
- For static or dynamic XQuery statements, the isolation level of the environment determines the isolation level that is used when the XQuery expression is evaluated.

**Note:** Many commercially-written applications provide a method for choosing the isolation level. Refer to the application documentation for information.

The isolation level can be specified in several different ways.

### Procedure

- **At the statement level:**

**Note:** Isolation levels for XQuery statements cannot be specified at the statement level.

Use the WITH clause. The WITH clause cannot be used on subqueries. The WITH UR option applies to read-only operations only. In other cases, the statement is automatically changed from UR to CS.

This isolation level overrides the isolation level that is specified for the package in which the statement appears. You can specify an isolation level for the following SQL statements:

- DECLARE CURSOR
- Searched DELETE
- INSERT
- SELECT
- SELECT INTO
- Searched UPDATE

- **For dynamic SQL within the current session:**

Use the SET CURRENT ISOLATION statement to set the isolation level for dynamic SQL issued within a session. Issuing this statement sets the CURRENT ISOLATION special register to a value that specifies the isolation level for any dynamic SQL statements that are issued within the current session. Once set, the CURRENT ISOLATION special register provides the isolation level for any subsequent dynamic SQL statement that is compiled within the session, regardless of which package issued the statement. This isolation level is in effect until the session ends or until the SET CURRENT ISOLATION...RESET statement is issued.

- **At precompile or bind time:**

For an application written in a supported compiled language, use the ISOLATION option of the **PREP** or **BIND** commands. You can also use the sqlaprep or sqlabndx API to specify the isolation level.

- If you create a bind file at precompile time, the isolation level is stored in the bind file. If you do not specify an isolation level at bind time, the default is the isolation level that was used during precompilation.
- If you do not specify an isolation level, the default level of cursor stability (CS) is used.

To determine the isolation level of a package, execute the following query:

```
select isolation from syscat.packages
  where pkgname = 'pkgname'
     and pkgschema = 'pkgschema'
```

where *pkgname* is the unqualified name of the package and *pkgschema* is the schema name of the package. Both of these names must be specified in uppercase characters.

- **When working with JDBC or SQLJ at run time:**

**Note:** JDBC and SQLJ are implemented with CLI on DB2 servers, which means that the `db2cli.ini` settings might affect what is written and run using JDBC and SQLJ.

To create a package (and specify its isolation level) in SQLJ, use the SQLJ profile customizer (`db2sqljcustomize` command).

- **From CLI or ODBC at run time:**

Use the **CHANGE ISOLATION LEVEL** command. With DB2 Call-level Interface (CLI), you can change the isolation level as part of the CLI configuration. At run time, use the `SQLSetConnectAttr` function with the `SQL_ATTR_TXN_ISOLATION` attribute to set the transaction isolation level for the current connection referenced by the `ConnectionHandle` argument. You can also use the `TXNISOLATION` keyword in the `db2cli.ini` file.

- **On database servers that support REXX:**

When a database is created, multiple bind files that support the different isolation levels for SQL in REXX are bound to the database. Other command line processor (CLP) packages are also bound to the database when a database is created.

REXX and the CLP connect to a database using the default CS isolation level. Changing this isolation level does not change the connection state.

To determine the isolation level that is being used by a REXX application, check the value of the `SQLISL` predefined REXX variable. The value is updated each time that the **CHANGE ISOLATION LEVEL** command executes.

## Results

### Currently committed semantics

Under *currently committed* semantics, only committed data is returned to readers. However, readers do not wait for writers to release row locks. Instead, readers return data that is based on the currently committed version of data: that is, the version of the data before the start of the write operation.

Lock timeouts and deadlocks can occur under the cursor stability (CS) isolation level with row-level locking, especially with applications that are not designed to prevent such problems. Some high-throughput database applications cannot tolerate waiting on locks that are issued during transaction processing. Also, some applications cannot tolerate processing uncommitted data but still require non-blocking behavior for read transactions.

Currently committed semantics are turned on by default for new databases. You do not have to make application changes to take advantage of the new behavior. To override the default behavior, set the `cur_commit` database configuration parameter to `DISABLED`. Overriding the behavior might be useful, for example, if applications require the blocking of writers to synchronize internal logic. During database upgrade from V9.5 or earlier, the `cur_commit` configuration parameter is set to `DISABLED` to maintain the same behavior as in previous releases. If you want to use currently committed on cursor stability scans, you need to set the `cur_commit` configuration parameter to `ON` after the upgrade.

Currently committed semantics apply only to read-only scans that do not involve catalog tables and internal scans that are used to evaluate or enforce constraints. Because currently committed semantics are decided at the scan level, the access plan of a writer might include currently committed scans. For example, the scan for a read-only subquery can involve currently committed semantics.

Because currently committed semantics obey isolation level semantics, applications running under currently committed semantics continue to respect isolation levels.

Currently committed semantics require increased log space for writers. Additional space is required for logging the first update of a data row during a transaction. This data is required for retrieving the currently committed image of the row. Depending on the workload, this can have an insignificant or measurable impact on the total log space used. The requirement for additional log space does not apply when `cur_commit` database configuration parameter is set to `DISABLED`.

## Restrictions

The following restrictions apply to currently committed semantics:

- The target table object in a section that is to be used for data update or deletion operations does not use currently committed semantics. Rows that are to be modified must be lock protected to ensure that they do not change after they have satisfied any query predicates that are part of the update operation.
- A transaction that makes an uncommitted modification to a row forces the currently committed reader to access appropriate log records to determine the currently committed version of the row. Although log records that are no longer in the log buffer can be physically read, currently committed semantics do not support the retrieval of log files from the log archive. This affects only databases that you configure to use infinite logging.
- The following scans do not use currently committed semantics:
  - Catalog table scans
  - Scans that are used to enforce referential integrity constraints
  - Scans that reference `LONG VARCHAR` or `LONG VARGRAPHIC` columns
  - Range-clustered table (RCT) scans
  - Scans that use spatial or extended indexes

## Example

Consider the following scenario, in which deadlocks are avoided by using currently committed semantics. In this scenario, two applications update two separate tables, as shown in step 1, but do not yet commit. Each application then attempts to use a read-only cursor to read from the table that the other application updated, as shown in step 2. These applications are running under the CS isolation level.

Step	Application A	Application B
1	update T1 set col1 = ? where col2 = ?	update T2 set col1 = ? where col2 = ?
2	select col1, col3, col4 from T2 where col2 >= ?	select col1, col5, from T1 where col5 = ? and col2 = ?
3	commit	commit

Without currently committed semantics, these applications running under the cursor stability isolation level might create a deadlock, causing one of the applications to fail. This happens when each application must read data that is being updated by the other application.

Under currently committed semantics, if one of the applications that is running a query in step 2 requires the data that is being updated by the other application, the first application does not wait for the lock to be released. As a result, a deadlock is



impossible. The first application locates and uses the previously committed version of the data instead.

### Option to disregard uncommitted insertions

The **DB2\_SKIPINSERTED** registry variable controls whether or not uncommitted data insertions can be ignored for statements that use the cursor stability (CS) or the read stability (RS) isolation level.

Uncommitted insertions are handled in one of two ways, depending on the value of the **DB2\_SKIPINSERTED** registry variable.

- When the value is ON, the DB2 server ignores uncommitted insertions, which in many cases can improve concurrency and is the preferred behavior for most applications. Uncommitted insertions are treated as though they had not yet occurred.
- When the value is OFF (the default), the DB2 server waits until the insert operation completes (commits or rolls back) and then processes the data accordingly. This is appropriate in certain cases. For example:
  - Suppose that two applications use a table to pass data between themselves, with the first application inserting data into the table and the second one reading it. The data must be processed by the second application in the order presented, such that if the next row to be read is being inserted by the first application, the second application must wait until the insert operation commits.
  - An application avoids UPDATE statements by deleting data and then inserting a new image of the data.

### Evaluate uncommitted data through lock deferral

To improve concurrency, the database manager in some situations permits the deferral of row locks for CS or RS isolation scans until a row is known to satisfy the predicates of a query.

By default, when row-level locking is performed during a table or index scan, the database manager locks each scanned row whose commitment status is unknown before determining whether the row satisfies the predicates of the query.

To improve the concurrency of such scans, enable the **DB2\_EVALUNCOMMITTED** registry variable so that predicate evaluation can occur on uncommitted data. A row that contains an uncommitted update might not satisfy the query, but if predicate evaluation is deferred until after the transaction completes, the row might indeed satisfy the query.

Uncommitted deleted rows are skipped during table scans, and the database manager skips deleted keys during index scans if the **DB2\_SKIPDELETED** registry variable is enabled.

The **DB2\_EVALUNCOMMITTED** registry variable setting applies at compile time for dynamic SQL or XQuery statements, and at bind time for static SQL or XQuery statements. This means that even if the registry variable is enabled at run time, the lock avoidance strategy is not deployed unless **DB2\_EVALUNCOMMITTED** was enabled at bind time. If the registry variable is enabled at bind time but not enabled at run time, the lock avoidance strategy is still in effect. For static SQL or XQuery statements, if a package is rebound, the registry variable setting that is in effect at bind time is the setting that applies. An implicit rebind of static SQL or XQuery statements will use the current setting of the **DB2\_EVALUNCOMMITTED** registry variable.

## Applicability of evaluate uncommitted for different access plans

Table 11. RID Index Only Access

Predicates		Evaluate Uncommitted
None		No
SARGable		Yes

Table 12. Data Only Access (relational or deferred RID list)

Predicates		Evaluate Uncommitted
None		No
SARGable		Yes

Table 13. RID Index + Data Access

Predicates		Evaluate Uncommitted	
Index	Data	Index access	Data access
None	None	No	No
None	SARGable	No	No
SARGable	None	Yes	No
SARGable	SARGable	Yes	No

Table 14. Block Index + Data Access

Predicates		Evaluate Uncommitted	
Index	Data	Index access	Data access
None	None	No	No
None	SARGable	No	Yes
SARGable	None	Yes	No
SARGable	SARGable	Yes	Yes

### Example

The following example provides a comparison between the default locking behavior and the evaluate uncommitted behavior. The table is the ORG table from the SAMPLE database.

DEPTNUMB	DEPTNAME	MANAGER	DIVISION	LOCATION
10	Head Office	160	Corporate	New York
15	New England	50	Eastern	Boston
20	Mid Atlantic	10	Eastern	Washington
38	South Atlantic	30	Eastern	Atlanta
42	Great Lakes	100	Midwest	Chicago
51	Plains	140	Midwest	Dallas
66	Pacific	270	Western	San Francisco
84	Mountain	290	Western	Denver

The following transactions occur under the default cursor stability (CS) isolation level.

Table 15. Transactions against the ORG table under the CS isolation level

SESSION 1	SESSION 2
connect to sample	connect to sample
+c update org set deptnumb=5 where manager=160	
	select * from org where deptnumb >= 10

The uncommitted UPDATE statement in Session 1 holds an exclusive lock on the first row in the table, preventing the query in Session 2 from returning a result set, even though the row being updated in Session 1 does not currently satisfy the query in Session 2. The CS isolation level specifies that any row that is accessed by a query must be locked while the cursor is positioned on that row. Session 2 cannot obtain a lock on the first row until Session 1 releases its lock.

Waiting for a lock in Session 2 can be avoided by using the evaluate uncommitted feature, which first evaluates the predicate and then locks the row. As such, the query in Session 2 would not attempt to lock the first row in the table, thereby increasing application concurrency. Note that this also means that predicate evaluation in Session 2 would occur with respect to the uncommitted value of deptnumb=5 in Session 1. The query in Session 2 would omit the first row in its result set, despite the fact that a rollback of the update in Session 1 would satisfy the query in Session 2.

If the order of operations were reversed, concurrency could still be improved with the evaluate uncommitted feature. Under default locking behavior, Session 2 would first acquire a row lock prohibiting the searched UPDATE in Session 1 from executing, even though the Session 1 UPDATE statement would not change the row that is locked by the Session 2 query. If the searched UPDATE in Session 1 first attempted to examine rows and then locked them only if they qualified, the Session 1 query would be non-blocking.

### Restrictions

- The **DB2\_EVALUNCOMMITTED** registry variable must be enabled.
- The isolation level must be CS or RS.
- Row-level locking is in effect.
- SARGable evaluation predicates exist.
- Evaluate uncommitted is not applicable to scans on the system catalog tables.
- For multidimensional clustering (MDC) or insert time clustering (ITC) tables, block-level locking can be deferred for an index scan; however, block-level locking cannot be deferred for table scans.
- Lock deferral will not occur on a table that is executing an inplace table reorganization.
- For Iscan-Fetch plans, row-level locking is not deferred to the data access; rather, the row is locked during index access before moving to the row in the table.
- Deleted rows are unconditionally skipped during table scans, but deleted index keys are skipped only if the **DB2\_SKIPDELETED** registry variable is enabled.

## Writing and tuning queries for optimal performance

There are several ways in which you can minimize the impact of SQL statements on DB2 database performance.

You can minimize this impact by:

- Writing SQL statements that the DB2 optimizer can more easily optimize. The DB2 optimizer might not be able to efficiently run SQL statements that contain non-equality join predicates, data type mismatches on join columns, unnecessary outer joins, and other complex search conditions.
- Correctly configuring the DB2 database to take advantage of DB2 optimization functionality. The DB2 optimizer can select the optimal query access plan if you have accurate catalog statistics and choose the best optimization class for your workload.
- Using the DB2 explain functionality to review potential query access plans and determine how to tune queries for best performance.

Best practices apply to general workloads, warehouse workloads, and SAP workloads.

Although there are a number of ways to deal with specific query performance issues after an application is written, good fundamental writing and tuning practices can be widely applied early on to help improve DB2 database performance.

Query performance is not a one-time consideration. You should consider it throughout the design, development, and production phases of the application development life cycle.

SQL is a very flexible language, which means that there are many ways to get the same correct result. This flexibility also means that some queries are better than others in taking advantage of the DB2 optimizer's strengths.

During query execution, the DB2 optimizer chooses a query access plan for each SQL statement. The optimizer models the execution cost of many alternative access plans and chooses the one with the minimum estimated cost. If a query contains many complex search conditions, the DB2 optimizer can rewrite the predicate in some cases, but there are some cases where it cannot.

The time to prepare or compile an SQL statement can be long for complex queries, such as those used in business intelligence (BI) applications. You can help minimize statement compilation time by correctly designing and configuring your database. This includes choosing the correct optimization class and setting other registry variables correctly.

The optimizer also requires accurate inputs to make accurate access plan decisions. This means that you need to gather accurate statistics, and potentially use advanced statistical features, such as statistical views and column group statistics.

You can use the DB2 tools, especially the DB2 explain facility, to tune queries. The DB2 compiler can capture information about the access plans and environments of static or dynamic queries. Use this captured information to understand how individual statements are run so that you can tune them and your database manager configuration to improve performance.

## **Writing SQL statements**

SQL is a powerful language that enables you to specify relational expressions in syntactically different but semantically equivalent ways. However, some semantically equivalent variations are easier to optimize than others. Although the DB2 optimizer has a powerful query rewrite capability, it might not always be able to rewrite an SQL statement into the most optimal form.

Certain SQL constructs can limit the access plans that are considered by the query optimizer, and these constructs should be avoided or replaced whenever possible.

#### **Avoiding complex expressions in search conditions:**

Avoid using complex expressions in search conditions where the expressions prevent the optimizer from using the catalog statistics to estimate an accurate selectivity.

The expressions might also limit the choices of access plans that can be used to apply the predicate. During the query rewrite phase of optimization, the optimizer can rewrite a number of expressions to allow the optimizer to estimate an accurate selectivity; it cannot handle all possibilities.

#### **Avoiding join predicates on expressions:**

Using expressions on join predicates can limit the join method used.

A hash join method will be considered for join predicates with an expression, as long as none of the following types of functions are used:

- A function that reads or modifies SQL data
- A function that is non-deterministic
- A function that has an external action
- A function that uses a scratchpad

If columns from both operands of the associated join are used on the same side of the join condition, hash joins are also considered, but cannot be chosen in most cases.

If a hash join cannot be used, then a potentially slower nested loop join will be used instead, and in these cases the cardinality estimate might be inaccurate.

An example of a join with an expression that is considered for a hash join:

```
WHERE UPPER(CUST.LASTNAME) = TRANS.NAME
```

An example of a join with expression that would not benefit from a hash join, but would use a nested loop join instead:

```
WHERE RAND() > 0.5
```

#### **Avoiding expressions over columns in local predicates:**

Instead of applying an expression over columns in a local predicate, use the inverse of the expression.

Consider the following examples:

```
XPRESSN(C) = 'constant'  
INTEGER(TRANS_DATE)/100 = 200802
```

You can rewrite these statements as follows:

```
C = INVERSEXPRESSN('constant')  
TRANS_DATE BETWEEN 20080201 AND 20080229
```

Applying expressions over columns prevents the use of index start and stop keys, leads to inaccurate selectivity estimates, and requires extra processing at query execution time.

These expressions also prevent query rewrite optimizations such as recognizing when columns are equivalent, replacing columns with constants, and recognizing when at most one row will be returned. Further optimizations are possible after it can be proven that at most one row will be returned, so the lost optimization opportunities are further compounded. Consider the following query:

```
SELECT LASTNAME, CUST_ID, CUST_CODE FROM CUST
WHERE (CUST_ID * 100) + INT(CUST_CODE) = 123456 ORDER BY 1,2,3
```

You can rewrite it as follows:

```
SELECT LASTNAME, CUST_ID, CUST_CODE FROM CUST
WHERE CUST_ID = 1234 AND CUST_CODE = '56' ORDER BY 1,2,3
```

If there is a unique index defined on CUST\_ID, the rewritten version of the query enables the query optimizer to recognize that at most one row will be returned. This avoids introducing an unnecessary SORT operation. It also enables the CUST\_ID and CUST\_CODE columns to be replaced by 1234 and '56', avoiding copying values from the data or index pages. Finally, it enables the predicate on CUST\_ID to be applied as an index start or stop key.

It might not always be apparent when an expression is present in a predicate. This can often occur with queries that reference views when the view columns are defined by expressions. For example, consider the following view definition and query:

```
CREATE VIEW CUST_V AS
  (SELECT LASTNAME, (CUST_ID * 100) + INT(CUST_CODE) AS CUST_KEY
   FROM CUST)

SELECT LASTNAME FROM CUST_V WHERE CUST_KEY = 123456
```

The query optimizer merges the query with the view definition, resulting in the following query:

```
SELECT LASTNAME FROM CUST
WHERE (CUST_ID * 100) + INT(CUST_CODE) = 123456
```

This is the same problematic predicate described in a previous example. You can observe the result of view merging by using the explain facility to display the optimized SQL.

If the inverse function is difficult to express, consider using a generated column. For example, if you want to find a last name that fits the criteria expressed by LASTNAME IN ('Woo', 'woo', 'WOO', 'Woo',...), you can create a generated column UCASE(LASTNAME) = 'WOO' as follows:

```
CREATE TABLE CUSTOMER (
  LASTNAME VARCHAR(100),
  U_LASTNAME VARCHAR(100) GENERATED ALWAYS AS (UCASE(LASTNAME))
)

CREATE INDEX CUST_U_LASTNAME ON CUSTOMER(U_LASTNAME)
```

Support for case-insensitive search, which was introduced in DB2 Database for Linux, UNIX, and Windows Version 9.5 Fix Pack 1, is designed to resolve the situation in this particular example. You can use `_Sx` attribute on a locale-sensitive UCA-based collation to control the strength of the collations. For example, a locale-sensitive UCA-based collation with the attributes `_LFR_S1` is a French collation that ignores case and accent.

**Avoiding no-op expressions in predicates to change the optimizer estimate:**

A "no-op" coalesce() predicate of the form COALESCE(X, X) = X introduces an estimation error into the planning of any query that uses it. Currently the DB2 query compiler does not have the capability of dissecting that predicate and determining that all rows actually satisfy it.

As a result, the predicate artificially reduces the estimated number of rows coming from some part of a query plan. This smaller row estimate usually reduces the row and cost estimates for the rest of query planning, and sometimes results in a different plan being chosen, because relative estimates between different candidate plans have changed.

Why can this do-nothing predicate sometimes improve query performance? The addition of the "no-op" coalesce() predicate introduces an error that masks something else that is preventing optimal performance.

What some performance enhancement tools do is a brute-force test: the tool repeatedly introduces the predicate into different places in a query, operating on different columns, to try to find a case where, by introducing an error, it stumbles onto a better-performing plan. This is also true of a query developer hand-coding the "no-op" predicate into a query. Typically, the developer will have some insight on the data to guide the placement of the predicate.

Using this method to improve query performance is a short-term solution that does not address root cause and might have the following implications:

- Potential areas for performance improvements are hidden.
- There are no guarantees that this workaround will provide permanent performance improvements, because the DB2 query compiler might eventually handle the predicate better, or other random factors might affect it.
- There might be other queries that are affected by the same root cause and the performance of your system in general might suffer as a result.

If you have followed best practices recommendations, but you believe that you are still getting less than optimal performance, you can provide explicit optimization guidelines to the DB2 optimizer, rather than introducing a "no-op" predicate. See "Optimization profiles and guidelines".

#### **Avoiding non-equality join predicates:**

Join predicates that use comparison operators other than equality should be avoided because the join method is limited to nested loop.

Additionally, the optimizer might not be able to compute an accurate selectivity estimate for the join predicate. However, non-equality join predicates cannot always be avoided. When they are necessary, ensure that an appropriate index exists on either table, because the join predicates will be applied to the inner table of the nested-loop join.

One common example of non-equality join predicates is the case in which dimension data in a star schema must be versioned to accurately reflect the state of a dimension at different points in time. This is often referred to as a *slowly changing dimension*. One type of slowly changing dimension involves including effective start and end dates for each dimension row. A join between the fact table and the dimension table requires checking that a date associated with the fact falls within the dimension's start and end date, in addition to joining on the dimension primary key. This is often referred to as a *type 6 slowly changing dimension*. The

range join back to the fact table to further qualify the dimension version by some fact transaction date can be expensive. For example:

```
SELECT...
  FROM PRODUCT P, SALES F
  WHERE
    P.PROD_KEY = F.PROD_KEY AND
    F.SALE_DATE BETWEEN P.START_DATE AND
    P.END_DATE
```

In this situation, ensure that there is an index on (SALES.PROD\_KEY, SALES.SALE\_DATE).

Consider creating a statistical view to help the optimizer compute a better selectivity estimate for this scenario. For example:

```
CREATE STATISTICAL VIEW V_PROD_FACT AS
  SELECT P.*
  FROM PRODUCT P, SALES F
  WHERE
    P.PROD_KEY = F.PROD_KEY AND
    F.SALE_DATE BETWEEN P.START_DATE AND
    P.END_DATE

ALTER VIEW V_PROD_FACT ENABLE QUERY OPTIMIZATION

RUNSTATS ON TABLE DB2USER.V_PROD_FACT WITH DISTRIBUTION
```

Specialized star schema joins, such as star join with index ANDing and hub joins, are not considered if there are any non-equality join predicates in the query block. (See “Ensuring that queries fit the required criteria for the star schema join”.)

#### **Avoiding unnecessary outer joins:**

The semantics of certain queries require outer joins (either left, right, or full). However, if the query semantics do not require an outer join, and the query is being used to deal with inconsistent data, it is best to deal with the inconsistent data problems at their root cause.

For example, in a data mart with a star schema, the fact table might contain rows for transactions but no matching parent dimension rows for some dimensions, due to data consistency problems. This could occur because the extract, transform, and load (ETL) process could not reconcile some business keys for some reason. In this scenario, the fact table rows are left outer joined with the dimensions to ensure that they are returned, even when they do not have a parent. For example:

```
SELECT...
  FROM DAILY_SALES F
  LEFT OUTER JOIN CUSTOMER C ON F.CUST_KEY = C.CUST_KEY
  LEFT OUTER JOIN STORE S ON F.STORE_KEY = S.STORE_KEY
  WHERE
    C.CUST_NAME = 'SMITH'
```

The left outer join can prevent a number of optimizations, including the use of specialized star-schema join access methods. However, in some cases the left outer join can be automatically rewritten to an inner join by the query optimizer. In this example, the left outer join between CUSTOMER and DAILY\_SALES can be converted to an inner join because the predicate C.CUST\_NAME = 'SMITH' will remove any rows with null values in this column, making a left outer join semantically unnecessary. So the loss of some optimizations due to the presence of



outer joins might not adversely affect all queries. However, it is important to be aware of these limitations and to avoid outer joins unless they are absolutely required.

**Using the OPTIMIZE FOR N ROWS clause with the FETCH FIRST N ROWS ONLY clause:**

The OPTIMIZE FOR  $n$  ROWS clause indicates to the optimizer that the application intends to retrieve only  $n$  rows, but the query will return the complete result set. The FETCH FIRST  $n$  ROWS ONLY clause indicates that the query should return only  $n$  rows.

The DB2 data server does not automatically assume OPTIMIZE FOR  $n$  ROWS when FETCH FIRST  $n$  ROWS ONLY is specified for the outer subselect. Try specifying OPTIMIZE FOR  $n$  ROWS along with FETCH FIRST  $n$  ROWS ONLY, to encourage query access plans that return rows directly from the referenced tables, without first performing a buffering operation such as inserting into a temporary table, sorting, or inserting into a hash join hash table.

Applications that specify OPTIMIZE FOR  $n$  ROWS to encourage query access plans that avoid buffering operations, yet retrieve the entire result set, might experience poor performance. This is because the query access plan that returns the first  $n$  rows fastest might not be the best query access plan if the entire result set is being retrieved.

**Ensuring that queries fit the required criteria for the star schema join:**

The optimizer considers three specialized join methods for queries based on star schema: star join, Cartesian hub join, and zigzag join. These join methods can help to significantly improve performance for such queries.

A query must meet the following criteria to be recognized as a star schema for the purposes of a zigzag join, star join, or Cartesian hub join plan.

- It must be a star-shaped query with one fact table and at least two dimension tables. If the query includes more than one fact table with common associated dimension tables (a multiple fact table query), the query optimizer will split the query into a query with multiple stars in it. The common dimension tables that join with more than one fact table are then used multiple times in the query. The explain output will show multiple zigzag join operators for these multiple fact table queries.
- The dimension tables must have a primary key, a unique constraint, or a unique index defined on them; the primary key can be a composite key. If the dimension tables do not have a primary key, a unique constraint, or a unique index, then an older star detection method is used to detect a star for Cartesian hub and star join methods. In that case, the Cartesian hub and star join must meet the criteria described in “Alternative Cartesian hub join and star join criteria” on page 168.
- The dimension tables and the fact table must be joined using equijoin predicates on all columns that are part of the primary keys for the dimension tables.
- For Cartesian hub joins and zigzag joins, there must be a multicolumn index on the fact table; columns that participate in the join are part of that index, which must have enough join columns from the fact table that at least two dimension tables are covered.
- For Cartesian hub joins and star index ANDing joins, a dimension table or a snowflake must filter the fact table. (Filtering is based on the optimizer's

estimates.) There are also cases where a star join will still occur if the dimension table is joined with the fact table not as a filter, but as a simple look-up type of join.

For example, suppose that there are three dimension tables D1, D2, and D3. Dimension table D1 has primary key A, and it joins with the fact table on column A; dimension table D2 has primary key (B,C), and it joins with the fact table on columns B and C; finally, dimension table D3 has primary key D, and it joins with the fact table on column D. Supported index usage is as follows:

- Any one of the following indexes would suffice, because each of these indexes covers at least two dimension tables: (A,D), (A,B,C), or (C,B,D).
- Index (A,B,C,D) is also suitable, because it covers three dimension tables.
- Index (A,B) cannot be used, because it does not completely cover dimension table D2.
- Index (B,A,C) cannot be used, because columns B and C, which join with the primary key of D2, do not appear in contiguous positions in the index.

A dimension table cannot participate in any of these joins methods (zigzag join, star join, or Cartesian hub join) if any of the following occurs:

- Sampling
- Non-deterministic functions
- Functions with side effects

Additionally, a zigzag join within a snowflake that causes duplication of keys from the dimension table is not supported.

Dimension tables that do not have these characteristics will be considered for inclusion in a zigzag join or star join by the optimizer using cost analysis; dimension tables that do have one or more of these characteristics can be joined using other join methods.

Nested zigzag joins are not supported; this means that a zigzag join plan may not be a dimension/snowflake to another zigzag join plan. Similarly, nested star joins are not supported; this means that a star join plan may not be a dimension/snowflake to another star join plan. In addition, zigzag join plans and star join plans cannot be nested inside one another.

Federated nicknames are excluded from the zigzag joins and star joins. Nicknames can be joined using other join methods. If the entire star is pushed down to a remote DB2 data server, the remote data server can use the zigzag join or star join method to execute the query.

### **Alternative Cartesian hub join and star join criteria**

When there is no primary key, unique constraint, or unique index defined on the dimension tables then to be recognized as a star schema for the purposes of a Cartesian hub join or star join, a query must meet the following criteria:

- For each query block
  - At least three different tables must be joined
  - All join predicates must be equality predicates
  - No subqueries can exist
  - No correlations or dependencies can exist between tables or outside of the query block

- A fact table
  - Is the largest table in the query block
  - Has at least 10 000 rows
  - Is a base table
  - Must be joined to at least two dimension tables or two groups called snowflakes
- A dimension table
  - Is not the fact table
  - Can be joined individually to the fact table or in snowflakes
- A dimension table or a snowflake
  - Must filter the fact table. (Filtering is based on the optimizer's estimates.)
  - Must have a join predicate to the fact table that uses a column in a fact table index. This criterion must be met in order for either star join or hub join to be considered, although a hub join will only need to use a single fact table index.

A query block representing a left or right outer join can reference only two tables, so a star-schema join does not qualify.

Explicitly declaring referential integrity is not required for the optimizer to recognize a star-schema join.

#### **Ensuring that queries fit the required criteria for the zigzag join:**

The query optimizer will use the zigzag join method if it determines that the tables and query fit the prerequisites for zigzag join, and if this method improves performance.

#### **About this task**

Use this task to ensure that your tables and query fit the prerequisites required for a zigzag join. In addition, you can use this task to manipulate the use of zigzag join, if you are not satisfied with the query optimizers choices.

The zigzag join method calculates the Cartesian product of rows from the dimension tables without actually materializing the Cartesian product and probes the fact table using a multicolumn index, so that the fact table is filtered along two or more dimension tables simultaneously. The probe into the fact table finds matching rows. The zigzag join then returns the next combination of values that is available from the fact table index. This next combination of values, known as feedback, is used to skip over probe values provided by the Cartesian product of dimension tables that will not find a match in the fact table. Filtering the fact table on two or more dimension tables simultaneously, and skipping probes that are known to be unproductive, together makes the zigzag join an efficient method for querying large fact tables.

#### **Procedure**

1. Ensure that the tables included in the zigzag join fit the required criteria. Each dimension tables must have a primary key, a unique constraint, or a unique index defined on it. To define primary keys, unique constraints, or unique indexes, use commands such as the following example:

```

-- defining a unique constraint on a dimension table using composite keys
create table dim1 (
  d0 int not null,
  d1 int not null,
  c1 int,
  constraint pk1_uniq unique (d0, d1)
);

-- defining a primary key on a dimension table
create table dim2 (
  d2 int primary key not null,
  c2 int
);

-- creating a unique index on a dimension table
create table dim3 (
  d3 int,
  c3 int
);
create unique index uniq_ind on dim3(d3);

```

- Write a suitable query. The query must have equality join predicates between each dimension table's primary key, unique index, or unique constraint and the fact table columns. For example:

```

select count(*)
  from dim1,dim2,dim3,fact
 where dim1.d0 = fact.f0
    and dim1.d1 = fact.f1
    and dim2.d2 = fact.f2
    and dim3.d3 = fact.f3
    and dim1.c1 = 10
    and dim2.c2 < 20;

```

- Ensure that there is a suitable multicolumn index on the fact table. The multicolumn index must include columns from the fact table that have join predicates with dimension table columns. To define such a multicolumn index, use a command such as the following:

```
create index fact_ind on fact (f0, f1, f2, f3);
```

If no suitable multicolumn index exists, an informational diagnostic message is displayed in the output of the **db2exfmt** command.

- Run the query in EXPLAIN mode and then issue the **db2exfmt** command to format the EXPLAIN output. Examine the output to determine whether the zigzag join was used and whether the desired performance was achieved.
- Optional: If the zigzag join method was not used or if the desired performance was not achieved, you may need to create another multicolumn index. Review the "Extended Diagnostic Information" section of **db2exfmt** command output. If an error message is listed in the output, follow the suggestions (to generate a new index, for instance).
- Optional: If the desired performance was not achieved, determine if there was a gap in the index. Review the gap information (Gap Info) section in the **db2exfmt** output.

Gap Info:	Status
-----	-----
Index Column 0:	No Gap
Index Column 1:	Positioning Gap
Index Column 2:	No Gap
Index Column 3:	No Gap
Index Column 4:	No Gap

If this section indicates that the query contains predicates that are inconsistent with a composite index, consider adding a new index or modifying an existing index to avoid the index gap.

*Zigzag join access plan examples:*

The following examples show the **db2exfmt** command output for different access plans possible with a zigzag join.

These examples use a star-shaped query with DAILY\_SALES as the fact table, and CUSTOMER and PERIOD as the dimension tables. The query asks for the total quantity of the products sold in the month of March 1996 to the customers in age-level 7, such that the results are shown aggregated by the income level description of the customer.

```
select income_level_desc, sum(quantity_sold) "Quantity"
from daily_sales s, customer c, period p
where calendar_date between '1996-03-01' and '1996-03-31'
and p.perkey = s.perkey
and s.custkey = c.custkey
and age_level = 7
group by income_level_desc;
```

Three types of fact table access plans are possible with a zigzag join.

- An index scan-fetch plan: In this plan, the index scan accesses the index over the fact table to retrieve RIDs from the fact table matching the input probe values. These fact table RIDs are then used to fetch the necessary fact table data from the fact table. Any dimension table payload columns are then retrieved from the dimension table and the result row is output by the zigzag join operator.
- A single probe list-prefetch plan: In this plan, a list prefetch plan is executed for every probe row from the combination of dimension tables and snowflakes. The index scan over the fact table finds fact table RIDs matching the input probe values. The SORT, RIDSCAN, and FETCH operators sort RIDs according to data page identifiers and list prefetchers start to get the fact table data. Any dimension table payload columns are then retrieved from the dimension tables and the result row is output by the zigzag join operator.
- An all-probes list-prefetch plan: In this plan, the index scan accesses the fact table index for all the probes from the combination of dimension tables and snowflakes. All such matching RIDs are sorted together in the order of fact table data pages and the list prefetchers start to retrieve the necessary data from the fact table. This method of sorting all RIDs helps achieve better prefetching. These queries will include two separate ZZJOIN operators, one of which represents a back-join between the fact table and the dimension tables.

**Example: Index scan-fetch access of the fact table**

			2.6623e+06			
			ZZJOIN			
			( 5)			
			7620.42			
			5.37556			
+-----+-----+				+-----+		
292.2	40000	0.227781				
TBSCAN	TBSCAN	FETCH				
( 6)	( 9)	( 13)				
56.2251	7596.78	11.8222				
1	2.92	1.22778				
		/---+-----\				
292.2	40000	0.227781				6.65576e+08

```

TEMP          TEMP          IXSCAN  TABLE: POPS
( 7)         ( 10)         ( 14)  DAILY_SALES
30.4233      4235.52      9.93701 Q3
  |          |          |
  292.2     40000      6.65576e+08
IXSCAN      FETCH      INDEX: POPS
( 8)       ( 11)    PER_CUST_ST_PROMO
29.9655    4235.07    Q3
  |          /-----\
  2922     40000      1e+06
INDEX: POPS IXSCAN  TABLE: POPS
PERX1      ( 12)  CUSTOMER
Q1         2763.52 Q2
          |
          1e+06
          INDEX: POPS
          CUSTX1
          Q2

```

The TBSCAN(6) and TBSCAN(9) operators show the following information:

IS\_TEMP\_INDEX : True/False

The scan builds an index over the temp for random access of the temp.

(If the flag is 'true')

The scan builds a fast integer sort structure for random access of the temp.

(If the flag is 'false')

The TBSCAN(6) and TBSCAN(9) operators show the information regarding the feedback predicates applied to the operators, in the form of start-stop key conditions.

Predicates:

```

-----
5) Start Key Predicate,
Comparison Operator: Equal (=)
Subquery Input Required: No
Filter Factor: 0.000342231

```

Predicate Text:

```

-----
(Q1.PERKEY = Q3.PERKEY)

```

```

5) Stop Key Predicate,
Comparison Operator: Equal (=)
Subquery Input Required: No
Filter Factor: 0.000342231

```

Predicate Text:

```

-----
(Q1.PERKEY = Q3.PERKEY)

```

The ZZJOIN(5) operator shows the collection of all the feedback predicates used in the processing of zigzag join.

Predicates:

```

-----
4) Feedback Predicate used in Join,
Comparison Operator: Equal (=)
Subquery Input Required: No
Filter Factor: 1e-06

```

Predicate Text:

```

-----
(Q3.CUSTKEY = Q2.CUSTKEY)

```

5) Feedback Predicate used in Join,  
 Comparison Operator: Equal (=)  
 Subquery Input Required: No  
 Filter Factor: 0.000342231

Predicate Text:

-----  
 (Q1.PERKEY = Q3.PERKEY)

**Example: Single probe list-prefetch access of the fact table**

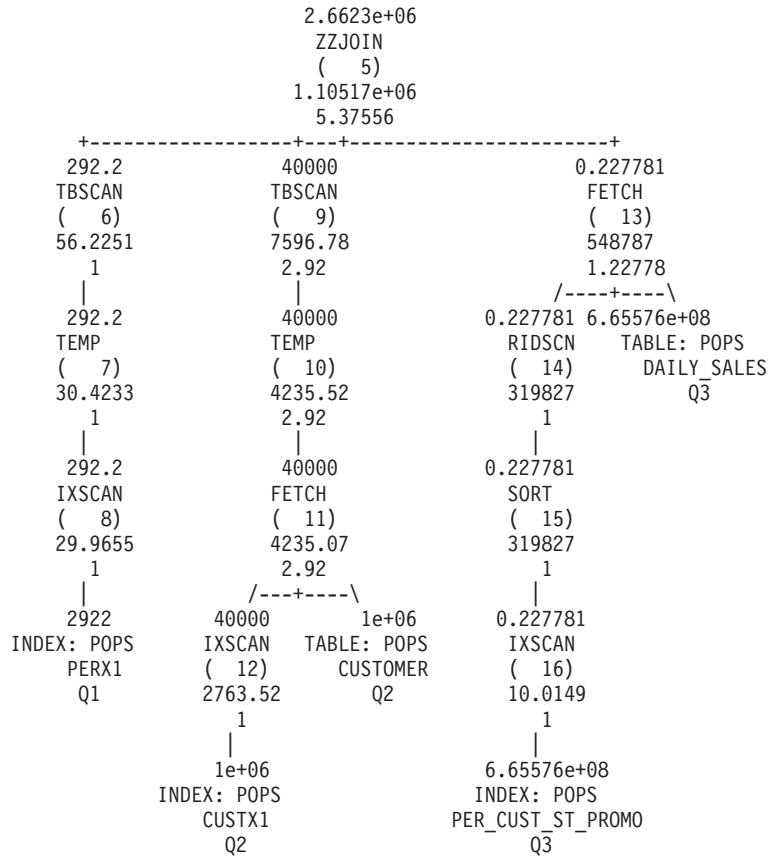

This shows that the difference between the index-scan plan and the single-probe plan is the way in which the fact table is accessed.

All other operators show the same information as the operators in the previous example.

**Example: All probes list-prefetch access of the fact table**

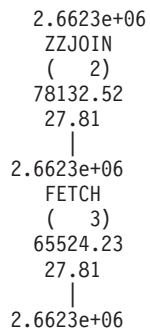

```

RIDSCAN
( 4)
56514.23
4.92
|
2.6623e+06
SORT
( 5)
56514.23
4.92
|
2.6623e+06
ZZJOIN
( 6)
7616.65
4.92
+-----+-----+
292.2          40000          0.227781
TBSCAN        TBSCAN        IXSCAN
( 7)          ( 10)         ( 14)
56.2251       7596.78       9.93701
|             2.92          |
|             |             |
292.2         40000         6.65576e+08
TEMP         TEMP         INDEX: POPS
( 8)         ( 11)        PER_CUST_ST_PROMO
30.4233      4235.52      Q3
|             2.92
|             |
292.2         40000
IXSCAN       FETCH
( 9)         ( 12)
29.9655      4235.07
|             2.92
|             /-----\
2922         40000         1e+06
INDEX: POPS  IXSCAN      TABLE: POPS
PERX1        ( 13)      CUSTOMER
Q1           2763.52    Q2
|
|             1
|             |
|             1e+06
|             INDEX: POPS
|             CUSTX1
|             Q2

```

Compared to the other access plans, the all probes list-prefetch plan shows an additional operator, ZZJOIN (2). This operator is being used to perform back-joins of the fact table with the dimension tables. It shows the following information:

Backjoin = True

*Zigzag joins with index gaps:*

Even if there is a gap in the composite indexes, due to a missing join predicate or a missing dimension in the query, the query optimizer recognizes the star shape of a query and can select an appropriate access plan with a zigzag join. However, the performance of access plan may not be optimal. Review the **db2exfmt** command output to find out whether there are any index gaps in your query and consider adding new indexes or modifying existing indexes to improve performance.

### Example: Zigzag join with a missing dimension

This example is based on the following query, where d1, d2, d3, d4, and d5 are dimensions and f1 is fact table.



```

select count(*)
from d1, d3, d4, d5, f1
where d1.pk = f1.fk1 and d3.pk = f1.fk3 and d4.pk = f1.fk4 and d5.pk = f1.fk5

```

An index on fact table f1 was created using the following command:

```

create index i11 on f1(fk1, fk2, fk3, fk4, fk5, fk6);

```

The query joins dimensions d1, d3, d4, d5 with fact table f1. Because the dimension d2 is not included in the query, there is no join predicate with the dimension d2 on the column fk2. The query optimizer recognizes fact column fk2 as a gap in the index and is able to use the index for a zigzag join.

The **db2exfmt** command output shows that the index scan is a jump scan, by indicating the JUMPSCAN=TRUE option. The output also shows the index gap information, specifically that the second index column has a positioning gap and the other columns do not.

```

Rows
RETURN
( 1)
Cost
I/O
|
1
GRPBY
( 2)
1539.45
33
|
1000
ZZJOIN
( 3)
1529.44
33
+-----+-----+-----+-----+-----+
1000      1000      1000      1000      1000
TBSCAN    TBSCAN    TBSCAN    TBSCAN    FETCH
( 4)      ( 9)      ( 14)     ( 19)     ( 24)
184.085   184.085   184.085   184.085   205.222
8         8         8         8         1
|         |         |         |         /-----\
1000      1000      1000      1000      1000      1000
TEMP      TEMP      TEMP      TEMP      RIDSCN    TABLE: STAR
( 5)      ( 10)     ( 15)     ( 20)     ( 25)     F1
184.003   184.003   184.003   184.003   55.5857   Q1
8         8         8         8         1
|         |         |         |         |
1000      1000      1000      1000      1000
TBSCAN    TBSCAN    TBSCAN    TBSCAN    SORT
( 6)      ( 11)     ( 16)     ( 21)     ( 26)
178.62    178.62    178.62    178.62    55.5342
8         8         8         8         1
|         |         |         |         |
1000      1000      1000      1000      1e-09
SORT      SORT      SORT      SORT      IXSCAN
( 7)      ( 12)     ( 17)     ( 22)     ( 27)
178.569   178.569   178.569   178.569   12.0497
8         8         8         8         1
|         |         |         |         |
1000      1000      1000      1000      1000
TBSCAN    TBSCAN    TBSCAN    TBSCAN    INDEX: STAR
( 8)      ( 13)     ( 18)     ( 23)     I11
135.093   135.093   135.093   135.093   Q1
8         8         8         8
|         |         |         |

```

```

1000          1000          1000          1000
TABLE: STAR   TABLE: STAR   TABLE: STAR   TABLE: STAR
  D1           D3           D4           D5
  Q5           Q4           Q3           Q2

```

```

JUMPSCAN: (Jump Scan Plan)
TRUE

```

```

Gap Info:          Status
-----
Index Column 0:    No Gap
Index Column 1:    Positioning Gap
Index Column 2:    No Gap
Index Column 3:    No Gap
Index Column 4:    No Gap

```

### Example: Zigzag join with missing join predicate on fact column

This example is based on the following query:

```

select count(*)
from d2, d3, d4, f1
where d2.pk = f1.fk2 and d3.pk = f1.fk3 and d4.pk = f1.fk4 and fk1=10

```

In this query, dimensions d2, d3 and d4 join with the fact table f1. There is no join predicate on fact column fk1, there is only a local predicate fk1=10.

The query optimizer recognizes the fact column fk1 as a gap, because there is no join predicate on it. The query optimizer is still able to use the index for zigzag join.

The **db2exfmt** command output shows that the index scan is a jump scan, by indicating the JUMPSCAN=TRUE option. The output also shows the index gap information, specifically that the first index column has a positioning gap and the other columns do not.

```

          Rows
          RETURN
          ( 1)
          Cost
          I/O
          |
          1
          GRPBY
          ( 2)
          893.899
          25.12
          |
          40
          HSJOIN
          ( 3)
          893.489
          25.12
          /-----+-----\
          1000          40
          TBSCAN          ZZJOIN
          ( 4)          ( 5)
          135.093          750.88
          8          17.12
          |          +-----+-----+
          1000          1000          1000          40
          TABLE: STAR  TBSCAN          TBSCAN          FETCH
          D4          ( 6)          ( 11)          ( 16)
          Q2          184.085          184.085          18.1845
          8          8          8          1.12004

```

```

      |           |           /---+---\
      1000       1000       40       1000
      TEMP      TEMP      RIDSCN  TABLE: STAR
      ( 7)      ( 12)     ( 17)      F1
      184.003   184.003   13.4358  Q1
      8         8         1.12
      |         |         |
      1000       1000       40
      TBSCAN    TBSCAN    SORT
      ( 8)      ( 13)     ( 18)
      178.62    178.62    13.3843
      8         8         1.12
      |         |         |
      1000       1000       4e-05
      SORT      SORT      IXSCAN
      ( 9)      ( 14)     ( 19)
      178.569   178.569   12.5738
      8         8         1.12
      |         |         |
      1000       1000       1000
      TBSCAN    TBSCAN    INDEX: STAR
      ( 10)     ( 15)     I11
      135.093   135.093   Q1
      8         8
      |         |
      1000       1000
      TABLE: STAR  TABLE: STAR
      D2         D3
      Q4         Q4

```

JUMPSCAN: (Jump Scan Plan)  
TRUE

Gap Info:	Status
-----	-----
Index Column 0:	Positioning Gap
Index Column 1:	No Gap
Index Column 2:	No Gap

### Avoiding redundant predicates:

Avoid redundant predicates, especially when they occur across different tables. In some cases, the optimizer cannot detect that the predicates are redundant. This might result in cardinality underestimation.

For example, within SAP business intelligence (BI) applications, the snowflake schema with fact and dimension tables is used as a query optimized data structure. In some cases, there is a redundant time characteristic column ("SID\_0CALMONTH" for month or "SID\_0FISCPER" for year) defined on the fact and dimension tables.

The SAP BI online analytical processing (OLAP) processor generates redundant predicates on the time characteristics column of the dimension and fact tables.

These redundant predicates might result in longer query run time.

The following section provides an example with two redundant predicates that are defined in the WHERE condition of a SAP BI query. Identical predicates are defined on the time dimension (DT) and fact (F) table:

```

AND ( "DT"."SID_0CALMONTH" = 199605
      AND "F"."SID_0CALMONTH" = 199605
      OR "DT"."SID_0CALMONTH" = 199705

```

```

AND "F". "SID_0CALMONTH" = 199705 )
AND NOT ( "DT". "SID_0CALMONTH" = 199803
AND "F". "SID_0CALMONTH" = 199803 )

```

The DB2 optimizer does not recognize the predicates as identical, and treats them as independent. This leads to underestimation of cardinalities, suboptimal query access plans, and longer query run times.

For that reason, the redundant predicates are removed by the DB2 database platform-specific software layer.

These predicates are transferred to the following ones and only the predicates on the fact table column "SID\_0CALMONTH" remain:

```

AND ( "F". "SID_0CALMONTH" = 199605
OR "F". "SID_0CALMONTH" = 199705 )
AND NOT ( "F". "SID_0CALMONTH" = 199803 )

```

Apply the instructions in SAP notes 957070 and 1144883 to remove the redundant predicates.

### Using constraints to improve query optimization

Consider defining unique, check, and referential integrity constraints. These constraints provide semantic information that allows the DB2 optimizer to rewrite queries to eliminate joins, push aggregation down through joins, push FETCH FIRST *n* ROWS down through joins, remove unnecessary DISTINCT operations, and perform a number of other optimizations.

Informational constraints can also be used for both check constraints and referential integrity constraints when the application itself can guarantee the relationships. The same optimizations are possible. Constraints that are enforced by the database manager when rows are inserted, updated, or deleted can lead to high system overhead, especially when updating a large number of rows that have referential integrity constraints. If an application has already verified information before updating a row, it might be more efficient to use informational constraints, rather than regular constraints. This type of informational constraint is also known as a NOT ENFORCED TRUSTED constraint.

For example, consider two tables, DAILY\_SALES and CUSTOMER. Each row in the CUSTOMER table has a unique customer key (CUST\_KEY). DAILY\_SALES contains a CUST\_KEY column and each row references a customer key in the CUSTOMER table. A referential integrity constraint could be created to represent this 1:N relationship between CUSTOMER and DAILY\_SALES. If the application were to enforce the relationship, the constraint could be defined as informational. The following query could then avoid performing the join between CUSTOMER and DAILY\_SALES, because no columns are retrieved from CUSTOMER, and every row from DAILY\_SALES will find a match in CUSTOMER. The query optimizer will automatically remove the join.

```

SELECT AMT_SOLD, SALE PRICE, PROD_DESC
FROM DAILY_SALES, PRODUCT, CUSTOMER
WHERE
DAILY_SALES.PROD_KEY = PRODUCT.PRODKEY AND
DAILY_SALES.CUST_KEY = CUSTOMER.CUST_KEY

```

The application must enforce informational constraints, otherwise queries might return incorrect results. In this example, if any rows in DAILY\_SALES do not have a corresponding customer key in the CUSTOMER table, the query would incorrectly return those rows.

Another type of informational constraint is the NOT ENFORCED NOT TRUSTED constraint. It can be useful to specify this type of informational constraint if an application cannot verify that the rows of a table will conform to the constraint. The NOT ENFORCED NOT TRUSTED constraint can be used to improve query optimization in cases where the DB2 optimizer can use the data to infer statistics from a statistical view. In these cases the strict matching between the values in the foreign keys and the primary keys are not needed. If a constraint is NOT TRUSTED and enabled for query optimization, then it will not be used to perform optimizations that depend on the data conforming completely to the constraint, such as join elimination.

### Using the REOPT bind option with input variables in complex queries

Input variables are essential for good statement preparation times in an online transaction processing (OLTP) environment, where statements tend to be simpler and query access plan selection is more straightforward.

Multiple executions of the same query with different input variable values can reuse the compiled access section in the dynamic statement cache, avoiding expensive SQL statement compilations whenever the input values change.

However, input variables can cause problems for complex query workloads, where query access plan selection is more complex and the optimizer needs more information to make good decisions. Moreover, statement compilation time is usually a small component of total execution time, and business intelligence (BI) queries, which do not tend to be repeated, do not benefit from the dynamic statement cache.

If input variables need to be used in a complex query workload, consider using the REOPT(ALWAYS) bind option. The **REOPT** bind option defers statement compilation from PREPARE to OPEN or EXECUTE time, when the input variable values are known. The values are passed to the SQL compiler so that the optimizer can use the values to compute a more accurate selectivity estimate. REOPT(ALWAYS) specifies that the statement should be recompiled for every execution. REOPT(ALWAYS) can also be used for complex queries that reference special registers, such as WHERE TRANS\_DATE = CURRENT DATE - 30 DAYS, for example. If input variables lead to poor access plan selection for OLTP workloads, and REOPT(ALWAYS) results in excessive overhead due to statement compilation, consider using REOPT(ONCE) for selected queries. REOPT(ONCE) defers statement compilation until the first input variable value is bound. The SQL statement is compiled and optimized using this first input variable value. Subsequent executions of the statement with different values reuse the access section that was compiled on the basis of the first input value. This can be a good approach if the first input variable value is representative of subsequent values, and it provides a better query access plan than one that is based on default values when the input variable values are unknown.

There are a number of ways that **REOPT** can be specified:

- For embedded SQL in C/C++ applications, use the **REOPT** bind option. This bind option affects re-optimization behavior for both static and dynamic SQL.
- For CLP packages, rebind the CLP package with the **REOPT** bind option. For example, to rebind the CLP package used for isolation level CS with **REOPT ALWAYS**, specify the following command:  

```
rebind nullid.SQLC2G13 reopt always
```
- For CLI applications, set the **REOPT** value in one of the following ways:

- Use the **REOPT** keyword setting in the `db2cli.ini` configuration file. The values and corresponding options are:
  - 2 = SQL\_REOPT\_NONE
  - 3 = SQL\_REOPT\_ONCE
  - 4 = SQL\_REOPT\_ALWAYS
- Use the `SQL_ATTR_REOPT` connection or statement attribute.
- Use the `SQL_ATTR_CURRENT_PACKAGE_SET` connection or statement attribute to specify either the `NULLID`, `NULLIDR1`, or `NULLIDRA` package sets. `NULLIDR1` and `NULLIDRA` are reserved package set names. When used, **REOPT ONCE** or **REOPT ALWAYS** are implied, respectively. These package sets have to be explicitly created with the following commands:
 

```
db2 bind db2clipk.bnd collection NULLIDR1
db2 bind db2clipk.bnd collection NULLIDRA
```
- For JDBC applications that use the IBM Data Server Driver for JDBC and SQLJ, specify the **-reopt** value when you run the **DB2Binder** utility.
- For SQL PL procedures, use one of the following approaches:
  - Use the `SET_ROUTINE_OPTS` stored procedure to set the bind options that are to be used for the creation of SQL PL procedures within the current session. For example, call:
 

```
sysproc.set_routine_opts('reopt always')
```
  - Use the **DB2\_SQLROUTINE\_PREOPTS** registry variable to set the SQL PL procedure options at the instance level. Values set using the `SET_ROUTINE_OPTS` stored procedure will override those specified with **DB2\_SQLROUTINE\_PREOPTS**.

You can also use optimization profiles to set **REOPT** for static and dynamic statements, as shown in the following example:

```
<STMTPROFILE ID="REOPT example ">
  <STMTKEY>
    <![CDATA[select acct_no from customer where name = ? ]]>
  </STMTKEY>
  <OPTGUIDELINES>
    <REOPT VALUE='ALWAYS' />
  </OPTGUIDELINES>
</STMTPROFILE>
```

## Using parameter markers to reduce compilation time for dynamic queries

The DB2 data server can avoid recompiling a dynamic SQL statement that has been run previously by storing the access section and statement text in the dynamic statement cache.

A subsequent prepare request for this statement will attempt to find the access section in the dynamic statement cache, avoiding compilation. However, statements that differ only in the literals that are used in predicates will not match. For example, the following two statements are considered different in the dynamic statement cache:

```
SELECT AGE FROM EMPLOYEE WHERE EMP_ID = 26790
SELECT AGE FROM EMPLOYEE WHERE EMP_ID = 77543
```

Even relatively simple SQL statements can result in excessive system CPU usage due to statement compilation, if they are run very frequently. If your system experiences this type of performance problem, consider changing the application to use parameter markers to pass predicate values to the DB2 compiler, rather than explicitly including them in the SQL statement. However, the access plan might not

be optimal for complex queries that use parameter markers in predicates. For more information, see “Using the REOPT bind option with input variables in complex queries”.

### Setting the **DB2\_REDUCED\_OPTIMIZATION** registry variable

If setting the optimization class does not reduce the compilation time sufficiently for your application, try setting the **DB2\_REDUCED\_OPTIMIZATION** registry variable.

This registry variable provides more control over the optimizer's search space than setting the optimization class. This registry variable lets you request either reduced optimization features or rigid use of optimization features at the specified optimization class. If you reduce the number of optimization techniques used, you also reduce time and resource use during optimization.

Although optimization time and resource use might be reduced, there is increased risk of producing a less than optimal query access plan.

First, try setting the registry variable to YES. If the optimization class is 5 (the default) or lower, the optimizer disables some optimization techniques that might consume significant prepare time and resources but that do not usually produce a better query access plan. If the optimization class is exactly 5, the optimizer reduces or disables some additional techniques, which might further reduce optimization time and resource use, but also further increase the risk of a less than optimal query access plan. For optimization classes lower than 5, some of these techniques might not be in effect in any case. If they are, however, they remain in effect.

If the YES setting does not provide a sufficient reduction in compilation time, try setting the registry variable to an integer value. The effect is the same as YES, with the following additional behavior for dynamically prepared queries optimized at class 5. If the total number of joins in any query block exceeds the setting, the optimizer switches to greedy join enumeration instead of disabling additional optimization techniques. The result is that the query will be optimized at a level that is similar to optimization class 2.

## Improving insert performance

Before data is inserted into a table, an insert search algorithm examines the free space control records (FSCRs) to find a page with enough space for the new data.

However, even when an FSCR indicates that a page has enough free space, that space might not be usable if it has been reserved by an uncommitted delete operation from another transaction.

The **DB2MAXFSCRSEARCH** registry variable specifies the number of FSCRs to search when adding a record to a table. The default is to search five FSCRs. Modifying this value enables you to balance insert speed with space reuse. Use large values to optimize for space reuse. Use small values to optimize for insert speed. Setting the value to -1 forces the database manager to search all FSCRs. If sufficient space is not found while searching FSCRs, the data is appended to the end of the table.

The APPEND ON option on the ALTER TABLE statement specifies that table data will be appended and that information about free space on pages will not be kept. Such tables must not have a clustering index. This option can improve performance for tables that only grow.

If a clustering index is defined on the table, the database manager attempts to insert records on the same page as other records with similar index key values. If there is no space on that page, surrounding pages are considered. If those pages are unsuitable, the FSCRs are searched, as described previously. In this case, however, a “worst-fit” approach is used instead of a “first-fit” approach. The worst-fit approach tends to choose pages with more free space. This method establishes a new clustering area for rows with similar key values.

If you have defined a clustering index on a table, use the PCTFREE clause on the ALTER TABLE statement before loading or reorganizing the table. The PCTFREE clause specifies the percentage of free space that should remain on a data page after a load or reorg operation. This increases the probability that the cluster index operation will find free space on the appropriate page.

## Efficient SELECT statements

Because SQL is a flexible high-level language, you can write several different SELECT statements to retrieve the same data. However, performance might vary for different forms of the statement, as well as for different optimization classes.

Consider the following guidelines for creating efficient SELECT statements:

- Specify only columns that you need. Specifying all columns with an asterisk (\*) results in unnecessary processing.
- Use predicates that restrict the answer set to only those rows that you need.
- When you need significantly fewer than the total number of rows that might be returned, specify the OPTIMIZE FOR clause. This clause affects both the choice of access plan and the number of rows that are blocked in the communication buffer.
- To take advantage of row blocking and improve performance, specify the FOR READ ONLY or FOR FETCH ONLY clause. Concurrency improves as well, because exclusive locks are never held on the rows that are retrieved. Additional query rewrites can also occur. Specifying these clauses, as well as the BLOCKING ALL bind option, can similarly improve the performance of queries running against nicknames in a federated database system.
- For cursors that will be used with positioned updates, specify the FOR UPDATE OF clause to enable the database manager to choose more appropriate locking levels initially and to avoid potential deadlocks. Note that FOR UPDATE cursors cannot take advantage of row blocking.
- For cursors that will be used with searched updates, specify the FOR READ ONLY and the USE AND KEEP UPDATE LOCKS clauses to avoid deadlocks and still allow row blocking by forcing U locks on affected rows.
- Avoid numeric data type conversions whenever possible. When comparing values, try to use items that have the same data type. If conversions are necessary, inaccuracies due to limited precision, and performance costs due to runtime conversions might result.

If possible, use the following data types:

- Character instead of varying character for short columns
  - Integer instead of float, decimal, or DECFLOAT
  - DECFLOAT instead of decimal
  - Datetime instead of character
  - Numeric instead of character
- To decrease the probability that a sort operation will occur, omit clauses such as DISTINCT or ORDER BY if such operations are not required.



- To check for the existence of rows in a table, select a single row. Either open a cursor and fetch one row, or perform a single-row SELECT INTO operation. Remember to check for the SQLCODE -811 error if more than one row is found. Unless you know that the table is very small, do not use the following statement to check for a non-zero value:

```
select count(*) from <table-name>
```

For large tables, counting all the rows impacts performance.

- If update activity is low and tables are large, define indexes on columns that are frequently used in predicates.
- Consider using an IN list if the same column appears in multiple predicates. For large IN lists that are used with host variables, looping a subset of the host variables might improve performance.

The following suggestions apply specifically to SELECT statements that access several tables.

- Use join predicates to join tables. A *join predicate* is a comparison between two columns from different tables in a join.
- Define indexes on the columns in a join predicate to enable the join to be processed more efficiently. Indexes also benefit UPDATE and DELETE statements containing SELECT statements that access several tables.
- If possible, avoid using OR clauses or expressions with join predicates.
- In a partitioned database environment, it is recommended that tables being joined are partitioned on the join column.

## Guidelines for restricting SELECT statements

The optimizer assumes that an application must retrieve all of the rows that are identified by a SELECT statement. This assumption is most appropriate in online transaction processing (OLTP) and batch environments.

However, in “browse” applications, queries often define a large potential answer set, but they retrieve only the first few rows, usually the number of rows that are required for a particular display format.

To improve performance for such applications, you can modify the SELECT statement in the following ways:

- Use the FOR UPDATE clause to specify the columns that could be updated by a subsequent positioned UPDATE statement.
- Use the FOR READ or FETCH ONLY clause to make the returned columns read-only.
- Use the OPTIMIZE FOR *n* ROWS clause to give priority to retrieving the first *n* rows from the full result set.
- Use the FETCH FIRST *n* ROWS ONLY clause to retrieve only a specified number of rows.
- Use the DECLARE CURSOR WITH HOLD statement to retrieve rows one at a time.

The following sections describe the performance advantages of each method.

## FOR UPDATE clause

The FOR UPDATE clause limits the result set by including only those columns that can be updated by a subsequent positioned UPDATE statement. If you specify the FOR UPDATE clause without column names, all columns that can be updated in the table or view are included. If you specify column names, each name must be unqualified and must identify a column of the table or view.

You cannot use the FOR UPDATE clause if:

- The cursor that is associated with the SELECT statement cannot be deleted
- At least one of the selected columns is a column that cannot be updated in a catalog table and that has not been excluded in the FOR UPDATE clause.

In CLI applications, you can use the CLI connection attribute `SQL_ATTR_ACCESS_MODE` for the same purpose.

## FOR READ or FETCH ONLY clause

The FOR READ ONLY clause or the FOR FETCH ONLY clause ensures that read-only results are returned. For result tables where updates and deletions are allowed, specifying the FOR READ ONLY clause can improve the performance of fetch operations if the database manager can retrieve blocks of data instead of using exclusive locks. Do not specify the FOR READ ONLY clause in queries that are used in positioned UPDATE or DELETE statements.

In CLI applications, you can use the CLI connection attribute `SQL_ATTR_ACCESS_MODE` for the same purpose.

## OPTIMIZE FOR *n* ROWS clause

The OPTIMIZE FOR clause declares the intent to retrieve only a subset of the result or to give priority to retrieving only the first few rows. The optimizer can then choose access plans that minimize the response time for retrieving the first few rows. In addition, the number of rows that are sent to the client as a single block are limited by the value of *n*. Thus the OPTIMIZE FOR clause affects how the server retrieves qualifying rows from the database, and how it returns those rows to the client.

For example, suppose you regularly query the EMPLOYEE table to determine which employees have the highest salary:

```
select lastname, firstnme, empno, salary
   from employee
  order by salary desc
```

Although you have previously defined a descending index on the SALARY column, this index is likely to be poorly clustered, because employees are ordered by employee number. To avoid many random synchronous I/Os, the optimizer would probably choose the list prefetch access method, which requires sorting the row identifiers of all rows that qualify. This sort causes a delay before the first qualifying rows can be returned to the application. To prevent this delay, add the OPTIMIZE FOR clause to the statement as follows:

```
select lastname, firstnme, empno, salary
   from employee
  order by salary desc
 optimize for 20 rows
```

In this case, the optimizer will likely choose to use the SALARY index directly, because only the 20 employees with the highest salaries are retrieved. Regardless of how many rows might be blocked, a block of rows is returned to the client every twenty rows.

With the OPTIMIZE FOR clause, the optimizer favors access plans that avoid bulk operations or flow interruptions, such as those that are caused by sort operations. You are most likely to influence an access path by using the OPTIMIZE FOR 1 ROW clause. Using this clause might have the following effects:

- Join sequences with composite inner tables are less likely, because they require a temporary table.
- The join method might change. A nested loop join is the most likely choice, because it has low overhead cost and is usually more efficient when retrieving a few rows.
- An index that matches the ORDER BY clause is more likely, because no sort is required for the ORDER BY.
- List prefetching is less likely, because this access method requires a sort.
- Sequential prefetching is less likely, because only a small number of rows is required.
- In a join query, the table with columns in the ORDER BY clause is likely to be chosen as the outer table if an index on the outer table provides the ordering that is needed for the ORDER BY clause.

Although the OPTIMIZE FOR clause applies to all optimization levels, it works best for optimization class 3 and higher, because classes below 3 use the *greedy join enumeration* search strategy. This method sometimes results in access plans for multi-table joins that do not lend themselves to quick retrieval of the first few rows.

If a packaged application uses the call-level interface (CLI or ODBC), you can use the **OPTIMIZEFORNROWS** keyword in the db2cli.ini configuration file to have CLI automatically append an OPTIMIZE FOR clause to the end of each query statement.

When data is selected from nicknames, results can vary depending on data source support. If the data source that is referenced by a nickname supports the OPTIMIZE FOR clause, and the DB2 optimizer pushes the entire query down to the data source, then the clause is generated in the remote SQL that is sent to the data source. If the data source does not support this clause, or if the optimizer decides that the least costly plan is local execution, the OPTIMIZE FOR clause is applied locally. In this case, the DB2 optimizer prefers access plans that minimize the response time for retrieving the first few rows of a query, but the options that are available to the optimizer for generating plans are slightly limited, and performance gains from the OPTIMIZE FOR clause might be negligible.

If the OPTIMIZE FOR clause and the FETCH FIRST clause are both specified, the lower of the two *n* values affects the communications buffer size. The two values are considered independent of each other for optimization purposes.

## FETCH FIRST *n* ROWS ONLY clause

The FETCH FIRST *n* ROWS ONLY clause sets the maximum number of rows that can be retrieved. Limiting the result table to the first several rows can improve performance. Only *n* rows are retrieved, regardless of the number of rows that the result set might otherwise contain.

If the FETCH FIRST clause and the OPTIMIZE FOR clause are both specified, the lower of the two *n* values affects the communications buffer size. The two values are considered independent of each other for optimization purposes.

## DECLARE CURSOR WITH HOLD statement

When you declare a cursor using a DECLARE CURSOR statement that includes the WITH HOLD clause, open cursors remain open when the transaction commits, and all locks are released, except those locks that protect the current cursor position. If the transaction is rolled back, all open cursors are closed, all locks are released, and any LOB locators are freed.

In CLI applications, you can use the CLI connection attribute SQL\_ATTR\_CURSOR\_HOLD for the same purpose. If a packaged application uses the call level interface (CLI or ODBC), use the **CURSORHOLD** keyword in the `db2cli.ini` configuration file to have CLI automatically assume the WITH HOLD clause for every declared cursor.

## Specifying row blocking to reduce overhead

Row blocking, which is supported for all statements and data types (including LOB data types), reduces database manager overhead for cursors by retrieving a block of rows in a single operation.

### About this task

This block of rows represents a number of pages in memory. It is not a multidimensional clustering (MDC) or insert time clustering (ITC) table block, which is physically mapped to an extent on disk.

Row blocking is specified by the following options on the **BIND** or **PREP** command:

#### **BLOCKING ALL**

Cursors that are declared with the FOR READ ONLY clause or that are not specified as FOR UPDATE will be blocked.

#### **BLOCKING NO**

Cursors will not be blocked.

#### **BLOCKING UNAMBIG**

Cursors that are declared with the FOR READ ONLY clause will be blocked. Cursors that are not declared with the FOR READ ONLY clause or the FOR UPDATE clause, that are not ambiguous, or that are read-only, will be blocked. Ambiguous cursors will not be blocked.

The following database manager configuration parameters are used during block-size calculations.

- The **as1heapsz** parameter specifies the size of the application support layer heap for local applications. It is used to determine the I/O block size when a blocking cursor is opened.

- The **rqrioblk** parameter specifies the size of the communication buffer between remote applications and their database agents on the database server. It is also used to determine the I/O block size at the data server runtime client when a blocking cursor is opened.

Before enabling the blocking of row data for LOB data types, it is important to understand the impact on system resources. More shared memory will be consumed on the server to store the references to LOB values in each block of data when LOB columns are returned. The number of such references will vary according to the value of the **rqrioblk** configuration parameter.

To increase the amount of memory allocated to the heap, modify the **database\_memory** database configuration parameter by:

- Setting its value to AUTOMATIC
- Increasing its value by 256 pages if the parameter is currently set to a user-defined numeric value

To increase the performance of an existing embedded SQL application that references LOB values, rebind the application using the **BIND** command and specifying either the **BLOCKING ALL** clause or the **BLOCKING UNAMBIG** clause to request blocking. Embedded applications will retrieve the LOB values, one row at a time, after a block of rows has been retrieved from the server. User-defined functions (UDFs) returning LOB results might cause the DB2 server to revert to single-row retrieval of LOB data when large amounts of memory are being consumed on the server.

## Procedure

To specify row blocking:

1. Use the values of the **aslheapsz** and **rqrioblk** configuration parameters to estimate how many rows are returned for each block. In both formulas, *orl* is the output row length, in bytes.

- Use the following formula for local applications:

$$\text{Rows per block} = \text{aslheapsz} * 4096 / \text{orl}$$

The number of bytes per page is 4096.

- Use the following formula for remote applications:

$$\text{Rows per block} = \text{rqrioblk} / \text{orl}$$

2. To enable row blocking, specify an appropriate value for the **BLOCKING** option on the **BIND** or **PREP** command.

If you do not specify the **BLOCKING** option, the default row blocking type is UNAMBIG. For the command line processor (CLP) and the call-level interface (CLI), the default row blocking type is ALL.

## Data sampling in queries

It is often impractical and sometimes unnecessary to access all of the data that is relevant to a query. In some cases, finding overall trends or patterns in a subset of the data will suffice. One way to do this is to run a query against a random sample from the database.

The DB2 product enables you to efficiently sample data for SQL and XQuery queries, potentially improving the performance of large queries by orders of magnitude, while maintaining a high degree of accuracy.

Sampling is commonly used for aggregate queries, such as AVG, COUNT, and SUM, where reasonably accurate values for the aggregates can be obtained from a sample of the data. Sampling can also be used to obtain a random subset of the rows in a table for auditing purposes or to speed up data mining and analysis.

Two methods of sampling are available: row-level sampling and page-level sampling.

### **Row-level Bernoulli sampling**

Row-level Bernoulli sampling obtains a sample of  $P$  percent of the table rows by means of a SARGable predicate that includes each row in the sample with a probability of  $P/100$  and excludes it with a probability of  $1-P/100$ .

Row-level Bernoulli sampling always produces a valid, random sample regardless of the degree of data clustering. However, the performance of this type of sampling is very poor if no index is available, because every row must be retrieved and the sampling predicate must be applied to it. If there is no index, there are no I/O savings over executing the query without sampling. If an index is available, performance is improved, because the sampling predicate is applied to the RIDs inside of the index leaf pages. In the usual case, this requires one I/O per selected RID, and one I/O per index leaf page.

### **System page-level sampling**

System page-level sampling is similar to row-level sampling, except that pages (not rows) are sampled. The probability of a page being included in the sample is  $P/100$ . If a page is included, all of the rows on that page are included.

The performance of system page-level sampling is excellent, because only one I/O is required for each page that is included in the sample. Compared with no sampling, page-level sampling improves performance by orders of magnitude. However, the accuracy of aggregate estimates tends to be worse under page-level sampling than row-level sampling. This difference is most pronounced when there are many rows per page, or when the columns that are referenced in the query exhibit a high degree of clustering within pages.

### **Specifying the sampling method**

Use the TABLESAMPLE clause to execute a query against a random sample of data from a table. TABLESAMPLE BERNOULLI specifies that row-level Bernoulli sampling is to be performed. TABLESAMPLE SYSTEM specifies that system page-level sampling is to be performed, unless the optimizer determines that it is more efficient to perform row-level Bernoulli sampling instead.

## **Parallel processing for applications**

The DB2 product supports parallel environments, specifically on symmetric multiprocessor (SMP) machines.

In SMP machines, more than one processor can access the database, allowing the execution of complex SQL requests to be divided among the processors. This *intra-partition parallelism* is the subdivision of a single database operation (for example, index creation) into multiple parts, which are then executed in parallel within a single database partition.

To specify the degree of parallelism when you compile an application, use the CURRENT DEGREE special register, or the DEGREE bind option. *Degree* refers to the number of query parts that can execute concurrently. There is no strict relationship between the number of processors and the value that you select for the degree of parallelism. You can specify a value that is more or less than the number of processors on the machine. Even for uniprocessor machines, you can set the degree to be higher than one to improve performance. Note, however, that each degree of parallelism adds to the system memory and processor overhead.

You can also specify the degree of parallelism for workloads using the MAXIMUM DEGREE workload attribute. In the affected workload, values set using MAXIMUM DEGREE will override values assigned by the CURRENT DEGREE special register, or the DEGREE bind option.

Some configuration parameters must be modified to optimize performance when you use parallel execution of queries. In an environment with a high degree of parallelism, you should review and modify configuration parameters that control the amount of shared memory and prefetching.

The following configuration parameters control and manage parallel processing.

- The **intra\_parallel** database manager configuration parameter enables or disables parallelism.
- The **max\_querydegree** database manager configuration parameter sets an upper limit on the degree of parallelism for any query in the database. This value overrides the CURRENT DEGREE special register and the DEGREE bind option.
- The **dft\_degree** database configuration parameter sets the default value for the CURRENT DEGREE special register and the DEGREE bind option.

To enable or disable intra-partition parallelism from within a database application, you can call the ADMIN\_SET\_INTRA\_PARALLEL procedure. Setting ADMIN\_SET\_INTRA\_PARALLEL will apply intra-partition parallelism only to your application. For your application, this value will override the **intra\_parallel** database manager configuration parameter.

To enable or disable intra-partition parallelism from within a workload, you can set the MAXIMUM DEGREE workload attribute. This will apply intra-partition parallelism only to your workload. This value will override both the the **intra\_parallel** database manager configuration parameter and any values assigned by the ADMIN\_SET\_INTRA\_PARALLEL procedure.

If a query is compiled with DEGREE = ANY, the database manager chooses the degree of intra-partition parallelism on the basis of a number of factors, including the number of processors and the characteristics of the query. The actual degree used at run time might be lower than the number of processors, depending on these factors and the amount of activity on the system. The degree of parallelism might be reduced before query execution if the system is busy.

Use the DB2 explain facility to display information about the degree of parallelism chosen by the optimizer. Use the database system monitor to display information about the degree of parallelism actually being used at run time.

## Parallelism in non-SMP environments

You can specify a degree of parallelism without having an SMP machine. For example, I/O-bound queries on a uniprocessor machine might benefit from

declaring a degree of 2 or more. In this case, the processor might not have to wait for I/O tasks to complete before starting to process a new query. Utilities such as `load` can control I/O parallelism independently.

---

## Lock management

Lock management is one of the factors that affect application performance. Review this section for details about lock management considerations that can help you to maximize the performance of database applications.

### Locks and concurrency control

To provide concurrency control and prevent uncontrolled data access, the database manager places locks on buffer pools, tables, data partitions, table blocks, or table rows.

A *lock* associates a database manager resource with an application, called the *lock owner*, to control how other applications access the same resource.

The database manager uses row-level locking or table-level locking, as appropriate, based on:

- The isolation level specified at precompile time or when an application is bound to the database. The isolation level can be one of the following:
  - Uncommitted read (UR)
  - Cursor stability (CS)
  - Read stability (RS)
  - Repeatable read (RR)

The different isolation levels are used to control access to uncommitted data, prevent lost updates, allow non-repeatable reads of data, and prevent phantom reads. To minimize performance impact, use the minimum isolation level that satisfies your application needs.

- The access plan selected by the optimizer. Table scans, index scans, and other methods of data access each require different types of access to the data.
- The `LOCKSIZE` attribute for the table. The `LOCKSIZE` clause on the `ALTER TABLE` statement indicates the granularity of the locks that are used when the table is accessed. The choices are: `ROW` for row locks, `TABLE` for table locks, or `BLOCKINSERT` for block locks on multidimensional clustering (MDC) tables only. When the `BLOCKINSERT` clause is used on an MDC table, row-level locking is performed, except during an insert operation, when block-level locking is done instead. Use the `ALTER TABLE...LOCKSIZE BLOCKINSERT` statement for MDC tables when transactions will be performing large inserts into disjointed cells. Use the `ALTER TABLE...LOCKSIZE TABLE` statement for read-only tables. This reduces the number of locks that are required for database activity. For partitioned tables, table locks are first acquired and then data partition locks are acquired, as dictated by the data that will be accessed.
- The amount of memory devoted to locking, which is controlled by the `locklist` database configuration parameter. If the lock list fills up, performance can degrade because of lock escalations and reduced concurrency among shared objects in the database. If lock escalations occur frequently, increase the value of `locklist`, `maxlocks`, or both. To reduce the number of locks that are held at one time, ensure that transactions commit frequently.



A buffer pool lock (exclusive) is set whenever a buffer pool is created, altered, or dropped. You might encounter this type of lock when collecting system monitoring data. The name of the lock is the identifier (ID) for the buffer pool itself.

In general, row-level locking is used unless one of the following is true:

- The isolation level is uncommitted read
- The isolation level is repeatable read and the access plan requires a scan with no index range predicates
- The table LOCKSIZE attribute is TABLE
- The lock list fills up, causing lock escalation
- An explicit table lock has been acquired through the LOCK TABLE statement, which prevents concurrent application processes from changing or using a table

In the case of an MDC table, block-level locking is used instead of row-level locking when:

- The table LOCKSIZE attribute is BLOCKINSERT
- The isolation level is repeatable read and the access plan involves predicates
- A searched update or delete operation involves predicates on dimension columns only

The duration of row locking varies with the isolation level being used:

- UR scans: No row locks are held unless row data is changing.
- CS scans: Row locks are generally held only while the cursor is positioned on the row. Note that in some cases, locks might not be held at all during a CS scan.
- RS scans: Qualifying row locks are held only for the duration of the transaction.
- RR scans: All row locks are held for the duration of the transaction.

## Lock granularity

If one application holds a lock on a database object, another application might not be able to access that object. For this reason, row-level locks, which minimize the amount of data that is locked and therefore inaccessible, are better for maximum concurrency than block-level, data partition-level, or table-level locks.

However, locks require storage and processing time, so a single table lock minimizes lock overhead.

The LOCKSIZE clause of the ALTER TABLE statement specifies the granularity of locks at the row, data partition, block, or table level. Row locks are used by default. Use of this option in the table definition does not prevent normal lock escalation from occurring.

The ALTER TABLE statement specifies locks globally, affecting all applications and users that access that table. Individual applications might use the LOCK TABLE statement to specify table locks at an application level instead.

A permanent table lock defined by the ALTER TABLE statement might be preferable to a single-transaction table lock using the LOCK TABLE statement if:

- The table is read-only, and will always need only S locks. Other users can also obtain S locks on the table.
- The table is usually accessed by read-only applications, but is sometimes accessed by a single user for brief maintenance, and that user requires an X lock.

While the maintenance program is running, read-only applications are locked out, but in other circumstances, read-only applications can access the table concurrently with a minimum of locking overhead.

For a multidimensional clustering (MDC) table, you can specify BLOCKINSERT with the LOCKSIZE clause in order to use block-level locking during insert operations only. When BLOCKINSERT is specified, row-level locking is performed for all other operations, but only minimally for insert operations. That is, block-level locking is used during the insertion of rows, but row-level locking is used to lock the next key if repeatable read (RR) scans are encountered in the record ID (RID) indexes as they are being updated. BLOCKINSERT locking might be beneficial when:

- There are multiple transactions doing mass insertions into separate cells
- Concurrent insertions into the same cell by multiple transactions is not occurring, or it is occurring with enough data inserted per cell by each of the transactions that the user is not concerned that each transaction will insert into separate blocks

## Lock attributes

Database manager locks have several basic attributes.

These attributes include the following:

**Mode** The type of access allowed for the lock owner, as well as the type of access allowed for concurrent users of the locked object. It is sometimes referred to as the *state* of the lock.

### Object

The resource being locked. The only type of object that you can lock explicitly is a table. The database manager also sets locks on other types of resources, such as rows and table spaces. Block locks can also be set for multidimensional clustering (MDC) or insert time clustering (ITC) tables, and data partition locks can be set for partitioned tables. The object being locked determines the *granularity* of the lock.

### Lock count

The length of time during which a lock is held. The isolation level under which a query runs affects the lock count.

Table 16 lists the lock modes and describes their effects, in order of increasing control over resources.

Table 16. Lock Mode Summary

Lock Mode	Applicable Object Type	Description
IN (Intent None)	Table spaces, blocks, tables, data partitions	The lock owner can read any data in the object, including uncommitted data, but cannot update any of it. Other concurrent applications can read or update the table.
IS (Intent Share)	Table spaces, blocks, tables, data partitions	The lock owner can read data in the locked table, but cannot update this data. Other applications can read or update the table.
IX (Intent Exclusive)	Table spaces, blocks, tables, data partitions	The lock owner and concurrent applications can read and update data. Other concurrent applications can both read and update the table.

Table 16. Lock Mode Summary (continued)

Lock Mode	Applicable Object Type	Description
NS (Scan Share)	Rows	The lock owner and all concurrent applications can read, but not update, the locked row. This lock is acquired on rows of a table, instead of an S lock, where the isolation level of the application is either RS or CS.
NW (Next Key Weak Exclusive)	Rows	When a row is inserted into an index, an NW lock is acquired on the next row. This occurs only if the next row is currently locked by an RR scan. The lock owner can read but not update the locked row. This lock mode is similar to an X lock, except that it is also compatible with NS locks.
S (Share)	Rows, blocks, tables, data partitions	The lock owner and all concurrent applications can read, but not update, the locked data.
SIX (Share with Intent Exclusive)	Tables, blocks, data partitions	The lock owner can read and update data. Other concurrent applications can read the table.
U (Update)	Rows, blocks, tables, data partitions	The lock owner can update data. Other units of work can read the data in the locked object, but cannot update it.
X (Exclusive)	Rows, blocks, tables, buffer pools, data partitions	The lock owner can both read and update data in the locked object. Only uncommitted read (UR) applications can access the locked object.
Z (Super Exclusive)	Table spaces, tables, data partitions	This lock is acquired on a table under certain conditions, such as when the table is altered or dropped, an index on the table is created or dropped, or for some types of table reorganization. No other concurrent application can read or update the table.

## Factors that affect locking

Several factors affect the mode and granularity of database manager locks.

These factors include:

- The type of processing that the application performs
- The data access method
- The values of various configuration parameters

### Locks and types of application processing

For the purpose of determining lock attributes, application processing can be classified as one of the following types: read-only, intent to change, change, and cursor controlled.

- Read-only

This processing type includes all SELECT statements that are intrinsically read-only, have an explicit FOR READ ONLY clause, or are ambiguous, but the query compiler assumes that they are read-only because of the BLOCKING option value that the **PREP** or **BIND** command specifies. This type requires only share locks (IS, NS, or S).

- Intent to change

This processing type includes all SELECT statements that have a FOR UPDATE clause, a USE AND KEEP UPDATE LOCKS clause, a USE AND KEEP EXCLUSIVE LOCKS clause, or are ambiguous, but the query compiler assumes that change is intended. This type uses share and update locks (S, U, or X for rows; IX, S, U, or X for blocks; and IX, U, or X for tables).

- Change

This processing type includes UPDATE, INSERT, and DELETE statements, but not UPDATE WHERE CURRENT OF or DELETE WHERE CURRENT OF. This type requires exclusive locks (IX or X).

- Cursor controlled

This processing type includes UPDATE WHERE CURRENT OF and DELETE WHERE CURRENT OF. This type requires exclusive locks (IX or X).

A statement that inserts, updates, or deletes data in a target table, based on the result from a subselect statement, does two types of processing. The rules for read-only processing determine the locks for the tables that return data in the subselect statement. The rules for change processing determine the locks for the target table.

## Locks and data-access methods

An *access plan* is the method that the optimizer selects to retrieve data from a specific table. The access plan can have a significant effect on lock modes.

If an index scan is used to locate a specific row, the optimizer will usually choose row-level locking (IS) for the table. For example, if the EMPLOYEE table has an index on employee number (EMPNO), access through that index might be used to select information for a single employee:

```
select * from employee
  where empno = '000310'
```

If an index is not used, the entire table must be scanned in sequence to find the required rows, and the optimizer will likely choose a single table-level lock (S). For example, if there is no index on the column SEX, a table scan might be used to select all male employees, as follows:

```
select * from employee
  where sex = 'M'
```

**Note:** Cursor-controlled processing uses the lock mode of the underlying cursor until the application finds a row to update or delete. For this type of processing, no matter what the lock mode of the cursor might be, an exclusive lock is always obtained to perform the update or delete operation.

Locking in range-clustered tables works slightly differently from standard key locking. When accessing a range of rows in a range-clustered table, all rows in the range are locked, even when some of those rows are empty. In standard key locking, only rows with existing data are locked.

Deferred access to data pages implies that access to a row occurs in two steps, which results in more complex locking scenarios. The timing of lock acquisition and the persistence of locks depend on the isolation level. Because the repeatable read (RR) isolation level retains all locks until the end of a transaction, the locks acquired in the first step are held, and there is no need to acquire further locks during the second step. For the read stability (RS) and cursor stability (CS) isolation levels, locks must be acquired during the second step. To maximize concurrency, locks are not acquired during the first step, and the reapplication of all predicates ensures that only qualifying rows are returned.

## Lock type compatibility

Lock compatibility becomes an issue when one application holds a lock on an object and another application requests a lock on the same object. When the two lock modes are compatible, the request for a second lock on the object can be granted.

If the lock mode of the requested lock is not compatible with the lock that is already held, the lock request cannot be granted. Instead, the request must wait until the first application releases its lock, and all other existing incompatible locks are released.

Table 17 shows which lock types are compatible (indicated by a **yes**) and which types are not (indicated by a **no**). Note that a timeout can occur when a requestor is waiting for a lock.

Table 17. Lock Type Compatibility

State Being Requested	State of Held Resource										
	None	IN	IS	NS	S	IX	SIX	U	X	Z	NW
None	yes	yes	yes	yes	yes	yes	yes	yes	yes	yes	yes
IN (Intent None)	yes	yes	yes	yes	yes	yes	yes	yes	yes	no	yes
IS (Intent Share)	yes	yes	yes	yes	yes	yes	yes	yes	no	no	no
NS (Scan Share)	yes	yes	yes	yes	yes	no	no	yes	no	no	yes
S (Share)	yes	yes	yes	yes	yes	no	no	yes	no	no	no
IX (Intent Exclusive)	yes	yes	yes	no	no	yes	no	no	no	no	no
SIX (Share with Intent Exclusive)	yes	yes	yes	no	no	no	no	no	no	no	no
U (Update)	yes	yes	yes	yes	yes	no	no	no	no	no	no
X (Exclusive)	yes	yes	no	no	no	no	no	no	no	no	no
Z (Super Exclusive)	yes	no	no	no	no	no	no	no	no	no	no
NW (Next Key Weak Exclusive)	yes	yes	no	yes	no	no	no	no	no	no	no

## Next-key locking

During insertion of a key into an index, the row that corresponds to the key that will follow the new key in the index is locked only if that row is currently locked by a repeatable read (RR) index scan. When this occurs, insertion of the new index key is deferred until the transaction that performed the RR scan completes.

The lock mode that is used for the next-key lock is NW (next key weak exclusive). This next-key lock is released before key insertion occurs; that is, before a row is inserted into the table.

Key insertion also occurs when updates to a row result in a change to the value of the index key for that row, because the original key value is marked deleted and the new key value is inserted into the index. For updates that affect only the include columns of an index, the key can be updated in place, and no next-key locking occurs.

During RR scans, the row that corresponds to the key that follows the end of the scan range is locked in S mode. If no keys follow the end of the scan range, an end-of-table lock is acquired to lock the end of the index. In the case of partitioned indexes for partitioned tables, locks are acquired to lock the end of each index partition, instead of just one lock for the end of the index. If the key that follows the end of the scan range is marked deleted, one of the following actions occurs:

- The scan continues to lock the corresponding rows until it finds a key that is not marked deleted
- The scan locks the corresponding row for that key
- The scan locks the end of the index

## Lock modes and access plans for standard tables

The type of lock that a standard table obtains depends on the isolation level that is in effect and on the data access plan that is being used.

The following tables show the types of locks that are obtained for standard tables under each isolation level for different access plans. Each entry has two parts: the table lock and the row lock. A hyphen indicates that a particular lock granularity is not available.

Tables 7-12 show the types of locks that are obtained when the reading of data pages is deferred to allow the list of rows to be further qualified using multiple indexes, or sorted for efficient prefetching.

- Table 1. Lock Modes for Table Scans with No Predicates
- Table 2. Lock Modes for Table Scans with Predicates
- Table 3. Lock Modes for RID Index Scans with No Predicates
- Table 4. Lock Modes for RID Index Scans with a Single Qualifying Row
- Table 5. Lock Modes for RID Index Scans with Start and Stop Predicates Only
- Table 6. Lock Modes for RID Index Scans with Index and Other Predicates (sargs, resids) Only
- Table 7. Lock Modes for Index Scans Used for Deferred Data Page Access: RID Index Scan with No Predicates
- Table 8. Lock Modes for Index Scans Used for Deferred Data Page Access: After a RID Index Scan with No Predicates
- Table 9. Lock Modes for Index Scans Used for Deferred Data Page Access: RID Index Scan with Predicates (sargs, resids)
- Table 10. Lock Modes for Index Scans Used for Deferred Data Page Access: After a RID Index Scan with Predicates (sargs, resids)
- Table 11. Lock Modes for Index Scans Used for Deferred Data Page Access: RID Index Scan with Start and Stop Predicates Only
- Table 12. Lock Modes for Index Scans Used for Deferred Data Page Access: After a RID Index Scan with Start and Stop Predicates Only

### Note:

1. Block-level locks are also available for multidimensional clustering (MDC) and insert time clustering (ITC) tables.
2. Lock modes can be changed explicitly with the *lock-request-clause* of a SELECT statement.

Table 18. Lock Modes for Table Scans with No Predicates

Isolation level	Read-only and ambiguous scans	Cursored operation		Searched update or delete	
		Scan	Where current of	Scan	Update or delete
RR	S/-	U/-	SIX/X	X/-	X/-
RS	IS/NS	IX/U	IX/X	IX/X	IX/X
CS	IS/NS	IX/U	IX/X	IX/X	IX/X
UR	IN/-	IX/U	IX/X	IX/X	IX/X

Table 19. Lock Modes for Table Scans with Predicates

Isolation level	Read-only and ambiguous scans	Cursored operation		Searched update or delete	
		Scan	Where current of	Scan	Update or delete
RR	S/-	U/-	SIX/X	U/-	SIX/X
RS	IS/NS	IX/U	IX/X	IX/U	IX/X
CS	IS/NS	IX/U	IX/X	IX/U	IX/X
UR	IN/-	IX/U	IX/X	IX/U	IX/X

**Note:** Under the UR isolation level, if there are predicates on include columns in the index, the isolation level is upgraded to CS and the locks are upgraded to an IS table lock or NS row locks.

Table 20. Lock Modes for RID Index Scans with No Predicates

Isolation level	Read-only and ambiguous scans	Cursored operations		Searched update or delete	
		Scan	Where current of	Scan	Update or delete
RR	S/-	IX/S	IX/X	X/-	X/-
RS	IS/NS	IX/U	IX/X	IX/X	IX/X
CS	IS/NS	IX/U	IX/X	IX/X	IX/X
UR	IN/-	IX/U	IX/X	IX/X	IX/X

Table 21. Lock Modes for RID Index Scans with a Single Qualifying Row

Isolation level	Read-only and ambiguous scans	Cursored operations		Searched update or delete	
		Scan	Where current of	Scan	Update or delete
RR	IS/S	IX/U	IX/X	IX/X	IX/X
RS	IS/NS	IX/U	IX/X	IX/X	IX/X
CS	IS/NS	IX/U	IX/X	IX/X	IX/X
UR	IN/-	IX/U	IX/X	IX/X	IX/X

Table 22. Lock Modes for RID Index Scans with Start and Stop Predicates Only

Isolation level	Read-only and ambiguous scans	Cursored operations		Searched update or delete	
		Scan	Where current of	Scan	Update or delete
RR	IS/S	IX/S	IX/X	IX/X	IX/X
RS	IS/NS	IX/U	IX/X	IX/X	IX/X
CS	IS/NS	IX/U	IX/X	IX/X	IX/X
UR	IN/-	IX/U	IX/X	IX/X	IX/X

Table 23. Lock Modes for RID Index Scans with Index and Other Predicates (sargs, resids) Only

Isolation level	Read-only and ambiguous scans	Cursored operations		Searched update or delete	
		Scan	Where current of	Scan	Update or delete
RR	IS/S	IX/S	IX/X	IX/S	IX/X
RS	IS/NS	IX/U	IX/X	IX/U	IX/X
CS	IS/NS	IX/U	IX/X	IX/U	IX/X
UR	IN/-	IX/U	IX/X	IX/U	IX/X

Table 24. Lock Modes for Index Scans Used for Deferred Data Page Access: RID Index Scan with No Predicates

Isolation level	Read-only and ambiguous scans	Cursored operations		Searched update or delete	
		Scan	Where current of	Scan	Update or delete
RR	IS/S	IX/S		X/-	
RS	IN/-	IN/-		IN/-	
CS	IN/-	IN/-		IN/-	
UR	IN/-	IN/-		IN/-	

Table 25. Lock Modes for Index Scans Used for Deferred Data Page Access: After a RID Index Scan with No Predicates

Isolation level	Read-only and ambiguous scans	Cursored operations		Searched update or delete	
		Scan	Where current of	Scan	Update or delete
RR	IN/-	IX/S	IX/X	X/-	X/-
RS	IS/NS	IX/U	IX/X	IX/X	IX/X
CS	IS/NS	IX/U	IX/X	IX/X	IX/X
UR	IN/-	IX/U	IX/X	IX/X	IX/X



Table 26. Lock Modes for Index Scans Used for Deferred Data Page Access: RID Index Scan with Predicates (sargs, resids)

Isolation level	Read-only and ambiguous scans	Cursored operations		Searched update or delete	
		Scan	Where current of	Scan	Update or delete
RR	IS/S	IX/S		IX/S	
RS	IN/-	IN/-		IN/-	
CS	IN/-	IN/-		IN/-	
UR	IN/-	IN/-		IN/-	

Table 27. Lock Modes for Index Scans Used for Deferred Data Page Access: After a RID Index Scan with Predicates (sargs, resids)

Isolation level	Read-only and ambiguous scans	Cursored operations		Searched update or delete	
		Scan	Where current of	Scan	Update or delete
RR	IN/-	IX/S	IX/X	IX/S	IX/X
RS	IS/NS	IX/U	IX/X	IX/U	IX/X
CS	IS/NS	IX/U	IX/X	IX/U	IX/X
UR	IN/-	IX/U	IX/X	IX/U	IX/X

Table 28. Lock Modes for Index Scans Used for Deferred Data Page Access: RID Index Scan with Start and Stop Predicates Only

Isolation level	Read-only and ambiguous scans	Cursored operations		Searched update or delete	
		Scan	Where current of	Scan	Update or delete
RR	IS/S	IX/S		IX/X	
RS	IN/-	IN/-		IN/-	
CS	IN/-	IN/-		IN/-	
UR	IN/-	IN/-		IN/-	

Table 29. Lock Modes for Index Scans Used for Deferred Data Page Access: After a RID Index Scan with Start and Stop Predicates Only

Isolation level	Read-only and ambiguous scans	Cursored operations		Searched update or delete	
		Scan	Where current of	Scan	Update or delete
RR	IN/-	IX/S	IX/X	IX/X	IX/X
RS	IS/NS	IX/U	IX/X	IX/U	IX/X
CS	IS/NS	IX/U	IX/X	IX/U	IX/X
UR	IS/-	IX/U	IX/X	IX/U	IX/X

## Lock modes for MDC and ITC tables and RID index scans

The type of lock that a multidimensional clustering (MDC) or insert time clustering (ITC) table obtains during a table or RID index scan depends on the isolation level that is in effect and on the data access plan that is being used.

The following tables show the types of locks that are obtained for MDC and ITC tables under each isolation level for different access plans. Each entry has three parts: the table lock, the block lock, and the row lock. A hyphen indicates that a particular lock granularity is not available.

Tables 9-14 show the types of locks that are obtained for RID index scans when the reading of data pages is deferred. Under the UR isolation level, if there are predicates on include columns in the index, the isolation level is upgraded to CS and the locks are upgraded to an IS table lock, an IS block lock, or NS row locks.

- Table 1. Lock Modes for Table Scans with No Predicates
- Table 2. Lock Modes for Table Scans with Predicates on Dimension Columns Only
- Table 3. Lock Modes for Table Scans with Other Predicates (sargs, resids)
- Table 4. Lock Modes for RID Index Scans with No Predicates
- Table 5. Lock Modes for RID Index Scans with a Single Qualifying Row
- Table 6. Lock Modes for RID Index Scans with Start and Stop Predicates Only
- Table 7. Lock Modes for RID Index Scans with Index Predicates Only
- Table 8. Lock Modes for RID Index Scans with Other Predicates (sargs, resids)
- Table 9. Lock Modes for Index Scans Used for Deferred Data Page Access: RID Index Scan with No Predicates
- Table 10. Lock Modes for Index Scans Used for Deferred Data Page Access: After a RID Index Scan with No Predicates
- Table 11. Lock Modes for Index Scans Used for Deferred Data Page Access: RID Index Scan with Predicates (sargs, resids)
- Table 12. Lock Modes for Index Scans Used for Deferred Data Page Access: After a RID Index Scan with Predicates (sargs, resids)
- Table 13. Lock Modes for Index Scans Used for Deferred Data Page Access: RID Index Scan with Start and Stop Predicates Only
- Table 14. Lock Modes for Index Scans Used for Deferred Data Page Access: After a RID Index Scan with Start and Stop Predicates Only

**Note:** Lock modes can be changed explicitly with the *lock-request-clause* of a SELECT statement.

Table 30. Lock Modes for Table Scans with No Predicates

Isolation level	Read-only and ambiguous scans	Cursored operation		Searched update or delete	
		Scan	Where current of	Scan	Update or delete
RR	S/-/-	U/-/-	SIX/IX/X	X/-/-	X/-/-
RS	IS/IS/NS	IX/IX/U	IX/IX/U	IX/X/-	IX/I/-
CS	IS/IS/NS	IX/IX/U	IX/IX/X	IX/X/-	IX/X/-
UR	IN/IN/-	IX/IX/U	IX/IX/X	IX/X/-	IX/X/-

Table 31. Lock Modes for Table Scans with Predicates on Dimension Columns Only

Isolation level	Read-only and ambiguous scans	Cursored operation		Searched update or delete	
		Scan	Where current of	Scan	Update or delete
RR	S/-/-	U/-/-	SIX/IX/X	U/-/-	SIX/X/-
RS	IS/IS/NS	IX/IX/U	IX/IX/X	IX/U/-	X/X/-
CS	IS/IS/NS	IX/IX/U	IX/IX/X	IX/U/-	X/X/-
UR	IN/IN/-	IX/IX/U	IX/IX/X	IX/U/-	X/X/-

Table 32. Lock Modes for Table Scans with Other Predicates (sargs, resids)

Isolation level	Read-only and ambiguous scans	Cursored operation		Searched update or delete	
		Scan	Where current of	Scan	Update or delete
RR	S/-/-	U/-/-	SIX/IX/X	U/-/-	SIX/IX/X
RS	IS/IS/NS	IX/IX/U	IX/IX/X	IX/IX/U	IX/IX/X
CS	IS/IS/NS	IX/IX/U	IX/IX/X	IX/IX/U	IX/IX/X
UR	IN/IN/-	IX/IX/U	IX/IX/X	IX/IX/U	IX/IX/X

Table 33. Lock Modes for RID Index Scans with No Predicates

Isolation level	Read-only and ambiguous scans	Cursored operation		Searched update or delete	
		Scan	Where current of	Scan	Update or delete
RR	S/-/-	IX/IX/S	IX/IX/X	X/-/-	X/-/-
RS	IS/IS/NS	IX/IX/U	IX/IX/X	X/X/X	X/X/X
CS	IS/IS/NS	IX/IX/U	IX/IX/X	X/X/X	X/X/X
UR	IN/IN/-	IX/IX/U	IX/IX/X	X/X/X	X/X/X

Table 34. Lock Modes for RID Index Scans with a Single Qualifying Row

Isolation level	Read-only and ambiguous scans	Cursored operation		Searched update or delete	
		Scan	Where current of	Scan	Update or delete
RR	IS/IS/S	IX/IX/U	IX/IX/X	X/X/X	X/X/X
RS	IS/IS/NS	IX/IX/U	IX/IX/X	X/X/X	X/X/X
CS	IS/IS/NS	IX/IX/U	IX/IX/X	X/X/X	X/X/X
UR	IN/IN/-	IX/IX/U	IX/IX/X	X/X/X	X/X/X

Table 35. Lock Modes for RID Index Scans with Start and Stop Predicates Only

Isolation level	Read-only and ambiguous scans	Cursored operation		Searched update or delete	
		Scan	Where current of	Scan	Update or delete
RR	IS/IS/S	IX/IX/S	IX/IX/X	IX/IX/X	IX/IX/X
RS	IS/IS/NS	IX/IX/U	IX/IX/X	IX/IX/X	IX/IX/X

Table 35. Lock Modes for RID Index Scans with Start and Stop Predicates Only (continued)

Isolation level	Read-only and ambiguous scans	Cursored operation		Searched update or delete	
		Scan	Where current of	Scan	Update or delete
CS	IS/IS/NS	IX/IX/U	IX/IX/X	IX/IX/X	IX/IX/X
UR	IN/IN/-	IX/IX/U	IX/IX/X	IX/IX/X	IX/IX/X

Table 36. Lock Modes for RID Index Scans with Index Predicates Only

Isolation level	Read-only and ambiguous scans	Cursored operation		Searched update or delete	
		Scan	Where current of	Scan	Update or delete
RR	IS/S/S	IX/IX/S	IX/IX/X	IX/IX/S	IX/IX/X
RS	IS/IS/NS	IX/IX/U	IX/IX/X	IX/IX/U	IX/IX/X
CS	IS/IS/NS	IX/IX/U	IX/IX/X	IX/IX/U	IX/IX/X
UR	IN/IN/-	IX/IX/U	IX/IX/X	IX/IX/U	IX/IX/X

Table 37. Lock Modes for RID Index Scans with Other Predicates (sargs, resids)

Isolation level	Read-only and ambiguous scans	Cursored operation		Searched update or delete	
		Scan	Where current of	Scan	Update or delete
RR	IS/S/S	IX/IX/S	IX/IX/X	IX/IX/S	IX/IX/X
RS	IS/IS/NS	IX/IX/U	IX/IX/X	IX/IX/U	IX/IX/X
CS	IS/IS/NS	IX/IX/U	IX/IX/X	IX/IX/U	IX/IX/X
UR	IN/IN/-	IX/IX/U	IX/IX/X	IX/IX/U	IX/IX/X

Table 38. Lock Modes for Index Scans Used for Deferred Data Page Access: RID Index Scan with No Predicates

Isolation level	Read-only and ambiguous scans	Cursored operation		Searched update or delete	
		Scan	Where current of	Scan	Update or delete
RR	IS/S/S	IX/IX/S		X/-/-	
RS	IN/IN/-	IN/IN/-		IN/IN/-	
CS	IN/IN/-	IN/IN/-		IN/IN/-	
UR	IN/IN/-	IN/IN/-		IN/IN/-	

Table 39. Lock Modes for Index Scans Used for Deferred Data Page Access: After a RID Index Scan with No Predicates

Isolation level	Read-only and ambiguous scans	Cursored operation		Searched update or delete	
		Scan	Where current of	Scan	Update or delete
RR	IN/IN/-	IX/IX/S	IX/IX/X	X/-/-	X/-/-

Table 39. Lock Modes for Index Scans Used for Deferred Data Page Access: After a RID Index Scan with No Predicates (continued)

Isolation level	Read-only and ambiguous scans	Cursored operation		Searched update or delete	
		Scan	Where current of	Scan	Update or delete
RS	IS/IS/NS	IX/IX/U	IX/IX/X	IX/IX/X	IX/IX/X
CS	IS/IS/NS	IX/IX/U	IX/IX/X	IX/IX/X	IX/IX/X
UR	IN/IN/-	IX/IX/U	IX/IX/X	IX/IX/X	IX/IX/X

Table 40. Lock Modes for Index Scans Used for Deferred Data Page Access: RID Index Scan with Predicates (sargs, resid)

Isolation level	Read-only and ambiguous scans	Cursored operation		Searched update or delete	
		Scan	Where current of	Scan	Update or delete
RR	IS/S/-	IX/IX/S		IX/IX/S	
RS	IN/IN/-	IN/IN/-		IN/IN/-	
CS	IN/IN/-	IN/IN/-		IN/IN/-	
UR	IN/IN/-	IN/IN/-		IN/IN/-	

Table 41. Lock Modes for Index Scans Used for Deferred Data Page Access: After a RID Index Scan with Predicates (sargs, resid)

Isolation level	Read-only and ambiguous scans	Cursored operation		Searched update or delete	
		Scan	Where current of	Scan	Update or delete
RR	IN/IN/-	IX/IX/S	IX/IX/X	IX/IX/S	IX/IX/X
RS	IS/IS/NS	IX/IX/U	IX/IX/X	IX/IX/U	IX/IX/X
CS	IS/IS/NS	IX/IX/U	IX/IX/X	IX/IX/U	IX/IX/X
UR	IN/IN/-	IX/IX/U	IX/IX/X	IX/IX/U	IX/IX/X

Table 42. Lock Modes for Index Scans Used for Deferred Data Page Access: RID Index Scan with Start and Stop Predicates Only

Isolation level	Read-only and ambiguous scans	Cursored operation		Searched update or delete	
		Scan	Where current of	Scan	Update or delete
RR	IS/IS/S	IX/IX/S		IX/IX/X	
RS	IN/IN/-	IN/IN/-		IN/IN/-	
CS	IN/IN/-	IN/IN/-		IN/IN/-	
UR	IN/IN/-	IN/IN/-		IN/IN/-	

Table 43. Lock Modes for Index Scans Used for Deferred Data Page Access: After a RID Index Scan with Start and Stop Predicates Only

Isolation level	Read-only and ambiguous scans	Cursored operation		Searched update or delete	
		Scan	Where current of	Scan	Update or delete
RR	IN/IN/-	IX/IX/S	IX/IX/X	IX/IX/X	IX/IX/X
RS	IS/IS/NS	IX/IX/U	IX/IX/X	IX/IX/U	IX/IX/X
CS	IS/IS/NS	IX/IX/U	IX/IX/X	IX/IX/U	IX/IX/X
UR	IS/-/-	IX/IX/U	IX/IX/X	IX/IX/U	IX/IX/X

## Lock modes for MDC block index scans

The type of lock that a multidimensional clustering (MDC) table obtains during a block index scan depends on the isolation level that is in effect and on the data access plan that is being used.

The following tables show the types of locks that are obtained for MDC tables under each isolation level for different access plans. Each entry has three parts: the table lock, the block lock, and the row lock. A hyphen indicates that a particular lock granularity is not available.

Tables 5-12 show the types of locks that are obtained for block index scans when the reading of data pages is deferred.

- Table 1. Lock Modes for Index Scans with No Predicates
- Table 2. Lock Modes for Index Scans with Predicates on Dimension Columns Only
- Table 3. Lock Modes for Index Scans with Start and Stop Predicates Only
- Table 4. Lock Modes for Index Scans with Predicates
- Table 5. Lock Modes for Index Scans Used for Deferred Data Page Access: Block Index Scan with No Predicates
- Table 6. Lock Modes for Index Scans Used for Deferred Data Page Access: After a Block Index Scan with No Predicates
- Table 7. Lock Modes for Index Scans Used for Deferred Data Page Access: Block Index Scan with Predicates on Dimension Columns Only
- Table 8. Lock Modes for Index Scans Used for Deferred Data Page Access: After a Block Index Scan with Predicates on Dimension Columns Only
- Table 9. Lock Modes for Index Scans Used for Deferred Data Page Access: Block Index Scan with Start and Stop Predicates Only
- Table 10. Lock Modes for Index Scans Used for Deferred Data Page Access: After a Block Index Scan with Start and Stop Predicates Only
- Table 11. Lock Modes for Index Scans Used for Deferred Data Page Access: Block Index Scan with Other Predicates (sargs, resids)
- Table 12. Lock Modes for Index Scans Used for Deferred Data Page Access: After a Block Index Scan with Other Predicates (sargs, resids)

**Note:** Lock modes can be changed explicitly with the *lock-request-clause* of a SELECT statement.

Table 44. Lock Modes for Index Scans with No Predicates

Isolation level	Read-only and ambiguous scans	Cursored operation		Searched update or delete	
		Scan	Where current of	Scan	Update or delete
RR	S/--/--	IX/IX/S	IX/IX/X	X/--/--	X/--/--
RS	IS/IS/NS	IX/IX/U	IX/IX/X	X/X/--	X/X/--
CS	IS/IS/NS	IX/IX/U	IX/IX/X	X/X/--	X/X/--
UR	IN/IN/-	IX/IX/U	IX/IX/X	X/X/--	X/X/--

Table 45. Lock Modes for Index Scans with Predicates on Dimension Columns Only

Isolation level	Read-only and ambiguous scans	Cursored operation		Searched update or delete	
		Scan	Where current of	Scan	Update or delete
RR	IS/-/-	IX/IX/S	IX/IX/X	X/-/-	X/-/-
RS	IS/IS/NS	IX/IX/U	IX/IX/X	IX/X/-	IX/X/-
CS	IS/IS/NS	IX/IX/U	IX/IX/X	IX/X/-	IX/X/-
UR	IN/IN/-	IX/IX/U	IX/IX/X	IX/X/-	IX/X/-

Table 46. Lock Modes for Index Scans with Start and Stop Predicates Only

Isolation level	Read-only and ambiguous scans	Cursored operation		Searched update or delete	
		Scan	Where current of	Scan	Update or delete
RR	IS/S/-	IX/IX/S	IX/IX/S	IX/IX/S	IX/IX/S
RS	IX/IX/S	IX/IX/U	IX/IX/X	IX/IX/-	IX/IX/-
CS	IX/IX/S	IX/IX/U	IX/IX/X	IX/IX/-	IX/IX/-
UR	IN/IN/-	IX/IX/U	IX/IX/X	IX/IX/-	IX/IX/-

Table 47. Lock Modes for Index Scans with Predicates

Isolation level	Read-only and ambiguous scans	Cursored operation		Searched update or delete	
		Scan	Where current of	Scan	Update or delete
RR	IS/S/-	IX/IX/S	IX/IX/X	IX/IX/S	IX/IX/X
RS	IS/IS/NS	IX/IX/U	IX/IX/X	IX/IX/U	IX/IX/X
CS	IS/IS/NS	IX/IX/U	IX/IX/X	IX/IX/U	IX/IX/X
UR	IN/IN/-	IX/IX/U	IX/IX/X	IX/IX/U	IX/IX/X

Table 48. Lock Modes for Index Scans Used for Deferred Data Page Access: Block Index Scan with No Predicates

Isolation level	Read-only and ambiguous scans	Cursored operation		Searched update or delete	
		Scan	Where current of	Scan	Update or delete
RR	IS/S/--	IX/IX/S		X/--/--	
RS	IN/IN/--	IN/IN/--		IN/IN/--	
CS	IN/IN/--	IN/IN/--		IN/IN/--	
UR	IN/IN/--	IN/IN/--		IN/IN/--	

Table 49. Lock Modes for Index Scans Used for Deferred Data Page Access: After a Block Index Scan with No Predicates

Isolation level	Read-only and ambiguous scans	Cursored operation		Searched update or delete	
		Scan	Where current of	Scan	Update or delete
RR	IN/IN/--	IX/IX/S	IX/IX/X	X/--/--	X/--/--
RS	IS/IS/NS	IX/IX/U	IX/IX/X	X/X/--	X/X/--
CS	IS/IS/NS	IX/IX/U	IX/IX/X	X/X/--	X/X/--
UR	IN/IN/--	IX/IX/U	IX/IX/X	X/X/--	X/X/--

Table 50. Lock Modes for Index Scans Used for Deferred Data Page Access: Block Index Scan with Predicates on Dimension Columns Only

Isolation level	Read-only and ambiguous scans	Cursored operation		Searched update or delete	
		Scan	Where current of	Scan	Update or delete
RR	IS/S/--	IX/IX/--		IX/S/--	
RS	IS/IS/NS	IX/--/--		IX/--/--	
CS	IS/IS/NS	IX/--/--		IX/--/--	
UR	IN/IN/--	IX/--/--		IX/--/--	

Table 51. Lock Modes for Index Scans Used for Deferred Data Page Access: After a Block Index Scan with Predicates on Dimension Columns Only

Isolation level	Read-only and ambiguous scans	Cursored operation		Searched update or delete	
		Scan	Where current of	Scan	Update or delete
RR	IN/IN/--	IX/IX/S	IX/IX/X	IX/S/--	IX/X/--
RS	IS/IS/NS	IX/IX/U	IX/IX/X	IX/U/--	IX/X/--
CS	IS/IS/NS	IX/IX/U	IX/IX/X	IX/U/--	IX/X/--
UR	IN/IN/--	IX/IX/U	IX/IX/X	IX/U/--	IX/X/--



Table 52. Lock Modes for Index Scans Used for Deferred Data Page Access: Block Index Scan with Start and Stop Predicates Only

Isolation level	Read-only and ambiguous scans	Cursored operation		Searched update or delete	
		Scan	Where current of	Scan	Update or delete
RR	IS/S/--	IX/IX/--		IX/X/--	
RS	IN/IN/--	IN/IN/--		IN/IN/--	
CS	IN/IN/--	IN/IN/--		IN/IN/--	
UR	IN/IN/--	IN/IN/--		IN/IN/--	

Table 53. Lock Modes for Index Scans Used for Deferred Data Page Access: After a Block Index Scan with Start and Stop Predicates Only

Isolation level	Read-only and ambiguous scans	Cursored operation		Searched update or delete	
		Scan	Where current of	Scan	Update or delete
RR	IN/IN/--	IX/IX/X		IX/X/--	
RS	IS/IS/NS	IN/IN/--		IN/IN/--	
CS	IS/IS/NS	IN/IN/--		IN/IN/--	
UR	IS/--/--	IN/IN/--		IN/IN/--	

Table 54. Lock Modes for Index Scans Used for Deferred Data Page Access: Block Index Scan with Other Predicates (sargs, resids)

Isolation level	Read-only and ambiguous scans	Cursored operation		Searched update or delete	
		Scan	Where current of	Scan	Update or delete
RR	IS/S/--	IX/IX/--		IX/IX/--	
RS	IN/IN/--	IN/IN/--		IN/IN/--	
CS	IN/IN/--	IN/IN/--		IN/IN/--	
UR	IN/IN/--	IN/IN/--		IN/IN/--	

Table 55. Lock Modes for Index Scans Used for Deferred Data Page Access: After a Block Index Scan with Other Predicates (sargs, resids)

Isolation level	Read-only and ambiguous scans	Cursored operation		Searched update or delete	
		Scan	Where current of	Scan	Update or delete
RR	IN/IN/--	IX/IX/S	IX/IX/X	IX/IX/S	IX/IX/X
RS	IS/IS/NS	IX/IX/U	IX/IX/X	IX/IX/U	IX/IX/X
CS	IS/IS/NS	IX/IX/U	IX/IX/X	IX/IX/U	IX/IX/X
UR	IN/IN/--	IX/IX/U	IX/IX/X	IX/IX/U	IX/IX/X

## Locking behavior on partitioned tables

In addition to an overall table lock, there is a lock for each data partition of a partitioned table.

This allows for finer granularity and increased concurrency compared to a nonpartitioned table. The data partition lock is identified in output from the `db2pd` command, event monitors, administrative views, and table functions.

When a table is accessed, a table lock is obtained first, and then data partition locks are obtained as required. Access methods and isolation levels might require the locking of data partitions that are not represented in the result set. After these data partition locks are acquired, they might be held as long as the table lock. For example, a cursor stability (CS) scan over an index might keep the locks on previously accessed data partitions to reduce the cost of reacquiring data partition locks later.

Data partition locks also carry the cost of ensuring access to table spaces. For nonpartitioned tables, table space access is handled by table locks. Data partition locking occurs even if there is an exclusive or share lock at the table level.

Finer granularity allows one transaction to have exclusive access to a specific data partition and to avoid row locking while other transactions are accessing other data partitions. This can be the result of the plan that is chosen for a mass update, or because of the escalation of locks to the data partition level. The table lock for many access methods is normally an intent lock, even if the data partitions are locked in share or exclusive mode. This allows for increased concurrency. However, if non-intent locks are required at the data partition level, and the plan indicates that all data partitions might be accessed, then a non-intent lock might be chosen at the table level to prevent data partition deadlocks between concurrent transactions.

### LOCK TABLE statements

For partitioned tables, the only lock acquired by the `LOCK TABLE` statement is a table-level lock. This prevents row locking by subsequent data manipulation language (DML) statements, and avoids deadlocks at the row, block, or data partition level. The `IN EXCLUSIVE MODE` option can be used to guarantee exclusive access when updating indexes, which is useful in limiting the growth of indexes during a large update.

### Effect of the LOCKSIZE TABLE option on the ALTER TABLE statement

The `LOCKSIZE TABLE` option ensures that a table is locked in share or exclusive mode with no intent locks. For a partitioned table, this locking strategy is applied to both the table lock and to data partition locks.

### Row- and block-level lock escalation

Row- and block-level locks in partitioned tables can be escalated to the data partition level. When this occurs, a table is more accessible to other transactions, even if a data partition is escalated to share, exclusive, or super exclusive mode, because other data partitions remain unaffected. The notification log entry for an escalation includes the impacted data partition and the name of the table.

Exclusive access to a nonpartitioned index cannot be ensured by lock escalation. For exclusive access, one of the following conditions must be true:

- The statement must use an exclusive table-level lock
- An explicit LOCK TABLE IN EXCLUSIVE MODE statement must be issued
- The table must have the LOCKSIZE TABLE attribute

In the case of partitioned indexes, exclusive access to an index partition is ensured by lock escalation of the data partition to an exclusive or super exclusive access mode.

## Interpreting lock information

The SNAPLOCK administrative view can help you to interpret lock information that is returned for a partitioned table. The following SNAPLOCK administrative view was captured during an offline index reorganization.

```
SELECT SUBSTR(TABNAME, 1, 15) TABNAME, TAB_FILE_ID, SUBSTR(TBSP_NAME, 1, 15) TBSP_NAME, DATA_PARTITION_ID, LOCK_OBJECT_TYPE,
LOCK_MODE, LOCK_ESCALATION FROM SYSIBMADM.SNAPLOCK where TABNAME like 'TP1' and LOCK_OBJECT_TYPE like 'TABLE_%'
ORDER BY TABNAME, DATA_PARTITION_ID, LOCK_OBJECT_TYPE, TAB_FILE_ID, LOCK_MODE
```

TABNAME	TAB_FILE_ID	TBSP_NAME	DATA_PARTITION_ID	LOCK_OBJECT_TYPE	LOCK_MODE	LOCK_ESCALATION
TP1	32768	-	-1	TABLE_LOCK	Z	0
TP1	4	USERSPACE1	0	TABLE_PART_LOCK	Z	0
TP1	5	USERSPACE1	1	TABLE_PART_LOCK	Z	0
TP1	6	USERSPACE1	2	TABLE_PART_LOCK	Z	0
TP1	7	USERSPACE1	3	TABLE_PART_LOCK	Z	0
TP1	8	USERSPACE1	4	TABLE_PART_LOCK	Z	0
TP1	9	USERSPACE1	5	TABLE_PART_LOCK	Z	0
TP1	10	USERSPACE1	6	TABLE_PART_LOCK	Z	0
TP1	11	USERSPACE1	7	TABLE_PART_LOCK	Z	0
TP1	12	USERSPACE1	8	TABLE_PART_LOCK	Z	0
TP1	13	USERSPACE1	9	TABLE_PART_LOCK	Z	0
TP1	14	USERSPACE1	10	TABLE_PART_LOCK	Z	0
TP1	15	USERSPACE1	11	TABLE_PART_LOCK	Z	0
TP1	4	USERSPACE1	-	TABLE_LOCK	Z	0
TP1	5	USERSPACE1	-	TABLE_LOCK	Z	0
TP1	6	USERSPACE1	-	TABLE_LOCK	Z	0
TP1	7	USERSPACE1	-	TABLE_LOCK	Z	0
TP1	8	USERSPACE1	-	TABLE_LOCK	Z	0
TP1	9	USERSPACE1	-	TABLE_LOCK	Z	0
TP1	10	USERSPACE1	-	TABLE_LOCK	Z	0
TP1	11	USERSPACE1	-	TABLE_LOCK	Z	0
TP1	12	USERSPACE1	-	TABLE_LOCK	Z	0
TP1	13	USERSPACE1	-	TABLE_LOCK	Z	0
TP1	14	USERSPACE1	-	TABLE_LOCK	Z	0
TP1	15	USERSPACE1	-	TABLE_LOCK	Z	0
TP1	16	USERSPACE1	-	TABLE_LOCK	Z	0

26 record(s) selected.

In this example, a lock object of type TABLE\_LOCK and a DATA\_PARTITION\_ID of -1 are used to control access to and concurrency on the partitioned table TP1. The lock objects of type TABLE\_PART\_LOCK are used to control most access to and concurrency on each data partition.

There are additional lock objects of type TABLE\_LOCK captured in this output (TAB\_FILE\_ID 4 through 16) that do not have a value for DATA\_PARTITION\_ID. A lock of this type, where an object with a TAB\_FILE\_ID and a TBSP\_NAME correspond to a data partition or index on the partitioned table, might be used to control concurrency with the online backup utility.

## Lock conversion

Changing the mode of a lock that is already held is called *lock conversion*.

Lock conversion occurs when a process accesses a data object on which it already holds a lock, and the access mode requires a more restrictive lock than the one already held. A process can hold only one lock on a data object at any given time, although it can request a lock on the same data object many times indirectly through a query.

Some lock modes apply only to tables, others only to rows, blocks, or data partitions. For rows or blocks, conversion usually occurs if an X lock is needed and an S or U lock is held.

IX and S locks are special cases with regard to lock conversion. Neither is considered to be more restrictive than the other, so if one of these locks is held and the other is required, the conversion results in a SIX (Share with Intent Exclusive) lock. All other conversions result in the requested lock mode becoming the held lock mode if the requested mode is more restrictive.

A dual conversion might also occur when a query updates a row. If the row is read through index access and locked as S, the table that contains the row has a covering intention lock. But if the lock type is IS instead of IX, and the row is subsequently changed, the table lock is converted to an IX and the row lock is converted to an X.

Lock conversion usually takes place implicitly as a query executes. The system monitor elements **lock\_current\_mode** and **lock\_mode** can provide information about lock conversions occurring in your database.

## Lock waits and timeouts

Lock timeout detection is a database manager feature that prevents applications from waiting indefinitely for a lock to be released.

For example, a transaction might be waiting for a lock that is held by another user's application, but the other user has left the workstation without allowing the application to commit the transaction, which would release the lock. To avoid stalling an application in such a case, set the **locktimeout** database configuration parameter to the maximum time that any application should have to wait to obtain a lock.

Setting this parameter helps to avoid global deadlocks, especially in distributed unit of work (DUOW) applications. If the time during which a lock request is pending is greater than the **locktimeout** value, an error is returned to the requesting application and its transaction is rolled back. For example, if APPL1 tries to acquire a lock that is already held by APPL2, APPL1 receives SQLCODE -911 (SQLSTATE 40001) with reason code 68 if the timeout period expires. The default value for **locktimeout** is -1, which means that lock timeout detection is disabled.

For table, row, data partition, and multidimensional clustering (MDC) block locks, an application can override the **locktimeout** value by changing the value of the CURRENT LOCK TIMEOUT special register.

To generate a report file about lock timeouts, set the **DB2\_CAPTURE\_LOCKTIMEOUT** registry variable to ON. The lock timeout report includes information about the key applications that were involved in lock contentions that resulted in lock timeouts, as well as details about the locks, such as lock name, lock type, row ID, table space ID, and table ID. Note that this variable is deprecated and might be

removed in a future release because there are new methods to collect lock timeout events using the CREATE EVENT MONITOR FOR LOCKING statement.

To log more information about lock-request timeouts in the **db2diag** log files, set the value of the **diaglevel** database manager configuration parameter to 4. The logged information includes the name of the locked object, the lock mode, and the application that is holding the lock. The current dynamic SQL or XQuery statement or static package name might also be logged. A dynamic SQL or XQuery statement is logged only at **diaglevel** 4.

You can get additional information about lock waits and lock timeouts from the lock wait information system monitor elements, or from the **db.apps\_waiting\_locks** health indicator.

### Specifying a lock wait mode strategy

An session can specify a lock wait mode strategy, which is used when the session requires a lock that it cannot obtain immediately.

The strategy indicates whether the session will:

- Return an SQLCODE and SQLSTATE when it cannot obtain a lock
- Wait indefinitely for a lock
- Wait a specified amount of time for a lock
- Use the value of the **locktimeout** database configuration parameter when waiting for a lock

The lock wait mode strategy is specified through the SET CURRENT LOCK TIMEOUT statement, which changes the value of the CURRENT LOCK TIMEOUT special register. This special register specifies the number of seconds to wait for a lock before returning an error indicating that a lock cannot be obtained.

Traditional locking approaches can result in applications blocking each other. This happens when one application must wait for another application to release its lock. Strategies to deal with the impact of such blocking usually provide a mechanism to specify the maximum acceptable duration of the block. That is the amount of time that an application will wait prior to returning without a lock. Previously, this was only possible at the database level by changing the value of the **locktimeout** database configuration parameter.

The value of **locktimeout** applies to all locks, but the lock types that are impacted by the lock wait mode strategy include row, table, index key, and multidimensional clustering (MDC) block locks.

## Deadlocks

A deadlock is created when two applications lock data that is needed by the other, resulting in a situation in which neither application can continue executing.

For example, in Figure 23 on page 212, there are two applications running concurrently: Application A and Application B. The first transaction for Application A is to update the first row in Table 1, and the second transaction is to update the second row in Table 2. Application B updates the second row in Table 2 first, and then the first row in Table 1. At time T1, Application A locks the first row in Table 1. At the same time, Application B locks the second row in Table 2. At time T2, Application A requests a lock on the second row in Table 2. However, at the same time, Application B tries to lock the first row in Table 1. Because Application A will not release its lock on the first row in Table 1 until it can complete an update to

the second row in Table 2, and Application B will not release its lock on the second row in Table 2 until it can complete an update to the first row in Table 1, a deadlock occurs. The applications wait until one of them releases its lock on the data.

### Deadlock concept

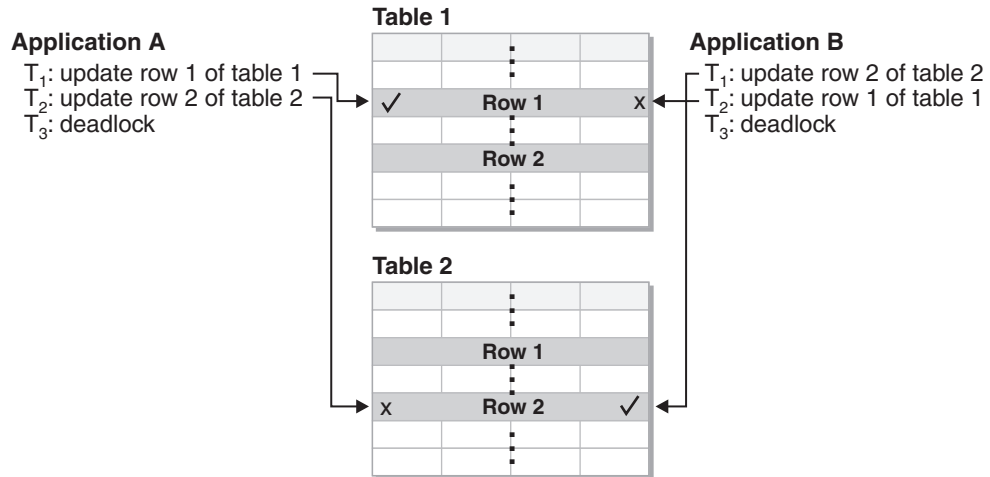

Figure 23. Deadlock between applications

Because applications do not voluntarily release locks on data that they need, a deadlock detector process is required to break deadlocks. The deadlock detector monitors information about agents that are waiting on locks, and awakens at intervals that are specified by the **dlchktime** database configuration parameter.

If it finds a deadlock, the deadlock detector arbitrarily selects one deadlocked process as the *victim process* to roll back. The victim process is awakened, and returns SQLCODE -911 (SQLSTATE 40001), with reason code 2, to the calling application. The database manager rolls back uncommitted transactions from the selected process automatically. When the rollback operation is complete, locks that belonged to the victim process are released, and the other processes involved in the deadlock can continue.

To ensure good performance, select an appropriate value for **dlchktime**. An interval that is too short causes unnecessary overhead, and an interval that is too long allows deadlocks to linger.

In a partitioned database environment, the value of **dlchktime** is applied only at the catalog database partition. If a large number of deadlocks are occurring, increase the value of **dlchktime** to account for lock waits and communication waits.

To avoid deadlocks when applications read data that they intend to subsequently update:

- Use the FOR UPDATE clause when performing a select operation. This clause ensures that a U lock is set when a process attempts to read data, and it does not allow row blocking.
- Use the WITH RR or WITH RS and USE AND KEEP UPDATE LOCKS clauses in queries. These clauses ensure that a U lock is set when a process attempts to read data, and they allow row blocking.

In a federated system, the data that is requested by an application might not be available because of a deadlock at the data source. When this happens, the DB2 server relies on the deadlock handling facilities at the data source. If deadlocks occur across more than one data source, the DB2 server relies on data source timeout mechanisms to break the deadlocks.

To log more information about deadlocks, set the value of the **diaglevel** database manager configuration parameter to 4. The logged information includes the name of the locked object, the lock mode, and the application that is holding the lock. The current dynamic SQL and XQuery statement or static package name might also be logged.

---

## Query optimization

Query optimization is one of the factors that affect application performance. Review this section for details about query optimization considerations that can help you to maximize the performance of database applications.

### The SQL and XQuery compiler process

The SQL and XQuery compiler performs several steps to produce an access plan that can be executed.

The *query graph model* is an internal, in-memory database that represents the query as it is processed through these steps, which are shown in Figure 24 on page 214. Note that some steps occur only for queries that will run against a federated database.

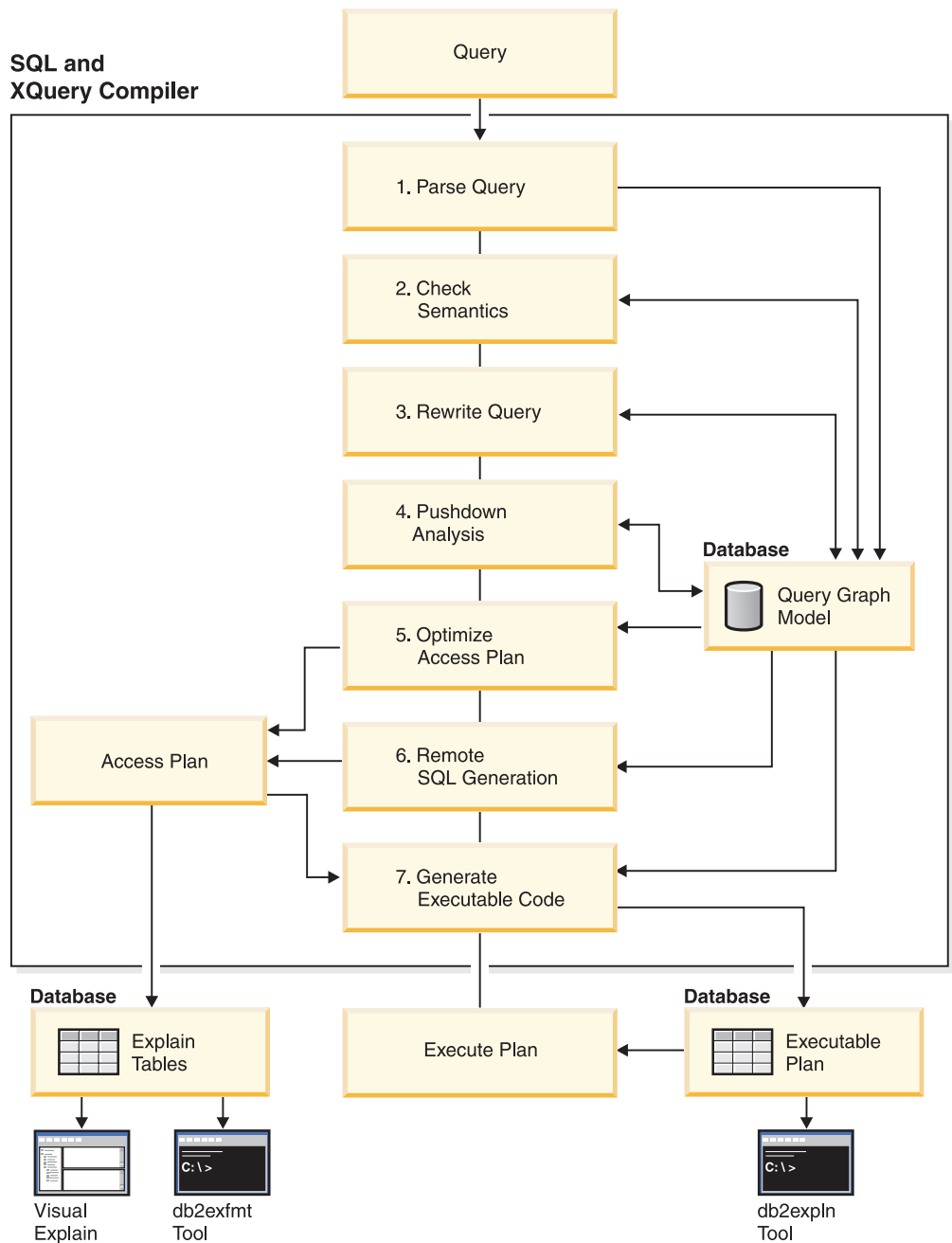

Figure 24. Steps performed by the SQL and XQuery compiler

### 1. Parse query

The SQL and XQuery compiler analyzes the query to validate the syntax. If any syntax errors are detected, the query compiler stops processing and returns an appropriate error to the application that submitted the query. When parsing is complete, an internal representation of the query is created and stored in the query graph model.

### 2. Check semantics

The compiler ensures that there are no inconsistencies among parts of the statement. For example, the compiler verifies that a column specified for the YEAR scalar function has been defined with a datetime data type.



The compiler also adds behavioral semantics to the query graph model, including the effects of referential constraints, table check constraints, triggers, and views. The query graph model contains all of the semantics for the query, including query blocks, subqueries, correlations, derived tables, expressions, data types, data type conversions, code page conversions, and distribution keys.

### 3. Rewrite query

The compiler uses the global semantics that are stored in the query graph model to transform the query into a form that can be optimized more easily. It then stores the result in the query graph model.

For example, the compiler might move a predicate, altering the level at which it is applied, thereby potentially improving query performance. This type of operation movement is called *general predicate pushdown*. In a partitioned database environment, the following query operations are more computationally intensive:

- Aggregation
- Redistribution of rows
- Correlated subqueries, which are subqueries that contain a reference to a column in a table that is outside of the subquery

For some queries in a partitioned database environment, decorrelation might occur as part of rewriting the query.

### 4. Pushdown analysis (federated databases only)

The major task in this step is to recommend to the optimizer whether an operation can be remotely evaluated or *pushed down* at a data source. This type of pushdown activity is specific to data source queries and represents an extension to general predicate pushdown operations.

### 5. Optimize access plan

Using the query graph model as input, the optimizer portion of the compiler generates many alternative execution plans for satisfying the query. To estimate the execution cost of each of these plans, the optimizer uses statistics for tables, indexes, columns and functions. It then chooses the plan with the smallest estimated execution cost. The optimizer uses the query graph model to analyze the query semantics and to obtain information about a wide variety of factors, including indexes, base tables, derived tables, subqueries, correlations, and recursion.

The optimizer can also consider another type of pushdown operation, *aggregation and sort*, which can improve performance by pushing the evaluation of these operations to the Data Management Services (DMS) component.

The optimizer also considers whether there are buffer pools of different sizes when determining page size selection. It considers whether the database is partitioned, or whether intraquery parallelism in a symmetric multiprocessor (SMP) environment is an option. This information is used by the optimizer to help select the best access plan for the query.

The output of this step is an access plan, and details about this access plan are captured in the explain tables. The information that is used to generate an access plan can be captured by an explain snapshot.

### 6. Remote SQL generation (federated databases only)

The final plan that is selected by the optimizer might consist of a set of steps that operate on a remote data source. The remote SQL generation step creates an efficient SQL statement for operations that are performed by each data source, based on the SQL dialect at that data source.

### 7. Generate executable code

In the final step, the compiler uses the access plan and the query graph model to create an executable access plan, or section, for the query. This code generation step uses information from the query graph model to avoid repetitive execution of expressions that need to be computed only once. This type of optimization is possible for code page conversions and when host variables are used.

To enable query optimization or reoptimization of static or dynamic SQL or XQuery statements that have host variables, special registers, or parameter markers, bind the package with the REOPT bind option. The access path for a statement belonging to such a package, and containing host variables, special registers, or parameter markers, will be optimized using the values of these variables rather than default estimates that are chosen by the compiler. This optimization takes place at query execution time when the values are available. Information about access plans for static SQL and XQuery statements is stored in the system catalog tables. When a package is executed, the database manager uses the information that is stored in the system catalog to determine how to access the data and provide results for the query. This information is used by the **db2exp1n** tool.

**Note:** Execute the **RUNSTATS** command at appropriate intervals against tables that change often. The optimizer needs up-to-date statistical information about tables and their data to create the most efficient access plans. Rebind your application to take advantage of updated statistics. If **RUNSTATS** is not executed, or the optimizer assumes that this command was executed against empty or nearly empty tables, it might use default values or attempt to derive certain statistics based on the number of file pages that are used to store the table on disk. See also “Automatic statistics collection”.

## Query rewriting methods and examples

During the query rewrite stage, the query compiler transforms SQL and XQuery statements into forms that can be optimized more easily; this can improve the possible access plans. Rewriting queries is particularly important for very complex queries, including those queries that have many subqueries or many joins. Query generator tools often create these types of very complex queries.

To influence the number of query rewrite rules that are applied to an SQL or XQuery statement, change the optimization class. To see some of the results of the query rewrite process, use the explain facility.

Queries might be rewritten in any one of the following ways:

- Operation merging

To construct a query so that it has the fewest number of operations, especially SELECT operations, the SQL and XQuery compiler rewrites queries to merge query operations. The following examples illustrate some of the operations that can be merged:

- Example - View merges

A SELECT statement that uses views can restrict the join order of the table and can also introduce redundant joining of tables. If the views are merged during query rewrite, these restrictions can be lifted.

- Example - Subquery to join transforms

If a SELECT statement contains a subquery, selection of order processing of the tables might be restricted.

- Example - Redundant join elimination

During query rewrite, redundant joins can be removed to simplify the SELECT statement.

- Example - Shared aggregation

When a query uses different functions, rewriting can reduce the number of calculations that need to be done.

- Operation movement

To construct a query with the minimum number of operations and predicates, the compiler rewrites the query to move query operations. The following examples illustrate some of the operations that can be moved:

- Example - DISTINCT elimination

During query rewrite, the optimizer can move the point at which the DISTINCT operation is performed, to reduce the cost of this operation. In some cases, the DISTINCT operation can be removed completely.

- Example - General predicate pushdown

During query rewrite, the optimizer can change the order in which predicates are applied, so that more selective predicates are applied to the query as early as possible.

- Example - Decorrelation

In a partitioned database environment, the movement of result sets among database partitions is costly. Reducing the size of what must be broadcast to other database partitions, or reducing the number of broadcasts, or both, is an objective of the query rewriting process.

- Predicate translation

The SQL and XQuery compiler rewrites queries to translate existing predicates into more optimal forms. The following examples illustrate some of the predicates that might be translated:

- Example - Addition of implied predicates

During query rewrite, predicates can be added to a query to enable the optimizer to consider additional table joins when selecting the best access plan for the query.

- Example - OR to IN transformations

During query rewrite, an OR predicate can be translated into an IN predicate for a more efficient access plan. The SQL and XQuery compiler can also translate an IN predicate into an OR predicate if this transformation would create a more efficient access plan.

### **Compiler rewrite example: View merges:**

A SELECT statement that uses views can restrict the join order of the table and can also introduce redundant joining of tables. If the views are merged during query rewrite, these restrictions can be lifted.

Suppose you have access to the following two views that are based on the EMPLOYEE table: one showing employees that have a high level of education and the other showing employees that earn more than \$35,000 per year:

```
create view emp_education (empno, firstnme, lastname, edlevel) as
select empno, firstnme, lastname, edlevel
from employee
where edlevel > 17
```

```

create view emp_salaries (empno, firstame, lastname, salary) as
  select empno, firstame, lastname, salary
  from employee
  where salary > 35000

```

The following user-written query lists those employees who have a high level of education and who earn more than \$35,000 per year:

```

select e1.empno, e1.firstame, e1.lastname, e1.edlevel, e2.salary
  from emp_education e1, emp_salaries e2
  where e1.empno = e2.empno

```

During query rewrite, these two views could be merged to create the following query:

```

select e1.empno, e1.firstame, e1.lastname, e1.edlevel, e2.salary
  from employee e1, employee e2
  where
    e1.empno = e2.empno and
    e1.edlevel > 17 and
    e2.salary > 35000

```

By merging the SELECT statements from the two views with the user-written SELECT statement, the optimizer can consider more choices when selecting an access plan. In addition, if the two views that have been merged use the same base table, additional rewriting might be performed.

### Example - Subquery to join transformations

The SQL and XQuery compiler will take a query containing a subquery, such as:

```

select empno, firstame, lastname, phoneno
  from employee
  where workdept in
    (select deptno
     from department
     where deptname = 'OPERATIONS')

```

and convert it to a join query of the form:

```

select distinct empno, firstame, lastname, phoneno
  from employee emp, department dept
  where
    emp.workdept = dept.deptno and
    dept.deptname = 'OPERATIONS'

```

A join is generally much more efficient to execute than a subquery.

### Example - Redundant join elimination

Queries sometimes have unnecessary joins.

```

select e1.empno, e1.firstame, e1.lastname, e1.edlevel, e2.salary
  from employee e1,
       employee e2
  where e1.empno = e2.empno
        and e1.edlevel > 17
        and e2.salary > 35000

```

The SQL and XQuery compiler can eliminate the join and simplify the query to:

```

select empno, firstame, lastname, edlevel, salary
  from employee
  where
    edlevel > 17 and
    salary > 35000

```

The following example assumes that a referential constraint exists between the EMPLOYEE and DEPARTMENT tables on the department number. First, a view is created.

```
create view peplview as
  select firstnme, lastname, salary, deptno, deptname, mgrno
  from employee e department d
  where e.workdept = d.deptno
```

Then a query such as the following:

```
select lastname, salary
  from peplview
```

becomes:

```
select lastname, salary
  from employee
  where workdept not null
```

Note that in this situation, even if you know that the query can be rewritten, you might not be able to do so because you do not have access to the underlying tables. You might only have access to the view (shown previously). Therefore, this type of optimization has to be performed by the database manager.

Redundancy in referential integrity joins likely occurs when:

- Views are defined with joins
- Queries are automatically generated

#### Example - Shared aggregation

Using multiple functions within a query can generate several calculations that take time. Reducing the number of required calculations improves the plan. The compiler takes a query that uses multiple functions, such as the following:

```
select sum(salary+bonus+comm) as osum,
  avg(salary+bonus+comm) as oavg,
  count(*) as ocount
  from employee
```

and transforms it:

```
select osum, osum/ocount ocount
  from (
  select sum(salary+bonus+comm) as osum,
  count(*) as ocount
  from employee
  ) as shared_agg
```

This rewrite halves the required number of sums and counts.

#### Compiler rewrite example: DISTINCT elimination:

During query rewrite, the optimizer can move the point at which the DISTINCT operation is performed, to reduce the cost of this operation. In some cases, the DISTINCT operation can be removed completely.

For example, if the EMPNO column of the EMPLOYEE table were defined as the primary key, the following query:

```
select distinct empno, firstnme, lastname
  from employee
```

could be rewritten by removing the DISTINCT clause:

```
select empno, firstnme, lastname
from employee
```

In this example, because the primary key is being selected, the compiler knows that each returned row is unique. In this case, the DISTINCT keyword is redundant. If the query is not rewritten, the optimizer must build a plan with necessary processing (such as a sort) to ensure that the column values are unique.

### Example - General predicate pushdown

Altering the level at which a predicate is normally applied can result in improved performance. For example, the following view provides a list of all employees in department D11:

```
create view d11_employee
(empno, firstnme, lastname, phoneno, salary, bonus, comm) as
select empno, firstnme, lastname, phoneno, salary, bonus, comm
from employee
where workdept = 'D11'
```

The following query against this view is not as efficient as it could be:

```
select firstnme, phoneno
from d11_employee
where lastname = 'BROWN'
```

During query rewrite, the compiler pushes the lastname = 'BROWN' predicate down into the D11\_EMPLOYEE view. This allows the predicate to be applied sooner and potentially more efficiently. The actual query that could be executed in this example is as follows:

```
select firstnme, phoneno
from employee
where
  lastname = 'BROWN' and
  workdept = 'D11'
```

Predicate pushdown is not limited to views. Other situations in which predicates can be pushed down include UNION, GROUP BY, and derived tables (nested table expressions or common table expressions).

### Example - Decorrelation

In a partitioned database environment, the compiler can rewrite the following query, which is designed to find all of the employees who are working on programming projects and who are underpaid.

```
select p.projno, e.empno, e.lastname, e.firstname,
       e.salary+e.bonus+e.comm as compensation
from employee e, project p
where
  p.empno = e.empno and
  p.projname like '%PROGRAMMING%' and
  e.salary+e.bonus+e.comm <
  (select avg(e1.salary+e1.bonus+e1.comm)
   from employee e1, project p1
   where
    p1.projname like '%PROGRAMMING%' and
    p1.projno = a.projno and
    e1.empno = p1.empno)
```

Because this query is correlated, and because both PROJECT and EMPLOYEE are unlikely to be partitioned on PROJNO, the broadcasting of each project to each database partition is possible. In addition, the subquery would have to be evaluated many times.

The compiler can rewrite the query as follows:

- Determine the distinct list of employees working on programming projects and call it DIST\_PROJS. It must be distinct to ensure that aggregation is done only once for each project:

```
with dist_projs(projno, empno) as
  (select distinct projno, empno
   from project p1
   where p1.projname like '%PROGRAMMING%')
```

- Join DIST\_PROJS with the EMPLOYEE table to get the average compensation per project, AVG\_PER\_PROJ:

```
avg_per_proj(projno, avg_comp) as
  (select p2.projno, avg(e1.salary+e1.bonus+e1.comm)
   from employee e1, dist_projs p2
   where e1.empno = p2.empno
   group by p2.projno)
```

- The rewritten query is:

```
select p.projno, e.empno, e.lastname, e.firstname,
       e.salary+e.bonus+e.comm as compensation
from project p, employee e, avg_per_proj a
where
  p.empno = e.empno and
  p.projname like '%PROGRAMMING%' and
  p.projno = a.projno and
  e.salary+e.bonus+e.comm < a.avg_comp
```

This query computes the avg\_comp per project (avg\_per\_proj). The result can then be broadcast to all database partitions that contain the EMPLOYEE table.

### Compiler rewrite example: Predicate pushdown for combined SQL/XQuery statements:

One fundamental technique for the optimization of relational SQL queries is to move predicates in the WHERE clause of an enclosing query block into an enclosed lower query block (for example, a view), thereby enabling early data filtering and potentially better index usage.

This is even more important in partitioned database environments, because early filtering potentially reduces the amount of data that must be shipped between database partitions.

Similar techniques can be used to move predicates or XPath filters inside of an XQuery. The basic strategy is always to move filtering expressions as close to the data source as possible. This optimization technique is called *predicate pushdown* in SQL and *extraction pushdown* (for filters and XPath extractions) in XQuery.

Because the data models employed by SQL and XQuery are different, you must move predicates, filters, or extractions across the boundary between the two languages. Data mapping and casting rules have to be considered when transforming an SQL predicate into a semantically equivalent filter and pushing it down into the XPath extraction. The following examples address the pushdown of relation predicates into XQuery query blocks.

Consider the following two XML documents containing customer information:

Document 1

Document 2

```

<customer>
  <name>John</name>
  <lastname>Doe</lastname>
  <date_of_birth>
    1976-10-10
  </date_of_birth>
  <address>
    <zip>95141.0</zip>
  </address>
</customer>
<customer>
  <name>Jane</name>
  <lastname>Doe</lastname>
  <date_of_birth>
    1975-01-01
  </date_of_birth>
  <address>
    <zip>95141.4</zip>
  </address>
</customer>

```

```

<customer>
  <name>Michael</name>
  <lastname>Miller </lastname>
  <date_of_birth>
    1975-01-01
  </date_of_birth>
  <address>
    <zip>95142.0</zip>
  </address>
</customer>
<customer>
  <name>Michaela</name>
  <lastname>Miller</lastname>
  <date_of_birth>
    1980-12-23
  </date_of_birth>
  <address>
    <zip>95140.5</zip>
  </address>
</customer>

```

### Example - Pushing INTEGER predicates

Consider the following query:

```

select temp.name, temp.zip
  from xmltable('db2-fn:xmlcolumn("T.XMLDOC")'
    columns name varchar(20) path 'customer/name',
    zip integer path 'customer/zip'
  ) as temp
 where zip = 95141

```

To use possible indexes on T.XMLDOC and to filter out records that are not needed early on, the `zip = 95141` predicate will be internally converted into the following equivalent XPATH filtering expression:

```
T.XMLCOL/customer/zip[. >= 95141.0 and . < 95142.0]
```

Because schema information for XML fragments is not used by the compiler, it cannot be assumed that ZIP contains integers only. It is possible that there are other numeric values with a fractional part and a corresponding double XML index on this specific XPath extraction. The XML2SQL cast would handle this transformation by truncating the fractional part before casting the value to INTEGER. This behavior must be reflected in the pushdown procedure, and the predicate must be changed to remain semantically correct.

### Example - Pushing DECIMAL(*x,y*) predicates

Consider the following query:

```

select temp.name, temp.volume
  from xmltable('db2-fn:xmlcolumn("T.XMLDOC")'
    columns name varchar(20) path 'customer/name',
    volume decimal(10,2) path 'customer/volume'
  ) as temp
 where volume = 100000.00

```

To use possible DECIMAL or DOUBLE indexes on T.XMLDOC and to filter out records that are not needed early on, similar to the handling for the INTEGER



type, the volume = 100000.00 predicate will be internally converted into the following XPATH range filtering expression:

```
T.XMLCOL/customer/volume[.>=100000.00 and .<100000.01]
```

### Example - Pushing VARCHAR(*n*) predicates

Consider the following query:

```
select temp.name, temp.lastname
   from xmltable('db2-fn:xmlcolumn("T.XMLDOC")'
    columns name varchar(20) path 'customer/name',
           lastname varchar(20) path 'customer/lastname'
    ) as temp
  where lastname = 'Miller'
```

To use possible indexes on T.XMLDOC and to filter out records that are not needed early on, the lastname = 'Miller' predicate will be internally converted into an equivalent XPATH filtering expression. A high-level representation of this expression is :

```
T.XMLCOL/customer/lastname[. >= rtrim("Miller") and . <
  RangeUpperBound("Miller", 20)]
```

Trailing blanks are treated differently in SQL than in XPath or XQuery. The original SQL predicate will not distinguish between the two customers whose last name is "Miller", even if one of them (Michael) has a trailing blank. Consequently, both customers are returned, which would not be the case if an unchanged predicate were pushed down.

The solution is to transform the predicate into a range filter.

- The first boundary is created by truncating all trailing blanks from the comparison value, using the RTRIM() function.
- The second boundary is created by looking up all possible strings that are greater than or equal to "Miller", so that all strings that begin with "Miller" are located. Therefore, the original string is replaced with an upperbound string that represents this second boundary.

### Compiler rewrite example: Implied predicates:

During query rewrite, predicates can be added to a query to enable the optimizer to consider additional table joins when selecting the best access plan for the query.

The following query returns a list of the managers whose departments report to department E01, and the projects for which those managers are responsible:

```
select dept.deptname dept.mgrno, emp.lastname, proj.projname
   from department dept, employee emp, project proj
  where
    dept.admrdept = 'E01' and
    dept.mgrno = emp.empno and
    emp.empno = proj.respemp
```

This query can be rewritten with the following implied predicate, known as a *predicate for transitive closure*:

```
dept.mgrno = proj.respemp
```

The optimizer can now consider additional joins when it tries to select the best access plan for the query.

During the query rewrite stage, additional local predicates are derived on the basis of the transitivity that is implied by equality predicates. For example, the following query returns the names of the departments whose department number is greater than E00, and the employees who work in those departments.

```
select empno, lastname, firstname, deptno, deptname
   from employee emp, department dept
  where
    emp.workdept = dept.deptno and
    dept.deptno > 'E00'
```

This query can be rewritten with the following implied predicate:

```
emp.workdept > 'E00'
```

This rewrite reduces the number of rows that need to be joined.

### Example - OR to IN transformations

Suppose that an OR clause connects two or more simple equality predicates on the same column, as in the following example:

```
select *
   from employee
  where
    deptno = 'D11' or
    deptno = 'D21' or
    deptno = 'E21'
```

If there is no index on the DEPTNO column, using an IN predicate in place of OR causes the query to be processed more efficiently:

```
select *
   from employee
  where deptno in ('D11', 'D21', 'E21')
```

In some cases, the database manager might convert an IN predicate into a set of OR clauses so that index ORing can be performed.

### Predicate typology and access plans

A *predicate* is an element of a search condition that expresses or implies a comparison operation. Predicates, which usually appear in the WHERE clause of a query, are used to reduce the scope of the result set that is returned by the query.

Predicates can be grouped into four categories, depending on how and when they are used in the evaluation process. The following list ranks these categories in order of best to worst performance:

1. Range-delimiting predicates
2. Index SARGable predicates
3. Data SARGable predicates
4. Residual predicates

A *SARGable* term is a term that can be used as a search *argument*.

Table 56 on page 225 summarizes the characteristics of these predicate categories.

Table 56. Summary of Predicate Type Characteristics

Characteristic	Predicate Type			
	Range-delimiting	Index-SARGable	Data-SARGable	Residual
Reduce index I/O	Yes	No	No	No
Reduce data page I/O	Yes	Yes	No	No
Reduce the number of rows that are passed internally	Yes	Yes	Yes	No
Reduce the number of qualifying rows	Yes	Yes	Yes	Yes

### Range-delimiting and index-SARGable predicates

Range-delimiting predicates limit the scope of an index scan. They provide start and stop key values for the index search. Index-SARGable predicates cannot limit the scope of a search, but can be evaluated from the index, because the columns that are referenced in the predicate are part of the index key. For example, consider the following index:

```
INDEX IX1: NAME ASC,
           DEPT ASC,
           MGR  DESC,
           SALARY DESC,
           YEARS ASC
```

Consider also a query that contains the following WHERE clause:

```
where
  name = :hv1 and
  dept = :hv2 and
  years > :hv5
```

The first two predicates (name = :hv1 and dept = :hv2) are range-delimiting predicates, and years > :hv5 is an index-SARGable predicate.

The optimizer uses index data instead of reading the base table when it evaluates these predicates. Index-SARGable predicates reduce the number of rows that need to be read from the table, but they do not affect the number of index pages that are accessed.

### Data SARGable predicates

Predicates that cannot be evaluated by the index manager, but that can be evaluated by Data Management Services (DMS), are called data-SARGable predicates. These predicates usually require access to individual rows in a table. If required, DMS retrieves the columns that are needed to evaluate a predicate, as well as any other columns that are needed for the SELECT list, but that could not be obtained from the index.

For example, consider the following index that is defined on the PROJECT table:

```
INDEX IX0: PROJNO ASC
```

In the following query, deptno = 'D11' is considered to be a data-SARGable predicate.

```
select projno, projname, respemp
  from project
  where deptno = 'D11'
  order by projno
```

## Residual predicates

Residual predicates are more expensive, in terms of I/O cost, than accessing a table. Such predicates might:

- Use correlated subqueries
- Use quantified subqueries, which contain ANY, ALL, SOME, or IN clauses
- Read LONG VARCHAR or LOB data, which is stored in a file that is separate from the table

Such predicates are evaluated by Relational Data Services (RDS).

Some predicates that are applied only to an index must be reapplied when the data page is accessed. For example, access plans that use index ORing or index ANDing always reapply the predicates as residual predicates when the data page is accessed.

## Federated database query-compiler phases

### Federated database pushdown analysis:

For queries that are to run against federated databases, the optimizer performs pushdown analysis to determine whether a particular operation can be performed at a remote data source.

An operation might be a function, such as a relational operator, or a system or user function; or it might be an SQL operator, such as, for example, ORDER BY or GROUP BY.

Be sure to update local catalog information regularly, so that the DB2 query compiler has access to accurate information about SQL support at remote data sources. Use DB2 data definition language (DDL) statements (such as CREATE FUNCTION MAPPING or ALTER SERVER, for example) to update the catalog.

If functions cannot be pushed down to the remote data source, they can significantly impact query performance. Consider the effect of forcing a selective predicate to be evaluated locally instead of at the data source. Such evaluation could require the DB2 server to retrieve the entire table from the remote data source and then filter it locally against the predicate. Network constraints and a large table could cause performance to suffer.

Operators that are not pushed down can also significantly affect query performance. For example, having a GROUP BY operator aggregate remote data locally could also require the DB2 server to retrieve an entire table from the remote data source.

For example, consider nickname N1, which references the data source table EMPLOYEE in a DB2 for z/OS data source. The table has 10 000 rows, one of the columns contains the last names of employees, and one of the columns contains

salaries. The optimizer has several options when processing the following statement, depending on whether the local and remote collating sequences are the same:

```
select lastname, count(*) from n1
  where
    lastname > 'B' and
    salary > 50000
  group by lastname
```

- If the collating sequences are the same, the query predicates can probably be pushed down to DB2 for z/OS. Filtering and grouping results at the data source is usually more efficient than copying the entire table and performing the operations locally. For this query, the predicates and the GROUP BY operation can take place at the data source.
- If the collating sequences are not the same, both predicates cannot be evaluated at the data source. However, the optimizer might decide to push down the salary > 50000 predicate. The range comparison must still be done locally.
- If the collating sequences are the same, and the optimizer knows that the local DB2 server is very fast, the optimizer might decide that performing the GROUP BY operation locally is the least expensive approach. The predicate is evaluated at the data source. This is an example of pushdown analysis combined with global optimization.

In general, the goal is to ensure that the optimizer evaluates functions and operators at remote data sources. Many factors affect whether a function or an SQL operator can be evaluated at a remote data source, including the following:

- Server characteristics
- Nickname characteristics
- Query characteristics

### **Server characteristics that affect pushdown opportunities**

Certain data source-specific factors can affect pushdown opportunities. In general, these factors exist because of the rich SQL dialect that is supported by the DB2 product. The DB2 data server can compensate for the lack of function that is available at another data server, but doing so might require that the operation take place at the DB2 server.

- SQL capabilities

Each data source supports a variation of the SQL dialect and different levels of functionality. For example, most data sources support the GROUP BY operator, but some limit the number of items on the GROUP BY list, or have restrictions on whether an expression is allowed on the GROUP BY list. If there is a restriction at the remote data source, the DB2 server might have to perform a GROUP BY operation locally.

- SQL restrictions

Each data source might have different SQL restrictions. For example, some data sources require parameter markers to bind values to remote SQL statements. Therefore, parameter marker restrictions must be checked to ensure that each data source can support such a bind mechanism. If the DB2 server cannot determine a good method to bind a value for a function, this function must be evaluated locally.

- SQL limits

Although the DB2 server might allow the use of larger integers than those that are permitted on remote data sources, values that exceed remote limits cannot be

embedded in statements that are sent to data sources, and any impacted functions or operators must be evaluated locally.

- Server specifics

Several factors fall into this category. For example, if null values at a data source are sorted differently from how the DB2 server would sort them, ORDER BY operations on a nullable expression cannot be remotely evaluated.

- Collating sequence

Retrieving data for local sorts and comparisons usually decreases performance. If you configure a federated database to use the same collating sequence that a data source uses and then set the COLLATING\_SEQUENCE server option to Y, the optimizer can consider pushing down many query operations. The following operations might be pushed down if collating sequences are the same:

- Comparisons of character or numeric data
- Character range comparison predicates
- Sorts

You might get unusual results, however, if the weighting of null characters is different between the federated database and the data source. Comparisons might return unexpected results if you submit statements to a case-insensitive data source. The weights that are assigned to the characters “I” and “i” in a case-insensitive data source are the same. The DB2 server, by default, is case sensitive and assigns different weights to these characters.

To improve performance, the federated server allows sorts and comparisons to take place at data sources. For example, in DB2 for z/OS, sorts that are defined by ORDER BY clauses are implemented by a collating sequence that is based on an EBCDIC code page. To use the federated server to retrieve DB2 for z/OS data that is sorted in accordance with ORDER BY clauses, configure the federated database so that it uses a predefined collating sequence based on the EBCDIC code page.

If the collating sequences of the federated database and the data source differ, the DB2 server retrieves the data to the federated database. Because users expect to see query results ordered by the collating sequence that is defined for the federated server, ordering the data locally ensures that this expectation is fulfilled. Submit your query in passthrough mode, or define the query in a data source view if you need to see the data ordered in the collating sequence of the data source.

- Server options

Several server options can affect pushdown opportunities, including COLLATING\_SEQUENCE, VARCHAR\_NO\_TRAILING\_BLANKS, and PUSHDOWN.

- DB2 type mapping and function mapping factors

The default local data type mappings on the DB2 server are designed to provide sufficient buffer space for each data source data type, which avoids loss of data. You can customize the type mapping for a specific data source to suit specific applications. For example, if you are accessing an Oracle data source column with a DATE data type, which by default is mapped to the DB2 TIMESTAMP data type, you might change the local data type to the DB2 DATE data type.

In the following three cases, the DB2 server can compensate for functions that a data source does not support:

- The function does not exist at the remote data source.
- The function exists, but the characteristics of the operand violate function restrictions. The IS NULL relational operator is an example of this situation.

Most data sources support it, but some might have restrictions, such as allowing a column name to appear only on the left hand side of the IS NULL operator.

- The function might return a different result if it is evaluated remotely. An example of this situation is the greater than (>) operator. For data sources with different collating sequences, the greater than operator might return different results if it is evaluated locally by the DB2 server.

### **Nickname characteristics that affect pushdown opportunities**

The following nickname-specific factors can affect pushdown opportunities.

- Local data type of a nickname column

Ensure that the local data type of a column does not prevent a predicate from being evaluated at the data source. Use the default data type mappings to avoid possible overflow. However, a joining predicate between two columns of different lengths might not be considered at a data source whose joining column is shorter, depending on how DB2 binds the longer column. This situation can affect the number of possibilities that the DB2 optimizer can evaluate in a joining sequence. For example, Oracle data source columns that were created using the INTEGER or INT data type are given the type NUMBER(38). A nickname column for this Oracle data type is given the local data type FLOAT, because the range of a DB2 integer is from  $2^{31}$  to  $(-2^{31})-1$ , which is roughly equivalent to NUMBER(9). In this case, joins between a DB2 integer column and an Oracle integer column cannot take place at the DB2 data source (because of the shorter joining column); however, if the domain of this Oracle integer column can be accommodated by the DB2 INTEGER data type, change its local data type with the ALTER NICKNAME statement so that the join can take place at the DB2 data source.

- Column options

Use the ALTER NICKNAME statement to add or change column options for nicknames.

Use the VARCHAR\_NO\_TRAILING\_BLANKS option to identify a column that contains no trailing blanks. The compiler pushdown analysis step will then take this information into account when checking all operations that are performed on such columns. The DB2 server might generate a different but equivalent form of a predicate to be used in the SQL statement that is sent to a data source. You might see a different predicate being evaluated against the data source, but the net result should be equivalent.

Use the NUMERIC\_STRING option to indicate whether the values in that column are always numbers without trailing blanks.

Table 57 on page 230 describes these options.

Table 57. Column Options and Their Settings

Option	Valid Settings	Default Setting
NUMERIC_STRING	<p>Y: Specifies that this column contains only strings of numeric data. It does not contain blank characters that could interfere with sorting of the column data. This option is useful when the collating sequence of a data source is different from that of the DB2 server. Columns that are marked with this option are not excluded from local (data source) evaluation because of a different collating sequence. If the column contains only numeric strings that are followed by trailing blank characters, do not specify Y.</p> <p>N: Specifies that this column is not limited to strings of numeric data.</p>	N
VARCHAR_NO_TRAILING_BLANKS	<p>Y: Specifies that this data source uses non-blank-padded VARCHAR comparison semantics, similar to the DB2 data server. For variable-length character strings that contain no trailing blank characters, non-blank-padded comparison semantics of some data servers return the same results as DB2 comparison semantics. Specify this value if you are certain that all VARCHAR table or view columns at a data source contain no trailing blank characters</p> <p>N: Specifies that this data source does not use non-blank-padded VARCHAR comparison semantics, similar to the DB2 data server.</p>	N

### Query characteristics that affect pushdown opportunities

A query can reference an SQL operator that might involve nicknames from multiple data sources. The operation must take place on the DB2 server to combine the results from two referenced data sources that use one operator, such as a set operator (for example, UNION). The operator cannot be evaluated at a remote data source directly.

### Guidelines for determining where a federated query is evaluated:

The DB2 explain utility, which you can start by invoking the **db2expln** command, shows where queries are evaluated. The execution location for each operator is included in the command output.

- If a query is pushed down, you should see a RETURN operator, which is a standard DB2 operator. If a SELECT statement retrieves data from a nickname, you also see a SHIP operator, which is unique to federated database operations: it changes the server property of the data flow and separates local operators from remote operators. The SELECT statement is generated using the SQL dialect that is supported by the data source.
- If an INSERT, UPDATE, or DELETE statement can be entirely pushed down to the remote data source, you might not see a SHIP operator in the access plan. All remotely executed INSERT, UPDATE, or DELETE statements are shown for the RETURN operator. However, if a query cannot be pushed down in its entirety, the SHIP operator shows which operations were performed remotely.



## Understanding why a query is evaluated at a data source instead of by the DB2 server

Consider the following key questions when you investigate ways to increase pushdown opportunities:

- Why isn't this predicate being evaluated remotely?

This question arises when a very selective predicate could be used to filter rows and reduce network traffic. Remote predicate evaluation also affects whether a join between two tables of the same data source can be evaluated remotely.

Areas to examine include:

- Subquery predicates. Does this predicate contain a subquery that pertains to another data source? Does this predicate contain a subquery that involves an SQL operator that is not supported by this data source? Not all data sources support set operators in a subquery predicate.
- Predicate functions. Does this predicate contain a function that cannot be evaluated by this remote data source? Relational operators are classified as functions.
- Predicate bind requirements. If it is remotely evaluated, does this predicate require bind-in of some value? Would that violate SQL restrictions at this data source?
- Global optimization. The optimizer might have decided that local processing is more cost effective.

- Why isn't the GROUP BY operator evaluated remotely?

Areas to examine include:

- Is the input to the GROUP BY operator evaluated remotely? If the answer is no, examine the input.
- Does the data source have any restrictions on this operator? Examples include:
  - A limited number of GROUP BY items
  - Limited byte counts for combined GROUP BY items
  - Column specifications only on the GROUP BY list
- Does the data source support this SQL operator?
- Global optimization. The optimizer might have decided that local processing is more cost effective.
- Does the GROUP BY clause contain a character expression? If it does, verify that the remote data source and the DB2 server have the same case sensitivity.

- Why isn't the set operator evaluated remotely?

Areas to examine include:

- Are both of its operands evaluated in their entirety at the same remote data source? If the answer is no, and it should be yes, examine each operand.
- Does the data source have any restrictions on this set operator? For example, are large objects (LOBs) or LONG field data valid input for this specific set operator?

- Why isn't the ORDER BY operation evaluated remotely?

Areas to examine include:

- Is the input to the ORDER BY operation evaluated remotely? If the answer is no, examine the input.
- Does the ORDER BY clause contain a character expression? If yes, do the remote data source and the DB2 server have different collating sequences or case sensitivities?

- Does the remote data source have any restrictions on this operator? For example, is there a limit to the number of ORDER BY items? Does the remote data source restrict column specification to the ORDER BY list?

### **Remote SQL generation and global optimization in federated databases:**

For a federated database query that uses relational nicknames, the access strategy might involve breaking down the original query into a set of remote query units and then combining the results. Such remote SQL generation helps to produce a globally optimized access strategy for a query.

The optimizer uses the output of pushdown analysis to decide whether each operation is to be evaluated locally at the DB2 server or remotely at a data source. It bases its decision on the output of its cost model, which includes not only the cost of evaluating the operation, but also the cost of shipping the data and messages between the DB2 server and the remote data source.

Although the goal is to produce an optimized query, the following factors significantly affect global optimization, and thereby query performance.

- Server characteristics
- Nickname characteristics

### **Server options that affect global optimization**

The following data source server options can affect global optimization:

- Relative ratio of processing speed  
Use the CPU\_RATIO server option to specify how fast or slow the processing speed at the data source should be relative to the processing speed at the DB2 server. A low ratio indicates that the processing speed at the data source is faster than the processing speed at the DB2 server; in this case, the DB2 optimizer is more likely to consider pushing processor-intensive operations down to the data source.
- Relative ratio of I/O speed  
Use the IO\_RATIO server option to specify how fast or slow the system I/O speed at the data source should be relative to the system I/O speed at the DB2 server. A low ratio indicates that the I/O speed at the data source is faster than the I/O speed at the DB2 server; in this case, the DB2 optimizer is more likely to consider pushing I/O-intensive operations down to the data source.
- Communication rate between the DB2 server and the data source  
Use the COMM\_RATE server option to specify network capacity. Low rates, which indicate slow network communication between the DB2 server and a data source, encourage the DB2 optimizer to reduce the number of messages that are sent to or from this data source. If the rate is set to 0, the optimizer creates an access plan that requires minimal network traffic.
- Data source collating sequence  
Use the COLLATING\_SEQUENCE server option to specify whether a data source collating sequence matches the local DB2 database collating sequence. If this option is not set to Y, the DB2 optimizer considers any data that is retrieved from this data source as being unordered.
- Remote plan hints  
Use the PLAN\_HINTS server option to specify that plan hints should be generated or used at a data source. By default, the DB2 server does not send any plan hints to the data source.

Plan hints are statement fragments that provide extra information to the optimizer at a data source. For some queries, this information can improve performance. The plan hints can help the optimizer at a data source to decide whether to use an index, which index to use, or which table join sequence to use.

If plan hints are enabled, the query that is sent to the data source contains additional information. For example, a statement with plan hints that is sent to an Oracle optimizer might look like this:

```
select /*+ INDEX (table1, t1index)*/
      col1
from table1
```

The plan hint is the string: `/*+ INDEX (table1, t1index)*/`

- Information in the DB2 optimizer knowledge base

The DB2 server has an optimizer knowledge base that contains data about native data sources. The DB2 optimizer does not generate remote access plans that cannot be generated by specific database management systems (DBMSs). In other words, the DB2 server avoids generating plans that optimizers at remote data sources cannot understand or accept.

### Nickname characteristics that affect global optimization

The following nickname-specific factors can affect global optimization.

- Index considerations

To optimize queries, the DB2 server can use information about indexes at data sources. For this reason, it is important that the available index information be current. Index information for a nickname is initially acquired when the nickname is created. Index information is not collected for view nicknames.

- Creating index specifications on nicknames

You can create an index specification for a nickname. Index specifications build an index definition (not an actual index) in the catalog for the DB2 optimizer to use. Use the `CREATE INDEX SPECIFICATION ONLY` statement to create index specifications. The syntax for creating an index specification on a nickname is similar to the syntax for creating an index on a local table. Consider creating index specifications in the following circumstances:

- When the DB2 server cannot retrieve any index information from a data source during nickname creation
- When you want an index for a view nickname
- When you want to encourage the DB2 optimizer to use a specific nickname as the inner table of a nested-loop join. You can create an index on the joining column, if none exists.

Before you issue `CREATE INDEX` statements against a nickname for a view, consider whether you need one. If the view is a simple `SELECT` on a table with an index, creating local indexes on the nickname to match the indexes on the table at the data source can significantly improve query performance. However, if indexes are created locally over a view that is not a simple `SELECT` statement, such as a view that is created by joining two tables, query performance might suffer. For example, if you create an index over a view that is a join between two tables, the optimizer might choose that view as the inner element in a nested-loop join. The query will perform poorly, because the join is evaluated several times. An alternate approach is to create nicknames for each of the tables that are referenced in the data source view, and then to create a local view at the DB2 server that references both nicknames.

- **Catalog statistics considerations**

System catalog statistics describe the overall size of nicknames and the range of values in associated columns. The optimizer uses these statistics when it calculates the least-cost path for processing queries that contain nicknames. Nickname statistics are stored in the same catalog views as table statistics.

Although the DB2 server can retrieve the statistical data that is stored at a data source, it cannot automatically detect updates to that data. Furthermore, the DB2 server cannot automatically detect changes to the definition of objects at a data source. If the statistical data for—or the definition of—an object has changed, you can:

- Run the equivalent of a **RUNSTATS** command at the data source, drop the current nickname, and then recreate it. Use this approach if an object's definition has changed.
- Manually update the statistics in the SYSSTAT.TABLES catalog view. This approach requires fewer steps, but it does not work if an object's definition has changed.

### **Global analysis of federated database queries:**

The DB2 explain utility, which you can start by invoking the **db2expln** command, shows the access plan that is generated by the remote optimizer for those data sources that are supported by the remote explain function. The execution location for each operator is included in the command output.

You can also find the remote SQL statement that was generated for each data source in the SHIP or RETURN operator, depending on the type of query. By examining the details for each operator, you can see the number of rows that were estimated by the DB2 optimizer as input to and output from each operator.

### **Understanding DB2 optimization decisions**

Consider the following key questions when you investigate ways to increase performance:

- Why isn't a join between two nicknames of the same data source being evaluated remotely?  
Areas to examine include:
  - Join operations. Can the remote data source support them?
  - Join predicates. Can the join predicate be evaluated at the remote data source? If the answer is no, examine the join predicate.
- Why isn't the GROUP BY operator being evaluated remotely?  
Examine the operator syntax, and verify that the operator can be evaluated at the remote data source.
- Why is the statement not being completely evaluated by the remote data source?  
The DB2 optimizer performs cost-based optimization. Even if pushdown analysis indicates that every operator can be evaluated at the remote data source, the optimizer relies on its cost estimate to generate a global optimization plan. There are a great many factors that can contribute to that plan. For example, even though the remote data source can process every operation in the original query, its processing speed might be much slower than the processing speed of the DB2 server, and it might turn out to be more beneficial to perform the operations at the DB2 server instead. If results are not satisfactory, verify your server statistics in the SYSCAT.SERVEROPTIONS catalog view.

- Why does a plan that is generated by the optimizer, and that is completely evaluated at a remote data source, perform much more poorly than the original query executed directly at the remote data source?

Areas to examine include:

- The remote SQL statement that is generated by the DB2 optimizer. Ensure that this statement is identical to the original query. Check for changes in predicate order. A good query optimizer should not be sensitive to the order of predicates in a query. The optimizer at the remote data source might generate a different plan, based on the order of input predicates. Consider either modifying the order of predicates in the input to the DB2 server, or contacting the service organization of the remote data source for assistance. You can also check for predicate replacements. A good query optimizer should not be sensitive to equivalent predicate replacements. The optimizer at the remote data source might generate a different plan, based on the input predicates. For example, some optimizers cannot generate transitive closure statements for predicates.
- Additional functions. Does the remote SQL statement contain functions that are not present in the original query? Some of these functions might be used to convert data types; be sure to verify that they are necessary.

## Data-access methods

When it compiles an SQL or XQuery statement, the query optimizer estimates the execution cost of different ways of satisfying the query.

Based on these estimates, the optimizer selects an optimal access plan. An *access plan* specifies the order of operations that are required to resolve an SQL or XQuery statement. When an application program is bound, a package is created. This *package* contains access plans for all of the static SQL and XQuery statements in that application program. Access plans for dynamic SQL and XQuery statements are created at run time.

There are three ways to access data in a table:

- By scanning the entire table sequentially
- By accessing an index on the table to locate specific rows
- By scan sharing

Rows might be filtered according to conditions that are defined in predicates, which are usually stated in a WHERE clause. The selected rows in accessed tables are joined to produce the result set, and this data might be further processed by grouping or sorting of the output.

Starting with DB2 9.7, *scan sharing*, which is the ability of a scan to use the buffer pool pages of another scan, is default behavior. Scan sharing increases workload concurrency and performance. With scan sharing, the system can support a larger number of concurrent applications, queries can perform better, and system throughput can increase, benefiting even queries that do not participate in scan sharing. Scan sharing is particularly effective in environments with applications that perform scans such as table scans or multidimensional clustering (MDC) block index scans of large tables. The compiler determines whether a scan is eligible to participate in scan sharing based on the type of scan, its purpose, the isolation level, how much work is done per record, and so on.

## Data access through index scans

An *index scan* occurs when the database manager accesses an index to narrow the set of qualifying rows (by scanning the rows in a specified range of the index) before accessing the base table; to order the output; or to retrieve the requested column data directly (*index-only access*).

When scanning the rows in a specified range of the index, the *index scan range* (the start and stop points of the scan) is determined by the values in the query against which index columns are being compared. In the case of index-only access, because all of the requested data is in the index, the indexed table does not need to be accessed.

If indexes are created with the ALLOW REVERSE SCANS option, scans can also be performed in a direction that is opposite to that with which they were defined.

The optimizer chooses a table scan if no appropriate index has been created, or if an index scan would be more costly. An index scan might be more costly if the table is small, the index-clustering ratio is low, the query requires most of the table rows, or additional sorts are required when a partitioned index (which cannot preserve the order in certain cases) is used. To determine whether the access plan uses a table scan or an index scan, use the DB2 explain facility.

## Index scans to limit a range

To determine whether an index can be used for a particular query, the optimizer evaluates each column of the index, starting with the first column, to see if it can be used to satisfy equality and other predicates in the WHERE clause. A *predicate* is an element of a search condition in a WHERE clause that expresses or implies a comparison operation. Predicates can be used to limit the scope of an index scan in the following cases:

- Tests for IS NULL or IS NOT NULL
- Tests for strict and inclusive inequality
- Tests for equality against a constant, a host variable, an expression that evaluates to a constant, or a keyword
- Tests for equality against a basic subquery, which is a subquery that does not contain ANY, ALL, or SOME; this subquery must not have a correlated column reference to its immediate parent query block (that is, the select for which this subquery is a subselect).

The following examples show how an index could be used to limit the range of a scan.

- Consider an index with the following definition:

```
INDEX IX1:  NAME  ASC,
           DEPT  ASC,
           MGR   DESC,
           SALARY DESC,
           YEARS ASC
```

The following predicates could be used to limit the range of a scan that uses index IX1:

```
where
  name = :hv1 and
  dept = :hv2
```

or

```

where
  mgr = :hv1 and
  name = :hv2 and
  dept = :hv3

```

The second WHERE clause demonstrates that the predicates do not have to be specified in the order in which the key columns appear in the index. Although the examples use host variables, other variables, such as parameter markers, expressions, or constants, could be used instead.

In the following WHERE clause, only the predicates that reference NAME and DEPT would be used for limiting the range of the index scan:

```

where
  name = :hv1 and
  dept = :hv2 and
  salary = :hv4 and
  years = :hv5

```

Because there is a key column (MGR) separating these columns from the last two index key columns, the ordering would be off. However, after the range is determined by the name = :hv1 and dept = :hv2 predicates, the other predicates can be evaluated against the remaining index key columns.

- Consider an index that was created using the ALLOW REVERSE SCANS option:
 

```
create index iname on tname (cname desc) allow reverse scans
```

In this case, the index (INAME) is based on descending values in the CNAME column. Although the index is defined for scans running in descending order, a scan can be done in ascending order. Use of the index is controlled by the optimizer when creating and considering access plans.

## Index scans to test inequality

Certain inequality predicates can limit the range of an index scan. There are two types of inequality predicates:

- Strict inequality predicates

The strict inequality operators that are used for range-limiting predicates are greater than (>) and less than (<).

Only one column with strict inequality predicates is considered for limiting the range of an index scan. In the following example, predicates on the NAME and DEPT columns can be used to limit the range, but the predicate on the MGR column cannot be used for that purpose.

```

where
  name = :hv1 and
  dept > :hv2 and
  dept < :hv3 and
  mgr < :hv4

```

However, in access plans that use jump scans, multiple columns with strict inequality predicates can be considered for limiting the range of an index scan. In the above example (assuming the optimizer chooses an access plan with a jump scan), the strict inequality predicates on the DEPT, and MGR columns can be used to limit the range. While this example focuses on strict inequality predicates, note that the equality predicate on the NAME column is also used to limit the range.

- Inclusive inequality predicates

The inclusive inequality operators that are used for range-limiting predicates are:

– >= and <=

- BETWEEN
- LIKE

Multiple columns with inclusive inequality predicates can be considered for limiting the range of an index scan or a jump scan. In the following example, all of the predicates can be used to limit the range.

```
where
  name = :hv1 and
  dept >= :hv2 and
  dept <= :hv3 and
  mgr <= :hv4
```

Suppose that :hv2 = 404, :hv3 = 406, and :hv4 = 12345. The database manager will scan the index for departments 404 and 405, but it will stop scanning department 406 when it reaches the first manager whose employee number (MGR column) is greater than 12345.

### Index scans to order data

If a query requires sorted output, an index can be used to order the data if the ordering columns appear consecutively in the index, starting from the first index key column. Ordering or sorting can result from operations such as ORDER BY, DISTINCT, GROUP BY, an “= ANY” subquery, a “> ALL” subquery, a “< ALL” subquery, INTERSECT or EXCEPT, and UNION. Exceptions to this are as follows:

- If the index is partitioned, it can be used to order the data only if the index key columns are prefixed by the table-partitioning key columns, or if partition elimination eliminations all but one partition.
- Ordering columns can be different from the first index key columns when index key columns are tested for equality against “constant values” or any expression that evaluates to a constant.

Consider the following query:

```
where
  name = 'JONES' and
  dept = 'D93'
order by mgr
```

For this query, the index might be used to order the rows, because NAME and DEPT will always be the same values and will therefore be ordered. That is, the preceding WHERE and ORDER BY clauses are equivalent to:

```
where
  name = 'JONES' and
  dept = 'D93'
order by name, dept, mgr
```

A unique index can also be used to truncate a sort-order requirement. Consider the following index definition and ORDER BY clause:

```
UNIQUE INDEX IX0: PROJNO ASC

select projno, projname, deptno
  from project
  order by projno, projname
```

Additional ordering on the PROJNAME column is not required, because the IX0 index ensures that PROJNO is unique: There is only one PROJNAME value for each PROJNO value.



## Jump scans

Queries against tables with composite (multi-column) indexes present a particular challenge when designing indexes for tables. Ideally, a query's predicates are consistent with a table's composite index. This would mean that each predicate could be used as a start-stop key, which would, in turn, reduce the scope of the index needing to be searched. When a query contains predicates that are inconsistent with a composite index, this is known as an *index gap*. As such, index gaps are a characteristic of how a query measures up to a table's indexes.

### Unconstrained index gap

Consider the following query against a table with the IX1 composite index defined earlier in this topic:

```
where
  name = :hv1 and
  dept = :hv2 and
  mgr = :hv3 and
  years = IS NOT NULL
```

This query contains an index gap: on the SALARY key part of the composite index (this is assuming that the access plan contains an index scan on the composite index). The SALARY column cannot be included as a start-stop predicate. The SALARY column is an example of an *unconstrained index gap*.

**Note:** For some queries it can be difficult to assess whether or not there are index gaps. Use the EXPLAIN output to determine if index gaps are present.

### Constrained index gap

Consider the following query against a table with the IX1 composite index defined earlier in this topic:

```
where
  name = :hv1 and
  dept = :hv2 and
  mgr = :hv3 and
  salary < :hv4 and
  years = :hv5
```

This query contains an index gap on the SALARY key part of the composite index (this is assuming that the access plan contains an index scan on the composite index). Since the SALARY column in the query is not an equality predicate, start/stop values cannot be generated for this column. The SALARY key part represents a *constrained index gap*.

To avoid poor performance in queries with index gaps, the optimizer can perform a *jump scan* operation. In a jump scan operation, the index manager identifies qualifying keys for small sections of a composite index where there are gaps, and fills these gaps with these qualifying keys. The end result is that the index manager skips over parts of the index that will not yield any results.

### Jump scan restrictions

For queries being issued where you expect a jump scan, verify that the target table has an appropriate composite index and that the query predicates introduce an index gap. The DB2 optimizer will not create plans with jump scans if there are no index gaps.

Jump scans do not scan the following types of indexes:

- range-clustered table indexes
- extended indexes (for example, spatial indexes)
- XML indexes
- text indexes (for Text Search)

With jump scans, a gap column with an IN-List predicate might be treated as an unconstrained gap column. Also, in databases with Unicode Collation Algorithm (UCA) collation, jump scans might treat LIKE predicates with host variables or parameter markers as unconstrained gaps.

**Note:** When evaluating queries, there can be cases where the optimizer chooses an access plan that does not include a jump scan operation, even if index gaps are present. This would occur if the optimizer deems an alternative to using a jump scan to be more efficient.

### Types of index access

In some cases, the optimizer might find that all of the data that a query requires can be retrieved from an index on the table. In other cases, the optimizer might use more than one index to access tables. In the case of range-clustered tables, data can be accessed through a “virtual” index, which computes the location of data records.

### Index-only access

In some cases, all of the required data can be retrieved from an index without accessing the table. This is known as *index-only access*. For example, consider the following index definition:

```
INDEX IX1: NAME    ASC,
           DEPT    ASC,
           MGR     DESC,
           SALARY  DESC,
           YEARS   ASC
```

The following query can be satisfied by accessing only the index, without reading the base table:

```
select name, dept, mgr, salary
   from employee
  where name = 'SMITH'
```

Often, however, required columns do not appear in an index. To retrieve the data from these columns, table rows must be read. To enable the optimizer to choose index-only access, create a unique index with include columns. For example, consider the following index definition:

```
create unique index ix1 on employee
  (name asc)
  include (dept, mgr, salary, years)
```

This index enforces the uniqueness of the NAME column and also stores and maintains data for the DEPT, MGR, SALARY, and YEARS columns. In this way, the following query can be satisfied by accessing only the index:

```
select name, dept, mgr, salary
   from employee
  where name = 'SMITH'
```

Be sure to consider whether the additional storage space and maintenance costs of include columns are justified. If queries that exploit include columns are rarely executed, the costs might not be justified.

## Multiple-index access

The optimizer can choose to scan multiple indexes on the same table to satisfy the predicates of a WHERE clause. For example, consider the following two index definitions:

```
INDEX IX2: DEPT    ASC
INDEX IX3: JOB     ASC,
           YEARS   ASC
```

The following predicates can be satisfied by using these two indexes:

```
where
  dept = :hv1 or
  (job = :hv2 and
   years >= :hv3)
```

Scanning index IX2 produces a list of record IDs (RIDs) that satisfy the dept = :hv1 predicate. Scanning index IX3 produces a list of RIDs that satisfy the job = :hv2 and years >= :hv3 predicate. These two lists of RIDs are combined, and duplicates are removed before the table is accessed. This is known as *index ORing*.

Index ORing can also be used for predicates that are specified by an IN clause, as in the following example:

```
where
  dept in (:hv1, :hv2, :hv3)
```

Although the purpose of index ORing is to eliminate duplicate RIDs, the objective of *index ANDing* is to find common RIDs. Index ANDing might occur when applications that create multiple indexes on corresponding columns in the same table run a query with multiple AND predicates against that table. Multiple index scans against each indexed column produce values that are hashed to create bitmaps. The second bitmap is used to probe the first bitmap to generate the qualifying rows for the final result set. For example, the following indexes:

```
INDEX IX4: SALARY  ASC
INDEX IX5: COMM    ASC
```

can be used to resolve the following predicates:

```
where
  salary between 20000 and 30000 and
  comm between 1000 and 3000
```

In this example, scanning index IX4 produces a bitmap that satisfies the salary between 20000 and 30000 predicate. Scanning IX5 and probing the bitmap for IX4 produces a list of qualifying RIDs that satisfy both predicates. This is known as *dynamic bitmap ANDing*. It occurs only if the table has sufficient cardinality, its columns have sufficient values within the qualifying range, or there is sufficient duplication if equality predicates are used.

To realize the performance benefits of dynamic bitmaps when scanning multiple indexes, it might be necessary to change the value of the **sortheap** database configuration parameter and the **sheapthres** database manager configuration parameter. Additional sort heap space is required when dynamic bitmaps are used in access plans. When **sheapthres** is set to be relatively close to **sortheap** (that is, less than a factor of two or three times per concurrent query), dynamic bitmaps with multiple index access must work with much less memory than the optimizer anticipated. The solution is to increase the value of **sheapthres** relative to **sortheap**.

The optimizer does not combine index ANDing and index ORing when accessing a single table.

### Index access in range-clustered tables

Unlike standard tables, a range-clustered table does not require a physical index (like a traditional B-tree index) that maps a key value to a row. Instead, it leverages the sequential nature of the column domain and uses a functional mapping to generate the location of a specific row in a table. In the simplest example of this type of mapping, the first key value in the range is the first row in the table, the second value in the range is the second row in the table, and so on.

The optimizer uses the range-clustered property of the table to generate access plans that are based on a perfectly clustered index whose only cost is computing the range clustering function. The clustering of rows within the table is guaranteed, because range-clustered tables retain their original key value order.

### Index access and cluster ratios

When it chooses an access plan, the optimizer estimates the number of I/Os that are required to fetch pages from disk to the buffer pool. This estimate includes a prediction of buffer pool usage, because additional I/Os are not required to read rows from a page that is already in the buffer pool.

For index scans, information from the system catalog helps the optimizer to estimate the I/O cost of reading data pages into a buffer pool. It uses information from the following columns in the SYSCAT.INDEXES view:

- **CLUSTERRATIO** information indicates the degree to which the table data is clustered in relation to this index. The higher the number, the better the rows are ordered in index key sequence. If table rows are in close to index-key sequence, rows can be read from a data page while the page is in the buffer. If the value of this column is -1, the optimizer uses **PAGE\_FETCH\_PAIRS** and **CLUSTERFACTOR** information, if it is available.
- The **PAGE\_FETCH\_PAIRS** column contains pairs of numbers that model the number of I/Os required to read the data pages into buffer pools of various sizes, together with **CLUSTERFACTOR** information. Data is collected for these columns only if you invoke the **RUNSTATS** command against the index, specifying the **DETAILED** clause.

If index clustering statistics are not available, the optimizer uses default values, which assume poor clustering of the data with respect to the index. The degree to which the data is clustered can have a significant impact on performance, and you should try to keep one of the indexes that are defined on the table close to 100 percent clustered. In general, only one index can be one hundred percent clustered, except when the keys for an index represent a superset of the keys for the clustering index, or when there is an actual correlation between the key columns of the two indexes.

When you reorganize a table, you can specify an index that will be used to cluster the rows and keep them clustered during insert processing. Because update and insert operations can make a table less clustered in relation to the index, you might need to periodically reorganize the table. To reduce the number of reorganizations for a table that experiences frequent insert, update, or delete operations, specify the **PCTFREE** clause on the **ALTER TABLE** statement.

## Scan sharing

*Scan sharing* refers to the ability of one scan to exploit the work done by another scan. Examples of shared work include disk page reads, disk seeks, buffer pool content reuse, decompression, and so on.

Heavy scans, such as table scans or multidimensional clustering (MDC) block index scans of large tables, are sometimes eligible for sharing page reads with other scans. Such shared scans can start at an arbitrary point in the table, to take advantage of pages that are already in the buffer pool. When a sharing scan reaches the end of the table, it continues at the beginning and finishes when it reaches the point at which it started. This is called a *wrapping scan*. Figure 25 shows the difference between regular scans and wrapping scans for both tables and indexes.

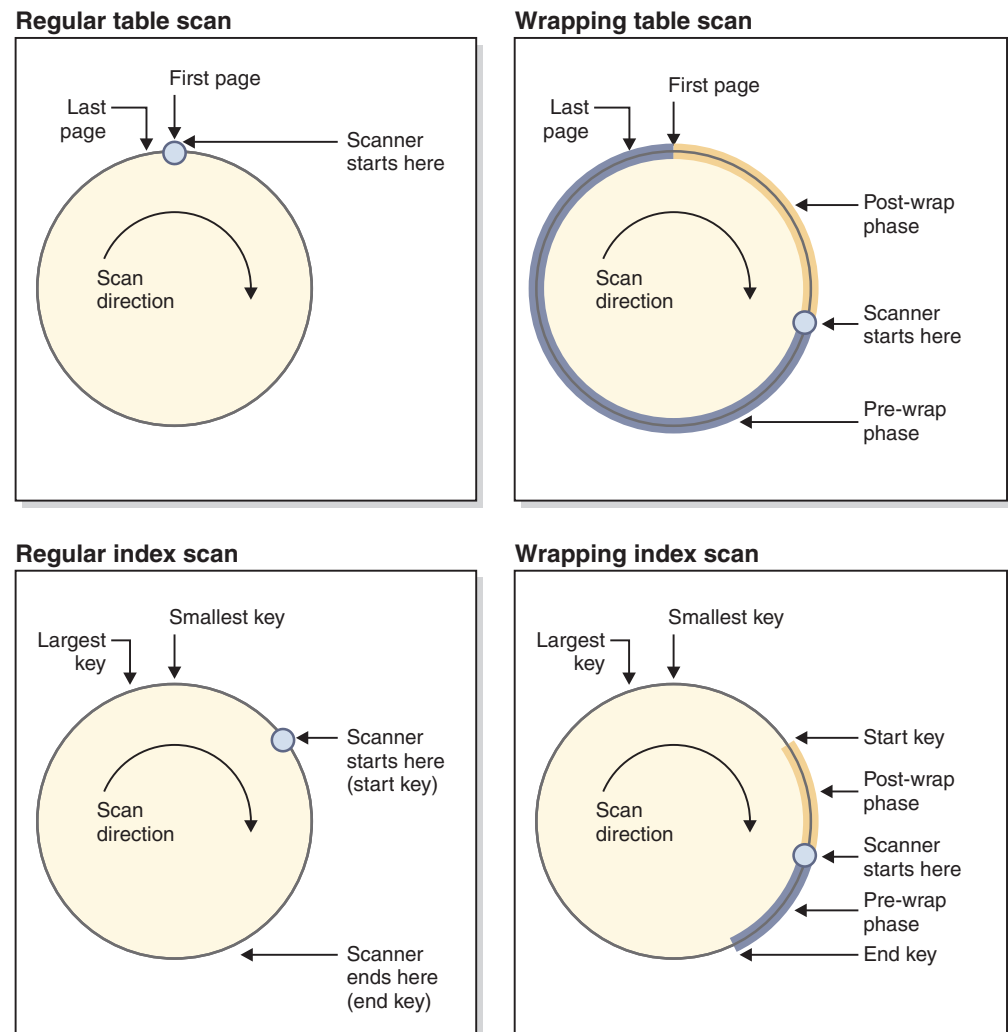

Figure 25. Conceptual view of regular and wrapping scans

The scan sharing feature is enabled by default, and eligibility for scan sharing and for wrapping are determined automatically by the SQL compiler. At run time, an eligible scan might or might not participate in sharing or wrapping, based on factors that were not known at compile time.

Shared scanners are managed in *share groups*. These groups keep their members together as long as possible, so that the benefits of sharing are maximized. If one scan is faster than another scan, the benefits of page sharing can be lost. In this situation, buffer pool pages that are accessed by the first scan might be cleared from the buffer pool before another scan in the share group can access them. The data server measures the distance between two scans in the same share group by the number of buffer pool pages that lies between them. The data server also monitors the speed of the scans. If the distance between two scans in the same share group grows too large, they might not be able to share buffer pool pages. To reduce this effect, faster scans can be throttled to allow slower scans to access the data pages before they are cleared. Figure 26 shows two sharing sets, one for a table and one for a block index. A *sharing set* is a collection of share groups that are accessing the same object (for example, a table) through the same access mechanism (for example, a table scan or a block index scan). For table scans, the page read order increases by page ID; for block index scans, the page read order increases by key value.

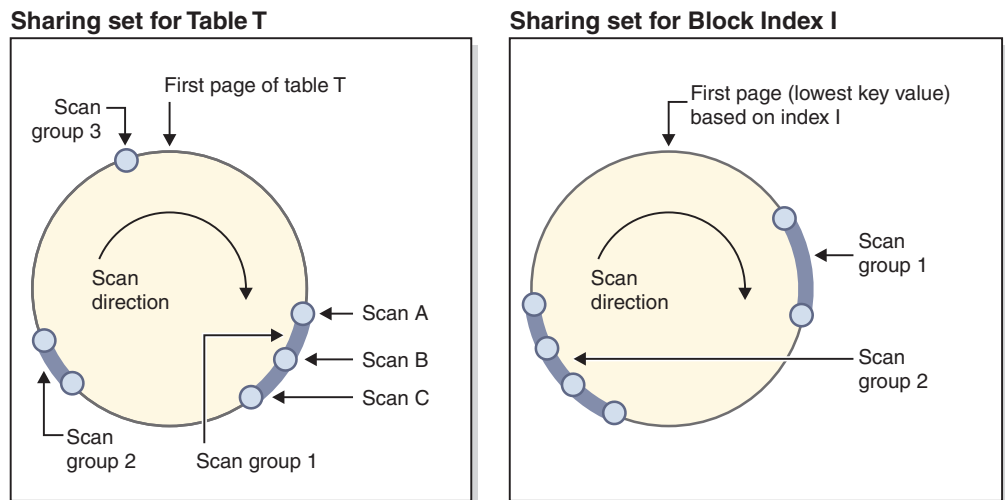

Figure 26. Sharing sets for table and block index scan sharing

The figure also shows how buffer pool content is reused within groups. Consider scan C, which is the leading scan of group 1. The following scans (A and B) are grouped with C, because they are close and can likely reuse the pages that C has brought into the buffer pool.

A high-priority scanner is never throttled by a lower priority one, and might move to another share group instead. A high priority scanner might be placed in a group where it can benefit from the work being done by the lower priority scanners in the group. It will stay in that group for as long as that benefit is available. By either throttling the fast scanner, or moving it to a faster share group (if the scanner encounters one), the data server adjusts the share groups to ensure that sharing remains optimized.

You can use the **db2pd** command to view information about scan sharing. For example, for an individual shared scan, the **db2pd** output will show data such as the scan speed and the amount of time that the scan was throttled. For a sharing group, the command output shows the number of scans in the group and the number of pages shared by the group.

The EXPLAIN\_ARGUMENT table has new rows to contain scan-sharing information about table scans and index scans (you can use the **db2exfmt** command to format and view the contents of this table).

You can use optimizer profiles to override decisions that the compiler makes about scan sharing (see “Access types”). Such overrides are for use only when a special need arises; for example, the wrapping hint can be useful when a repeatable order of records in a result set is needed, but an ORDER BY clause (which might trigger a sort) is to be avoided. Otherwise, it is recommended that you not use these optimization profiles unless requested to do so by DB2 Service.

## Predicate processing for queries

A predicate is an element of a search condition that expresses or implies a comparison operation. Predicates can be grouped into four categories that are determined by how and when the predicate is used in the evaluation process. The categories are provided in the following list, ordered in terms of performance starting with the most favorable:

- Range delimiting predicates are those used to bracket an index scan; they provide start or stop key values for the index search. These predicates are evaluated by the index manager.
- Index sargable predicates are not used to bracket a search, but are evaluated from the index if one is chosen, because the columns involved in the predicate are part of the index key. These predicates are also evaluated by the index manager.
- Data sargable predicates are predicates that cannot be evaluated by the index manager, but can be evaluated by Data Management Services (DMS). Typically, these predicates require the access of individual rows from a base table. If necessary, DMS will retrieve the columns needed to evaluate the predicate, as well as any others to satisfy the columns in the SELECT list that could not be obtained from the index.
- Residual predicates are those that require I/O beyond the simple accessing of a base table. Examples of residual predicates include those using quantified subqueries (subqueries with ANY, ALL, SOME, or IN), or reading large object (LOB) data that is stored separately from the table. These predicates are evaluated by Relational Data Services (RDS) and are the most expensive of the four categories of predicates.

The following table provides examples of various predicates and identifies their type based on the context in which they are used.

**Note:** In these examples, assume that a multi-column ascending index exists on (c1, c2, c3) and is used in evaluating the predicates where appropriate. If any column in the index is in descending order, the start and stop keys might be switched for range delimiting predicates.

Table 58. Predicate processing for different queries

Predicates	Column c1	Column c2	Column c3	Comments
c1 = 1 and c2 = 2 and c3 = 3	Range delimiting (start-stop)	Range delimiting (start-stop)	Range delimiting (start-stop)	The equality predicates on all the columns of the index can be applied as start-stop keys.

Table 58. Predicate processing for different queries (continued)

Predicates	Column c1	Column c2	Column c3	Comments
c1 = 1 and c2 = 2 and c3 ≥ 3	Range delimiting (start-stop)	Range delimiting (start-stop)	Range delimiting (start)	Columns c1 and c2 are bound by equality predicates, and the predicate on c3 is only applied as a start key.
c1 ≥ 1 and c2 = 2	Range delimiting (start)	Range delimiting (start-stop)	Not applicable	The leading column c1 has a ≥ predicate and can be used as a start key. The following column c2 has an equality predicate, and therefore can also be applied as a start-stop key.
c1 = 1 and c3 = 3	Range delimiting (start-stop)	Not applicable	Index sargable	The predicate on c3 cannot be used as a start-stop key, because there is no predicate on c2. It can, however, be applied as an index sargable predicate.
c1 = 1 and c2 > 2 and c3 = 3	Range delimiting (start-stop)	Range delimiting (start)	Index sargable	The predicate on c3 cannot be applied as a start-stop predicate because the previous column has a > predicate. Had it been a ≥ instead, we would be able to use it as a start-stop key.
c1 = 1 and c2 ≤ 2 and c4 = 4	Range delimiting (start-stop)	Range delimiting (stop)	Data sargable	Here the predicate on c2 is a ≤ predicate. It can be used as a stop key. The predicate on c4 cannot be applied on the index and is applied as a data sargable predicate during the FETCH.
c2 = 2 and UDF_with_ external_ action(c4)	Not applicable	Index sargable	Residual	The leading column c1 does not have a predicate, and therefore the predicate on c2 can be applied as an index sargable predicate where the whole index is scanned. The predicate involving the user-defined function with external action is applied as a residual predicate.



Table 58. Predicate processing for different queries (continued)

Predicates	Column c1	Column c2	Column c3	Comments
c1 = 1 or c2 = 2	Index sargable	Index sargable	Not applicable	The presence of an OR does not allow us this multi-column index to be used as start-stop keys. This might have been possible had there been two indexes, one with a leading column on c1, and the other with a leading column on c2, and the DB2 optimizer chose an "index-ORing" plan. However, in this case the two predicates are treated as index sargable predicates.
c1 < 5 and (c2 = 2 or c3 = 3)	Range delimiting (stop)	Index sargable	Index sargable	Here the leading column c1 is exploited to stop the index scan from using the predicate with a stop key. The OR predicate on c2 and c3 are applied as index sargable predicates.

The DB2 optimizer employs the query rewrite mechanism to transform many complex user-written predicates into better performing queries, as shown in the following table:

Table 59. Query rewrite predicates

Original predicate or query	Optimized predicates	Comments
c1 between 5 and 10	c1 ≥ 5 and c1 ≤ 10	The BETWEEN predicates are rewritten into the equivalent range delimiting predicates so that they can be used internally as though the user specified the range delimiting predicates.
c1 not between 5 and 10	c1 < 5 or c1 > 10	The presence of the OR predicate does not allow the use of a start-stop key unless the DB2 optimizer chooses an index-ORing plan.
SELECT * FROM t1 WHERE EXISTS (SELECT c1 FROM t2 WHERE t1.c1 = t2.c1)	SELECT t1.* FROM t1 EOJOIN t2 WHERE t1.c1= t2.c1	The subquery might be transformed into a join.
SELECT * FROM t1 WHERE t1.c1 IN (SELECT c1 FROM t2)	SELECT t1.* FROM t1 EOJOIN t2 WHERE t1.c1= t2.c1	This is similar to the transformation for the EXISTS predicate example in the previous row.

Table 59. Query rewrite predicates (continued)

Original predicate or query	Optimized predicates	Comments
c1 like 'abc%'	c1 ≥ 'abc X X X ' and c1 ≤ 'abc Y Y Y'	If we have c1 as the leading column of an index, DB2 generates these predicates so that they can be applied as range-delimiting start-stop predicates. Here the characters X and Y are symbolic of the lowest and highest collating character.
c1 like 'abc%def'	c1 ≥ 'abc X X X ' and c1 ≤ 'abc Y Y Y' and c1 like 'abc%def'	This is similar to the previous case, except that we have to also apply the original predicate as an index sargable predicate. This ensures that the characters def match correctly.

## Joins

A *join* is the process of combining data from two or more tables based on some common domain of information. Rows from one table are paired with rows from another table when information in the corresponding rows match on the basis of the joining criterion (the *join predicate*).

For example, consider the following two tables:

TABLE1		TABLE2	
PROJ	PROJ_ID	PROJ_ID	NAME
A	1	1	Sam
B	2	3	Joe
C	3	4	Mary
D	4	1	Sue
		2	Mike

To join TABLE1 and TABLE2, such that the PROJ\_ID columns have the same values, use the following SQL statement:

```
select proj, x.proj_id, name
  from table1 x, table2 y
 where x.proj_id = y.proj_id
```

In this case, the appropriate join predicate is: where x.proj\_id = y.proj\_id.

The query yields the following result set:

PROJ	PROJ_ID	NAME
A	1	Sam
A	1	Sue
B	2	Mike
C	3	Joe
D	4	Mary

Depending on the nature of any join predicates, as well as any costs determined on the basis of table and index statistics, the optimizer chooses one of the following join methods:

- Nested-loop join
- Merge join
- Hash join

When two tables are joined, one table is selected as the outer table and the other table is regarded as the inner table of the join. The outer table is accessed first and is scanned only once. Whether the inner table is scanned multiple times depends on the type of join and the indexes that are available. Even if a query joins more than two tables, the optimizer joins only two tables at a time. If necessary, temporary tables are created to hold intermediate results.

You can provide explicit join operators, such as `INNER` or `LEFT OUTER JOIN`, to determine how tables are used in the join. Before you alter a query in this way, however, you should allow the optimizer to determine how to join the tables, and then analyze query performance to decide whether to add join operators.

## Join methods

The optimizer can choose one of three basic join strategies when queries require tables to be joined: nested-loop join, merge join, or hash join.

### Nested-loop join

A nested-loop join is performed in one of the following two ways:

- Scanning the inner table for each accessed row of the outer table  
For example, column A in table T1 and column A in table T2 have the following values:

Outer table T1: Column A	Inner table T2: Column A
2	3
3	2
3	2
	3
	1

To complete a nested-loop join between tables T1 and T2, the database manager performs the following steps:

1. Read the first row in T1. The value for A is 2.
  2. Scan T2 until a match (2) is found, and then join the two rows.
  3. Repeat Step 2 until the end of the table is reached.
  4. Go back to T1 and read the next row (3).
  5. Scan T2 (starting at the first row) until a match (3) is found, and then join the two rows.
  6. Repeat Step 5 until the end of the table is reached.
  7. Go back to T1 and read the next row (3).
  8. Scan T2 as before, joining all rows that match (3).
- Performing an index lookup on the inner table for each accessed row of the outer table

This method can be used if there is a predicate of the form:

```
expr(outer_table.column) relop inner_table.column
```

where `relop` is a relative operator (for example `=`, `>`, `>=`, `<`, or `<=`) and `expr` is a valid expression on the outer table. For example:

```
outer.c1 + outer.c2 <= inner.c1
outer.c4 < inner.c3
```

This method might significantly reduce the number of rows that are accessed in the inner table for each access of the outer table; the degree of benefit depends on a number of factors, including the selectivity of the join predicate.

When it evaluates a nested-loop join, the optimizer also decides whether to sort the outer table before performing the join. If it sorts the outer table, based on the join columns, the number of read operations against the inner table to access pages on disk might be reduced, because they are more likely to be in the buffer pool already. If the join uses a highly clustered index to access the inner table, and the outer table has been sorted, the number of accessed index pages might be minimized.

If the optimizer expects that the join will make a later sort more expensive, it might also choose to perform the sort before the join. A later sort might be required to support a GROUP BY, DISTINCT, ORDER BY, or merge join operation.

### Merge join

A merge join, sometimes known as a *merge scan join* or a *sort merge join*, requires a predicate of the form `table1.column = table2.column`. This is called an *equality join predicate*. A merge join requires ordered input on the joining columns, either through index access or by sorting. A merge join cannot be used if the join column is a LONG field column or a large object (LOB) column.

In a merge join, the joined tables are scanned at the same time. The outer table of the merge join is scanned only once. The inner table is also scanned once, unless repeated values occur in the outer table. If repeated values occur, a group of rows in the inner table might be scanned again.

For example, column A in table T1 and column A in table T2 have the following values:

Outer table T1: Column A	Inner table T2: Column A
2	1
3	2
3	2
	3
	3

To complete a merge join between tables T1 and T2, the database manager performs the following steps:

1. Read the first row in T1. The value for A is 2.
2. Scan T2 until a match (2) is found, and then join the two rows.
3. Keep scanning T2 while the columns match, joining rows.
4. When the 3 in T2 is read, go back to T1 and read the next row.
5. The next value in T1 is 3, which matches T2, so join the rows.
6. Keep scanning T2 while the columns match, joining rows.
7. When the end of T2 is reached, go back to T1 to get the next row. Note that the next value in T1 is the same as the previous value from T1, so T2 is scanned again, starting at the first 3 in T2. The database manager remembers this position.

## Hash join

A hash join requires one or more predicates of the form `table1.columnX = table2.columnY`. None of the columns can be either a LONG field column or a LOB column.

A hash join is performed as follows: First, the designated inner table is scanned and rows are copied into memory buffers that are drawn from the sort heap specified by the **sortheap** database configuration parameter. The memory buffers are divided into sections, based on a hash value that is computed on the columns of the join predicates. If the size of the inner table exceeds the available sort heap space, buffers from selected sections are written to temporary tables.

When the inner table has been processed, the second (or outer) table is scanned and its rows are matched with rows from the inner table by first comparing the hash value that was computed for the columns of the join predicates. If the hash value for the outer row column matches the hash value for the inner row column, the actual join predicate column values are compared.

Outer table rows that correspond to portions of the table that are not written to a temporary table are matched immediately with inner table rows in memory. If the corresponding portion of the inner table was written to a temporary table, the outer row is also written to a temporary table. Finally, matching pairs of table portions from temporary tables are read, the hash values of their rows are matched, and the join predicates are checked.

Hash join processing can also use filters to improve performance. If the optimizer chooses to use filters, and sufficient memory is available, filters can often reduce the number of outer table rows which need to be processed by the join.

For the full performance benefit of hash joins, you might need to change the value of the **sortheap** database configuration parameter and the **sheapthres** database manager configuration parameter.

Hash join performance is best if you can avoid hash loops and overflow to disk. To tune hash join performance, estimate the maximum amount of memory that is available for **sheapthres**, and then tune the **sortheap** parameter. Increase its setting until you avoid as many hash loops and disk overflows as possible, but do not reach the limit that is specified by the **sheapthres** parameter.

Increasing the **sortheap** value should also improve the performance of queries that have multiple sorts.

## Strategies for selecting optimal joins

The optimizer uses various methods to select an optimal join strategy for a query. Among these methods, which are determined by the optimization class of the query, are several search strategies, star-schema joins, early out joins, and composite tables.

The join-enumeration algorithm is an important determinant of the number of plan combinations that the optimizer explores.

- Greedy join enumeration
  - Is efficient with respect to space and time requirements
  - Uses single direction enumeration; that is, once a join method is selected for two tables, it is not changed during further optimization

- Might miss the best access plan when joining many tables. If your query joins only two or three tables, the access plan that is chosen by greedy join enumeration is the same as the access plan that is chosen by dynamic programming join enumeration. This is particularly true if the query has many join predicates on the same column that are either explicitly specified, or implicitly generated through predicate transitive closure.
- Dynamic programming join enumeration
  - Is not efficient with respect to space and time requirements, which increase exponentially as the number of joined tables increases
  - Is efficient and exhaustive when searching for the best access plan
  - Is similar to the strategy that is used by DB2 for z/OS

## Star-schema joins

The tables that are referenced in a query are almost always related by join predicates. If two tables are joined without a join predicate, the Cartesian product of the two tables is formed. In a Cartesian product, every qualifying row of the first table is joined with every qualifying row of the second table. This creates a result table that is usually very large, because its size is the cross product of the size of the two source tables. Because such a plan is unlikely to perform well, the optimizer avoids even determining the cost of this type of access plan.

The only exceptions occur when the optimization class is set to 9, or in the special case of star schemas. A *star schema* contains a central table called the *fact table*, and other tables called *dimension tables*. The dimension tables have only a single join that attaches them to the fact table, regardless of the query. Each dimension table contains additional values that expand information about a particular column in the fact table. A typical query consists of multiple local predicates that reference values in the dimension tables and contains join predicates connecting the dimension tables to the fact table. For these queries, it might be beneficial to compute the Cartesian product of multiple small dimension tables before accessing the large fact table. This technique is useful when multiple join predicates match a multicolumn index.

The DB2 data server can recognize queries against databases that were designed with star schemas having at least two dimension tables, and can increase the search space to include possible plans that compute the Cartesian product of dimension tables. A zigzag join is considered before the Cartesian product is even materialized. It probes the fact table using a multicolumn index, so that the fact table is filtered along two or more dimension tables simultaneously. When a zigzag join is used, it returns the next combination of values that is available from the fact table index. This next combination of values, known as feedback, is used to skip over probe values provided by the Cartesian product of dimension tables that will not find a match in the fact table. Filtering the fact table on two or more dimension tables simultaneously, and skipping probes that are known to be unproductive, together makes the zigzag join an efficient method for querying large fact tables.

This star schema join strategy assumes that primary key indexes are used in the join. Another scenario involves foreign key indexes. If the foreign key columns in the fact table are single-column indexes, and there is relatively high selectivity across all dimension tables, the following star-schema join technique can be used:

1. Process each dimension table by:
  - Performing a semi-join between the dimension table and the foreign key index on the fact table

- Hashing the record ID (RID) values to dynamically create a bitmap
2. For each bitmap, use AND predicates against the previous bitmap.
  3. Determine the surviving RIDs after processing the last bitmap.
  4. Optionally sort these RIDs.
  5. Fetch a base table row.
  6. Rejoin the fact table with each of its dimension tables, accessing the columns in dimension tables that are needed for the SELECT clause.
  7. Reapply the residual predicates.

This technique does not require multicolumn indexes. Explicit referential integrity constraints between the fact table and the dimension tables are not required, but are recommended.

The dynamic bitmaps that are created and used by star-schema join techniques require sort heap memory, the size of which is specified by the **sortheap** database configuration parameter.

### Early out joins

The optimizer might select an early out join when it detects that each row from one of the tables only needs to be joined with at most one row from the other table.

An early out join is possible when there is a join predicate on the key column or columns of one of the tables. For example, consider the following query that returns the names of employees and their immediate managers.

```
select employee.name as employee_name,
       manager.name as manager_name
   from employee as employee, employee as manager
  where employee.manager_id = manager.id
```

Assuming that the ID column is a key in the EMPLOYEE table and that every employee has at most one manager, this join avoids having to search for a subsequent matching row in the MANAGER table.

An early out join is also possible when there is a DISTINCT clause in the query. For example, consider the following query that returns the names of car makers with models that sell for more than \$30000.

```
select distinct make.name
   from make, model
  where
    make.make_id = model.make_id and
    model.price > 30000
```

For each car maker, we only need to determine whether any one of its manufactured models sells for more than \$30000. Joining a car maker with all of its manufactured models selling for more than \$30000 is unnecessary, because it does not contribute towards the accuracy of the query result.

An early out join is also possible when the join feeds a GROUP BY clause with a MIN or MAX aggregate function. For example, consider the following query that returns stock symbols with the most recent date before the year 2000, for which a particular stock's closing price is at least 10% higher than its opening price:

```

select dailystockdata.symbol, max(dailystockdata.date) as date
  from sp500, dailystockdata
  where
    sp500.symbol = dailystockdata.symbol and
    dailystockdata.date < '01/01/2000' and
    dailystockdata.close / dailystockdata.open >= 1.1
  group by dailystockdata.symbol

```

The *qualifying set* is the set of rows from the DAILYSTOCKDATA table that satisfies the date and price requirements and joins with a particular stock symbol from the SP500 table. If the qualifying set from the DAILYSTOCKDATA table (for each stock symbol row from the SP500 table) is ordered as descending on DATE, it is only necessary to return the first row from the qualifying set for each symbol, because that first row represents the most recent date for a particular symbol. The other rows in the qualifying set are not required.

## Composite tables

When the result of joining a pair of tables is a new table (known as a *composite table*), this table usually becomes the outer table of a join with another inner table. This is known as a *composite outer join*. In some cases, particularly when using the greedy join enumeration technique, it is useful to make the result of joining two tables the inner table of a later join. When the inner table of a join consists of the result of joining two or more tables, this plan is known as a *composite inner join*. For example, consider the following query:

```

select count(*)
  from t1, t2, t3, t4
  where
    t1.a = t2.a and
    t3.a = t4.a and
    t2.z = t3.z

```

It might be beneficial to join table T1 and T2 (T1xT2), then join T3 and T4 (T3xT4), and finally, to select the first join result as the outer table and the second join result as the inner table. In the final plan ( (T1xT2) x (T3xT4) ), the join result (T3xT4) is known as a *composite inner join*. Depending on the query optimization class, the optimizer places different constraints on the maximum number of tables that can be the inner table of a join. Composite inner joins are allowed with optimization classes 5, 7, and 9.

## Replicated materialized query tables in partitioned database environments

Replicated materialized query tables (MQTs) improve the performance of frequently executed joins in a partitioned database environment by allowing the database to manage precomputed values of the table data.

Note that a replicated MQT in this context pertains to intra-database replication. Inter-database replication is concerned with subscriptions, control tables, and data that is located in different databases and on different operating systems.

In the following example:

- The SALES table is in a multi-partition table space named REGIONTABLESPACE, and is split on the REGION column.
- The EMPLOYEE and DEPARTMENT tables are in a single-partition database partition group.

Create a replicated MQT based on information in the EMPLOYEE table.



```

create table r_employee as (
  select empno, firstname, midinit, lastname, workdept
  from employee
)
data initially deferred refresh immediate
in regiontablespace
replicated

```

Update the content of the replicated MQT:

```
refresh table r_employee
```

After using the REFRESH statement, you should invoke the runstats utility against the replicated table, as you would against any other table.

The following query calculates sales by employee, the total for the department, and the grand total:

```

select d.mgrno, e.empno, sum(s.sales)
  from department as d, employee as e, sales as s
  where
    s.sales_person = e.lastname and
    e.workdept = d.deptno
  group by rollup(d.mgrno, e.empno)
  order by d.mgrno, e.empno

```

Instead of using the EMPLOYEE table, which resides on only one database partition, the database manager uses R\_EMPLOYEE, the MQT that is replicated on each of the database partitions on which the SALES table is stored. The performance enhancement occurs because the employee information does not have to be moved across the network to each database partition when performing the join.

### Replicated materialized query tables in collocated joins

Replicated MQTs can also assist in the collocation of joins. For example, if a star schema contains a large fact table that is spread across twenty database partitions, the joins between the fact table and the dimension tables are most efficient if these tables are collocated. If all of the tables are in the same database partition group, at most one dimension table is partitioned correctly for a collocated join. The other dimension tables cannot be used in a collocated join, because the join columns in the fact table do not correspond to the distribution key for the fact table.

Consider a table named FACT (C1, C2, C3, ...), split on C1; a table named DIM1 (C1, dim1a, dim1b, ...), split on C1; a table named DIM2 (C2, dim2a, dim2b, ...), split on C2; and so on. In this case, the join between FACT and DIM1 is perfect, because the predicate `dim1.c1 = fact.c1` is collocated. Both of these tables are split on column C1.

However, the join involving DIM2 and the predicate `dim2.c2 = fact.c2` cannot be collocated, because FACT is split on column C1, not on column C2. In this case, you could replicate DIM2 in the database partition group of the fact table so that the join occurs locally on each database partition.

When you create a replicated MQT, the source table can be a single-partition table or a multi-partition table in a database partition group. In most cases, the replicated table is small and can be placed in a single-partition database partition group. You can limit the data that is to be replicated by specifying only a subset of the columns from the table, or by restricting the number of qualifying rows through predicates.

A replicated MQT can also be created in a multi-partition database partition group, so that copies of the source table are created on all of the database partitions. Joins between a large fact table and the dimension tables are more likely to occur locally in this environment, than if you broadcast the source table to all database partitions.

Indexes on replicated tables are not created automatically. You can create indexes that are different from those on the source table. However, to prevent constraints violations that are not present in the source table, you cannot create unique indexes or define constraints on replicated tables, even if the same constraints occur on the source table.

Replicated tables can be referenced directly in a query, but you cannot use the DBPARTITIONNUM scalar function with a replicated table to see the table data on a particular database partition.

Use the DB2 explain facility to determine whether a replicated MQT was used by the access plan for a query. Whether or not the access plan that is chosen by the optimizer uses a replicated MQT depends on the data that is to be joined. A replicated MQT might not be used if the optimizer determines that it would be cheaper to broadcast the original source table to the other database partitions in the database partition group.

### **Join strategies for partitioned databases**

Join strategies for a partitioned database environment can be different than strategies for a nonpartitioned database environment. Additional techniques can be applied to standard join methods to improve performance.

Table collocation should be considered for tables that are frequently joined. In a partitioned database environment, *table collocation* refers to a state that occurs when two tables that have the same number of compatible partitioning keys are stored in the same database partition group. When this happens, join processing can be performed at the database partition where the data is stored, and only the result set needs to be moved to the coordinator database partition.

### **Table queues**

Descriptions of join techniques in a partitioned database environment use the following terminology:

- *Table queue* (sometimes referred to as TQ) is a mechanism for transferring rows between database partitions, or between processors in a single-partition database.
- *Directed table queue* (sometimes referred to as DTQ) is a table queue in which rows are hashed to one of the receiving database partitions.
- *Broadcast table queue* (sometimes referred to as BTQ) is a table queue in which rows are sent to all of the receiving database partitions, but are not hashed.

A table queue is used to pass table data:

- From one database partition to another when using inter-partition parallelism
- Within a database partition when using intra-partition parallelism
- Within a database partition when using a single-partition database

Each table queue passes the data in a single direction. The compiler decides where table queues are required, and includes them in the plan. When the plan is executed, connections between the database partitions initiate the table queues. The table queues close as processes end.

There are several types of table queues:

- Asynchronous table queues

These table queues are known as asynchronous, because they read rows in advance of any fetch requests from an application. When a FETCH statement is issued, the row is retrieved from the table queue.

Asynchronous table queues are used when you specify the FOR FETCH ONLY clause on the SELECT statement. If you are only fetching rows, the asynchronous table queue is faster.

- Synchronous table queues

These table queues are known as synchronous, because they read one row for each FETCH statement that is issued by an application. At each database partition, the cursor is positioned on the next row to be read from that database partition.

Synchronous table queues are used when you do not specify the FOR FETCH ONLY clause on the SELECT statement. In a partitioned database environment, if you are updating rows, the database manager will use synchronous table queues.

- Merging table queues

These table queues preserve order.

- Non-merging table queues

These table queues, also known as *regular table queues*, do not preserve order.

- Listener table queues (sometimes referred to as LTQ)

These table queues are used with correlated subqueries. Correlation values are passed down to the subquery, and the results are passed back up to the parent query block using this type of table queue.

## Join methods for partitioned databases

Several join methods are available for partitioned database environments, including: collocated joins, broadcast outer-table joins, directed outer-table joins, directed inner-table and outer-table joins, broadcast inner-table joins, and directed inner-table joins.

In the following diagrams, q1, q2, and q3 refer to table queues. The referenced tables are divided across two database partitions, and the arrows indicate the direction in which the table queues are sent. The coordinator database partition is database partition 0.

If the join method chosen by the compiler is hash join, the filters created at each remote database partition may be used to eliminate tuples before they are sent to the database partition where the hash join is processed, thus improving performance.

## Collocated joins

A collocated join occurs locally on the database partition on which the data resides. The database partition sends the data to the other database partitions after the join is complete. For the optimizer to consider a collocated join, the joined tables must be collocated, and all pairs of the corresponding distribution keys must participate

in the equality join predicates. Figure 27 provides an example.

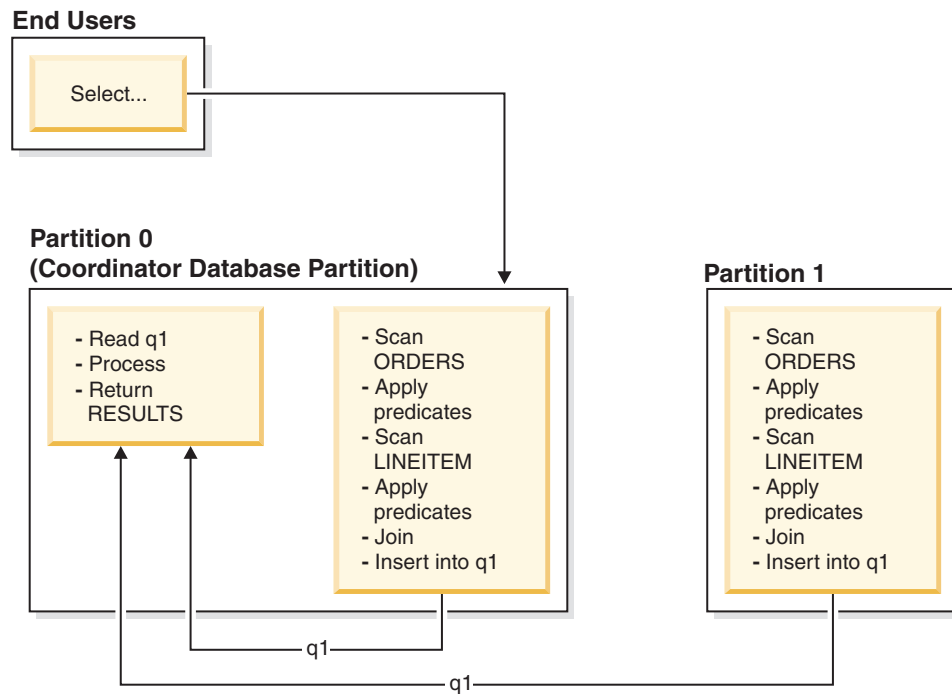

Figure 27. Collocated Join Example

The LINEITEM and ORDERS tables are both partitioned on the ORDERKEY column. The join is performed locally at each database partition. In this example, the join predicate is assumed to be: `orders.orderkey = lineitem.orderkey`.

Replicated materialized query tables (MQTs) enhance the likelihood of collocated joins.

### Broadcast outer-table joins

Broadcast outer-table joins represent a parallel join strategy that can be used if there are no equality join predicates between the joined tables. It can also be used in other situations in which it proves to be the most cost-effective join method. For example, a broadcast outer-table join might occur when there is one very large table and one very small table, neither of which is split on the join predicate columns. Instead of splitting both tables, it might be cheaper to broadcast the smaller table to the larger table. Figure 28 on page 259 provides an example.

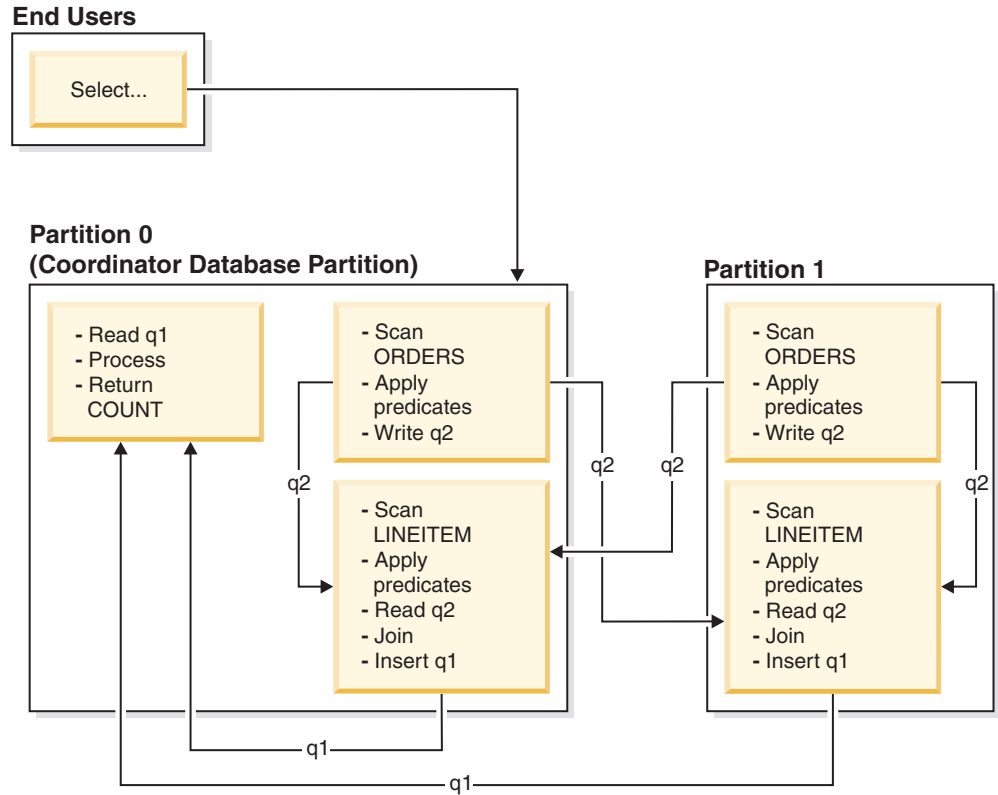
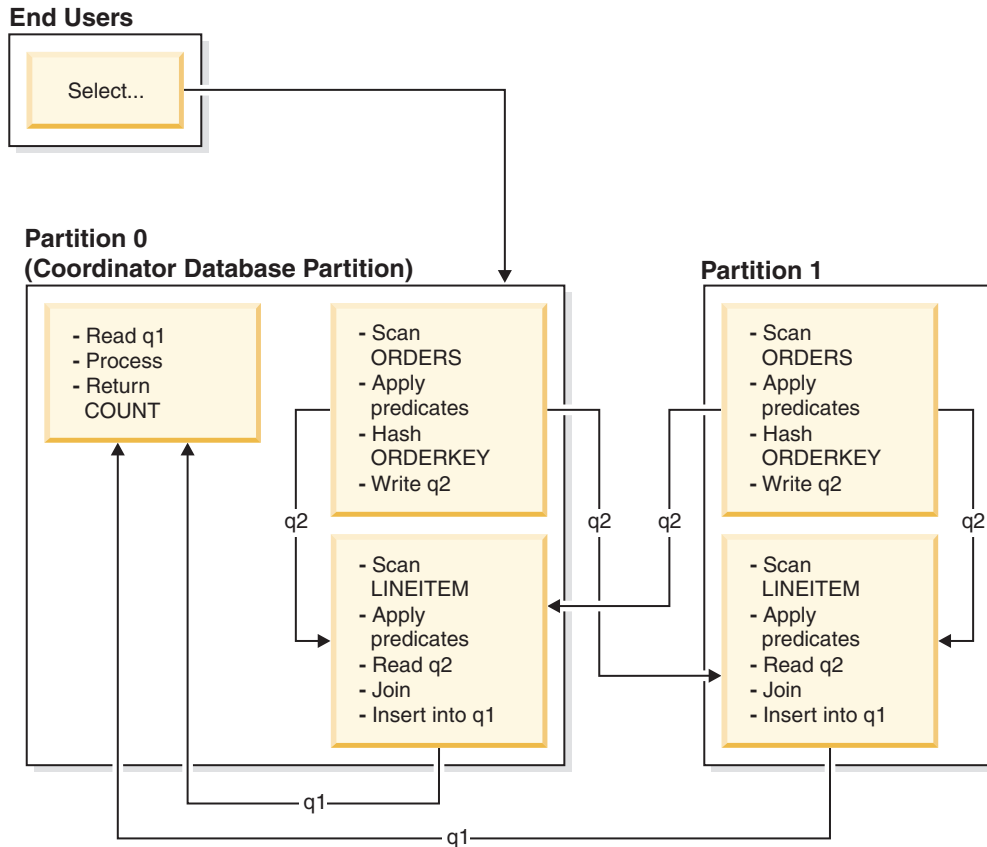

Figure 28. Broadcast Outer-Table Join Example

The ORDERS table is sent to all database partitions that have the LINEITEM table. Table queue q2 is broadcast to all database partitions of the inner table.

### Directed outer-table joins

In the directed outer-table join strategy, each row of the outer table is sent to one portion of the inner table, based on the splitting attributes of the inner table. The join occurs on this database partition. Figure 29 on page 260 provides an example.



The LINEITEM table is partitioned on the ORDERKEY column. The ORDERS table is partitioned on a different column. The ORDERS table is hashed and sent to the correct database partition of the LINEITEM table. In this example, the join predicate is assumed to be: `orders.orderkey = lineitem.orderkey`.  
 Figure 29. Directed Outer-Table Join Example

### Directed inner-table and outer-table joins

In the directed inner-table and outer-table join strategy, rows of both the outer and inner tables are directed to a set of database partitions, based on the values of the joining columns. The join occurs on these database partitions. Figure 30 on page 261 provides an example.

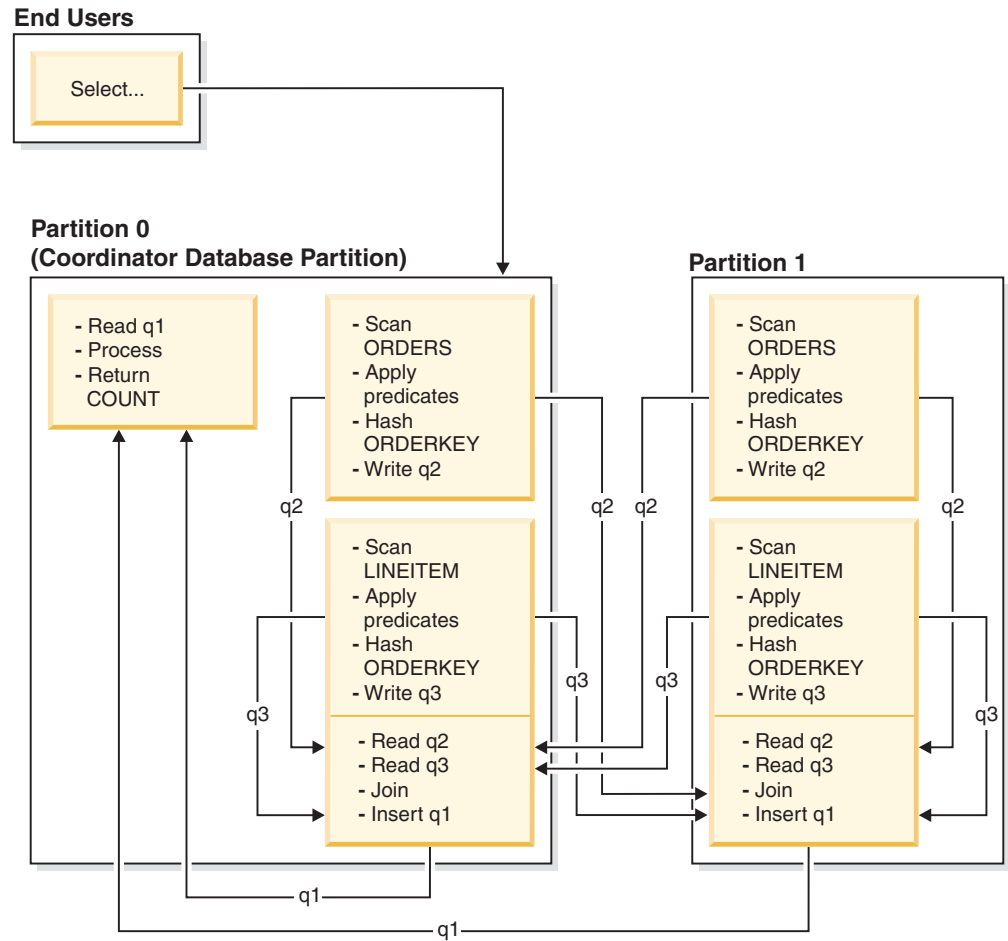
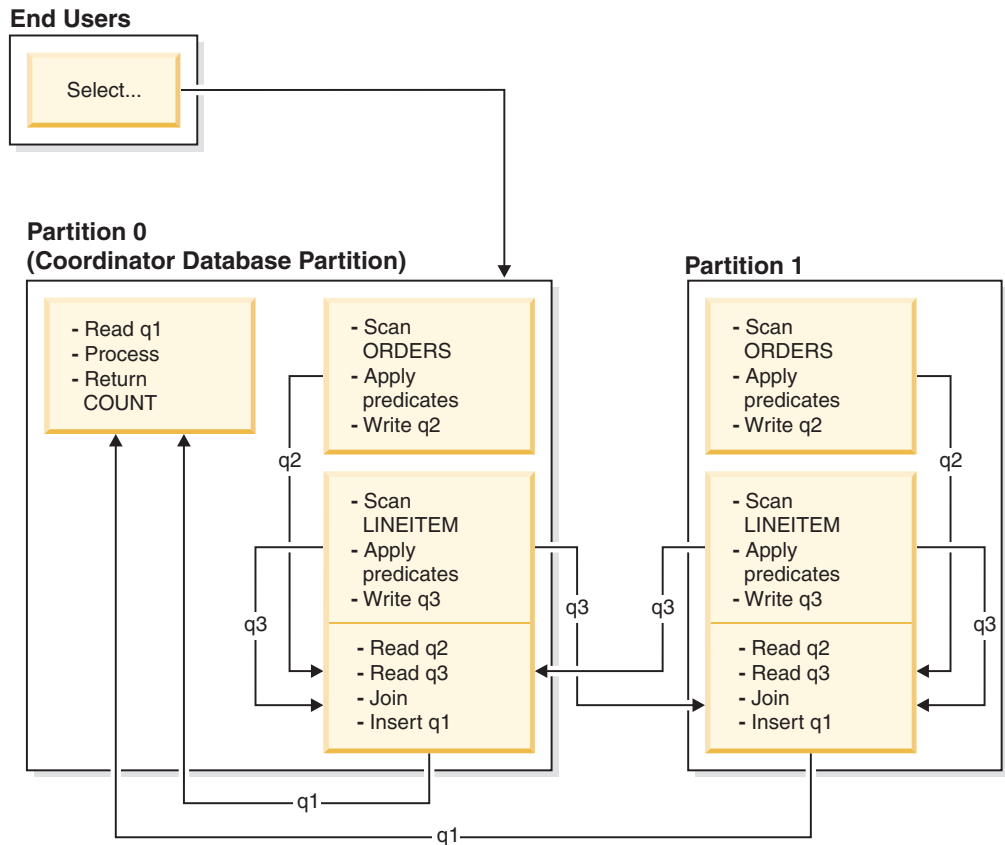

Figure 30. Directed Inner-Table and Outer-Table Join Example

Neither table is partitioned on the ORDERKEY column. Both tables are hashed and sent to new database partitions, where they are joined. Both table queue q2 and q3 are directed. In this example, the join predicate is assumed to be: `orders.orderkey = lineitem.orderkey`.

### Broadcast inner-table joins

In the broadcast inner-table join strategy, the inner table is broadcast to all the database partitions of the outer table. Figure 31 on page 262 provides an example.



The LINEITEM table is sent to all database partitions that have the ORDERS table. Table queue q3 is broadcast to all database partitions of the outer table.  
*Figure 31. Broadcast Inner-Table Join Example*

### Directed inner-table joins

In the directed inner-table join strategy, each row of the inner table is sent to one database partition of the outer table, based on the splitting attributes of the outer table. The join occurs on this database partition. Figure 32 on page 263 provides an example.



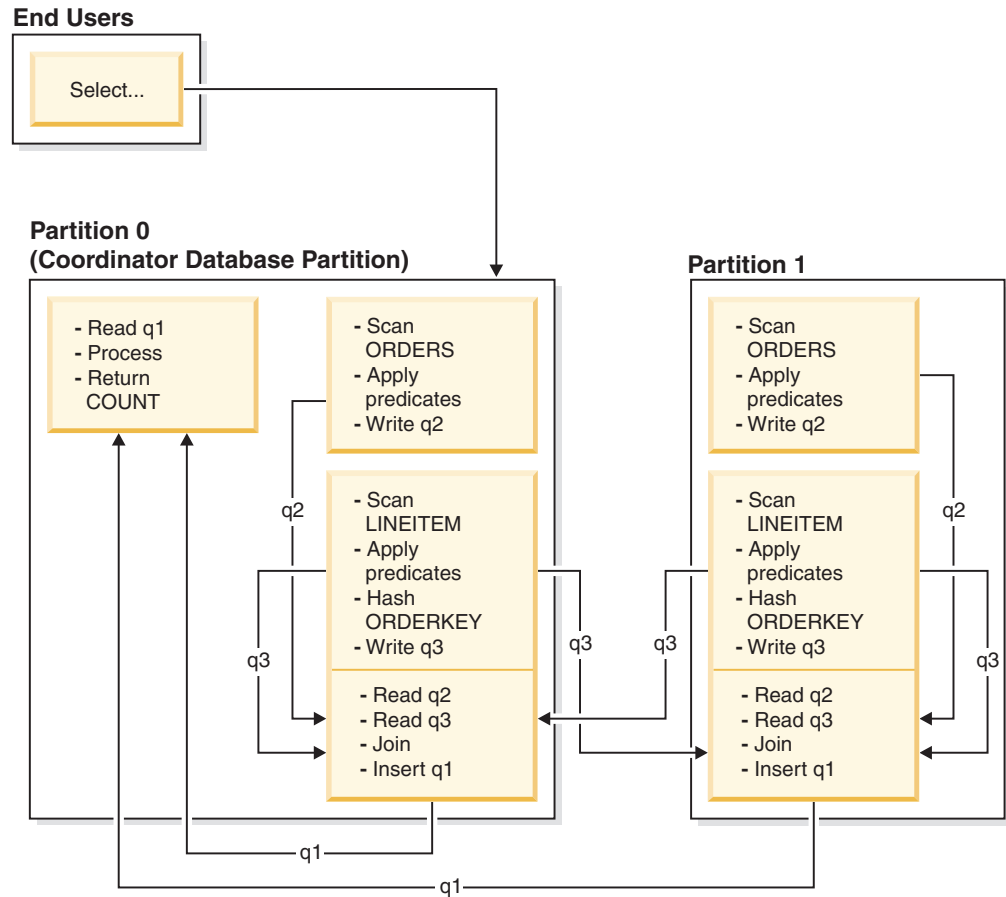

The ORDERS table is partitioned on the ORDERKEY column. The LINEITEM table is partitioned on a different column. The LINEITEM table is hashed and sent to the correct database partition of the ORDERS table. In this example, the join predicate is assumed to be: `orders.orderkey = lineitem.orderkey`.  
 Figure 32. Directed Inner-Table Join Example

## Effects of sorting and grouping on query optimization

When the optimizer chooses an access plan, it considers the performance impact of sorting data. Sorting occurs when no index satisfies the requested ordering of fetched rows. Sorting might also occur when the optimizer determines that a sort is less expensive than an index scan.

The optimizer handles sorted data in one of the following ways:

- It pipes the results of the sort when the query executes
- It lets the database manager handle the sort internally

### Piped and non-piped sorts

If the final sorted list of data can be read in a single sequential pass, the results can be *pipable*. Piping is quicker than non-piped ways of communicating the results of a sort. The optimizer chooses to pipe the results of a sort whenever possible.

Whether or not a sort is piped, the sort time depends on a number of factors, including the number of rows to be sorted, the key size and the row width. If the

rows to be sorted occupy more than the space that is available in the sort heap, several sort passes are performed. A subset of the entire set of rows is sorted during each pass. Each pass is stored in a temporary table in the buffer pool. If there is not enough space in the buffer pool, pages from this temporary table might be written to disk. When all of the sort passes are complete, these sorted subsets are merged into a single sorted set of rows. If the sort is piped, the rows are passed directly to Relational Data Services (RDS) as they are merged. (RDS is the DB2 component that processes requests to access or manipulate the contents of a database.)

## Group and sort pushdown operators

In some cases, the optimizer can choose to push down a sort or aggregation operation to Data Management Services (DMS) from RDS. (DMS is the DB2 component that controls creating, removing, maintaining, and accessing the tables and table data in a database.) Pushing down these operations improves performance by allowing DMS to pass data directly to a sort or aggregation routine. Without this pushdown, DMS first passes this data to RDS, which then interfaces with the sort or aggregation routines. For example, the following query benefits from this type of optimization:

```
select workdept, avg(salary) as avg_dept_salary
  from employee
  group by workdept
```

## Group operations in sorts

When sorting produces the order that is required for a GROUP BY operation, the optimizer can perform some or all of the GROUP BY aggregations while doing the sort. This is advantageous if the number of rows in each group is large. It is even more advantageous if doing some of the grouping during the sort reduces or eliminates the need for the sort to spill to disk.

Aggregation during sorting requires one or more of the following three stages of aggregation to ensure that proper results are returned.

- The first stage of aggregation, *partial aggregation*, calculates the aggregate values until the sort heap is filled. During partial aggregation, non-aggregated data is taken in and partial aggregates are produced. If the sort heap is filled, the rest of the data spills to disk, including all of the partial aggregations that have been calculated in the current sort heap. After the sort heap is reset, new aggregations are started.
- The second stage of aggregation, *intermediate aggregation*, takes all of the spilled sort runs and aggregates further on the grouping keys. The aggregation cannot be completed, because the grouping key columns are a subset of the distribution key columns. Intermediate aggregation uses existing partial aggregates to produce new partial aggregates. This stage does not always occur. It is used for both intra-partition and inter-partition parallelism. In intra-partition parallelism, the grouping is finished when a global grouping key is available. In inter-partition parallelism, this occurs when the grouping key is a subset of the distribution key dividing groups across database partitions, and thus requires redistribution to complete the aggregation. A similar case exists in intra-partition parallelism, when each agent finishes merging its spilled sort runs before reducing to a single agent to complete the aggregation.
- The last stage of aggregation, *final aggregation*, uses all of the partial aggregates and produces final aggregates. This step always takes place in a GROUP BY operator. Sorting cannot perform complete aggregation, because it cannot be

guaranteed that the sort will not split. Complete aggregation takes in non-aggregated data and produces final aggregates. This method of aggregation is usually used to group data that is already in the correct order.

## Optimization strategies

### Optimization strategies for intra-partition parallelism

The optimizer can choose an access plan to execute a query in parallel within a single database partition if a degree of parallelism is specified when the SQL statement is compiled.

At run time, multiple database agents called subagents are created to execute the query. The number of subagents is less than or equal to the degree of parallelism that was specified when the SQL statement was compiled.

To parallelize an access plan, the optimizer divides it into a portion that is run by each subagent and a portion that is run by the coordinating agent. The subagents pass data through table queues to the coordinating agent or to other subagents. In a partitioned database environment, subagents can send or receive data through table queues from subagents in other database partitions.

### Intra-partition parallel scan strategies

Relational scans and index scans can be performed in parallel on the same table or index. For parallel relational scans, the table is divided into ranges of pages or rows, which are assigned to subagents. A subagent scans its assigned range and is assigned another range when it has completed work on the current range.

For parallel index scans, the index is divided into ranges of records based on index key values and the number of index entries for a key value. The parallel index scan proceeds like a parallel table scan, with subagents being assigned a range of records. A subagent is assigned a new range when it has completed work on the current range.

Parallel table scans can be run against range partitioned tables, and similarly, parallel index scans can be run against partitioned indexes. For a parallel scan, partitioned indexes are divided into ranges of records, based on index key values and the number of key entries for a key value. When a parallel scan begins, subagents are assigned a range of records, and once the subagent completes a range, it is assigned a new range. The index partitions are scanned sequentially with subagents potentially scanning unreserved index partitions at any point in time without waiting for each other. Only the subset of index partitions that is relevant to the query based on data partition elimination analysis is scanned.

The optimizer determines the scan unit (either a page or a row) and the scan granularity.

Parallel scans provide an even distribution of work among the subagents. The goal of a parallel scan is to balance the load among the subagents and to keep them equally busy. If the number of busy subagents equals the number of available processors, and the disks are not overworked with I/O requests, the machine resources are being used effectively.

Other access plan strategies might cause data imbalance as the query executes. The optimizer chooses parallel strategies that maintain data balance among subagents.

## Intra-partition parallel sort strategies

The optimizer can choose one of the following parallel sort strategies:

- Round-robin sort  
This is also known as a *redistribution sort*. This method uses shared memory to efficiently redistribute the data as evenly as possible to all subagents. It uses a round-robin algorithm to provide the even distribution. It first creates an individual sort for each subagent. During the insert phase, subagents insert into each of the individual sorts in a round-robin fashion to achieve a more even distribution of data.
- Partitioned sort  
This is similar to the round-robin sort in that a sort is created for each subagent. The subagents apply a hash function to the sort columns to determine into which sort a row should be inserted. For example, if the inner and outer tables of a merge join are a partitioned sort, a subagent can use merge join to join the corresponding table portions and execute in parallel.
- Replicated sort  
This sort is used if each subagent requires all of the sort output. One sort is created and subagents are synchronized as rows are inserted into the sort. When the sort is complete, each subagent reads the entire sort. If the number of rows is small, this sort can be used to rebalance the data stream.
- Shared sort  
This sort is the same as a replicated sort, except that subagents open a parallel scan on the sorted result to distribute the data among the subagents in a way that is similar to a round-robin sort.

## Intra-partition parallel temporary tables

Subagents can cooperate to produce a temporary table by inserting rows into the same table. This is called a *shared temporary table*. The subagents can open private scans or parallel scans on the shared temporary table, depending on whether the data stream is to be replicated or split.

## Intra-partition parallel aggregation strategies

Aggregation operations can be performed by subagents in parallel. An aggregation operation requires the data to be ordered on the grouping columns. If a subagent can be guaranteed to receive all the rows for a set of grouping column values, it can perform a complete aggregation. This can happen if the stream is already split on the grouping columns because of a previous partitioned sort.

Otherwise, the subagent can perform a partial aggregation and use another strategy to complete the aggregation. Some of these strategies are:

- Send the partially aggregated data to the coordinator agent through a merging table queue. The coordinator agent completes the aggregation.
- Insert the partially aggregated data into a partitioned sort. The sort is split on the grouping columns and guarantees that all rows for a set of grouping columns are contained in one sort partition.
- If the stream needs to be replicated to balance processing, the partially aggregated data can be inserted into a replicated sort. Each subagent completes the aggregation using the replicated sort, and receives an identical copy of the aggregation result.

## Intra-partition parallel join strategies

Join operations can be performed by subagents in parallel. Parallel join strategies are determined by the characteristics of the data stream.

A join can be parallelized by partitioning or by replicating the data stream on the inner and outer tables of the join, or both. For example, a nested-loop join can be parallelized if its outer stream is partitioned for a parallel scan and the inner stream is again evaluated independently by each subagent. A merged join can be parallelized if its inner and outer streams are value-partitioned for partitioned sorts.

Data filtering and data skew can cause workloads between subagents to become imbalanced while a query executes. The inefficiency of imbalanced workloads is magnified by joins and other computationally expensive operations. The optimizer looks for sources of imbalance in the query's access plan and applies a balancing strategy, ensuring that work is evenly divided between the subagents. For an unordered outer data stream, the optimizer balances the join using the REBAL operator on the outer data stream. For an ordered data stream (where ordered data is produced by an index access or a sort), the optimizer balances the data using a shared sort. A shared sort will not be used if the sort overflows into the temporary tables, due to the high cost of a sort overflow.

## Optimization strategies for MDC tables

If you create multidimensional clustering (MDC) tables, the performance of many queries might improve, because the optimizer can apply additional optimization strategies. These strategies are primarily based on the improved efficiency of block indexes, but the advantage of clustering on more than one dimension also permits faster data retrieval.

MDC table optimization strategies can also exploit the performance advantages of intra-partition parallelism and inter-partition parallelism. Consider the following specific advantages of MDC tables:

- Dimension block index lookups can identify the required portions of the table and quickly scan only the required blocks.
- Because block indexes are smaller than record identifier (RID) indexes, lookups are faster.
- Index ANDing and ORing can be performed at the block level and combined with RIDs.
- Data is guaranteed to be clustered on extents, which makes retrieval faster.
- Rows can be deleted faster when rollout can be used.

Consider the following simple example for an MDC table named SALES with dimensions defined on the REGION and MONTH columns:

```
select * from sales
  where month = 'March' and region = 'SE'
```

For this query, the optimizer can perform a dimension block index lookup to find blocks in which the month of March and the SE region occur. Then it can scan only those blocks to quickly fetch the result set.

## Rollout deletion

When conditions permit delete using rollout, this more efficient way to delete rows from MDC tables is used. The required conditions are:

- The DELETE statement is a searched DELETE, not a positioned DELETE (the statement does not use the WHERE CURRENT OF clause).
- There is no WHERE clause (all rows are to be deleted), or the only conditions in the WHERE clause apply to dimensions.
- The table is not defined with the DATA CAPTURE CHANGES clause.
- The table is not the parent in a referential integrity relationship.
- The table does not have ON DELETE triggers defined.
- The table is not used in any MQTs that are refreshed immediately.
- A cascaded delete operation might qualify for rollout if its foreign key is a subset of the table's dimension columns.
- The DELETE statement cannot appear in a SELECT statement executing against the temporary table that identifies the set of affected rows prior to a triggering SQL operation (specified by the OLD TABLE AS clause on the CREATE TRIGGER statement).

During a rollout deletion, the deleted records are not logged. Instead, the pages that contain the records are made to look empty by reformatting parts of the pages. The changes to the reformatted parts are logged, but the records themselves are not logged.

The default behavior, *immediate cleanup rollout*, is to clean up RID indexes at delete time. This mode can also be specified by setting the **DB2\_MDC\_ROLLOUT** registry variable to IMMEDIATE, or by specifying IMMEDIATE on the SET CURRENT MDC ROLLOUT MODE statement. There is no change in the logging of index updates, compared to a standard delete operation, so the performance improvement depends on how many RID indexes there are. The fewer RID indexes, the better the improvement, as a percentage of the total time and log space.

An estimate of the amount of log space that is saved can be made with the following formula:

$$S + 38*N - 50*P$$

where *N* is the number of records deleted, *S* is total size of the records deleted, including overhead such as null indicators and VARCHAR lengths, and *P* is the number of pages in the blocks that contain the deleted records. This figure is the reduction in actual log data. The savings on active log space required is double that value, due to the saving of space that was reserved for rollback.

Alternatively, you can have the RID indexes updated after the transaction commits, using *deferred cleanup rollout*. This mode can also be specified by setting the **DB2\_MDC\_ROLLOUT** registry variable to DEFER, or by specifying DEFERRED on the SET CURRENT MDC ROLLOUT MODE statement. In a deferred rollout, RID indexes are cleaned up asynchronously in the background after the delete commits. This method of rollout can result in significantly faster deletion times for very large deletes, or when a number of RID indexes exist on the table. The speed of the overall cleanup operation is increased, because during a deferred index cleanup, the indexes are cleaned up in parallel, whereas in an immediate index cleanup, each row in the index is cleaned up one by one. Moreover, the transactional log space requirement for the DELETE statement is significantly reduced, because the asynchronous index cleanup logs the index updates by index page instead of by index key.

**Note:** Deferred cleanup rollout requires additional memory resources, which are taken from the database heap. If the database manager is unable to allocate the memory structures it requires, the deferred cleanup rollout fails, and a message is written to the administration notification log.

### When to use a deferred cleanup rollout

If delete performance is the most important factor, and there are RID indexes defined on the table, use deferred cleanup rollout. Note that prior to index cleanup, index-based scans of the rolled-out blocks suffer a small performance penalty, depending on the amount of rolled-out data. The following issues should also be considered when deciding between immediate index cleanup and deferred index cleanup:

- Size of the delete operation  
Choose deferred cleanup rollout for very large deletions. In cases where dimensional DELETE statements are frequently issued on many small MDC tables, the overhead to asynchronously clean index objects might outweigh the benefit of time saved during the delete operation.
- Number and type of indexes  
If the table contains a number of RID indexes, which require row-level processing, use deferred cleanup rollout.
- Block availability  
If you want the block space freed by the delete operation to be available immediately after the DELETE statement commits, use immediate cleanup rollout.
- Log space  
If log space is limited, use deferred cleanup rollout for large deletions.
- Memory constraints  
Deferred cleanup rollout consumes additional database heap space on all tables that have deferred cleanup pending.

To disable rollout behavior during deletions, set the **DB2\_MDC\_ROLLOUT** registry variable to OFF or specify NONE on the SET CURRENT MDC ROLLOUT MODE statement.

**Note:** In DB2 Version 9.7 and later releases, deferred cleanup rollout is not supported on a data partitioned MDC table with partitioned RID indexes. Only the NONE and IMMEDIATE modes are supported. The cleanup rollout type will be IMMEDIATE if the **DB2\_MDC\_ROLLOUT** registry variable is set to DEFER, or if the CURRENT MDC ROLLOUT MODE special register is set to DEFERRED to override the **DB2\_MDC\_ROLLOUT** setting.

If only nonpartitioned RID indexes exist on the MDC table, deferred index cleanup rollout is supported.

### Optimization strategies for partitioned tables

Data partition elimination refers to the database server's ability to determine, based on query predicates, that only a subset of the data partitions in a table need to be accessed to answer a query. Data partition elimination is particularly useful when running decision support queries against a partitioned table.

A partitioned table uses a data organization scheme in which table data is divided across multiple storage objects, called data partitions or ranges, according to values in one or more table partitioning key columns of the table. Data from a table is

partitioned into multiple storage objects based on specifications provided in the PARTITION BY clause of the CREATE TABLE statement. These storage objects can be in different table spaces, in the same table space, or a combination of both.

The following example demonstrates the performance benefits of data partition elimination.

```
create table custlist(
  subdate date, province char(2), accountid int)
partition by range(subdate) (
  starting from '1/1/1990' in ts1,
  starting from '1/1/1991' in ts1,
  starting from '1/1/1992' in ts1,
  starting from '1/1/1993' in ts2,
  starting from '1/1/1994' in ts2,
  starting from '1/1/1995' in ts2,
  starting from '1/1/1996' in ts3,
  starting from '1/1/1997' in ts3,
  starting from '1/1/1998' in ts3,
  starting from '1/1/1999' in ts4,
  starting from '1/1/2000' in ts4,
  starting from '1/1/2001'
  ending '12/31/2001' in ts4)
```

Assume that you are only interested in customer information for the year 2000.

```
select * from custlist
  where subdate between '1/1/2000' and '12/31/2000'
```

As Figure 33 shows, the database server determines that only one data partition in table space TS4 must be accessed to resolve this query.

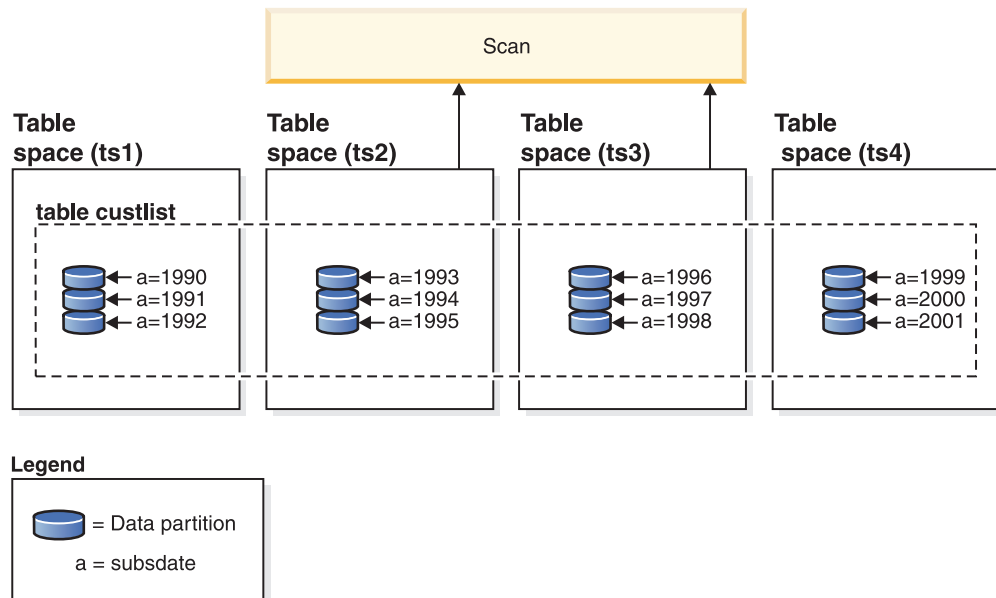

Figure 33. The performance benefits of data partition elimination

Another example of data partition elimination is based on the following scheme:

```
create table multi (
  sale_date date, region char(2))
partition by (sale_date) (
  starting '01/01/2005'
  ending '12/31/2005'
  every 1 month)
```



```

create index sx on multi(sale_date)

create index rx on multi(region)

```

Assume that you issue the following query:

```

select * from multi
  where sale_date between '6/1/2005'
    and '7/31/2005' and region = 'NW'

```

Without table partitioning, one likely plan is index ANDing. Index ANDing performs the following tasks:

- Reads all relevant index entries from each index
- Saves both sets of row identifiers (RIDs)
- Matches RIDs to determine which occur in both indexes
- Uses the RIDs to fetch the rows

As Figure 34 demonstrates, with table partitioning, the index is read to find matches for both REGION and SALE\_DATE, resulting in the fast retrieval of matching rows.

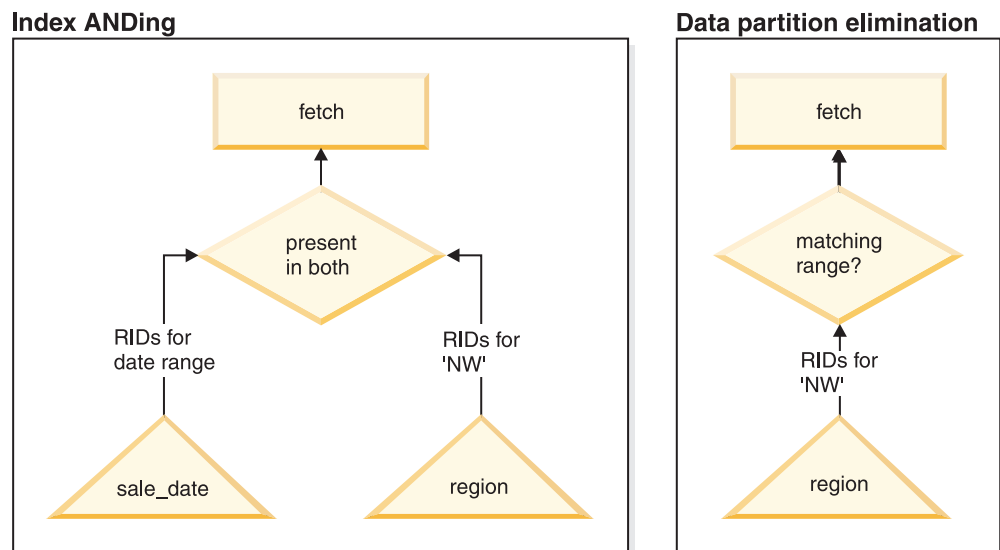

Figure 34. Optimizer decision path for both table partitioning and index ANDing

## DB2 Explain

You can also use the explain facility to determine the data partition elimination plan that was chosen by the query optimizer. The “DP Elim Predicates” information shows which data partitions are scanned to resolve the following query:

```

select * from custlist
  where subdate between '12/31/1999' and '1/1/2001'

```

Arguments:

```

-----
DPESTFLG: (Number of data partitions accessed are Estimated)
          FALSE
DPLSTPRT: (List of data partitions accessed)
          9-11
DPNUMPRT: (Number of data partitions accessed)

```

DP Elim Predicates:

```
-----
Range 1)
  Stop Predicate: (Q1.A <= '01/01/2001')
  Start Predicate: ('12/31/1999' <= Q1.A)
```

Objects Used in Access Plan:

```
-----
Schema: MRSRINI
Name:    CUSTLIST
Type:    Data Partitioned Table
Time of creation: 2005-11-30-14.21.33.857039
Last statistics update: 2005-11-30-14.21.34.339392
Number of columns: 3
Number of rows: 100000
Width of rows: 19
Number of buffer pool pages: 1200
Number of data partitions: 12
Distinct row values: No
Tablespace name: <VARIOUS>
```

## Multi-column support

Data partition elimination works in cases where multiple columns are used as the table partitioning key. For example:

```
create table sales (
  year int, month int)
partition by range(year, month) (
  starting from (2001,1)
  ending at (2001,3) in ts1,
  ending at (2001,6) in ts2,
  ending at (2001,9) in ts3,
  ending at (2001,12) in ts4,
  ending at (2002,3) in ts5,
  ending at (2002,6) in ts6,
  ending at (2002,9) in ts7,
  ending at (2002,12) in ts8)

select * from sales where year = 2001 and month < 8
```

The query optimizer deduces that only data partitions in TS1, TS2, and TS3 must be accessed to resolve this query.

**Note:** In the case where multiple columns make up the table partitioning key, data partition elimination is only possible when you have predicates on the leading columns of the composite key, because the non-leading columns that are used for the table partitioning key are not independent.

## Multi-range support

It is possible to obtain data partition elimination with data partitions that have multiple ranges (that is, those that are ORed together). Using the SALES table that was created in the previous example, execute the following query:

```
select * from sales
  where (year = 2001 and month <= 3)
         or (year = 2002 and month >= 10)
```

The database server only accesses data for the first quarter of 2001 and the last quarter of 2002.

## Generated columns

You can use generated columns as table partitioning keys. For example:

```
create table sales (  
  a int, b int generated always as (a / 5)  
  in ts1,ts2,ts3,ts4,ts5,ts6,ts7,ts8,ts9,ts10  
  partition by range(b) (  
    starting from (0)  
    ending at (1000) every (50))
```

In this case, predicates on the generated column are used for data partition elimination. In addition, when the expression that is used to generate the columns is monotonic, the database server translates predicates on the source columns into predicates on the generated columns, which enables data partition elimination on the generated columns. For example:

```
select * from sales where a > 35
```

The database server generates an extra predicate on b ( $b > 7$ ) from a ( $a > 35$ ), thus allowing data partition elimination.

## Join predicates

Join predicates can also be used in data partition elimination, if the join predicate is pushed down to the table access level. The join predicate is only pushed down to the table access level on the inner join of a nested loop join (NLJN).

Consider the following tables:

```
create table t1 (a int, b int)  
  partition by range(a,b) (  
    starting from (1,1)  
    ending (1,10) in ts1,  
    ending (1,20) in ts2,  
    ending (2,10) in ts3,  
    ending (2,20) in ts4,  
    ending (3,10) in ts5,  
    ending (3,20) in ts6,  
    ending (4,10) in ts7,  
    ending (4,20) in ts8)  
  
create table t2 (a int, b int)
```

The following two predicates will be used:

```
P1: T1.A = T2.A  
P2: T1.B > 15
```

In this example, the exact data partitions that will be accessed at compile time cannot be determined, due to unknown outer values of the join. In this case, as well as cases where host variables or parameter markers are used, data partition elimination occurs at run time when the necessary values are bound.

During run time, when T1 is the inner of an NLJN, data partition elimination occurs dynamically, based on the predicates, for every outer value of T2.A. During run time, the predicates  $T1.A = 3$  and  $T1.B > 15$  are applied for the outer value  $T2.A = 3$ , which qualifies the data partitions in table space TS6 to be accessed.

Suppose that column A in tables T1 and T2 have the following values:

Outer table T2: column A	Inner table T1: column A	Inner table T1: column B	Inner table T1: data partition location
2	3	20	TS6
3	2	10	TS3
3	2	18	TS4
	3	15	TS6
	1	40	TS3

To perform a nested loop join (assuming a table scan for the inner table), the database manager performs the following steps:

1. Reads the first row from T2. The value for A is 2.
2. Binds the T2.A value (which is 2) to the column T2.A in the join predicate T1.A = T2.A. The predicate becomes T1.A = 2.
3. Applies data partition elimination using the predicates T1.A = 2 and T1.B > 15. This qualifies data partitions in table space TS4.
4. After applying T1.A = 2 and T1.B > 15, scans the data partitions in table space TS4 of table T1 until a row is found. The first qualifying row found is row 3 of T1.
5. Joins the matching row.
6. Scans the data partitions in table space TS4 of table T1 until the next match (T1.A = 2 and T1.B > 15) is found. No more rows are found.
7. Repeats steps 1 through 6 for the next row of T2 (replacing the value of A with 3) until all the rows of T2 have been processed.

## Indexes over XML data

Starting in DB2 Version 9.7 Fix Pack 1, you can create an index over XML data on a partitioned table as either partitioned or nonpartitioned. The default is a partitioned index.

Partitioned and nonpartitioned XML indexes are maintained by the database manager during table insert, update, and delete operations in the same way as any other relational indexes on a partitioned table are maintained. Nonpartitioned indexes over XML data on a partitioned table are used in the same way as indexes over XML data on a nonpartitioned table to speed up query processing. Using the query predicate, it is possible to determine that only a subset of the data partitions in the partitioned table need to be accessed to answer the query.

Data partition elimination and indexes over XML columns can work together to enhance query performance. Consider the following partitioned table:

```
create table employee (a int, b xml, c xml)
index in tbspx
partition by (a) (
  starting 0 ending 10,
  ending 20,
  ending 30,
  ending 40)
```

Now consider the following query:

```
select * from employee
where a > 21
and xmlexist('$doc/Person/Name/First[.="Eric"]'
  passing "EMPLOYEE"."B" as "doc")
```

The optimizer can immediately eliminate the first two partitions based on the predicate  $a > 21$ . If the nonpartitioned index over XML data on column B is chosen by the optimizer in the query plan, an index scan using the index over XML data will be able to take advantage of the data partition elimination result from the optimizer and only return results belonging to partitions that were not eliminated by the relational data partition elimination predicates.

## Improving query optimization with materialized query tables

Materialized query tables (MQTs) are a powerful way to improve response time for complex queries.

This is especially true for queries that might require one or more of the following operations:

- Aggregate data over one or more dimensions
- Joins and aggregate data over a group of tables
- Data from a commonly accessed subset of data; that is, from a “hot” horizontal or vertical database partition
- Re-partitioned data from a table, or part of a table, in a partitioned database environment

Knowledge of MQTs is integrated into the SQL and XQuery compiler. In the compiler, the query rewrite phase and the optimizer match queries with MQTs and determine whether to substitute an MQT in a query that accesses the base tables. If an MQT is used, the explain facility can provide information about which MQT was selected. In this case, users need access privileges against the base tables, not rerouted MQTs.

Because MQTs behave like regular tables in many ways, the same guidelines for optimizing data access using table space definitions and indexes, and by invoking the runstats utility, apply to MQTs.

To help you to understand the power of MQTs, the following example shows how a multidimensional analysis query can take advantage of MQTs. Consider a database warehouse that contains a set of customers and a set of credit card accounts. The warehouse records the set of transactions that are made with the credit cards. Each transaction contains a set of items that are purchased together. This schema is classified as a multi-star schema, because it has two large tables, one containing transaction items, and the other identifying the purchase transactions.

Three hierarchical dimensions describe a transaction: product, location, and time. The product hierarchy is stored in two normalized tables representing the product group and the product line. The location hierarchy contains city, state, and country, region, or territory information, and is stored in a single denormalized table. The time hierarchy contains day, month, and year information, and is encoded in a single date field. The date dimensions are extracted from the date field of the transaction using built-in functions. Other tables in this schema represent account information for customers, and customer information.

An MQT is created for sales at each level of the following hierarchies:

- Product
- Location
- Time, composed of year, month, and day

Many queries can be satisfied by this stored aggregate data. The following example shows how to create an MQT that computes the sum and count of sales data along the product group and line dimensions; along the city, state, and country, region, or territory dimensions; and along the time dimension. It also includes several other columns in its GROUP BY clause.

```
create table dba.pg_salessum
as (
select l.id as prodline, pg.id as pgroup,
       loc.country, loc.state, loc.city,
       l.name as linename, pg.name as pgroupname,
       year(pdate) as year, month(pdate) as month,
       t.status,
       sum(ti.amount) as amount,
       count(*) as count
from cube.transitem as ti, cube.trans as t,
     cube.loc as loc, cube.pgroup as pg, cube.prodline as l
where
     ti.transid = t.id and
     ti.pgid = pg.id and
     pg.lineid = l.id and
     t.locid = loc.id and
     year(pdate) > 1990
group by l.id, pg.id, loc.country, loc.state, loc.city,
         year(pdate), month(pdate), t.status, l.name, pg.name
)
data initially deferred refresh deferred;

refresh table dba.pg_salessum;
```

Queries that can take advantage of such precomputed sums include the following:

- Sales by month and product group
- Total sales for the years after 1990
- Sales for 1995 or 1996
- The sum of sales for a specific product group or product line
- The sum of sales for a specific product group or product line in 1995 and 1996
- The sum of sales for a specific country, region, or territory

Although the precise answer for any of these queries is not included in the MQT, the cost of computing the answer by MQT could be significantly less than the cost of using a large base table, because a portion of the answer is already computed. MQTs can reduce the need for expensive joins, sorts, and aggregation of base data.

The following sample queries obtain significant performance improvements because they can use the already computed results in the example MQT.

The first query returns the total sales for 1995 and 1996:

```
set current refresh age=any

select year(pdate) as year, sum(ti.amount) as amount
from cube.transitem as ti, cube.trans as t,
     cube.loc as loc, cube.pgroup as pg, cube.prodline as l
where
     ti.transid = t.id and
     ti.pgid = pg.id and
     pg.lineid = l.id and
     t.locid = loc.id and
     year(pdate) in (1995, 1996)
group by year(pdate);
```

The second query returns the total sales by product group for 1995 and 1996:

```

set current refresh age=any

select pg.id as "PRODUCT GROUP", sum(ti.amount) as amount
  from cube.transitem as ti, cube.trans as t,
       cube.loc as loc, cube.pgroup as pg, cube.prodline as l
 where
   ti.transid = t.id and
   ti.pgid = pg.id and
   pg.lineid = l.id and
   t.locid = loc.id and
   year(pdate) in (1995, 1996)
 group by pg.id;

```

The larger the base tables, the more significant are the potential improvements in response time when using MQTs. MQTs can effectively eliminate overlapping work among queries. Computations are performed only once when MQTs are built, and once each time that they are refreshed, and their content can be reused during the execution of many queries.

## Explain facility

The DB2 explain facility provides detailed information about the access plan that the optimizer chooses for an SQL or XQuery statement.

The information provided describes the decision criteria that are used to choose the access plan. The information can also help you to tune the statement or your instance configuration to improve performance. More specifically, explain information can help you with the following tasks:

- Understanding how the database manager accesses tables and indexes to satisfy your query.
- Evaluating your performance-tuning actions. After altering a statement or making a configuration change, examine the new explain information to determine how your action has affected performance.

The captured information includes the following information:

- The sequence of operations that were used to process the query
- Cost information
- Predicates and selectivity estimates for each predicate
- Statistics for all objects that were referenced in the SQL or XQuery statement at the time that the explain information was captured
- Values for host variables, parameter markers, or special registers that were used to reoptimize the SQL or XQuery statement

The explain facility is invoked by issuing the EXPLAIN statement, which captures information about the access plan chosen for a specific explainable statement and writes this information to explain tables. You must create the explain tables prior to issuing the EXPLAIN statement. You can also set CURRENT EXPLAIN MODE or CURRENT EXPLAIN SNAPSHOT, special registers that control the behavior of the explain facility.

For privileges and authorities that are required to use the explain utility, see the description of the EXPLAIN statement. The EXPLAIN authority can be granted to an individual who requires access to explain information but not to the data that is stored in the database. This authority is a subset of the database administrator authority and has no inherent privilege to access data stored in tables.

To display explain information, you can use a command-line tool. The tool that you use determines how you set the special registers that control the behavior of the explain facility. If you expect to perform detailed analysis with one of the command-line utilities or with custom SQL or XQuery statements against the explain tables, capture all explain information.

In IBM Data Studio Version 3.1 or later, you can generate a diagram of the current access plan for an SQL or XPATH statement. For more details, see Diagramming access plans with Visual Explain.

## Tuning SQL statements using the explain facility

The explain facility is used to display the query access plan that was chosen by the query optimizer to run an SQL statement.

It contains extensive details about the relational operations used to run the SQL statement, such as the plan operators, their arguments, order of execution, and costs. Because the query access plan is one of the most critical factors in query performance, it is important to understand explain facility output when diagnosing query performance problems.

Explain information is typically used to:

- Understand why application performance has changed
- Evaluate performance tuning efforts

## Analyzing performance changes

To help you understand the reasons for changes in query performance, perform the following steps to obtain “before and after” explain information:

1. Capture explain information for the query before you make any changes, and save the resulting explain tables. Alternatively, you can save output from the **db2exfmt** utility. However, having explain information in the explain tables makes it easy to query them with SQL, and facilitates more sophisticated analysis. As well, it provides all of the obvious maintenance benefits of having data in a relational DBMS. The **db2exfmt** tool can be run at any time.
2. Save or print the current catalog statistics. You can also use the **db2look** command to help perform this task. In DB2 Version 9.7, you can collect an explain snapshot when the explain tables are populated. The explain snapshot contains all of the relevant statistics at the time that the statement is explained. The **db2exfmt** utility will automatically format the statistics that are contained in the snapshot. This is especially important when using automatic or real-time statistics collection, because the statistics used for query optimization might not yet be in the system catalog tables, or they might have changed between the time that the statement was explained and when the statistics were retrieved from the system catalog.
3. Save or print the data definition language (DDL) statements, including those for CREATE TABLE, CREATE VIEW, CREATE INDEX, and CREATE TABLESPACE. The **db2look** command will also perform this task.

The information that you collect in this way provides a reference point for future analysis. For dynamic SQL statements, you can collect this information when you run your application for the first time. For static SQL statements, you can also collect this information at bind time. It is especially important to collect this information before a major system change, such as the installation of a new service level or DB2 release, or before a significant configuration change, such as adding or dropping database partitions and redistributing data. This is because these types



of system changes might result in an adverse change to access plans. Although access plan regression should be a rare occurrence, having this information available will help you to resolve performance regressions faster. To analyze a performance change, compare the information that you collected previously with information about the query and environment that you collect when you start your analysis.

As a simple example, your analysis might show that an index is no longer being used as part of an access plan. Using the catalog statistics information displayed by **db2exfmt**, you might notice that the number of index levels (NLEVELS column) is now substantially higher than when the query was first bound to the database. You might then choose to perform one of the following actions:

- Reorganize the index
- Collect new statistics for your table and indexes
- Collect explain information when rebinding your query

After you perform one of these actions, examine the access plan again. If the index is being used once again, query performance might no longer be a problem. If the index is still not being used, or if performance is still a problem, try a second action and examine the results. Repeat these steps until the problem is resolved.

## Evaluating performance tuning efforts

You can take a number of actions to help improve query performance, such as adjusting configuration parameters, adding containers, or collecting fresh catalog statistics.

After you make a change in any of these areas, you can use the explain facility to determine the affect, if any, that the change has had on the chosen access plan. For example, if you add an index or materialized query table (MQT) based on index guidelines, the explain data can help you to determine whether the index or materialized query table is actually being used as expected.

Although the explain output provides information that allows you to determine the access plan that was chosen and its relative cost, the only way to accurately measure the performance improvement for a query is to use benchmark testing techniques.

## Explain tables and the organization of explain information

An *explain instance* represents one invocation of the explain facility for one or more SQL or XQuery statements. The explain information that is captured in one explain instance includes information about the compilation environment and the access plan that is chosen to satisfy the SQL or XQuery statement that is being compiled.

For example, an explain instance might consist of any one of the following items:

- All eligible SQL or XQuery statements in one package, for static query statements. For SQL statements (including those that query XML data), you can capture explain information for CALL, compound SQL (dynamic), DELETE, INSERT, MERGE, REFRESH TABLE, SELECT, SELECT INTO, SET INTEGRITY, UPDATE, VALUES, and VALUES INTO statements. In the case of XQuery statements, you can obtain explain information for XQUERY db2-fn:xmlcolumn and XQUERY db2-fn:sqlquery statements.

**Note:** REFRESH TABLE and SET INTEGRITY statements are compiled only dynamically.

- One particular SQL statement, for incremental bind SQL statements.
- One particular SQL statement, for dynamic SQL statements.
- Each EXPLAIN statement (dynamic or static).

The explain facility, which you can invoke by issuing the EXPLAIN statement or by using the section explain interfaces, captures information about the access plan that is chosen for a specific explainable statement and writes this information to explain tables. You must create the explain tables before issuing the EXPLAIN statement. To create the tables, use one of the following methods:

- Run the EXPLAIN.DDL script in the misc subdirectory of the sqllib subdirectory.
- Use the SYSPROC.SYSINSTALLOBJECTS procedure. You can also use this procedure to drop and validate explain tables.

You can create the tables under a specific schema and table space. You can find an example in the EXPLAIN.DDL file.

Explain tables can be common to more than one user. You can define tables for one user and then create aliases pointing to the defined tables for each additional user. Alternatively, you can define the explain tables under the SYSTOOLS schema. The explain facility uses the SYSTOOLS schema as the default if no explain tables or aliases are found under your session ID (for dynamic SQL or XQuery statements) or under the statement authorization ID (for static SQL or XQuery statements). Each user sharing common explain tables must hold the INSERT privilege on those tables.

The following table summarizes the purpose of each explain table.

*Table 60. Summary of the explain tables*

Table Name	Description
ADVISE_INDEX	Stores information about recommended indexes. The table can be populated by the query compiler or the <b>db2advsi</b> command, or you can populate it. This table is used to get recommended indexes and to evaluate proposed indexes.
ADVISE_INSTANCE	Contains information about <b>db2advsi</b> command execution, including start time. This table contains one row for each execution of the <b>db2advsi</b> command.
ADVISE_MQT	Contains the following information: <ul style="list-style-type: none"> <li>• The query that defines each recommended materialized query table (MQT)</li> <li>• The column statistics for each MQT, such as COLSTATS (in XML form) and NUMROWS</li> <li>• The sampling query to obtain detailed statistics for each MQT</li> </ul>
ADVISE_PARTITION	Stores virtual database partitions that are generated and evaluated by the <b>db2advsi</b> command.
ADVISE_TABLE	Stores the data definition language (DDL) statements for table creation, using the final Design Advisor recommendations for MQTs, multidimensional clustering tables (MDCs), and database partitioning.

Table 60. Summary of the explain tables (continued)

Table Name	Description
ADVISE_WORKLOAD	Contains a row for each SQL or XQuery statement in a workload. The <b>db2adv</b> command uses this table to collect and store workload information.
EXPLAIN_ACTUALS	Contains the explain section actuals information.
EXPLAIN_ARGUMENT	Contains information about the unique characteristics of each operator, if any.
EXPLAIN_DIAGNOSTIC	Contains an entry for each diagnostic message that is produced for a particular instance of an explained statement in the EXPLAIN_STATEMENT table.
EXPLAIN_DIAGNOSTIC_DATA	Contains message tokens for diagnostic messages that are recorded in the EXPLAIN_DIAGNOSTIC table. The message tokens provide additional information that is specific to the execution of the SQL statement that generated the message.
EXPLAIN_INSTANCE	Is the main control table for all explain information. Each row in the explain tables is linked to a unique row in this table. Basic information about the source of the SQL or XQuery statements being explained and environmental information are kept in this table.
EXPLAIN_OBJECT	Identifies the data objects that are required by the access plan that is generated to satisfy an SQL or XQuery statement.
EXPLAIN_OPERATOR	Contains all of the operators that the query compiler needs to satisfy an SQL or XQuery statement.
EXPLAIN_PREDICATE	Identifies the predicates that are applied by a specific operator.
EXPLAIN_STATEMENT	<p>Contains the text of the SQL or XQuery statement for the different levels of explain information. The SQL or XQuery statement that you issued and the version that the optimizer uses to choose an access plan are stored in this table.</p> <p>When an explain snapshot is requested, additional explain information is recorded to describe the access plan that was selected by the query optimizer. This information is stored in the SNAPSHOT column of the EXPLAIN_STATEMENT table.</p>
EXPLAIN_STREAM	Represents the input and output data streams between individual operators and data objects. The operators are represented in the EXPLAIN_OPERATOR table. The data objects are represented in the EXPLAIN_OBJECT table.

Table 60. Summary of the explain tables (continued)

Table Name	Description
OBJECT_METRICS	<p>Contains runtime statistics for each object that is referenced in a specific execution of a section at a specific time. If object statistics are collected on multiple members, this table contains a row for each member on which the object was referenced. If object statistics are collected for a partitioned object, this table contains a row for each data partition.</p> <p>This table contains information only if the activity event monitor captures section actuals.</p>

### Explain information for data objects:

A single access plan might use one or more data objects to satisfy an SQL or XQuery statement.

#### Object statistics

The explain facility records information about each object, such as the following:

- The creation time
- The last time that statistics were collected for the object
- Whether or not the data in the object is sorted (only table or index objects)
- The number of columns in the object (only table or index objects)
- The estimated number of rows in the object (only table or index objects)
- The number of pages that the object occupies in the buffer pool
- The total estimated overhead, in milliseconds, for a single random I/O to the specified table space where the object is stored
- The estimated transfer rate, in milliseconds, to read a 4-KB page from the specified table space
- Prefetch and extent sizes, in 4-KB pages
- The degree of data clustering within the index
- The number of leaf pages that are used by the index for this object, and the number of levels in the tree
- The number of distinct full key values in the index for this object
- The total number of overflow records in the table

### Explain information for data operators:

A single access plan can perform several operations on the data to satisfy the SQL or XQuery statement and provide results back to you. The query compiler determines the operations that are required, such as a table scan, an index scan, a nested loop join, or a group-by operator.

In addition to showing information about each operator that is used in an access plan, explain output also shows the cumulative effects of the access plan.

## Estimated cost information

The following cumulative cost estimates for operators are recorded. These costs are for the chosen access plan, up to and including the operator for which the information is captured.

- The total cost (in timerons)
- The number of page I/Os
- The number of processing instructions
- The cost (in timerons) of fetching the first row, including any required initial overhead
- The communication cost (in frames)

A *timeron* is an invented relative unit of measurement. Timeron values are determined by the optimizer, based on internal values such as statistics that change as the database is used. As a result, the timeron values for an SQL or XQuery statement are not guaranteed to be the same every time an estimated cost in timerons is determined.

If there is more than one network adapter involved, the cumulative communication cost for the adapter with the highest value is returned. These communication cost values only include the costs of network traffic between physical machines. They do not include the cost of passing frames between node partitions on the same physical machine in a partitioned database environment, which therefore do not flow across the network.

## Operator properties

The following information that describes the properties of each operator is recorded by the explain facility:

- The set of tables that have been accessed
- The set of columns that have been accessed
- The columns on which the data is ordered, if the optimizer has determined that this ordering can be used by subsequent operators
- The set of predicates that have been applied
- The estimated number of rows that will be returned (cardinality)

## Explain information for instances:

Explain instance information is stored in the EXPLAIN\_INSTANCE table. Additional specific information about each query statement in an instance is stored in the EXPLAIN\_STATEMENT table.

## Explain instance identification

The following information helps you to identify a specific explain instance and to associate the information about certain statements with a specific invocation of the explain facility:

- The user who requested the explain information
- When the explain request began
- The name of the package that contains the explained statement
- The SQL schema of the package that contains the explained statement
- The version of the package that contains the statement

- Whether snapshot information was collected

### Environmental settings

Information about the database manager environment in which the query compiler optimized your queries is captured. The environmental information includes the following:

- The version and release number of the DB2 product
- The degree of parallelism under which the query was compiled  
The CURRENT DEGREE special register, the DEGREE bind option, the **SET RUNTIME DEGREE** command, and the **dft\_degree** database configuration parameter determine the degree of parallelism under which a particular query is compiled.
- Whether the statement is dynamic or static
- The query optimization class used to compile the query
- The type of row blocking for cursors that occurs when compiling the query
- The isolation level under which the query runs
- The values of various configuration parameters when the query was compiled. Values for the following parameters are recorded when an explain snapshot is taken:
  - Sort heap size (**sortheap**)
  - Average number of active applications (**avg\_appls**)
  - Database heap (**dbheap**)
  - Maximum storage for lock list (**locklist**)
  - Maximum percent of lock list before escalation (**maxlocks**)
  - CPU speed (**cpuspeed**)
  - Communications bandwidth (**comm\_bandwidth**)

### Statement identification

More than one statement might have been explained for each explain instance. In addition to information that uniquely identifies the explain instance, the following information helps to identify individual query statements:

- The type of statement: SELECT, DELETE, INSERT, UPDATE, positioned DELETE, positioned UPDATE, or SET INTEGRITY
- The statement and section number of the package issuing the statement, as recorded in the SYSCAT.STATEMENTS catalog view

The QUERYTAG and QUERYNO fields in the EXPLAIN\_STATEMENT table contain identifiers that are set as part of the explain process. When EXPLAIN MODE or EXPLAIN SNAPSHOT is active, and dynamic explain statements are submitted during a command line processor (CLP) or call-level interface (CLI) session, the QUERYTAG value is set to “CLP” or “CLI”, respectively. In this case, the QUERYNO value defaults to a number that is incremented by one or more for each statement. For all other dynamic explain statements that are not from the CLP or CLI, or that do not use the EXPLAIN statement, the QUERYTAG value is set to blanks and QUERYNO is always 1.

## Cost estimation

For each explained statement, the optimizer records an estimate of the relative cost of executing the chosen access plan. This cost is stated in an invented relative unit of measure called a *timeron*. No estimate of elapsed times is provided, for the following reasons:

- The query optimizer does not estimate elapsed time but only resource consumption.
- The optimizer does not model all factors that can affect elapsed time. It ignores factors that do not affect the efficiency of the access plan. A number of runtime factors affect the elapsed time, including the system workload, the amount of resource contention, the amount of parallel processing and I/O, the cost of returning rows to the user, and the communication time between the client and server.

## Statement text

Two versions of the statement text are recorded for each explained statement. One version is the code that the query compiler receives from the application. The other version is reverse-translated from the internal (compiler) representation of the query. Although this translation looks similar to other query statements, it does not necessarily follow correct query language syntax, nor does it necessarily reflect the actual content of the internal representation as a whole. This translation is provided only to enable you to understand the context in which the optimizer chose the access plan. To understand how the compiler has rewritten your query for better optimization, compare the user-written statement text to the internal representation of the query statement. The rewritten statement also shows you other factors that affect your statement, such as triggers or constraints. Some keywords that are used in this “optimized” text include the following:

**\$C $n$**  The name of a derived column, where  $n$  represents an integer value.

### **\$CONSTRAINT\$**

This tag identifies a constraint that was added to the original statement during compilation, and is seen in conjunction with the **\$WITH\_CONTEXT\$** prefix.

### **\$DERIVED.T $n$**

The name of a derived table, where  $n$  represents an integer value.

### **\$INTERNAL\_FUNC\$**

This tag indicates the presence of a function that is used by the compiler for the explained query but that is not available for general use.

### **\$INTERNAL\_PRED\$**

This tag indicates the presence of a predicate that was added during compilation of the explained query but that is not available for general use. An internal predicate is used by the compiler to satisfy additional context that is added to the original statement because of triggers or constraints.

### **\$INTERNAL\_XPATH\$**

This tag indicates the presence of an internal table function that takes a single annotated XPath pattern as an input parameter and returns a table with one or more columns that match that pattern.

**\$RID\$** This tag identifies the row identifier (RID) column for a particular row.

## **\$TRIGGERS\$**

This tag identifies a trigger that was added to the original statement during compilation, and is seen in conjunction with the `$WITH_CONTEXT$` prefix.

## **\$WITH\_CONTEXT\$(...)**

This prefix appears at the beginning of the text when additional triggers or constraints have been added to the original query statement. A list of the names of any triggers or constraints that affect the compilation and resolution of the statement appears after this prefix.

## **Guidelines for capturing explain information**

Explain data can be captured by request when an SQL or XQuery statement is compiled.

If incremental bind SQL or XQuery statements are compiled at run time, data is placed in the explain tables at run time, not at bind time. For these statements, the inserted explain table qualifier and authorization ID are that of the package owner, not of the user running the package.

Explain information is captured only when an SQL or XQuery statement is compiled. After initial compilation, dynamic query statements are recompiled when a change to the environment requires it, or when the explain facility is active. If you issue the same PREPARE statement for the same query statement, the query is compiled and explain data is captured every time that this statement is prepared or executed.

If a package is bound using the **REOPT ONCE** or **REOPT ALWAYS** bind option, SQL or XQuery statements containing host variables, parameter markers, global variables, or special registers are compiled, and the access path is created using real values for these variables if they are known, or default estimates if the values are not known at compilation time.

If the **REOPT ONCE** option is used, an attempt is made to match the specified SQL or XQuery statement with the same statement in the package cache. Values for this already re-optimized and cached query statement will be used to re-optimize the specified query statement. If the user has the required access privileges, the explain tables will contain the newly re-optimized access plan and the values that were used for re-optimization.

In a multi-partition database system, the statement should be explained on the same database partition on which it was originally compiled and re-optimized using **REOPT ONCE**; otherwise, an error is returned.

## **Capturing information in the explain tables**

- Static or incremental bind SQL and XQuery statements
  - Specify either **EXPLAIN ALL** or **EXPLAIN YES** options on the **BIND** or the **PREP** command, or include a static EXPLAIN statement in the source program.
- Dynamic SQL and XQuery statements
  - Explain table information is captured in any of the following cases.
    - If the CURRENT EXPLAIN MODE special register is set to:
      - YES: The SQL and XQuery compiler captures explain data and executes the query statement.
      - EXPLAIN: The SQL and XQuery compiler captures explain data, but does not execute the query statement.



- RECOMMEND INDEXES: The SQL and XQuery compiler captures explain data, and recommended indexes are placed in the ADVISE\_INDEX table, but the query statement is not executed.
- EVALUATE INDEXES: The SQL and XQuery compiler uses indexes that were placed by the user in the ADVISE\_INDEX table for evaluation. In this mode, all dynamic statements are explained as though these virtual indexes were available. The query compiler then chooses to use the virtual indexes if they improve the performance of the statements. Otherwise, the indexes are ignored. To find out if proposed indexes are useful, review the EXPLAIN results.
- REOPT: The query compiler captures explain data for static or dynamic SQL or XQuery statements during statement re-optimization at execution time, when actual values for host variables, parameter markers, global variables, or special registers are available.
- If the **EXPLAIN ALL** option has been specified on the **BIND** or **PREP** command, the query compiler captures explain data for dynamic SQL and XQuery statements at run time, even if the CURRENT EXPLAIN MODE special register is set to NO.

### Capturing explain snapshot information

When an explain snapshot is requested, explain information is stored in the SNAPSHOT column of the EXPLAIN\_STATEMENT table.

Explain snapshot data is captured when an SQL or XQuery statement is compiled and explain data has been requested, as follows:

- Static or incremental bind SQL and XQuery statements
 

An explain snapshot is captured when either the **EXPLSNAP ALL** or the **EXPLSNAP YES** clause is specified on the **BIND** or the **PREP** command, or when the source program includes a static EXPLAIN statement that uses a FOR SNAPSHOT or a WITH SNAPSHOT clause.
- Dynamic SQL and XQuery statements
 

An explain snapshot is captured in any of the following cases.

  - You issue an EXPLAIN statement with a FOR SNAPSHOT or a WITH SNAPSHOT clause. With the former, only explain snapshot information is captured; with the latter, all explain information is captured.
  - If the CURRENT EXPLAIN SNAPSHOT special register is set to:
    - YES: The SQL and XQuery compiler captures explain snapshot data and executes the query statement.
    - EXPLAIN: The SQL and XQuery compiler captures explain snapshot data, but does not execute the query statement.
  - You specify the **EXPLSNAP ALL** option on the **BIND** or **PREP** command. The query compiler captures explain snapshot data at run time, even if the CURRENT EXPLAIN SNAPSHOT special register is set to NO.

### Guidelines for capturing section explain information

The section explain functionality captures (either directly or via tooling) explain information about a statement using only the contents of the runtime section. The section explain is similar to the functionality provided by the **db2exp1n** command, but the section explain gives a level of detail approaching that which is provided by the explain facility.

By explaining a statement using the contents of the runtime section, you can obtain information and diagnostics about what will actually be run (or was run, if the section was captured after execution), as opposed to issuing an EXPLAIN statement which might produce a different access plan (for example, in the case of dynamic SQL, the statistics might have been updated since the last execution of the statement resulting in a different access plan being chosen when the EXPLAIN statement compiles the statement being explained).

The section explain interfaces will populate the explain tables with information that is similar to what is produced by an EXPLAIN statement. However, there are some differences. After the data has been written to the explain tables, it may be processed by any of the existing explain tools you want to use (for example, the **db2exfmt** command).

### Section explain interfaces

There are four interface procedures, in the following list, that can perform a section explain. The procedures differ by only the input that is provided (that is, the means by which the section is located):

#### EXPLAIN\_FROM\_ACTIVITY

Takes application ID, activity ID, uow ID, and activity event monitor name as input. The procedure searches for the section corresponding to this activity in the activity event monitor (an SQL activity is a specific execution of a section). A section explain using this interface contains section actuals because a specific execution of the section is being performed.

#### EXPLAIN\_FROM\_CATALOG

Takes package name, package schema, unique ID, and section number as input. The procedure searches the catalog tables for the specific section.

#### EXPLAIN\_FROM\_DATA

Takes executable ID, section, and statement text as input.

#### EXPLAIN\_FROM\_SECTION

Takes executable ID and location as input, where location is specified by using one of the following:

- In-memory package cache
- Package cache event monitor name

The procedure searches for the section in the given location.

An executable ID uniquely and consistently identifies a section. The executable ID is an opaque, binary token generated at the data server for each section that has been executed. The executable ID is used as input to query monitoring data for the section, and to perform a section explain.

In each case, the procedure performs an explain, using the information contained in the identified runtime section, and writes the explain information to the explain tables identified by an *explain\_schema* input parameter. It is the responsibility of the caller to perform a commit after invoking the procedure.

### Investigating query performance using Explain information obtained from a section:

You can use the explain facility to examine the access plan for a specific statement *as it will actually run* (or as it was run) by generating the access plan from the

section for the statement itself. By contrast, using the EXPLAIN statement creates the access plan by recompiling the statement. The resulting access plans from each of these two methods of creating access plans can be different. For example, if the statement in a section was compiled, say, 2 hours ago, then the access plan it uses might be different than the one produced by running the EXPLAIN statement against the statement.

If you have activity event monitor information available, you can generate the access plan for the section after it has run using the EXPLAIN\_FROM\_ACTIVITY procedure. (If section actuals are being collected, you can also view this information along with the estimates generated by the explain facility in the access plan. See “Capturing and accessing section actuals” on page 295 for more information.)

If there is no activity event monitor information available for the statement, you can use the EXPLAIN\_FROM\_SECTION procedure to generate the access plan for the statement as it will run based on the section stored in the package cache. This topic shows how to use EXPLAIN\_FROM\_SECTION to view access plan information for a statement based on section information in the package cache.

### Before you begin

This task assumes that you have already created the explain tables required by the explain facility.

### About this task

In this topic, assume that you want to use the explain facility to examine the most CPU-intensive statement in the package cache.

### Procedure

The first part of this procedure shows how to identify the most CPU-intensive statement. Then, it shows how to use the EXPLAIN\_FROM\_SECTION procedure to view the access plan information for that statement as it will actually run.

1. Identify the statement that using the most processor time:

```
SELECT SECTION_TYPE,
       CASE
         WHEN SUM(NUM_COORD_EXEC_WITH_METRICS) > 0 THEN
           SUM(TOTAL_CPU_TIME)/SUM(NUM_COORD_EXEC_WITH_METRICS)
         ELSE
           0
       END as AVG_CPU_TIME,
       EXECUTABLE_ID,
       VARCHAR(STMT_TEXT, 200) AS TEXT
FROM TABLE(MON_GET_PKG_CACHE_STMT ('D', NULL, NULL, -2)) as T
WHERE T.NUM_EXEC_WITH_METRICS <> 0 AND STMT_TYPE_ID LIKE 'DML%'
GROUP BY EXECUTABLE_ID, VARCHAR(STMT_TEXT, 200)
ORDER BY AVG_CPU_TIME DESC
```

The preceding SQL is written to avoid division by 0 when calculating the average processor time across members. It also examines DML statements only, since the explain facility does not operate on DDL statements. The results of this query are as follows:

SECTION_TYPE	AVG_CPU_TIME	EXECUTABLE_ID	TEXT
D	250000	x'010000000000000005F00000000000000000000000020020101108135629359000'	select cust_last_name, cust_cc_number, cust_intere
SQL0445W	Value	"SELECT POLICY FROM SYSTOOLS.POLICY WHERE MED='DB2TableMaInte"	has been truncated. SQLSTATE=01004

```

D      15625 x'01000000000000001B0000000000000000000000000000000020020101108135017625000' UPDATE SYSTOOLS.HMON_ATM_INFO SET STATS_LOCK = 'N'
D      15625 x'0100000000000000200000000000000000000000000000000020020101108135018296001' UPDATE SYSTOOLS.HMON_ATM_INFO AS ATM SET ATM.STATS
D      15625 x'0100000000000000021000000000000000000000000000000020020101108135018312001' UPDATE SYSTOOLS.HMON_ATM_INFO AS ATM SET STATS_FLA
D      7812 x'0100000000000000015000000000000000000000000000000020020101108135016984000' SELECT COLNAME, TYPENAME FROM SYSCAT.COLUMNS WHERE
D      0 x'0100000000000000016000000000000000000000000000000020020101108135017156000' SELECT TRIGNAME FROM SYSCAT.TRIGGERS WHERE TABNAM
D      0 x'0100000000000000019000000000000000000000000000000020020101108135017484000' SELECT TABNAME FROM SYSCAT.TABLES WHERE TABNAME='
D      0 x'010000000000000001A000000000000000000000000000000020020101108135017500000' SELECT TABNAME FROM SYSCAT.TABLES WHERE TABNAME='
D      0 x'010000000000000001C000000000000000000000000000000020020101108135017750002' SELECT CREATOR, NAME, CTIME FROM SYSIBM.SYSTABLES
D      0 x'010000000000000001D000000000000000000000000000000020020101108135017828001' SELECT CREATE_TIME FROM SYSTOOLS.HMON_ATM_INFO WHERE
D      0 x'010000000000000001E000000000000000000000000000000020020101108135018000001' DELETE FROM SYSTOOLS.HMON_ATM_INFO AS ATM WHERE NO
D      0 x'010000000000000001F000000000000000000000000000000020020101108135018093000' SELECT POLICY FROM SYSTOOLS.POLICY WHERE MED='DB2T
D      0 x'010000000000000002000000000000000000000000000000020020101108135018328001' SELECT IBM.TID, IBM.FID FROM SYSIBM.SYSTABLES AS I
D      0 x'010000000000000002300000000000000000000000000000020020101108135018343001' SELECT POLICY FROM SYSTOOLS.POLICY WHERE MED='DB2C

```

14 record(s) selected with 1 warning messages printed.

- Based on the output of the preceding query, use the EXPLAIN\_FROM\_SECTION procedure to generate explain information from the section for the most CPU-intensive statement:

```
CALL EXPLAIN_FROM_SECTION (x'01000000000000005F0000000000000000000000000000000020020101108135629359000' , 'M', NULL, 0, NULL, ?, ?, ?, ?, ? )
```

The output of the EXPLAIN\_FROM\_SECTION procedure is as follows:

```

Value of output parameters
-----
Parameter Name : EXPLAIN_SCHEMA
Parameter Value : DB2DOCS

Parameter Name : EXPLAIN_REQUESTER
Parameter Value : DB2DOCS

Parameter Name : EXPLAIN_TIME
Parameter Value : 2010-11-08-13.57.52.984001

Parameter Name : SOURCE_NAME
Parameter Value : SQLC2H21

Parameter Name : SOURCE_SCHEMA
Parameter Value : NULLID

Parameter Name : SOURCE_VERSION
Parameter Value :

```

- You can now examine the explain information, either by examining the explain tables using SQL, or using the **db2exfmt** command to format the information for easier reading. For example, running **db2exfmt -d gsdB -e db2docs -w 2010-11-08-13.57.52.984001 -n SQLC2H21 -s NULLID -t -#0** against the explain information collected from the previous step generates the following output:

```

Connecting to the Database.
DB2 Universal Database Version 9.7, 5622-044 (c) Copyright IBM Corp. 1991, 2008
Licensed Material - Program Property of IBM
IBM DATABASE 2 Explain Table Format Tool

```

```

***** EXPLAIN INSTANCE *****
DB2_VERSION:      09.07.2
SOURCE_NAME:      SQLC2H21
SOURCE_SCHEMA:    NULLID
SOURCE_VERSION:
EXPLAIN_TIME:     2010-11-08-13.57.52.984001
EXPLAIN_REQUESTER: DB2DOCS

```

```

Database Context:
-----
Parallelism:      None
CPU Speed:        8.029852e-007
Comm Speed:       100
Buffer Pool size: 21418
Sort Heap size:   6590
Database Heap size: 1196

```

```

Lock List size:      21386
Maximum Lock List:  97
Average Applications: 1
Locks Available:    663821

```

Package Context:

```

-----
SQL Type:           Dynamic
Optimization Level: 5
Blocking:           Block All Cursors
Isolation Level:    Cursor Stability

```

----- STATEMENT 1 SECTION 201 -----

```

QUERYNO:           0
QUERYTAG:          CLP
Statement Type:    Select
Updatable:        No
Deletable:        No
Query Degree:      1

```

Original Statement:

```

-----
select cust_last_name, cust_cc_number, cust_interest_code
from gosalesct.cust_crdt_card C, gosalesct.cust_customer D,
     gosalesct.cust_interest E
where C.cust_code=d.cust_code AND c.cust_code=e.cust_code
group by d.cust_last_name,      c.cust_cc_number, e.cust_interest_code
order by d.cust_last_name ASC, c.cust_cc_number DESC, e.cust_interest_code
        ASC

```

Optimized Statement:

```

-----
SELECT Q5.CUST_LAST_NAME AS "CUST_LAST_NAME", Q5.CUST_CC_NUMBER AS
     "CUST_CC_NUMBER", Q5.CUST_INTEREST_CODE AS "CUST_INTEREST_CODE"
FROM
  (SELECT Q4.CUST_LAST_NAME, Q4.CUST_CC_NUMBER, Q4.CUST_INTEREST_CODE
   FROM
     (SELECT Q2.CUST_LAST_NAME, Q3.CUST_CC_NUMBER, Q1.CUST_INTEREST_CODE
      FROM GOSALESCT.CUST_INTEREST AS Q1, GOSALESCT.CUST_CUSTOMER AS Q2,
           GOSALESCT.CUST_CRDT_CARD AS Q3
      WHERE (Q3.CUST_CODE = Q1.CUST_CODE) AND (Q1.CUST_CODE = Q2.CUST_CODE))
     AS Q4
   GROUP BY Q4.CUST_INTEREST_CODE, Q4.CUST_CC_NUMBER, Q4.CUST_LAST_NAME) AS
  Q5
ORDER BY Q5.CUST_LAST_NAME, Q5.CUST_CC_NUMBER DESC, Q5.CUST_INTEREST_CODE

```

Explain level: Explain from section

Access Plan:

```

-----
Total Cost:        1255.29
Query Degree:      1

```

```

      Rows
RETURN
( 1)
Cost
I/O
|
31255
GRPBY
( 2)
1255.29
NA
|
31255
TBSCAN
( 3)
1249.02
NA
|
31255
SORT
( 4)
1242.74
NA

```

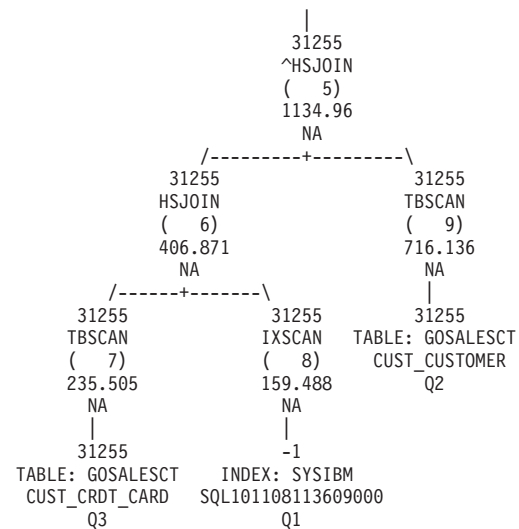

:  
 Objects Used in Access Plan:  
 -----

```

Schema: SYSIBM
Name:     SQL101108113609000
Type:     Index
Last statistics update: 2010-11-08-13.29.58.531000
Number of rows: -1
Number of buffer pool pages: -1
Distinct row values: Yes
Tablespace name: GOSALES_TS
Tablespace overhead: 7.500000
Tablespace transfer rate: 0.060000
Prefetch page count: 32
Container extent page count: 32
Index clustering statistic: 1.000000
Index leaf pages: 37
Index tree levels: 2
Index full key cardinality: 31255
Base Table Schema: GOSALESCT
Base Table Name: CUST_INTEREST
Columns in index:
  CUST_CODE(A)
  CUST_INTEREST_CODE(A)
  
```

```

Schema: GOSALESCT
Name:     CUST_CRDT_CARD
Type:     Table
Last statistics update: 2010-11-08-11.59.58.531000
Number of rows: 31255
Number of buffer pool pages: 192
Distinct row values: No
Tablespace name: GOSALES_TS
Tablespace overhead: 7.500000
Tablespace transfer rate: 0.060000
Prefetch page count: 32
Container extent page count: 32
Table overflow record count: 0
Table Active Blocks: -1
Average Row Compression Ratio: 0
Percentage Rows Compressed: 0
Average Compressed Row Size: 0
  
```

```

Schema: GOSALESCT
Name:     CUST_CUSTOMER
Type:     Table
Last statistics update: 2010-11-08-11.59.59.437000
Number of rows: 31255
Number of buffer pool pages: 672
Distinct row values: No
Tablespace name: GOSALES_TS
Tablespace overhead: 7.500000
Tablespace transfer rate: 0.060000
  
```

```

Prefetch page count:      32
Container extent page count:  32
Table overflow record count: 0
Table Active Blocks:      -1
Average Row Compression Ratio: 0
Percentage Rows Compressed: 0
Average Compressed Row Size: 0

```

Base Table For Index Not Already Shown:

```

-----
Schema: GOSALESCT
Name:   CUST_INTEREST
Time of creation:      2010-11-08-11.30.28.203002
Last statistics update: 2010-11-08-13.29.58.531000
Number of rows:       31255
Number of pages:      128
Number of pages with rows: 124
Table overflow record count: 0
Indexspace name:      GOSALES_TS
Tablespace name:      GOSALES_TS
Tablespace overhead:  7.500000
Tablespace transfer rate: 0.060000
Prefetch page count:  -1
Container extent page count: 32

Long tablespace name:  GOSALES_TS

```

(The preceding output has had several lines removed for presentation purposes.)

### What to do next

Analyze the explain output to see where there are opportunities to tune the query.

### Differences between section explain and EXPLAIN statement output:

The results obtained after issuing a section explain are similar to those collected after running the EXPLAIN statement. There are slight differences which are described per affected explain table and by the implications, if any, to the output generated by the **db2exfmt** utility.

The stored procedure output parameters EXPLAIN\_REQUESTER, EXPLAIN\_TIME, SOURCE\_NAME, SOURCE\_SCHEMA, and SOURCE\_VERSION comprise the key used to look up the information for the section in the explain tables. Use these parameters with any existing explain tools (for example, **db2exfmt**) to format the explain information retrieved from the section.

### EXPLAIN\_INSTANCE table

The following columns are set differently for the row generated by a section explain:

- EXPLAIN\_OPTION is set to value S
- SNAPSHOT\_TAKEN is always set to N
- REMARKS is always NULL

### EXPLAIN\_STATEMENT table

When a section explain has generated an explain output, the EXPLAIN\_LEVEL column is set to value S. It is important to note that the EXPLAIN\_LEVEL column is part of the primary key of the table and part of the foreign key of most other EXPLAIN tables; hence, this EXPLAIN\_LEVEL value will also be present in those other tables.

In the EXPLAIN\_STATEMENT table, the remaining column values that are usually associated with a row with EXPLAIN\_LEVEL = P, are instead present when EXPLAIN\_LEVEL = S, with the exception of SNAPSHOT. SNAPSHOT is always NULL when EXPLAIN\_LEVEL is S.

If the original statement was not available at the time the section explain was generated (for example, if the statement text was not provided to the EXPLAIN\_FROM\_DATA procedure), STATEMENT\_TEXT is set to the string UNKNOWN when EXPLAIN\_LEVEL is set to 0.

In the **db2exfmt** output for a section explain, the following extra line is shown after the optimized statement:

```
Explain level:    Explain from section
```

#### **EXPLAIN\_OPERATOR table**

Considering all of the columns recording a cost, only the TOTAL\_COST and FIRST\_ROW\_COST columns are populated with a value after a section explain. All the other columns recording cost have a value of -1.

In the **db2exfmt** output for a section explain, the following differences are obtained:

- In the access plan graph, the I/O cost is shown as NA
- In the details for each operator, the only costs shown are Cumulative Total Cost and Cumulative First Row Cost

#### **EXPLAIN\_PREDICATE table**

No differences.

#### **EXPLAIN\_ARGUMENT table**

A small number of argument types are not written to the EXPLAIN\_ARGUMENT table when a section explain is issued.

#### **EXPLAIN\_STREAM table**

The following columns do not have values after a section explain:

- SINGLE\_NODE
- PARTITION\_COLUMNS
- SEQUENCE\_SIZES

The following column always has a value of -1 after a section explain:

- PREDICATE\_ID

The following columns will have values only for streams originating from a base table object or default to no value and -1 respectively after a section explain:

- COLUMN\_NAMES
- COLUMN\_COUNT

In the **db2exfmt** output for a section explain, the information from these listed columns is omitted from the Input Streams and Output Streams section for each operator when they do not have values, or have a value of -1.



## EXPLAIN\_OBJECT table

After issuing a section explain, the STATS\_SRC column is always set to an empty string and the CREATE\_TIME column is set to NULL.

The following columns always have values of -1 after a section explain:

- COLUMN\_COUNT
- WIDTH
- FIRSTKEYCARD
- FIRST2KEYCARD
- FIRST3KEYCARD
- FIRST4KEYCARD
- SEQUENTIAL\_PAGES
- DENSITY
- AVERAGE\_SEQUENCE\_GAP
- AVERAGE\_SEQUENCE\_FETCH\_GAP
- AVERAGE\_SEQUENCE\_PAGES
- AVERAGE\_SEQUENCE\_FETCH\_PAGES
- AVERAGE\_RANDOM\_PAGES
- AVERAGE\_RANDOM\_FETCH\_PAGES
- NUMRIDS
- NUMRIDS\_DELETED
- NUM\_EMPTY\_LEAFS
- ACTIVE\_BLOCKS
- NUM\_DATA\_PART

In the **db2exfmt** output for a section explain, the information from these listed columns is omitted from the per-table and per-index statistical information found near the bottom of the output.

Section explain does not include compiler-referenced objects in its output (that is, rows where OBJECT\_TYPE starts with a +). These objects are not shown in the **db2exfmt** output.

### Capturing and accessing section actuals:

Section actuals are runtime statistics collected during the execution of the section for an access plan. To capture a section with actuals, you use the activity event monitor. To access the section actuals, you perform a section explain using the EXPLAIN\_FROM\_ACTIVITY stored procedure.

To be able to view section actuals, you must perform a section explain on a section for which section actuals were captured (that is, both the section and the section actuals are the inputs to the explain facility). Information about enabling, capturing, and accessing section actuals is provided here.

## Enabling section actuals

Section actuals will only be updated at runtime if they have been enabled. Enable section actuals for the entire database using the **section\_actuals** database configuration parameter or for a specific application using the `WLM_SET_CONN_ENV` procedure.

Section actuals will only be updated at runtime if they have been enabled. Enable section actuals using the **section\_actuals** database configuration parameter. To enable section actuals, set the parameter to `BASE` (the default value is `NONE`). For example:

```
db2 update database configuration using section_actuals base
```

To enable section actuals for a specific application, use the `WLM_SET_CONN_ENV` procedure and specify `BASE` for the **section\_actuals** element. For example:

```
CALL WLM_SET_CONN_ENV(NULL,  
    '<collectactdata>WITH DETAILS, SECTION</collectactdata>  
    <collectsectionactuals>BASE</collectsectionactuals>  
    ')
```

### Note:

1. The setting of the **section\_actuals** database configuration parameter that was in effect at the start of the unit of work is applied to all statements in that unit of work. When the **section\_actuals** database configuration parameter is changed dynamically, the new value will not be seen by an application until the next unit of work.
2. The **section\_actuals** setting specified by the `WLM_SET_CONN_ENV` procedure for an application takes effect immediately. Section actuals will be collected for the next statement issued by the application.
3. Section actuals cannot be enabled if automatic statistics profile generation is enabled (SQLCODE -5153).

## Capturing section actuals

The mechanism for capturing a section, with section actuals, is the activity event monitor. An activity event monitor writes out details of an activity when the activity completes execution, if collection of activity information is enabled. Activity information collection is enabled using the `COLLECT ACTIVITY DATA` clause on a workload, service class, threshold, or work action. To specify collection of a section and actuals (if the latter is enabled), the `SECTION` option of the `COLLECT ACTIVITY DATA` clause is used. For example, the following statement indicates that any SQL statement, issued by a connection associated with the `WL1` workload, will have information (including section and actuals) collected by any active activity event monitor when the statement completes:

```
ALTER WORKLOAD WL1 COLLECT ACTIVITY DATA WITH DETAILS,SECTION
```

In a partitioned database environment, section actuals are captured by an activity event monitor on all partitions where the activity was executed, if the statement being executed has a `COLLECT ACTIVITY DATA` clause applied to it and the `COLLECT ACTIVITY DATA` clause specifies both the `SECTION` keyword and the `ON ALL DATABASE PARTITIONS` clause. If the `ON ALL DATABASE PARTITIONS` clause is not specified, then actuals are captured on only the coordinator partition. In addition, besides the `COLLECT ACTIVITY DATA` clause on a workload, service class, threshold, or work action, activity collection can be

enabled (for an individual application) using the `WLM_SET_CONN_ENV` procedure with a second argument that includes the `collectactdata` tag with a value of "WITH DETAILS, SECTION".

### Limitations

The limitations, with respect to the capture of section actuals, are the following:

- Section actuals will not be captured when the `WLM_CAPTURE_ACTIVITY_IN_PROGRESS` stored procedure is used to send information about a currently executing activity to an activity event monitor. Any activity event monitor record generated by the `WLM_CAPTURE_ACTIVITY_IN_PROGRESS` stored procedure will have a value of 1 in its `partial_record` column.
- When a reactive threshold has been violated, section actuals will be captured on only the coordinator partition.
- Explain tables must be migrated to DB2 Version 9.7 Fix Pack 1, or later, before section actuals can be accessed using a section explain. If the explain tables have not been migrated, the section explain will work, but section actuals information will not be populated in the explain tables. In this case, an entry will be written to the `EXPLAIN_DIAGNOSTIC` table.
- Existing DB2 V9.7 activity event monitor tables (in particular, the activity table) must be recreated before section actuals data can be captured by the activity event monitor. If the activity logical group does not contain the `SECTION_ACTUALS` column, a section explain may still be performed using a section captured by the activity event monitor, but the explain will not contain any section actuals data.

### Accessing section actuals

Section actuals can be accessed using the `EXPLAIN_FROM_ACTIVITY` procedure. When you perform a section explain on an activity for which section actuals were captured, the `EXPLAIN_ACTUALS` explain table will be populated with the actuals information.

**Note:** Section actuals are only available when a section explain is performed using the `EXPLAIN_FROM_ACTIVITY` procedure.

The `EXPLAIN_ACTUALS` table is the child table of the existing `EXPLAIN_OPERATOR` explain table. When `EXPLAIN_FROM_ACTIVITY` is invoked, if the section actuals are available, the `EXPLAIN_ACTUALS` table will be populated with the actuals data. If the section actuals are collected on multiple database partitions, there is one row per database partition for each operator in the `EXPLAIN_ACTUALS` table.

*Obtaining a section explain with actuals to investigate poor query performance:*

To resolve a SQL query performance slow down, you can begin by obtaining a section explain that includes section actuals information. The section actuals values can then be compared with the estimated access plan values generated by the optimizer to assess the validity of the access plan. This task takes you through the process of obtaining section actuals to investigate poor query performance.

## Before you begin

You have completed the diagnosis phase of your investigation and determined that indeed you have a SQL query performance slow down and you have determined which statement is suspected to be involved in the performance slow down.

## About this task

This task takes you through the process of obtaining section actuals to investigate poor query performance. The information contained in the sections actuals, when compared with the estimated values generated by the optimizer, can help to resolve the query performance slow down.

## Restrictions

See the limitations in “Capturing and accessing section actuals”.

## Procedure

To investigate poor query performance for a query executed by the myApp.exe application, complete the following steps:

1. Enable section actuals:

```
DB2 UPDATE DATABASE CONFIGURATION USING SECTION_ACTUALS BASE
```

2. Create the EXPLAIN tables in the MYSCHEMA schema using the SYSINSTALLOBJECTS procedure:

```
CALL SYSINSTALLOBJECTS( 'EXPLAIN', 'C', NULL, 'MYSCHEMA' )
```

**Note:** This step can be skipped if you have already created the EXPLAIN tables.

3. Create a workload MYCOLLECTWL to collect activities submitted by the myApp.exe application and enable collection of section data for those activities by issuing the following two commands:

```
CREATE WORKLOAD MYCOLLECTWL APPLNAME( 'MYAPP.EXE' )  
COLLECT ACTIVITY DATA WITH DETAILS,SECTION
```

Followed by:

```
GRANT USAGE ON WORKLOAD MYCOLLECTWL TO PUBLIC
```

**Note:** Choosing to use a separate workload limits the amount of information captured by the activity event monitor

4. Create an activity event monitor, called ACTEVMON, by issuing the following statement:

```
CREATE EVENT MONITOR ACTEVMON FOR ACTIVITIES WRITE TO TABLE
```

5. Activate the activity event monitor ACTEVMON by executing the following statement:

```
SET EVENT MONITOR ACTEVMON STATE 1
```

6. Run the myApp.exe application. All statements, issued by the application, are captured by the activity event monitor.

7. Query the activity event monitor tables to find the identifier information for the statement of interest by issuing the following statement:

```
SELECT APPL_ID,  
       UOW_ID,  
       ACTIVITY_ID,  
       STMT_TEXT  
FROM ACTIVITYSTMT_ACTEVMON
```

The following is an example of the output that was generated as a result of the issued select statement:

```

APPL_ID          UOW_ID  ACTIVITY_ID  STMT_TEXT
-----
*N2.DB2INST1.0B5A12222841      1      1  SELECT * FROM ...

```

8. Use the activity identifier information as input to the EXPLAIN\_FROM\_ACTIVITY procedure to obtain a section explain with actuals, as shown in the following call statement:

```
CALL EXPLAIN_FROM_ACTIVITY( '*N2.DB2INST1.0B5A12222841', 1, 1, 'ACTEVMON',
'MYSCHEMA', '?', '?', '?', '?', '?' )
```

The following is a sample output resulting from the EXPLAIN\_FROM\_ACTIVITY call:

```

Value of output parameters
-----
Parameter Name : EXPLAIN_SCHEMA
Parameter Value : MYSCHEMA

Parameter Name : EXPLAIN_REQUESTER
Parameter Value : SWALKTY

Parameter Name : EXPLAIN_TIME
Parameter Value : 2009-08-24-12.33.57.525703

Parameter Name : SOURCE_NAME
Parameter Value : SQLC2H20

Parameter Name : SOURCE_SCHEMA
Parameter Value : NULLID

Parameter Name : SOURCE_VERSION
Parameter Value :

Return Status = 0

```

9. Format the explain data using the **db2exfmt** command and specifying, as input, the explain instance key that was returned as output from the EXPLAIN\_FROM\_ACTIVITY procedure, such as the following:

```
db2exfmt -d test -w 2009-08-24-12.33.57.525703 -n SQLC2H20 -s NULLID -# 0 -t
```

The explain instance output was the following:

```

***** EXPLAIN INSTANCE *****
DB2_VERSION:      09.07.1
SOURCE_NAME:      SQLC2H20
SOURCE_SCHEMA:    NULLID
SOURCE_VERSION:
EXPLAIN_TIME:     2009-08-24-12.33.57.525703
EXPLAIN_REQUESTER: SWALKTY

```

Database Context:

```

-----
Parallelism:      None
CPU Speed:        4.000000e-05
Comm Speed:       0
Buffer Pool size: 198224
Sort Heap size:   1278
Database Heap size: 2512
Lock List size:   6200
Maximum Lock List: 60
Average Applications: 1
Locks Available:  119040

```

Package Context:

```
-----
```

```

SQL Type:           Dynamic
Optimization Level: 5
Blocking:           Block All Cursors
Isolation Level:   Cursor Stability

```

----- STATEMENT 1 SECTION 201 -----

```

QUERYNO:           0
QUERYTAG:          CLP
Statement Type:    Select
Updatable:         No
Deletable:         No
Query Degree:      1

```

Original Statement:

```

-----
select *
from syscat.tables

```

Optimized Statement:

```

-----
SELECT Q10.$C67 AS "TABSHEMA", Q10.$C66 AS "TABNAME", Q10.$C65 AS "OWNER",
       Q10.$C64 AS "OWNERTYPE", Q10.$C63 AS "TYPE", Q10.$C62 AS "STATUS",
       Q10.$C61 AS "BASE_TABSCHEMA", Q10.$C60 AS "BASE_TABNAME", Q10.$C59 AS
       "ROWTYPESHEMA", Q10.$C58 AS "ROWTYPENAME", Q10.$C57 AS "CREATE_TIME",
       Q10.$C56 AS "ALTER_TIME", Q10.$C55 AS "INVALIDATE_TIME", Q10.$C54 AS
       "STATS_TIME", Q10.$C53 AS "COLCOUNT", Q10.$C52 AS "TABLEID", Q10.$C51
       AS "TBSPACEID", Q10.$C50 AS "CARD", Q10.$C49 AS "NPAGES", Q10.$C48 AS
       "FPAGES", Q10.$C47 AS "OVERFLOW", Q10.$C46 AS "TBSPACE", Q10.$C45 AS
       "INDEX_TBSPACE", Q10.$C44 AS "LONG_TBSPACE", Q10.$C43 AS "PARENTS",
       Q10.$C42 AS "CHILDREN", Q10.$C41 AS "SELFREFS", Q10.$C40 AS
       "KEYCOLUMNS", Q10.$C39 AS "KEYINDEXID", Q10.$C38 AS "KEYUNIQUE",
       Q10.$C37 AS "CHECKCOUNT", Q10.$C36 AS "DATACAPTURE", Q10.$C35 AS
       "CONST_CHECKED", Q10.$C34 AS "PMAP_ID", Q10.$C33 AS "PARTITION_MODE",
       '0' AS "LOG_ATTRIBUTE", Q10.$C32 AS "PCTFREE", Q10.$C31 AS
       "APPEND_MODE", Q10.$C30 AS "REFRESH", Q10.$C29 AS "REFRESH_TIME",
...

```

Explain level: Explain from section

Access Plan:

```

-----
Total Cost:           154.035
Query Degree:         1

Rows
Rows Actual
RETURN
( 1)
Cost
I/O
|
54
396
>^HSJOIN
( 2)
153.056
NA
/-----+-----\
54                      20
396                      0
>^HSJOIN                 TBSCAN
( 3)                     ( 12)
140.872                  11.0302
NA                        NA
(continued below)        |

```

(continued from above)

```

/-----+-----\
54 6
396 0
>^HSJOIN IXSCAN
( 4) ( 11)
138.033 2.01136
NA NA
|
/-----+-----\
54 6
396 0
>^HSJOIN IXSCAN INDEX: SYSIBM
( 5) ( 10) INDCOLLATIONS04
135.193 2.01136
NA NA
|
/-----+-----\
54 6
396 0
>^HSJOIN IXSCAN INDEX: SYSIBM
( 6) ( 9) INDCOLLATIONS04
132.354 2.01136
NA NA
|
/-----+-----\
54 6
396 0
TBSCAN IXSCAN INDEX: SYSIBM
( 7) ( 8) INDCOLLATIONS04
129.57 2.01136
NA NA
|
54 -1
NA NA
TABLE: SYSIBM INDEX: SYSIBM
SYSTABLES INDCOLLATIONS04
  
```

...

10. Examine the section actuals information in the explain output. Compare the section actuals values with the estimated values of the access plan generated by the optimizer. If a discrepancy occurs between the section actuals and estimated values for the access plan, ascertain what is causing the discrepancy and take the appropriate action. As an example for the purposes of discussion, you ascertain that the table statistics are out of date for one of the tables being queried. This leads the optimizer to select an incorrect access plan which might account for the query performance slow down. The course of action to take, in this case, is to run the **RUNSTATS** command on the table to update the table statistics.
11. Retry the application to determine if the query slow down persists.

**Analysis of section actuals information in explain output:**

Section actuals, when available, are displayed in different parts of the explain output. Where to find section actuals information, operator details, and object statistics in explain output is described here.

## Section actuals in db2exfmt command graph output

If explain actuals are available, they are displayed in the graph under the estimated rows. Graph output includes actuals only for operators, not for objects. NA (not applicable) is displayed for objects in the graph.

An example of graph output from the **db2exfmt** command is as follows:

```

      Rows
Rows Actual
      RETURN
      ( 1)
      Cost
      I/O
      |
      3.21948 << The estimated rows that are used by the optimizer
      301 << The actuals rows that are collected in run time
      DTQ
      ( 2)
      75.3961
      NA
      |
      3.21948
      130
      HSJOIN
      ( 3)
      72.5927
      NA
      /--+----\
      674      260
      220    130
      TBSCAN  TBSCAN
      ( 4)    ( 5)
      40.7052 26.447
      NA      NA
      |      |
      337    130
      NA    NA << Graph output does not include actuals for objects
      TABLE: FF  TABLE: FF
      T1          T2
```

In a partitioned database environment, the cardinality that is displayed in the graph is the average cardinality for the database partitions where the actuals are collected. The average is displayed because that is the value that is estimated by the optimizer. The actual average is a meaningful value to compare against the estimated average. In addition, a breakdown of section actuals per database partition is provided in the operator details output. You can examine these details to determine other information, such as total (across all partitions), minimum, and maximum.

## Operator details in db2exfmt command output

The actual cardinality for an operator is displayed in the stream section following the line containing Estimated number of rows (Actual number of rows in the explain output). In a partitioned database environment, if the operator is running on more than one database member, the actual cardinality that is displayed is the average cardinality for the environment. The values per database partition are displayed under a separate section, Explain Actuals. This section is shown only for a partitioned database environment, but not in the serial mode. If the actuals are not available for a particular database partition, NA is displayed in the list of values per database partition next to the partition number. Actual number of rows in the section Output Streams is also shown as NA.



An example of operator details output from the **db2exfmt** command is as follows:

```
9) UNION : (Union)
Cumulative Total Cost:    10.6858
Cumulative First Row Cost:  9.6526

Arguments:
-----
UNIONALL: (UnionAll Parameterized Base Table)
DISJOINT

Input Streams:
-----
 5) From Operator #10

    Estimated number of rows: 30
    Actual number of rows:   63
    Partition Map ID:        3

 7) From Operator #11

    Estimated number of rows: 16
    Actual number of rows:   99
    Partition Map ID:        3

Output Streams:
-----
 8) To Operator #8

    Estimated number of rows: 30
    Actual number of rows:  162
    Partition Map ID:        3

Explain Actuals:    << This section is shown only show in a partitioned database environment
-----
  DB Partition number  Cardinality
  -----
           1             193
           2             131
```

### Object statistics in db2exfmt command output

The explain output includes statistics for each object that is used in the access plan. For partitioned tables and indexes, the statistics are per data partition. In a partitioned database environment or DB2 pureScale environment, the statistics are per member. If the statistics are not available for a particular member, NA is displayed in the values list for that member next to the member number.

The following example shows how object statistics are displayed in the output of the **db2exfmt** command:

```
Runtime statistics for objects Used in Access Plan:
-----

Schema: GOSALES
Name:   ORDER_DETAILS
Type:   Table

          Member 0
          -----

                Metrics
                -----
lock_wait_time:85899
lock_wait_time_global:25769
```

```
lock_waits_local:21474
lock_waits_global:85899
lock_escals_local:17179
lock_escals_global:2
direct_writes:12884
direct_read_reqs:1
pool_data_gbp_invalid_pages:446
pool_data_lbp_pages_found:445
pool_xda_l_reads:446
pool_xda_p_reads:15
```

## Guidelines for using explain information

You can use explain information to understand why application performance has changed or to evaluate performance tuning efforts.

### Analysis of performance changes

To help you understand the reasons for changes in query performance, you need “before and after” explain information, which you can obtain by performing the following steps:

1. Capture explain information for the query before you make any changes and save the resulting explain tables. Alternatively, save output from the **db2exfmt** explain tool.
2. Save or print the current catalog statistics. You could use the **db2look** productivity tool to help you perform this task.
3. Save or print the data definition language (DDL) statements, including CREATE TABLE, CREATE VIEW, CREATE INDEX, or CREATE TABLESPACE.

The information that you collect in this way provides a reference point for future analysis. For dynamic SQL or XQuery statements, you can collect this information when you run your application for the first time. For static SQL and XQuery statements, you can collect this information at bind time. To analyze a performance change, compare the information that you collect with this reference information that was collected previously.

For example, your analysis might show that an index is no longer being used when determining an access path. Using the catalog statistics information, you might notice that the number of index levels (the NLEVELS column) is now substantially higher than when the query was first bound to the database. You might then choose to perform one of the following actions:

- Reorganize the index
- Collect new statistics for your table and indexes
- Collect explain information when rebinding your query

After you perform one of these actions, examine the access plan again. If the index is being used, query performance might no longer be a problem. If the index is still not being used, or if performance is still a problem, choose another action from this list and examine the results. Repeat these steps until the problem is resolved.

### Evaluation of performance tuning efforts

You can take a number of actions to help improve query performance, such as updating configuration parameters, adding containers, collecting fresh catalog statistics, and so on.

After you make a change in any of these areas, use the explain facility to determine what affect, if any, the change has had on the chosen access plan. For example, if you add an index or materialized query table (MQT) based on the index guidelines, the explain data can help you to determine if the index or MQT is actually being used as expected.

Although the explain output enables you to determine the access plan that was chosen and its relative cost, the only way to accurately measure the performance improvement for a specific query is to use benchmark testing techniques.

### Guidelines for analyzing explain information

The primary use for explain information is the analysis of access paths for query statements. There are a number of ways in which analyzing the explain data can help you to tune your queries and environment.

Consider the following kinds of analysis:

- Index use

The proper indexes can significantly benefit performance. Using explain output, you can determine whether the indexes that you have created to help a specific set of queries are being used. Look for index usage in the following areas:

- Join predicates
- Local predicates
- GROUP BY clause
- ORDER BY clause
- WHERE XMLEXISTS clause
- The select list

You can also use the explain facility to evaluate whether a different index or no index at all might be better. After you create a new index, use the **RUNSTATS** command to collect statistics for that index, and then recompile your query. Over time, you might notice (through explain data) that a table scan is being used instead of an index scan. This can result from a change in the clustering of the table data. If the index that was previously being used now has a low cluster ratio, you might want to:

- Reorganize the table to cluster its data according to that index
- Use the **RUNSTATS** command to collect statistics for both index and table
- Recompile the query

To determine whether reorganizing the table has improved the access plan, examine explain output for the recompiled query.

- Access type

Analyze the explain output, and look for data access types that are not usually optimal for the type of application that you are running. For example:

- Online transaction processing (OLTP) queries

OLTP applications are prime candidates for index scans with range-delimiting predicates, because they tend to return only a few rows that are qualified by an equality predicate against a key column. If your OLTP queries are using a table scan, you might want to analyze the explain data to determine why an index scan is not being used.

- Browse-only queries

The search criteria for a “browse” type query can be very vague, resulting in a large number of qualifying rows. If users usually look at only a few screens of output data, you might specify that the entire answer set need not be

computed before some results are returned. In this case, the goals of the user are different than the basic operating principle of the optimizer, which attempts to minimize resource consumption for the entire query, not just the first few screens of data.

For example, if the explain output shows that both merge scan join and sort operators were used in the access plan, the entire answer set will be materialized in a temporary table before any rows are returned to the application. In this case, you can attempt to change the access plan by using the OPTIMIZE FOR clause on the SELECT statement. If you specify this option, the optimizer can attempt to choose an access plan that does not produce the entire answer set in a temporary table before returning the first rows to the application.

- **Join methods**

If a query joins two tables, check the type of join being used. Joins that involve more rows, such as those in decision-support queries, usually run faster with a hash join or a merge join. Joins that involve only a few rows, such as those in OLTP queries, typically run faster with nested-loop joins. However, there might be extenuating circumstances in either case—such as the use of local predicates or indexes—that could change how these typical joins work.

## **Using access plans to self-diagnose performance problems with REFRESH TABLE and SET INTEGRITY statements**

Invoking the explain utility against REFRESH TABLE or SET INTEGRITY statements enables you to generate access plans that can be used to self-diagnose performance problems with these statements. This can help you to better maintain your materialized query tables (MQTs).

To get the access plan for a REFRESH TABLE or a SET INTEGRITY statement, use either of the following methods:

- Use the EXPLAIN PLAN FOR REFRESH TABLE or EXPLAIN PLAN FOR SET INTEGRITY option on the EXPLAIN statement.
- Set the CURRENT EXPLAIN MODE special register to EXPLAIN before issuing the REFRESH TABLE or SET INTEGRITY statement, and then set the CURRENT EXPLAIN MODE special register to NO afterwards.

### **Restrictions**

- The REFRESH TABLE and SET INTEGRITY statements do not qualify for re-optimization; therefore, the REOPT explain mode (or explain snapshot) is not applicable to these two statements.
- The WITH REOPT ONCE clause of the EXPLAIN statement, which indicates that the specified explainable statement is to be re-optimized, is not applicable to the REFRESH TABLE and SET INTEGRITY statements.

### **Scenario**

This scenario shows how you can generate and use access plans from EXPLAIN and REFRESH TABLE statements to self-diagnose the cause of your performance problems.

1. Create and populate your tables. For example:

```
create table t (  
  i1 int not null,  
  i2 int not null,  
  primary key (i1)  
);
```

```

insert into t values (1,1), (2,1), (3,2), (4,2);

create table mqt as (
  select i2, count(*) as cnt from t group by i2
)
data initially deferred
refresh deferred;

```

- Issue the EXPLAIN and REFRESH TABLE statements, as follows:

```
explain plan for refresh table mqt;
```

This step can be replaced by setting the EXPLAIN mode on the SET CURRENT EXPLAIN MODE special register, as follows:

```

set current explain mode explain;
refresh table mqt;
set current explain mode no;

```

- Use the **db2exfmt** command to format the contents of the explain tables and obtain the access plan. This tool is located in the `misc` subdirectory of the instance `sqliib` directory.

```
db2exfmt -d dbname -o refresh.exp -1
```
- Analyze the access plan to determine the cause of the performance problem. In the previous example, if T is a large table, a table scan would be very expensive. Creating an index might improve the performance of the query.

### Tools for collecting and analyzing explain information

The DB2 database server has a comprehensive explain facility that provides detailed information about the access plan that the optimizer chooses for an SQL or XQuery statement.

The tables that store explain data are accessible on all supported platforms and contain information for both static and dynamic SQL and XQuery statements. Several tools are available to give you the flexibility that you need to capture, display, and analyze explain information.

Detailed query optimizer information that enables the in-depth analysis of an access plan is stored in explain tables that are separate from the actual access plan itself. Use one or more of the following methods to get information from the explain tables:

- Use the **db2exfmt** tool to display explain information in formatted output.
- Write your own queries against the explain tables. Writing your own queries enables the easy manipulation of output, comparisons among different queries, or comparisons among executions of the same query over time.

Use the **db2expln** tool to see the access plan information that is available for one or more packages of static SQL or XQuery statements. This utility shows the actual implementation of the chosen access plan; it does not show optimizer information. By examining the generated access plan, the **db2expln** tool provides a relatively compact, verbal overview of the operations that will occur at run time.

The command line explain tools can be found in the `misc` subdirectory of the `sqliib` directory.

The following table summarizes the different tools that are available with the DB2 explain facility. Use this table to select the tool that is most suitable for your environment and needs.

Table 61. Explain Facility Tools

Desired characteristics	Explain tables	db2expln	db2exfmt
Text output		Yes	Yes
“Quick and dirty” static SQL and XQuery analysis		Yes	
Static SQL and XQuery support	Yes	Yes	Yes
Dynamic SQL and XQuery support	Yes	Yes	Yes
CLI application support	Yes		Yes
Available to DRDA® Application Requesters	Yes		
Detailed optimizer information	Yes		Yes
Suited for analysis of multiple statements	Yes	Yes	Yes
Information is accessible from within an application	Yes		

In addition to these tools, you can use IBM Data Studio Version 3.1 or later to generate a diagram of the current access plan for SQL or XPATH statements. For more details, see *Diagramming access plans with Visual Explain*.

### Displaying catalog statistics that are in effect at explain time

The explain facility captures the statistics that are in effect when a statement is explained. These statistics might be different than those that are stored in the system catalog, especially if real-time statistics gathering is enabled. If the explain tables are populated, but an explain snapshot was not created, only some statistics are recorded in the EXPLAIN\_OBJECT table.

To capture all catalog statistics that are relevant to the statement being explained, create an explain snapshot at the same time that explain tables are being populated, then use the SYSPROC.EXPLAIN\_FORMAT\_STATS scalar function to format the catalog statistics in the snapshot.

If the **db2exfmt** tool is used to format the explain information, and an explain snapshot was collected, the tool automatically uses the SYSPROC.EXPLAIN\_FORMAT\_STATS function to display the catalog statistics.

### SQL and XQuery explain tool

The **db2expln** command describes the access plan selected for SQL or XQuery statements.

You can use this tool to obtain a quick explanation of the chosen access plan when explain data was not captured. For static SQL and XQuery statements, **db2expln** examines the packages that are stored in the system catalog. For dynamic SQL and XQuery statements, **db2expln** examines the sections in the query cache.

The explain tool is located in the bin subdirectory of your instance sqllib directory. If **db2expln** is not in your current directory, it must be in a directory that appears in your PATH environment variable.

The **db2expln** command uses the db2expln.bnd, db2exsrv.bnd, and db2exdyn.bnd files to bind itself to a database the first time the database is accessed.

### Description of `db2expln` output:

Explain output from the `db2expln` command includes both package information and section information for each package.

- Package information includes the date of the bind operation and relevant bind options
- Section information includes the section number and the SQL or XQuery statement being explained

Explain output pertaining to the chosen access plan for the SQL or XQuery statement appears below the section information.

The steps of an access plan, or section, are presented in the order that the database manager executes them. Each major step is shown as a left-aligned heading with information about that step indented below it. Indentation bars are displayed in the left margin of the explain output for an access plan. These bars also mark the scope of each operation. Operations at a lower level of indentation, farther to the right, are processed before those that appear in the previous level of indentation.

The chosen access plan is based on an augmented version of the original SQL statement, the *effective SQL statement* if statement concentrator is enabled, or the XQuery statement that is shown in the output. Because the query rewrite component of the compiler might convert the SQL or XQuery statement into an equivalent but more efficient format, the access plan shown in explain output might differ substantially from what you expect. The explain facility, which includes the explain tables, and the SET CURRENT EXPLAIN MODE statement, shows the actual SQL or XQuery statement that was used for optimization in the form of an SQL- or XQuery-like statement that is created by reverse-translating the internal representation of the query.

When you compare output from `db2expln` to output from the explain facility, the operator ID option (-opids) can be useful. Each time that `db2expln` begins processing a new operator from the explain facility, the operator ID number is printed to the left of the explained plan. The operator IDs can be used to compare steps in the different representations of the access plan. Note that there is not always a one-to-one correspondence between the operators in explain facility output and the operations shown by `db2expln`.

#### *Table access information:*

A statement in `db2expln` output provides the name and type of table being accessed.

Information about regular tables includes one of the following table access statements:

```
Access Table Name = schema.name ID = ts,n
Access Hierarchy Table Name = schema.name ID = ts,n
Access Materialized Query Table Name = schema.name ID = ts,n
```

where:

- *schema.name* is the fully-qualified name of the table being accessed
- ID is the corresponding TABLESPACEID and TABLEID from the SYSCAT.TABLES catalog view entry for the table

Information about temporary tables includes one of the following table access statements:

```
Access Temp Table ID = tn
Access Global Temp Table ID = ts,tn
```

where ID is the corresponding TABLESPACEID from the SYSCAT.TABLES catalog view entry for the table (*ts*) or the corresponding identifier assigned by **db2expln** (*tn*).

After the table access statement, the following additional statements are provided to further describe the access.

- Number of columns
- Block access
- Parallel scan
- Scan direction
- Row access
- Lock intent
- Predicate
- Miscellaneous

#### **Number of columns statement**

The following statement indicates the number of columns that are being used from each row of the table:

```
#Columns = n
```

#### **Block access statement**

The following statement indicates that the table has one or more dimension block indexes defined on it:

```
Clustered by Dimension for Block Index Access
```

If this statement does not appear, the table was created without the ORGANIZE BY DIMENSIONS clause.

#### **Parallel scan statement**

The following statement indicates that the database manager will use several subagents to read the table in parallel:

```
Parallel Scan
```

If this statement does not appear, the table will be read by only one agent (or subagent).

#### **Scan direction statement**

The following statement indicates that the database manager will read rows in reverse order:

```
Scan Direction = Reverse
```

If this statement does not appear, the scan direction is forward, which is the default.



## Row access statements

One of the following statements will indicate how qualifying rows in the table are being accessed.

- The Relation Scan statement indicates that the table is being sequentially scanned for qualifying rows.
  - The following statement indicates that no prefetching of data will be done:

```
Relation Scan
| Prefetch: None
```

- The following statement indicates that the optimizer has determined the number of pages that will be prefetched:

```
Relation Scan
| Prefetch: n Pages
```

- The following statement indicates that data should be prefetched:

```
Relation Scan
| Prefetch: Eligible
```

- The following statement indicates that qualifying rows are being identified and accessed through an index:

```
Index Scan: Name = schema.name ID = xx
| Index type
| Index Columns:
```

where:

- *schema.name* is the fully-qualified name of the index that is being scanned
- ID is the corresponding IID column in the SYSCAT.INDEXES catalog view
- Index type is one of:

```
Regular index (not clustered)
Regular index (clustered)
Dimension block index
Composite dimension block index
Index over XML data
```

This is followed by one line of output for each column in the index. Valid formats for this information are as follows:

```
n: column_name (Ascending)
n: column_name (Descending)
n: column_name (Include Column)
```

The following statements are provided to clarify the type of index scan.

- The range-delimiting predicates for the index are shown by the following statements:

```
#Key Columns = n
| Start Key: xxxxx
| Stop Key: xxxxx
```

where *xxxxx* is one of:

- Start of Index
- End of Index
- Inclusive Value: or Exclusive Value:

An inclusive key value will be included in the index scan. An exclusive key value will not be included in the scan. The value of the key is determined by one of the following items for each part of the key:

```
n: 'string'
n: nnn
n: yyyy-mm-dd
```

```

n: hh:mm:ss
n: yyyy-mm-dd hh:mm:ss.uuuuuu
n: NULL
n: ?

```

Only the first 20 characters of a literal string are displayed. If the string is longer than 20 characters, this is indicated by an ellipsis (...) at the end of the string. Some keys cannot be determined until the section is executed. This is indicated by a question mark (?) as the value.

– Index-Only Access

If all of the needed columns can be obtained from the index key, this statement displays and no table data will be accessed.

- The following statement indicates that no prefetching of index pages will be done:

```
Index Prefetch: None
```

- The following statement indicates that for index prefetching sequential detection prefetching is enabled and it shows the MAXPAGES value for this type of prefetching denoted by *x*:

```
Index Prefetch: Sequential (x)
```

- The following statement indicates that for index prefetching readahead prefetching is enabled:

```
Index Prefetch: Readahead
```

- The following statement indicates that for index prefetching sequential detection and readahead prefetching are enabled. It also shows the MAXPAGES value for sequential detection prefetching denoted by *x*:

```
Index Prefetch: Sequential (x), Readahead
```

- The following statement indicates that no prefetching of data pages will be done:

```
Data Prefetch: None
```

- The following statement indicates that for data prefetching sequential detection prefetching is enabled and it shows the MAXPAGES value for this type of prefetching denoted by *x*:

```
Data Prefetch: Sequential (x)
```

- The following statement indicates that for data prefetching readahead prefetching is enabled:

```
Data Prefetch: Readahead
```

- The following statement indicates that for data prefetching sequential detection and readahead prefetching are enabled. It also shows the MAXPAGES value for sequential detection prefetching denoted by *x*:

```
Data Prefetch: Sequential (x), Readahead
```

- If there are predicates that can be passed to the index manager to help qualify index entries, the following statement is used to show the number of these predicates:

```
Sargable Index Predicate(s)
| #Predicates = n
```

- If the qualifying rows are being accessed through row IDs (RIDs) that were prepared earlier in the access plan, this will be indicated by the following statement:

```
Fetch Direct Using Row IDs
```

If the table has one or more block indexes defined on it, rows can be accessed by either block or row IDs. This is indicated by the following statement:

**Lock intent statements**

For each table access, the type of lock that will be acquired at the table and row levels is shown with the following statement:

```
Lock Intents
| Table: xxxx
| Row : xxxx
```

Possible values for a table lock are:

- Exclusive
- Intent Exclusive
- Intent None
- Intent Share
- Share
- Share Intent Exclusive
- Super Exclusive
- Update

Possible values for a row lock are:

- Exclusive
- Next Key Weak Exclusive
- None
- Share
- Update

**Predicate statements**

There are three types of statement that provide information about the predicates that are used in an access plan.

- The following statement indicates the number of predicates that will be evaluated for each block of data that is retrieved from a blocked index:

```
Block Predicate(s)
| #Predicates = n
```

- The following statement indicates the number of predicates that will be evaluated while the data is being accessed. This number does not include pushdown operations, such as aggregation or sort:

```
Sargable Predicate(s)
| #Predicates = n
```

- The following statement indicates the number of predicates that will be evaluated after the data has been returned:

```
Residual Predicate(s)
| #Predicates = n
```

The number of predicates shown in these statements might not reflect the number of predicates that are provided in the query statement, because predicates can be:

- Applied more than once within the same query
- Transformed and extended with the addition of implicit predicates during the query optimization process
- Transformed and condensed into fewer predicates during the query optimization process

## Miscellaneous table statements

- The following statement indicates that only one row will be accessed:  
Single Record
- The following statement appears when the isolation level that is used for table access is different than the isolation level for the statement:  
Isolation Level: xxxx

There are a number of possible reasons for this. For example:

- A package that was bound with the repeatable read (RR) isolation level is impacting certain referential integrity constraints; access to the parent table for the purpose of checking these constraints is downgraded to the cursor stability (CS) isolation level to avoid holding unnecessary locks on this table.
  - A package that was bound with the uncommitted read (UR) isolation level includes a DELETE statement; access to the table for the delete operation is upgraded to CS.
- The following statement indicates that some or all of the rows that are read from a temporary table will be cached outside of the buffer pool if sufficient **sortheap** memory is available:  
Keep Rows In Private Memory
  - The following statement indicates that the table has the volatile cardinality attribute set:  
Volatile Cardinality

### *Temporary table information:*

A temporary table is used as a work table during access plan execution. Generally, temporary tables are used when subqueries need to be evaluated early in the access plan, or when intermediate results will not fit into the available memory.

If a temporary table is needed, one of the following statements will appear in **db2expln** command output.

```
Insert Into Temp Table ID = tn --> ordinary temporary table
Insert Into Shared Temp Table ID = tn --> ordinary temporary table will be created
                                         by multiple subagents in parallel
Insert Into Sorted Temp Table ID = tn --> sorted temporary table
Insert Into Sorted Shared Temp Table ID = tn --> sorted temporary table will be created
                                         by multiple subagents in parallel

Insert Into Global Temp Table ID = ts,tn --> declared global temporary table
Insert Into Shared Global Temp Table ID = ts,tn --> declared global temporary table
                                                will be created by multiple subagents
                                                in parallel
Insert Into Sorted Global Temp Table ID = ts,tn --> sorted declared global temporary table
Insert Into Sorted Shared Global Temp Table ID = ts,tn --> sorted declared global temporary
                                                table will be created by
                                                multiple subagents in parallel
```

The ID is an identifier that is assigned by **db2expln** for convenience when referring to the temporary table. This ID is prefixed with the letter 't' to indicate that the table is a temporary table.

Each of these statements is followed by:

```
#Columns = n
```

which indicates how many columns there are in each row that is being inserted into the temporary table.

## Sorted temporary tables

Sorted temporary tables can result from such operations as:

- ORDER BY
- DISTINCT
- GROUP BY
- Merge join
- '= ANY' subquery
- '<> ALL' subquery
- INTERSECT or EXCEPT
- UNION (without the ALL keyword)

A number of statements that are associated with a sorted temporary table can appear in **db2exp1n** command output.

- The following statement indicates the number of key columns that are used in the sort:

```
#Sort Key Columns = n
```

One of the following lines is displayed for each column in the sort key:

```
Key n: column_name (Ascending)
Key n: column_name (Descending)
Key n: (Ascending)
Key n: (Descending)
```

- The following statements provide estimates of the number of rows and the row size so that the optimal sort heap can be allocated at run time:

```
Sortheap Allocation Parameters:
| #Rows      = n
| Row Width = n
```

- The following statement is displayed if only the first rows of the sorted result are needed:

```
Sort Limited To Estimated Row Count
```

- For sorts that are performed in a symmetric multiprocessor (SMP) environment, the type of sort that is to be performed is indicated by one of the following statements:

```
Use Partitioned Sort
Use Shared Sort
Use Replicated Sort
Use Round-Robin Sort
```

- The following statements indicate whether or not the sorted result will be left in the sort heap:

```
Piped
Not Piped
```

If a piped sort is indicated, the database manager will keep the sorted output in memory, rather than placing it in another temporary table.

- The following statement indicates that duplicate values will be removed during the sort operation:

```
Duplicate Elimination
```

- If aggregation is being performed during the sort operation, one of the following statements is displayed:

```
Partial Aggregation
Intermediate Aggregation
Buffered Partial Aggregation
Buffered Intermediate Aggregation
```

### Temporary table completion

A completion statement is displayed whenever a temporary table is created within the scope of a table access. This statement can be one of the following:

```
Temp Table Completion ID = tn
Shared Temp Table Completion ID = tn
Sorted Temp Table Completion ID = tn
Sorted Shared Temp Table Completion ID = tn
```

### Table functions

Table functions are user-defined functions (UDFs) that return data to the statement in the form of a table. A table function is indicated by the following statements, which detail the attributes of the function. The specific name uniquely identifies the table function that is invoked.

```
Access User Defined Table Function
| Name = schema.funcname
| Specific Name = specificname
| SQL Access Level = accesslevel
| Language = lang
| Parameter Style = parmstyle
| Fenced
| Called on NULL Input          Not Deterministic
|                               Disallow Parallel
| Not Federated                Not Threadsafe
```

*Binary join information:*

Output from the **db2expln** command can contain information about joins in an explained statement.

Whenever a binary join is performed, one of the following statements is displayed:

```
Hash Join
Merge Join
Nested Loop Join
```

A left outer join is indicated by one of the following statements:

```
Left Outer Hash Join
Left Outer Merge Join
Left Outer Nested Loop Join
```

In the case of a merge or nested loop join, the outer table of the join is the table that was referenced in the previous access statement (shown in the output). The inner table of the join is the table that was referenced in the access statement that is contained within the scope of the join statement. In the case of a hash join, the access statements are reversed: the outer table is contained within the scope of the join, and the inner table appears before the join.

In the case of a hash or merge join, the following additional statements might appear:

- Early Out: Single Match Per Outer Row

In some circumstances, a join simply needs to determine whether any row in the inner table matches the current row in the outer table.

- Residual Predicate(s)  
| #Predicates = n

It is possible to apply predicates after a join has completed. This statement displays the number of predicates being applied.

In the case of a hash join, the following additional statements might appear:

- Process Hash Table For Join

The hash table is built from the inner table. This statement displays if the building of the hash table was pushed down into a predicate during access to the inner table.

- Process Probe Table For Hash Join

While accessing the outer table, a probe table can be built to improve the performance of the join. This statement displays if a probe table was built during access to the outer table.

- Estimated Build Size: n

This statement displays the estimated number of bytes that are needed to build the hash table.

- Estimated Probe Size: n

This statement displays the estimated number of bytes that are needed to build the probe table.

In the case of a nested loop join, the following statement might appear immediately after the join statement:

Piped Inner

This statement indicates that the inner table of the join is the result of another series of operations. This is also referred to as a *composite inner*.

If a join involves more than two tables, the explain steps should be read from top to bottom. For example, suppose the explain output has the following flow:

```
Access ..... W
Join
| Access ..... X
Join
| Access ..... Y
Join
| Access ..... Z
```

The steps of execution would be:

1. Take a qualifying row from table W.
2. Join a row from W with the next row from table X and call the result P1 (for partial join result number 1).
3. Join P1 with the next row from table Y to create P2.
4. Join P2 with the next row from table Z to create one complete result row.
5. If there are more rows in Z, go to step 4.
6. If there are more rows in Y, go to step 3.
7. If there are more rows in X, go to step 2.
8. If there are more rows in W, go to step 1.

*Data stream information:*

Within an access plan, there is often a need to control the creation and flow of data from one series of operations to another. The data stream concept enables a group of operations within an access plan to be controlled as a unit.

The start of a data stream is indicated by the following statement in **db2exp1n** output:

```
Data Stream n
```

where *n* is a unique identifier assigned by **db2exp1n** for ease of reference.

The end of a data stream is indicated by:

```
End of Data Stream n
```

All operations between these statements are considered to be part of the same data stream.

A data stream has a number of characteristics, and one or more statements can follow the initial data stream statement to describe these characteristics:

- If the operation of the data stream depends on a value that is generated earlier in the access plan, the data stream is marked with:

```
Correlated
```

- Similar to a sorted temporary table, the following statements indicate whether or not the results of the data stream will be kept in memory:

```
Piped  
Not Piped
```

A piped data stream might be written to disk if there is insufficient memory at execution time. The access plan provides for both possibilities.

- The following statement indicates that only a single record is required from this data stream:

```
Single Record
```

When a data stream is accessed, the following statement will appear in the output:

```
Access Data Stream n
```

*Insert, update, and delete information:*

The explain text for the INSERT, UPDATE, or DELETE statement is self-explanatory.

Statement text for these SQL operations in **db2exp1n** output can be:

```
Insert: Table Name = schema.name ID = ts,n  
Update: Table Name = schema.name ID = ts,n  
Delete: Table Name = schema.name ID = ts,n  
Insert: Hierarchy Table Name = schema.name ID = ts,n  
Update: Hierarchy Table Name = schema.name ID = ts,n  
Delete: Hierarchy Table Name = schema.name ID = ts,n  
Insert: Materialized Query Table = schema.name ID = ts,n  
Update: Materialized Query Table = schema.name ID = ts,n  
Delete: Materialized Query Table = schema.name ID = ts,n  
Insert: Global Temporary Table ID = ts, tn  
Update: Global Temporary Table ID = ts, tn  
Delete: Global Temporary Table ID = ts, tn
```

*Block and row identifier preparation information:*



For some access plans, it is more efficient if the qualifying row and block identifiers are sorted and duplicates are removed (in the case of index ORing), or if a technique is used to determine which identifiers appear in all of the indexes being accessed (in the case of index ANDing) before the table is accessed.

There are three main uses of the identifier preparation information that is shown in explain output:

- Either of the following statements indicates that Index ORing was used to prepare the list of qualifying identifiers:

```
Index ORing Preparation
Block Index ORing Preparation
```

*Index ORing* refers to the technique of accessing more than one index and combining the results to include the distinct identifiers that appear in any of the indexes. The optimizer considers index ORing when predicates are connected by OR keywords or there is an IN predicate.

- Either of the following statements indicates that input data was prepared for use during list prefetching:

```
List Prefetch Preparation
Block List Prefetch RID Preparation
```

- *Index ANDing* refers to the technique of accessing more than one index and combining the results to include the identifiers that appear in all of the accessed indexes. Index ANDing begins with either of the following statements:

```
Index ANDing
Block Index ANDing
```

If the optimizer has estimated the size of the result set, the estimate is shown with the following statement:

```
Optimizer Estimate of Set Size: n
```

Index ANDing filter operations process identifiers and use bit filter techniques to determine the identifiers that appear in every accessed index. The following statements indicate that identifiers were processed for index ANDing:

```
Index ANDing Bitmap Build Using Row IDs
Index ANDing Bitmap Probe Using Row IDs
Index ANDing Bitmap Build and Probe Using Row IDs
Block Index ANDing Bitmap Build Using Block IDs
Block Index ANDing Bitmap Build and Probe Using Block IDs
Block Index ANDing Bitmap Build and Probe Using Row IDs
Block Index ANDing Bitmap Probe Using Block IDs and Build Using Row IDs
Block Index ANDing Bitmap Probe Using Block IDs
Block Index ANDing Bitmap Probe Using Row IDs
```

If the optimizer has estimated the size of the result set for a bitmap, the estimate is shown with the following statement:

```
Optimizer Estimate of Set Size: n
```

If list prefetching can be performed for any type of identifier preparation, it will be so indicated with the following statement:

```
Prefetch: Enabled
```

*Aggregation information:*

Aggregation is performed on rows satisfying criteria that are represented by predicates in an SQL statement.

If an aggregate function executes, one of the following statements appears in **db2exp1n** output:

```
Aggregation
Predicate Aggregation
Partial Aggregation
Partial Predicate Aggregation
Hashed Partial Aggregation
Hashed Partial Predicate Aggregation
Intermediate Aggregation
Intermediate Predicate Aggregation
Final Aggregation
Final Predicate Aggregation
```

Predicate aggregation means that the aggregation operation was processed as a predicate when the data was accessed.

The aggregation statement is followed by another statement that identifies the type of aggregate function that was performed:

```
Group By
Column Function(s)
Single Record
```

The specific column function can be derived from the original SQL statement. A single record is fetched from an index to satisfy a MIN or MAX operation.

If predicate aggregation has been performed, there is an aggregation completion operation and corresponding output:

```
Aggregation Completion
Partial Aggregation Completion
Hashed Partial Aggregation Completion
Intermediate Aggregation Completion
Final Aggregation Completion
```

#### *Parallel processing information:*

Executing an SQL statement in parallel (using either intra-partition or inter-partition parallelism) requires some special access plan operations.

- When running an intra-partition parallel plan, portions of the plan are executed simultaneously using several subagents. The creation of these subagents is indicated by the statement in output from the **db2exp1n** command:

```
Process Using n Subagents
```

- When running an inter-partition parallel plan, the section is broken into several subsections. Each subsection is sent to one or more database partitions to be run. An important subsection is the *coordinator subsection*. The coordinator subsection is the first subsection in every plan. It acquires control first, and is responsible for distributing the other subsections and returning results to the calling application.

- The distribution of subsections is indicated by the following statement:

```
Distribute Subsection #n
```

- The following statement indicates that the subsection will be sent to a database partition within the database partition group, based on the value of the columns.

```
Directed by Hash
| #Columns = n
| Partition Map ID = n, Nodegroup = nname, #Nodes = n
```

- The following statement indicates that the subsection will be sent to a predetermined database partition. (This is common when the statement uses the DBPARTITIONNUM() scalar function.)
  - Directed by Node Number
- The following statement indicates that the subsection will be sent to the database partition that corresponds to a predetermined database partition number in the database partition group. (This is common when the statement uses the HASHEDVALUE scalar function.)
  - Directed by Partition Number
    - | Partition Map ID = n, Nodegroup = nname, #Nodes = n
- The following statement indicates that the subsection will be sent to the database partition that provided the current row for the application's cursor.
  - Directed by Position
- The following statement indicates that only one database partition, determined when the statement was compiled, will receive the subsection.
  - Directed to Single Node
    - | Node Number = n
- Either of the following statements indicates that the subsection will be executed on the coordinator database partition.
  - Directed to Application Coordinator Node
  - Directed to Local Coordinator Node
- The following statement indicates that the subsection will be sent to all of the listed database partitions.
  - Broadcast to Node List
    - | Nodes = n1, n2, n3, ...
- The following statement indicates that only one database partition, determined as the statement is executing, will receive the subsection.
  - Directed to Any Node
- Table queues are used to move data between subsections in a partitioned database environment or between subagents in a symmetric multiprocessor (SMP) environment.
  - The following statements indicate that data is being inserted into a table queue:
    - Insert Into Synchronous Table Queue ID = qn
    - Insert Into Asynchronous Table Queue ID = qn
    - Insert Into Synchronous Local Table Queue ID = qn
    - Insert Into Asynchronous Local Table Queue ID = qn
  - For database partition table queues, the destination for rows that are inserted into the table queue is described by one of the following statements:
    - Each row is sent to the coordinator database partition:
      - Broadcast to Coordinator Node
    - Each row is sent to every database partition on which the given subsection is running:
      - Broadcast to All Nodes of Subsection n
    - Each row is sent to a database partition that is based on the values in the row:
      - Hash to Specific Node
    - Each row is sent to a database partition that is determined while the statement is executing:
      - Send to Specific Node

Each row is sent to a randomly determined database partition:

```
Send to Random Node
```

- In some situations, a database partition table queue will have to overflow some rows to a temporary table. This possibility is identified by the following statement:

```
Rows Can Overflow to Temporary Table
```

- After a table access that includes a pushdown operation to insert rows into a table queue, there is a "completion" statement that handles rows that could not be sent immediately. In this case, one of the following lines is displayed:

```
Insert Into Synchronous Table Queue Completion ID = qn  
Insert Into Asynchronous Table Queue Completion ID = qn  
Insert Into Synchronous Local Table Queue Completion ID = qn  
Insert Into Asynchronous Local Table Queue Completion ID = qn
```

- The following statements indicate that data is being retrieved from a table queue:

```
Access Table Queue ID = qn  
Access Local Table Queue ID = qn
```

These statements are always followed by the number of columns being retrieved.

```
#Columns = n
```

- If the table queue sorts the rows at the receiving end, one of the following statements appears:

```
Output Sorted  
Output Sorted and Unique
```

These statements are followed by the number of keys being used for the sort operation.

```
#Key Columns = n
```

For each column in the sort key, one of the following statements is displayed:

```
Key n: (Ascending)  
Key n: (Descending)
```

- If predicates will be applied to rows at the receiving end of the table queue, the following statement appears:

```
Residual Predicate(s)  
| #Predicates = n
```

- Some subsections in a partitioned database environment explicitly loop back to the start of the subsection, and the following statement is displayed:

```
Jump Back to Start of Subsection
```

*Federated query information:*

Executing an SQL statement in a federated database requires the ability to perform portions of the statement on other data sources.

The following output from the **db2exp1n** command indicates that a data source will be read:

```
Ship Distributed Subquery #n  
| #Columns = n
```

If predicates are applied to data that is returned from a distributed subquery, the number of predicates being applied is indicated by the following statements:

```
Residual Predicate(s)
| #Predicates = n
```

An insert, update, or delete operation that occurs at a data source is indicated by one of the following statements:

```
Ship Distributed Insert #n
Ship Distributed Update #n
Ship Distributed Delete #n
```

If a table is explicitly locked at a data source, the following statement appears:

```
Ship Distributed Lock Table #n
```

Data definition language (DDL) statements against a data source are split into two parts. The part that is invoked at the data source is indicated by the following statement:

```
Ship Distributed DDL Statement #n
```

If the federated server is a partitioned database, part of the DDL statement must be run at the catalog database partition. This is indicated by the following statement:

```
Distributed DDL Statement #n Completion
```

The details for each distributed sub-statement are displayed separately.

- The data source for the subquery is indicated by one of the following statements:

```
Server: server_name (type, version)
Server: server_name (type)
Server: server_name
```

- If the data source is relational, the SQL for the sub-statement is displayed as follows:

```
SQL Statement:
statement
```

Non-relational data sources are indicated with:

```
Non-Relational Data Source
```

- Nicknames that are referenced in the sub-statement are listed as follows:

```
Nicknames Referenced:
schema.nickname ID = n
```

If the data source is relational, the base table for the nickname is displayed as follows:

```
Base = baseschema.basetable
```

If the data source is non-relational, the source file for the nickname is displayed as follows:

```
Source File = filename
```

- If values are passed from the federated server to the data source before executing the sub-statement, the number of values is indicated by the following statement:

```
#Input Columns: n
```

- If values are passed from the data source to the federated server after executing the sub-statement, the number of values is indicated by the following statement:

```
#Output Columns: n
```

*Miscellaneous explain information:*

Output from the `db2expln` command contains additional useful information that cannot be readily classified.

- Sections for data definition language (DDL) statements are indicated in the output with the following statement:

```
DDL Statement
```

No additional explain output is provided for DDL statements.

- Sections for SET statements pertaining to updatable special registers, such as `CURRENT EXPLAIN SNAPSHOT`, are indicated in the output with the following statement:

```
SET Statement
```

No additional explain output is provided for SET statements.

- If the SQL statement contains a `DISTINCT` clause, the following statement might appear in the output:

```
Distinct Filter #Columns = n
```

where  $n$  is the number of columns involved in obtaining distinct rows. To retrieve distinct row values, the rows must first be sorted to eliminate duplicates. This statement will not appear if the database manager does not have to explicitly eliminate duplicates, as in the following cases:

- A unique index exists and all of the columns in the index key are part of the `DISTINCT` operation
- Duplicates can be eliminated during sorting
- The following statement appears if a partial early distinct (PED) operation was performed to remove many, if not all, duplicates. This reduces the amount of data that must be processed later in the query evaluation.

```
Hashed partial distinct filter
```

- The following statement appears if the next operation is dependent on a specific record identifier:

```
Positioned Operation
```

If the positioned operation is against a federated data source, the statement becomes:

```
Distributed Positioned Operation
```

This statement appears for any SQL statement that uses the `WHERE CURRENT OF` syntax.

- The following statement appears if there are predicates that must be applied to the result but that could not be applied as part of another operation:

```
Residual Predicate Application  
| #Predicates = n
```

- The following statement appears if the SQL statement contains a `UNION` operator:

```
UNION
```

- The following statement appears if there is an operation in the access plan whose sole purpose is to produce row values for use by subsequent operations:

```
Table Constructor  
| n-Row(s)
```

Table constructors can be used for transforming values in a set into a series of rows that are then passed to subsequent operations. When a table constructor is prompted for the next row, the following statement appears:

Access Table Constructor

- The following statement appears if there is an operation that is only processed under certain conditions:

```
Conditional Evaluation
| Condition #n:
| #Predicates = n
| Action #n:
```

Conditional evaluation is used to implement such activities as the CASE statement, or internal mechanisms such as referential integrity constraints or triggers. If no action is shown, then only data manipulation operations are processed when the condition is true.

- One of the following statements appears if an ALL, ANY, or EXISTS subquery is being processed in the access plan:

```
ANY/ALL Subquery
EXISTS Subquery
EXISTS SINGLE Subquery
```

- Prior to certain update or delete operations, it is necessary to establish the position of a specific row within the table. This is indicated by the following statement:

Establish Row Position

- One of the following statements appears for delete operations on multidimensional clustering tables that qualify for rollout optimization:

```
CELL DELETE with deferred cleanup
CELL DELETE with immediate cleanup
```

- The following statement appears if rows are being returned to the application:

```
Return Data to Application
| #Columns = n
```

If the operation was pushed down into a table access, a completion phase statement appears in the output:

Return Data Completion

- The following statements appear if a stored procedure is being invoked:

```
Call Stored Procedure
| Name = schema.funcname
| Specific Name = specificname
| SQL Access Level = accesslevel
| Language = lang
| Parameter Style = parmstyle
| Expected Result Sets = n
| Fenced                               Not Deterministic
| Called on NULL Input                 Disallow Parallel
| Not Federated                         Not Threadsafe
```

- The following statement appears if one or more large object (LOB) locators are being freed:

Free LOB Locators

## Optimizing query access plans

### Statement concentrator reduces compilation overhead

The statement concentrator modifies dynamic SQL statements at the database server so that similar, but not identical, SQL statements can share the same access plan.

In online transaction processing (OLTP), simple statements might repeatedly be generated with different literal values. In such workloads, the cost of recompiling the statements can add significant overhead. The statement concentrator avoids this overhead by allowing compiled statements to be reused, regardless of the values of the literals.

The statement concentrator is disabled by default. It can be enabled for all dynamic statements in a database by setting the **stmt\_conc** database configuration parameter to LITERALS.

The statement concentrator improves performance by modifying incoming dynamic SQL statements. In a workload that is suitable for the statement concentrator, the overhead that is associated with modifying the incoming SQL statements is minor compared to the savings that are realized by reusing statements that are already in the package cache.

If a dynamic statement is modified as a result of statement concentration, both the original statement and the modified statement are displayed in the explain output. The event monitor logical monitor elements, as well as output from the MON\_GET\_ACTIVITY\_DETAILS table function show the original statement if the statement concentrator has modified the original statement text. Other monitor interfaces show only the modified statement text.

Consider the following example, in which the **stmt\_conc** database configuration parameter is set to LITERALS and the following two statements are executed:

```
select firstme, lastname from employee where empno='000020'  
select firstme, lastname from employee where empno='000070'
```

These statements share the same entry in the package cache, and that entry uses the following statement:

```
select firstme, lastname from employee where empno=:L0
```

The data server provides a value for :L0 (either '000020' or '000070'), based on the literal that was used in the original statements.

Because statement concentration alters the statement text, it has an impact on access plan selection. The statement concentrator should be used when similar statements in the package cache have similar access plans. If different literal values in a statement result in significantly different access plans, the statement concentrator should not be enabled for that statement.

The statement concentrator may cause the length attributes for VARCHAR and VARCHAR2 string literals to be greater than the length of the string literal.

### Access plan reuse

You can request that the access plans that are chosen for static SQL statements in a package stay the same as, or be very similar to, existing access plans across several bind or rebind operations.



Access plan reuse can prevent significant plan changes from occurring without your explicit approval. Although this can mean that your queries do not benefit from potential access plan improvements, the control that access plan reuse provides will give you the ability to test and implement those improvements when you are ready to do so. Until then, you can continue to use existing access plans for stable and predictable performance.

Enable access plan reuse through the ALTER PACKAGE statement, or by using the APREUSE option on the BIND, REBIND, or PRECOMPILE command. Packages that are subject to access plan reuse have the value Y in the APREUSE column of the SYSCAT.PACKAGES catalog view.

The ALTER\_ROUTINE\_PACKAGE procedure is a convenient way to enable access plan reuse for compiled SQL objects, such as SQL procedures. However, access plans cannot be reused during compiled object revalidation, because the object is dropped before being rebound. In this case, APREUSE will only take effect the next time that the package is bound or rebound.

Access plan reuse is most effective when changes to the schema and compilation environment are kept to a minimum. If significant changes are made, it might not be possible to recreate the previous access plan. Examples of such significant changes include dropping an index that is being used in an access plan, or recompiling an SQL statement at a different optimization level. Significant changes to the query compiler's analysis of the statement can also result in the previous access plan no longer being reusable.

You can combine access plan reuse with optimization guidelines. A statement-level guideline takes precedence over access plan reuse for the static SQL statement to which it applies. Access plans for static statements that do not have statement-level guidelines can be reused if they do not conflict with any general optimization guidelines that have been specified. A statement profile with an empty guideline can be used to disable access plan reuse for a specific statement, while leaving plan reuse available for the other static statements in the package.

**Note:** Access plans from packages that were produced by releases prior to Version 9.7 cannot be reused.

If an access plan cannot be reused, compilation continues, but a warning (SQL20516W) is returned with a reason code that indicates why the attempt to reuse the access plan was not successful. Additional information is sometimes provided in the diagnostic messages that are available through the explain facility.

### **Optimization classes**

When you compile an SQL or XQuery statement, you can specify an optimization class that determines how the optimizer chooses the most efficient access plan for that statement.

The optimization classes differ in the number and type of optimization strategies that are considered during the compilation of a query. Although you can specify optimization techniques individually to improve runtime performance for the query, the more optimization techniques that you specify, the more time and system resources query compilation will require.

You can specify one of the following optimization classes when you compile an SQL or XQuery statement.

- 0 This class directs the optimizer to use minimal optimization when generating an access plan, and has the following characteristics:
- Frequent-value statistics are not considered by the optimizer.
  - Only basic query rewrite rules are applied.
  - Greedy join enumeration is used.
  - Only nested loop join and index scan access methods are enabled.
  - List prefetch is not used in generated access methods.
  - The star-join strategy is not considered.

This class should only be used in circumstances that require the lowest possible query compilation overhead. Query optimization class 0 is appropriate for an application that consists entirely of very simple dynamic SQL or XQuery statements that access well-indexed tables.

- 1 This optimization class has the following characteristics:
- Frequent-value statistics are not considered by the optimizer.
  - Only a subset of query rewrite rules are applied.
  - Greedy join enumeration is used.
  - List prefetch is not used in generated access methods.

Optimization class 1 is similar to class 0, except that merge scan joins and table scans are also available.

- 2 This class directs the optimizer to use a degree of optimization that is significantly higher than class 1, while keeping compilation costs for complex queries significantly lower than class 3 or higher. This optimization class has the following characteristics:
- All available statistics, including frequent-value and quantile statistics, are used.
  - All query rewrite rules (including materialized query table routing) are applied, except computationally intensive rules that are applicable only in very rare cases.
  - Greedy join enumeration is used.
  - A wide range of access methods is considered, including list prefetch and materialized query table routing.
  - The star-join strategy is considered, if applicable.

Optimization class 2 is similar to class 5, except that it uses greedy join enumeration instead of dynamic programming join enumeration. This class has the most optimization of all classes that use the greedy join enumeration algorithm, which considers fewer alternatives for complex queries, and therefore consumes less compilation time than class 3 or higher. Class 2 is recommended for very complex queries in a decision support or online analytic processing (OLAP) environment. In such environments, a specific query is not likely to be repeated in exactly the same way, so that an access plan is unlikely to remain in the cache until the next occurrence of the query.

- 3 This class represents a moderate amount of optimization, and comes closest to matching the query optimization characteristics of DB2 for z/OS. This optimization class has the following characteristics:
- Frequent-value statistics are used, if available.
  - Most query rewrite rules are applied, including subquery-to-join transformations.

- Dynamic programming join enumeration is used, with:
  - Limited use of composite inner tables
  - Limited use of Cartesian products for star schemas involving lookup tables
- A wide range of access methods is considered, including list prefetch, index ANDing, and star joins.

This class is suitable for a broad range of applications, and improves access plans for queries with four or more joins.

- 5 This class directs the optimizer to use a significant amount of optimization to generate an access plan, and has the following characteristics:
- All available statistics, including frequent-value and quantile statistics, are used.
  - All query rewrite rules (including materialized query table routing) are applied, except computationally intensive rules that are applicable only in very rare cases.
  - Dynamic programming join enumeration is used, with:
    - Limited use of composite inner tables
    - Limited use of Cartesian products for star schemas involving lookup tables
  - A wide range of access methods is considered, including list prefetch, index ANDing, and materialized query table routing.

Optimization class 5 (the default) is an excellent choice for a mixed environment with both transaction processing and complex queries. This optimization class is designed to apply the most valuable query transformations and other query optimization techniques in an efficient manner.

If the optimizer detects that additional resources and processing time for complex dynamic SQL or XQuery statements are not warranted, optimization is reduced. The extent of the reduction depends on the machine size and the number of predicates. When the optimizer reduces the amount of query optimization, it continues to apply all of the query rewrite rules that would normally be applied. However, it uses greedy join enumeration and it reduces the number of access plan combinations that are considered.

- 7 This class directs the optimizer to use a significant amount of optimization to generate an access plan. It is similar to optimization class 5, except that in this case, the optimizer never considers reducing the amount of query optimization for complex dynamic SQL or XQuery statements.
- 9 This class directs the optimizer to use all available optimization techniques. These include:
- All available statistics
  - All query rewrite rules
  - All possibilities for join enumeration, including Cartesian products and unlimited composite inners
  - All access methods

This class increases the number of possible access plans that are considered by the optimizer. You might use this class to determine whether more comprehensive optimization would generate a better access plan for very

complex or very long-running queries that use large tables. Use explain and performance measurements to verify that a better plan has actually been found.

### Choosing an optimization class:

Setting the optimization class can provide some of the advantages of explicitly specifying optimization techniques.

This is true, particularly when:

- Managing very small databases or very simple dynamic queries
- Accommodating memory limitations on your database server at compile time
- Reducing query compilation time; for example, during statement preparation

Most statements can be adequately optimized with a reasonable amount of resource by using the default optimization class 5. Query compilation time and resource consumption are primarily influenced by the complexity of a query; in particular, by the number of joins and subqueries. However, compilation time and resource consumption are also affected by the amount of optimization that is performed.

Query optimization classes 1, 2, 3, 5, and 7 are all suitable for general use. Consider class 0 only if you require further reductions in query compilation time, and the SQL and XQuery statements are very simple.

**Tip:** To analyze a long-running query, run the query with **db2batch** to determine how much time is spent compiling and executing the query. If compilation time is excessive, reduce the optimization class. If execution time is a problem, consider a higher optimization class.

When you select an optimization class, consider the following general guidelines:

- Start by using the default query optimization class 5.
- When choosing a class other than the default, try class 1, 2, or 3 first. Classes 0, 1, and 2 use the greedy join enumeration algorithm.
- Use optimization class 1 or 2 if you have many tables with many join predicates on the same column, and if compilation time is a concern.
- Use a low optimization class (0 or 1) for queries that have very short run times of less than one second. Such queries tend to:
  - Access a single table or only a few tables
  - Fetch a single row or only a few rows
  - Use fully qualified and unique indexes
  - Be involved in online transaction processing (OLTP)
- Use a higher optimization class (3, 5, or 7) for queries that have longer run times of more than 30 seconds.
- Class 3 or higher uses the dynamic programming join enumeration algorithm, which considers many more alternative plans, and might incur significantly more compilation time than classes 0, 1, or 2, especially as the number of tables increases.
- Use optimization class 9 only if you have extraordinary optimization requirements for a query.

Complex queries might require different amounts of optimization to select the best access plan. Consider using higher optimization classes for queries that have:

- Access to large tables
- A large number of views
- A large number of predicates
- Many subqueries
- Many joins
- Many set operators, such as UNION or INTERSECT
- Many qualifying rows
- GROUP BY and HAVING operations
- Nested table expressions

Decision support queries or month-end reporting queries against fully normalized databases are good examples of complex queries for which at least the default query optimization class should be used.

Use higher query optimization classes for SQL and XQuery statements that were produced by a query generator. Many query generators create inefficient queries. Poorly written queries require additional optimization to select a good access plan. Using query optimization class 2 or higher can improve such queries.

For SAP applications, always use optimization class 5. This optimization class enables many DB2 features optimized for SAP, such as setting the **DB2\_REDUCED\_OPTIMIZATION** registry variable.

In a federated database, the optimization class does not apply to the remote optimizer.

#### **Setting the optimization class:**

When you specify an optimization level, consider whether a query uses static or dynamic SQL and XQuery statements, and whether the same dynamic query is repeatedly executed.

#### **About this task**

For static SQL and XQuery statements, the query compilation time and resources are expended only once, and the resulting plan can be used many times. In general, static SQL and XQuery statements should always use the default query optimization class (5). Because dynamic statements are bound and executed at run time, consider whether the overhead of additional optimization for dynamic statements improves overall performance. However, if the same dynamic SQL or XQuery statement is executed repeatedly, the selected access plan is cached. Such statements can use the same optimization levels as static SQL and XQuery statements.

If you are not sure whether a query might benefit from additional optimization, or you are concerned about compilation time and resource consumption, consider benchmark testing.

#### **Procedure**

To specify a query optimization class:

1. Analyze performance factors.

- For a dynamic query statement, tests should compare the average run time for the statement. Use the following formula to estimate the average run time:

$$\frac{\text{compilation time} + \text{sum of execution times for all iterations}}{\text{number of iterations}}$$

The number of iterations represents the number of times that you expect the statement might be executed each time that it is compiled.

**Note:** After initial compilation, dynamic SQL and XQuery statements are recompiled whenever a change to the environment requires it. If the environment does not change after a statement is cached, subsequent PREPARE statements reuse the cached statement.

- For static SQL and XQuery statements, compare the statement run times. Although you might also be interested in the compilation time of static SQL and XQuery statements, the total compilation and execution time for a static statement is difficult to assess in any meaningful context. Comparing the total times does not recognize the fact that a static statement can be executed many times whenever it is bound, and that such a statement is generally not bound during run time.

## 2. Specify the optimization class.

- Dynamic SQL and XQuery statements use the optimization class that is specified by the CURRENT QUERY OPTIMIZATION special register. For example, the following statement sets the optimization class to 1:

```
SET CURRENT QUERY OPTIMIZATION = 1
```

To ensure that a dynamic SQL or XQuery statement always uses the same optimization class, include a SET statement in the application program.

If the CURRENT QUERY OPTIMIZATION special register has not been set, dynamic statements are bound using the default query optimization class. The default value for both dynamic and static queries is determined by the value of the **dft\_queryopt** database configuration parameter, whose default value is 5. The default values for the bind option and the special register are also read from the **dft\_queryopt** database configuration parameter.

- Static SQL and XQuery statements use the optimization class that is specified on the **PREP** and **BIND** commands. The QUERYOPT column in the SYSCAT.PACKAGES catalog view records the optimization class that is used to bind a package. If the package is rebound, either implicitly or by using the **REBIND PACKAGE** command, this same optimization class is used for static statements. To change the optimization class for such static SQL and XQuery statements, use the **BIND** command. If you do not specify the optimization class, the data server uses the default optimization class, as specified by the **dft\_queryopt** database configuration parameter.

## Using optimization profiles if other tuning options do not produce acceptable results

If you have followed best practices recommendations, but you believe that you are still getting less than optimal performance, you can provide explicit optimization guidelines to the DB2 optimizer.

These optimization guidelines are contained in an XML document called the optimization profile. The profile defines SQL statements and their associated optimization guidelines.

If you use optimization profiles extensively, they require a lot of effort to maintain. More importantly, you can only use optimization profiles to improve performance for existing SQL statements. Following best practices consistently can help you to achieve query performance stability for all queries, including future ones.

## Optimization profiles and guidelines

An optimization profile is an XML document that can contain optimization guidelines for one or more SQL statements. The correspondence between each SQL statement and its associated optimization guidelines is established using the SQL text and other information that is needed to unambiguously identify an SQL statement.

The DB2 optimizer is one of the most sophisticated cost-based optimizers in the industry. However, in rare cases the optimizer might select a less than optimal execution plan. As a DBA familiar with the database, you can use utilities such as **db2advls**, **runstats**, and **db2exp1n**, as well as the optimization class setting to help you tune the optimizer for better database performance. If you do not receive expected results after all tuning options have been exhausted, you can provide explicit optimization guidelines to the DB2 optimizer.

For example, suppose that even after you had updated the database statistics and performed all other tuning steps, the optimizer still did not choose the I\_SUPPKEY index to access the SUPPLIERS table in the following subquery:

```
SELECT S.S_NAME, S.S_ADDRESS, S.S_PHONE, S.S_COMMENT
FROM PARTS P, SUPPLIERS S, PARTSUPP PS
WHERE P.PARTKEY = PS.PS_PARTKEY
      AND S.S_SUPPKEY = PS.PS_SUPPKEY
      AND P.P_SIZE = 39
      AND P.P_TYPE = 'BRASS'
      AND S.S_NATION = 'MOROCCO'
      AND S.S_NATION IN ('MOROCCO', 'SPAIN')
      AND PS.PS_SUPPLYCOST = (SELECT MIN(P.S1.PS_SUPPLYCOST)
                             FROM PARTSUPP P.S1, SUPPLIERS S1
                             WHERE P.P.PARTKEY = P.S1.PS_PARTKEY
                                   AND S1.S_SUPPKEY = PS.PS_SUPPKEY
                                   AND S1.S_NATION = S.S_NATION))
```

In this case, an explicit optimization guideline can be used to influence the optimizer. For example:

```
<OPTGUIDELINES><IXSCAN TABLE="S" INDEX="I_SUPPKEY"/></OPTGUIDELINES>
```

Optimization guidelines are specified using a simple XML specification. Each element within the OPTGUIDELINES element is interpreted as an optimization guideline by the DB2 optimizer. There is one optimization guideline element in this example. The IXSCAN element requests that the optimizer use index access. The TABLE attribute of the IXSCAN element indicates the target table reference (using the exposed name of the table reference) and the INDEX attribute specifies the index.

The following example is based on the previous query, and shows how an optimization guideline can be passed to the DB2 optimizer using an optimization profile.

```
<?xml version="1.0" encoding="UTF-8"?>
<OPTPROFILE VERSION="9.1.0.0">
<STMTPROFILE ID="Guidelines for TPCD Q9">
<STMTKEY SCHEMA="TPCD">
SELECT S.S_NAME, S.S_ADDRESS, S.S_PHONE, S.S_COMMENT
FROM PARTS P, SUPPLIERS S, PARTSUPP PS
WHERE P.PARTKEY = PS.PS_PARTKEY
      AND S.S_SUPPKEY = PS.PS_SUPPKEY
      AND P.P_SIZE = 39
      AND P.P_TYPE = 'BRASS'
      AND S.S_NATION = 'MOROCCO'
      AND S.S_NATION IN ('MOROCCO', 'SPAIN')
```

```

AND PS.PS_SUPPLYCOST = (SELECT MIN(PS1.PS_SUPPLYCOST)
                        FROM PARTSUPP PS1, SUPPLIERS S1
                        WHERE P.P_PARTKEY = PS1.PS_PARTKEY
                        AND S1.S_SUPPKEY = PS1.PS_SUPPKEY
                        AND S1.S_NATION = S.S_NATION))
</STMTKEY>
<OPTGUIDELINES><IXSCAN TABLE="S" INDEX="I_SUPPKEY"/></OPTGUIDELINES>
</STMTPROFILE>
</OPTPROFILE>

```

Each STMTPROFILE element provides a set of optimization guidelines for one application statement. The targeted statement is identified by the STMTKEY subelement. The optimization profile is then given a schema-qualified name and inserted into the database. The optimization profile is put into effect for the statement by specifying this name on the **BIND** or **PRECOMPILE** command.

Optimization profiles allow optimization guidelines to be provided to the optimizer without application or database configuration changes. You simply compose the simple XML document, insert it into the database, and specify the name of the optimization profile on the **BIND** or **PRECOMPILE** command. The optimizer automatically matches optimization guidelines to the appropriate statement.

Optimization guidelines do not need to be comprehensive, but should be targeted to a desired execution plan. The DB2 optimizer still considers other possible access plans using the existing cost-based methods. Optimization guidelines targeting specific table references cannot override general optimization settings. For example, an optimization guideline specifying the merge join between tables A and B is not valid at optimization class 0.

The optimizer ignores invalid or inapplicable optimization guidelines. If any optimization guidelines are ignored, an execution plan is created and SQL0437W with reason code 13 is returned. You can then use the EXPLAIN statement to get detailed diagnostic information regarding optimization guidelines processing.

### Optimization profiles:

#### *Anatomy of an optimization profile:*

An optimization profile can contain global optimization guidelines, and it can contain specific optimization guidelines that apply to individual DML statements in a package. Global optimization guidelines apply to all data manipulation language (DML) statements that are executed while the profile is in effect.

For example:

- You could write a global optimization guideline requesting that the optimizer refer to the materialized query tables (MQTs) Test.SumSales and Test.AvgSales whenever a statement is processed while the current optimization profile is active.
- You could write a statement-level optimization guideline requesting that the optimizer use the I\_SUPPKEY index to access the SUPPLIERS table whenever the optimizer encounters the specified statement.

You can specify these two types of guidelines in the two major sections of an optimization profile:

- The global optimization guidelines section can contain one OPTGUIDELINES element



- The statement profiles section that can contain any number of STMTPROFILE elements

An optimization profile must also contain an OPTPROFILE element, which includes metadata and processing directives.

The following code is an example of a valid optimization profile. The optimization profile contains a global optimization guidelines section and a statement profile section with one STMTPROFILE element.

```
<?xml version="1.0" encoding="UTF-8"?>
<OPTPROFILE>

  <!--
    Global optimization guidelines section.
    Optional but at most one.
  -->
  <OPTGUIDELINES>
    <MQT NAME="Test.AvgSales"/>
    <MQT NAME="Test.SumSales"/>
  </OPTGUIDELINES>

  <!--
    Statement profile section.
    Zero or more.
  -->
  <STMTPROFILE ID="Guidelines for TPCD Q9">
    <STMTKEY SCHEMA="TPCD">
      <![CDATA[SELECT S.S_NAME, S.S_ADDRESS, S.S_PHONE,
S.S_COMMENT FROM PARTS P, SUPPLIERS S, PARTSUPP PS
WHERE P.PARTKEY = PS.PS_PARTKEY AND S.S_SUPPKEY = PS.PS_SUPPKEY
AND P.P_SIZE = 39 AND P.P_TYPE = 'BRASS'
AND S.S_NATION = 'MOROCCO' AND S.S_NATION IN ('MOROCCO', 'SPAIN')
AND PS.PS_SUPPLYCOST = (SELECT MIN(PS1.PS_SUPPLYCOST)
FROM PARTSUPP PS1, SUPPLIERS S1
WHERE P.P_PARTKEY = PS1.PS_PARTKEY AND S1.S_SUPPKEY = PS1.PS_SUPPKEY
AND S1.S_NATION = S.S_NATION)]]>
    </STMTKEY>
    <OPTGUIDELINES>
      <IXSCAN TABID="Q1" INDEX="I_SUPPKEY"/>
    </OPTGUIDELINES>
  </STMTPROFILE>
</OPTPROFILE>
```

### The OPTPROFILE element

An optimization profile begins with the OPTPROFILE element. In the preceding example, this element consists of a VERSION attribute specifying that the optimization profile version is 9.1.

### The global optimization guidelines section

Global optimization guidelines apply to all statements for which the optimization profile is in effect. The global optimization guidelines section is defined in the global OPTGUIDELINES element. In the preceding example, this section contains a single global optimization guideline telling the optimizer to consider the MQTs Test.AvgSales and Test.SumSales when processing any statements for which the optimization profile is in effect.

## The statement profile section

A statement profile defines optimization guidelines that apply to a specific statement. There can be zero or more statement profiles in an optimization profile. The statement profile section is defined in the STMTPROFILE element. In the preceding example, this section contains guidelines for a specific statement for which the optimization profile is in effect.

Each statement profile contains a statement key and statement-level optimization guidelines, represented by the STMTKEY and OPTGUIDELINES elements, respectively:

- The statement key identifies the statement to which the statement-level optimization guidelines apply. In the example, the STMTKEY element contains the original statement text and other information that is needed to unambiguously identify the statement. Using the statement key, the optimizer matches a statement profile with the appropriate statement. This relationship enables you to provide optimization guidelines for a statement without having to modify the application.
- The statement-level optimization guidelines section of the statement profile is represented by the OPTGUIDELINES element. This section is made up of one or more access or join requests, which specify methods for accessing or joining tables in the statement. After a successful match with the statement key in a statement profile, the optimizer refers to the associated statement-level optimization guidelines when optimizing the statement. The example contains one access request, which specifies that the SUPPLIERS table referenced in the nested subselect use an index named I\_SUPPKEY.

## Elements common to both the global optimization guidelines and statement profile sections

Other than the OPTGUIDELINES element the REGISTRY and STMTMATCH element are other elements available for both of these sections:

- The REGISTRY element can set certain registry variables at either the statement or global level. The REGISTRY element is nested in the OPTGUIDELINES element.

The REGISTRY element contains an OPTION element. The OPTION element has NAME and VALUE attributes which are used to set the value of the named registry variable.

If you specify a value for a registry variable at the global level, that value applies to all the statements in the connection on which the profile is applied. If you specify a value for a registry variable at the statement level, that value applies only to that statement within the STMTKEY. This value at the statement level takes precedence over the value at the global level.

- The STMTMATCH element sets the matching type used when the compiling statement is matched to the statements in the optimization profile.

The STMTMATCH element has an EXACT attribute which can be set to either TRUE or FALSE. The default value of STMTMATCH EXACT is TRUE.

If STMTMATCH EXACT is set to TRUE, exact matching is applied. If STMTMATCH EXACT is set to FALSE, inexact matching is applied.

### *Creating an optimization profile:*

An optimization profile is an XML document that contains optimization guidelines for one or more Data Manipulation Language (DML) statements.

## About this task

Because an optimization profile can contain many combinations of guidelines, the following information specifies only those steps that are common to creating any optimization profile.

## Procedure

To create an optimization profile:

1. Launch an XML editor. If possible, use one that has schema validation capability. The optimizer does not perform XML validation. An optimization profile must be valid according to the current optimization profile schema.
2. Create an XML document by using a name that makes sense to you. You might want to give it a name that describes the scope of statements to which it applies. For example: `inventory_db.xml`
3. Add the XML declaration to the document. If you do not specify an encoding format, UTF-8 is assumed. Save the document with UTF-16 encoding, if possible. The data server is more efficient when processing this encoding.

```
<?xml version="1.0" encoding="UTF-16"?>
```
4. Add an optimization profile section to the document.

```
<OPTPROFILE>
</OPTPROFILE>
```
5. Within the OPTPROFILE element, create global or statement-level optimization guidelines, as appropriate, and save the file.

## What to do next

After you have the XML document created, configure the data server to use the optimization profile by inserting the optimization profile into the SYSTOOLS.OPT\_PROFILE table.

*SQL compiler registry variables in an optimization profile:*

Optimization profiles can have different registry variable values applied to a specific query statement or to many query statements used in an application.

Setting registry variables in an optimization profile can increase the flexibility you have in using different query statements for different applications. When you use the **db2set** command to set registry variables, the registry variable values are applied to the entire instance. In optimization profiles, the registry variable values apply only to the statements specified in the optimization profile. By setting registry variables in an optimization profile, you can tailor specific statements for applications without worrying about the registry variable settings of other query statements.

Only a subset of registry variables can be set in an optimization profile. The following registry variables can be set in an optimization profile:

- **DB2\_ANTIJOIN**
- **DB2\_EXTENDED\_OPTIMIZATION** (Only the ON, OFF, and IXOR values are supported)
- **DB2\_INLIST\_TO\_NLJN**
- **DB2\_MINIMIZE\_LISTPREFETCH**
- **DB2\_NEW\_CORR\_SQ\_FF**
- **DB2\_OPT\_MAX\_TEMP\_SIZE**

- **DB2\_REDUCED\_OPTIMIZATION**
- **DB2\_RESOLVE\_CALL\_CONFLICT**
- **DB2\_SELECTIVITY**
- **DB2\_SELUDI\_COMM\_BUFFER**
- **DB2\_SORT\_AFTER\_TQ**

Registry variables can be set at both the global level and statement level. If the registry variable is set at the global level, it uses the registry variable settings for all the statements in the optimization profile. If the registry variable is set at the statement level the setting for that registry variable applies only to that specific statement. If the same registry variable is set at both the global and statement levels, the registry variable value at the statement level takes precedence.

### Syntax for setting registry variables

Each registry variable is defined and set in an OPTION XML element, with a NAME and a VALUE attribute, all of which are nested in a REGISTRY element. For example:

```
<REGISTRY>
  <OPTION NAME='DB2_SELECTIVITY' VALUE='YES' />
  <OPTION NAME='DB2_REDUCED_OPTIMIZATION' VALUE='NO' />
</REGISTRY>
```

To have OPTION elements apply to all statements in the application that uses this profile, include the REGISTRY and OPTION elements in the global OPTGUIDELINES element.

To have OPTION elements apply to just a specific SQL statement, include the REGISTRY and OPTION elements in the applicable statement-level STMTPROFILE element. Different STMTPROFILE elements can have different OPTION element settings.

The following example shows registry variable settings at the application and statement level:

```
<?xml version="1.0" encoding="UTF-8"?>
<OPTPROFILE>

  <!--Global section -->
  <OPTGUIDELINES>
    <!-- New: registry variables that apply to all SQL statements that
         use this profile -->
    <REGISTRY>
      <OPTION NAME='DB2_SELECTIVITY' VALUE='YES' />
      <OPTION NAME='DB2_REDUCED_OPTIMIZATION' VALUE='NO' />
    </REGISTRY>
  </OPTGUIDELINES>

  <!-- First statement level profile -->
  <STMTPROFILE ID='S1'>
    <STMTKEY>
      <![CDATA[select t1.c1, count(*) from t1,t2 where t1.c1 = t2.c1
                group by t1.c1]]>
    </STMTKEY>
    <OPTGUIDELINES>
      <!-- New: registry variables that JUST applies to the above
           SQL statement when using this profile -->
      <REGISTRY>
        <OPTION NAME='DB2_REDUCED_OPTIMIZATION' VALUE='NO_SORT_NLJOIN' />
      </REGISTRY>
```

```

        <NLJOIN>
            <TBSCAN TABLE='T1' />
            <TBSCAN TABLE='T2' />
        </NLJOIN>
    </OPTGUIDELINES>
</STMTPROFILE>

<!-- Second statement level profile -->
<STMTPROFILE ID='S2'>
    <STMTKEY><![CDATA[select * from T1 where c1 in( 10,20)]]></STMTKEY>
    <OPTGUIDELINES>
        <!-- New: registry variables that JUST applies to the above
             SQL statement when using this profile -->
        <REGISTRY>
            <OPTION NAME='DB2_REDUCED_OPTIMIZATION' VALUE='YES' />
        </REGISTRY>
    </OPTGUIDELINES>
</STMTPROFILE>
</OPTPROFILE>

```

### Order of precedence

The example sets the same registry variables in multiple places. In addition to these settings, the **db2set** command can also have been used to set registry variables. Registry variables are applied in the following order of precedence, from highest to lowest:

1. Statement level optimization profile settings, which are defined in a statement-level optimization guideline.
2. Overall optimization profile settings, which are defined in a global optimization guideline.
3. Registry variables set by the **db2set** command.

### Explain facility

The explain facility captures information about all SQL compiler registry variables that affect data manipulation language (DML) compilation and writes this information to explain tables.

You can use the Explain facility to determine which registry variables are being used for a particular statement. Activate the Explain facility and run the query. Two strings in the ENVVAR sections indicate where the setting has come from:

- [Global Optimization Guideline]
- [Statement-level Optimization Guideline]

For example:

```

ENVVAR : (Environment Variable)
        DB2_EXTENDED_OPTIMIZATION = ON

ENVVAR : (Environment Variable)
        DB2_EXTENDED_OPTIMIZATION = ON [Global Optimization Guideline]

ENVVAR : (Environment Variable)
        DB2_EXTENDED_OPTIMIZATION = ON [Statement-level Optimization Guideline]

```

If the registry variables are set in different places, the registry variable with the highest precedence is the only one displayed in the explain output.

*Configuring the data server to use an optimization profile:*

After an optimization profile has been created and its contents validated against the current optimization profile schema (COPS), the contents must be associated with a unique schema-qualified name and stored in the SYSTOOLS.OPT\_PROFILE table.

## Procedure

To configure the data server to use an optimization profile:

1. Create the optimization profile table.  
Refer to “SYSTOOLS.OPT\_PROFILE table” on page 397. Each row of the table can contain one optimization profile: the SCHEMA and NAME columns identify the optimization profile, and the PROFILE column contains the text of the optimization profile.
2. Optional: You can grant any authority or privilege on the table that satisfies your database security requirements. This has no effect on the optimizer's ability to read the table.
3. Insert any optimization profiles that you want to use into the table.

*STMTKEY field in optimization profiles:*

Within a STMTPROFILE, the targeted statement is identified by the STMTKEY sub-element. The statement defined in the STMTKEY field must match exactly to the statement being executed by the application, allowing DB2 to unambiguously identify the targeted statement. However, 'whitespace' within the statement is tolerated.

Once DB2 finds a statement key that matches the current compilation key it stops looking; therefore, if there were multiple statement profiles in an optimization profile whose statement key matches the current compilation key, only the first such statement profile is used (based on document order). Moreover, no error or warning is issued in this case.

The statement key will match the statement `select * from orders where foo(orderkey)>20,` provided the compilation key has a default schema of `COLLEGE` and a function path of `SYSIBM,SYSFUN,SYSPROC,DAVE`.

```
<STMTKEY SCHEMA='COLLEGE' FUNCPATH='SYSIBM,SYSFUN,SYSPROC,DAVE'>  
<![CDATA[select * from orders where foo(orderkey)>20[>  
</stmtkey>
```

*Specifying which optimization profile the optimizer is to use:*

Use the **OPTPROFILE** bind option to specify that an optimization profile is to be used at the package level, or use the CURRENT OPTIMIZATION PROFILE special register to specify that an optimization profile is to be used at the statement level.

This special register contains the qualified name of the optimization profile used by statements that are dynamically prepared for optimization. For CLI applications, you can use the **CURRENTOPTIMIZATIONPROFILE** client configuration option to set this special register for each connection.

The **OPTPROFILE** bind option setting also specifies the default optimization profile for the CURRENT OPTIMIZATION PROFILE special register. The order of precedence for defaults is as follows:

- The **OPTPROFILE** bind option applies to all static statements, regardless of any other settings.

- For dynamic statements, the value of the CURRENT OPTIMIZATION PROFILE special register is determined by the following, in order of lowest to highest precedence:
  - The **OPTPROFILE** bind option
  - The **CURRENTOPTIMIZATIONPROFILE** client configuration option
  - The most recent SET CURRENT OPTIMIZATION PROFILE statement in the application

*Setting an optimization profile within an application:*

You can control the setting of the current optimization profile for dynamic statements in an application by using the SET CURRENT OPTIMIZATION PROFILE statement.

### About this task

The optimization profile name that you provide in the statement must be a schema-qualified name. If you do not provide a schema name, the value of the CURRENT SCHEMA special register is used as the implicit schema qualifier.

The optimization profile that you specify applies to all subsequent dynamic statements until another SET CURRENT OPTIMIZATION PROFILE statement is encountered. Static statements are not affected, because they are preprocessed and packaged before this setting is evaluated.

### Procedure

To set an optimization profile within an application:

- Use the SET CURRENT OPTIMIZATION PROFILE statement anywhere within your application. For example, the last statement in the following sequence is optimized according to the JON.SALES optimization profile.

```
EXEC SQL SET CURRENT OPTIMIZATION PROFILE = 'NEWTON.INVENTDB';

/* The following statements are both optimized with 'NEWTON.INVENTDB' */
EXEC SQL PREPARE stmt FROM SELECT ... ;
EXEC SQL EXECUTE stmt;

EXEC SQL EXECUTE IMMEDIATE SELECT ... ;

EXEC SQL SET CURRENT OPTIMIZATION PROFILE = 'JON.SALES';

/* This statement is optimized with 'JON.SALES' */
EXEC SQL EXECUTE IMMEDIATE SELECT ... ;
```

- If you want the optimizer to use the default optimization profile that was in effect when the application started running, specify the null value. For example:

```
EXEC SQL SET CURRENT OPTIMIZATION PROFILE = NULL;
```

- If you don't want the optimizer to use optimization profiles, specify the empty string. For example:

```
EXEC SQL SET CURRENT OPTIMIZATION PROFILE = '';
```

- If you are using a call level interface (CLI) application, you can add the CURRENTOPTIMIZATIONPROFILE parameter to the db2cli.ini file, using the **UPDATE CLI CONFIGURATION** command. For example:

```
update cli cfg for section sanfran using currentoptimizationprofile jon.sales
```

This results in the following entry in the db2cli.ini file:

```
[SANFRAN]
CURRENTOPTIMIZATIONPROFILE=JON.SALES
```

**Note:** Any SET CURRENT OPTIMIZATION PROFILE statements in the application override this setting.

*Binding an optimization profile to a package:*

When you prepare a package by using the **BIND** or **PRECOMPILE** command, you can use the **OPTPROFILE** command parameter to specify the optimization profile for the package.

### About this task

This method is the only way to apply an optimization profile to static statements, and the specified profile applies to all static statements in the package. An optimization profile that is specified in this manner is also the default optimization profile that is used for dynamic statements within the package.

### Procedure

You can bind an optimization profile in SQLJ or embedded SQL using APIs (for example, sqlaprep) or the command line processor (CLP).

For example, the following code shows how to bind an inventory database optimization profile to an inventory application from the CLP:

```
db2 prep inventapp.sqc bindfile optprofile newton.inventdb
db2 bind inventapp.bnd
db2 connect reset
db2 terminate
xlc -I$HOME/sqllib/include -c inventapp.c -o inventapp.o
xlc -o inventapp inventapp.o -ldb2 -L$HOME/sqllib/lib
```

If you do not specify a schema name for the optimization profile, the **QUALIFIER** command parameter is used as the implicit qualifier.

*Modifying an optimization profile:*

When you make a change to an optimization profile there are certain steps that need to be taken in order for the changes in the optimization profiles to take effect.

### About this task

When an optimization profile is referenced, it is compiled and cached in memory; therefore, these references must also be removed. Use the **FLUSH OPTIMIZATION PROFILE CACHE** statement to remove the old profile from the optimization profile cache. The statement also invalidates any statement in the dynamic plan cache that was prepared by using the old profile (*logical invalidation*).

### Procedure

To modify an optimization profile:

1. Edit the optimization profile XML file on disk, make the necessary changes, save the file to disk.
2. Validate that the changes made to the file are well formed XML as defined in the current optimization profile schema (COPS) in the DB2OptProfile.xsd file, which is located in the misc subdirectory of the sqllib directory.
3. Update the existing row in the SYSTOOLS.OPT\_PROFILE table with the new profile.



4. If you did not create triggers to flush the optimization profile cache, issue the `FLUSH OPTIMIZATION PROFILE CACHE` statement. The statement removes any versions of the optimization profile that might be contained in the optimization profile cache.

When you flush the optimization profile cache, any dynamic statements that were prepared with the old optimization profile are also invalidated in the dynamic plan cache.

## Results

Any subsequent reference to the optimization profile causes the optimizer to read the new profile and to reload it into the optimization profile cache. Statements prepared under the old optimization profile are logically invalidated. Calls made to those statements are prepared under the new optimization profile and recached in the dynamic plan cache.

*Deleting an optimization profile:*

You can remove an optimization profile that is no longer needed by deleting it from the `SYSTOOLS.OPT_PROFILE` table. When an optimization profile is referenced, it is compiled and cached in memory; therefore, if the original profile has already been used, you must also flush the deleted optimization profile from the optimization profile cache.

## Procedure

To delete an optimization profile:

1. Delete the optimization profile from the `SYSTOOLS.OPT_PROFILE` table. For example:

```
delete from systools.opt_profile
where schema = 'NEWTON' and name = 'INVENTDB'
```

2. If you did not create triggers to flush the optimization profile cache, issue the `FLUSH OPTIMIZATION PROFILE CACHE` statement to remove any versions of the optimization profile that might be contained in the optimization profile cache. See “Triggers to flush the optimization profile cache” on page 398.

**Note:** When you flush the optimization profile cache, any dynamic statements that were prepared with the old optimization profile are also invalidated in the dynamic plan cache.

## Results

Any subsequent reference to the optimization profile causes the optimizer to return `SQL0437W` with reason code 13.

## Optimization guidelines:

*Types of optimization guidelines:*

The DB2 optimizer processes a statement in two phases: the query rewrite optimization phase and the plan optimization phase.

The optimized statement is determined by the *query rewrite optimization phase*, which transforms the original statement into a semantically equivalent statement that can be more easily optimized in the plan optimization phase. The *plan*

*optimization phase* determines the optimal access methods, join methods, and join orders for the *optimized statement* by enumerating a number of alternatives and choosing the alternative that minimizes an execution cost estimate.

The query transformations, access methods, join methods, join orders, and other optimization alternatives that are considered during the two optimization phases are governed by various DB2 parameters, such as the CURRENT QUERY OPTIMIZATION special register, the REOPT bind option, and the **DB2\_REDUCED\_OPTIMIZATION** registry variable. The set of optimization alternatives is known as the *search space*.

The following types of statement optimization guidelines are supported:

- *General optimization guidelines*, which can be used to affect the setting of general optimization parameters, are applied first, because they can affect the search space.
- *Query rewrite guidelines*, which can be used to affect the transformations that are considered during the query rewrite optimization phase, are applied next, because they can affect the statement that is optimized during the plan optimization phase.
- *Plan optimization guidelines*, which can be used to affect the access methods, join methods, and join orders that are considered during the plan optimization phase, are applied last.

*General optimization guidelines:*

General optimization guidelines can be used to set general optimization parameters.

Each of these guidelines has statement-level scope.

*Query rewrite optimization guidelines:*

Query rewrite guidelines can be used to affect the transformations that are considered during the query rewrite optimization phase, which transforms the original statement into a semantically equivalent optimized statement.

The optimal execution plan for the optimized statement is determined during the plan optimization phase. Consequently, query rewrite optimization guidelines can affect the applicability of plan optimization guidelines.

Each query rewrite optimization guideline corresponds to one of the optimizer's query transformation rules. The following query transformation rules can be affected by query rewrite optimization guidelines:

- IN-LIST-to-join
- Subquery-to-join
- NOT-EXISTS-subquery-to-antijoin
- NOT-IN-subquery-to-antijoin

Query rewrite optimization guidelines are not always applicable. Query rewrite rules are enforced one at a time. Consequently, query rewrite rules that are enforced before a subsequent rule can affect the query rewrite optimization guideline that is associated with that rule. The environment configuration can affect the behavior of some rewrite rules which, in turn, affects the applicability of a query rewrite optimization guideline to a specific rule.

To get the same results each time, query rewrite rules have certain conditions that are applied before the rules are enforced. If the conditions that are associated with a rule are not satisfied when the query rewrite component attempts to apply the rule to the query, the query rewrite optimization guideline for the rule is ignored. If the query rewrite optimization guideline is not applicable, and the guideline is an enabling guideline, SQL0437W with reason code 13 is returned. If the query rewrite optimization guideline is not applicable, and the guideline is a disabling guideline, no message is returned. The query rewrite rule is not applied in this case, because the rule is treated as if it were disabled.

Query rewrite optimization guidelines can be divided into two categories: statement-level guidelines and predicate-level guidelines. All of the query rewrite optimization guidelines support the statement-level category. Only INLIST2JOIN supports the predicate-level category. The statement-level query rewrite optimization guidelines apply to the entire query. The predicate-level query rewrite optimization guideline applies to the specific predicate only. If both statement-level and predicate-level query rewrite optimization guidelines are specified, the predicate-level guideline overrides the statement-level guideline for the specific predicate.

Each query rewrite optimization guideline is represented by a corresponding rewrite request element in the optimization guideline schema.

The following example illustrates an IN-LIST-to-join query rewrite optimization guideline, as represented by the INLIST2JOIN rewrite request element.

```
SELECT S.S_NAME, S.S_ADDRESS, S.S_PHONE, S.S_COMMENT
FROM "Tpcd".PARTS P, "Tpcd".SUPPLIERS S, "Tpcd".PARTSUPP PS
WHERE P.PARTKEY = PS.PS_PARTKEY
      AND S.S_SUPPKEY = PS.PS_SUPPKEY
      AND P.SIZE IN (35, 36, 39, 40)
      AND S.S_NATION IN ('INDIA', 'SPAIN')
      AND PS.PS_SUPPLYCOST = (SELECT MIN(PS1.PS_SUPPLYCOST)
                              FROM "Tpcd".PARTSUPP PS1, "Tpcd".SUPPLIERS S1
                              WHERE P.PARTKEY = PS1.PS_PARTKEY
                                   AND S1.S_SUPPKEY = PS1.PS_SUPPKEY
                                   AND S1.S_NATION = S.S_NATION)
ORDER BY S.S_NAME
<OPTGUIDELINES><INLIST2JOIN TABLE='P' /></OPTGUIDELINES>;
```

This particular query rewrite optimization guideline specifies that the list of constants in the predicate P.SIZE IN (35, 36, 39, 40) should be transformed into a table expression. This table expression would then be eligible to drive an indexed nested-loop join access to the PARTS table in the main subselect. The TABLE attribute is used to identify the target IN-LIST predicate by indicating the table reference to which this predicate applies. If there are multiple IN-LIST predicates for the identified table reference, the INLIST2JOIN rewrite request element is considered ambiguous and is ignored.

In such cases, a COLUMN attribute can be added to further qualify the target IN-LIST predicate. For example:

```
SELECT S.S_NAME, S.S_ADDRESS, S.S_PHONE, S.S_COMMENT
FROM "Tpcd".PARTS P, "Tpcd".SUPPLIERS S, "Tpcd".PARTSUPP PS
WHERE P.PARTKEY = PS.PS_PARTKEY
      AND S.S_SUPPKEY = PS.PS_SUPPKEY
      AND P.SIZE IN (35, 36, 39, 40)
      AND P.TYPE IN ('BRASS', 'COPPER')
      AND S.S_NATION IN ('INDIA', 'SPAIN')
      AND PS.PS_SUPPLYCOST = (SELECT MIN(PS1.PS_SUPPLYCOST)
                              FROM "Tpcd".PARTSUPP PS1, "Tpcd".SUPPLIERS S1
```

```

WHERE P.P_PARTKEY = PS1.PS_PARTKEY
      AND S1.S_SUPPKEY = PS1.PS_SUPPKEY
      AND S1.S_NATION = S.S_NATION)
ORDER BY S.S_NAME
<OPTGUIDELINES><INLIST2JOIN TABLE='P' COLUMN='P_SIZE' /></OPTGUIDELINES>;

```

The TABLE attribute of the INLIST2JOIN element identifies the PARTS table reference in the main subselect. The COLUMN attribute is used to identify the IN-LIST predicate on the P\_SIZE column as the target. In general, the value of the COLUMN attribute can contain the unqualified name of the column referenced in the target IN-LIST predicate. If the COLUMN attribute is provided without the TABLE attribute, the query rewrite optimization guideline is considered invalid and is ignored.

The OPTION attribute can be used to enable or disable a particular query rewrite optimization guideline. Because the OPTION attribute is set to DISABLE in the following example, the list of constants in the predicate P\_SIZE IN (35, 36, 39, 40) will not be transformed into a table expression. The default value of the OPTION attribute is ENABLE. ENABLE and DISABLE must be specified in uppercase characters.

```

<OPTGUIDELINES>
  <INLIST2JOIN TABLE='P' COLUMN='P_SIZE' OPTION='DISABLE' />
</OPTGUIDELINES>

```

In the following example, the INLIST2JOIN rewrite request element does not have a TABLE attribute. The optimizer interprets this as a request to disable the IN-LIST-to-join query transformation for all IN-LIST predicates in the statement.

```

<OPTGUIDELINES><INLIST2JOIN OPTION='DISABLE' /></OPTGUIDELINES>

```

The following example illustrates a subquery-to-join query rewrite optimization guideline, as represented by the SUBQ2JOIN rewrite request element. A subquery-to-join transformation converts a subquery into an equivalent table expression. The transformation applies to subquery predicates that are quantified by EXISTS, IN, =SOME, =ANY, <>SOME, or <>ANY. The subquery-to-join query rewrite optimization guideline does not ensure that a subquery will be merged. A particular subquery cannot be targeted by this query rewrite optimization guideline. The transformation can only be enabled or disabled at the statement level.

```

SELECT S.S_NAME, S.S_ADDRESS, S.S_PHONE, S.S_COMMENT
FROM "Tpcd".PARTS P, "Tpcd".SUPPLIERS S, "Tpcd".PARTSUPP PS
WHERE P.P_PARTKEY = PS.PS_PARTKEY
      AND S.S_SUPPKEY = PS.PS_SUPPKEY
      AND P_SIZE IN (35, 36, 39, 40)
      AND P_TYPE = 'BRASS'
      AND S.S_NATION IN ('INDIA', 'SPAIN')
      AND PS.PS_SUPPLYCOST = (SELECT MIN(PS1.PS_SUPPLYCOST)
                             FROM "Tpcd".PARTSUPP PS1, "Tpcd".SUPPLIERS S1
                             WHERE P.P_PARTKEY = PS1.PS_PARTKEY
                                   AND S1.S_SUPPKEY = PS1.PS_SUPPKEY
                                   AND S1.S_NATION = S.S_NATION)
ORDER BY S.S_NAME
<OPTGUIDELINES><SUBQ2JOIN OPTION='DISABLE' /></OPTGUIDELINES>;

```

The following example illustrates a NOT-EXISTS-to-anti-join query rewrite optimization guideline, as represented by the NOTEX2AJ rewrite request element. A NOT-EXISTS-to-anti-join transformation converts a subquery into a table expression that is joined to other tables using anti-join semantics (only nonmatching rows are returned). The NOT-EXISTS-to-anti-join query rewrite optimization guideline applies to subquery predicates that are quantified by NOT

EXISTS. The NOT-EXISTS-to-anti-join query rewrite optimization guideline does not ensure that a subquery will be merged. A particular subquery cannot be targeted by this query rewrite optimization guideline. The transformation can only be enabled or disabled at the statement level.

```
SELECT S.S_NAME, S.S_ADDRESS, S.S_PHONE, S.S_COMMENT
FROM "Tpcd".PARTS P, "Tpcd".SUPPLIERS S, "Tpcd".PARTSUPP PS
WHERE P.PARTKEY = PS.PS_PARTKEY
      AND S.S_SUPPKEY = PS.PS_SUPPKEY
      AND P.SIZE IN (35, 36, 39, 40)
      AND P.TYPE = 'BRASS'
      AND S.S_NATION IN ('INDIA', 'SPAIN')
      AND NOT EXISTS (SELECT 1
                      FROM "Tpcd".SUPPLIERS S1
                      WHERE S1.S_SUPPKEY = PS.PS_SUPPKEY)
ORDER BY S.S_NAME
<OPTGUIDELINES><NOTEX2AJ OPTION='ENABLE' /></OPTGUIDELINES>;
```

**Note:** The enablement of a query transformation rule at the statement level does not ensure that the rule will be applied to a particular part of the statement. The usual criteria are used to determine whether query transformation will take place. For example, if there are multiple NOT EXISTS predicates in the query block, the optimizer will not consider converting any of them into anti-joins. Explicitly enabling query transformation at the statement level does not change this behavior.

The following example illustrates a NOT-IN-to-anti-join query rewrite optimization guideline, as represented by the NOTIN2AJ rewrite request element. A NOT-IN-to-anti-join transformation converts a subquery into a table expression that is joined to other tables using anti-join semantics (only nonmatching rows are returned). The NOT-IN-to-anti-join query rewrite optimization guideline applies to subquery predicates that are quantified by NOT IN. The NOT-IN-to-anti-join query rewrite optimization guideline does not ensure that a subquery will be merged. A particular subquery cannot be targeted by this query rewrite optimization guideline. The transformation can only be enabled or disabled at the statement level.

```
SELECT S.S_NAME, S.S_ADDRESS, S.S_PHONE, S.S_COMMENT
FROM "Tpcd".PARTS P, "Tpcd".SUPPLIERS S, "Tpcd".PARTSUPP PS
WHERE P.PARTKEY = PS.PS_PARTKEY
      AND S.S_SUPPKEY = PS.PS_SUPPKEY
      AND P.SIZE IN (35, 36, 39, 40)
      AND P.TYPE = 'BRASS'
      AND S.S_NATION IN ('INDIA', 'SPAIN')
      AND PS.PS_SUPPKEY NOT IN (SELECT S1.S_SUPPKEY
                               FROM "Tpcd".SUPPLIERS S1
                               WHERE S1.S_NATION = 'CANADA')
ORDER BY S.S_NAME
<OPTGUIDELINES><NOTIN2AJ OPTION='ENABLE' /></OPTGUIDELINES>
```

A particular query rewrite optimization guideline might not be applicable when considered within the context of other query rewrite transformations being applied to the statement. That is, if a guideline request to enable a transform cannot be applied, a warning is returned. For example, an INLIST2JOIN rewrite enable request element targeting a predicate that is eliminated from the query by another query transformation would not be applicable. Moreover, the successful application of a query rewrite optimization guideline might change the applicability of other query rewrite transformation rules. For example, a request to transform an IN-LIST to a table expression might prevent a different IN-LIST from being transformed to a table expression, because the optimizer will only apply a single IN-LIST-to-join transformation per query block.

### *Plan optimization guidelines:*

Plan optimization guidelines are applied during the cost-based phase of optimization, where access methods, join methods, join order, and other details of the execution plan for the statement are determined.

Plan optimization guidelines need not specify all aspects of an execution plan. Unspecified aspects of the execution plan are determined by the optimizer in a cost-based fashion.

There are two categories of plan optimization guidelines:

- `accessRequest` – An access request specifies an access method for satisfying a table reference in a statement.
- `joinRequest` – A join request specifies a method and sequence for performing a join operation. Join requests are composed of access or other join requests.

Access request optimization guidelines correspond to the optimizer's data access methods, such as table scan, index scan, and list prefetch. Join request guidelines correspond to the optimizer's join methods, such as nested-loop join, hash join, and merge join. Each access request and join request is represented by a corresponding access request element and join request element in the statement optimization guideline schema.

The following example illustrates an index scan access request, as represented by the `IXSCAN` access request element. This particular request specifies that the optimizer is to use the `I_SUPPKEY` index to access the `SUPPLIERS` table in the main subselect of the statement. The optional `INDEX` attribute identifies the desired index. The `TABLE` attribute identifies the table reference to which the access request is applied. A `TABLE` attribute must identify the target table reference using its exposed name, which in this example is the correlation name `S`.

SQL statement:

```
select s.s_name, s.s_address, s.s_phone, s.s_comment
  from "Tpcd".parts, "Tpcd".suppliers s, "Tpcd".partsupp ps
  where p_partkey = ps.ps_partkey and
        s.s_suppkey = ps.ps_suppkey and
        p_size = 39 and
        p_type = 'BRASS' and
        s.s_nation in ('MOROCCO', 'SPAIN') and
        ps.ps_supplycost = (select min(ps1.ps_supplycost)
                           from "Tpcd".partsupp ps1, "Tpcd".suppliers s1
                           where "Tpcd".parts.p_partkey = ps1.ps_partkey and
                                s1.s_suppkey = ps1.ps_suppkey and
                                s1.s_nation = s.s_nation)

  order by s.s_name
```

Optimization guideline:

```
<OPTGUIDELINES>
  <IXSCAN TABLE='S' INDEX='I_SUPPKEY' />
</OPTGUIDELINES>
```

The following index scan access request element specifies that the optimizer is to use index access to the `PARTS` table in the main subselect of the statement. The optimizer will choose the index in a cost-based fashion, because there is no `INDEX` attribute. The `TABLE` attribute uses the qualified table name to refer to the target table reference, because there is no associated correlation name.

```

<OPTGUIDELINES>
  <IXSCAN TABLE='Tpcd'.PARTS' />
</OPTGUIDELINES>

```

The following list prefetch access request is represented by the LPREFETCH access request element. This particular request specifies that the optimizer is to use the I\_SNATION index to access the SUPPLIERS table in the nested subselect of the statement. The TABLE attribute uses the correlation name S1, because that is the exposed name identifying the SUPPLIERS table reference in the nested subselect.

```

<OPTGUIDELINES>
  <LPREFETCH TABLE='S1' INDEX='I_SNATION' />
</OPTGUIDELINES>

```

The following index scan access request element specifies that the optimizer is to use the I\_SNAME index to access the SUPPLIERS table in the main subselect. The FIRST attribute specifies that this table is to be the first table that is accessed in the join sequence chosen for the corresponding FROM clause. The FIRST attribute can be added to any access or join request; however, there can be at most one access or join request with the FIRST attribute referring to tables in the same FROM clause.

SQL statement:

```

select s.s_name, s.s_address, s.s_phone, s.s_comment
  from "Tpcd".parts, "Tpcd".suppliers s, "Tpcd".partsupp ps
 where p_partkey = ps.ps_partkey
       s.s_suppkey = ps.ps_suppkey and
       p_size = 39 and
       p_type = 'BRASS' and
       s.s_nation in ('MOROCCO', 'SPAIN') and
       ps.ps_supplycost = (select min(ps1.ps_supplycost)
                          from "Tpcd".partsupp ps1, "Tpcd".suppliers s1
                          where "Tpcd".parts.p_partkey = ps1.ps_partkey and
                                s1.s_suppkey = ps1.ps_suppkey and
                                s1.s_nation = s.s_nation)

 order by s.s_name
 optimize for 1 row

```

Optimization guidelines:

```

<OPTGUIDELINES>
  <IXSCAN TABLE='S' INDEX='I_SNAME' FIRST='TRUE' />
</OPTGUIDELINES>

```

The following example illustrates how multiple access requests are passed in a single statement optimization guideline. The TBSCAN access request element represents a table scan access request. This particular request specifies that the SUPPLIERS table in the nested subselect is to be accessed using a full table scan. The LPREFETCH access request element specifies that the optimizer is to use the I\_SUPPKEY index during list prefetch index access to the SUPPLIERS table in the main subselect.

```

<OPTGUIDELINES>
  <TBSCAN TABLE='S1' />
  <LPREFETCH TABLE='S' INDEX='I_SUPPKEY' />
</OPTGUIDELINES>

```

The following example illustrates a nested-loop join request, as represented by the NLJOIN join request element. In general, a join request element contains two child elements. The first child element represents the desired outer input to the join operation, and the second child element represents the desired inner input to the join operation. The child elements can be access requests, other join requests, or combinations of access and join requests. In this example, the first IXSCAN access

request element specifies that the PARTS table in the main subselect is to be the outer table of the join operation. It also specifies that PARTS table access be performed using an index scan. The second IXSCAN access request element specifies that the PARTSUPP table in the main subselect is to be the inner table of the join operation. It, too, specifies that the table is to be accessed using an index scan.

```
<OPTGUIDELINES>
  <NLJOIN>
    <IXSCAN TABLE='Tpcd'.Parts' />
    <IXSCAN TABLE="PS" />
  </NLJOIN>
</OPTGUIDELINES>
```

The following example illustrates a hash join request, as represented by the HSJOIN join request element. The ACCESS access request element specifies that the SUPPLIERS table in the nested subselect is to be the outer table of the join operation. This access request element is useful in cases where specifying the join order is the primary objective. The IXSCAN access request element specifies that the PARTSUPP table in the nested subselect is to be the inner table of the join operation, and that the optimizer is to choose an index scan to access that table.

```
<OPTGUIDELINES>
  <HSJOIN>
    <ACCESS TABLE='S1' />
    <IXSCAN TABLE='PS1' />
  </HSJOIN>
</OPTGUIDELINES>
```

The following example illustrates how larger join requests can be constructed by nesting join requests. The example includes a merge join request, as represented by the MSJOIN join request element. The outer input of the join operation is the result of joining the PARTS and PARTSUPP tables of the main subselect, as represented by the NLJOIN join request element. The inner input of the join request element is the SUPPLIERS table in the main subselect, as represented by the IXSCAN access request element.

```
<OPTGUIDELINES>
  <MSJOIN>
    <NLJOIN>
      <IXSCAN TABLE='Tpcd'.Parts' />
      <IXSCAN TABLE="PS" />
    </NLJOIN>
    <IXSCAN TABLE='S' />
  </MSJOIN>
</OPTGUIDELINES>
```

If a join request is to be valid, all access request elements that are nested either directly or indirectly inside of it must reference tables in the same FROM clause of the optimized statement.

### Optimization guidelines for MQT matching

Users can override the optimizer's decision and force it to choose specific materialized query tables (MQTs) with the MQTENFORCE element. The MQTENFORCE element, can be specified at both the global and statement profile level, is used with one of the following attributes:

#### NAME

specifies the partial or fully qualified name of MQT to choose

**TYPE** specifies a group of MQTs by their types. Possible values are:



- NORMAL: all non-replicated MQTs
- REPLICATED: all replicated MQTs
- ALL: all MQTs

The following example illustrates an example of a guideline that enforces all replicated MQTs, as well as, the TPCD.PARTSMQT:

```
<OPTGUIDELINES>
  <MQTENFORCE NAME='TPCD.PARTSMQT' />
  <MQTENFORCE TYPE='REPLICATED' />
</OPTGUIDELINES>
```

**Note:** If you specify more than one attribute at a time, only the first one will be used. So in the following example

```
<MQTENFORCE NAME='TPCD.PARTSMQT' TYPE='REPLICATED' />
```

Only PARTSMQT MQT will be enforced

*Creating statement-level optimization guidelines:*

The statement-level optimization guidelines section of the statement profile is made up of one or more access or join requests, which specify methods for accessing or joining tables in the statement.

### Before you begin

Exhaust all other tuning options. For example:

1. Ensure that the data distribution statistics have been recently updated by the **RUNSTATS** utility.
2. Ensure that the data server is running with the proper optimization class setting for the workload.
3. Ensure that the optimizer has the appropriate indexes to access tables that are referenced in the query.

### Procedure

To create statement-level optimization guidelines:

1. Create the optimization profile in which you want to insert the statement-level guidelines. See “Creating an optimization profile” on page 336.
2. Run the explain facility against the statement to determine whether optimization guidelines would be helpful. Proceed if that appears to be the case.
3. Obtain the *original* statement by running a query that is similar to the following:

```
select statement_text
  from explain_statement
 where explain_level = '0' and
        explain_requester = 'SIMMEN' and
        explain_time      = '2003-09-08-16.01.04.108161' and
        source_name       = 'SQLC2E03' and
        source_version    = '' and
        queryno           = 1
```

4. Edit the optimization profile and create a statement profile, inserting the statement text into the statement key. For example:

```

<STMTPROFILE ID="Guidelines for TPCD Q9">
  <STMTKEY SCHEMA="TPCD"><![CDATA[SELECT S.S_NAME, S.S_ADDRESS, S.S_PHONE,
    S.S_COMMENT
    FROM PARTS P, SUPPLIERS S, PARTSUPP PS
    WHERE P.PARTKEY = PS.PS_PARTKEY AND S.S_SUPPKEY = PS.PS_SUPPKEY
    AND P.P_SIZE = 39 AND P.P_TYPE = 'BRASS' AND S.S_NATION
    = 'MOROCCO' AND
    PS.PS_SUPPLYCOST = (SELECT MIN(PS1.PS_SUPPLYCOST)
    FROM PARTSUPP PS1, SUPPLIERS S1
    WHERE P.P_PARTKEY = PS1.PS_PARTKEY AND S1.S_SUPPKEY = PS1.PS_SUPPKEY
    AND S1.S_NATION = S.S_NATION)]]>
  </STMTKEY>
</STMTPROFILE>

```

5. Insert statement-level optimization guidelines after the statement key. Use exposed names to identify the objects that are referenced in access and join requests. The following is an example of a join request:

```

<OPTGUIDELINES>
  <HSJOIN>
    <TBSCAN TABLE='PS1' />
    <IXSCAN TABLE='S1'
      INDEX='I1' />
  </HSJOIN>
</OPTGUIDELINES>

```

6. Validate the file and save it.

## Results

If expected results are not achieved, make changes to the guidelines or create additional guidelines, and update the optimization profile, as appropriate.

*Forming table references in optimization guidelines:*

The term *table reference* is used to mean any table, view, table expression, or the table which an alias references in an SQL statement or view definition. An optimization guideline can identify a table reference using either its exposed name in the original statement or the unique correlation name that is associated with the table reference in the optimized statement.

Extended names, which are sequences of exposed names, help to uniquely identify table references that are embedded in views. An alias name cannot be used as a table reference in an optimization guideline, in such a case any guideline targeting the table reference will be ignored. Optimization guidelines that identify exposed or extended names that are not unique within the context of the entire statement are considered ambiguous and are not applied. Moreover, if more than one optimization guideline identifies the same table reference, all optimization guidelines identifying that table reference are considered conflicting and are not applied. The potential for query transformations makes it impossible to guarantee that an exposed or extended name will still exist during optimization; therefore, any guideline that identifies such table references is ignored.

### Using exposed names in the original statement to identify table references

A table reference is identified by using the exposed name of the table. The exposed name is specified in the same way that a table would be qualified in an SQL statement.

The rules for specifying SQL identifiers also apply to the TABLE attribute value of an optimization guideline. The TABLE attribute value is compared to each exposed

name in the statement. Only a single match is permitted in this DB2 release. If the TABLE attribute value is schema-qualified, it matches any equivalent exposed qualified table name. If the TABLE attribute value is unqualified, it matches any equivalent correlation name or exposed table name. The TABLE attribute value is therefore considered to be implicitly qualified by the default schema that is in effect for the statement. These concepts are illustrated by the following example. Assume that the statement is optimized using the default schema Tpcd.

```
select s_name, s_address, s_phone, s_comment
  from parts, suppliers, partsupp ps
 where p_partkey = ps.ps_partkey and
        s.s_suppkey = ps.ps_suppkey and
        p_size = 39 and
        p_type = 'BRASS'
```

TABLE attribute values that identify a table reference in the statement include "'Tpcd'.PARTS', 'PARTS', 'Parts' (because the identifier is not delimited, it is converted to uppercase characters). TABLE attribute values that fail to identify a table reference in the statement include "'Tpcd2'.SUPPLIERS', 'PARTSUPP' (not an exposed name), and 'Tpcd.PARTS' (the identifier Tpcd must be delimited; otherwise, it is converted to uppercase characters).

The exposed name can be used to target any table reference in the original statement, view, SQL function, or trigger.

### Using exposed names in the original statement to identify table references in views

Optimization guidelines can use extended syntax to identify table references that are embedded in views, as shown in the following example:

```
create view "Rick".v1 as
  (select * from employee a where salary > 50000)

create view "Gustavo".v2 as
  (select * from "Rick".v1
   where deptno in ('52', '53', '54'))

select * from "Gustavo".v2 a
  where v2.hire_date > '01/01/2004'

<OPTGUIDELINES>
  <IXSCAN TABLE='A/"Rick".V1/A' />
</OPTGUIDELINES>
```

The IXSCAN access request element specifies that an index scan is to be used for the EMPLOYEE table reference that is embedded in the views "Gustavo".V2 and "Rick".V1. The extended syntax for identifying table references in views is a series of exposed names separated by a slash character. The value of the TABLE attribute A/"Rick".V1/A illustrates the extended syntax. The last exposed name in the sequence (A) identifies the table reference that is a target of the optimization guideline. The first exposed name in the sequence (A) identifies the view that is directly referenced in the original statement. The exposed name or names in the middle ("Rick".V1) pertain to the view references along the path from the direct view reference to the target table reference. The rules for referring to exposed names from optimization guidelines, described in the previous section, apply to each step of the extended syntax.

Had the exposed name of the EMPLOYEE table reference in the view been unique with respect to all tables that are referenced either directly or indirectly by the statement, the extended name syntax would not be necessary.

Extended syntax can be used to target any table reference in the original statement, SQL function, or trigger.

### Identifying table references using correlation names in the optimized statement

An optimization guideline can also identify a table reference using the unique correlation names that are associated with the table reference in the optimized statement. The optimized statement is a semantically equivalent version of the original statement, as determined during the query rewrite phase of optimization. The optimized statement can be retrieved from the explain tables. The TABID attribute of an optimization guideline is used to identify table references in the optimized statement. For example:

#### Original statement:

```
select s.s_name, s.s_address, s.s_phone, s.s_comment
  from sm_tpcd.parts p, sm_tpcd.suppliers s, sm_tpcd.partsupp ps
 where p_partkey = ps.ps_partkey and
       s.s_suppkey = ps.ps_suppkey and
       p.p_size = 39 and
       p.p_type = 'BRASS' and
       s.s_nation in ('MOROCCO', 'SPAIN') and
       ps.ps_supplycost = (select min(ps1.ps_supplycost)
                          from sm_tpcd.partsupp ps1, sm_tpcd.suppliers s1
                          where p.p_partkey = ps1.ps_partkey and
                                s1.s_suppkey = ps1.ps_suppkey and
                                s1.s_nation = s.s_nation)
```

```
<OPTGUIDELINES>
  <HSJOIN>
    <TBSCAN TABLE='S1' />
    <IXSCAN TABID='Q2' />
  </HSJOIN>
</OPTGUIDELINES>
```

#### Optimized statement:

```
select q6.s_name as "S_NAME", q6.s_address as "S_ADDRESS",
       q6.s_phone as "S_PHONE", q6.s_comment as "S_COMMENT"
  from (select min(q4.$c0)
        from (select q2.ps_supplycost
              from sm_tpcd.suppliers as q1, sm_tpcd.partsupp as q2
              where q1.s_nation = 'MOROCCO' and
                    q1.s_suppkey = q2.ps_suppkey and
                    q7.p_partkey = q2.ps_partkey
              ) as q3
        ) as q4, sm_tpcd.partsupp as q5, sm_tpcd.suppliers as q6,
        sm_tpcd.parts as q7
 where p_size = 39 and
       q5.ps_supplycost = q4.$c0 and
       q6.s_nation in ('MOROCCO', 'SPAIN') and
       q7.p_type = 'BRASS' and
       q6.s_suppkey = q5.ps_suppkey and
       q7.p_partkey = q5.ps_partkey
```

This optimization guideline shows a hash join request, where the SUPPLIERS table in the nested subselect is the outer table, as specified by the TBSCAN access request element, and where the PARTSUPP table in the nested subselect is the inner table, as specified by the IXSCAN access request element. The TBSCAN

access request element uses the TABLE attribute to identify the SUPPLIERS table reference using the corresponding exposed name in the original statement. The IXSCAN access request element, on the other hand, uses the TABID attribute to identify the PARTSUPP table reference using the unique correlation name that is associated with that table reference in the optimized statement.

If a single optimization guideline specifies both the TABLE and TABID attributes, they must identify the same table reference, or the optimization guideline is ignored.

**Note:** There is currently no guarantee that correlation names in the optimized statement will be stable when upgrading to a new release of the DB2 product.

### Ambiguous table references

An optimization guideline is considered invalid and is not applied if it matches multiple exposed or extended names. For example:

```
create view v1 as
  (select * from employee
   where salary > (select avg(salary) from employee))

select * from v1
  where deptno in ('M62', 'M63')

<OPTGUIDE>
  <IXSCAN TABLE='V1/EMPLOYEE' />
</OPTGUIDE>
```

The optimizer considers the IXSCAN access request ambiguous, because the exposed name EMPLOYEE is not unique within the definition of view V1.

To eliminate the ambiguity, the view can be rewritten to use unique correlation names, or the TABID attribute can be used. Table references that are identified by the TABID attribute are never ambiguous, because all correlation names in the optimized statement are unique.

### Conflicting optimization guidelines

Multiple optimization guidelines cannot identify the same table reference. For example:

```
<OPTGUIDELINES>
  <IXSCAN TABLE='Tpcd'.PARTS' INDEX='I_PTYPE' />
  <IXSCAN TABLE='Tpcd'.PARTS' INDEX='I_SIZE' />
</OPTGUIDELINES>
```

Each of the IXSCAN elements references the "Tpcd".PARTS table in the main subselect.

When two or more guidelines refer to the same table, only the first is applied; all other guidelines are ignored, and an error is returned.

Only one INLIST2JOIN query rewrite request element at the predicate level per query can be enabled. The following example illustrates an unsupported query rewrite optimization guideline, where two IN-LIST predicates are enabled at the predicate level. Both guidelines are ignored, and a warning is returned.

```

<OPTGUIDELINES>
  <INLIST2JOIN TABLE='P' COLUMN='P_SIZE' />
  <INLIST2JOIN TABLE='P' COLUMN='P_TYPE' />
</OPTGUIDELINES>

```

*Verifying that optimization guidelines have been used:*

The optimizer makes every attempt to adhere to the optimization guidelines that are specified in an optimization profile; however, the optimizer can reject invalid or inapplicable guidelines.

### Before you begin

Explain tables must exist before you can use the explain facility. The data definition language (DDL) for creating the explain tables is contained in EXPLAIN.DDL, which can be found in the misc subdirectory of the sqllib directory.

### Procedure

To verify that a valid optimization guideline has been used:

1. Issue the EXPLAIN statement against the statement to which the guidelines apply. If an optimization guideline was in effect for the statement using an optimization profile, the optimization profile name appears as a RETURN operator argument in the EXPLAIN\_ARGUMENT table. And if the optimization guideline contained an SQL embedded optimization guideline or statement profile that matched the current statement, the name of the statement profile appears as a RETURN operator argument. The types of these two new argument values are OPT\_PROF and STMTPROF.
2. Examine the results of the explained statement. The following query against the explain tables can be modified to return the optimization profile name and the statement profile name for your particular combination of EXPLAIN\_REQUESTER, EXPLAIN\_TIME, SOURCE\_NAME, SOURCE\_VERSION, and QUERYNO:

```

SELECT VARCHAR(B.ARGUMENT_TYPE, 9) as TYPE,
       VARCHAR(B.ARGUMENT_VALUE, 24) as VALUE
FROM   EXPLAIN_STATEMENT A, EXPLAIN_ARGUMENT B
WHERE  A.EXPLAIN_REQUESTER = 'SIMMEN'
      AND A.EXPLAIN_TIME    = '2003-09-08-16.01.04.108161'
      AND A.SOURCE_NAME     = 'SQLC2E03'
      AND A.SOURCE_VERSION  = ''
      AND A.QUERYNO         = 1
      AND A.EXPLAIN_REQUESTER = B.EXPLAIN_REQUESTER
      AND A.EXPLAIN_TIME     = B.EXPLAIN_TIME
      AND A.SOURCE_NAME      = B.SOURCE_NAME
      AND A.SOURCE_SCHEMA    = B.SOURCE_SCHEMA
      AND A.SOURCE_VERSION   = B.SOURCE_VERSION
      AND A.EXPLAIN_LEVEL    = B.EXPLAIN_LEVEL
      AND A.STMTNO           = B.STMTNO
      AND A.SECTNO           = B.SECTNO
      AND A.EXPLAIN_LEVEL    = 'P'
      AND (B.ARGUMENT_TYPE = 'OPT_PROF' OR ARGUMENT_TYPE = 'STMTPROF')
      AND B.OPERATOR_ID = 1

```

If the optimization guideline is active and the explained statement matches the statement that is contained in the STMTKEY element of the optimization

guideline, a query that is similar to the previous example produces output that is similar to the following output. The value of the STMTPROF argument is the same as the ID attribute in the STMTPROFILE element.

TYPE	VALUE
OPT_PROF	NEWTON.PROFILE1
STMTPROF	Guidelines for TPCD Q9

### XML schema for optimization profiles and guidelines:

#### *Current optimization profile schema:*

The valid optimization profile contents for a given DB2 release is described by an XML schema that is known as the current optimization profile schema (COPS). An optimization profile applies only to DB2 Database for Linux, UNIX, and Windows servers.

The following listing represents the COPS for the current release of the DB2 product. The COPS can also be found in DB2OptProfile.xsd, which is located in the misc subdirectory of the sql1ib directory.

```
<?xml version="1.0" encoding="UTF-8"?>
<xs:schema xmlns:xs="http://www.w3.org/2001/XMLSchema" elementFormDefault="qualified" version="1.0">
<!--*****-->
<!-- Licensed Materials - Property of IBM -->
<!-- (C) Copyright International Business Machines Corporation 2009. All rights reserved. -->
<!-- U.S. Government Users Restricted Rights; Use, duplication or disclosure restricted by -->
<!-- GSA ADP Schedule Contract with IBM Corp. -->
<!--*****-->
<!--*****-->
<!-- Definition of the current optimization profile schema for V9.7.0.0 -->
<!-- -->
<!-- An optimization profile is composed of the following sections: -->
<!-- -->
<!-- + A global optimization guidelines section (at most one) which defines optimization -->
<!-- guidelines affecting any statement for which the optimization profile is in effect. -->
<!-- -->
<!-- + Zero or more statement profile sections, each of which defines optimization -->
<!-- guidelines for a particular statement for which the optimization profile -->
<!-- is in effect. -->
<!-- -->
<!-- The VERSION attribute indicates the version of this optimization profile -->
<!-- schema. -->
<!--*****-->
<xs:element name="OPTPROFILE">
  <xs:complexType>
    <xs:sequence>
      <!-- Global optimization guidelines section. At most one can be specified. -->
      <xs:element name="OPTGUIDELINES" type="globalOptimizationGuidelinesType" minOccurs="0"/>
      <!-- Statement profile section. Zero or more can be specified -->
      <xs:element name="STMTPROFILE" type="statementProfileType" minOccurs="0" maxOccurs="unbounded"/>
    </xs:sequence>
    <!-- Version attribute is currently optional -->
    <xs:attribute name="VERSION" use="optional"/>
  </xs:complexType>
</xs:element>

<!--*****-->
<!-- Global optimization guidelines supported in this version: -->
<!-- + MQTOptimizationChoices elements influence the MQTs considered by the optimizer. -->
<!-- + computationalPartitionGroupOptimizationsChoices elements can affect repartitioning -->
<!-- optimizations involving nicknames. -->
<!-- + General requests affect the search space which defines the alternative query -->
<!-- transformations, access methods, join methods, join orders, and other optimizations, -->
<!-- considered by the compiler and optimizer. -->
<!-- + MQT enforcement requests specify semantically matchable MQTs whose usage in access -->
<!-- plans should be enforced regardless of cost estimates. -->
<!-- *****-->
<xs:complexType name="globalOptimizationGuidelinesType">
  <xs:sequence>
    <xs:group ref="MQTOptimizationChoices" />
    <xs:group ref="computationalPartitionGroupOptimizationsChoices" />
  </xs:sequence>
</xs:complexType>
```

```

        <xs:group ref="generalRequest"/>
        <xs:group ref="mqtEnforcementRequest" />
    </xs:sequence>
</xs:complexType>
<!-- *****-->
<!-- Elements for affecting materialized query table (MQT) optimization. -->
<!-- -->
<!-- + MQTOPT - can be used to disable materialized query table (MQT) optimization. -->
<!-- If disabled, the optimizer will not consider MQTs to optimize the statement. -->
<!-- -->
<!-- + MQT - multiple of these can be specified. Each specifies an MQT that should be -->
<!-- considered for optimizing the statement. Only specified MQTs will be considered. -->
<!-- -->
<!-- *****-->
<xs:group name="MQTOptimizationChoices">
    <xs:choice>
        <xs:element name="MQTOPT" minOccurs="0" maxOccurs="1">
            <xs:complexType>
                <xs:attribute name="OPTION" type="optionType" use="optional"/>
            </xs:complexType>
        </xs:element>
        <xs:element name="MQT" minOccurs="0" maxOccurs="unbounded">
            <xs:complexType>
                <xs:attribute name="NAME" type="xs:string" use="required"/>
            </xs:complexType>
        </xs:element>
    </xs:choice>
</xs:group>
<!-- *****-->
<!-- Elements for affecting computational partition group (CPG) optimization. -->
<!-- -->
<!-- + PARTOPT - can be used disable the computational partition group (CPG) optimization -->
<!-- which is used to dynamically redistributes inputs to join, aggregation, -->
<!-- and union operations when those inputs are results of remote queries. -->
<!-- -->
<!-- + PART - Define the partition groups to be used in CPG optimizations. -->
<!-- -->
<!-- *****-->
<xs:group name="computationalPartitionGroupOptimizationChoices">
    <xs:choice>
        <xs:element name="PARTOPT" minOccurs="0" maxOccurs="1">
            <xs:complexType>
                <xs:attribute name="OPTION" type="optionType" use="optional"/>
            </xs:complexType>
        </xs:element>
        <xs:element name="PART" minOccurs="0" maxOccurs="1">
            <xs:complexType>
                <xs:attribute name="NAME" type="xs:string" use="required"/>
            </xs:complexType>
        </xs:element>
    </xs:choice>
</xs:group>
<!-- *****-->
<!-- Definition of a statement profile. -->
<!-- Comprised of a statement key and optimization guidelines. -->
<!-- The statement key specifies semantic information used to identify the statement to -->
<!-- which optimization guidelines apply. The optional ID attribute provides the statement -->
<!-- profile with a name for use in EXPLAIN output. -->
<!-- *****-->
<xs:complexType name="statementProfileType">
    <xs:sequence>
        <!-- Statement key element -->
        <xs:element name="STMTKEY" type="statementKeyType"/>
        <xs:element name="OPTGUIDELINES" type="optGuidelinesType"/>
    </xs:sequence>
    <!-- ID attribute.Used in explain output to indicate the statement profile was used. -->
    <xs:attribute name="ID" type="xs:string" use="optional"/>
</xs:complexType>
<!-- *****-->
<!-- Definition of the statement key. The statement key provides semantic information used -->
<!-- to identify the statement to which the optimization guidelines apply. -->
<!-- The statement key is comprised of: -->
<!-- + statement text (as written in the application) -->
<!-- + default schema (for resolving unqualified table names in the statement) -->
<!-- + function path (for resolving unqualified types and functions in the statement) -->
<!-- The statement text is provided as element data whereas the default schema and function -->
<!-- path are provided via the SCHEMA and FUNCPATH elements, respectively. -->
<!-- *****-->
<xs:complexType name="statementKeyType" mixed="true">

```



```

    <xs:attribute name="SCHEMA" type="xs:string" use="optional"/>
    <xs:attribute name="FUNCPATH" type="xs:string" use="optional"/>
</xs:complexType>

<!--*****-->
<!--
<!-- Optimization guideline elements can be chosen from general requests, rewrite
requests access requests, or join requests.
<!--
<!-- General requests affect the search space which defines the alternative query
transformations, access methods, join methods, join orders, and other optimizations,
considered by the optimizer.
<!--
<!-- Rewrite requests affect the query transformations used in determining the optimized
statement.
<!--
<!-- Access requests affect the access methods considered by the cost-based optimizer,
and join requests affect the join methods and join order used in the execution plan.
<!--
<!-- MQT enforcement requests specify semantically matchable MQTs whose usage in access
plans should be enforced regardless of cost estimates.
<!--
<!--*****-->
<xs:element name="OPTGUIDELINES" type="optGuidelinesType"/>
<xs:complexType name="optGuidelinesType">
  <xs:sequence>
    <xs:group ref="generalRequest" minOccurs="0" maxOccurs="1"/>
    <xs:choice maxOccurs="unbounded">
      <xs:group ref="rewriteRequest" />
      <xs:group ref="accessRequest"/>
      <xs:group ref="joinRequest"/>
      <xs:group ref="mqtEnforcementRequest"/>
    </xs:choice>
  </xs:sequence>
</xs:complexType>
<!--*****-->
<!-- Choices of general request elements.
<!-- REOPT can be used to override the setting of the REOPT bind option.
<!-- DPFXMLMOVEMENT can be used to affect the optimizer's plan when moving XML documents
between database partitions. The value can be NONE, REFERENCE or COMBINATION. The
default value is NONE.
<!--*****-->
<xs:group name="generalRequest">
  <xs:sequence>
    <xs:element name="REOPT" type="reoptType" minOccurs="0" maxOccurs="1"/>
    <xs:element name="DEGREE" type="degreeType" minOccurs="0" maxOccurs="1"/>
    <xs:element name="QRYOPT" type="qryoptType" minOccurs="0" maxOccurs="1"/>
    <xs:element name="RTS" type="rtsType" minOccurs="0" maxOccurs="1"/>
    <xs:element name="DPFXMLMOVEMENT" type="dpfXMLMovementType" minOccurs="0" maxOccurs="1"/>
  </xs:sequence>
</xs:group>
<!--*****-->
<!-- Choices of rewrite request elements.
<!--*****-->
<xs:group name="rewriteRequest">
  <xs:sequence>
    <xs:element name="INLIST2JOIN" type="inListToJoinType" minOccurs="0"/>
    <xs:element name="SUBQ2JOIN" type="subqueryToJoinType" minOccurs="0"/>
    <xs:element name="NOTEX2AJ" type="notExistsToAntiJoinType" minOccurs="0"/>
    <xs:element name="NOTIN2AJ" type="notInToAntiJoinType" minOccurs="0"/>
  </xs:sequence>
</xs:group>
<!--*****-->
<!-- Choices for access request elements.
<!-- TBSCAN - table scan access request element
<!-- IXSCAN - index scan access request element
<!-- LPREFETCH - list prefetch access request element
<!-- IXAND - index ANDing access request element
<!-- IXOR - index ORing access request element
<!-- XISCAN - xml index access request element
<!-- XANDOR - XANDOR access request element
<!-- ACCESS - indicates the optimizer should choose the access method for the table
<!--*****-->
<xs:group name="accessRequest">
  <xs:choice>
    <xs:element name="TBSCAN" type="tableScanType"/>
    <xs:element name="IXSCAN" type="indexScanType"/>
    <xs:element name="LPREFETCH" type="listPrefetchType"/>
    <xs:element name="IXAND" type="indexAndingType"/>
  </xs:choice>
</xs:group>

```

```

        <xs:element name="IXOR" type="indexOringType"/>
        <xs:element name="XISCAN" type="indexScanType"/>
        <xs:element name="XANDOR" type="XANDORType"/>
        <xs:element name="ACCESS" type="anyAccessType"/>
    </xs:choice>
</xs:group>
<!-- ***** -->
<!-- Choices for join request elements. -->
<!-- NLJOIN - nested-loops join request element -->
<!-- MSJOIN - sort-merge join request element -->
<!-- HSJOIN - hash join request element -->
<!-- JOIN - indicates that the optimizer is to choose the join method. -->
<!-- ***** -->
<xs:group name="joinRequest">
    <xs:choice>
        <xs:element name="NLJOIN" type="nestedLoopJoinType"/>
        <xs:element name="HSJOIN" type="hashJoinType"/>
        <xs:element name="MSJOIN" type="mergeJoinType"/>
        <xs:element name="JOIN" type="anyJoinType"/>
    </xs:choice>
</xs:group>
<!-- ***** -->
<!-- MQT enforcement request element. -->
<!-- MQTENFORCE - This element can be used to specify semantically matchable MQTs whose -->
<!-- usage in access plans should be enforced regardless of Optimizer cost estimates. -->
<!-- MQTs can be specified either directly with the NAME attribute or generally using -->
<!-- the TYPE attribute. -->
<!-- Only the first valid attribute found is used and all subsequent ones are ignored. -->
<!-- Since this element can be specified multiple times, more than one MQT can be -->
<!-- enforced at a time. -->
<!-- Note however, that if there is a conflict when matching two enforced MQTs to the -->
<!-- same data source (base-table or derived) an MQT will be picked based on existing -->
<!-- tie-breaking rules, i.e., either heuristic or cost-based. -->
<!-- Finally, this request overrides any other MQT optimization options specified in -->
<!-- a profile, i.e., enforcement will take place even if MQTOPT is set to DISABLE or -->
<!-- if the specified MQT or MQTs do not exist in the eligibility list specified by -->
<!-- any MQT elements. -->
<!-- ***** -->
<xs:group name="mqtEnforcementRequest">
    <xs:sequence>
        <xs:element name="MQTENFORCE" type="mqtEnforcementType" minOccurs="0" maxOccurs="unbounded"/>
    </xs:sequence>
</xs:group>
<!-- ***** -->
<!-- REOPT general request element. Can override REOPT setting at the package, db, -->
<!-- dbm level. -->
<!-- ***** -->
<xs:complexType name="reoptType">
    <xs:attribute name="VALUE" use="required">
        <xs:simpleType>
            <xs:restriction base="xs:string">
                <xs:enumeration value="ONCE"/>
                <xs:enumeration value="ALWAYS"/>
            </xs:restriction>
        </xs:simpleType>
    </xs:attribute>
</xs:complexType>
<!-- ***** -->
<!-- RTS general request element to enable, disable or provide a time budget for -->
<!-- real-time statistics collection. -->
<!-- OPTION attribute allows enabling or disabling real-time statistics. -->
<!-- TIME attribute provides a time budget in milliseconds for real-time statistics collection.-->
<!-- ***** -->
<xs:complexType name="rtsType">
    <xs:attribute name="OPTION" type="optionType" use="optional" default="ENABLE"/>
    <xs:attribute name="TIME" type="xs:nonNegativeInteger" use="optional"/>
</xs:complexType>
<!-- ***** -->
<!-- Definition of an "IN list to join" rewrite request -->
<!-- OPTION attribute allows enabling or disabling the alternative. -->
<!-- TABLE attribute allows request to target IN list predicates applied to a -->
<!-- specific table reference. COLUMN attribute allows request to target a specific IN list -->
<!-- predicate. -->
<!-- ***** -->
<xs:complexType name="inListToJoinType">
    <xs:attribute name="OPTION" type="optionType" use="optional" default="ENABLE"/>
    <xs:attribute name="TABLE" type="xs:string" use="optional"/>
    <xs:attribute name="COLUMN" type="xs:string" use="optional"/>
</xs:complexType>

```

```

<!--*****-->
<!-- Definition of a "subquery to join" rewrite request -->
<!-- The OPTION attribute allows enabling or disabling the alternative. -->
<!--*****-->
<xs:complexType name="subqueryToJoinType">
  <xs:attribute name="OPTION" type="optionType" use="optional" default="ENABLE"/>
</xs:complexType>
<!--*****-->
<!-- Definition of a "not exists to anti-join" rewrite request -->
<!-- The OPTION attribute allows enabling or disabling the alternative. -->
<!--*****-->
<xs:complexType name="notExistsToAntiJoinType">
  <xs:attribute name="OPTION" type="optionType" use="optional" default="ENABLE"/>
</xs:complexType>
<!--*****-->
<!-- Definition of a "not IN to anti-join" rewrite request -->
<!-- The OPTION attribute allows enabling or disabling the alternative. -->
<!--*****-->
<xs:complexType name="notInToAntiJoinType">
  <xs:attribute name="OPTION" type="optionType" use="optional" default="ENABLE"/>
</xs:complexType>
<!--*****-->
<!-- Effectively the superclass from which all access request elements inherit. -->
<!-- This type currently defines TABLE and TABID attributes, which can be used to tie an -->
<!-- access request to a table reference in the query. -->
<!-- The TABLE attribute value is used to identify a table reference using identifiers -->
<!-- in the original SQL statement. The TABID attribute value is used to identify a table -->
<!-- referece using the unique correlation name provided via the -->
<!-- optimized statement. If both the TABLE and TABID attributes are specified, the TABID -->
<!-- field is ignored. The FIRST attribute indicates that the access should be the first -->
<!-- access in the join sequence for the FROM clause. -->
<!-- The SHARING attribute indicates that the access should be visible to other concurrent -->
<!-- similar accesses that may therefore share bufferpool pages. The WRAPPING attribute -->
<!-- indicates that the access should be allowed to perform wrapping, thereby allowing it to -->
<!-- start in the middle for better sharing with other concurrent accesses. The THROTTLE -->
<!-- attribute indicates that the access should be allowed to be throttled if this may -->
<!-- benefit other concurrent accesses. The SHARESPEED attribute is used to indicate whether -->
<!-- the access should be considered fast or slow for better grouping of concurrent accesses. -->
<!--*****-->
<xs:complexType name="accessType" abstract="true">
  <xs:attribute name="TABLE" type="xs:string" use="optional"/>
  <xs:attribute name="TABID" type="xs:string" use="optional"/>
  <xs:attribute name="FIRST" type="xs:string" use="optional" fixed="TRUE"/>
  <xs:attribute name="SHARING" type="optionType" use="optional" default="ENABLE"/>
  <xs:attribute name="WRAPPING" type="optionType" use="optional" default="ENABLE"/>
  <xs:attribute name="THROTTLE" type="optionType" use="optional" default="ENABLE"/>
  <xs:attribute name="SHARESPEED" type="shareSpeed" use="optional"/>
</xs:complexType>
<!--*****-->
<!-- Definition of an table scan access request method. -->
<!--*****-->
<xs:complexType name="tableScanType">
  <xs:complexContent>
    <xs:extension base="accessType"/>
  </xs:complexContent>
</xs:complexType>
<!--*****-->
<!-- Definition of an index scan access request element. The index name is optional. -->
<!--*****-->
<xs:complexType name="indexScanType">
  <xs:complexContent>
    <xs:extension base="accessType">
      <xs:attribute name="INDEX" type="xs:string" use="optional"/>
    </xs:extension>
  </xs:complexContent>
</xs:complexType>
<!--*****-->
<!-- Definition of a list prefetch access request element. The index name is optional. -->
<!--*****-->
<xs:complexType name="listPrefetchType">
  <xs:complexContent>
    <xs:extension base="accessType">
      <xs:attribute name="INDEX" type="xs:string" use="optional"/>
    </xs:extension>
  </xs:complexContent>
</xs:complexType>
<!--*****-->
<!-- Definition of an extended access element which will be used by IXAND and ACCESS -->
<!-- requests. -->

```

```

<!-- A single index scan be specified via the INDEX attribute. Multiple indexes -->
<!-- can be specified via INDEX elements. The index element specification supersedes the -->
<!-- attribute specification. If a single index is specified, the optimizer will use the -->
<!-- index as the first index of the index ANDing access method and will choose addi- -->
<!-- tional indexes using cost. If multiple indexes are specified the optimizer will -->
<!-- use exactly those indexes in the specified order. If no indexes are specified -->
<!-- via either the INDEX attribute or INDEX elements, then the optimizer will choose -->
<!-- all indexes based upon cost. -->
<!-- Extension for XML support: -->
<!-- TYPE: Optional attribute. The allowed value is XMLINDEX. When the type is not -->
<!-- specified, the optimizer makes a cost based decision. -->
<!-- ALLINDEXES: Optional attribute. The allowed value is TRUE. The default -->
<!-- value is FALSE. -->
<!--***** -->
<xs:complexType name="extendedAccessType">
  <xs:complexContent>
    <xs:extension base="accessType">
      <xs:sequence minOccurs="0">
        <xs:element name="INDEX" type="indexType" minOccurs="2" maxOccurs="unbounded"/>
      </xs:sequence>
      <xs:attribute name="INDEX" type="xs:string" use="optional"/>
      <xs:attribute name="TYPE" type="xs:string" use="optional" fixed="XMLINDEX"/>
      <xs:attribute name="ALLINDEXES" type="boolType" use="optional" fixed="TRUE"/>
    </xs:extension>
  </xs:complexContent>
</xs:complexType>
<!--***** -->
<!-- Definition of an index ANDing access request element. -->
<!-- Extension for XML support: -->
<!-- All attributes and elements in extendedAccessType are included. -->
<!-- Note that ALLINDEXES is a valid option only if TYPE is XMLINDEX. -->
<!-- STARJOIN index ANDing: Specifying STARJOIN='TRUE' or one or more NLJOIN elements -->
<!-- identifies the index ANDing request as a star join index ANDing request. When that -->
<!-- is the case: -->
<!-- TYPE cannot be XMLINDEX (and therefore ALLINDEXES cannot be specified). -->
<!-- Neither the INDEX attribute nor INDEX elements can be specified. -->
<!-- The TABLE or TABID attribute identifies the fact table. -->
<!-- Zero or more semijoins can be specified using NLJOIN elements. -->
<!-- If no semijoins are specified, the optimizer will choose them. -->
<!-- If a single semijoin is specified, the optimizer will use it as the first semijoin -->
<!-- and will choose the rest itself. -->
<!-- If multiple semijoins are specified the optimizer will use exactly those semijoins -->
<!-- in the specified order. -->
<!--***** -->
<xs:complexType name="indexAndingType">
  <xs:complexContent>
    <xs:extension base="extendedAccessType">
      <xs:sequence minOccurs="0">
        <xs:element name="NLJOIN" type="nestedLoopJoinType" minOccurs="1" maxOccurs="unbounded"/>
      </xs:sequence>
      <xs:attribute name="STARJOIN" type="boolType" use="optional"/>
    </xs:extension>
  </xs:complexContent>
</xs:complexType>
<!--***** -->
<!-- Definition of an INDEX element method. Index set is optional. If specified, -->
<!-- at least 2 are required. -->
<!--***** -->
<xs:complexType name="indexType">
  <xs:attribute name="IXNAME" type="xs:string" use="optional"/>
</xs:complexType>
<!--***** -->
<!-- Definition of an XANDOR access request method. -->
<!--***** -->
<xs:complexType name="XANDORType">
  <xs:complexContent>
    <xs:extension base="accessType"/>
  </xs:complexContent>
</xs:complexType>
<!--***** -->
<!-- Use for derived table access or other cases where the access method is not of -->
<!-- consequence. -->
<!-- Extension for XML support: -->
<!-- All attributes and elements in extendedAccessType are included. -->
<!-- Note that INDEX attribute/elements and ALLINDEXES are valid options only if TYPE -->
<!-- is XMLINDEX. -->
<!--***** -->
<xs:complexType name="anyAccessType">
  <xs:complexContent>

```

```

        <xs:extension base="extendedAccessType"/>
    </xs:complexContent>
</xs:complexType>
<!-- *****-->
<!-- Definition of an index ORing access -->
<!-- Cannot specify more details (e.g indexes). Optimizer will choose the details based -->
<!-- upon cost. -->
<!-- *****-->
<xs:complexType name="indexOringType">
    <xs:complexContent>
        <xs:extension base="accessType"/>
    </xs:complexContent>
</xs:complexType>
<!-- *****-->
<!-- Effectively the super class from which join request elements inherit. -->
<!-- This type currently defines join element inputs and also the FIRST attribute. -->
<!-- A join request must have exactly two nested sub-elements. The sub-elements can be -->
<!-- either an access request or another join request. The first sub-element represents -->
<!-- outer table of the join operation while the second element represents the inner -->
<!-- table. The FIRST attribute indicates that the join result should be the first join -->
<!-- relative to other tables in the same FROM clause. -->
<!-- *****-->
<xs:complexType name="joinType" abstract="true">
    <xs:choice minOccurs="2" maxOccurs="2">
        <xs:group ref="accessRequest"/>
        <xs:group ref="joinRequest"/>
    </xs:choice>
    <xs:attribute name="FIRST" type="xs:string" use="optional" fixed="TRUE"/>
</xs:complexType>
<!-- *****-->
<!-- Definition of nested loop join access request. Subclass of joinType. -->
<!-- Does not add any elements or attributes. -->
<!-- *****-->
<xs:complexType name="nestedLoopJoinType">
    <xs:complexContent>
        <xs:extension base="joinType"/>
    </xs:complexContent>
</xs:complexType>
<!-- *****-->
<!-- Definition of merge join access request. Subclass of joinType. -->
<!-- Does not add any elements or attributes. -->
<!-- *****-->
<xs:complexType name="mergeJoinType">
    <xs:complexContent>
        <xs:extension base="joinType"/>
    </xs:complexContent>
</xs:complexType>
<!-- *****-->
<!-- Definition of hash join access request. Subclass of joinType. -->
<!-- Does not add any elements or attributes. -->
<!-- *****-->
<xs:complexType name="hashJoinType">
    <xs:complexContent>
        <xs:extension base="joinType"/>
    </xs:complexContent>
</xs:complexType>
<!-- *****-->
<!-- Any join is a subclass of binary join. Does not extend it in any way. -->
<!-- Does not add any elements or attributes. -->
<!-- *****-->
<xs:complexType name="anyJoinType">
    <xs:complexContent>
        <xs:extension base="joinType"/>
    </xs:complexContent>
</xs:complexType>
<!-- *****-->
<!-- The MQTENFORCE element can be specified with one of two attributes: -->
<!-- NAME: Specify the MQT name directly as a value to this attribute. -->
<!-- TYPE: Specify the type of the MQTs that should be enforced with this attribute. -->
<!-- Note that only the value of the first valid attribute found will be used. All -->
<!-- subsequent attributes will be ignored. -->
<!-- *****-->
<xs:complexType name="mqtEnforcementType">
    <xs:attribute name="NAME" type="xs:string"/>
    <xs:attribute name="TYPE" type="mqtEnforcementTypeType"/>
</xs:complexType>
<!-- *****-->
<!-- Allowable values for the TYPE attribute of an MQTENFORCE element: -->
<!-- NORMAL: Enforce usage of all semantically matchable MQTs, except replicated MQTs. -->

```

```

<!-- REPLICATED: Enforce usage of all semantically matchable replicated MQTs only. -->
<!-- ALL: Enforce usage of all semantically matchable MQTs. -->
<!--***** -->
<xs:simpleType name="mqtEnforcementType">
  <xs:restriction base="xs:string">
    <xs:enumeration value="NORMAL"/>
    <xs:enumeration value="REPLICATED"/>
    <xs:enumeration value="ALL"/>
  </xs:restriction>
</xs:simpleType>
<!--***** -->
<!-- Allowable values for a boolean attribute. -->
<!--***** -->
<xs:simpleType name="boolType">
  <xs:restriction base="xs:string">
    <xs:enumeration value="TRUE"/>
    <xs:enumeration value="FALSE"/>
  </xs:restriction>
</xs:simpleType>
<!--***** -->
<!-- Allowable values for an OPTION attribute. -->
<!--***** -->
<xs:simpleType name="optionType">
  <xs:restriction base="xs:string">
    <xs:enumeration value="ENABLE"/>
    <xs:enumeration value="DISABLE"/>
  </xs:restriction>
</xs:simpleType>
<!--***** -->
<!-- Allowable values for a SHARESPEED attribute. -->
<!--***** -->
<xs:simpleType name="shareSpeed">
  <xs:restriction base="xs:string">
    <xs:enumeration value="FAST"/>
    <xs:enumeration value="SLOW"/>
  </xs:restriction>
</xs:simpleType>
<!--***** -->
<!-- Definition of the qryopt type: the only values allowed are 0, 1, 2, 3, 5, 7 and 9 -->
<!--***** -->
<xs:complexType name="qryoptType">
  <xs:attribute name="VALUE" use="required">
    <xs:simpleType>
      <xs:restriction base="xs:string">
        <xs:enumeration value="0"/>
        <xs:enumeration value="1"/>
        <xs:enumeration value="2"/>
        <xs:enumeration value="3"/>
        <xs:enumeration value="5"/>
        <xs:enumeration value="7"/>
        <xs:enumeration value="9"/>
      </xs:restriction>
    </xs:simpleType>
  </xs:attribute>
</xs:complexType>
<!--***** -->
<!-- Definition of the degree type: any number between 1 and 32767 or the strings ANY or -1 -->
<!--***** -->
<xs:simpleType name="intStringType">
  <xs:union>
    <xs:simpleType>
      <xs:restriction base="xs:integer">
        <xs:minInclusive value="1"/></xs:minInclusive>
        <xs:maxInclusive value="32767"/></xs:maxInclusive>
      </xs:restriction>
    </xs:simpleType>
    <xs:simpleType>
      <xs:restriction base="xs:string">
        <xs:enumeration value="ANY"/>
        <xs:enumeration value="-1"/>
      </xs:restriction>
    </xs:simpleType>
  </xs:union>
</xs:simpleType>

<xs:complexType name="degreeType">
  <xs:attribute name="VALUE" type="intStringType"/></xs:attribute>
</xs:complexType>
<!--***** -->

```

```

<!-- Definition of DPF XML movement types -->
<!--***** -->
<xs:complexType name="dpfXMLMovementType">
  <xs:attribute name="VALUE" use="required">
    <xs:simpleType>
      <xs:restriction base="xs:string">
        <xs:enumeration value="REFERENCE"/>
        <xs:enumeration value="COMBINATION"/>
      </xs:restriction>
    </xs:simpleType>
  </xs:attribute>
</xs:complexType>
</xs:schema>

```

*XML schema for the OPTPROFILE element:*

The OPTPROFILE element is the root of an optimization profile.

This element is defined as follows:

XML Schema

```

<xs:element name="OPTPROFILE">
  <xs:complexType>
    <xs:sequence>
      <!-- Global optimization guidelines section. -->
      <!-- At most one can be specified. -->
      <xs:element name="OPTGUIDELINES"
        type="globalOptimizationGuidelinesType" minOccurs="0"/>
      <!-- Statement profile section. Zero or more can be specified -->
      <xs:element name="STMTPROFILE" type="statementProfileType"
        minOccurs="0" maxOccurs="unbounded"/>
    </xs:sequence>
    <!-- Version attribute is currently optional -->
    <xs:attribute name="VERSION" use="optional"/>
  </xs:complexType>
</xs:element>

```

## Description

The optional OPTGUIDELINES sub-element defines the global optimization guidelines for the optimization profile. Each STMTPROFILE sub-element defines a statement profile. The VERSION attribute identifies the current optimization profile schema against which a specific optimization profile was created and validated.

*XML schema for the global OPTGUIDELINES element:*

The OPTGUIDELINES element defines the global optimization guidelines for the optimization profile.

It is defined by the complex type globalOptimizationGuidelinesType.

XML Schema

```

<xs:complexType name="globalOptimizationGuidelinesType">
  <xs:sequence>
    <xs:group ref="MQTOptimizationChoices"/>
    <xs:group ref="computationalPartitionGroupOptimizationChoices"/>
    <xs:group ref="generalRequest"/>
    <xs:group ref="mqtEnforcementRequest"/>
  </xs:sequence>
</xs:complexType>

```

## Description

Global optimization guidelines can be defined with elements from the groups MQTOptimizationChoices, computationalPartitionGroupChoices, or generalRequest.

- MQTOptimizationChoices group elements can be used to influence MQT substitution.
- computationalPartitionGroupOptimizationChoices group elements can be used to influence computational partition group optimization, which involves the dynamic redistribution of data read from remote data sources. It applies only to partitioned federated database configurations.
- The generalRequest group elements are not specific to a particular phase of the optimization process, and can be used to change the optimizer's search space. They can be specified globally or at the statement level.
- MQT enforcement requests specify semantically matchable materialized query tables (MQTs) whose use in access plans should be enforced regardless of cost estimates.

*MQT optimization choices:*

The MQTOptimizationChoices group defines a set of elements that can be used to influence materialized query table (MQT) optimization. In particular, these elements can be used to enable or disable consideration of MQT substitution, or to specify the complete set of MQTs that are to be considered by the optimizer.

XML Schema

```
<xs:group name="MQTOptimizationChoices">
  <xs:choice>
    <xs:element name="MQTOPT" minOccurs="0" maxOccurs="1">
      <xs:complexType>
        <xs:attribute name="OPTION" type="optionType" use="optional"/>
      </xs:complexType>
    </xs:element>
    <xs:element name="MQT" minOccurs="0" maxOccurs="unbounded">
      <xs:complexType>
        <xs:attribute name="NAME" type="xs:string" use="required"/>
      </xs:complexType>
    </xs:element>
  </xs:choice>
</xs:group>
```

## Description

The MQTOPT element is used to enable or disable consideration of MQT optimization. The OPTION attribute can take the value ENABLE (default) or DISABLE.

The NAME attribute of an MQT element identifies an MQT that is to be considered by the optimizer. The rules for forming a reference to an MQT in the NAME attribute are the same as those for forming references to exposed table names. If one or more MQT elements are specified, only those MQTs are considered by the optimizer. The decision to perform MQT substitution using one or more of the specified MQTs remains a cost-based decision.

## Examples

The following example shows how to disable MQT optimization.



```

<OPTGUIDELINES>
  <MQTOPT OPTION='DISABLE' />
</OPTGUIDELINES>

```

The following example shows how to limit MQT optimization to the Tpcd.PARTSMQT table and the COLLEGE.STUDENTS table.

```

<OPTGUIDELINES>
  <MQT NAME='Tpcd.PARTSMQT' />
  <MQT NAME='COLLEGE.STUDENTS' />
</OPTGUIDELINES>

```

*Computational partition group optimization choices:*

The computationalPartitionGroupOptimizationChoices group defines a set of elements that can be used to influence computational partition group optimization. In particular, these elements can be used to enable or disable computational group optimization, or to specify the partition group that is to be used for computational partition group optimization.

XML Schema

```

<xs:group name="computationalPartitionGroupOptimizationChoices">
  <xs:choice>
    <xs:element name="PARTOPT" minOccurs="0" maxOccurs="1">
      <xs:complexType>
        <xs:attribute name="OPTION" type="optionType" use="optional"/>
      </xs:complexType>
    </xs:element>
    <xs:element name="PART" minOccurs="0" maxOccurs="1">
      <xs:complexType>
        <xs:attribute name="NAME" type="xs:string" use="required"/>
      </xs:complexType>
    </xs:element>
  </xs:choice>
</xs:group>

```

### Description

The PARTOPT element is used to enable or disable consideration of computational partition group optimization. The OPTION attribute can take the value ENABLE (default) or DISABLE.

The PART element can be used to specify the partition group that is to be used for computational partition group optimization. The NAME attribute must identify an existing partition group. The decision to perform dynamic redistribution using the specified partition group remains a cost-based decision.

### Examples

The following example shows how to disable computational partition group optimization.

```

<OPTGUIDELINES>
  <PARTOPT OPTION='DISABLE' />
</OPTGUIDELINES>

```

The following example shows how to specify that the WORKPART partition group is to be used for computational partition group optimization.

```

<OPTGUIDELINES>
  <MQT NAME='Tpcd.PARTSMQT' />
  <PART NAME='WORKPART' />
</OPTGUIDELINES>

```

*General optimization guidelines as global requests:*

The generalRequest group defines guidelines that are not specific to a particular phase of the optimization process, and can be used to change the optimizer's search space.

General optimization guidelines can be specified at both the global and statement levels. The description and syntax of general optimization guideline elements is the same for both global optimization guidelines and statement-level optimization guidelines. For more information, see "XML schema for general optimization guidelines".

*XML schema for the STMTPROFILE element:*

The STMTPROFILE element defines a statement profile within an optimization profile.

It is defined by the complex type statementProfileType.

XML Schema

```
<xs:complexType name="statementProfileType">
  <xs:sequence>
    <xs:element name="STMTMATCH" type="stmtMatchType" minOccurs="0"/>
    <xs:element name="STMTKEY" type="statementKeyType"/>
    <xs:element name="OPTGUIDELINES" type="optGuidelinesType"/>
  </xs:sequence>
  <xs:attribute name="ID" type="xs:string" use="optional"/>
</xs:complexType>
```

## Description

A statement profile specifies optimization guidelines for a particular statement, and includes the following parts:

- Statement matching

The statements in an optimization profile are either exactly or inexactly matched to the statement or statements that are compiled. The value of the STMTMATCH attribute represents which matching method is applied.

- Statement key

An optimization profile can be in effect for more than one statement in an application. Using the statement key, the optimizer automatically matches each statement profile to a corresponding statement in the application. This matching provides optimization guidelines for a statement without editing the application. The statement key includes the text of the statement (as written in the application), as well as other information that is needed to unambiguously identify the correct statement. The STMTKEY subelement represents the statement key.

- Statement-level optimization guidelines

This part of the statement profile specifies the optimization guidelines in effect for the statement that is identified by the statement key. For information, see "XML schema for the statement-level OPTGUIDELINES element".

- Statement profile name

A user-specified name that appears in diagnostic output to identify a particular statement profile.

*XML schema for the STMTMATCH element:*

The STMTMATCH element enables the matching method used for the optimization profile or for specific statements in the optimization profile.

It is defined by the complex type stmtMatchType.

XML Schema

```
<xs:complexType name="stmtMatchType">
  <xs:attribute name="EXACT" type="boolean" use="optional" default="TRUE"/>
</xs:complexType>
```

### Description

The optional EXACT attribute specifies the matching method. If the value is set to TRUE, exact matching is applied. If the value is set to FALSE, inexact matching is applied. Exact matching is the default setting.

### Example

The following example shows an STMTMATCH element definition at the statement level which enables inexact matching for the statement in the STMTKEY element.

```
<STMTPROFILE ID='S1'>
  <STMTMATCH EXACT='FALSE' />
  <STMTKEY>
    <![CDATA[select t1.c1, count(*) from t1,t2 where t1.c1 = t2.c1 and t1.c1 > 0]]>
  </STMTKEY>
  ...
</STMTPROFILE>
```

*XML schema for the STMTKEY element:*

The STMTKEY element enables the optimizer to match a statement profile to a corresponding statement in an application.

It is defined by the complex type statementKeyType.

XML Schema

```
<xs:complexType name="statementKeyType" mixed="true">
  <xs:attribute name="SCHEMA" type="xs:string" use="optional"/>
  <xs:attribute name="FUNCPATH" type="xs:string" use="optional"/>
</xs:complexType>
</xs:schema>
```

### Description

The optional SCHEMA attribute can be used to specify the default schema part of the statement key.

The optional FUNCPATH attribute can be used to specify the function path part of the statement key. Multiple paths must be separated by commas, and the specified function paths must match exactly the function paths that are specified in the compilation key.

### Example

The following example shows a statement key definition that associates a particular statement with a default schema of 'COLLEGE' and a function path of 'SYSIBM,SYSFUN,SYSPROC,DAVE'.

```

<STMTKEY SCHEMA='COLLEGE' FUNCPATH='SYSIBM,SYSFUN,SYSPROC,DAVE'>
  <![CDATA[select * from orders" where foo(orderkey) > 20]]>
</STMTKEY>

```

CDATA tagging (starting with <![CDATA[ and ending with ]]) is necessary because the statement text contains the special XML character '>'.

*XML schema for the STMTMATCH element:*

The STMTMATCH element enables the matching method used for the optimization profile or for specific statements in the optimization profile.

It is defined by the complex type stmtMatchType.

XML Schema

```

<xs:complexType name="stmtMatchType">
  <xs:attribute name="EXACT" type="boolean" use="optional" default="TRUE"/>
</xs:complexType>

```

### Description

The optional EXACT attribute specifies the matching method. If the value is set to TRUE, exact matching is applied. If the value is set to FALSE, inexact matching is applied. Exact matching is the default setting.

### Example

The following example shows an STMTMATCH element definition at the statement level which enables inexact matching for the statement in the STMTKEY element.

```

<STMTPROFILE ID='S1'>
  <STMTMATCH EXACT='FALSE' />
  <STMTKEY>
    <![CDATA[select t1.c1, count(*) from t1,t2 where t1.c1 = t2.c1 and t1.c1 > 0]]>
  </STMTKEY>
  ...
</STMTPROFILE>

```

*Statement key and compilation key matching:*

The statement key identifies the application statement to which statement-level optimization guidelines apply. The matching method can be specified using the STMTMATCH element in the optimization profile.

When an SQL statement is compiled, various factors influence how the statement is interpreted semantically by the compiler. The SQL statement and the settings of SQL compiler parameters together form the compilation key. Each part of a statement key corresponds to some part of a compilation key.

A statement key is made of the following parts:

- Statement text, which is the text of the statement as written in the application
- Default schema, which is the schema name that is used as the implicit qualifier for unqualified table names. This part is optional but should be provided if there are unqualified table names in the statement.
- Function path, which is the function path that is used when resolving unqualified function and data-type references. This part is optional but should be provided if there are unqualified user-defined functions or user-defined types in the statement.

When the data server compiles an SQL statement and finds an active optimization profile, it attempts to match each statement key in the optimization profile with the current compilation key. The type of matching depends if exact or inexact matching is specified in the optimization profile. You can specify which type of matching to use by specifying the STMTMATCH element in the optimization profile. By setting the EXACT attribute to TRUE or FALSE, you can enable either exact or inexact matching. If you do not specify the STMTMATCH element, exact matching is automatically enabled.

For exact matching, a statement key and compilation key match if each specified part of the statement key matches the corresponding part of the compilation key. If a part of the statement key is not specified, the omitted part is considered matched by default. Each unspecified part of the statement key is treated as a wild card that matches the corresponding part of any compilation key.

With inexact matching, literals, host variables, and parameter markers are ignored when the statement text from the statement key and compilation key is being matched.

Exact and inexact matching operates as follows:

- Matching is case insensitive for keywords. For example, select can match SELECT.
- Matching is case insensitive for nondelimited identifiers. For example, T1 can match t1.
- Delimited and nondelimited identifiers can match except for one case. For example, T1 and "T1" will match, and so will t1 and "t1". However, t1 will not match with "t1".

There is no match between t1 and "t1" because t1 and "t1" represent different tables. The nondelimited identifier t1 is changed to uppercase and represents the table T1 but in the case of the delimited identifier "t1" is not changed and represents the table t1. In this scenario, the case sensitivity matters because the two identifiers represent different tables.

After the data server finds a statement key that matches the current compilation key, it stops searching. If there are multiple statement profiles whose statement keys match the current compilation key, only the first such statement profile (based on document order) is used.

*Inexact matching:*

During compilation, if there is an active optimization profile, the compiling statements are matched either exactly or inexactly with the statements in the optimization profile.

Inexact matching is used for flexible matching between the compiling statements and the statements within the optimization profile. Inexact matching ignores literals, host variables, and parameter markers when matching the compiling statement to the optimization profile statements. Therefore, you can compile many different statements with different literal values in the predicate and the statements still match. For example, the following statements match inexactly but they do not match exactly:

```
select c1 into :hv1 from t1 where c1 > 10
```

```
select c1 into :hv2 from t1 where c1 > 20
```

Inexact matching is applied to both SQL and XQuery statements. However, string literals that are passed as function parameters representing SQL or XQuery statements or statement fragments, including individual column names are not inexactly matched. XML functions such as XMLQUERY, XMLTABLE, and XMLEXISTS that are used in an SQL statement are exactly matched. String literals could contain the following items:

- A whole statement with SQL embedded inside XQuery, or XQuery embedded inside an SQL statement
- An identifier, such as a column name
- An XML expression that contains a search path

For XQuery, inexact matching ignores only the literals. The following literals are ignored in inexact matching with some restrictions on the string literals:

- decimal literals
- double literals
- integer literals
- string literals that are not input parameters for functions: db2-fn:sqlquery, db2-fn:xmlcolumn, db2-fn:xmlcolumn-contains

The following XQuery statements match if inexact matching is enabled:

```
xquery let $i:= db2-fn:sqlquery("select c1 from tab1")/a/b[c=1] return $i
```

```
xquery let $i:= db2-fn:sqlquery("select c1 from tab1")/a/b[c=2] return $i
```

For inexact matching, the special register is not supported. The following examples show some of the type of statements that do not match in inexact matching:

- c1 between 5 and :hv  
5 between c1 and c2
- c1 in (select c1 from t1)  
c1 in (1,2,3)
- c1 in (c1, 1, 2)  
c1 in (c2, 1, 2)
- A = 5  
A = 5 + :hv
- with RR  
with RS
- c2 < CURRENT TIME  
c2 < '11:12:40'
- c3 > CURRENT TIMESTAMP  
c3 > '07/29/2010'

### Syntax for specifying matching

Within the optimization profile, you can set either exact or inexact matching at either the global level or at the statement-level. The XML element STMTMATCH can be used to set the matching method.

The STMTMATCH element has an EXACT attribute which can be set to either TRUE or FALSE. If you specify the value TRUE, exact matching is enabled. If you specify the value FALSE, inexact matching is enabled. If you do not specify this element or if you specify only the STMTMATCH element without the EXACT attribute, exact matching is enabled by default.

To have a matching method apply to all statements within the optimization profile, place the STMTMATCH element at the global level just after the top OPTPROFILE element.

To have a matching method apply to a specific statement within the optimization profile, place the STMTMATCH element just after the STMTPROFILE element.

The following example shows an optimization profile with a STMTMATCH element at both the global level and statement level:

```
<?xml version="1.0" encoding="UTF-8"?>
<OPTPROFILE>

<!--Global section -->
  <STMTMATCH EXACT='FALSE' />

<!-- Statement level profile -->

  <STMTPROFILE ID='S1'>
    <STMTMATCH EXACT='TRUE' />
    <STMTKEY>
      <![CDATA[select t1.c1, count(*) from t1,t2 where t1.c1 = t2.c1 and t1.c1 > 0]]>
    </STMTKEY>
    <OPTGUIDELINES>
      <NLJOIN>
        <TBSCAN TABLE='T1' />
        <TBSCAN TABLE='T2' />
      </NLJOIN>
    </OPTGUIDELINES>
  </STMTPROFILE>

  <STMTPROFILE ID='S2'>
    <STMTKEY><![CDATA[select * from T1 where c1 in( 10,20)]]>
    </STMTKEY>
    <OPTGUIDELINES>
      <REGISTRY>
        <OPTION NAME='DB2_REDUCED_OPTIMIZATION' VALUE='YES' />
      </REGISTRY>
    </OPTGUIDELINES>
  </STMTPROFILE>

</OPTPROFILE>
```

### Order of precedence

In the example the STMTMATCH element has been set at both the global and statement level. Therefore, to determine which matching method gets executed depends on the order of precedence. The following is the order of precedence from highest to lowest:

1. Statement level profile settings
2. Global level profile settings

This order means that in the example, inexact matching is set at the global level because EXACT is set to FALSE. Therefore, inexact matching is applied to all the statements in the profile unless the compiling statement matches the first statement. Then, exact matching is enabled for that statement because the STMTMATCH element for that statement has EXACT set to TRUE.

The last statement in the example optimization profile file does not have an STMTMATCH element. The global setting takes precedence and inexact matching is applied to this statement.

*Inexact matching examples for SQL statements in optimization profiles:*

Inexact matching in optimization profiles occurs if you set the EXACT attribute to false in the STMTMATCH tag. The compiling statement is then matched to the

statements in an active optimization profile. The compiler matches these statements based on different default matching rules and rules that are specific to inexact matching.

The following examples show where inexact matching is successful for matching SQL statements.

#### Example 1: Inexact matching in the predicate clause

Each of the following pair of statement fragments have different literal values for the predicate, but still match:

```
between '07/29/2010' and '08/29/2010'  
between '09/29/2010' and '10/29/2010'
```

```
'ab'      like :hv1  
'AYYANG' like :hv2
```

```
(A=1 AND B=1)      OR (A=2 AND B=2)  
(A=:hv1 AND B=:hv2) OR (A=3 AND B=3)
```

```
c1 > 0 selectivity 0.1  
c1 > 0 selectivity 0.9
```

```
c1 = ?  
c1 = :hv1
```

#### Example 2: Inexact matching in the IN list predicate

All of the following statement fragments have different values in the IN list predicate, but still match:

```
c1 in (:hv1, :hv2, :hv3);
```

```
c1 in (:hv2, :hv3);
```

```
c1 in ( ?, ?, ?, ? );
```

```
c1 in (c1, c2 );
```

```
c1 in (:hv1, :hv2, c1, 1, 2, 3, c2, ?, ?);
```

#### Example 3: Inexact matching in the select list

The following statement fragment has different host variables in the select list, but still matches:

```
select c1 into :hv1 from t1  
select c1 into :hv2 from t1
```

The following statement fragment has different literals in the select list, but still matches:

```
select 1, c1 from t1  
select 2, c1 from t1
```

The following statement fragment has a different subquery in the select list, but still matches:

```
select c1, (select c1 from t1 where c2 = 0) from t1  
select c1, (select c1 from t1 where c2 = 5) from t1
```

The following statement fragment has a different expression in the select list, but still matches:

```
select c1 + 1  
select c1 + 2
```

#### Example 4: Inexact matching for different clauses

The following statement fragment has different rows for the optimize clause, but still matches:



```
optimize for 1 row
optimize for 10 row
```

The following statement fragment has different rows for the fetch clause, but still matches:

```
fetch first 10 rows only
fetch first 50 rows only
```

The following statement fragment has different literal value for the having clause, but still matches:

```
having c1 > 0
having c1 > 10
```

Each of the following pairs of statement fragments either have different column positioning for the order by clause or have different literal values for the expression in the order by clause, but still match:

```
order by 1,2,3
order by 4,5,6
```

```
order by c1+1, c2 + 2, 3
order by c1+2, c2 + 3, 4
```

Each of the following pairs of statement fragments either have different literal values or host variables for the set clause, but still match:

```
set c1 = 1
set c1 = 2
```

```
set queryno = 2
set queryno = 3
```

```
set querytag = 'query1'
set querytag = 'query2'
```

```
SET :HV00001 :HI00001 = <subquery>
SET :HV00009 :HI00009 = <subquery>
```

Each of the following pairs of statement fragments have different literal values for the group by clause, but still match:

```
group by c1 + 1
group by c1 + 2
```

```
group by 1,2,3
group by 3,2,1
```

Each of the following pairs of statement fragments have different literal values for the values clause, but still match:

```
values 1,2,3
values 3,4,5
```

```
values ( 10, 'xml', 'a' )
values ( 20, 'xml', 'ab' )
```

### Example 5: Inexact matching for non-XML functions

Each of the following pairs of statement fragments have different literal values in the function call, but have the same number of literals and still match:

```
decimal(c1, 5, 2)
decimal(c1, 9, 3)
```

```
Blob('%abc%')
Blob('cde%')
```

```
max(1, 100, 200)
max(INFINITY, NAN, SNAN)
```

### Example 6: Inexact matching for special expressions

Each of the following pairs of statement fragments have different literal values in either the case when expression or the mod expression, but still match:

```
order by mod(c1, 2)
order by mod(c1, 4)
```

```
case when b1 < 10 then 'A' else 'B' end
case when b1 < 20 then 'C' else 'D' end
```

*XML schema for the statement-level OPTGUIDELINES element:*

The OPTGUIDELINES element of a statement profile defines the optimization guidelines in effect for the statement that is identified by the associated statement key. It is defined by the type optGuidelinesType.

XML Schema

```
<xs:element name="OPTGUIDELINES" type="optGuidelinesType"/>
<xs:complexType name="optGuidelinesType">
  <xs:sequence>
    <xs:group ref="general request" minOccurs="0" maxOccurs="1"/>
    <xs:choice maxOccurs="unbounded">
      <xs:group ref="rewriteRequest"/>
      <xs:group ref="accessRequest"/>
      <xs:group ref="joinRequest"/>
      <xs:group ref="mqtEnforcementRequest"/>
    </xs:choice>
  </xs:sequence>
</xs:complexType>
```

### Description

The optGuidelinesType group defines the set of valid sub-elements of the OPTGUIDELINES element. Each sub-element is interpreted as an optimization guideline by the DB2 optimizer. Sub-elements can be categorized as either general request elements, rewrite request elements, access request elements, or join request elements.

- *General request elements* are used to specify general optimization guidelines, which can be used to change the optimizer's search space.
- *Rewrite request elements* are used to specify query rewrite optimization guidelines, which can be used to affect the query transformations that are applied when the optimized statement is being determined.
- *Access request elements* and *join request elements* are plan optimization guidelines, which can be used to affect access methods, join methods, and join orders that are used in the execution plan for the optimized statement.
- *MQT enforcement request elements* specify semantically matchable materialized query tables (MQTs) whose use in access plans should be enforced regardless of cost estimates.

**Note:** Optimization guidelines that are specified in a statement profile take precedence over those that are specified in the global section of an optimization profile.

*XML schema for general optimization guidelines:*

The generalRequest group defines guidelines that are not specific to a particular phase of the optimization process. The guidelines can be used to change the optimizer search space.

```

<!--***** --> \
<!-- Choices of general request elements. --> \
<!-- REOPT can be used to override the setting of the REOPT bind option. --> \
<!-- DPFXMLMOVEMENT can be used to affect the optimizer's plan when moving XML documents --> \
<!-- between database partitions. The allowed value can be REFERENCE or COMBINATION. The --> \
<!-- default value is NONE. --> \
<!--***** --> \
<xs:group name="generalRequest">
  <xs:sequence>
    <xs:element name="REOPT" type="reoptType" minOccurs="0" maxOccurs="1"/>
    <xs:element name="DEGREE" type="degreeType" minOccurs="0" maxOccurs="1"/>
    <xs:element name="QRYOPT" type="qryoptType" minOccurs="0" maxOccurs="1"/>
    <xs:element name="RTS" type="rtsType" minOccurs="0" maxOccurs="1"/>
    <xs:element name="DPFXMLMOVEMENT" type="dpfXMLMovementType" minOccurs="0" maxOccurs="1"/>
    <xs:element name="REGISTRY" type="registryType" minOccurs="0" maxOccurs="1"/>
  </xs:sequence>
</xs:group>

```

General optimization guidelines can be specified at both the global and statement levels. The description and syntax of general optimization guideline elements is the same for both global optimization guidelines and statement-level optimization guidelines.

### Description

General request elements define general optimization guidelines, which affect the optimization search space. Affecting the optimization search space can affect the applicability of rewrite and cost-based optimization guidelines.

#### *DEGREE requests:*

The DEGREE general request element can be used to override the setting of the **DEGREE** bind parameter, the value of the **dft\_degree** database configuration parameter, or the result of a previous SET CURRENT DEGREE statement.

The DEGREE general request element is only considered if the instance is configured for intra-partition parallelism; otherwise, a warning is returned. It is defined by the complex type degreeType.

#### XML Schema

```

<xs:simpleType name="intStringType">
  <xs:union>
    <xs:simpleType>
      <xs:restriction base="xs:integer">
        <xs:minInclusive value="1"/></xs:minInclusive>
        <xs:maxInclusive value="32767"/></xs:maxInclusive>
      </xs:restriction>
    </xs:simpleType>
    <xs:simpleType>
      <xs:restriction base="xs:string">
        <xs:enumeration value="ANY"/>
        <xs:enumeration value="-1"/>
      </xs:restriction>
    </xs:simpleType>
  </xs:union>
</xs:simpleType>

<xs:complexType name="degreeType">
  <xs:attribute name="VALUE"
    type="intStringType"/></xs:attribute>
</xs:complexType>

```

### Description

The DEGREE general request element has a required VALUE attribute that specifies the setting of the DEGREE option. The attribute can take an integer value

from 1 to 32 767 or the string value -1 or ANY. The value -1 (or ANY) specifies that the degree of parallelism is to be determined by the data server. A value of 1 specifies that the query should not use intra-partition parallelism.

*DPFXMLMOVEMENT requests:*

The DPFXMLMOVEMENT general request element can be used in partitioned database environments to override the optimizer's decision to choose a plan in which either a column of type XML is moved or only a reference to that column is moved between database partitions. It is defined by the complex type `dpfXMLMovementType`.

```
<xs:complexType name="dpfXMLMovementType">
  <xs:attribute name="VALUE" use="required">
    <xs:simpleType>
      <xs:restriction base="xs:string"
        <xs:enumeration value="REFERENCE"/>
        <xs:enumeration value="COMBINATION"/>
      </xs:restriction>
    </xs:simpleType>
  </xs:attribute>
</xs:complexType>
```

### Description

In partitioned database environments, data must sometimes be moved between database partitions during statement execution. In the case of XML columns, the optimizer can choose to move the actual documents that are contained in those columns or merely a reference to the source documents on the original database partitions.

The DPFXMLMOVEMENT general request element has a required VALUE attribute with the following possible values: REFERENCE or COMBINATION. If a row that contains an XML column needs to be moved from one database partition to another:

- REFERENCE specifies that references to the XML documents are to be moved through the table queue (TQ) operator. The documents themselves remain on the source database partition.
- COMBINATION specifies that some XML documents are moved, and that only references to the remaining XML documents are moved through the TQ operator.

The decision of whether the documents or merely references to those documents are moved depends on the conditions that prevail when the query runs. If the DPFXMLMOVEMENT general request element has not been specified, the optimizer makes cost-based decisions that are intended to maximize performance.

*QRYOPT requests:*

The QRYOPT general request element can be used to override the setting of the **QUERYOPT** bind parameter, the value of the `dft_queryopt` database configuration parameter, or the result of a previous SET CURRENT QUERY OPTIMIZATION statement. It is defined by the complex type `qryoptType`.

XML Schema

```
<xs:complexType name="qryoptType">
  <xs:attribute name="VALUE" use="required">
    <xs:simpleType>
      <xs:restriction base="xs:string">
```

```

        <xs:enumeration value="0"/>
        <xs:enumeration value="1"/>
        <xs:enumeration value="2"/>
        <xs:enumeration value="3"/>
        <xs:enumeration value="5"/>
        <xs:enumeration value="7"/>
        <xs:enumeration value="9"/>
    </xs:restriction>
</xs:simpleType>
</xs:attribute>
</xs:complexType>

```

### Description

The QRYOPT general request element has a required VALUE attribute that specifies the setting of the QUERYOPT option. The attribute can take any of the following values: 0, 1, 2, 3, 5, 7, or 9. For detailed information about what these values represent, see “Optimization classes”.

*REOPT requests:*

The REOPT general request element can be used to override the setting of the **REOPT** bind parameter, which affects the optimization of statements that contain parameter markers or host variables. It is defined by the complex type reoptType.

XML Schema

```

<xs:complexType name="reoptType">
  <xs:attribute name="VALUE" use="required">
    <xs:simpleType>
      <xs:restriction base="xs:string">
        <xs:enumeration value="ONCE"/>
        <xs:enumeration value="ALWAYS"/>
      </xs:restriction>
    </xs:simpleType>
  </xs:attribute>
</xs:complexType>

```

### Description

The REOPT general request element has a required VALUE attribute that specifies the setting of the REOPT option. The attribute can take the value ONCE or ALWAYS. ONCE specifies that the statement should be optimized for the first set of host variable or parameter marker values. ALWAYS specifies that the statement should be optimized for each set of host variable or parameter marker values.

*REGISTRY requests:*

The REGISTRY element is used to set registry variables in the optimization profile. Embedded in the REGISTRY element is the OPTION element where the registry variable is set.

The REGISTRY element is defined by the complex type registryType and the OPTION element is defined by the complex type genericOptionType.

XML Schema

```

<xs:complexType name="registryType">
  <xs:sequence>
    <xs:element name="OPTION" type="genericOptionType"
      minOccurs="1" maxOccurs="unbounded"/>
  </xs:sequence>
</xs:complexType>

```

```

<xs:complexType name="genericOptionType">
  <xs:attribute name="NAME" type="xs:string" use="required"/>
  <xs:attribute name="VALUE" type="xs:string" use="required"/>
</xs:complexType>

```

## Description

The REGISTRY element sets registry variables at the global level, statement level, or both. The OPTION element which is embedded in the REGISTRY element has a NAME and VALUE attribute. These attributes specify the registry variable name and value that are applied to the profile or to specific statements in the profile.

*RTS requests:*

The RTS general request element can be used to enable or disable real-time statistics collection. It can also be used to limit the amount of time taken by real-time statistics collection.

For certain queries or workloads, it might be good practice to limit real-time statistics collection so that extra overhead at statement compilation time can be avoided. The RTS general request element is defined by the complex type rtsType.

```

<!--*****--> \
<!-- RTS general request element to enable, disable or provide a time budget for --> \
<!-- real-time statistics collection. --> \
<!-- OPTION attribute allows enabling or disabling real-time statistics. --> \
<!-- TIME attribute provides a time budget in milliseconds for real-time statistics collection.--> \
<!--*****--> \
<xs:complexType name="rtsType">
  <xs:attribute name="OPTION" type="optionType" use="optional" default="ENABLE"/>
  <xs:attribute name="TIME" type="xs:nonNegativeInteger" use="optional"/>
</xs:complexType>

```

## Description

The RTS general request element has two optional attributes.

- The OPTION attribute is used to enable or disable real-time statistics collection. It can take the value ENABLE (default) or DISABLE.
- The TIME attribute specifies the maximum amount of time (in milliseconds) that can be spent (per statement) on real-time statistics collection at statement compilation time.

If ENABLE is specified for the OPTION attribute, automatic statistics collection and real-time statistics must be enabled through their corresponding configuration parameters. Otherwise, the optimization guideline will not be applied, and SQL0437W with reason code 13 is returned.

*XML schema for query rewrite optimization guidelines:*

The rewriteRequest group defines guidelines that impact the query rewrite phase of the optimization process.

XML Schema

```

<xs:group name="rewriteRequest">
  <xs:sequence>
    <xs:element name="INLIST2JOIN" type="inListToJoinType" minOccurs="0"/>
    <xs:element name="SUBQ2JOIN" type="subqueryToJoinType" minOccurs="0"/>
    <xs:element name="NOTEX2AJ" type="notExistsToAntiJoinType" minOccurs="0"/>
    <xs:element name="NOTIN2AJ" type="notInToAntiJoinType" minOccurs="0"/>
  </xs:sequence>
</xs:group>

```

## Description

If the INLIST2JOIN element is used to specify both statement-level and predicate-level optimization guidelines, the predicate-level guidelines override the statement-level guidelines.

*IN-LIST-to-join query rewrite requests:*

A INLIST2JOIN query rewrite request element can be used to enable or disable the IN-LIST predicate-to-join rewrite transformation. It can be specified as a statement-level optimization guideline or a predicate-level optimization guideline. In the latter case, only one guideline per query can be enabled. The INLIST2JOIN request element is defined by the complex type inListToJoinType.

XML Schema

```
<xs:complexType name="inListToJoinType">
  <xs:attribute name="OPTION" type="optionType" use="optional" default="ENABLE"/>
  <xs:attribute name="TABLE" type="xs:string" use="optional"/>
  <xs:attribute name="COLUMN" type="xs:string" use="optional"/>
</xs:complexType>
```

## Description

The INLIST2JOIN query rewrite request element has three optional attributes and no sub-elements. The OPTION attribute can take the value ENABLE (default) or DISABLE. The TABLE and COLUMN attributes are used to specify an IN-LIST predicate. If these attributes are not specified, or are specified with an empty string (""), the guideline is handled as a statement-level guideline. If one or both of these attributes are specified, it is handled as a predicate-level guideline. If the TABLE attribute is not specified, or is specified with an empty string value, but the COLUMN attribute is specified, the optimization guideline is ignored and SQL0437W with reason code 13 is returned.

*NOT-EXISTS-to-anti-join query rewrite requests:*

The NOTEX2AJ query rewrite request element can be used to enable or disable the NOT-EXISTS predicate-to-anti-join rewrite transformation. It can be specified as a statement-level optimization guideline only. The NOTEX2AJ request element is defined by the complex type notExistsToAntiJoinType.

XML Schema

```
<xs:complexType name="notExistsToAntiJoinType">
  <xs:attribute name="OPTION" type="optionType" use="optional" default="ENABLE"/>
</xs:complexType>
```

## Description

The NOTEX2AJ query rewrite request element has one optional attribute and no sub-elements. The OPTION attribute can take the value ENABLE (default) or DISABLE.

*NOT-IN-to-anti-join query rewrite requests:*

The NOTIN2AJ query rewrite request element can be used to enable or disable the NOT-IN predicate-to-anti-join rewrite transformation. It can be specified as a statement-level optimization guideline only. The NOTIN2AJ request element is defined by the complex type notInToAntiJoinType.

XML Schema

```
<xs:complexType name="notInToAntiJoinType">
  <xs:attribute name="OPTION" type="optionType" use="optional" default="ENABLE"/>
</xs:complexType>
```

### Description

The NOTIN2AJ query rewrite request element has one optional attribute and no sub-elements. The OPTION attribute can take the value ENABLE (default) or DISABLE.

*Subquery-to-join query rewrite requests:*

The SUBQ2JOIN query rewrite request element can be used to enable or disable the subquery-to-join rewrite transformation. It can be specified as a statement-level optimization guideline only. The SUBQ2JOIN request element is defined by the complex type subqueryToJoinType.

XML Schema

```
<xs:complexType name="subqueryToJoinType">
  <xs:attribute name="OPTION" type="optionType" use="optional" default="ENABLE"/>
</xs:complexType>
```

### Description

The SUBQ2JOIN query rewrite request element has one optional attribute and no sub-elements. The OPTION attribute can take the value ENABLE (default) or DISABLE.

*XML schema for plan optimization guidelines:*

Plan optimization guidelines can consist of access requests or join requests.

- An *access request* specifies an access method for a table reference.
- A *join request* specifies a method and sequence for performing a join operation. Join requests are composed of other access or join requests.

Most of the available access requests correspond to the optimizer's data access methods, such as table scan, index scan, and list prefetch, for example. Most of the available join requests correspond to the optimizer's join methods, such as nested-loop join, hash join, and merge join. Each access request or join request element can be used to influence plan optimization.

*Access requests:*

The accessRequest group defines the set of valid access request elements. An access request specifies an access method for a table reference.

XML Schema

```
<xs:group name="accessRequest">
  <xs:choice>
    <xs:element name="TBSCAN" type="tableScanType"/>
    <xs:element name="IXSCAN" type="indexScanType"/>
    <xs:element name="LPREFETCH" type="listPrefetchType"/>
    <xs:element name="IXAND" type="indexAndingType"/>
    <xs:element name="IXOR" type="indexOringType"/>
    <xs:element name="XISCAN" type="indexScanType"/>
  </xs:choice>
</xs:group>
```



```

        <xs:element name="XANDOR" type="XANDORType"/>
        <xs:element name="ACCESS" type="anyAccessType"/>
    </xs:choice>
</xs:group>

```

### Description

- TBSCAN, IXSCAN, LPREFETCH, IXAND, IXOR, XISCAN, and XANDOR  
These elements correspond to DB2 data access methods, and can only be applied to local tables that are referenced in a statement. They cannot refer to nicknames (remote tables) or derived tables (the result of a subselect).
- ACCESS  
This element, which causes the optimizer to choose the access method, can be used when the join order (not the access method) is of primary concern. The ACCESS element must be used when the target table reference is a derived table. For XML queries, this element can also be used with attribute TYPE = XMLINDEX to specify that the optimizer is to choose XML index access plans.

*Access types:*

Common aspects of the TBSCAN, IXSCAN, LPREFETCH, IXAND, IXOR, XISCAN, XANDOR, and ACCESS elements are defined by the abstract type `accessType`.

XML Schema

```

<xs:complexType name="accessType" abstract="true">
  <xs:attribute name="TABLE" type="xs:string" use="optional"/>
  <xs:attribute name="TABID" type="xs:string" use="optional"/>
  <xs:attribute name="FIRST" type="xs:string" use="optional" fixed="TRUE"/>
  <xs:attribute name="SHARING" type="optionType" use="optional"
    default="ENABLE"/>
  <xs:attribute name="WRAPPING" type="optionType" use="optional"
    default="ENABLE"/>
  <xs:attribute name="THROTTLE" type="optionType" use="optional"/>
  <xs:attribute name="SHARESPEED" type="shareSpeed" use="optional"/>
</xs:complexType>

<xs:complexType name="extendedAccessType">
  <xs:complexContent>
    <xs:extension base="accessType">
      <xs:sequence minOccurs="0">
        <xs:element name="INDEX" type="indexType" minOccurs="2"
          maxOccurs="unbounded"/>
      </xs:sequence>
      <xs:attribute name="INDEX" type="xs:string" use="optional"/>
      <xs:attribute name="TYPE" type="xs:string" use="optional"
        fixed="XMLINDEX"/>
      <xs:attribute name="ALLINDEXES" type="boolType" use="optional"
        fixed="TRUE"/>
    </xs:extension>
  </xs:complexContent>
</xs:complexType>

```

### Description

All access request elements extend the complex type `accessType`. Each such element must specify the target table reference using either the TABLE or TABID attribute. For information on how to form proper table references from an access request element, see “Forming table references in optimization guidelines”.

Access request elements can also specify an optional FIRST attribute. If the FIRST attribute is specified, it must have the value TRUE. Adding the FIRST attribute to

an access request element indicates that the execution plan should include the specified table as the first table in the join sequence of the corresponding FROM clause. Only one access or join request per FROM clause can specify the FIRST attribute. If multiple access or join requests targeting tables of the same FROM clause specify the FIRST attribute, all but the first such request is ignored and a warning (SQL0437W with reason code 13) is returned.

New optimizer guidelines enable you to influence the compiler's scan sharing decisions. In cases where the compiler would have allowed sharing scans, wrapping scans, or throttling, specifying the appropriate guideline will prevent sharing scans, wrapping scans, or throttling. A sharing scan can be seen by other scans that are participating in scan sharing, and those scans can base certain decisions on that information. A wrapping scan is able to start at an arbitrary point in the table to take advantage of pages that are already in the buffer pool. A throttled scan has been delayed to increase the overall level of sharing.

Valid optionType values (for the SHARING, WRAPPING, and THROTTLE attributes) are DISABLE and ENABLE (the default). SHARING and WRAPPING cannot be enabled when the compiler chooses to disable them. Using ENABLE will have no effect in those cases. THROTTLE can be either enabled or disabled. Valid SHARESPEED values (to override the compiler's estimate of scan speed) are FAST and SLOW. The default is to allow the compiler to determine values, based on its estimate.

The only supported value for the TYPE attribute is XMLINDEX, which indicates to the optimizer that the table must be accessed using one of the XML index access methods, such as IXAND, IXOR, XANDOR, or XISCAN. If this attribute is not specified, the optimizer makes a cost-based decision when selecting an access plan for the specified table.

The optional INDEX attribute can be used to specify an index name.

The optional INDEX element can be used to specify two or more names of indexes as index elements. If the INDEX attribute and the INDEX element are both specified, the INDEX attribute is ignored.

The optional ALLINDEXES attribute, whose only supported value is TRUE, can only be specified if the TYPE attribute has a value of XMLINDEX. If the ALLINDEXES attribute is specified, the optimizer must use all applicable relational indexes and indexes over XML data to access the specified table, regardless of cost.

*Any access requests:*

The ACCESS access request element can be used to specify that the optimizer is to choose an appropriate method for accessing a table, based on cost, and must be used when referencing a derived table. A derived table is the result of another subselect. This access request element is defined by the complex type anyAccessType.

XML Schema

```
<xs:complexType name="anyAccessType">
  <xs:complexContent>
    <xs:extension base="extendedAccessType"/>
  </xs:complexContent>
</xs:complexType>
```

## Description

The complex type `anyAccessType` is a simple extension of the abstract type `extendedAccessType`. No new elements or attributes are added.

The `TYPE` attribute, whose only supported value is `XMLINDEX`, indicates to the optimizer that the table must be accessed using one of the XML index access methods, such as `IXAND`, `IXOR`, `XANDOR`, or `XISCAN`. If this attribute is not specified, the optimizer makes a cost-based decision when selecting an access plan for the specified table.

The optional `INDEX` attribute can be used to specify an index name only if the `TYPE` attribute has a value of `XMLINDEX`. If this attribute is specified, the optimizer might choose one of the following plans:

- An `XISCAN` plan using the specified index over XML data
- An `XANDOR` plan, such that the specified index over XML data is one of the indexes under `XANDOR`; the optimizer will use all applicable indexes over XML data in the `XANDOR` plan
- An `IXAND` plan, such that the specified index is the leading index of `IXAND`; the optimizer will add more indexes to the `IXAND` plan in a cost-based fashion
- A cost-based `IXOR` plan

The optional `INDEX` element can be used to specify two or more names of indexes as index elements only if the `TYPE` attribute has a value of `XMLINDEX`. If this element is specified, the optimizer might choose one of the following plans:

- An `XANDOR` plan, such that the specified indexes over XML data appear under `XANDOR`; the optimizer will use all applicable indexes over XML data in the `XANDOR` plan
- An `IXAND` plan, such that the specified indexes are the indexes of `IXAND`, in the specified order
- A cost-based `IXOR` plan

If the `INDEX` attribute and the `INDEX` element are both specified, the `INDEX` attribute is ignored.

The optional `ALLINDEXES` attribute, whose only supported value is `TRUE`, can only be specified if the `TYPE` attribute has a value of `XMLINDEX`. If this attribute is specified, the optimizer must use all applicable relational indexes and indexes over XML data to access the specified table, regardless of cost. The optimizer chooses one of the following plans:

- An `XANDOR` plan with all applicable indexes over XML data appearing under the `XANDOR` operator
- An `IXAND` plan with all applicable relational indexes and indexes over XML data appearing under the `IXAND` operator
- An `IXOR` plan
- An `XISCAN` plan if only a single index is defined on the table and that index is of type XML

## Examples

The following guideline is an example of an any access request:

```

<OPTGUIDELINES>
  <HSJOIN>
    <ACCESS TABLE='S1' />
    <IXSCAN TABLE='PS1' />
  </HSJOIN>
</OPTGUIDELINES>

```

The following example shows an ACCESS guideline specifying that some XML index access to the SECURITY table should be used. The optimizer might pick any XML index plan, such as an XISCAN, IXAND, XANDOR, or IXOR plan.

```

SELECT * FROM security
  WHERE XMLEXISTS('$SDOC/Security/SecurityInformation/
    StockInformation[Industry= "OfficeSupplies"]')

```

```

<OPTGUIDELINES>
  <ACCESS TABLE='SECURITY' TYPE='XMLINDEX' />
</OPTGUIDELINES>

```

The following example shows an ACCESS guideline specifying that all possible index access to the SECURITY table should be used. The choice of method is left to the optimizer. Assume that two XML indexes, SEC\_INDUSTRY and SEC\_SYMBOL, match the two XML predicates. The optimizer chooses either the XANDOR or the IXAND access method using a cost-based decision.

```

SELECT * FROM security
  WHERE XMLEXISTS('$SDOC/Security/SecurityInformation/
    StockInformation[Industry= "Software"]') AND
    XMLEXISTS('$SDOC/Security/Symbol[.="IBM"']')

```

```

<OPTGUIDELINES>
  <ACCESS TABLE='SECURITY' TYPE='XMLINDEX' ALLINDEXES='TRUE' />
</OPTGUIDELINES>

```

The following example shows an ACCESS guideline specifying that the SECURITY table should be accessed using at least the SEC\_INDUSTRY XML index. The optimizer chooses one of the following access plans in a cost-based fashion:

- An XISCAN plan using the SEC\_INDUSTRY XML index
- An IXAND plan with the SEC\_INDUSTRY index as the first leg of the IXAND. The optimizer is free to use more relational or XML indexes in the IXAND plan following cost-based analysis. If a relational index were available on the TRANS\_DATE column, for example, that index might appear as an additional leg of the IXAND if that were deemed to be beneficial by the optimizer.
- A XANDOR plan using the SEC\_INDUSTRY index and other applicable XML indexes

```

SELECT * FROM security
  WHERE trans_date = CURRENT DATE AND
    XMLEXISTS('$SDOC/Security/SecurityInformation/
    StockInformation[Industry= "Software"]') AND
    XMLEXISTS('$SDOC/Security/Symbol[.="IBM"']')

```

```

<OPTGUIDELINES>
  <ACCESS TABLE='SECURITY' TYPE='XMLINDEX' INDEX='SEC_INDUSTRY' />
</OPTGUIDELINES>

```

*Index ANDing access requests:*

The IXAND access request element can be used to specify that the optimizer is to use the index ANDing data access method to access a local table. It is defined by the complex type indexAndingType.

## XML Schema

```
<xs:complexType name="indexAndingType">
  <xs:complexContent>
    <xs:extension base="extendedAccessType">
      <xs:sequence minOccurs="0">
        <xs:element name="NLJOIN" type="nestedLoopJoinType" minOccurs="1"
          maxOccurs="unbounded"/>
      </xs:sequence>
      <xs:attribute name="STARJOIN" type="boolType" use="optional"/>
    </xs:extension>
  </xs:complexContent>
</xs:complexType>
```

## Description

The complex type `indexAndingType` is an extension of `extendedAccessType`. When the `STARJOIN` attribute and `NLJOIN` elements are not specified, `indexAndingType` becomes a simple extension of `extendedAccessType`. The `extendedAccessType` type extends the abstract type `accessType` by adding an optional `INDEX` attribute, optional `INDEX` sub-elements, an optional `TYPE` attribute, and an optional `ALLINDEXES` attribute. The `INDEX` attribute can be used to specify the first index that is to be used in the index ANDing operation. If the `INDEX` attribute is used, the optimizer chooses additional indexes and the access sequence in a cost-based fashion. The `INDEX` sub-elements can be used to specify the exact set of indexes and access sequence. The order in which the `INDEX` sub-elements appear indicates the order in which the individual index scans should be performed. The specification of `INDEX` sub-elements supersedes the specification of the `INDEX` attribute.

- If no indexes are specified, the optimizer chooses both the indexes and the access sequence in a cost-based fashion.
- If indexes are specified using either the attribute or sub-elements, these indexes must be defined on the table that is identified by the `TABLE` or `TABID` attribute.
- If there are no indexes defined on the table, the access request is ignored and `SQL0437W` with reason code 13 is returned.

The `TYPE` attribute, whose only supported value is `XMLINDEX`, indicates to the optimizer that the table must be accessed using one or more indexes over XML data.

The optional `INDEX` attribute can be used to specify an XML index name only if the `TYPE` attribute has a value of `XMLINDEX`. A relational index can be specified in the optional `INDEX` attribute regardless of the `TYPE` attribute specification. The specified index is used by the optimizer as the leading index of an `IXAND` plan. The optimizer will add more indexes to the `IXAND` plan in a cost-based fashion.

The optional `INDEX` element can be used to specify two or more names of indexes over XML data as index elements only if the `TYPE` attribute has a value of `XMLINDEX`. Relational indexes can be specified in the optional `INDEX` elements regardless of the `TYPE` attribute specification. The specified indexes are used by the optimizer as the indexes of an `IXAND` plan in the specified order.

If the `TYPE` attribute is not present, `INDEX` attributes and `INDEX` elements are still valid for relational indexes.

If the `INDEX` attribute and the `INDEX` element are both specified, the `INDEX` attribute is ignored.

The optional ALLINDEXES attribute, whose only supported value is TRUE, can only be specified if the TYPE attribute has a value of XMLINDEX. If this attribute is specified, the optimizer must use all applicable relational indexes and indexes over XML data in an IXAND plan to access the specified table, regardless of cost.

If the TYPE attribute is specified, but neither INDEX attribute, INDEX element, nor ALLINDEXES attribute is specified, the optimizer will choose an IXAND plan with at least one index over XML data. Other indexes in the plan can be either relational indexes or indexes over XML data. The order and choice of indexes is determined by the optimizer in a cost-based fashion.

Block indexes must appear before record indexes in an index ANDing access request. If this requirement is not met, SQL0437W with reason code 13 is returned. The index ANDing access method requires that at least one predicate is able to be indexed for each index. If index ANDing is not eligible because the required predicate does not exist, the access request is ignored and SQL0437W with reason code 13 is returned. If the index ANDing data access method is not in the search space that is in effect for the statement, the access request is ignored and SQL0437W with reason code 13 is returned.

You can use the IXAND access request element to request a star join index ANDing plan. The optional STARJOIN attribute on the IXAND element specifies that the IXAND is for a star join index ANDing plan. NLJOINS can be sub-elements of the IXAND, and must be properly constructed star join semi-joins. STARJOIN="FALSE" specifies a request for a regular base access index ANDing plan. STARJOIN="TRUE" specifies a request for a star join index ANDing plan. The default value is determined by context: If the IXAND has one or more semi-join child elements, the default is TRUE; otherwise, the default is FALSE. If STARJOIN="TRUE" is specified:

- The INDEX, TYPE, and ALLINDEXES attributes cannot be specified
- INDEX elements cannot be specified

If NLJOIN elements are specified:

- The INDEX, TYPE, and ALLINDEXES attributes cannot be specified
- INDEX elements cannot be specified
- The only supported value for the STARJOIN attribute is TRUE

The following example illustrates an index ANDing access request:

SQL statement:

```
select s.s_name, s.s_address, s.s_phone, s.s_comment
  from "Tpcd".parts, "Tpcd".suppliers s, "Tpcd".partsupp ps
  where p_partkey = ps.ps_partkey and
        s.s_suppkey = ps.ps_suppkey and
        p_size = 39 and
        p_type = 'BRASS' and
        s.s_nation in ('MOROCCO', 'SPAIN') and
        ps.ps_supplycost = (select min(ps1.ps_supplycost)
                             from "Tpcd".partsupp ps1, "Tpcd".suppliers s1
                             where "Tpcd".parts.p_partkey = ps1.ps_partkey and
                                   s1.s_suppkey = ps1.ps_suppkey and
                                   s1.s_nation = s.s_nation)

  order by s.s_name
  optimize for 1 row
```

Optimization guideline:

<OPTGUIDELINES>

```

<IXAND TABLE="'Tpcd',PARTS' FIRST='TRUE'>
  <INDEX IXNAME='ISIZE' />
  <INDEX IXNAME='ITYPE' />
</IXAND>
</OPTGUIDELINES>

```

The index ANDing request specifies that the PARTS table in the main subselect is to be satisfied using an index ANDing data access method. The first index scan will use the ISIZE index, and the second index scan will use the ITYPE index. The indexes are specified by the IXNAME attribute of the INDEX element. The FIRST attribute setting specifies that the PARTS table is to be the first table in the join sequence with the SUPPLIERS, PARTSUPP, and derived tables in the same FROM clause.

The following example illustrates a star join index ANDing guideline that specifies the first semi-join but lets the optimizer choose the remaining ones. It also lets the optimizer choose the specific access method for the outer table and the index for the inner table in the specified semi-join.

```

<IXAND TABLE="F">
  <NLJOIN>
    <ACCESS TABLE="D1" />
    <IXSCAN TABLE="F" />
  </NLJOIN>
</IXAND>

```

The following guideline specifies all of the semi-joins, including details, leaving the optimizer with no choices for the plan at and below the IXAND.

```

<IXAND TABLE="F" STARJOIN="TRUE">
  <NLJOIN>
    <TBSCAN TABLE="D1" />
    <IXSCAN TABLE="F" INDEX="FX1" />
  </NLJOIN>
  <NLJOIN>
    <TBSCAN TABLE="D4" />
    <IXSCAN TABLE="F" INDEX="FX4" />
  </NLJOIN>
  <NLJOIN>
    <TBSCAN TABLE="D3" />
    <IXSCAN TABLE="F" INDEX="FX3" />
  </NLJOIN>
</IXAND>

```

*Index ORing access requests:*

The IXOR access request element can be used to specify that the optimizer is to use the index ORing data access method to access a local table. It is defined by the complex type indexOringType.

XML Schema

```

<xs:complexType name="indexOringType">
  <xs:complexContent>
    <xs:extension base="accessType" />
  </xs:complexContent>
</xs:complexType>

```

### Description

The complex type indexOringType is a simple extension of the abstract type accessType. No new elements or attributes are added. If the index ORing access method is not in the search space that is in effect for the statement, the access

request is ignored and SQL0437W with reason code 13 is returned. The optimizer chooses the predicates and indexes that are used in the index ORing operation in a cost-based fashion. The index ORing access method requires that at least one IN predicate is able to be indexed or that a predicate with terms is able to be indexed and connected by a logical OR operation. If index ORing is not eligible because the required predicate or indexes do not exist, the request is ignored and SQL0437W with reason code 13 is returned.

The following example illustrates an index ORing access request:

SQL statement:

```
select s.s_name, s.s_address, s.s_phone, s.s_comment
  from "Tpcd".parts, "Tpcd".suppliers s, "Tpcd".partsupp ps
 where p_partkey = ps.ps_partkey and
       s.s_suppkey = ps.ps_suppkey and
       p_size = 39 and
       p_type = 'BRASS' and
       s.s_nation in ('MOROCCO', 'SPAIN') and
       ps.ps_supplycost = (select min(ps1.ps_supplycost)
                          from "Tpcd".partsupp ps1, "Tpcd".suppliers s1
                          where "Tpcd".parts.p_partkey = ps1.ps_partkey and
                                s1.s_suppkey = ps1.ps_suppkey and
                                s1.s_nation = s.s_nation)

 order by s.s_name
 optimize for 1 row
```

Optimization guideline:

```
<OPTGUIDELINES>
  <IXOR TABLE='S' />
</OPTGUIDELINES>
```

This index ORing access request specifies that an index ORing data access method is to be used to access the SUPPLIERS table that is referenced in the main subselect. The optimizer will choose the appropriate predicates and indexes for the index ORing operation in a cost-based fashion.

*Index scan access requests:*

The IXSCAN access request element can be used to specify that the optimizer is to use an index scan to access a local table. It is defined by the complex type `indexScanType`.

XML Schema

```
<xs:complexType name="indexScanType">
  <xs:complexContent>
    <xs:extension base="accessType">
      <xs:attribute name="INDEX" type="xs:string" use="optional"/>
    </xs:extension>
  </xs:complexContent>
</xs:complexType>
```

## Description

The complex type `indexScanType` extends the abstract `accessType` by adding an optional `INDEX` attribute. The `INDEX` attribute specifies the name of the index that is to be used to access the table.

- If the index scan access method is not in the search space that is in effect for the statement, the access request is ignored and SQL0437W with reason code 13 is returned.



- If the INDEX attribute is specified, it must identify an index defined on the table that is identified by the TABLE or TABID attribute. If the index does not exist, the access request is ignored and SQL0437W with reason code 13 is returned.
- If the INDEX attribute is not specified, the optimizer chooses an index in a cost-based fashion. If no indexes are defined on the target table, the access request is ignored and SQL0437W with reason code 13 is returned.

The following guideline is an example of an index scan access request:

```
<OPTGUIDELINES>
  <IXSCAN TABLE='S' INDEX='I_SUPPKEY' />
</OPTGUIDELINES>
```

*List prefetch access requests:*

The LPREFETCH access request element can be used to specify that the optimizer is to use a list prefetch index scan to access a local table. It is defined by the complex type listPrefetchType.

XML Schema

```
<xs:complexType name="listPrefetchType">
  <xs:complexContent>
    <xs:extension base="accessType">
      <xs:attribute name="INDEX" type="xs:string" use="optional"/>
    </xs:extension>
  </xs:complexContent>
</xs:complexType>
```

## Description

The complex type listPrefetchType extends the abstract type accessType by adding an optional INDEX attribute. The INDEX attribute specifies the name of the index that is to be used to access the table.

- If the list prefetch access method is not in the search space that is in effect for the statement, the access request is ignored and SQL0437W with reason code 13 is returned.
- The list prefetch access method requires that at least one predicate is able to be indexed. If the list prefetch access method is not eligible because the required predicate does not exist, the access request is ignored and SQL0437W with reason code 13 is returned.
- If the INDEX attribute is specified, it must identify an index defined on the table that is specified by the TABLE or TABID attribute. If the index does not exist, the access request is ignored and SQL0437W with reason code 13 is returned.
- If the INDEX attribute is not specified, the optimizer chooses an index in a cost-based fashion. If no indexes are defined on the target table, the access request is ignored and SQL0437W with reason code 13 is returned.

The following guideline is an example of a list prefetch access request:

```
<OPTGUIDELINES>
  <LPREFETCH TABLE='S1' INDEX='I_SNATION' />
</OPTGUIDELINES>
```

*Table scan access requests:*

The TBSCAN access request element can be used to specify that the optimizer is to use a sequential table scan to access a local table. It is defined by the complex type tableScanType.

XML Schema

```
<xs:complexType name="tableScanType">
  <xs:complexContent>
    <xs:extension base="accessType"/>
  </xs:complexContent>
</xs:complexType>
```

### Description

The complex type `tableScanType` is a simple extension of the abstract type `accessType`. No new elements or attributes are added. If the table scan access method is not in the search space that is in effect for the statement, the access request is ignored and `SQL0437W` with reason code 13 is returned.

The following guideline is an example of a table scan access request:

```
<OPTGUIDELINES>
  <TBSCAN TABLE='S1' />
</OPTGUIDELINES>
```

*XML index ANDing and ORing access requests:*

The `XANDOR` access request element can be used to specify that the optimizer is to use multiple `XANDORed` index over XML data scans to access a local table. It is defined by the complex type `XANDORType`.

XML Schema

```
<xs:complexType name="XANDORType">
  <xs:complexContent>
    <xs:extension base="accessType"/>
  </xs:complexContent>
</xs:complexType>
```

### Description

The complex type `XANDORType` is a simple extension of the abstract type `accessType`. No new elements or attributes are added.

### Example

Given the following query:

```
SELECT * FROM security
  WHERE trans_date = CURRENT DATE AND
        XMLEXISTS('$SDOC/Security/SecurityInformation/
  StockInformation[Industry = "Software"']) AND
        XMLEXISTS('$SDOC/Security/Symbol[.="IBM"'])
```

The following `XANDOR` guideline specifies that the `SECURITY` table should be accessed using a `XANDOR` operation against all applicable XML indexes. Any relational indexes on the `SECURITY` table will not be considered, because a relational index cannot be used with a `XANDOR` operator.

```
<OPTGUIDELINES>
  <XANDOR TABLE='SECURITY' />
</OPTGUIDELINES>
```

*XML index scan access requests:*

The XISCAN access request element can be used to specify that the optimizer is to use an index over XML data scan to access a local table. It is defined by the complex type `indexScanType`.

XML Schema

```
<xs:complexType name="indexScanType">
  <xs:complexContent>
    <xs:extension base="accessType"/>
    <xs:attribute name="INDEX" type="xs:string" use="optional"/>
  </xs:extension>
</xs:complexContent>
</xs:complexType>
```

## Description

The complex type `indexScanType` extends the abstract `accessType` by adding an optional `INDEX` attribute. The `INDEX` attribute specifies the name of the index over XML data that is to be used to access the table.

- If the index over XML data scan access method is not in the search space that is in effect for the statement, the access request is ignored and `SQL0437W` with reason code 13 is returned.
- If the `INDEX` attribute is specified, it must identify an index over XML data defined on the table that is identified by the `TABLE` or `TABID` attribute. If the index does not exist, the access request is ignored and `SQL0437W` with reason code 13 is returned.
- If the `INDEX` attribute is not specified, the optimizer chooses an index over XML data in a cost-based fashion. If no indexes over XML data are defined on the target table, the access request is ignored and `SQL0437W` with reason code 13 is returned.

## Example

Given the following query:

```
SELECT * FROM security
WHERE XMLEXISTS('$SDOC/Security/SecurityInformation/
  StockInformation[Industry = "OfficeSupplies"]')
```

The following XISCAN guideline specifies that the `SECURITY` table should be accessed using an XML index named `SEC_INDUSTRY`.

```
<OPTGUIDELINES>
  <XISCAN TABLE='SECURITY' INDEX='SEC_INDUSTRY'/>
</OPTGUIDELINES>
```

*Join requests:*

The `joinRequest` group defines the set of valid join request elements. A join request specifies a method for joining two tables.

XML Schema

```
<xs:group name="joinRequest">
  <xs:choice>
    <xs:element name="NLJOIN" type="nestedLoopJoinType"/>
    <xs:element name="HSJOIN" type="hashJoinType"/>
    <xs:element name="MSJOIN" type="mergeJoinType"/>
    <xs:element name="JOIN" type="anyJoinType"/>
  </xs:choice>
</xs:group>
```

## Description

- NLJOIN, MSJOIN, and HSJOIN  
These elements correspond to the nested-loop, merge, and hash join methods, respectively.
- JOIN  
This element, which causes the optimizer to choose the join method, can be used when the join order is not of primary concern.

All join request elements contain two sub-elements that represent the input tables of the join operation. Join requests can also specify an optional FIRST attribute.

The following guideline is an example of a join request:

```
<OPTGUIDELINES>
  <HSJOIN>
    <ACCESS TABLE='S1' />
    <IXSCAN TABLE='PS1' />
  </HSJOIN>
</OPTGUIDELINES>
```

The nesting order ultimately determines the join order. The following example illustrates how larger join requests can be constructed from smaller join requests:

```
<OPTGUIDELINES>
  <MSJOIN>
    <NLJOIN>
      <IXSCAN TABLE='"Tpced".Parts' />
      <IXSCAN TABLE="PS" />
    </NLJOIN>
    <IXSCAN TABLE='S' />
  </MSJOIN>
</OPTGUIDELINES>
```

*Join types:*

Common aspects of all join request elements are defined by the abstract type `joinType`.

XML Schema

```
<xs:complexType name="joinType" abstract="true">
  <xs:choice minOccurs="2" maxOccurs="2">
    <xs:group ref="accessRequest" />
    <xs:group ref="joinRequest" />
  </xs:choice>
  <xs:attribute name="FIRST" type="xs:string" use="optional" fixed="TRUE" />
</xs:complexType>
```

## Description

Join request elements that extend the complex type `joinType` must have exactly two sub-elements. Either sub-element can be an access request element chosen from the `accessRequest` group, or another join request element chosen from the `joinRequest` group. The first sub-element appearing in the join request specifies the outer table of the join operation, and the second element specifies the inner table.

If the `FIRST` attribute is specified, it must have the value `TRUE`. Adding the `FIRST` attribute to a join request element indicates that you want an execution plan in which the tables that are targeted by the join request are the outermost tables in the join sequence for the corresponding `FROM` clause. Only one access or join request per `FROM` clause can specify the `FIRST` attribute. If multiple access or join

requests that target tables of the same FROM clause specify the FIRST attribute, all but the initial request are ignored and SQL0437W with reason code 13 is returned.

*Any join requests:*

The JOIN join request element can be used to specify that the optimizer is to choose an appropriate method for joining two tables in a particular order.

Either table can be local or derived, as specified by an access request sub-element, or it can be the result of a join operation, as specified by a join request sub-element. A derived table is the result of another subselect. This join request element is defined by the complex type anyJoinType.

XML Schema

```
<xs:complexType name="anyJoinType">
  <xs:complexContent>
    <xs:extension base="joinType"/>
  </xs:complexContent>
</xs:complexType>
```

### Description

The complex type anyJoinType is a simple extension of the abstract type joinType. No new elements or attributes are added.

The following example illustrates the use of the JOIN join request element to force a particular join order for a set of tables:

SQL statement:

```
select s.s_name, s.s_address, s.s_phone, s.s_comment
from "Tpcd".parts, "Tpcd".suppliers s, "Tpcd".partsupp ps
where p_partkey = ps.ps_partkey and
      s.s_suppkey = ps.ps_suppkey and
      p_size = 39 and
      p_type = 'BRASS' and
      s.s_nation in ('MOROCCO', 'SPAIN') and
      ps.ps_supplycost = (select min(ps1.ps_supplycost)
                          from "Tpcd".partsupp ps1, "Tpcd".suppliers s1
                          where "Tpcd".parts.p_partkey = ps1.ps_partkey and
                                s1.s_suppkey = ps1.ps_suppkey and
                                s1.s_nation = s.s_nation)

order by s.s_name
```

Optimization guideline:

```
<OPTGUIDELINES>
  <JOIN>
    <JOIN>
      <ACCESS TABLE='Tpcd'.PARTS' />
      <ACCESS TABLE='S' />
    </JOIN>
    <ACCESS TABLE='PS'>
  </JOIN>
</OPTGUIDELINES>
```

The JOIN join request elements specify that the PARTS table in the main subselect is to be joined with the SUPPLIERS table, and that this result is to be joined to the PARTSUPP table. The optimizer will choose the join methods for this particular sequence of joins in a cost-based fashion.

*Hash join requests:*

The HSJOIN join request element can be used to specify that the optimizer is to join two tables using a hash join method.

Either table can be local or derived, as specified by an access request sub-element, or it can be the result of a join operation, as specified by a join request sub-element. A derived table is the result of another subselect. This join request element is defined by the complex type hashJoinType.

XML Schema

```
<xs:complexType name="hashJoinType">
  <xs:complexContent>
    <xs:extension base="joinType"/>
  </xs:complexContent>
</xs:complexType>
```

### Description

The complex type hashJoinType is a simple extension of the abstract type joinType. No new elements or attributes are added. If the hash join method is not in the search space that is in effect for the statement, the join request is ignored and SQL0437W with reason code 13 is returned.

The following guideline is an example of a hash join request:

```
<OPTGUIDELINES>
  <HSJOIN>
    <ACCESS TABLE='S1' />
    <IXSCAN TABLE='PS1' />
  </HSJOIN>
</OPTGUIDELINES>
```

*Merge join requests:*

The MSJOIN join request element can be used to specify that the optimizer is to join two tables using a merge join method.

Either table can be local or derived, as specified by an access request sub-element, or it can be the result of a join operation, as specified by a join request sub-element. A derived table is the result of another subselect. This join request element is defined by the complex type mergeJoinType.

XML Schema

```
<xs:complexType name="mergeJoinType">
  <xs:complexContent>
    <xs:extension base="joinType"/>
  </xs:complexContent>
</xs:complexType>
```

### Description

The complex type mergeJoinType is a simple extension of the abstract type joinType. No new elements or attributes are added. If the merge join method is not in the search space that is in effect for the statement, the join request is ignored and SQL0437W with reason code 13 is returned.

The following guideline is an example of a merge join request:

```
<OPTGUIDELINES>
  <MSJOIN>
    <NLJOIN>
      <IXSCAN TABLE='Tpcd'.Parts' />
    </NLJOIN>
  </MSJOIN>
</OPTGUIDELINES>
```

```

        <IXSCAN TABLE="PS"/>
    </NLJOIN>
    <IXSCAN TABLE='S' />
</MSJOIN>
</OPTGUIDELINES>

```

*Nested-loop join requests:*

The NLJOIN join request element can be used to specify that the optimizer is to join two tables using a nested-loop join method.

Either table can be local or derived, as specified by an access request sub-element, or it can be the result of a join operation, as specified by a join request sub-element. A derived table is the result of another subselect. This join request element is defined by the complex type nestedLoopJoinType.

XML Schema

```

<xs:complexType name="nestedLoopJoinType">
  <xs:complexContent>
    <xs:extension base="joinType"/>
  </xs:complexContent>
</xs:complexType>

```

## Description

The complex type nestedLoopJoinType is a simple extension of the abstract type joinType. No new elements or attributes are added. If the nested-loop join method is not in the search space that is in effect for the statement, the join request is ignored and SQL0437W with reason code 13 is returned.

The following guideline is an example of a nested-loop join request:

```

<OPTGUIDELINES>
  <NLJOIN>
    <IXSCAN TABLE='Tpcd'.Parts' />
    <IXSCAN TABLE="PS" />
  </NLJOIN>
</OPTGUIDELINES>

```

## SYSTOOLS.OPT\_PROFILE table:

The SYSTOOLS.OPT\_PROFILE table contains all of the optimization profiles.

There are two methods to create this table:

- Call the SYSINSTALLOBJECTS procedure:
 

```
db2 "call sysinstallobjects('opt_profiles', 'c', '', '')"
```
- Issue the CREATE TABLE statement:
 

```
create table systools.opt_profile (
  schema varchar(128) not null,
  name varchar(128) not null,
  profile blob (2m) not null,
  primary key (schema, name)
)
```

The columns in the SYSTOOLS.OPT\_PROFILE table are defined as follows:

### SCHEMA

Specifies the schema name for an optimization profile. The name can include up to 30 alphanumeric or underscore characters, but define it as VARCHAR(128), as shown.

## NAME

Specifies the base name for an optimization profile. The name can include up to 128 alphanumeric or underscore characters.

## PROFILE

Specifies an XML document that defines the optimization profile.

*Triggers to flush the optimization profile cache:*

The optimization profile cache is automatically flushed whenever an entry in the SYSTOOLS.OPT\_PROFILE table is updated or deleted.

The following SQL procedure and triggers must be created before automatic flushing of the profile cache can occur.

```
CREATE PROCEDURE SYSTOOLS.OPT_FLUSH_CACHE( IN SCHEMA VARCHAR(128),
                                           IN NAME VARCHAR(128) )
LANGUAGE SQL
MODIFIES SQL DATA
BEGIN ATOMIC
-- FLUSH stmt (33) + quoted schema (130) + dot (1) + quoted name (130) = 294
DECLARE FSTMT VARCHAR(294) DEFAULT 'FLUSH OPTIMIZATION PROFILE CACHE '; --

IF NAME IS NOT NULL THEN
  IF SCHEMA IS NOT NULL THEN
    SET FSTMT = FSTMT || ''' || SCHEMA || '.'; --
  END IF; --

  SET FSTMT = FSTMT || ''' || NAME || '''; --

  EXECUTE IMMEDIATE FSTMT; --
END IF; --
END;

CREATE TRIGGER SYSTOOLS.OPT_PROFILE_UTRIG AFTER UPDATE ON SYSTOOLS.OPT_PROFILE
REFERENCING OLD AS O
FOR EACH ROW
  CALL SYSTOOLS.OPT_FLUSH_CACHE( O.SCHEMA, O.NAME );

CREATE TRIGGER SYSTOOLS.OPT_PROFILE_DTRIG AFTER DELETE ON SYSTOOLS.OPT_PROFILE
REFERENCING OLD AS O
FOR EACH ROW
  CALL SYSTOOLS.OPT_FLUSH_CACHE( O.SCHEMA, O.NAME );
```

*Managing the SYSTOOLS.OPT\_PROFILE table:*

Optimization profiles must be associated with a unique schema-qualified name and stored in the SYSTOOLS.OPT\_PROFILE table. You can use the **LOAD**, **IMPORT**, and **EXPORT** commands to manage the files in that table.

For example, the **IMPORT** command can be used from any DB2 client to insert or update data in the SYSTOOLS.OPT\_PROFILE table. The **EXPORT** command can be used to copy a profile from the SYSTOOLS.OPT\_PROFILE table into a file.

The following example shows how to insert three new profiles into the SYSTOOLS.OPT\_PROFILE table. Assume that the files are in the current directory.

1. Create an input file (for example, profiledata) with the schema, name, and file name for each profile on a separate line:

```
"ROBERT", "PROF1", "ROBERT.PROF1.xml"
"ROBERT", "PROF2", "ROBERT.PROF2.xml"
"DAVID", "PROF1", "DAVID.PROF1.xml"
```

2. Execute the **IMPORT** command:



```
import from profiledata of del
modified by lobsinfile
insert into systools.opt_profile
```

To update existing rows, use the `INSERT_UPDATE` option on the **IMPORT** command:

```
import from profiledata of del
modified by lobsinfile
insert_update into systools.opt_profile
```

To copy the `ROBERT.PROF1` profile into `ROBERT.PROF1.xml`, assuming that the profile is less than 32 700 bytes long, use the **EXPORT** command:

```
export to robert.prof1.xml of del
select profile from systools.opt_profile
where schema='ROBERT' and name='PROF1'
```

For more information, including how to export more than 32 700 bytes of data, see “EXPORT command”.

### Database partition group impact on query optimization

In partitioned database environments, the optimizer recognizes and uses the collocation of tables when it determines the best access plan for a query.

If tables are frequently involved in join queries, they should be divided among database partitions in such a way that the rows from each table being joined are located on the same database partition. During the join operation, the collocation of data from both joined tables prevents the movement of data from one database partition to another. Place both tables in the same database partition group to ensure that the data is collocated.

Depending on the size of the table, spreading data over more database partitions reduces the estimated time to execute a query. The number of tables, the size of the tables, the location of the data in those tables, and the type of query (such as whether a join is required) all affect the cost of the query.

### Collecting accurate catalog statistics, including advanced statistics features

Accurate database statistics are critical for query optimization. Perform **RUNSTATS** command operations regularly on any tables that are critical to query performance.

You might also want to collect statistics on system catalog tables, if an application queries these tables directly and if there is significant catalog update activity, such as that resulting from the execution of data definition language (DDL) statements. Automatic statistics collection can be enabled to allow the DB2 data server to automatically perform a **RUNSTATS** command operation. Real-time statistics collection can be enabled to allow the DB2 data server to provide even more timely statistics by collecting them immediately before queries are optimized.

If you are collecting statistics manually by using the **RUNSTATS** command, use the following options at a minimum:

```
RUNSTATS ON TABLE DB2USER.DAILY_SALES
WITH DISTRIBUTION AND SAMPLED DETAILED INDEXES ALL
```

Distribution statistics make the optimizer aware of data skew. Detailed index statistics provide more details about the I/O required to fetch data pages when the table is accessed by using a particular index. Collecting detailed index statistics uses considerable processing time and memory for large tables. The **SAMPLED** option

provides detailed index statistics with nearly the same accuracy but requires a fraction of the CPU and memory. These options are used by the automatic statistics collection when a statistical profile has not been provided for a table.

To improve query performance, consider collecting more advanced statistics, such as column group statistics or LIKE statistics, or creating statistical views.

Statistical views are helpful when gathering statistics for complex relationships. Gathering statistics for statistical views can be automated through the automatic statistics collection feature in DB2 Database for Linux, UNIX, and Windows. Enabling or disabling the automatic statistic collection of statistical views is done by using the **auto\_stats\_views** database configuration parameter. To enable this function, issue the following command:

```
update db cfg for dbname using auto_stats_views on
```

To disable this feature, issue the following command:

```
update db cfg for dbname using auto_stats_views off
```

This database configuration parameter is off by default. The command that is issued to automatically collect statistics on statistical views is equivalent to the following command:

```
runstats on view view_name with distribution
```

Collecting statistics for a large table or statistical view can be time consuming. Statistics of the same quality can often be collected by considering just a small sample of the overall data. Consider enabling automatic sampling for all background statistic collections; this may reduce the statistic collection time. To enable this function, issue the following command:

```
update db cfg for dbname using auto_sampling on
```

## Column group statistics

If your query has more than one join predicate joining two tables, the DB2 optimizer calculates how selective each of the predicates is before choosing a plan for executing the query.

For example, consider a manufacturer who makes products from raw material of various colors, elasticities, and qualities. The finished product has the same color and elasticity as the raw material from which it is made. The manufacturer issues the query:

```
SELECT PRODUCT.NAME, RAWMATERIAL.QUALITY
   FROM PRODUCT, RAWMATERIAL
  WHERE
    PRODUCT.COLOR = RAWMATERIAL.COLOR AND
    PRODUCT.ELASTICITY = RAWMATERIAL.ELASTICITY
```

This query returns the names and raw material quality of all products. There are two join predicates:

```
PRODUCT.COLOR = RAWMATERIAL.COLOR
PRODUCT.ELASTICITY = RAWMATERIAL.ELASTICITY
```

The optimizer assumes that the two predicates are independent, which means that all variations of elasticity occur for each color. It then estimates the overall selectivity of the pair of predicates by using catalog statistics information for each table based on the number of levels of elasticity and the number of different colors. Based on this estimate, it might choose, for example, a nested loop join in preference to a merge join, or the reverse.

However, these two predicates might not be independent. For example, highly elastic materials might be available in only a few colors, and the very inelastic materials might be available in a few other colors that are different from the elastic ones. In that case, the combined selectivity of the predicates eliminates fewer rows and the query returns more rows. Without this information, the optimizer might no longer choose the best plan.

To collect the column group statistics on `PRODUCT.COLOR` and `PRODUCT.ELASTICITY`, issue the following **RUNSTATS** command:

```
RUNSTATS ON TABLE PRODUCT ON COLUMNS ((COLOR, ELASTICITY))
```

The optimizer uses these statistics to detect cases of correlation and to dynamically adjust the combined selectivities of correlated predicates, thus obtaining a more accurate estimate of the join size and cost.

When a query groups data by using keywords such as `GROUP BY` or `DISTINCT`, column group statistics also enable the optimizer to compute the number of distinct groupings.

Consider the following query:

```
SELECT DEPTNO, YEARS, AVG(SALARY)
FROM EMPLOYEE
GROUP BY DEPTNO, MGR, YEAR_HIRED
```

Without any index or column group statistics, the optimizer estimates the number of groupings (and, in this case, the number of rows returned) as the product of the number of distinct values in `DEPTNO`, `MGR`, and `YEAR_HIRED`. This estimate assumes that the grouping key columns are independent. However, this assumption could be incorrect if each manager manages exactly one department. Moreover, it is unlikely that each department hires employees every year. Thus, the product of distinct values of `DEPTNO`, `MGR`, and `YEAR_HIRED` could be an overestimate of the actual number of distinct groups.

Column group statistics collected on `DEPTNO`, `MGR`, and `YEAR_HIRED` provide the optimizer with the exact number of distinct groupings for the previous query:

```
RUNSTATS ON TABLE EMPLOYEE ON COLUMNS ((DEPTNO, MGR, YEAR_HIRED))
```

In addition to `JOIN` predicate correlation, the optimizer manages correlation with simple equality predicates, such as:

```
DEPTNO = 'Sales' AND MGR = 'John'
```

In this example, predicates on the `DEPTNO` column in the `EMPLOYEE` table are likely to be independent of predicates on the `YEAR` column. However, the predicates on `DEPTNO` and `MGR` are not independent, because each department would usually be managed by one manager at a time. The optimizer uses statistical information about columns to determine the combined number of distinct values and then adjusts the cardinality estimate to account for correlation between columns.

Column group statistics can also be used on statistical views. The column group statistics help adjust the skewed statistics in the statistical view when there is more than one strong correlation in the queries. The optimizer can use these statistics to obtain better cardinality estimates which might result in better access plans.

## Correlation of simple equality predicates

In addition to join predicate correlation, the optimizer manages correlation with simple equality predicates of the type `COL =`.

For example, consider a table of different types of cars, each having a MAKE (that is, a manufacturer), MODEL, YEAR, COLOR, and STYLE, such as sedan, station wagon, or sports-utility vehicle. Because almost every manufacturer makes the same standard colors available for each of their models and styles, year after year, predicates on COLOR are likely to be independent of those on MAKE, MODEL, STYLE, or YEAR. However, predicates based on MAKE and MODEL are not independent, because only a single car maker would make a model with a particular name. Identical model names used by two or more car makers is very unlikely.

If an index on the two columns MAKE and MODEL exists, or column group statistics are collected, the optimizer uses statistical information about the index or columns to determine the combined number of distinct values and to adjust the selectivity or cardinality estimates for the correlation between these two columns. If the predicates are local equality predicates, the optimizer does not need a unique index to make an adjustment.

## Statistical views

The DB2 cost-based optimizer uses an estimate of the number of rows processed by an access plan operator to accurately cost that operator. This cardinality estimate is the single most important input to the optimizer cost model, and its accuracy largely depends upon the statistics that the **RUNSTATS** command collects from the database.

More sophisticated statistics are required to represent more complex relationships, such as the following relationships:

- Comparisons involving expressions. For example, `price > MSRP + Dealer_markup`.
- Relationships spanning multiple tables. For example, `product.name = 'Alloy wheels'` and `product.key = sales.product_key`.
- Any relationships other than predicates involving independent attributes and simple comparison operations.

Statistical views are able to represent these types of complex relationships, because statistics are collected on the result set returned by the view, rather than the base tables referenced by the view.

When a query is compiled, the optimizer matches the query to the available statistical views. When the optimizer computes cardinality estimates for intermediate result sets, it uses the statistics from the view to compute a better estimate.

Queries do not need to reference the statistical view directly in order for the optimizer to use the statistical view. The optimizer uses the same matching mechanism that is used for materialized query tables (MQTs) to match queries to statistical views. In this respect, statistical views are similar to MQTs, except that they are not stored permanently, do not consume disk space, and do not have to be maintained.

A statistical view is created by first creating a view and then enabling it for optimization by using the `ALTER VIEW` statement. The **RUNSTATS** command is then

run against the statistical view, populating the system catalog tables with statistics for the view. For example, to create a statistical view that represents the join between the TIME dimension table and the fact table in a star schema, run the following statements and commands:

```
CREATE VIEW SV_TIME_FACT AS (  
  SELECT T.* FROM TIME T, SALES S  
  WHERE T.TIME_KEY = S.TIME_KEY)  
  
ALTER VIEW SV_TIME_FACT ENABLE QUERY OPTIMIZATION  
  
RUNSTATS ON TABLE DB2DBA.SV_TIME_FACT WITH DISTRIBUTION
```

This statistical view can be used to improve the cardinality estimate and, consequently, the access plan and query performance for queries such as the following query:

```
SELECT SUM(S.PRICE)  
  FROM SALES S, TIME T, PRODUCT P  
  WHERE  
    T.TIME_KEY = S.TIME_KEY AND  
    T.YEAR_MON = 200712 AND  
    P.PROD_KEY = S.PROD_KEY AND  
    P.PROD_DESC = 'Power drill'
```

Without a statistical view, the optimizer assumes that all fact table TIME\_KEY values corresponding to a particular TIME dimension YEAR\_MON value occur uniformly within the fact table. However, sales might have been strong in December, resulting in many more sales transactions than during other months.

Statistics that are gathered on queries that have complex expressions in the predicate can be used by the optimizer to calculate accurate cardinality estimates which results in better access plans.

For many star join queries many statistical views might need to be created, however, if you have referential integrity constraints you can narrow down these many statistical views. The statistics for the other views can be inferred from the reduced number of statistical views by using referential integrity constraints.

Another way to obtain better access plans is to apply column group statistics on statistical views. These group statistics help to adjust filter factors which help to gather more accurate statistics which the optimizer can use to obtain accurate cardinality estimates.

Statistics can also be gathered automatically from statistical views through the automatic statistics collection feature in DB2 Database for Linux, UNIX, and Windows. This new feature can be enabled or disabled by using the **auto\_stats\_views** database configuration parameter. This database configuration parameter is off by default and can be enabled by using the **UPDATE DB CFG** command. The statistics collected by the automatic statistics collection is equivalent to issuing the command `runstats on view view_name with distribution`.

Utility throttling can be used for statistical views to restrict the performance impact on the workload. For example, the command `runstats on view view_name util_impact_priority 10` contains the impact on the workload within a limit specified by the **util\_impact\_lim** database manager configuration parameter while statistics are collected on statistical views.

## Using statistical views

A view must be enabled for optimization before its statistics can be used to optimize a query. A view that is enabled for optimization is known as a *statistical view*.

### About this task

A view that is not a statistical view is said to be disabled for optimization and is known as a *regular view*. A view is disabled for optimization when it is first created. Use the `ALTER VIEW` statement to enable a view for optimization. For privileges and authorities that are required to perform this task, see the description of the `ALTER VIEW` statement. For privileges and authorities that are required to use the `RUNSTATS` utility against a view, see the description of the `RUNSTATS` command.

A view cannot be enabled for optimization if any one of the following conditions is true:

- The view directly or indirectly references a materialized query table (MQT). (An MQT or statistical view can reference a statistical view.)
- The view is inoperative.
- The view is a typed view.
- There is another view alteration request in the same `ALTER VIEW` statement.

If the definition of a view that is being altered to enable optimization contains any of the following items, a warning is returned, and the optimizer will not exploit the view's statistics:

- Aggregation or distinct operations
- Union, except, or intersect operations
- OLAP specification

### Procedure

1. Enable the view for optimization.

A view can be enabled for optimization using the `ENABLE OPTIMIZATION` clause on the `ALTER VIEW` statement. A view that has been enabled for optimization can subsequently be disabled for optimization using the `DISABLE OPTIMIZATION` clause. For example, to enable `MYVIEW` for optimization, enter the following:

```
alter view myview enable query optimization
```

2. Invoke the `RUNSTATS` command. For example, to collect statistics on `MYVIEW`, enter the following:

```
runstats on table db2dba.myview
```

To use row-level sampling of 10 percent of the rows while collecting view statistics, including distribution statistics, enter the following:

```
runstats on table db2dba.myview with distribution tablesample bernoulli (10)
```

To use page-level sampling of 10 percent of the pages while collecting view statistics, including distribution statistics, enter the following:

```
runstats on table db2dba.myview with distribution tablesample system (10)
```

3. Optional: If queries that are impacted by the view definition are part of static SQL packages, rebind those packages to take advantage of changes to access plans resulting from the new statistics.

## View statistics that are relevant to optimization

Only statistics that characterize the data distribution of the query that defines a statistical view, such as CARD and COLCARD, are considered during query optimization.

The following statistics that are associated with view records can be collected for use by the optimizer.

- Table statistics (SYSCAT.TABLES, SYSSTAT.TABLES)
  - CARD - Number of rows in the view result
- Column statistics (SYSCAT.COLUMNS, SYSSTAT.COLUMNS)
  - COLCARD - Number of distinct values of a column in the view result
  - AVGCOLLEN - Average length of a column in the view result
  - HIGH2KEY - Second highest value of a column in the view result
  - LOW2KEY - Second lowest value of a column in the view result
  - NUMNULLS - Number of null values in a column in the view result
  - SUB\_COUNT - Average number of sub-elements in a column in the view result
  - SUB\_DELIM\_LENGTH - Average length of each delimiter separating sub-elements
- Column distribution statistics (SYSCAT.COLDIST, SYSSTAT.COLDIST)
  - DISTCOUNT - Number of distinct quantile values that are less than or equal to COLVALUE statistics
  - SEQNO - Frequency ranking of a sequence number to help uniquely identify a row in the table
  - COLVALUE - Data value for which frequency or quantile statistics are collected
  - VALCOUNT - Frequency with which a data value occurs in a view column; or for quantiles, the number of values that are less than or equal to the data value (COLVALUE)

Statistics that do not describe data distribution (such as NPAGES and FPAGES) can be collected, but are ignored by the optimizer.

## Scenario: Improving cardinality estimates using statistical views

In a data warehouse, fact table information often changes quite dynamically, whereas dimension table data is static. This means that dimension attribute data might be positively or negatively correlated with fact table attribute data.

Traditional base table statistics currently available to the optimizer do not allow it to discern relationships across tables. Column and table distribution statistics on statistical views (and MQTs) can be used to give the optimizer the necessary information to correct these types of cardinality estimation errors.

Consider the following query that computes annual sales revenue for golf clubs sold during July of each year:

```
select sum(f.sales_price), d2.year
  from product d1, period d2, daily_sales f
 where d1.prodkey = f.prodkey
       and d2.perkey = f.perkey
       and d1.item_desc = 'golf club'
       and d2.month = 'JUL'
 group by d2.year
```

A star join query execution plan can be an excellent choice for this query, provided that the optimizer can determine whether the semi-join involving PRODUCT and DAILY\_SALES, or the semi-join involving PERIOD and DAILY\_SALES, is the most selective. To generate an efficient star join plan, the optimizer must be able to choose the most selective semi-join for the outer leg of the index ANDing operation.

Data warehouses often contain records for products that are no longer on store shelves. This can cause the distribution of PRODUCT columns after the join to appear dramatically different than their distribution before the join. Because the optimizer, for lack of better information, will determine the selectivity of local predicates based solely on base table statistics, the optimizer might become overly optimistic regarding the selectivity of the predicate `item_desc = 'golf club'`

For example, if golf clubs historically represent 1% of the products manufactured, but now account for 20% of sales, the optimizer would likely overestimate the selectivity of `item_desc = 'golf club'`, because there are no statistics describing the distribution of `item_desc` after the join. And if sales in all twelve months are equally likely, the selectivity of the predicate `month = 'JUL'` would be around 8%, and thus the error in estimating the selectivity of the predicate `item_desc = 'golf club'` would mistakenly cause the optimizer to perform the seemingly more selective semi-join between PRODUCT and DAILY\_SALES as the outer leg of the star join plan's index ANDing operation.

The following example provides a step-by-step illustration of how to set up statistical views to solve this type of problem.

Consider a database from a typical data warehouse, where STORE, CUSTOMER, PRODUCT, PROMOTION, and PERIOD are the dimension tables, and DAILY\_SALES is the fact table. The following tables provide the definitions for these tables.

*Table 62. STORE (63 rows)*

Column	storekey	store_number	city	state	district	...
Attribute	integer not null primary key	char(2)	char(20)	char(5)	char(14)	...

*Table 63. CUSTOMER (1 000 000 rows)*

Column	custkey	name	address	age	gender	...
Attribute	integer not null primary key	char(30)	char(40)	smallint	char(1)	...

*Table 64. PRODUCT (19 450 rows)*

Column	prodkey	category	item_desc	price	cost	...
Attribute	integer not null primary key	integer	char(30)	decimal(11)	decimal(11)	...



Table 65. PROMOTION (35 rows)

Column	promokey	promotype	promodesc	promovalue	...
Attribute	integer not null primary key	integer	char(30)	decimal(5)	...

Table 66. PERIOD (2922 rows)

Column	perkey	calendar_date	month	period	year	...
Attribute	integer not null primary key	date	char(3)	smallint	smallint	...

Table 67. DAILY\_SALES (754 069 426 rows)

Column	storekey	custkey	prodkey	promokey	perkey	sales_price	...
Attribute	integer	integer	integer	integer	integer	decimal(11)	...

Suppose the company managers want to determine whether or not consumers will buy a product again if they are offered a discount on a return visit. Moreover, suppose this study is done only for store '01', which has 18 locations nationwide. Table 68 shows information about the different categories of promotion that are available.

Table 68. PROMOTION (35 rows)

promotype	promodesc	COUNT (promotype)	percentage of total
1	Return customers	1	2.86%
2	Coupon	15	42.86%
3	Advertisement	5	14.29%
4	Manager's special	3	8.57%
5	Overstocked items	4	11.43%
6	End aisle display	7	20.00%

The table indicates that discounts for return customers represents only 2.86% of the 35 kinds of promotions that were offered.

The following query returns a count of 12 889 514:

```
select count(*)
  from store d1, promotion d2, daily_sales f
 where d1.storekey = f.storekey
       and d2.promokey = f.promokey
       and d1.store_number = '01'
       and d2.promotype = 1
```

This query executes according to the following plan that is generated by the optimizer. In each node of this diagram, the first row is the cardinality estimate, the second row is the operator type, and the third row (the number in parentheses) is the operator ID.

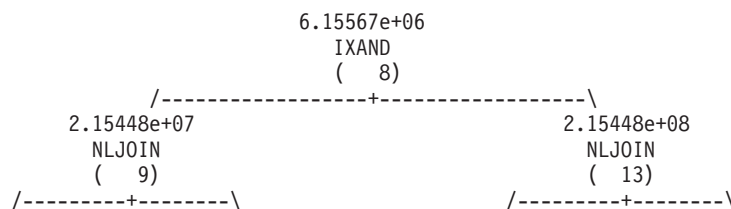

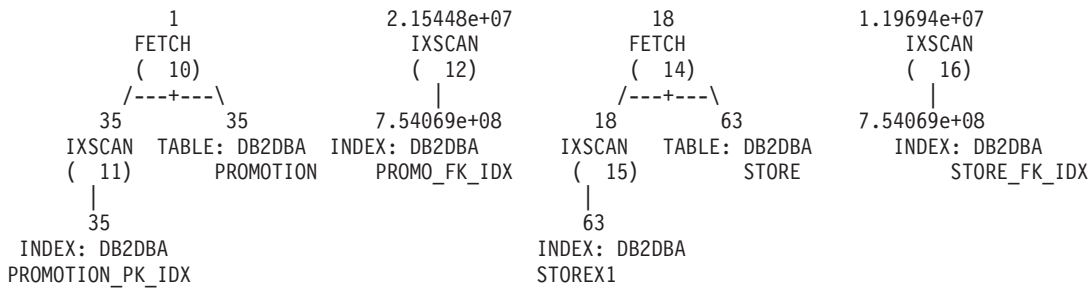

At the nested loop join (number 9), the optimizer estimates that around 2.86% of the product sold resulted from customers coming back to buy the same products at a discounted price ( $2.15448e+07 \div 7.54069e+08 \approx 0.0286$ ). Note that this is the same value before and after joining the PROMOTION table with the DAILY\_SALES table. Table 69 summarizes the cardinality estimates and their percentage (the filtering effect) before and after the join.

Table 69. Cardinality estimates before and after joining with DAILY\_SALES.

Predicate	Before Join		After Join	
	count	percentage of rows qualified	count	percentage of rows qualified
store_number = '01'	18	28.57%	2.15448e+08	28.57%
promotype = 1	1	2.86%	2.15448e+07	2.86%

Because the probability of promotype = 1 is less than that of store\_number = '01', the optimizer chooses the semi-join between PROMOTION and DAILY\_SALES as the outer leg of the star join plan's index ANDing operation. This leads to an estimated count of approximately 6 155 670 products sold using promotion type 1 — an incorrect cardinality estimate that is off by a factor of 2.09 ( $12\ 889\ 514 \div 6\ 155\ 670 \approx 2.09$ ).

What causes the optimizer to only estimate half of the actual number of records satisfying the two predicates? Store '01' represents about 28.57% of all the stores. What if other stores had more sales than store '01' (less than 28.57%)? Or what if store '01' actually sold most of the product (more than 28.57%)? Likewise, the 2.86% of products sold using promotion type 1 shown in Table 69 can be misleading. The actual percentage in DAILY\_SALES could very well be a different figure than the projected one.

We can use statistical views to help the optimizer correct its estimates. First, we need to create two statistical views representing each semi-join in the previous query. The first statistical view provides the distribution of stores for all daily sales. The second statistical view represents the distribution of promotion types for all daily sales. Note that each statistical view can provide the distribution information for any particular store number or promotion type. In this example, we use a 10% sample rate to retrieve the records in DAILY\_SALES for the respective views and save them in global temporary tables. We then query those tables to collect the necessary statistics to update the two statistical views.

1. Create a view representing the join of STORE with DAILY\_SALES.

```

create view sv_store_dailysales as
(select s.*
 from store s, daily_sales ds
 where s.storekey = ds.storekey)
  
```

2. Create a view representing the join of PROMOTION with DAILY\_SALES.

```
create view sv_promotion_dailysales as
(select p.*
 from promotion.p, daily_sales ds
 where p.promokey = ds.promokey)
```

3. Make the views statistical views by enabling them for query optimization:

```
alter view sv_store_dailysales enable query optimization
alter view sv_promotion_dailysales enable query optimization
```

4. Execute the **RUNSTATS** command to collect statistics on the views:

```
runstats on table db2dba.sv_store_dailysales with distribution
runstats on table db2dba.sv_promotion_dailysales with distribution
```

5. Run the query again so that it can be re-optimized. Upon reoptimization, the optimizer will match SV\_STORE\_DAILYSALES and SV\_PROMOTION\_DAILYSALES with the query, and will use the view statistics to adjust the cardinality estimate of the semi-joins between the fact and dimension tables, causing a reversal of the original order of the semi-joins chosen without these statistics. The new plan is as follows:

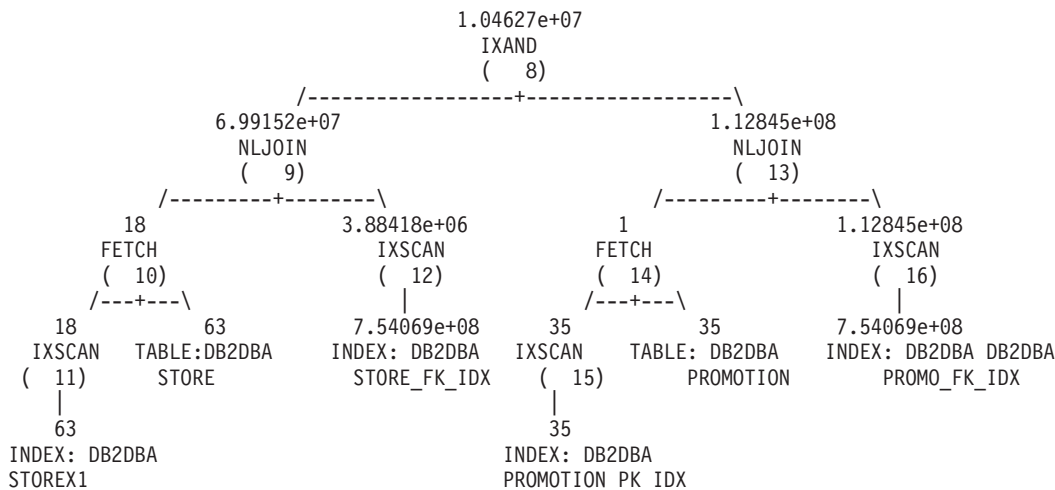

Table 70 summarizes the cardinality estimates and their percentage (the filtering effect) before and after the join for each semi-join.

Table 70. Cardinality estimates before and after joining with DAILY\_SALES.

Predicate	Before Join		After Join (no statistical views)		After Join (with statistical views)	
	count	percentage of rows qualified	count	percentage of rows qualified	count	percentage of rows qualified
store_number = '01'	18	28.57%	2.15448e+08	28.57%	6.99152e+07	9.27%
promotype = 1	1	2.86%	2.15448e+07	2.86%	1.12845e+08	14.96%

Note that this time, the semi-join between STORE and DAILY\_SALES is performed on the outer leg of the index ANDing plan. This is because the two statistical views essentially tell the optimizer that the predicate store\_number = '01' will filter more rows than promotype = 1. This time, the optimizer estimates that there are approximately 10 462 700 products sold. This estimate is off by a factor of 1.23 (12 889 514 ÷ 10 462 700 ≈ 1.23), which is a significant improvement over the estimate without statistical views (in Table 69 on page 408).

## Statistics used from expression columns in statistical views

The DB2 query optimizer can use statistics from the expression columns in statistical views to obtain accurate cardinality estimates which results in better access plans.

For example, consider a query that uses the UCASE scalar function:

```
SELECT * FROM t1, t2 WHERE t2.c2 = UCASE(t1.c1)
```

The DB2 query optimizer can use the statistics from a statistical view for these types of queries to obtain better access plans.

The earlier example query would benefit from a statistical view that includes the UCASE scalar function on column c1. For example, the following:

```
CREATE VIEW sv AS (SELECT UCASE(c1) AS c1 FROM t1)
ALTER VIEW sv ENABLE QUERY OPTIMIZATION
RUNSTATS ON TABLE dba.sv WITH DISTRIBUTION
```

To obtain statistics for these types of queries, one side of the predicate must be an expression that matches an expression in the statistical view column definition exactly.

Here are some examples where the DB2 query optimizer does not use the statistics from a statistical view:

- One side of the predicate in the query is an expression matched with more than one expression column in a statistical view:

```
create view SV14(c1, c2) as (select c1+c2, c1*c2 from t1 where c1 > 3);
alter view SV14 enable query optimization;
runstats on table schema.sv1 with distribution;
select * from t1 where (c1+c2) + (c1*c2) > 5 and c1 > 3;
```

Here the expression  $(c1+c2) + (c1*c2)$  matched to two columns in view SV14. The statistics of view SV14 for this expression are not used.

- One side of the predicate in the query is an expression partially matched with an expression column in a statistical view:

```
create view SV15(c1, c2) as (select c1+c2, c1*c2 from t1 where c1 > 3);
alter view SV15 enable query optimization;
runstats on table schema.SV15 with distribution;
select * from t1 where (c1+c2) + 10 > 5 and c1 > 3;
```

Here the expression  $(c1+c2) + 10$  is partially matched to  $c1+c2$  in view SV15. The statistics of view SV15 for this expression are not used.

- One side of the predicate in the query is indirectly matched to an expression column in a statistical view:

```
create view SV16(c1, c2) as (select c1+c2, c1*c2 from t1 where c1 > 3);
alter view SV16 enable query optimization;
runstats on table schema.SV16 with distribution;
select * from t3 left join table (select ta.c1 from t2 left join table
(select c1+c2,c3 from t1 where c1 > 3) as ta(c1,c3) on t2.c1 = ta.c3) as
tb(c1) on t3.c1= TB.C1;
```

Here the column TB.C1 indirectly matches the expression  $c1+c2$  in view SV16. The statistics of view SV16 for this expression are not used.

## Referential integrity constraints help reduce the number of statistical views

Statistical views can be used to obtain good cardinality estimates for the DB2 query optimizer, but they also require resources to maintain and process. However, by using referential integrity constraints, you can cut down on the number of statistical views used to gather statistics.

If you want to collect accurate statistics for a star join query that joins different sets of tables, you can create multiple statistical views or one statistical view by using referential integrity constraints.

For example, consider a schema which has tables D1, D2, D3, D4, D5, and F:

```
create table D1 (D1_PK int not null primary key,
                D1_C1 int,
                D1_C2 int,
                D1_C3 int,
                D1_FK int not null);
create table D2 (D2_PK int not null primary key,
                D2_C1 int,
                D2_C2 int,
                D2_C3 int,
                D2_FK int not null);
create table D3 (D3_PK int not null primary key,
                D3_C1 int,
                D3_C2 int,
                D3_C3 int,
                D3_FK int not null);
create table D4 (D4_PK int not null primary key,
                D4_C1 int,
                D4_C2 int,
                D4_C3 int,
                D4_FK int not null);
create table D5 (D5_PK int not null primary key,
                D5_C1 int,
                D5_C2 int,
                D5_C3 int,
                D5_FK int not null);
create table F (F_FK1 int not null,
                F_FK2 int not null,
                F_FK3 int not null,
                F_FK4 int not null,
                F_FK5 int not null,
                F_C1 int, F_C2 int);
```

Consider that table F is altered in the following way:

```
alter table F add foreign key (F_FK1)
  references D1 (D1_PK) on delete cascade;
alter table F add foreign key (F_FK2)
  references D2 (D2_PK) on delete cascade;
alter table F add foreign key (F_FK3)
  references D3 (D3_PK) on delete cascade;
alter table F add foreign key (F_FK4)
  references D4 (D4_PK) on delete cascade;
alter table F add foreign key (F_FK5)
  references D5 (D5_PK) on delete cascade;
```

Also, consider that you want to provide statistics for the following query:

```
select distinct * from F, D1, D2, D3 where F_FK1 = D1_PK and F_FK2
  = D2_PK and F_FK3 = D3_PK and D1_C1='ON' and D2_C2>='2009-01-01';
```

To gather accurate statistics you can create the complete set of views, as follows:

```

create view SV1 as (select D1.* from F, D1 where F_FK1 = D1_PK);
alter view SV1 enable query optimization;

create view SV2 as(select D2.* from F, D2 where F_FK2 = D2_PK);
alter view SV2 enable query optimization;

create view SV3 as(select D3.* from F, D3 where F_FK3 = D3_PK);
alter view SV3 enable query optimization;

create view SV4 as(select D1.*, D2.*, D3.* from F, D1, D2, D3 where
F_FK1 = D1_PK and F_FK2 = D2_PK and F_FK3 = D3_PK);
alter view SV4 enable query optimization;

```

You can reduce the number of statistical views created to obtain accurate statistics if referential integrity constraints exist between join columns. This reduction in the number of statistical views needed, saves you time in creating, updating, and maintaining statistical views. For this example, the following single statistical view would be sufficient to obtain the same statistics as the complete set of statistical views created earlier:

```

create view SV5 as (select D1.*, D2.*, D3.*, D4.*, D5.* from F, D1, D2, D3, D4, D5
where
    F_FK1 = D1_PK and F_FK2 = D2_PK and F_FK3 = D3_PK
    and F_FK4 = D4_PK and F_FK5 = D5_PK
);
alter view SV5 enable query optimization;

```

The statistics for SV4, SV3, SV2, and SV1 are inferred from SV5 based on referential integrity constraints. The referential integrity constraints between F, D1, D2, D3, D4, and D5 ensure that the joins among them are lossless. These lossless joins let us infer that the following cardinalities are the same:

- The cardinality of the join result between F and D1
- The cardinality of SV1
- The cardinality of the statistical view SV5

The same reasoning applies to the joins between F and D2, F and D3, and F and D4. This reasoning shows that just one statistical view SV5 is required by the DB2 optimizer to obtain improved cardinality estimates for the earlier query.

For referential integrity constraints that permit NULL values, the percentage of NULL values that are in foreign key values can affect statistics inferred from a statistical view.

If the NULL values are a significant percentage of the foreign key values, the statistics and cardinality estimates inferred by the DB2 optimizer by using the constraints can be inaccurate. Prevent these inaccuracies by preventing the referential integrity constraints from being used to infer statistics. To prevent the constraints from being used to infer statistics, disable query optimization by using the `DISABLE QUERY OPTIMIZATION` option of the `ALTER TABLE` command.

You can detect this situation by using the explain facility. The explain facility shows the proportion of NULL values in the foreign key by producing an explain diagnostic message if the number of NULL values is possibly too high and if statistics are being inferred from a statistical view.

## Statistics used from column group statistics on statistical views

In complex scenarios where statistics need to be gathered for a query, creating a statistical view or gathering column group statistics on a table is not enough. You might need to combine the two to collect column group statistics on a statistical

view. This combination of statistical view and column group statistics can help the DB2 optimizer to generate better access plans.

The use of column groups statistics on statistical views usually occurs when additional correlation exists on top of a typical situation that statistical views would normally handle.

For example, consider the following query and statistical view:

```
select * from T1,T2 where T1.C1=T2.D1 and T1.C2=5 and T2.D3=10;
create view SV2 as (select * from T1,T2 where T1.C1=T2.D1);
alter view SV2 enable query optimization;
runstats on table db2.SV2 on all columns with distribution;
```

This query might run slowly and the cardinality estimate can be inaccurate. If you check the access plan, you might find that there is a strong correlation between T1.C2 and T2.D3 although the cardinality estimate has been adjusted by the statistical view. Therefore, the cardinality estimate is inaccurate.

To resolve this situation, you can collect column group statistics of the view SV2 by issuing the following command:

```
runstats on table db2.SV2 on all columns and columns((C2,D3)) with distribution;
```

These additional statistics help improve the cardinality estimates which might result in better access plans.

**Note:** Collecting distribution statistics for a list of columns in a statistical view is not supported.

Collecting column group statistics on statistical views can also be used to compute the number of distinct groupings, or the grouping key cardinality, for queries that require data to be grouped in a certain way. A grouping requirement can result from operations such as the GROUP BY or DISTINCT operations.

For example, consider the following query and statistical view:

```
select T1.C1, T1.C2 from T1,T2 where T1.C3=T2.C3 group by T1.C1, T1.C2;
create view SV2 as (select T1.C1, T1.C2 from T1,T2 where T1.C3=T2.C3);
alter view SV2 enable query optimization;
```

Collecting column group statistics on the statistical view covering the join predicate helps the optimizer estimate the grouping key cardinality more accurately. Issue the following command to collect the column group statistics:

```
runstats on table db2.SV2 on columns((C1,C2));
```

## Catalog statistics

When the query compiler optimizes query plans, its decisions are heavily influenced by statistical information about the size of the database tables, indexes, and statistical views. This information is stored in system catalog tables.

The optimizer also uses information about the distribution of data in specific columns of tables, indexes, and statistical views if these columns are used to select rows or to join tables. The optimizer uses this information to estimate the costs of alternative access plans for each query.

Statistical information about the cluster ratio of indexes, the number of leaf pages in indexes, the number of table rows that overflow their original pages, and the

number of filled and empty pages in a table can also be collected. You can use this information to decide when to reorganize tables or indexes.

Table statistics in a partitioned database environment are collected only for that portion of the table that resides on the database partition on which the utility is running, or for the first database partition in the database partition group that contains the table. Information about statistical views is collected for all database partitions.

### Statistics that are updated by the runstats utility

Catalog statistics are collected by the runstats utility, which can be started by issuing the **RUNSTATS** command, calling the ADMIN\_CMD procedure, or calling the db2Runstats API. Updates can be initiated either manually or automatically.

In IBM Data Studio Version 3.1 or later, you can use the task assistant for collecting catalog statistics. Task assistants can guide you through the process of setting options, reviewing the automatically generated commands to perform the task, and running these commands. For more details, see *Administering databases with task assistants*.

Statistics about declared temporary tables are not stored in the system catalog, but are stored in memory structures that represent the catalog information for declared temporary tables. It is possible (and in some cases, it might be useful) to perform runstats on a declared temporary table.

The runstats utility collects the following information about tables and indexes:

- The number of pages that contain rows
- The number of pages that are in use
- The number of rows in the table (the *cardinality*)
- The number of rows that overflow
- For multidimensional clustering (MDC) and insert time clustering (ITC) tables, the number of blocks that contain data
- For partitioned tables, the degree of data clustering within a single data partition
- Data distribution statistics, which are used by the optimizer to estimate efficient access plans for tables and statistical views whose data is not evenly distributed and whose columns have a significant number of duplicate values
- Detailed index statistics, which are used by the optimizer to determine how efficient it is to access table data through an index
- Subelement statistics for LIKE predicates, especially those that search for patterns within strings (for example, LIKE %disk%), are also used by the optimizer

The runstats utility collects the following statistics for each data partition in a table. These statistics are only used for determining whether a partition needs to be reorganized:

- The number of pages that contain rows
- The number of pages that are in use
- The number of rows in the table (the *cardinality*)
- The number of rows that overflow
- For MDC and ITC tables, the number of blocks that contain data



Distribution statistics are not collected:

- When the **num\_freqvalues** and **num\_quantiles** database configuration parameters are set to 0
- When the distribution of data is known, such as when each data value is unique
- When the column contains a LONG, LOB, or structured data type
- For row types in sub-tables (the table-level statistics NPAGES, FPAGES, and OVERFLOW are not collected)
- If quantile distributions are requested, but there is only one non-null value in the column
- For extended indexes or declared temporary tables

The runstats utility collects the following information about each column in a table or statistical view, and the first column in an index key:

- The cardinality of the column
- The average length of the column (the average space, in bytes, that is required when the column is stored in database memory or in a temporary table)
- The second highest value in the column
- The second lowest value in the column
- The number of null values in the column

For columns that contain large object (LOB) or LONG data types, the runstats utility collects only the average length of the column and the number of null values in the column. The average length of the column represents the length of the data descriptor, except when LOB data is located inline on the data page. The average amount of space that is required to store the column on disk might be different than the value of this statistic.

The runstats utility collects the following information about each XML column:

- The number of NULL XML documents
- The number of non-NULL XML documents
- The number of distinct paths
- The sum of the node count for each distinct path
- The sum of the document count for each distinct path
- The  $k$  pairs of (path, node count) with the largest node count
- The  $k$  pairs of (path, document count) with the largest document count
- The  $k$  triples of (path, value, node count) with the largest node count
- The  $k$  triples of (path, value, document count) with the largest document count
- For each distinct path that leads to a text or attribute value:
  - The number of distinct values that this path can take
  - The highest value
  - The lowest value
  - The number of text or attribute nodes
  - The number of documents that contain the text or attribute nodes

Each row in an XML column stores an XML document. The node count for a path or path-value pair refers to the number of nodes that are reachable by that path or path-value pair. The document count for a path or path-value pair refers to the number of documents that contain that path or path-value pair.

For DB2 V9.7 Fix Pack 1 and later releases, the following apply to the collection of distribution statistics on an XML column:

- Distribution statistics are collected for each index over XML data specified on an XML column.
- The runstats utility must collect both distribution statistics and table statistics to collect distribution statistics for an index over XML data. Table statistics must be gathered in order for distribution statistics to be collected since XML distribution statistics are stored with table statistics.

Collecting only index statistics, or collecting index statistics during index creation, will not collect distribution statistics for an index over XML data.

As the default, the runstats utility collects a maximum of 250 quantiles for distribution statistics for each index over XML data. The maximum number of quantiles for a column can be specified when executing the runstats utility.

- Distribution statistics are collected for indexes over XML data of type VARCHAR, DOUBLE, TIMESTAMP, and DATE. XML distribution statistics are not collected for indexes over XML data of type VARCHAR HASHED.
- XML distribution statistics are collected when automatic table runstats operations are performed.
- XML distribution statistics are not created when loading data with the STATISTICS option.
- XML distribution statistics are not collected for partitioned indexes over XML data defined on a partitioned table.

The runstats utility collects the following information about column groups:

- A timestamp-based name for the column group
- The cardinality of the column group

The runstats utility collects the following information about indexes:

- The number of index entries (the *index cardinality*)
- The number of leaf pages
- The number of index levels
- The degree of clustering of the table data to the index
- The degree of clustering of the index keys with regard to data partitions
- The ratio of leaf pages located on disk in index key order to the number of pages in the range of pages occupied by the index
- The number of distinct values in the first column of the index
- The number of distinct values in the first two, three, and four columns of the index
- The number of distinct values in all columns of the index
- The number of leaf pages located on disk in index key order, with few or no large gaps between them
- The average leaf key size, without include columns
- The average leaf key size, with include columns
- The number of pages on which all record identifiers (RIDs) are marked deleted
- The number of RIDs that are marked deleted on pages where not all RIDs are marked deleted

If you request detailed index statistics, additional information about the degree of clustering of the table data to the index, and the page fetch estimates for different buffer sizes, is collected.

For a partitioned index, these statistics are representative of a single index partition, with the exception of the distinct values in the first column of the index; the first two, three, and four columns of the index; and in all columns of the index. Per-index partition statistics are also collected for the purpose of determining whether an index partition needs to be reorganized.

Statistics collection invalidates cached dynamic statements that reference tables for which statistics have been collected. This is done so that cached dynamic statements can be re-optimized with the latest statistics.

### Catalog statistics tables

Statistical information about the size of database tables, indexes, and statistical views is stored in system catalog tables.

The following tables provide a brief description of this statistical information and show where it is stored.

- The “Table” column indicates whether a particular statistic is collected if the **FOR INDEXES** or **AND INDEXES** parameter on the **RUNSTATS** command is not specified.
- The “Indexes” column indicates whether a particular statistic is collected if the **FOR INDEXES** or **AND INDEXES** parameter is specified.

Some statistics can be provided only by the table, some can be provided only by the indexes, and some can be provided by both.

- Table 1. Table Statistics (SYSCAT.TABLES and SYSSTAT.TABLES)
- Table 2. Column Statistics (SYSCAT.COLUMNS and SYSSTAT.COLUMNS)
- Table 3. Multi-column Statistics (SYSCAT.COLGROUPS and SYSSTAT.COLGROUPS)
- Table 4. Multi-column Distribution Statistics (SYSCAT.COLGROUPDIST and SYSSTAT.COLGROUPDIST)
- Table 5. Multi-column Distribution Statistics (SYSCAT.COLGROUPDISTCOUNTS and SYSSTAT.COLGROUPDISTCOUNTS)
- Table 6. Index Statistics (SYSCAT.INDEXES and SYSSTAT.INDEXES)
- Table 7. Column Distribution Statistics (SYSCAT.COLDIST and SYSSTAT.COLDIST)

The multi-column distribution statistics listed in Table 4. Multi-column Distribution Statistics (SYSCAT.COLGROUPDIST and SYSSTAT.COLGROUPDIST) and Table 5. Multi-column Distribution Statistics (SYSCAT.COLGROUPDISTCOUNTS and SYSSTAT.COLGROUPDISTCOUNTS) are not collected by the **RUNSTATS** utility. You cannot update them manually.

*Table 71. Table Statistics (SYSCAT.TABLES and SYSSTAT.TABLES)*

Statistic	Description	RUNSTATS Option	
		Table	Indexes
FPAGES	Number of pages being used by a table	Yes	Yes
NPAGES	Number of pages containing rows	Yes	Yes
OVERFLOW	Number of rows that overflow	Yes	No
CARD	Number of rows in a table (cardinality)	Yes	Yes (Note 1)

Table 71. Table Statistics (SYSCAT.TABLES and SYSSTAT.TABLES) (continued)

Statistic	Description	RUNSTATS Option	
		Table	Indexes
ACTIVE_BLOCKS	For MDC tables, the total number of occupied blocks	Yes	No
<b>Note:</b>			
1. If the table has no indexes defined and you request statistics for indexes, no CARD statistics are updated. The previous CARD statistics are retained.			

Table 72. Column Statistics (SYSCAT.COLUMNS and SYSSTAT.COLUMNS)

Statistic	Description	RUNSTATS Option	
		Table	Indexes
COLCARD	Column cardinality	Yes	Yes (Note 1)
AVGCOLLEN	Average length of a column	Yes	Yes (Note 1)
HIGH2KEY	Second highest value in a column	Yes	Yes (Note 1)
LOW2KEY	Second lowest value in a column	Yes	Yes (Note 1)
NUMNULLS	The number of null values in a column	Yes	Yes (Note 1)
SUB_COUNT	The average number of sub-elements	Yes	No (Note 2)
SUB_DELIM_LENGTH	The average length of each delimiter separating sub-elements	Yes	No (Note 2)
<b>Note:</b>			
1. Column statistics are collected for the first column in the index key.			
2. These statistics provide information about data in columns that contain a series of sub-fields or sub-elements that are delimited by blanks. The SUB_COUNT and SUB_DELIM_LENGTH statistics are collected only for columns of type CHAR and VARCHAR with a code page attribute of single-byte character set (SBCS), FOR BIT DATA, or UTF-8.			

Table 73. Multi-column Statistics (SYSCAT.COLGROUPS and SYSSTAT.COLGROUPS)

Statistic	Description	RUNSTATS Option	
		Table	Indexes
COLGROUPCARD	Cardinality of the column group	Yes	No

Table 74. Multi-column Distribution Statistics (SYSCAT.COLGROUPDIST and SYSSTAT.COLGROUPDIST)

Statistic	Description	RUNSTATS Option	
		Table	Indexes
TYPE	F = Frequency value Q = Quantile value	Yes	No

Table 74. Multi-column Distribution Statistics (SYSCAT.COLGROUPDIST and SYSSTAT.COLGROUPDIST) (continued)

Statistic	Description	RUNSTATS Option	
		Table	Indexes
ORDINAL	Ordinal number of the column in the group	Yes	No
SEQNO	Sequence number <i>n</i> that represents the <i>n</i> th TYPE value	Yes	No
COLVALUE	The data value as a character literal or a null value	Yes	No

Table 75. Multi-column Distribution Statistics (SYSCAT.COLGROUPDISTCOUNTS and SYSSTAT.COLGROUPDISTCOUNTS)

Statistic	Description	RUNSTATS Option	
		Table	Indexes
TYPE	F = Frequency value Q = Quantile value	Yes	No
SEQNO	Sequence number <i>n</i> that represents the <i>n</i> th TYPE value	Yes	No
VALCOUNT	If TYPE = F, VALCOUNT is the number of occurrences of COLVALUE for the column group with this SEQNO. If TYPE = Q, VALCOUNT is the number of rows whose value is less than or equal to COLVALUE for the column group with this SEQNO.	Yes	No
DISTCOUNT	If TYPE = Q, this column contains the number of distinct values that are less than or equal to COLVALUE for the column group with this SEQNO. Null if unavailable.	Yes	No

Table 76. Index Statistics (SYSCAT.INDEXES and SYSSTAT.INDEXES)

Statistic	Description	RUNSTATS Option	
		Table	Indexes
NLEAF	Number of index leaf pages	No	Yes

Table 76. Index Statistics (SYSCAT.INDEXES and SYSSTAT.INDEXES) (continued)

Statistic	Description	RUNSTATS Option	
		Table	Indexes
NLEVELS	Number of index levels	No	Yes
CLUSTERRATIO	Degree of clustering of table data	No	Yes (Note 2)
CLUSTERFACTOR	Finer degree of clustering	No	Detailed (Notes 1,2)
DENSITY	Ratio (percentage) of SEQUENTIAL_PAGES to number of pages in the range of pages that is occupied by the index (Note 3)	No	Yes
FIRSTKEYCARD	Number of distinct values in the first column of the index	No	Yes
FIRST2KEYCARD	Number of distinct values in the first two columns of the index	No	Yes
FIRST3KEYCARD	Number of distinct values in the first three columns of the index	No	Yes
FIRST4KEYCARD	Number of distinct values in the first four columns of the index	No	Yes
FULLKEYCARD	Number of distinct values in all columns of the index, excluding any key value in an index for which all record identifiers (RIDs) are marked deleted	No	Yes
PAGE_FETCH_PAIRS	Page fetch estimates for different buffer sizes	No	Detailed (Notes 1,2)
AVGPARTITION_CLUSTERRATIO	Degree of data clustering within a single data partition	No	Yes (Note 2)
AVGPARTITION_CLUSTERFACTOR	Finer measurement of degree of clustering within a single data partition	No	Detailed (Notes 1,2)
AVGPARTITION_PAGE_FETCH_PAIRS	Page fetch estimates for different buffer sizes, generated on the basis of a single data partition	No	Detailed (Notes 1,2)

Table 76. Index Statistics (SYSCAT.INDEXES and SYSSTAT.INDEXES) (continued)

Statistic	Description	RUNSTATS Option	
		Table	Indexes
DATAPARTITION_CLUSTERFACTOR	Number of data partition references during an index scan	No (Note 6)	Yes (Note 6)
SEQUENTIAL_PAGES	Number of leaf pages located on disk in index key order, with few, or no large gaps between them	No	Yes
AVERAGE_SEQUENCE_PAGES	Average number of index pages that are accessible in sequence; this is the number of index pages that the prefetchers can detect as being in sequence	No	Yes
AVERAGE_RANDOM_PAGES	Average number of random index pages between sequential page accesses	No	Yes
AVERAGE_SEQUENCE_GAP	Gap between sequences	No	Yes
AVERAGE_SEQUENCE_FETCH_PAGES	Average number of table pages that are accessible in sequence; this is the number of table pages that the prefetchers can detect as being in sequence when they fetch table rows using the index	No	Yes (Note 4)
AVERAGE_RANDOM_FETCH_PAGES	Average number of random table pages between sequential page accesses when fetching table rows using the index	No	Yes (Note 4)
AVERAGE_SEQUENCE_FETCH_GAP	Gap between sequences when fetching table rows using the index	No	Yes (Note 4)
NUMRIDS	The number of RIDs in the index, including deleted RIDs	No	Yes
NUMRIDS_DELETED	The total number of RIDs in the index that are marked deleted, except RIDs on those leaf pages where all RIDs are marked deleted	No	Yes

Table 76. Index Statistics (SYSCAT.INDEXES and SYSSTAT.INDEXES) (continued)

Statistic	Description	RUNSTATS Option	
		Table	Indexes
NUM_EMPTY_LEAFS	The total number of leaf pages on which all RIDs are marked deleted	No	Yes
INDCARD	Number of index entries (index cardinality)	No	Yes
<p><b>Note:</b></p> <ol style="list-style-type: none"> <li>Detailed index statistics are collected by specifying the <b>DETAILED</b> clause on the <b>RUNSTATS</b> command.</li> <li><b>CLUSTERFACTOR</b> and <b>PAGE_FETCH_PAIRS</b> are not collected with the <b>DETAILED</b> clause unless the table is of sufficient size (greater than about 25 pages). In this case, <b>CLUSTERRATIO</b> is -1 (not collected). If the table is relatively small, only <b>CLUSTERRATIO</b> is collected by the <b>RUNSTATS</b> utility; <b>CLUSTERFACTOR</b> and <b>PAGE_FETCH_PAIRS</b> are not collected. If the <b>DETAILED</b> clause is not specified, only <b>CLUSTERRATIO</b> is collected.</li> <li>This statistic measures the percentage of pages in the file containing the index that belongs to that table. For a table with only one index defined on it, <b>DENSITY</b> should be 100. <b>DENSITY</b> is used by the optimizer to estimate how many irrelevant pages from other indexes might be read, on average, if the index pages were prefetched.</li> <li>This statistic cannot be computed when the table is in a DMS table space.</li> <li>Prefetch statistics are not collected during a load or create index operation, even if statistics collection is specified when the command is invoked. Prefetch statistics are also not collected if the <b>seqdetect</b> database configuration parameter is set to <b>NO</b>.</li> <li>When <b>RUNSTATS</b> options for table is "No", statistics are not collected when table statistics are collected; when <b>RUNSTATS</b> options for indexes is "Yes", statistics are collected when the <b>RUNSTATS</b> command is used with the <b>INDEXES</b> options.</li> </ol>			

Table 77. Column Distribution Statistics (SYSCAT.COLDIST and SYSSTAT.COLDIST)

Statistic	Description	RUNSTATS Option	
		Table	Indexes
DISTCOUNT	If TYPE = Q, DISTCOUNT is the number of distinct values that are less than or equal to COLVALUE statistics	Distribution (Note 2)	No
TYPE	Indicator of whether the row provides frequent-value or quantile statistics	Distribution	No
SEQNO	Frequency ranking of a sequence number to help uniquely identify the row in the table	Distribution	No
COLVALUE	Data value for which a frequency or quantile statistic is collected	Distribution	No



Table 77. Column Distribution Statistics (SYSCAT.COLDIST and SYSTAT.COLDIST) (continued)

Statistic	Description	RUNSTATS Option	
		Table	Indexes
VALCOUNT	Frequency with which the data value occurs in a column; for quantiles, the number of values that are less than or equal to the data value (COLVALUE)	Distribution	No
<p><b>Note:</b></p> <ol style="list-style-type: none"> <li>1. Column distribution statistics are collected by specifying the <b>WITH DISTRIBUTION</b> clause on the <b>RUNSTATS</b> command. Distribution statistics cannot be collected unless there is a sufficient lack of uniformity in the column values.</li> <li>2. DISTCOUNT is collected only for columns that are the first key column in an index.</li> </ol>			

### Automatic statistics collection

The DB2 optimizer uses catalog statistics to determine the most efficient access plan for a query. Out-of-date or incomplete table or index statistics might lead the optimizer to select a suboptimal plan, which slows down query execution. However, deciding which statistics to collect for a given workload is complex, and keeping these statistics up-to-date is time-consuming.

With automatic statistics collection, part of the DB2 automated table maintenance feature, you can let the database manager determine whether statistics need to be updated. Automatic statistics collection can occur *synchronously* at statement compilation time by using the real-time statistics (RTS) feature, or the **RUNSTATS** command can be enabled to simply run in the background for *asynchronous* collection. Although background statistics collection can be enabled while real-time statistics collection is disabled, background statistics collection must be enabled for real-time statistics collection to occur. Automatic background statistics collection **auto\_runstats** and automatic real-time statistics collection **auto\_stmt\_stats** are enabled by default when you create a database.

Starting with DB2 Version 9, you can use the Configuration Advisor to determine the initial configuration for new databases including the appropriate setting for the **auto\_stmt\_stats** database configuration parameter.

In IBM Data Studio Version 3.1 or later, you can use the task assistant for configuring automatic statistics collection. Task assistants can guide you through the process of setting options, reviewing the automatically generated commands to perform the task, and running these commands. For more details, see *Administering databases with task assistants*.

### Understanding asynchronous and real-time statistics collection

When real-time statistics collection is enabled, statistics can be fabricated by using certain metadata. *Fabrication* means deriving or creating statistics, rather than collecting them as part of normal **RUNSTATS** command activity. For example, the number of rows in a table can be derived from knowing the number of pages in the table, the page size, and the average row width. In some cases, statistics are not derived, but are maintained by the index and data manager and can be stored

directly in the catalog. For example, the index manager maintains a count of the number of leaf pages and levels in each index.

The query optimizer determines how statistics are collected, based on the needs of the query and the amount of table update activity (the number of update, insert, or delete operations).

Real-time statistics collection provides more timely and more accurate statistics. Accurate statistics can result in better query execution plans and improved performance. Regardless of whether real-time statistics is enabled, asynchronous statistics collection occurs at two-hour intervals. This interval might not be frequent enough to provide accurate statistics for some applications.

Real-time statistics collection also initiates asynchronous collection requests when:

- Table activity is not high enough to require synchronous collection, but is high enough to require asynchronous collection
- Synchronous statistics collection used sampling because the table was large
- Synchronous statistics were fabricated
- Synchronous statistics collection failed because the collection time was exceeded

At most, two asynchronous requests can be processed at the same time, but only for different tables. One request must have been initiated by real-time statistics collection, and the other must have been initiated by asynchronous statistics collection checking.

The performance impact of automatic statistics collection is minimized in several ways:

- Asynchronous statistics collection is performed by using a throttled **RUNSTATS** utility. Throttling controls the amount of resource that is consumed by the **RUNSTATS** utility, based on current database activity: as database activity increases, the utility runs more slowly, reducing its resource demands.
- Synchronous statistics collection is limited to 5 seconds per query. This value can be controlled by the RTS optimization guideline. If synchronous collection exceeds the time limit, an asynchronous collection request is submitted.
- Synchronous statistics collection does not store the statistics in the system catalog. Instead, the statistics are stored in a statistics cache and are later stored in the system catalog by an asynchronous operation. This storage sequence avoids the overhead and possible lock contention involved when updating the system catalog. Statistics in the statistics cache are available for subsequent SQL compilation requests.
- Only one synchronous statistics collection operation occurs per table. Other agents requiring synchronous statistics collection fabricate statistics, if possible, and continue with statement compilation. This behavior is also enforced in a partitioned database environment, where agents on different database partitions might require synchronous statistics.
- You can customize the type of statistics that are collected by enabling statistics profiling, which uses information about previous database activity to determine which statistics are required by the database workload, or by creating your own statistics profile for a particular table.
- Only tables with missing statistics or high levels of activity (as measured by the number of update, insert, or delete operations) are considered for statistics collection. Even if a table meets the statistics collection criteria, synchronous

statistics are not collected unless query optimization requires them. In some cases, the query optimizer can choose an access plan without statistics.

- For asynchronous statistics collection checking, large tables (tables with more than 4000 pages) are sampled to determine whether high table activity changed the statistics. Statistics for such large tables are collected only if warranted.
- For asynchronous statistics collection, the **RUNSTATS** utility is automatically scheduled to run during the online maintenance window that is specified in your maintenance policy. This policy also specifies the set of tables that are within the scope of automatic statistics collection, further minimizing unnecessary resource consumption.
- Synchronous statistics collection and fabrication do not follow the online maintenance window that is specified in your maintenance policy, because synchronous requests must occur immediately and have limited collection time. Synchronous statistics collection and fabrication follow the policy that specifies the set of tables that are within the scope of automatic statistics collection.
- While automatic statistics collection is being performed, the affected tables are still available for regular database activity (update, insert, or delete operations).
- Real-time statistics (synchronous or fabricated) are not collected for nicknames. To refresh nickname statistics in the system catalog for synchronous statistics collection, call the SYSPROC.NNSTAT procedure. For asynchronous statistics collection, DB2 Database for Linux, UNIX, and Windows automatically calls the SYSPROC.NNSAT procedure to refresh the nickname statistics in the system catalog.
- Real-time statistics (synchronous or fabricated) are not collected for statistical views.
- Declared temporary tables (DGTs) can have only Real-time statistics collected.

Although real-time statistics collection is designed to minimize statistics collection overhead, try it in a test environment first to ensure that there is no negative performance impact. There might be a negative performance impact in some online transaction processing (OLTP) scenarios, especially if there is an upper boundary for how long a query can run.

Real-time synchronous statistics collection is performed for regular tables, materialized query tables (MQTs), and global temporary tables. Asynchronous statistics are not collected for global temporary tables.

Automatic statistics collection (synchronous or asynchronous) does not occur for:

- Tables that are marked VOLATILE (tables that have the VOLATILE field set in the SYSCAT.TABLES catalog view)
- Created temporary tables (CGTs)
- Tables that had their statistics manually updated, by issuing UPDATE statements directly against SYSSTAT catalog views

When you modify table statistics manually, the database manager assumes that you are now responsible for maintaining their statistics. To induce the database manager to maintain statistics for a table that had its statistics manually updated, collect statistics by using the **RUNSTATS** command or specify statistics collection when using the **LOAD** command. Tables created before Version 9.5 that had their statistics updated manually before upgrading are not affected, and their statistics are automatically maintained by the database manager until they are manually updated.

Statistics fabrication does not occur for:

- Statistical views
- Tables that had their statistics manually updated, by issuing UPDATE statements directly against SYSSTAT catalog views. If real-time statistics collection is not enabled, some statistics fabrication still occurs for tables that had their statistics manually updated.

In a partitioned database environment, statistics are collected on a single database partition and then extrapolated. The database manager always collects statistics (both synchronous and asynchronous) on the first database partition of the database partition group.

No real-time statistics collection activity will occur until at least five minutes after database activation.

Real-time statistics processing occurs for both static and dynamic SQL.

A table that was truncated, either by using the TRUNCATE statement or by using the **IMPORT** command, is automatically recognized as having out of date statistics.

Automatic statistics collection, both synchronous and asynchronous, invalidates cached dynamic statements that reference tables for which statistics were collected. This is done so that cached dynamic statements can be re-optimized with the latest statistics.

Asynchronous automatic statistics collection operations might be interrupted when the database is deactivated. If the database was not explicitly activated using the **ACTIVATE DATABASE** command or API, then the database is deactivated when the last user disconnects from the database. If operations are interrupted, then error messages might be recorded in the DB2 diagnostic log file. To avoid interrupting asynchronous automatic statistics collection operations, explicitly activate the database.

## Real-time statistics and explain processing

There is no real-time processing for a query that is only explained (not executed) by using the EXPLAIN facility. The following table summarizes the behavior under different values of the CURRENT EXPLAIN MODE special register.

*Table 78. Real-time statistics collection as a function of the value of the CURRENT EXPLAIN MODE special register*

CURRENT EXPLAIN MODE value	Real-time statistics collection considered
YES	Yes
EXPLAIN	No
NO	Yes
REOPT	Yes
RECOMMEND INDEXES	No
EVALUATE INDEXES	No

## Automatic statistics collection and the statistics cache

A statistics cache was introduced in DB2 Version 9.5 to make synchronously collected statistics available to all queries. This cache is part of the catalog cache. In a partitioned database environment, the statistics cache resides only on the catalog

database partition even though each database partition has a catalog cache. When real-time statistics collection is enabled, catalog cache requirements are higher. Consider tuning the value of the **catalogcache\_sz** database configuration parameter when real-time statistics collection is enabled.

Starting with DB2 Version 9, you can use the Configuration Advisor to determine the initial configuration for new databases. The Configuration Advisor recommends the **auto\_stmt\_stats** database configuration parameter be set to ON.

### Automatic statistics collection and statistical profiles

Synchronous and asynchronous statistics are collected according to a statistical profile that is in effect for a table, with the following exceptions:

- To minimize the overhead of synchronous statistics collection, the database manager might collect statistics by using sampling. In this case, the sampling rate and method might be different from those rates and methods that are specified in the statistical profile.
- Synchronous statistics collection might choose to fabricate statistics, but it might not be possible to fabricate all statistics that are specified in the statistical profile. For example, column statistics such as COLCARD, HIGH2KEY, and LOW2KEY cannot be fabricated unless the column is leading in some index.

If synchronous statistics collection cannot collect all statistics that are specified in the statistical profile, an asynchronous collection request is submitted.

#### Enabling automatic statistics collection:

Having accurate and complete database statistics is critical to efficient data access and optimal workload performance. Use the automatic statistics collection feature of the automated table maintenance functionality to update and maintain relevant database statistics.

#### About this task

You can enhance this functionality in environments where a single database partition operates on a single processor by collecting query data and generating statistics profiles that help the DB2 server to automatically collect the exact set of statistics that is required by your workload. This option is not available in partitioned database environments, certain federated database environments, or environments in which intrapartition parallelism is enabled.

To enable automatic statistics collection, you must first configure your database by setting the **auto\_maint** and the **auto\_tbl\_maint** database configuration parameters to ON.

#### Procedure

After setting the **auto\_maint** and the **auto\_tbl\_maint** database configuration parameters to ON, you have the following options:

- To enable background statistics collection, set the **auto\_runstats** database configuration parameter to ON.
- To enable background statistics collection for statistical views, set both the **auto\_stats\_views** and **auto\_runstats** database configuration parameters to ON.
- To enable background statistics collection to use sampling automatically for large tables and statistical views, also set the **auto\_sampling** database configuration

parameter to ON. Use this setting in addition to **auto\_runstats** (tables only) or to **auto\_runstats** and **auto\_stats\_views** (tables and statistical views).

- To enable real-time statistics collection, set both **auto\_stmt\_stats** and **auto\_runstats** database configuration parameters to ON.

### Collecting statistics using a statistics profile:

The **RUNSTATS** utility provides the option to register and use a statistics profile, which specifies the type of statistics that are to be collected for a particular table; for example, table statistics, index statistics, or distribution statistics. This feature simplifies statistics collection by enabling you to store **RUNSTATS** options for convenient future use.

To register a profile and collect statistics at the same time, issue the **RUNSTATS** command with the **SET PROFILE** parameter. To register a profile only, issue the **RUNSTATS** command with the **SET PROFILE ONLY** parameter. To collect statistics using a profile that was already registered, issue the **RUNSTATS** command with the **USE PROFILE** parameter.

To see what options are currently specified in the statistics profile for a particular table, query the SYSCAT.TABLES catalog view. For example:

```
SELECT STATISTICS_PROFILE FROM SYSCAT.TABLES WHERE TABNAME = 'EMPLOYEE'
```

### Automatic statistics profiling

Statistics profiles can also be generated automatically with the DB2 automatic statistics profiling feature. When this feature is enabled, information about database activity is collected and stored in the query feedback warehouse. A statistics profile is then generated based on this data. Enabling this feature can alleviate the uncertainty about which statistics are relevant to a particular workload.

**Important:** Automatic statistics profiling is deprecated in Version 10.1 and might be removed in a future release. For more information, see “Automatic statistics profiling is deprecated” in *What’s New for DB2 Version 10.1*.

Automatic statistics profiling can be used with automatic statistics collection, which schedules statistics maintenance operations based on information contained in the automatically generated statistics profile.

To enable automatic statistics profiling, ensure that automatic table maintenance was already enabled by setting the appropriate database configuration parameters. For more information, see “auto\_maint - Automatic maintenance configuration parameter”. The **auto\_stats\_prof** configuration parameter activates the collection of query feedback data, and the **auto\_prof\_upd** configuration parameter activates the generation of a statistics profile for use by automatic statistics collection.

Automatic statistics profile generation is not supported in partitioned database environments, in certain federated database environments, in DB2 pureScale environments, or when intra-partition parallelism is enabled. Automatic statistics profile generation cannot be enabled if the **section\_actuals** database configuration parameter is enabled (SQLCODE -5153).

Automatic statistics profiling is best suited to systems running large complex queries that have many predicates, use large joins, or specify extensive grouping. It is less suited to systems with primarily transactional workloads.

In a development environment, where the performance overhead of runtime monitoring can easily be tolerated, set the **auto\_stats\_prof** and **auto\_prof\_upd** configuration parameters to ON. When a test system uses realistic data and queries, appropriate statistics profiles can be transferred to the production system, where queries can benefit without incurring additional monitoring overhead.

In a production environment, if performance problems with a particular set of queries (problems that can be attributed to faulty statistics) are detected, you can set the **auto\_stats\_prof** configuration parameter to ON and execute the target workload for a period of time. Automatic statistics profiling analyzes the query feedback and create recommendations in the SYSTOOLS.OPT\_FEEDBACK\_RANKING tables. You can inspect these recommendations and refine the statistics profiles manually, as appropriate. To have the DB2 server automatically update the statistics profiles based on these recommendations, enable **auto\_prof\_upd** when you enable **auto\_stats\_prof**.

### **Creating the query feedback warehouse**

The query feedback warehouse, which is required for automatic statistics profiling, consists of five tables in the SYSTOOLS schema. These tables store information about the predicates that are encountered during query execution, as well as recommendations for statistics collection. The five tables are:

- OPT\_FEEDBACK\_PREDICATE
- OPT\_FEEDBACK\_PREDICATE\_COLUMN
- OPT\_FEEDBACK\_QUERY
- OPT\_FEEDBACK\_RANKING
- OPT\_FEEDBACK\_RANKING\_COLUMN

Use the SYSINSTALOBJECTS procedure to create the query feedback warehouse. For more information about this procedure, which is used to create or drop objects in the SYSTOOLS schema, see “SYSINSTALOBJECTS”.

### **Storage used by automatic statistics collection and profiling:**

The automatic statistics collection and reorganization features store working data in tables that are part of your database. These tables are created in the SYSTOOLSPACE table space.

SYSTOOLSPACE is created automatically with default options when the database is activated. Storage requirements for these tables are proportional to the number of tables in the database and can be estimated at approximately 1 KB per table. If this is a significant size for your database, you might want to drop and then recreate the table space yourself, allocating storage appropriately. Although the automatic maintenance and health monitoring tables in the table space are automatically recreated, any history that was captured in those tables is lost when you drop the table space.

### **Automatic statistics collection activity logging:**

The statistics log is a record of all of the statistics collection activities (both manual and automatic) that have occurred against a specific database.

The default name of the statistics log is `db2optstats.number.log`. It resides in the `$diagpath/events` directory. The statistics log is a rotating log. Log behavior is controlled by the `DB2_OPTSTATS_LOG` registry variable.

The statistics log can be viewed directly or it can be queried using the `SYSPROC.PD_GET_DIAG_HIST` table function. This table function returns a number of columns containing standard information about any logged event, such as the timestamp, DB2 instance name, database name, process ID, process name, and thread ID. The log also contains generic columns for use by different logging facilities. The following table describes how these generic columns are used by the statistics log.



Table 79. Generic columns in the statistics log file

Column name	Data type	Description
OBJTYPE	VARCHAR(64)	<p>The type of object to which the event applies. For statistics logging, this is the type of statistics to be collected. OBJTYPE can refer to a statistics collection background process when the process starts or stops. It can also refer to activities that are performed by automatic statistics collection, such as a sampling test, initial sampling, and table evaluation.</p> <p>Possible values for statistics collection activities are:</p> <p><b>TABLE STATS</b> Table statistics are to be collected.</p> <p><b>INDEX STATS</b> Index statistics are to be collected.</p> <p><b>TABLE AND INDEX STATS</b> Both table and index statistics are to be collected.</p> <p>Possible values for automatic statistics collection are:</p> <p><b>EVALUATION</b> The automatic statistics background collection process has begun an evaluation phase. During this phase, tables will be checked to determine if they need updated statistics, and statistics will be collected, if necessary.</p> <p><b>INITIAL SAMPLING</b> Statistics are being collected for a table using sampling. The sampled statistics are stored in the system catalog. This allows automatic statistics collection to proceed quickly for a table with no statistics. Subsequent operations will collect statistics without sampling. Initial sampling is performed during the evaluation phase of automatic statistics collection.</p> <p><b>SAMPLING TEST</b> Statistics are being collected for a table using sampling. The sampled statistics are not stored in the system catalog. The sampled statistics will be compared to the current catalog statistics to determine if and when full statistics should be collected for this table. The sampling is performed during the evaluation phase of automatic statistics collection.</p> <p><b>STATS DAEMON</b> The statistics daemon is a background process used to handle requests that are submitted by real-time statistics processing. This object type is logged when the background process starts or stops.</p>

Table 79. Generic columns in the statistics log file (continued)

Column name	Data type	Description
OBJNAME	VARCHAR(255)	The name of the object to which the event applies, if available. For statistics logging, this is the table or index name. If OBJTYPE is STATS DAEMON or EVALUATION, OBJNAME is the database name and OBJNAME_QUALIFIER is NULL.
OBJNAME_QUALIFIER	VARCHAR(255)	For statistics logging, this is the schema of the table or index.
EVENTTYPE	VARCHAR(24)	<p>The event type is the action that is associated with this event. Possible values for statistics logging are:</p> <p><b>COLLECT</b> This action is logged for a statistics collection operation.</p> <p><b>START</b> This action is logged when the real-time statistics background process (OBJTYPE = STATS DAEMON) or an automatic statistics collection evaluation phase (OBJTYPE = EVALUATION) starts.</p> <p><b>STOP</b> This action is logged when the real-time statistics background process (OBJTYPE = STATS DAEMON) or an automatic statistics collection evaluation phase (OBJTYPE = EVALUATION) stops.</p> <p><b>ACCESS</b> This action is logged when an attempt has been made to access a table for statistics collection purposes. This event type is used to log an unsuccessful access attempt when the object is unavailable.</p> <p><b>WRITE</b> This action is logged when previously collected statistics that are stored in the statistics cache are written to the system catalog.</p>
FIRST_EVENTQUALIFIERTYPE	VARCHAR(64)	The type of the first event qualifier. Event qualifiers are used to describe what was affected by the event. For statistics logging, the first event qualifier is the timestamp for when the event occurred. For the first event qualifier type, the value is AT.
FIRST_EVENTQUALIFIER	CLOB(16k)	The first qualifier for the event. For statistics logging, the first event qualifier is the timestamp for when the statistics event occurred. The timestamp of the statistics event might be different than the timestamp of the log record, as represented by the TIMESTAMP column.
SECOND_EVENTQUALIFIERTYPE	VARCHAR(64)	The type of the second event qualifier. For statistics logging, the value can be BY or NULL. This field is not used for other event types.

Table 79. Generic columns in the statistics log file (continued)

Column name	Data type	Description
SECOND_EVENTQUALIFIER	CLOB(16k)	<p>The second qualifier for the event. For statistics logging, this represents how statistics were collected for COLLECT event types. Possible values are:</p> <p><b>User</b> Statistics collection was performed by a DB2 user invoking the <b>LOAD</b>, <b>REDISTRIBUTE</b>, or <b>RUNSTATS</b> command, or issuing the CREATE INDEX statement.</p> <p><b>Synchronous</b> Statistics collection was performed at SQL statement compilation time by the DB2 server. The statistics are stored in the statistics cache but not the system catalog.</p> <p><b>Synchronous sampled</b> Statistics collection was performed using sampling at SQL statement compilation time by the DB2 server. The statistics are stored in the statistics cache but not the system catalog.</p> <p><b>Fabricate</b> Statistics were fabricated at SQL statement compilation time using information that is maintained by the data and index manager. The statistics are stored in the statistics cache but not the system catalog.</p> <p><b>Fabricate partial</b> Only some statistics were fabricated at SQL statement compilation time using information that is maintained by the data and index manager. In particular, only the HIGH2KEY and LOW2KEY values for certain columns were fabricated. The statistics are stored in the statistics cache but not the system catalog.</p> <p><b>Asynchronous</b> Statistics were collected by a DB2 background process and are stored in the system catalog.</p> <p>This field is not used for other event types.</p>
THIRD_EVENTQUALIFIERTYPE	VARCHAR(64)	<p>The type of the third event qualifier. For statistics logging, the value can be DUE TO or NULL.</p>

Table 79. Generic columns in the statistics log file (continued)

Column name	Data type	Description
THIRD_EVENTQUALIFIER	CLOB(16k)	<p>The third qualifier for the event. For statistics logging, this represents the reason why a statistics activity could not be completed. Possible values are:</p> <p><b>Timeout</b> Synchronous statistics collection exceeded the time budget.</p> <p><b>Error</b> The statistics activity failed due to an error.</p> <p><b>RUNSTATS error</b> Synchronous statistics collection failed due to a <b>RUNSTATS</b> error. For some errors, SQL statement compilation might have completed successfully, even though statistics could not be collected. For example, if there was insufficient memory to collect statistics, SQL statement compilation will continue.</p> <p><b>Object unavailable</b> Statistics could not be collected for the database object because it could not be accessed. Some possible reasons include:</p> <ul style="list-style-type: none"> <li>• The object is locked in super exclusive (Z) mode</li> <li>• The table space in which the object resides is unavailable</li> <li>• The table indexes need to be recreated</li> </ul> <p><b>Conflict</b> Synchronous statistics collection was not performed because another application was already collecting synchronous statistics.</p> <p>Check the FULLREC column or the <b>db2diag</b> log files for the error details.</p>
EVENTSTATE	VARCHAR(255)	<p>State of the object or action as a result of the event. For statistics logging, this indicates the state of the statistics operation. Possible values are:</p> <ul style="list-style-type: none"> <li>• Start</li> <li>• Success</li> <li>• Failure</li> </ul>

### Example

In this example, the query returns statistics log records for events up to one year prior to the current timestamp by invoking PD\_GET\_DIAG\_HIST.

```
select pid, tid,
       substr(eventtype, 1, 10),
       substr(objtype, 1, 30) as objtype,
       substr(objname_qualifier, 1, 20) as objschema,
       substr(objname, 1, 10) as objname,
       substr(first_eventqualifier, 1, 26) as event1,
       substr(second_eventqualifiertype, 1, 2) as event2_type,
       substr(second_eventqualifier, 1, 20) as event2,
       substr(third_eventqualifiertype, 1, 6) as event3_type,
       substr(third_eventqualifier, 1, 15) as event3,
```

```

substr(eventstate, 1, 20) as eventstate
from table(sysproc.pd_get_diag_hist
('optstats', 'EX', 'NONE',
current_timestamp - 1 year, cast(null as timestamp))) as s1
order by timestamp(varchar(substr(first_eventqualifier, 1, 26), 26));

```

The results are ordered by the timestamp stored in the FIRST\_EVENTQUALIFIER column, which represents the time of the statistics event.

PID	TID	EVENTTYPE	OBJTYPE	OBJSHEMA	OBJNAME	EVENT1	EVENT2_	EVENT2	EVENT3_	EVENT3	EVENTSTATE
						TYPE		TYPE			
28399	1082145120	START	STATS DAEMON	-	PROD_DB	2007-07-09-18.37.40.398905	-	-	-	-	success
28389	183182027104	COLLECT	TABLE AND INDEX STATS	DB2USER	DISTRICT	2007-07-09-18.37.43.261222	BY	Synchronous	-	-	start
28389	183182027104	COLLECT	TABLE AND INDEX STATS	DB2USER	DISTRICT	2007-07-09-18.37.43.407447	BY	Synchronous	-	-	success
28399	1082145120	COLLECT	TABLE AND INDEX STATS	DB2USER	CUSTOMER	2007-07-09-18.37.43.471614	BY	Asynchronous	-	-	start
28399	1082145120	COLLECT	TABLE AND INDEX STATS	DB2USER	CUSTOMER	2007-07-09-18.37.43.524496	BY	Asynchronous	-	-	success
28399	1082145120	STOP	STATS DAEMON	-	PROD_DB	2007-07-09-18.37.43.526212	-	-	-	-	success
28389	183278496096	COLLECT	TABLE STATS	DB2USER	ORDER_LINE	2007-07-09-18.37.48.676524	BY	Synchronous sampled	-	-	start
28389	183278496096	COLLECT	TABLE STATS	DB2USER	ORDER_LINE	2007-07-09-18.37.53.677546	BY	Synchronous sampled	DUE TO	Timeout	failure
28389	1772561034	START	EVALUATION	-	PROD_DB	2007-07-10-12.36.11.092739	-	-	-	-	success
28389	8231991291	COLLECT	TABLE AND INDEX STATS	DB2USER	DISTRICT	2007-07-10-12.36.30.737603	BY	Asynchronous	-	-	start
28389	8231991291	COLLECT	TABLE AND INDEX STATS	DB2USER	DISTRICT	2007-07-10-12.36.34.029756	BY	Asynchronous	-	-	success
28389	1772561034	STOP	EVALUATION	-	PROD_DB	2007-07-10-12.36.39.685188	-	-	-	-	success
28399	1504428165	START	STATS DAEMON	-	PROD_DB	2007-07-10-12.37.43.319291	-	-	-	-	success
28399	1504428165	COLLECT	TABLE AND INDEX STATS	DB2USER	CUSTOMER	2007-07-10-12.37.43.471614	BY	Asynchronous	-	-	start
28399	1504428165	COLLECT	TABLE AND INDEX STATS	DB2USER	CUSTOMER	2007-07-10-12.37.44.524496	BY	Asynchronous	-	-	failure
28399	1504428165	STOP	STATS DAEMON	-	PROD_DB	2007-07-10-12.37.45.905975	-	-	-	-	success
28399	4769515044	START	STATS DAEMON	-	PROD_DB	2007-07-10-12.48.33.319291	-	-	-	-	success
28389	4769515044	WRITE	TABLE AND INDEX STATS	DB2USER	CUSTOMER	2007-07-10-12.48.33.969888	BY	Asynchronous	-	-	start
28389	4769515044	WRITE	TABLE AND INDEX STATS	DB2USER	CUSTOMER	2007-07-10-12.48.34.215230	BY	Asynchronous	-	-	success

### Improving query performance for large statistics logs:

If the statistics log files are large, you can improve query performance by copying the log records into a table, creating indexes, and then gathering statistics.

#### Procedure

1. Create a table with appropriate columns for the log records.

```

create table db2user.stats_log (
  pid          bigint,
  tid          bigint,
  timestamp    timestamp,
  dbname       varchar(128),
  retcode      integer,
  eventtype    varchar(24),
  objtype      varchar(30),
  objschema    varchar(20),
  objname      varchar(30),
  event1_type  varchar(20),
  event1       timestamp,
  event2_type  varchar(20),
  event2       varchar(40),
  event3_type  varchar(20),
  event3       varchar(40),
  eventstate   varchar(20))

```

2. Declare a cursor for a query against SYSPROC.PD\_GET\_DIAG\_HIST.

```

declare c1 cursor for
select pid, tid, timestamp, dbname, retcode, eventtype,
substr(objtype, 1, 30) as objtype,
substr(objname_qualifier, 1, 20) as objschema,
substr(objname, 1, 30) as objname,
substr(first_eventqualifiertype, 1, 20),
substr(first_eventqualifier, 1, 26),
substr(second_eventqualifiertype, 1, 20),
substr(second_eventqualifier, 1, 40),
substr(third_eventqualifiertype, 1, 20),
substr(third_eventqualifier, 1, 40),
substr(eventstate, 1, 20)
from table (sysproc.pd_get_diag_hist
('optstats', 'EX', 'NONE',
current_timestamp - 1 year, cast(null as timestamp ))) as s1

```

3. Load the statistics log records into the table.

```
load from c1 of cursor replace into db2user.stats_log
```

4. Create indexes and then gather statistics on the table.

```
create index sl_ix1 on db2user.stats_log(eventtype, event1);  
create index sl_ix2 on db2user.stats_log(objtype, event1);  
create index sl_ix3 on db2user.stats_log(objname);
```

```
runstats on table db2user.stats_log  
with distribution and sampled detailed indexes all;
```

## Guidelines for collecting and updating statistics

The **RUNSTATS** utility collects statistics on tables, indexes, and statistical views to provide the optimizer with accurate information for access plan selection.

Use the **RUNSTATS** utility to collect statistics in the following situations:

- After data is loaded into a table and appropriate indexes are created
- After creating an index on a table
- After a table is reorganized with the **REORG** utility
- After a table and its indexes are significantly modified through update, insert, or delete operations
- Before binding application programs whose performance is critical
- When you want to compare current and previous statistics
- When the prefetch value has changed
- After executing the **REDISTRIBUTE DATABASE PARTITION GROUP** command
- When you have XML columns. When **RUNSTATS** is used to collect statistics for XML columns only, existing statistics for non-XML columns that were collected during a load operation or a previous **RUNSTATS** operation are retained. If statistics on some XML columns were collected previously, those statistics are either replaced or dropped if the current **RUNSTATS** operation does not include those columns.

To improve **RUNSTATS** performance and save disk space used to store statistics, consider specifying only those columns for which data distribution statistics should be collected.

You should rebind application programs after executing **RUNSTATS**. The query optimizer might choose different access plans if new statistics are available.

If a full set of statistics cannot be collected at one time, use the **RUNSTATS** utility on subsets of the objects. If inconsistencies occur as a result of ongoing activity against those objects, a warning message (SQL0437W, reason code 6) is returned during query optimization. If this occurs, use **RUNSTATS** again to update the distribution statistics.

To ensure that index statistics are synchronized with the corresponding table, collect both table and index statistics at the same time. If a table was modified extensively since the last time that statistics were gathered, updating only the index statistics for that table leaves the two sets of statistics out of synchronization with each other.

Using the **RUNSTATS** utility on a production system might negatively affect workload performance. The utility now supports a throttling option that can be used to limit the performance impact of **RUNSTATS** execution during high levels of database activity.

When you collect statistics for a table in a partitioned database environment, **RUNSTATS** operates only on the database partition from which the utility is executed. The results from this database partition are extrapolated to the other database partitions. If this database partition does not contain a required portion of the table, the request is sent to the first database partition in the database partition group that contains the required data.

Statistics for a statistical view are collected on all database partitions containing base tables that are referenced by the view.

Consider the following tips to improve the efficiency of **RUNSTATS** and the usefulness of the statistics:

- Collect statistics only for columns that are used to join tables or for columns that are referenced in the **WHERE**, **GROUP BY**, or similar clauses of queries. If the columns are indexed, you can specify these columns with the **ONLY ON KEY COLUMNS** clause on the **RUNSTATS** command.
- Customize the values of the **num\_freqvalues** and **num\_quantiles** database configuration parameters for specific tables and columns.
- When you create an index for a populated table, use the **COLLECT STATISTICS** clause to create statistics as the index is created.
- When significant numbers of table rows are added or removed, or if data in columns for which you collect statistics is updated, use **RUNSTATS** again to update the statistics.
- Because **RUNSTATS** collects statistics on only a single database partition, the statistics are less accurate if the data is not distributed consistently across all database partitions. If you suspect that there is skewed data distribution, consider redistributing the data across database partitions by using the **REDISTRIBUTE DATABASE PARTITION GROUP** command before using the **RUNSTATS** utility.
- For DB2 V9.7 Fix Pack 1 and later releases, distribution statistics can be collected on an XML column. Distribution statistics are collected for each index over XML data specified on the XML column. By default, a maximum of 250 quantiles are used for distribution statistics for each index over XML data.

When collecting distribution statistics on an XML column, you can change maximum number of quantiles. You can lower the maximum number of quantiles to reduce the space requirements for XML distribution statistics based on your particular data size, or you can increase the maximum number of quantiles if 250 quantiles are not sufficient to capture the distribution statistics of the data set for an index over XML data.

### Collecting catalog statistics:

Use the **RUNSTATS** utility to collect catalog statistics on tables, indexes, and statistical views. The query optimizer uses this information to choose the best access plans for queries.

### About this task

For privileges and authorities that are required to use this utility, see the description of the **RUNSTATS** command.

### Procedure

To collect catalog statistics:

1. Connect to the database that contains the tables, indexes, or statistical views for which you want to collect statistical information.
2. Collect statistics for queries that run against the tables, indexes, or statistical views by using one of the following methods:
  - From the DB2 command line, execute the **RUNSTATS** command with appropriate options. These options enable you to tailor the statistics that are collected for queries that run against the tables, indexes, or statistical views.
  - From IBM Data Studio, open the task assistant for the **RUNSTATS** command.
3. When the runstats operation completes, issue a COMMIT statement to release locks.
4. Rebind any packages that access the tables, indexes, or statistical views for which you have updated statistical information.

## Results

### Note:

1. The **RUNSTATS** command does not support the use of nicknames. If queries access a federated database, use **RUNSTATS** to update statistics for tables in all databases, then drop and recreate the nicknames that access remote tables to make the new statistics available to the optimizer.
2. When you collect statistics for a table in a partitioned database environment, **RUNSTATS** only operates on the database partition from which the utility is executed. The results from this database partition are extrapolated to the other database partitions. If this database partition does not contain a required portion of the table, the request is sent to the first database partition in the database partition group that contains the required data.

Statistics for a statistical view are collected on all database partitions containing base tables that are referenced by the view.
3. For DB2 V9.7 Fix Pack 1 and later releases, the following apply to the collection of distribution statistics on a column of type XML:
  - Distribution statistics are collected for each index over XML data specified on an XML column.
  - The **RUNSTATS** command must collect both distribution statistics and table statistics to collect distribution statistics for an index over XML data.
  - As the default, the **RUNSTATS** command collects a maximum of 250 quantiles for distribution statistics for each index over XML data. The maximum number of quantiles for a column can be specified when executing the **RUNSTATS** command.
  - Distribution statistics are collected on indexes over XML data of type VARCHAR, DOUBLE, TIMESTAMP, and DATE. XML distribution statistics are not collected on indexes over XML data of type VARCHAR HASHED.
  - Distribution statistics are not collected on partitioned indexes over XML data defined on a partitioned table.

### Related information:

#### Collecting statistics on a sample of the data:

Table statistics are used by the query optimizer to select the best access plan for a query, so it is important that statistics remain current. With the ever-increasing size of databases, efficient statistics collection becomes more challenging.



An effective approach is to collect statistics on a random sample of table and index data. For I/O-bound or processor-bound systems, the performance benefits can be enormous.

The DB2 product enables you to efficiently sample data for statistics collection, potentially improving the performance of the **RUNSTATS** utility by orders of magnitude, while maintaining a high degree of accuracy.

Two methods of sampling are available: row-level sampling and page-level sampling. For a description of these sampling methods, see “Data sampling in queries”.

Performance of page-level sampling is excellent, because only one I/O operation is required for each selected page. With row-level sampling, I/O costs are not reduced, because every table page is retrieved in a full table or index scan. However, row-level sampling provides significant performance improvements, even if the amount of I/O is not reduced, because collecting statistics is processor-intensive.

Row-level table sampling provides a better sample than page-level table sampling in situations where the data values are highly clustered. Compared to page-level table sampling, the row-level table sample set will likely be a better reflection of the data, because it will include *P* percent of the rows from each data page. With page-level table sampling, all the rows of *P* percent of the pages will be in the sample set. If the rows are distributed randomly over the table, the accuracy of row-sampled statistics will be similar to the accuracy of page-sampled statistics.

Each table sample is randomly generated across repeated invocations of the **RUNSTATS** command, unless the **REPEATABLE** parameter is used, in which case the previous table sample is regenerated. This option can be useful in cases where consistent statistics are required for tables whose data remains constant.

**REPEATABLE** does not apply to the index sampling (**INDEXSAMPLE**) - there is no similar functionality.

In IBM Data Studio Version 3.1 or later, you can use the task assistant for collecting statistics. Task assistants can guide you through the process of setting options, reviewing the automatically generated commands to perform the task, and running these commands. For more details, see Administering databases with task assistants.

#### **Sub-element statistics:**

If you specify LIKE predicates using the % wildcard character in any position other than at the end of the pattern, you should collect basic information about the sub-element structure.

As well as the wildcard LIKE predicate (for example, `SELECT...FROM DOCUMENTS WHERE KEYWORDS LIKE '%simulation%'`), the columns and the query must fit certain criteria to benefit from sub-element statistics.

Table columns should contain sub-fields or sub-elements separated by blanks. For example, a four-row table `DOCUMENTS` contains a `KEYWORDS` column with lists of relevant keywords for text retrieval purposes. The values in `KEYWORDS` are:

```
'database simulation analytical business intelligence'  
'simulation model fruit fly reproduction temperature'  
'forestry spruce soil erosion rainfall'  
'forest temperature soil precipitation fire'
```

In this example, each column value consists of five sub-elements, each of which is a word (the keyword), separated from the others by one blank.

The query should reference these columns in WHERE clauses.

The optimizer always estimates how many rows match each predicate. For these wildcard LIKE predicates, the optimizer assumes that the column being matched contains a series of elements concatenated together, and it estimates the length of each element based on the length of the string, excluding leading and trailing % characters. If you collect sub-element statistics, the optimizer will have information about the length of each sub-element and the delimiter. It can use this additional information to more accurately estimate how many rows will match the predicate.

To collect sub-element statistics, execute the **RUNSTATS** command with the **LIKE STATISTICS** parameter.

*Runstats statistics about sub-elements:*

The **RUNSTATS** utility collects statistics for columns of type CHAR and VARCHAR with a code page attribute of single-byte character set (SBCS), FOR BIT DATA, or UTF-8 when you specify the **LIKE STATISTICS** clause.

#### **SUB\_COUNT**

The average number of sub-elements.

#### **SUB\_DELIM\_LENGTH**

The average length of each delimiter separating the sub-elements. A delimiter, in this context, is one or more consecutive blank characters.

To examine the values of the sub-element statistics, query the SYSCAT.COLUMNS catalog view. For example:

```
select substr(colname, 1, 16), sub_count, sub_delim_length  
from syscat.columns where tabname = 'DOCUMENTS'
```

The **RUNSTATS** utility might take longer to complete if you use the **LIKE STATISTICS** clause. If you are considering this option, assess the improvements in query performance against this additional overhead.

#### **General rules for updating catalog statistics manually:**

When you update catalog statistics, the most important general rule is to ensure that valid values, ranges, and formats of the various statistics are stored in the views for those statistics.

It is also important to preserve the consistency of relationships among various statistics. For example, COLCARD in SYSSTAT.COLUMNS must be less than CARD in SYSSTAT.TABLES (the number of distinct values in a column cannot be greater than the number of rows in a table). Suppose that you want to reduce COLCARD from 100 to 25, and CARD from 200 to 50. If you update SYSSTAT.TABLES first, an error is returned, because CARD would be less than COLCARD.

In some cases, however, a conflict is difficult to detect, and an error might not be returned, especially if the impacted statistics are stored in different catalog tables.

Before updating catalog statistics, ensure (at a minimum) that:

- Numeric statistics are either -1 or greater than or equal to zero.
- Numeric statistics representing percentages (for example, CLUSTERRATIO in SYSSTAT.INDEXES) are between 0 and 100.

When a table is created, catalog statistics are set to -1 to indicate that the table has no statistics. Until statistics are collected, the DB2 server uses default values for SQL or XQuery statement compilation and optimization. Updating the table or index statistics might fail if the new values are inconsistent with the default values. Therefore, it is recommended that you use the runstats utility after creating a table, and before attempting to update statistics for the table or its indexes.

**Note:**

1. For row types, the table-level statistics NPAGES, FPAGES, and OVERFLOW are not updatable for a subtable.
2. Partition-level table and index statistics are not updatable.

*Rules for updating column statistics manually:*

There are certain guidelines that you should follow when updating statistics in the SYSSTAT.COLUMNS catalog view.

- When manually updating HIGH2KEY or LOW2KEY values, ensure that:
  - The values are valid for the data type of the corresponding user column.
  - The length of the values must be the smaller of 33 or the maximum length of the target column data type, not including additional quotation marks, which can increase the length of the string to 68. This means that only the first 33 characters of the value in the corresponding user column will be considered in determining the HIGH2KEY or LOW2KEY values.
  - The values are stored in such a way that they can be used with the SET clause of an UPDATE statement, as well as for cost calculations. For character strings, this means that single quotation marks are added to the beginning and at the end of the string, and an extra quotation mark is added for every quotation mark that is already in the string. Examples of user column values and their corresponding values in HIGH2KEY or LOW2KEY are provided in Table 80.

*Table 80. HIGH2KEY and LOW2KEY values by data type*

Data type in user column	User data	Corresponding HIGH2KEY or LOW2KEY value
INTEGER	-12	-12
CHAR	abc	'abc'
CHAR	ab'c	'ab"c'

- HIGH2KEY is greater than LOW2KEY whenever there are more than three distinct values in the corresponding column.
- The cardinality of a column (COLCARD in SYSSTAT.COLUMNS) cannot be greater than the cardinality of its corresponding table or statistical view (CARD in SYSSTAT.TABLES).

- The number of null values in a column (NUMNULLS in SYSSTAT.COLUMNS) cannot be greater than the cardinality of its corresponding table or statistical view (CARD in SYSSTAT.TABLES).
- Statistics are not supported for columns that are defined with LONG or large object (LOB) data types.

*Rules for updating table and nickname statistics manually:*

There are certain guidelines that you should follow when updating statistics in the SYSSTAT.TABLES catalog view.

- The only statistical values that you can update in SYSSTAT.TABLES are CARD, FPAGES, NPAGES, AVGCOMPRESSEDROWSIZE, AVGGROWCOMPRESSIONRATIO, PCTROWSCOMPRESSED, OVERFLOW and, for multidimensional clustering (MDC) tables, ACTIVE\_BLOCKS.
- The value of the CARD statistic must meet the following criteria:
  - It must be greater than or equal to all COLCARD statistic values for the corresponding table in SYSSTAT.COLUMNS.
  - It must be greater than the value of the NPAGES statistic.
  - It must not be less than or equal to any “fetch” value in the PAGE\_FETCH\_PAIRS column of any index (assuming that the CARD statistic is relevant to the index).
- The value of the FPAGES statistic must be greater than the value of the NPAGES statistic.
- The value of the NPAGES statistic must be less than or equal to any “fetch” value in the PAGE\_FETCH\_PAIRS column of any index (assuming that the NPAGES statistic is relevant to the index).
- Valid values for the AVGCOMPRESSEDROWSIZE statistic are -1 or between 0 and the value of the AVGGROWSIZE statistic.
- Valid values for the AVGGROWCOMPRESSIONRATIO statistic are -1 or greater than 1.
- Valid values for the PCTROWSCOMPRESSED statistic are -1 or 0 - 100, inclusive.

In a federated database system, use caution when manually updating statistics for a nickname over a remote view. Statistical information, such as the number of rows that a nickname returns, might not reflect the real cost of evaluating this remote view and therefore might mislead the DB2 optimizer. In certain cases, however, remote views can benefit from statistics updates; these include remote views that you define on a single base table with no column functions applied to the SELECT list. Complex views might require a complex tuning process in which you tune each query. Consider creating local views over nicknames so that the DB2 optimizer knows how to derive the cost of those views more accurately.

### Detailed index statistics

A **RUNSTATS** operation for indexes with the **DETAILED** parameter collects statistical information that allows the optimizer to estimate how many data page fetches are required, depending on the buffer pool size. This additional information helps the optimizer to better estimate the cost of accessing a table through an index.

Detailed statistics provide concise information about the number of physical I/Os that are required to access the data pages of a table if a complete index scan is performed under different buffer pool sizes. As the **RUNSTATS** utility scans the pages of an index, it models the different buffer sizes, and estimates how often a page

fault occurs. For example, if only one buffer page is available, each new page that is referenced by the index results in a page fault. In the worst case, each row might reference a different page, resulting in at most the same number of I/Os as the number of rows in the indexed table. At the other extreme, when the buffer is big enough to hold the entire table (subject to the maximum buffer size), all table pages are read at once. As a result, the number of physical I/Os is a monotonic, nonincreasing function of the buffer size.

The statistical information also provides finer estimates of the degree of clustering of the table rows to the index order. The less clustering, the more I/Os are required to access table rows through the index. The optimizer considers both the buffer size and the degree of clustering when it estimates the cost of accessing a table through an index.

Collect detailed index statistics when:

- Queries reference columns that are not included in the index
- The table has multiple non-clustered indexes with varying degrees of clustering
- The degree of clustering among the key values is nonuniform
- Index values are updated in a nonuniform manner

It is difficult to identify these conditions without previous knowledge or without forcing an index scan under varying buffer sizes and then monitoring the resulting physical I/Os. Perhaps the least expensive way to determine whether any of these conditions exist is to collect and examine the detailed statistics for an index, and to retain them if the resulting `PAGE_FETCH_PAIRS` are nonlinear.

When you collect detailed index statistics, the **RUNSTATS** operation takes longer to complete and requires more memory and processing time. The **DETAILED** option (equivalent to the **SAMPLED DETAILED** parameter), for example, requires 2 MB of the statistics heap. Allocate an additional 488 4-KB pages to the `stat_heap_sz` database configuration parameter setting for this memory requirement. If the heap is too small, the **RUNSTATS** utility returns an error before it attempts to collect statistics.

`CLUSTERFACTOR` and `PAGE_FETCH_PAIRS` are not collected unless the table is of sufficient size (greater than about 25 pages). In this case, `CLUSTERFACTOR` will be a value between 0 and 1, and `CLUSTERRATIO` is -1 (not collected). If the table is relatively small, only `CLUSTERRATIO`, with a value between 0 and 100, is collected by the **RUNSTATS** utility; `CLUSTERFACTOR` and `PAGE_FETCH_PAIRS` are not collected. If the **DETAILED** clause is not specified, only `CLUSTERRATIO` is collected.

### Collecting index statistics:

Collect index statistics to help the optimizer decide whether a specific index should be used to resolve a query.

### About this task

The following example is based on a database named `SALES` that contains a `CUSTOMERS` table with indexes `CUSTIDX1` and `CUSTIDX2`.

For privileges and authorities that are required to use the **RUNSTATS** utility, see the description of the **RUNSTATS** command.

## Procedure

To collect detailed statistics for an index:

1. Connect to the SALES database.
2. Execute one of the following commands from the DB2 command line, depending on your requirements:
  - To collect detailed statistics on both CUSTIDX1 and CUSTIDX2:  
`runstats on table sales.customers and detailed indexes all`
  - To collect detailed statistics on both indexes, but with sampling instead of detailed calculations on each index entry:  
`runstats on table sales.customers and sampled detailed indexes all`

The **SAMPLED DETAILED** parameter requires 2 MB of the statistics heap. Allocate an additional 488 4-KB pages to the **stat\_heap\_sz** database configuration parameter setting for this memory requirement. If the heap is too small, the **RUNSTATS** utility returns an error before it attempts to collect statistics.

- To collect detailed statistics on sampled indexes, as well as distribution statistics for the table so that index and table statistics are consistent:  
`runstats on table sales.customers  
with distribution on key columns  
and sampled detailed indexes all`

## Rules for updating index statistics manually:

There are certain guidelines that you should follow when updating statistics in the SYSSTAT.INDEXES catalog view.

- The following rules apply to PAGE\_FETCH\_PAIRS:
  - Individual values in the PAGE\_FETCH\_PAIRS statistic must not be longer than 10 digits and must be less than the maximum integer value (2 147 483 647).
  - Individual values in the PAGE\_FETCH\_PAIRS statistic must be separated by a blank character delimiter.
  - There must always be a valid PAGE\_FETCH\_PAIRS statistic if CLUSTERFACTOR is greater than zero.
  - There must be exactly 11 pairs in a single PAGE\_FETCH\_PAIRS statistic.
  - Buffer size values in a PAGE\_FETCH\_PAIRS statistic (the first value in each pair) must appear in ascending order.
  - Any buffer size value in a PAGE\_FETCH\_PAIRS statistic cannot be greater than MIN(NPAGES, 524 287) for a 32-bit operating system, or MIN(NPAGES, 2 147 483 647) for a 64-bit operating system, where NPAGES (stored in SYSSTAT.TABLES) is the number of pages in the corresponding table.
  - Page fetch values in a PAGE\_FETCH\_PAIRS statistic (the second value in each pair) must appear in descending order, with no individual value being less than NPAGES or greater than CARD for the corresponding table.
  - If the buffer size value in two consecutive pairs is identical, the page fetch value in both of the pairs must also be identical.

An example of a valid PAGE\_FETCH\_PAIRS statistic is:

```
PAGE_FETCH_PAIRS =  
'100 380 120 360 140 340 160 330 180 320 200 310 220 305 240 300  
260 300 280 300 300 300'
```

where

```
NPAGES = 300
CARD = 10000
CLUSTERRATIO = -1
CLUSTERFACTOR = 0.9
```

- The following rules apply to CLUSTERRATIO and CLUSTERFACTOR:
  - Valid values for CLUSTERRATIO are -1 or between 0 and 100.
  - Valid values for CLUSTERFACTOR are -1 or between 0 and 1.
  - At least one of the CLUSTERRATIO and CLUSTERFACTOR values must be -1 at all times.
  - If CLUSTERFACTOR is a positive value, it must be accompanied by a valid PAGE\_FETCH\_PAIRS value.
- For relational indexes, the following rules apply to FIRSTKEYCARD, FIRST2KEYCARD, FIRST3KEYCARD, FIRST4KEYCARD, FULLKEYCARD, and INDCARD:
  - For a single-column index, FIRSTKEYCARD must be equal to FULLKEYCARD.
  - FIRSTKEYCARD must be equal to SYSSTAT.COLUMNS.COLCARD for the corresponding column.
  - If any of these index statistics are not relevant, set them to -1. For example, if you have an index with only three columns, set FIRST4KEYCARD to -1.
  - For multiple column indexes, if all of the statistics are relevant, the relationship among them must be as follows:

```
FIRSTKEYCARD <= FIRST2KEYCARD <= FIRST3KEYCARD <= FIRST4KEYCARD
<= FULLKEYCARD <= INDCARD == CARD
```
- For indexes over XML data, the relationship among FIRSTKEYCARD, FIRST2KEYCARD, FIRST3KEYCARD, FIRST4KEYCARD, FULLKEYCARD, and INDCARD must be as follows:

```
FIRSTKEYCARD <= FIRST2KEYCARD <= FIRST3KEYCARD <= FIRST4KEYCARD
<= FULLKEYCARD <= INDCARD
```
- The following rules apply to SEQUENTIAL\_PAGES and DENSITY:
  - Valid values for SEQUENTIAL\_PAGES are -1 or between 0 and NLEAF.
  - Valid values for DENSITY are -1 or between 0 and 100.

## Distribution statistics

You can collect two kinds of data distribution statistics: frequent-value statistics and quantile statistics.

- *Frequent-value statistics* provide information about a column and the data value with the highest number of duplicates, the value with the second highest number of duplicates, and so on, to the level that is specified by the value of the **num\_freqvalues** database configuration parameter. To disable the collection of frequent-value statistics, set **num\_freqvalues** to 0. You can also use the **NUM\_FREQVALUES** clause on the **RUNSTATS** command for a specific table, statistical view, or column.
- *Quantile statistics* provide information about how data values are distributed in relation to other values. Called *K*-quantiles, these statistics represent the value *V* at or below which at least *K* values lie. You can compute a *K*-quantile by sorting the values in ascending order. The *K*-quantile value is the value in the *K*th position from the low end of the range.

To specify the number of “sections” (quantiles) into which the column data values should be grouped, set the **num\_quantiles** database configuration parameter to a value between **2** and **32 767**. The default value is **20**, which

ensures a maximum optimizer estimation error of plus or minus 2.5% for any equality, less-than, or greater-than predicate, and a maximum error of plus or minus 5% for any BETWEEN predicate. To disable the collection of quantile statistics, set `num_quantiles` to `0` or `1`.

You can set `num_quantiles` for a specific table, statistical view, or column.

**Note:** The `RUNSTATS` utility consumes more processing resources and memory (specified by the `stat_heap_sz` database configuration parameter) if larger `num_freqvalues` and `num_quantiles` values are used.

## When to collect distribution statistics

To decide whether distribution statistics for a table or statistical view would be helpful, first determine:

- Whether the queries in an application use host variables.

Distribution statistics are most useful for dynamic and static queries that do not use host variables. The optimizer makes limited use of distribution statistics when assessing queries that contain host variables.

- Whether the data in columns is uniformly distributed.

Create distribution statistics if at least one column in the table has a highly “nonuniform” distribution of data, and the column appears frequently in equality or range predicates; that is, in clauses such as the following:

```
where c1 = key;
where c1 in (key1, key2, key3);
where (c1 = key1) or (c1 = key2) or (c1 = key3);
where c1 <= key;
where c1 between key1 and key2;
```

Two types of nonuniform data distribution can occur, and possibly together.

- Data might be highly clustered instead of being evenly spread out between the highest and lowest data value. Consider the following column, in which the data is clustered in the range (5,10):

```
0.0
5.1
6.3
7.1
8.2
8.4
8.5
9.1
93.6
100.0
```

Quantile statistics help the optimizer to deal with this kind of data distribution.

Queries can help you to determine whether column data is not uniformly distributed. For example:

```
select c1, count(*) as occurrences
from t1
group by c1
order by occurrences desc
```

- Duplicate data values might often occur. Consider a column in which the data is distributed with the following frequencies:



Table 81. Frequency of data values in a column

Data Value	Frequency
20	5
30	10
40	10
50	25
60	25
70	20
80	5

Both frequent-value and quantile statistics help the optimizer to deal with numerous duplicate values.

### When to collect index statistics only

You might consider collecting statistics that are based only on index data in the following situations:

- A new index was created since the **RUNSTATS** utility was run, and you do not want to collect statistics again on the table data.
- There were many changes to the data that affect the first column of an index.

### What level of statistical precision to specify

Use the **num\_quantiles** and **num\_freqvalues** database configuration parameters to specify the precision with which distribution statistics are stored. You can also specify the precision with corresponding **RUNSTATS** command options when you collect statistics for a table or for columns. The higher you set these values, the greater the precision that the **RUNSTATS** utility uses when it creates and updates distribution statistics. However, greater precision requires more resources, both during the **RUNSTATS** operation itself, and for storing more data in the catalog tables.

For most databases, specify between 10 and 100 as the value of the **num\_freqvalues** database configuration parameter. Ideally, frequent-value statistics should be created in such a way that the frequencies of the remaining values are either approximately equal to one another or negligible when compared to the frequencies of the most frequent values. The database manager might collect fewer than this number, because these statistics are collected only for data values that occur more than once. If you need to collect only quantile statistics, set the value of **num\_freqvalues** to zero.

To specify the number of quantiles, set the **num\_quantiles** database configuration parameter to a value between 20 and 50.

- First determine the maximum acceptable error when estimating the number of rows for any range query, as a percentage  $P$ .
- The number of quantiles should be approximately  $100/P$  for BETWEEN predicates, and  $50/P$  for any other type of range predicate (<, <=, >, or >=).

For example, 25 quantiles should result in a maximum estimate error of 4% for BETWEEN predicates and 2% for ">" predicates. In general, specify at least 10 quantiles. More than 50 quantiles should be necessary only for extremely nonuniform data. If you need only frequent-value statistics, set **num\_quantiles** to 0.

If you set this parameter to 1, because the entire range of values fits within one quantile, no quantile statistics are collected.

### Optimizer use of distribution statistics:

The optimizer uses distribution statistics for better estimates of the cost of different query access plans.

Unless it has additional information about the distribution of values between the low and high values, the optimizer assumes that data values are evenly distributed. If data values differ widely from each other, are clustered in some parts of the range, or contain many duplicate values, the optimizer will choose a less than optimal access plan.

Consider the following example: To select the least expensive access plan, the optimizer needs to estimate the number of rows with a column value that satisfies an equality or range predicate. The more accurate the estimate, the greater the likelihood that the optimizer will choose the optimal access plan. For the following query:

```
select c1, c2
  from table1
 where c1 = 'NEW YORK'
 and c2 <= 10
```

Assume that there is an index on both columns C1 and C2. One possible access plan is to use the index on C1 to retrieve all rows with C1 = 'NEW YORK', and then to check whether C2 <= 10 for each retrieved row. An alternate plan is to use the index on C2 to retrieve all rows with C2 <= 10, and then to check whether C1 = 'NEW YORK' for each retrieved row. Because the primary cost of executing a query is usually the cost of retrieving the rows, the best plan is the one that requires the fewest retrievals. Choosing this plan means estimating the number of rows that satisfy each predicate.

When distribution statistics are not available, but the runstats utility has been used on a table or a statistical view, the only information that is available to the optimizer is the second-highest data value (HIGH2KEY), the second-lowest data value (LOW2KEY), the number of distinct values (COLCARD), and the number of rows (CARD) in a column. The number of rows that satisfy an equality or range predicate is estimated under the assumption that the data values in the column have equal frequencies and that the data values are evenly distributed between LOW2KEY and HIGH2KEY. Specifically, the number of rows that satisfy an equality predicate (C1 = KEY) is estimated as CARD/COLCARD, and the number of rows that satisfy a range predicate (C1 BETWEEN KEY1 AND KEY2) can be estimated with the following formula:

$$\frac{\text{KEY2} - \text{KEY1}}{\text{HIGH2KEY} - \text{LOW2KEY}} \times \text{CARD}$$

These estimates are accurate only when the true distribution of data values within a column is reasonably uniform. When distribution statistics are unavailable, and either the frequency of data values varies widely, or the data values are very unevenly distributed, the estimates can be off by orders of magnitude, and the optimizer might choose a suboptimal access plan.

When distribution statistics are available, the probability of such errors can be greatly reduced by using frequent-value statistics to estimate the number of rows

that satisfy an equality predicate, and by using both frequent-value statistics and quantile statistics to estimate the number of rows that satisfy a range predicate.

### Collecting distribution statistics for specific columns:

For efficient **RUNSTATS** operations and subsequent query-plan analysis, collect distribution statistics on only those columns that queries reference in **WHERE**, **GROUP BY**, and similar clauses. You can also collect cardinality statistics on combined groups of columns. The optimizer uses such information to detect column correlation when it estimates selectivity for queries that reference the columns in a group.

### About this task

The following example is based on a database named **SALES** that contains a **CUSTOMERS** table with indexes **CUSTIDX1** and **CUSTIDX2**.

For privileges and authorities that are required to use the **RUNSTATS** utility, see the description of the **RUNSTATS** command.

When you collect statistics for a table in a partitioned database environment, **RUNSTATS** operates only on the database partition from which the utility is executed. The results from this database partition are extrapolated to the other database partitions. If this database partition does not contain a required portion of the table, the request is sent to the first database partition in the database partition group that contains the required data.

### Procedure

To collect statistics on specific columns:

1. Connect to the **SALES** database.
2. Execute one of the following commands from the DB2 command line, depending on your requirements:
  - To collect distribution statistics on columns **ZIP** and **YTDTOTAL**:

```
runstats on table sales.customers
with distribution on columns (zip, ytdtotal)
```
  - To collect distribution statistics on the same columns, but with different distribution options:

```
runstats on table sales.customers
with distribution on columns (
zip, ytdtotal num_freqvalues 50 num_quantiles 75)
```
  - To collect distribution statistics on the columns that are indexed in **CUSTIDX1** and **CUSTIDX2**:

```
runstats on table sales.customer
on key columns
```
  - To collect statistics for columns **ZIP** and **YTDTOTAL** and a column group that includes **REGION** and **TERRITORY**:

```
runstats on table sales.customers
on columns (zip, (region, territory), ytdtotal)
```
  - Suppose that statistics for non-XML columns were collected previously using the **LOAD** command with the **STATISTICS** parameter. To collect statistics for the XML column **MISCINFO**:

```
runstats on table sales.customers
on columns (miscinfo)
```

- To collect statistics for the non-XML columns only:

```
runstats on table sales.customers
excluding xml columns
```

The **EXCLUDING XML COLUMNS** clause takes precedence over all other clauses that specify XML columns.

- For DB2 V9.7 Fix Pack 1 and later releases, the following command collects distribution statistics using a maximum of 50 quantiles for the XML column MISCINFO. A default of 20 quantiles is used for all other columns in the table:

```
runstats on table sales.customers
with distribution on columns ( miscinfo num_quantiles 50 )
default num_quantiles 20
```

**Note:** The following are required for distribution statistics to be collected on the XML column MISCINFO:

- Both table and distribution statistics must be collected.
- An index over XML data must be defined on the column, and the data type specified for the index must be VARCHAR, DOUBLE, TIMESTAMP, or DATE.

#### Extended examples of the use of distribution statistics:

Distribution statistics provide information about the frequency and distribution of table data that helps the optimizer build query access plans when the data is not evenly distributed and there are many duplicates.

The following examples will help you to understand how the optimizer might use distribution statistics.

#### Example with frequent-value statistics

Consider a query that contains an equality predicate of the form  $C1 = KEY$ . If frequent-value statistics are available, the optimizer can use those statistics to choose an appropriate access plan, as follows:

- If  $KEY$  is one of the  $N$  most frequent values, the optimizer uses the frequency of  $KEY$  that is stored in the catalog.
- If  $KEY$  is not one of the  $N$  most frequent values, the optimizer estimates the number of rows that satisfy the predicate under the assumption that the  $(COLCARD - N)$  non-frequent values have a uniform distribution. That is, the number of rows is estimated by the following formula (1):

$$\frac{CARD - NUM\_FREQ\_ROWS}{COLCARD - N}$$

where  $CARD$  is the number of rows in the table,  $COLCARD$  is the cardinality of the column, and  $NUM\_FREQ\_ROWS$  is the total number of rows with a value equal to one of the  $N$  most frequent values.

For example, consider a column  $C1$  whose data values exhibit the following frequencies:

Data Value	Frequency
1	2
2	3

Data Value	Frequency
3	40
4	4
5	1

The number of rows in the table is 50 and the column cardinality is 5. Exactly 40 rows satisfy the predicate  $C1 = 3$ . If it is assumed that the data is evenly distributed, the optimizer estimates the number of rows that satisfy the predicate as  $50/5 = 10$ , with an error of -75%. But if frequent-value statistics based on only the most frequent value (that is,  $N = 1$ ) are available, the number of rows is estimated as 40, with no error.

Consider another example in which two rows satisfy the predicate  $C1 = 1$ . Without frequent-value statistics, the number of rows that satisfy the predicate is estimated as 10, an error of 400%:

$$\frac{\text{estimated rows} - \text{actual rows}}{\text{actual rows}} \times 100$$

$$\frac{10 - 2}{2} \times 100 = 400\%$$

Using frequent-value statistics ( $N = 1$ ), the optimizer estimates the number of rows containing this value using the formula (1) given previously as:

$$\frac{(50 - 40)}{(5 - 1)} = 3$$

and the error is reduced by an order of magnitude:

$$\frac{3 - 2}{2} = 50\%$$

### Example with quantile statistics

The following discussion of quantile statistics uses the term “K-quantile”. The *K-quantile* for a column is the smallest data value,  $V$ , such that at least  $K$  rows have data values that are less than or equal to  $V$ . To compute a K-quantile, sort the column values in ascending order; the K-quantile is the data value in the Kth row of the sorted column.

If quantile statistics are available, the optimizer can better estimate the number of rows that satisfy a range predicate, as illustrated by the following examples. Consider a column  $C1$  that contains the following values:

0.0  
5.1  
6.3  
7.1  
8.2  
8.4  
8.5  
9.1  
93.6  
100.0

Suppose that  $K$ -quantiles are available for  $K = 1, 4, 7,$  and  $10,$  as follows:

$K$	$K$ -quantile
1	0.0
4	7.1
7	8.5
10	100.0

- Exactly seven rows satisfy the predicate  $C \leq 8.5.$  Assuming a uniform data distribution, the following formula (2):

$$\frac{\text{KEY2} - \text{KEY1}}{\text{HIGH2KEY} - \text{LOW2KEY}} \times \text{CARD}$$

with  $\text{LOW2KEY}$  in place of  $\text{KEY1},$  estimates the number of rows that satisfy the predicate as:

$$\frac{8.5 - 5.1}{93.6 - 5.1} \times 10 \approx 0$$

where  $\approx$  means “approximately equal to”. The error in this estimate is approximately -100%.

If quantile statistics are available, the optimizer estimates the number of rows that satisfy this predicate by the value of  $K$  that corresponds to 8.5 (the highest value in one of the quantiles), which is 7. In this case, the error is reduced to 0.

- Exactly eight rows satisfy the predicate  $C \leq 10.$  If the optimizer assumes a uniform data distribution and uses formula (2), the number of rows that satisfy the predicate is estimated as 1, an error of -87.5%.

Unlike the previous example, the value 10 is not one of the stored  $K$ -quantiles. However, the optimizer can use quantiles to estimate the number of rows that satisfy the predicate as  $r_1 + r_2,$  where  $r_1$  is the number of rows satisfying the predicate  $C \leq 8.5$  and  $r_2$  is the number of rows satisfying the predicate  $C > 8.5$  AND  $C \leq 10.$  As in the previous example,  $r_1 = 7.$  To estimate  $r_2,$  the optimizer uses linear interpolation:

$$r_2 \approx \frac{10 - 8.5}{100 - 8.5} \times (\text{number of rows with value } > 8.5 \text{ and } \leq 100.0)$$

$$r_2 \approx \frac{10 - 8.5}{100 - 8.5} \times (10 - 7)$$

$$r_2 \approx \frac{1.5}{91.5} \times (3)$$

$$r_2 \approx 0$$

The final estimate is  $r_1 + r_2 \approx 7,$  and the error is only -12.5%.

Quantiles improve the accuracy of the estimates in these examples because the real data values are “clustered” in a range from 5 to 10, but the standard estimation formulas assume that the data values are distributed evenly between 0 and 100.

The use of quantiles also improves accuracy when there are significant differences in the frequencies of different data values. Consider a column having data values with the following frequencies:

Data Value	Frequency
20	5
30	5
40	15
50	50
60	15
70	5
80	5

Suppose that  $K$ -quantiles are available for  $K = 5, 25, 75, 95,$  and  $100$ :

$K$	$K$ -quantile
5	20
25	40
75	50
95	70
100	80

Suppose also that frequent-value statistics are available, based on the three most frequent values.

Exactly 10 rows satisfy the predicate  $C$  BETWEEN 20 AND 30. Assuming a uniform data distribution and using formula (2), the number of rows that satisfy the predicate is estimated as:

$$\frac{30 - 20}{70 - 30} \times 100 = 25$$

an error of 150%.

Using frequent-value statistics and quantile statistics, the number of rows that satisfy the predicate is estimated as  $r_1 + r_2$ , where  $r_1$  is the number of rows that satisfy the predicate ( $C = 20$ ) and  $r_2$  is the number of rows that satisfy the predicate  $C > 20$  AND  $C \leq 30$ . Using formula (1),  $r_1$  is estimated as:

$$\frac{100 - 80}{7 - 3} = 5$$

Using linear interpolation,  $r_2$  is estimated as:

$$\frac{30 - 20}{40 - 20} \times (\text{number of rows with a value } > 20 \text{ and } \leq 40)$$

$$= \frac{30 - 20}{40 - 20} \times (25 - 5)$$

$$= 10$$

This yields a final estimate of 15 and reduces the error by a factor of three.

### Rules for updating distribution statistics manually:

There are certain guidelines that you should follow when updating statistics in the SYSSTAT.COLDIST catalog view.

- Frequent-value statistics:
  - VALCOUNT values must be unchanging or decreasing with increasing values of SEQNO.
  - The number of COLVALUE values must be less than or equal to the number of distinct values in the column, which is stored in SYSSTAT.COLUMNS.COLCARD.
  - The sum of the values in VALCOUNT must be less than or equal to the number of rows in the column, which is stored in SYSSTAT.TABLES.CARD.
  - In most cases, COLVALUE values should lie between the second-highest and the second-lowest data values for the column, which are stored in HIGH2KEY and LOW2KEY in SYSSTAT.COLUMNS, respectively. There can be one frequent value that is greater than HIGH2KEY and one frequent value that is less than LOW2KEY.
- Quantile statistics:
  - COLVALUE values must be unchanging or decreasing with increasing values of SEQNO.
  - VALCOUNT values must be increasing with increasing values of SEQNO.
  - The largest COLVALUE value must have a corresponding entry in VALCOUNT that is equal to the number of rows in the column.
  - In most cases, COLVALUE values should lie between the second-highest and the second-lowest data values for the column, which are stored in HIGH2KEY and LOW2KEY in SYSSTAT.COLUMNS, respectively.

Suppose that distribution statistics are available for column C1 with  $R$  rows, and that you want to modify the statistics to correspond with a column that has the same relative proportions of data values, but with  $(F \times R)$  rows. To scale up the frequent-value or quantile statistics by a factor of  $F$ , multiply each VALCOUNT entry by  $F$ .

### Statistics for user-defined functions

To create statistical information for user-defined functions (UDFs), edit the SYSSTAT.ROUTINES catalog view.

The runstats utility does not collect statistics for UDFs. If UDF statistics are available, the optimizer can use them when it estimates costs for various access plans. If statistics are not available, the optimizer uses default values that assume a simple UDF.

Table 82 lists the catalog view columns for which you can provide estimates to improve performance. Note that only column values in SYSSTAT.ROUTINES (not SYSCAT.ROUTINES) can be modified by users.

Table 82. Function Statistics (SYSCAT.ROUTINES and SYSSTAT.ROUTINES)

Statistic	Description
IOS_PER_INVOC	Estimated number of read or write requests executed each time a function is called



Table 82. Function Statistics (SYSCAT.ROUTINES and SYSSTAT.ROUTINES) (continued)

Statistic	Description
INSTS_PER_INVOC	Estimated number of machine instructions executed each time a function is called
IOS_PER_ARGBYTE	Estimated number of read or write requests executed per input argument byte
INSTS_PER_ARGBYTE	Estimated number of machine instructions executed per input argument byte
PERCENT_ARGBYTES	Estimated average percent of input argument bytes that a function will actually process
INITIAL_IOS	Estimated number of read or write requests executed the first or last time a function is invoked
INITIAL_INSTS	Estimated number of machine instructions executed the first or last time a function is invoked
CARDINALITY	Estimated number of rows generated by a table function

For example, consider EU\_SHOE, a UDF that converts an American shoe size to the equivalent European shoe size. For this UDF, you might set the values of statistic columns in SYSSTAT.ROUTINES as follows:

- INSTS\_PER\_INVOC. Set to the estimated number of machine instructions required to:
  - Call EU\_SHOE
  - Initialize the output string
  - Return the result
- INSTS\_PER\_ARGBYTE. Set to the estimated number of machine instructions required to convert the input string into a European shoe size
- PERCENT\_ARGBYTES. Set to 100, indicating that the entire input string is to be converted
- INITIAL\_INSTS, IOS\_PER\_INVOC, IOS\_PER\_ARGBYTE, and INITIAL\_IOS. Each set to 0, because this UDF only performs computations

PERCENT\_ARGBYTES would be used by a function that does not always process the entire input string. For example, consider LOCATE, a UDF that accepts two arguments as input and returns the starting position of the first occurrence of the first argument within the second argument. Assume that the length of the first argument is small enough to be insignificant relative to the second argument and that, on average, 75% of the second argument is searched. Based on this information and the following assumptions, PERCENT\_ARGBYTES should be set to 75:

- Half the time the first argument is not found, which results in searching the entire second argument
- The first argument is equally likely to appear anywhere within the second argument, which results in searching half of the second argument (on average) when the first argument is found

You can use INITIAL\_INSTS or INITIAL\_IOS to record the estimated number of machine instructions or read or write requests that are performed the first or last time that a function is invoked; this might represent the cost, for example, of setting up a scratchpad area.

To obtain information about I/Os and the instructions that are used by a UDF, use output provided by your programming language compiler or by monitoring tools that are available for your operating system.

## Monitoring the progress of RUNSTATS operations

You can use the **LIST UTILITIES** command or the **db2pd** command to monitor the progress of **RUNSTATS** operations on a database.

### Procedure

Issue the **LIST UTILITIES** command and specify the **SHOW DETAIL** parameter:

```
list utilities show detail
```

or issue the **db2pd** command and specify the **-runstats** parameter:

```
db2pd -runstats
```

### Results

The following is an example of the output for monitoring the performance of a **RUNSTATS** operation using the **LIST UTILITIES** command:

```
ID = 7
Type = RUNSTATS
Database Name = SAMPLE
Partition Number = 0
Description = YIWEIANG.EMPLOYEE
Start Time = 08/04/2011 12:39:35.155398
State = Executing
Invocation Type = User
Throttling:
  Priority = Unthrottled
```

The following is an example of the output for monitoring the performance of a **RUNSTATS** operation using the **db2pd** command:

```
db2pd -runstats
```

Table Runstats Information:

```
Retrieval Time: 08/13/2009 20:38:20
TbpaceID: 2      TableID: 4
Schema: SCHEMA  TableName: TABLE
Status: Completed Access: Allow write
Sampling: No     Sampling Rate: -
Start Time: 08/13/2009 20:38:16 End Time: 08/13/2009 20:38:17
Total Duration: 00:00:01
Cur Count: 0      Max Count: 0
```

Index Runstats Information:

```
Retrieval Time: 08/13/2009 20:38:20
TbpaceID: 2      TableID: 4
Schema: SCHEMA  TableName: TABLE
Status: Completed Access: Allow write
Start Time: 08/13/2009 20:38:17 End Time: 08/13/2009 20:38:18
Total Duration: 00:00:01
Prev Index Duration [1]: 00:00:01
Prev Index Duration [2]: -
```

Prev Index Duration [3]: -  
Cur Index Start: 08/13/2009 20:38:18  
Cur Index: 2                      Max Index: 2                      Index ID: 2  
Cur Count: 0    Max Count: 0

## Catalog statistics for modeling and what-if planning

You can observe the effect on database performance of changes to certain statistical information in the system catalog for planning purposes.

The ability to update selected system catalog statistics enables you to:

- Model query performance on a development system using production system statistics
- Perform “what-if” query performance analysis

Do not manually update statistics on a production system. Otherwise, the optimizer might not choose the best access plan for production queries that contain dynamic SQL or XQuery statements.

To modify statistics for tables and indexes and their components, you must have explicit DBADM authority for the database. Users holding DATAACCESS authority can execute UPDATE statements against views that are defined in the SYSSTAT schema to change values in these statistical columns.

Users without DATAACCESS authority can see only rows that contain statistics for objects on which they have CONTROL privilege. If you do not have DATAACCESS authority, you can change statistics for individual database objects if you hold the following privileges on each object:

- Explicit CONTROL privilege on tables. You can also update statistics for columns and indexes on these tables.
- Explicit CONTROL privilege on nicknames in a federated database system. You can also update statistics for columns and indexes on these nicknames. Note that these updates only affect local metadata (datasource table statistics are not changed), and only affect the global access strategy that is generated by the DB2 optimizer.
- Ownership of user-defined functions (UDFs)

The following code is an example of updating statistics for the EMPLOYEE table:

```
update sysstat.tables
  set
    card = 10000,
    npages = 1000,
    fpages = 1000,
    overflow = 2
  where tabschema = 'MELNYK'
     and tabname = 'EMPLOYEE'
```

Care must be taken when manually updating catalog statistics. Arbitrary changes can seriously alter the performance of subsequent queries. You can use any of the following methods to return the statistics on your development system to a consistent state:

- Roll back the unit of work in which your manual changes were made (assuming that the unit of work has not yet been committed).
- Use the runstats utility to refresh the catalog statistics.
- Update the catalog statistics to specify that statistics have not been collected; for example, setting the NPAGES column value to -1 indicates that this statistic has not been collected.

- Undo the changes that you made. This method is possible only if you used the **db2look** command to capture the statistics before you made any changes.

If it determines that some value or combination of values is not valid, the optimizer will use default values and return a warning. This is quite rare, however, because most validation is performed when the statistics are updated.

#### **Statistics for modeling production databases:**

Sometimes you might want your development system to contain a subset of the data in your production system. However, access plans that are selected on development systems are not necessarily the same as those that would be selected on the production system.

In some cases, it is necessary that the catalog statistics and the configuration of the development system be updated to match those of the production system.

The **db2look** command in mimic mode (specifying the **-m** option) can be used to generate the data manipulation language (DML) statements that are required to make the catalog statistics of the development and production databases match.

After running the UPDATE statements that are produced by **db2look** against the development system, that system can be used to validate the access plans that are being generated on the production system. Because the optimizer uses the configuration of table spaces to estimate I/O costs, table spaces on the development system must be of the same type (SMS or DMS) and have the same number of containers as do those on the production system. The test system may have less physical memory than the production system. Setting memory related configuration parameters on the test system same as values of those on the production system might not be feasible. You can use the **db2fopt** command to assign values to be used by the optimizer during statement compilation. For example, if the production system is running with **sortheap=20000** and the test system can only run with **sortheap=5000**, you can use **db2fopt** on the test system to set **opt\_sortheap** to 20000. **opt\_sortheap** instead of **sortheap**, will be used by the query optimizer during statement compilation when evaluating access plans.

#### **Avoiding manual updates to the catalog statistics**

The DB2 data server supports manually updating catalog statistics by issuing UPDATE statements against views in the SYSSTAT schema.

This feature can be useful when mimicking a production database on a test system in order to examine query access plans. The **db2look** utility is very helpful for capturing the DDL and UPDATE statements against views in the SYSSTAT schema for playback on another system.

Avoid influencing the query optimizer by manually providing incorrect statistics to force a particular query access plan. Although this practice might result in improved performance for some queries, it can result in performance degradation for others. Consider other tuning options (such as using optimization guidelines and profiles) before resorting to this approach. If this approach does become necessary, be sure to record the original statistics in case they need to be restored.

## **Minimizing RUNSTATS impact**

There are several approaches available to improve **RUNSTATS** performance.

To minimize the performance impact of this utility:

- Limit the columns for which statistics are collected by using the **COLUMNS** clause. Many columns are never referenced by predicates in the query workload, so they do not require statistics.
- Limit the columns for which distribution statistics are collected if the data tends to be uniformly distributed. Collecting distribution statistics requires more CPU and memory than collecting basic column statistics. However, determining whether the values for a column are uniformly distributed requires either having existing statistics or querying the data. This approach also assumes that the data remains uniformly distributed as the table is modified.
- Limit the number of pages and rows processed by using page- or row-level table sampling (by specifying the **TABLESAMPLE SYSTEM** or **TABLESAMPLE BERNOULLI** clause) and by using page- or row-level index sampling (by specifying **INDEXSAMPLE SYSTEM** or **INDEXSAMPLE BERNOULLI** clause). Start with a 10% page-level sample, by specifying **TABLESAMPLE SYSTEM(10)** and **INDEXSAMPLE SYSTEM(10)**. Check the accuracy of the statistics and whether system performance has degraded due to changes in access plan. If it has degraded, try a 10% row-level sample instead, by specifying **TABLESAMPLE BERNOULLI(10)**. Likewise, experiment with the **INDEXSAMPLE** parameter to get the right rate for index sampling. If the accuracy of the statistics is insufficient, increase the sampling amount. When using **RUNSTATS** page- or row-level sampling, use the same sampling rate for tables that are joined. This is important to ensure that the join column statistics have the same level of accuracy.
- Collect index statistics during index creation by specifying the **COLLECT STATISTICS** option on the **CREATE INDEX** statement. This approach is faster than performing a separate **RUNSTATS** operation after the index is created. It also ensures that the new index has statistics generated immediately after creation, to allow the optimizer to accurately estimate the cost of using the index.
- Collect statistics when executing the **LOAD** command with the **REPLACE** option. This approach is faster than performing a separate **RUNSTATS** operation after the load operation completes. It also ensures that the table has the most current statistics immediately after the data is loaded, to allow the optimizer to accurately estimate the cost of using the table.

In a partitioned database environment, the **RUNSTATS** utility collects statistics from a single database partition. If the **RUNSTATS** command is issued on a database partition on which the table resides, statistics are collected there. If not, statistics are collected on the first database partition in the database partition group for the table. For consistent statistics, ensure that statistics for joined tables are collected from the same database partition.

---

## Data compression and performance

You can use data compression to reduce the amount of data that must be read from or written to disk, thereby reducing I/O cost.

Generally speaking, the more repetitive patterns that exist in data rows, the better your compression rates will be. If your data does not contain repetitive strings, as might be the case if you have mainly numeric data, or include inline BLOB data, compression might not yield as much in the way of storage savings. In addition, when data does not compress well, you still incur the performance impact of the database manager attempting to compress data, only to find that the storage benefits are not worth retaining any compression dictionaries. To check on the possible storage savings that you can achieve with compression, use the **ADMIN\_GET\_TAB\_COMPRESS\_INFO** table function.

Two forms of data compression are available:

### **Row compression**

There are two types of row compression available:

#### *Classic row compression*

Classic row compression involves replacing repeating patterns that span multiple column values within a row with shorter symbol strings. A sampling of rows are scanned to find instances of repetitive data. From this scan, a table-level compression dictionary is created. This dictionary is used to replace the repetitive data with shorter symbol strings.

Table-level compression dictionaries are static; after they are first created, they do not change unless you rebuild them during a classic table reorganization.

#### *Adaptive row compression*

Adaptive row compression involves the use of two compression approaches: classic row compression and *page-level compression*. Page-level compression involves replacing repeating patterns that span multiple column values *within a single page* of data with shorter symbol strings. As a page fills with data, page compression logic scans the page for repetitive data. From this scan, a page-level compression dictionary is created. This dictionary is used to replace the repetitive data with shorter symbol strings.

Page-level dictionaries are dynamic; they are rebuilt automatically if necessary.

### **Value compression**

Value compression involves removing duplicate entries for a value, storing only one copy, and keeping track of the location of any references to the stored value.

Row compression is also used for temporary tables. Compressing temporary tables reduces the amount of temporary disk space that is required for large and complex queries, thus increasing query performance. Compression for temporary tables is enabled automatically under the DB2 Storage Optimization Feature. Each temporary table that is eligible for row compression requires an additional 2 - 3 MB of memory for the creation of its compression dictionary. This memory remains allocated until the compression dictionary has been created.

You can also compress index objects, which reduces storage costs. This kind of compression is especially useful for large online transaction processing (OLTP) and data warehouse environments, where it is common to have many very large indexes. In both of these cases, index compression can significantly improve performance in I/O-bound environments while causing little or no performance degradation in CPU-bound environments.

If you enable compression on a table with an XML column, the XML data that is stored in the XDA object is also compressed. A separate compression dictionary for the XML data is stored in the XDA object. If you use DB2 Version 9.7 or later to add XML columns to a table created using DB2 Version 9.5, these XML columns are compressed. However, XML columns added to a table using DB2 Version 9.5 are not compressed; in such tables, only the data object is compressed.

---

## Reducing logging overhead to improve DML performance

The database manager maintains log files that record all database changes. There are two logging strategies: circular logging and archive logging.

- With *circular logging*, log files are reused (starting with the initial log file) when the available files have filled up. The overwritten log records are not recoverable.
- With *archive logging*, log files are archived when they fill up with log records. Log retention enables rollforward recovery, in which changes to the database (completed units of work or transactions) that are recorded in the log files can be reapplied during disaster recovery.

All changes to regular data and index pages are written to the log buffer before being written to disk by the logger process. SQL statement processing must wait for log data to be written to disk:

- On COMMIT
- Until the corresponding data pages are written to disk, because the DB2 server uses write-ahead logging, in which not all of the changed data and index pages need to be written to disk when a transaction completes with a COMMIT statement
- Until changes (mostly resulting from the execution of data definition language statements) are made to the metadata
- When the log buffer is full

The database manager writes log data to disk in this way to minimize processing delays. If many short transactions are processing concurrently, most of the delay is caused by COMMIT statements that must wait for log data to be written to disk. As a result, the logger process frequently writes small amounts of log data to disk. Additional delays are caused by log I/O. To balance application response time with logging delays, set the `mincommit` database configuration parameter to a value that is greater than 1. This setting might cause longer COMMIT delays for some applications, but more log data might be written in one operation.

Changes to large objects (LOBs) and LONG VARCHARs are tracked through shadow paging. LOB column changes are not logged unless you specify `log retain` and the LOB column has been defined without the NOT LOGGED clause on the CREATE TABLE statement. Changes to allocation pages for LONG or LOB data types are logged like regular data pages. Inline LOB values participate fully in update, insert, or delete logging, as though they were VARCHAR values.

---

## Inline LOBs improve performance

Some applications make extensive use of large objects (LOBs). In many cases, these LOBs are not very large—at most, a few kilobytes in size. The performance of LOB data access can now be improved by placing such LOB data within the formatted rows on data pages instead of in the LOB storage object.

Such LOBs are known as *inline LOBs*. Previously, the processing of such LOBs could create bottlenecks for applications. Inline LOBs improve the performance of queries that access LOB data, because no additional I/O is required to fetch, insert, or update this data. Moreover, inline LOB data is eligible for row compression.

This feature is enabled through the `INLINE LENGTH` option on the CREATE TABLE statement or the ALTER TABLE statement. The `INLINE LENGTH` option

applies to structured types, the XML type, or LOB columns. In the case of a LOB column, the inline length indicates the maximum byte size of a LOB value (including four bytes for overhead) that can be stored in a base table row.

This feature is also implicitly enabled for all LOB columns in new or existing tables (when LOB columns are added), and for all existing LOB columns on database upgrade. Every LOB column has reserved row space that is based on its defined maximum size. An implicit `INLINE LENGTH` value for each LOB column is defined automatically and stored as if it had been explicitly specified.

LOB values that cannot be stored inline are stored separately in the LOB storage object.

Note that when a table has columns with inline LOBs, fewer rows fit on a page, and the performance of queries that return only non-LOB data can be adversely affected. LOB inlining is helpful for workloads in which most of the statements include one or more LOB columns.

Although LOB data is not necessarily logged, inline LOBs are always logged and can therefore increase logging overhead.



---

## Chapter 4. Establishing a performance tuning strategy

---

### The Design Advisor

The DB2 Design Advisor is a tool that can help you significantly improve your workload performance. The task of selecting which indexes, materialized query tables (MQTs), clustering dimensions, or database partitions to create for a complex workload can be daunting. The Design Advisor identifies all of the objects that are needed to improve the performance of your workload.

Given a set of SQL statements in a workload, the Design Advisor generates recommendations for:

- New indexes
- New clustering indexes
- New MQTs
- Conversion to multidimensional clustering (MDC) tables
- The redistribution of tables

The Design Advisor can implement some or all of these recommendations immediately, or you can schedule them to run at a later time.

Use the **db2adv** command to launch the Design Advisor utility.

The Design Advisor can help simplify the following tasks:

#### **Planning for and setting up a new database**

While designing your database, use the Design Advisor to generate design alternatives in a test environment for indexing, MQTs, MDC tables, or database partitioning.

In partitioned database environments, you can use the Design Advisor to:

- Determine an appropriate database partitioning strategy before loading data into a database
- Assist in upgrading from a single-partition database to a multi-partition database
- Assist in migrating from another database product to a multi-partition DB2 database

#### **Workload performance tuning**

After your database is set up, you can use the Design Advisor to:

- Improve the performance of a particular statement or workload
- Improve general database performance, using the performance of a sample workload as a gauge
- Improve the performance of the most frequently executed queries, as identified, for example, by the IBM InfoSphere Optim Performance Manager
- Determine how to optimize the performance of a new query
- Respond to Data Studio Health Monitor recommendations regarding shared memory utility or sort heap problems with a sort-intensive workload
- Find objects that are not used in a workload

IBM InfoSphere Optim Query Workload Tuner provides tools for improving the performance of single SQL statements and the performance of groups of SQL statements, which are called query workloads. For more information about this product, see the product overview page at <http://www.ibm.com/software/data/optim/query-workload-tuner-db2-luw/index.html>. In Version 3.1.1 or later, you can also use the Workload Design Advisor to perform many operations that were available in the DB2 Design Advisor wizard. For more information see the documentation for the Workload Design Advisor at <http://publib.boulder.ibm.com/infocenter/dstudio/v3r1/topic/com.ibm.datatools.qrytune.workloadtunedb2luw.doc/topics/genrecsdsgn.html>.

## Design Advisor output

Design Advisor output is written to standard output by default, and saved in the `ADVISE_*` tables:

- The `ADVISE_INSTANCE` table is updated with one new row each time that the Design Advisor runs:
  - The `START_TIME` and `END_TIME` fields show the start and stop times for the utility.
  - The `STATUS` field contains a value of `COMPLETED` if the utility ended successfully.
  - The `MODE` field indicates whether the `-m` parameter was used on the `db2adv` command.
  - The `COMPRESSION` field indicates the type of compression that was used.
- The `USE_TABLE` column in the `ADVISE_TABLE` table contains a value of `Y` if MQT, MDC table, or database partitioning strategy recommendations were made.

MQT recommendations can be found in the `ADVISE_MQT` table; MDC recommendations can be found in the `ADVISE_TABLE` table; and database partitioning strategy recommendations can be found in the `ADVISE_PARTITION` table. The `RUN_ID` column in these tables contains a value that corresponds to the `START_TIME` value of a row in the `ADVISE_INSTANCE` table, linking it to the same Design Advisor run.

When MQT, MDC, or database partitioning recommendations are provided, the relevant `ALTER TABLE` stored procedure call is placed in the `ALTER_COMMAND` column of the `ADVISE_TABLE` table. The `ALTER TABLE` stored procedure call might not succeed due to restrictions on the table for the `ALTOBJ` stored procedure.

- The `USE_INDEX` column in the `ADVISE_INDEX` table contains a value of `Y` (index recommended or evaluated) or `R` (an existing clustering RID index was recommended to be unclustered) if index recommendations were made.
- The `COLSTATS` column in the `ADVISE_MQT` table contains column statistics for an MQT. These statistics are contained within an XML structure as follows:

```
<?xml version="1.0" encoding="USASCII"?>
<colstats>
  <column>
    <name>COLNAME1</name>
    <colcard>1000</colcard>
    <high2key>999</high2key>
    <low2key>2</low2key>
  </column>
  ....
  <column>
    <name>COLNAME100</name>
```

```

        <colcard>55000</colcard>
        <high2key>49999</high2key>
        <low2key>100</low2key>
    </column>
</colstats>

```

You can save Design Advisor recommendations to a file using the **-o** parameter on the **db2adv** command. The saved Design Advisor output consists of the following elements:

- CREATE statements associated with any new indexes, MQTs, MDC tables, or database partitioning strategies
- REFRESH statements for MQTs
- **RUNSTATS** commands for new objects

An example of this output is as follows:

```

--<?xml version="1.0"?>
--<design-advisor>
--<mqt>
--<identifier>
--<name>MQT612152202220000</name>
--<schema>ZILIO2 </schema>
--</identifier>
--<statementlist>3</statementlist>
--<benefit>1013562.481682</benefit>
--<overhead>1468328.200000</overhead>
--<diskspace>0.004906</diskspace>
--</mqt>
.....
--<index>
--<identifier>
--<name>IDX612152221400000</name>
--<schema>ZILIO2 </schema>
--</identifier>
--<table><identifier>
--<name>PART</name>
--<schema>TPCD </schema>
--</identifier></table>
--<statementlist>22</statementlist>
--<benefit>820160.000000</benefit>
--<overhead>0.000000</overhead>
--<diskspace>9.063500</diskspace>
--</index>
.....
--<statement>
--<statementnum>11</statementnum>
--<statementtext>
--
-- select
-- c_name, c_custkey, o_orderkey, o_orderdate, o_totalprice,
-- sum(l_quantity) from tpcd.customer, tpcd.orders,
-- tpcd.lineitem where o_orderkey in( select
-- l_orderkey from tpcd.lineitem group by l_orderkey
-- having sum(l_quantity) > 300 ) and c_custkey
-- = o_custkey and o_orderkey = l_orderkey group by
-- c_name, c_custkey, o_orderkey, o_orderdate, o_totalprice
-- order by o_totalprice desc, o_orderdate fetch first
-- 100 rows only
--</statementtext>
--<objects>
--<identifier>
--<name>MQT612152202490000</name>
--<schema>ZILIO2 </schema>
--</identifier>
--<identifier>

```

```

--<name>ORDERS</name>
--<schema>TPCD </schema>
--</identifier>
--<identifier>
--<name>CUSTOMER</name>
--<schema>TPCD </schema>
--</identifier>
--<identifier>
--<name>IDX612152235020000</name>
--<schema>ZILIO2 </schema>
--</identifier>
--<identifier>
--<name>IDX612152235030000</name>
--<schema>ZILIO2 </schema>
--</identifier>
--<identifier>
--<name>IDX612152211360000</name>
--<schema>ZILIO2 </schema>
--</identifier>
--</objects>
--<benefit>2091459.000000</benefit>
--<frequency>1</frequency>
--</statement>

```

This XML structure can contain more than one column. The column cardinality (that is, the number of values in each column) is included and, optionally, the HIGH2KEY and LOW2KEY values.

The base table on which an index is defined is also included. Ranking of indexes and MQTs can be done using the benefit value. You can also rank indexes using (benefit - overhead) and MQTs using (benefit - 0.5 \* overhead).

Following the list of indexes and MQTs is the list of statements in the workload, including the SQL text, the statement number for the statement, the estimated performance improvement (benefit) from the recommendations, and the list of tables, indexes, and MQTs that were used by the statement. The original spacing in the SQL text is preserved in this output example, but the SQL text is normally split into 80 character commented lines for increased readability.

Existing indexes or MQTs are included in the output if they are being used to execute a workload.

MDC and database partitioning recommendations are not explicitly shown in this XML output example.

After some minor modifications, you can run this output file as a CLP script to create the recommended objects. The modifications that you might want to perform include:

- Combining all of the **RUNSTATS** commands into a single **RUNSTATS** invocation against the new or modified objects
- Providing more usable object names in place of system-generated IDs
- Removing or commenting out any data definition language (DDL) for objects that you do not want to implement immediately

## Using the Design Advisor

You can run the Design Advisor by invoking the **db2adv** command.

## Procedure

1. Define your workload. See “Defining a workload for the Design Advisor”.
2. Run the **db2adv** command against this workload.

**Note:** If the statistics on your database are not current, the generated recommendations are less reliable.

3. Interpret the output from **db2adv** and make any necessary modifications.
4. Implement the Design Advisor recommendations, as appropriate.

## Defining a workload for the Design Advisor

When the Design Advisor analyzes a specific workload, it considers factors such as the type of statements that are included in the workload, the frequency with which a particular statement occurs, and characteristics of your database to generate recommendations that minimize the total cost of running the workload.

### About this task

A *workload* is a set of SQL statements that the database manager must process during a period of time. The Design Advisor can be run against:

- A single SQL statement that you enter inline with the **db2adv** command
- A set of dynamic SQL statements that were captured in a DB2 snapshot
- A set of SQL statements that are contained in a workload file

You can create a workload file or modify a previously existing workload file. You can import statements into the file from several sources, including:

- A delimited text file
- An event monitor table
- Explained statements in the EXPLAIN\_STATEMENT table
- Recent SQL statements that were captured with a DB2 snapshot
- Workload manager activity tables
- Workload manager event monitor tables by using the **-wlm** option from the command line

After you import the SQL statements into a workload file, you can add, change, modify, or remove statements and modify their frequency.

## Procedure

- To run the Design Advisor against dynamic SQL statements:
  1. Reset the database monitor with the following command:

```
db2 reset monitor for database database-name
```
  2. Wait for an appropriate amount of time to allow for the execution of dynamic SQL statements against the database.
  3. Invoke the **db2adv** command using the **-g** parameter. If you want to save the dynamic SQL statements in the ADVISE\_WORKLOAD table for later reference, use the **-p** parameter as well.
- To run the Design Advisor against a set of SQL statements in a workload file:
  1. Create a workload file manually, separating each SQL statement with a semicolon, or import SQL statements from one or more of the sources listed previously.
  2. Set the frequency of the statements in the workload. Every statement in a workload file is assigned a frequency of 1 by default. The frequency of an

SQL statement represents the number of times that the statement occurs within a workload relative to the number of times that other statements occur. For example, a particular `SELECT` statement might occur 100 times in a workload, whereas another `SELECT` statement occurs 10 times. To represent the relative frequency of these two statements, you can assign the first `SELECT` statement a frequency of 10; the second `SELECT` statement has a frequency of 1. You can manually change the frequency or weight of a particular statement in the workload by inserting the following line after the statement: `-- # SET FREQUENCY n`, where `n` is the frequency value that you want to assign to the statement.

3. Invoke the `db2adv` command using the `-i` parameter followed by the name of the workload file.
- To run the Design Advisor against a workload that is contained in the `ADVISE_WORKLOAD` table, invoke the `db2adv` command using the `-w` parameter followed by the name of the workload.

## Using the Design Advisor to convert from a single-partition to a multi-partition database

You can use the Design Advisor to help you convert a single-partition database into a multi-partition database.

### About this task

In addition to making recommendations about new indexes, materialized query tables (MQTs), and multidimensional clustering (MDC) tables, the Design Advisor can provide you with recommendations for distributing data.

### Procedure

1. Use the `db2licm` command to register the partitioned database environment license key.
2. Create at least one table space in a multi-partition database partition group.

**Note:** The Design Advisor can only recommend data redistribution to existing table spaces.

3. Run the Design Advisor with the partitioning option specified on the `db2adv` command.
4. Modify the `db2adv` output file slightly before running the DDL statements that were generated by the Design Advisor. Because database partitioning must be set up before you can run the DDL script that the Design Advisor generates, recommendations are commented out of the script that is returned. It is up to you to transform your tables in accordance with the recommendations.

## Design Advisor limitations and restrictions

There are certain limitations and restrictions associated with Design Advisor recommendations about indexes, materialized query tables (MQTs), multidimensional clustering (MDC) tables, and database partitioning.

### Restrictions on index recommendations

- Indexes that are recommended for MQTs are designed to improve workload performance, not MQT refresh performance.
- A clustering RID index is recommended only for MDC tables. The Design Advisor will include clustering RID indexes as an option rather than create an MDC structure for the table.

- The Version 9.7 Design Advisor does not recommend partitioned indexes on a partitioned table. All indexes are recommended with an explicit NOT PARTITIONED clause.

### Restrictions on MQT recommendations

- The Design Advisor will not recommend incremental MQTs. If you want to create incremental MQTs, you can convert REFRESH IMMEDIATE MQTs into incremental MQTs with your choice of staging tables.
- Indexes that are recommended for MQTs are designed to improve workload performance, not MQT refresh performance.
- If update, insert, or delete operations are not included in the workload, the performance impact of updating a recommended REFRESH IMMEDIATE MQT is not considered.
- It is recommended that REFRESH IMMEDIATE MQTs have unique indexes created on the implied unique key, which is composed of the columns in the GROUP BY clause of the MQT query definition.

### Restrictions on MDC recommendations

- An existing table must be populated with sufficient data before the Design Advisor considers MDC for the table. A minimum of twenty to thirty megabytes of data is recommended. Tables that are smaller than 12 extents are excluded from consideration.
- MDC recommendations for new MQTs will not be considered unless the sampling option, -r, is used with the **db2adv** command.
- The Design Advisor does not make MDC recommendations for typed, temporary, or federated tables.
- Sufficient storage space (approximately 1% of the table data for large tables) must be available for the sampling data that is used during the execution of the **db2adv** command.
- Tables that have not had statistics collected are excluded from consideration.
- The Design Advisor does not make recommendations for multicolumn dimensions.

### Restrictions on database partitioning recommendations

The Design Advisor can recommend database partitioning only for DB2 Enterprise Server Edition.

### Additional restrictions

Temporary simulation catalog tables are created when the Design Advisor runs. An incomplete run can result in some of these tables not being dropped. In this situation, you can use the Design Advisor to drop these tables by restarting the utility. To remove the simulation catalog tables, specify both the -f option and the -n option (for -n, specifying the same user name that was used for the incomplete execution). If you do not specify the -f option, the Design Advisor will only generate the DROP statements that are required to remove the tables; it will not actually remove them.

**Note:** As of Version 9.5, the -f option is the default. This means that if you run **db2adv** with the MQT selection, the database manager automatically drops all local simulation catalog tables using the same user ID as the schema name.

You should create a separate table space on the catalog database partition for storing these simulated catalog tables, and set the `DROPPED TABLE RECOVERY` option on the `CREATE` or `ALTER TABLESPACE` statement to `OFF`. This enables easier cleanup and faster Design Advisor execution.



---

## Part 2. Techniques for troubleshooting problems

The first step in good problem analysis is to describe the problem completely. Without a problem description, you will not know where to start investigating the cause of the problem.

This step includes asking yourself such basic questions as:

- What are the symptoms?
- Where is the problem happening?
- When does the problem happen?
- Under which conditions does the problem happen?
- Is the problem reproducible?

Answering these and other questions will lead to a good description to most problems, and is the best way to start down the path of problem resolution.

### What are the symptoms?

When starting to describe a problem, the most obvious question is "What is the problem?" This might seem like a straightforward question; however, it can be broken down into several other questions to create a more descriptive picture of the problem. These questions can include:

- Who or what is reporting the problem?
- What are the error codes and error messages?
- How does it fail? For example: loop, hang, stop, performance degradation, incorrect result.
- What is the affect on business?

### Where is the problem happening?

Determining where the problem originates is not always easy, but it is one of the most important steps in resolving a problem. Many layers of technology can exist between the reporting and failing components. Networks, disks, and drivers are only a few components to be considered when you are investigating problems.

- Is the problem platform specific, or common to multiple platforms?
- Is the current environment and configuration supported?
- Is the application running locally on the database server or on a remote server?
- Is there a gateway involved?
- Is the database stored on individual disks, or on a RAID disk array?

These types of questions will help you isolate the problem layer, and are necessary to determine the problem source. Remember that just because one layer is reporting a problem, it does not always mean the root cause exists there.

Part of identifying where a problem is occurring is understanding the environment in which it exists. You should always take some time to completely describe the problem environment, including the operating system, its version, all corresponding software and versions, and hardware information. Confirm you are running within an environment that is a supported configuration, as many problems can be explained by discovering software levels that are not meant to run

together, or have not been fully tested together.

### **When does the problem happen?**

Developing a detailed time line of events leading up to a failure is another necessary step in problem analysis, especially for those cases that are one-time occurrences. You can most easily do this by working backwards --start at the time an error was reported (as exact as possible, even down to milliseconds), and work backwards through available logs and information. Usually you only have to look as far as the first suspicious event that you find in any diagnostic log, however, this is not always easy to do and will only come with practice. Knowing when to stop is especially difficult when there are multiple layers of technology each with its own diagnostic information.

- Does the problem only happen at a certain time of day or night?
- How often does it happen?
- What sequence of events leads up to the time the problem is reported?
- Does the problem happen after an environment change such as upgrading existing or installing new software or hardware?

Responding to questions like this will help you create a detailed time line of events, and will provide you with a frame of reference in which to investigate.

### **Under which conditions does the problem happen?**

Knowing what else is running at the time of a problem is important for any complete problem description. If a problem occurs in a certain environment or under certain conditions, that can be a key indicator of the problem cause.

- Does the problem always occur when performing the same task?
- Does a certain sequence of events need to occur for the problem to surface?
- Do other applications fail at the same time?

Answering these types of questions will help you explain the environment in which the problem occurs, and correlate any dependencies. Remember that just because multiple problems might have occurred around the same time, it does not necessarily mean that they are always related.

### **Is the problem reproducible?**

From a problem description and investigation standpoint, the "ideal" problem is one that is reproducible. With reproducible problems you almost always have a larger set of tools or procedures available to use to help your investigation. Consequently, reproducible problems are usually easier to debug and solve.

However, reproducible problems can have a disadvantage: if the problem is of significant business impact, you don't want it recurring. If possible, recreating the problem in a test or development environment is often preferable in this case.

- Can the problem be recreated on a test machine?
- Are multiple users or applications encountering the same type of problem?
- Can the problem be recreated by running a single command, a set of commands, or a particular application, or a stand-alone application?
- Can the problem be recreated by entering the equivalent command/query from a DB2 command line?

Recreating a single incident problem in a test or development environment is often preferable, as there is usually much more flexibility and control when investigating.



---

## Chapter 5. Tools for troubleshooting

Tools are available to help collect, format or analyze diagnostic data.

---

### Checking archive log files with the **db2cklog** tool

Checking your archive log files ensures that known good log files are available in case a rollforward recovery becomes necessary and that the recovery operation does not fail because of a problem with a log file. The information in this topic tells you how to check log files with the **db2cklog** tool, and what to do if a log file does fail validation.

#### Before you begin

You need to have read permission on the archive log files, so that the **db2cklog** tool can read the log files and perform its checks. Only log files that are closed, such as archive log files, can be validated successfully. If you run the tool on a log file that is still active, the tool cannot check that file accurately and you will receive a warning to let you know that the file is still active.

#### About this task

The **db2cklog** tool reads either single log files or a range of numbered log files and performs checks on the internal validity of the files. Log files that pass validation without any error messages or warnings are known good files and you can use them during a rollforward recovery operation. If an archive log file fails validation with an error message or if a warning is returned, then you must not use that log file during rollforward recovery. An archive log file that fails validation cannot be repaired and you should follow the response outlined in this task for what to do next.

Checking your archive log files is useful in the following scenarios:

- Immediately before a rollforward operation is started: If it becomes necessary to perform a rollforward recovery operation, you can first run the **db2cklog** tool against all the archive log files that are required to perform the rollforward operation to ensure that the log files are valid. Running the **db2cklog** tool against the log files beforehand helps avoid a situation where a recovery operation fails partway through because of a problem with a log file, necessitating a follow-on recovery operation.
- Every time a log file is closed and copied to the log archive directory: As part of your day-to-day operations, archive log files can be checked as an added precaution to make sure that known good log files are always available. With this preventive measure, you know right away whether you need to locate a copy of a log file or if a full database backup to establish a new recovery point is needed. This helps to reduce any delay in the event that a rollforward recovery becomes necessary.

#### Procedure

To check your archive log files, you issue the **db2cklog** command from the command line and include the log file or files you want checked. Note that you do not specify full log file names with the **db2cklog** command but only the numeric identifiers that are part of the log file names. The numeric identifier of the

S0000001.LOG log file is 1, for example; to check that log file, you specify `db2cklog 1`. If the archive log files are not in the current directory, include the relative or absolute path to the log files with the optional **ARCHLOGPATH** parameter.

1. If you want to check the validity of a single archive log file, you specify the numeric identifier of that log file as *log-file-number1* with the command. For example, to check the validity of the S0000000.LOG log file in the `/home/amytang/tests` directory, you issue the command `db2cklog 0 ARCHLOGPATH /home/amytang/tests`.
2. If you want to check the validity of a range of archive log files, you include the first and last numeric identifier of that range with the command (from *log-file-number1* to *log-file-number2*). All log files in the range are checked, unless the upper end of the range specified with *log-file-number2* is numerically lower than the beginning of the range (specified with *log-file-number1*). In that case, only *log-file-number1* is checked. For example, to check the validity of the log files ranging from S0000000.LOG to S0000005.LOG in the `/home/nrichers/tests` directory, you issue the command `db2cklog 0 TO 5 ARCHLOGPATH /home/nrichers/tests`

## Results

The **db2cklog** tool will return a return code of zero for any file that passes validation. If a range of numbered archive log files is specified, the **db2cklog** tool will read each file in sequence, perform its checks and issue a return code for each file. The tool stops at the first error it encounters, even if a range of log files was specified and there are additional files the tool has not yet checked. The DBT message that is returned when an error is found can provide you with some more information about why an archive log file failed validation, but you cannot fix an invalid log file. If you receive a DBT warning message that a log file might still be active but know for certain that the file is an archive log file, then you should treat the archive log file as invalid and follow the response for what to do next outlined in this task.

## Example

The following example shows the typical output of the **db2cklog** command as it parses a log file, in this case S0000002.LOG. This file passes validation with a return code of zero.

```
$ db2cklog 2
```

---

```
          _____
          |           |
          |   D B 2 C K L O G   |
          |           |
          |_____|
          |
          | DB2 Check Log File tool
          |   I   B   M
          |_____|
```

```
          |
          | The db2cklog tool is a utility can be used to test the integrity
          | of an archive log file and to determine whether or not the log file
          | can be used in the rollforward database command.
          |_____|
```

---

```
=====
"db2cklog": Processing log file header of "S0000002.LOG"
```

```

"db2cklog": Processing log pages of "S0000002.LOG" (total log pages: "316840")
==> page "1" ...
==> page "25001" ...
==> page "50001" ...
==> page "75001" ...
==> page "100001" ...
==> page "125001" ...
==> page "150001" ...
==> page "175001" ...
==> page "200001" ...
==> page "225001" ...
==> page "250001" ...
==> page "275001" ...
==> page "300001" ...

```

```

"db2cklog": Finished processing log file "S0000002.LOG". Return code: "0".
=====

```

## What to do next

If an archive log file fails validation, your response depends on whether or not you have a copy of the log file that can pass validation by the **db2cklog** tool. If you are not sure whether you have a copy of the log file, check the setting for the **logarchmeth2** configuration parameter, which determines whether your database server archives a secondary copy of each log file. If you are validating logs as they are being archived and log mirroring is also configured on your data server, you might still be able to locate a copy of the log file in the log mirror path, as your data server does not recycle log files immediately after archiving.

- If you have a copy of the archive log file, use the **db2cklog** command against that copy. If the copy of the log file passes validation, replace the log file that cannot be read with the valid copy of the log file.
- If you have only one copy of the archive log file and that copy cannot be validated, the log file is beyond repair and cannot be used for rollforward recovery purposes. In this case, you must make a full database backup as soon as possible to establish a new, more recent recovery point that does not depend on the unusable log file for rollforward recovery.

---

## Overview of the db2dart tool

The **db2dart** command can be used to verify the architectural correctness of databases and the objects within them. It can also be used to display the contents of database control files in order to extract data from tables that might otherwise be inaccessible.

To display all of the possible options, issue the **db2dart** command without any parameters. Some options that require parameters, such as the table space ID, are prompted for if they are not explicitly specified on the command line.

By default, the **db2dart** utility will create a report file with the name `databaseName.RPT`. For single-partition database partition environments, the file is created in the current directory. For multiple-partition database partition environments, the file is created under a subdirectory in the diagnostic directory. The subdirectory is called `DART####`, where `####` is the database partition number.

In a DB2 pureScale environment, some metadata files (such as bufferpool configuration files) exist for each member and are validated or updated on a per-member basis (rather than per-database).

The **db2dart** utility accesses the data and metadata in a database by reading them directly from disk. Because of that, you should never run the tool against a database that still has active connections. If there are connections, the tool will not know about pages in the buffer pool or control structures in memory, for example, and might report false errors as a result. Similarly, if you run **db2dart** against a database that requires crash recovery or that has not completed rollforward recovery, similar inconsistencies might result due to the inconsistent nature of the data on disk.

## Comparison of INSPECT and db2dart

The **INSPECT** command inspects a database for architectural integrity, checking the pages of the database for page consistency. The **INSPECT** command checks that the structures of table objects and structures of table spaces are valid. Cross object validation conducts an online index to data consistency check. The **db2dart** command examines databases for architectural correctness and reports any encountered errors.

The **INSPECT** command is similar to the **db2dart** command in that it allows you to check databases, table spaces, and tables. A significant difference between the two commands is that the database needs to be deactivated before you run **db2dart**, whereas **INSPECT** requires a database connection and can be run while there are simultaneous active connections to the database.

If you do not deactivate the database, **db2dart** will yield unreliable results.

The following tables list the differences between the tests that are performed by the **db2dart** and **INSPECT** commands.

*Table 83. Feature comparison of db2dart and INSPECT for table spaces*

Tests performed	db2dart	INSPECT
<b>SMS table spaces</b>		
Check table space files	YES	NO
Validate contents of internal page header fields	YES	YES
<b>DMS table spaces</b>		
Check for extent maps pointed at by more than one object	YES	NO
Check every extent map page for consistency bit errors	NO	YES
Check every space map page for consistency bit errors	NO	YES
Validate contents of internal page header fields	YES	YES
Verify that extent maps agree with table space maps	YES	NO

*Table 84. Feature comparison of db2dart and INSPECT for data objects*

Tests performed	db2dart	INSPECT
Check data objects for consistency bit errors	YES	YES



Table 84. Feature comparison of db2dart and INSPECT for data objects (continued)

Tests performed	db2dart	INSPECT
Check the contents of special control rows	YES	NO
Check the length and position of variable length columns	YES	NO
Check the LONG VARCHAR, LONG VARGRAPHIC, and large object (LOB) descriptors in table rows	YES	NO
Check the summary total pages, used pages and free space percentage	NO	YES
Validate contents of internal page header fields	YES	YES
Verify each row record type and its length	YES	YES
Verify that rows are not overlapping	YES	YES

Table 85. Feature comparison of db2dart and INSPECT for index objects

Tests performed	db2dart	INSPECT
Check for consistency bit errors	YES	YES
Check the location and length of the index key and whether there is overlapping	YES	YES
Check the ordering of keys in the index	YES	NO
Determine the summary total pages and used pages	NO	YES
Validate contents of internal page header fields	YES	YES
Verify the uniqueness of unique keys	YES	NO
Check for the existence of the data row for a given index entry	NO	YES
Verify each key to a data value	NO	YES

Table 86. Feature comparison of db2dart and INSPECT for block map objects

Tests performed	db2dart	INSPECT
Check for consistency bit errors	YES	YES
Determine the summary total pages and used pages	NO	YES

Table 86. Feature comparison of db2dart and INSPECT for block map objects (continued)

Tests performed	db2dart	INSPECT
Validate contents of internal page header fields	YES	YES

Table 87. Feature comparison of db2dart and INSPECT for long field and LOB objects

Tests performed	db2dart	INSPECT
Check the allocation structures	YES	YES
Determine the summary total pages and used pages (for LOB objects only)	NO	YES

In addition, the following actions can be performed using the **db2dart** command:

- Format and dump data pages
- Format and dump index pages
- Format data rows to delimited ASCII
- Mark an index invalid

The **INSPECT** command cannot be used to perform those actions.

---

## Analyzing db2diag log files using db2diag tool

The primary log file intended for use by database and system administrators is the administration notification log. The **db2diag** log files are intended for use by IBM Software Support for troubleshooting purposes.

Administration notification log messages are also logged to the **db2diag** log files using a standardized message format.

The **db2diag** tool serves to filter and format the volume of information available in the **db2diag** log files. Filtering **db2diag** log file records can reduce the time required to locate the records needed when troubleshooting problems.

### Example 1: Filtering the db2diag log files by database name

If there are several databases in the instance, and you want to only see those messages which pertain to the database "SAMPLE", you can filter the **db2diag** log files as follows:

```
db2diag -g db=SAMPLE
```

Thus you would only see **db2diag** log file records that contained "DB: SAMPLE", such as:

```
2006-02-15-19.31.36.114000-300 E21432H406          LEVEL: Error
PID      : 940                TID   : 660          PROC  : db2syscs.exe
INSTANCE: DB2                NODE  : 000          DB    : SAMPLE
APPHDL   : 0-1056            APPID: *LOCAL.DB2.060216003103
FUNCTION: DB2 UDB, base sys utilities, sqlDatabaseQuiesce, probe:2
MESSAGE  : ADM7507W Database quiesce request has completed successfully.
```

## Example 2: Filtering the db2diag log files by process ID

The following command can be used to display all severe error messages produced by processes running on partitions 0,1,2, or 3 with the process ID (PID) 2200:

```
db2diag -g level=Severe,pid=2200 -n 0,1,2,3
```

Note that this command could have been written a couple of different ways, including **db2diag -l severe -pid 2200 -n 0,1,2,3**. It should also be noted that the **-g** option specifies case-sensitive search, so here "Severe" will work but will fail if "severe" is used. These commands would successfully retrieve **db2diag** log file records which meet these requirements, such as:

```
2006-02-13-14.34.36.027000-300 I18366H421          LEVEL: Severe
PID       : 2200                TID : 660      PROC : db2syscs.exe
INSTANCE: DB2                  NODE : 000     DB  : SAMPLE
APPHDL   : 0-1433              APPID: *LOCAL.DB2.060213193043
FUNCTION: DB2 UDB, data management, sqlPoolCreate, probe:273
RETCODE  : ZRC=0x8002003C=-2147352516=SQLB_BAD_CONTAINER_PATH
          "Bad container path"
```

## Example 3: Formatting the db2diag tool output

The following command filters all records occurring after January 1, 2006 containing non-severe and severe errors logged on partitions 0,1 or 2. It outputs the matched records such that the time stamp, partition number and level appear on the first line, pid, tid and instance name on the second line, and the error message follows thereafter:

```
db2diag -time 2006-01-01 -node "0,1,2" -level "Severe, Error" | db2diag -fmt
"Time: %{ts}
Partition: %node Message Level: %{level} \nPid: %{pid} Tid: %{tid}
Instance: %instance\nMessage: @{msg}\n"
```

An example of the output produced is as follows:

```
Time: 2006-02-15-19.31.36.099000 Partition: 000 Message Level: Error
Pid: 940 Tid:940 Instance: DB2
Message: ADM7506W Database quiesce has been requested.
```

For more information, issue the following commands:

- **db2diag -help** provides a short description of all available options
- **db2diag -h brief** provides descriptions for all options without examples
- **db2diag -h notes** provides usage notes and restrictions
- **db2diag -h examples** provides a small set of examples to get started
- **db2diag -h tutorial** provides examples for all available options
- **db2diag -h all** provides the most complete list of options

## Example 4: Filtering messages from different facilities

The following examples show how to only see messages from a specific facility (or from all of them) from within the database manager. The supported facilities are:

- ALL which returns records from all facilities
- MAIN which returns records from DB2 general diagnostic logs such as the **db2diag** log files and the administration notification log
- OPTSTATS which returns records related to optimizer statistics

To read messages from the MAIN facility:

```
db2diag -facility MAIN
```

To display messages from the OPTSTATS facility and filter out records having a level of Severe:

```
db2diag -fac OPTSTATS -level Severe
```

To display messages from all facilities available and filter out records having instance=harmistr and level=Error:

```
db2diag -fac all -g instance=harmistr,level=Error
```

To display all messages from the OPTSTATS facility having a level of Error and then outputting the Timestamp and PID field in a specific format:

```
db2diag -fac optstats -level Error -fmt " Time :%{ts} Pid :%{pid}"
```

### Example 5: Merging files and sorting records according to timestamps

This example shows how to merge two or more **db2diag** log files and sort the records according to timestamps.

The two **db2diag** log files to merge are the following:

- db2diag.0.log; contains records of Level:Error with the following timestamps:
  - 2009-02-26-05.28.49.822637
  - 2009-02-26-05.28.49.835733
  - 2009-02-26-05.28.50.258887
  - 2009-02-26-05.28.50.259685
- db2diag.1.log; contains records of Level:Error with the following timestamps:
  - 2009-02-26-05.28.11.480542
  - 2009-02-26-05.28.49.764762
  - 2009-02-26-05.29.11.872184
  - 2009-02-26-05.29.11.872968

To merge the two diagnostic log files and sort the records according to timestamps, execute the following command:

```
db2diag -merge db2diag.0.log db2diag.1.log -fmt %{ts} -level error
```

The result of the merge and sort of the records is the following:

- 2009-02-26-05.28.11.480542
- 2009-02-26-05.28.49.764762
- 2009-02-26-05.28.49.822637
- 2009-02-26-05.28.49.835733
- 2009-02-26-05.28.50.258887
- 2009-02-26-05.28.50.259685
- 2009-02-26-05.29.11.872184
- 2009-02-26-05.29.11.872968

where the timestamps are merged and sorted chronologically.

### Example 6: Merging diagnostic directory path files from a single host and sorting records by timestamps

By default, each member and CF log to a different **db2diag** log file. The following is a list of the three **db2diag** log files to merge:

- ~/sql11ib/db2dump/DIAG0000/db2diag.log
- ~/sql11ib/db2dump/DIAG0001/db2diag.log
- ~/sql11ib/db2dump/DIAG0002/db2diag.log

To merge the three diagnostic log files and sort the records according to timestamps, execute the following command:

```
db2diag -merge
```

### Example 7: Merging diagnostic directory path files from multiple hosts and database partitions

This example shows how to obtain an output of all the records from all the diagnostic logs and merge the diagnostic log files from three database partitions on each of two hosts, bower and horton. The following is a list of the six **db2diag** log files:

- ~/sql11ib/db2dump/HOST\_bower/DIAG0000/db2diag.log
- ~/sql11ib/db2dump/HOST\_bower/DIAG0001/db2diag.log
- ~/sql11ib/db2dump/HOST\_bower/DIAG0002/db2diag.log
- ~/sql11ib/db2dump/HOST\_horton/DIAG0003/db2diag.log
- ~/sql11ib/db2dump/HOST\_horton/DIAG0004/db2diag.log
- ~/sql11ib/db2dump/HOST\_horton/DIAG0005/db2diag.log

To output the records from all six **db2diag** log files, run the following command:

```
db2diag -global
```

To merge all six **db2diag** log files in the diagnostic data directory path from all three database partitions on each of the hosts bower and horton and format the output based on the timestamp, execute the following command:

```
db2diag -global -merge -sdir /temp/keon -fmt %{ts}
```

where /temp/keon is a shared directory, shared by the hosts bower and horton, to store temporary merged files from each host during processing.

### Example 8: Filtering and merging only recent diagnostic log entries

In this example, **db2diag** log file records are filtered to display only a specific number of recent entries. To display the last 5 formatted records for each of the 3 partitions in a partitioned database environment, merged and formatted by timestamp, enter:

```
db2diag -lastrecords 5 -global -merge -sdir /home/vbmithun -fmt %{ts}
```

```
2010-10-08-04.46.02.092192
2010-10-08-04.46.02.092821
2010-10-08-04.46.02.093497
2010-10-08-04.46.02.094431
2010-10-08-04.46.02.095317
2010-10-08-04.46.05.068648
2010-10-08-04.46.05.069212
2010-10-08-04.46.05.069900
2010-10-08-04.46.05.071008
2010-10-08-04.46.05.071831
2010-10-08-04.46.07.302051
```

```
2010-10-08-04.46.07.302727
2010-10-08-04.46.07.303544
2010-10-08-04.46.07.304647
2010-10-08-04.46.07.305391
```

You can also filter recent diagnostic log records further to return only messages of a specific level. For example, to return only those records in the last 10 records that have a severe message level, enter:

```
$ db2diag db2diag.log -lastrecords 10 -level Severe -fmt %{ts}
```

```
2010-08-11-04.11.33.733807
2010-08-11-04.11.33.735398
```

### Example 9: Archiving the db2diag log files on an instance-less client

You can use the **db2diag -archive** (or **-A**) option, which is available with IBM Data Server Driver Package and IBM Data Server for ODBC and CLI, to archive the diagnostic log file on an instance-less client. For example:

```
$ db2diag -A
db2diag: Moving "/home/usr1/clidriver/db2dump/db2diag.log"
to "/home/usr1/clidriver/db2dump/db2diag.log_2010-09-14-01.16.26"
```

If you specify options other than **-archive** or **-A**, an error message is returned. For example:

```
$ db2diag -x
db2diag: Unrecognized option: -x

$ db2diag -pid 1234
db2diag: Unrecognized option: -pid
```

---

## Displaying and altering the global registry (UNIX) using db2greg

You can view the global registry using the **db2greg** command on UNIX and Linux platforms.

In DB2 Version 9.7 and higher, the DB2 global profile registries are not recorded in the text file <DB2DIR>/default.env. The global registry file `global.reg` is now used to register the DB2 global profile settings related to the current DB2 installation.

The global registry exists only on UNIX and Linux platforms:

- For root installations, the global registry file is located at `/var/db2/global.reg` (`/var/opt/db2/global.reg` on HP-UX).
- For non-root installations, the global registry file is located at `$HOME/sql1lib/global.reg`, where `$HOME` is the non-root user's home directory.

The global registry consists of three different record types:

- "Service": Service records contain information at the product level - for example, version, and install path.
- "Instance": Instance records contain information at the instance level - for example, Instance name, instance path, version, and the "start-at-boot" flag.
- "Variable": Variable records contain information at the variable level - for example, Variable name, Variable value.
- Comment.

You can view the global registry with the **db2greg** tool. This tool is located in `sqllib/bin`, and in the `install` directory under `bin` as well (for use when logged in as root).

You can edit the global registry with the **db2greg** tool. Editing the global registry in root installations requires root authority.

Only use the **db2greg** in specific cases as instructed, or when requested to do so by IBM Software Support. Incorrect usage of this command can damage the global registry.

---

## Identifying the version and service level of your product

The **db2level** command will help you determine the version and service level (build level and fix pack number) of your DB2 instance.

To determine if your DB2 instance is at the latest service level, compare your `db2level` output to information in the fix pack download pages at the DB2 Support website: [www.ibm.com/support/docview.wss?rs=71&uid=swg27007053](http://www.ibm.com/support/docview.wss?rs=71&uid=swg27007053).

A typical result of running the **db2level** command on a Windows system would be:

```
DB21085I Instance "DB2" uses "32" bits and DB2 code release "SQL09010" with
level identifier "01010107".
Informational tokens are "DB2 v9.1.0.189", "n060119", "", and Fix Pack "0".
Product is installed at "c:\SQLLIB" with DB2 Copy Name "db2build".
```

The combination of the four informational tokens uniquely identify the precise service level of your DB2 instance. This information is essential when contacting IBM Software Support for assistance.

For JDBC or SQLJ applications, if you are using the IBM DB2 Driver for SQLJ and JDBC, you can determine the level of the driver by running the `db2jcc` utility:

```
db2jcc -version
```

```
IBM DB2 JDBC Driver Architecture 2.3.63
```

---

## Mimicking databases using db2look

There are many times when it is advantageous to be able to create a database that is similar in structure to another database. For example, rather than testing out new applications or recovery plans on a production system, it makes more sense to create a test system that is similar in structure and data, and to then do the tests against it instead.

This way, the production system will not be affected by the adverse performance impact of the tests or by the accidental destruction of data by an errant application. Also, when you are investigating a problem (such as invalid results, performance issues, and so on), it might be easier to debug the problem on a test system that is identical to the production system.

You can use the **db2look** tool to extract the required DDL statements needed to reproduce the database objects of one database in another database. The tool can also generate the required SQL statements needed to replicate the statistics from the one database to the other, as well as the statements needed to replicate the database configuration, database manager configuration, and registry variables.

This is important because the new database might not contain the exact same set of data as the original database but you might still want the same access plans chosen for the two systems. The **db2look** command should only be issued on databases running on DB2 Servers of Version 9.5 and higher levels.

The **db2look** tool is described in detail in the *DB2 Command Reference* but you can view the list of options by executing the tool without any parameters. A more detailed usage can be displayed using the **-h** option.

## Using db2look to mimic the tables in a database

To extract the DDL for the tables in the database, use the **-e** option. For example, create a copy of the SAMPLE database called SAMPLE2 such that all of the objects in the first database are created in the new database:

```
C:\>db2 create database sample2
DB20000I The CREATE DATABASE command completed successfully.
C:\>db2look -d sample -e > sample.ddl
-- USER is:
-- Creating DDL for table(s)
-- Binding package automatically ...
-- Bind is successful
-- Binding package automatically ...
-- Bind is successful
```

**Note:** If you want the DDL for the user-defined spaces, database partition groups and buffer pools to be produced as well, add the **-l** flag after **-e** in the preceding command. The default database partition groups, buffer pools, and table spaces will not be extracted. This is because they already exist in every database by default. If you want to mimic these, you must alter them yourself manually.

Bring up the file `sample.ddl` in a text editor. Since you want to run the DDL in this file against the new database, you must change the `CONNECT TO SAMPLE` statement to `CONNECT TO SAMPLE2`. If you used the **-l** option, you might need to alter the path associated with the table space commands, such that they point to appropriate paths as well. While you are at it, take a look at the rest of the contents of the file. You should see `CREATE TABLE`, `ALTER TABLE`, and `CREATE INDEX` statements for all of the user tables in the sample database:

```
...
-----
-- DDL Statements for table "DB2"."ORG"
-----

CREATE TABLE "DB2"."ORG" (
  "DEPTNUMB" SMALLINT NOT NULL ,
  "DEPTNAME" VARCHAR(14) ,
  "MANAGER" SMALLINT ,
  "DIVISION" VARCHAR(10) ,
  "LOCATION" VARCHAR(13) )
  IN "USERSPACE1" ;
...

```

Once you have changed the connect statement, run the statements, as follows:

```
C:\>db2 -tvf sample.ddl > sample2.out
```

Take a look at the `sample2.out` output file -- everything should have been executed successfully. If errors have occurred, the error messages should state what the problem is. Fix those problems and run the statements again.



As you can see in the output, DDL for all of the user tables are exported. This is the default behavior but there are other options available to be more specific about the tables included. For example, to only include the STAFF and ORG tables, use the **-t** option:

```
C:\>db2look -d sample -e -t staff org > staff_org.ddl
```

To only include tables with the schema DB2, use the **-z** option:

```
C:\>db2look -d sample -e -z db2 > db2.ddl
```

## Mimicking statistics for tables

If the intent of the test database is to do performance testing or to debug a performance problem, it is essential that access plans generated for both databases are identical. The optimizer generates access plans based on statistics, configuration parameters, registry variables, and environment variables. If these things are identical between the two systems then it is very likely that the access plans will be the same.

If both databases have the exact same data loaded into them and the same options of RUNSTATS is performed on both, the statistics should be identical. However, if the databases contain different data or if only a subset of data is being used in the test database then the statistics will likely be very different. In such a case, you can use **db2look** to gather the statistics from the production database and place them into the test database. This is done by creating UPDATE statements against the SYSSTAT set of updatable catalog tables as well as RUNSTATS commands against all of the tables.

The option for creating the statistic statements is **-m**. Going back to the SAMPLE/SAMPLE2 example, gather the statistics from SAMPLE and add them into SAMPLE2:

```
C:\>db2look -d sample -m > stats.dml
-- USER is:
-- Running db2look in mimic mode
```

As before, the output file must be edited such that the CONNECT TO SAMPLE statement is changed to CONNECT TO SAMPLE2. Again, take a look at the rest of the file to see what some of the RUNSTATS and UPDATE statements contain:

```
...
-- Mimic table ORG
RUNSTATS ON TABLE "DB2"."ORG" ;

UPDATE SYSSTAT.INDEXES
SET NLEAF=-1,
    NLEVELS=-1,
    FIRSTKEYCARD=-1,
    FIRST2KEYCARD=-1,
    FIRST3KEYCARD=-1,
    FIRST4KEYCARD=-1,
    FULLKEYCARD=-1,
    CLUSTERFACTOR=-1,
    CLUSTERRATIO=-1,
    SEQUENTIAL_PAGES=-1,
    PAGE_FETCH_PAIRS='',
    DENSITY=-1,
    AVERAGE_SEQUENCE_GAP=-1,
    AVERAGE_SEQUENCE_FETCH_GAP=-1,
    AVERAGE_SEQUENCE_PAGES=-1,
    AVERAGE_SEQUENCE_FETCH_PAGES=-1,
    AVERAGE_RANDOM_PAGES=-1,
```

```

    AVERAGE_RANDOM_FETCH_PAGES=-1,
    NUMRIDS=-1,
    NUMRIDS_DELETED=-1,
    NUM_EMPTY_LEAFS=-1
WHERE TABNAME = 'ORG' AND TABSCHEMA = 'DB2  ';
...

```

As with the **-e** option that extracts the DDL, the **-t** and **-z** options can be used to specify a set of tables.

## Extracting configuration parameters and environment variables

The optimizer chooses plans based on statistics, configuration parameters, registry variables, and environment variables. As with the statistics, **db2look** can be used to generate the necessary configuration update and set statements. This is done using the **-f** option. For example:

```

c:\>db2look -d sample -f>config.txt
-- USER is: DB2INST1
-- Binding package automatically ...
-- Bind is successful
-- Binding package automatically ...
-- Bind is successful

```

The config.txt contains output similar to the following example:

```

-- This CLP file was created using DB2LOOK Version 9.1
-- Timestamp: 2/16/2006 7:15:17 PM
-- Database Name: SAMPLE
-- Database Manager Version: DB2/NT Version 9.1.0
-- Database Codepage: 1252
-- Database Collating Sequence is: UNIQUE

CONNECT TO SAMPLE;

-----
-- Database and Database Manager configuration parameters
-----

UPDATE DBM CFG USING cpuspeed 2.991513e-007;
UPDATE DBM CFG USING intra_parallel NO;
UPDATE DBM CFG USING comm_bandwidth 100.000000;
UPDATE DBM CFG USING federated NO;

...

-----
-- Environment Variables settings
-----

COMMIT WORK;

CONNECT RESET;

```

**Note:** Only those parameters and variables that affect DB2 compiler will be included. If a registry variable that affects the compiler is set to its default value, it will not show up under "Environment Variables settings".

---

## Listing DB2 database products installed on your system (Linux and UNIX)

On supported Linux and UNIX operating systems, the **db21s** command lists the DB2 database products and features installed on your system, including the DB2 Version 10.1 HTML documentation.

### Before you begin

At least one DB2 Version 9 (or later) database product must already be installed by a root user for a symbolic link to the **db21s** command to be available in the `/usr/local/bin` directory.

### About this task

With the ability to install multiple copies of DB2 database products on your system and the flexibility to install DB2 database products and features in the path of your choice, you need a tool to help you keep track of what is installed and where it is installed. On supported Linux and UNIX operating systems, the **db21s** command lists the DB2 products and features installed on your system, including the DB2 HTML documentation.

The **db21s** command can be found both in the installation media and in a DB2 install copy on the system. The **db21s** command can be run from either location. The **db21s** command can be run from the installation media for all products except IBM Data Server Driver Package.

The **db21s** command can be used to list:

- Where DB2 database products are installed on your system and list the DB2 database product level
- All or specific DB2 database products and features in a particular installation path

### Restrictions

The output that the **db21s** command lists is different depending on the ID used:

- When the **db21s** command is run with root authority, only root DB2 installations are queried.
- When the **db21s** command is run with a non-root ID, root DB2 installations and the non-root installation owned by matching non-root ID are queried. DB2 installations owned by other non-root IDs are not queried.

The **db21s** command is the only method to query a DB2 database product. You *cannot* query DB2 database products using Linux or UNIX operating system native utilities, such as **pkginfo**, **rpm**, **SMIT**, or **swlist**. Any existing scripts containing a native installation utility that you use to query and interface with DB2 installations must change.

You *cannot* use the **db21s** command on Windows operating systems.

### Procedure

- To list the path where DB2 database products are installed on your system and list the DB2 database product level, enter:

```
db21s
```

The command lists the following information for each DB2 database product installed on your system:

- Installation path
- Level
- Fix pack
- Special Install Number. This column is used by IBM DB2 Support.
- Installation date. This column shows when the DB2 database product was last modified.
- Installer UID. This column shows the UID with which the DB2 database product was installed.
- To list information about DB2 database products or features in a particular installation path the **q** parameter must be specified:

```
db2ls -q -p -b baseInstallDirectory
```

where:

- **q** specifies that you are querying a product or feature. This parameter is mandatory.
- **p** specifies that the listing displays products rather than listing the features.
- **b** specifies the installation directory of the product or feature. This parameter is mandatory if you are not running the command from the installation directory.

## Results

Depending on the parameters provided, the command lists the following information:

- Installation path. This is specified only once, not for each feature.
- The following information is displayed:
  - Response file ID for the installed feature, or if the **p** option is specified, the response file ID for the installed product. For example, ENTERPRISE\_SERVER\_EDITION.
  - Feature name, or if the **p** option is specified, product name.
  - Product version, release, modification level, fix pack level (VRMF). For example, 10.1.0.0
  - Fix pack, if applicable. For example, if Fix Pack 1 is installed, the value displayed is 1. This includes interim fix packs, such as Fix Pack 1a.
- If any of the product's VRMF information do not match, a warning message displays at the end of the output listing. The message suggests the fix pack to apply.

---

## Monitoring and troubleshooting using db2pd command

The **db2pd** command is used for troubleshooting because it can return quick and immediate information from the DB2 memory sets.

### Overview

The tool collects information without acquiring any latches or using any engine resources. It is therefore possible (and expected) to retrieve information that is changing while **db2pd** is collecting information; hence the data might not be completely accurate. If changing memory pointers are encountered, a signal handler is used to prevent **db2pd** from ending abnormally. This can result in

messages such as "Changing data structure forced command termination" to appear in the output. Nonetheless, the tool can be helpful for troubleshooting. Two benefits to collecting information without latching include faster retrieval and no competition for engine resources.

If you want to capture information about the database management system when a specific SQLCODE, ZRC code or ECF code occurs, this can be accomplished using the **db2pdcfg -catch** command. When the errors are caught, the db2cos (callout script) is launched. The db2cos script can be dynamically altered to run any **db2pd** command, operating system command, or any other command needed to resolve the problems. The template db2cos script file is located in `sqllib/bin` on UNIX and Linux. On the Windows operating system, db2cos is located in the `$DB2PATH\bin` directory.

When adding a new node, you can monitor the progress of the operation on the database partition server, that is adding the node, using the **db2pd -addnode** command with the optional `oldviewapps` and `detail` parameters for more detailed information.

If you require a list of event monitors that are currently active or have been, for some reason, deactivated, run the **db2pd -gfw** command. This command also returns statistics and information about the targets, into which event monitors write data, for each fast writer EDU.

## Examples

The following list is a collection of examples in which the **db2pd** command can be used to expedite troubleshooting:

- Example 1: Diagnosing a lockwait
- Example 2: Using the **-wlocks** parameter to capture all the locks being waited on
- Example 3: Using the **-apinfo** parameter to capture detailed runtime information about the lock owner and the lock waiter
- Example 4: Using the callout scripts when considering a locking problem
- Example 5: Mapping an application to a dynamic SQL statement
- Example 6: Monitoring memory usage
- Example 7: Determine which application is using up your table space
- Example 8: Monitoring recovery
- Example 9: Determining the amount of resources a transaction is using
- Example 10: Monitoring log usage
- Example 11: Viewing the sysplex list
- Example 12: Generating stack traces
- Example 13: Viewing memory statistics for a database partition
- Example 14: Monitoring the progress of index reorganization
- Example 15: Displaying the top EDUs by processor time consumption and displaying EDU stack information
- Example 16: Displaying agent event metrics

### Example 1: Diagnosing a lockwait

If you run **db2pd -db databasename -locks -transactions -applications -dynamic**, the results are similar to the following ones:

```

Locks:
Address          TranHdl Lockname                                     Type Mode Sts Owner Dur HldCnt Att  ReleaseFlg
0x07800000202E5238 3          0002000200000040000000052 Row  ..X G  3    1  0    0x0000 0x40000000
0x07800000202E4668 2          0002000200000040000000052 Row  ..X W* 2    1  0    0x0000 0x40000000

```

For the database that you specified using the `-db` database name option, the first results show the locks for that database. The results show that TranHdl 2 is waiting on a lock held by TranHdl 3.

```

Transactions:
Address          AppHandl [nod-index] TranHdl Locks State Tflag Tflag2 FirstIsn LastIsn FirstIsr LastIsr LogSpace SpaceReserved...
0x0780000020251880 11 [000-00011] 2 4 READ 0x00000000 0x00000000 0x000000000000 0x000000000000 0x000000000000 0x000000000000 0 0 ...
0x0780000020252900 12 [000-00012] 3 4 WRITE 0x00000000 0x00000000 0x00000002AC04 0x00000002AC04 0x000000FA000C 0x000000FA000C 113 154 ...

```

We can see that TranHdl 2 is associated with AppHandl 11 and TranHdl 3 is associated with AppHandl 12.

```

Applications:
Address          AppHandl [nod-index] NumAgents CoordPid Status C-AnchID C-StmtUID L-AnchID L-StmtUID Appid
0x0780000006879E0 12 [000-00012] 1 1073336 UOW-Waiting 0 0 17 1 *LOCAL.burford.060303225602
0x078000000685E80 11 [000-00011] 1 1040570 UOW-Executing 17 1 94 1 *LOCAL.burford.060303225601

```

We can see that AppHandl 12 last ran dynamic statement 17, 1. AppHandl 11 is currently running dynamic statement 17, 1 and last ran statement 94, 1.

```

Dynamic SQL Statements:
Address          AnchID StmtUID NumEnv NumVar NumRef NumExe Text
0x07800000209FD800 17 1 1 1 2 2 update pdtest set c1 = 5
0x07800000209FC000 94 1 1 1 2 2 set lock mode to wait 1

```

We can see that the text column shows the SQL statements that are associated with the lock timeout.

**Example 2:** Using the `-wlocks` parameter to capture all the locks being waited on

If you run `db2pd -wlocks -db pdtest`, results similar to the following ones are generated. They show that the first application (AppHandl 47) is performing an insert on a table and that the second application (AppHandl 46) is performing a select on that table:

```

venus@boson:/home/venus =>db2pd -wlocks -db pdtest

Database Partition 0 -- Database PDTEST -- Active -- Up 0 days 00:01:22

Locks being waited on :
AppHandl [nod-index] TranHdl Lockname                                     Type Mode Conv Sts CoordEDU AppName AuthID AppID
47 [000-00047] 8 00020004000000000840000652 Row  ..X G 5160 db2bp VENUS *LOCAL.venus.071207213730
46 [000-00046] 2 00020004000000000840000652 Row  .NS W 5913 db2bp VENUS *LOCAL.venus.071207213658

```

**Example 3:** Using the `-apinfo` parameter to capture detailed runtime information about the lock owner and the lock waiter

The following sample output was generated under the same conditions as those for Example 2:

```

venus@boson:/home/venus =>db2pd -apinfo 47 -db pdtest

Database Partition 0 -- Database PDTEST -- Active -- Up 0 days 00:01:30

Application :
Address : 0x0780000001676480
AppHandl [nod-index] : 47 [000-00047]
Application PID : 876558
Application Node Name : boson
IP Address: n/a
Connection Start Time : (1197063450)Fri Dec 7 16:37:30 2007
Client User ID : venus
System Auth ID : VENUS
Coordinator EDU ID : 5160
Coordinator Partition : 0

```

```

Number of Agents :      1
Locks timeout value :  4294967294 seconds
Locks Escalation :    No
Workload ID :         1
Workload Occurrence ID : 2
Trusted Context :     n/a
Connection Trust Type : non trusted
Role Inherited :      n/a
Application Status :   UOW-Waiting
Application Name :     db2bp
Application ID :       *LOCAL.venus.071207213730

ClientUserID :         n/a
ClientWrkstnName :    n/a
ClientApplName :      n/a
ClientAcctng :        n/a

```

```

List of inactive statements of current UOW :
UOW-ID :              2
Activity ID :         1
Package Schema :     NULLID
Package Name :       SQLC2G13
Package Version :
Section Number :    203
SQL Type :          Dynamic
Isolation :         CS
Statement Type :    DML, Insert/Update/Delete
Statement :         insert into pdtest values 99

```

```
venus@boson:/home/venus =>db2pd -apinfo 46 -db pdtest
```

```
Database Partition 0 -- Database PDTEST -- Active -- Up 0 days 00:01:39
```

```

Application :
Address :              0x0780000000D77A60
AppHandl [nod-index] : 46          [000-00046]
Application PID :     881102
Application Node Name : boson
IP Address:           n/a
Connection Start Time : (1197063418)Fri Dec 7 16:36:58 2007
Client User ID :      venus
System Auth ID :      VENUS
Coordinator EDU ID :  5913
Coordinator Partition : 0
Number of Agents :    1
Locks timeout value :  4294967294 seconds
Locks Escalation :    No
Workload ID :         1
Workload Occurrence ID : 1
Trusted Context :     n/a
Connection Trust Type : non trusted
Role Inherited :      n/a
Application Status :   Lock-wait
Application Name :     db2bp
Application ID :       *LOCAL.venus.071207213658

ClientUserID :         n/a
ClientWrkstnName :    n/a
ClientApplName :      n/a
ClientAcctng :        n/a

```

```

List of active statements :
*UOW-ID :              3
Activity ID :         1
Package Schema :     NULLID
Package Name :       SQLC2G13

```

```

Package Version :
Section Number : 201
SQL Type :      Dynamic
Isolation :     CS
Statement Type : DML, Select (blockable)
Statement :     select * from pdtest

```

**Example 4:** Using the callout scripts when considering a locking problem

To use the callout scripts, find the db2cos output files. The location of the files is controlled by the database manager configuration parameter **diagpath**. The contents of the output files will differ depending on what commands you enter in the db2cos script file. An example of the output provided when the db2cos script file contains a **db2pd -db sample -locks** command is as follows:

```

Lock Timeout Caught
Thu Feb 17 01:40:04 EST 2006
Instance DB2
Database: SAMPLE
Partition Number: 0
PID: 940
TID: 2136
Function: sqlplnfd
Component: lock manager
Probe: 999
Timestamp: 2006-02-17-01.40.04.106000
AppID: *LOCAL.DB2...
AppHdl:
...
Database Partition 0 -- Database SAMPLE -- Active -- Up 0 days 00:06:53
Locks:
Address      TranHdl Lockname                                     Type Mode Sts Owner Dur HldCnt Att Rlse
0x402C6B30 3          00020003000000040000000052 Row  ..X W* 3   1  0    0  0x40

```

In the output, W\* indicates the lock that experienced the timeout. In this case, a lockwait has occurred. A lock timeout can also occur when a lock is being converted to a higher mode. This is indicated by C\* in the output.

You can map the results to a transaction, an application, an agent, or even an SQL statement with the output provided by other **db2pd** commands in the db2cos file. You can narrow down the output or use other commands to collect the information that you need. For example, you can use the **db2pd -locks wait** parameters to print only locks with a wait status. You can also use the **-app** and **-agent** parameters.

**Example 5:** Mapping an application to a dynamic SQL statement

The command **db2pd -applications -dynamic** reports the current and last anchor ID and statement unique ID for dynamic SQL statements. This allows direct mapping from an application to a dynamic SQL statement.

```

Applications:
Address          AppHndl [nod-index] NumAgents  CoordPid  Status
0x00000002006D2120 780    [000-00780] 1          10615    UOW-Executing

C-AnchID C-StmtUID L-AnchID L-StmtUID Appid
163      1         110      1         *LOCAL.burford.050202200412

Dynamic SQL Statements:
Address          AnchID StmtUID NumEnv NumVar NumRef NumExe Text
0x0000000220A02760 163    1        2        2        2        1    CREATE VIEW MYVIEW
0x0000000220A0B460 110    1        2        2        2        1    CREATE VIEW YOURVIEW

```

**Example 6:** Monitoring memory usage



The **db2pd -memblock** command can be useful when you are trying to understand memory usage, as shown in the following sample output:

All memory blocks in DBMS set.

Address	PoolID	PoolName	BlockAge	Size(Bytes)	I	LOC	File
0x0780000000740068	62	resynch	2	112	1	1746	1583816485
0x0780000000725688	62	resynch	1	108864	1	127	1599127346
0x07800000001F4348	57	ostrack	6	5160048	1	3047	698130716
0x07800000001B5608	57	ostrack	5	240048	1	3034	698130716
0x07800000001A0068	57	ostrack	1	80	1	2970	698130716
0x07800000001A00E8	57	ostrack	2	240	1	2983	698130716
0x07800000001A0208	57	ostrack	3	80	1	2999	698130716
0x07800000001A0288	57	ostrack	4	80	1	3009	698130716
0x0780000000700068	70	apmh	1	360	1	1024	3878879032
0x07800000007001E8	70	apmh	2	48	1	914	1937674139
0x0780000000700248	70	apmh	3	32	1	1000	1937674139
...							

This is followed by the sorted 'per-pool' output:

Memory blocks sorted by size for ostrack pool:

PoolID	PoolName	TotalSize(Bytes)	TotalCount	LOC	File
57	ostrack	5160048	1	3047	698130716
57	ostrack	240048	1	3034	698130716
57	ostrack	240	1	2983	698130716
57	ostrack	80	1	2999	698130716
57	ostrack	80	1	2970	698130716
57	ostrack	80	1	3009	698130716
Total size for ostrack pool: 5400576 bytes					

Memory blocks sorted by size for apmh pool:

PoolID	PoolName	TotalSize(Bytes)	TotalCount	LOC	File
70	apmh	40200	2	121	2986298236
70	apmh	10016	1	308	1586829889
70	apmh	6096	2	4014	1312473490
70	apmh	2516	1	294	1586829889
70	apmh	496	1	2192	1953793439
70	apmh	360	1	1024	3878879032
70	apmh	176	1	1608	1953793439
70	apmh	152	1	2623	1583816485
70	apmh	48	1	914	1937674139
70	apmh	32	1	1000	1937674139
Total size for apmh pool: 60092 bytes					
...					

The final section of output sorts the consumers of memory for the entire memory set:

All memory consumers in DBMS memory set:

PoolID	PoolName	TotalSize(Bytes)	%Bytes	TotalCount	%Count	LOC	File
57	ostrack	5160048	71.90	1	0.07	3047	698130716
50	sqlch	778496	10.85	1	0.07	202	2576467555
50	sqlch	271784	3.79	1	0.07	260	2576467555
57	ostrack	240048	3.34	1	0.07	3034	698130716
50	sqlch	144464	2.01	1	0.07	217	2576467555
62	resynch	108864	1.52	1	0.07	127	1599127346
72	eduah	108048	1.51	1	0.07	174	4210081592
69	krcbh	73640	1.03	5	0.36	547	4210081592
50	sqlch	43752	0.61	1	0.07	274	2576467555
70	apmh	40200	0.56	2	0.14	121	2986298236
69	krcbh	32992	0.46	1	0.07	838	698130716
50	sqlch	31000	0.43	31	2.20	633	3966224537
50	sqlch	25456	0.35	31	2.20	930	3966224537
52	kerh	15376	0.21	1	0.07	157	1193352763
50	sqlch	14697	0.20	1	0.07	345	2576467555
...							

You can also report memory blocks for private memory on UNIX and Linux operating systems. For example, if you run **db2pd -memb pid=159770**, results similar to the following ones are generated:

All memory blocks in Private set.

Address	PoolID	PoolName	BlockAge	Size(Bytes)	I LOC	File
0x0000000110469068	88	private	1	2488	1 172	4283993058
0x0000000110469A48	88	private	2	1608	1 172	4283993058
0x000000011046A0A8	88	private	3	4928	1 172	4283993058
0x000000011046B408	88	private	4	7336	1 172	4283993058
0x000000011046D0C8	88	private	5	32	1 172	4283993058
0x000000011046D108	88	private	6	6728	1 172	4283993058
0x000000011046EB68	88	private	7	168	1 172	4283993058
0x000000011046EC28	88	private	8	24	1 172	4283993058
0x000000011046EC68	88	private	9	408	1 172	4283993058
0x000000011046EE28	88	private	10	1072	1 172	4283993058
0x000000011046F288	88	private	11	3464	1 172	4283993058
0x0000000110470028	88	private	12	80	1 172	4283993058
0x00000001104700A8	88	private	13	480	1 1534	862348285
0x00000001104702A8	88	private	14	480	1 1939	862348285
0x0000000110499FA8	88	private	80	6551	1 1779	4231792244

Total set size: 94847 bytes

Memory blocks sorted by size:

PoolID	PoolName	TotalSize(Bytes)	TotalCount	LOC	File
88	private	6551	1	1779	4231792244
88	private	28336	12	172	4283993058
88	private	480	1	1939	862348285
88	private	480	1	1534	862348285

Total set size: 94847 bytes

**Example 7:** Determine which application is using up your table space

Using **db2pd -tcbstats** command, you can identify the number of inserts for a table. The following example shows sample information for a user-defined global temporary table called TEMP1:

```
TCB Table Information:
Address      TbspaceID TableID PartID MasterTbs MasterTab TableName SchemaNm ObjCClass DataSize LfSize LobSize XMLSize
0x0780000020B62AB0 3 2 n/a 3 2 TEMP1 SESSION Temp 966 0 0 0

TCB Table Stats:
Address      TableName Scans UDI PgReorgs NoChgUpdts Reads FscrUpdates Inserts Updates Deletes OvFlReads OvFlCrtes
0x0780000020B62AB0 TEMP1 0 0 0 0 0 0 43968 0 0 0 0
```

You can then obtain the information for table space 3 by using the **db2pd -tablespaces** command. Sample output is as follows:

```
Tablespace 3 Configuration:
Address      Type Content PageSz ExtentSz Auto Prefetch BufID BufIDDisk FSC NumCnts MaxStripe LastConsecPg Name
0x0780000020B1B5A0 DMS UsrTmp 4096 32 Yes 32 1 1 On 1 0 31 TEMPSPACE2

Tablespace 3 Statistics:
Address      TotalPgs UsablePgs UsedPgs PndFreePgs FreePgs HWM State MinRecTime Nquiescers
0x0780000020B1B5A0 5000 4960 1088 0 3872 1088 0x00000000 0 0

Tablespace 3 Autoresize Statistics:
Address      AS AR InitSize IncSize IIP MaxSize LastResize LRF
0x0780000020B1B5A0 No No 0 0 No 0 None No

Containers:
Address      ContainNum Type TotalPgs UseablePgs StripeSet Container
0x0780000020B1DCC0 0 File 5000 4960 0 /home/db2inst1/tempspace2a
```

The FreePgs column shows that space is filling up. As the free pages value decreases, there is less space available. Notice also that the value for FreePgs plus the value for UsedPgs equals the value of UsablePgs.

Once this is known, you can identify the dynamic SQL statement that is using the table TEMP1 by running the **db2pd -db sample -dyn:**

```
Database Partition 0 -- Database SAMPLE -- Active -- Up 0 days 00:13:06

Dynamic Cache:
Current Memory Used 1022197
Total Heap Size 1271398
Cache Overflow Flag 0
Number of References 237
Number of Statement Inserts 32
Number of Statement Deletes 13
Number of Variation Inserts 21
Number of Statements 19

Dynamic SQL Statements:
Address      AnchID StmtUID NumEnv NumVar NumRef NumExe Text
0x0000000220A08C40 78 1 2 2 3 2 declare global temporary table temp1 (c1 char(6)) not logged
0x0000000220A08D960 253 1 1 1 24 24 insert into session.temp1 values('TEST')
```

Finally, you can map the information from the preceding output to the applications output to identify the application by running **db2pd -db sample -app**.

Applications:

```
Address          AppHandl [nod-index] NumAgents  CoorPid Status
0x00000000200661840 501      [000-00501] 1          11246  UOW-Waiting
```

```
C-AnchID C-StmtUID  L-AnchID L-StmtUID Appid
0         0         253     1         *LOCAL.db2inst1.050202160426
```

You can use the anchor ID (AnchID) value that identified the dynamic SQL statement to identify the associated application. The results show that the last anchor ID (L-AnchID) value is the same as the anchor ID (AnchID) value. You use the results from one run of **db2pd** in the next run of **db2pd**.

The output from **db2pd -agent** shows the number of rows read (in the Rowsread column) and rows written (in the Rowswrtn column) by the application. These values give you an idea of what the application has completed and what the application still has to complete, as shown in the following sample output:

```
Address          AppHandl [nod-index] AgentPid Priority Type DBName
0x00000000200698080 501      [000-00501] 11246     0       Coord SAMPLE
```

```
State      ClientPid Userid  ClientNm Rowsread  Rowswrtn  LkTmOt
Inst-Active 26377   db2inst1 db2bp    22        9588     NotSet
```

You can map the values for AppHandl and AgentPid resulting from running the **db2pd -agent** command to the corresponding values for AppHandl and CoorPid resulting from running the **db2pd -app** command.

The steps are slightly different if you suspect that an internal temporary table is filling up the table space. You still use **db2pd -tcbstats** to identify tables with large numbers of inserts, however. Following is sample information for an implicit temporary table:

```
TCB Table Information:
Address      TbspaceID TableID PartID MasterTbs MasterTab TableName          SchemaNm ObjClass  DataSize ...
0x0780000020CC0D30 1 2 n/a 1 2 TEMP (00001,00002) <30> <JMC Temp 2470 ...
0x0780000020CC14B0 1 3 n/a 1 3 TEMP (00001,00003) <31> <JMC Temp 2367 ...
0x0780000020CC21B0 1 4 n/a 1 4 TEMP (00001,00004) <30> <JMC Temp 1872 ...

TCB Table Stats:
Address      TableName          Scans  UDI  PgReorgs  NoChgUpdts Reads  FscrUpdates Inserts ...
0x0780000020CC0D30 TEMP (00001,00002) 0 0 0 0 0 0 43219 ...
0x0780000020CC14B0 TEMP (00001,00003) 0 0 0 0 0 0 42485 ...
0x0780000020CC21B0 TEMP (00001,00004) 0 0 0 0 0 0 0 ...
```

In this example, there are a large number of inserts for tables with the naming convention TEMP (TbspaceID, TableID). These are implicit temporary tables. The values in the SchemaNm column have a naming convention of the value for AppHandl concatenated with the value for SchemaNm, which makes it possible to identify the application doing the work.

You can then map that information to the output from **db2pd -tablespaces** to see the used space for table space 1. Take note of the relationship between the UsedPgs and UsablePgs values in the table space statistics in the following output:

```
Tablespace Configuration:
Address      Id  Type Content PageSz ExtentSz Auto Prefetch BufID BufIDDisk FSC NumCntrs MaxStripe LastConsecPg Name
0x07800000203FB5A0 1 SMS SysTmp 4096 32 Yes 320 1 1 On 10 0 31 TEMPSPACE1

Tablespace Statistics:
Address      Id  TotalPgs UsablePgs UsedPgs PndFreePgs FreePgs HWM State MinRecTime NQuiescers
0x07800000203FB5A0 1 6516 6516 6516 0 0 0 0x00000000 0 0

Tablespace Autoresize Statistics:
Address      Id  AS AR InitSize IncSize IIP MaxSize LastResize LRF
0x07800000203FB5A0 1 No No 0 0 No 0 None No

Containers:
...
```

You can then identify application handles 30 and 31 (because you saw them in the **-tcbstats** output) by using the command **db2pd -app**:

```
Applications:
Address          AppHandl [nod-index] NumAgents  CoorPid  Status      C-AnchID C-StmtUID  L-AnchID  L-StmtUID  Appid
0x0780000006FB880 31 [000-00031] 1 4784182 UOW-Waiting 0 0 107 1 *LOCAL.db2inst1.051215214142
0x0780000006F9CE0 30 [000-00030] 1 8966270 UOW-Executing 107 1 107 1 *LOCAL.db2inst1.051215214013
```

Finally, map the information from the preceding output to the Dynamic SQL output obtained by running the **db2pd -dyn** command:

```
Dynamic SQL Statements:
Address          AnchID StmtUID  NumEnv  NumVar  NumRef  NumExe  Text
0x0780000020B296C0 107 1 1 1 43 43 select c1, c2 from test group by c1,c2
```

### Example 8: Monitoring recovery

If you run the command **db2pd -recovery**, the output shows several counters that you can use to verify that recovery is progressing, as shown in the following sample output. The Current Log and Current LSO values provide the log position. The CompletedWork value is the number of bytes completed thus far.

```
Recovery:
Recovery Status      0x00000401
Current Log          S0000005.LOG
Current LSN          000001F07BC
Current LSO          000002551BEA
Job Type             ROLLFORWARD RECOVERY
Job ID               7
Job Start Time       (1107380474) Wed Feb 2 16:41:14 2005
Job Description       Database Rollforward Recovery
Invoker Type         User
Total Phases         2
Current Phase        1

Progress:
Address          PhaseNum Description StartTime          CompletedWork TotalWork
0x0000000200667160 1 Forward Wed Feb 2 16:41:14 2005 2268098 bytes Unknown
0x0000000200667258 2 Backward NotStarted 0 bytes Unknown
```

### Example 9: Determining the amount of resources a transaction is using

If you run the command **db2pd -transactions**, the output shows the number of locks, the first log sequence number (LSN), the last LSN, the first LSO, the last LSO, the log space used, and the space reserved, as shown in the following sample output. This can be useful for understanding the behavior of a transaction.

```
Transactions:
Address          AppHandl [nod-index] TranHdl  Locks  State  Tflag
0x000000022026D980 797 [000-00797] 2 108 WRITE 0x00000000
0x000000022026E600 806 [000-00806] 3 157 WRITE 0x00000000
0x000000022026F280 807 [000-00807] 4 90 WRITE 0x00000000

Tflag2  Firstlsn  Lastlsn  Firstlso  Lastlso
0x00000000 0x0000001A4212 0x0000001C2022 0x000001072262 0x0000010B2C8C
0x00000000 0x000000107320 0x0000001S3462 0x000001057574 0x0000010B3340
0x00000000 0x0000001BC00C 0x0000001X2F03 0x00000107CF0C 0x0000010B2FDE
LogSpace  SpaceReserved  TID  AxRegCnt  GXID
4518 95450 0x000000000451 1 0
6576 139670 0x0000000003E0 1 0
3762 79266 0x000000000472 1 0
```

### Example 10: Monitoring log usage

The command **db2pd -logs** is useful for monitoring log usage for a database. By using the Pages Written value, as shown in the following sample output, you can determine whether the log usage is increasing:

```

Logs:
Current Log Number      2
Pages Written          846
Method 1 Archive Status Success
Method 1 Next Log to Archive 2
Method 1 First Failure  n/a
Method 2 Archive Status Success
Method 2 Next Log to Archive 2
Method 2 First Failure  n/a

Address      StartLSN      StartLSO      State      Size  Pages  Filename
0x000000023001BF58 0x00000022F032 0x000001B58000 0x00000000 1000 1000  S0000002.LOG
0x000000023001BE98 0x000000000000 0x000001F40000 0x00000000 1000 1000  S0000003.LOG
0x0000000230008F58 0x000000000000 0x000002328000 0x00000000 1000 1000  S0000004.LOG

```

You can identify two types of problems by using this output:

- If the most recent log archive fails, Archive Status is set to a value of Failure. If there is an ongoing archive failure, preventing logs from being archived at all, Archive Status is set to a value of First Failure.
- If log archiving is proceeding very slowly, the Next Log to Archive value is lower than the Current Log Number value. If archiving is very slow, space for active logs might run out, which in turn might prevent any data changes from occurring in the database.

**Note:** S0000003.LOG and S0000004.LOG do not contain any log records yet and therefore the StartLSN is 0x0

#### Example 11: Viewing the sysplex list

Without the **db2pd -sysplex** command showing the following sample output, the only other way to report the sysplex list is by using a DB2 trace.

```

Sysplex List:
Alias:          HOST
Location Name:  HOST1
Count:         1

IP Address      Port      Priority  Connections  Status  PRDID
1.2.34.56      400      1        0             0

```

#### Example 12: Generating stack traces

You can use the **db2pd -stack all** command for Windows operating systems or the **-stack** command for UNIX operating systems to produce stack traces for all processes in the current database partition. You might want to use this command iteratively when you suspect that a process or thread is looping or hanging.

You can obtain the current call stack for a particular engine dispatchable unit (EDU) by issuing the command **db2pd -stack eduid**, as shown in the following example:

```

Attempting to dump stack trace for eduid 137.
See current DIAGPATH for trapfile.

```

If the call stacks for all of the DB2 processes are desired, use the command **db2pd -stack all**, for example (on Windows operating systems):

```

Attempting to dump all stack traces for instance.
See current DIAGPATH for trapfiles.

```

If you are using a partitioned database environment with multiple physical nodes, you can obtain the information from all of the partitions by using the command **db2\_all "; db2pd -stack all"**. If the partitions are all logical partitions on the same machine, however, a faster method is to use **db2pd -alldbp -stacks**.

You can also redirect the output of the **db2pdb -stacks** command to a specific directory path with the **dumpdir** parameter and redirect the output for a specific duration only with the **timeout** parameter. For example, to redirect the output of stack traces for all processes to `/home/waleed/mydir` for 30 seconds, issue the following command:

```
db2pd -alldbp -stack all dumpdir=/home/waleed/mydir timeout=30
```

**Example 13:** Viewing memory statistics for a database partition

The **db2pd -dbptnmem** command shows how much memory the DB2 server is currently consuming and, at a high level, which areas of the server are using that memory.

The following example shows the output from running **db2pd -dbptnmem** on an AIX machine:

Database Partition Memory Controller Statistics

```
Controller Automatic: Y
Memory Limit:      122931408 KB
Current usage:     651008 KB
HWM usage:         651008 KB
Cached memory:     231296 KB
```

The descriptions of these data fields and columns are as follows:

**Controller Automatic**

Indicates the memory controller setting. It shows the value "Y" if the **instance\_memory** configuration parameter is set to AUTOMATIC. This means that database manager automatically determines the upper boundary of memory consumption.

**Memory Limit**

If an instance memory limit is enforced, the value of the **instance\_memory** configuration parameter is the upper bound limit of DB2 server memory that can be consumed.

**Current usage**

The amount of memory the server is currently consuming.

**HWM usage**

The high water mark (HWM) or peak memory usage that has been consumed since the activation of the database partition (when the **db2start** command was run).

**Cached memory**

The amount of the current usage that is not currently being used but is cached for performance reasons for future memory requests.

Following is the continuation of the sample output from running **db2pd -dbptnmem** on an AIX operating system:

```
Individual Memory Consumers:
Name           Mem Used (KB)   HWM Used (KB)   Cached (KB)
=====
APPL-DBONE     160000          160000          159616
DBMS-name      38528           38528           3776
FMP_RESOURCES  22528           22528           0
PRIVATE        13120           13120           740
FCM_RESOURCES  10048           10048           0
LCL-p606416    128             128             0
DB-DBONE      406656          406656          67200
```

All registered “consumers” of memory within the DB2 server are listed with the amount of the total memory they are consuming. The column descriptions are as follows:

**Name** A short, distinguishing name of a consumer of memory, such as the following ones:

**APPL-*dbname***

Application memory consumed for database *dbname*

**DBMS-*name***

Global database manager memory requirements

**FMP\_RESOURCES**

Memory required to communicate with **db2fmps**

**PRIVATE**

Miscellaneous private memory requirements

**FCM\_RESOURCES**

Fast Communication Manager resources

**LCL-*pid***

The memory segment used to communicate with local applications

**DB-*dbname***

Database memory consumed for database *dbname*

**Mem Used (KB)**

The amount of memory that is currently allotted to the consumer

**HWM Used (KB)**

The high-water mark (HWM) of the memory, or the peak memory, that the consumer has used

**Cached (KB)**

Of the Mem Used (KB), the amount of memory that is not currently being used but is immediately available for future memory allocations

**Example 14:** Monitoring the progress of index reorganization

In DB2 Version 9.8 Fix Pack 3 and later fix packs, the progress report of an index reorganization has the following characteristics:

- The **db2pd -reorgs index** command reports index reorg progress for partitioned indexes (Fix Pack 1 introduced support for only non-partitioned indexes).
- The **db2pd -reorgs index** command supports the monitoring of index reorg at the partition level (that is, during reorganization of a single partition).
- The reorg progress for non-partitioned and partitioned indexes is reported in separate outputs. One output shows the reorg progress for non-partitioned indexes, and the following outputs show the reorg progress for partitioned indexes on each table partition; the index reorg statistics of only one partition is reported in each output.
- Non-partitioned indexes are processed first, followed by partitioned indexes in serial fashion.
- The **db2pd -reorgs index** command displays the following additional information fields in the output for partitioned indexes:
  - **MaxPartition** - Total number of partitions for the table being processed. For partition-level reorg, **MaxPartition** will always have a value of 1 since only a single partition is being reorganized.
  - **PartitionID** - The data partition identifier for the partition being processed.

The following example shows an output obtained using the **db2pd -reorgs index** command which reports the index reorg progress for a range-partitioned table with 2 partitions.

**Note:** The first output reports the Index Reorg Stats of the non-partitioned indexes. The following outputs report the Index Reorg Stats of the partitioned indexes on each partition.

```
Index Reorg Stats:
Retrieval Time: 02/08/2010 23:04:21
TbspaceID: -6      TableID: -32768
Schema: ZORAN     TableName: BIGRPT
Access: Allow none
Status: Completed
Start Time: 02/08/2010 23:03:55   End Time: 02/08/2010 23:04:04
Total Duration: 00:00:08
Prev Index Duration: -
Cur Index Start: -
Cur Index: 0          Max Index: 2          Index ID: 0
Cur Phase: 0          ( - )      Max Phase: 0
Cur Count: 0          Max Count: 0
Total Row Count: 750000

Retrieval Time: 02/08/2010 23:04:21
TbspaceID: 2       TableID: 5
Schema: ZORAN     TableName: BIGRPT
PartitionID: 0    MaxPartition: 2
Access: Allow none
Status: Completed
Start Time: 02/08/2010 23:04:04   End Time: 02/08/2010 23:04:08
Total Duration: 00:00:04
Prev Index Duration: -
Cur Index Start: -
Cur Index: 0          Max Index: 2          Index ID: 0
Cur Phase: 0          ( - )      Max Phase: 0
Cur Count: 0          Max Count: 0
Total Row Count: 375000

Retrieval Time: 02/08/2010 23:04:21
TbspaceID: 2       TableID: 6
Schema: ZORAN     TableName: BIGRPT
PartitionID: 1    MaxPartition: 2
Access: Allow none
Status: Completed
Start Time: 02/08/2010 23:04:08   End Time: 02/08/2010 23:04:12
Total Duration: 00:00:04
Prev Index Duration: -
Cur Index Start: -
Cur Index: 0          Max Index: 2          Index ID: 0
Cur Phase: 0          ( - )      Max Phase: 0
Cur Count: 0          Max Count: 0
Total Row Count: 375000
```

**Example 15:** Displaying the top EDUs by processor time consumption and displaying EDU stack information

If you issue the **db2pd** command with the **-edus** parameter option, the output lists all engine dispatchable units (EDUs). Output for EDUs can be returned at the level of granularity you specify, such as at the instance level or at the member. On Linux and UNIX operating systems only, you can also specify the **interval** parameter suboption so that two snapshots of all EDUs are taken, separated by an interval you specify. When the **interval** parameter is specified, two additional columns in the output indicate the delta of processor user time (USR DELTA column) and the delta of processor system time (SYS DELTA column) across the interval.



In the following example, the deltas for processor user time and processor system time are given across a five-second interval:

```
$ db2pd -edus interval=5
```

```
Database Partition 0 -- Active -- Up 0 days 00:53:29 -- Date 06/04/2010 03:34:59
```

```
List of all EDUs for database partition 0
```

```
db2sysc PID: 1249522
```

```
db2wdog PID: 2068678
```

EDU ID	TID	Kernel TID	EDU Name	USR	SYS	USR DELTA	SYS DELTA
6957	6957	13889683	db2agntdp (SAMPLE ) 0	58.238506	0.820466	1.160726	0.014721
6700	6700	11542589	db2agent (SAMPLE) 0	52.856696	0.754420	1.114821	0.015007
5675	5675	4559055	db2agntdp (SAMPLE ) 0	60.386779	0.854234	0.609233	0.014304
3088	3088	13951225	db2agntdp (SAMPLE ) 0	80.073489	2.249843	0.499766	0.006247
3615	3615	2887875	db2loggw (SAMPLE) 0	0.939891	0.410493	0.011694	0.004204
4900	4900	6344925	db2pfchr (SAMPLE) 0	1.748413	0.014378	0.014343	0.000103
7986	7986	13701145	db2agntdp (SAMPLE ) 0	1.410225	0.025900	0.003636	0.000074
2571	2571	8503329	db2ipccm 0	0.251349	0.083787	0.002551	0.000857
7729	7729	14168193	db2agntdp (SAMPLE ) 0	1.717323	0.029477	0.000998	0.000038
7472	7472	11853991	db2agnta (SAMPLE) 0	1.860115	0.032926	0.000860	0.000012
3358	3358	2347127	db2loggr (SAMPLE) 0	0.151042	0.184726	0.000387	0.000458
515	515	13820091	db2aiiothr 0	0.405538	0.312007	0.000189	0.000178
7215	7215	2539753	db2agntdp (SAMPLE ) 0	1.165350	0.019466	0.000291	0.000008
6185	6185	2322517	db2w1md (SAMPLE) 0	0.061674	0.034093	0.000169	0.000100
6442	6442	2756793	db2evmli (DB2DETAILDEADLOCK) 0	0.072142	0.052436	0.000092	0.000063
4129	4129	15900799	db2glock (SAMPLE) 0	0.013239	0.000741	0.000064	0.000001
2	2	11739383	db2alarm 0	0.036904	0.028367	0.000009	0.000009
4386	4386	13361367	db2dlock (SAMPLE) 0	0.015653	0.001281	0.000014	0.000003
1029	1029	15040579	db2fcms 0	0.041929	0.016598	0.000010	0.000004
5414	5414	14471309	db2pfchr (SAMPLE) 0	0.000093	0.000002	0.000000	0.000000
258	258	13656311	db2sysc 0	8.369967	0.263539	0.000000	0.000000
5157	5157	7934145	db2pfchr (SAMPLE) 0	0.027598	0.000177	0.000000	0.000000
1543	1543	2670647	db2fcmr 0	0.004191	0.000079	0.000000	0.000000
1286	1286	8417339	db2extev 0	0.000312	0.000043	0.000000	0.000000
2314	2314	14360813	db2licc 0	0.000371	0.000051	0.000000	0.000000
5928	5928	3137537	db2taskd (SAMPLE) 0	0.004903	0.000572	0.000000	0.000000
3872	3872	2310357	db2lfr (SAMPLE) 0	0.000126	0.000007	0.000000	0.000000
4643	4643	11694287	db2pc1nr (SAMPLE) 0	0.000094	0.000002	0.000000	0.000000
1800	1800	5800175	db2extev 0	0.001212	0.002137	0.000000	0.000000
772	772	7925817	db2thc1n 0	0.000429	0.000072	0.000000	0.000000
2057	2057	6868993	db2pdbc 0	0.002423	0.001603	0.000000	0.000000
2828	2828	10866809	db2resync 0	0.016764	0.003098	0.000000	0.000000

To provide information only about the EDUs that are the top consumers of processor time and to reduce the amount of output returned, you can further include the **top** parameter option. In the following example, only the top five EDUs are returned, across an interval of 5 seconds. Stack information is also returned, and can be found stored separately in the directory path specified by **DUMPPDIR**, which defaults to **diagpath**.

```
$ db2pd -edus interval=5 top=5 stacks
```

```
Database Partition 0 -- Active -- Up 0 days 00:54:00 -- Date 06/04/2010 03:35:30
```

```
List of all EDUs for database partition 0
```

```
db2sysc PID: 1249522
```

```
db2wdog PID: 2068678
```

EDU ID	TID	Kernel TID	EDU Name	USR	SYS	USR DELTA	SYS DELTA
3358	3358	2347127	db2loggr (SAMPLE) 0	0.154906	0.189223	0.001087	0.001363
3615	3615	2887875	db2loggw (SAMPLE) 0	0.962744	0.419617	0.001779	0.000481
515	515	13820091	db2aiiothr 0	0.408039	0.314045	0.000658	0.000543
258	258	13656311	db2sysc 0	8.371388	0.264812	0.000653	0.000474
6700	6700	11542589	db2agent (SAMPLE) 0	54.814420	0.783323	0.000455	0.000310

```
$ ls -ltr
```

```
total 552
```

```
drwxrwxr-t 2 vbmithun build 256 05-31 09:59 events/
drwxrwxr-t 2 vbmithun build 256 06-04 03:17 stmmlog/
```

```

-rw-r--r-- 1 vbmithun build      46413 06-04 03:35 1249522.3358.000.stack.txt
-rw-r--r-- 1 vbmithun build      22819 06-04 03:35 1249522.3615.000.stack.txt
-rw-r--r-- 1 vbmithun build      20387 06-04 03:35 1249522.515.000.stack.txt
-rw-r--r-- 1 vbmithun build      50426 06-04 03:35 1249522.258.000.stack.txt
-rw-r--r-- 1 vbmithun build     314596 06-04 03:35 1249522.6700.000.stack.txt
-rw-r--r-- 1 vbmithun build      94913 06-04 03:35 1249522.000.processObj.txt

```

### Example 16: Displaying agent event metrics

The **db2pd** command supports returning event metrics for agents. If you need to determine whether an agent changed state during a specific period of time, use the event option together with the **-agents** parameter. The **AGENT\_STATE\_LAST\_UPDATE\_TIME(Tick Value)** column that is returned shows the last time that the event being processed by the agent was changed. Together with a previously obtained value for **AGENT\_STATE\_LAST\_UPDATE\_TIME(Tick Value)**, you can determine whether an agent has moved on to a new task or whether it continues to process the same task over an extended period of time.

```

db2pd -agents event
Database Partition 0 -- Active -- Up 0 days 03:18:52 -- Date 06/27/2011 11:47:10

```

```

Agents:
Current agents:      12
Idle agents:         0
Active coord agents: 10
Active agents total: 10
Pooled coord agents: 2
Pooled agents total: 2

```

```

AGENT_STATE_LAST_UPDATE_TIME(Tick Value)  EVENT_STATE  EVENT_TYPE  EVENT_OBJECT  EVENT_OBJECT_NAME
2011-06-27-14.44.38.859785(5622972377924968075)  IDLE         WAIT        REQUEST      n/a

```

---

## Collecting environment information with the db2support command

When it comes to collecting information for a DB2 problem, the most important DB2 utility you need to run is **db2support**. The **db2support** command automatically collects all DB2 and system diagnostic information available. It also has an optional interactive "Question and Answer" session, which poses questions about the circumstances of your problem.

### About this task

Using the **db2support** utility avoids possible user errors, as you do not need to manually type commands such as **GET DATABASE CONFIGURATION FOR *database-name*** or **LIST TABLESPACES SHOW DETAIL**. Also, you do not require instructions on which commands to run or files to collect, therefore it takes less time to collect the data.

### Procedure

- Execute the command **db2support -h** to display the complete list of command options.
- Collect data using the appropriate **db2support** command.

To collect all necessary information without an error, run the **db2support** utility as a user with SYSADM authority, such as an instance owner. If you run the command without SYSADM authority, SQL errors (for example, SQL1092N) might result when the utility runs commands such as **QUERY CLIENT** or **LIST ACTIVE DATABASES**.

To use the **db2support** command to help collect information for IBM Software Support, run the **db2support** command while the system is experiencing the problem. That way, the tool collects timely information, such as operating system performance details. If you cannot run the utility at the time of the

problem, you can still issue the **db2support** command after the problem stops because some first occurrence data capture (FODC) diagnostic files are produced automatically.

If an FODC package is stored in a directory path that is different from the default diagnostic path or not in a path specified by an FODCPATH setting, indicate the FODC path to the **db2support** command with the **-fodcpath** parameter, so that the FODC package can be included in the `db2support.zip` file.

The following basic invocation is typically sufficient for collecting most of the information required to debug a problem, unless you need to include the path to an FODC package with the **-fodcpath** parameter:

```
db2support <output path> -d <database name>
```

The **db2support** tool collects most diagnostic data specific to DB2 pureScale components by default. If you specify the **-purecluster**, **-purescale**, **-cm**, **-cfs**, or **-udapl** parameter, the **db2support** command collects additional diagnostic data that is space intensive or takes a longer time to collect, but helps determining the source of problem faster in DB2 pureScale environments.

The output is conveniently collected and stored in a compressed ZIP archive, `db2support.zip`, so that it can be transferred and extracted easily on any system.

## Results

The type of information that **db2support** captures depends on the way the command is invoked, whether the database manager is started, and whether it is possible to connect to the database.

The **db2support** utility collects the following information under all conditions:

- **db2diag** log files
- All trap files
- Locklist files
- Dump files
- Various system-related files
- Output from various system commands
- `db2cli.ini`

Depending on the circumstances, the **db2support** utility might also collect:

- Active log files
- Buffer pool and table space (SQLSPCS.1 and SQLSPCS.2) control files (with **-d** option)
- Contents of the `db2dump` directory
- Extended system information (with **-s** option)
- Database configuration settings (with **-d** option)
- Database manager configuration settings files
- First occurrence data capture (FODC) information (with the **-fodc** and **-fodcpath** options)
- Log file header file (with **-d** option)
- Recovery history file (with **-d** option)
- Formatted data for SYSIBM.SYSTABLES, SYSIBM.SYSINDEXES, and SYSIBM.SYSDATAPARTITIONS system catalog tables (with **-d** option and **db2support** command not in optimizer mode)

The **db2support** utility collects the following information in DB2 pureScale environments:

- Diagnostic data for DB2 pureScale components, such as cluster manager, cluster file system, and uDAPL
- Additional diagnostic data for cluster manager (with **-cm** option)
- Additional diagnostic data for cluster file system (with **-cfs** option)
- Additional diagnostic data for uDAPL (with **-udapl** option)
- Additional DB2 diagnostic data (with **-purecluster** or **-purescale** option)

The HTML report `db2support.html` always includes the following information:

- Problem record (PMR) number (if **-n** was specified)
- Operating system and level (for example, AIX 5.1)
- DB2 release information
- An indication of whether it is a 32- or 64-bit environment
- DB2 installation path information
- Contents of `db2nodes.cfg`
- Number of processors and disks and how much memory
- List of databases in the instance
- Registry information and environment, including `PATH` and `LIBPATH`
- Disk free space for current file system and inodes for UNIX
- Java SDK level
- Java JCC version
- Java JCC configuration
- Database manager configuration
- **ls -lR** output (or Windows equivalent) of the `sql1lib` directory
- The result of the **LIST NODE DIRECTORY** command
- The result of the **LIST ADMIN NODE DIRECTORY** command
- The result of the **LIST DCS DIRECTORY** command
- The result of the **LIST DCS APPLICATIONS EXTENDED** command
- The result of the **db2prereqcheck** command
- List of all installed software
- DB2 license information
- DB2 compliance report
- Audit configuration information
- CLI configuration information
- Problem determination settings
- Status of the **db2trc** command
- Listing of log directory

The `db2support.html` file contains the following additional information if the DB2 database manager is started:

- Client connection state
- Database and database manager configuration (Database configuration requires the **-d** option)
- Application snapshot
- Memory pool info (size and consumed). Complete data is collected if the **-d** option is used

- The result of the **LIST ACTIVE DATABASES** command
- The result of the **LIST DCS APPLICATIONS** command

The `db2support.html` file contains the following information when a connection to the database was successfully established:

- Number of user tables
- Approximate size of database data
- Database snapshot
- Application snapshot
- Buffer pool information
- The result of the **LIST APPLICATIONS** command
- The result of the **LIST COMMAND OPTIONS** command
- The result of the **LIST DATABASE DIRECTORY** command
- The result of the **LIST INDOUBT TRANSACTIONS** command
- The result of the **LIST DATABASE PARTITION GROUPS** command
- The result of the **LIST DBPARTITIONNUMS** command
- The result of the **LIST ODBC DATA SOURCES** command
- The result of the **LIST PACKAGES/TABLES** command
- The result of the **LIST TABLESPACE CONTAINERS** command
- The result of the **LIST TABLESPACES** command
- The result of the **LIST DRDA IN DOUBT TRANSACTIONS** command
- DB2 workload manager information
- Listing of the database recovery history file
- Optimizer database configuration
- Database configuration
- Nodegroup information
- Storage group information
- Number of string IDs
- List of tables

A `db2support.html` file is included at the top level of the **db2support** package to help you to quickly search for any diagnostic data that is collected by the **db2support** command. This HTML file includes links of the data collected in the `db2support.html` file that point to its corresponding flat files in the subdirectory of the **db2support** package. A plain text version of the map file called `db2support.map` file is also included in the **db2support** package.

## Example contents of `db2support.zip` file

You can use the **db2support** command with the **-unzip** parameter to extract the contents of the `db2support.zip` file locally, optionally specifying the directory path where you want the contents extracted to. You can also use the **-unzip** option to extract the contents of archived diagnostic data without the need for additional software. If you want to know only what files are included in a `db2support.zip` file, without extracting the actual content, you can instead use the **-unzip list** parameters with the **db2support** command.

For an example of the contents of a `db2support.zip` file, the following command was executed:

```
db2support . -d sample -c -f -st "select * from staff"
```

Extracting the `db2support.zip` file, the following files and directories were collected:

- `DB2CONFIG/` - Configuration information (for example, database, database manager, BP, CLI, and Java developer kit, among others)
- `DB2DUMP/` - `db2diag` log file contents for the past three days
- `DB2MISC/` - List of the `sqllib` directory
- `DB2SNAP/` - Output of DB2 commands (for example, **db2set**, **LIST TABLES**, **LIST INDOUBT TRANSACTIONS**, and **LIST APPLICATIONS**)
- `PURESCALE/` - Diagnostic information for DB2 pureScale components, such as cluster manager, cluster file system and uDAPL
- `db2supp_opt.zip` - Diagnostic information for optimizer problems
- `db2supp_system.zip` - Operating system information
- `db2support.html` - Map to flat files collected in each subdirectory of the `db2support.zip` file listed in HTML format and diagnostic information formatted into HTML sections
- `db2support.log` - Diagnostic log information for **db2support** collection
- `db2support_options.in` - Command-line options used to start the **db2support** collection
- `db2support.map` - Map to flat files collected in each subdirectory of the `db2support.zip` file listed in plain text format

Information about Optimizer can be found in the `db2supp_opt.zip` file. Extraction of this file finds the following directories:

- `OPTIMIZER/` - Diagnostic information for optimizer problems
- `OPTIMIZER/optimizer.log` - File contains a log of all activities
- `OPTIMIZER/CATALOGS` - All the catalogs with LOBs in the following subdirectories (generated only if the LOB column in the catalog table is not empty):
  - `FUNCTIONS`
  - `INDEXES`
  - `NODEGROUPS`
  - `ROUTINES`
  - `SEQUENCES`
  - `TABLES`
  - `VIEWS`
- `OPTIMIZER/DB2DUMP` - `db2serv` output (`serv.*` and `serv2.*` output files)

System information can be found in the `db2supp_system.zip` file. Extraction of this file finds the following file and directories:

- `DB2CONFIG/` - `db2cli.ini` (files from `~/sqllib/cfg`)
- `DB2MISC/` - `DB2SYSTEM` file (binary), among others
- `OSCONFIG/` - Different operating system information files (for example, `netstat`, `services`, `vfs`, `ulimit`, and `hosts`)
- `OSSNAP/` - Operating system snapshots (for example, **iostat**, **netstat**, **uptime**, **vmstat**, and **ps\_elf**)
- `SQLDBDIR/` - Important buffer pool meta files (`~/sqllib/sqldbdir`)
- `SQLGWDIR/` - DCS directory (files from `~/sqllib/sqlgwdir`)
- `SQLNODIR/` - Node directory (files from `~/sqllib/sqlnodir`)

- SPMLOG/ - Files from ~/sql11ib/spml0g
- report.log - Log of all collection activities

---

## Validating your DB2 copy

The **db2val** command ensures that your DB2 copy is functioning properly.

### About this task

The **db2val** tool verifies the core function of a DB2 copy by validating installation files, instances, database creation, connections to that database, and the state of partitioned database environments. This validation can be helpful if you have manually deployed a DB2 copy on Linux and UNIX operating systems using tar.gz files. The **db2val** command can quickly ensure that all the configuration has been correctly done and ensure that the DB2 copy is what you expect it to be. You can specify instances and databases or you can run **db2val** against all of the instances. The **db2val** command can be found in the *DB2-install-path\bin* and *sql11ib/bin* directories.

### Example

For example, to validate all the instances for the DB2 copy, run the following command:

```
db2val -a
```

For complete **db2val** command details and further example, refer to the “db2val - DB2 copy validation tool command” topic.

---

## Basic trace diagnostics

If you experience a recurring and reproducible problem with DB2, tracing sometimes allows you to capture additional information about it. Under normal circumstances, you should only use a trace if asked to by IBM Software Support. The process of taking a trace entails setting up the trace facility, reproducing the error and collecting the data.

The amount of information gathered by a trace grows rapidly. When you take the trace, capture only the error situation and avoid any other activities whenever possible. When taking a trace, use the smallest scenario possible to reproduce a problem.

Collecting a trace often has a detrimental effect on the performance of a DB2 instance. The degree of performance degradation is dependent on the type of problem and on how many resources are being used to gather the trace information.

IBM Software Support should provide the following information when traces are requested:

- Simple, step by step procedures
- An explanation of where each trace is to be taken
- An explanation of what should be traced
- An explanation of why the trace is requested
- Backout procedures (for example, how to disable all traces)

Though you should be counseled by IBM Software Support as to which traces to obtain, here are some general guidelines as to when you'd be asked to obtain particular traces:

- If the problem occurs during installation, and the default installation logs are not sufficient to determine the cause of the problem, installation traces are appropriate.
- If the problem manifests in a CLI application, and the problem cannot be recreated outside of the application, then a CLI trace is appropriate.
- If the problem manifests in a JDBC application, and the problem cannot be recreated outside of the application, then a JDBC trace is appropriate.
- If the problem is directly related to information that is being communicated at the DRDA layer, a DRDA trace is appropriate.
- For all other situations where a trace is feasible, a DB2 trace is most likely to be appropriate.

Trace information is not always helpful in diagnosing an error. For example, it might not capture the error condition in the following situations:

- The trace buffer size you specified was not large enough to hold a complete set of trace events, and useful information was lost when the trace stopped writing to the file or wrapped.
- The traced scenario did not re-create the error situation.
- The error situation was recreated, but the assumption as to where the problem occurred was incorrect. For example, the trace was collected at a client workstation while the actual error occurred on a server.

## DB2 traces

### Obtaining a DB2 trace using `db2trc`

The `db2trc` command controls the trace facility provided with DB2. The trace facility records information about operations and formats this information into a readable form.

Keep in mind that there is additional processor usage when a trace is running so enabling the trace facility might impact your system's performance.

In general, IBM Software Support and development teams use DB2 traces for troubleshooting. You might run a trace to gain information about a problem that you are investigating, but its use is rather limited without knowledge of the DB2 source code.

Nonetheless, it is important to know how to correctly turn on tracing and how to dump trace files, just in case you are asked to obtain them.

**Note:** You will need one of SYSADM, SYSCTRL or SYSMANT authority to use `db2trc`

To get a general idea of the options available, execute the `db2trc` command without any parameters:

```
C:\>db2trc
Usage: db2trc (chg|clr|dmp|flw|fmt|inf|off|on) options
```

For more information about a specific `db2trc` command parameter, use the `-u` option. For example, to see more information about turning the trace on, execute the following command:



```
db2trc on -u
```

This will provide information about all of the additional options (labeled as "facilities") that can be specified when turning on a DB2 trace.

When turning trace on, the most important option is `-L`. This specifies the size of the memory buffer that will be used to store the information being traced. The buffer size can be specified in either bytes or megabytes. (To specify megabytes append either "M" or "m" after the value). The trace buffer size must be a power of two megabytes. If you specify a size that does not meet this requirement, the buffer size will automatically be rounded down to the nearest power of two.

If the buffer is too small, information might be lost. By default only the most recent trace information is kept if the buffer becomes full. If the buffer is too large, it might be difficult to send the file to the IBM Software Support team.

If tracing an operation that is relatively short (such as a database connection), a size of approximately 8 MB is usually sufficient:

```
C:\> db2trc on -l 8M
Trace is turned on
```

However, if you are tracing a larger operation or if a lot of work is going on at the same time, a larger trace buffer might be required.

On most platforms, tracing can be turned on at any time and works as described previously. However, there are certain situations to be aware of:

1. On multiple database partition systems, you must run a trace for each physical (as opposed to logical) database partition.
2. On HP-UX, Linux and Solaris platforms, if the trace is turned off after the instance has been started, a very small buffer will be used the next time the trace is started regardless of the size specified. For example, yesterday you turned trace on by using `db2trc on -l 8m`, then collected a trace, and then turned the trace off (`db2trc off`). Today you want to run a trace with the memory buffer set for 32 megabytes (`db2trc on -l 32m`) without bringing the instance down and restarting. You will find that in this case trace will only get a small buffer. To effectively run a trace on these platforms, turn the trace on before starting the instance with the size buffer you need and "clear" the buffer as necessary afterwards.

To reduce the amount of data collected or formatted, the `db2trc` command supports several mask options. Reducing the amount of data collected is useful, because it can reduce the additional processor usage incurred due to an ongoing trace collection, and because you can collect data more selectively. Collecting data more selectively can also help speed up problem diagnosis.

You typically use the `-m` mask option under the guidance of IBM support. However, you can use the `-p` mask option to collect a trace only for specific process IDs (and optionally thread IDs). For example, to enable tracing for process 77 with threads 1, 2, 3, and 4, and for process 88 with threads 5, 6, 7, and 8 the syntax is:

```
db2trc on -p 77.1.2.3.4,88.5.6.7.8
```

## Using the `trcon` and `trcoff` scripts to control trace collection

Two scripts are available to make trace collection simpler by replacing several manually issued commands with a single script invocation.

The `db2trcon` script turns on tracing and supports several options. You can use this script to turn on `db2trc` for a specified amount of time, specify to collect a trace for only the top processor time consuming engine dispatchable units (EDUs), and generate dump, flow and format files automatically. For example, to turn tracing on for a duration of 45 seconds for the top 5 processor time consuming EDUs, sampled in 15 second intervals from the time the script is run, issue the following command:

```
db2trcon
-duration 45 -top 5 -interval 15 -flw -fmt
```

When `db2trc` is turned off after the specified duration, `db2trcon` automatically generates the dump, flow and format files for you.

The `db2trcoff` turns off tracing and can generate dump, flow and format files automatically with a single command. For example, to turn `db2trc` off with `-force` and generate flow format and dump files, issue the following command:

```
db2trcoff -flw
-fmt -force
```

Note that if you turned tracing on with the `db2trcon` script and specified a duration, you do not need to issue the `db2trcoff` command separately.

## Dumping a DB2 trace file

After the trace facility has been enabled using the `ON` option, all subsequent work done by the instance will be traced.

While the trace is running, you can use the `clr` option to clear out the trace buffer. All existing information in the trace buffer will be removed.

```
C:\>db2trc clr
Trace has been cleared
```

Once the operation being traced has finished, use the `dmp` option followed by a trace file name to dump the memory buffer to disk. For example:

```
C:\>db2trc dmp trace.dmp
Trace has been dumped to file
```

The trace facility will continue to run after dumping the trace buffer to disk. To turn tracing off, use the `OFF` option:

```
C:\>db2trc off
Trace is turned off
```

## Formatting a DB2 trace file

The dump file created by the command `db2trc dmp` is in binary format and is not readable. To verify that a trace file can be read, format the binary trace file to show the flow control and send the formatted output to a null device.

The following example shows the command to perform this task:

```
db2trc flw example.trc nul
```

where `example.trc` is a binary file that was produced using the `dmp` option.

The output for this command will explicitly tell you if there is a problem reading the file, and whether or not the trace was wrapped.

At this point, the dump file can be sent to IBM Software Support. They would then format it based on your DB2 service level. However, you might sometimes be asked to format the dump file into ASCII format before sending it. This is accomplished via the **flw** and **fmt** options. You must provide the name of the binary dump file along with the name of the ASCII file that you want to create:

```
C:\>db2trc flw trace.dmp trace.flw
C:\Temp>db2trc flw trace.dmp trace.flw
Total number of trace records      : 18854
Trace truncated                    : NO
Trace wrapped                      : NO
Number of trace records formatted  : 1513 (pid: 2196 tid 2148 node: -1)
Number of trace records formatted  : 100 (pid: 1568 tid 1304 node: 0)
...

C:\>db2trc fmt trace.dmp trace.fmt
C:\Temp>db2trc fmt trace.dmp trace.fmt
Trace truncated                    : NO
Trace wrapped                      : NO
Total number of trace records      : 18854
Number of trace records formatted  : 18854
```

If this output indicates "Trace wrapped" is "YES", then this means that the trace buffer was not large enough to contain all of the information collected during the trace period. A wrapped trace might be okay depending on the situation. If you are interested in the most recent information (this is the default information that is maintained, unless the **-i** option is specified), then what is in the trace file might be sufficient. However, if you are interested in what happened at the beginning of the trace period or if you are interested in everything that occurred, you might want to redo the operation with a larger trace buffer.

There are options available when formatting a binary file into a readable text file. For example, you can use `db2trc fmt -xml trace.dmp trace.fmt` to convert the binary data and output the result into an XML parsable format. Additional options are shown in the detailed description of the trace command (**db2trc**).

Another thing to be aware of is that on Linux and UNIX operating systems, DB2 will automatically dump the trace buffer to disk when it shuts the instance down due to a severe error. Thus if tracing is enabled when an instance ends abnormally, a file will be created in the diagnostic directory and its name will be `db2trdmp.###`, where `###` is the database partition number. This does not occur on Windows platforms. You have to dump the trace manually in those situations.

To summarize, the following is an example of the common sequence of **db2trc** commands:

```
db2trc on -l 8M
db2trc clr
<Execute problem recreation commands>
db2trc dump db2trc.dmp
db2trc off
db2trc flw db2trc.dmp <filename>.flw
db2trc fmt db2trc.dmp <filename>.fmt
db2trc fmt -c db2trc.dmp <filename>.fmtd
```

## DRDA trace files

Before analyzing DRDA traces, you must understand that DRDA is an open standard for the definition of data and communication structures. For example,

DRDA comprises a set of rules about how data should be organized for transmission and how communication of that information should occur.

These rules are defined in the following reference manuals:

- DRDA V3 Vol. 1: Distributed Relational Database Architecture™
- DRDA V3 Vol. 2: Formatted Data Object Content Architecture
- DRDA V3 Vol. 3: Distributed Data Management Architecture

PDF versions of these manuals are available on [www.opengroup.org](http://www.opengroup.org).

The **db2drdat** utility records the data interchanged between a DRDA Application Requestor (AR) and a DB2 DRDA Application Server (AS) (for example between DB2 Connect and a host or Power Systems™ Servers database server).

### Trace utility

The **db2drdat** utility records the data interchanged between the DB2 Connect server (on behalf of the IBM data server client) and the IBM mainframe database server.

As a database administrator (or application developer), you might find it useful to understand how this flow of data works, because this knowledge can help you determine the origin of a particular problem. Suppose you found yourself in the following situation: you issue a `CONNECT T0` database statement for a IBM mainframe database server but the command fails and you receive an unsuccessful return code. If you understand exactly what information was conveyed to the IBM mainframe database server management system, you might be able to determine the cause of the failure even if the return code information is general. Many failures are caused by simple user errors.

Output from `db2drdat` lists the data streams exchanged between the DB2 Connect workstation and the IBM mainframe database server management system. Data sent to the IBM mainframe database server is labeled `SEND BUFFER` and data received from the IBM mainframe database server is labeled `RECEIVE BUFFER`.

If a receive buffer contains `SQLCA` information, it will be followed by a formatted interpretation of this data and labeled `SQLCA`. The `SQLCODE` field of an `SQLCA` is the *unmapped* value as returned by the IBM mainframe database server. The send and receive buffers are arranged from the oldest to the most recent within the file. Each buffer has:

- The process ID
- A `SEND BUFFER`, `RECEIVE BUFFER`, or `SQLCA` label. The first DDM command or object in a buffer is labeled `DSS TYPE`.

The remaining data in send and receive buffers is divided into five columns, consisting of:

- A byte count.
- Columns 2 and 3 represent the DRDA data stream exchanged between the two systems, in ASCII or EBCDIC.
- An ASCII representation of columns 2 and 3.
- An EBCDIC representation of columns 2 and 3.

### Trace output

The **db2drdat** utility writes the following information to *tracefile*:

- -r

- Type of DRDA reply/object
- Receive buffer
- -s
  - Type of DRDA request
  - Send buffer
- -c
  - SQLCA
- TCP/IP error information
  - Receive function return code
  - Severity
  - Protocol used
  - API used
  - Function
  - Error number.

**Note:**

1. A value of zero for the exit code indicates that the command completed successfully, and a non-zero value indicates that it did not.
2. The fields returned vary based on the API used.
3. The fields returned vary based on the platform on which DB2 Connect is running, even for the same API.
4. If the **db2drdat** command sends the output to a file that already exists, the old file will be erased unless the permissions on the file do not allow it to be erased.

**Trace output file analysis**

The following information is captured in a **db2drdat** trace :

- The process ID (PID) of the client application
- The RDB\_NAME cataloged in the database connection services (DCS) directory
- The DB2 Connect CCSID(s)
- The IBM mainframe database server CCSID(s)
- The IBM mainframe database server management system with which the DB2 Connect system is communicating.

The first buffer contains the Exchange Server Attributes (EXCSAT) and Access RDB (ACCRDB) commands sent to the IBM mainframe database server management system. It sends these commands as a result of a CONNECT TO database command. The next buffer contains the reply that DB2 Connect received from the IBM mainframe database server management system. It contains an Exchange Server Attributes Reply Data (EXCSATRD) and an Access RDB Reply Message (ACCRDBRM).

**EXCSAT**

The **EXCSAT** command contains the workstation name of the client specified by the Server Name (SRVNAM) object, which is code point X'116D', according to DDM specification. The **EXCSAT** command is found in the first buffer. Within the **EXCSAT** command, the values X'9481A292' (coded in CCSID 500) are translated to *mask* once the X'116D' is removed.

The **EXCSAT** command also contains the EXTNAM (External Name) object, which is often placed in diagnostic information about the IBM mainframe database management system. It consists of a 20-byte application ID

followed by an 8-byte process ID (or 4-byte process ID and 4-byte thread ID). It is represented by code point X'115E', and in this example its value is db2bp padded with blanks followed by 000C50CC. On a Linux or UNIX IBM data server client, this value can be correlated with the **ps** command, which returns process status information about active processes to standard output.

### **ACCRDB**

The **ACCRDB** command contains the RDB\_NAME in the RDBNAM object, which is code point X'2110'. The **ACCRDB** command follows the **EXCSAT** command in the first buffer. Within the **ACCRDB** command, the values X'E2E3D3C5C3F1' are translated to STLEC1 once the X'2110' is removed. This corresponds to the target database name field in the DCS directory.

The accounting string has code point X'2104'.

The code set configured for the DB2 Connect workstation is shown by locating the CCSID object CCSIDSBC (CCSID for single-byte characters) with code point X'119C' in the **ACCRDB** command. In this example, the CCSIDSBC is X'0333', which is 819.

The additional objects CCSIDDBC (CCSID for double-byte characters) with code points X'119D' and CCSIDMBC (CCSID for mixed-byte characters) with code point X'119E', are also present in the **ACCRDB** command. In this example, the CCSIDDBC is X'04B0', which is 1200, and the CCSIDMBC is X'0333', which is 819.

### **EXCSATRD and ACCRDBRM**

CCSID values are also returned from the IBM mainframe database server in the Access RDB Reply Message (ACCRDBRM) within the second buffer. This buffer contains the EXCSATRD followed by the ACCRDBRM. The example output file contains two CCSID values for the IBM mainframe database server system. The values are 1208 (for both single-byte and mixed byte characters) and 1200 (for double-byte characters).

If DB2 Connect does not recognize the code page coming back from the IBM mainframe database server, SQLCODE -332 will be returned to the user with the source and target code pages. If the IBM mainframe database server doesn't recognize the code set sent from DB2 Connect, it will return VALNSPRM (Parameter Value Not Supported, with DDM code point X'1252'), which gets translated into SQLCODE -332 for the user.

The ACCRDBRM also contains the parameter PRDID (Product-specific Identifier, with code point X'112E'). The value is X'C4E2D5F0F8F0F1F5' which is DSN08015 in EBCDIC. According to standards, DSN is DB2 for z/OS®. The version number is also indicated. ARI is DB2 Server for VSE & VM, SQL is DB2 database or DB2 Connect, and QSQ is IBM DB2 for IBM i.

## **Trace output file samples**

The following figures show sample output illustrating some DRDA data streams exchanged between DB2 Connect workstations and a host or System i® database server. From the user's viewpoint, a CONNECT TO database command has been issued using the command line processor (CLP).

Figure 35 on page 517 uses DB2 Connect Enterprise Edition Version 9.1 and DB2 for z/OS Version 8 over a TCP/IP connection.

1 data DB2 UDB DRDA Communication Manager sqljcsend fnc (3.3.54.5.0.100)  
 pid 807116 tid 1 cpid -1 node 0 sec 0 nsec 0 probe 100  
 bytes 16

Data1 (PD\_TYPE\_UINT,8) unsigned integer:  
 233

2 data DB2 UDB DRDA Communication Manager sqljcsend fnc (3.3.54.5.0.1177)  
 pid 807116 tid 1 cpid -1 node 0 sec 0 nsec 19532 probe 1177  
 bytes 250

SEND BUFFER(AR):

	EXCSAT RQSDSS	(ASCII)	(EBCDIC)
	0 1 2 3 4 5 6 7 8 9 A B C D E F	0123456789ABCDEF	0123456789ABCDEF
0000	00C3D041000100BD 1041007F115E8482	...A.....A...^..	.C}.....";db
0010	F282974040404040 4040404040404040	...@@@@@@@@@@@@	2bp
0020	4040F0F0F0C3F5F0 C3C3F0F0F0000000	@@.....	000C50CC000...
0030	0000000000000000 0000000000000000	.....	.....
0040	0000000000000000 000000000060F0F0	.....	.....-00
0050	F0F1A2A495404040 4040404040404040	...@@@@@@@@@@	01sun
0060	4040404040404040 4040404040404040	@@@@@@@@@@@@@@	
0070	C4C5C3E5F8404040 F0A2A49540404040	....@@@....@@@	DECV8 0sun
0080	4040404040404040 4000181404140300	@@@@@@@@@.....	.....
0090	0724070008147400 05240F0008144000	.\$....t.\$....@.	.....
00A0	08000E1147D8C4C2 F261C1C9E7F6F400	....G....a.....	.....QDB2/AIX64.
00B0	08116D9481A29200 0C115AE2D8D3F0F9	..m.....Z.....	.._mask...]SQL09
00C0	F0F0F0	...	000

	ACCSEC RQSDSS	(ASCII)	(EBCDIC)
	0 1 2 3 4 5 6 7 8 9 A B C D E F	0123456789ABCDEF	0123456789ABCDEF
0000	0026D00100020020 106D000611A20003	.&.....m.....	..}.....s...
0010	00162110E2E3D3C5 C3F1404040404040	..!.....@@@@@	...STLEC1
0020	40404040404040	@@@@@	

3 data DB2 UDB DRDA Communication Manager sqljcreceive fnc (3.3.54.3.0.100)  
 pid 807116 tid 1 cpid -1 node 0 sec 0 nsec 110546200 probe 100  
 bytes 12

Data1 (PD\_TYPE\_UINT,4) unsigned integer:  
 105

4 data DB2 UDB DRDA Communication Manager sqljcreceive fnc (3.3.54.3.0.1178)  
 pid 807116 tid 1 cpid -1 node 0 sec 0 nsec 110549755 probe 1178  
 bytes 122

RECEIVE BUFFER(AR):

	EXCSATRD OBJDSS	(ASCII)	(EBCDIC)
	0 1 2 3 4 5 6 7 8 9 A B C D E F	0123456789ABCDEF	0123456789ABCDEF
0000	0059D04300010053 1443000F115EE5F8	.Y.C...S.C...^..	..}.....;V8
0010	F1C14BE2E3D3C5C3 F100181404140300	..K.....	1A.STLEC1.....
0020	0724070007147400 05240F0007144000	.\$....t.\$....@.	.....
0030	0700081147D8C4C2 F20014116DE2E3D3	....G.....m...	....QDB2..._STL
0040	C5C3F14040404040 4040404040000C11	...@@@@@@@@@...	EC1 ...
0050	5AC4E2D5F0F8F0F1 F5	Z.....	]DSN08015

	ACCSECRD OBJDSS	(ASCII)	(EBCDIC)
	0 1 2 3 4 5 6 7 8 9 A B C D E F	0123456789ABCDEF	0123456789ABCDEF
0000	0010D0030002000A 14AC000611A20003	.....	..}.....s...

5 data DB2 UDB DRDA Communication Manager sqljcsend fnc (3.3.54.5.0.100)  
 pid 807116 tid 1 cpid -1 node 0 sec 0 nsec 110656806 probe 100  
 bytes 16

Data1 (PD\_TYPE\_UINT,8) unsigned integer:  
 233

Figure 35. Example of Trace Output (TCP/IP connection)

6 data DB2 UDB DRDA Communication Manager sqljcSend fnc (3.3.54.5.0.1177)  
 pid 807116 tid 1 cpid -1 node 0 sec 0 nsec 110659711 probe 1177  
 bytes 250

SEND BUFFER(AR):

	SECCHK RQSDSS	(ASCII)	(EBCDIC)
	0 1 2 3 4 5 6 7 8 9 A B C D E F	0123456789ABCDEF	0123456789ABCDEF
0000	003CD04100010036	106E000611A20003	..<.A...6.n.....
0010	00162110E2E3D3C5	C3F1404040404040	..!.....@@@
0020	40404040404000C	11A1D9858799F485	@@@.....
0030	A599000A11A09585	A6A39695	.....vr....newton

	ACCRDB RQSDSS	(ASCII)	(EBCDIC)
	0 1 2 3 4 5 6 7 8 9 A B C D E F	0123456789ABCDEF	0123456789ABCDEF
0000	00ADD001000200A7	20010006210F2407	.....!.\$.
0010	00172135C7F9F1C1	F0C4F3C14BD7C1F8	..!5.....K...
0020	F806030221064600	162110E2E3D3C5C3	.....!F...!
0030	F140404040404040	4040404040000C11	.....1
0040	2EE2D8D3F0F9F0F0	F000D002FD8E3C4	...../...
0050	E2D8D3C1E2C30016	00350006119C0333	.....5.....3
0060	0006119D04B00006	119E0333003C2104	.....3.

7 data DB2 UDB DRDA Communication Manager sqljcReceive fnc (3.3.54.3.0.100)  
 pid 807116 tid 1 cpid -1 node 0 sec 0 nsec 259908001 probe 100  
 bytes 12

Data1 (PD\_TYPE\_UINT,4) unsigned integer:  
 176

8 data DB2 UDB DRDA Communication Manager sqljcReceive fnc (3.3.54.3.0.1178)  
 pid 807116 tid 1 cpid -1 node 0 sec 0 nsec 259911584 probe 1178  
 bytes 193

RECEIVE BUFFER(AR):

	SECCHKRM RPYDSS	(ASCII)	(EBCDIC)
	0 1 2 3 4 5 6 7 8 9 A B C D E F	0123456789ABCDEF	0123456789ABCDEF
0000	0015D0420001000F	1219000611490000	...B.....I..
0010	000511A400		.....u.

	ACCRDBRM RPYDSS	(ASCII)	(EBCDIC)
	0 1 2 3 4 5 6 7 8 9 A B C D E F	0123456789ABCDEF	0123456789ABCDEF
0000	009BD00200020095	2201000611490000	....."....I..
0010	000D002FD8E3C4E2	D8D3F3F7F0000C11	.../.....
0020	2EC4E2D5F0F8F0F1	F500160035000611	.....5....
0030	9C04B80006119E04	B80006119D04B000	.....
0040	0C11A0D5C5E6E3D6	D540400006212524	.....@...!%\$
0050	34001E244E000624	4C00010014244D00	4..\$N..\$L...\$M.
0060	06244FFFFF000A11	E8091E768301BE00	.\$0.....v....
0070	2221030000000005	68B3B8C7F9F1C1F0	"!.....h.....
0080	C4F3C1D7C1F8F840	4040400603022106	.....@@@...!
0090	46000A11E8091E76	831389	F.....v....

9 data DB2 UDB DRDA Communication Manager sqljcSend fnc (3.3.54.5.0.100)  
 pid 807116 tid 1 cpid -1 node 0 sec 2 nsec 364420503 probe 100  
 bytes 16

Data1 (PD\_TYPE\_UINT,8) unsigned integer:  
 10

Figure 36. Example of Trace Output (TCP/IP connection) continued



```

10 data DB2 UDB DRDA Communication Manager sqljcsend fnc (3.3.54.5.0.1177)
pid 807116 tid 1 cpid -1 node 0 sec 2 nsec 364440751 probe 1177
bytes 27

SEND BUFFER(AR):

          RDBCMM RQSDSS                (ASCII)                (EBCDIC)
          0 1 2 3 4 5 6 7 8 9 A B C D E F 0123456789ABCDEF 0123456789ABCDEF
0000 000AD00100010004 200E                .....                ..}.....

11 data DB2 UDB DRDA Communication Manager sqljcreceive fnc (3.3.54.3.0.100)
pid 807116 tid 1 cpid -1 node 0 sec 2 nsec 475009631 probe 100
bytes 12

Data1 (PD_TYPE_UINT,4) unsigned integer:
54

12 data DB2 UDB DRDA Communication Manager sqljcreceive fnc (3.3.54.3.0.1178)
pid 807116 tid 1 cpid -1 node 0 sec 2 nsec 475014579 probe 1178
bytes 71

RECEIVE BUFFER(AR):

          ENDUOWRM RPYDSS                (ASCII)                (EBCDIC)
          0 1 2 3 4 5 6 7 8 9 A B C D E F 0123456789ABCDEF 0123456789ABCDEF
0000 002BD05200010025 220C000611490004 .+.R...%"....I.. ..}.....
0010 00162110E2E3D3C5 C3F1404040404040 ..!.....@@@@@ ..STLEC1
0020 4040404040400005 211501                @@@@...!..        .....

          SQLCARD OBJDSS                (ASCII)                (EBCDIC)
          0 1 2 3 4 5 6 7 8 9 A B C D E F 0123456789ABCDEF 0123456789ABCDEF
0000 000BD00300010005 2408FF                .....$.                ..}.....

13 data DB2 UDB DRDA Communication Manager sqljcsend fnc (3.3.54.5.0.100)
pid 807116 tid 1 cpid -1 node 0 sec 5 nsec 721710319 probe 100
bytes 16

Data1 (PD_TYPE_UINT,8) unsigned integer:
126

14 data DB2 UDB DRDA Communication Manager sqljcsend fnc (3.3.54.5.0.1177)
pid 807116 tid 1 cpid -1 node 0 sec 5 nsec 721727276 probe 1177
bytes 143

SEND BUFFER(AR):

          EXCSQLIMM RQSDSS                (ASCII)                (EBCDIC)
          0 1 2 3 4 5 6 7 8 9 A B C D E F 0123456789ABCDEF 0123456789ABCDEF
0000 0053D0510001004D 200A00442113E2E3 .S.Q...M ..D!.. ..}....(.....ST
0010 D3C5C3F140404040 4040404040404040 ....@@@@@@@@@@@@ LEC1
0020 D5E4D3D3C9C44040 4040404040404040 .....@@@@@@@@@@@@ NULLID
0030 4040E2D8D3C3F2C6 F0C1404040404040 @@.....@@@@@ SQLC2F0A
0040 4040404041414141 41484C5600CB0005 @@@@AAAAAHLV.... .....<.....
0050 2105F1                !..                ..1

          SQLSTT OBJDSS                (ASCII)                (EBCDIC)
          0 1 2 3 4 5 6 7 8 9 A B C D E F 0123456789ABCDEF 0123456789ABCDEF
0000 002BD00300010025 2414000000001B64 .+....%$......d ..}.....
0010 656C657465206672 6F6D206464637375 elete from ddcsu .%.....?_.....
0020 73312E6D79746162 6C65FF                sl.mytable.        .._`./.%..

15 data DB2 UDB DRDA Communication Manager sqljcreceive fnc (3.3.54.3.0.100)
pid 807116 tid 1 cpid -1 node 0 sec 5 nsec 832901261 probe 100
bytes 12

Data1 (PD_TYPE_UINT,4) unsigned integer:
102

```

Figure 37. Example of Trace Output (TCP/IP connection) continued

16 data DB2 UDB DRDA Communication Manager sqljcReceive fnc (3.3.54.3.0.1178)  
 pid 807116 tid 1 cpid -1 node 0 sec 5 nsec 832906528 probe 1178  
 bytes 119

RECEIVE BUFFER(AR):

	SQLCARD OBJDSS	(ASCII)	(EBCDIC)
	0 1 2 3 4 5 6 7 8 9 A B C D E F	0123456789ABCDEF	0123456789ABCDEF
0000	0066D00300010060	240800FFFFFF3434	.f.....`\$. ....44 ..}....-.....
0010	3237303444534E58	4F544C2000FFFFFFE	2704DSNXOTL .... ..+!<.....
0020	0C00000000000000	00FFFFFFF000000	.....
0030	0000000000572020	2057202020202020	....W W .....
0040	001053544C454331	2020202020202020	..STLEC1 ..<.....
0050	2020000F44444353	5553312E4D595441	..DDCSUS1.MYTA .....
0060	424C450000FF		BLE... ..<....

17 data DB2 UDB DRDA Communication Manager sqljcSend fnc (3.3.54.5.0.100)  
 pid 807116 tid 1 cpid -1 node 0 sec 5 nsec 833156953 probe 100  
 bytes 16

Data1 (PD\_TYPE\_UINT,8) unsigned integer:  
 10

18 data DB2 UDB DRDA Communication Manager sqljcSend fnc (3.3.54.5.0.1177)  
 pid 807116 tid 1 cpid -1 node 0 sec 5 nsec 833159843 probe 1177  
 bytes 27

SEND BUFFER(AR):

	RDBRLLBCK RQSDSS	(ASCII)	(EBCDIC)
	0 1 2 3 4 5 6 7 8 9 A B C D E F	0123456789ABCDEF	0123456789ABCDEF
0000	000AD00100010004	200F	..... . ..}.....

19 data DB2 UDB DRDA Communication Manager sqljcReceive fnc (3.3.54.3.0.100)  
 pid 807116 tid 1 cpid -1 node 0 sec 5 nsec 943302832 probe 100  
 bytes 12

Data1 (PD\_TYPE\_UINT,4) unsigned integer:  
 54

20 data DB2 UDB DRDA Communication Manager sqljcReceive fnc (3.3.54.3.0.1178)  
 pid 807116 tid 1 cpid -1 node 0 sec 5 nsec 943306288 probe 1178  
 bytes 71

RECEIVE BUFFER(AR):

	ENDUOWRM RPYDSS	(ASCII)	(EBCDIC)
	0 1 2 3 4 5 6 7 8 9 A B C D E F	0123456789ABCDEF	0123456789ABCDEF
0000	002BD05200010025	220C000611490004	+.R...%"....I.. ..}.....
0010	00162110E2E3D3C5	C3F1404040404040	..!.....@#@#@@ ..STLEC1
0020	4040404040400005	211502	@#@#@@...!... .....
	SQLCARD OBJDSS	(ASCII)	(EBCDIC)
	0 1 2 3 4 5 6 7 8 9 A B C D E F	0123456789ABCDEF	0123456789ABCDEF
0000	000BD00300010005	2408FF	.....\$.. ..}.....

Figure 38. Example of Trace Output (TCP/IP connection) continued

## Subsequent buffer information for DRDA traces

You can analyze subsequent send and receive buffers for additional information. The next request contains a commit. The **commit** command instructs the IBM mainframe database server management system to commit the current unit of work. The fourth buffer is received from the IBM mainframe database server database management system as a result of a commit or rollback. It contains the End Unit of Work Reply Message (ENDUOWRM), which indicates that the current unit of work has ended.

In this example, trace entry 12 contains a null SQLCA, indicated by DDM code point X'2408' followed by X'FF'. A null SQLCA (X'2408FF') indicates success (SQLCODE 0).

Figure 35 on page 517 shows an example of a receive buffer containing an error SQLCA at trace entry 16.

## JDBC trace

### Obtaining traces of applications that use the DB2 Universal JDBC Driver

This task will describe how to obtain a trace of an application that uses the DB2 Universal JDBC Driver.

#### Procedure

If you have an SQLJ or JDBC application that is using the DB2 Universal JDBC Driver, a JDBC trace can be enabled in several different ways:

- If you use the `DataSource` interface to connect to a data source, then use the `DataSource.setTraceLevel()` and `DataSource.setTraceFile()` method to enable tracing.
- If you use the `DriverManager` interface to connect to a data source, the easiest way to enable tracing will be to set the `logWriter` on `DriverManager` before obtaining a connection.

For example:

```
DriverManager.setLogWriter(new PrintWriter(new FileOutputStream("trace.txt")));
```

- If you are using the `DriverManager` interface, you can alternatively specify the `traceFile` and `traceLevel` properties as part of the URL when you load the driver.

For example:

```
String databaseURL =  
"jdbc:db2://hal:50000/sample:traceFile=c:/temp/trace.txt;" ;
```

## CLI trace files

Applications that access the CLI driver can make use of the CLI trace utility. This utility records all function calls made by the CLI drivers to a trace file which is useful for problem determination.

This type of trace is applicable for situations where a problem is encountered in:

- a CLI application
- an ODBC application (since ODBC applications use the CLI interface to access DB2)
- CLI stored procedures

When diagnosing ODBC applications it is often easiest to determine the problem by using an ODBC trace or CLI trace. If you are using an ODBC driver manager, it will likely provide the capability to take an ODBC trace. Consult your driver manager documentation to determine how to enable ODBC tracing. CLI traces are specific to the DB2 software and will often contain more information than a generic ODBC trace. Both traces are usually quite similar, listing entry and exit points for all CLI calls from an application; including any parameters and return codes to those calls.

**Note:** The CLI trace offers very little information about the internal workings of the CLI driver.

This topic discusses the following subjects:

- CLI trace
- CLI trace options and the `db2cli.ini` file
- CLI driver trace versus ODBC driver manager trace
- CLI driver, and DB2 trace
- CLI trace and CLI stored procedures

The CLI for Linux, UNIX, and Windows offers comprehensive tracing utility. By default, the trace utility is disabled and use no additional computing resources. When enabled, the trace utility generate one or more text trace files whenever an application accesses the CLI driver. These trace files provide the listed information:

- The order in which CLI functions were called by the application
- The contents of input and output parameters passed to and received from CLI functions
- The return codes and any error or warning messages generated by CLI functions

CLI trace file analysis can benefit application developers in a number of ways. First, subtle program logic and parameter initialization errors are often evident in the traces. Second, CLI traces might suggest ways of better tuning an application or the databases it accesses. For example, if a CLI trace shows a table being queried many times on a particular set of columns, you might want to create an index corresponding to one of the columns on the table to improve application performance. Finally, analysis of CLI trace files can help application developers understand how a vendor-acquired application or interface is behaving.

## CLI trace

You can enable CLI trace by using the `db2cli.ini` configuration file, programmatically setting the **SQL\_ATTR\_TRACE** environment attribute or by using the DB2 trace utility (the **db2trc** command).

Typically, the values of the configuration keywords in the `db2cli.ini` file are read only when an application that uses the CLI driver is initialized. The location of the `db2cli.ini` file might change based on the listed factors:

- The operating system on which DB2 product is installed.
- The type of data source names (DSNs) that you are using.
- The type of DB2 product that you install.
- Whether you set the **DB2CLIINIPATH** registry variable.
- Whether you set the "DB2 Common Application Data path" or **DB2\_COMMON\_APP\_DATA\_TOP\_PATH** response file keyword during the DB2 product installation (only available on Windows operating systems).

To view the current settings of the configuration keywords in the `db2cli.ini` file from the command line processor, issue the following command:

```
db2 GET CLI CFG FOR SECTION COMMON
```

There are two ways to modify the `db2cli.ini` file to configure the CLI trace facilities:

- Edit the `db2cli.ini` file by using a text editor.

- Issue **UPDATE CLI CFG** commands from the command line processor (If command line processor is available). For example, issuing the following commands from the command line processor updates the `db2cli.ini` file and enables the CLI trace:

```
DB2 UPDATE CLI CFG FOR SECTION COMMON USING Trace 1
DB2 UPDATE CLI CFG FOR SECTION COMMON USING TracePathName c:\TMP\trace
DB2 UPDATE CLI CFG FOR SECTION COMMON USING TraceComm 1
DB2 UPDATE CLI CFG FOR SECTION COMMON USING TraceFlush 1
DB2 UPDATE CLI CFG FOR SECTION COMMON USING TraceTimestamp 1
```

Typically, the CLI trace configuration keywords are read from the `db2cli.ini` file only when an application is initialized. However, you can use a special `db2cli.ini` file option, **TraceRefreshInterval** to indicate an interval at which the values of specific CLI trace keywords are reread from the `db2cli.ini` file.

**Note:**

1. If `TracePathName` keyword is used, the path specified must exist before start of CLI tracing and it must have global read and write permissions.
2. The IBM Data Server Driver Package and IBM Data Server Driver for ODBC and CLI installations do not contain the DB2 command line processor. To change the settings of trace configuration keywords, you can modify the `db2cli.ini` file manually.

You can also configure the CLI trace by setting the **SQL\_ATTR\_TRACE** environment attribute from the application using the **SQLSetEnvAttr()** API. This attribute overrides the settings in the `db2cli.ini` file.

To enable a CLI trace without having to restart the application, use the **db2trc** command with a **-CLI** parameter:

```
db2trc on -f <filename> -cli
```

The DB2 trace utility creates a binary dump file with a file name specified in the `<filename>` parameter, which you can format to generate a CLI trace. For example, after enabling a DB2 trace with a **-CLI** parameter, issue **db2trc** command with an **off** parameter to turn off the trace:

```
db2trc off
```

When **db2trc** is turned off, binary file with name specified in the `<filename>` is generated in the local path where trace command was issued. Format the binary file to a CLI trace using the **db2trc** command with **fmt** and **-cli** parameters:

```
db2trc fmt -cli <filename> <cli-filename>
```

A `<filename>` is the name of a binary file generated from the **db2trc** command and `<cli-filename>` is the name of the CLI trace output.

**Important:** Disable the CLI trace when you do not need it. Unnecessary tracing can reduce application performance and generate unwanted trace files. The CLI trace files are not deleted, and new trace information is either created in a new file or appended to existing trace files.

## CLI Trace options and the db2cli.ini file

When an application using the CLI driver begins running, the driver checks for CLI trace keywords in the **[COMMON]** section of the `db2cli.ini` file.

```
[COMMON]
Trace=1
TracePathName=c:\TMP\trace
TraceFlush=1
```

You can define listed CLI trace keywords:

- com.ibm.db2.luw.admin.trb.doc/com.ibm.db2.luw.apdv.cli.doc/doc/r0008821.dita
- com.ibm.db2.luw.admin.trb.doc/com.ibm.db2.luw.apdv.cli.doc/doc/r0008822.dita
- com.ibm.db2.luw.admin.trb.doc/com.ibm.db2.luw.apdv.cli.doc/doc/r0011527.dita
- com.ibm.db2.luw.admin.trb.doc/com.ibm.db2.luw.apdv.cli.doc/doc/r0008823.dita
- com.ibm.db2.luw.admin.trb.doc/com.ibm.db2.luw.apdv.cli.doc/doc/r0008824.dita
- com.ibm.db2.luw.admin.trb.doc/com.ibm.db2.luw.apdv.cli.doc/doc/r0011528.dita
- com.ibm.db2.luw.admin.trb.doc/com.ibm.db2.luw.apdv.cli.doc/doc/r0008825.dita
- com.ibm.db2.luw.admin.trb.doc/com.ibm.db2.luw.apdv.cli.doc/doc/r0008826.dita
- com.ibm.db2.luw.admin.trb.doc/com.ibm.db2.luw.apdv.cli.doc/doc/r0008827.dita
- com.ibm.db2.luw.admin.trb.doc/com.ibm.db2.luw.apdv.cli.doc/doc/r0008839.dita
- com.ibm.db2.luw.admin.trb.doc/com.ibm.db2.luw.apdv.cli.doc/doc/r0008828.dita
- com.ibm.db2.luw.admin.trb.doc/com.ibm.db2.luw.apdv.cli.doc/doc/r0008829.dita
- com.ibm.db2.luw.admin.trb.doc/com.ibm.db2.luw.apdv.cli.doc/doc/r0008840.dita
- com.ibm.db2.luw.admin.trb.doc/com.ibm.db2.luw.apdv.cli.doc/doc/r0008831.dita

#### Usage notes:

1. Because CLI trace keywords are in the **[COMMON]** section of the `db2cli.ini` file, their values apply to all database connections through the CLI driver.
2. CLI trace keywords are not case-sensitive. However, path and file name keyword values might be case-sensitive on some operating systems, such as the UNIX operating system.
3. If either a CLI trace keyword or its associated value in the `db2cli.ini` file is invalid, the CLI trace utility ignores the value. If valid CLI keyword is specified with invalid value, the default value for that trace keyword is used instead.
4. Unless you set the **TraceRefreshInterval** keyword, CLI trace keywords are read from the `db2cli.ini` file only once, at application initialization time. If you set the **TraceRefreshInterval** keyword, **Trace** and **TracePIDList** keywords are reread from the `db2cli.ini` file at the specified interval and applied, as appropriate, to the currently executing application.

## CLI driver trace versus ODBC driver manager trace

It is important to understand the difference between an ODBC driver manager trace and a CLI driver trace. An ODBC driver manager trace shows the ODBC function calls that an ODBC application makes to the ODBC driver manager. The ODBC driver manager is not part of a DB2 product and it is acquired separately from an independent software vendor. In contrast, a CLI driver trace shows the function calls that the ODBC driver manager makes to the CLI driver on behalf of the application.

An ODBC driver manager might forward some function calls directly from the application to the CLI driver. However, the ODBC driver manager might also delay or avoid forwarding some function calls to the driver. The ODBC driver manager might also modify application function arguments or map application functions to other functions before forwarding the call to the CLI driver. The ODBC driver manager intervenes to perform listed tasks:

- ODBC 2.0 functions that have been deprecated in ODBC 3.0 are mapped to new functions.
- ODBC 2.0 function arguments that have been deprecated in ODBC 3.0 are mapped to equivalent ODBC 3.0 arguments.
- The Microsoft cursor library maps calls to functions such as the `SQLExtendedFetch()` function to multiple calls to the `SQLFetch()` function and other supporting functions to achieve the same result.
- ODBC driver manager connection pooling usually defers `SQLDisconnect()` function call requests or avoids them altogether if the connection is reused.

For these and other reasons, you might find an ODBC driver manager trace to be a useful complement to the CLI driver trace.

For more information about capturing and interpreting ODBC driver manager traces, refer to the ODBC driver manager documentation provided by independent software vendor. On Windows operating systems, refer to the Microsoft ODBC 3.0 Software Development Kit and Programmer's Reference, available online at: <http://www.msdn.microsoft.com/>.

## CLI driver and DB2 trace

The CLI driver uses many internal DB2 functions to do its work. These internal DB2 function calls are logged in the DB2 trace. The DB2 traces are meant to assist IBM Service in problem determination and resolution.

## CLI trace and CLI stored procedures

On all workstation platforms, you can use the CLI trace utility to trace the execution of CLI stored procedures.

Most of the CLI trace information and instructions given in earlier sections is generic and applies to both applications and stored procedures. However, unlike applications that are clients of a database server and typically execute on a machine that is separate from the database server, stored procedures execute at the database server. Therefore, you must take listed additional steps when tracing the execution of CLI stored procedures:

- Specify the trace keyword options in the `db2cli.ini` file at the DB2 server.
- Ensure that you correctly set all keywords before issuing the **db2start** command to start the database manager.
- Use of CLI keywords, **TRACEREFRESHINTERVAL** and **QUERYTIMEINTERVAL** are ignored if it used inside a stored procedure or routine that uses CLI API calls.

## Obtaining CLI traces

To turn on a CLI trace you must enable a set of CLI configuration keywords.

### Before you begin

**Note:** There are lots of keywords that can be added to the `db2cli.ini` file that can affect application behavior. These keywords can resolve or be the cause of application problems. There are also some keywords that are not covered in the CLI documentation. Those are only available from IBM Software Support. If you have keywords in your `db2cli.ini` file that are not documented, it is likely that they were recommended by the IBM Software Support team.

## About this task

When you use the trace facility to diagnose application issues, keep in mind that it does have an impact on application performance and that it affects all applications, not only your test application. This is why it is important to remember to turn it off after the problem has been identified.

## Procedure

To obtain a CLI trace:

1. Create a path for the trace files.

It is important to create a path that every user can write to. For example, on Windows operating systems:

```
mkdir c:\temp\trace
```

On Linux and UNIX operating systems:

```
mkdir /tmp/trace  
chmod 777 /tmp/trace
```

2. Update the CLI configuration keywords.

This can be done by either manually editing the `db2cli.ini` file or using the **UPDATE CLI CFG** command.

- To manually edit the `db2cli.ini` file:
  - a. Open up the `db2cli.ini` file in a plain text editor. The location of the `db2cli.ini` file might change based on whether the Microsoft ODBC Driver Manager is used, the type of data source names (DSN) used, the type of client or driver being installed, and whether the registry variable **DB2CLIINIPATH** is set. For more information, see the “`db2cli.ini` initialization file” topic in the *Call Level Interface Guide and Reference Volume 1*.
  - b. Add the following section to the file (or if the **COMMON** section already exists, just append the variables):

```
[COMMON]  
Trace=1  
TracePathName=path  
TraceComm=1  
TraceFlush=1  
TraceTimeStamp=1
```

where *path* is, for example, `C:\temp\trace` on Windows, or `/tmp/trace` on Linux and UNIX.

- c. Save the file with at least one blank line at the end of the file. (This prevents some parsing errors.)
- To use the **UPDATE CLI CFG** command to update the CLI configuration keywords, issue the following commands:

```
db2 UPDATE CLI CFG FOR SECTION COMMON USING Trace 1  
db2 UPDATE CLI CFG FOR SECTION COMMON USING TracePathName path  
db2 UPDATE CLI CFG FOR SECTION COMMON USING TraceComm 1  
db2 UPDATE CLI CFG FOR SECTION COMMON USING TraceFlush 1  
db2 UPDATE CLI CFG FOR SECTION COMMON USING TraceTimeStamp 3
```

where *path* is, for example, `C:\temp\trace` on Windows, or `/tmp/trace` on Linux and UNIX.

3. Confirm the `db2cli.ini` configuration.



Issue the following command to verify that the correct keywords are set and being picked up:

```
db2 GET CLI CFG FOR SECTION COMMON
```

4. Restart the application.

The `db2cli.ini` file is only read on application start, therefore, for any changes to take effect, the application must be restarted.

If tracing a CLI stored procedure, this means restarting the DB2 instance.

5. Capture the error.

Run the application until the error is generated, then terminate the application. If it is possible to reduce the situation, such that only applications related to the problem recreation are running at the time of the trace, this makes for much clearer trace analysis.

6. Disable the CLI trace.

Set the **Trace** keyword to a value of zero in the `[COMMON]` section of the `db2cli.ini` manually, or issue:

```
db2 UPDATE CLI CFG FOR SECTION COMMON USING Trace 0
```

7. (Optional) Restart any applications that might be running and tracing.

## Results

The CLI trace files will be written to the path specified in the **TracePathName** keyword. The filenames have a format of `ppidttid.cli` where *pid* is the operating system assigned process ID, and *tid* is a numeric counter (starting at 0) for each thread generated by the application process. For example, `p1234t1.cli`. If you are working with IBM Software Support to diagnose a problem, they will want to see all of the files that were generated in the trace path.

## Interpreting input and output parameters in CLI trace files

As is the case with any regular function, DB2 Call Level Interface (CLI) functions have input and output parameters. In a CLI trace, these input and output parameters can be seen, providing details about how each application is invoking a particular CLI API. The input and output parameters for any CLI function, as shown in the CLI trace, can be compared to the definition of that CLI function in the CLI Reference sections of the documentation.

Here is a snippet from a CLI trace file:

```
SQLConnect( hDbc=0:1, szDSN="sample", cbDSN=-3, szUID="",
           cbUID=-3, szAuthStr="", cbAuthStr=-3 )
----> Time elapsed - +6.960000E-004 seconds
```

```
SQLRETURN  SQLConnect      (
           SQLHDBC        ConnectionHandle, /* hdbc */
           SQLCHAR         *FAR ServerName,   /* szDSN */
           SQLSMALLINT     NameLength1,      /* cbDSN */
           SQLCHAR         *FAR UserName,     /* szUID */
           SQLSMALLINT     NameLength2,      /* cbUID */
           SQLCHAR         *FAR Authentication, /* szAuthStr */
           SQLSMALLINT     NameLength3);     /* cbAuthStr */
```

The initial call to the CLI function shows the input parameters and the values being assigned to them (as appropriate).

When CLI functions return, they show the resultant output parameters, for example:

```
SQLAllocStmt( phStmt=1:1 )
<--- SQL_SUCCESS Time elapsed - +4.444000E-003 seconds
```

In this case, the CLI function SQLAllocStmt() is returning an output parameter phStmt with a value of "1:1" (connection handle 1, statement handle 1).

## Analyzing Dynamic SQL in CLI traces

CLI Traces also show how dynamic SQL is performed by the declaration and use of parameter markers in SQLPrepare() and SQLBindParameter(). This gives you the ability to determine at runtime what SQL statements will be performed.

The following trace entry shows the preparation of the SQL statement (a question mark (?) or a colon followed by a name (:name) denotes a parameter marker):

```
SQLPrepare( hStmt=1:1, pszSqlStr=
  "select * from employee where empno = ?",
  cbSqlStr=-3 )
---> Time elapsed - +1.648000E-003 seconds
( StmtOut="select * from employee where empno = ?" )
SQLPrepare( )
<--- SQL_SUCCESS Time elapsed - +5.929000E-003 seconds
```

The following trace entry shows the binding of the parameter marker as a CHAR with a maximum length of 7:

```
SQLBindParameter( hStmt=1:1, iPar=1, fParamType=SQL_PARAM_INPUT,
fCType=SQL_C_CHAR, fSQLType=SQL_CHAR, cbColDef=7, ibScale=0,
  rgbValue=&00854f28, cbValueMax=7, pcbValue=&00858534 )
---> Time elapsed - +1.348000E-003 seconds
SQLBindParameter( )
<--- SQL_SUCCESS Time elapsed - +7.607000E-003 seconds
```

The dynamic SQL statement is now executed. The rgbValue="000010" shows the value that was substituted for the parameter marker by the application at run time:

```
SQLExecute( hStmt=1:1 )
---> Time elapsed - +1.317000E-003 seconds
( iPar=1, fCType=SQL_C_CHAR, rgbValue="000010" - X"303030303130",
  pcbValue=6, piIndicatorPtr=6 )
  sqlccsend( ulBytes - 384 )
  sqlccsend( Handle - 14437216 )
  sqlccsend( ) - rc - 0, time elapsed - +1.915000E-003
  sqlccrecv( )
  sqlccrecv( ulBytes - 1053 ) - rc - 0, time elapsed - +8.808000E-003
SQLExecute( )
<--- SQL_SUCCESS Time elapsed - +2.213300E-002 seconds
```

## Interpreting timing information in CLI traces

There are a few ways to gather timing information from a CLI trace. By default, a CLI trace captures the time spent in the application since the last CLI API call was made on a particular thread.

As well as the time spent in DB2, it includes the network time between the ent and server. For example:

```
SQLAllocStmt( hDbc=0:1, phStmt=&0012ee48 )
---> Time elapsed - +3.964187E+000 seconds
```

(This time value indicates the time spent in the application since last CLI API was called)

```
SQLAllocStmt( phStmt=1:1 )
<--- SQL_SUCCESS Time elapsed - +4.444000E-003 seconds
```

(Since the function has completed, this time value indicates the time spent in DB2, including the network time)

The other way to capture timing information is using the CLI keyword: TraceTimeStamp. This keyword will generate a timestamp for every invocation and result of a CLI API call. The keyword has 4 display options: no timestamp information, processor ticks and ISO timestamp, processor ticks, or ISO timestamp.

This can be very useful when working with timing related problems such as CLI0125E - function sequence errors. It can also be helpful when attempting to determine which event happened first when working with multithreaded applications.

### Interpreting unknown values in CLI traces

It is possible that a CLI function might return "Unknown value" as a value for an input parameter in a CLI trace.

This can occur if the CLI driver is looking for something specific for that input parameter, yet the application provides a different value. For example, this can occur if you're following outdated definitions of CLI functions or are using CLI functions which have been deprecated.

It is also possible that you could see a CLI function call return an "Option value changed" or a "Keyset Parser Return Code". This is a result of the keyset cursor displaying a message, such as when the cursor is being downgraded to a static cursor for some specific reason.

```
SQLExecDirect( hStmt=1:1, pszSqlStr="select * from org", cbSqlStr=-3 )
  ---> Time elapsed - +5.000000E-002 seconds
( StmtOut="select * from org" )
( COMMIT=0 )
( StmtOut=" SELECT A.TABSCHEMA, ..... )
( StmtOut=" SELECT A.TABSCHEMA, ..... )
( Keyset Parser Return Code=1100 )

SQLExecDirect( )
  <--- SQL_SUCCESS_WITH_INFO Time elapsed - +1.06E+001 seconds
```

In this CLI trace, the keyset parser has indicated a return code of 1100, which indicates that there is not a unique index or primary key for the table, and therefore a keyset cursor cannot be created. These return codes are not externalized and thus at this point you must contact IBM Software Support if you want further information about the meaning of the return code.

Calling SQLError or SQLDiagRec will indicate that the cursor type was changed. The application should then query the cursor type and concurrency to determine which attribute was changed.

### Interpreting multi-threaded CLI trace output

CLI traces can trace multi-threaded applications. The best way to trace a multithreaded application is by using the CLI keyword: TracePathName. This will produce trace files named p<pid>t<tid>.cli where <tid> is the actual thread id of the application.

If you must know what the actual thread id is, this information can be seen in the CLI Trace Header:

```
[ Process: 3500, Thread: 728 ]
[ Date & Time:          02/17/2006 04:28:02.238015 ]
[ Product:              QDB2/NT DB2 v9.1.0.190 ]
...
```

You can also trace a multithreaded application to one file, using the CLI keyword: `TraceFileName`. This method will generate one file of your choice, but can be cumbersome to read, as certain API's in one thread can be executed at the same time as another API in another thread, which could potentially cause some confusion when reviewing the trace.

It is usually recommended to turn `TraceTimeStamp` on so that you can determine the true sequence of events by looking at the time that a certain API was executed. This can be very useful for investigating problems where one thread caused a problem in another thread (for example, `CLI0125E - Function sequence error`).

### Analyzing CLI trace file created using the `db2cli.ini` file

Applications that access the CLI driver can make use of the CLI trace utility. This utility records all function calls made by the CLI drivers to a trace file, which is useful for problem determination.

This topic discusses how to access and interpret the trace files generated by the tracing utility:

- CLI trace file location
- CLI trace file interpretation

#### CLI trace file location

If the `TraceFileName` keyword was used in the `db2cli.ini` file to specify a fully qualified file name, then the CLI trace file will be in the location specified. If a relative file name was specified for the CLI trace file name, the location of that file will depend on what the operating system considers to be the current path of the application.

**Note:** If the user executing the application does not have sufficient authority to write to the trace file in the specified path, no file will be generated and no warning or error is given.

The CLI trace utility automatically use the application's process ID and thread sequence number to name the trace files when the `TracePathName` keyword have been set. For example, a CLI trace of an application with three threads might generate the following CLI trace files: `p1680t3124.cli`, `p1680t3125.cli`, `p1680t3126.cli`.

If no CLI trace output files appear to have been created:

- Verify that the trace configuration keywords are set correctly in the `db2cli.ini` file. Issuing the `db2 GET CLI CFG FOR SECTION COMMON` command from the command line processor is a quick way to do this.
- Ensure the application is restarted after updating the `db2cli.ini` file. The CLI trace utility are initialized during application startup. The CLI trace utility can be reconfigured at run time but only if the `TraceRefreshInterval` keyword was appropriately specified before the application startup.

**Note:** Only the `Trace` and `TracePIDList` CLI keywords can be reconfigured at run time. *Changes made to other CLI keywords, including `TraceRefreshInterval`, have no effect without an application restart.*

- If the **TraceRefreshInterval** keyword was specified before the application startup, and if the **Trace** keyword was initially set to 0, ensure that enough time has elapsed for the CLI trace facility to reread the **Trace** keyword value.
- If the **TracePathName** keyword is used to specify trace directory ensure given directory exist before starting the application.
- Ensure the application has write access to the specified trace file or trace directory.
- Check the **DB2CLIINIPATH** environment variable. If set, the CLI trace facilities expect the `db2cli.ini` file to be at the location specified by this variable.
- If "DB2 Common Application Data path" or **DB2\_COMMON\_APP\_DATA\_TOP\_PATH** response file keyword was specified during the DB2 product installation, check the path specified in **DB2\_COMMON\_APP\_DATA\_PATH** environment variable (only available on Windows operating systems).
- If the application uses ODBC to interface with the CLI driver, verify that one of the `SQLConnect()`, `SQLDriverConnect()` or `SQLBrowseConnect()` functions have been successfully called. No entries will be written to the CLI trace files until a database connection has successfully been made.

## CLI trace file interpretation

CLI traces always begin with a header that identifies the process ID and thread ID of the application that generated the trace, the time the trace began, and product specific information such as the local DB2 build level and CLI driver version. For example:

```

1 [ Process: 1356, Thread: 5656 ]
2 [ Date & Time:           08/05/2011 15:35:00.326001 ]
3 [ Product:              QDB2/NT DB2 v9.7.400.501 ]
4 [ Level Identifier:     08050107 ]
5 [ CLI Driver Version:   09.02.0000 ]
6 [ Informational Tokens: "DB2 v9.7.400.501","s110330","IP23237","Fixpack 4" ]
7 [ Install Path:        C:\PROGRAM*1\IBM\SQLLIB ]
8 [ db2cli.ini Location2: C:\Documents and Settings\A11 Users\Application Data\IBM\DB2\DB2COPY1\cfg\
db2cli.ini ]
9 [ CLI Driver Type:     IBM Data Server Runtime Client ]

```

**Note:** Trace examples used in this section have line numbers added to the left side of the trace. These line numbers have been added to aid the discussion and will *not* appear in an actual CLI trace.

Immediately following the trace header, there are usually a number of trace entries related to environment and connection handle allocation and initialization. For example:

```

10 SQLAllocEnv( phEnv=&bffff684 )
11     —> Time elapsed - +9.200000E-004 seconds

12 SQLAllocEnv( phEnv=0:1 )
13     <— SQL_SUCCESS Time elapsed - +7.500000E-004 seconds

14 SQLAllocConnect( hEnv=0:1, phDbc=&bffff680 )
15     —> Time elapsed - +2.334000E-003 seconds

16 SQLAllocConnect( phDbc=0:1 )
17     <— SQL_SUCCESS Time elapsed - +5.280000E-004 seconds

18 SQLSetConnectOption( hDbc=0:1, fOption=SQL_ATTR_AUTOCOMMIT, vParam=0 )
19     —> Time elapsed - +2.301000E-003 seconds

20 SQLSetConnectOption( )
21     <— SQL_SUCCESS Time elapsed - +3.150000E-004 seconds

22 SQLConnect( hDbc=0:1, szDSN="SAMPLE", cbDSN=-3, szUID="", cbUID=-3,

```

```

                                szAuthStr="", cbAuthStr=-3 )
23      —> Time elapsed - +7.000000E-005 seconds
24 ( DBMS NAME="DB2/LINUX", Version="07.01.0000", Fixpack="0x22010105" )

25 SQLConnect( )
26      <— SQL_SUCCESS   Time elapsed - +5.209880E-001 seconds
27 ( DSN=""SAMPLE"" )

28 ( UID=" " )

29 ( PWD="*" )

```

In the trace example, notice that there are two entries for each CLI function call (for example, lines 22-24 and 25-29 for the SQLConnect() function call). This is always the case in CLI traces. The first entry shows the input parameter values passed to the function call while the second entry shows the function output parameter values and return code returned to the application.

The trace example shows that the SQLAllocEnv() function successfully allocated an environment handle ( phEnv=0:1 ) at line 12. That handle was then passed to the SQLAllocConnect() function which successfully allocated a database connection handle ( phDbc=0:1 ) as of line 16. Next, the SQLSetConnectOption() function was used to set the phDbc=0:1 connection's SQL\_ATTR\_AUTOCOMMIT attribute to SQL\_AUTOCOMMIT\_OFF ( vParam=0 ) at line 18. Finally, SQLConnect() was called to connect to the target database ( SAMPLE ) at line 22.

Included in the input trace entry of the SQLConnect() function on line 24 is the build and Fix Pack level of the target database server. Other information that might also appear in this trace entry includes input connection string keywords and the code pages of the client and server. For example, suppose the following information also appeared in the SQLConnect() trace entry:

```

( Application Codepage=819, Database Codepage=819,
  Char Send/Recv Codepage=819, Graphic Send/Recv Codepage=819,
  Application Char Codepage=819, Application Graphic Codepage=819 )

```

This would mean the application and the database server were using the same code page ( 819 ).

The return trace entry of the SQLConnect() function also contains important connection information (lines 27-29 in the trace example). Additional information that might be displayed in the return entry includes any **PATCH1** or **PATCH2** keyword values that apply to the connection. For example, if PATCH2=27,28 was specified in the db2cli.ini file under the COMMON section, the following line should also appear in the SQLConnect() return entry:

```

( PATCH2="27,28" )

```

Following the environment and connection related trace entries are the statement related trace entries. For example:

```

30 SQLAllocStmt( hDbc=0:1, phStmt=&bffff684 )
31      —> Time elapsed - +1.868000E-003 seconds

32 SQLAllocStmt( phStmt=1:1 )
33      <— SQL_SUCCESS   Time elapsed - +6.890000E-004 seconds

34 SQLExecDirect( hStmt=1:1, pszSqlStr="CREATE TABLE GREETING (MSG
                                VARCHAR(10))", cbSqlStr=-3 )
35      —> Time elapsed - +2.863000E-003 seconds
36 ( StmtOut="CREATE TABLE GREETING (MSG VARCHAR(10))" )

```

```

37 SQLExecDirect( )
38    <— SQL_SUCCESS   Time elapsed - +2.387800E-002 seconds

```

In the trace example, the database connection handle ( phDbc=0:1 ) was used to allocate a statement handle ( phStmt=1:1 ) at line 32. An unprepared SQL statement was then executed on that statement handle at line 34. If the TraceComm=1 keyword had been set in the db2cli.ini file, the SQLExecDirect() function call trace entries would have shown additional client-server communication information as follows:

```

SQLExecDirect( hStmt=1:1, pszSqlStr="CREATE TABLE GREETING (MSG
                                VARCHAR(10))", cbSqlStr=-3 )
    —> Time elapsed - +2.876000E-003 seconds
( StmtOut="CREATE TABLE GREETING (MSG VARCHAR(10))" )

    sqlccsend( ulBytes - 232 )
    sqlccsend( Handle - 1084869448 )
    sqlccsend( ) - rc - 0, time elapsed - +1.150000E-004
    sqlccrecv( )
    sqlccrecv( ulBytes - 163 ) - rc - 0, time elapsed - +2.243800E-002

SQLExecDirect( )
    <— SQL_SUCCESS   Time elapsed - +2.384900E-002 seconds

```

Notice the additional sqlccsend() and sqlccrecv() function call information in this trace entry. The sqlccsend() call information reveals how much data was sent from the client to the server, how long the transmission took, and the success of that transmission ( 0 = SQL\_SUCCESS ). The sqlccrecv() call information then reveals how long the client waited for a response from the server and the amount of data included in the response.

Often, multiple statement handles will appear in the CLI trace. By paying close attention to the statement handle identifier, one can easily follow the execution path of a statement handle independent of all other statement handles appearing in the trace.

Statement execution paths appearing in the CLI trace are usually more complicated than the trace example. For example:

```

39 SQLAllocStmt( hDbc=0:1, phStmt=&bffff684 )
40    —> Time elapsed - +1.532000E-003 seconds

41 SQLAllocStmt( phStmt=1:2 )
42    <— SQL_SUCCESS   Time elapsed - +6.820000E-004 seconds

43 SQLPrepare( hStmt=1:2, pszSqlStr="INSERT INTO GREETING VALUES ( ? )",
              cbSqlStr=-3 )
44    —> Time elapsed - +2.733000E-003 seconds
45 ( StmtOut="INSERT INTO GREETING VALUES ( ? )" )

46 SQLPrepare( )
47    <— SQL_SUCCESS   Time elapsed - +9.150000E-004 seconds

48 SQLBindParameter( hStmt=1:2, iPar=1, fParamType=SQL_PARAM_INPUT,
                   fCType=SQL_C_CHAR, fSQLType=SQL_CHAR, cbColDef=14,
                   ibScale=0, rgbValue=&080eca70, cbValueMax=15,
                   pcbValue=&080eca4c )
49    —> Time elapsed - +4.091000E-003 seconds

50 SQLBindParameter( )
51    <— SQL_SUCCESS   Time elapsed - +6.780000E-004 seconds

52 SQLExecute( hStmt=1:2 )
53    —> Time elapsed - +1.337000E-003 seconds

```

```

54 ( iPar=1, fCType=SQL_C_CHAR, rgbValue="Hello World!!!", pcbValue=14,
    piIndicatorPtr=14 )
55 SQLExecute( )
56 <— SQL_ERROR Time elapsed - +5.951000E-003 seconds

```

In the trace example, the database connection handle ( phDbc=0:1 ) was used to allocate a second statement handle ( phStmt=1:2 ) at line 41. An SQL statement with one parameter marker was then prepared on that statement handle at line 43. Next, an input parameter ( iPar=1 ) of the appropriate SQL type ( SQL\_CHAR ) was bound to the parameter marker at line 48. Finally, the statement was executed at line 52. Notice that both the contents and length of the input parameter ( rgbValue="Hello World!!!", pcbValue=14 ) are displayed in the trace on line 54.

The SQLExecute() function fails at line 52. If the application calls a diagnostic CLI function like SQLError() to diagnose the cause of the failure, then that cause will appear in the trace. For example:

```

57 SQLError( hEnv=0:1, hDbc=0:1, hStmt=1:2, pszSqlState=&bffff680,
           pfNativeError=&bffffee78, pszErrorMsg=&bffff280,
           cbErrorMsgMax=1024, pcbErrorMsg=&bffffee76 )
58 —> Time elapsed - +1.512000E-003 seconds
59 SQLError( pszSqlState="22001", pfNativeError=-302, pszErrorMsg="[IBM][CLI
  Driver][DB2/LINUX] SQL0302N The value of a host variable in the EXECUTE
  or OPEN statement is too large for its corresponding use.
  SQLSTATE=22001", pcbErrorMsg=157 )
60 <— SQL_SUCCESS Time elapsed - +8.060000E-004 seconds

```

The error message returned at line 59 contains the DB2 native error code that was generated ( SQL0302N ), the sqlstate that corresponds to that code ( SQLSTATE=22001 ) and a brief description of the error. In this example, the source of the error is evident: on line 52, the application is trying to insert a string with 14 characters into a column defined as VARCHAR(10) on line 34.

If the application does not respond to a CLI function warning or error return code by calling a diagnostic function like SQLError(), the warning or error message should still be written to the CLI trace. However, the location of that message in the trace may not be close to where the error actually occurred. Furthermore, the trace will indicate that the error or warning message was not retrieved by the application. For example, if not retrieved, the error message in the example might not appear until a later, seemingly unrelated CLI function call as follows:

```

SQLDisconnect( hDbc=0:1 )
  —> Time elapsed - +1.501000E-003 seconds
  sqlccsend( ulBytes - 72 )
  sqlccsend( Handle - 1084869448 )
  sqlccsend( ) - rc - 0, time elapsed - +1.080000E-004
  sqlccrecv( )
  sqlccrecv( ulBytes - 27 ) - rc - 0, time elapsed - +1.717950E-001
  ( Unretrieved error message="SQL0302N The value of a host variable in the
  EXECUTE or OPEN statement is too large for its corresponding use.
  SQLSTATE=22001" )
SQLDisconnect( )
  <— SQL_SUCCESS Time elapsed - +1.734130E-001 seconds

```

The final part of a CLI trace should show the application releasing the database connection and environment handles that it allocated earlier in the trace. For example:



```

58 SQLTransact( hEnv=0:1, hDbc=0:1, fType=SQL_ROLLBACK )
59     → Time elapsed - +6.085000E-003 seconds
60 ( ROLLBACK=0 )

61 SQLTransact( )
62     ← SQL_SUCCESS Time elapsed - +2.220750E-001 seconds

63 SQLDisconnect( hDbc=0:1 )
64     → Time elapsed - +1.511000E-003 seconds

65 SQLDisconnect( )
66     ← SQL_SUCCESS Time elapsed - +1.531340E-001 seconds

67 SQLFreeConnect( hDbc=0:1 )
68     → Time elapsed - +2.389000E-003 seconds

69 SQLFreeConnect( )
70     ← SQL_SUCCESS Time elapsed - +3.140000E-004 seconds

71 SQLFreeEnv( hEnv=0:1 )
72     → Time elapsed - +1.129000E-003 seconds

73 SQLFreeEnv( )
74     ← SQL_SUCCESS Time elapsed - +2.870000E-004 seconds

```

---

## Platform-specific tools

### Diagnostic tools (Windows)

Three useful diagnostic tools on Windows systems are described.

The following diagnostic tools are available for Windows operating systems:

#### Event viewer, performance monitor, and other administrative tools

The Administrative Tools folder provides a variety of diagnostic information, including access to the event log and access to performance information.

#### Task Manager

The Task Manager shows all of the processes running on the Windows server, along with details about memory usage. Use this tool to find out which DB2 processes are running, and to diagnose performance problems. Using this tool, you can determine memory usage, memory limits, swapper space used, and memory leakage for a process.

To open the Task Manager, press Ctrl + Alt + Delete, and click **Task Manager** from the available options.

#### Dr. Watson

The Dr. Watson utility is invoked in the event of a General Protection Fault (GPF). It logs data that might help in diagnosing a problem, and saves this information to a file. You must start this utility by typing drwatson on the command line.

### Diagnostic tools (Linux and UNIX)

This section describes some essential commands for troubleshooting and performance monitoring on Linux and UNIX platforms.

For details on any one of these commands, precede it with "man" on the command line. Use these commands to gather and process data that can help identify the

cause of a problem you are having with your system. Once the data is collected, it can be examined by someone who is familiar with the problem, or provided to IBM Software Support if requested.

## Troubleshooting commands (AIX)

The following AIX system commands are useful for DB2 troubleshooting:

- errpt** The **errpt** command reports system errors such as hardware errors and network failures.
- For an overview that shows one line per error, use **errpt**
  - For a more detailed view that shows one page for each error, use **errpt -a**
  - For errors with an error number of "1581762B", use **errpt -a -j 1581762B**
  - To find out if you ran out of paging space in the past, use **errpt | grep SYSVMM**
  - To find out if there are token ring card or disk problems, check the **errpt** output for the phrases "disk" and "tr0"

**lspcs** The **lspcs -a** command monitors and displays how paging space is being used.

**lsattr** This command displays various operating system parameters. For example, use the following command to find out the amount of real memory on the database partition:

```
lsattr -l sys0 -E
```

### xmperf

For AIX systems using Motif, this command starts a graphical monitor that collects and displays system-related performance data. The monitor displays three-dimensional diagrams for each database partition in a single window, and is good for high-level monitoring. However, if activity is low, the output from this monitor is of limited value.

### spmon

If you are using system partitioning as part of the Parallel System Support Program (PSSP), you might need to check if the SP Switch is running on all workstations. To view the status of all database partitions, use one of the following commands from the control workstation:

- **spmon -d** for ASCII output
- **spmon -g** for a graphical user interface

Alternatively, use the command **netstat -i** from a database partition workstation to see if the switch is down. If the switch is down, there is an asterisk (\*) beside the database partition name. For example:

```
css0* 65520 <Link>0.0.0.0.0.0
```

The asterisk does not display if the switch is up.

## Troubleshooting commands (Linux and UNIX)

The following system commands are for all Linux and UNIX systems, including AIX, unless otherwise noted.

**df** The **df** command lets you see if file systems are full.

- To see how much free space is in all file systems (including mounted ones), use **df**
- To see how much free space is in all file systems with names containing "dev", use **df | grep dev**
- To see how much free space is in your home file system, use **df /home**
- To see how much free space is in the file system "tmp", use **df /tmp**
- To see if there is enough free space on the machine, check the output from the following commands: **df /usr** , **df /var** , **df /tmp** , and **df /home**

**truss** This command is useful for tracing system calls in one or more processes.

**pstack** Available for Solaris 2.5.1 or later, the **/usr/proc/bin/pstack** command displays stack traceback information. The **/usr/proc/bin** directory contains other tools for debugging processes that seem to be suspended.

## Performance Monitoring Tools

The following tools are available for monitoring the performance of your system.

### vmstat

This command is useful for determining if something is suspended or just taking a long time. You can monitor the paging rate, found under the page in (pi) and page out (po) columns. Other important columns are the amount of allocated virtual storage (avm) and free virtual storage (fre).

**iostat** This command is useful for monitoring I/O activities. You can use the read and write rate to estimate the amount of time required for certain SQL operations (if they are the only activity on the system).

### netstat

This command lets you know the network traffic on each database partition, and the number of error packets encountered. It is useful for isolating network problems.

### system file

Available for Solaris operating system, the **/etc/system** file contains definitions for kernel configuration limits such as the maximum number of users allowed on the system at a time, the maximum number of processes per user, and the interprocess communication (IPC) limits on size and number of resources. These limits are important because they affect DB2 performance on a Solaris operating system machine.



---

## Chapter 6. Troubleshooting DB2 database

In general, the troubleshooting process requires that you isolate and identify a problem, then seek a resolution. This section will provide troubleshooting information related to specific features of DB2 products.

As common problems are identified, the findings will be added to this section in the form of checklists. If the checklist does not lead you to a resolution, you can collect additional diagnostic data and analyze it yourself, or submit the data to IBM Software Support for analysis.

The following questions direct you to appropriate troubleshooting tasks:

1. Have you applied all known fix packs? If not, consider “Getting fixes” on page 705.
2. Does the problem occur when you are:
  - Installing DB2 database servers or clients? If so, refer to “Collecting data for installation problems” on page 560.
  - Creating, dropping, updating or upgrading an instance or the DB2 Administration Server (DAS)? If so, refer to “Collecting data for DAS and instance management problems” on page 540.
  - Moving data using **EXPORT**, **IMPORT**, **LOAD** or **db2move** commands? If so, refer to “Collecting data for data movement problems” on page 540.

If your problem does not fall into one of these categories, basic diagnostic data might still be required if you are contacting IBM Software Support. Refer to “Collecting data for DB2.”

---

### Collecting data for DB2

Sometimes you cannot solve a problem simply by troubleshooting the symptoms. In such cases, you must collect diagnostic data. The diagnostic data that you must collect and the sources from which you collect that data are dependent on the type of problem that you are investigating. These steps represent how to collect the base set of information that you typically must provide when you submit a problem to IBM Software Support.

#### Before you begin

To obtain the most complete output, the **db2support** utility should be invoked by the instance owner.

#### Procedure

To collect the base set of diagnostic information in a compressed file archive, enter the **db2support** command:

```
db2support output_directory -s -d database_name -c
```

Using **-s** will give system details about the hardware used and the operating system. Using **-d** will give details about the specified database. Using **-c** allows for an attempt to connect to the specified database.

The output is conveniently collected and stored in a compressed ZIP archive, `db2support.zip`, so that it can be transferred and extracted easily on any system.

## What to do next

For specific symptoms, or for problems in a specific part of the product, you might have to collect additional data. Refer to the problem-specific "Collecting data" documents.

You can do any of the following tasks next:

- Analyze the data
- Submit the data to IBM Software Support

## Collecting data for data movement problems

If you are experiencing problems while performing data movement commands and you cannot determine the cause of the problem, collect diagnostic data that either you or IBM Software Support can use to diagnose and resolve the problem.

Follow the data collection instructions, appropriate for the circumstance you are experiencing, from the following list:

- To collect data for problems related to the **db2move** command, go to the directory where you issued the command. Locate the following file(s), depending on the action you specified in the command:
  - For the COPY action, look for files called `COPY.timestamp.ERR` and `COPYSCHEMA.timestamp.MSG`. If you also specified either `LOAD_ONLY` or `DDL_AND_LOAD` mode, look for a file called `LOADTABLE.timestamp.MSG` as well.
  - For the EXPORT action, look for a file called `EXPORT.out`.
  - For the IMPORT action, look for a file called `IMPORT.out`.
  - For the LOAD action, look for a file called `LOAD.out`.
- To collect data for problems related to **EXPORT**, **IMPORT**, or **LOAD** commands, determine whether your command included the `MESSAGES` parameter. If it did, collect the output file. These utilities use the current directory and the default drive as the destination if you do not specify otherwise.
- To collect data for problems related to a **REDISTRIBUTE** command, look for a file called "`databasename.database_partition_groupname.timestamp`" on Linux and UNIX operating systems and "`databasename.database_partition_groupname.date.time`" on Windows operating systems. It is located in the `$HOME/sql1lib/db2dump` directory on Linux and UNIX operating systems and in the `$DB2PATH\sql1lib\redist` directory on Windows operating systems, where `$HOME` is the home directory of the instance owner.

## Collecting data for DAS and instance management problems

If you are experiencing problems while performing DB2 Administration Server (DAS) or instance management and you cannot determine the cause of the problem, collect diagnostic data that either you or IBM Software Support can use to diagnose and resolve the problem.

**Important:** The DB2 Administration Server (DAS) has been deprecated in Version 9.7 and might be removed in a future release. The DAS is not supported in DB2 pureScale environments. Use software programs that use the Secure Shell protocol for remote administration. For more information, see "DB2 administration server (DAS) has been deprecated" at .

These steps are only for situations where you can re-create the problem and you are using DB2 on Linux or UNIX.

To collect diagnostic data for DAS or instance management problems:

1. Repeat the failing command with tracing or debug mode enabled. Example commands:

```
db2setup -t trace.out
dascrt -u DASUSER -d
dasdrop -d
dasmigr -d
dasupdt -d
db2icrt -d INSTNAME
db2idrop INSTNAME -d
db2iupgrade -d INSTNAME
db2iupdt -d INSTNAME
```

2. Locate the diagnostic files. More than one file might be present, so compare the timestamps to ensure that you are obtaining all of the appropriate files.

The output will be found in the /tmp directory by default.

Example file names are: dascrt.log, dasdrop.log, dasupdt.log, db2icrt.log.PID, db2idrop.log.PID, db2iupgrade.log.PID, and db2iupdt.log.PID, where PID is the process ID.

3. Provide the diagnostic file(s) to IBM Software Support.

If the problem is that the **db2start** or START DATABASE MANAGER command is failing, look for a file named *db2start.timestamp.log* in the *insthome/sqllib/log* directory, where *insthome* is the home directory for the instance owner. Likewise if the problem is that the **db2stop** or STOP DATABASE MANAGER command is failing, look for a file named *db2stop.timestamp.log*. These files will only be found if the database manager did not respond to the command within the amount of time specified in the **start\_stop\_time** database manager configuration parameter.

## Collecting diagnostic data for specific performance problems

Collecting diagnostic data for performance problems that is as problem-specific as possible helps you avoid the impact of collecting the full set of performance-related diagnostic data, which is especially important on a system that is already resource constrained. The performance problems that you can collect specific diagnostic data for must be related to processor usage, memory or database connections.

Collecting diagnostic data for these problems can start once you observe that one or more of the problem symptoms exists. To collect the data required to diagnose the problem, use the **db2fodc** command together with one of the **-connections**, **-cpu**, or **-memory** parameters.

For problems that occur only sometimes, you can also create a threshold rule with the **db2fodc -detect** command that will detect a specific problem condition and start the collection of diagnostic data if the trigger conditions you specify are exceeded.

### Symptoms

Depending on the specific problem that exists, you might observe some of the following symptoms on your data server:

- For performance problems related to database connections, you might observe sudden spikes in the number of application in the executing or compiling state or new database connections are being denied.
- For performance problems related to processor usage, you might observe high processor utilization rates, a high number of running processes, or high processor wait times.

- For performance problems related to memory usage, you might observe that no free memory is available, that swap space is being used at a high rate, that excessive paging is taking place, or you might suspect a memory leak.

## Diagnosing the problem

To check for application connections to the database, you can issue the **db2pd -applications** command. Apart from determining how many connections to the database exist, the Status field can tell you if the applications are in the executing or compiling state. If the number of applications connected to the database continues to grow over time without ever becoming lower, or if the number of application connections spikes suddenly, you might have a problem related to connections that needs to be diagnosed further.

On UNIX and Linux operating systems, you can check whether you have a potential problem related to processor usage by issuing the **vmstat** command with the appropriate parameters for the specific operating system to return the user processor usage value (us). You can also check the values returned for sy to obtain system processor usage and the combined user and system processor usage information. You can issue the **vmstat** command several times to arrive at a more accurate conclusion about whether the problem symptoms are persisting over time. If you notice that the us value is frequently greater than 90% then this indicates that you might have a problem related to processor usage that needs to be diagnosed further. On Windows operating systems, you can use the **db2pd -vmstat** command to obtain similar information.

To check if you have a potential memory-related problem, you can issue the appropriate operating system command that returns the used swap space value (on Linux operating systems you can use the **free** command, for example). If the used swap space value is consistently greater than 90% then you might have a memory-related performance problem.

## Resolving the problem

The following examples use the **db2fodc** command together with the **-connection**, **-cpu**, **-memory**, and **-detect** parameters. You can run these commands yourself, but you need to be aware of the potential impact: on a very resource constrained system even very problem-specific diagnostic data collection can place additional demands on the system that might not be acceptable. It is preferable to run these commands under the guidance of IBM support. Typically, the collected data is sent to IBM technical support for analysis.

- To collect diagnostic data for problems related to database connections, issue the following command:

```
db2fodc -connections
```

This command collects connection-related diagnostic data and places it in a `FODC_Connections_timestamp_member` directory, where *timestamp* is the time when the **db2fodc -connections** command was executed and *member* is the member or members the collection was performed for.

- To collect diagnostic data for problems related to processor usage when you are already observing related problem symptoms, you can issue the following command:

```
db2fodc -cpu
```



The **db2fodc -cpu** command collects processor-related diagnostic data and places it in a `FODC_Cpu_timestamp_member` directory, where *timestamp* is the time when the **db2fodc -connections** command was executed and *member* is the member or members the collection was performed for. As an alternative when the problem is intermittent or if you want to configure your system ahead of time to collect diagnostic data when a specific problem condition exists, you can issue a variation of the following command:

```
db2fodc -cpu basic -detect us">=90" rqueue"<=1000" condition="and" interval="2"
sleeptime="500" triggercount="3" iteration="4" duration="500" -member all
```

The **-detect** parameter with the threshold rules specified delays the collection of processor-related information until the trigger conditions specified by the threshold rule are detected. You can specify your own rules for the **-detect** parameter to determine when to start diagnostic data collection. In the previous example, conditions for user processor usage and the run queue must both be met three times over the course of three iterations. This means that the trigger conditions must exist for 6 seconds total to trigger diagnostic data collection on all members (a trigger count of 3 x 2 second intervals = a trigger condition that must exist for 6 seconds). The `iteration` option specifies that trigger condition detection followed by diagnostic data collection is performed three times, with a sleep time of 500 seconds between each iteration.

- To collect diagnostic data for problems related to memory usage when you are already observing related problem symptoms, you can issue the following command:

```
db2fodc -memory
```

The **db2fodc -memory** command collects memory-related diagnostic data and places it in the `FODC_Memory_timestamp_member`, where *timestamp* is the time when the **db2fodc -connections** command was executed and *member* is the member or members the collection was performed for. As an alternative when the problem is intermittent or if you want to configure your system ahead of time to collect diagnostic data when a specific problem condition exists, you can issue a variation of the following command:

```
db2fodc -memory basic -detect free"<=10" connections">=1000" sleeptime="1"
iteration="10" interval="10" triggercount="4" duration="5" -member 3
```

The **-detect** parameter with the rules specified delays collection until the rules are detected. In this example, the trigger condition for free memory and the number of connections to the database must exist for 40 seconds to trigger diagnostic data collection on member 3 (trigger count of 4 x 10 second intervals = 40 seconds total). Ten iterations of detection and diagnostic data collection can be performed, enabled over a duration of 5 hours.

- To only detect trigger conditions but not to perform diagnostic data collection, you can use the **db2fodc -detect** command together with the `nocollect` option. An entry is logged in the `db2diag` log files anytime the problem condition specified is detected as a threshold hit. If you choose not to collect diagnostic data, then, for detailed threshold hits, the `db2diag` log entry must be used to determine if a problem condition that you created a threshold rule for was detected.

```
2011-05-31-15.53.42.639270-240 I2341E790 LEVEL: Event
PID : 13279 TID : 47188095859472PROC : db2fodc
INSTANCE: kunxu NODE : 000
FUNCTION: DB2 UDB, RAS/PD component, pdFodcDetectAndRunCollection, probe:100
CHANGE :
```

```
Hostname: hotel36 Member(s): 0 Iteration: 0
```

```
Thresholds hit 0: cs(0)>=0 us(0)<=50 rQueue(0)>=0 free(7980936)>=100
avm(7297432)>=1 swapused(0)>=0 UOW_Executing(4)>=3
Thresholds hit 1: cs(0)>=0 us(0)<=50 rQueue(0)>=0 free(7981000)>=100
avm(7297528)>=1 swapused(0)>=0 UOW_Executing(4)>=3
Thresholds hit 2: cs(0)>=0 us(0)<=50 rQueue(0)>=0 bQueue(1)>=1
free(7981420)>=100 avm(7297596)>=1 swapused(0)>=0 UOW_Executing(4)>=3
Thresholds hit 3: cs(0)>=0 us(0)<=50 rQueue(0)>=0 free(7981436)>=100
avm(7297668)>=1 swapused(0)>=0 UOW_Executing(4)>=3
```

In this example, the problem condition specified is detected as a threshold hit four times on member 0. Both the values you specified for each threshold rule and the actual values detected are logged.

---

## Analyzing data for DB2

After you collect data, you must determine how that data can help you to resolve your particular problem. The type of analysis depends on the type of problem that you are investigating and the data that you have collected. These steps represent how to start your investigation of any basic DB2 diagnostic data.

### Procedure

To analyze diagnostic data, take the following actions:

- Have a clear understanding of how the various pieces of data relate to each other. For example, if the data spans more than one system, keep your data well organized so that you know which pieces of data come from which sources.
- Confirm that each piece of diagnostic data is relevant to the timing of the problem by checking timestamps. Note that data from different sources can have different timestamp formats; be sure to understand the sequence of the different elements in each timestamp format so that you can tell when the different events occurred.
- Determine which data sources are most likely to contain information about the problem, and start your analysis there. For example, if the problem is related to installation, start your analysis with the installation log files (if any), rather than starting with the general product or operating system log files.
- The specific method of analysis is unique to each data source, but one tip that is applicable to most traces and log files is to start by identifying the point in the data where the problem occurs. After you identify that point, you can work backward in time through the data to unravel the root cause of the problem.
- If you are investigating a problem for which you have comparative data from an environment that is working and one that is not, start by comparing the operating system and product configuration details for each environment.

---

## Recovering from sustained traps

The DB2 instance prepares the first occurrence data capture (FODC) package for the trap that you have encountered. By default, the DB2 instance has been configured for trap resiliency. The DB2 instance has also determined whether or not the trap is sustainable. The term “sustainable” means that the trapped DB2 engine thread has been suspended and the DB2 instance continues to run.

### About this task

By default, the DB2 instance has been configured for trap resiliency based on the default setting of the **DB2RESILIENCY** registry variable.

### Recognizing a sustained trap

Traps are sustained to minimize the effect on the database system when traps (DB2 programming errors) occur. A sustained trap results in the following diagnostics:

1. An FODC directory is created under the fully qualified path specified with the **diagpath** database manager configuration parameter.
2. Error message ADM14013C is logged to the administration notification and db2diag log files.

**Note:** ADM14011C is logged if the trap could not be sustained, resulting in the instance being shut down.

3. Error sqlcode -1224 is returned to the application.
4. The EDU thread is suspended, which can be observed in the output of **db2pd -edus**.

### Recovery

While it is expected that a sustained trap does not hamper the regular operation of the instance, a suspended EDU thread does hold on to some resources, and it is recommended to stop and restart the instance at your earliest convenience by following these steps:

1. To terminate all active applications which issue a COMMIT or ROLLBACK within the timeout period, which minimizes the recovery window for crash recovery when the **db2start** command is run, issue the following command:

```
db2 quiesce instance instance_name user user_name
      defer with timeout minutes
```

2. [Optional] To terminate any applications that did not COMMIT or ROLLBACK during the timeout period in Step 1 and any new applications which accessed the database after the timeout period completed, issue the following command:

```
db2 quiesce instance instance_name user user_name immediate
```

3. To shut down the instance, issue:

```
db2stop force
```

4. Restart the DB2 instance using either one of the following commands:

```
db2start
```

or

```
START DATABASE MANAGER
```

### Diagnosis

Locate the FODC directory that is specified under the **diagpath** database manager configuration parameter. The location of the FODC directory can also be confirmed by viewing the administration notification or db2diag log files. Forward the FODC information to IBM Software Support.

---

## Identifying db2diag log entries for a load operation

Identifying diagnostic information for a load operation and finding the **db2diag** command log messages associated with that load operation are important steps in troubleshooting problematic load operations.

### Symptoms

When issuing multiple load operations you might notice that a load operation is taking longer to complete than normal or appears to be hanging.

## Resolving the problem

To determine which of the load operations are being problematic:

1. Issue the **db2pd -utilities** command to display the IDs of all load operations. In the following example output, there is only one load operation that is taking place, with an ID of LOADID: 16.2011-05-13-12.44.34.638811.0 (3;5):

```
Database Partition 0 -- Active -- Up 0 days 00:16:15 -- Date 05/13/2011 13:00:33

Utilities:
Address      ID  Type  State  Invoker  Priority  StartTime      DBName  NumPhases  CurPhase  Description
0x000000020120E2A0 1  LOAD  0      0        0      Fri May 13 12:44:34  SAMPLE  2          2          [LOADID: 16.2011-05-13-12.44.34.638811.0 (3;5)]...

Progress:
Address      ID  PhaseNum  CompletedWork  TotalWork  StartTime      Description
0x000000020120E600 1  1         0 bytes        0 bytes      Fri May 13 12:44:34  SETUP
0x000000020120E7E0 1  2         0 rows         0 rows      Fri May 13 12:44:34  LOAD
```

2. Issue the **db2diag -g 'dataobj:=loadID'** command, where *loadID* is the ID of the load operation found in the previous step. This command displays all the diagnostic log messages from the **db2diag** command log related to the specified load operation. The following example shows what is displayed when this command is issued with the load operation ID identified previously:

```
$ db2diag -g 'dataobj:= LOADID: 16.2011-05-13-12.44.34.638811.0 (3;5)'
```

```
2011-05-13-14.27.03.134598-240 I1700E525          LEVEL: Warning

PID      : 29615          TID      : 47039995963712PROC : db2sysc

INSTANCE: vivmak          NODE     : 000          DB       : SAMPLE

APPHDL   : 0-7          APPID: *LOCAL.vivmak.110513164421

AUTHID   : VIVMAK

EDUID    : 44          EDUNAME: db2lrid

FUNCTION: DB2 UDB, database utilities, sqlulPrintPhaseMsg, probe:314

DATA #1 : String, 99 bytes

LOADID: 16.2011-05-13-12.44.34.638811.0 (3;5)

Completed LOAD phase at 05/13/2011 14:27:03.134463.
```

After you complete these steps, you have enough information to identify the problematic load operation. However, if you need more information about the load operation, issue the **db2pd -db <dbname> -load loadID="LOADID" stacks** command to obtain a stack trace. The **stacks** option is available on UNIX and Linux operating systems only. The following example shows what is displayed when this command is issued on a sample database with the load operation ID identified previously:

```
$ db2pd -db sample -load loadID="LOADID: 16.2011-05-13-12.34.34.638811.0 (3;5)" stacks

Attempting to produce stack traces for LOAD edu 40
Attempting to produce stack traces for LOAD edu 41
Attempting to produce stack traces for LOAD edu 42
Attempting to produce stack traces for LOAD edu 44
Attempting to produce stack traces for LOAD edu 45

Database Partition 0 -- Database SAMPLE -- Active -- Up 0 days 00:00:27 -- Date 05/13/2011 14:28:32

Node Number : 0
Database Name : SAMPLE
```

LoadID	EDUID	EDUNAME	TableName	SchemaName	AppHandl	[nod-index]	Application ID	StartTime	LoadPhase
LOADID: 16.2011-05-13-12.44.34.638811.0 (3;5)	40	db21frm0	T1	VIVMAK	7	[000-00007]	*LOCAL.vivmak.110513164421	2011-05-13-12.44.34.638811	LOAD
LOADID: 16.2011-05-13-12.44.34.638811.0 (3;5)	41	db21frm1	T1	VIVMAK	7	[000-00007]	*LOCAL.vivmak.110513164421	2011-05-13-12.44.34.638811	LOAD
LOADID: 16.2011-05-13-12.44.34.638811.0 (3;5)	42	db21frm2	T1	VIVMAK	7	[000-00007]	*LOCAL.vivmak.110513164421	2011-05-13-12.44.34.638811	LOAD
LOADID: 16.2011-05-13-12.44.34.638811.0 (3;5)	44	db21rid	T1	VIVMAK	7	[000-00007]	*LOCAL.vivmak.110513164421	2011-05-13-12.44.34.638811	LOAD
LOADID: 16.2011-05-13-12.44.34.638811.0 (3;5)	45	db21bm0	T1	VIVMAK	7	[000-00007]	*LOCAL.vivmak.110513164421	2011-05-13-12.44.34.638811	LOAD

The **db2pd -db <dbname> -load loadID="LOADID" stacks** command displays all the EDU information related to the load operation specified and produces stack trace files in the diagpath directory.

You can use all the information retrieved to perform further troubleshooting techniques, such as monitoring or terminating the load operation. Also, the information gathered might be requested by IBM technical support to troubleshoot problematic load operations.

You can also use the collected information to run the **db2trc** command for further troubleshooting. To run the **db2trc** command for a specific load operation by using the retrieved information:

1. Run the **db2pd -load** command to retrieve the application ID of the specific load operation that you are interested in.
2. Run the **db2trc -appid** or **db2trc -apphdl** command to record further information about the load operation.

In the following example, the application ID \*LOCAL.vivmak.110513164421 of the load ID LOADID: 16.2011-05-13-12.44.34.638811.0 (3;5) from the previous example in this topic, is used to run the **db2trc** command:

```
$ db2trc on -appid *LOCAL.vivmak.110513164421
```

```
Trace is turned on
```

```
$ db2trc info
```

```
Marker                : @TRACE@
Trace version          :      7.0
Platform               : Linux/X
Build level            : n110612
maxBufferSize          : 33554432 bytes (32 MB)
auxBufferSize          : 524288 bytes (0 MB)
allocationCount        : 2
DB2TRCD pid           : 0
Trace destination     : <shared memory buffer>
numSuspended           : 0
Trace starting time    : 2011-06-16-10.07.52.209999-240

Buffer size            : 33554432 bytes (32 MB)
Allow buffer to wrap   : yes
Mask                   : *.*.*.*.*
```

```

Timestamps          : disabled
PID.TID mask       : all
Fixed data mask #1  : all
Fixed data mask #2  : all
Max system errors   : infinite
Treat this rc as sys err: none
Member mask         : none
Application handle mask : none
Application ID mask  : *LOCAL.vivmak.110513164421

```

In the next example, the application handle obtained from the output of the **db2pd -load** command is used to change the trace options that are in effect for the **db2trc** command:

```

$ db2trc chg -apphd1 7

Trace has been changed

$ db2trc info

Marker              : @TRACE@
Trace version       :      7.0
Platform           : Linux/X
Build level        : n110612
maxBufferSize      : 33554432 bytes (32 MB)
auxBufferSize      : 524288 bytes (0 MB)
allocationCount    : 2
DB2TRCD pid        : 0
Trace destination  : <shared memory buffer>
numSuspended       : 0
Trace starting time : 2011-06-16-10.10.11.816264-240

Buffer size        : 33554432 bytes (32 MB)
Allow buffer to wrap : yes
Mask               : *.*.*.*.*
Timestamps        : disabled
PID.TID mask       : all
Fixed data mask #1 : all
Fixed data mask #2 : all

```

Max system errors : infinite  
Treat this rc as sys err: none  
Member mask : none  
Application handle mask : 7  
Application ID mask : none

---

## Troubleshooting administrative task scheduler

This checklist can help you troubleshoot problems that occur while running tasks in the administrative task scheduler.

### Procedure

1. If your task does not execute as expected, the first thing you should do is look for a execution status record in the ADMIN\_TASK\_STATUS administrative view.
  - If there is a record, examine the various values. In particular, pay attention to the STATUS, INVOCATION, SQLCODE, SQLSTATE, SQLERRMC and RC columns. The values often identify the root cause of the problem.
  - If there is no execution status record in the view, the task did not execute. There are a number of possible explanations for this:
    - The administrative task scheduler is disabled. Tasks will not execute if the administrative task scheduler is disabled. To enable the scheduler, set the **DB2\_ATS\_ENABLE** registry variable.
    - The task was removed. Someone may have removed the task. Confirm the task exists by querying the ADMIN\_TASK\_LIST administrative view.
    - The scheduler is unaware of the task. The administrative task scheduler looks for new and updated tasks by connecting to each active database every five minutes. Until this period has elapsed, the scheduler is unaware of your task. Wait at least five minutes.
    - The database is inactive. The administrative task scheduler cannot retrieve or execute tasks unless the database is active. Activate the database.
    - The transaction is uncommitted. The administrative task scheduler ignores uncommitted tasks. Be sure to commit after adding, updating, or removing a task.
    - The schedule is invalid. The task's schedule might prevent the task from running. For example, the task may have already reached the maximum number of invocations. Review the task's schedule in the ADMIN\_TASK\_LIST view and update the schedule if necessary.
2. If you cannot determine the cause of the problem by referring to the ADMIN\_TASK\_STATUS administrative view, refer to the DB2 diagnostic log. All critical errors are logged to the **db2diag** log file. Informational event messages are also logged by the administrative task scheduler daemon during task execution. These errors and messages are by identified by the "Administrative Task Scheduler" component.

### What to do next

If you follow the preceding steps and are still unable to determine the cause of the problem, consider opening a problem management record (PMR) with IBM Software Support. Inform them that you have followed these instructions and send them the diagnostic data that you collected.

---

## Operation fails because database is currently in use

Some database operations such as dropping a database, terminating a database connection, and creating a backup copy of a database require the associated database to be inactive and the database can have no applications connected to it. When you attempt such an operation with an active database that has applications connected to it, the operation fails and an error with SQL code -1035N might be returned.

### Symptoms

When you attempt certain database operations such as dropping a database, terminating a database connection, and creating a backup copy of a database, the operation fails and an error stating that the database is currently in use might be returned.

### Causes

This SQL1035N error message might be returned in one of the following scenarios:

1. There are open connections to the database preventing the attempted operation from succeeding. This can occur in the following situations:
  - Exclusive use was requested, but the database is already in use as a shared database by another user (in the same process).
  - Exclusive use was requested, but the database is already in use as an exclusive database. This means that two different processes are trying to access the same database.
  - The maximum number of connections to the database has been reached.
  - The database is being used by another user on another system.
2. The database has been activated explicitly, preventing the operation from succeeding.
3. The database is active because it is in the WRITE SUSPEND state.

### Resolving the problem

1. Take one of the following actions:
  - Resubmit the command later when the database is not in use.
  - Change the authorization to match the current user or wait until the database is not in use.
  - Wait until the database is not in exclusive use.
  - Wait until other users on another system have disconnected from the database.
  - Issue the **QUIESCE DATABASE DEFER WITH TIMEOUT** *<minutes>* command and a **CONNECT RESET** command to free connections to the database and prevent application users from reconnecting. The DEFER option will wait for applications until they commit the current unit of work instead of rolling back all running transactions.
  - Issue the **LIST APPLICATIONS** command to list connections to the database. Issue a **FORCE APPLICATION ALL** command to free connections to the database.

**Note:** The **FORCE APPLICATION ALL** command is an asynchronous command which might return as successful even though it is still continuing to clean up connections. A varying interval of time might be required for the command to complete.



2. Deactivate the database using the **DEACTIVATE DATABASE** *<database-alias>* command.
3. Issue a **SET WRITE RESUME FOR DATABASE** command to resume write operations for the database.
4. Restart the member where the offline operation was taking place by issuing the following command:  
`db2start member <member-number>`
5. Reissue the operation that had initially failed.

---

## Troubleshooting compression

### Data compression dictionary is not automatically created

You have a large table or a large XML storage object for the table, but the data compression dictionary was not created. You would like to understand why the creation of the data compression dictionary did not occur as you were expecting. This information applies to both the compression dictionary for the table object and the compression dictionary for the XML storage object.

You may find yourself in the following situation:

- You have a table where the COMPRESS attribute has been set to YES.
- The table has existed for some time and data has been added and removed.
- The size of the table appears to be close to the threshold size. You are expecting the data compression dictionary to be automatically created.
- You run a table data population operation (such as INSERT, LOAD INSERT, or REDISTRIBUTE) which you expect will increase the size of the table beyond the threshold size.
- Automatic creation of the data compression dictionary does not occur. The data compression dictionary is not created and placed into the table. You expect compression to occur on data added to the table after that point, but the data remains decompressed.
- For XML data, the data is in the DB2 Version 9.7 storage format.

Compression of data in the XML storage object of a table is not supported if the table contains XML columns that were created using DB2 Version 9.5 or earlier. If you enable such a table for data row compression, only the table row data in the table object is compressed. If the XML storage object cannot be compressed during an insert, load, or reorg operation, a message is written to a db2diag log file only if the XML columns were created with DB2 V9 or DB2 V9.5.

Why is the data compression not occurring?

Although the data is larger than the threshold size to enable automatic creation of the compression dictionary, there is another condition that is checked. The condition is that there must be sufficient data present in the object to be able to create the dictionary, and message ADM5591W will inform you of this requirement. Past activity against the data may also have included the deletion or removal of data. There may be large sections within the object where there is no data. This is how you can have a large object which meets or exceeds the object size threshold, but there may not be enough data in the object to enable the creation of the dictionary.

If you experience a lot of activity against the object, you need to reorganize the object on a regular basis. For XML data, you need to reorganize the table with the

longlobdata option. If you do not, the object size may be large, but it may be sparsely populated with data. Reorganizing the object will eliminate fragmented data and compact the data in the object. Following the reorganization, the object will be smaller and be more densely populated. The reorganized object will more accurately represent the amount of data in the object and may be smaller than the threshold size to enable automatic creation of the data compression dictionary.

If the object is sparsely populated, a reorganization of the table can be performed using the **REORG TABLE** command (use the LONGLOBDATA option for XDA) to create the dictionary. By default, KEEPDICTIONARY is specified. RESETDICTIONARY may be specified to force dictionary creation.

Use the **REORGCHK** command to determine if a table needs to be reorganized.

Automatic Dictionary Creation (ADC) will not occur for a table when the table is not enabled for data row compression. Message ADM5594I is returned when ADC processing is disabled for the database and describes the reason for it.

If the table contains XML columns that were created using DB2 Version 9.5 or earlier, use the ADMIN\_MOVE\_TABLE stored procedure to upgrade the table and then enable data row compression.

## Row compression not reducing disk storage space for temporary tables

There are known situations that might occur which result in a lack of expected savings in disk storage space for temporary tables even though the Storage Optimization feature is licensed.

### Symptoms

Potential disk space savings by enabling row compression on temporary tables are not being realized as expected.

### Causes

- This situation occurs mostly as a result of a large number of applications running at the same time and creating temporary tables, each of which consumes a portion of the database manager memory. This results in not enough memory being available to create the compression dictionary. Notification is not given when this situation occurs.
- Rows are compressed using a dictionary-based approach according to an algorithm. If a row of a temporary table is large enough to yield appreciable savings in disk space, the row will be compressed. Small rows in temporary tables will not be compressed and this will account for the lack of expected savings in disk storage space. Notification is not given when this situation occurs.

### Risk

There is no risk to the system aside from row compression not being used on temporary tables with row sizes that do not meet the threshold. There could be other adverse effects to the database manager if available memory remains highly constricted.

## Data replication process cannot decompress a compressed row image

There are known situations that may occur which result in a data replication solution being unable to successfully decompress a log record with a compressed row image. For transient (temporary) errors, the SQL code returned will correspond to the cause of the error, while a permanent error is typically signalled by a SQL0204N notification. Only transient error situations might result in a subsequent successful decompression of a row image in a log record. The db2ReadLog API will continue processing other log records even if it cannot decompress a log record.

### Symptoms

It is possible that the log reader may encounter transient and permanent errors while reading log records that contain compressed user data. Here are non-exhaustive example lists of the two classes of errors that may be encountered while reading log records with compressed data (row images).

#### Transient errors:

- Table space access not allowed
- Unable to access the table (lock timeout)
- Out of memory (to load and store the required dictionary)

#### Permanent errors:

- Table space in which the table resides does not exist
- Table or table partition to which the log record belongs does not exist
- A dictionary does not exist for the table or table partition
- The log record contains row images compressed with a dictionary older than the dictionaries in the table

### Causes

It is possible that a replication solution, or any other log reader, may fall behind database activities and receive an error reading a log record which contains compressed user data (see Scenario 1). Such a case could arise if the log record being read contains compressed user data that was compressed by an older compression dictionary than what is available in the table (at the time of the log read).

Similarly, if a table is dropped, the dictionaries associated with the table will also be removed. Compressed row images for the table cannot be decompressed in this case (see Scenario 2). Note that this restriction does not apply to row images that are not in a compressed state, as these row images can still be read and replicated even if the table is dropped.

For any one table, there can be only one active data compression dictionary and one historical dictionary.

Scenario 1:

Table t6 has compression enabled. The DATA CAPTURE CHANGES attribute, for replication purposes, is enabled for the table. The table is being replicated by a data replication application and the log reader is reading log records that contain compressed data (row images). A client log reader, using the db2ReadLog API, is

reading the first log record for the first INSERT statement as a **LOAD** operation is performed on table t6, after a REORG TABLE command has been issued (causing the table's dictionary to be rebuilt).

The following statements are executed against table t6, which already contains a compression dictionary and has the DATA CAPTURE CHANGES attribute is enabled:

```
-> db2 alter table t6 data capture changes
-> db2 insert into t6 values (...)
-> db2 insert into t6 values (...)
```

Since a data compression dictionary already exists for table t6, the two INSERTs after the ALTER will be compressed (using Table t6's compression dictionary). At this point, the log reader has not yet reached the first INSERT statement.

The following **REORG TABLE** command causes a new compression dictionary to be built for table t6, and the current compression dictionary is kept as the historical dictionary, thus making the log reader one dictionary behind the current compression dictionary (however, the historical dictionary is not loaded into memory after the REORG):

```
-> db2 reorg table t6 resetdictionary
```

As the log reader is reading the INSERT log for the INSERT statements, which now requires the historical dictionary to be read in memory, the table t6 is undergoing a **LOAD** operation:

```
-> db2 load from data.del of del insert into table t6 allow no access
```

When the LOAD is executed on the source table, table t6 will be Z-locked due to the specified ALLOW NO ACCESS option. The log reader must load the historical dictionary into memory to decompress row images found in the INSERT log records, however, fetching the dictionary requires an IN table lock. In this case, the log reader will fail to acquire the lock. This results in the sqlcode member of the db2ReadLogFilterData structure to return SQL code SQL2048N. This corresponds to a transient error (that is, the log record *might* be decompressed if the API is called again). The log reader will return the compressed row image in the log record and continue on reading the next log record.

Scenario 2:

Table t7 has the DATA CAPTURE CHANGES attribute enabled. Compression is enabled for the table in order to reduce storage costs. The table is being replicated by a data replication application, however, the log reader has fallen behind on the source table activity and the data compression dictionary has already been rebuilt twice before the log reader reads from the log records again.

The following statements are executed against Table t7, with the DATA CAPTURE CHANGES attribute already enabled, table compression is enabled, and a new dictionary is built:

```
-> db2 alter table t7 compress yes
-> db2 reorg table t7 resetdictionary
-> db2 insert into t7 values (...)
```

A client log reader, using the db2ReadLog API, is about to read the next log corresponding to the first INSERT statement in the following statements:

```
-> db2 insert into t7 values (...)  
...  
-> db2 reorg table t7 resetdictionary  
-> db2 insert into t7 values (...)  
...  
-> db2 reorg table t7 resetdictionary
```

The db2ReadLog API will not be able to decompress the contents of the log record in this case, because the log reader has fallen behind two or more **REORG RESETDICTIONARY** operations. The dictionary required to decompress the row image in the log record would not be found in the table; only the compression dictionary of the second REORG and the compression dictionary of the last REORG is stored with the table. However, the db2ReadLog API would not fail with an error. Instead, the uncompressed row image will be returned in the user buffer, and, in the db2ReadLogFilterData structure preceding the log record, the sqlcode member will return SQL code SQL0204N. This code corresponds to a permanent error (that is, the log record cannot ever be decompressed).

## Environment

This failure to successfully decompress a compressed log record, due to a missing old compression dictionary, can occur on any platform on which a data replication solution uses the db2ReadLog API and the DATA CAPTURE CHANGES attribute is set for the table.

## Resolving the problem

For transient errors, it may be possible to reissue the read request and successfully read the log. For example, if the log record belongs to a table residing in a table space and access to the table is not allowed, the dictionary may not be accessible to decompress the log record (see Scenario 1). The table space may become available at a later time, and reissuing the log read request at that time may successfully decompress the log record.

- If a transient error is returned (see Scenario 1), read the error information in order to take appropriate action. This may include waiting for the table operation to complete, which could allow a re-read of the log record and decompression to be successful.
- If a permanent error occurs (see Scenario 2), the row image in the log record cannot be decompressed since the compression dictionary, which was used to compress the row image, is no longer available. For this case, replication solutions may need to re-initialize the affected (target) table.

---

## Troubleshooting global variable problems

In general, troubleshooting applications with regard to global variables is not a problem if the user experiencing the problem has permission to READ the global variables. Having READ permission is all that is needed to know what the value of the global variable is by issuing a VALUES(Global Variable Name) statement. There will be cases where the user running the application will not have access to READ the global variable.

The first scenario illustrates a possible problem when referencing global variables that has a simple solution. The second scenario presents a more likely situation where the permission to READ the global variables needs to be granted to the appropriate users.

## Scenario 1

References to global variables must be properly qualified. It is possible that there exists a variable with the same name and a different schema where the incorrect schema is encountered earlier in the PATH register value. One solution is to ensure that the references to the global variable are fully qualified.

## Scenario 2

An application developer (developerUser) creates a highly complex series of procedures, views, triggers, and so on based upon the value of some session global variables (as opposed to database global variables) to which only he has read access. An end user of the application (finalUser) logs in and starts issuing SQL using the environment created by developerUser. finalUser complains to developerUser that he cannot see data that he must be allowed to see. As part of troubleshooting this problem, developerUser changes his authorization ID to that of finalUser, logs in as finalUser, and tries the same SQL as finalUser. developerUser finds that finalUser is right, and there is a problem.

developerUser has to determine whether finalUser sees the same session global variable values as he does. developerUser runs SET SESSION USER to see the session global variable values that the finalUser sees. Here is a proposed method to determine this problem and solve it.

developerUser asks the security administrator (secadmUser) to grant him permission to use SET SESSION USER as finalUser. Then developerUser logs in as himself and uses the SET SESSION AUTHORIZATION statement to set the SESSION\_USER special register to that of finalUser. After running the SQL that is the problem, he then switches back to developerUser using another SET SESSION AUTHORIZATION statement. developerUser can now issue a VALUES statement and see the actual value of the session global variable.

What follows is sample SQL showing the actions taken in the database by developerUser.

```
#####
# developerUser connects to database and creates needed objects
#####

db2 "connect to sample user developerUser using xxxxxxxx"

db2 "create table security.users \
(userid varchar(10) not null primary key, \
firstname varchar(10), \
lastname varchar(10), \
authlevel int)"

db2 "insert into security.users values ('ZUBIRI', 'Adriana', 'Zubiri', 1)"
db2 "insert into security.users values ('SMITH', 'Mary', 'Smith', 2)"
db2 "insert into security.users values ('NEWTON', 'John', 'Newton', 3)"

db2 "create variable security.gv_user varchar(10) default (SESSION_USER)"
db2 "create variable security.authorization int default 0"

# Create a procedure that depends on a global variable
db2 "CREATE PROCEDURE SECURITY.GET_AUTHORIZATION() \
SPECIFIC GET_AUTHORIZATION \
RESULT SETS 1 \
LANGUAGE SQL \
SELECT authlevel INTO security.authorization \
FROM security.users \
```

```

WHERE userid = security.gv_user"

db2 "grant all on variable security.authorization to public"
db2 "grant execute on procedure security.get_authorization to public"
db2 "terminate"

#####
# secadmUser grants setsessionuser
#####
db2 "connect to sample user secadmUser using xxxxxxxx"
db2 "grant setsessionuser on user finalUser to user developerUser"
db2 "terminate"

#####
# developerUser will debug the problem now
#####

echo "-----"
echo " Connect as developerUser "
echo "-----"
db2 "connect to sample user developerUser using xxxxxxxx"

echo "-----"
echo " SET SESSION AUTHORIZATION = finalUser "
echo "-----"
db2 "set session authorization = finalUser"

echo "--- TRY to get the value of gv_user as finalUser (we must not be able to)"
db2 "values(security.gv_user)"

echo "--- Now call the procedure---"
db2 "call security.get_authorization()"

echo "--- if it works it must return 3 ---"
db2 "values(security.authorization)"

echo "-----"
echo " SET SESSION AUTHORIZATION = developerUser "
echo "-----"

db2 "set session authorization = developerUser"

echo "--- See what the variable looks like ----"
db2 "values(security.gv_user)"

db2 "terminate"

```

---

## Troubleshooting inconsistencies

### Troubleshooting data inconsistencies

Diagnosing where data inconsistencies exist within the database is very important. One way to determine data inconsistencies is to use the output from the **INSPECT** command to identify where a problem exists. When inconsistencies are found, you will have to decide how to deal with the problem.

Once you have determined that there is a data consistency problem, you have two options:

- Contact IBM Software Support and ask for their assistance in recovering from the data inconsistency
- Drop and rebuild the database object that has the data consistency problem.

You will use the **INSPECT CHECK** variation from the **INSPECT** command to check the database, table space, or table that has evidence of a data inconsistency. Once the results of the **INSPECT CHECK** command are produced, you should format the inspection results using the **db2inspf** command.

If the **INSPECT** command does not finish, then contact IBM Software Support.

## Troubleshooting index to data inconsistencies

Indexes must be accurate to allow quick access to the right data in tables otherwise your database is corrupt.

You can use the **INSPECT** command to carry out an online check for index to data inconsistency by using the **INDEXDATA** option in the cross object checking clause. Index data checking is not performed by default when using the **INSPECT** command; it must be explicitly requested.

When there is an error discovered due to an index data inconsistency while **INSPECT** performs an **INDEXDATA** inspection, the error message **SQL1141N** is returned. At the same time this error message is returned, data diagnostic information is collected and dumped to the **db2diag** log file. An urgent message is also logged in the administration notification log. Use the **db2diag** log file analysis tool (**db2diag**) to filter and format the contents of the **db2diag** log file.

### Locking implications

While checking for index to data inconsistencies by using the **INSPECT** command with the **INDEXDATA** option, the inspected tables are only locked in IS mode.

When the **INDEXDATA** option is specified, by default only the values of explicitly specified level clause options are used. For any level clause options which are not explicitly specified, the default levels (**INDEX NORMAL** and **DATA NORMAL**) are overwritten from **NORMAL** to **NONE**.

## Troubleshooting a database in an inconsistent state

### Symptoms

When attempting to perform database operations you might receive an error message stating that the database is in an inconsistent state.

### Causes

The possible causes of this are:

- The database is offline as a result of an abnormal termination of the previous session (for example, a power failure).
- If the error was encountered when issuing the **db2ckupgrade** command:
  - The database is online and SQL has been issued which modified data in the database.
  - The database is online and HADR has been enabled.
- In DB2 pureScale environments only, possible causes also include:
  - The database on this DB2 member is offline as a result of an abnormal termination of the previous session.



- The database is offline across the entire DB2 pureScale environment instance as a result of an abnormal termination of the previous session.
- If add/drop operations are done in the instance, recoverable databases are already put into backup pending state. Add and drop operations are not allowed until backup of database is done.
- An attempt was made to modify the cluster topology (for example, adding or deleting a member) while the database was in one of the following states: backup pending, restore pending, rollforward pending.

## Resolving the problem

- If the database is offline as a result of an abnormal termination of the previous session, respond with the following actions
  1. Restart the database using the **RESTART DATABASE** command. In a partitioned database server environment, the command must be issued on all database partitions.
- If this error was encountered when issuing the **db2ckupgrade** command, respond with the following actions:
  1. Perform a clean shutdown of the database.
  2. After shutdown, if HADR has been enabled on the database, issue the **STOP HADR** command on the database.
  3. Re-issue the **db2ckupgrade** command.
- In a DB2 pureScale environment environment only:
  1. If the database on this DB2 member is offline as a result of an abnormal termination of the previous session, respond with the following actions:
    - a. By default, member crash recovery is automatically initiated in a DB2 pureScale environment environment, so no user action is required. If member crash recovery is not automatically enabled, perform member crash recovery on this DB2 member by issuing the **RESTART DATABASE** command.
    - b. Some database operations can still complete on other, consistent members even if one member is inconsistent. To access the database during member crash recovery, connect to an active DB2 member. To access this specific member, wait for member crash recovery to complete.
  2. If the database is offline across the entire DB2 pureScale environment instance as a result of an abnormal termination of the previous session, warn users that the database will not be available until recovery completes. The next step depends on whether group crash recovery is automatically enabled. If it is enabled (the default) then no user action is required. If automatic group crash recovery is not enabled, respond with the following actions:
    - a. Perform group crash recovery by issuing the **RESTART DATABASE** command.
    - b. After the recovery completes, perform member crash recovery on any other members that have in-doubt transactions.
  3. Back up databases that are in backup pending state, and resubmit add or drop operation.
  4. If the database is in a state that is not compatible with a topology change, then address the issue and then attempt the topology change request again.

---

## Troubleshooting installation of DB2 database systems

If problems occur while you are installing DB2 database products, confirm that your system meets the installation requirements and review the list of common installation issues.

## Procedure

To troubleshoot installation problems for DB2 database systems:

- Ensure that your system meets all of the installation requirements.
- If you are encountering licensing errors, ensure that you have applied the appropriate licenses.

Review the list of frequently asked questions in the “Knowledge Collection: DB2 license issues” technote: <http://www.ibm.com/support/docview.wss?rs=71&uid=swg21322757>

- Review the list of installation issues in the documentation and on the DB2 Technical Support website: [www.ibm.com/software/data/db2/support/db2\\_9/troubleshoot.html](http://www.ibm.com/software/data/db2/support/db2_9/troubleshoot.html)

## What to do next

If you complete these steps but cannot yet identify the source of the problem, begin collecting diagnostic data to obtain more information.

## Collecting data for installation problems

If you are experiencing installation problems and cannot determine the cause of the problem, collect diagnostic data that either you or IBM Software Support can use to diagnose and resolve the problem.

To collect diagnostic data for installation problems:

1. Optional: Repeat the installation attempt with tracing enabled. For example:

On Linux and UNIX operating systems

```
db2setup -t /filepath/trace.out
```

On Windows operating systems

```
setup -t \filepath\trace.out
```

2. Locate the installation log files.

- On Windows, the default file name is "DB2-ProductAbbreviation-DateTime.log". For example: DB2-ESE-Wed Jun 21 11\_59\_37 2006.log. The default location for the installation log is the "My Documents"\DB2LOG\ directory.

**Note:** If DB2 is installed using SYSTEM user, for example using Microsoft Systems Center Configuration Manager (SCCM) or Tivoli®, an install log is not created. The SYSTEM user does not have a "My Documents" folder for the install log to be created in. In order to view the install log, use the -l option of the setup command to create the log file in a different location.

- On Linux and UNIX, the default file names are db2setup.log, db2setup.his, and db2setup.err.

If you recreated the problem with tracing (or debug mode) enabled, additional files might be created, such as: dasprt.log, dasdrop.log, dasupdt.log, db2icrt.log.PID, db2idrop.log.PID, db2iupgrade.log.PID, and db2iupdt.log.PID, where PID is the process ID.

The default location for all of these files is the /tmp directory. For the trace file (trace.out), there is no default directory if not given, so you must specify the file path to the folder in which the trace output file was created.

3. Optional: If you intend to submit the data to IBM Software Support, collect data for DB2 as well. See "Collecting data for DB2" for additional information.

## Analyzing data for installation problems

After you collect diagnostic data about installation problems, you can analyze the data to determine the cause of the problem. These steps are optional. If the cause of the problem is not easily determined, submit the data to IBM Software Support.

### Before you begin

These steps assume that you have obtained the files described in Collecting data for installation problems.

### Procedure

1. Ensure that you are looking at the appropriate installation log file. Check the file's creation date, or the timestamp included in the file name (on Windows operating systems).
  2. Determine whether the installation completed successfully.
    - On Windows operating systems, success is indicated by a message similar to the following at the bottom of the installation log file:

```
Property(C): INSTALL_RESULT = Setup Complete Successfully
=== Logging stopped: 6/21/2006 16:03:09 ===
MSI (c) (34:38) [16:03:09:109]:
Product: DB2 Enterprise Server Edition - DB2COPY1 -- Installation operation
completed successfully.
```
    - On Linux and UNIX operating systems, success is indicated by a message at the bottom of the installation log file (the one named db2setup.log by default).
  3. OPTIONAL: Determine whether any errors occurred. If the installation completed successfully, but you received an error message during the installation process, locate these errors in the installation log file.
    - On Windows operating systems, most errors will be prefaced with "ERROR:" or "WARNING:". For example:

```
1: ERROR:An error occurred while running the command
"D:\IBM\SQLLIB\bin\db2.exe
CREATE TOOLS CATALOG SYSTOOLS USE EXISTING DATABASE TOOLSDB FORCE" to
initialize and/or migrate the DB2 tools catalog database.
The return value is "4".

1: WARNING:A minor error occurred while installing "DB2 Enterprise Server
Edition - DB2COPY1" on this computer. Some features may not function
correctly.
```
    - On Linux and UNIX operating systems, a file with a default name of db2setup.err will be present if any errors were returned by Java (for example, exceptions and trap information).
- If you had enabled an installation trace, there will be more entries in the installation log files and the entries will be more detailed.

### Results

If analyzing this data does not help you to resolve your problem, and if you have a maintenance contract with IBM Software Support, you can open a problem report. IBM Software Support will ask you to submit any data that you have collected, and they might also ask you about any analysis that you performed.

## What to do next

If your investigation has not solved the problem, submit the data to IBM Software Support.

## Gathering diagnostic information for instance creation problems

If you encounter problems when creating or upgrading an instance, you might need to collect diagnostic information to help troubleshoot the problem. The **db2fodc -c1p** command helps to quickly gather the necessary diagnostic information for IBM support to analyze and troubleshoot the problem.

### Symptoms

While creating or upgrading an instance, you might receive an error when trying to update the DBM CFG as part of instance creation. The error code that you might receive is DBI1281E. However, this error might not give the root cause of the problem and diagnostic information is needed to further troubleshoot the instance creation problem.

### Resolving the problem

To quickly gather the diagnostic information needed to troubleshoot the problem, under the guidance of IBM support, you need to perform the following steps:

1. Issue the **db2fodc -c1p** command. This command collects environment and configuration related information that is targeted to diagnosing an instance creation problem. After collection is completed the information is stored in a newly created directory named `FODC_C1p_<timestamp>_<member>`.

After collection is completed you can send the `FODC_C1p_<timestamp>_<member>` directory to IBM support for analysis.

## Known problems and solutions

### Errors when installing a DB2 database product as a non-root user to the default path on a system WPAR (AIX)

Various errors can occur if you install DB2 database products as a non-root user in the default installation path (`/opt/IBM/db2/V9.7`) on a system workload partition (WPAR) on AIX 6.1. To avoid these problems, install DB2 database products on a file system that is accessible only to the WPAR.

### Symptoms

If you install DB2 database products in the `/usr` or `/opt` directories on a system WPAR, various errors can occur depending on how you configured the directories. System WPARs can be configured to either share the `/usr` and `/opt` directories with the global environment (in which case the `/usr` and `/opt` directories will be readable but not write accessible from the WPAR) or to have a local copy of the `/usr` and `/opt` directories.

In the first scenario, if a DB2 database product is installed to the default path on the global environment, that installation will be visible in the system WPAR. This will give the appearance that DB2 is installed on the WPAR, however attempts to create a DB2 instance will result in this error: DBI1288E The execution of the

program db2icrt failed. This program failed because you do not have write permission on the directory or file /opt/IBM/db2/V9.7/profiles.reg,/opt/IBM/db2/V9.7/default.env.

In the second scenario, if a DB2 database product is installed to the default path on the global environment then when the WPAR creates the local copy of the /usr and /opt directories the DB2 database product installation will also be copied. This can cause unexpected problems if a system administrator attempts to use the database system. Since the DB2 database product was intended for another system, inaccurate information might be copied over. For example, any DB2 instances originally created on the global environment will appear to be present in the WPAR. This can cause confusion for the system administrator with respect to which instances are actually installed on the system.

### **Causes**

These problems are caused by installing DB2 database products in /usr or /opt directories on a system WPAR.

### **Resolving the problem**

Do not install DB2 database products in the default path on the global environment.

Mount a file system that is accessible only to the WPAR and install the DB2 database product on that file system.

### **Beta and non-beta versions of DB2 database products cannot coexist**

A DB2 copy can contain one or more different DB2 database products, but it cannot contain both beta and non-beta products. Do not install beta and non-beta versions of DB2 database products in the same location.

This restriction applies to both client and server components of DB2 database products.

### **Resolving the problem**

Uninstall the beta version of DB2 Version 9.7 before installing the non-beta version or else choose a different installation path.

### **Resolving service name errors when you install DB2 database products**

If you choose a non-default service name or port number for the DB2 database product or DB2 Information Center to use, ensure that you do not specify values that are already in use.

### **Symptoms**

When you attempt to install a DB2 database product or the *DB2 Information Center*, the DB2 Setup wizard reports an error that states "The service name specified is in use".

## Causes

The DB2 Setup wizard will prompt you to choose port numbers and service names when you install:

- The *DB2 Information Center*
- A DB2 database product that will accept TCP/IP communications from clients
- A DB2 database product that will act as a database partition server

This error can occur if you choose a service name and port number rather than accepting the default values. If you choose a service name that already exists in the `services` file on the system and you only change the port number, this error will occur.

## Resolving the problem

Take one of the following actions:

- Use the default values.
- Use a service name and port number that are both already in the `services` file.
- Add an unused service name and an unused port number to the `services` file. Specify these values in the DB2 Setup wizard.

---

## Troubleshooting license issues

### Analyzing DB2 license compliance reports

To verify the license compliance of your DB2 features, analyze a DB2 license compliance report.

#### Before you begin

The following steps assume that you have used the `db2licm` command to generate a DB2 license compliance report.

#### Procedure

1. Open the file that contains the DB2 license compliance report.
2. Examine the status of each DB2 feature in the compliance report. The report displays one of the following values for each feature:

##### In compliance

Indicates that no violations were detected. The feature has been used and is properly licensed.

##### Not used

Indicates that you have not performed any activities that require this particular feature.

##### Violation

Indicates that the feature is not licensed and has been used.

3. If there are any violations, use the `db2licm -l` command to view your license information.

If the DB2 feature is listed with a status of "Not licensed", you must obtain a license for that feature. The license key and instructions for registering it are available on the Activation CD that you receive when you purchase a DB2 feature.

**Note:** On DB2 Workgroup Server Edition and DB2 Express® Edition, the SAMPLE database includes materialized query tables (MQT), and multidimensional cluster tables (MDC) that causes a license violation. This violation can only be removed by upgrading to DB2 Enterprise Server Edition.

4. Use the following commands to determine which objects or settings in your DB2 database product are causing the license violations:

- For the DB2 Advanced Access Control Feature:

Check for tables that use label based access control (LBAC). Run the following command against every database in every instance in the DB2 copy:

```
SELECT TABSCHEMA, TABNAME
FROM SYSCAT.TABLES
WHERE SECPOLICYID>0
```

- For the DB2 Performance Optimization Feature:

- Check whether there are any materialized query tables. Run the following command against every database in every instance in the DB2 copy:

```
SELECT OWNER, TABNAME
FROM SYSCAT.TABLES WHERE TYPE='S'
```

- Check whether there are any multidimensional cluster tables. Run the following command against every database in every instance in the DB2 copy:

```
SELECT A.TABSCHEMA, A.TABNAME, A.INDNAME, A.INDSCHEMA
FROM SYSCAT.INDEXES A, SYSCAT.TABLES B
WHERE (A.TABNAME=B.TABNAME AND A.TABSCHEMA=B.TABSCHEMA)
AND A.INDEXTYPE='BLOK'
```

- Check whether any of your instances use query parallelism (also known as *interquery parallelism*). Run the following command once in each instance in the DB2 copy:

```
SELECT NAME, VALUE
FROM SYSIBMADM.DBMCFG
WHERE NAME IN ('intra_parallel')
```

- Check if connection concentrator is enabled. Run the following command against every instance in the DB2 copy:

```
db2 get dbm cfg
```

This command displays the current values of database manager configuration parameters including MAX\_CONNECTIONS and MAX\_COORDAGENTS. If the value of the MAX\_CONNECTIONS is greater than the value of the MAX\_COORDAGENTS then connection concentrator is enabled. If you are not using DB2 Enterprise Server Edition, DB2 Advanced Enterprise Server Edition, or DB2 Connect Server products, ensure that connection concentrator is disabled. This is because connection concentrator is only supported for DB2 Enterprise Server Edition, DB2 Advanced Enterprise Server Edition, or DB2 Connect Server products.

- For the DB2 Storage Optimization Feature:

- Check if any tables have row level compression enabled. Run the following command against every database in every instance in the DB2 copy:

```
SELECT TABSCHEMA, TABNAME
FROM SYSCAT.TABLES
WHERE COMPRESSION IN ('R', 'B')
```

- Check if any compression dictionary still exists for a table that has row level compression deactivated. Run the following command against every database in every instance in the DB2 copy:

```
SELECT TABSCHEMA, TABNAME
FROM SYSIBMADM.ADMINTABINFO
WHERE DICTIONARY_SIZE <> 0 OR XML_DICTIONARY_SIZE <> 0
```

**Note:** This query might be resource intensive and might take a long time to run. Run this query only if Storage Optimization license violations are being reported even though there are no tables that have row level compression enabled.

---

## Diagnosing and resolving locking problems

To resolve a locking problem, you need to start by diagnosing the type of lock event causing the SQL query performance slowdown, or query completion failure, and the SQL statement or statements involved. The steps to help in diagnosing the type of locking problem and the steps that can then be taken to help resolve the locking issue are provided here.

### Introduction

A locking problem is the proper diagnosis if you are experiencing a failure of applications to complete their tasks or a slow down in the performance of SQL queries due to locks. Therefore, the ideal objective is not to have any lock timeouts or deadlocks on a database system, both of which result in applications failing to complete their tasks.

Lock waits are normal expected events, but if the time spent waiting for a lock becomes large, then lock waits can slow down both SQL query performance and completion of an application. Excessive lock wait durations have a risk of becoming lock timeouts which result in the application not completing its tasks.

Lock escalations are a consideration as a locking problem when they contribute to causing lock timeouts. Ideally, the objective is not to have any lock escalations, but a small number can be acceptable if adverse effects are not occurring.

It is suggested that you monitor lock wait, lock timeout, and deadlock locking events at all times; typically at the workload level for lock waits, and at the database level for lock timeouts and deadlocks.

The diagnosis of the type of locking problem that is occurring and its resolution begins with the collection of information and looking for diagnostic indicators. The following sections help to guide you through this process.

### Collect information

In general, to be able to objectively assess that your system is demonstrating abnormal behavior which can include processing delays and poor performance, you must have information that describes the typical behavior (baseline) of your system. A comparison can then be made between your observations of suspected abnormal behavior and the baseline. Collecting baseline data, by scheduling periodic operational monitoring tasks, is a key component of the troubleshooting process. For more detailed information about establishing the baseline operation of your system, see: "Operational monitoring of system performance" in *Troubleshooting and Tuning Database Performance*.

To confirm what type of locking problem is the reason for your SQL query performance slowdown or query completion failure, it is necessary to collect



information that would help to identify what type of lock event is involved, which application is requesting or holding this lock, what was the application doing during this event, and the SQL statement or statements that are involved in being noticeably slow.

The creation of a locking event monitor, use of a table function, or use of the **db2pd** command can collect this type of information. The information gathered by the locking event monitor can be categorized into three main categories:

- Information about the lock in question
- Information about the application requesting this lock and its current activities. In the case of a deadlock, this is information about the statement referred to as the victim.
- Information about the application owning the lock and its current activities. In the case of a deadlock, this is information about the statement referred to as the participant.

For instructions about how to monitor lock wait, lock timeout, and deadlock locking events, see: “Monitoring locking events” in the *Database Monitoring Guide and Reference*.

## Look for diagnostic indicators

The locking event monitor, a table function, or running the **db2pd** command can collect information that can help isolate the nature of a locking problem. Specifically, the following topics contain diagnostically indicative information to help you to diagnose and confirm the particular type of locking problem you are experiencing.

- If you are experiencing long wait times and no lock timeouts, then you likely have a lock wait problem. To confirm: “Diagnosing a lock wait problem.”
- If you are experiencing an increased number of deadlocks than the baseline number, then you likely have a deadlock problem. To confirm: “Diagnosing a deadlock problem” on page 570.
- If you are experiencing an increased number of lock timeouts and the **locktimeout** database configuration parameter is set to a nonzero time value, then you likely have a lock timeout problem. To confirm (also consider lock wait problem): “Diagnosing a lock timeout problem” on page 573
- If you are experiencing a higher than typical number of lock waits and the locking event monitor indicates that lock escalations are occurring (Yes), then you likely have a lock escalation problem. To confirm: “Diagnosing a lock escalation problem” on page 576

## Diagnosing a lock wait problem

A lock wait occurs when a transaction tries to obtain a lock on a resource that is already held by another transaction. When the duration of the lock wait time is extended, this results in a slow down of SQL query execution. You likely have a lock wait problem if you are experiencing long or unexpected lock wait times and no lock timeouts.

### Before you begin

In general, to be able to objectively assess that your system is demonstrating abnormal behavior which can include processing delays and poor performance, you must have information that describes the typical behavior (baseline) of your system. A comparison can then be made between your observations of suspected

abnormal behavior and the baseline. Collecting baseline data, by scheduling periodic operational monitoring tasks, is a key component of the troubleshooting process. For more detailed information about establishing the baseline operation of your system, see: “Operational monitoring of system performance” on page 11.

For instructions about how to monitor lock wait locking events, see: “Monitoring locking events” in *Database Monitoring Guide and Reference*.

## About this task

### Diagnosis

A lock wait occurs when one transaction (composed of one or more SQL statements) tries to acquire a lock whose mode conflicts with a lock held by another transaction. Excessive lock wait time often translates into poor response time, so it is important to monitor. The amount of lock wait time is best normalized to one thousand transactions because lock wait time on a single transaction is typically quite low and a normalized measurement is easier to handle.

There are different qualities of lock wait that must be taken into consideration when attempting to confirm diagnosis of each of them. The following list shows the three different qualities of lock wait and how best to diagnose them:

- Long individual lock wait
  - Check for peak lock wait time from service class and workload. Set up the locking event monitor on workload to obtain that value.
- Long lock wait time but short individual lock waits
  - Typically a result of a lock convoy. Use the **db2pd -locks wait** command to detect wait chains.
- Types of lock being waited on
  - Checking this might help determine the problem. Find the agent that is waiting on the lock to get information about the lock type. Use the lock type information to determine if something obvious is occurring. For example, a package lock might indicate a **BIND/REBIND** command or DDL colliding with a user of that package; an internal c (catalog cache) lock might indicate a DDL colliding with a statement compilation.

### Indicative signs

Look for the following indicative signs of lock waits:

- The number of lock waits is increasing (increasing **lock\_waits** monitor element value)
- A high percentage of active agents waiting on locks (for example, 20%, or more, of the total active agents). For information about how to obtain this information, see the next section, “What to monitor”.
- An increasing value of lock wait time (**lock\_wait\_time** monitor element) captured at database or workload level

### What to monitor

Unlike many other types of DB2 monitor data, locking information is very transient. Apart from **lock\_wait\_time**, which is a running total, most other lock information goes away when the locks themselves are released. Thus, lock and lock wait event data are most valuable if collected periodically over a period of time, so that the evolving picture can be better understood.

To collect information about active agents waiting on locks, use the `WLM_GET_SERVICE_CLASS_AGENTS` table function. Agents waiting for locks are indicated by agents with the following attribute-value pairs:

- `EVENT_OBJECT = LOCK`
- `EVENT_TYPE = ACQUIRE`

You can also use application snapshot, the lock administrative views, or the lock wait option of the `db2pd -wlocks` command to obtain information about active agents waiting on locks.

These are the key indicator monitoring elements:

- `lock_waits` value is increasing
- long `lock_wait_time` value

If you have observed one or more of the indicative signs listed here, then you are likely experiencing a problem with lock waits. Follow the link in the “What to do next” section to resolve this issue.

## What to do next

After having diagnosed that lock waits are likely causing the problem you are experiencing, take steps to resolve the issue: “Resolving lock wait problems”

## Resolving lock wait problems

After diagnosing a lock wait problem, the next step is to attempt to resolve the issue resulting from an application having to wait too long for a lock. Guidelines are provided here to help you resolve lock wait problems and assist you in preventing such incidents from occurring in future.

## Before you begin

Confirm that you are experiencing a lock wait problem by taking the necessary diagnostic steps for locking problems outlined in “Diagnosing and resolving locking problems” on page 566.

## About this task

The guidelines provided here can help you to resolve the lock wait problem you are experiencing and help you to prevent such future incidents.

## Procedure

Use the following steps to diagnose the cause of the unacceptable lock wait problem and to apply a remedy:

1. Obtain information from the administration notification log about all tables where agents are spending long periods of time waiting for locks.
2. Use the information in the administration notification log to decide how to resolve the lock wait problem. There are a number of guidelines that help to reduce lock contention and lock wait time. Consider the following options:
  - If possible, avoid very long transactions and WITH HOLD cursors. The longer locks are held, the more chance that they cause contention with other applications. This is only an issue if you are using a high isolation level.
  - It is best practice to commit the following actions as soon as possible:

- Write actions such as delete, insert, and update
- Data definition language (DDL) statements, for example ALTER, CREATE, and DROP statements
- **BIND** and **REBIND** commands
- After issuing ALTER or DROP DDL statements, run the SYSPROC.ADMIN\_REVALIDATE\_DB\_OBJECTS procedure to revalidate any data objects and the **db2rbind** command to rebind any packages.
- Avoid fetching result sets that are larger than necessary, especially under the repeatable read (RR) isolation level. The more that rows are touched, the more that locks are held, and the greater the opportunity to run into a lock that is held by someone else. In practical terms, this often means pushing down row selection criteria into a WHERE clause of the SELECT statement, rather than bringing back more rows and filtering them at the application.

For example:

```
exec sql declare curs for
  select c1,c2 from t
  where c1 not null;
exec sql open curs;
do {
  exec sql fetch curs
  into :c1, :c2;
} while( P(c1) != someVar );
```

==>

```
exec sql declare curs for
  select c1,c2 from t
  where c1 not null
  and myUdfP(c1) = :someVar;
exec sql open curs;
exec sql fetch curs
  into :c1, :c2;
```

- Avoid using higher isolation levels than necessary. Repeatable read might be necessary to preserve result set integrity in your application; however, it does incur extra cost in terms of locks held and potential lock conflicts.
- If appropriate for the business logic in the application, consider modifying locking behavior through the **DB2\_EVALUNCOMMITTED**, **DB2\_SKIPDELETED**, and **DB2\_SKIPINSERTED** registry variables. These registry variables enable DB2 database manager to delay or avoid taking locks in some circumstances, thereby reducing contention and potentially improving throughput.
- Eliminate lock escalations wherever possible.

## What to do next

Rerun the application or applications to ensure that the locking problem has been eliminated by checking the administration notification log for lock-related entries or checking the lock wait and lock wait time metrics for the appropriate workload, connection, service subclass, unit of work, and activity levels.

## Diagnosing a deadlock problem

A deadlock is created when two applications lock data that is needed by the other, resulting in a situation in which neither application can continue executing without the intervention of the deadlock detector. The deadlock slows down the participant transaction while it waits for deadlock detection, wastes system resources by rolling back the victim transaction, and causes extra system work and transaction

log access during the whole process. You likely have a deadlock problem if you are experiencing an increased number of deadlocks than the baseline number and transactions are being re-executed.

## Before you begin

In general, any observed deadlock is considered abnormal. To be able to objectively assess that your system is demonstrating abnormal behavior which can include processing delays and poor performance, you must have information that describes the typical behavior (baseline) of your system. A comparison can then be made between your observations of suspected abnormal behavior and the baseline. Collecting baseline data, by scheduling periodic operational monitoring tasks, is a key component of the troubleshooting process. .

For instructions about how to monitor deadlock locking events, see: “Monitoring locking events” in *Database Monitoring Guide and Reference*.

## About this task

### Diagnosis

A deadlock is created when two applications lock data that is needed by the other, resulting in a situation in which neither application can continue executing without the intervention of the deadlock detector. The victim application has to re-execute the transaction from the beginning after the system automatically rolls back the previous deadlocked transaction. Monitoring the rate at which this happens helps avoid the case where many deadlocks drive significant extra load on the system without the DBA being aware.

### Indicative signs

Look for the following indicative signs of deadlocks:

- One or more applications are occasionally re-executing transactions
- Deadlock message entries in the administration notification log
- Increased number of deadlocks displayed for the **deadlocks** monitor element
- Increased number of roll backs displayed for the **int\_deadlock\_rollbacks** monitor element
- Increased amount of time an agent spends waiting for log records to be flushed to disk which is displayed for the **log\_disk\_wait\_time** monitor element

### What to monitor

The cost of a deadlock varies, and is directly proportional to the length of the rolled-back transaction. All the same, any deadlock generally indicates a problem.

There are essentially three approaches to detecting deadlock events:

1. Set a locking event monitor and set the **mon\_deadlock** database configuration parameter to capture details on all deadlock events that occur database-wide
2. Monitor the administration notification log for deadlock messages and basic information that accompanies them

**Note:** To enable deadlock messages to be written to the administration notification log file, set the `mon_lck_msg_lvl` database configuration parameter to a value of 2.

3. Monitor the indicator monitoring elements by way of a table function

Most users adopt the first approach. By monitoring the key indicator monitor elements to detect when a deadlock occurs, users can then obtain detailed information by checking the information collected by the event monitor.

These are the key indicator monitoring elements:

- **deadlocks** value is non-zero
- **int\_deadlock\_rollbacks** shows increase in number of roll backs due to deadlock events
- **log\_disk\_wait\_time** shows increase in amount of time agents spend waiting for logs to be flushed to disk

If you have observed one or more of the indicative signs listed here, then you are likely experiencing a problem with deadlocks. Follow the link in the “What to do next” section to resolve this issue.

## What to do next

After having diagnosed that deadlocks are likely causing the problem you are experiencing, take steps to resolve the issue: “Resolving deadlock problems”

## Resolving deadlock problems

After diagnosing a deadlock problem, the next step is to attempt to resolve the deadlock issue resulting between two concurrently running applications each of which have locked a resource the other application needs. The guidelines provided here can help you to resolve the deadlock problem you are experiencing and help you to prevent such future incidents.

## Before you begin

Confirm that you are experiencing a deadlock problem by taking the necessary diagnostic steps for locking problems outlined in “Diagnosing and resolving locking problems” on page 566.

## About this task

The guidelines provided here can help you to resolve the deadlock problem you are experiencing and help you to prevent such future incidents.

## Procedure

Use the following steps to diagnose the cause of the unacceptable deadlock problem and to apply a remedy:

1. Obtain information from the lock event monitor or administration notification log about all tables where agents are experiencing deadlocks.
2. Use the information in the administration notification log to decide how to resolve the deadlock problem. There are a number of guidelines that help to reduce lock contention and lock wait time. Consider the following options:

- Each application connection should process its own set of rows to avoid lock waits.
  - Deadlock frequency can sometimes be reduced by ensuring that all applications access their common data in the same order – meaning, for example, that they access (and therefore lock) rows in Table A, followed by Table B, followed by Table C, and so on. If two applications take incompatible locks on the same objects in different order, they run a much larger risk of deadlocking.
  - A lock timeout is not much better than a deadlock, because both cause a transaction to be rolled back, but if you must minimize the number of deadlocks, you can do it by ensuring that a lock timeout will usually occur before a potential related deadlock can be detected. To do this, set the value of the **locktimeout** database configuration parameter (units of seconds) to be much lower than the value of the **dlchktime** database configuration parameter (units of milliseconds). Otherwise, if **locktimeout** is longer than the **dlchktime** interval, the deadlock detector could wake up just after the deadlock situation began, and detect the deadlock before the lock timeout occurs.
  - Avoid concurrent DDL operations if possible. For example, DROP TABLE statements can result in a large number of catalog updates as rows might have to be deleted for the table indexes, primary keys, check constraints, and so on, in addition to the table itself. If other DDL operations are dropping or creating objects, there can be lock conflicts and even occasional deadlocks.
  - It is best practice to commit the following actions as soon as possible:
    - Write actions such as delete, insert, and update
    - Data definition language (DDL) statements, such as ALTER, CREATE, and DROP
    - **BIND** and **REBIND** commands
3. The deadlock detector is unable to know about and resolve the following situation, so your application design must guard against this. An application, particularly a multithreaded one, can have a deadlock involving a DB2 lock wait and a wait for a resource outside of the DB2 software, such as a semaphore. For example, connection A can be waiting for a lock held by connection B, and B can be waiting for a semaphore held by A.

### What to do next

Rerun the application or applications to ensure that the locking problem has been eliminated by checking the administration notification log for lock-related entries.

## Diagnosing a lock timeout problem

A lock timeout occurs when a transaction, waiting for a resource lock, waits long enough to have surpassed the wait time value specified by the **locktimeout** database configuration parameter. This consumes time which causes a slow down in SQL query performance. You likely have a lock timeout problem if you are experiencing an increased number of lock timeouts and the **locktimeout** database configuration parameter is set to a nonzero time value.

### Before you begin

In general, to be able to objectively assess that your system is demonstrating abnormal behavior which can include processing delays and poor performance, you must have information that describes the typical behavior (baseline) of your

system. A comparison can then be made between your observations of suspected abnormal behavior and the baseline. Collecting baseline data, by scheduling periodic operational monitoring tasks, is a key component of the troubleshooting process. .

For instructions about how to monitor lock timeout locking events, see: “Monitoring locking events” in *Database Monitoring Guide and Reference*.

## About this task

### Diagnosis

Sometimes, lock wait situations lead to lock timeouts that cause transactions to be rolled back. The period of time until a lock wait leads to a lock timeout is specified by the database configuration parameter **locktimeout**. Lock timeouts, in excessive numbers, can be as disruptive to a system as deadlocks. Although deadlocks are comparatively rare in most production systems, lock timeouts can be more common. The application usually has to handle them in a similar way: re-executing the transaction from the beginning. Monitoring the rate at which this happens helps avoid the case where many lock timeouts drive significant extra load on the system without the DBA being aware.

### Indicative signs

Look for the following indicative signs of lock timeouts:

- An application is frequently re-executing transactions
- **lock\_timeouts** monitor element value is climbing
- Lock timeout message entries in the administration notification log

### What to monitor

Due to the relatively transient nature of locking events, lock event data is most valuable if collected periodically over a period of time, so that the evolving picture can be better understood.

You can monitor the administration notification log for lock timeout messages.

**Note:** To enable lock timeout messages to be written to the administration notification log file, set the **mon\_lck\_msg\_lvl** database configuration parameter to a value of 3.

Create an event monitor to capture lock timeout data for a workload or database.

These are the key indicator monitoring elements:

- **lock\_timeouts** value is climbing
- **int\_rollbacks** value is climbing

If you have observed one or more of the indicative signs listed here, then you are likely experiencing a problem with lock timeouts. Follow the link in the “What to do next” section to resolve this issue.

## What to do next

After having diagnosed that lock timeouts are likely causing the problem you are experiencing, take steps to resolve the issue: “Resolving lock timeout problems” on page 575



## Resolving lock timeout problems

After diagnosing a lock timeout problem, the next step is to attempt to resolve the issue resulting from an application or applications waiting for locks until the lock timeout period has elapsed. The guidelines provided here can help you to resolve the lock timeout problem you are experiencing and help you to prevent such future incidents.

### Before you begin

Confirm that you are experiencing a lock timeout problem by taking the necessary diagnostic steps for locking problems outlined in “Diagnosing and resolving locking problems” on page 566.

### About this task

The guidelines provided here can help you to resolve the lock timeout problem you are experiencing and help you to prevent such future incidents.

### Procedure

Use the following steps to diagnose the cause of the unacceptable lock timeout problem and to apply a remedy:

1. Obtain information from the lock event monitor or administration notification log about all tables where agents are experiencing lock timeouts.
2. Use the information in the administration notification log to decide how to resolve the lock timeout problem. There are a number of guidelines that help to reduce lock contention and lock wait time that can result in a reduced number of lock timeouts. Consider the following options:
  - Tune the **locktimeout** database configuration parameter to a number of seconds appropriate for your database environment.
  - If possible, avoid very long transactions and WITH HOLD cursors. The longer locks are held, the more chance that they cause contention with other applications.
  - It is best practice to commit the following actions as soon as possible:
    - Write actions such as delete, insert, and update
    - Data definition language (DDL) statements, such as ALTER, CREATE, and DROP
    - **BIND** and **REBIND** commands
  - Avoid fetching result sets that are larger than necessary, especially under the repeatable read (RR) isolation level. The more that rows are touched, the more that locks are held, and the greater the opportunity to run into a lock that is held by someone else. In practical terms, this often means pushing down row selection criteria into a WHERE clause of the SELECT statement, rather than bringing back more rows and filtering them at the application. For example:

```
exec sql declare curs for
  select c1,c2 from t
  where c1 not null;
exec sql open curs;
do {
  exec sql fetch curs
    into :c1, :c2;
} while( P(c1) != someVar );
```

==>

```

exec sql declare curs for
  select c1,c2 from t
  where c1 not null
  and myUdfP(c1) = :someVar;
exec sql open curs;
exec sql fetch curs
  into :c1, :c2;

```

- Avoid using higher isolation levels than necessary. Repeatable read might be necessary to preserve result set integrity in your application; however, it does incur extra cost in terms of locks held and potential lock conflicts.
- If appropriate for the business logic in the application, consider modifying locking behavior through the **DB2\_EVALUNCOMMITTED**, **DB2\_SKIPDELETED**, and **DB2\_SKIPINSERTED** registry variables. These registry variables enable DB2 database manager to delay or avoid taking locks in some circumstances, thereby reducing contention and potentially improving throughput.

### What to do next

Rerun the application or applications to ensure that the locking problem has been eliminated by checking the administration notification log for lock-related entries or checking the lock wait and lock wait time metrics for the appropriate workload, connection, service subclass, unit of work, and activity levels.

## Diagnosing a lock escalation problem

A lock escalation occurs when, in the interest of reducing memory that is allocated to locks (lock space), numerous row-level locks are escalated into a single, memory-saving table lock. This situation, although automated and saves memory space devoted to locks, can reduce concurrency to an unacceptable level. You likely have a lock escalation problem if you are experiencing a higher than typical number of lock waits and the administration notification log entries indicate that lock escalations are occurring.

### Before you begin

In general, to be able to objectively assess that your system is demonstrating abnormal behavior which can include processing delays and poor performance, you must have information that describes the typical behavior (baseline) of your system. A comparison can then be made between your observations of suspected abnormal behavior and the baseline. Collecting baseline data, by scheduling periodic operational monitoring tasks, is a key component of the troubleshooting process. For more detailed information about establishing the baseline operation of your system, see: “Operational monitoring of system performance” on page 11.

### About this task

#### Diagnosis

Lock escalation from multiple row-level locks to a single table-level lock can occur for the following reasons:

- The total amount of memory consumed by many row-level locks held against a table exceeds the percentage of total memory allocated for storing locks
- The lock list runs out of space. The application that caused the lock list to be exhausted will have its locks forced through the lock escalation process, even though the application is not the holder of the most locks.

The threshold percentage of total memory allocated for storing locks, that has to be exceeded by an application for a lock escalation to occur, is defined by the **maxlocks** database configuration parameter and the allocated memory for locks is defined by the **locklist** database configuration parameter. In a well-configured database, lock escalation is rare. If lock escalation reduces concurrency to an unacceptable level, you can analyze the problem and decide on the best course of action.

Lock escalation is less of an issue, from the memory space perspective, if self tuning memory manager (STMM) is managing the memory for locks that is otherwise only allocated by the **locklist** database configuration parameter. STMM will automatically adjust the memory space for locks if it ever runs out of free memory space.

#### **Indicative signs**

Look for the following indicative signs of lock escalations:

- Lock escalation message entries in the administration notification log

#### **What to monitor**

Due to the relatively transient nature of locking events, lock event data is most valuable if collected periodically over a period of time, so that the evolving picture can be better understood.

Check this monitoring element for indications that lock escalations might be a contributing factor in the SQL query performance slow down:

- **lock\_escals**

If you have observed one or more of the indicative signs listed here, then you are likely experiencing a problem with lock escalations. Follow the link in the “What to do next” section to resolve this issue.

### **What to do next**

After having diagnosed that lock escalations are likely causing the problem you are experiencing, take steps to resolve the issue: “Resolving lock escalation problems”

### **Resolving lock escalation problems**

After diagnosing a lock escalation problem, the next step is to attempt to resolve the issue resulting from the database manager automatically escalating locks from row level to table level. The guidelines provided here can help you to resolve the lock escalation problem you are experiencing and help you to prevent such future incidents.

#### **Before you begin**

Confirm that you are experiencing a lock escalation problem by taking the necessary diagnostic steps for locking problems outlined in “Diagnosing and resolving locking problems” on page 566.

#### **About this task**

The guidelines provided here can help you to resolve the lock escalation problem you are experiencing and help you to prevent such future incidents.

The objective is to minimize lock escalations, or eliminate them, if possible. A combination of good application design and database configuration for lock handling can minimize or eliminate lock escalations. Lock escalations can lead to reduced concurrency and potential lock timeouts, so addressing lock escalations is an important task. The **lock\_escal**s monitor element and messages written to the administration notification log can be used to identify and correct lock escalations.

First, ensure that lock escalation information is being recorded. Set the value of the **mon\_lock\_msg\_lvl** database configuration parameter to 1. This is the default setting. When a lock escalation event occurs, information regarding the lock, workload, application, table, and error SQLCODEs are recorded. The query is also logged if it is a currently executing dynamic SQL statement.

## Procedure

Use the following steps to diagnose the cause of the unacceptable lock escalation problem and to apply a remedy:

1. Gather information from the administration notification log about all tables whose locks have been escalated and the applications involved. This log file includes the following information:
  - The number of locks currently held
  - The number of locks needed before lock escalation is completed
  - The table identifier and table name of each table being escalated
  - The number of non-table locks currently held
  - The new table-level lock to be acquired as part of the escalation. Usually, an S or X lock is acquired.
  - The internal return code that is associated with the acquisition of the new table-level lock
2. Use the administration notification log information about the applications involved in the lock escalations to decide how to resolve the escalation problems. Consider the following options:
  - Check and possibly adjust either the **maxlocks** or **locklist** database configuration parameters, or both. In a partitioned database system, make this change on all database partitions. The value of the **locklist** configuration parameter may be too small for your current workload. If multiple applications are experiencing lock escalation, this could be an indication that the lock list size needs to be increased. Growth in workloads or the addition of new applications could cause the lock list to be too small. If only one application is experiencing lock escalations, then adjusting the **maxlocks** configuration parameter could resolve this. However, you may want to consider increasing **locklist** at the same time you increase **maxlocks** — if one application is allowed to use more of the lock list, all the other applications could now exhaust the remaining locks available in the lock list and experience escalations.
  - You might want to consider the isolation level at which the application and the SQL statements are being run, for example RR, RS, CS, or UR. RR and RS isolation levels tend to cause more escalations because locks are held until a COMMIT is issued. CS and UR isolation levels do not hold locks until a COMMIT is issued, and therefore lock escalations are less likely. Use the lowest possible isolation level that can be tolerated by the application.
  - Increase the frequency of commits in the application, if business needs and the design of the application allow this. Increasing the frequency of commits reduces the number of locks that are held at any given time. This helps to

prevent the application from reaching the **maxlocks** value, which triggers a lock escalation, and helps to prevent all the applications from exhausting the lock list.

- You can modify the application to acquire table locks using the LOCK TABLE statement. This is a good strategy for tables where concurrent access by many applications and users is not critical; for example, when the application uses a permanent work table (for example, not a DGTT) that is uniquely named for this instance of the application. Acquiring table locks would be a good strategy in this case as it will reduce the number of locks being held by the application and increase the performance because row locks no longer need to be acquired and released on the rows that are accessed in the work table.

If the application does not have work tables and you cannot increase the values for **locklist** or **maxlocks** configuration parameters, then you can have the application acquire a table lock. However, care must be taken in choosing the table or tables to lock. Avoid tables that are accessed by many applications and users because locking these tables will lead to concurrency problems which can affect response time, and, in the worst case, can lead to applications experiencing lock timeouts.

### What to do next

Rerun the application or applications to ensure that the locking problem has been eliminated by checking the administration notification log for lock-related entries.

---

## Troubleshooting SQL performance

### Individual SQL queries run well, but performance decreases when running multiple queries

There are a number of steps that can be taken to improve the performance of SQL queries that run slowly as a group.

A query might perform well when run by itself in a test environment, but then run slowly in a production environment with other queries running at the same time.

#### Symptoms

An SQL query runs reasonably well on its own, but then slows down in a production system when other queries are running at the same time. This may occur every day at a specific time, or seemingly at random.

Looking at the SQL statement there are no apparent reasons for the intermittent performance problem.

#### Causes

Often these types of performance issues are a result of sort heap memory allocation problems.

Sort heap memory is used by a range of queries (the list is included in the **sortheap** documentation), so it is important to consider the settings of the following configuration parameters:

- Sort heap size (**sortheap**) which specifies the amount of memory allocated for each individual sort

- Sort heap threshold (**sheapthres**) which specifies the total amount of memory that is available for all the sorts running across the instance

As the number of queries running at the same time increases, the system might reach the **sheapthres** threshold, resulting in performance issues.

## Resolving the problem

In many cases, the DB2 self-tuning memory manager (STMM) can adjust the sort memory allocation to keep queries running efficiently. See the **self\_tuning\_mem** database configuration parameter documentation for more details. If the system is not running STMM then consider the following options:

### Modifying SQL

It may be possible to reduce the amount of sort heap memory used by modifying the SQL:

1. Are all the appropriate indexes created for the query? If a column is known to contain unique values, for example, creating a unique index may reduce the need for sort heap memory.
2. Determine whether one or more of the SQL statements can be modified to use less sort memory. Is each of the ORDER BY clauses required in the query? Can GROUP BY be used instead of DISTINCT in a subquery?
3. Make use of column group statistics or statistical views, which in some cases enable the DB2 query optimizer to determine an access plan that uses less sort heap memory.

### Increasing **sheapthres** size

If none of the previous changes to the SQL are possible, or do not improve performance, then increasing the value of the **sheapthres** parameter is the next consideration. This parameter defines the total amount of memory used by all the private sorts running at any time. When the total private sort memory consumption for an instance reaches this limit, the memory allocated for additional incoming private sort requests is considerably reduced. The **post\_threshold\_sorts** monitor element is used to track sort requests that must run with reduced memory once the **sheapthres** threshold has been exceeded.

See the **sheapthres** documentation for details on how to increase the amount of memory allocated for all sorts, and how to balance SQL sort performance with memory usage. You will need to consider the amount of memory set aside for any one sort (**sortheap**) and the typical number of sorts that might occur on the system when performance begins to drop. To verify the effectiveness of increasing the value of **sheapthres** you should see a decrease in the number of **post\_threshold\_sorts** after the change.

### Decreasing **sortheap** size

Finally, in some situations where you are unable to increase the overall sort heap memory (**sheapthres**) and you have many small sorts, it may be beneficial to decrease the individual sort heap size **sortheap** parameter instead. This results in less memory allocated for each individual sort, but an increase in the number of sorts that can run at any one time.

You should only consider this option, however, if you can verify that you have many small sorts, each small enough to run within a smaller sort heap. If you set **sortheap** too small then the sorts will start spilling to disk, which slows down performance because disk I/O is much slower than in-memory operations. You can use the NumSpills value returned as part of

the **-sort** parameter when running the **db2pd** command to determine whether the individual sort heap size **sortheap** is set too small for the queries.

## Performance overview

*Performance* refers to the way that a computer system behaves in response to a particular workload. Performance is measured in terms of system response time, throughput, and resource utilization.

Performance is also affected by:

- The resources that are available on the system
- How well those resources are used and shared

In general, you will want to tune your system to improve its cost-benefit ratio. Specific goals could include:

- Processing larger, or more demanding, workloads without increasing processing costs
- Obtaining faster system response times, or higher throughput, without increasing processing costs
- Reducing processing costs without degrading service to users

Some benefits of performance tuning, such as a more efficient use of resources and the ability to add more users to the system, are tangible. Other benefits, such as greater user satisfaction because of quicker response times, are intangible.

## Performance tuning guidelines

Keep the following guidelines in mind when developing an overall approach to performance tuning.

- **Remember the law of diminishing returns:** The greatest performance benefits usually come from your initial efforts.
- **Do not tune just for the sake of tuning:** Tune to relieve identified constraints. Tuning resources that are not the primary cause of performance problems can actually make subsequent tuning work more difficult.
- **Consider the whole system:** You cannot tune one parameter or resource in isolation. Before you make an adjustment, consider how the change will affect the system as a whole. Performance tuning requires trade-offs among various system resources. For example, you might increase buffer pool sizes to achieve improved I/O performance, but larger buffer pools require more memory, and that might degrade other aspects of performance.
- **Change one parameter at a time:** Do not change more than one factor at a time. Even if you are sure that all the changes will be beneficial, you will have no way of assessing the contribution of each change.
- **Measure and configure by levels:** Tune one level of your system at a time. System levels include:
  - Hardware
  - Operating system
  - Application server and requester
  - Database manager
  - SQL and XQuery statements
  - Application programs

- **Check for hardware as well as software problems:** Some performance problems can be corrected by applying service to your hardware, your software, or both. Do not spend excessive time monitoring and tuning your system before applying service to the hardware or software.
- **Understand the problem before you upgrade your hardware:** Even if it seems that additional storage or processor power could immediately improve performance, take the time to understand where your bottlenecks are. You might spend money on additional disk storage, only to find that you do not have the processing power or the channels to exploit it.
- **Put fallback procedures in place before you start tuning:** If tuning efforts result in unexpected performance degradation, the changes made should be reversed before you attempt an alternative approach. Save your original settings so that you can easily undo changes that you do not want to keep.

## Developing a performance improvement process

The performance improvement process is an iterative approach to monitoring and tuning aspects of performance. Depending on the results of this performance monitoring, you will adjust the configuration of the database server and make changes to the applications that use the database server.

Base your performance monitoring and tuning decisions on your knowledge of the kinds of applications that use the data and on your understanding of patterns of data access. Different kinds of applications have different performance requirements.

Any performance improvement process includes the following fundamental steps:

1. Define the performance objectives.
2. Establish performance indicators for the major constraints in the system.
3. Develop and execute a performance monitoring plan.
4. Continually analyze monitoring results to determine which resources require tuning.
5. Make one adjustment at a time.

If, at some point, you can no longer improve performance by tuning the database server or applications, it might be time to upgrade the hardware.

## Performance information that users can provide

The first sign that your system requires tuning might be complaints from users. If you do not have enough time to set performance objectives and to monitor and tune in a comprehensive manner, you can address performance issues by listening to your users. Start by asking a few simple questions, such as the following:

- What do you mean by “slow response”? Is it 10% slower than you expect it to be, or tens of times slower?
- When did you notice the problem? Is it recent, or has it always been there?
- Do other users have the same problem? Are these users one or two individuals or a whole group?
- If a group of users is experiencing the same problem, are these users connected to the same local area network?
- Does the problem seem to be related to a specific type of transaction or application program?



- Do you notice any pattern of occurrence? For example, does the problem occur at a specific time of day, or is it continuous?

## Performance tuning limits

The benefits of performance tuning are limited. When considering how much time and money should be spent on improving system performance, be sure to assess the degree to which the investment of additional time and money will help the users of the system.

Tuning can often improve performance if the system is encountering response time or throughput problems. However, there is a point beyond which additional tuning cannot help. At this point, consider revising your goals and expectations. For more significant performance improvements, you might need to add more disk storage, faster CPUs, additional CPUs, more main memory, faster communication links, or a combination of these.

## Tuning sort performance

Because queries often require sorted or grouped results, proper configuration of the sort heap is crucial to good query performance.

Sorting is required when:

- No index that satisfies a requested order exists (for example, a SELECT statement that uses the ORDER BY clause)
- An index exists, but sorting would be more efficient than using the index
- An index is created
- An index is dropped, which causes index page numbers to be sorted

## Elements that affect sorting

The following factors affect sort performance:

- Settings for the following configuration parameters:
  - Sort heap size (**sortheap**), which specifies the amount of memory to be used for each sort
  - Sort heap threshold (**sheapthres**) and the sort heap threshold for shared sorts (**sheapthres\_shr**), which control the total amount of memory that is available for sorting across the instance
- The number of statements in a workload that require a large amount of sorting
- The presence or absence of indexes that might help avoid unnecessary sorting
- The use of application logic that does not minimize the need for sorting
- Parallel sorting, which improves sort performance, but which can only occur if the statement uses intra-partition parallelism
- Whether or not the sort is *overflowed*. If the sorted data cannot fit into the sort heap, which is a block of memory that is allocated each time a sort is performed, the data overflows into a temporary table that is owned by the database.
- Whether or not the results of the sort are *pipelined*. If sorted data can return directly without requiring a temporary table to store the sorted list, it is a piped sort. In a piped sort, the sort heap is not freed until the application closes the cursor that is associated with the sort. A piped sort can continue to use up memory until the cursor is closed.

Although a sort can be performed entirely in sort memory, this might cause excessive page swapping. In this case, you lose the advantage of a large sort heap. For this reason, you should use an operating system monitor to track changes in system paging whenever you adjust the sorting configuration parameters.

## Techniques for managing sort performance

Identify particular applications and statements where sorting is a significant performance problem:

1. Set up event monitors at the application and statement level to help you identify applications with the longest total sort time.
2. Within each of these applications, find the statements with the longest *total sort time*.  
You can also search through the explain tables to identify queries that have sort operations.
3. Use these statements as input to the Design Advisor, which will identify and can create indexes to reduce the need for sorting.

You can use the self-tuning memory manager (STMM) to automatically and dynamically allocate and deallocate memory resources required for sorting. To use this feature:

- Enable self-tuning memory for the database by setting the **self\_tuning\_mem** configuration parameter to ON.
- Set the **sortheap** and **sheapthres\_shr** configuration parameters to AUTOMATIC.
- Set the **sheapthres** configuration parameter to 0.

You can also use the database system monitor and benchmarking techniques to help set the **sortheap**, **sheapthres\_shr**, and **sheapthres** configuration parameters. For each database manager and for each database:

1. Set up and run a representative workload.
2. For each applicable database, collect average values for the following performance variables over the benchmark workload period:
  - Total sort heap in use (the value of the **sort\_heap\_allocated** monitor element)
  - Active sorts and active hash joins (the values of the **active\_sorts** and **active\_hash\_joins** monitor elements)
3. Set **sortheap** to the average *total sort heap in use* for each database.

**Note:** If long keys are used for sorts, you might need to increase the value of the **sortheap** configuration parameter.

4. Set the **sheapthres**. To estimate an appropriate size:
  - a. Determine which database in the instance has the largest **sortheap** value.
  - b. Determine the average size of the sort heap for this database.  
If this is too difficult to determine, use 80% of the maximum sort heap.
  - c. Set **sheapthres** to the average number of active sorts, times the average size of the sort heap computed previously. This is a recommended initial setting. You can then use benchmark techniques to refine this value.

IBM InfoSphere Optim Query Workload Tuner provides tools for improving the performance of single SQL statements and the performance of groups of SQL statements, which are called query workloads. For more information about this product, see the product overview page at <http://www.ibm.com/software/data/>

optim/query-workload-tuner-db2-luw/index.html. In Version 3.1.1 or later, you can also use the Workload Design Advisor to perform many operations that were available in the DB2 Design Advisor wizard. For more information see the documentation for the Workload Design Advisor at <http://publib.boulder.ibm.com/infocenter/dstudio/v3r1/topic/com.ibm.datatools.qrytune.workloadtunedb2luw.doc/topics/genrecsdsgn.html>.

## Minimizing RUNSTATS impact

There are several approaches available to improve **RUNSTATS** performance.

To minimize the performance impact of this utility:

- Limit the columns for which statistics are collected by using the **COLUMNS** clause. Many columns are never referenced by predicates in the query workload, so they do not require statistics.
- Limit the columns for which distribution statistics are collected if the data tends to be uniformly distributed. Collecting distribution statistics requires more CPU and memory than collecting basic column statistics. However, determining whether the values for a column are uniformly distributed requires either having existing statistics or querying the data. This approach also assumes that the data remains uniformly distributed as the table is modified.
- Limit the number of pages and rows processed by using page- or row-level table sampling (by specifying the **TABLESAMPLE SYSTEM** or **TABLESAMPLE BERNOULLI** clause) and by using page- or row-level index sampling (by specifying **INDEXSAMPLE SYSTEM** or **INDEXSAMPLE BERNOULLI** clause). Start with a 10% page-level sample, by specifying **TABLESAMPLE SYSTEM(10)** and **INDEXSAMPLE SYSTEM(10)**. Check the accuracy of the statistics and whether system performance has degraded due to changes in access plan. If it has degraded, try a 10% row-level sample instead, by specifying **TABLESAMPLE BERNOULLI(10)**. Likewise, experiment with the **INDEXSAMPLE** parameter to get the right rate for index sampling. If the accuracy of the statistics is insufficient, increase the sampling amount. When using **RUNSTATS** page- or row-level sampling, use the same sampling rate for tables that are joined. This is important to ensure that the join column statistics have the same level of accuracy.
- Collect index statistics during index creation by specifying the **COLLECT STATISTICS** option on the **CREATE INDEX** statement. This approach is faster than performing a separate **RUNSTATS** operation after the index is created. It also ensures that the new index has statistics generated immediately after creation, to allow the optimizer to accurately estimate the cost of using the index.
- Collect statistics when executing the **LOAD** command with the **REPLACE** option. This approach is faster than performing a separate **RUNSTATS** operation after the load operation completes. It also ensures that the table has the most current statistics immediately after the data is loaded, to allow the optimizer to accurately estimate the cost of using the table.

In a partitioned database environment, the **RUNSTATS** utility collects statistics from a single database partition. If the **RUNSTATS** command is issued on a database partition on which the table resides, statistics are collected there. If not, statistics are collected on the first database partition in the database partition group for the table. For consistent statistics, ensure that statistics for joined tables are collected from the same database partition.

## Data compression and performance

You can use data compression to reduce the amount of data that must be read from or written to disk, thereby reducing I/O cost.

Generally speaking, the more repetitive patterns that exist in data rows, the better your compression rates will be. If your data does not contain repetitive strings, as might be the case if you have mainly numeric data, or include inline BLOB data, compression might not yield as much in the way of storage savings. In addition, when data does not compress well, you still incur the performance impact of the database manager attempting to compress data, only to find that the storage benefits are not worth retaining any compression dictionaries. To check on the possible storage savings that you can achieve with compression, use the `ADMIN_GET_TAB_COMPRESS_INFO` table function.

Two forms of data compression are available:

### **Row compression**

There are two types of row compression available:

#### *Classic row compression*

Classic row compression involves replacing repeating patterns that span multiple column values within a row with shorter symbol strings. A sampling of rows are scanned to find instances of repetitive data. From this scan, a table-level compression dictionary is created. This dictionary is used to replace the repetitive data with shorter symbol strings.

Table-level compression dictionaries are static; after they are first created, they do not change unless you rebuild them during a classic table reorganization.

#### *Adaptive row compression*

Adaptive row compression involves the use of two compression approaches: classic row compression and *page-level compression*. Page-level compression involves replacing repeating patterns that span multiple column values *within a single page* of data with shorter symbol strings. As a page fills with data, page compression logic scans the page for repetitive data. From this scan, a page-level compression dictionary is created. This dictionary is used to replace the repetitive data with shorter symbol strings.

Page-level dictionaries are dynamic; they are rebuilt automatically if necessary.

### **Value compression**

Value compression involves removing duplicate entries for a value, storing only one copy, and keeping track of the location of any references to the stored value.

Row compression is also used for temporary tables. Compressing temporary tables reduces the amount of temporary disk space that is required for large and complex queries, thus increasing query performance. Compression for temporary tables is enabled automatically under the DB2 Storage Optimization Feature. Each temporary table that is eligible for row compression requires an additional 2 - 3 MB of memory for the creation of its compression dictionary. This memory remains allocated until the compression dictionary has been created.

You can also compress index objects, which reduces storage costs. This kind of compression is especially useful for large online transaction processing (OLTP) and data warehouse environments, where it is common to have many very large indexes. In both of these cases, index compression can significantly improve performance in I/O-bound environments while causing little or no performance degradation in CPU-bound environments.

If you enable compression on a table with an XML column, the XML data that is stored in the XDA object is also compressed. A separate compression dictionary for the XML data is stored in the XDA object. If you use DB2 Version 9.7 or later to add XML columns to a table created using DB2 Version 9.5, these XML columns are compressed. However, XML columns added to a table using DB2 Version 9.5 are not compressed; in such tables, only the data object is compressed.

---

## Troubleshooting optimization

### Troubleshooting optimization guidelines and profiles

Diagnostics support for optimization guidelines (passed by optimization profiles) is provided by EXPLAIN tables.

You will receive an SQL0437W warning with reason code 13 if the optimizer does not apply an optimization guideline. Diagnostic information detailing why an optimization guideline was not applied is added to the EXPLAIN tables. There are two EXPLAIN tables for receiving optimizer diagnostic output:

- EXPLAIN\_DIAGNOSTIC - Each entry in this table represents a diagnostic message pertaining to the optimization of a particular statement. Each diagnostic message is represented using a numeric code.
- EXPLAIN\_DIAGNOSTIC\_DATA - Each entry in this table is diagnostic data relating to a particular diagnostic message in the EXPLAIN\_DIAGNOSTIC table.

The DDLs used to create the diagnostic explain tables is shown in Figure 39 on page 588.

The following steps can help you troubleshoot problems that occur when you are using optimization guidelines:

1. “Verify that optimization guidelines have been used” in *Troubleshooting and Tuning Database Performance*.
2. Examine the full error message using the built-in “EXPLAIN\_GET\_MSGS table function” in *Administrative Routines and Views*.

If you finish these steps but cannot yet identify the source of the problem, begin collecting diagnostic data and consider contacting IBM Software Support.

```

CREATE TABLE EXPLAIN_DIAGNOSTIC
( EXPLAIN_REQUESTER VARCHAR(128) NOT NULL,
  EXPLAIN_TIME       TIMESTAMP   NOT NULL,
  SOURCE_NAME        VARCHAR(128) NOT NULL,
  SOURCE_SCHEMA      VARCHAR(128) NOT NULL,
  SOURCE_VERSION     VARCHAR(64)  NOT NULL,
  EXPLAIN_LEVEL      CHAR(1)     NOT NULL,
  STMTNO             INTEGER      NOT NULL,
  SECTNO             INTEGER      NOT NULL,
  DIAGNOSTIC_ID     INTEGER      NOT NULL,
  CODE               INTEGER      NOT NULL,
  PRIMARY KEY (EXPLAIN_REQUESTER,
               EXPLAIN_TIME,
               SOURCE_NAME,
               SOURCE_SCHEMA,
               SOURCE_VERSION,
               EXPLAIN_LEVEL,
               STMTNO,
               SECTNO,
               DIAGNOSTIC_ID),
  FOREIGN KEY (EXPLAIN_REQUESTER,
               EXPLAIN_TIME,
               SOURCE_NAME,
               SOURCE_SCHEMA,
               SOURCE_VERSION,
               EXPLAIN_LEVEL,
               STMTNO,
               SECTNO)
  REFERENCES EXPLAIN_STATEMENT ON DELETE CASCADE);

CREATE TABLE EXPLAIN_DIAGNOSTIC_DATA
( EXPLAIN_REQUESTER VARCHAR(128) NOT NULL,
  EXPLAIN_TIME       TIMESTAMP   NOT NULL,
  SOURCE_NAME        VARCHAR(128) NOT NULL,
  SOURCE_SCHEMA      VARCHAR(128) NOT NULL,
  SOURCE_VERSION     VARCHAR(64)  NOT NULL,
  EXPLAIN_LEVEL      CHAR(1)     NOT NULL,
  STMTNO             INTEGER      NOT NULL,
  SECTNO             INTEGER      NOT NULL,
  DIAGNOSTIC_ID     INTEGER      NOT NULL,
  ORDINAL            INTEGER      NOT NULL,
  TOKEN              VARCHAR(1000),
  TOKEN_LONG         BLOB(3M) NOT LOGGED,
  FOREIGN KEY (EXPLAIN_REQUESTER,
               EXPLAIN_TIME,
               SOURCE_NAME,
               SOURCE_SCHEMA,
               SOURCE_VERSION,
               EXPLAIN_LEVEL,
               STMTNO,
               SECTNO,
               DIAGNOSTIC_ID)
  REFERENCES EXPLAIN_DIAGNOSTIC ON DELETE CASCADE);

```

**Note:** The EXPLAIN\_REQUESTER, EXPLAIN\_TIME, SOURCE\_NAME, SOURCE\_SCHEMA, SOURCE\_VERSION, EXPLAIN\_LEVEL, STMTNO, and SECTNO columns are part of both tables in order to form the foreign key to the EXPLAIN\_STATEMENT table and the parent-child relationship between EXPLAIN\_DIAGNOSTIC and EXPLAIN\_DIAGNOSTIC\_DATA.

*Figure 39. DDLs used to create the diagnostic explain tables*

This DDL is included in the EXPLAIN.DDL file located in the misc subdirectory of the sqllib directory.

---

## Troubleshooting partitioned database environments

### FCM problems related to 127.0.0.2 (Linux and UNIX)

In a partitioned database environment, the fast communications manager (FCM) might encounter problems if there is an entry for 127.0.0.2 in the `/etc/hosts` file.

#### Symptoms

Various error messages might occur, depending on the circumstances. For example, the following error can occur when you create a database: SQL1229N The current transaction has been rolled back because of a system error. SQLSTATE=40504

#### Causes

The problem is caused by the presence of an entry for the IP address 127.0.0.2 in the `/etc/hosts` file, where 127.0.0.2 maps to the fully qualified hostname of the machine. For example:

```
127.0.0.2 ServerA.ibm.com ServerA
```

where "ServerA.ibm.com" is the fully qualified hostname.

#### Environment

The problem is limited to partitioned database environments.

#### Resolving the problem

Remove the entry from the `/etc/hosts` file, or convert it into a comment. For example:

```
# 127.0.0.2 ServerA.ibm.com ServerA
```

### Creating a database partition on an encrypted file system (AIX)

The AIX operating system supports the ability to encrypt a JFS2 file system or set of files. This feature is not supported with partitioned database environments in DB2 database products. An SQL10004C error will occur if you attempt to create a partitioned database environment using EFS (encrypted file systems) on AIX.

#### Symptoms

If you attempt to create a database on an encrypted file system in a multiple partition database environment, you will receive the following error: SQL10004C An I/O error occurred while accessing the database directory. SQLSTATE=58031

#### Causes

At this time it is not possible to create a partitioned database environment using EFS (encrypted file systems) on AIX. Since partitioned database partitions use `rsh` or `ssh`, the keystore in EFS is lost and database partitions are unable to access the database files that are stored on the encrypted file system.

## Diagnosing the problem

The DB2 diagnostic (**db2diag**) log files will contain the error message and the following text: OSERR : ENOATTR (112) "No attribute found".

## Resolving the problem

To create a database successfully in a partitioned database environment, you must have a file system that is available to all of the machines and it must not be an encrypted file system.

## Troubleshooting table states during data redistribution

Before starting a redistribution operation, ensure that all tables in the database partition group are in full access mode and are in normal state.

### Symptoms

If table states cause the redistribution to fail, the error message indicates that the database partition group cannot be redistributed or that the operation is not allowed. For example, SQL02436N, SQL6056N, and SQL0668N messages can be symptoms of this problem.

**Note:** If the error message lists a table name, it might not be the only problematic table in the database partition group. By troubleshooting the table states for all of the tables in the database partition group, you can avoid multiple unsuccessful redistribution attempts.

## Diagnosing the problem

### User response:

1. Determine which tables are in an inoperative state (SYSCAT.TABLES.STATUS='X').

Issue the following query:

```
SELECT TABNAME
FROM SYSCAT.TABLES AS TABLES, SYSCAT.TABLESPACES AS TABLESPACES
WHERE TABLES.TBSPACE = TABLESPACES.TBSPACE AND TABLES.STATUS = 'X'
AND TABLESPACES.DBPGNAME = 'IBMDEFAULTGROUP'
```

where *IBMDEFAULTGROUP* is the database partition group name.

2. Determine which tables are in the "set integrity pending" state (SYSCAT.TABLES.STATUS='C').

Issue the following query:

```
SELECT TABNAME
FROM SYSCAT.TABLES AS TABLES, SYSCAT.TABLESPACES AS TABLESPACES
WHERE TABLES.TBSPACE = TABLESPACES.TBSPACE AND TABLES.STATUS = 'C'
AND TABLESPACES.DBPGNAME = 'IBMDEFAULTGROUP'
```

where *IBMDEFAULTGROUP* is the database partition group name.

3. Determine which tables are in a normal state, but are not in full access mode.

Issue the following query:

```
SELECT DISTINCT TRIM(T.OWNER) || '\'.'\ ' || TRIM(T.TABNAME)
AS NAME, T.ACCESS_MODE, A.LOAD_STATUS
FROM SYSCAT.TABLES T, SYSCAT.DBPARTITIONGROUPS N,
SYSIBMADM.ADMINTABINFO A
WHERE T.PMAP_ID = N.PMAP_ID
```



```

AND A.TABSCHEMA = T.OWNER
AND A.TABNAME = T.TABNAME
AND N.DBPGNAME = 'IBMDEFAULTGROUP'
AND (T.ACCESS_MODE <> 'F' OR A.LOAD_STATUS IS NOT NULL)
AND T.STATUS='N'

```

where *IBMDEFAULTGROUP* is the database partition group name. If this query takes a long time to execute, terminate the query, issue the **RUNSTATS** command on all of the tables involved in this query, and then reissue the query.

## Resolving the problem

### User response:

1. Take the required corrective action:
  - a. For each table in an inoperative state, use the **LOAD QUERY** command to determine the specific table state.
    - For tables in "load in progress" state, wait until the load operation has finished. You can use the **LOAD QUERY** command to monitor the progress the load operation.
    - For tables in "load pending" state, restart or terminate the previously failed load operation by issuing the **LOAD** command with **RESTART** or **TERMINATE** command parameters.
    - For tables in "read access only" state, use the **LOAD QUERY** command to check whether the table is in the process of being loaded. If yes, wait until the load utility has completed, or if necessary, restart or terminate the previously failed load operation. If a load operation is currently not in progress, issue the **SET INTEGRITY** statement with the **IMMEDIATE CHECKED** option. This action validates the constraints in the newly loaded portion of the table.
    - For tables in "reorg pending" state, perform a classic reorg operation to make the table accessible.
    - For tables in "not load restartable" state, issue a **LOAD TERMINATE** or **LOAD REPLACE** command.
    - For tables in "unavailable" state, drop the table or restore it from a backup.
  - b. For the tables in "set integrity pending" state, execute the **SET INTEGRITY** statement with the **IMMEDIATE CHECKED** option.
  - c. For the tables that are not in full access mode, execute the **SET INTEGRITY** statement with the **IMMEDIATE CHECKED** option on the dependent immediate materialized query and staging tables.

**Note:** You can also choose to defer resolving the problem and temporarily omit the tables from the redistribution operation by specifying the **EXCLUDE** parameter in the **REDISTRIBUTE DATABASE PARTITION GROUP** command. In this case, the redistribution operation completes successfully, but the database partition group is only partially redistributed. As a result, redistributed tables in the database partition group could use a different partitioning map than tables that have not been redistributed. Also, if collocation between redistributed and non-redistributed tables existed before the redistribute operation, the collocation property between these tables is temporarily disabled. Query performance might not be optimal until a full redistribution occurs.

2. If a previous redistribution operation failed, resubmit it using either the **CONTINUE** or **ABORT** option. **CONTINUE** completes the previously aborted redistribution operation and **ABORT** undoes the effects of the previously aborted operation.

---

## Troubleshooting scripts

You may have internal tools or scripts that are based on the processes running in the database engine. These tools or scripts may no longer work because all agents, prefetchers, and page cleaners are now considered threads in a single, multi-threaded process.

Your internal tools and scripts will have to be modified to account for a threaded process. For example, you may have scripts that start the **ps** command to list the process names; and then perform tasks against certain agent processes. Your scripts must be rewritten.

The problem determination database command **db2pd** will have a new option **-edu** (short for “engine dispatchable unit”) to list all agent names along with their thread IDs. The **db2pd -stack** command continues to work with the threaded engine to dump individual EDU stacks or to dump all EDU stacks for the current node.

---

## Recompile the static section to collect section actuals after applying Fix Pack 1

After applying DB2 Version 9.7 Fix Pack 1, section actuals cannot be collected for a static section compiled prior to applying the fix pack. The static section must be recompiled to collect section actuals after applying Fix Pack 1.

### Symptoms

Section actuals are not collected when the **EXPLAIN\_FROM\_ACTIVITY** routine is executed.

### Causes

Section actuals cannot be collected for a static section that was compiled prior to applying the fix pack.

### Resolving the problem

After you install DB2 V9.7 Fix Pack 1, verify that the static section has been rebound, using the **REBIND** command, since the fix pack was applied. To do this, check the **LAST\_BIND\_TIME** column in the **SYSCAT.PACKAGES** catalog view.

---

## Troubleshooting storage key support

Storage protection keys (hardware keys at a thread level) are used to help the DB2 engine have greater resilience by protecting memory from access attempts that are not valid. To resolve any error that you have encountered while enabling this feature, follow the instructions in the next section.

## About this task

When setting the registry variable “DB2\_MEMORY\_PROTECT” in *Database Administration Concepts and Configuration Reference*, an Invalid value (DBI1301E) error was returned. This error occurs for one of the following reasons:

- The value given for the registry variable is not valid. Refer to the registry variable usage for **DB2\_MEMORY\_PROTECT** for information about valid values.
- The hardware and operating system may not support storage protection keys and the feature cannot be enabled.



---

## Chapter 7. Troubleshooting the DB2 pureScale Feature

This troubleshooting section contains information that will help you to understand, isolate, and resolve problems that are specific to the IBM DB2 pureScale Feature. The information found here complements the DB2 troubleshooting and the DB2 pureScale monitoring information found in the DB2 Information Center.

**Note:** If you require support for any IBM product that is packaged as part of the DB2 pureScale software stack, then open a service request or problem management record (PMR) for the DB2 pureScale Feature. Opening a PMR for the DB2 pureScale Feature helps resolve problems more efficiently.

---

### How to diagnose a problem with the DB2 pureScale Feature

When you encounter a problem, it is important to define and isolate the problem accurately before you attempt to resolve it. Use the diagnostic steps in this topic to guide yourself through the problem-determination process with the troubleshooting tools that are included with the DB2 pureScale Feature. In many cases, you might be able to resolve the problem yourself.

The major areas covered in the troubleshooting documentation include the following ones:

- Obtaining diagnostic information, both logs and traces
- Installation, getting started with, and uninstallation of the DB2 pureScale Feature
- Component failures, such as host or members failures, including how to identify and resolve states, alerts, and restart conditions
- Communication failures (uDAPL)
- Cluster file system problems and failures (GPFS™)
- Cluster manager software failures (Tivoli SA MP)
- Problem scenarios where you should call IBM Service

#### Is it a current problem or a recurring problem?

Once you have installed the DB2 pureScale Feature and are up and running, problems broadly fall into one of two categories: Problems that affect your server right now, and problems that occurred at some point in the past but were probably recovered from automatically by the DB2 pureScale Feature.

##### Problems that affect your server right now

These problems typically exhibit one or several readily apparent symptoms that affect your server in some way. For example, you might receive user reports that there is a performance slowdown or you might be able to observe that there is a loss of capacity in the system yourself. Overall, the system continues to be available. Such symptoms are indicative of a problem with a member or a cluster caching facility (CF), which you can investigate directly.

If you observe a complete system outage, there are several possible culprits, but the first one you should check is whether there is at least one CF up and running to provide essential infrastructure services to the instance. Without a CF, there is no component available to handle locking and caching for members, and the instance cannot run.

### Problems that occurred at some point in the past

These problems typically do not appear to affect your server now, but you might have some indication that there was a problem in the past. For example, you might see some unexplained log entries that point to something going on in your system that should be diagnosed. The highly available and fault tolerant character of the DB2 pureScale Feature can mask some problems, because the instance continues to recover from most component failures without requiring your intervention, even if a component fails repeatedly. Effectively, you need to monitor for intermittent or recurring problems over time to determine whether or not there exists a hidden problem on your server that keeps getting fixed by itself only to recur later on, and then resolve the underlying cause.

### Diagnostic information you should look at

You need to understand when and why the problem occurs, based on your problem definition and the diagnostic data available to you. As you go through the diagnostic data, look for events or alerts that correlate the symptoms in your problem definition with a possible cause.

The DB2 pureScale-specific commands you use for troubleshooting can be run from any member or cluster caching facility host to obtain instance-wide information. Even if the database is unavailable or the instance is stopped, reporting of some data is often still possible, as long as the DB2 pureScale cluster manager component is available on the host where you issue the command.

The recommended sequence of diagnostic steps for the DB2 pureScale Feature is:

1. Issue the **db2instance -list** command to identify current issues affecting the instance. Check for alerts that affect host computers first, then check the CFs and the members for alerts. You can find the current state of members, cluster caching facilities, and hosts in the output, which will indicate whether alerts, errors or recovery-related states exist.
2. Issue the **db2cluster -cm -list -alert** command to check for recommended actions for these alerts. The output of the **db2cluster** command will tell you what alerts exist, what the effects of the alert conditions are, and what you need to do to resolve them. See if you can resolve the problem through the suggested action. You can also clear alerts with this command.
3. Check the diagnostic logs available to you for any hints that might indicate a possible cause for the problem. If you know roughly when the problem started, you can narrow down your search by checking log entries with a corresponding timestamp.
  - Check the `DIAGPATH` file path for any diagnostic files produced and check the FODC directories
  - Check the `CF_DIAGPATH` file path for any cluster caching facility diagnostic data produced
  - Check the `db2diag.log` diagnostic log file for recent diagnostic information and error messages
  - Check the notification log for recent messages that might indicate the starting point of the problem
  - Run the **errpt -a** command to view the system error log. Look for log entries that correlate with the time of failure

## Next steps

The result of stepping through the available diagnostic information will determine what troubleshooting scenarios you should look at next. Once you have narrowed down the scope of the problem, you can navigate through the DB2 pureScale troubleshooting documentation to find the context that most likely applies to your problem definition. Often, you will find two types of troubleshooting content, very context-specific answers to frequently asked troubleshooting questions (FAQs), and more comprehensive troubleshooting scenarios that show you how to interpret the diagnostic data and resolve the problem.

For example, if the diagnostic information you looked at shows that a member has an alert and is waiting to fail back to its home host after having failed over to a guest host for recovery purposes (an operation known as a restart light), you can locate the associated failure scenario in the troubleshooting documentation by looking at the DB2 pureScale instance operation scenarios, and then at the subsection for a members or host with alert. Not all possible failure scenarios are covered, but many are.

---

## Manual trace and log file collection

Trace and log files contain information that help troubleshoot problems. If you cannot collect diagnostic data for the IBM DB2 pureScale Feature by using the **db2support** command, you can collect trace and log information manually.

**Important:** If you can use the **db2support** command with the **-install** parameter, then you do not need to follow the manual instructions in this topic. The manual instructions help you collect similar diagnostic information but require more steps to complete.

IBM Support requires the following files to be submitted, if the files are available. Create a single .zip file or .tar archive of all of these files.

- Files from the /tmp directory:
  - Current installation or instance log and trace files in the /tmp directory on the installation-initiating host (IIH). To ensure that the trace and log files that you collect are relevant to the DB2 installation and configuration commands that returned errors, reissue any commands that failed with the trace option turned on (typically by including the **-d** or the **-t** parameter). For example, if you reissue the **db2icrt** command, include the **-d** command parameter to turn the trace on. The trace output file is named /tmp/db2icrt.trc.*pid* where *pid* is a process identifier.
  - Other trace and log files in the /tmp directory:
    - The /tmp/db2trc.trc.\* files.
    - The files in the /tmp/db2log.*pid* directory on the IIH.
    - The /tmp/ibm.db2.cluster.\* files generated on the IIH during installation.
    - The files in the /tmp/db2log directory on all remote hosts.
- Files from the \$HOME/sqllib directory:
  - The \$HOME/sqllib/db2nodes.cfg file
  - The \$HOME/sqllib/db2dump/db2diag.log file.

If the \$HOME/sqllib directory does not exist, collect the /tmp/db2nodes.cfg\* and /tmp/db2diag.log\* files.

- The /etc/services file from each host.

- Error and trace logs for IBM Tivoli System Automation for Multiplatforms (Tivoli SA MP) from the `/var/ct/db2domain/log/mc/*` directories and the `/tmp/db2_cluster_manager_spooling/` trace spooling directory.
- Output of the following commands:
  - `db2instance -list`, issued as the instance owner
  - `lssam > /tmp/lssam.out`
  - `lslpp -l all | grep "sam.* > /tmp/lslpp_sam.out`
  - `lslpp -l all | grep gpfs > /tmp/lslpp_gpfs.out`
  - `lslpp -l all | grep rsct > /tmp/lslpp_rsct.out`
  - `lsrsrc IBM.Equivalency > /tmp/lsrsrc_IBM.Equivalency.out`
  - `lsrsrc IBM.Application > /tmp/lsrsrc_IBM.Application.out`
  - `db2greg -dump`, from all hosts
  - `ps -fe | grep db2 and ipcs`, from all hosts.
  - `id`, issued as the instance owner and the fenced user on all hosts
  - `uname -a`, from all hosts
  - `errpt -a`, from all hosts
- GPFS cluster file system logs from the `/var/adm/ras/` directory.
- A `.zip` file or `.tar` archive of all files in the instance owner's `db2dump` directory (`$HOME/sql1lib/db2dump`).

---

## Installation, instance creation and rollback

The DB2 installer installs the DB2 binaries, creates the instance across all hosts (setting up the GPFS cluster and the RSCT peer domain on all DB2 members and CFs), and optionally creates users and groups.

This section contains information that will help you understand and resolve problems that you may encounter during the installation, instance creation and rollback process in a DB2 pureScale environment.

### The DB2 Setup wizard does not launch

If the DB2 Setup wizard fails to launch, consult the error log found in the `DB2DIR/tmp` directory, where `DB2DIR` represents the installation location of your DB2 copy.

Possible reasons for the DB2 Setup wizard not launching include:

- Your system does not meet the installation prerequisites. Review the installation prerequisites and address any problems.
- You do not have an XServer running on the X Window client machine.
- You might not have correctly exported your display. Export your display using the following command:

```
export DISPLAY=IP_Address:0.0
```

where `IP_Address` represents the IP address of the X Window client machine you are using to launch the installation.

### Collecting diagnostic data for installation and instance-creation problems

You might have to collect diagnostic data to solve problems that you encounter when installing DB2 software or creating an instance. If the DB2 installer generates



the DBI2047E error message, informing you that installation or instance creation failed, you can use the **db2support** command to automatically collect diagnostic data.

## Before you begin

To help ensure that you collect diagnostic data from the largest possible number of sources, you must have root authority. If you issue the **db2support** command with non-root authority, diagnostic data from some sources might not be collected.

To gather information about remote hosts with the **-host** parameter, you require an SSH connection.

## About this task

The information that you gather by using the **db2support -install** command might be required by IBM Support to perform analysis. Diagnostic data is collected by issuing the **db2support** command both from log files on disk and from the output of other diagnostic commands.

The **db2support** command that is shipped with DB2 installation images supports only a subset of the command parameters that are available after you install the DB2 product. Until you have installed the DB2 product, the only **db2support** command parameters that you can use are the **-install** and **-host** parameters.

## Procedure

To gather diagnostic data:

1. Use the information in the DBI2047E error message to determine the host or hosts where the failure occurred.
2. Issue the **db2support** command in one of the following ways:
  - To collect diagnostic data on the local host, issue the following command:  
`db2support -install`
  - To collect diagnostic data on a remote host, issue the following command:  
`db2support -install -host hostname`

where *hostname* is the name of the remote host for which you want to collect diagnostic data. For example, to collect diagnostic data on the host `hotel1nx96`, issue the following command:

```
db2support -install -host hotel1nx96
```

- To collect diagnostic data on multiple hosts, issue the following command:  
`db2support -install -host hostname_list`

where *hostname\_list* is a comma-separated list of hosts for which you want to collect diagnostic data. For example, to collect diagnostic data on the hosts `hotel1nx96`, `hotel1nx97`, and `hotel1nx98`, issue the following command:

```
db2support -install -host hotel1nx96,hotel1nx97,hotel1nx98
```

## Results

The diagnostic data is collected in the `db2support.zip` file. The file is created in the current directory, if the current directory is writeable; otherwise, the file is placed in your home directory.

## Example

The following example shows the typical output of the `db2support -install` command. In this case, diagnostic data is collected on the local host.

```
_____ D B 2  S u p p o r t _____

Output file is "/home/hotellnx96/db2docs1/db2support.zip"
Time and date of this collection: 2010-11-01-10.06.16.559562
Creating directory /home/hotellnx96/db2docs1/DB2SUPPORT
Starting collection on host hotellnx96
  Creating directory /home/hotellnx96/db2docs1/DB2SUPPORT/hotellnx96_IIH
Collecting resources group information
Collecting user identity information
Collecting current process information
Collecting active interprocess communications facilities information
Collecting system information
Collecting detailed data on system and hardware errors
Collecting registry contents
Collecting GPFS information
Collecting configuration, log and trace information for RSCT
Collecting information about installed DB2 products
Collecting information about state of db2 instance
Collecting "/home/hotellnx96/db2docs1/sqllib/db2dump/db2diag.log"
Collecting /etc/services
Collecting /home/hotellnx96/db2docs1/sqllib/db2nodes.cfg
Collecting directory /home/hotellnx96/db2docs1/sqllib/db2dump
Collection on host hotellnx96 completed
Compressing files in /home/hotellnx96/db2docs1/DB2SUPPORT directory
Collecting /home/hotellnx96/db2docs1/db2support.log
Collecting db2support.out
```

db2support is now complete.

An archive file has been produced: "/home/hotellnx96/db2docs1/db2support.zip"

## What to do next

If you are working with IBM Support to troubleshoot a DB2 installation or instance-creation problem, you might be given instructions on how to upload the `db2support.zip` file for analysis by support personnel.

## Creating instance resources returns an error

This example scenario involves a failure while creating the DB2 instance and cluster services resources as part of the installation process. The objective is to determine the problem and diagnose the cause of the failure.

### Symptoms

The initial symptom is the following error that is returned while in the step of creating the instance as part of the install.

```
Creating resources for the instance "db2inst1" has failed.
There was an error with one of the issued cluster manager commands. Refer to
the db2diag log file and the DB2 Information Center for details.
```

### Diagnosis / resolution

- Check the `/tmp/db2diag.log` for messages similar to the following
  - Line # : 6884---2610-403 The resource is stale. or
  - Line # : 9578---2610-422 Cannot execute the command on node <hostname>. The resource manager IBM.RecoveryRM is not available.

**Note:** If you see these errors, this indicates that the IBM Tivoli System Automation for Multiplatforms (SA MP) recovery resource manager daemon experienced a problem. The daemon serves as the decision engine for Tivoli SA MP and is identified as IBM.RecoveryRM in the system. Diagnostic data will be written by Tivoli SA MP to diagnose the problem.

- Tivoli SA MP diagnostic data is written into the directories `/var/ct/db2domain/log/mc/` (error logs) and `/var/ct/db2domain/run/mc/` (core dumps) and `/tmp/db2_cluster_manager_spooling/` (default trace directory).
- IBM service and development teams use trace and core files for troubleshooting. If you would need IBM service to analyze the diagnostic data, gather the data listed in “Manual trace and log file collection” on page 597.
- Follow these instructions to upload data to IBM Technical Support:
  - Submitting diagnostic information to IBM Technical Support for problem determination
- The IBM Technical Support website is a good source of information, where you can identify known problems based on symptoms or error log messages
  - DB2 for Linux UNIX and Windows support.

## Investigating Tivoli SA MP states with DB2 commands

This topic details how to map the states shown by Tivoli SA MP and RSCT to the states returned by DB2 tools.

### Scenarios

Commands from Tivoli SA MP and RSCT which show information can be safely run, however, it is not recommended to run commands that change a state or cause actions to occur in Tivoli SA MP or RSCT. DB2 cluster services controls these resources via the policies setup, and so external changes may result in unexpected actions to occur.

**Note:** Only the most important mappings are shown in this topic.

The DB2 cluster services tooling commands that show this information are:

- **db2cluster -list -alert**
- **db2instance -list**

When running the `lssam` command and the following scenario is encountered:

- **A resource is failed offline**
  - A failed offline resource may not indicate a problem, based on what is specified in the output. To see if this maps to a problem, run the following commands:
    - 1. **db2instance -list**
      2. **db2cluster -list -alert**
    - Run the **db2cluster -list -alert** command and follow the instructions returned by that command. If you are unable to resolve the issue, follow the instructions that follow:
      - If a **db2start** command was issued, see “The instance does not start” on page 611.
      - If a **db2start** command was not issued, contact IBM Service.

- Failed offline states may be cleared via the **db2cluster -clear -alert** command if the alert appears in the **db2cluster -list -alert** command output. It is not recommended to clear these states via Tivoli SA MP or RSCT commands.
- Failed offline states on an idle resource might not be cleared by running the **db2cluster -cm -clear -alert** command. For more information, see “Clearing a failed offline state on an idle resource” on page 630.
- **A resource is pending online**
  - Wait for the resource to come online if a **db2start** command was issued, or if the resource is undergoing a restart operation.
    - If the state later moves to failed offline see **A resource is failed offline** .
  - Run **db2instance -list** to see whether or not the instance has been started. Pending Online states may appear in lssam output when the instance is stopped, and is waiting for **db2start** to be issued by the user.
- **A resource is offline**
  - **db2stop** has been issued and has completed.
  - **db2start** has been issued, a dependent resource may be unavailable. Issue **db2cluster -list -alert** to see if there are any alerts that may need to be cleared, or investigated. For instance, a network adapter may be malfunctioning, or a host may be unavailable.
- **A resource is pending offline**
  - If **db2stop** was issued, wait for the resource to change to offline.
  - If **db2stop** was not issued, this could be the result of a member returning to its home host. Run **db2instance -list** to verify that it comes up again. Run **db2cluster -list -alert** to verify that there are no issues that may have caused the Pending Offline to occur. See the section on '**A resource is offline** if the pending offline transitions to offline.
- **A resource is unknown**
  - This is a transient state. Rerun **lssam** to see if the state clears itself.
  - A machine may be offline, resulting in the inability to run the monitor.
  - run **db2instance -list** to see whether the host is active. If the host is not active, contact IBM Service.
- **A resource group has an ineligible state**
  - This may be a transient state. Rerun **lssam** to see if the state clears itself.
    - If the problem persists then run **db2instance -list** and **db2cluster -list -alert** for more information about what steps to take next.

## Creating instance resources hangs the installation

This example scenario involves a hang while creating the DB2 instance and cluster services resources as part of the installation process. The objective is to determine the problem and diagnose the cause of the hang. There are two cases for this scenario.

### Case 1: Messages exist in the install log or the db2diag log file

#### Symptoms

The initial symptom in this case is a hang during the installation process. More specifically, the hang occurs during the process of creating the instance.

Diagnosis and resolution:

- Check the /tmp/db2setup.log and/or the /tmp/db2icrt.log. For this example, the following message exists

```
Creating resources for the instance "db2inst1" has failed.
There was an error with one of the issued cluster manager commands.
Refer to the db2diag log file and the DB2 Information Center for details.
```

Check to see if you have a similar message.

- Check the /tmp/db2diag.log for messages similar to the following:
  - Line # : 6884---2610-403 The resource is stale. or
  - Line # : 9578---2610-422 Cannot execute the command on node <hostname>. The resource manager IBM.RecoveryRM is not available.
- If you see these errors, this indicates the IBM Tivoli System Automation for Multiplatforms (SA MP) recovery resource manager daemon experienced a problem. The daemon serves as the decision engine for Tivoli SA MP and is identified as IBM.RecoveryRM in the system. Diagnostic data will be written by Tivoli SA MP to diagnose the problem.
- Tivoli SA MP diagnostic data is written into the directories /var/ct/db2domain/log/mc/ (for error logs) and /var/ct/db2domain/run/mc/ (core dumps) and /tmp/db2\_cluster\_manager\_spooling/ (default trace directory).
- IBM service and development teams use trace and core files for troubleshooting. If you would like IBM service to analyze the diagnostic data, gather the data listed under the topic “Manual trace and log file collection” on page 597
- Follow these instructions to upload data to IBM Technical Support:
  - Submitting diagnostic information to IBM Technical Support for problem determination
- The IBM Technical Support website is a good source of information, where you can identify known problems based on symptoms or error log messages
  - DB2 for Linux UNIX and Windows support.

## Case 2: No errors or messages in the install log or the db2diag log file

### Symptoms

- The initial symptom is a hang during the installation process.
- The state of the hang is such that there might not be any messages reported into the /tmp/db2setup.log install log, or the log does not exist

### Diagnosis and resolution:

- If the /tmp/db2setup.log and/or /tmp/db2icrt.log exist, check if you have a similar message to:
  - Creating resources for the instance "db2inst1" has failed.
  - There was an error with one of the issued cluster manager commands. Refer to the db2diag log file and the DB2 Information Center for details.
- If the /tmp/db2diag.log exists check or messages similar to the following:
  - Line # : 6884---2610-403 The resource is stale. or
  - Line # : 9578---2610-422 Cannot execute the command on node <hostname>. The resource manager IBM.RecoveryRM is not available.
- If you see these errors, this indicates the Tivoli SA MP recovery resource manager daemon experienced a problem. The daemon serves as the decision

engine for Tivoli SA MP and is identified as IBM.RecoveryRM in the system. Diagnostic data will be written by Tivoli SA MP to diagnose the problem.

- Tivoli SA MP diagnostic data is written into the directories `/var/ct/db2domain/log/mc/` (for error logs) and `/var/ct/db2domain/run/mc/` (core dumps) and `/tmp/db2_cluster_manager_spooling/` (default trace directory).
- If the `/tmp/db2setup.log` or `/tmp/db2diag.log` files do not exist or are empty, gather as much of the remaining data listed under the topic “Manual trace and log file collection” on page 597 as possible. Contact IBM service for assistance.
- Follow these instructions to upload data to IBM Technical Support:
  - Submitting diagnostic information to IBM Technical Support for problem determination

## Frequently asked questions about DB2 pureScale Feature host validation problems

The following sections provide possible solutions to problems you might encounter when attempting to validate remote hosts.

### What if the user id specified is invalid?

The DB2 installer validates the existing user id specified. If the user id specified is invalid, ensure the user id exists on the installation-initiating host (IIH) and on each of the remote hosts. Ensure the user id has the exact same uid, gid, group name, and directory path. To create a user id, see the “Required users for a DB2 pureScale Feature installation” topic.

### What if the ports specified are invalid?

Before instance creation, the DB2 installer validates the ports you specified. If the ports you specified are not available, review the TCP/IP ports that are already in use the IIH and on the remote hosts by opening the `/etc/services` file. After you have determined a range of free ports, enter the new ports into the applicable ports fields in the Advanced Settings Panel of the Add Host Panel and have them validated by the DB2 installer.

### What if a host already belongs to another GPFS cluster?

A host cannot be a member of two GPFS clusters. If the IIH is not part of a GPFS cluster, then the remote host should not belong to a GPFS cluster. If the IIH is part of a GPFS cluster, then the remote host should either not belong to a GPFS cluster or belong to the same GPFS cluster. After you have resolved this, try adding the host to the host list again.

### What if the global registry variable record on the host indicates a GPFS Cluster already exists?

In some cases, the clean up of the global registry might not have been complete, leaving behind a record (`GPFS_CLUSTER`) that indicates there is a GPFS cluster in use by DB2 on the host when in fact there is not one. Contact IBM Software Support.

### What if the IIH cannot connect with the target host?

This error can occur as the DB2 installer tries to verifying ssh communication from the IIH to the target host. Ensure that the settings for ssh and scp are correctly

setup. ssh and scp need to be setup without a password prompt between the hosts for the root user. For more information, see the "Installing and setting up OpenSSH on AIX" topic.

If the problem occurs outside the DB2 installer, you can check a variety of items to determine the source of the problem. For example, this communication failure could result from a bad physical connection, a defective or unresponsive network adapter driver, or a misconfigured network.

### **What if the attempt to communicate with a target host times out?**

If an attempt to validate a host did not finish within the time out period, it will time out. Check the connections to the host and try to add it again. You can also change the time out variable and re-run the installation command.

### **What if the DB2 installer detects an existing RSCT peer domain on a host?**

During a DB2 installation, only one RSCT peer domain can be active at a time. The peer domain that was not created by the DB2 installer must be stopped or removed before creating a RSCT peer domain to be used by the IBM DB2 pureScale Feature.

To stop the RSCT peer domain using the `db2cluster` command on the host `db2host1`, log on to a host that belongs to the same active RSCT peer domain, run the `db2cluster -cm -stop -host db2host1` command. If the `db2cluster` command is not available, run the `stoprpdomain <domain name>` command. Run the `lsrpdomain` command to determine the domain name to specify.

If an attempt to validate host did not finish within the time out period, it will time out. Check the connections to the host and try to add it again. You can also change the time out variable and re-run the installation command.

To remove the RSCT peer domain:

1. Remove the remote host from the host list.
2. If the remote host "db2host1" belongs to a different DB2 pureScale instance, remove it from that DB2 pureScale instance using the "db2iupdt -drop" command.

To remove the host from a DB2 pureScale instance:

1. Log on to a different host which belongs to the same DB2 pureScale instance
2. Run  

```
db2iupdt [-d] -add -m|cf <host_name>:<interconnect_name> -u <fenced_id>  
<instance_owner>
```

To remove a remote host that does not belong to a DB2 instance, run one of the following:

- `db2cluster -cm -remove -host <hostname>`
- `rnrpnode <hostname>`

## **What if there is a conflict between the DEFAULT\_INSTPROF record and the instance shared directory specified?**

The DB2 installer has detected a conflict between the DEFAULT\_INSTPROF record and the instance shared directory specified. Do not specify the instance shared directory. The DEFAULT\_INSTPROF record in the global registry indicates the instance shared file system has already been set up by DB2.

In this case, the following options or keywords are not needed.

- For a response file installation: INSTANCE\_SHARED\_DEVICE\_PATH and INSTANCE\_SHARED\_DIR.
- For db2icrt or db2iupdt: instance\_shared\_dev and instance\_shared\_dir.

If the value for INSTANCE\_SHARED\_DIR / instance\_shared\_dir matches with the existing instance shared file system mount point, the DB2 installer will still allow to pass. However, if the value does not match, the installation will fail.

## **What if the PVID for the device path on the install-initiating host (IIH) does not exist on a target host?**

Ensure that PVID is setup on the IIH and all the hosts. See the “Configuring PVIDs for a DB2 pureScale Feature instance” topic for more details.

## **What if the cluster interconnect netname specified is invalid?**

This error occurs because the DB2 installer cannot identify the cluster interconnect netname. Try following methods to solve the problem:

1. Check the command for a typo error.
2. Check the machine's network configuration (for example check /etc/hosts).
3. Use the ping and nslookup tools to confirm the cluster interconnect netname maps to the same IP address on all hosts. Check that IP address maps back to the same cluster interconnect netname on all hosts.

## **What if the cluster interconnect netname for a target host failed to ping the IIH?**

When adding a new host, the DB2 installer checks to see if the new host can send a small data packet to the IIH and receive a reply. This send-reply test is commonly known as a ping - this message is the result of a failed ping. If there is a problem, you can verify the results by running this command line from the remote host's console: ping IIH address\_or\_name.

If this test fails, ensure that the ssh communication between the IIH and the remote hosts is set up correctly.

After it is verified that the problem occurs outside the DB2 installer, there are various things the you can check find the source of the problem, for example bad physical connections (for example, loose cable), a faulty network adapter driver, or an improperly setup network. Check the network adapter and cable, or choose a different one.



## What if the cluster interconnect netname for a target host is not on the same subnet as the IIH?

You can reconfigure the network adapter or choose a different one. This error occurs when the cluster interconnect netname for a host is not on the same subnet as the installation-initiating host. All cluster interconnects for CF need to be on the same subnet for performance reasons (all hosts within the same subnet can usually be reached in one routing hop).

For example if the cluster interconnect network is configured with the network address 192.168.0.0/24, then all cluster interconnect netname addresses should start with 192.168.0 (for example, 192.168.0.1, 192.168.0.2, and so on).

Check the network card configuration on the new host (for example, run the `ifconfig -a` command) and check `/etc/hosts` if a name was used instead of an address.

## Frequently asked questions about installation, instance creation, and rollback problems with the DB2 pureScale Feature

Use the answers in this list of frequently asked questions to help you provide possible solutions to problems that might arise during the installation process of the IBM DB2 pureScale Feature.

Ensure that you issue any installation or creation commands with the debug (`-d`) parameter to generate the trace file which will assist in any debugging attempts.

### Where can I find the installation log files?

The most important source of information for troubleshooting installation problems are the installation log files. The DB2 setup log file, `db2setup.log` by default, captures all DB2 installation information including errors. The DB2 error log file, `db2setup.err`, captures any error output that is returned by Java applications (for example, exceptions and trap information).

By default, the log files are located in the `DB2DIR/tmp` directory. You might have overridden this default when you issue the `db2setup` command. The DB2 installer copies the DB2 setup log file to the `DB2DIR/install/logs/` directory, and renames it `db2install.history`. If there are insufficient details in the log files on the installation-initiating host (IIH), you can also check the host logs that detail the actions on each remote host, and can be found under the `DB2DIR/tmp/db2log.xxxx` directory (where `xxxx` represents the process id) and `DB2DIR/tmp/db2log` directory.

### What is a rollback?

A rollback occurs when an operation was unsuccessful and the DB2 installer will clean up the environment. You can have an instance rollback and a DB2 binaries rollback. If the DB2 installer fails to create a DB2 instance, it will trigger a rollback of the instance on all hosts. An instance rollback does not rollback DB2 binaries.

A partial rollback occurs when you can set up an instance, but it cannot be extended to a particular host.

## What if the DB2 binary installation fails on one or more hosts?

Check the installation logs on the IHH and if more failure details are required, check the logs on the appropriate remote hosts. Resolve the errors and restart the installation.

## What if my instance was not created?

If your instance creation has failed, a rollback of the instance on all involved hosts has occurred. Refer to the installation log for more details. If the DB2 binaries are successfully installed on a host, they will not be rolled back. Resolve the errors outlined in the installation logs and run the appropriate command (**db2isetup** or **db2icrt**) command to create the instance again. You do not need to launch the DB2 installer.

## What if my instance was only partially created? What if my instance was created, but some of my members and CFs were not created?

It might occur during an installation that your instance was created only on some of the target hosts. Instance rollback happens on the hosts where the instance creation was not completed without triggering a binary rollback. You will receive a post installation message showing the hosts that have not been included in the instance due to an error.

Resolve any errors outlined in the installation logs. After you've resolved the problem, you can run the **db2isetup** or **db2iupdt** command to add the members or CFs:

- You can validate the host and add it to the instance by using the DB2 Instance Setup wizard (by issuing **db2isetup** command).
- You can extend your instance by issuing the **db2iupdt -add** command from a host that already belongs to the instance.

## Frequently asked questions about DB2 cluster file system problems

Use the following information to determine possible solutions to problems with the DB2 cluster file system, which is based on GPFS.

### What if the GPFS cluster failed to be created?

During instance creation, the GPFS cluster might fail to be created. This failure will trigger an instance creation rollback. Review the log file found in the DB2DIR/tmp directory. The **db2cluster** command is used to create an instance. The **db2cluster** command log file can be found in DB2DIR/tmp/ibm.db2.cluster.\*. After reviewing the contents of that log file, contact IBM Software Support.

### What if the GPFS cluster fails to extend to the target host?

If the GPFS cluster extension to the host fails, you can review the log file, found in the DB2DIR/tmp directory to determine why the extension was prevented on that host.

## What if the "GPFS\_CLUSTER" global registry variable record on the target hosts was not created?

As with any errors, review the installation log for specific details. Ensure that the GPFS cluster has been properly created. If the log indicates that the GPFS\_CLUSTER global registry variable record was not created on the specified hosts, contact IBM Software Support.

## What if the GPFS cluster was not deleted during a failed installation?

If a failed attempt to install a DB2 product results in a rollback, the DB2 installer might be unable to remove the newly created GPFS file system. To understand why the GPFS cluster was not removed, review the log file found in the *DB2DIR/tmp* directory .

## Frequently asked questions about RSCT peer domain problems

The following sections provide possible solutions to problems with your RSCT peer domain.

### What if the "PEER\_DOMAIN" global registry variable record on the target hosts was not created?

As with any errors, review the installation log for specific details. If the log indicates that the PEER\_DOMAIN global registry variable record was not created on the specified hosts, contact IBM Software Support.

### What if the Tivoli SA MP resource failed to be created?

The Tivoli SA MP resource failed to be created during instance creation. This error has triggered an instance rollback. See the log file to determine the reason why the Tivoli SA MP resource failed.

The log file can be found in *instance\_user/sqllib/db2dump/db2diag.log*. Because a rollback rolls back the contents *instance\_user/sqllib*, the file is backed up as */tmp/db2diag.log.process\_id*. There are multiple causes for this error. A possible reason for this is that the *db2nodes.cfg* is incorrect or failed to be created. The file can be found at *instance\_user/sqllib/db2nodes.cfg*.

Fix the problem and run the **db2icrt** command. If you are unable to resolve the problem, contact IBM Software Support with all log and trace files.

---

## Frequently asked questions about response file installation problems with the DB2 pureScale Feature

Use this topic to help you resolve response file problems during installation.

### Where is the generated response file saved?

By default, the response file generated by the DB2 Setup wizard or the DB2 Instance wizard is saved in the *DB2DIR/tmp/* directory with the name *db2ese\_dsf.rsp*. *DB2DIR* represents the installation location of your DB2 copy.

You can specify the name and location of the response file in the **Response file name** field of the “Select installation, response file creation, or both” Panel of the DB2 Setup wizard or the DB2 Instance wizard. You should save the response file from a host that will be designated a DB2 member.

### **Where can I find the IBM DB2 pureScale Feature sample response file?**

The DB2 pureScale Feature sample response file, `db2dsf.rsp`, is located in `DB2DIR/install/db2/platform/samples` directory, where *platform* refers to the appropriate operating system.

### **Which keywords are mandatory for a DB2 pureScale Feature installation?**

The DB2 pureScale Feature release introduced new keywords some of which are mandatory depending on the environment you want to create. Review the list of keywords to determine which keys are mandatory for your environment. See the “Response file keywords” topic for more details.

---

## **Frequently asked questions about DB2 pureScale Feature licensing problems**

Use this topic to help resolve problems with IBM DB2 pureScale Feature licensing.

### **What if my host is not licensed?**

You might realize you have a licensing problem if one of the following situations occurs:

- When you try to use the row level, table, or index compression, the licensing error message SQL8029N will be displayed in the output and logged in the `db2diag` log file.
- When you try to generate the compliance report by running the `db2licm -g` command, the report will show the warning message ADM12026W.

The DB2 pureScale Feature license is installed automatically by the DB2 installer. The DB2 pureScale Feature installation image includes a copy of the DB2 Enterprise Server Edition code, but does not come with a license entitlement for DB2 Enterprise Server Edition Version 9.7. You must have purchased a separate entitlement for DB2 Enterprise Server Edition Version 9.7 sufficient to cover all users or processors in your cluster. You must also register the DB2 Enterprise Server Edition license on the DB2 pureScale Feature host.

### **Where can I find the DB2 Version 9.7 license key?**

The license key can be found on the Version 9.7 Activation CD, which is included in your product package or can be downloaded from the Passport Advantage® website, <http://www.ibm.com/software/lotus/passportadvantage>. You can then use the `db2licm` command on each host to register the license.

### **How do I check if my license status on all hosts?**

You need to run the `db2licm` command on each host. To list your license status, run the `DB2DIR/adm/db2licm -l` command. If the command output displays

"License not registered", you must register the DB2 Enterprise Server Edition license on that host.

## How do I register a missing license?

To register the missing licenses, you need to run the `db2licm` command with the `add` option on the host that do not have the proper license entitlement:

```
DB2DIR/adm/db2licm -a license-certificate-file-name
```

---

## Post-installation

This section contains information that will help you understand, isolate, and resolve problems that you might encounter after the installation of the IBM DB2 pureScale Feature.

### The instance does not start

If your instance does not start, the cause might be a component failure. Use the information in this topic to help you diagnose whether a member component a cluster caching facility (CF) component failed.

#### Symptoms

A DB2 instance fails to start on the execution of the `db2start` command.

#### Diagnosing a member start failure

- Refer to the SQLCODEs in the `db2start` command output.
- The state of each member can be viewed by issuing the `db2instance -list` command. This information might show members in a STOPPED or ERROR state if the startup has failed, depending on when the failure occurs.
  - The following example shows a sample output from the `db2instance -list` command:

ID	TYPE	STATE	HOME_HOST	CURRENT_HOST	...
0	MEMBER	ERROR	host01	host01	
1	MEMBER	STARTED	host02	host02	
2	MEMBER	STARTED	host03	host03	
128	CF	PRIMARY	host04	host04	
129	CF	PEER	host05	host05	

ALERT	PARTITION_NUMBER	LOGICAL_PORT	NETNAME	...
YES	0	0	host01-ib0	
NO	0	0	host02-ib0	
NO	0	0	host03-ib0	
NO	-	0	host04-ib0	
NO	-	0	host05-ib0	

HOSTNAME	STATE	INSTANCE_STOPPED	ALERT
host01	ACTIVE	NO	NO
host02	ACTIVE	NO	NO
host03	ACTIVE	NO	NO
host04	ACTIVE	NO	NO
host05	ACTIVE	NO	NO

- For more information about the listed alerts, run the **db2cluster -cm -list -alert** command. For example, the **db2cluster -cm -list -alert** command might return something like the following alert:

Alert: DB2 member '0' failed to start on its home host 'host01'. The cluster manager will attempt to restart the DB2 member in restart light mode on another host. Check the db2diag log file for messages concerning failures on hosts 'host01' for member '0'

Action:

This alert must be cleared manually with the command:

```
db2cluster -cm -clear -alert.
```

Impact: Member 0 will not be able to service requests until this alert has been cleared and the member returns to its home host.

- Check the <instance\_owner>.nfy log for information about when the failure occurred. Look in this member's db2diag log file for more details on why the failure occurred. Look for error messages that are related to db2rstar or db2rstop in the db2diag log file.
- The system error log for the affected host can also be consulted if the cause of the error is still unknown. For example:
  - In the output shown previously, member 0 is not started.
  - Login to host01 and view the system error log by running the **errpt -a** command (AIX) or looking at the /var/log/messages (Linux).
  - In the system error log, look for related log entries at the time of the failure.
- If an alert was shown from **db2cluster -list -alert**, run **db2cluster -clear -alert** after the problem is resolved, and try the **db2start** command again.

## Diagnosing a CF server failure

- Refer to the SQLCODEs in the **db2start** command output.
- To determine whether a CF has not started, run **db2instance -list**. This information might show CFs in a STOPPED or ERROR state if the startup has failed, depending on when the failure occurs.
  - The following example shows a sample output from **db2instance -list**

ID	TYPE	STATE	HOME_HOST	CURRENT_HOST	...
0	MEMBER	STOPPED	host01	host01	
1	MEMBER	STOPPED	host02	host02	
2	MEMBER	STOPPED	host03	host03	
128	CF	STOPPED	host04	host04	
129	CF	STOPPED	host05	host05	

ALERT	PARTITION_NUMBER	LOGICAL_PORT	NETNAME	...
NO	0	0	host01-ib0	
NO	0	0	host02-ib0	
NO	0	0	host03-ib0	
NO	-	0	host04-ib0	
NO	-	0	host05-ib0	

HOSTNAME	STATE	INSTANCE_STOPPED	ALERT
host01	ACTIVE	NO	NO
host02	ACTIVE	NO	NO
host03	ACTIVE	NO	NO
host04	ACTIVE	NO	NO
host05	ACTIVE	NO	NO

- If any alerts are present, run **db2cluster -cm -list -alerts** for more information. The alerts will provide more information about what might need to be fixed (for example, a network adapter or host is offline), or point to the `cfdiag*.log` files for more information.
- Look for errors related in the CF's `db2diag` log file that pertain to the time when the **db2start** command was run:

```
2009-11-09-02.32.46.967563-300 I261372A332          LEVEL: Severe
PID      : 1282088                TID : 1          KTID : 4751433
PROC     : db2start
INSTANCE: db2inst1              NODE : 000
HOSTNAME: host04
EDUID    : 1
FUNCTION: DB2 UDB, base sys utilities, sqlIssueStartStop, probe:3973
MESSAGE  : Failed to start any CF.
```

- Search the sections of the `db2diag` log file preceding previous trace point for more information as to why the CF has not started. For example, if cluster services cannot start a CF, the `db2diag` log file might show:

```
2009-11-09-02.12.40.882897-300 I256778A398          LEVEL: Error
PID      : 737522                TID : 1          KTID : 2371807if
PROC     : db2havend
INSTANCE: db2inst1              NODE : 000
EDUID    : 1
FUNCTION: DB2 UDB, high avail services, db2haOnlineResourceGroup, probe:5982
DATA #1 : <preformatted>
Timeout waiting for resource group ca_db2inst1_0-rg to be online, last known
OpState is 2
```

- Each CF writes information to the `cfdiag*.log` and dumps more diagnostic data when required. The files reside in the directory set by the database manager configuration parameter **cf\_diagpath** or if not set, the **diagpath**, or `$INSTHOME/sqlllib_shared/db2dump/ $m` by default.
  - CF diagnostic log files (`cfdiag-<timestamp>.<cf_id>*.log`)
    - Each of these files keeps a log of the activities that are related to a CF. Events, errors, warnings, or additional debugging information will be logged there. This log has a similar structure to the `db2diag` log file. A new log is created each time that a CF starts. The logging level is controlled by the **cf\_diaglevel** database manager configuration parameter .
    - Note that there is a static CF diagnostic log name that always points to the most current diagnostic logging file for each CF and has the following format: `cfdiag.<cf_id>.log`
  - CF output dump diagnostic files `cfdump.out.<cf_pid>.<hostname>.<cf_id>`
    - These files contain information regarding CF startup and stop. There might be some additional output in these files.
  - Management LightWeight Daemon diagnostic log file (`mgmnt_lwd_log.<cf_pid>`)
    - This log file displays the log entries that pertain to the LightWeight Daemon (LWD) process for a particular CF. Errors in this log file indicate that the LWD has not started properly.
  - CF stack files (`CAPD.<cf_pid>.<tid>.thrstk`)
    - These are stack files produced by the CF when it encounters a signal. These files are important for diagnosing a problem with the CF.
  - CF trace files (`CAPD.trace.log.<cf_pid>`)
    - A default lightweight trace is enabled for the CF.
    - These trace files appear whenever the CF terminates or stops.

- The trace files might indicate a problem with the CF, but these files are useful for diagnosing errors only when used in combination with other diagnostic data.
- If the CF process starts successfully, a startup and initialized message is written to the CF dump files.
- For example, the contents of `cfdump.out.1548476.host04.128` include a message that shows a successful process start:
 

```
CA Server IPC component Initialised: LWD BG buffer count: 16
      Session ID: 1d
CA Server IPC component Acknowledged LWD Startup Message
      Waiting for LWD to Configure Server
Processors: (4:4) PowerPC_POWER5 running at 1498 MHz

Cluster Accelerator initialized

Cluster Accelerator Object Information:
OS: AIX 64-bit
Compiler: xLC VRM (900)
SVN Revision: 7584
Built on: Oct 12 2009 at 17:00:54
Executable generated with symbols
Model Components Loaded: CACHE LIST LOCK
Transport: uDAPL
Number of HCAs: 1
Device[0]: hca0
CA Port[0]: 50638
Mgmt Port Type: TCP/IP
Mgmt Port: 50642
IPC Key: 0xe50003d
Total Workers: 4
Conn/Worker: 128
Notify conns: 256
Processor Speed: 1498.0000 MHz
```
- If the `cfdump.out.*` file does not contain the "cluster caching facility initialized" line or "cluster caching facility Object Information" and other lines shown in the following example, the CF process did not start successfully. An error message might be shown instead. Contact IBM Support for more information.
- In this example, `cfdiag-20091109015035000037.128.log` contains a successful process start. If the CF did not start properly, this log might be empty or contain error messages.

```
2009-11-09-01.50.37.0051837000-300 E123456789A779 LEVEL : Event
PID      : 688182 TID :          1
HOSTNAME : host04
FUNCTION  : CA svr_init, mgmnt_castart
MESSAGE   : CA server log has been started.
DATA #1   :
Log Level: Error
Debugging : active
Cluster Accelerator Object Information
  AIX 64-bit
  Compiler: xLC VRM (900)
  SVN Revision: 7584
  Built on Oct 12 2009 at 17:00:59
  Executable generated with symbols.
  Executable generated with asserts.
  Model Components Loaded: CACHE, LIST, LOCK
  Transport: uDAPL
  Number of HCAs: 1
  Device[0]: hca0
  CA Port[0]: 50638
  Total Workers: 4
```



Conn/Worker: 128  
Notify conns: 256  
Processor Speed: 1498.000000 Mhz.  
Allocatable Structure memory: 170 MB

- Look for core files or stack traceback files in the CF\_DIAGPATH directory.
- However, if the CFs did not started successfully, there might be a related error in the db2diag log file. For example:

```
2009-11-09-02.32.46.967563-300 I261372A332          LEVEL: Severe
PID      : 1282088                TID   : 1                KTID  : 4751433
PROC     : db2start
INSTANCE: db2inst1              NODE  : 000
HOSTNAME: host04
EDUID    : 1
FUNCTION: DB2 UDB, base sys utilities, sqlcIssueStartStop, probe:3973
MESSAGE  : Failed to start any CA.
```

- Search around the time of this message to find related errors. For example, if cluster services cannot start a CF, the db2diag log file might show:

```
2009-11-09-02.12.40.882897-300 I256778A398    LEVEL: Error
PID      : 737522                TID   : 1                KTID  : 2371807
PROC     : db2havend
INSTANCE: db2inst1              NODE  : 000
EDUID    : 1
FUNCTION: DB2 UDB, high avail services, db2haOnlineResourceGroup, probe:5982
DATA #1 : <preformatted>
Timeout waiting for resource group ca_db2inst1_0-rg to be online, last known
OpState is 2
```

- Look for core files or stack traceback files in the CF\_DIAGPATH directory.
- The system error log for the affected host might also be consulted if the cause of the error is still unknown. Log onto the CF host that has not been started and view the system error log by running the **errpt -a** command (on Linux, look in the /var/log/messages file). Look for related log entries at the time of the failure. In the example shown here, login to host04 and host05, because CF 128 and CF 129 reside on these hosts.
- If an alert was shown from **db2cluster -list -alert**, run **db2cluster -clear -alert** after the problem is resolved, and then reissue the **db2start** command.

## Mapping the db2diag log file to the correct cfdump.out\* file

Diagnostic log files contain information that can help you identify relevant information if the **db2start** command fails. This topic gives details on mapping the **db2diag** log file to the correct **cfdump.out\*** file.

### About this task

When the **db2start** command fails, check the diagnostic log files located in the `sqllib/db2dump` directory. The **diagpath** and **cf\_diagpath** database manager configuration parameters determine which **cfdiag\*.log** file is relevant to the failure.

### Procedure

To map the **db2diag** log file information to the correct **cfdump\*.out** file:

1. Check the contents of the **db2diag** log file for entries similar to the following ones:

```
2009-11-09-10.51.11.132220-300 E25081A841          LEVEL: Event
PID      : 463088                TID   : 1                KTID  : 3551445
PROC     : ca-wdog 129
INSTANCE: svtdbm9              NODE  : 129
HOSTNAME: coralpib08
```

```

EDUID      : 1                      EDUNAME: ca-wdog 129
FUNCTION:  DB2 UDB, base sys utilities, sqlSendCFServerConfig, probe:1470
DATA #1   : String, 469 bytes
CF Server 129 Configuration:

```

```

Number of worker threads : 1
Memory size (MB)         : 3907
Connections per worker   : 128
Notify connections       : 256
Number of HCA            : 1
  port[0]                 : 50639
  device name[0]          : hca0
Transport type           : UDAPL
Dump file path           :
Log path                 : /coralpgpfs2/svtdbm9/sql1lib/db2dump/
                          cfdiag-20091109105110000098.129.log
Log level                 : 2

```

2. The **db2diag** log file shows the path and name of the relevant `cfdiag*.log` file in the following format `cfdiag-timestamp.cfmember#.log`. Open and review the `cfdiag*.log` file. Using the example in Step 1, the following shows sample entries that you would find in `cfdiag-20091109105110000098.129.log`.

```

2009-11-09-10.53.31.3382320-300 E123456789A269    LEVEL   : Event
PID      : 26981 TID : 1075841344
HOSTNAME : coralpib08
FUNCTION  : CF svr_mgmt, dmon_config_cf
MESSAGE   : LWD Log shmem_id IPC message received by daemon.
DATA #1   :
Shared Memory Segment ID: 0

```

3. Take the `PID` and `HOSTNAME` values in the `cfdiag*.log` entry from Step 2 coupled with the information from Step 1, and you have the information needed to piece together the name of the required `cfdump*.out` file. The `cfdump*.out` file has the following format `cfdump.out.pid.hostname.cfmember#.log`. In this example the log is `cfdump.out.26981.coralpib08.129.log`.

## Identifying uDAPL over InfiniBand communication errors

Using diagnostic logs, operating system commands and system traces you can identify and resolve uDAPL communication errors.

After you enter **db2start**, first connection activation of the database or member restart, errors might occur, as shown in the following examples of messages in a **db2diag** log file:

```

2009-04-27-15.41.03.299437-240 I9450505A370    LEVEL: Severe
PID      : 651462                TID : 258          KTID : 2674775 PROC : db2sysc 0
INSTANCE: db2inst1              NODE : 000
EDUID    : 258                  EDUNAME: db2sysc 0
FUNCTION: DB2 UDB, RAS/PD component, pdLogCaPrintf, probe:876
DATA #1  : <preformatted>
ca_svr_connect: dat_evd_wait failed: 0xf0000

```

```

2009-04-27-15.41.03.363542-240 I9450876A367    LEVEL: Severe
PID      : 651462                TID : 258          KTID : 2674775 PROC : db2sysc 0
INSTANCE: db2inst1              NODE : 000
EDUID    : 258                  EDUNAME: db2sysc 0
FUNCTION: DB2 UDB, RAS/PD component, pdLogCaPrintf, probe:876
DATA #1  : <preformatted>
CACConnect: cmd_connect failed: 0x80090001

```

```

2009-04-27-15.41.03.421934-240 I9451244A1356    LEVEL: Severe
PID      : 651462                TID : 258          KTID : 2674775 PROC : db2sysc 0
INSTANCE: db2inst1              NODE : 000
EDUID    : 258                  EDUNAME: db2sysc 0

```

```

FUNCTION: DB2 UDB, Shared Data Structure Abstraction Layer ,
        SQLE_CA_CONN_ENTRY_DATA::sqlCaCeConnect, probe:622
MESSAGE : CA RC= 2148073473
DATA #1 : String, 17 bytes
CAConnect failed.
DATA #2 : CAToken_t, PD_TYPE_SD_CATOKEN, 8 bytes
0x07000000003EE0B8 : 0000 0001 1064 AF90          .....d..
DATA #3 : CA Retry Position, PD_TYPE_SAL_CA_RETRY, 8 bytes
0
CALLSTCK:
[0] 0x0900000012FF274C sqlCaCeConnect__23SQLE_CA_CONN_ENTRY_DATAFCP7CATokenC1
    + 0x40C
[1] 0x0900000012FF2CF8 sqlSingleCaCreateAndAddNewConnectionsToPool__
    21SQLE_SINGLE_CA_HANDLEFCUIT1Cb + 0x278
[2] 0x0900000012FF9188 sqlSingleCaInitialize__21SQLE_SINGLE_CA_HANDLEFRC27SQLE_
    CA_CONN_POOL_NODE_INFOCU1P13SQLO_MEM_POOL + 0x448
[3] 0x0900000013001C50 sqlCaCpAddCa__17SQLE_CA_CONN_POOLFSCPU1 + 0x350
[4] 0x000000001000118AC sqlInitSysCtlr__FPiT1 + 0x140C
[5] 0x00000000100013008 sqlSysCtlr__Fv + 0x4A8
[6] 0x0900000012E15C78 sqloSystemControllerMain__FCUiPFv_iPfi_vPPvCPi + 0xD58
[7] 0x0900000012E177AC sqloRunInstance + 0x20C
[8] 0x00000000100006ECC DB2main + 0xAEC
[9] 0x0900000012C99048 sqloEDUMainEntry__FPcUi + 0xA8

```

The **db2diag** log file might also show messages similar to the following:

```

2009-04-27-15.41.04.595936-240 I9453087A387      LEVEL: Severe
PID      : 1249362          TID : 258          KTID : 4395063 PROC : db2sysc 1
INSTANCE: db2inst1        NODE : 001
EDUID    : 258            EDUNAME: db2sysc 1
FUNCTION: DB2 UDB, RAS/PD component, pdLogCaPrintf, probe:876
DATA #1 : <preformatted>
xport_send: dat_ep_post_rdma_write of the MCB failed: 0x70000

2009-04-27-15.42.04.329724-240 I9505628A1358    LEVEL: Severe
PID      : 1249362          TID : 258          KTID : 4395063 PROC : db2sysc 1
INSTANCE: db2inst1        NODE : 001
EDUID    : 258            EDUNAME: db2sysc 1
FUNCTION: DB2 UDB, Shared Data Structure Abstraction Layer ,
        SQLE_CA_CONN_ENTRY_DATA::sqlCaCeConnect, probe:622
MESSAGE : CA RC= 2148073485
DATA #1 : String, 17 bytes
CAConnect failed.
DATA #2 : CAToken_t, PD_TYPE_SD_CATOKEN, 8 bytes
0x07000000003EE0B8 : 0000 0001 1064 AFD0          .....d..
DATA #3 : CA Retry Position, PD_TYPE_SAL_CA_RETRY, 8 bytes
894
CALLSTCK:
[0] 0x0900000012FF274C sqlCaCeConnect__23SQLE_CA_CONN_ENTRY_DATAFCP7CATokenC1
    + 0x40C
[1] 0x0900000012FF2CF8 sqlSingleCaCreateAndAddNewConnectionsToPool__
    21SQLE_SINGLE_CA_HANDLEFCUIT1Cb + 0x278
[2] 0x0900000012FF9188 sqlSingleCaInitialize__21SQLE_SINGLE_CA_HANDLEFRC27SQLE_
    CA_CONN_POOL_NODE_INFOCU1P13SQLO_MEM_POOL + 0x448
[3] 0x0900000013001C50 sqlCaCpAddCa__17SQLE_CA_CONN_POOLFSCPU1 + 0x350
[4] 0x000000001000118AC sqlInitSysCtlr__FPiT1 + 0x140C
[5] 0x00000000100013008 sqlSysCtlr__Fv + 0x4A8
[6] 0x0900000012E15C78 sqloSystemControllerMain__FCUiPFv_iPfi_vPPvCPi + 0xD58
[7] 0x0900000012E177AC sqloRunInstance + 0x20C
[8] 0x00000000100006ECC DB2main + 0xAEC
[9] 0x0900000012C99048 sqloEDUMainEntry__FPcUi + 0xA8

```

These messages indicate a communication error between a CF and a member.

Follow these steps:

1. Locate the `pdLogCfPrintf` messages and search for the message string `CF RC=`. For example, `CF RC= 2148073491`.

2. Take the numeric value adjacent to this string; in this example it is 2148073491. This value represents the reason code from the network or communication layer.
3. To find more details on this error, run the **db2diag** tool with the **-cfrc** parameter followed by the value. Example: `db2diag -cfrc 2148073491`.
4. If the system was recently enabled with uDAPL and InfiniBand, check your uDAPL configuration.
5. Ping the IB hostnames from each member host that is showing the previously listed errors to the CFs IB hostnames, and from the CF hosts to the IB hostnames of those members.
6. If pinging the IB hostnames fails, verify that the port state is up. To verify if the port state is up, run **ibstat -v**. In the following example, the link should be good because Physical Port Physical State has a value of Link Up, Logical Port State has a value of Active, and Physical Port State has a value of Active:

```
$ ibstat -v
```

```
-----
IB NODE INFORMATION (iba0)
-----
Number of Ports:                2
Globally Unique ID (GUID):      00.02.55.00.02.38.59.00
Maximum Number of Queue Pairs:  16367
Maximum Outstanding Work Requests: 32768
Maximum Scatter Gather per WQE:  252
Maximum Number of Completion Queues: 16380
Maximum Multicast Groups:       32
Maximum Memory Regions:         61382
Maximum Memory Windows:         61382
Hw Version info:                0x10000002
Number of Reliable Datagram Domains: 0
Total QPs in use:                3
Total CQs in use:                4
Total EQs in use:                1
Total Memory Regions in use:     7
Total MultiCast Groups in use:   2
Total QPs in MCast Groups in use: 2
EQ Event Bus ID:                 0x90000300
EQ Event ISN:                    0x1004
NEQ Event Bus ID:                0x90000300
NEQ Event ISN:                   0x90101
-----
```

```
-----
IB PORT 1 INFORMATION (iba0)
-----
Global ID Prefix:                fe.80.00.00.00.00.00.00
Local ID (LID):                  000e
Local Mask Control (LMC):        0000
Logical Port State:               Active
Physical Port State:              Active
Physical Port Physical State:     Link Up
Physical Port Speed:              2.5G
Physical Port Width:              4X
Maximum Transmission Unit Capacity: 2048
Current Number of Partition Keys: 1
Partition Key List:
  P_Key[0]:                       ffff
Current Number of GUID's:         1
Globally Unique ID List:
  GUID[0]:                         00.02.55.00.02.38.59.00
-----
```

7. Check the Galaxy InfiniBand adapter card, InfiniBand switch, and cable connections for failures on the physical server.

8. The AIX system error log might also show related messages. You can check the error log by running the **errpt -a** command.
9. Ensure that the InfiniBand network interface, the host channel adapter, and the icm values all are Available, as shown in the following example:

```
$ lsdev -C | grep ib
fcnet0      Defined    00-08-01 Fibre Channel Network Protocol Device
fcnet1      Defined    00-09-01 Fibre Channel Network Protocol Device
ib0         Available  IP over Infiniband Network Interface
iba0        Available  InfiniBand host channel adapter
icm         Available  Infiniband Communication Manager
```

- If setup was performed correctly, and the hardware is functioning correctly, all three values should be 'Available'.
  - If the network interface is not 'Available', you can change the device state manually. To change the device state manually you can use the following:  

```
$ chdev -l ib0 -a state=up
ib0 changed
```
  - If iba0 or icm are not in the Available state, check for errors on the device. To check for errors on the device, run **/usr/sbin/cfgmgr -vl iba0** or **/usr/sbin/cfgmgr -vl icm** as a root user.
  - If iba0 is not found or remains in the Defined state, confirm that the Host Channel Adapter is currently assigned to the host on the HMC.
10. Verify that the cf-server processes were running on the CF server hosts at the time of the error. If the CF hosts were not up, not initialized, or were restarted at that time (when performing **db2instance -list** at the time, the primary CF was PRIMARY and the secondary was in PEER), check `cfdump.out*`, `cfdiag*.log`, and core files for more details. However, if the CF servers were up and initialized at the time of the error, then there might be a uDAPL communication problem.
  11. If a **db2start** command or a CONNECT statement was issued, to determine whether there is a different failure that caused these errors to appear as a side effect, see “The instance does not start” on page 611.
  12. If this is not the case, a trace of the failing scenario is often useful to determine the cause for the error. If CF trace was enabled, dump it. To dump CF trace, run the following command: `db2trc cf dump fileName` where you define the value for the *fileName* parameter.
  13. To enable CF trace if it was not already enabled, run the following command:  

```
db2trc cf on -m "*.CF.xport_udapl.*.*" .
```
  14. IBM Service might additionally request an AIX system trace and AIX memory traces to facilitate problem determination.
  15. If CF trace on `xport_udapl` and any AIX system trace were recorded, collect this information. Run the **db2support** command to collect further diagnostic logs. Run **snap -Y** as root on all hosts, and contact IBM Service for further help.

## Running a trace for uDAPL over InfiniBand connections

When reporting a problem to IBM Service, a detailed trace of the uDAPL communication layer and lower communication layers might be requested.

These instructions can be used as a general reference for taking AIX traces.

### About this task

Enabling the AIX system trace facility (OFF by default) might impact your system's performance depending on how it is used. As a result, use the trace facility to

diagnose connectivity problems only when directed by IBM Service. The optimal values that are to be used for the trace mode, trace buffer size, file size, and trace hooks vary depending on the type of problem. IBM Service analyzes the problem and gives recommended values for these variables.

## Procedure

To trace uDAPL over InfiniBand connections:

1. Adjust any component trace levels to refine which events should be traced for certain trace hooks. For example, to include detail level events for the InfiniBand communication layer in any subsequent AIX system trace, run the following command:

```
ctctrl -t network_ib -r systracedetail
```

2. Turn the trace on. To turn on the trace, use the **trace** command:

```
trace -T bufferize -L filesize -a -j trace_hooks
```

where:

- The default trace mode is used. Two global buffers are used to continuously gather trace data, with one buffer being written to the log file, while data is gathered in the other buffer
- **-T** *bufferize* specifies the trace buffer size
- **-L** *filesize* specifies the output trace log file size
- **-a** specifies to run the trace in the background
- **-j** *trace\_hooks* specifies the type of event to trace. Multiple events can be specified as a comma-separated list

**Note:** Values for trace mode, buffer scope, *bufferize*, *filesize*, and *trace\_hooks* depend on the problem that is being experienced. Contact IBM Service for recommended values.

3. Reproduce the problem
4. Turn off the trace. Use the **trcstop** command.
5. Dump the trace buffer to a file. Use the **trcrpt** command:

```
trcrpt > filename
```

where *filename* specifies the file you dump the trace buffer to. For information about the AIX tracing facility, see [AIX Information Center: Trace Facility](#)

AIX also supports in-memory only traces for some components. These include default on traces, that were selected such that there is minimal performance impact. The traces are not written to a disk log file without explicit action by IBM Service personnel. To increase the InfiniBand in-memory tracing to a detailed level, use the following command:

```
ctctrl -t network_ib -r memtracedetail
```

## Obtaining a file system trace

When reporting a problem to IBM Service, you might be asked for a detailed trace for the DB2 cluster file system, which is based on GPFS. Use the following information to take a GPFS trace.

### About this task

Enabling the trace facility (OFF by default) might impact the performance of your system. As a result, use the trace facility only when directed by IBM Technical Support. The optimal values that are to be used for the trace buffer size, file size,

and tracing levels vary depending on the type of problem. IBM Technical Support analyzes the problem and gives recommended values for these variables.

The **mmchconfig** command can be used to configure GPFS tracing parameters.

The configuration changes are automatically applied to all nodes in the cluster.

### Procedure

To obtain a GPFS trace, run the following steps as the root user:

1. Make sure the `/tmp/mmfs` directory exists on all nodes. Trace reports and internal dumps are written to this directory.
2. Set up the trace level on each GPFS cluster by entering the following command:

```
mmchconfig trace = trace_hooks
```

where *trace\_hooks* specifies the type of event to trace.

**Note:** Values for the trace hooks depend on the problem that is being experienced. Contact IBM Technical support for recommended values.

3. Increase the size of the trace buffer and trace file by entering the following command:

```
mmchconfig traceFileSize = filesize
```

where *filesize* specifies the output trace log file size

**Note:** The value for *filesize* depends on the problem that is being experienced. Contact IBM Technical support for recommended values.

4. To start the trace run the **mmtrace** command on all hosts that are affected by the problem.
5. To check whether the trace is started run **ps -ef | grep trace**. The command `/bin/trace` might be displayed.
6. Reproduce the problem that you want to trace.
7. Dump the trace buffer by entering the **mmtrace** command on each GPFS node.
8. Turn off the trace by entering the following command:

```
mmtrace stop
```

## Frequently asked questions about post-installation problems

Use the answers in this list of frequently asked questions to help you resolve problems that arise after the installation of the IBM DB2 pureScale Feature.

### What if my members or cluster caching facilities are not in STARTED, PEER, or CATCHUP state?

If one of your members or cluster caching facilities is not in the STARTED, PEER, or CATCHUP state, perform the following steps:

1. Stop the instance by issuing the **db2stop** command.
2. Restart the instance by issuing the **db2start** command.
3. Review the messages from the failed **db2start** command, and resolve the problem.
4. If the problem persists, review the `db2diag` log file, which might have more details about the problem.

5. If reviewing the file does not yield a probable cause of the problem, perform the following steps:
  - a. Drop the member or cluster caching facility by issuing the **db2iupdt -drop** command.
  - b. Add the member or cluster caching facility again by issuing the **db2iupdt -add** command.

### What if the **db2start** command fails with **SQL1517N**?

This error indicates that there are inconsistencies between the `db2nodes.cfg` file and the cluster manager. See the “Repairing the cluster manager resource model” topic for more details on how to repair the cluster manager resource model.

### What if I can't create my database?

If you attempted to create a database using the create database command and received an SQL1032N error (No START DATABASE MANAGER command was issued). Ensure that you are logged on to a host that is acting as a DB2 member. You cannot create a database on a host that is acting as a cluster caching facility. Log onto a DB2 member and issue the CREATE DATABASE command again.

### What if the **db2iupdt -drop** command failed to shrink the RSCT peer domain?

To manually remove failed hosts from the RSCT peer domain:

1. Check whether there are still resources attached to the peer domain by logging on to the failed host as the root user and issuing the **lssam** command. The **lssam** command shows all resources in the domain, not just those on a particular host. Review the listing to ensure that the host that you are attempting to drop does not have any resources attached.
2. If no resources are attached, from the installation-initiating host (IIH), enter `db2cluster -cm -remove -host host_name .`
3. If there are still resources attached, perform the following steps:
  - a. From the IIH, switch to the instance owner by entering `su - instance_owner .`
  - b. Remove the resource by entering `db2cluster -cm -delete -resources`. This step deletes all resources in the cluster.
  - c. Switch back to root.
  - d. Remove the failed hosts from the RSCT peer domain by entering `db2cluster -cm -remove -host host_name.`
  - e. Switch to the instance owner again.
  - f. Re-create the resources on the hosts that did not fail by entering `db2cluster -cm -create -resources`.
  - g. Switch back to root.

---

## Host or member issues

When you encounter a problem, it is important to diagnose and then troubleshoot the problem. Details are given on how to identify alerts or errors and to diagnose and troubleshoot symptoms that might occur in a DB2 pureScale environment.



In a DB2 pureScale environment, the **db2instance -list** command can be run from any host where a member or cluster caching facility is located to get information about problem symptoms that might occur.

The three distinct state elements member, cluster caching facility and host can show symptoms such as alerts, errors and WAITING\_FOR\_FAILBACK.

If the database is unavailable, reporting of some data is still possible if the DB2 pureScale instance manager is still available on the host because you can use the **db2instance -list** command if there is no current database connection or if the instance is stopped.

Further basic diagnostic steps include:

1. run **db2cluster -cm/-cfs -list -alert** to check for alerts
2. check the db2diag log file for data diagnostic information and error messages
3. check the DIAGPATH for any diagnostic files produced and FODC directories
4. check the CF\_DIAGPATH for any cluster caching facility diagnostic data produced
5. run **errpt -a** to view the system error log. Look for related log entries at the time of the failure.

For details on how to find out the state of hosts, members or cluster caching facilities see the links to the following concept topics in the related information section

- Monitoring in a DB2 pureScale environment
- Status monitoring of a DB2 pureScale instance

## Summary of instance status information from the **db2instance -list** command

This topic provides a summary overview of the states returned by the **db2instance -list** command, which you can use to look up troubleshooting information.

Use the following table to obtain more information about output from the **db2instance -list** command.

*Table 88. Permutations based on the output of the **db2instance -list** command*

Member State	Member Alert	Host State	Host Alert	Further information
WAITING_FOR_FAILBACK	YES	INACTIVE	YES	See "Member WAITING_FOR_FAILBACK, alert, corresponding host is in INACTIVE state with alert" on page 624
WAITING_FOR_FAILBACK	NO	INACTIVE	YES	See "Member WAITING_FOR_FAILBACK, no alerts, corresponding host is in INACTIVE state with alert" on page 631
WAITING_FOR_FAILBACK	NO	ACTIVE	YES	See "Member WAITING_FOR_FAILBACK, no alerts, the corresponding host is in ACTIVE state with an alert" on page 632
STARTED	YES	ACTIVE	NO	See "Member shows alert while in STARTED state, all hosts are in ACTIVE state with no alerts" on page 624

STARTED	NO	ACTIVE	NO	The output of the "db2instance -list" command shows the primary cluster caching facility switched state from PRIMARY to PEER, and the secondary cluster caching facility switched state from PEER to PRIMARY. See "Primary role moves between cluster caching facility hosts" on page 642
ERROR	YES	ACTIVE	NO	See "Member is in ERROR state" on page 629

## Member or host with alert

If the output of the **db2instance -list** command shows that a member or a host has an alert, use the following topics that match the alerts on your instance to help diagnose the problem.

### Member WAITING\_FOR\_FAILBACK, alert, corresponding host is in INACTIVE state with alert:

The output of the **db2instance -list** command shows that at least one member is in the WAITING\_FOR\_FAILBACK state with an alert and that one or more corresponding hosts are in the INACTIVE state with alerts.

This is a sample output from the **db2instance -list** command where there are three members and two cluster caching facilities

```

ID      TYPE      STATE      HOME_HOST  CURRENT_HOST  ALERT  PARTITION_NUMBER  LOGICAL_PORT  NETNAME
---      ---      ---      ---        ---          ---    ---              ---          ---
0       MEMBER    WAITING_FOR_FAILBACK  hostA      hostC         YES    0                1             hostC-ib0
1       MEMBER    STARTED    hostB      hostB         NO     0                0             hostB-ib0
2       MEMBER    STARTED    hostC      hostC         NO     0                0             hostC-ib0
128    CF        PRIMARY    hostD      hostD         NO     -                0             hostD-ib0
129    CF        PEER      hostE      hostE         NO     -                0             hostE-ib0

HOSTNAME  STATE  INSTANCE_STOPPED  ALERT
-----
hostA     INACTIVE  NO                YES
hostB     ACTIVE   NO                NO
hostC     ACTIVE   NO                NO
hostD     ACTIVE   NO                NO
hostE     ACTIVE   NO                NO

```

Member 0 experienced a problem with its home host, hostA, and is running in light mode on hostC.

Member 0 shows that an ALERT has occurred. Run **db2cluster -cm -list -alert** to find out what the ALERT is for.

Because hostA is unavailable, the state for the host is set to INACTIVE. Member 0 can not fail back while hostA is in the INACTIVE state; member 0 remains in the WAITING\_FOR\_FAILBACK state. Because restart light failed on hostB, an alert was raised as an indication to the administrator to investigate the problem.

If hostA becomes available again, its state will change from INACTIVE to ACTIVE. Member 0 will fail back to hostA, and its state will change from WAITING\_FOR\_FAILBACK to STARTED. This is covered in further details at .

For information about diagnosing this symptom, see the link "HostA fails, restart light works on a hostC, but not the first hostB"

*Member shows alert while in STARTED state, all hosts are in ACTIVE state with no alerts:*

This symptom observed occurs as a follow on from the the scenario "Member WAITING\_FOR\_FAILBACK, alert, corresponding host(s) is in INACTIVE state with

alert". The output of the **db2instance -list** command shows a member with an alert while its state is STARTED. All hosts are in ACTIVE state with no alerts.

This is a sample output from the **db2instance -list** command showing a three member, two cluster caching facility environment:

ID	TYPE	STATE	HOME_HOST	CURRENT_HOST	ALERT	PARTITION_NUMBER	LOGICAL_PORT	NETNAME
0	MEMBER	STARTED	hostA	hostA	YES	0	0	hostA-ib0
1	MEMBER	STARTED	hostB	hostB	NO	0	0	hostB-ib0
2	MEMBER	STARTED	hostC	hostC	NO	0	0	hostC-ib0
128	CF	PRIMARY	hostD	hostD	NO	-	0	hostD-ib0
129	CF	PEER	hostE	hostE	NO	-	0	hostE-ib0

HOSTNAME	STATE	INSTANCE_STOPPED	ALERT
hostA	ACTIVE	NO	NO
hostB	ACTIVE	NO	NO
hostC	ACTIVE	NO	NO
hostD	ACTIVE	NO	NO
hostE	ACTIVE	NO	NO

Member 0 still has its alert flagged as an indicator to the administrator to investigate the problem that occurred on hostB that prevented the member from performing a restart light.

**Note:** The hostB problem is detailed in the parent topic Member WAITING\_FOR\_FAILBACK, alert, corresponding host(s) is in INACTIVE state with alert.

For information about diagnosis, see the related link "Host (A) fails, restart light works on a host (C), but not the first host (B), failback N/A".

*Restart light fails on one host, but completes on another host:*

During a restart light, a member fails over to a guest host, so that the recovery process can complete. Use the information in this topic to help you diagnose why a restart light on the initial guest host is unsuccessful, but then completes successfully on a second guest host.

## Symptoms

The following sample output from the **db2instance -list** command shows an environment with three members and two cluster caching facilities:

ID	TYPE	STATE	HOME_HOST	CURRENT_HOST	ALERT	PARTITION_NUMBER	LOGICAL_PORT	NETNAME
0	MEMBER	WAITING_FOR_FAILBACK	hostA	hostC	YES	0	1	hostC-ib0
1	MEMBER	STARTED	hostB	hostB	NO	0	0	hostB-ib0
2	MEMBER	STARTED	hostC	hostC	NO	0	0	hostC-ib0
128	CF	PRIMARY	hostD	hostD	NO	-	0	hostD-ib0
129	CF	PEER	hostE	hostE	NO	-	0	hostE-ib0

HOSTNAME	STATE	INSTANCE_STOPPED	ALERT
hostA	INACTIVE	NO	YES
hostB	ACTIVE	NO	NO
hostC	ACTIVE	NO	NO
hostD	ACTIVE	NO	NO
hostE	ACTIVE	NO	NO

Member 0 experienced a problem with its home host, hostA, and attempted a restart light on hostB. However, the restart light failed on hostB. The member then attempted a restart light on hostC, which was successful.

If hostA becomes available again, its state will change from INACTIVE to ACTIVE. member 0 will fail back to hostA, and the state of the member will change from WAITING\_FOR\_FAILBACK to STARTED.

ID	TYPE	STATE	HOME_HOST	CURRENT_HOST	ALERT	PARTITION_NUMBER	LOGICAL_PORT	NETNAME
0	MEMBER	STARTED	hostA	hostA	YES	0	0	hostA-ib0
1	MEMBER	STARTED	hostB	hostB	NO	0	0	hostB-ib0
2	MEMBER	STARTED	hostC	hostC	NO	0	0	hostC-ib0

```

128    CF          PRIMARY      hostD      hostD      NO          -          0      hostD-ib0
129    CF          PEER         hostE      hostE      NO          -          0      hostE-ib0

HOSTNAME STATE      INSTANCE_STOPPED ALERT
-----
hostA    ACTIVE    NO              NO
hostB    ACTIVE    NO              NO
hostC    ACTIVE    NO              NO
hostD    ACTIVE    NO              NO
hostE    ACTIVE    NO              NO

```

## Troubleshooting steps

To help troubleshoot the restart light failure on hostB, take one or both of the following steps:

- Check the db2diag log file for information about the failure, and then investigate it.

The following sample output shows the restart light attempt on hostB:

```

2009-08-27-23.37.52.416270-240 I6733A457          LEVEL: Event
PID      : 1093874          TID      : 1          KTID     : 2461779
PROC     : db2star2
INSTANCE:          NODE   : 000
HOSTNAME: hostB
EDUID    : 1
FUNCTION: DB2 UDB, base sys utilities, DB2StartMain, probe:3368
MESSAGE  : Idle process taken over by member
DATA #1 : Database Partition Number, PD_TYPE_NODE, 2 bytes
996
DATA #2 : Database Partition Number, PD_TYPE_NODE, 2 bytes
0

```

Check the diag messages to analyze the errors corresponding to the restart light failure on hostB.

- See “Diagnosing a host reboot with a restart light” on page 645 for steps to diagnose the host failure on hostA.
- See “Diagnosing a cluster file system failure that occurred during restart light” for an example on how to troubleshoot this scenario.
- After you diagnose the problem, clear the alert for the member.

*Diagnosing a cluster file system failure that occurred during restart light:*

A member attempts to perform a restart light, but a cluster file system error occurs, which causes the restart light to fail.

## Symptoms

The objective of this topic is to diagnose the cause of the failure. This is a sample output from the **db2instance -list** command showing a three member, two cluster caching facility environment:

```

ID      TYPE      STATE      HOME_HOST  CURRENT_HOST  ALERT  PARTITION_NUMBER  LOGICAL_PORT  NETNAME
---      ---      ---      ---
0      MEMBER    RESTARTING hostA      hostB        No     0                 1             hostB-ib0
1      MEMBER    STARTED    hostB      hostB        NO     0                 0             hostB-ib0
2      MEMBER    STARTED    hostC      hostC        NO     0                 0             hostC-ib0
128    CF        PRIMARY    hostD      hostD        NO     -                 0             hostD-ib0
129    CF        PEER      hostE      hostE        NO     -                 0             hostE-ib0

HOSTNAME STATE      INSTANCE_STOPPED ALERT
-----
hostA    INACTIVE  NO              YES
hostB    ACTIVE    NO              NO
hostC    ACTIVE    NO              NO
hostD    ACTIVE    NO              NO
hostE    ACTIVE    NO              NO

```

There is a state of RESTARTING for member 0 occurring on hostB. The home host for member 0 is hostA. This output indicates member 0 is actively performing a restart light on hostB

HostA has a state of `INACTIVE` with an corresponding alert. This indicates an abnormal host shutdown such as a power failure or a failure to access the host due to a network communication failure.

A subsequent `db2instance -list` output shows that the restart light failed on hostB. The member then attempts the restart light on hostC and is successful. Member 0 is left in the `WAITING_FOR_FAILBACK` state because hostA remains offline.

ID	TYPE	STATE	HOME_HOST	CURRENT_HOST	ALERT	PARTITION_NUMBER	LOGICAL_PORT	NETNAME
0	MEMBER	WAITING_FOR_FAILBACK	hostA	hostC	YES	0	1	hostC-ib0
1	MEMBER	STARTED	hostB	hostB	NO	0	0	hostB-ib0
2	MEMBER	STARTED	hostC	hostC	NO	0	0	hostC-ib0
128	CF	PRIMARY	hostD	hostD	NO	-	0	hostD-ib0
129	CF	PEER	hostE	hostE	NO	-	0	hostE-ib0

HOSTNAME	STATE	INSTANCE_STOPPED	ALERT
hostA	INACTIVE	NO	YES
hostB	ACTIVE	NO	NO
hostC	ACTIVE	NO	NO
hostD	ACTIVE	NO	NO
hostE	ACTIVE	NO	NO

If hostA comes online, the host state will return to `ACTIVE`, and member 0 will fail back to hostA as shown in the following `db2instance -list` output

ID	TYPE	STATE	HOME_HOST	CURRENT_HOST	ALERT	PARTITION_NUMBER	LOGICAL_PORT	NETNAME
0	MEMBER	STARTED	hostA	hostA	YES	0	0	hostA-ib0
1	MEMBER	STARTED	hostB	hostB	NO	0	0	hostB-ib0
2	MEMBER	STARTED	hostC	hostC	NO	0	0	hostC-ib0
128	CF	PRIMARY	hostD	hostD	NO	-	0	hostD-ib0
129	CF	PEER	hostE	hostE	NO	-	0	hostE-ib0

HOSTNAME	STATE	INSTANCE_STOPPED	ALERT
hostA	ACTIVE	NO	NO
hostB	ACTIVE	NO	NO
hostC	ACTIVE	NO	NO
hostD	ACTIVE	NO	NO
hostE	ACTIVE	NO	NO

## Diagnosis and resolution

To help diagnose the restart light error, take one or more of the following steps:

- Check the `$INSTHOME/sql/lib/db2dump/db2diag.log` file. There should be a message corresponding to the time of the restart light attempt on hostB, as shown in the following output:

```
2009-08-27-23.37.52.416270-240 I6733A457          LEVEL: Event
PID      : 1093874                TID   : 1          KTID   : 2461779
PROC     : db2star2
INSTANCE:                          NODE   : 000
HOSTNAME: hostB
EDUID    : 1
FUNCTION: DB2 UDB, base sys utilities, DB2StartMain, probe:3368
MESSAGE  : Idle process taken over by member
DATA #1 : Database Partition Number, PD_TYPE_NODE, 2 bytes
996
DATA #2 : Database Partition Number, PD_TYPE_NODE, 2 bytes
0
```

- Check the `db2diag` log file to analyze the error message corresponding to the restart light failure on hostB. The following output is generated during the restart light attempt:

```
2009-08-27-23.37.53.260582-240 E596165A1624      LEVEL: Error (OS)
PID      : 667736                TID   : 1          PROC   : db2rocm
INSTANCE:                          NODE   : 000
HOSTNAME: hostB
EDUID    : 1
FUNCTION: DB2 UDB, oper system services, sqloflock, probe:100
MESSAGE  : ZRC=0x83000037=-2097151945
CALLED   : OS, -, fcntl
OSERR    : EINPROGRESS (55) "Operation now in progress"
```

```

DATA #1 : File handle, PD_TYPE_SQO_FILE_HDL, 8 bytes
File Handle           = 3
File System Block Size = 32768 bytes
File System Type     = mmfs
File Handle Flags :
  Require Sector Align = No
  DIO/CIO Mode         = No
  Raw Block Device     = No
  Reserved Handle      = No
  Flush On Close       = No
  Thread-Level Lock    = No
  Write-through Mode   = No
  File Not Tracked     = No

```

The output shows that the `fcntl()` operating system function was called and generated an error message and code of `EINPROGRESS (55)` "Operation now in progress". The File System Type is `mmfs`, which is the General Parallel File System (GPFS).

- Run the **`errpt -a`** operating system command to view the contents of the AIX `errpt` system log. In the scenario, as shown in the following sample output, the AIX `errpt` log from `hostB` contains `MMFS_*` messages (for example, `MMFS_MOREINFO`) that were generated at approximately the same time as the aforementioned restart light message. These `MMFS*` messages indicate that the problem originated in the GPFS subsystem.

```

LABEL:                MMFS_MOREINFO
IDENTIFIER:           E7AA68A1

Date/Time:            Thu Aug 27 23:37:53 EDT 2009
Sequence Number:     356562
Machine Id:           0006DA8AD700
Node Id:              hostB
Class:                S
Type:                 PERM
WPAR:                 Global
Resource Name:        mmfs

Description
SOFTWARE PROGRAM ERROR

```

See the topic "Diagnosing a host reboot with a restart light" on page 645 for help in diagnosing the cause of the host failure that initiated the restart light.

Further assistance for host and restart light problems is available on the IBM Technical Support website (DB2 for Linux UNIX and Windows support), where you can get information about known problems based on symptoms or error log messages. In addition, if you want IBM Technical Support to analyze your diagnostic data, obtain a **`db2support`** package by running **`db2support`** output directory **`-d`** database name **`-s`** on each node in the cluster. To submit data to IBM Technical Support, see Submitting diagnostic information to IBM Technical Support for problem determination.

#### **Member WAITING\_FOR\_FAILBACK, alert, corresponding host is in ACTIVE state without alert:**

The output of the **`db2instance -list`** command shows that at least one member is in the `WAITING_FOR_FAILBACK` state with an alert and that one or more corresponding hosts are in the `ACTIVE` state without alerts.

This is a sample output from the **`db2instance -list`** command where there are three members and two cluster caching facilities:

ID	TYPE	STATE	HOME_HOST	CURRENT_HOST	ALERT	PARTITION_NUMBER	LOGICAL_PORT	NETNAME
0	MEMBER	STOPPED	hostA	hostA	NO	0	0	-
1	MEMBER	WAITING_FOR_FAILBACK	hostB	hostC	YES	0	1	-
2	MEMBER	STARTED	hostC	hostC	NO	0	0	-
128	CF	CATCHUP	hostB	hostB	NO	-	0	-
129	CF	PRIMARY	hostC	hostC	NO	-	0	-

HOSTNAME	STATE	INSTANCE_STOPPED	ALERT
hostC	ACTIVE	NO	NO
hostB	ACTIVE	NO	NO
hostA	ACTIVE	NO	NO

Member 1 experienced a problem with its home host, hostB, and is running in light mode on hostC.

Member 1 shows that an ALERT has occurred. Running **db2cluster -cm -list -alert** provides information about the alert, as the following output example shows:

1.

Alert: DB2 member '1' is currently awaiting failback to its home host 'coral18'. The cluster manager has restarted the DB2 member in restart light mode on another host. The home host for the member is available however automatic failback to home has been disabled.

Action: In order to move the member back its home host, the alert must be manually cleared with the command: 'db2cluster -cm -clear -alert'.

Impact: DB2 member '1' will not be able to service requests until this alert has been cleared and the DB2 member returns to its home host.

When hostB is available, the state for the host is set to ACTIVE. Member 1 cannot failback to hostB because automatic failback is disabled; member 1 remains in the WAITING\_FOR\_FAILBACK state until an administrator clears the alert and manually enables automatic failback by running the following command:

```
db2cluster -cm -option autofailback -value on
```

The instance must be restarted for the setting of the previous command to become effective.

## Member has an alert

The output of the **db2instance -list** command shows that a member is in the ALERT state but the host has an alert.

### Member is in ERROR state:

Techniques to identify and diagnose a scenario when there is a member in ERROR state in the output of the **db2instance -list** command are outlined.

This is a sample output from the **db2instance -list** command showing a three member, two cluster caching facility environment:

ID	TYPE	STATE	HOME_HOST	CURRENT_HOST	ALERT	PARTITION_NUMBER	LOGICAL_PORT	NETNAME
0	MEMBER	<b>ERROR</b>	hostA	hostA	<b>YES</b>	0	0	hostA-ib0
1	MEMBER	STARTED	hostB	hostB	NO	0	0	hostB-ib0
2	MEMBER	STARTED	hostC	hostC	NO	0	0	hostC-ib0
128	CF	PRIMARY	hostD	hostD	NO	-	0	hostD-ib0
129	CF	PEER	hostE	hostE	NO	-	0	hostE-ib0

HOSTNAME	STATE	INSTANCE_STOPPED	ALERT
hostA	ACTIVE	NO	NO
hostB	ACTIVE	NO	NO
hostC	ACTIVE	NO	NO
hostD	ACTIVE	NO	NO
hostE	ACTIVE	NO	NO

This output shows that DB2 cluster services could not restart the failed member on its home host or on any other host in the cluster. As shown in the STATE column, member 0 is in the ERROR state. Manual intervention is required, as indicated by the alert flagged for member 0

For information about diagnosing this symptom, see "Host failed and restart light does not work on any host, failback did not happen."

*Host failed and restart light does not work on any host:*

A member and a host fail. Restart light is not successful on any host; failback does not happen.

Find out why the member failed and why the restart light was unsuccessful.

- On the home host, check the db2diag log file and errpt files for FODC directories.
- Check for cluster caching facilities states by issuing the **db2cluster** command, as follows:

```
db2cluster -cm -list -host -state
db2cluster -cfs -list -host -state
```

- See "Diagnosing a host reboot with a restart light" on page 645

#### Clearing a failed offline state on an idle resource:

If the failed offline state on an idle resource is not cleared by running the **db2cluster -cm -clear -alert** command, use the information in this topic to help you clear the failed offline state.

You must be an instance user or the DB2 cluster services administrator.

#### Symptoms

The failed offline state on an idle resources might not be cleared by running the **db2cluster -cm -clear -alert** command.

#### Resolving the problem

1. Issue the **lssam** command to find the idle resources that are in the failed offline state. If your cluster has any idle resources that are in the failed offline state, you will see an output similar to the following:

```
Failed offline IBM.ResourceGroup:idle_rmsinst_999_pub21-rg Nominal=Offline
'- Failed offline IBM.Application:idle_rmsinst_999_pub21-rs
'- Failed offline IBM.Application:idle_rmsinst_999_pub21-rs:pub21
```

In this example, the idle resource that is in the failed offline state has the instance name as rmsinst, the idle number as 999, and the host name as pub21.

2. Check the contents of the db2diag.log file, which is located at the directory specified by the **DIAGPATH** configuration parameter, for entries similar to the following ones:

```
2011-09-14-02.36.43.179141+540 I19433062A1157 LEVEL: Error
PID : 12582956 TID : 1 PROC :db2rocm 999[rmsinst]
INSTANCE: rmsinst NODE : 999
HOSTNAME: pub21
EDUID : 1 EDUNAME: db2rocm 999 [rmsinst]
FUNCTION: DB2 UDB,high avail services,sqlhaMonitorPartitionProcess,probe:647
MESSAGE : ZRC=0x827301BF=-2106392129=HA_ZRC_MONITOR_FAULT_FORCED
"The monitor fault is being forced."
```



```

DATA #1 : String, 54 bytes
Monitor override is detected, returning failed offline
DATA #2 : PGRP File Contents, PD_TYPE_SQLO_PGRP_FILE_CONTENTS, 2512 bytes
pgrpFile->iPgrpFileVersion : 2225
pgrpFile->iPgrpID : NOT_INITIALIZED
pgrpFile->iWdogPgrpId : NOT_INITIALIZED
pgrpFile->iSubPgrpId : NOT_INITIALIZED
pgrpFile->iIndex : NOT_INITIALIZED
pgrpFile->iNumber : NOT_INITIALIZED
pgrpFile->iMonitorOverride : 2
pgrpFile->crashCounter : 0
pgrpFile->firstCrashTime : 1970-01-01 09:00:00.000000
pgrpFile->monitorTimeoutCounter : 0
pgrpFile->firstMonitorTimeoutTime : 1970-01-01 09:00:00.000000
pgrpFile->lastMonitorTimeoutTime: 1970-01-01 09:00:00.000000
pgrpFile->hostname : pub21
pgrpFile->iNumHCAs : 0

```

3. Verify that the following are correct:
  - The timestamp in the `db2diag.log` file is for the current time.
  - The idle number in the `lssam` command output matches the NODE number in the `db2diag.log` file.
  - The host name in the `lssam` command output matches the host name in the `db2diag.log` file.
4. To clear the alert, remove the following files at the same time using the `rm` command:

```

rm sqllib/ctrlha/.idle.idle_number.hostname.pgrp sqllib/ctrlhamirror/.idle.
idle_number.hostname.pgrp.mirror

```

where `idle_number` is the number of the idle resource and `hostname` is the name of the current host.

In this example, you need to issue the following command to clear the alert:

```

rm sqllib/ctrlha/.idle.999.pub21.pgrp sqllib/ctrlhamirror/.idle.999.pub21.
pgrp.mirror

```

**Note:** Wait for up to 10 minutes to allow the idle resource to be automatically restarted. If the idle resource remains in the failed offline state, contact IBM Service.

## Host has an alert

The output of the `db2instance -list` shows at least one host is in ALERT but nomembers are in ALERT.

## Member WAITING\_FOR\_FAILBACK, no alerts, corresponding host is in INACTIVE state with alert:

The output of the `db2instance -list` command shows at least one member in WAITING\_FOR\_FAILBACK state with no alerts, and the corresponding host is in INACTIVE state with an alert.

This is a sample output from the `db2instance -list` command showing a three member, two cluster caching facility environment:

ID	TYPE	STATE	HOME_HOST	CURRENT_HOST	ALERT	PARTITION_NUMBER	LOGICAL_PORT	NETNAME
0	MEMBER	WAITING_FOR_FAILBACK	hostA	hostB	NO	0	1	hostB-ib0
1	MEMBER	STARTED	hostB	hostB	NO	0	0	hostB-ib0
2	MEMBER	STARTED	hostC	hostC	NO	0	0	hostC-ib0
128	CF	PRIMARY	hostD	hostD	NO	-	0	hostD-ib0
129	CF	PEER	hostE	hostE	NO	-	0	hostE-ib0

HOSTNAME	STATE	INSTANCE_STOPPED	ALERT
-----	-----	-----	-----

hostA	INACTIVE	NO	YES
hostB	ACTIVE	NO	NO
hostC	ACTIVE	NO	NO
hostD	ACTIVE	NO	NO
hostE	ACTIVE	NO	NO

Member 0 has experienced a problem with its home host, hostA, and performed a successful restart light on hostB.

Running the **db2instance -list** at this point shows no alerts for the member 0 after it performed a restart light. This is indicated in the ALERT column for member 0. This means member 0 was successful on its first attempt at performing restart light on hostB.

Since hostA is unavailable, the state for the host is set to INACTIVE. member 0 can not fail back while hostA is in the INACTIVE state; member 0 will therefore remain in WAITING\_FOR\_FAILBACK state.

If hostA becomes available again, its state will change from INACTIVE to ACTIVE. member 0 will fail back to hostA, and its state will change from WAITING\_FOR\_FAILBACK to STARTED. To diagnose this symptom see Diagnosing a host reboot with a restart light.

**Member WAITING\_FOR FAILBACK, no alerts, the corresponding host is in ACTIVE state with an alert:**

The output of the **db2instance -list** command shows at least one member in WAITING\_FOR\_FAILBACK state with no alerts, and the corresponding host is in ACTIVE state with an alert.

This is a sample output from the **db2instance -list** command showing a three member, two cluster caching facility environment:

ID	TYPE	STATE	HOME_HOST	CURRENT_HOST	ALERT	PARTITION_NUMBER	LOGICAL_PORT	NETNAME
0	MEMBER	WAITING_FOR_FAILBACK	hostA	hostB	NO	0	1	hostB-ib0
1	MEMBER	STARTED	hostB	hostB	NO	0	0	hostB-ib0
2	MEMBER	STARTED	hostC	hostC	NO	0	0	hostC-ib0
128	CF	PRIMARY	hostD	hostD	NO	-	0	hostD-ib0
129	CF	PEER	hostE	hostE	NO	-	0	hostE-ib0

HOSTNAME	STATE	INSTANCE_STOPPED	ALERT
hostA	ACTIVE	NO	YES
hostB	ACTIVE	NO	NO
hostC	ACTIVE	NO	NO
hostD	ACTIVE	NO	NO
hostE	ACTIVE	NO	NO

This **db2instance -list** output shows that member 0 experienced a problem with its home host, hostA, and performed a successful restart light on hostB.

Running the **db2instance -list** at this point shows no alerts on the member 0 after it performed a restart light. This is indicated in the ALERT column for the member. This means member 0 was successful on its first attempt at restart light, which was performed on hostB.

There is an alert flagged for hostA, which is an indication to the administrator to investigate a problem on hostA. Although hostA is ACTIVE, there could be an issue preventing its usage in the cluster such as a file system or network problem.

For information about diagnosis for this symptom see the related link "Host fails, restarted light successfully, failback fails or cannot restart on home host".

*A member cannot restart on the home host after a successful restart light:*

After a host failure, the member fails over to a guest host in restart light mode successfully, but then cannot fail back, and you are unable to restart the member on the home host manually.

### **Why failback might not succeed**

#### **If the host is still down**

Check for hardware failure or power loss.

#### **If /var is full**

DB2 will not be able to start on the current host, and will attempt to restart in restart light mode on another.

**Note:** Failback might not occur in this situation since /var would still be full. Ensure that there is plenty of space. The recommendation is for at least 3GB.

- The cluster filesystem's log files are stored in /var/adm/ras. Any core files relating to the cluster manager (if core dumping is enabled) will go to /var/ct/<domain>/run/mc/\*/\* . Check this path to see if core files are there
  - Old files in these paths might be cleaned up along with any old system logs.
  - Increase the disk space for the /var file system to have at least 3 GB free space.
- Start GPFS, run **db2cluster -cfs -start host** <failedHost>
- Run **db2cluster -cm -list -alert** to list the alert
- Run **db2cluster -cm -clear -alert** to clear the alert
- If there is still a problem, run **db2support** <output directory> **-d** <database name> **-s** and contact IBM Technical Support.

#### **If the host is up, but you cannot attach or restart due to communication failure, no communication through uDAPL**

Perform the following diagnosis steps to determine if a communication failure through uDAPL is the reason why the failback is not succeeding.

- Ping between the failed host and the cluster caching facility hosts.
- Run **lsdev -C | grep ib** to verify that the InfiniBand components are in the Available State. The state should display as available.
- Use the **ibstat -v** to check the InfiniBand state. Verify that the port is active and that the link is up.
- Check the cfdump.out\*, core files, cfdiag\*.log, mgmnt\_lwd\_log to see if there are failures from the cluster caching facilities not starting up, . If there are failures, run **db2instance -list**, this will show *primary* in something other than the **STARTED** state, and *secondary* in something other than the **PEER** state.
  - If cfdump.out shows no initialized or object information, then it is likely that the cluster caching facility did not start successfully.
  - If the cfdump.out has the information, then the cluster caching facility had started successfully at some point.
- Check the physical IB network cable connections
  - See “Member timeout and failure due to uDAPL communication failure” on page 636.

- If you cannot communicate, run **db2support** <output directory> -d <database name> -s and contact IBM Technical Support.

**If the host is up, but sys log shows a fibre channel card problem/disk error/SAN cable connection problem (causing a connection to the GPFS disk to fail on the host)**

See “Disk failure causing DB2 cluster file system failure” on page 637 or if GPFS does not get remounted

- Run **db2cluster -cfs -list -host -state** .
- mount | grep mmfs to see if any results show filesystem type=mmfs.
- Check connections, cards, disks, and restart GPFS using **db2cluster -cfs -start host** <failedHost>.

### Why the host fails

#### To find out why the host fails

- Check for hardware failure or power loss.
- See “Diagnosing a host reboot with a restart light” on page 645 for steps to diagnose the host failure on hostA.

*Significant disk usage or full /var file path, or SQL30108N error:*

This scenario illustrates a failure of the IBM Tivoli System Automation for Multiplatforms recovery resource manager daemon, which serves as the decision engine for Tivoli SA MP and is identified as IBM.RecoveryRM in the system. If the daemon fails, symptoms include significant disk usage or a full /var file path, or an SQL30108N

There are two cases for this scenario.

#### Case 1: Significant disk usage (or full) '/var' file system

The following scenario shows the symptoms for this error:

- If the IBM Tivoli System Automation for Multiplatforms recovery resource manager daemon fails during runtime, Tivoli SA MP will automatically try to restart the daemon so that end users or applications are not affected and database processing will continue. There will not be any noticeable symptoms. Tivoli SA MP will write diagnostic information into /var/ct/db2domain/log/mc/ (error logs) and /var/ct/db2domain/run/mc/ (core dumps) and /tmp/db2\_cluster\_manager\_spooling (default trace directory). Check the var/... directories for an accumulation of diagnostic data.

The following instructions give details on diagnosis and resolution:

- If you see a continuous accumulation of diagnostic data written into the aforementioned directories, it is safe to archive old diagnostic data to an archive location. For example
  - mv /var/ct/db2domain/run/mc/IBM.RecoveryRM/trace.6.sp /archivepath  
where /var/ct/db2domain/run/mc/IBM.RecoveryRM/trace.6.sp is a Tivoli SA MP diagnostic destination path

**Note:** /archivepath is an arbitrary file system

- It is important to monitor the /var/ct/db2domain/log/mc/ and /var/ct/db2domain/run/mc/ directories on a regular basis and maintain free space of at least 3 GB for the /var file system.

- IBM service and development teams use trace and core files for troubleshooting. For IBM Technical Support to analyze the diagnostic data, obtain a **db2support** package by running the following command on each member in the cluster
  - **db2support** output\_directory -d database\_name -s
- Follow these instructions to upload data to IBM Technical Support:
  - Submitting diagnostic information to IBM Technical Support for problem determination
- The IBM Technical Support website is a good source of information, where you can identify known problems based on symptoms or error log messages
  - DB2 for Linux UNIX and Windows support.

## Case 2: SQL30108N

This case occurs if restarting the daemon fails with an error, resulting in a restart light onto another host in the cluster.

The following scenario shows the symptoms for this error:

- The application returns an SQL30108N error message.
- Check for an accumulation of diagnostic data under the /var file system. Tivoli SA MP will write diagnostic information into /var/ct/db2domain/log/mc/ (error logs) and /var/ct/db2domain/run/mc/ (trace and core dumps) and /tmp/db2\_cluster\_manager\_spooling (default trace directory). .

The following instructions give details on diagnosis and resolution:

- Check the db2diag log file for messages similar to the following one:
  - DATA #6 : String, 48 bytes  
Line # : 6884---2610-403 The resource is stale.
  - or
  - DATA #6 : String, 142 bytes  
Line # : 9578---2610-422 Cannot execute the command on node coralxib38.torolab.ibm.com. The resource manager IBM.RecoveryRM is not available.

If you see the previous errors, this indicates that the Tivoli SA MP recovery resource manager daemon experienced a problem. Diagnostic data will be written by Tivoli SA MP to diagnose the problem.

- If there is a continuous accumulation of diagnostic data written into the /var/ct/db2domain/log/mc/ and /var/ct/db2domain/run/mc/ directories, it is safe to archive old diagnostic data to an archive location. For example
  - mv /var/ct/db2domain/run/mc/IBM.RecoveryRM/trace.6.sp /archivepath  
where /var/ct/db2domain/run/mc/IBM.RecoveryRM/trace.6.sp is a Tivoli SA MP diagnostic destination path

**Note:** /archivepath is an arbitrary archive file system

- It is important to monitor the /var/ct/db2domain/log/mc/ and /var/ct/db2domain/run/mc/ directories on a regular basis and maintain free space of at least 3 GB for the /var file system.
- IBM service and development teams use trace and core files for troubleshooting. If you would like IBM Technical Support to analyze the diagnostic data, obtain a **db2support** package by running the following command on each node in the cluster
  - **db2support** output\_directory -d database\_name -s

- Follow these instructions to upload data to IBM Technical Support:
  - Submitting diagnostic information to IBM Technical Support for problem determination
- The IBM Technical Support website is a good source of information, where you can identify known problems based on symptoms or error log messages
  - DB2 for Linux UNIX and Windows support.

*Member timeout and failure due to uDAPL communication failure:*

Diagnosis and resolution of uDAPL communication timeouts causing a member to sporadically fail and restart.

## Symptoms

A member sporadically experiences failures during startup or normal day-to-day OLTP processing. The member is subsequently restarted successfully on its home host, or restarted light onto another host if restarting on the home host is not possible. Informational stack traceback files, dump files, and other data that is normally dumped is written into the **diagpath** and **cf\_diagpath**.

A possible symptom is that there is an increased pace of disk space usage within the db2dump file system due to the writing of such diagnostics data.

## Diagnosis and resolution

To diagnose and resolve this problem carry out the following steps:

- Check the `~/sqlllib_shared/db2dump/ $m` to see whether the member's **db2diag** log file is abnormally large or many diagnostic dump directories exist within it. On checking the **db2diag** log file, there might be messages from function `pdLogCaPrintf` :

```
2009-01-23-17.33.23.976179-300 I5463632A503      LEVEL: Severe
PID      : 602310          TID   : 15422      PROC  : db2sysc 0
INSTANCE:                NODE   : 000        DB    :
APPHDL   : 0-53          APPID:
AUTHID   :
EDUID    : 15422          EDUNAME: db2agent (    ) 0
FUNCTION: DB2 UDB, RAS/PD component, pdLogCaPrintf, probe:876
DATA #1 : <preformatted>
xport_send: Timed-out waiting for completion of dat_ep_post_rdma_write of an MCB
```

```
2009-01-23-17.33.24.473642-300 I5464136A467      LEVEL: Severe
PID      : 602310          TID   : 15422      PROC  : db2sysc 0
INSTANCE:                NODE   : 000        DB    :
APPHDL   : 0-53          APPID:
AUTHID   :
EDUID    : 15422          EDUNAME: db2agent (    ) 0
FUNCTION: DB2 UDB, RAS/PD component, pdLogCaPrintf, probe:876
DATA #1 : <preformatted>
ClientXport.send (CARAR:) failed: 0x80090013
```

- Check the **db2diag** log file for Restart Light messages after the aforementioned diag messages. See “Restart events that might occur in DB2 pureScale environments” on page 639 for more information about the various restart messages including the Restart Light message.

```
2009-08-27-23.37.52.416270-240 I6733A457      LEVEL: Event
PID      : 1093874        TID   : 1          KTID  : 2461779
PROC     : db2star2
INSTANCE:                NODE   : 001
HOSTNAME: hostC
```

```

EDUID      : 1
FUNCTION:  DB2 UDB, base sys utilities, DB2StartMain, probe:3368
MESSAGE   : Idle process taken over by member
DATA #1   : Database Partition Number, PD_TYPE_NODE, 2 bytes
          996
DATA #2   : Database Partition Number, PD_TYPE_NODE, 2 bytes
          1

```

- After locating the pdLogCfPrintf messages, search for the diag message string CF RC=. For example, CF RC= 2148073491
- Take the numeric value adjacent to this string, in this example it is 2148073491. This represents the reason code from the network or communications layer.
- To find more details on this error, use the **db2diag** tool. For example, db2diag -cfrc 2148073491
- Ping the cluster caching facility to see if it is online. If the ping is successful, gather a **db2support** package by running db2support *output\_directory* -d *database\_name* -s on each cluster and contact IBM Technical Support.
- A uDAPL trace might be requested by IBM Service for diagnosing such problems, see “Running a trace for uDAPL over InfiniBand connections” on page 619.

*Disk failure causing DB2 cluster file system failure:*

A failure of the DB2 cluster file system, which is based on GPFS, on one member that causes all shared file systems (including the db2dump) to be unmounted for that member. GPFS stayed down.

### Symptoms

**Note:** The db2dump directory will only be lost if it is on the GPFS file system. If it has been set to something else (For example, **diagpath**) then this GPFS failure will not affect it.

This is a sample output from the **db2instance -list** command showing a three member, two cluster caching facility environment, where there has been a host alert:

```

db2instance -list
ID  TYPE  STATE                HOME_HOST  CURRENT_HOST  ALERT  PARTITION_NUMBER  LOGICAL_PORT  NETNAME
--  ---  -----
0   MEMBER  WAITING_FOR_FAILBACK hostA      hostB         NO     0                 1             hostB-ib0
1   MEMBER  STARTED             hostB      hostB         NO     0                 0             hostB-ib0
2   MEMBER  STARTED             hostC      hostC         NO     0                 0             hostC-ib0
128 CF      PRIMARY            hostD      hostD         NO     -                 0             hostD-ib0
129 CF      PEER               hostE      hostE         NO     -                 0             hostE-ib0

HOSTNAME          STATE  INSTANCE_STOPPED  ALERT
-----
hostA             ACTIVE NO                YES
hostB             ACTIVE NO                NO
hostC             ACTIVE NO                NO
hostD             ACTIVE NO                NO
hostE             ACTIVE NO                NO

```

### Diagnosis / resolution

This scenario can be identified through GPFS error messages

- Check the alert message by running **db2cluster -cm -list -alert**, for example
 

```
db2cluster -cm -list -alert
```

 The host "hostA.torolab.ibm.com" is not able to access the following file systems:
 

```
"/db2cfs/db2inst1/sqllib/db2dump".
```

 Check the disk connections and mount the file system. See the DB2 Information Center for more details.

This alert must be cleared manually via the command  
 db2cluster -clear -alert -host hostA.torolab.ibm.com  
 While the file system is offline, the db2 members on this  
 host will be in restart light mode on other systems and will  
 be WAITING\_FOR\_FAILBACK

- Confirm that you can access the file systems in question by using the **ls** or **cd** operating system commands.

```
ls /db2cfs/db2inst1/sqllib/db2dump
cd /db2cfs/db2inst1/sqllib/db2dump
```

If the file systems are inaccessible or offline, these commands will return a message indicating that the directory does not exist or is not available.

- If the file system is inaccessible by running the **ls** or **cd** commands, confirm if the file systems are considered mounted on the problematic host.
  - Using this example scenario, on hostA run

```
mount |grep sqllib
```

If it is not mounted the /db2cfs/db2inst1/sqllib file system will not be shown in the result set.

- To mount the file systems in question run the command **db2cluster -cfs -mount -filesystem fs\_name**

- Check the **db2diag** log file at the **diagpath** location. If you require further information about the failure, look for relevant messages to ascertain the problem leading to the restart light. There might be a **db2diag** log record corresponding to the time of the restart, for example

```
2009-08-27-23.37.52.416270-240 I6733A457          LEVEL: Event
PID      : 1093874          TID   : 1          KTID  : 2461779
PROC     : db2star2
INSTANCE:                   NODE   : 000
HOSTNAME: hostB
EDUID    : 1
FUNCTION: DB2 UDB, base sys utilities, DB2StartMain, probe:3368
MESSAGE  : Idle process taken over by member
DATA #1 : Database Partition Number, PD_TYPE_NODE, 2 bytes
996
DATA #2 : Database Partition Number, PD_TYPE_NODE, 2 bytes
0
```

See “Restart events that might occur in DB2 pureScale environments” on page 639 for more information about the various restart messages including the Restart Light message.

- Another source of reference for diagnosing problems is the system log. Run the operating system command **errpt -a** to view the contents of the AIX errpt system log. In this scenario example, by looking at the AIX errpt log from hostA just before the time of the aforementioned Restart Light message, you see MMFS\_\* messages (For example MMFS\_GENERIC, MMFS\_PHOENIX in errpt) with text that is similar to the following text:

```
message: "GPFS: 6027-752 Lost membership in cluster hostA. Unmounting file systems.
```

- Check the disks, disk connections, and fibre channel cards. The root cause in this example scenario was faulty interconnects between the host and the SAN.
- For IBM Technical Support to analyze the diagnostic data, obtain a **db2support** package by running **db2support output\_directory -d database\_name** on each member in the cluster. Follow the instructions at 'Submitting diagnostic information to IBM Technical Support for problem determination' to upload data to IBM Technical Support:



*Restart events that might occur in DB2 pureScale environments:*

Information on types of restart events that might occur in DB2 pureScale. Restart Light diag message should not be confused with other types of restart messages.

The following events are types of restart events that might occur in DB2 pureScale environments.

### 1. Member Local Restart

```
2009-11-08-18.56.29.767906-300 I151976017E340      LEVEL: Event
PID : 26319                      TID : 46989525792064 KTID : 26319
PROC : db2rocm 1
INSTANCE: inst1                  NODE : 001
HOSTNAME: hostA
FUNCTION: DB2 UDB, high avail services, sqlhaStartPartition, probe:1636
DATA #1 : <preformatted>
Successful start of member
```

```
2009-11-08-18.56.29.769311-300 I151976358E373      LEVEL: Event
PID : 26319                      TID : 46989525792064 KTID : 26319
PROC : db2rocm 1
INSTANCE: inst1                  NODE : 001
HOSTNAME: hostA
FUNCTION: DB2 UDB, high avail services, db2rocm_main, probe:1381
DATA #1 : String, 30 bytes
db2rocm 1 DB2 inst1 1 START
DATA #2 : String, 7 bytes
SUCCESS
```

Note the Successful start of member string from function sqlhaStartPartition, which indicates a Local Restart has initiated.

### 2. Member Restart Light

```
2009-08-27-23.37.52.416270-240 I6733A457          LEVEL: Event
PID   : 1093874                  TID   : 1              KTID  : 2461779
PROC   : db2star2
INSTANCE:                        NODE   : 001
HOSTNAME: hostC
EDUID  : 1
FUNCTION: DB2 UDB, base sys utilities, DB2StartMain, probe:3368
MESSAGE : Idle process taken over by member
DATA #1 : Database Partition Number, PD_TYPE_NODE, 2 bytes
996
DATA #2 : Database Partition Number, PD_TYPE_NODE, 2 bytes
1
```

Note the Idle process taken over by member which indicates that a recovery idle process was activated to perform a Restart Light where member 1 failed over to hostC.

### 3. Member crash recovery

```
2009-11-09-13.55.08.330120-300 I338293E831          LEVEL: Info
PID   : 24616                    TID   : 47881260099904 KTID  : 24731
PROC   : db2sysc 0
INSTANCE:                        NODE   : 000          DB    :
APPHDL : 0-52                    APPID: *N0.DB2.091109185417
EDUID  : 24                      EDUNAME: db2agent (    ) 0
FUNCTION: DB2 UDB, data protection services, sqlpgint, probe:430
DATA #1 : <preformatted>
Crash recovery decision:
Is this member consistent? No
Is the database marked consistent in the GLFH? No
Is the database restore pending? No
Is the database rollforward pending? No
Were the CF structures valid on startup? No
Are we performing an offline restore? No
Are we performing group crash recovery? No
```

**Are we performing member crash recovery? Yes**  
Are we initializing the LFS for the group? No

.....

2009-11-09-13.55.09.002292-300 I50967394E495 LEVEL: Info  
PID : 24616 TID : 47881260099904 KTID : 24731  
PROC : db2sysc 0  
INSTANCE: NODE : 000 DB :  
APPHDL : 0-52 APPID: \*N0.DB2.091109185417  
AUTHID :  
EDUID : 24 EDUNAME: db2agent ( ) 0  
FUNCTION: DB2 UDB, recovery manager, sqlpresr, probe:3170  
DATA #1 : <preformatted>  
Crash recovery completed. Next LSN is 00000000006DB3D1

The Are we performing member crash recovery? Yes string shows a members crash recovery event occurred.

4. Group Restart
5. Group Crash Recovery

2009-11-09-22.24.41.330120-300 I338293E831 LEVEL: Info  
PID : 10900 TID : 46949294139712 KTID : 18929  
PROC : db2sysc 2  
INSTANCE: NODE : 002 DB :  
APPHDL : 2-52 APPID: \*N2.DB2.091110032438  
EDUID : 24 EDUNAME: db2agnti ( ) 2  
FUNCTION: DB2 UDB, data protection services, sqlpgint, probe:430  
DATA #1 : <preformatted>

Crash recovery decision:  
Is this member consistent? No  
Is the database marked consistent in the GLFH? No  
Is the database restore pending? No  
Is the database rollforward pending? No  
Were the CF structures valid on startup? No  
Are we performing an offline restore? No  
**Are we performing group crash recovery? Yes**  
Are we performing member crash recovery? No  
Are we initializing the LFS for the group? Yes

2009-11-09-22.24.41.540562-300 E365262E436 LEVEL: Info  
PID : 10900 TID : 46949294139712 KTID : 18929  
PROC : db2sysc 2  
INSTANCE: NODE : 002 DB :  
APPHDL : 2-52 APPID: \*N2.DB2.091110032438  
EDUID : 24 EDUNAME: db2agnti ( ) 2  
FUNCTION: DB2 UDB, base sys utilities, sqlledint, probe:3559  
MESSAGE : Crash Recovery is needed.

2009-11-09-22.24.53.177348-300 E431539E458 LEVEL: Info  
PID : 10900 TID : 46949294139712 KTID : 18929  
PROC : db2sysc 2  
INSTANCE: NODE : 002 DB :  
APPHDL : 2-52 APPID: \*N2.DB2.091110032438  
EDUID : 24 EDUNAME: db2agnti ( ) 2  
FUNCTION: DB2 UDB, recovery manager, sqlpresr, probe:210  
MESSAGE : ADM1527I **Group crash recovery has been initiated.**

.....

2009-11-09-22.25.14.432113-300 E552559E467 LEVEL: Info  
PID : 10900 TID : 46949294139712 KTID : 18929  
PROC : db2sysc 2  
INSTANCE: NODE : 002 DB :  
APPHDL : 2-52 APPID: \*N2.DB2.091110032438

```

EDUID   : 24                               EDUNAME: db2agnti (      ) 2
FUNCTION: DB2 UDB, recovery manager, sqlpresr, probe:3110
MESSAGE : ADM1528I  Group crash recovery has completed successfully.

```

- The following lines from the message log indicate a Group Crash Recovery event occurred.

```

Are we performing group crash recovery? Yes
Group crash recovery has been initiated.
Group crash recovery has completed successfully.

```

### Member ACTIVE, but host has an alert related to /var file system:

The output of the **db2instance -list** command shows that all members are in ACTIVE state, but at least one host has an alert related to the /var file system.

This is a sample output from the **db2instance -list** command showing a three-member, two-cluster caching facility environment:

ID	TYPE	STATE	HOME_HOST	CURRENT_HOST	ALERT	PARTITION_NUMBER	LOGICAL_PORT	NETNAME
0	MEMBER	STARTED	hostA	hostA	NO	0	0	-
1	MEMBER	STARTED	hostB	hostB	NO	0	0	-
2	MEMBER	STARTED	hostC	hostC	NO	0	0	-
128	CF	PRIMARY	hostD	hostD	NO	-	0	-
129	CF	PEER	hostE	hostE	NO	-	0	-

HOSTNAME	STATE	INSTANCE_STOPPED	ALERT
hostA	ACTIVE	NO	YES
hostB	ACTIVE	NO	NO
hostC	ACTIVE	NO	NO
hostD	ACTIVE	NO	NO
hostE	ACTIVE	NO	NO

This output shows that hostA has an alert set on it. To gather more information about the alert, use the **db2cluster** command with the **-cm -list -alert** option. If the /var file system free space is less than 25 MB on any host, the following alert message will appear for that host:

```

Alert: Host name hostA has 10 MB free space available on /var file system. Failure
to write to /var due to no
space will result in DB2 cluster failure.

```

```

Action: The file system requires a minimum of 25 MB free disk space is available.
Free up space on /var file system.
The alert will be cleared automatically when a
sufficient amount of space becomes available on the filesystem.

```

```

Impact: DB2 Cluster Services may not function properly on the specified host and
may eventually lead to a DB2 instance failure.

```

Even though this alert is only informative, it is extremely important that you monitor this situation and take action to increase the file system space on the affected host.

Another possibility is that DB2 is unable to gather information about the /var file system usage for a host. In this case, the following alert message will appear for that host:

```

Alert: There was a failure to retrieve /var file system usage on host name
db2dev07. Check the db2diag.log for messages
concerning failures on host
'hostA' for /var file system.

```

```

Action: The failure needs to be resolved to clear the alert.

```

```

Impact: DB2 cluster will fail to write information about important errors and
events. This will cause DB2 cluster failure.

```

Because it is essential that the host file system usage is monitored, you should take action as soon as possible.

### Member or host without any alert

The output for the **db2instance -list** command shows no alerts for any members or hosts, but other problems might have occurred.

### Primary role moves between cluster caching facility hosts:

The primary role is not on the same host as the last time the **db2instance -list** command was run, that is, the primary role has moved to another cluster caching facility host. This host change indicates a problem with the cluster caching facility at some point in the past that might need to be investigated.

This is a sample output from the **db2instance -list** command showing a three member, two cluster caching facility environment:

ID	TYPE	STATE	HOME_HOST
0	MEMBER	STARTED	hostA
1	MEMBER	STARTED	hostB
2	MEMBER	STARTED	hostC
128	CF	PEER	hostD
129	CF	PRIMARY	hostE

CURRENT_HOST	ALERT	PARTITION_NUMBER	LOGICAL_PORT	NETNAME
hostA	NO	0	0	hostA-ib0
hostB	NO	0	0	hostB-ib0
hostC	NO	0	0	hostC-ib0
hostD	NO	-	0	hostD-ib0
hostE	NO	-	0	hostE-ib0

HOSTNAME	STATE	INSTANCE_STOPPED	ALERT
hostA	ACTIVE	NO	NO
hostB	ACTIVE	NO	NO
hostC	ACTIVE	NO	NO
hostD	ACTIVE	NO	NO
hostE	ACTIVE	NO	NO

Like members, each cluster caching facility will log information into the `cfdiag*.log` and dump more diagnostic data when required. The files will reside in the directory set by the database manager configuration parameter **cf\_diagpath** or if not set, the **diagpath** or `$INSTHOME/sqllib_shared/db2dump/ $m` by default.

- cluster caching facility Diagnostic Log Files (`cfdiag-timestamp.cf_id.log`)
  - Each of these files keep a log of the activities related to a cluster caching facility. Events, errors, warnings, or additional debugging information will be logged here. This log has a similar appearance to the **db2diag** log file. A new log is created each time a cluster caching facility starts.
  - Note that there is a single static cluster caching facility diagnostic log name that always points to the most current diagnostic logging file for each cluster caching facility and has the following format: `cfdiag.cf_id.log`
- cluster caching facility Output Dump Diagnostic Files (`cfdump.out.cf_pid.hostname.cf_id`)
  - These files contain information regarding cluster caching facility startup and stop. There might be some additional output shown here.
- Management LWD Diagnostic Log File (`mgmnt_lwd_log.cf_pid`)

- This log file displays the log entries of a particular cluster caching facility's LightWeight Daemon (LWD) process. Errors presented in this log file indicate the LWD has not started properly. A successful start will not have ERROR messages in the log.
- cluster caching facility stack files (CAPD.cf\_pid.tid.thrstk)
  - These are stack files produced by the cluster caching facility when it encounters a signal. These files are important for diagnosing a problem with the cluster caching facility.
- cluster caching facility trace files (CAPD.tracelog.cf\_pid)
  - A default lightweight trace is enabled for the cluster caching facility. These trace files appear whenever the cluster caching facility terminates or stops. These might indicate a problem with the cluster caching facility, only in combination with other diagnostic data can these files be useful in diagnosing any errors.

A startup and initialization message will be shown in the cluster caching facility dump files. For example, the message for cfdump.out.1548476.host04.128 contains the message that shows a successful process start:

```
CA Server IPC component Initialised: LWD BG buffer count: 16
      Session ID: 1d
CA Server IPC component Acknowledged LWD Startup Message
      Waiting for LWD to Configure Server
Processors: (4:4) PowerPC_POWER5 running at 1498 MHz
```

Cluster Accelerator initialized

```
Cluster Accelerator Object Information:
OS: AIX 64-bit
Compiler: x1C VRM (900)
SVN Revision: 7584
Built on: Oct 12 2009 at 17:00:54
Executable generated with symbols
Model Components Loaded: CACHE LIST LOCK
Transport: uDAPL
Number of HCAs: 1
Device[0]: hca0
CF Port[0]: 50638
Mgmt Port Type: TCP/IP
Mgmt Port: 50642
IPC Key: 0xe50003d
Total Workers: 4
Conn/Worker: 128
Notify conns: 256
Processor Speed: 1498.0000 MHz
```

In this example, cfdiag-20091109015035000037.128.log contains a successful process start. If the cluster caching facility did not start properly, this log might be either empty or contain error messages. For example:

```
2009-11-09-01.50.37.0051837000-300 E123456789A779 LEVEL : Event
PID : 688182 TID : 1
HOSTNAME : host04
FUNCTION : CA svr_init, mgmnt_cfstart
MESSAGE : CA server log has been started.
DATA #1 :
Log Level: Error
Debugging : active
Cluster Accelerator Object Information
AIX 64-bit
Compiler: x1C VRM (900)
SVN Revision: 7584
Built on Oct 12 2009 at 17:00:59
```

```

Executable generated with symbols.
Executable generated with asserts.
Model Components Loaded: CACHE, LIST, LOCK
Transport: uDAPL
Number of HCAs: 1
Device[0]: hca0
CF Port[0]: 50638
Total Workers: 4
Conn/Worker: 128
Notify conns: 256
Processor Speed: 1498.000000 Mhz.
Allocatable Structure memory: 170 MB

```

Look for the relevant cluster caching facility diagnostic log files by looking for the `cfdiag` log that has the same CF ID as the failed cluster caching facility. For example, if CF ID 128 failed (as it did in the previous `db2instance -list` command), use the following command:

```

$ ls cfdiag*.128.log

cfdiag.128.log -> cfdiag-20091109015035000215.128.log
cfdiag-20091110023022000037.128.log
cfdiag-20091109015035000215.128.log

```

Note that `cfdiag.128.log` always points to the most current `cfdiag` log for CF 128. Look into `cfdiag-20091109015035000037.128.log` (the previous `cfdiag` log) and the `db2diag` log file at a time corresponding to 2009-11-10-02.30.22.000215 for errors.

The system error log for the affected host can also be consulted if the cause of the error is still unknown. Log onto the unstarted cluster caching facility host and view the system error log by running the `errpt -a` command (on Linux, look in the `/var/log/messages` file). In the example shown here, log in to `hostD` because CF 128 experienced the failure.

### Multiple member restarts on the home host:

There are no apparent problems in the output of the `db2instance -list` command, and there are no alerts flagged in the `ALERT` column for either the members or the hosts. There might however exist a large or growing number of FODC directories, or space usage in the `diagpath` diagnostic dump directory (`$INSTHOME/sqllib/db2dump/ $m` by default) continues to grow at an abnormal pace (based on historical behavior).

This is a sample output from the `db2instance -list` command showing a three member, two cluster caching facility environment:

ID	TYPE	STATE	HOME_HOST	CURRENT_HOST	ALERT	PARTITION_NUMBER	LOGICAL_PORT	NETNAME
0	MEMBER	STARTED	hostA	hostA	NO	0	0	hostA-ib0
1	MEMBER	STARTED	hostB	hostB	NO	0	0	hostB-ib0
2	MEMBER	STARTED	hostC	hostC	NO	0	0	hostC-ib0
128	CF	PRIMARY	hostD	hostD	NO	-	0	hostD-ib0
129	CF	PEER	hostE	hostE	NO	-	0	hostE-ib0

HOSTNAME	STATE	INSTANCE_STOPPED	ALERT
hostA	ACTIVE	NO	NO
hostB	ACTIVE	NO	NO
hostC	ACTIVE	NO	NO
hostD	ACTIVE	NO	NO
hostE	ACTIVE	NO	NO

This symptom can be caused by a member restart on the home host. Ongoing or a repetition of problems causing multiple member restarts on the home host can lead to the growing space usage of the `diagpath` diagnostic dump directory (`$INSTHOME/sqllib/db2dump/ $m` by default)

- Check the *instance\_owner.nfy* log for information about when the failure occurred.
- Look for entries in this member's **db2diag** log file around this timestamp for more details on why the failure occurred.

**Note:** Check for error messages related to db2rstar in the **db2diag** log file.

- Look for FODC directories in the **diagpath** location (or `sqllib/db2dump/ $m` directory by default). If there are FODC directories see the related link to "First occurrence data capture information" for instructions on how to proceed.
- If there are no FODC directories and the cause of the error is still unknown, consult the system error log for the affected host.
  - Log in to each host
  - On AIX, run the **errpt -a** command to view the system error log.
  - On Linux, look in `/var/log/messages`
  - Look for evidence of a host reboot event, see "Diagnosing a host reboot with a restart light."

*Diagnosing a host reboot with a restart light:*

A host gets rebooted during runtime and a restart light has occurred. This identifies and gives details on how to diagnose the various situations that might have occurred.

## Diagnosis

This section describes how to identify a restart light that has occurred due to a host reboot.

A message will display in the db2diag log file showing a restart light event, for example

```
2009-11-02-22.56.30.416270-240 I6733A457 LEVEL: Event
PID      : 1093874          TID   : 1    KTID  : 2461779
PROC     : db2star2
INSTANCE:                   NODE   : 001
HOSTNAME: hostC
EDUID    : 1
FUNCTION: DB2 UDB, base sys utilities, DB2StartMain, probe:3368
MESSAGE  : Idle process taken over by member
DATA #1  : Database Partition Number, PD_TYPE_NODE, 2 bytes
          996
DATA #2  : Database Partition Number, PD_TYPE_NODE, 2 bytes
          1
```

A message might display in the AIX error log showing a reboot based on the time of the db2diag log file entry shown previously. Run **errpt -a** to access the AIX error log. The following scenarios are three possible reasons for this occurrence:

- **A user-initiated host shutdown and reboot has occurred.**

To determine whether this situation occurred, look in the AIX `errpt` log for an entry similar to the following one:

```
LABEL:          REBOOT_ID
IDENTIFIER:     2BFA76F6

Date/Time:     Mon Nov  2 22:56:28 EST 2009
Sequence Number: 11878
Machine Id:    00057742D900
Node Id:       coralpib17
```

Class: S  
Type: TEMP  
WPAR: Global  
Resource Name: SYSPROC

Description  
**SYSTEM SHUTDOWN BY USER**

Probable Causes  
**SYSTEM SHUTDOWN**

Detail Data  
USER ID  
0  
0=SOFT IPL 1=HALT 2=TIME REBOOT  
0  
TIME TO REBOOT (FOR TIMED REBOOT ONLY)  
0

In this example, a user has initiated the reboot.

- **Tivoli SA MP/RSCT initiated the reboot.**

To determine whether this situation occurred, look in the AIX errpt log for an entry similar to the following one:

LABEL: TS\_CRITICAL\_CLNT\_ER  
IDENTIFIER: 75FA8C75

Date/Time: Tue Mar 31 10:58:49 EDT 2009  
Sequence Number: 358837  
Machine Id: 0006DA8AD700  
Node Id: coralp08  
Class: S  
Type: PERM  
WPAR: Global  
Resource Name: cthats

Description  
Critical client blocked/exited

Probable Causes  
Group Services daemon was blocked too long or exited

Failure Causes  
Group Services daemon blocked: resource contention  
Group Services daemon blocked: protocol problems  
Group Services daemon exited: internal failure  
Group Services daemon exited: critical client failure

Recommended Actions  
Group Services daemon blocked: reduce system load  
Group Services daemon exited: diagnose Group Services

Detail Data  
DETECTING MODULE  
rsct,monitor.C,1.124.1.3,5520  
ERROR ID  
6plcyp/dyWo7/1Sx/p3k37.....  
REFERENCE CODE

Critical client - program name  
hagsd  
Failure Code  
BLOCKED  
Action  
**NODE REBOOT**



In this example, RSCT has rebooted the host to protect critical resources in the cluster.

- **A kernel panic caused a reboot.**

Reviewing a `KERNEL_PANIC` message in the AIX errpt log, or the message written before it, can help identify the underlying trigger of a kernel panic. If the `LABEL`, `PANIC STRING`, or `Detail Data` fields in the message contain `MMFS_*` (For example, `MMFS_GENERIC`, `MMFS_PHOENIX`), then this can indicate GPFS is the trigger. Similarly, if any of the fields contain `TS_*` or `RSCT*`, then this can indicate that Tivoli SA MP is the trigger. To determine whether this situation occurred, look in the AIX errpt log for an entry similar to the following one:

```

LABEL:          KERNEL_PANIC
IDENTIFIER:     225E3B63

Date/Time:      Mon May 26 08:02:03 EDT 2008
Sequence Number: 976
Machine Id:     0006DA8AD700
Node Id:        coralpib08
Class:          S
Type:           TEMP
Resource Name:  PANIC

Description
SOFTWARE PROGRAM ABNORMALLY TERMINATED

Recommended Actions
PERFORM PROBLEM DETERMINATION PROCEDURES
  
```

For further details, see the Related Reference.

## Troubleshooting

If the affected host is online, run the `db2instance -list` command. If the `db2instance -list` shows that the member is reported as `WAITING_FOR_FAILBACK`, look for alerts in the output. Check the alert(s), you might have to clear an alert before the member can fail back to its home host. If there is still no failback, see “A member cannot restart on the home host after a successful restart light” on page 633.

*GPFS filesystem outage with a kernel panic:*

A kernel panic has occurred on a member host that is due to a IBM General Parallel File System ( GPFS) trigger. The trigger repeats on a sporadic but recurring basis.

## Symptoms

The output of the `db2instance -list` command includes a pending failback operation, as shown in the following example:

ID	TYPE	STATE	HOME_HOST	CURRENT_HOST	ALERT	PARTITION_NUMBER	LOGICAL_PORT	NETNAME
0	MEMBER	WAITING_FOR_FAILBACK	hostA	hostB	NO	0	1	hostB-ib0
1	MEMBER	STARTED	hostB	hostB	NO	0	0	hostB-ib0
2	MEMBER	STARTED	hostC	hostC	NO	0	0	hostC-ib0
128	CF	PRIMARY	hostD	hostD	NO	-	0	hostD-ib0
129	CF	PEER	hostE	hostE	NO	-	0	hostE-ib0

HOSTNAME	STATE	INSTANCE_STOPPED	ALERT
hostA	INACTIVE	NO	YES
hostB	ACTIVE	NO	NO
hostC	ACTIVE	NO	NO
hostD	ACTIVE	NO	NO
hostE	ACTIVE	NO	NO

In the previous example, hostA has a state of INACTIVE, and an ALERT field is marked as YES. This output of the **db2instance -list** command is seen when hostA is offline or rebooting. Since the home host for member 0, hostA is offline, member 0 has failed over to hostB. Member 0 is now waiting to failback to its home host, as indicated by the WAITING\_FOR\_FAILBACK state. After hostA is rebooted from the panic, member 1 will fail back to hostA.

## Diagnosis

When you check the db2diag log file, you can find many log entries that indicate that a restart light operation has occurred, as shown in the following example:

```
2009-08-27-23.37.52.416270-240 I6733A457          LEVEL: Event
PID      : 1093874          TID : 1          KTID : 2461779
PROC     : db2star2
INSTANCE:                   NODE : 000
HOSTNAME: hostB
EDUID    : 1
FUNCTION: DB2 UDB, base sys utilities, DB2StartMain, probe:3368
MESSAGE : Idle process taken over by member
DATA #1 : Database Partition Number, PD_TYPE_NODE, 2 bytes
          996
DATA #2 : Database Partition Number, PD_TYPE_NODE, 2 bytes
          0
```

Another way to diagnose this type of problem is to check the system log. Run the OS command **errpt -a** to view the contents of the AIX errpt system log. In the AIX errpt log, you might see log entries similar in the following example, which is for hostA:

```
LABEL:          KERNEL_PANIC
IDENTIFIER:     225E3B63

Date/Time:      Mon May 26 08:02:03 EDT 2008
Sequence Number: 976
Machine Id:     0006DA8AD700
Node Id:        hostA
Class:          S
Type:           TEMP
Resource Name:  PANIC
```

```
Description
SOFTWARE PROGRAM ABNORMALLY TERMINATED
```

```
Recommended Actions
PERFORM PROBLEM DETERMINATION PROCEDURES
```

```
Detail Data
ASSERT STRING
5.1: xmemout succeeded rc=d
```

```
PANIC STRING
kx.C:2024:0:0:04A53FA8::adv0bjP == ofP->advLk0bjP
```

If you see a KERNEL\_PANIC log entry as shown in the previous example, the system reboot might be due to an operating system kernel panic that was triggered by a problem in the GPFS subsystem. A kernel panic and system reboot can be the result of excessive processor usage or heavy paging on the system when the GPFS daemons do not receive enough system resources to perform critical tasks. If you experience GPFS filesystem outages that are related to kernel panics, the underlying processor usage or paging issues must be resolved first. If you cannot resolve the underlying issues, run the **db2support** command for the database with

the **-s** parameter to collect diagnostic information and contact IBM Technical Support.

---

## Troubleshooting options for the **db2cluster** command

The advanced help menu of the **db2cluster** command lists a number of options that can help diagnose and troubleshoot issues with the cluster manager or the shared file system cluster. It is recommended that you only use these options with the guidance of Service.

### Repairing the cluster manager resource model

If there are inconsistencies between the cluster manager resource model and the `db2nodes.cfg` file, attempts to start the DB2 pureScale instance or new resources fail. In this situation, you must repair the cluster manager resource model and reissue the **db2start** command.

#### Before you begin

The DB2 instance must be completely stopped before running this command.

#### About this task

This task shows you how to repair the cluster manager resource model after it has been detected that there are inconsistencies between the `db2nodes.cfg` file and the cluster manager (usually when **db2start** fails). These inconsistencies occur if any of these situations have occurred:

- The `db2nodes.cfg` file was manually edited
- The resource model was manually edited
- An attempt to add or drop a node failed

The **db2cluster** command is used to remove and re-create the resource model by using information stored in an internal file.

To perform this operation, you must be a user in the SYSADM, SYSCTL, or SYSMANT group.

#### Procedure

To repair the cluster manager resource model, issue this command from an online host:

```
db2cluster -cm -repair -resources
```

#### Results

If the cluster resource model cannot be repaired, contact an IBM Service Representative for more information about how to recover from this problem.

### Repairing the cluster manager domain

If a failure situation occurs with a DB2 pureScale instance which requires the cluster manager domain to be re-created, use the **db2cluster** command to re-create it.

## Before you begin

The DB2 instance must be stopped before performing this task; all nodes in the cluster must be online.

## About this task

Use the **db2cluster** command to remove and re-create the domain and the resource model of the instance.

The domain is re-created using the same topology and configuration as the existing domain (such as the cluster services tiebreaker, host failure detection time).

Restrictions

The command used in this task can only be run as the DB2 cluster services administrator.

## Procedure

1. Use the **DB2INSTANCE** environment variable to specify the target instance.  
`export DB2INSTANCE=<inst-name>`
2. Issue the **db2cluster** command with the **-repair -cluster** option.  
`db2cluster -cm -repair -domain <domain-name>`

If there are any resources still online, **db2cluster** fails and issues a message indicating that the command must be reissued using the **-force** option.

## Results

After successful re-creation of the cluster manager domain, bring the instance back online using the **db2start** command.

If the cluster manager domain cannot be successfully re-created, contact an IBM Service Representative for more information about how to recover from this problem. You might be asked to provide the original cluster manager configuration information, which **db2cluster** saves to a text file (`/tmp/ibm.db2.db2cluster_cm_repar_domain_config_<TIMESTAMP>`) before it tears down the cluster manager domain.

## Example

A DBA with DB2 cluster services authority needs to re-create a cluster manager domain, MYDOMAIN, in DB2 instance MYINST.

```
export DB2INSTANCE=myinst1
db2cluster -cm -repair -domain mydomain
```

As the domain is torn down and re-created, **db2cluster** issues informational messages about the progress and the successful completion of the operation:

```
Deleting the domain 'mydomain' from the cluster ...
Deleting the domain 'mydomain' from the cluster was successful.
Creating domain 'mydomain' in the cluster ...
Creating domain 'mydomain' in the cluster was successful.
Configuring quorum device for domain 'mydomain' ...
Configuring quorum device for domain 'mydomain' was successful.
```

The host failure detection time has been set to 8 seconds.  
The resource model for the instance 'myinst1' has been re-created.  
The cluster manager domain has been successfully repaired.

## Setting the unhealthy host response

In rare situations, it is possible that excessive load or paging on a single host in the cluster impacts throughput or availability in the rest of the cluster.

The standard response to this situation is make configuration or hardware changes to increase memory; however, if that is not possible, you can also specify that automatic corrective action is taken, an *unhealthy host response*, to prevent any impact on the cluster.

### Before you begin

To perform this task, you need to be the DB2 cluster services administrator.

### About this task

By default, DB2 cluster services takes no action if this unhealthy host problem occurs; no information related to this unhealthy host feature is written to the log and you must use other tools to monitor the relevant system specifics related to the unhealthy hosts. This task describes how to specify that when this problem is detected, one of two actions automatically occurs:

#### reboot the host

This reboots the host, forcing any member on that host to restart in light mode on another host and any primary cluster caching facility to fail over the primary role to the secondary cluster caching facility. After the reboot is complete, any resident member restarts on that host (unless automatic failback is disabled), and any cluster caching facility restarts as the secondary cluster caching facility. Because this provides the strongest assurance that the issues on the unhealthy host will have the least impact on the rest of the cluster, this is the preferred option.

#### offline the member or cluster caching facility

This takes any member or cluster caching facility on the host offline. Any processes on the member are stopped and it will restart in light mode on another host. If the primary cluster caching facility is on that host, the secondary cluster caching facility will take over the primary role. An alert is raised that needs to be cleared manually for the member to failback or for the cluster caching facility to start again. This option is suitable if there are other things on the host that you do not want to be impacted or if you want to keep the host available for diagnosing the problem. The manual clearing of the raised alert is also a possible reason for choosing this option.

It bears repeating that setting this option is really a last-resort response for preventing unplanned cluster issues. If you suspect that this unhealthy host state might occur, the best response is to add memory resources to the host.

## Procedure

To set up the unhealthy host response:

- If you want to automatically reboot the host, issue the following command:  
`db2cluster -cm -create -unhealthy_host_response -option -reboot_host -option -apply_to_current_host`

- If you want to automatically take any member or cluster caching facility on the host offline, issue the following command:

```
db2cluster -cm -create -unhealthy_host_response -option -offline_member -option
-apply_to_current_host
```

## Results

If you specified host reboot as the automatic response and the host is successfully rebooted, then any member should be restarted on the host. After a reboot, the member should be restarted on the host, unless automatic failback is disabled. Any cluster caching facility on the host should be restarted on the host, but if it was previously the primary cluster caching facility on the host, it will now be the secondary cluster caching facility on the host. Information about the reboot event is written to the **syslog** file. For more information, see the “Related links” section.

If you specified that the member or cluster caching facility should be taken offline and this does occur, the member or cluster caching facility will have an alert on it. The offlined member will not restart on or failback to its home host until this alert is removed. The offlined cluster caching facility will not restart until this alert is removed.

---

## Uninstallation

This section contains information that will help you understand and resolve problems that you might encounter while uninstalling the IBM DB2 pureScale Feature.

### Cleaning up an incomplete DB2 pureScale instance drop

When the **db2idrop** command has failed to completely drop the instance, you must complete the clean up of a DB2 pureScale instance.

#### Procedure

To clean up an incomplete DB2 pureScale instance drop:

1. Remove the RSCT Peer Domain (PD) forcefully:

- Try to run `rmrpdomain -f domain_name`.

If you do not know what the domain name is, run **lsrpdomain** and look for the domain name under the Name column.

```
$ lsrpdomain
Name      OpState RSCTActiveVersion MixedVersions TSPort  GSPort
db2domain Online  2.5.3.5           No           12347  12348
```

2. Clean up the DB2 cluster file system.
3. Clean up `$HOME/sqllib` for the instance user on all hosts.
4. Clean up the entries in `/etc/services` for the DB2 pureScale instance user.
5. Remove instance signature  
`installed_path/instance/db2iset -d instance_name`
6. Remove following global registries on all hosts:

- INSTPROF
- PEER\_DOMAIN

For example

```
installed_path/bin/db2greg -del varrec
service=GPFSC_CLUSTER,variable=NAME,installpath=-
```

```

installed_path/bin/db2greg -delvarrec
service=PEER_DOMAIN,variable=NAME,installpath=-
installed_path/bin/db2greg -delvarrec
service=DEFAULT_INSTPROF,variable=DEFAULT,installpath=-
installed_path/bin/db2greg -delvarrec
service=INSTPROF,variable=<instance name>,installpath=-

```

## Cleaning up an IBM Reliable Scalable Cluster Technology peer domain

This topic will guide you through the required steps to manually clean up a Reliable Scalable Cluster Technology (RSCT) peer domain. Uninstalling DB2 Enterprise Server Edition with IBM DB2 pureScale Feature will normally handle the removal of RSCT. Follow these steps if an unexpected error occurs and a manual cleanup is required.

### About this task

The **db2idrop -g** command should automatically remove the IBM Reliable Scalable Cluster Technology (RSCT) peer domain. The following manual steps are needed only when problems occur.

### Procedure

1. List all of the existing peer domains by running the **lsrpdomain** command. The output of this command should be similar to the following:

```
lsrpdomain
```

If nothing is listed, there is no active peer domain. Only one RSCT peer domain can be active (online) at any given time, and any operations (stopping, removing, or adding a node) will only affect this online domain.

2. List all of the nodes in this active peer domain by running the **db2cluster -cm -list -host -state** command. The output of this command should be similar to the following:

```

HOSTNAME  STATE
-----  -
coralpib135  ONLINE
coralpib136  ONLINE

```

3. Remove the entire peer domain, including all nodes. The peer domain must be online for the following command to be successful. Run the **db2cluster -cm -delete -domain db2domain** command. The output of this command should be similar to the following:

```

Deleting the domain db2domain from the cluster ...
Deleting the domain db2domain from the cluster was successful.

```

4. To confirm that the peer domain has been removed appropriately, run the **db2cluster -cm -list -domain** command.

## Frequently asked questions about uninstallation problems with the DB2 pureScale Feature

Use this topic to determine possible solutions to problems with uninstalling the IBM DB2 pureScale Feature.

## What if the `db2idrop` command failed to remove the host from the GPFS cluster?

To help determine the cause of the failure, review the `db2cluster` command log file in the `DB2DIR/tmp/ibm.db2.cluster.*` directory. After resolving the problem, reissue the `db2idrop` command.

## What if the `db2idrop` command failed because the instance is not usable?

To help determine the cause of the failure, review the `db2idrop` command log in the `DB2DIR/tmp` directory. Check if `instance_user/sql1lib/db2nodes.cfg` is valid.

## What if the `db2idrop` command failed when removing the GPFS CLUSTER global registry (or the PEER DOMAIN global registry) on specific hosts?

If this failure occurs, contact IBM Software Support.

## What if the `db2idrop` command failed to remove the RSCT peer domain?

If the `db2idrop` command failed to remove the RSCT peer domain, you will have to manually remove it by following these steps:

1. Check if there is still resource attached to the peer domain by running the `lssam` command.
2. If there are still resources attached, perform the following steps:
  - a. Switch to the instance owner by entering `su - instance_owner`.
  - b. Remove the resource by entering `db2cluster -cm -delete -resources`.
  - c. Switch back to root.
3. Remove RSCT peer domain by running the `db2cluster -cm -delete -domain domain_name` command from the `DB2DIR/bin` directory. Run the `lsrpdomain` command to determine the domain name to specify.

For more information, see Manually cleaning up an IBM Reliable Scalable Cluster Technology peer domain.

## What if the `db2_deinstall` command failed?

The `db2_deinstall` command can uninstall DB2 database products, features, or languages on the host where the `db2_deinstall` command is run. The `db2_deinstall` command might fail because the host is still part of the GPFS cluster or the host still belongs to the RSCT peer domain. If the host is still part of the GPFS cluster, run the `db2_deinstall -s GPFS` command to remove it.

If there still exists a DB2 pureScale instance, you can use the `db2iupdt -drop` or `db2idrop -g` command to remove the DB2 pureScale instance. Then rerun the `db2_deinstall` command.

If you want to keep the peer domain, you can bypass the IBM Tivoli System Automation for Multiplatforms binary file removal by running the `db2_deinstall -a -s TSAMP`. If there are no resources using the peer domain on this host, before reissuing the command, manually remove the Tivoli SA MP.



---

## Chapter 8. Troubleshooting DB2 Text Search

Troubleshooting and maintenance tasks for DB2 Text Search include, for example, deleting orphaned text search collections and adjusting log and trace properties.

There are three resources that can help you perform problem determination for DB2 Text Search: the event table, the **db2trc** command, command, and the log and trace facilities of the DB2 Text Search server.

---

### Using the DB2 trace facility for text search operations

If you need to report an error to an IBM representative, you might be asked to switch on tracing so that information can be written to a file that can be used for locating the error.

#### About this task

You can use the DB2 tracing facility, **db2trc**, to capture information about the problems that might occur while you are performing text searches or administrative operations associated with text searches.

Because system performance is affected when tracing is switched on, use the trace facility only when directed by an IBM Support Center representative or by your technical support representative.

To turn tracing on and receive information specific to DB2 Text Search, run the **db2trc** command using a mask with a component code for CIE (155), as follows:

```
db2trc on -m '*.*.CIE.*.*'
```

To help diagnose severe errors, it might also help to look in the **db2diag** log file.

Additional tracing facilities are available for the Text Search server. For details, see the topic about logging and tracing for the DB2 Text Search server.

---

### Logging and tracing for the DB2 Text Search server

The DB2 Text Search server logs system messages and trace messages to help you determine the source of problems that might occur. Diagnostic data that you collect, and the sources from which you collect that data, depend on the type of problem that you are investigating.

For specific symptoms, you might need to collect additional problem-specific data from the following locations:

- *<install-path>*
- *<DBPATH>/db2tss* for the integrated text search server
- *<ECMTS\_HOME>* for the stand-alone text search server
- *<absolute-path-to-config-folder>* the location for configuration files for the text search server
- *<collection-path>* the directory specified as COLLECTION DIRECTORY in the CREATE INDEX operation (only for integrated text search servers), or if the default is used, in the defaultDataDirectory (for integrated and stand-alone text search servers).

- 

To collect diagnostic data for the stand-alone DB2 Text Search server:

1. Run the administration tool with the version command:  
`adminTool version -configPath <absolute-path-to-config-folder>`
2. Collect log files that are stored in the `logpath` configured for the text search server.
3. In some cases you might want to capture more detailed information:
  - Configure command-line tool logging properties by editing the `ecmts_config_logging.properties` file in the directory `<absolute_path_to_config_folder>`.
  - Configure trace logging properties by editing the `ecmts_logging.properties` file in the directory `<absolute_path_to_config_folder>`.
  - Enable tracing by using the `adminTool` command  
`adminTool configureTrace -configPath <absolute-path-to-config-folder> -trace on`
4. Gather the following configuration files from the `<absolute-path-to-config>` directory:
  - a. `config.xml`
  - b. `jetty.xml`
  - c. `key.txt`
  - d. `authentication.xml`
  - e. `constructors.xml`
5. If you encounter a collection-related issue when creating, deleting, indexing, or searching a collection, locate the collection configuration file in the `<collection-path>` directory, and if required, collection data from the `<collection-path>/data` directory
6. If you encounter an issue that is related to stop words, collect the stop word XML files from the `<install-path>/resource/uima` folder.  
Stop word XML files are named as `<language_code>-Stw.xml`.
7. If you encounter an issue that is related to synonyms, collect the synonyms from the `<collection-path>/data/synonym` directory.

---

## Monitoring queues for DB2 Text Search index updates

You can gather monitoring information which can be used to tune the DB2 Text Search server configuration if you experience indexing performance issues.

You can monitor input and output queues by starting the DB2 Text Search server with the `-monitorQueues` flag. When you start the server with the `-monitorQueues` flag, information about the current state of the input and output queues is printed to the `InputQueueSizes.csv` and `OutputQueueSizes.csv` files. These files are stored in the `ECMTS_HOME\logs` directory. Each file provides the following information:

- The time.
- The current number of documents that are waiting to be preprocessed and indexed.
- The number of documents that are currently being preprocessed and indexed.
- The current queue size. The maximum queue size is a configurable parameter.
- The total number of documents that passed through the queue, that is, the number of documents that were preprocessed and indexed since the last server startup.

**Important:** The CSV files are recreated each time the server is started. If you want to store the information in these files, back them up before you restart the server.

To start the server in monitor queue mode:

1. Stop the server.
2. and edit the startup script in the *ECMETS\_HOME\bin* directory.
3. Add the `-monitorQueues` flag to one of the startup commands. For example:
 

```
"%JAVA_HOME%\bin\java" -classpath "%CLASSPATH%"
com.ibm.es.nuvo.launcher.Launcher "%CONFIG_XML%" -monitorQueues
-Xmx%HEAP_SIZE% %1 %2 %3 %4 %5 %6 %7 %8 %9 %IPv6Flag% %JVM_OPTIONS%
```
4. Save the startup script and restart the server.

Use the information in the following table to troubleshoot indexing performance based on queue status.

*Table 89. Troubleshooting indexing performance based on queue status*

Queue status	Troubleshooting strategy
Input queue is empty	Documents are not being received from the client. Ensure that the client is pushing documents fast enough to the server.
Input queue is full, output queue is empty	Check the logs for preprocessing errors and consider increasing the number of preprocessing threads. Low CPU levels (less than 60%) on servers in a large multiprocessor system can also indicate that the number of preprocessing threads should be increased. The number of preprocessing threads should not exceed the number of processors. In a distributed architecture, ensure that each preprocessing server is running and is configured correctly. For example, verify that the connection parameters (indexing server host name, port number, and token) are configured correctly on each preprocessing server. You can check the connectivity by monitoring the input queue on each preprocessing server to ensure that documents are received. You can also try to increase the number of preprocessing threads on each preprocessing server.

Table 89. Troubleshooting indexing performance based on queue status (continued)

Queue status	Troubleshooting strategy
Both input and output queues are full	<p>Try one or more of the following strategies:</p> <ul style="list-style-type: none"> <li>• Increase the number of index threads.</li> <li>• Configure more frequent, shorter merges by reducing the value of the <b>MaxMergeDocs</b> parameter in the <code>ECMTS_HOME\config\collections\collection_name\collection.xml</code> file.</li> <li>• Increase the batch size. Indexing documents in small batches can degrade performance, since the index is flushed and saved to disk for every batch that is indexed.</li> <li>• Increase the <b>BufferSize</b> parameter in the <code>ECMTS_HOME\config\collections\collection_name\collection.xml</code> file.</li> <li>• Index one collection at a time</li> <li>• Ensure that the disk speed and network connection is fast enough.</li> </ul>

## Troubleshooting hints and tips for DB2 Text Search

Use the information in the following table to help troubleshoot problems.

Table 90. Issues and solutions

Issue	Solution
If you drop and re-create a text index while a DB2 connection session is active, a plan for a previously used query (for Net Search Extender or DB2 Text Search) might be cached and reused, thus producing incorrect results. If the DB2 Text Search engine encounters this issue, <code>IQQG0037W</code> will be returned, indicating that an incorrect collection name was used for the search.	Use the <code>FLUSH PACKAGE CACHE DYNAMIC</code> statement to remove the execution plans for the SQL statements from the statement cache.
If you drop or update your DB2 instance using the <code>db2idrop</code> , <code>db2iupdt</code> , or <code>db2iupgrade</code> command, the entire <code>sqllib</code> directory in the instance is removed, including the <code>sqllib/db2tss/config</code> directory. This will make it hard to reuse text search instance databases.	Back up the <code>sqllib/db2tss/config</code> directory before issuing the <code>db2idrop</code> , <code>db2iupdt</code> , or <code>db2iupgrade</code> command. Also, use the <code>printAll</code> option of the <code>configTool</code> command to save a record of the configuration parameters, which should help you to configure the new instance.
A disk full error might cause the text index metadata to be inconsistent.	Use the Administration Tool to check whether there are any orphaned collections and to remove them, as outlined in “Deleting orphaned Text Search collections” in the DB2 Text Search documentation. Note that you might not be able to reuse the text index name that was being used when you encountered the disk full error.

Table 90. Issues and solutions (continued)

Issue	Solution
<p>You receive the message CIE00301 "Insufficient authority" or CIE00377 "Only instance owner &lt;instance-owner&gt; can use that command" after issuing a db2ts <b>START FOR TEXT</b> command.</p>	<p>For Windows users, have a user with sufficient authorization issue db2ts <b>START FOR TEXT</b>. For Linux and UNIX, have the instance owner issue this command.</p>
<p>If the Text Search server encounters a disk full error, it might return the following error message:            IQQD0085E The requested operation cannot be done. The server is running in safe mode due to index has an IO error.</p>	<p>The DB2 Text Search server is running in a restricted mode. Shutdown the text search server, and restart it after resolving the disk space issue.</p>
<p>You receive the message CIE00311 telling you that an internal file cannot be opened. This message can indicate a missing configuration directory, or indicate that a file may have been lost or corrupted, for example, due to a disk full error on the filesystem where db2tss/config is located, or because of a problem during the backup of the db2tss/config directory.</p>	<p>Check to see if the instance has a config directory for text search.</p> <ul style="list-style-type: none"> <li>• If the config directory is missing ensure that DB2 Text Search was installed and configured.</li> <li>• If the config directory is in another location, add a symbolic link to it (UNIX).</li> </ul> <p>If this error is being caused by a missing or corrupted file, contact IBM Support.</p>
<p>You receive the message CIE00445N telling you that the requested operation cannot be executed. Run the <b>REBIND</b>. This message can indicate that one of the previous DB2 commands has invalidated packages "NULLID.SYSSH100, NULLID.SYSSH200, NULLID.SYSSN100, NULLID.SYSSN200 or NULLID.SYSLH202" which is required for DB2 Text Search.</p>	<p>User needs to manually rebind the package "NULLID.SYSSH100, NULLID.SYSSH200, NULLID.SYSSN100, NULLID.SYSSN200 or NULLID.SYSLH202". before continuously executing db2ts commands. The package invalidation usually occurs when revoke or grant commands are executed.</p> <p>User can prevent running into this error by checking the packages state through the following SQL statement:</p> <pre>select 1 from syscat.packages where VALID = 'N' AND ((PKGSHEMA='NULLID' AND PKGNAME= 'SYSSH100') OR (PKGSHEMA='NULLID' AND PKGNAME= 'SYSSH200') OR (PKGSHEMA='NULLID' AND PKGNAME= 'SYSSN100') OR (PKGSHEMA='NULLID' AND PKGNAME= 'SYSSN200') OR (PKGSHEMA='NULLID' AND PKGNAME= 'SYSLH202')) FETCH FIRST 1 ROWS ONLY FOR READ ONLY;</pre> <p>If the return value is 1 through this SQL statement, user needs to rebind the packages NULLID.SYSSH100, NULLID.SYSSH200, NULLID.SYSSN100, NULLID.SYSSN200 or NULLID.SYSLH202 before executing DB2 Text Search commands.</p>
<p>A text index update with a large number of documents to process fails with an 'insufficient memory' message in the db2diag.log file.</p>	<p>If it is not feasible to increase available memory, decrease the documentqueueresultsize value in sysibmts.tsdefaults administrative view and try again.</p>

Table 90. Issues and solutions (continued)

<b>Issue</b>	<b>Solution</b>
You encounter message <code>IQQG0037W</code> message in a query about a missing collection after a data redistribution.	Ensure that the <code>FOR DATA REDISTRIBUTION</code> option is used the next time a text search <code>UPDATE INDEX</code> command is issued.

---

## Chapter 9. Learning more about troubleshooting

At some point when working with DB2 database products, you may encounter a problem. This problem might be reported by the database manager, by an application running against the database, or by your users as they give feedback to you that “something is not quite right” with the database.

The concepts and tools presented here are to introduce you to, and to help you with, the task of troubleshooting a real or perceived problem in the operations of your database. The importance of capturing the right data at the right time is emphasized and so first occurrence data capture is the first tool discussed. Other logs and files that are used by the database manager to capture data about the operations of the database are presented including mention of operating system diagnostic tools.

---

### Learning more

The following topics can help you to acquire the conceptual information that you need to effectively troubleshoot problems with the DB2 product:

- About troubleshooting

Troubleshooting is a systematic approach to solving a problem. The goal is to determine why something does not work as expected and how to resolve the problem.

- About the diagnostic data directory path

Depending on your platform, DB2 diagnostic information contained in a dump file, trap file, diagnostic log file, administration notification log file, alert log file, and first occurrence data collection (FODC) package can be found in the diagnostic data directory specified by the **diagpath** database manager configuration parameter.

- About administration notification log files

The DB2 database manager writes the following kinds of information to the administration notification log: the status of DB2 utilities such as **REORG** and **BACKUP**; client application errors; service class changes, licensing activity; log file paths and storage problems; monitoring and indexing activities; and table space problems. A database administrator can use this information to diagnose problems, tune the database, or monitor the database.

- About DB2 diagnostic (db2diag) log files

With the addition of administration notification log messages being logged to the **db2diag** log files using a standardized message format, viewing the **db2diag** log files is an excellent first task in understanding what has been happening to the database.

- About platform-specific error logs

There are many other files and utilities available outside of DB2 to help analyze problems. Often they are just as important to determining root cause as the information made available in the DB2 files.

- About messages

Learning more about messages can help you to identify an error or problem and resolve the problem by using the appropriate recovery action. This information can also be used to understand where messages are generated and logged.

- About internal return codes

There are two types of internal return codes: ZRC values and ECF values. They are displayed in DB2 trace output and in the **db2diag** log files. ZRC and ECF values are typically negative numbers and are used to represent error conditions.

- About dump files

Dump files are created when an error occurs for which there is additional information that would be useful in diagnosing a problem (such as internal control blocks). Every data item written to the dump files has a timestamp associated with it to help with problem determination. Dump files are in binary format and are intended for DB2 customer support representatives.

- About trap files

DB2 generates a trap file if it cannot continue processing because of a trap, segmentation violation, or exception. All signals or exceptions received by DB2 are recorded in the trap file. The trap file also contains the function sequence that was running when the error occurred. This sequence is sometimes referred to as the "function call stack" or "stack trace." The trap file also contains additional information about the state of the process when the signal or exception was caught.

- About first occurrence data capture (FODC)

First occurrence data capture (FODC) is the process used to capture scenario-based data about a DB2 instance. FODC can be invoked manually by a DB2 user based on a particular symptom or invoked automatically when a predetermined scenario or symptom is detected. This information reduces the need to reproduce errors to get diagnostic information.

- About callout script (db2cos) output files

A db2cos script is invoked by default when the database manager cannot continue processing due to a panic, trap, segmentation violation or exception.

- About combining DB2 and OS diagnostics

Diagnosing some problems related to memory, swap files, CPU, disk storage, and other resources requires a thorough understanding of how a given operating system manages these resources. At a minimum, defining resource-related problems requires knowing how much of that resource exists, and what resource limits might exist per user.

## Diagnostic data directory path

Depending on your platform, DB2 diagnostic information contained in a dump file, trap file, diagnostic log file, administration notification log file, alert log file, and first occurrence data collection (FODC) package can be found in the diagnostic data directory specified by the **diagpath** or **alt\_diagpath** database manager configuration parameters.

### Overview

The specification of the diagnostic data directory path or the alternate diagnostic data directory path, using the **diagpath** or **alt\_diagpath** database manager configuration parameters, can determine which one of the following directory path methods can be used for diagnostic data storage:

#### Primary diagnostic data directory path

All diagnostic data for the DB2 instance is stored within a single directory, no matter whether the database is partitioned or not. In a partitioned database environment, diagnostic data from different partitions within the host is all dumped to this single diagnostic data directory path. This single



diagnostic data directory path is the default condition when the **diagpath** value is set to null or any valid path name without the \$h or \$n pattern identifiers.

### Alternate diagnostic data directory path

The **alt\_diagpath** database manager configuration parameter is an alternate diagnostic data directory path that provides a secondary path for storing diagnostic information. The path specified by the **alt\_diagpath** parameter is used only when the database manager fails to write to the path specified in **diagpath** and ensures that important diagnostic information is not lost. For the alternate diagnostic data directory path to be available, you must set the **alt\_diagpath** configuration parameter. For greater resiliency, it is recommended that you set this parameter to a path that is on a different file system than **diagpath**.

### Split diagnostic data directory paths

For partitioned database environments, diagnostic data can be stored separately within a directory named according to the host, database partition, or both. Therefore, each type of diagnostic file, within a given diagnostic directory, contains diagnostic information from only one host, or from only one database partition, or from both one host and one database partition. To split both the diagnostic data directory path and the alternate diagnostic data directory path, you must follow the procedure for splitting once for **diagpath** then again for **alt\_diagpath**.

## Benefits

The benefits of specifying the diagnostic data directory path are as follows:

- Diagnostic information, from several database partitions and hosts, can be consolidated in a central location for easy access by setting a single diagnostic data directory path.
- Diagnostic logging performance can be improved because of less contentions on the **db2diag** log file if you split the diagnostic data directory path per host or per database partition.

The benefits of specifying a secondary diagnostic data path, **alt\_diagpath**, are:

- Increased resiliency to the loss of important diagnostic information.
- Compatibility with some tools used for **diagpath** such as splitting.

## Merging files and sorting records

Merging and sorting records of multiple diagnostic files of the same type, based on timestamps, can be done with the **db2diag -merge** command in the case of a split diagnostic data directory path. For more information, see: “db2diag - db2diag logs analysis tool command” in the *Command Reference*.

## Space requirements for diagnostic data

Diagnostic data collection in the path specified by the **diagpath** parameter can generate large volumes of diagnostic information, especially if core file dumps and first occurrence data capture (FODC) data is not redirected to a separate directory path or if you use a single **db2diag.log** file that grows in size indefinitely. Enough space must be available to store the diagnostic data, and you must perform regular house keeping in the diagnostic path to ensure sufficient space remains available.

You can use the following recommendations when configuring diagnostic data logging on your data server to make sure space requirements for diagnostic data are met:

#### **Meet minimum space requirements for diagnostic**

The minimum amount of free space available in the diagnostic directory path should be two times the amount of physical memory installed on the machine (minimum free space = 2x physical memory). For example, if a machine has 64 GB of physical memory installed, a minimum of 128 GB of space for diagnostic data should be available in the file system.

#### **Redirect core file dumps and FODC data to a different directory path**

Both core file dumps and FODC data can consume significant disk space quickly and both send data to the directory path specified by the **diagpath** database manager configuration parameter by default. To keep more space available in the diagnostic directory path, core file dumps and FODC data can be redirected to a different directory path or file system. You can control where core files are generated through the *DB2FODC* registry variable by setting the *DUMPDIR* variable to point to a directory path that is different from **diagpath**. Similarly, you can control where FODC package directories are created by setting *FODCPATH* variable to point to a different directory path.

#### **Move or remove files that are no longer needed**

If you run the `db2support` command without specifying an output path that is different than **diagpath**, the resulting compressed archive is stored in the diagnostic directory path. Once you have uploaded the file to IBM, remember to move the compressed archive out of the diagnostic directory path or it will continue to consume available disk space.

#### **Configure for rotating diagnostic logs and archive log files**

By default, if you use a single `db2diag.log` file, the DB2 diagnostic log file will grow in size indefinitely. If you configure for rotating diagnostic logs by setting the **diagsize** database manager configuration parameter, then a series of rotating diagnostic log files and a series of rotating administration notification log files are used that fit into the size defined by **diagsize**. As log files fill up, the oldest files are deleted and new log files are created. To avoid losing information too quickly because of file rotation (the deletion of the oldest log file), set **diagsize** to a value that is greater than 50 MB but not more than 80% of the free space in the directory paths that you specify with the **diagpath** and **alt\_diagpath** parameters. You can also preserve rotating diagnostic log files by archiving them from **diagpath** with the `db2diag -archive` command.

#### **Configure an alternate diagnostic path**

As a fail-safe to prevent the loss of important diagnostic information, the **alt\_diagpath** database manager configuration parameter provides an alternate diagnostic data directory path for storing diagnostic information. If the database manager fails to write to the path specified by **diagpath**, the path specified by **alt\_diagpath** is used to store diagnostic information until **diagpath** becomes available again. For greater resiliency, point the **alt\_diagpath** parameter to a different file system than the **diagpath** parameter.

#### **Splitting a diagnostic data directory path by database partition server, database partition, or both**

The default DB2 diagnostic data directory path setting of the **diagpath** database manager configuration parameter collects all diagnostic information within a single diagnostic data directory. You can split the diagnostic data directory path so that

separate directories are created and named according to the database partition server, database partition, or both. In this way, diagnostic dump files, previously stored in a single directory, are now stored in separate directories according to the database partition server or database partition from which the diagnostic data dump originated.

## Before you begin

DB2 Version 9.7 Fix Pack 1 or a later fix pack is required.

## About this task

You will be able to split a diagnostic data directory path to separately store diagnostic information according to the database partition server or database partition from which the diagnostic data dump originated.

Restrictions

Splitting a diagnostic data directory path, to keep multiple sources of diagnostic information separated, is mostly useful in partitioned database environments.

## Procedure

- **Splitting diagnostic data directory path per physical database partition server**
  - To split the default diagnostic data directory path, execute the following step:
    - Set the **diagpath** database manager configuration parameter to split the default diagnostic data directory path per physical database partition server by issuing the following command:

```
db2 update dbm cfg using diagpath "$h"
```

This command creates a subdirectory under the default diagnostic data directory with the computer name, as in the following:

```
Default_diagpath/HOST_db-partition-server-name
```

- To split a user specified diagnostic data directory path (for example, /home/usr1/db2dump/), execute the following step:
  - Set the **diagpath** database manager configuration parameter to split the /home/usr1/db2dump/ diagnostic data directory path per database partition server by issuing the following command:

```
db2 update dbm cfg using diagpath "/home/usr1/db2dump/ $h"
```

**Note:** A blank space must separate /home/usr1/db2dump/ and \$h.

This command creates a subdirectory under the /home/usr1/db2dump/ diagnostic data directory with the database partition server name, as in the following:

```
/home/usr1/db2dump/HOST_db-partition-server-name
```

- **Splitting diagnostic data directory path per database partition**
  - To split the default diagnostic data directory path, execute the following step:
    - Set the **diagpath** database manager configuration parameter to split the default diagnostic data directory path per database partition by issuing the following command:

```
db2 update dbm cfg using diagpath "$n"
```

This command creates a subdirectory for each partition under the default diagnostic data directory with the partition number, as in the following:

*Default\_diagpath/NODEnumber*

- To split a user specified diagnostic data directory path (for example, /home/usr1/db2dump/), execute the following step:
  - Set the **diagpath** database manager configuration parameter to split the /home/usr1/db2dump/ diagnostic data directory path per database partition by issuing the following command:  
db2 update dbm cfg using diagpath '/home/usr1/db2dump/ \$n'

**Note:** A blank space must separate /home/usr1/db2dump/ and \$n.

This command creates a subdirectory for each partition under the /home/usr1/db2dump/ diagnostic data directory with the partition number, as in the following:

*/home/usr1/db2dump/NODEnumber*

- **Splitting diagnostic data directory path per physical database partition server and per database partition**

- To split the default diagnostic data directory path, execute the following step:
  - Set the **diagpath** database manager configuration parameter to split the default diagnostic data directory path per physical database partition server and per database partition by issuing the following command:  
db2 update dbm cfg using diagpath '\$h\$n'

This command creates a subdirectory for each logical partition on the database partition server under the default diagnostic data directory with the database partition server name and partition number, as in the following:

*Default\_diagpath/HOST\_db-partition-server-name/NODEnumber*

- To split a user specified diagnostic data directory path (for example, /home/usr1/db2dump/), execute the following step:
  - Set the **diagpath** database manager configuration parameter to split the /home/usr1/db2dump/ diagnostic data directory path per database partition server and per database partition by issuing the following command:  
db2 update dbm cfg using diagpath '/home/usr1/db2dump/ \$h\$n'

**Note:** A blank space must separate /home/usr1/db2dump/ and \$h\$n.

This command creates a subdirectory for each logical partition on the database partition server under the /home/usr1/db2dump/ diagnostic data directory with the database partition server name and partition number, as in the following:

*/home/usr1/db2dump/HOST\_db-partition-server-name/NODEnumber*

For example, an AIX database partition server, named boson, has 3 database partitions with node numbers 0, 1, and 2. An example of a list output for the directory is similar to the following:

```
usr1@boson /home/user1/db2dump->ls -R *  
HOST_boson:
```

```
HOST_boson:  
NODE0000 NODE0001 NODE0002
```

```
HOST_boson/NODE0000:  
db2diag.log db2eventlog.000 db2resync.log db2samp1_Import.msg events usr1.nfy
```

```
HOST_boson/NODE0000/events:  
db2optstats.0.log
```

```
HOST_boson/NODE0001:  
db2diag.log db2eventlog.001 db2resync.log usr1.nfy stmmlog
```

```
HOST_boson/NODE0001/stmmlog:  
stmm.0.log
```

```
HOST_boson/NODE0002:  
db2diag.log db2eventlog.002 db2resync.log usr1.nfy
```

## What to do next

### Note:

- If a diagnostic data directory path split per database partition is specified (\$n or \$h\$n), the NODE0000 directory will always be created for each database partition server. The NODE0000 directory can be ignored if database partition 0 does not exist on the database partition server where the NODE0000 directory was created.

- To check that the setting of the diagnostic data directory path was successfully split, execute the following command:

```
db2 get dbm cfg | grep DIAGPATH
```

A successfully split diagnostic data directory path returns the values \$h, \$n, or \$h\$n with a preceding blank space. For example, the output returned is similar to the following:

```
Diagnostic data directory path          (DIAGPATH) = /home/usr1/db2dump/ $h$n
```

To merge separate **db2diag** log files to make analysis and troubleshooting easier, use the **db2diag -merge** command. For additional information, see: “db2diag - db2diag logs analysis tool command” in the *Command Reference* and “Analyzing db2diag log files using db2diag tool” on page 480..

## Administration notification log

The administration notification log (*instance\_name.nfy*) is the repository from which information about numerous database administration and maintenance activities can be obtained. A database administrator can use this information to diagnose problems, tune the database, or simply monitor the database.

The DB2 database manager writes the following kinds of information to the administration notification log on UNIX and Linux operating system platforms (on Windows operating system platforms, the event log is used to record administration notification events):

- Status of DB2 utilities such **REORG** and **BACKUP**
- Client application errors
- Service class changes
- Licensing activity
- File paths
- Storage problems
- Monitoring activities
- Indexing activities
- Table space problems

Administration notification log messages are also logged to the **db2diag** log files using a standardized message format.

Notification messages provide additional information to supplement the SQLCODE that is provided.

The administration notification log file can exist in two different forms:

#### **Single administration notification log file**

One active administration notification log file, named *instance\_name.nfy*, that grows in size indefinitely. This is the default form and it exists whenever the **diagsize** database manager configuration parameter has the value of 0 (the default value for this parameter is 0).

#### **Rotating administration notification log files**

A single active log file (named *instance\_name.N.nfy*, where *N* is the file name index that is a continuously growing number starting from 0), although a series of administration notification log files can be found in the location defined by the **diagpath** configuration parameter, each growing until reaching a limited size, at which time the log file is closed and a new one is created and opened for logging with an incremented file name index (*instance\_name.N+1.nfy*). It exists whenever the **diagsize** database manager configuration parameter has a nonzero value.

**Note:** Neither single nor rotating administration notification log files are available on the Windows operating system platform.

You can choose which of these two forms exist on your system by appropriately setting the **diagsize** database manager configuration parameter.

## **Configurations**

The administration notification log files can be configured in size, location, and the types of events and level of detail recorded, by setting the following database manager configuration parameters:

#### **diagsize**

The value of **diagsize** decides what form of administration notification log file will be adopted. If the value is 0, a single administration notification log file will be adopted. If the value is not 0, rotating administration notification log files will be adopted, and this nonzero value also specifies the total size of all rotating diagnostic log files and all rotating administration notification log files. The instance must be restarted for the new value of the **diagsize** parameter to take effect. See the “diagsize - Diagnostic log file size configuration parameter” topic for complete details.

#### **diagpath**

Diagnostic information can be specified to be written to administration notification log files in the location defined by the **diagpath** configuration parameter. See the “diagpath - Diagnostic data directory path configuration parameter” topic for complete details.

#### **notifylevel**

The types of events and the level of detail written to the administration notification log files can be specified with the **notifylevel** configuration parameter. See the “notifylevel - Notify level configuration parameter” topic for complete details.

**Note:** If the **diagsize** configuration parameter is set to a non-zero value, that value specifies the total size of the combination of all rotating administration notification log files and all rotating diagnostic log files contained within the diagnostic data directory. For example, if a system with 4 database partitions has **diagsize** set to 1 GB, the maximum total size of the combined notification and diagnostic logs can reach is 4 GB (4 x 1 GB).

## Interpreting administration notification log file entries

You can use a text editor to view the administration notification log file on the machine where you suspect a problem to have occurred. The most recent events recorded are the furthest down the file.

Generally, each entry contains the following parts:

- A timestamp
- The location reporting the error. Application identifiers allow you to match up entries pertaining to an application on the logs of servers and clients.
- A diagnostic message (usually beginning with "DIA" or "ADM") explaining the error.
- Any available supporting data, such as SQLCA data structures and pointers to the location of any extra dump or trap files.

The following example shows the header information for a sample log entry, with all the parts of the log identified.

**Note:** Not every log entry will contain all of these parts.

```
2006-02-15-19.33.37.630000 1 Instance:DB2 2 Node:000 3  
PID:940(db2syscs.exe) TID: 660 4 Appid:*LOCAL.DB2.020205091435 5  
recovery manager 6 sqlpresr 7 Probe:1 8 Database:SAMPLE 9  
ADM1530E 10 Crash recovery has been initiated. 11
```

### Legend:

1. A timestamp for the message.
2. The name of the instance generating the message.
3. For multi-partition systems, the database partition generating the message. (In a nonpartitioned database, the value is "000".)
4. The process identifier (PID), followed by the name of the process, followed by the thread identifier (TID) that are responsible for the generation of the message.
- 5.

Identification of the application for which the process is working. In this example, the process generating the message is working on behalf of an application with the ID \*LOCAL.DB2.020205091435.

This value is the same as the **app1\_id** monitor element data. For detailed information about how to interpret this value, see the documentation for the **app1\_id** monitor element.

To identify more about a particular application ID, either:

- Use the **LIST APPLICATIONS** command on a DB2 server or **LIST DCS APPLICATIONS** on a DB2 Connect gateway to view a list of application IDs. From this list, you can determine information about the client experiencing the error, such as its node name and its TCP/IP address.
  - Use the **GET SNAPSHOT FOR APPLICATION** command to view a list of application IDs.
6. The DB2 component that is writing the message. For messages written by user applications using the db2AdminMsgWrite API, the component will read "User Application".
  7. The name of the function that is providing the message. This function operates within the DB2 component that is writing the message. For messages written by user applications using the db2AdminMsgWrite API, the function will read "User Function".

8. Unique internal identifier. This number allows DB2 customer support and development to locate the point in the DB2 source code that reported the message.
9. The database on which the error occurred.
10. When available, a message indicating the error type and number as a hexadecimal code.
11. When available, message text explaining the logged event.

## Setting the error capture level for the administration notification log file

This task describes how to set the error capture level for the administration notification log file.

### About this task

The information that DB2 records in the administration notification log is determined by the **notifylevel** setting.

### Procedure

- To check the current setting, issue the **GET DBM CFG** command.

Look for the following variable:

```
Notify Level          (NOTIFYLEVEL) = 3
```

- To alter the setting, use the **UPDATE DBM CFG** command. For example:

```
DB2 UPDATE DBM CFG USING NOTIFYLEVEL X
```

where *X* is the notification level you want.

## DB2 diagnostic (db2diag) log files

The DB2 diagnostic **db2diag** log files are primarily intended for use by IBM Software Support for troubleshooting purposes. The administration notification log is primarily intended for troubleshooting use by database and system administrators. Administration notification log messages are also logged to the **db2diag** log files using a standardized message format.

### Overview

With DB2 diagnostic and administration notification messages both logged within the **db2diag** log files, this often makes the **db2diag** log files the first location to examine in order to obtain information about the operation of your databases. Help with the interpretation of the contents of these diagnostic log files is provided in the topics listed in the "Related links" section. If your troubleshooting attempts are unable to resolve your problem and you feel you require assistance, you can contact IBM Software Support (for details, see the "Contacting IBM Software Support" topic). In gathering relevant diagnostic information that will be requested to be sent to IBM Software Support, you can expect to include your **db2diag** log files among other sources of information which includes other relevant logs, storage dumps, and traces.

The **db2diag** log file can exist in two different forms:

#### Single diagnostic log file

One active diagnostic log file, named **db2diag.log**, that grows in size indefinitely. This is the default form and it exists whenever the **diagsize** database manager configuration parameter has the value of 0 (the default value for this parameter is 0).



### Rotating diagnostic log files

A single active log file (named `db2diag.N.log`, where *N* is the file name index that is a continuously growing number starting from 0), although a series of diagnostic log files can be found in the location defined by the **diagpath** configuration parameter, each growing until reaching a limited size, at which time the log file is closed and a new one is created and opened for logging with an incremented file name index (`db2diag.N+1.log`). It exists whenever the **diagsize** database manager configuration parameter has a nonzero value.

You can choose which of these two forms exist on your system by appropriately setting the **diagsize** database manager configuration parameter.

## Configurations

The **db2diag** log files can be configured in size, location, and the types of diagnostic errors recorded by setting the following database manager configuration parameters:

### **diagsize**

The value of **diagsize** decides what form of diagnostic log file will be adopted. If the value is 0, a single diagnostic log file will be adopted. If the value is not 0, rotating diagnostic log files will be adopted, and this nonzero value also specifies the total size of all rotating diagnostic log files and all rotating administration notification log files. The instance must be restarted for the new value of the **diagsize** parameter to take effect. See the "diagsize - Diagnostic log file size configuration parameter" topic for complete details.

### **diagpath**

Diagnostic information can be specified to be written to **db2diag** log files in the location defined by the **diagpath** configuration parameter. See the "diagpath - Diagnostic data directory path configuration parameter" topic for complete details.

### **alt\_diagpath**

The **alt\_diagpath** database manager configuration parameter provides an alternate diagnostic data directory path for storing diagnostic information. If the database manager fails to write to the path specified by **diagpath**, the path specified by **alt\_diagpath** is used to store diagnostic information.

### **diaglevel**

The types of diagnostic errors written to the **db2diag** log files can be specified with the **diaglevel** configuration parameter. See the "diaglevel - Diagnostic error capture level configuration parameter" topic for complete details.

**Note:** If the **diagsize** configuration parameter is set to a non-zero value, that value specifies the total size of the combination of all rotating administration notification log files and all rotating diagnostic log files contained within the diagnostic data directory. For example, if a system with 4 database partitions has **diagsize** set to 1 GB, the maximum total size of the combined notification and diagnostic logs can reach is 4 GB (4 x 1 GB).

## Interpretation of diagnostic log file entries

Use the **db2diag** log files analysis tool (**db2diag**) to filter and format the **db2diag** log files. With the addition of administration notification log messages being

logged to the **db2diag** log files using a standardized message format, viewing the **db2diag** log files first is a recommended choice to understand what has been happening to the database.

As an alternative to using **db2diag**, you can use a text editor to view the diagnostic log file on the machine where you suspect a problem to have occurred. The most recent events recorded are the furthest down the file.

**Note:** The administration notification (*instance\_name.nfy*) and diagnostic (*db2diag*) logs grow *continuously* as single log files. When the **diagsize** database manager configuration parameter is set to a nonzero value, both the administration notification and the *db2diag* log files become a series of rotating log files (*instance\_name.N.nfy* and *db2diag.N.log*) having a limited total size which is determined by the value of the **diagsize** configuration parameter.

The following example shows the header information for a sample log entry, with all the parts of the log identified.

**Note:** Not every log entry will contain all of these parts. Only the first several fields (timestamp to TID) and FUNCTION will be present in all the **db2diag** log file records.

```
2007-05-18-14.20.46.973000-240 1 I27204F655 2 LEVEL: Info 3
PID : 3228 4 TID : 8796 5 PROC : db2syscs.exe 6
INSTANCE: DB2MPP 7 NODE : 002 8 DB : WIN3DB1 9
APPHDL : 0-51 10 APPID: 9.26.54.62.45837.070518182042 11
AUTHID : UDBADM 12
EDUID : 8796 13 EDUNAME: db2agntp 14 (WIN3DB1) 2
FUNCTION: 15 DB2 UDB, data management, sqlInitDBCBC, probe:4820
DATA #1 : 16 String, 26 bytes
Setting ADC Threshold to:
DATA #2 : unsigned integer, 8 bytes
1048576
```

#### Legend:

1. A timestamp and timezone for the message.

**Note:** Timestamps in the **db2diag** log files contain a time zone. For example: 2006-02-13-14.34.35.965000-300, where "-300" is the difference between UTC (Coordinated Universal Time, formerly known as GMT) and local time at the application server in minutes. Thus -300 represents UTC - 5 hours, for example, EST (Eastern Standard Time).

2. The record ID field. The recordID of the **db2diag** log files specifies the file offset at which the current message is being logged (for example, "27204") and the message length (for example, "655") for the platform where the DB2 diagnostic log was created.
3. The diagnostic level associated with an error message. For example, Info, Warning, Error, Severe, or Event
4. The process ID
5. The thread ID
6. The process name
7. The name of the instance generating the message.
8. For multi-partition systems, the database partition generating the message. (In a non-partitioned database, the value is "000".)

9. The database name
10. The application handle. This value aligns with that used in **db2pd** output and lock dump files. It consists of the coordinator partition number followed by the coordinator index number, separated by a dash.
11. Identification of the application for which the process is working. In this example, the process generating the message is working on behalf of an application with the ID 9.26.54.62.45837.070518182042.

A TCP/IP-generated application ID is composed of three sections

1. **IP address:** It is represented as a 32-bit number displayed as a maximum of 8 hexadecimal characters.
2. **Port number:** It is represented as 4 hexadecimal characters.
3. A **unique identifier** for the instance of this application.

**Note:** When the hexadecimal versions of the IP address or port number begin with 0 through to 9, they are changed to G through to P. For example, "0" is mapped to "G", "1" is mapped to "H", and so on. The IP address, AC10150C.NA04.006D07064947 is interpreted as follows: The IP address remains AC10150C, which translates to 172.16.21.12. The port number is NA04. The first character is "N", which maps to "7". Therefore, the hexadecimal form of the port number is 7A04, which translates to 31236 in decimal form.

This value is the same as the *appl\_id* monitor element data. For detailed information about how to interpret this value, see the documentation for the *appl\_id* monitor element.

To identify more about a particular application ID, either:

- Use the **LIST APPLICATIONS** command on a DB2 server or LIST DCS APPLICATIONS on a DB2 Connect gateway to view a list of application IDs. From this list, you can determine information about the client experiencing the error, such as its database partition name and its TCP/IP address.
- Use the **GET SNAPSHOT FOR APPLICATION** command to view a list of application IDs.
- Use the **db2pd -applications -db <dbname>** command.

12. The authorization identifier.
13. The engine dispatchable unit identifier.
14. The name of the engine dispatchable unit.
15. The product name ("DB2"), component name ("data management"), and function name ("sqlInitDBC") that is writing the message (as well as the probe point ("4820") within the function).
16. The information returned by a called function. There may be multiple data fields returned.

Now that you have seen a sample **db2diag** log file entry, here is a list of all of the possible fields:

```

<timestamp><timezone>          <recordID>          LEVEL: <level> (<source>)
PID      : <pid>                TID   : <tid>        PROC  : <procName>
INSTANCE: <instance>          NODE  : <node>       DB    : <database>
APPHDL  : <appHandle>         APPID: <appID>
AUTHID  : <authID>
EDUID   : <eduID>             EDUNAME: <engine dispatchable unit name>

```

```

FUNCTION: <prodName>, <compName>, <funcName>, probe:<probeNum>
MESSAGE : <messageID> <msgText>
CALLED  : <prodName>, <compName>, <funcName>  OSERR: <errorName> (<errno>)
RETCODE : <type>=<retCode> <errorDesc>
ARG #N  : <typeTitle>, <typeName>, <size> bytes
... argument ...
DATA #N : <typeTitle>, <typeName>, <size> bytes
... data ...

```

The fields which were not already explained in the example, are:

- - <source> Indicates the origin of the logged error. (You can find it at the end of the first line in the sample.) The possible values are:
    - origin - message is logged by the function where error originated (inception point)
    - OS - error has been produced by the operating system
    - received - error has been received from another process (client/server)
    - sent - error has been sent to another process (client/server)
- - MESSAGE Contains the message being logged. It consists of:
    - <messageID> - message number, for example, ECF=0x9000004A or DIA8604C
    - <msgText> - error description
 When the CALLED field is also present, <msgText> is an impact of the error returned by the CALLED function on the function logging a message (as specified in the FUNCTION field)
- - CALLED This is the function that returned an error. It consists of:
    - <prodName> - The product name: "OS", "DB2", "DB2 Tools" or "DB2 Common"
    - <compName> - The component name ('-' in case of a system call)
    - <funcName> - The called function name
- OSERR This is the operating system error returned by the CALLED system call. (You can find it at the end of the same line as CALLED.) It consists of:
  - <errorName> - the system specific error name
  - <errno> - the operating system error number
- ARG This section lists the arguments of a function call that returned an error. It consists of:
  - <N> - The position of an argument in a call to the "called" function
  - <typeTitle> - The label associated with the Nth argument typename
  - <typeName> - The name of the type of argument being logged
  - <size> - The size of argument to be logged
- DATA This contains any extra data dumped by the logging function. It consists of:
  - <N> - The sequential number of data object being dumped
  - <typeTitle> - The label of data being dumped
  - <typeName> - The name of the type of data field being logged, for example, PD\_TYPE\_UINT32, PD\_TYPE\_STRING
  - <size> - The size of a data object

### Interpreting the informational record of the db2diag log files

The first message in the **db2diag** log files should always be an informational record.

An example of an informational record is as follows:

```
2006-02-09-18.07.31.059000-300 I1H917          LEVEL: Event
PID      : 3140                               TID   : 2864          PROC  : db2start.exe
INSTANCE: DB2                                NODE  : 000
FUNCTION: DB2 UDB, RAS/PD component, _pdlogInt, probe:120
START   : New Diagnostic Log file
DATA #1 : Build Level, 124 bytes
Instance "DB2" uses "32" bits and DB2 code release "SQL09010"
with level identifier "01010107".
Informational tokens are "DB2 v9.1.0.190", "s060121", "", Fix Pack "0".
DATA #2 : System Info, 1564 bytes
System: WIN32_NT MYSRVR Service Pack 2 5.1 x86 Family 15, model 2, stepping 4
CPU: total:1 online:1 Cores per socket:1 Threading degree per core:1
Physical Memory(MB): total:1024 free:617 available:617
Virtual Memory(MB): total:2462 free:2830
Swap Memory(MB): total:1438 free:2213
Information in this record is only valid at the time when this file was created
(see this record's time stamp)
```

The Informational record is output for **db2start** on every logical partition. This results in multiple informational records: one per logical partition. Since the informational record contains memory values which are different on every partition, this information might be useful.

## Setting the error capture level of the diagnostic log files

The DB2 diagnostic (**db2diag**) log files are files that contain text information logged by DB2 database systems. This information is used for troubleshooting and much of it is primarily intended for IBM Software Support.

### About this task

The types of diagnostic errors that are recorded in the **db2diag** log files are determined by the **diaglevel** database manager configuration parameter setting.

### Procedure

- To check the current setting, issue the command **GET DBM CFG**.

Look for the following variable:

```
Diagnostic error capture level          (DIAGLEVEL) = 3
```

- To change the value dynamically, use the **UPDATE DBM CFG** command.

To change a database manager configuration parameter online:

```
db2 attach to instance-name
db2 update dbm cfg using parameter-name value
db2 detach
```

For example:

```
DB2 UPDATE DBM CFG USING DIAGLEVEL X
```

where *X* is the notification level you want. If you are diagnosing a problem that can be reproduced, IBM Software Support personnel might suggest that you use **diaglevel** 4 while performing troubleshooting.

## Combining DB2 database and OS diagnostics

Diagnosing some problems related to memory, swap files, CPU, disk storage, and other resources requires a thorough understanding of how a given operating system manages these resources. At a minimum, defining resource-related problems requires knowing how much of that resource exists, and what resource limits might exist per user. (The relevant limits are typically for the user ID of the DB2 instance owner.)

Here is some of the important configuration information that you must obtain:

- Operating system patch level, installed software, and upgrade history
- Number of CPUs
- Amount of RAM
- Swap and file cache settings
- User data and file resource limits and per user process limit
- IPC resource limits (message queues, shared memory segments, semaphores)
- Type of disk storage
- What else is the machine used for? Does your DB2 server compete for resources?
- Where does authentication occur?

Most platforms have straightforward commands for retrieving resource information. However, you will rarely be required to obtain that information manually, since the **db2support** utility collects this data and much more. The `detailed_system_info.html` file produced by **db2support** (when the options **-s** and **-m** are specified) contains the syntax for many of the operating system commands used to collect this information.

The following exercises are intended to help you discover system configuration and user environment information in various DB2 diagnostic files. The first exercise familiarizes you with the steps involved in running the **db2support** utility. Subsequent exercises cover trap files, which provide more generated data about the DB2 server that can be useful in understanding the user environment and resource limits.

#### Exercise 1: Running the **db2support** command

1. Start the DB2 instance with the **db2start** command.
2. Assuming you already have the SAMPLE database available, create a directory for storing the output from **db2support**.
3. Change to that directory and issue:  
`db2support <directory> -d sample -s -m`
4. Review the console output, especially the types of information that are collected.

You should see output like this (when run on Windows):

```
...
Collecting "System files"
    "db2cache.prf"
    "db2cos9402136.0"
    "db2cos9402840.0"
    "db2dbamr.prf"
    "db2diag.bak"
    "db2eventlog.000"
    "db2misc.prf"
    "db2nodes.cfg"
    "db2profile.bat"
    "db2system"
    "db2tools.prf"
    "HealthRulesV82.reg"
    "db2dasdiag.log"
...
Collecting "Detailed operating system and hardware information"
Collecting "System resource info (disk, CPU, memory)"
Collecting "Operating system and level"
Collecting "JDK Level"
Collecting "DB2 Release Info"
Collecting "DB2 install path info"
```

```

Collecting "Registry info"
...
Creating final output archive
  "db2support.html"
  "db2_sqllib_directory.txt"
  "detailed_system_info.html"
  "db2supp_system.zip"
  "dbm_detailed.supp_cfg"
  "db2diag.log"
db2support is now complete.
An archive file has been produced: "db2support.zip"

```

5. Now use a Web browser to view the `detailed_system_info.html` file. On each of your systems, identify the following information:
  - Number of CPUs
  - Operating system level
  - User environment
  - User resource limits (UNIX `ulimit` command)

### Exercise 2: Locating environment information in a DB2 trap file

1. Ensure a DB2 instance is started, then issue `db2pd -stack all`  
 The call stacks are placed in files in the diagnostic directory (as defined by the **diagpath** database manager configuration parameter).
2. Locate the following in one of the trap files:
  - DB2 code level
  - Data seg top (this is the maximum private address space that has been required)
  - Cur data size (this is the maximum private address space limit)
  - Cur core size (this is the maximum core file limit)
  - Signal Handlers (this information might not appear in all trap files)
  - Environment variables (this information might not appear in all trap files)
  - map output (shows loaded libraries)

Example trap file from Windows (truncated):

```

...
<DB2TrapFile version="1.0">
<Trap>
<Header>
DB2 build information: DB2 v9.1.0.190 s060121 SQL09010
timestamp: 2006-02-17-14.03.43.846000
uname: S:Windows
comment:
process id: 940
thread id: 3592
</Header>
<SystemInformation>
Number of Processors: 1
Processor Type: x86 Family 15 Model 2 Stepping 4
OS Version: Microsoft Windows XP, Service Pack 2 (5.1)
Current Build: 2600
</SystemInformation>
<MemoryInformation>
<Usage>
Physical Memory:    1023 total,    568 free.
Virtual Memory :    2047 total,    1882 free.
Paging File   :    2461 total,    2011 free.
Ext. Virtual   :         0 free.

```

```

</Usage>
</MemoryInformation>
<EnvironmentVariables>
<![CDATA[
[e] DB2PATH=C:\Program Files\IBM\SQLLIB
[g] DB2_EXTSECURITY=YES
[g] DB2SYSTEM=MYSRVR
[g] DB2PATH=C:\Program Files\IBM\SQLLIB
[g] DB2INSTDEF=DB2
[g] DB2ADMINSERVER=DB2DAS00
]]></EnvironmentVariables>

```

## Correlating DB2 and system events or errors

System messages and error logs are too often ignored. You can save hours, days, and even weeks on the time it takes to solve a problem if you take the time to perform one simple task at the initial stage of problem definition and investigation. That task is to compare entries in different logs and take note of any that appear to be related both in time and in terms of what resource the entries are referring to.

While not always relevant to problem diagnosis, in many cases the best clue is readily available in the system logs. If you can correlate a reported system problem with DB2 errors, you will have often identified what is directly causing the DB2 symptom. Obvious examples are disk errors, network errors, and hardware errors. Not so obvious are problems reported on different machines, for example domain controllers which can affect connection time or authentication.

System logs can be investigated in order to assess stability, especially when problems are reported on brand new systems. Intermittent traps occurring in common applications can be a sign that there is an underlying hardware problem.

Here is some other information provided by system logs.

- Significant events such as when the system was rebooted
- Chronology of DB2 traps on the system (and errors, traps, or exceptions from other software that is failing)
- Kernel panics, out-of-filesystem-space, and out-of-swap-space errors (which can prevent the system from creating or forking a new process)

System logs can help to rule out crash entries in the **db2diag** log files as causes for concern. If you see a crash entry in DB2 administration notification or DB2 diagnostic logs with no preceding errors, the DB2 crash recovery is likely a result of a system shutdown.

This principle of correlating information extends to logs from any source and to any identifiable user symptoms. For example, it can be very useful to identify and document correlating entries from another application's log even if you can't fully interpret them.

The summation of this information is a very complete understanding of your server and of all of the varied events which are occurring at the time of the problem.



## db2cos (callout script) output files

A **db2cos** script is invoked by default when the database manager cannot continue processing due to a panic, trap, segmentation violation or exception. Each default **db2cos** script will invoke **db2pd** commands to collect information in an unlatched manner.

The names for the **db2cos** scripts are in the form **db2cos\_hang**, **db2cos\_trap**, and so on. Each script behaves in a similar way except **db2cos\_hang** which is called from the **db2fodc** tool.

The default **db2cos** scripts are found under the `bin` directory. On UNIX operating systems, this directory is read-only. You can copy the **db2cos** script file to the `adm` directory and modify the file at that location if required. If a **db2cos** script is found in the `adm` directory, it is run; otherwise, the script in the `bin` directory is run.

In a multiple partition configuration, the script will only be invoked for the trapping agent on the partition encountering the trap. If it is required to collect information from other partitions, you can update the **db2cos** script to use the **db2\_all** command or, if all of the partitions are on the same machine, specify the **-alldbpartitionnums** option on the **db2pd** command.

The types of signals that trigger the invocation of **db2cos** are also configurable via the **db2pdcfg -cos** command. The default configuration is for the **db2cos** script to run when either a panic or trap occurs. However, generated signals will not launch the **db2cos** script by default.

The order of events when a panic, trap, segmentation violation or exception occurs is as follows:

1. Trap file is created
2. Signal handler is called
3. **db2cos** script is called (depending on the **db2cos** settings enabled)
4. An entry is logged in the administration notification log
5. An entry is logged in the **db2diag** log file

The default information collected by the **db2pd** command in the **db2cos** script includes details about the operating system, the Version and Service Level of the installed DB2 product, the database manager and database configuration, as well as information about the state of the agents, memory pools, memory sets, memory blocks, applications, utilities, transactions, buffer pools, locks, transaction logs, table spaces and containers. In addition, it provides information about the state of the dynamic, static, and catalog caches, table and index statistics, the recovery status, as well as the reoptimized SQL statements and an active statement list. If you have to collect further information, update the **db2cos** script with the additional commands.

When the default **db2cos** script is called, it produces output files in the directory specified by the `DIAGPATH` database manager configuration parameter. The files are named `XXX.YYY.ZZZ.cos.txt`, where `XXX` is the process ID (PID), `YYY` is the thread ID (TID) and `ZZZ` is the database partition number (or 000 for single partition databases). If multiple threads trap, there will be a separate invocation of the **db2cos** script for each thread. In the event that a PID and TID combination occurs more than once, the data will be appended to the file. There will be a timestamp present so you can distinguish the iterations of output.

The **db2cos** output files will contain different information depending on the commands specified in the **db2cos** script. If the default script is not altered, entries similar to the following will be displayed (followed by detailed **db2pd** output):

```
2005-10-14-10.56.21.523659
PID      : 782348          TID : 1          PROC : db2cos
INSTANCE: db2inst1      NODE : 0          DB  : SAMPLE
APPHDL  :                APPID: *LOCAL.db2inst1.051014155507
FUNCTION: oper system services, sqloEDUCodeTrapHandler, probe:999
EVENT   : Invoking /home/db2inst1/sqllib/bin/db2cos from
oper system services sqloEDUCodeTrapHandler
Trap Caught
```

Instance db2inst1 uses 64 bits and DB2 code release SQL09010

...

Operating System Information:

```
OSName:   AIX
NodeName: n1
Version:  5
Release:  2
Machine:  000966594C00
```

...

The **db2diag** log files will contain entries related to the occurrence as well. For example:

```
2005-10-14-10.42.17.149512-300 I19441A349          LEVEL: Event
PID      : 782348          TID : 1          PROC : db2sysc
INSTANCE: db2inst1      NODE : 000
FUNCTION: DB2 UDB, trace services, pdInvokeCalloutScript, probe:10
START   : Invoking /home/db2inst1/sqllib/bin/db2cos from oper system
services sqloEDUCodeTrapHandler

2005-10-14-10.42.23.173872-300 I19791A310          LEVEL: Event
PID      : 782348          TID : 1          PROC : db2sysc
INSTANCE: db2inst1      NODE : 000
FUNCTION: DB2 UDB, trace services, pdInvokeCalloutScript, probe:20
STOP    : Completed invoking /home/db2inst1/sqllib/bin/db2cos

2005-10-14-10.42.23.519227-300 E20102A509          LEVEL: Severe
PID      : 782348          TID : 1          PROC : db2sysc
INSTANCE: db2inst1      NODE : 000
FUNCTION: DB2 UDB, oper system services, sqloEDUCodeTrapHandler, probe:10
MESSAGE : ADM0503C An unexpected internal processing error has occurred. ALL
DB2 PROCESSES ASSOCIATED WITH THIS INSTANCE HAVE BEEN SHUTDOWN.
Diagnostic information has been recorded. Contact IBM Support for
further assistance.

2005-10-14-10.42.23.520111-300 E20612A642          LEVEL: Severe
PID      : 782348          TID : 1          PROC : db2sysc
INSTANCE: db2inst1      NODE : 000
FUNCTION: DB2 UDB, oper system services, sqloEDUCodeTrapHandler, probe:20
DATA #1 : Signal Number Recieved, 4 bytes
11
DATA #2 : Siginfo, 64 bytes
0x0FFFFFFFFFD5C0 : 0000 000B 0000 0000 0000 0000 0009 0000 0000 .....
0x0FFFFFFFFFD5D0 : 0000 0000 0000 0000 0000 0000 0000 0000 0000 .....
0x0FFFFFFFFFD5E0 : 0000 0000 0000 0000 0000 0000 0000 0000 0000 .....
0x0FFFFFFFFFD5F0 : 0000 0000 0000 0000 0000 0000 0000 0000 0000 .....
```

## Dump files

Dump files are created when an error occurs for which there is additional information that would be useful in diagnosing a problem (such as internal control blocks). Every data item written to the dump files has a timestamp associated with

it to help with problem determination. Dump files are in binary format and are intended for IBM Software Support representatives.

When a dump file is created or appended, an entry is made in the **db2diag** log file indicating the time and the type of data written. These **db2diag** log entries resemble the following example:

---

```
2007-05-18-12.28.11.277956-240 I24861950A192 LEVEL: Severe
PID:1056930 TID:225448 NODE:000 Title: dynamic memory buffer
Dump File:/home/svtdbm5/sqllib/db2dump/1056930.225448.000.dump.bin
```

---

**Note:** For partitioned database environments, the file extension identifies the partition number. For example, the following entry indicates that the dump file was created by a DB2 process running on partition 10:

```
Dump File: /home/db2/sqllib/db2dump/6881492.2.010.dump.bin
```

## First occurrence data capture information

First occurrence data capture (FODC) collects diagnostic information about a DB2 instance, host or member when a problem occurs. FODC reduces the need to reproduce a problem to obtain diagnostic information, because diagnostic information can be collected as the problem occurs.

FODC can be invoked manually with the **db2fodc** command when you observe a problem or invoked automatically whenever a predetermined scenario or symptom is detected. After the diagnostic information has been collected, it is used to help determine the potential causes of the problem. In some cases, you might be able to determine the problem cause yourself, or involvement from IBM support personnel will be required.

Once execution of the **db2fodc** command has finished, the **db2support** tool must be executed to collect the resulting diagnostic files and prepare the FODC package to be submitted to IBM Support. The **db2support** command will collect the contents of all FODC package directories found or specified with the **-fodcpath** parameter. This is done to avoid additional requests, from IBM Support for diagnostic information.

## Collecting diagnosis information based on common outage problems

Diagnostic information can be gathered automatically in a first occurrence data collection (FODC) package as the problem that affects an instance, host, or member is occurring. The information in the FODC package can also be collected manually.

## Automatic collection of diagnostic information

The database manager invokes the **db2fodc** command for automatic First Occurrence Data Capture (FODC), which in turn invokes one of the DB2 call-out scripts (COS).

To correlate the outage with the DB2 diagnostic logs and the other troubleshooting files, a diagnostic message is written to both the administration notification and the **db2diag** log files. The FODC package directory name includes the FODC\_ prefix, the outage type, the timestamp when the FODC directory was created, and the member or partition number where the problem occurred. The FODC package description file is placed in the new FODC package directory.

Table 91. Automatic FODC types and packages

Package	Description	Invocation type	Script executed
FODC_Trap_timestamp_memberNumber	An instance wide trap has occurred	Automatic	db2cos_trap (.bat)
FODC_Panic_timestamp_memberNumber	Engine detected an incoherence and decided not to continue	Automatic	db2cos_trap (.bat)
FODC_BadPage_timestamp_memberNumber	A Bad Page has been detected	Automatic	db2cos_datacorruption (.bat)
FODC_DBMarkedBad_timestamp_memberNumber	A database has been marked bad due to an error	Automatic	db2cos (.bat)
FODC_IndexError_timestamp_PID_EDUID_memberNumber	An EDU wide index error occurred.	Automatic	db2cos_indexerror_short (.bat) or db2cos_indexerror_long (.bat)
FODC_Member_timestamp_memberNumber	A member or partition has failed or has received a kill signal	Automatic	db2cos_member (.bat)

### Manual collection of diagnostic information

You use the **db2fodc** command manually when you suspect a problem is occurring. Problem scenarios that you can collect diagnostic data for include apparent system hangs, performance issues, or when an upgrade operation or instance creation did not complete as expected. When the **db2fodc** command is run manually, a new FODC package directory is created. The FODC package directory name includes the FODC\_ prefix, the problem scenario, the timestamp when the FODC directory was created, and the member(s) or partition number(s) where FODC was performed.

Table 92. Manual FODC types and packages

Package	Description	Invocation type	Script executed
FODC_Clp_timestamp_member	User invoked <b>db2fodc -c1p</b> to collect environment and configuration related information, used to troubleshoot problems related to instance creation.	Manual	db2cos_c1p script (.bat)
FODC_Connections_timestamp_member	User invoked <b>db2fodc -connections</b> to collect connection-related diagnostic data, used to diagnose problems such as sudden spikes in the number of applications in the executing or compiling state or new database connections being denied.	Manual	db2cos_threshold script (.bat)

Table 92. Manual FODC types and packages (continued)

Package	Description	Invocation type	Script executed
<b>FODC_Cpu_timestamp_member</b>	User invoked <b>db2fodc -cpu</b> to collect processor-related performance and diagnostic data, used to diagnose problems such as high processor utilization rates, a high number of running processes, or high processor wait times.	Manual	<b>db2cos_threshold</b> script (.bat)
<b>FODC_Hang_timestamp_memberList</b>	User invoked <b>db2fodc -hang</b> to collect data for hang troubleshooting (or severe performance)	Manual	<b>db2cos_hang</b> (.bat)
<b>FODC_Memory_timestamp_member</b>	User invoked <b>db2fodc -memory</b> to collect memory-related diagnostic data, used to diagnose problems such as no free memory available, swap space being used at a high rate, excessive paging or a suspected a memory leak.	Manual	<b>db2cos_threshold</b> script (.bat)
<b>FODC_Perf_timestamp_memberList</b>	User invoked <b>db2fodc -perf</b> to collect data for performance troubleshooting	Manual	<b>db2cos_perf</b> (.bat)
<b>FODC_Preupgrade_timestamp_member</b>	User invoked <b>db2fodc -preupgrade</b> to collect performance related information before a critical upgrade or update such as upgrading an instance or updating to the next fix pack	Manual	<b>db2cos_preupgrade</b> (.bat)
<b>Scripts located in FODC_IndexError_timestamp_PID_EDUID_memberList</b>	<p>User could issue <b>db2fodc -indexerror</b> <i>FODC_IndexError_directory</i> [<b>basic</b>   <b>full</b>] (default is basic) to invoke the <b>db2dart</b> commands in the script(s).</p> <p>On partitioned database environments, use <b>db2_a11</b> "&lt;&lt;+node#&lt; <b>db2fodc -indexerror</b> <i>FODC_IndexError_directory</i> [<b>basic</b>   <b>full</b>]". The <i>node#</i> is the last number in the <i>FODC_IndexError_directory</i> directory name. An absolute path is required when using <b>db2fodc -indexerror</b> with the <b>db2_a11</b> command.</p>	Manual	<b>db2cos_indexerror_long</b> (.bat) or <b>db2cos_indexerror_short</b> (.bat)

## First occurrence data capture configuration

First occurrence data capture configuration (FODC) behaviour, including the path used to store the FODC package, is controlled by the *DB2FODC* registry variable, which can be set persistently with the **db2set** command or changed dynamically (in-memory only) through the **db2pdcfg** command. FODC behavior can also be customized by updating the call-out scripts (COS) invoked during FODC.

Each partition or member in the instance has its own FODC settings, and you can control how FODC takes place at the partition or member level. If FODC settings exist both at the member or partition level and at the instance level, the member or partition level settings override the instance level settings. For manual FODC, settings can also be overridden by command line parameters you specify, such as the **-fodcpath** parameter. In partitioned or DB2 pureScale database environments, if you specify a list of members or partitions for manual FODC, the settings for the first member or partition specified are used.

Persistent settings made with the **db2set** command do not become effective until the instance is recycled; dynamic settings made with the **db2pdcfg** command are effective immediately and remain effective in memory until the instance is recycled.

To help you control how FODC packages are handled, several *DB2FODC* registry variable settings are available, but not all settings are available on all platforms. You can control the following behaviors through the *DB2FODC* registry variable:

- Where the generated FODC packages are stored (with the *FODCPATH* setting)
- Whether core dump files are generated or not (with the *DUMPCORE* setting)
- How big core dump files can become (with the *CORELIMIT* setting)
- Where the generated dump files are stored (with the *DUMPPDIR* setting)

FODC by default invokes a **db2cos** call-out script to collect diagnostic information when the database manager cannot continue processing due to a panic, trap, segmentation violation or exception. To help you control the call-out script that is invoked during FODC, several *COS* parameter settings are available. You can control the following behaviors through the *COS* parameter of the *DB2FODC* registry variable:

- Whether the **db2cos** script is invoked when the database manager cannot continue processing (with the *ON* and *OFF* setting; the default is *ON*)
- How often the **db2cos** script checks the size of the output files generated (with the *COS\_SLEEP* setting)
- How long FODC should wait for the **db2cos** script to finish (with the *COS\_TIMEOUT* setting)
- How often the **db2cos** script is invoked during a database manager trap (with the *COS\_COUNT* setting)
- Whether the **db2cos** script is enabled when the *SQLO\_SIG\_DUMP* signal is received (with the *COS\_SQLO\_SIG\_DUMP* setting)

## FODC package directory settings (FODCPATH)

FODC packages can result in the generation of large volumes of diagnostic data that require space to store and can impose a significant processor usage on the system. You can control what directory path FODC sends diagnostic data to, so that you can pick a directory path with sufficient free space available.

The following order is used to determine what FODC path to use:

## Automatic FODC

### FODCPATH registry variable setting

The **FODCPATH** parameter for the **DB2FODC** registry variable can be set at the member or partition level and at the instance level. FODC uses the **FODCPATH** parameter setting for each partition or member, if set. If a partition or member level setting does not exist, the instance level setting is used.

### No FODC path settings

By default, if you do not specify any **FODCPATH** setting at either the member or instance level, FODC sends diagnostic information to the current diagnostic directory path (**diagpath** or **alt\_diagpath**).

## Manual FODC

### db2fodc -fodcpath command parameter option

When manually invoking the **db2fodc** command, you can indicate the location where the FODC package directory is created by specifying the **-fodcpath** parameter option together with the command. If you specify the **-fodcpath** parameter with a valid path name, the FODCpackage directory is created in that path.

### FODCPATH registry variable setting

If you do not specify the **-fodcpath** parameter with the **db2fodc** command, and you specified a list of partitions or members, the **db2fodc** command uses the **FODCPATH** parameter setting for the **DB2FODC** registry variable of the first partition or member from the list specified. If the value for that **FODCPATH** parameter is not set, **db2fodc** uses the instance level **FODCPATH** setting. If you do not specify the **-fodcpath** parameter and do not specify a list of partitions or members, the **db2fodc** command first tries to use the **FODCPATH** parameter setting for the current partition or member; if not set, the instance level setting is used.

### No FODC path settings

By default, if you do not specify any FODC path, first occurrence data capture sends diagnostic information to the current diagnostic directory path (**diagpath** or **alt\_diagpath**).

Assume that you have a partitioned database environment with 3 members or partitions (0, 1, and 2). The following example shows how to set the FODC path persistently at the instance level for all 3 partitions or members using the **db2set** command:

```
db2set DB2FODC=FODCPATH=/home/hote149/juntang/FODC
```

FODC path settings can also be performed persistently at the member level for each member, overriding the instance level setting. To make these settings effective, the instance must be recycled. For example, to change the FODC path on member 0, issue the following command:

```
db2set DB2FODC=FODCPATH=/home/hote149/juntang/FODC/FODC0 -i juntang 0
```

If you now want to change the FODC path dynamically on member 1 and member 2, you use the following **db2pdcfg** commands. These settings are effective immediately and remain in memory until the instance is recycled.

```
db2pdcfg -fodc FODCPATH=/home/hote149/juntang/FODC/FODC1 -member 1
```

```
db2pdcfg -fodc FODCPATH=/home/hote149/juntang/FODC/FODC2 -member 2
```

If you want to know what the current FODC settings are for each member or partition in a system, you can use the **db2pdcfg -fodc -member all** command (in the example, output is abridged and only the FODC path output is shown):

```
Database Member 0
FODC package path (FODCPATH)= /home/hote149/juntang/FODC/FODC0/

Database Member 1
FODC package path (FODCPATH)= /home/hote149/juntang/FODC/FODC1/

Database Member 2
FODC package path (FODCPATH)= /home/hote149/juntang/FODC/FODC2/
```

## Customized data collection

The behavior of data collection by **db2fodc -hang** and **db2fodc -perf** is also controlled by parameters defined in the TOOL OPTIONS section of the DB2 call-out script that is invoked during FODC. These parameters can be customized by changing the script that is executed during FODC.

To customize the data collection on UNIX systems, copy the script placed in */bin/db2cos\_symptom* to */adm/db2cos\_symptom*, where *symptom* is either *hang* or *perf*. Once in this new directory, modify the script as you like. On Windows systems, simply modify the default script *\bin\db2cos\_symptom.bat*. On UNIX systems, **db2fodc** first tries to execute the script in */adm/db2cos\_symptom*, and, if it is not found, executes the original script in */bin/db2cos\_symptom*. On Windows systems, the script *\bin\db2cos\_symptom.bat* is always executed.

## Data collected as part of FODC

First occurrence data capture (FODC) results in the creation of a FODC package directory and subdirectories where diagnostic information is collected. The parent package directory, subdirectories and files that get collected are collectively known as a FODC package.

## Files containing diagnostic information that are collected by FODC

FODC collects diagnostic information from a number of sources. The exact diagnostic information captured by FODC depends on the type of problem encountered and might include:

### Administration notification log (*instance\_name.nfy*)

- Operating system: All
- Default location:
  - Linux and UNIX: Located in the directory specified by the **diagpath** database manager configuration parameter.
  - Windows: Use the Event Viewer Tool (**Start > Control Panel > Administrative Tools > Event Viewer**)
- Created automatically when the instance is created.
- When significant events occur, DB2 writes information to the administration notification log. The information is intended for use by database and system administrators. The type of message recorded in this file is determined by the **notifylevel** configuration parameter.

**Note:** When the **diagsize** database manager configuration parameter is set to a nonzero value, the single administration notification log file behavior (*instance\_name.nfy*) will be changed to a rotating log behavior (*instance\_name.N.nfy*).



### DB2 diagnostic log (db2diag log file)

- Operating system: All
- Default location: Located in the directory identified by the **diagpath** database manager configuration parameter.
- Created automatically when the instance is created.
- This text file contains diagnostic information about error and warnings encountered by the instance. This information is used for troubleshooting and is intended for technicians at IBM Software Support. The type of message recorded in this file is determined by the **diaglevel** database manager configuration parameter.

**Note:** When the **diagsize** database manager configuration parameter is set to a nonzero value, the single diagnostic log file behavior (a single db2diag.log file) will be changed to a rotating log behavior (db2diag.N.log).

### DB2 administration server (DAS) diagnostic log (db2dasdiag.log)

- Operating system: All
- Default location:
  - Linux and UNIX: Located in DASHOME/das/dump, where DASHOME is the home directory of the DAS owner
  - Windows: Located in "dump" folder, in the DAS home directory. For example: C:\Program Files\IBM\SQLLIB\DB2DAS00\dump
- Created automatically when the DAS is created.
- This text file contains diagnostic information about errors and warnings encountered by the DAS.

### DB2 event log (db2eventlog.xxx, where xxx is the database partition number)

- Operating system: All
- Default location: Located in the directory specified by the **diagpath** database manager configuration parameter
- Created automatically when the instance is created.
- The DB2 event log file is a circular log of infrastructure-level events occurring in the database manager. The file is fixed in size, and acts as circular buffer for the specific events that are logged as the instance runs. Every time you stop the instance, the previous event log will be replaced, not appended. If the instance traps, a db2eventlog.XXX.crash file is also generated. These files are intended for use by IBM Software Support.

### DB2 callout script (db2cos) output files

- Operating system: All
- Default location: Located in the directory specified by the **diagpath** database manager configuration parameter
- If db2cos scripts are executed as a consequence of an FODC outage, db2cos output files will be placed under the FODC directory that was created in the location specified by the **diagpath** database manager configuration parameter.
- Created automatically when a panic, trap or segmentation violation occurs. Can also be created during specific problem scenarios, as specified using the **db2pdcfg** command.
- The default db2cos script will invoke **db2pd** commands to collect information in an unlatched manner. The contents of the db2cos output

files will vary depending on the commands contained in the db2cos script, such as operating system commands and other DB2 diagnosing tools. For more details on the tools that are executed with the db2cos script, open the script file in a text editor.

- The db2cos script is shipped under the bin/ directory. On UNIX, this directory is read-only. To create your own modifiable version of this script, copy the db2cos script to the adm/ directory. You are free to modify this version of the script. If the script is found in the adm/ directory, it is that version that is run. Otherwise, the default version in the bin/ directory is run.

### Dump files

- Operating system: All
- Default location: Located in the directory specified by the **diagpath** database manager configuration parameter
- If these files are dumped during an FODC outage, they will be placed under the FODC directory.
- Created automatically when particular problem scenarios arise.
- For some error conditions, extra information is logged in binary files named after the failing process ID. These files are intended for use by IBM Software Support.

### Trap files

- Operating system: All
- Default location: Located in the directory specified by the **diagpath** database manager configuration parameter
- If these files are dumped during an FODC outage, they will be placed under the FODC directory.
- Created automatically when the instance ends abnormally. Can also be created at will using the **db2pd** command.
- The database manager generates a trap file if it cannot continue processing due to a trap, segmentation violation, or exception.

### Core files

- Operating system: Linux and UNIX
- Default location: Located in the directory specified by the **diagpath** database manager configuration parameter
- If these files are dumped during an FODC outage, they will be placed under the FODC directory.
- Created by the operating system when the DB2 instance terminates abnormally.
- Among other things, the core image will include most or all of the memory allocations of DB2, which may be required for problem descriptions.

### FODC package path and contents

FODC creates the FODC package directory in the FODC path specified. You specify the FODC path through the **FODCPATH** registry variable setting or the **db2fodc -fodcpath** command parameter option. If you do not specify any FODC path, first occurrence data capture sends diagnostic information to the current diagnostic directory path (**diagpath** or **alt\_diagpath**). A **db2diag** log file diagnostic message is logged to identify the directory name used for FODC. The capture of

diagnostic information can generate a significant volume of diagnostic data, depending on what parameters are specified, and enough space must be available in the directory path where FODC stores diagnostic information. To avoid a scenario where FODC fills all the available space in the file system and impacts your data server, it is recommended that you specify a FODC path where FODC can store the diagnostic data.

For automatic FODC, a package is collected for the member or partition where the problem is occurring; if the problem is occurring on multiple members, multiple packages are collected in separate FODC package directories. The FODC package directory follows the naming convention

*FODC\_outageType\_timestamp\_member\_number*, where *outageType* is the problem symptom, *timestamp* is the time of FODC invocation, and *member\_number* is the member or partition number where the problem occurred. For example, when a trap occurs on member 1, FODC might automatically create a package named like *FODC\_Trap\_2010-11-17-20.58.30.695243\_0001*.

For manual FODC, a package is collected for the member(s) or partition(s) you specify. The naming convention for the FODC package directory is *FODC\_manualOutageType\_timestamp\_memberList*, where *manualOutageType* is the problem symptom, *timestamp* is the time of FODC invocation, and *memberList* is a list of the members or partitions where the problem occurred. For example, the manually issued command **db2fodc -hang -basic -member 1,2,3 -db sample** creates a manual FODC package for members 1,2 and 3, and might be named like *FODC\_hang\_2010-11-17-20.58.30.695243\_0001.0002.0003*.

One or more of the following subdirectories is created under the FODC package directory:

- DB2CONFIG containing DB2 configuration output and files
- DB2PD containing **db2pd** output or output files
- DB2SNAPS containing DB2 snapshots
- DB2TRACE containing DB2 traces
- OSCONFIG containing operating system configuration files
- OSSNAPS containing operating system monitor information
- OSTRACE containing operating system traces

Not all of these directories might exist, depending on your FODC configuration and the outage type for which the **db2fodc** command is run.

FODC sends the following diagnostic information to the FODC package directory:

**db2fodc -c1p** collects the following information:

- Operating system information
- Instance and database configuration information

**db2fodc -hang** collects the following information:

**db2fodc -hang** collects the following info:

- Basic operating system information. The problem could be due to OS level, patches, and so on.
- Basic DB2 configuration information.
- Operating system monitor information: *vmstat*, *netstat*, *iostat*, and so on.
  - 2 iterations at least: with timestamps saved
- Partial call stacks: DB2 stack traces of top CPU agents.
- Operating system trace: trace on AIX.

- Diagnostic information collected by **db2pd**.
- DB2 trace.
- Full DB2 call stacks.
- Second round of DB2 configuration information.
  - Including second DB2 trace collection.
- Snapshot information: **db2 get snapshot for** database, applications, tables, and so on.
  - Information will be collected per node in case of multiple logical nodes.

**db2fodc -perf** monitors the system possibly collecting the following information:

- Snapshots
- Stacktraces
- Virtual Memory (Vmstat)
- Input/Output information (Iostat)
- traces
- Some other information depending on the case. See the script for more details.

**db2fodc -indexerror** collects the following information:

- Basic Mode
  - `db2cos_indexerror_short(.bat)` script is run. See script for additional details.
  - If applicable **db2dart** commands exist in the script, the **db2dart /DD**, **db2dart /DI**, or both data formatting actions are run with number of pages limited to 100.
- Full Mode
  - `db2cos_indexerror_short(.bat)` and `db2cos_indexerror_long(.bat)` scripts are run. See scripts for additional details.
  - If applicable **db2dart** commands exist in the script `db2cos_indexerror_short(.bat)`, the **db2dart /DD**, **db2dart /DI**, or both data formatting actions are run with number of pages limited to 100.
  - If applicable **db2dart** commands exist in the script `db2cos_indexerror_long(.bat)`, the **db2dart /DD**, **db2dart /DI**, or both data formatting actions are run with no limit to the number of pages.
  - If applicable **db2dart** commands exist in the `db2cos_indexerror_long(.bat)` script, the **db2dart /T** command is run. This command requires the database be offline.

**db2fodc -preupgrade** collects the following information:

- Operating system information
- Instance and database configuration information, such as output of the **db2level** command, environment variables, output of the **db2 get dbm cfg** command, and the `db2nodes.cfg` file
- System catalog data and statistics, such as optimizer information collected by the **db2support -d dbname -c -s -c1 0** command
- Operating system monitoring data, such as output of the **netstat -v** and **ps -elf** commands
- System files

- Package information, as returned by the DB2 LIST PACKAGES FOR SCHEMA *schema-name* SHOW DETAIL command for all schema names
- Any FODC\_Preupgrade directories found in db2dump/. These directories contain information such as performance data, top dynamic SQL queries, and explain plans
- The logfile from the **db2ckupgrade** command in /tmp/db2ckupgrade.log.*processID*, if it exists
- Output from the **db2prereqcheck** command

The following diagnostic information is also included when you specify the members on which to collect:

- Snapshots (after turning on all monitor switches)
- The **db2pd** command output for the -everything, -agents, -applications, -mempools, and -fcm parameters
- The dynamic SQL statements used most frequently
- The query plans for SQL statements
- The explain plans for static packages

Manual **db2fodc** command invocation results in the creation of a log file named db2fodc\_*symptom*.log in the FODC\_*symptom* directory, where *symptom* is one of the collection types, such as hang or perf. Inside this file, the **db2fodc** command also stores status information and metadata describing the FODC package inside the FODC subdirectory. This file contains information about the type of FODC, the timestamp of the start and end of data collection, and other information useful for the analysis of the FODC package.

### Automatic FODC data generation

When an outage occurs and automatic first occurrence data capture (FODC) is enabled, data is collected based on symptoms. The data collected is specific to what is needed to diagnose the outage.

One or many messages, including those defined as "critical" are used to mark the origin of an outage.

Trap files contain information such as:

- The amount of free virtual storage
- Values associated with the product's configuration parameters and registry variables at the time the trap occurred
- Estimated amount of memory used by the DB2 product at the time of the trap
- Information that provides a context for the outage

The raw stack dump might be included in an ASCII trap file.

Dump files that are specific to components within the database manager are stored in the appropriate FODC package directory.

### Monitor and audit facilities using First Occurrence Data Capture (FODC)

If you find you are required to investigate monitor or audit facility problems, there are logs that contain information about the probable cause for the difficulties you may be experiencing.

#### DB2 audit log ("db2audit.log")

- Operating system: All

- Default location:
  - Windows: Located in the `$DB2PATH\instance_name\security` directory
  - Linux and UNIX: Located in the `$HOME\sql11ib\security` directory, where `$HOME` is the instance owner's home directory
- Created when the **db2audit** facility is started.
- Contains audit records generated by the DB2 audit facility for a series of predefined database events.

**DB2 governor log ("*mylog.x*", where *x* is the number of database partitions on which the governor is running)**

- Operating system: All
- Default location:
  - Windows: Located in the `$DB2PATH\instance_name\log` directory
  - Linux and UNIX: Located in the `$HOME\sql11ib\log` directory, where `$HOME` is the instance owner's home directory
- Created when using the governor utility. The base of the log file name is specified in the **db2gov** command.
- Records information about actions performed by the governor daemon (for example, forcing an application, reading the governor configuration file, starting or ending the utility) as well as errors and warnings.

**Event monitor file (for example, "00000000.evt")**

- Operating system: All
- Default location: When you create a file event monitor, all of the event records are written to the directory specified in the CREATE EVENT MONITOR statement.
- Generated by the event monitor when events occur.
- Contains event records that are associated with the event monitor.

**Graphical tools using First Occurrence Data Capture (FODC)**

If you find you are required to investigate Data Warehouse Center, or Information Catalog Center problems, there are logs that contain information about the probable cause for the difficulties you may be experiencing.

**Data Warehouse Center IWH2LOGC.log file**

- Operating system: All
- Default location: Located in the directory that is specified by the `VWS_LOGGING` environment variable. The default path is the `$DB2PATH\sql11ib\logging` directory on Windows and in the `$HOME/sql11ib/logging` directory on Linux and UNIX, where `HOME` is the instance owner's home directory
- Created automatically by the Data Warehouse Center if the logger stops.
- Contains messages written by the Data Warehouse Center and OLE server that could not be sent in the situation where the logger stops. This log may be viewed using the Log Viewer window in the Data Warehouse Center.

**Data Warehouse Center IWH2LOG.log file**

- Operating system: All
- Default location: Located in the directory that is specified by the `VWS_LOGGING` environment variable. The default path is the

\$DB2PATH\sql1ib\logging directory on Windows and in the \$HOME/sql1ib/logging directory on Linux and UNIX, where HOME is the instance owner's home directory

- Created automatically by the Data Warehouse Center when it cannot start itself or when a trace is activated.
- Contains diagnostic information for situations when the Data Warehouse Center logger cannot start itself and cannot write to the Data Warehouse Center log (IWH2LOGC.log). This log may be viewed using the Log Viewer window in the Data Warehouse Center.

#### **Data Warehouse Center IWH2SERV.log file**

- Operating system: All
- Default location: Located in the directory that is specified by the VWS\_LOGGING environment variable. The default path is the \$DB2PATH\sql1ib\logging directory on Windows and in the \$HOME/sql1ib/logging directory on Linux and UNIX, where HOME is the instance owner's home directory
- Created automatically by the Data Warehouse Center server trace facility.
- Contains Data Warehouse Center start up messages and logs messages created by the server trace facility. This log may be viewed using the Log Viewer window in the Data Warehouse Center.

#### **Information Catalog Center tag file EXPORT log**

- Operating system: All
- Default location: The exported tag file path and log file name are specified in the **Options** tab of the Export tool in the Information Catalog Center
- Generated by the Export tool in the Information Catalog Center
- Contains tag file export information, such as the times and dates when the export process started and stopped. It also includes any error messages that are encountered during the export operation.

#### **Information Catalog Center tag file IMPORT log**

- Operating system: All
- Default location: The imported tag file path and log file name are specified in the Import tool in the Information Catalog Center
- Generated by the Import tool in the Information Catalog Center
- Contains tag file import history information, such as the times and dates when the import process started and stopped. It also includes any error messages that are encountered during the import operation.

## **Internal return codes**

There are two types of internal return codes: ZRC values and ECF values. These are return codes that will generally only be visible in diagnostic tools intended for use by IBM Software Support.

For example, they are displayed in DB2 trace output and in the **db2diag** log files.

ZRC and ECF values basically serve the same purpose, but have slightly different formats. Each ZRC value has the following characteristics:

- Class name
- Component
- Reason code

- Associated SQLCODE
- SQLCA message tokens
- Description

However, ECF values consist of:

- Set name
- Product ID
- Component
- Description

ZRC and ECF values are typically negative numbers and are used to represent error conditions. ZRC values are grouped according to the type of error that they represent. These groupings are called "classes". For example, ZRC values that have names starting with "SQLZ\_RC\_MEMHEP" are generally errors related to insufficient memory. ECF values are similarly grouped into "sets".

An example of a **db2diag** log file entry containing a ZRC value is as follows:

```
2006-02-13-14.34.35.965000-300      I17502H435      LEVEL: Error
PID      : 940                      TID : 660      PROC : db2syscs.exe
INSTANCE: DB2                      NODE : 000      DB   : SAMPLE
APPHDL   : 0-1433                  APPID: *LOCAL.DB2.050120082811
FUNCTION: DB2 UDB, data protection, sqlpsize, probe:20
RETCODE  : ZRC=0x860F000A=-2045837302=SQLO_FNEX "File not found."
          DIA8411C A file "" could not be found.
```

Full details about this ZRC value can be obtained using the **db2diag** command, for example:

```
c:\>db2diag -rc 0x860F000A
```

```
Input ZRC string '0x860F000A' parsed as 0x860F000A (-2045837302).
```

```
ZRC value to map: 0x860F000A (-2045837302)
V7 Equivalent ZRC value: 0xFFFFE60A (-6646)
```

```
ZRC class :
    Critical Media Error (Class Index: 6)
Component:
    SQLO ; oper system services (Component Index: 15)
Reason Code:
    10 (0x000A)
```

```
Identifer:
    SQLO_FNEX
    SQLO_MOD_NOT_FOUND
Identifer (without component):
    SQLZ_RC_FNEX
```

```
Description:
    File not found.
```

```
Associated information:
    Sqlcode -980
SQL0980C A disk error occurred. Subsequent SQL statements cannot be
processed.
```

```
Number of sqlca tokens : 0
Diaglog message number: 8411
```

The same information is returned if you issue the commands **db2diag -rc -2045837302** or **db2diag -rc SQLO\_FNEX**.



An example of the output for an ECF return code is as follows:

```
c:\>db2diag -rc 0x90000076
```

```
Input ECF string '0x90000076' parsed as 0x90000076 (-1879048074).
```

```
ECF value to map: 0x90000076 (-1879048074)
```

```
ECF Set :  
    setecf (Set index : 1)  
Product :  
    DB2 Common  
Component:  
    OSSe  
Code:  
    118 (0x0076)  
  
Identifier:  
    ECF_LIB_CANNOT_LOAD
```

```
Description:  
    Cannot load the specified library
```

The most valuable troubleshooting information in the **db2diag** command output is the description and the associated information (for ZRC return codes only).

For a full listing of the ZRC values, use the **db2diag -rc zrc** command and for a full listing of the ECF values, use the **db2diag -rc ecf** command.

## Introduction to messages

It is assumed that you are familiar with the functions of the operating system where DB2 is installed. You can use the information contained in the following chapters to identify an error or problem and resolve the problem by using the appropriate recovery action. This information can also be used to understand where messages are generated and logged.

### Message Structure

Message help describes the cause of a message and describes any action you should take in response to the message.

Message identifiers consist of a three character message prefix, followed by a four or five digit message number, followed by a single letter suffix. For example, *SQL1042C*. For a list of message prefixes, see “Invoking message help” on page 696 and “Other DB2 Messages” on page 697. The single letter suffix describes the severity of the error message.

In general, message identifiers ending with a *C* are for severe messages; those ending with an *E* indicate urgent messages; those ending with an *N* indicate error messages; those ending with a *W* indicate warning messages; and those ending with an *I* indicate informational message.

For ADM messages, message identifiers ending with a *C* indicate severe messages; those ending with an *E* indicate urgent messages; those ending with a *W* indicate important messages; and those ending with an *I* indicate informational messages.

For SQL messages, message identifiers ending with a *C* indicate critical system errors; those ending with an *N* indicate error messages; those ending with a *W* indicate warning or informational messages.

Some messages include tokens, sometimes also called message variables. When a message containing tokens is generated by DB2, each token is replaced by a value specific to the error condition that was encountered, to help the user diagnose the cause of the error message. For example, the DB2 message SQL0107N is as follows:

- from the command line processor:  
SQL0107N The name "<name>" is too long. The maximum length is "<length>".
- from the DB2 information center:  
SQL0107N The name *name* is too long. The maximum length is *length*.

This message includes the two tokens "<name>" and "<length>". When this message is generated at runtime, the message tokens would be replaced by the actual name of the object that caused the error, and the maximum length allowed for that type of object, respectively.

In some cases a token is not applicable for a specific instance of an error, and the value \*N is returned instead, for example:

SQL20416N The value provided ("\*N") could not be converted to a security label. Labels for the security policy with a policy ID of "1" should be "8" characters long. The value is "0" characters long. SQLSTATE=23523

## Invoking message help

To invoke message help, open the command line processor and enter:

```
? XXXnnnnn
```

where *XXX* represents a valid message prefix and *nnnnn* represents a valid message number.

The message text associated with a given SQLSTATE value can be retrieved by issuing:

```
? nnnnn
```

or

```
? nn
```

where *nnnnn* is a five digit SQLSTATE (alphanumeric) and *nn* is the two digit SQLSTATE class code (first two digits of the SQLSTATE value).

**Note:** The message identifier accepted as a parameter of the **db2** command is not case sensitive. Also, the single letter suffix is optional and is ignored.

Therefore, the following commands will produce the same result:

- ? SQL0000N
- ? sql0000
- ? SQL0000w

To invoke message help on the command line of a UNIX based system, enter:

```
db2 "? XXXnnnnn"
```

where *XXX* represents a valid message prefix  
and *nnnnn* represents a valid message number.

If the message text is too long for your screen, use the following command (on Unix-based systems and others which support 'more'):

db2 "? XXXnnnnn" | more

## Other DB2 Messages

Some DB2 components return messages that are not available online or are not described in this manual. Some of the message prefixes might include:

**AUD** Messages generated by the DB2 Audit facility.

**DIA** Diagnostics messages generated by many DB2 components. These messages are written in the DB2 diagnostic (db2diag) log files, and are intended to provide additional information for users and DB2 service personnel when investigating errors.

In most cases, these messages provide sufficient information to determine the cause of the warning or error. For more information on the command or utility that generated the messages, please refer to the appropriate manual where the command or utility is documented.

## Other Message Sources

When running other programs on the system, you may receive messages with prefixes other than those mentioned in this reference.

For information on these messages, refer to the information available for that program product.

## Platform-specific error log information

There are many other files and utilities available outside of DB2 to help analyze problems. Often they are just as important to determining root cause as the information made available in the DB2 files.

The other files and utilities provide access to information contained in logs and traces that is concerned with the following areas:

- Operating systems
- Applications and third-party vendors
- Hardware

Based on your operating environment, there might be more places outside of what has been described here, so be aware of all of the potential areas you might have to investigate when debugging problems in your system.

## Operating systems

Every operating system has its own set of diagnostic files to keep track of activity and failures. The most common (and usually most useful) is an error report or event log. Here is a list of how this information can be collected:

- AIX: the `/usr/bin/errpt -a` command
- Solaris: `/var/adm/messages*` files or the `/usr/bin/dmesg` command
- Linux: the `/var/log/messages*` files or the `/bin/dmesg` command
- HP-UX: the `/var/adm/syslog/syslog.log` file or the `/usr/bin/dmesg` command
- Windows : the system, security, and application event log files and the `windir\drwtsn32.log` file (where `windir` is the Windows install directory)

There are always more tracing and debug utilities for each operating system. See your operating system documentation and support material to determine what further information is available.

## Applications and third-party vendors

Each application should have its own logging and diagnostic files. These files will complement the DB2 set of information to provide you with a more accurate picture of potential problem areas.

## Hardware

Hardware devices usually log information into operating system error logs. However, sometimes additional information is required. In those cases, you must identify what hardware diagnostic files and utilities might be available for piece of hardware in your environment. An example of such a case is when a bad page, or a corruption of some type is reported by DB2. Usually this is reported due to a disk problem, in which case the hardware diagnostics must be investigated. See your hardware documentation and support material to determine what further information is available.

Some information, such as information from hardware logs, is time-sensitive. When an error occurs you should make every effort to gather as much information as you can from the relevant sources as soon as is possible.

In summary, to completely understand and evaluate a problem, you might have to collect all information available from DB2, your applications, the operating system and underlying hardware. The **db2support** tool automates the collection of most DB2 and operating system information that you will require, but you should still be aware of any information outside of this that might help the investigation.

## System core files (Linux and UNIX)

If a program terminates abnormally, a core file is created by the system to store a memory image of the terminated process. Errors such as memory address violations, illegal instructions, bus errors, and user-generated quit signals cause core files to be dumped.

The core file is named "core", and is placed in the directory specified by the **diagpath** database manager configuration parameter, by default, unless otherwise configured using the values in the **DB2FODC** registry variable. Note that system core files are distinct from DB2 trap files.

## Core file control settings

Core files can result in the generation of large volumes of diagnostic data that require space to store and can impose a significant processor usage on the system. To help you control how core files are handled, several **DB2FODC** registry variable settings are available. You can make **DB2FODC** registry variable settings persistently with the **db2set** command or change them dynamically (in-memory only) through the **db2pdcfg** command. Persistent settings made with the **db2set** command do not become effective until the instance is recycled; dynamic settings made with the **db2pdcfg** command are effective immediately and until the instance is recycled.

You can control the following core file behaviors through the **DB2FODC** registry variable:

- Whether core files are generated or not (with the **DUMPCORE** setting)

- How big core files can become (with the **CORELIMIT** setting)
- Where the generated core files are stored (with the **DUMPDIR** setting)

As a rule, a core file can become as large as the amount of physical memory installed on the machine where the core file is generated. For example, if your data server has 64 GB of physical memory, there must be at least 64 GB of space available in the directory path where the core file will be stored. It is possible to limit the size of the core file, but it is recommended that you configure core file behaviour to point to a file system with enough space available instead. If you must limit the amount of space a core file can use, ensure that the amount of space available is at least as great as the amount of physical memory on the machine or you risk truncating the core file and losing diagnostic information. For example, to limit the amount of space available for core file generation to 64 GB and to redirect core files to /tmp persistently, issue the following command. The settings will become effective only after the instance is recycled.

```
db2set DB2FODC="CORELIMIT=64000000000 DUMPDIR=/tmp"
```

When a core file is generated, it can impose a significant processor usage on the system, which in turn can affect system availability. If the performance impact to system availability during core file generation is unacceptable, you can disable core file generation, but it is recommended that you do not disable it permanently. Core files contain diagnostic information that can be required in order to troubleshoot a problem successfully. If diagnostic information is not available because core file generation was turned off permanently, troubleshooting a problem with your data server might become impossible. For example, to turn core file generation off dynamically, effective immediately and until the instance is recycled, issue the following command:

```
db2pdcfg DB2FODC="DUMPCORE=OFF"
```

## Accessing system core file information (Linux and UNIX)

The **dbx** system command helps you determine which function caused a system core file to be created. This is a simple check that will help you identify whether the database manager is in error, or whether an operating system or application error is responsible for the problem.

### Before you begin

- You must have the **dbx** command installed. This command is operating system-specific: on AIX and Solaris, use **dbx**; on HP-UX, use **xdb**, and on Linux use **gdb**.
- On AIX, ensure that the full core option has been enabled using the **chdev** command or **smitty**.

### Procedure

To determine the function that caused the core file dump to occur:

1. Enter the following command from a UNIX command prompt:

```
dbx program_name core_filename
```

*program\_name* is the name of the program that terminated abnormally, and *core\_filename* is the name of the file containing the core file dump. The *core\_filename* parameter is optional. If you do not specify it, the default name "core" is used.

2. Examine the call stack in the core file. Information about how to do this can be obtained by issuing `man dbx` from a UNIX command prompt

3. To end the **dbx** command, type **quit** at the **dbx** prompt.

### Example

The following example shows how to use the **dbx** command to read the core file for a program called "main".

1. At a command prompt, enter:

```
dbx main
```

2. Output similar to the following appears on your display:

```
dbx version 3.1 for AIX.  
Type 'help' for help.  
reading symbolic information ...  
[using memory image in core]  
segmentation.violation in freeSegments at line 136  
136      (void) shmdt((void *) pcAddress[i]);
```

3. The name of the function that caused the core dump is "freeSegments". Enter **where** at the **dbx** prompt to display the program path to the point of failure.

```
(dbx) where  
freeSegments(numSegs = 2, iSetId = 0x2ff7f730, pcAddress = 0x2ff7f758, line  
136  
in "main.c"  
main (0x1, 2ff7f7d4), line 96 in "main.c"
```

In this example, the error occurred at line 136 of `freeSegments`, which was called from line 96 in `main.c`.

4. To end the **dbx** command, type **quit** at the **dbx** prompt.

### Accessing event logs (Windows)

This task describes how to access the Windows event logs.

#### About this task

Windows event logs can also provide useful information. While the system event log tends to be the most useful in the case of DB2 crashes or other mysterious errors related to system resources, it is worthwhile obtaining all three types of event logs:

- System
- Application
- Security

#### Procedure

View the event logs using the Windows Event Viewer. The method used to open the viewer will differ, depending on the Windows operating system you are using. For example, to open the Event Viewer on Windows XP, click **Start > Control Panel**. Select **Administrative Tools**, and then double-click **Event Viewer**.

### Exporting event logs (Windows)

This task describes how to export Windows event logs.

#### About this task

From the Windows event viewer, you can export event logs in two formats:

- log-file format
- text or comma-delimited format.

## Procedure

Export the event logs from the Windows event viewer.

- You can load the log-file format (\*.evt) data back into an event viewer (for example, on another workstation). This format is easy to work with since you can use the viewer to switch the chronology order, filter for certain events, and advance forwards or backwards.
- You can open the text (\*.txt) or comma-delimited (\*.csv) format logs in most text editors. They also avoid a potential problem with respect to timestamps. When you export event logs in .evt format, the timestamps are in Coordinated Universal Time and get converted to the local time of the workstation in the viewer. If you are not careful, you can overlook key events because of time zone differences. Text files are also easier to search.

## Accessing the Dr. Watson log file (Windows)

This task describes how to access the Dr. Watson log files on Windows systems.

### About this task

The Dr. Watson log, `drwtsn32.log`, is a chronology of all the exceptions that have occurred on the system. The DB2 trap files are more useful than the Dr. Watson log, though it can be helpful in assessing overall system stability and as a document of the history of DB2 traps.

### Procedure

Locate the Dr. Watson log file. The default path is `<install_drive>:\Documents and Settings \All Users\Documents\DrWatson`

## Trap files

DB2 generates a trap file if it cannot continue processing because of a trap, segmentation violation, or exception.

All signals or exceptions received by DB2 are recorded in the trap file. The trap file also contains the function sequence that was running when the error occurred. This sequence is sometimes referred to as the "function call stack" or "stack trace." The trap file also contains additional information about the state of the process when the signal or exception was caught.

A trap file is also generated when an application is forced to stop while running a fenced threadsafe routine. The trap occurs as the process is shutting down. This is not a fatal error and it is nothing to be concerned about.

The files are located in the directory specified by the **diagpath** database manager configuration parameter.

On all platforms, the trap file name begins with a process identifier (PID), followed by a thread identifier (TID), followed by the partition number (000 on single partition databases), and concluded with ".trap.txt".

There are also diagnostic traps, generated by the code when certain conditions occur which don't warrant crashing the instance, but where it is useful to see the stack. Those traps are named with the PID in decimal format, followed by the partition number (0 in a single partition database).

**Examples:**

- 6881492.2.000.trap.txt is a trap file with a process identifier (PID) of 6881492, and a thread identifier (TID) of 2.
- 6881492.2.010.trap.txt is a trap file whose process and thread is running on partition 10.

You can generate trap files on demand using the **db2pd** command with the **-stack all** or **-dump** option. In general, though, this should only be done as requested by IBM Software Support.

You can generate stack trace files with **db2pd -stacks** or **db2pd -dumps** commands. These files have the same contents as trap file but are generated for diagnostic purposes only. Their names will be similar to 6881492.2.000.stack.txt.

**Formatting trap files (Windows)**

You can format trap files (\*.TRP) with a command called **db2xpvt**. It formats the DB2 database binary trap files into a human readable ASCII file.

**About this task**

The **db2xpvt** tool uses DB2 symbol files in order to format the trap files. A subset of these .PDB files are included with the DB2 database products.

**Example**

If a trap file called "DB30882416.TRP" had been produced in your directory specified by the **diagpath** database manager configuration parameter, you could format it as follows:

```
db2xpvt DB30882416.TRP DB30882416.FMT
```



---

## Chapter 10. Searching knowledge bases

---

### How to search effectively for known problems

There are many resources available that describe known problems, including DB2 APARs, whitepapers, IBM Redbooks® publications, Technotes, and manuals. It is important to be able to effectively search these (and other) resources in order to quickly determine whether a solution already exists for the problem you are experiencing.

Before searching, you should have a clear understanding of your problem situation.

Once you have a clear understanding of what the problem situation is, you need to create a list of search keywords to increase your chances of finding the existing solutions. Here are some tips:

1. Use multiple words in your search. The more pertinent search terms you use, the better your search results will be.
2. Start with specific results, and then go to broader results if necessary. For example, if too few results are returned, then remove some of the less pertinent search terms and try it again. Alternatively, if you are uncertain which keywords to use, you can perform a broad search with a few keywords, look at the type of results that you receive, and be able to make a more informed choice of additional keywords.
3. Sometimes it is more effective to search for a specific phrase. For example, if you enter: "administration notification file" (with the quotation marks) you will get only those documents that contain the exact phrase in the exact order in which you type it. (As opposed to all documents that contain any combination of those three words).
4. Use wildcards. If you are encountering a specific SQL error, search for "SQL5005<wildcard>", where <wildcard> is the appropriate wildcard for the resource you're searching. This is likely to return more results than if you had merely searched for "SQL5005" or "SQL5005c".
5. If you are encountering a situation where your instance ends abnormally and produces trap files, search for known problems using the first two or three functions in the trap or core file's stack traceback. If too many results are returned, try adding keywords "trap", "abend" or "crash".
6. If you are searching for keywords that are operating-system-specific (such as signal numbers or errno values), try searching on the constant name, not the value. For example, search for "EFBIG" instead of the error number 27.

In general, search terms that are successful often involve:

- Words that describe the command run
- Words that describe the symptoms
- Tokens from the diagnostics

---

### Troubleshooting resources

A wide variety of troubleshooting information is available to assist you in using DB2 database products.

## **DB2 documentation**

Troubleshooting information can be found throughout the *DB2 Information Center*, as well as throughout the PDF books that make up the DB2 library.

## **DB2 Technical Support website**

Refer to the DB2 Technical Support website if you are experiencing problems and want help finding possible causes and solutions. The Technical Support site has links to the latest DB2 publications, TechNotes, Authorized Program Analysis Reports (APARs), fix packs and other resources. You can search through this knowledge base to find possible solutions to your problems.

Access the DB2 Technical Support website at: [www.ibm.com/software/data/db2/support/db2\\_9/](http://www.ibm.com/software/data/db2/support/db2_9/)

---

## Chapter 11. Getting DB2 product fixes

Fix packs contain code updates and fixes for problems found by IBM during product testing and by customers as they use the product. How to find the latest fix pack and how to apply the fixes to your database environment are discussed.

---

### Getting fixes

A product fix might be available to resolve your problem. You can get fixes by following these steps.

#### Procedure

1. You can view fix lists and obtain fix packs from the following Web pages:
  - IBM Support Portal: Downloads
  - Fixes by version for DB2 for Linux, UNIX, and Windows
2. Determine which fix pack you need. In order to avoid encountering problems caused by software defects already known and corrected, the installation of the most recent fix pack is generally recommended.
3. Download the fix pack and extract the files by double-clicking the self-extracting executable package. Open the `SERVER/doc/your_language/readme.txt` document and follow the provided link to the *DB2 Information Center* to obtain installation instructions.
4. Apply the fix. For instructions, see: “Applying fix packs” in *Installing DB2 Servers*.

### Fix packs, interim fix packs and test fixes

An Authorized Program Analysis Report (APAR) is a formal report of a problem caused by a suspected defect in a current unaltered release of an IBM program. APARs describe problems found during testing by IBM, as well as problems reported by customers.

The modified DB2 code that resolves the problem described in the APAR can be delivered in fix packs, interim fix packs and test fixes.

#### Fix pack

A fix pack is a cumulative collection of APAR fixes. In particular, fix packs address the APARs that arise between new releases of DB2. They are intended to allow you to move up to a specific maintenance level. Fix packs have the following characteristics:

- They are cumulative. Fix packs for a particular release of DB2 supersede or contain all of the APAR fixes shipped in previous fix packs and interim fix packs for that release.
- They are available for all supported operating systems and DB2 database products.
- They contain many APARs.
- They are published on the DB2 Technical Support website and are generally available to customers who have purchased products under the Passport Advantage program.
- They are fully tested by IBM.

- They are accompanied by documentation that describes changes to the database products, and how to install and remove the fix pack.

**Note:** The status of an APAR is changed from "Open" to "Closed as program error" when the APAR fix is provided in a fix pack. You can determine the status of individual APARs by examining the APAR descriptions on the DB2 Technical Support website.

### **Interim fix pack**

An interim fix pack is a cumulative collection of important APAR fixes that arise between fix packs. To qualify for inclusion in an interim fix pack, an APAR must be considered pervasive or otherwise important. Candidate APARs are evaluated and approved by experts on the DB2 technical support team. Interim fix packs have the following characteristics:

- They are cumulative. Interim fix packs for a particular release of DB2 supersede or contain all of the APAR fixes shipped in previous fix packs and interim fix packs for that release.
- They are available for a subset of operating systems and DB2 database products.
- They usually contain 20 to 30 new APARs.
- They are published on the DB2 Technical Support website and are generally available to customers who have purchased products under the Passport Advantage program.
- They are fully tested by IBM.
- They are accompanied by documentation that describes how to install and remove the interim fix pack.

Interim fix packs are supported in production for two years after they are released. They are available at the approximate midpoint between fix packs and are intended as the preferred alternative to test fixes, which do not receive the same level of testing or enjoy the same level of support as interim fix packs.

### **Test fix**

A test fix is a temporary solution that is supplied to specific customers for testing in response to a reported problem. Test fixes are sometimes referred to as "special builds" and they have the following characteristics:

- They usually contain a single APAR.
- They are obtained from DB2 Support and are not generally available to the public.
- They undergo limited IBM testing.
- They include minimal documentation, including a description of how the test fix should be applied, the APARs it fixes, and instructions for the removal of the test fix.

Test fixes are supplied in situations where a new problem has been uncovered, there is no workaround or bypass for the problem and you cannot wait until the next fix pack or interim fix pack becomes available. For example, if the problem is causing critical impact on your business, a test fix might be provided to alleviate the situation until the APAR is addressed in a fix pack or interim fix pack.

It is recommended that you keep your DB2 environment running at the latest fix pack level to ensure problem-free operation. To receive notification of the

availability of new fix packs, subscribe to "My notifications" email updates on the DB2 Technical Support website at: [http://www.ibm.com/software/data/db2/support/db2\\_9/](http://www.ibm.com/software/data/db2/support/db2_9/)

To learn more about the role and purpose of DB2 fixes and fix packs, see the support policy statement.

## Applying test fixes

A test fix is a temporary fix that is supplied to specific customers for testing in response to a reported problem. A Readme file accompanies every test fix. The test fix Readme file provides instructions for installing and uninstalling the test fix, and a list of the APARs (if any) included in the test fix.

### Before you begin

Each test fix has specific prerequisites. Refer to the Readme file that accompanies the test fix for details.

### About this task

There are two types of test fixes:

- A test fix for an individual DB2 product. These test fixes can be applied on an existing installation of the product, or can be used to perform a full product installation where there is no existing DB2 installation.
- Universal test fixes (Linux and UNIX only). A universal test fix services installations where more than one DB2 product has been installed.

If national languages have been installed, you might also require a separate national language test fix. The national language test fix can only be applied if it is at the same test fix level as the installed DB2 product. If you are applying a universal test fix, you must apply both the universal test fix and the national language test fix to update the DB2 products.

### Procedure

Obtain the test fix from IBM Software Support and follow the instructions in the Readme file with respect to installing, testing and removing (if necessary) the test fix.

When installing a test fix in a multi-partition database partition environment, the system must be offline and all computers participating in the instance must be upgraded to the same test fix level.

### Results



---

## Chapter 12. Support

---

### Contacting IBM Software Support

---

IBM Software Support provides assistance with product defects.

#### Before you begin

Before contacting IBM Software Support, your company must have an active IBM software maintenance contract, and you must be authorized to submit problems to IBM. For information about the types of maintenance contracts available, see “Premium Support” in the *Software Support Handbook* at: [techsupport.services.ibm.com/guides/services.html](http://techsupport.services.ibm.com/guides/services.html)

#### Procedure

Complete the following steps to contact IBM Software Support with a problem:

1. Define the problem, gather background information, and determine the severity of the problem. For help, see the “Contacting IBM” in the *Software Support Handbook*: [techsupport.services.ibm.com/guides/beforecontacting.html](http://techsupport.services.ibm.com/guides/beforecontacting.html)
2. Gather diagnostic information.
3. Submit your problem to IBM Software Support in one of the following ways:
  - Online: Click the **ESR** (Electronic Service Request) link on the IBM Software Support, Open Service Request site: [www.ibm.com/software/support/probsub.html](http://www.ibm.com/software/support/probsub.html)
  - By phone: For the phone number to call in your country/region, go to the Contacts page of the *Software Support Handbook*: [techsupport.services.ibm.com/guides/contacts.html](http://techsupport.services.ibm.com/guides/contacts.html)

**Note:** If you require support for any IBM product that is packaged as part of the DB2 pureScale software stack, then open a service request or problem management record (PMR) for the IBM DB2 pureScale Feature. Opening a PMR for the DB2 pureScale Feature helps resolve problems more efficiently.

#### What to do next

If the problem you submit is for a software defect or for missing or inaccurate documentation, IBM Software Support creates an Authorized Program Analysis Report (APAR). The APAR describes the problem in detail. Whenever possible, IBM Software Support provides a workaround that you can implement until the APAR is resolved and a fix is delivered. IBM publishes resolved APARs on the IBM Software Support website daily, so that other users who experience the same problem can benefit from the same resolution.

### Exchanging information with IBM

To diagnose or identify a problem, you might need to provide IBM Support with data and information from your system. In other cases, IBM Support might provide you with tools or utilities to use for problem determination.

## Sending information to IBM Support

You can submit data to IBM Software Support by FTP or by using the Electronic Service Request (ESR) tool. Instructions are provided here.

### Before you begin

The steps assume that you have already opened a problem management record (PMR) with IBM Software Support.

### About this task

You can send diagnostic data, such as log files and configuration files, to IBM Software Support using one of several methods, including:

- FTP
- Electronic Service Request (ESR) tool

These and other data exchange methods that might be available are explained on the IBM Support website.

### Procedure

- To submit files (via FTP) to the Enhanced Centralized Client Data Repository (EcuRep):
  1. Package the data files that you collected into ZIP or TAR format, and name the package according to your Problem Management Record (PMR) identifier.

Your file must use the following naming convention in order to be correctly associated with the PMR: `xxxx.bbb.ccc.yyy.yyy`, where `xxxx` is the PMR number, `bbb` is the PMR's branch number, `ccc` is the PMR's territory code, and `yyy.yyy` is the file name.
  2. Using an FTP utility, connect to the server `ftp.emea.ibm.com`.
  3. Log in as the userid "anonymous" and enter your email address as your password.
  4. Go to the `toibm` directory. For example, `cd toibm`.
  5. Go to one of the operating system-specific subdirectories. For example, the subdirectories include: `aix`, `linux`, `unix`, or `windows`.
  6. Change to binary mode. For example, enter `bin` at the command prompt.
  7. Put your file on the server by using the `put` command. Use the following file naming convention to name your file and put it on the server. Your PMR will be updated to list where the files are stored using the format: `xxxx.bbb.ccc.yyy.yyy`. (`xxx` is the PMR number, `bbb` is the branch, `ccc` is the territory code, and `yyy.yyy` is the description of the file type such as `tar.Z` or `xyz.zip`.) You can send files to the FTP server, but you cannot update them. Any time that you must subsequently change the file, you must create a new file name.
  8. Enter the `quit` command.
- To submit files using the ESR tool:
  1. Sign onto ESR.
  2. On the Welcome page, enter your PMR number in the **Enter a report number** field, and click **Go**.
  3. Scroll down to the **Attach Relevant File** field.
  4. Click **Browse** to locate the log, trace, or other diagnostic file that you want to submit to IBM Software Support.



5. Click **Submit**. Your file is transferred to IBM Software Support through FTP, and it is associated with your PMR.

### What to do next

For more information about the EcuRep service, see IBM EMEA Centralized Customer Data Store Service.

For more information about ESR, see Electronic Service Request (ESR) help.

### Receiving information from IBM Support

Occasionally an IBM technical-support representative might ask you to download diagnostic tools or other files. You can use FTP to download these files.

### Before you begin

Ensure that your IBM technical-support representative provided you with the preferred server to use for downloading the files and the exact directory and file names to access.

### Procedure

To download files from IBM Support:

1. Use FTP to connect to the site that your IBM technical-support representative provided and log in as anonymous. Use your email address as the password.
2. Change to the appropriate directory:
  - a. Change to the `/fromibm` directory.  
`cd fromibm`
  - b. Change to the directory that your IBM technical-support representative provided.  
`cd nameofdirectory`
3. Enable binary mode for your session.  
`binary`
4. Use the **get** command to download the file that your IBM technical-support representative specified.  
`get filename.extension`
5. End your FTP session.  
`quit`

## Subscribing to Support updates

By subscribing to receive updates about DB2 Database for Linux, UNIX, and Windows, you can receive important technical information and updates for specific IBM Support tools and resources.

### About this task

You can subscribe to updates by using one of two approaches:

#### RSS feeds and social media subscriptions

The following RSS feeds and social media subscriptions are available for DB2 Database for Linux, UNIX, and Windows:

- DB2 for Linux UNIX and Windows
- DB2 Merge Backup for Linux UNIX and Windows

For general information about RSS, including steps for getting started and a list of RSS-enabled IBM web pages, visit the IBM Software Support RSS feeds site.

### **My Notifications**

With My Notifications, you can subscribe to Support updates for any IBM product. My Notifications replaces My Support, which is a similar tool that you might have used in the past. With My Notifications, you can specify that you want to receive daily or weekly email announcements. You can specify what type of information you want to receive, such as publications, hints and tips, product flashes (also known as alerts), downloads, and drivers. My Notifications enables you to customize and categorize the products about which you want to be informed and the delivery methods that best suit your needs.

### **Procedure**

To subscribe to Support updates:

1. Subscribe to the DB2 RSS feeds by pointing your browser to the URL for the one of the RSS feeds and clicking **Subscribe Now**.
2. Subscribe to My Notifications by going to the IBM Support Portal and click **My Notifications** in the **Notifications** portlet.
3. Sign in using your IBM ID and password, and click **Submit**.
4. Identify what and how you want to receive updates.
  - a. Click the **Subscribe** tab.
  - b. Select the appropriate software brand or type of hardware.
  - c. Select one or more products by name and click **Continue**.
  - d. Select your preferences for how to receive updates, whether by email, online in a designated folder, or as an RSS or Atom feed.
  - e. Select the types of documentation updates that you want to receive, for example, new information about product downloads and discussion group comments.
  - f. Click **Submit**.

### **Results**

Until you modify your RSS feeds and My Notifications preferences, you receive notifications of updates that you have requested. You can modify your preferences when needed.

---

## Part 3. Appendixes



---

## Appendix A. Overview of the DB2 technical information

DB2 technical information is available in multiple formats that can be accessed in multiple ways.

DB2 technical information is available through the following tools and methods:

- DB2 Information Center
  - Topics (Task, concept and reference topics)
  - Sample programs
  - Tutorials
- DB2 books
  - PDF files (downloadable)
  - PDF files (from the DB2 PDF DVD)
  - printed books
- Command-line help
  - Command help
  - Message help

**Note:** The DB2 Information Center topics are updated more frequently than either the PDF or the hardcopy books. To get the most current information, install the documentation updates as they become available, or refer to the DB2 Information Center at [ibm.com](http://ibm.com).

You can access additional DB2 technical information such as technotes, white papers, and IBM Redbooks publications online at [ibm.com](http://ibm.com). Access the DB2 Information Management software library site at <http://www.ibm.com/software/data/sw-library/>.

### Documentation feedback

We value your feedback on the DB2 documentation. If you have suggestions for how to improve the DB2 documentation, send an email to [db2docs@ca.ibm.com](mailto:db2docs@ca.ibm.com). The DB2 documentation team reads all of your feedback, but cannot respond to you directly. Provide specific examples wherever possible so that we can better understand your concerns. If you are providing feedback on a specific topic or help file, include the topic title and URL.

Do not use this email address to contact DB2 Customer Support. If you have a DB2 technical issue that the documentation does not resolve, contact your local IBM service center for assistance.

---

## DB2 technical library in hardcopy or PDF format

The following tables describe the DB2 library available from the IBM Publications Center at [www.ibm.com/e-business/linkweb/publications/servlet/pbi.wss](http://www.ibm.com/e-business/linkweb/publications/servlet/pbi.wss). English and translated DB2 Version 10.1 manuals in PDF format can be downloaded from [www.ibm.com/support/docview.wss?rs=71&uid=swg2700947](http://www.ibm.com/support/docview.wss?rs=71&uid=swg2700947).

Although the tables identify books available in print, the books might not be available in your country or region.

The form number increases each time a manual is updated. Ensure that you are reading the most recent version of the manuals, as listed below.

**Note:** The *DB2 Information Center* is updated more frequently than either the PDF or the hard-copy books.

*Table 93. DB2 technical information*

<b>Name</b>	<b>Form Number</b>	<b>Available in print</b>	<b>Last updated</b>
<i>Administrative API Reference</i>	SC27-3864-00	Yes	April, 2012
<i>Administrative Routines and Views</i>	SC27-3865-00	No	April, 2012
<i>Call Level Interface Guide and Reference Volume 1</i>	SC27-3866-00	Yes	April, 2012
<i>Call Level Interface Guide and Reference Volume 2</i>	SC27-3867-00	Yes	April, 2012
<i>Command Reference</i>	SC27-3868-00	Yes	April, 2012
<i>Database Administration Concepts and Configuration Reference</i>	SC27-3871-00	Yes	April, 2012
<i>Data Movement Utilities Guide and Reference</i>	SC27-3869-00	Yes	April, 2012
<i>Database Monitoring Guide and Reference</i>	SC27-3887-00	Yes	April, 2012
<i>Data Recovery and High Availability Guide and Reference</i>	SC27-3870-00	Yes	April, 2012
<i>Database Security Guide</i>	SC27-3872-00	Yes	April, 2012
<i>DB2 Workload Management Guide and Reference</i>	SC27-3891-00	Yes	April, 2012
<i>Developing ADO.NET and OLE DB Applications</i>	SC27-3873-00	Yes	April, 2012
<i>Developing Embedded SQL Applications</i>	SC27-3874-00	Yes	April, 2012
<i>Developing Java Applications</i>	SC27-3875-00	Yes	April, 2012
<i>Developing Perl, PHP, Python, and Ruby on Rails Applications</i>	SC27-3876-00	No	April, 2012
<i>Developing User-defined Routines (SQL and External)</i>	SC27-3877-00	Yes	April, 2012
<i>Getting Started with Database Application Development</i>	GI13-2046-00	Yes	April, 2012

*Table 93. DB2 technical information (continued)*

<b>Name</b>	<b>Form Number</b>	<b>Available in print</b>	<b>Last updated</b>
<i>Getting Started with DB2 Installation and Administration on Linux and Windows</i>	GI13-2047-00	Yes	April, 2012
<i>Globalization Guide</i>	SC27-3878-00	Yes	April, 2012
<i>Installing DB2 Servers</i>	GC27-3884-00	Yes	April, 2012
<i>Installing IBM Data Server Clients</i>	GC27-3883-00	No	April, 2012
<i>Message Reference Volume 1</i>	SC27-3879-00	No	April, 2012
<i>Message Reference Volume 2</i>	SC27-3880-00	No	April, 2012
<i>Net Search Extender Administration and User's Guide</i>	SC27-3895-00	No	April, 2012
<i>Partitioning and Clustering Guide</i>	SC27-3882-00	Yes	April, 2012
<i>pureXML Guide</i>	SC27-3892-00	Yes	April, 2012
<i>Spatial Extender User's Guide and Reference</i>	SC27-3894-00	No	April, 2012
<i>SQL Procedural Languages: Application Enablement and Support</i>	SC27-3896-00	Yes	April, 2012
<i>SQL Reference Volume 1</i>	SC27-3885-00	Yes	April, 2012
<i>SQL Reference Volume 2</i>	SC27-3886-00	Yes	April, 2012
<i>Text Search Guide</i>	SC27-3888-00	Yes	April, 2012
<i>Troubleshooting and Tuning Database Performance</i>	SC27-3889-00	Yes	April, 2012
<i>Upgrading to DB2 Version 10.1</i>	SC27-3881-00	Yes	April, 2012
<i>What's New for DB2 Version 10.1</i>	SC27-3890-00	Yes	April, 2012
<i>XQuery Reference</i>	SC27-3893-00	No	April, 2012

*Table 94. DB2 Connect-specific technical information*

<b>Name</b>	<b>Form Number</b>	<b>Available in print</b>	<b>Last updated</b>
<i>DB2 Connect Installing and Configuring DB2 Connect Personal Edition</i>	SC27-3861-00	Yes	April, 2012
<i>DB2 Connect Installing and Configuring DB2 Connect Servers</i>	SC27-3862-00	Yes	April, 2012
<i>DB2 Connect User's Guide</i>	SC27-3863-00	Yes	April, 2012

---

## Displaying SQL state help from the command line processor

DB2 products return an SQLSTATE value for conditions that can be the result of an SQL statement. SQLSTATE help explains the meanings of SQL states and SQL state class codes.

### Procedure

To start SQL state help, open the command line processor and enter:

```
? sqlstate or ? class code
```

where *sqlstate* represents a valid five-digit SQL state and *class code* represents the first two digits of the SQL state.

For example, ? 08003 displays help for the 08003 SQL state, and ? 08 displays help for the 08 class code.

---

## Accessing different versions of the DB2 Information Center

Documentation for other versions of DB2 products is found in separate information centers on [ibm.com](http://ibm.com)<sup>®</sup>.

### About this task

For DB2 Version 10.1 topics, the *DB2 Information Center* URL is <http://publib.boulder.ibm.com/infocenter/db2luw/v10r1>.

For DB2 Version 9.8 topics, the *DB2 Information Center* URL is <http://publib.boulder.ibm.com/infocenter/db2luw/v9r8/>.

For DB2 Version 9.7 topics, the *DB2 Information Center* URL is <http://publib.boulder.ibm.com/infocenter/db2luw/v9r7/>.

For DB2 Version 9.5 topics, the *DB2 Information Center* URL is <http://publib.boulder.ibm.com/infocenter/db2luw/v9r5/>.

For DB2 Version 9.1 topics, the *DB2 Information Center* URL is <http://publib.boulder.ibm.com/infocenter/db2luw/v9/>.

For DB2 Version 8 topics, go to the *DB2 Information Center* URL at: <http://publib.boulder.ibm.com/infocenter/db2luw/v8/>.

---

## Updating the DB2 Information Center installed on your computer or intranet server

A locally installed DB2 Information Center must be updated periodically.

### Before you begin

A DB2 Version 10.1 Information Center must already be installed. For details, see the “Installing the DB2 Information Center using the DB2 Setup wizard” topic in *Installing DB2 Servers*. All prerequisites and restrictions that applied to installing the Information Center also apply to updating the Information Center.



## About this task

An existing DB2 Information Center can be updated automatically or manually:

- Automatic updates update existing Information Center features and languages. One benefit of automatic updates is that the Information Center is unavailable for a shorter time compared to during a manual update. In addition, automatic updates can be set to run as part of other batch jobs that run periodically.
- Manual updates can be used to update existing Information Center features and languages. Automatic updates reduce the downtime during the update process, however you must use the manual process when you want to add features or languages. For example, a local Information Center was originally installed with both English and French languages, and now you want to also install the German language; a manual update will install German, as well as, update the existing Information Center features and languages. However, a manual update requires you to manually stop, update, and restart the Information Center. The Information Center is unavailable during the entire update process. In the automatic update process the Information Center incurs an outage to restart the Information Center after the update only.

This topic details the process for automatic updates. For manual update instructions, see the “Manually updating the DB2 Information Center installed on your computer or intranet server” topic.

## Procedure

To automatically update the DB2 Information Center installed on your computer or intranet server:

1. On Linux operating systems,
  - a. Navigate to the path where the Information Center is installed. By default, the DB2 Information Center is installed in the `/opt/ibm/db2ic/V10.1` directory.
  - b. Navigate from the installation directory to the `doc/bin` directory.
  - c. Run the `update-ic` script:

```
update-ic
```
2. On Windows operating systems,
  - a. Open a command window.
  - b. Navigate to the path where the Information Center is installed. By default, the DB2 Information Center is installed in the `<Program Files>\IBM\DB2 Information Center\Version 10.1` directory, where `<Program Files>` represents the location of the Program Files directory.
  - c. Navigate from the installation directory to the `doc\bin` directory.
  - d. Run the `update-ic.bat` file:

```
update-ic.bat
```

## Results

The DB2 Information Center restarts automatically. If updates were available, the Information Center displays the new and updated topics. If Information Center updates were not available, a message is added to the log. The log file is located in `doc\eclipse\configuration` directory. The log file name is a randomly generated number. For example, `1239053440785.log`.

---

## Manually updating the DB2 Information Center installed on your computer or intranet server

If you have installed the DB2 Information Center locally, you can obtain and install documentation updates from IBM.

### About this task

Updating your locally installed *DB2 Information Center* manually requires that you:

1. Stop the *DB2 Information Center* on your computer, and restart the Information Center in stand-alone mode. Running the Information Center in stand-alone mode prevents other users on your network from accessing the Information Center, and allows you to apply updates. The Workstation version of the DB2 Information Center always runs in stand-alone mode. .
2. Use the Update feature to see what updates are available. If there are updates that you must install, you can use the Update feature to obtain and install them

**Note:** If your environment requires installing the *DB2 Information Center* updates on a machine that is not connected to the internet, mirror the update site to a local file system by using a machine that is connected to the internet and has the *DB2 Information Center* installed. If many users on your network will be installing the documentation updates, you can reduce the time required for individuals to perform the updates by also mirroring the update site locally and creating a proxy for the update site.

If update packages are available, use the Update feature to get the packages. However, the Update feature is only available in stand-alone mode.

3. Stop the stand-alone Information Center, and restart the *DB2 Information Center* on your computer.

**Note:** On Windows 2008, Windows Vista (and higher), the commands listed later in this section must be run as an administrator. To open a command prompt or graphical tool with full administrator privileges, right-click the shortcut and then select **Run as administrator**.

### Procedure

To update the *DB2 Information Center* installed on your computer or intranet server:

1. Stop the *DB2 Information Center*.
  - On Windows, click **Start > Control Panel > Administrative Tools > Services**. Then right-click **DB2 Information Center** service and select **Stop**.
  - On Linux, enter the following command:  

```
/etc/init.d/db2icdv10 stop
```
2. Start the Information Center in stand-alone mode.
  - On Windows:
    - a. Open a command window.
    - b. Navigate to the path where the Information Center is installed. By default, the *DB2 Information Center* is installed in the *Program\_Files\IBM\DB2 Information Center\Version 10.1* directory, where *Program\_Files* represents the location of the Program Files directory.
    - c. Navigate from the installation directory to the `doc\bin` directory.
    - d. Run the `help_start.bat` file:

```
help_start.bat
```

- On Linux:
  - a. Navigate to the path where the Information Center is installed. By default, the *DB2 Information Center* is installed in the `/opt/ibm/db2ic/V10.1` directory.
  - b. Navigate from the installation directory to the `doc/bin` directory.
  - c. Run the `help_start` script:

```
help_start
```

The systems default Web browser opens to display the stand-alone Information Center.

3. Click the **Update** button (🔧). (JavaScript must be enabled in your browser.) On the right panel of the Information Center, click **Find Updates**. A list of updates for existing documentation displays.
4. To initiate the installation process, check that the selections you want to install, then click **Install Updates**.
5. After the installation process has completed, click **Finish**.
6. Stop the stand-alone Information Center:
  - On Windows, navigate to the `doc\bin` directory within the installation directory, and run the `help_end.bat` file:

```
help_end.bat
```

**Note:** The `help_end` batch file contains the commands required to safely stop the processes that were started with the `help_start` batch file. Do not use `Ctrl-C` or any other method to stop `help_start.bat`.
  - On Linux, navigate to the `doc/bin` directory within the installation directory, and run the `help_end` script:

```
help_end
```

**Note:** The `help_end` script contains the commands required to safely stop the processes that were started with the `help_start` script. Do not use any other method to stop the `help_start` script.
7. Restart the *DB2 Information Center*.
  - On Windows, click **Start > Control Panel > Administrative Tools > Services**. Then right-click **DB2 Information Center** service and select **Start**.
  - On Linux, enter the following command:

```
/etc/init.d/db2icdv10 start
```

## Results

The updated *DB2 Information Center* displays the new and updated topics.

---

## DB2 tutorials

The DB2 tutorials help you learn about various aspects of DB2 database products. Lessons provide step-by-step instructions.

### Before you begin

You can view the XHTML version of the tutorial from the Information Center at <http://publib.boulder.ibm.com/infocenter/db2luw/v10r1/>.

Some lessons use sample data or code. See the tutorial for a description of any prerequisites for its specific tasks.

## DB2 tutorials

To view the tutorial, click the title.

### “pureXML®” in *pureXML Guide*

Set up a DB2 database to store XML data and to perform basic operations with the native XML data store.

---

## DB2 troubleshooting information

A wide variety of troubleshooting and problem determination information is available to assist you in using DB2 database products.

### DB2 documentation

Troubleshooting information can be found in the *Troubleshooting and Tuning Database Performance* or the Database fundamentals section of the *DB2 Information Center*, which contains:

- Information about how to isolate and identify problems with DB2 diagnostic tools and utilities.
- Solutions to some of the most common problem.
- Advice to help solve other problems you might encounter with your DB2 database products.

### IBM Support Portal

See the IBM Support Portal if you are experiencing problems and want help finding possible causes and solutions. The Technical Support site has links to the latest DB2 publications, TechNotes, Authorized Program Analysis Reports (APARs or bug fixes), fix packs, and other resources. You can search through this knowledge base to find possible solutions to your problems.

Access the IBM Support Portal at [http://www.ibm.com/support/entry/portal/Overview/Software/Information\\_Management/DB2\\_for\\_Linux,\\_UNIX\\_and\\_Windows](http://www.ibm.com/support/entry/portal/Overview/Software/Information_Management/DB2_for_Linux,_UNIX_and_Windows)

---

## Terms and conditions

Permissions for the use of these publications are granted subject to the following terms and conditions.

**Applicability:** These terms and conditions are in addition to any terms of use for the IBM website.

**Personal use:** You may reproduce these publications for your personal, noncommercial use provided that all proprietary notices are preserved. You may not distribute, display or make derivative work of these publications, or any portion thereof, without the express consent of IBM.

**Commercial use:** You may reproduce, distribute and display these publications solely within your enterprise provided that all proprietary notices are preserved. You may not make derivative works of these publications, or reproduce, distribute or display these publications or any portion thereof outside your enterprise, without the express consent of IBM.

**Rights:** Except as expressly granted in this permission, no other permissions, licenses or rights are granted, either express or implied, to the publications or any information, data, software or other intellectual property contained therein.

IBM reserves the right to withdraw the permissions granted herein whenever, in its discretion, the use of the publications is detrimental to its interest or, as determined by IBM, the above instructions are not being properly followed.

You may not download, export or re-export this information except in full compliance with all applicable laws and regulations, including all United States export laws and regulations.

IBM MAKES NO GUARANTEE ABOUT THE CONTENT OF THESE PUBLICATIONS. THE PUBLICATIONS ARE PROVIDED "AS-IS" AND WITHOUT WARRANTY OF ANY KIND, EITHER EXPRESSED OR IMPLIED, INCLUDING BUT NOT LIMITED TO IMPLIED WARRANTIES OF MERCHANTABILITY, NON-INFRINGEMENT, AND FITNESS FOR A PARTICULAR PURPOSE.

**IBM Trademarks:** IBM, the IBM logo, and ibm.com are trademarks or registered trademarks of International Business Machines Corp., registered in many jurisdictions worldwide. Other product and service names might be trademarks of IBM or other companies. A current list of IBM trademarks is available on the Web at [www.ibm.com/legal/copytrade.shtml](http://www.ibm.com/legal/copytrade.shtml)



---

## Appendix B. Notices

This information was developed for products and services offered in the U.S.A. Information about non-IBM products is based on information available at the time of first publication of this document and is subject to change.

IBM may not offer the products, services, or features discussed in this document in other countries. Consult your local IBM representative for information about the products and services currently available in your area. Any reference to an IBM product, program, or service is not intended to state or imply that only that IBM product, program, or service may be used. Any functionally equivalent product, program, or service that does not infringe any IBM intellectual property right may be used instead. However, it is the user's responsibility to evaluate and verify the operation of any non-IBM product, program, or service.

IBM may have patents or pending patent applications covering subject matter described in this document. The furnishing of this document does not grant you any license to these patents. You can send license inquiries, in writing, to:

IBM Director of Licensing  
IBM Corporation  
North Castle Drive  
Armonk, NY 10504-1785  
U.S.A.

For license inquiries regarding double-byte character set (DBCS) information, contact the IBM Intellectual Property Department in your country or send inquiries, in writing, to:

Intellectual Property Licensing  
Legal and Intellectual Property Law  
IBM Japan, Ltd.  
1623-14, Shimotsuruma, Yamato-shi  
Kanagawa 242-8502 Japan

**The following paragraph does not apply to the United Kingdom or any other country/region where such provisions are inconsistent with local law:**

INTERNATIONAL BUSINESS MACHINES CORPORATION PROVIDES THIS PUBLICATION "AS IS" WITHOUT WARRANTY OF ANY KIND, EITHER EXPRESS OR IMPLIED, INCLUDING, BUT NOT LIMITED TO, THE IMPLIED WARRANTIES OF NON-INFRINGEMENT, MERCHANTABILITY, OR FITNESS FOR A PARTICULAR PURPOSE. Some states do not allow disclaimer of express or implied warranties in certain transactions; therefore, this statement may not apply to you.

This information could include technical inaccuracies or typographical errors. Changes are periodically made to the information herein; these changes will be incorporated in new editions of the publication. IBM may make improvements, changes, or both in the product(s) and/or the program(s) described in this publication at any time without notice.

Any references in this information to websites not owned by IBM are provided for convenience only and do not in any manner serve as an endorsement of those

websites. The materials at those websites are not part of the materials for this IBM product and use of those websites is at your own risk.

IBM may use or distribute any of the information you supply in any way it believes appropriate without incurring any obligation to you.

Licenses of this program who wish to have information about it for the purpose of enabling: (i) the exchange of information between independently created programs and other programs (including this one) and (ii) the mutual use of the information that has been exchanged, should contact:

IBM Canada Limited  
U59/3600  
3600 Steeles Avenue East  
Markham, Ontario L3R 9Z7  
CANADA

Such information may be available, subject to appropriate terms and conditions, including, in some cases, payment of a fee.

The licensed program described in this document and all licensed material available for it are provided by IBM under terms of the IBM Customer Agreement, IBM International Program License Agreement, or any equivalent agreement between us.

Any performance data contained herein was determined in a controlled environment. Therefore, the results obtained in other operating environments may vary significantly. Some measurements may have been made on development-level systems, and there is no guarantee that these measurements will be the same on generally available systems. Furthermore, some measurements may have been estimated through extrapolation. Actual results may vary. Users of this document should verify the applicable data for their specific environment.

Information concerning non-IBM products was obtained from the suppliers of those products, their published announcements, or other publicly available sources. IBM has not tested those products and cannot confirm the accuracy of performance, compatibility, or any other claims related to non-IBM products. Questions on the capabilities of non-IBM products should be addressed to the suppliers of those products.

All statements regarding IBM's future direction or intent are subject to change or withdrawal without notice, and represent goals and objectives only.

This information may contain examples of data and reports used in daily business operations. To illustrate them as completely as possible, the examples include the names of individuals, companies, brands, and products. All of these names are fictitious, and any similarity to the names and addresses used by an actual business enterprise is entirely coincidental.

#### COPYRIGHT LICENSE:

This information contains sample application programs in source language, which illustrate programming techniques on various operating platforms. You may copy, modify, and distribute these sample programs in any form without payment to IBM, for the purposes of developing, using, marketing or distributing application programs conforming to the application programming interface for the operating



platform for which the sample programs are written. These examples have not been thoroughly tested under all conditions. IBM, therefore, cannot guarantee or imply reliability, serviceability, or function of these programs. The sample programs are provided "AS IS", without warranty of any kind. IBM shall not be liable for any damages arising out of your use of the sample programs.

Each copy or any portion of these sample programs or any derivative work must include a copyright notice as follows:

© (*your company name*) (*year*). Portions of this code are derived from IBM Corp. Sample Programs. © Copyright IBM Corp. *\_enter the year or years\_*. All rights reserved.

## Trademarks

IBM, the IBM logo, and [ibm.com](http://ibm.com) are trademarks or registered trademarks of International Business Machines Corp., registered in many jurisdictions worldwide. Other product and service names might be trademarks of IBM or other companies. A current list of IBM trademarks is available on the web at "Copyright and trademark information" at [www.ibm.com/legal/copytrade.shtml](http://www.ibm.com/legal/copytrade.shtml).

The following terms are trademarks or registered trademarks of other companies

- Linux is a registered trademark of Linus Torvalds in the United States, other countries, or both.
- Java and all Java-based trademarks and logos are trademarks or registered trademarks of Oracle, its affiliates, or both.
- UNIX is a registered trademark of The Open Group in the United States and other countries.
- Intel, Intel logo, Intel Inside, Intel Inside logo, Celeron, Intel SpeedStep, Itanium, and Pentium are trademarks or registered trademarks of Intel Corporation or its subsidiaries in the United States and other countries.
- Microsoft, Windows, Windows NT, and the Windows logo are trademarks of Microsoft Corporation in the United States, other countries, or both.

Other company, product, or service names may be trademarks or service marks of others.



---

# Index

## Special characters

**db2diag** log files  
interpreting  
informational record 675

## A

about this book vii  
access plans  
column correlation for multiple predicates 400  
grouping 263  
indexes  
scans 236  
structure 62  
information capture  
explain facility 277  
locks  
granularity 190  
modes 194  
modes for standard tables 196  
REFRESH TABLE statements 306  
reusing  
details 327  
SET INTEGRITY statements 306  
sharing 326  
sorting 263  
access request elements  
ACCESS 384  
IXAND 387  
IXOR 389  
IXSCAN 390  
LPREFETCH 391  
TBSCAN 392  
XANDOR 392  
XISCAN 393  
access type  
explain information 305  
ACCRDB command 515  
ACCRDBRM command 515  
ACCSEC command 515  
administration notification log  
details 667  
first occurrence data capture (FODC) 681  
interpreting 669  
administrative task scheduler  
troubleshooting 549  
agents  
client connections 45  
managing 39  
partitioned databases 46  
worker agent types 38  
aggregate functions  
db2expln command 320  
AIX  
configuration  
best practices 47  
alerts 632  
DB2 pureScale  
hosts 624, 628, 631  
interpreting 624, 629, 642

alerts (*continued*)  
DB2 pureScale (*continued*)  
members 624, 625, 628, 629  
DB2 pureScale environments  
hosts 625  
host 637  
application design  
application performance 147  
application processes  
details 147  
effect on locks 193  
applications  
performance  
application design 147  
lock management 190  
modeling using catalog statistics 458  
modeling using manually adjusted catalog  
statistics 457  
architecture  
overview 31  
asynchronous index cleanup  
details 65  
audit facility  
troubleshooting 691  
authorized program analysis reports (APARs) 705  
automatic maintenance  
index reorganization  
volatile tables 141  
automatic memory tuning 94  
automatic reorganization  
details 139  
enabling 141  
automatic statistics collection  
enabling 427  
storage 429  
automatic statistics profiling  
storage 429

## B

benchmarking  
db2batch command 7  
executing 8  
overview 5  
preparing 6  
sample report 10  
SQL statements for 6  
best practices  
queries 162  
binding  
isolation levels 155  
block identifiers  
preparing before table access 319  
block-based buffer pools 111  
blocking  
row 186  
buffer pool hit ratios 105  
buffer pools  
advantages of large 101  
block-based 111  
managing multiple 101

- buffer pools (*continued*)
  - memory
    - allocation at startup 101
  - overview 98
  - page-cleaning methods 103
  - tuning
    - page cleaners 99

## C

- call level interface (CLI)
  - applications
    - trace facility configuration 525
  - isolation levels 155
  - trace facility
    - starting 525
  - trace file
    - overview 530
  - trace files
    - troubleshooting overview 521
- cardinality estimates
  - statistical views 405
- catalog statistics
  - avoiding manual updates 458
  - catalog table descriptions 417
  - collecting
    - distribution statistics on specific columns 449
    - general 437
    - guidelines 436
    - index statistics 443
  - detailed index data 442
  - distribution statistics 445, 450
  - index cluster ratio 242
  - manual adjustments for modeling 457
  - manual update rules
    - column statistics 441
    - distribution statistics 454
    - general 440
    - index statistics 444
    - nickname statistics 442
    - table statistics 442
  - modeling production databases 458
  - overview 413
  - sub-elements in columns 439
  - user-defined functions 454
- classic table reorganization 122
- clearing failed offline state on idle
  - troubleshooting
    - DB2 pureScale Feature 630
- CLI and ODBC
  - traces
    - files 521
- cluster file systems
  - failures 624, 625, 626
- cluster manager domain
  - repairing 650
- cluster manager resource model
  - repairing 649
- clustering indexes
  - partitioned tables 81
- code pages
  - best practices 47
- collations
  - best practices 47
- columns
  - distribution statistics
    - collecting 449
- columns (*continued*)
  - group statistics 400
  - statistics 441
  - sub-element statistics 439
- commands
  - ACCRDB 515
  - ACCRDBRM 515
  - ACCSEC 515
  - commit 515
  - db2cklog 475
  - db2dart
    - INSPECT command comparison 478
    - overview 477
  - db2diag
    - analyzing db2diag log files 480
  - db2drdat
    - overview 514
  - db2gov
    - starting DB2 Governor 17
    - stopping DB2 Governor 29
  - db2inspf
    - formatting inspection results 557
  - db2level
    - determining version and service level 485
  - db2look
    - creating similar databases 485
  - db2ls
    - listing DB2 products and features 489
  - db2pd
    - examples 490
    - run by db2cos command 679
  - db2pdcfg
    - overview 681
  - db2support
    - collecting environment information 504
    - example 676
  - db2trc
    - formatting trace file 512
    - obtaining trace 510
  - EXCSAT 515
  - EXCSATRD 515
  - INSPECT
    - db2dart command comparison 478
  - SECCHK 515
- commit command 515
- commits
  - lock releasing 147
- compilation key 370
- compilation time
  - DB2\_REDUCED\_OPTIMIZATION registry variable 181
- dynamic queries
  - using parameter markers to reduce 180
- compiler rewrites
  - adding implied predicates 223
  - correlated subqueries 219
  - merge view 217
- compilers
  - capturing information using explain facility 277
- compression
  - data row
    - performance effects 459, 586
  - index
    - performance effects 459, 586
- concentrator
  - statement 326
- concurrency
  - federated databases 149

- concurrency (*continued*)
  - improving 157
  - issues 149
  - locks 190
- configuration
  - IOCP (AIX) 115
- Configuration Advisor
  - performance tuning 54
- configuration files
  - governor utility
    - rule clauses 21
    - rule details 19
- configuration parameters
  - appl\_memory 86
  - asl\_heap\_sz 86
  - audit\_buf\_sz 86
  - database memory 86
  - fcm\_num\_buffers 86
  - fcm\_num\_channels 86
  - mon\_heap\_sz 86
  - sheapthres 86
- configuration settings
  - best practices 47
- connection concentrator
  - agents in partitioned database 46
  - client-connection improvements 45
- connections
  - first-user scenarios 116
- consistency
  - points 147
- constraints
  - improving query optimization 178
- coordinator agents
  - connection-concentrator use 45
  - details 32, 40
- core files
  - Linux systems 698
  - UNIX systems 698
- correlation
  - simple equality predicates 402
- cross-partition monitoring 11
- cur\_commit database configuration parameter
  - overview 157
- CURRENT EXPLAIN MODE special register
  - explain data 286
- CURRENT EXPLAIN SNAPSHOT special register
  - explain data 286
- CURRENT LOCK TIMEOUT special register
  - lock wait mode strategy 211
- CURRENT MEMBER
  - DB2 pureScale environments 74
- cursor stability (CS)
  - details 150

**D**

- daemons
  - governor utility 18
- data objects
  - explain information 282
- data operators
  - explain information 282
- data pages
  - standard tables 57
- data partition elimination 269
- data representation
  - access
    - methods 235
    - scan sharing 243
  - compacting 118
  - inconsistencies 557
  - sampling in queries 187
- data sources
  - performance 232
- data stream information
  - db2expln command 318
- Data Warehouse Center
  - troubleshooting 692
- database agents
  - managing 39
- database analysis and reporting tool command
  - overview 477
- database engine processes 592
- database manager
  - shared memory 87
- database partition groups
  - query optimization impact 399
- database partitions
  - creating 589
- database\_memory database configuration parameter
  - self-tuning 91
- databases
  - corrupt 558
  - deactivating
    - first-user connection scenarios 116
  - names
    - RDBNAM object 515
- DB2 Governor
  - configuration file 19
  - daemons 18
  - log files 26
  - overview 16
  - rule clauses 21
  - starting 17
  - stopping 29
  - troubleshooting 691
- DB2 Information Center
  - updating 718, 720
  - versions 718
- DB2 products
  - list 489
- DB2 pureScale
  - creating 607
  - diagnostic data collection
    - manual 597
  - diagnostic data collectiontroubleshooting
    - automaticautomatic data collection 599
  - host reboot with restart light 645
  - installingtroubleshooting 598, 607
  - log files 597
  - removing 652, 654
  - restart events 639
  - trace files 597
  - troubleshooting
    - DB2 Setup wizard 598
    - db2start command 611
    - diagnostics 595
    - GPFS 608
    - host reboot with restart light 645
    - installation rollbacks instance creation 598, 607
    - kernel panic with GPFS outage 647
    - licensing 610

- DB2 pureScale (*continued*)
  - troubleshooting (*continued*)
    - manual data collection 597
    - mapping db2diag log file entries to cfdump.out\* files 615
    - mapping Tivoli SA MP states to DB2 cluster services states 601
    - overview 595
    - post-installation 611, 621
    - reducing sharing between members 74
    - removal 652, 654
    - response file installations 609
    - RSCT peer domains 609
    - tracing uDAPL over InfiniBand connections 619
    - uDAPL communication errors 616
    - uninstallation 652
- DB2 pureScale Feature
  - troubleshooting
    - clearing failed offline state on idle 630
- DB2 pureScale instances
  - hosts
    - troubleshooting 623
  - members
    - troubleshooting 623
  - troubleshooting
    - hosts 623
    - members 623
- DB2 Setup wizard
  - DB2 pureScale
    - launch problems 598
- DB2 Text Search 655, 656
  - maintaining 655
  - problem determination 655
  - tracing problems 655
  - troubleshooting 655
  - troubleshooting tips 658
- DB2 Universal JDBC Driver
  - trace facility configuration 521
- DB2\_EVALUNCOMMITTED registry variable
  - deferral of row locks 159
- DB2\_FMP\_COMM\_HEAPSZ variable
  - FMP memory set configuration 86
- DB2\_REDUCED\_OPTIMIZATION registry variable
  - reducing compilation time 181
- DB2\_SKIPINSERTED registry variable
  - details 159
- DB2\_USE\_ALTERNATE\_PAGE\_CLEANING registry variable
  - proactive page cleaning 103
- db2batch command
  - overview 7
- db2cklog command
  - troubleshooting 475
- db2cli.ini file
  - trace configuration 525
- db2cluster command
  - automatic host reboot 651
  - automatic offlining of cluster caching facility 651
  - automatic offlining of member 651
  - repairing the cluster manager domain 650
  - sample output 628
  - troubleshooting options 649
- db2cos script 679
- db2dart command
  - INSPECT command comparison 478
  - troubleshooting overview 477
- db2diag command
  - examples 480
- db2diag logs
  - details 670
  - first occurrence data capture (FODC) information 681
  - interpreting
    - overview 672
    - using db2diag tool 480
  - merging 662
- db2drdat command
  - output file 514
- db2expln command
  - information displayed
    - aggregation 320
    - block identifier preparation 319
    - data stream 318
    - delete 318
    - federated query 322
    - insert 318
    - join 316
    - miscellaneous 324
    - parallel processing 320
    - row identifier preparation 319
    - table access 309
    - temporary table 314
    - update 318
  - output description 309
- DB2FODC registry variable
  - collecting diagnostic information 681
- db2gov command
  - details 16
  - starting DB2 Governor 17
  - stopping DB2 Governor 29
- db2inspf command
  - troubleshooting 557
- db2instance command
  - host status 623
  - member status 623
  - sample output 624, 628, 642, 644
- db2level command
  - service-level identification 485
  - version-level identification 485
- db2licm command
  - compliance report 564
- db2look command
  - creating databases 485
- db2ls command
  - listing installed products and features 489
- db2mtrk command
  - sample output 98
- db2pd command
  - output collected by default db2cos script 679
  - troubleshooting examples 490
- db2pdcfg command
  - setting options in DB2FODC registry variable 681
- db2start command
  - troubleshooting
    - DB2 pureScale 611
- db2support command
  - details 504
  - diagnostic data collection 599
  - running 676
- db2trc command
  - dumping trace output 512
  - formatting trace output 512
  - overview 510
- db2val command
  - validating DB2 copy 509
- ddcstrc utility 514

- deadlock detector 211
- deadlocks
  - avoiding 157
  - overview 211
- decision support system (DSS) 514
- deferred index cleanup
  - monitoring 67
- defragmentation
  - index 68
- DEGREE general request element 377
- Design Advisor
  - converting single-partition to multipartition databases 468
  - defining workloads 467
  - details 463
  - restrictions 468
  - running 467
- diaglevel configuration parameter
  - updating 675
- diagnostic information
  - analyzing 544, 564
  - applications 697
  - data movement problems 540
  - DB2 administration server (DAS) problems 540
  - Dr. Watson logs 701
  - first occurrence data capture (FODC)
    - configuring 684
    - details 681
    - files 681
  - hardware 697
  - installation problems 560
  - instance management problems 540
  - Linux
    - diagnostic tools 535
    - obtaining information 697
    - system core file 698
  - overview 539
  - submitting to IBM Software Support 710
  - UNIX
    - diagnostic tools 535
    - obtaining information 697
    - system core file 698
  - Windows
    - diagnostic tools 535
    - event logs 700
    - obtaining information 697
- diagnostics
  - troubleshooting 595
- dirty read 150
- disks
  - storage performance factors 55
- Distributed Data Management (DDM)
  - db2drdat output 514
- distribution statistics
  - details 445
  - examples 450
  - manual update rules 454
  - query optimization 448
- documentation
  - overview 715
  - PDF files 715
  - printed 715
  - terms and conditions of use 722
- domains
  - peer
    - manually cleaning up Reliable Scalable Cluster Technology (RSCT) 653
- DPFXMLMOVEMENT general request element 378
- dump files
  - error reports 681
- dumping trace to file
  - overview 512
- dynamic queries
  - setting the optimization class 331
  - using parameter markers to reduce compilation time 180
- dynamic SQL
  - isolation levels 155

## E

- ECF return codes 693
- end unit of work reply message (ENDUOWRM) 515
- equality predicates 402
- event monitors
  - troubleshooting 691
- ExampleBANK reclaiming space scenario
  - converting to insert time clustering tables 144
  - index maintenance 145
  - insert time clustering table 143
  - overview 142
  - reclaiming space
    - from a table 143
    - from an index 144
  - space management policies 142
- ExampleBANK space reclaim scenario
  - AUTO\_REORG policy 146
- exchange server attributes command 515
- EXCSAT command 515
- EXCSATRD command 515
- explain facility
  - analyzing information 305
  - capturing information 286
  - capturing section actuals information 295
  - capturing section explain information 288
  - creating snapshots 286
  - data object information 282
  - data operator information 282
  - db2exfmt command 307
  - db2expln command 307
  - determining where federated queries are evaluated 230
  - explain instances 279
  - EXPLAIN statement 293
  - explain tables 279
  - federated databases 234
  - guidelines for using information 304
  - information 279
  - instance information 283
  - output
    - generated from sections in package cache 289
    - section actuals 302
  - overview 277, 307, 308
  - section explain 293
  - tuning SQL 278
- EXPLAIN statement
  - comparison with EXPLAIN\_FROM\_SECTION 289
- explain tables
  - organization 279
- EXPLAIN\_FROM\_SECTION procedure
  - example 289
- exporting
  - displays 598
- expressions
  - over columns 163
  - search conditions 163
- EXTNAM object 515

## F

- FCM
  - memory requirements 90
- federated databases
  - concurrency control 149
  - determining where queries are evaluated 230
  - global analysis of queries 234
  - global optimization 232
  - pushdown analysis 226
  - server options 83
- federated query information
  - db2expln command 322
- FETCH FIRST N ROWS ONLY clause
  - using with OPTIMIZE FOR N ROWS clause 167
- first failure data capture (FFDC) trap files 701
- first occurrence data capture
  - see FODC 681
- fix packs
  - acquiring 705
  - overview 705
- FODC
  - data generation 691
  - details 681
  - dump files 681
  - platform-specific 697
  - subdirectories 686
  - trap files 702
- formulas
  - buffer pool hit ratios 105
- fragment elimination
  - see data partition elimination 269
- free space control record (FSCR)
  - ITC tables 60
  - MDC tables 60
  - standard tables 57
- frequent-value distribution statistics 445

## G

- general optimization guidelines 368
- global optimization
  - guidelines 368
- global registry
  - altering 484
- global variables
  - troubleshooting 555
- GPFS
  - traces 620
  - troubleshooting 608
- GPFS error messages 637
- granularity
  - lock 191
- grouping effect on access plans 263

## H

- hardware
  - configuration best practices 47
- hash joins
  - details 249
- help
  - SQL statements 718
- host 632
- hosts 642
  - DB2 pureScale
    - alerts 631

- hosts (*continued*)
  - DB2 pureScale environments
    - statesalerts 623
    - troubleshooting 623
- how this book is structured vii
- HP-UX
  - configuration best practices 47

## I

- I/O
  - parallelism
    - managing 114
    - prefetching 112
- I/O completion ports (IOCPs)
  - AIX 115
  - configuring 115
- IBM
  - submitting data to software support 710
  - Support updates
    - subscribing 711
- IBM Data Server
  - messages 695
- IBM Tivoli System Automation for Multiplatforms recovery
  - resource manager daemon
    - failuresignificant disk usageSQL30108N 634
- implicitly hidden columns
  - DB2 pureScale environments 74
- IN (Intent None) 192
- index compression
  - database performance 459, 586
- index reorganization
  - automatic 141
  - costs 137
  - overview 118, 129
  - reducing need 138
  - volatile tables 141
- index scans
  - details 236
  - lock modes 196
  - previous leaf pointers 62
  - search processes 62
- indexes
  - advantages 69
  - asynchronous cleanup 65, 67
  - catalog statistics 443
  - cluster ratio 242
  - clustering
    - details 81
  - data consistency 558
  - data-access methods 240
  - deferred cleanup 67
  - Design Adviser 463
  - explain information to analyze use 305
  - managing
    - ITC tables 60
    - MDC tables 60
    - overview 64
    - standard tables 57
  - online defragmentation 68
  - partitioned tables
    - details 76
  - performance tips 73
  - planning 71
  - statistics
    - detailed 442
    - manual update rules 444



- indexes (*continued*)
  - structure 62
- Information Catalog Center
  - troubleshooting 692
- inline LOBs 461
- INLIST2JOIN query rewrite request element 381
- inplace table reorganization 125
- insert time clustering (ITC) tables
  - lock modes
    - table and RID index scans 200
  - management of tables and indexes 60
- inserting data
  - disregarding uncommitted insertions 159
  - performance 181
- INSPECT command
  - CHECK clause 557
  - db2dart comparison 478
- installation
  - DB2 products
    - known problems 563
    - troubleshooting 560
  - DB2 pureScale Feature
    - troubleshooting 598, 607
  - error logs 560
  - Information Center
    - problems 563
  - listing DB2 database products 489
  - problems
    - analyzing 561
    - troubleshooting 562
- instance\_name.nfy log file 667
- instances
  - explain information 283
- interim fix packs
  - details 705
- intra-partition parallelism
  - details 188
  - optimization strategies 265
- IOCPs (I/O completion ports)
  - AIX 115
- IS (Intent Share) 192
- isolation levels
  - comparison 150
  - cursor stability (CS) 150
  - lock granularity 190
  - performance 150
  - read stability (RS) 150
  - repeatable read (RR) 150
  - specifying 155
  - uncommitted read (UR) 150
- ISV applications
  - best practices 47
- IX (Intent Exclusive) lock mode 192

## J

- JDBC
  - applications
    - trace facility configuration 521
  - isolation levels 155
- join predicates 165
- join request elements
  - HSJOIN 396
  - JOIN 395
  - MSJOIN 396
  - NLJOIN 397

- joins
  - explain information 305, 316
  - hash 249
  - merge 249
  - methods 257
  - nested-loop 249
  - optimizer selection 251
  - overview 248
  - partitioned database environments
    - methods 257
    - table queue strategy 256
  - shared aggregation 217
  - star schema 167
  - subquery transformation by optimizer 217
  - unnecessary outer 166
  - zigzag
    - examples 171
    - with index gaps 174

## K

- keys
  - compilation 370
  - statement 370

## L

- large objects (LOBs)
  - inline 461
- licenses
  - compliance
    - report 564
- Linux
  - configuring
    - best practices 47
  - listing DB2 database products 489
- list prefetching 111
- lock granularity
  - factors affecting 193
  - overview 191
- lock modes
  - compatibility 195
  - details 192
  - IN (Intent None) 192
  - insert time clustering (ITC) tables
    - RID index scans 200
    - table scans 200
  - IS (Intent Share) 192
  - IX (Intent Exclusive) 192
  - multidimensional clustering (MDC) tables
    - block index scans 204
    - RID index scans 200
    - table scans 200
  - NS (Scan Share) 192
  - NW (Next Key Weak Exclusive) 192
  - S (Share) 192
  - SIX (Share with Intent Exclusive) 192
  - U (Update) 192
  - X (Exclusive) 192
  - Z (Super Exclusive) 192
- locklist configuration parameter
  - lock granularity 190
- locks
  - application performance 190
  - application type effect 193
  - concurrency control 190

- locks (*continued*)
  - conversion 210
  - data-access plan effect 194
  - deadlocks 211
  - deferral 159
  - granting simultaneously 195
  - isolation levels 150
  - lock count 192
  - next-key locking 195
  - objects 192
  - overview 147
  - partitioned tables 208
  - standard tables 196
  - timeouts
    - avoiding 157
    - overview 210
  - waits
    - overview 210
    - resolving 211
- log buffers
  - improving DML performance 461
- log files
  - checking validity 475
- log sequence numbers (LSNs)
  - gap 103
- logging
  - stand-alone DB2 Text Search server 655
- logical partitions
  - multiple 40
- logs
  - administering 667
  - archive 461
  - circular logging 461
  - governor utility 26
  - statistics 430, 435

## M

- materialized query tables (MQTs)
  - automatic summary tables 275
  - partitioned databases 254
  - replicated 254
- maxappls configuration parameter
  - effect on memory use 83
- maxcoordagents configuration parameter 83
- members 632
  - alerts
    - interpreting 623
  - states
    - interpreting 623
  - troubleshooting
    - overview 623
- memory
  - allocating
    - overview 83
    - parameters 90
    - see also memory set 86
  - bufferpool allocation at startup 101
  - configuring
    - see also memory set 86
  - database manager 87
  - FCM buffer pool 90
  - partitioned database environments 97
  - self-tuning 91
  - troubleshooting
    - sort heap 579

- memory set
  - configuration parameters 86
  - overview 86
  - registry variables 86
  - types 86
- Memory Tracker command
  - sample output 98
- merge joins
  - details 249
- messages 695
- monitoring
  - abnormal values 16
  - application behavior 16
  - capturing section explain information 288
  - cross-partition 11
  - index reorg 132
  - runstats 456
  - system performance 11, 12
- monitoring queues 656
- multidimensional clustering (MDC) tables
  - block-level locking 190
  - deferred index cleanup 67
  - lock modes
    - block index scans 204
    - table and RID index scans 200
  - management of tables and indexes 60
  - optimization strategies 267
  - rollout deletion 267
- multiple restarts
  - member 644
- multiple-partition databases
  - converting from single-partition databases 468

## N

- nested-loop joins
  - details 249
- next-key locks 195
- nicknames
  - statistics 442
- no alerts
  - DB2 pureScale
    - hosts 642
    - members 642
- no-op expressions 165
- non-repeatable reads
  - concurrency control 149
  - isolation levels 150
- NOTEX2AJ query rewrite request element 381
- notices 725
- notify level configuration parameter
  - updating 670
- NOTIN2AJ query rewrite request element 382
- NS (Scan Share) lock mode 192
- numdb database manager configuration parameter
  - effect on memory use 83
- NW (Next Key Weak Exclusive) lock mode 192

## O

- ODBC
  - applications
    - trace facility configuration 525
  - specifying isolation level 155
  - traces 530

- offline index reorganization
    - space requirements 137
  - offline table reorganization
    - advantages 120
    - disadvantages 120
    - failure 124
    - improving performance 125
    - locking conditions 122
    - performing 123
    - phases 122
    - recovery 124
    - space requirements 137
    - temporary files created during 122
  - online index reorganization
    - concurrency 131
    - locking 131
    - log space requirements 137
  - online table reorganization
    - advantages 120
    - concurrency 128
    - details 125
    - disadvantages 120
    - locking 128
    - log space requirements 137
    - pausing 128
    - performing 127
    - recovery 127
    - restarting 128
  - operations
    - merged by optimizer 216
    - moved by optimizer 216
  - OPTGUIDELINES element
    - global 365
    - statement-level 376
  - optimization
    - access plans
      - column correlation 400
      - effect of sorting and grouping 263
      - index access methods 240
      - using indexes 236
    - classes
      - choosing 330
      - details 327
      - setting 331
    - data-access methods 235
    - guidelines
      - general 344
      - plan 348
      - query rewrite 344
      - table references 352
      - troubleshooting 587
      - types 343
      - verifying use 356
    - intra-partition parallelism 265
    - join strategies 251
    - joins in partitioned database environments 257
    - MDC tables 267
    - partitioned tables 269
    - queries
      - improving through constraints 178
      - query rewriting methods 216
      - reorganizing tables and indexes 118
      - statistics 405
  - optimization classes
    - overview 327
  - optimization guidelines
    - overview 333
  - optimization guidelines (*continued*)
    - statement-level 351
    - XML schema
      - general optimization guidelines 377
      - plan optimization guidelines 382
      - query rewrite optimization guidelines 380
  - optimization profile cache 398
  - optimization profiles
    - binding to package 342
    - configuring data server to use 340
    - creating 337
    - deleting 343
    - details 334
    - inexact matching 371
    - inexact matching examples 374
    - managing 398
    - matching 370
    - modifying 342
    - overview 332, 333
    - setting SQL compiler registry variables 337
    - specifying for application 341
    - specifying for optimizer 340
    - SYSTOOLS.OPT\_PROFILE table 397
    - troubleshooting 587
    - XML schema 357
  - OPTIMIZE FOR N ROWS clause 167
  - optimizer
    - statistical views
      - creating 404
      - overview 402
    - tuning 333
  - OPTPROFILE element 365
  - outer joins
    - unnecessary 166
  - overflow records
    - performance effect 134
    - standard tables 57
- ## P
- page cleaners
    - tuning 99
  - pages
    - overview 57
  - parallelism
    - db2expln command information 320
    - I/O
      - managing 114
      - I/O server configuration 112
    - intra-partition
      - optimization strategies 265
      - overview 188
    - non-SMP environments 188
  - parameter markers
    - reducing compilation time for dynamic queries 180
  - parameters
    - autonomic
      - best practices 47
      - memory allocation 90
      - PRDID 515
  - partitioned databases
    - best practices 47
    - decorrelation of queries 219
    - join methods 257
    - join strategies 256
    - replicated materialized query tables 254
    - self-tuning memory 95, 97

- partitioned tables
  - clustering indexes 81
  - indexes 76
  - locking 208
  - optimization strategies 269
- peer domains
  - Reliable Scalable Cluster Technology (RSCT)
    - manually cleaning up 653
- performance
  - analyzing changes 278
  - application design 147
  - Configuration Advisor 54
  - db2batch command 7
  - disk-storage factors 55
  - enhancements
    - relational indexes 73
  - evaluating 278
  - explain information 304
  - guidelines 1, 581
  - isolation level effect 150
  - limits 1, 581
  - locks
    - managing 190
  - overview 1, 581
  - queries 162, 213
  - runstats
    - improving 458, 585
  - SQL query
    - explain generated from section 289
    - using section actuals 298
  - system
    - monitoring 11, 12
  - troubleshooting 1, 581
- phantom reads
  - concurrency control 149
  - isolation levels 150
- physical database design
  - best practices 47
- points of consistency
  - database 147
- PRDID parameter 515
- precompilation
  - specifying isolation level 155
- predicate pushdown query optimization
  - combined SQL/XQuery statements 221
- predicates
  - avoiding redundant 177
  - characteristics 224
  - implied
    - example 223
  - join
    - non-equality 165
    - on expressions 163
  - local
    - with expressions over columns 163
  - no-op expressions 165
  - query processing 245
  - simple equality 402
  - translation by optimizer 216
- prefetching
  - block-based buffer pools 111
  - I/O server configuration 112
  - list 111
  - parallel I/O 112
  - performance effects 107
  - readahead 110
  - sequential 108

- primary role moves
  - member 642
- problem determination
  - information available 722
  - installation problems 560
  - tutorials 722
- process model
  - details 32, 40
- process status utility
  - command 515
- processes
  - overview 31
- profiles
  - optimization
    - details 334
    - overview 332
  - statistics 428
- ps command
  - EXTNAM object 515
- pushdown analysis
  - federated database queries 226

## Q

- QRYOPT general request element 378
- quantile distribution statistics 445
- queries
  - criteria for star schema joins 167
  - dynamic 180
  - input variables 179
  - tuning
    - restricting SELECT statements 183
    - SELECT statements 182
- query optimization
  - catalog statistics 399
  - classes 327, 330
  - database partition group effects 399
  - distribution statistics 448
  - improving through constraints 178
  - no-op expressions in predicates 165
  - performance 213
  - profiles 332
  - table space effects 55
- query rewrite
  - examples 219
  - optimization guidelines 344

## R

- read stability (RS)
  - details 150
- readahead prefetching 110
- RECEIVE BUFFER 514
- record identifiers (RIDs)
  - standard tables 57
- REGISTRY general request element 379
- registry variables
  - DB2\_FMP\_COMM\_HEAPSZ 86
- relational indexes
  - advantages 69
- Reliable Scalable Cluster Technology (RSCT)
  - peer domain
    - manually cleaning up 653
  - peer domains
    - troubleshooting 609
- REOPT bind option 179

- REOPT general request element 379
- REORG TABLE command
  - performing offline 123
- reorg utility
  - monitoring progress 132
- reorganization
  - automatic 139
    - indexes in volatile tables 141
  - error handling 129
  - ExampleBANK
    - see ExampleBANK reclaiming space scenario 142
- indexes
  - automatic 141
  - costs 137
  - determining need 134
  - online (locking and concurrency) index reclaim 131
  - overview 129
  - procedure 118
- methods 120
- monitoring 129
- reducing need 138
- scenario
  - see ExampleBANK reclaiming space scenario 142
- tables
  - automatic 141
  - costs 137
  - determining need 134
  - necessity 119
  - offline (compared with online) 120
  - offline (details) 122
  - offline (failure and recovery) 124
  - offline (improving performance) 125
  - online (details) 125
  - online (failure and recovery) 127
  - online (locking and concurrency) 128
  - online (pausing and restarting) 128
  - online (procedure) 127
  - procedure 118
- repeatable read (RR)
  - details 150
- response files
  - DB2 pureScale Feature
    - troubleshooting 609
- restart light
  - failures 624, 630
- return codes
  - internal 693
- REXX language
  - specifying isolation level 155
- rollbacks
  - overview 147
- rollout deletion
  - deferred cleanup 67
- row blocking
  - specifying 186
- row compression
  - performance effects 459, 586
- row identifiers
  - preparing before table access 319
- RSCT (Reliable Scalable Cluster Technology)
  - peer domain
    - manually cleaning up 653
  - peer domains
    - troubleshooting 609
- RTS general request element 380
- RUNSTATS command
  - automatic statistics collection 423

- RUNSTATS command (*continued*)
  - sampling statistics 439
- runstats utility
  - monitoring progress 456
- RUNSTATS utility
  - automatic statistics collection 427
  - improving performance 458, 585
  - information about sub-elements 440
  - statistics collected 413

## S

- S (Share) lock mode
  - details 192
- sampling
  - data 187
- SARGable predicates
  - overview 224
- scan sharing
  - overview 243
- scenarios
  - access plans 306
  - improving cardinality estimates 405
- scripts
  - troubleshooting 592
- SECCHK command 515
- section actuals
  - explain facility output 302
- SELECT statement
  - eliminating DISTINCT clauses 219
  - prioritizing output for 183
- self-tuning memory
  - details 91
  - disabling 93
  - enabling 92
  - monitoring 94
  - overview 91
  - partitioned database environments 95, 97
- self-tuning memory manager
  - see self-tuning memory 91
- send buffer
  - tracing data 514
- sequential prefetching 108
- SET CURRENT QUERY OPTIMIZATION statement
  - setting query optimization class 331
- shadow paging
  - long objects 461
- SIX (Share with Intent Exclusive) lock mode 192
- snapshot monitoring
  - system performance 11
- Solaris operating systems
  - configuration best practices 47
- sortheap database configuration parameter
  - troubleshooting 579
- sorting
  - access plans 263
  - performance tuning 116, 583
- SQL compiler
  - process details 213
- SQL statements
  - benchmarking 6
  - explain tool 308
  - help
    - displaying 718
  - isolation levels 155
  - rewriting 216

- SQL statements (*continued*)
  - tuning
    - explain facility 278
    - restricting SELECT statements 183
    - SELECT statements 182
  - writing
    - best practices 163
- SQLCA
  - buffers of data 514
  - SQLCODE field 514
- SQLCODE
  - field in SQLCA 514
- SQLJ
  - isolation levels 155
- SRVNAM object 515
- state
  - hostWAITING\_FOR\_FAILBACK 633
- statement concentrator
  - details 326
- statement keys 370
- states 632
  - DB2 pureScale
    - hostsACTIVE 628
    - hostsINACTIVE 624
    - hostsWAITING\_FOR\_FAILBACK 630
    - hostsWAITING\_FOR\_FAILBACKINACTIVEmembers 624
    - membersERROR 629, 630
    - membersWAITING\_FOR\_FAILBACK 624, 628
    - WAITING\_FOR\_FAILBACK 631
  - DB2 pureScale instances
    - hostsINACTIVE 625
    - membersWAITING\_FOR\_FAILBACKINACTIVE 625
  - lock modes 192
  - member
    - WAITING\_FOR\_FAILBACK 637
- static queries
  - setting optimization class 331
- static SQL
  - isolation levels 155
- statistical views
  - creating 404
  - improving cardinality estimates 405
  - optimization statistics 405
  - overview 402
  - reducing the number of statistical views with referential integrity constraints 411
  - statistics used from column group statistics 413
  - statistics used from expression columns 410
- statistics
  - catalog
    - avoid manual updates 458
    - details 413
  - collection
    - automatic 423, 427
    - based on sample table data 439
    - guidelines 436
  - column group 400
  - query optimization 399
  - updating manually 440
- statistics profile 428
- STMM
  - see self-tuning memory 91
- STMTKEY element 369
- STMTKEY field 340
- STMTMATCH element 369, 370
- STMTPROFILE element 368
- storage keys
  - troubleshooting 593
- sub-element statistics
  - runstats utility 440
- SUBQ2JOIN query rewrite request element
  - XML schema 382
- subqueries
  - correlated 219
- summary tables
  - materialized query tables (MQTs) 275
- system commands
  - dbx (UNIX) 699
  - gdb (Linux) 699
  - xdb (HP-UX) 699
- system core files
  - Linux
    - accessing information 699
    - overview 698
  - UNIX
    - accessing information 699
    - overview 698
- system performance
  - monitoring 11
- system processes 32
- SYSTOOLS.OPT\_PROFILE table 397

**T**

- table and space reclaim scenario
  - see ExampleBANK reclaiming space scenario 142
- table spaces
  - query optimization 55
- tables
  - access information 309
  - insert time clustering (ITC) 60
  - join strategies in partitioned databases 256
  - lock modes 196
  - multidimensional clustering (MDC) 60
  - offline reorganization
    - details 122
    - improving performance 125
    - recovery 124
  - online reorganization
    - details 125
    - pausing and restarting 128
    - recovery 127
  - overview 119
  - partitioned
    - clustering indexes 81
  - queues 256
  - reorganization
    - automatic 141
    - costs 137
    - determining need for 134
    - error handling 129
    - methods 120
    - monitoring 129
    - offline 123
    - online 127
    - overview 119
    - procedure 118
    - reducing the need for 138
  - standard
    - managing 57
  - statistics
    - manual update rules 442

- tasks
  - troubleshooting 549
- TCP/IP
  - ACCSEC command 515
  - SECCHK command 515
- temporary table information
  - db2expln command 314
- terms and conditions
  - publications 722
- test fixes
  - applying 707
  - details 705
  - types 707
- threads
  - process model 32, 40
  - troubleshooting scripts 592
- timeouts
  - lock 210
- tools
  - diagnostic
    - Linux 535
    - UNIX 535
    - Windows 535
- trace utility (db2drdat) 514
- traces
  - CLI
    - analyzing 527, 528, 529
    - obtaining 525
    - overview 521
  - data between DB2 Connect and server 514
  - DB2 510, 512
  - DRDA
    - buffer information 520
    - interpreting 514
    - samples 516
  - JDBC applications
    - DB2 Universal JDBC Driver 521
  - output file 514
  - output file samples 516
  - overview 509
  - troubleshooting overview 509
- trap files
  - formatting (Windows) 702
  - overview 701
- troubleshooting 558
  - administrative task scheduler 549
  - beta versions of products 563
  - compression dictionary not automatically created 551
  - contacting IBM Support 709
  - database creation 589
  - database is currently in use 550
  - DB2 database products 539
  - DB2 pureScale
    - creation 598, 607
    - DB2 Setup wizard 598
    - db2start command 611
    - host reboot with restart light 645
    - mapping db2diag log file entries to cfdump.out\* files 615
    - mapping Tivoli SA MP states to DB2 cluster services states 601
    - RSCT peer domains 609
    - tracing uDAPL over InfiniBand connections 619
    - uDAPL communication errors 616
  - DB2 pureScale environments
    - kernel panic with GPFS outage 647
- troubleshooting (continued)
  - DB2 pureScale Feature
    - /var file system 641
    - clearing failed offline state on idle 630
    - diagnostics 595
    - GPFS 608
    - licensing 610
    - overview 595
    - post-installation 611, 621
    - removal 652, 654
    - response file installations 609
    - uninstallation 652
  - DB2 pureScale FeatureDB2 pureScale
    - installationinstallation 598, 607
  - DB2 pureScale instances
    - hosts 623
    - members 623
  - db2diag log file entry interpretation 672
  - db2fodc -clp 562
  - db2pd -load 545
  - db2pd -utilities 545
  - deadlock problems
    - diagnosing 571
    - resolving 572
  - diagnostic data
    - alt\_diagpath 662
    - automatic collection 681
    - collecting base set 539
    - configuring collection 684
    - DAS 540
    - data movement 540
    - diagpath 662
    - directory path 662
    - installation 560
    - instance management 540
    - manual collection 681
    - splitting by database partition server, database partition, or both 665
  - diagnostic logs 670
  - disk storage space for temporary tables 552
  - FCM problems 589
  - gathering information 485, 490, 504, 539, 710
  - getting fixes 705
  - host validation 604
  - installation problems 560, 562, 563
  - internal return codes 693
  - load operations 545
  - lock problems
    - lock escalations 576, 577
    - lock timeouts 573, 575
    - lock waits 567, 569
    - overview 566
  - log filesdb2cklog command 475
  - log record decompression 553
  - online information 722
  - operation fails 550
  - overview 471, 661
  - performance
    - memory 579
    - sort heap 579
  - performance related problems 541
  - problem re-creation 485
  - redistribution of data 590
  - resource-related problems 676
  - resources 704
  - searching for solutions to problems 703
  - section actuals collection 592

- troubleshooting *(continued)*
  - SQL1035N 550
  - storage keys 593
  - sustained traps 544
  - table states 590
  - tasks 549
  - tools 475
  - traces
    - CLI applications 521, 525
    - DRDA 516, 520
    - JDBC applications 521
    - obtaining using db2trc command 510
    - ODBC applications 521, 525
    - overview 509
  - tutorials 722
- troubleshooting and support
  - subscribing to Support updates 711
- tuning
  - guidelines 1, 581
  - limitations 1, 581
  - queries 162
  - sorts 116, 583
  - SQL with explain facility 278
- tuning partition
  - determining 97
- tutorials
  - list 721
  - problem determination 722
  - pureXML 721
  - troubleshooting 722

## U

- U (Update) lock mode 192
- uDAPL communication
  - failure 636
- UDFs
  - entering statistics for 454
- uncommitted data
  - concurrency control 149
- uncommitted read (UR) isolation level
  - details 150
- uninstallation
  - troubleshooting 652
- units of work
  - overview 147
- UNIX
  - listing DB2 database products 489
- updates
  - data
    - performance 104
  - DB2 Information Center 718, 720
  - lost 149
- utilities
  - db2drdat 514
  - ps (process status) 515
  - trace 514

## V

- validation
  - DB2 copies 509
- views
  - merging by optimizer 217
  - predicate pushdown by optimizer 219

## W

- WAITING\_FOR FAILBACK 632
- workloads
  - performance tuning
    - Design Advisor 463, 467
- writing queries
  - best practices 162

## X

- X (Exclusive) lock mode 192
- XML data
  - partitioned indexes 76
- XML schemas
  - ACCESS access request element 384
  - access request elements 383
  - accessRequest group 382
  - computationalPartitionGroupOptimizationChoices group 367
  - current optimization profile 357
  - DEGREE general request element 377
  - DPFXMLMOVEMENT general request element 378
  - general optimization guidelines 377
  - generalRequest group 377
  - global OPTGUIDELINES element 365
  - HSJOIN join request element 396
  - INLIST2JOIN query rewrite request element 381
  - IXAND access request element 387
  - IXOR access request element 389
  - IXSCAN access request element 390
  - JOIN join request element 395
  - join request elements 394
  - joinRequest group 393
  - LPREFETCH access request element 391
  - MQTOptimizationChoices group 366
  - MSJOIN join request element 396
  - NLJOIN join request element 397
  - NOTEX2AJ query rewrite request element 381
  - NOTIN2AJ query rewrite request element 382
  - OPTGUIDELINES element 376
  - OPTPROFILE element 365
  - plan optimization guidelines 382
  - QRYOPT general request element 378
  - query rewrite optimization guidelines 380
  - REGISTRY general request element 379
  - REOPT general request element 379
  - rewriteRequest group 380
  - RTS general request element 380
  - STMTKEY element 369
  - STMTMATCH element 369, 370
  - STMTPROFILE element 368
  - SUBQ2JOIN query rewrite request element 382
  - TBSCAN access request element 392
  - XANDOR access request element 392
  - XISCAN access request element 393
- XQuery compiler
  - process details 213
- XQuery statements
  - explain tool for 308
  - isolation levels 155
  - rewriting 216

## Z

- Z (Super Exclusive) lock mode 192



zigzag join  
  prerequisites 169  
ZRC return codes 693







Printed in USA

SC27-3889-00



Spine information:

IBM DB2 10.1 for Linux, UNIX, and Windows

Troubleshooting and Tuning Database Performance

