

IBM DB2 10.1
for Linux, UNIX, and Windows

*SQL Procedural Languages: Application
Enablement and Support*
Updated January, 2013



IBM DB2 10.1
for Linux, UNIX, and Windows

*SQL Procedural Languages: Application
Enablement and Support*
Updated January, 2013



Note

Before using this information and the product it supports, read the general information under Appendix B, "Notices," on page 513.

Edition Notice

This document contains proprietary information of IBM. It is provided under a license agreement and is protected by copyright law. The information contained in this publication does not include any product warranties, and any statements provided in this manual should not be interpreted as such.

You can order IBM publications online or through your local IBM representative.

- To order publications online, go to the IBM Publications Center at <http://www.ibm.com/shop/publications/order>
- To find your local IBM representative, go to the IBM Directory of Worldwide Contacts at <http://www.ibm.com/planetwide/>

To order DB2 publications from DB2 Marketing and Sales in the United States or Canada, call 1-800-IBM-4YOU (426-4968).

When you send information to IBM, you grant IBM a nonexclusive right to use or distribute the information in any way it believes appropriate without incurring any obligation to you.

© Copyright IBM Corporation 2013.

US Government Users Restricted Rights – Use, duplication or disclosure restricted by GSA ADP Schedule Contract with IBM Corp.

Contents

Part 1. SQL Procedural Language (SQL PL)	1
Chapter 1. Inline SQL PL	3
Chapter 2. SQL PL in SQL procedures.	5
Chapter 3. Inline SQL functions, triggers, and compound SQL statements	7
Chapter 4. Error location in the SQLCA structure	9
Chapter 5. SQL PL data types	13
Anchored data type	13
Features of the anchored data type	13
Restrictions on the anchored data type	14
Anchored data type variables	14
Declaring local variables of the anchored data type	14
Examples: Anchored data type use	15
Row types	17
Features of the row data type	17
Restrictions on the row data type	17
Row variables	18
Creating row variables	18
Assigning values to row variables	19
Comparing row variables and row field values	22
Referencing row values	22
Passing rows as routine parameters	24
Dropping a row data type	25
Examples: Row data type use	25
Array types	31
Comparison of arrays and associative arrays	32
Ordinary array data type	32
Associative array data type	45
Cursor types	50
Overview of cursor data types	51
Cursor variables	53
Cursor predicates	53
Creating cursor variables	54
Assigning values to cursor variables	57
Referencing cursor variables	58
Determining the number of fetched rows for a cursor	59
Example: Cursor variable use	61
Boolean data type	63
Restrictions on the Boolean data type	63
Chapter 6. SQL routines	65
Overview of SQL routines	65
CREATE statements for SQL routines	66

Determining when to use SQL routines or external routines	66
Determining when to use SQL procedures or SQL functions	67
Determining when to use SQL routines or dynamically prepared compound SQL statements	68
Rewriting SQL procedures as SQL user-defined functions	70
SQL procedures	71
Features of SQL procedures	72
Designing SQL procedures	72
Creating SQL procedures	97
Improving the performance of SQL procedures	100
SQL functions	105
Features of SQL functions	105
Designing SQL functions	106
Creating SQL scalar functions	108
Creating SQL table functions	110

Chapter 7. Compound statements	113
Creating compound statements	113

Part 2. PL/SQL support 115

Chapter 8. PL/SQL features	117
-----------------------------------	------------

Chapter 9. Creating PL/SQL procedures and functions from a CLP script	119
--	------------

Chapter 10. Restrictions on PL/SQL support	121
---	------------

Chapter 11. PL/SQL sample schema	123
---	------------

Chapter 12. Obfuscation.	131
---------------------------------	------------

Chapter 13. Blocks (PL/SQL)	133
Anonymous block statement (PL/SQL)	133

Chapter 14. Procedures (PL/SQL)	137
CREATE PROCEDURE statement (PL/SQL)	137
Procedure references (PL/SQL)	140
Function invocation syntax support (PL/SQL)	140

Chapter 15. Functions (PL/SQL)	143
CREATE FUNCTION statement (PL/SQL)	143
Function references (PL/SQL)	145

Chapter 16. Collection, record, and object types (PL/SQL)	147
VARRAY collection type declaration (PL/SQL)	147

CREATE TYPE (VARRAY) statement (PL/SQL)	148
CREATE TYPE (Nested table) statement (PL/SQL)	149
Records (PL/SQL).	150
CREATE TYPE (Object) statement (PL/SQL)	151
Associative arrays (PL/SQL)	152
Collection methods (PL/SQL)	156

Chapter 17. Variables (PL/SQL) 161

Variable declarations (PL/SQL)	161
Parameter modes (PL/SQL)	162
Data types (PL/SQL).	164
%TYPE attribute in variable declarations (PL/SQL)	166
SUBTYPE definitions (PL/SQL)	168
%ROWTYPE attribute in record type declarations (PL/SQL).	169

Chapter 18. Basic statements (PL/SQL) 171

NULL statement (PL/SQL).	171
Assignment statement (PL/SQL)	171
EXECUTE IMMEDIATE statement (PL/SQL).	172
SQL statements (PL/SQL)	176
BULK COLLECT INTO clause (PL/SQL)	176
RETURNING INTO clause (PL/SQL)	177
Statement attributes (PL/SQL).	180

Chapter 19. Control statements (PL/SQL) 181

IF statement (PL/SQL)	181
CASE statement (PL/SQL)	185
Simple CASE statement (PL/SQL)	185
Searched CASE statement (PL/SQL).	187
Loops (PL/SQL)	188
FOR (cursor variant) statement (PL/SQL)	189
FOR (integer variant) statement (PL/SQL).	189
FORALL statement (PL/SQL)	191
EXIT statement (PL/SQL)	193
LOOP statement (PL/SQL).	193
WHILE statement (PL/SQL)	194
CONTINUE statement (PL/SQL).	195
Exception handling (PL/SQL)	196
Raise application error (PL/SQL).	198
RAISE statement (PL/SQL).	199
Oracle-DB2 error mapping (PL/SQL)	200

Chapter 20. Cursors (PL/SQL) 203

Static cursors (PL/SQL)	203
Parameterized cursors (PL/SQL)	203
Opening a cursor (PL/SQL)	204
Fetching rows from a cursor (PL/SQL).	205
Closing a cursor (PL/SQL).	207
Using %ROWTYPE with cursors (PL/SQL)	207
Cursor attributes (PL/SQL).	208
Cursor variables (PL/SQL)	209
SYS_REFCURSOR cursor variables (PL/SQL)	209
User-defined REF CURSOR type variables (PL/SQL).	210
Dynamic queries with cursor variables (PL/SQL).	210

Example: Returning a REF CURSOR from a procedure (PL/SQL)	212
Example: Modularizing cursor operations (PL/SQL).	213

Chapter 21. Triggers (PL/SQL) 217

Types of triggers (PL/SQL).	217
Trigger variables (PL/SQL).	217
Trigger event predicates (PL/SQL)	218
Transactions and exceptions (PL/SQL)	218
CREATE TRIGGER statement (PL/SQL)	218
Dropping triggers (PL/SQL)	222
Examples: Triggers (PL/SQL)	222

Chapter 22. Packages (PL/SQL) 227

Package components (PL/SQL)	227
Creating packages (PL/SQL)	227
Creating package specifications (PL/SQL)	227
CREATE PACKAGE statement (PL/SQL)	228
Creating the package body (PL/SQL)	229
CREATE PACKAGE BODY statement (PL/SQL)	231
Referencing package objects (PL/SQL)	233
Packages with user-defined types (PL/SQL)	233
Dropping packages (PL/SQL)	236

Part 3. Built-in modules 239

Chapter 23. DBMS_ALERT module 241

REGISTER procedure - Register to receive a specified alert	242
REMOVE procedure - Remove registration for a specified alert	243
REMOVEALL procedure - Remove registration for all alerts	243
SET_DEFAULTS - Set the polling interval for WAITONE and WAITANY	244
SIGNAL procedure - Signal occurrence of a specified alert	244
WAITANY procedure - Wait for any registered alerts	245
WAITONE procedure - Wait for a specified alert	247

Chapter 24. DBMS_DDL module 249

WRAP function - Obfuscate a DDL statement	249
CREATE_WRAPPED procedure - Deploy an obfuscated object	250

Chapter 25. DBMS_JOB module 253

BROKEN procedure - Set the state of a job to either broken or not broken.	255
CHANGE procedure - Modify job attributes	255
INTERVAL procedure - Set run frequency	256
NEXT_DATE procedure - Set the date and time when a job is run	257
REMOVE procedure - Delete the job definition from the database	257
RUN procedure - Force a broken job to run	258
SUBMIT procedure - Create a job definition and store it in the database	258

WHAT procedure - Change the SQL statement run by a job 259

Chapter 26. DBMS_LOB module . . . 261

APPEND procedures - Append one large object to another 262
CLOSE procedures - Close an open large object 262
COMPARE function - Compare two large objects 263
CONVERTTOBLOB procedure - Convert character data to binary 264
CONVERTTOCLOB procedure - Convert binary data to character 265
COPY procedures - Copy one large object to another 265
ERASE procedures - Erase a portion of a large object 266
GET_STORAGE_LIMIT function - Return the limit on the largest allowable large object. 267
GETLENGTH function - Return the length of the large object 267
INSTR function - Return the location of the *n*th occurrence of a given pattern 268
ISOPEN function - Test if the large object is open 268
OPEN procedures - Open a large object 269
READ procedures - Read a portion of a large object 269
SUBSTR function - Return a portion of a large object 270
TRIM procedures - Truncate a large object to the specified length 271
WRITE procedures - Write data to a large object 271
WRITEAPPEND procedures - Append data to the end of a large object 272

Chapter 27. DBMS_OUTPUT module 273

DISABLE procedure - Disable the message buffer 274
ENABLE procedure - Enable the message buffer 274
GET_LINE procedure - Get a line from the message buffer 275
GET_LINES procedure - Get multiple lines from the message buffer 276
NEW_LINE procedure - Put an end-of-line character sequence in the message buffer 278
PUT procedure - Put a partial line in the message buffer 278
PUT_LINE procedure - Put a complete line in the message buffer 279

Chapter 28. DBMS_PIPE module . . . 281

CREATE_PIPE function - Create a pipe. 283
NEXT_ITEM_TYPE function - Return the data type code of the next item. 284
PACK_MESSAGE function - Put a data item in the local message buffer 285
PACK_MESSAGE_RAW procedure - Put a data item of type RAW in the local message buffer 286
PURGE procedure - Remove unreceived messages from a pipe 287
RECEIVE_MESSAGE function - Get a message from a specified pipe. 288
REMOVE_PIPE function - Delete a pipe 290

RESET_BUFFER procedure - Reset the local message buffer 291
SEND_MESSAGE procedure - Send a message to a specified pipe 292
UNIQUE_SESSION_NAME function - Return a unique session name 293
UNPACK_MESSAGE procedures - Get a data item from the local message buffer 294

Chapter 29. DBMS_SQL module . . . 297

BIND_VARIABLE_BLOB procedure - Bind a BLOB value to a variable. 300
BIND_VARIABLE_CHAR procedure - Bind a CHAR value to a variable 300
BIND_VARIABLE_CLOB procedure - Bind a CLOB value to a variable. 301
BIND_VARIABLE_DATE procedure - Bind a DATE value to a variable. 301
BIND_VARIABLE_DOUBLE procedure - Bind a DOUBLE value to a variable 302
BIND_VARIABLE_INT procedure - Bind an INTEGER value to a variable 302
BIND_VARIABLE_NUMBER procedure - Bind a NUMBER value to a variable 303
BIND_VARIABLE_RAW procedure - Bind a RAW value to a variable. 303
BIND_VARIABLE_TIMESTAMP procedure - Bind a TIMESTAMP value to a variable 304
BIND_VARIABLE_VARCHAR procedure - Bind a VARCHAR value to a variable 304
CLOSE_CURSOR procedure - Close a cursor 305
COLUMN_VALUE_BLOB procedure - Return a BLOB column value into a variable 305
COLUMN_VALUE_CHAR procedure - Return a CHAR column value into a variable. 306
COLUMN_VALUE_CLOB procedure - Return a CLOB column value into a variable 307
COLUMN_VALUE_DATE procedure - Return a DATE column value into a variable 307
COLUMN_VALUE_DOUBLE procedure - Return a DOUBLE column value into a variable 308
COLUMN_VALUE_INT procedure - Return an INTEGER column value into a variable. 308
COLUMN_VALUE_LONG procedure - Return a LONG column value into a variable. 309
COLUMN_VALUE_NUMBER procedure - Return a DECIMAL column value into a variable 310
COLUMN_VALUE_RAW procedure - Return a RAW column value into a variable 311
COLUMN_VALUE_TIMESTAMP procedure - Return a TIMESTAMP column value into a variable 311
COLUMN_VALUE_VARCHAR procedure - Return a VARCHAR column value into a variable 312
DEFINE_COLUMN_BLOB- Define a BLOB column in the SELECT list. 313
DEFINE_COLUMN_CHAR procedure - Define a CHAR column in the SELECT list 313
DEFINE_COLUMN_CLOB - Define a CLOB column in the SELECT list 314
DEFINE_COLUMN_DATE - Define a DATE column in the SELECT list 314

DEFINE_COLUMN_DOUBLE - Define a DOUBLE column in the SELECT list	315
DEFINE_COLUMN_INT- Define an INTEGER column in the SELECT list	315
DEFINE_COLUMN_LONG procedure - Define a LONG column in the SELECT list	315
DEFINE_COLUMN_NUMBER procedure - Define a DECFLOAT column in the SELECT list	316
DEFINE_COLUMN_RAW procedure - Define a RAW column or expression in the SELECT list	316
DEFINE_COLUMN_TIMESTAMP - Define a TIMESTAMP column in the SELECT list	317
DEFINE_COLUMN_VARCHAR procedure - Define a VARCHAR column in the SELECT list	317
DESCRIBE_COLUMNS procedure - Retrieve a description of the columns in a SELECT list	318
DESCRIBE_COLUMNS2 procedure - Retrieve a description of column names in a SELECT list	321
EXECUTE procedure - Run a parsed SQL statement.	323
EXECUTE_AND_FETCH procedure - Run a parsed SELECT command and fetch one row	324
FETCH_ROWS procedure - Retrieve a row from a cursor	327
IS_OPEN procedure - Check if a cursor is open	329
LAST_ROW_COUNT procedure - return the cumulative number of rows fetched	330
OPEN_CURSOR procedure - Open a cursor	333
PARSE procedure - Parse an SQL statement	333
VARIABLE_VALUE_BLOB procedure - Return the value of a BLOB INOUT or OUT parameter	335
VARIABLE_VALUE_CHAR procedure - Return the value of a CHAR INOUT or OUT parameter	336
VARIABLE_VALUE_CLOB procedure - Return the value of a CLOB INOUT or OUT parameter	336
VARIABLE_VALUE_DATE procedure - Return the value of a DATE INOUT or OUT parameter	337
VARIABLE_VALUE_DOUBLE procedure - Return the value of a DOUBLE INOUT or OUT parameter.	337
VARIABLE_VALUE_INT procedure - Return the value of an INTEGER INOUT or OUT parameter	338
VARIABLE_VALUE_NUMBER procedure - Return the value of a DECFLOAT INOUT or OUT parameter	338
VARIABLE_VALUE_RAW procedure - Return the value of a BLOB(32767) INOUT or OUT parameter.	339
VARIABLE_VALUE_TIMESTAMP procedure - Return the value of a TIMESTAMP INOUT or OUT parameter	339
VARIABLE_VALUE_VARCHAR procedure - Return the value of a VARCHAR INOUT or OUT parameter	340

Chapter 30. DBMS_UTILITY module 341

ANALYZE_DATABASE procedure - Gather statistics on tables, clusters, and indexes	342
ANALYZE_PART_OBJECT procedure - Gather statistics on a partitioned table or partitioned index	343
ANALYZE_SCHEMA procedure - Gather statistics on schema tables, clusters, and indexes.	344
CANONICALIZE procedure - Canonicalize a string	345

COMMA_TO_TABLE procedures - Convert a comma-delimited list of names into a table of names	347
COMPILE_SCHEMA procedure - Compile all functions, procedures, triggers, and packages in a schema	348
DB_VERSION procedure - Retrieve the database version	349
EXEC_DDL_STATEMENT procedure - Run a DDL statement.	350
GET_CPU_TIME function - Retrieve the current CPU time.	350
GET_DEPENDENCY procedure - List objects dependent on the given object.	351
GET_HASH_VALUE function - Compute a hash value for a given string	353
GET_TIME function - Return the current time	354
NAME_RESOLVE procedure - Obtain the schema and other membership information for a database object	354
NAME_TOKENIZE procedure - Parse the given name into its component parts	359
TABLE_TO_COMMA procedures - Convert a table of names into a comma-delimited list of names	362
VALIDATE procedure - Change an invalid routine into a valid routine	363

Chapter 31. MONREPORT module 365

CONNECTION procedure - Generate a report on connection metrics.	366
CURRENTAPPS procedure - Generate a report of point-in-time application processing metrics	377
CURRENTSQL procedure - Generate a report that summarizes activities.	377
DBSUMMARY procedure - Generate a summary report of system and application performance metrics	378
LOCKWAIT procedure - Generate a report of current lock waits	382
PKGCACHE procedure - Generate a summary report of package cache metrics	385

Chapter 32. UTL_DIR module 387

CREATE_DIRECTORY procedure - Create a directory alias	387
CREATE_OR_REPLACE_DIRECTORY procedure - Create or replace a directory alias	388
DROP_DIRECTORY procedure - Drop a directory alias	389
GET_DIRECTORY_PATH procedure - Get the path for a directory alias	389

Chapter 33. UTL_FILE module 391

FCLOSE procedure - Close an open file	392
FCLOSE_ALL procedure - Close all open files	393
FCOPY procedure - Copy text from one file to another	394
FFLUSH procedure - Flush unwritten data to a file	395
FOPEN function - Open a file	396
FREMOVE procedure - Remove a file	398

FRENAME procedure - Rename a file	398
GET_LINE procedure - Get a line from a file	399
IS_OPEN function - Determine whether a specified file is open	401
NEW_LINE procedure - Write an end-of-line character sequence to a file	401
PUT procedure - Write a string to a file	403
PUT_LINE procedure - Write a line of text to a file	404
PUTF procedure - Write a formatted string to a file	406
UTL_FILE.FILE_TYPE	407

Chapter 34. UTL_MAIL module 409

SEND procedure - Send an e-mail to an SMTP server	409
SEND_ATTACH_RAW procedure - Send an e-mail with a BLOB attachment to an SMTP server	411
SEND_ATTACH_VARCHAR2 procedure - Send an e-mail with a VARCHAR attachment to an SMTP server	412

Chapter 35. UTL_SMTP module. 415

CLOSE_DATA procedure - End an e-mail message	417
COMMAND procedure - Run an SMTP command	417
COMMAND_REPLIES procedure - Run an SMTP command where multiple reply lines are expected	418
DATA procedure - Specify the body of an e-mail message	419
EHLO procedure - Perform initial handshaking with an SMTP server and return extended information	419
HELO procedure - Perform initial handshaking with an SMTP server	420
HELP procedure - Send the HELP command	421
MAIL procedure - Start a mail transaction	421
NOOP procedure - Send the null command	422
OPEN_CONNECTION function - Return a connection handle to an SMTP server	423
OPEN_CONNECTION procedure - Open a connection to an SMTP server	423
OPEN_DATA procedure - Send the DATA command to the SMTP server	424
QUIT procedure - Close the session with the SMTP server	424
RCPT procedure - Provide the e-mail address of the recipient	425
RSET procedure - End the current mail transaction	425
VERFY procedure - Validate and verify the recipient's e-mail address	426
WRITE_DATA procedure - Write a portion of an e-mail message	427
WRITE_RAW_DATA procedure - Add RAW data to an e-mail message	427

Part 4. DB2 compatibility features 429

Chapter 36. DB2 compatibility features introduction 431

Chapter 37. DB2_COMPATIBILITY_VECTOR registry variable 433

Chapter 38. Setting up the DB2 environment for Oracle application enablement 437

Chapter 39. Data types 441

DATE data type based on TIMESTAMP(0).	441
NUMBER data type	443
VARCHAR2 and NVARCHAR2 data types	446

Chapter 40. Character and graphic constant handling 451

Chapter 41. SQL data-access-level enforcement 453

Chapter 42. Outer join operator. 455

Chapter 43. Hierarchical queries 459

CONNECT_BY_ROOT unary operator	463
PRIOR unary operator	464
SYS_CONNECT_BY_PATH.	465

Chapter 44. Compatibility database configuration parameters 469

Chapter 45. ROWNUM pseudocolumn 471

Chapter 46. DUAL table 473

Chapter 47. Insensitive cursor 475

Chapter 48. INOUT parameters 477

Chapter 49. Currently committed semantics 479

Chapter 50. Oracle data dictionary-compatible views 481

Chapter 51. Oracle database link syntax 483

Chapter 52. Terminology mapping: Oracle to DB2 products 485

Part 5. DB2CI application development 491

Chapter 53. IBM Data Server Driver for DB2CI 493

Chapter 54. Building DB2CI applications 495

DB2CI application compile and link options (AIX) 495
DB2CI application compile and link options (HP-UX) 496
DB2CI application compile and link options (Linux) 497
DB2CI application compile and link options (Solaris) 498
DB2CI application compile and link options (Windows) 499

Part 6. Appendixes 501

Appendix A. Overview of the DB2 technical information 503

DB2 technical library in hardcopy or PDF format 503
Displaying SQL state help from the command line processor 506
Accessing different versions of the DB2 Information Center 506
Updating the DB2 Information Center installed on your computer or intranet server 506
Manually updating the DB2 Information Center installed on your computer or intranet server . . 508
DB2 tutorials 510
DB2 troubleshooting information 510
Terms and conditions. 510

Appendix B. Notices 513

Index 517

Part 1. SQL Procedural Language (SQL PL)

The SQL Procedural Language (SQL PL) is a language extension of SQL that consists of statements and language elements that can be used to implement procedural logic in SQL statements.

SQL PL provides statements for declaring variables and condition handlers, assigning values to variables, and for implementing procedural logic.

Chapter 1. Inline SQL PL

Inline SQL PL is a subset of SQL PL features that can be used in compound SQL (inlined) statements.

Compound SQL (inlined) statements can be executed independently or can be used to implement the body of a trigger, SQL function, or SQL method. Compound SQL (inlined) statements can be executed independently from the DB2® CLP when it is in interactive mode to provide support for a basic SQL scripting language.

Inline SQL PL is described as "inline", because the logic is expanded into and executed with the SQL statements that reference them.

The following SQL PL statements are considered to be part of the set of inline SQL PL statements:

- Variable related statements
 - DECLARE <variable>
 - DECLARE <condition>
 - SET statement (assignment statement)
- Conditional statements
 - IF
 - CASE expression
- Looping statements
 - FOR
 - WHILE
- Transfer of control statements
 - GOTO
 - ITERATE
 - LEAVE
 - RETURN
- Error management statements
 - SIGNAL
 - GET DIAGNOSTICS

Other SQL PL statements that are supported in SQL procedures are not supported in compound SQL (inlined) statements. Cursors and condition handlers are not supported in inline SQL PL and therefore neither is the RESIGNAL statement.

Because inline SQL PL statements must be executed in compound SQL (inlined) statements, there is no support for PREPARE, EXECUTE, or EXECUTE IMMEDIATE statements.

Also, because ATOMIC must be specified in a compound SQL (inlined) statement that is dynamically prepared or executed, all or none of the member statements must commit successfully. Therefore the COMMIT and ROLLBACK statements are not supported either.

As for the LOOP and REPEAT statements, the WHILE statement can be used to implement equivalent logic.

Standalone scripting with inline SQL PL consists of executing a compound SQL (inlined) statement that is dynamically prepared or executed within a Command Line Processor (CLP) script or directly from a CLP prompt. Compound SQL (inlined) statements that are dynamically prepared or executed are bounded by the keywords BEGIN and END and must end with a non-default terminator character. They can contain SQL PL and other SQL statements.

Because inline SQL PL statements are expanded within the SQL statements that reference them rather than being individually compiled, there are some minor performance considerations that should be considered when you are planning on whether to implement your procedural logic in SQL PL in an SQL procedure or with inline SQL PL in a function, trigger, or compound SQL (compiled) statement that is dynamically prepared or executed.

Chapter 2. SQL PL in SQL procedures

SQL PL statements are primarily used in SQL procedures. SQL procedures can contain basic SQL statements for querying and modifying data, but they can also include SQL PL statements for implementing control flow logic around the other SQL statements. The complete set of SQL PL statements can be

used in SQL procedures.

SQL PL statements are primarily used in SQL procedures. SQL procedures can contain basic SQL statements for querying and modifying data, but they can also include SQL PL statements for implementing control flow logic around the other SQL statements. The complete set of SQL PL statements can be used in SQL procedures.

SQL procedures also support parameters, variables, assignment statements, a powerful condition and error handling mechanism, nested and recursive calls, transaction and savepoint support, and the ability to return multiple result sets to the procedure caller or a client application.

SQL PL, when used within SQL procedures, allows you to effectively program in SQL. The high-level language of SQL PL and the additional features that SQL procedures provide makes programming with SQL PL fast and easy to do.

As a simple example of SQL PL statements being used in a SQL procedure, consider the following example:

```
CREATE PROCEDURE UPDATE_SAL (IN empNum CHAR(6),
                             INOUT rating SMALLINT)
LANGUAGE SQL
BEGIN
  IF rating = 1 THEN
    UPDATE employee
      SET salary = salary * 1.10, bonus = 1000
      WHERE empno = empNum;
  ELSEIF rating = 2 THEN
    UPDATE employee
      SET salary = salary * 1.05, bonus = 500
      WHERE empno = empNum;
  ELSE
    UPDATE employee
      SET salary = salary * 1.03, bonus = 0
      WHERE empno = empNum;
  END IF;
END
```

Chapter 3. Inline SQL functions, triggers, and compound SQL statements

Inline SQL PL statements can be executed in compound SQL (compiled) statements, compound SQL (inlined) statements, SQL functions, and triggers.

A compound SQL (inlined) statement is one that allows you to group multiple SQL statements into an optionally atomic block in which you can declare variables, and condition handling elements. These statements are compiled by DB2 as a single SQL statement and can contain inline SQL PL statements.

The bodies of SQL functions and triggers can contain compound SQL (inlined) statements and can also include some inline SQL PL statements.

On their own, compound SQL (inlined) statements are useful for creating short scripts that perform small units of logical work with minimal control flow, but that have significant data flow. Within functions and triggers, they allow for more complex logic to be executed when those objects are used.

As an example of a compound SQL (inlined) statement that contains SQL PL, consider the following:

```
BEGIN ATOMIC
  FOR row AS
    SELECT pk, c1, discretize(c1) AS v FROM source
  DO
    IF row.v is NULL THEN
      INSERT INTO except VALUES(row.pk, row.c1);
    ELSE
      INSERT INTO target VALUES(row.pk, row.d);
    END IF;
  END FOR;
END
```

The compound SQL (inlined) statement is bounded by the keywords BEGIN and END. It includes use of both the FOR and IF/ELSE control-statements that are part of SQL PL. The FOR statement is used to iterate through a defined set of rows. For each row a column's value is checked and conditionally, based on the value, a set of values is inserted into another table.

As an example of a trigger that contains SQL PL, consider the following:

```
CREATE TRIGGER validate_sched
NO CASCADE BEFORE INSERT ON c1_sched
FOR EACH ROW
MODE DB2SQL
Vs: BEGIN ATOMIC

  IF (n.ending IS NULL) THEN
    SET n.ending = n.starting + 1 HOUR;
  END IF;

  IF (n.ending > '21:00') THEN
    SIGNAL SQLSTATE '80000' SET MESSAGE_TEXT =
      'Class ending time is after 9 PM';
  ELSE IF (n.DAY=1 or n.DAY=7) THEN
```

```

        SIGNAL SQLSTATE '80001' SET MESSAGE_TEXT =
            'Class cannot be scheduled on a weekend';
    END IF;
END vs;

```

This trigger is activated upon an insert to a table named `c1_sched` and uses SQL PL to check for and provide a class end time if one has not been provided and to raise an error if the class end time is after 9 pm or if the class is scheduled on a weekend. As an example of a scalar SQL function that contains SQL PL, consider the following:

```

CREATE FUNCTION GetPrice (Vendor CHAR(20), Pid INT)
RETURNS DECIMAL(10,3)
LANGUAGE SQL MODIFIES SQL
BEGIN ATOMIC
    DECLARE price DECIMAL(10,3);

    IF Vendor = 'Vendor 1'
        THEN SET price = (SELECT ProdPrice FROM V1Table WHERE Id = Pid);
    ELSE IF Vendor = 'Vendor 2'
        THEN SET price = (SELECT Price FROM V2Table WHERE Pid = GetPrice.Pid);
    END IF;

    RETURN price;
END

```

This simple function returns a scalar price value, based on the value of an input parameter that identifies a vendor. It also uses the IF statement.

For more complex logic that requires output parameters, the passing of result sets or other more advanced procedural elements SQL procedures might be more appropriate.

Chapter 4. Error location in the SQLCA structure

When an error occurs during the compilation or execution of an SQL PL object, the SQLCA structure that is returned by the DB2 database manager contains information that helps in identifying the origin of the error.

Compile-time errors

When an error is raised during the compilation of an SQL PL object (either inlined or compiled), the `sqlerrd(3)` field in the returned SQLCA structure contains the line number of the error as reported by the DB2 SQL compiler.

In the following example, the procedure `myproc` contains an invalid statement in line 5. The statement is invalid because the data types of the source and target portions of the SET statement do not match.

```
create procedure myproc (parm1 integer)
begin
  declare var1 date;
  set var1 = parm1;
end @
```

Assuming that this procedure is stored in file `script1.db2`, an attempt is made to process this file using the command line processor (CLP) with the following command:

```
db2 -td@ -a -f script1.db2
```

Where using the `-a` option causes the CLP to display the SQLCA. The result would be similar to the following information:

SQLCA Information

```
sqlcaid : SQLCA      sqlcabc: 136   sqlcode: -408
sqlerrml: 4
sqlerrmc: VAR1
sqlerrd : (1) 0      (2) 0      (3) 5
          (4) 0      (5) 0      (6) 0
...
sqlstate: 42821
```

The value of 5 in the `sqlerrd(3)` field indicates that the error was in line 5 of the CREATE PROCEDURE statement.

The CLP was used as the client interface for this example because it provides a simple way of showing the SQLCA structure that results from the execution of a statement. However, when compiling SQL PL statements using the CLP, it is not necessary to display the SQLCA structure to identify the line number of an error. The CLP automatically displays the line number when it formats the error message. For the created procedure (`myproc`), an invocation of the CLP that did not include the `-a` option would return the following message, which shows that the error was in line 5:

```
SQL0408N A value is not compatible with the data type of its assignment
target. Target name is "VAR1". LINE NUMBER=5. SQLSTATE=42821
```

Runtime errors

When an error is raised during the execution of a compiled SQL PL routine or trigger, the SQLCA structure that is returned by the DB2 database manager contains both the line number of the statement that caused the error and a numeric value that uniquely identifies the SQL PL routine or trigger that contains that statement.

In the following example, a statement creates the table `table1` with one integer column. A second statement creates the procedure `appdev.proc2` with two integer parameters, `parm1` and `parm2`, that inserts into the table the value that results from dividing `parm1` by `parm2`. The CALL statement with arguments 1 and 0 results in a division-by-zero runtime error.

```
create table table1 (col1 integer) @

create procedure appdev.proc2(in parm1 integer, parm2 integer)
specific appdev_proc2
begin
    insert into table1 (parm1 / parm2);
end @

call proc2(1, 0) @
```

Assuming that these statements are stored in file `script2.db2.`, an attempt is made to process this file by using the CLP with the following command:

```
db2 -td@ -a -f script2.db2
```

After executing the call, the result from CLP would be similar to the following output:

SQLCA Information

```
sqlcaid : SQLCAM    sqlcabc: 136    sqlcode: -801
...
sqlerrd : (1) 0      (2) 0      (3) 4
          (4) 13152254 (5) 0      (6) 0
...
sqlstate: 22012
```

The value of `sqlcode -801` in the result corresponds to division by zero (SQLSTATE 22012). Similar to compile-time errors, the value in the `sqlerrd(3)` field indicates the line number within the SQL PL object where the error originated (line number 4 in this case). Additionally, the value in the `sqlerrd(4)` field contains an integer value that uniquely identifies that SQL PL object. The `SYSPROC.GET_ROUTINE_NAME` procedure can be used to map the unique identifier to the name of the object that raised the error. This procedure takes as an input parameter the value in the `sqlerrd(4)` field and returns information in five output parameters, as shown in the following example:

```
db2 CALL SYSPROC.GET_ROUTINE_NAME(13152254, ?, ?, ?, ?, ?)
```

Value of output parameters

```
Parameter Name : TYPE
Parameter Value : P
```

```
Parameter Name : SCHEMA
Parameter Value : APPDEV
```

```
Parameter Name : MODULE
Parameter Value : -
```

Parameter Name : NAME
Parameter Value : PROC2

Parameter Name : SPECIFIC_NAME
Parameter Value : APPDEV_PROC2

Return Status = 0

The value 'P' for the TYPE parameter indicates that the object is a procedure.
Because the object does not belong to a module, the MODULE parameter is NULL.

Note: The SQLCA structure does not contain line number information for errors that are raised during the execution of inline SQL PL objects.

Chapter 5. SQL PL data types

Anchored data type

An anchored data type is a data type that is defined to be the same as that of another object. If the underlying object data type changes, the anchored data type also changes.

The following topics provide more information about anchored data types:

Features of the anchored data type

An anchored type defines a data type based on another SQL object such as a column, global variable, SQL variable, SQL parameter, or the row of a table or view.

A data type defined using an anchored type definition maintains a dependency on the object to which it is anchored. Any change in the data type of the anchor object will impact the anchored data type. If anchored to the row of a table or view, the anchored data type is ROW with the fields defined by the columns of the anchor table or anchor view.

This data type is useful when declaring variables in cases where you require that the variable have the same data type as another object, for example a column in a table, but you do not know exactly what is the data type.

An anchored data type can be of the same type as one of:

- a row in a table
- a row in a view
- a cursor variable row definition
- a column in a table
- a column in a view
- a local variable, including a local cursor variable or row variable
- a global variable

Anchored data types can only be specified when declaring or creating one of the following:

- a local variable in an SQL procedure, including a row variable
- a local variable in a compiled SQL function, including a row variable
- a routine parameter
- a user-defined cursor data type using the CREATE TYPE statement.
 - It cannot be referenced in a DECLARE CURSOR statement.
- a function return data type
- a global variable

To define an anchored data type specify the ANCHOR DATA TYPE TO clause (or the shorter form ANCHOR clause) to specify what the data type will be. If the anchored data type is a row data type, the ANCHOR ROW OF clause, or one of its synonyms, must be specified. These clauses are supported within the following statements:

- DECLARE
- CREATE TYPE
- CREATE VARIABLE
 - In this version, global variables can only be anchored to other global variables, a column in a table, or a column in a view.

Restrictions on the anchored data type

Review the restrictions on the use of the anchored data type before declaring variables of this type or when troubleshooting problems related to their use.

The following restrictions apply to the use of anchored data types:

- Anchored data types are not supported in inline SQL functions.
- Anchored data types cannot reference nicknames or columns in nicknames.
- Anchored data types cannot reference typed tables, columns of typed tables, typed views, or columns of typed views.
- Anchored data types cannot reference declared temporary tables, or columns of declared temporary tables.
- Anchored data types cannot reference row definitions associated with a weakly typed cursor.
- Anchored data types cannot reference objects with a code page or collation that is different from the database code page or database collation.

Anchored data type variables

An anchored variable is a local variable or parameter with a data type that is an anchored data type.

Anchored variables are supported in the following contexts:

- SQL procedures
 - In SQL procedures, parameters and local variables can be specified to be of an anchored data type.
- Compiled SQL functions
 - SQL functions created using the CREATE FUNCTION statement that specify the BEGIN clause instead of the BEGIN ATOMIC clause can include parameter or local variable specification that are of the anchored data type.
- Module variables
 - Anchored variables can be specified as published or unpublished variables defined within a module.
- Global variables
 - Global variables can be created of the anchored data type.

Anchored variables are declared using the DECLARE statement.

Declaring local variables of the anchored data type

Declaring local variables or parameters of the anchored data type is a task that you would perform whenever it is necessary that the data type of the variable or parameter remain consistent with the data type of the object to which it is anchored.

Before you begin

The object of the data type that the variable will be anchored to must be defined.

Procedure

1. Formulate a DECLARE statement
 - a. Specify the name of the variable.
 - b. Specify the ANCHOR DATA TYPE TO clause.
 - c. Specify the name of the object that is of the data type that the variable is to be anchored.
2. Execute the DECLARE statement from a supported DB2 interface.

Results

If the DECLARE statement executes successfully, the variable is defined in the database with the specified anchor data type.

Example

The following is an example of an anchored data type declaration in which a variable named v1 is anchored to the data type of a column named c1 in a table named emp:

```
DECLARE v1 ANCHOR DATA TYPE TO emp.c1;
```

What to do next

Once the variable is defined it can be assigned a value, be referenced, or passed as a parameter to routines.

Examples: Anchored data type use

Examples of anchored data type use can be useful as a reference when using this data type.

The following topics include examples of anchored data type use:

Example: Variable declarations of anchored data types

Examples of anchored data type declarations can be useful references when declaring variables.

The following is an example of a declaration of a variable named v1 that has the same data type as the column name in table staff:

```
DECLARE v1 ANCHOR DATA TYPE TO staff.name;
```

The following is an example of a CREATE TYPE statement that defines a type named empRow1 that is anchored to a row defined in a table named employee:

```
CREATE TYPE empRow1 AS ROW ANCHOR DATA TYPE TO ROW OF employee;
```

For variables declared of type empRow1, the field names are the same as the table column names.

If the data type of the column name is VARCHAR(128), then the variable v1 will also be of data type VARCHAR(128).

Examples: Anchored data type use in SQL routines

Examples of anchored data type use in SQL routines are useful to reference when creating your own SQL routines.

The following set of examples demonstrate various features and uses of anchored data types in SQL routines. The anchored data type features are demonstrated more so than the features of the SQL routines that contain them.

The following is an example that demonstrates a declared variable that is anchored to the data type of a column in a table:

```
CREATE TABLE tab1(col1 INT, col2 CHAR)@

INSERT INTO tab1 VALUES (1,2)@

INSERT INTO tab1 VALUES (3,4)@

CREATE TABLE tab2 (col1a INT, col2a CHAR)@

CREATE PROCEDURE p1()
BEGIN
    DECLARE var1 ANCHOR tab1.col1;
    SELECT col1 INTO var1 FROM tab1 WHERE col2 = 2;
    INSERT INTO tab2 VALUES (var1, 'a');
END@

CALL p1()@
```

When the procedure p1 is called, the value of the column col1 for a particular row is selected into the variable var1 of the same type.

The following CLP script includes an example of a function that demonstrates the use of an anchored data type for a parameter to a function:

```
-- Create a table with multiple columns
CREATE TABLE tt1 (c1 VARCHAR(18), c2 CHAR(8), c3 INT, c4 FLOAT)
@

INSERT INTO tt1 VALUES ('aaabbb', 'ab', 1, 1.1)
@

INSERT INTO tt1 VALUES ('ccddd', 'cd', 2, 2.2)
@

SELECT c1, c2, c3, c4 FROM tt1
@

-- Creation of the function
CREATE FUNCTION func_a(p1 ANCHOR tt1.c3)
RETURNS INT
BEGIN
    RETURN p1 + 1;
END
@

-- Invocation of the function
SELECT c1, c2 FROM tt1 WHERE c3 = func_a(2)
@

-- Another invocation of the function
SELECT c1, c2 FROM tt1 WHERE c3 = func_a(1)
@

DROP FUNCTION func_a
@

DROP TABLE tt1
@
```

When the function `func_a` is invoked, the function performs a basic operation using the value of the anchored data type parameter.

Row types

A row data type is a user-defined type containing an ordered sequence of named fields each with an associated data type.

A row type can be used as the type for global variables, SQL variables, and SQL parameters in SQL PL to provide flexible manipulation of the columns in a row of data, typically retrieved using a query.

Features of the row data type

The features of the row data type make it useful for simplifying SQL PL code.

The row data type is supported for use with the SQL Procedural language only. It is a structure composed of multiple fields each with their own name and data type that can be used to store the column values of a row in a result set or other similarly formatted data.

This data type can be used to:

- Simplify the coding of logic within SQL Procedural Language applications. For example, database applications process records one at a time and require parameters and variables to temporarily store records. A single row data type can replace the multiple parameters and variables required to otherwise process and store the record values. This greatly simplifies the ability to pass row values as parameters within applications and routines.
- Facilitate the porting to DB2 SQL PL of code written in other procedural SQL languages that support a similar data type.
- Reference row data in data-change statements and queries including: INSERT statement, FETCH statement, VALUES INTO statement and SELECT INTO statement.

Row data types must be created using the CREATE TYPE (ROW) statement. Once created, variables of the defined data type can be declared within SQL PL contexts using the DECLARE statements. These variables can then be used to store values of the row type.

Row field values can be explicitly assigned and referenced using single-dot, "." notation.

Restrictions on the row data type

It is important to note the restrictions on the use of the row data type before using it or when troubleshooting an error that might be related to its use.

The following restrictions apply to the row data type:

- The maximum number of fields supported in a row data type is 1012.
- The row data type cannot be passed as an input parameter value to procedures and functions from the CLP.
- The row data type cannot be passed as an input-output or output parameter value from procedures and functions to the CLP.
- Row data type variables cannot be directly compared. To compare row type variables, each field can be compared.

- The following data types are not supported for row fields:
 - XML data type
 - LONG VARCHAR
 - LONG VARGRAPHIC
 - structured data types
 - row data types
 - array data types
- Global variables of type row that contain one or more fields of type LOB are not supported.
- Use of the CAST function to cast a parameter value to a row data type is not supported.

Other general restrictions might apply related to the use of a data type, authorizations, execution of SQL, scope of use of the data type or other causes.

Row variables

Row variables are variables based on user-defined row data types. Row variables can be declared, assigned a value, set to another value, or passed as a parameter to and from SQL procedures. Row variables inherit the properties of the row data types upon which they are based. Row variables are used to hold a row of data from within a result set or can be assigned other tuple-format data.

Row variables can be declared within SQL procedures using the DECLARE statement.

Creating row variables

To create row variables you must first create the row type and then declare the row variable.

The following topics show you how to create the row data type and variable:

Creating a row data type

Creating a row data type is a prerequisite to creating a row variable.

Before you create a row data type:

- Read: “Row types” on page 17
- Read: “Restrictions on the row data type” on page 17

This task can be done from any interface that supports the execution of the CREATE TYPE statement.

To create a row data type within a database, you must successfully execute the CREATE TYPE (ROW) statement from any DB2 interface that supports the execution of SQL statements.

1. Formulate a CREATE TYPE (ROW) statement:
 - a. Specify a name for the type.
 - b. Specify the row field definition for the row by specifying a name and data type for each field in the row.

The following is an example of how to create a row data type that can be associated with result sets with the same format as the empRow row data type:

```
CREATE TYPE empRow AS ROW (name VARCHAR(128), id VARCHAR(8));
```

2. Execute the CREATE TYPE statement from a supported DB2 interface.

If the CREATE TYPE statement executes successfully, the row data type is created in the database. If the statement does not execute successfully, verify the syntax of the statement and verify that the data type does not already exist.

Once the row data type is created, row variables can be declared based on this data type.

Declaring local variables of type row

Variables of type row can be declared once the row data type has been created.

Before you create a row data type:

- Read: "Row types" on page 17
- Read: "Restrictions on the row data type" on page 17

Row data type variables can only be declared in SQL PL contexts including SQL procedures and functions where execution of the DECLARE statement is supported.

The following steps must be followed to declare a local row variable:

1. Formulate a declare statement:
 - a. Specify a name for the variable.
 - b. Specify the row data type that will define the variable. The specified row data type must be already defined in the database.

The following is an example of how to formulate a DECLARE statement that defines a row variable of type empRow:

```
DECLARE r1 empRow;
```

2. Execute the DECLARE statement within a supported context.

If execution of the DECLARE statement is successful, the row variable is created.

Upon creation of a row variable each field in the row is initialized to a NULL value.

The row variable can be assigned values, be referenced, or passed as a parameter.

Assigning values to row variables

Values can be assigned to variables of type row in multiple ways. A row variable value can be assigned to another row variable. Variable field values can be assigned and referenced. Field values of a row are referenced by using a single-dot "." notation.

The following topics show how to assign values to row type variables and arrays of row type variables:

Supported assignments to row data types

A variety of values are supported for assignment to rows and row fields.

When a row variable or parameter is declared, each field in the row has a default value of NULL until a value is assigned to it.

The following types of values can be assigned to a row variable:

- another row variable of the same row data type using the SET statement
 - Row variable values can only be assigned to row variables if they are type compatible. Two row variables are compatible if they are both of the same row data type or if the source row variable is anchored to a table or view definition. For two variables to be type compatible, it is not sufficient for them to have the same field names and field data types.
For example, if a row data type named row1 is created and another data type named row2 is created and they are identical in definition, the value of a variable of type row1 cannot be assigned to the variable of type row2. Nor can the value of the variable of type row2 be assigned to the variable of type row1. However, the value of variable v1 of type row1 can be assigned to a variable v2 that is also of type row1.
- A tuple with the same number of elements as the row and elements of the same data types as the fields of the row.
 - The following is an example of a literal tuple being assigned to a row:
`SET v1 = (1, 'abc')`
- expression that resolves to a row value
 - An example of an expression that resolves to a row value that can be assigned to a row variable is the resolved expression in a VALUES ... INTO statement. The following is an example of such an assignment:
`VALUES (1, 'abc') INTO rv1`
- the return type of a function (if it is of the same row data type as the target variable):
 - The following is an example where the return type of a function named foo is of the same row data type as the target variable:
`SET v1 = foo()`

If the return data type is defined as an anchored data type, the anchored data type assignment rules apply.
- the single row result set of a query
 - The result set must have the same number of elements as the row and the columns must be assignable to the same data types as the fields of the row. The following is an example of this type of assignment:
`SET v1 = (select c1, c2 from T)`
- NULL
 - When NULL is assigned to a row variable, all the row fields are set to NULL but the row variable itself remains NOT NULL.

The following types of values can be assigned to a row variable field:

- literal
- parameter
- variable
- expression
- NULL

Values can be assigned to row field values in the following ways:

- Using the SET statement
- Using a SELECT INTO statement that resolves to a row value
- Using a FETCH INTO statement that resolves to a row value
- Using a VALUES INTO statement that resolves to a row value

The ROW data type can be specified as the return-type of an SQL scalar function.

Assigning values to a row variable using the SET statement

Assigning values to a row variable can be done using the SET statement. A row value can be assigned to a row variable. A row field value or expression can be assigned to a row field.

Row values can be assigned to row variables using the SET statement if they are both of the same user-defined row data type.

The following is an example of how to assign a row value to a row variable of the same format:

```
SET empRow = newHire;
```

The row value newHire has the same format as the empRow variable - the number and types of the row fields are identical:

```
empRow.lastName      /* VARCHAR(128) */
empRow.firstName     /* VARCHAR(128) */
empRow.id            /* VARCHAR(10)  */
empRow.hireDate      /* TIMESTAMP  */
empRow.dept          /* VARCHAR(3)  */

newHire.lastName     /* VARCHAR(128) */
newHire.firstName    /* VARCHAR(128) */
newHire.id           /* VARCHAR(10)  */
newHire.hireDate     /* TIMESTAMP  */
newHire.dept         /* VARCHAR(3)  */
```

If you attempt to assign a row value to a variable that does not have an identical format an error will be raised.

Row values can be assigned by assigning values to the individual fields in a row. The following is an example of how to assign values to the fields in the row named empRow using the SET statement:

```
SET empRow.lastName = 'Brown';           // Literal value assignment
SET empRow.firstName = parmFirstName;    // Parameter value of same type assignment
SET empRow.id = var1;                   // Local variable of same type assignment
SET empRow.hiredate = CURRENT_TIMESTAMP; // Special register expression assignment
SET empRow.dept = NULL;                 // NULL value assignment
```

Any supported field assignment can be used to initialize a row value.

Assigning row values to row variables using SELECT, VALUES, or FETCH statements

A row value can be assigned to a variable of type row by using a SELECT INTO statement, a VALUES INTO statement, or a FETCH INTO statement. The field values of the source row value must be assignable to the field values of the target row variable.

The following is an example of how to assign a single row value to a row variable named empRow using a SELECT statement:

```
SELECT * FROM employee
INTO empRow
WHERE id=5;
```

If the select query resolves to more than one row value, an error is raised.

The following is an example of how to assign a row value to a row variable named empEmpBasics using a VALUES INTO statement:

```
VALUES (5, 'Jane Doe', 10000) INTO empBasics;
```

The following is an example of how to assign a row value to a row variable named empRow using a FETCH statement that references a cursor named cur1 that defines a row with compatible field values as the variable empRow:

```
FETCH cur1 INTO empRow;
```

Other variations of use are possible with each of these statements.

Comparing row variables and row field values

Row variables cannot be directly compared even if they are the same row data type, however individual row fields can be compared.

Individual fields within a row type can be compared to other values and the comparison rules for the data type of the field apply.

To compare two row variables, individual corresponding field values must be compared.

The following is an example of a comparison of two row values with compatible field definitions in SQL PL:

```
IF ROW1.field1 = ROW2.field1 AND
   ROW1.field2 = ROW2.field2 AND
   ROW1.field3 = ROW2.field3
THEN
  SET EQUAL = 1;
ELSE
  SET EQUAL = 0;
```

In the example the IF statement is used to perform the procedural logic which sets a local variable EQUAL to 1 if the field values are equal, or 0 if the field values are not equal.

Referencing row values

Row values and row field values can be referenced within SQL and SQL statements.

The following topics demonstrate where and how row values can be referenced:

Referencing row variables

Row variable values can be referenced by name wherever row variable data type references are supported.

Supported row variable reference contexts include the following:

- Source or target of a SET statement
- INSERT statement
- Target of SELECT INTO, VALUES INTO, or FETCH statements

The following is an example of a row variable being assigned to another row variable with the same definition using the SET statement:

```
-- Referencing row variables as source and
target of a SET statement
SET v1 = v2;
```

The following is an example of row variables being referenced in an INSERT statement that inserts two rows. The row variables v1 and v2 have a field definition that is type compatible with the column definition of the table that is the target of the INSERT statement:

```
-- Referencing row variables in an INSERT statement
INSERT INTO employee VALUES v1, v2;
```

The following is an example of a row variable being referenced in a FETCH statement. The row variable empRow has the same column definition as the result set associated with the cursor c1:

```
-- Referencing row variables in a FETCH statement
FETCH c1 INTO empRow;
```

The following is an example of a row variable named v3 being referenced in a SELECT statement. Two column values in the employee table are being selected into the two fields of the variable v3:

```
-- Referencing row variables in a SELECT statement
SELECT id, name INTO v3 FROM employee;
```

Referencing fields in row variables

Field values can be referenced in multiple contexts.

A row field value can be referenced wherever a value of the field's data type is permitted. The following contexts are supported for referencing row fields:

- Wherever a value of the field's data type is permitted including, but not limited to:
 - As the source of an assignment (SET statement)
 - As the target of an assignment (SET statement)
 - As the target of SELECT INTO, VALUES INTO, or FETCH INTO statement.

To reference the values of fields in a row variable a single-dot notation is used. Field values are associated with variables as follows:

```
<row-variable-name>.<field-name>
```

The following is an example of how to access the field id of variable employee:
employee.id

Examples of supported references to row variable field values follow.

The following is an example that shows how to assign a literal value to a field in row variable v1:

```
-- Literal assignment to a row variable field
SET v1.c1 = 5;
```

The following example shows how to assign literal and expression values to multiple row variable fields:

```
-- Literal assignment to fields of row variable
SET (emp.id, emp.name) = (v1.c1 + 1, 'James');
```

The following example shows how to reference field values in an INSERT statement:

```
-- Field references in an INSERT statement
INSERT INTO employee
VALUES(v1.c1, 'Beth'),
      (emp.id, emp.name);
```

The following example shows how to reference field values in an UPDATE statement:

```
-- Field references in an UPDATE statement
UPDATE employee
SET name = 'Susan'
WHERE id = v1.c1;
```

The following example shows how to reference field values in a SELECT INTO statement:

```
-- Field references in a SELECT INTO statement
SELECT employee.firstname INTO v2.c1
FROM employee
WHERE name=emp.name;
```

Referencing row variables in INSERT statements

Row variables can be used in INSERT statements to append or modify an entire table row.

The following is an example of an INSERT statement that inserts a row into tabled employee:

```
INSERT INTO employee VALUES empRow;
```

For the INSERT statement, the number of fields in the row variable must match the number of columns in the implicit or explicit target column list.

The INSERT statement shown previously inserts into each column in the table, the corresponding row field value. Thus the previously shown INSERT statement is equivalent to the following INSERT statement:

```
INSERT INTO employee VALUES (emp.id,
                              emp.name,
                              emp.salary,
                              emp.phone);
```

Passing rows as routine parameters

Row type values and arrays of row type variables can be passed as parameters to procedures and functions. Procedures support these data types as IN, OUT, and INOUT parameters.

The following is an example of a procedure that takes a CHAR type as an input parameter, modifies a field in the output row parameter and then returns.

```
CREATE PROCEDURE p(IN basicChar CHAR, OUT outEmpRow empRow)
BEGIN
    SET outEmpRow.field2 = basicChar;
END@
```

The following is an example of a CALL statement that invokes the procedure:

```
CALL p('1', myEmpRow)@
```

Dropping a row data type

Dropping a row data type is done when the row data type is no longer required or when you want to reuse the name of an existing row data type.

Before you begin

The following prerequisites must be met before you can drop a row data type:

- A connection to the database must be established.
- The row data type must exist in the database.

About this task

Dropping a row data type is done when the row data type is no longer required or when you want to reuse the name of an existing row data type. Dropping a row can be done from any interface that supports the execution of the DROP statement.

Procedure

1. Formulate a DROP statement that specifies the name of the row data type to be dropped.
2. Execute the DROP statement from a supported DB2 interface.

Example

The following is an example of how to drop a row data type named simpleRow.

```
DROP TYPE simpleRow;
```

What to do next

If the DROP statement executes successfully, the row data type is dropped from the database.

Examples: Row data type use

Examples of row data type use provide a useful reference for understanding how and when to use the row data type.

The following topics demonstrate how to use the row data type:

Example: Row data type use in a CLP script

Some basic features of row data types are shown within a DB2 CLP script to demonstrate how row data types are most commonly used.

The following DB2 CLP script demonstrates the use of the row data type and its related operations. It includes demonstrations of:

- Creating row data types
- Creating a table
- Creating a procedure that includes:
 - Row data type declarations
 - Inserting values to a type that include some row field values
 - Updating row values based on a row field value
 - Selecting values into a row field value
 - Assigning a row value to a row
 - Assigning row field values to a parameter

- Calling the procedure
- Dropping the row data types and table

```
-- Creating row types

CREATE TYPE row01 AS ROW (c1 INTEGER)@

CREATE TYPE empRow AS ROW (id INTEGER, name VARCHAR(10))@

CREATE TABLE employee (id INTEGER, name VARCHAR(10))@

CREATE procedure proc01 (OUT p0 INTEGER, OUT p1 INTEGER)
BEGIN
  DECLARE v1, v2 row01;
  DECLARE emp empRow;

  -- Assigning values to row fields
  SET v1.c1 = 5;
  SET (emp.id, emp.name) = (v1.c1 + 1, 'James');

  -- Using row fields in DML
  INSERT INTO employee
  VALUES (v1.c1, 'Beth'), (emp.id, emp.name);

  UPDATE employee
  SET name = 'Susan' where id = v1.c1;

  -- SELECT INTO a row field
  SELECT id INTO v2.c1
  FROM employee
  WHERE name = emp.name;

  -- Row level assignment
  SET v1 = v2;

  -- Assignment to parameters
  SET (p0, p1) = (v1.c1, emp.id);

END@

CALL proc01(?, ?)@

SELECT * FROM employee@

DROP procedure proc01@

DROP TABLE employee@

-- Dropping row types
DROP TYPE empRow@

DROP TYPE row01@
```

This script can be saved and run from a DB2 Command Line by issuing the following:

```
DB2 -td@ -vf <filename>;
```

The following is the output of running the script:

```
CREATE TYPE row01 AS ROW (c1 INTEGER)
DB20000I The SQL command completed successfully.

CREATE TYPE empRow AS ROW (id INTEGER, name VARCHAR(10))
DB20000I The SQL command completed successfully.

CREATE TABLE employee (id INTEGER, name VARCHAR(10))
```

DB20000I The SQL command completed successfully.

```
CREATE procedure proc01 (OUT p0 INTEGER, OUT p1 INTEGER)
  BEGIN DECLARE v1, v2 row01;
  DECLARE emp empRow;
  SET v1.c1 = 5;
  SET (emp.id, emp.name) = (v1.c1 + 1, 'James');
  INSERT INTO employee VALUES (v1.c1, 'Beth'), (emp.id, emp.name);
  UPDATE employee SET name = 'Susan' where id = v1.c1;
  SELECT id INTO v2.c1 FROM employee WHERE name = emp.name;
  SET v1 = v2;
  SET (p0, p1) = (v1.c1, emp.id);
END
```

DB20000I The SQL command completed successfully.

```
CALL proc01(?, ?)
```

Value of output parameters

Parameter Name : P0
Parameter Value : 6

Parameter Name : P1
Parameter Value : 6

Return Status = 0

```
SELECT * FROM employee
```

```
ID          NAME
-----
           5 Susan
           6 James
```

2 record(s) selected.

```
DROP procedure proc01
```

DB20000I The SQL command completed successfully.

```
DROP TABLE employee
```

DB20000I The SQL command completed successfully.

```
DROP TYPE empRow
```

DB20000I The SQL command completed successfully.

```
DROP TYPE row01
```

DB20000I The SQL command completed successfully.

Example: Row data type use in an SQL procedure

The row data type can be used in SQL procedures to retrieve record data and pass it as a parameter.

This topic contains an example of a CLP script that includes the definitions of multiple SQL procedures that demonstrate some of the many uses of rows.

The procedure named ADD_EMP takes a row data type as an input parameter which it then inserts into a table.

The procedure named NEW_HIRE uses a SET statement to assign values to a row variable and passes a row data type value as a parameter in a CALL statement that invokes another procedure.

The procedure named FIRE_EMP selects a row of table data into a row variable and inserts row field values into a table.

The following is the CLP script - it is followed by the output of running the script from the CLP in verbose mode:

```
--#SET TERMINATOR @;
CREATE TABLE employee (id INT,
                        name VARCHAR(10),
                        salary DECIMAL(9,2))@

INSERT INTO employee VALUES (1, 'Mike', 35000),
                              (2, 'Susan', 35000)@

CREATE TABLE former_employee (id INT, name VARCHAR(10))@

CREATE TYPE empRow AS ROW ANCHOR ROW OF employee@
CREATE PROCEDURE ADD_EMP (IN newEmp empRow)
BEGIN
    INSERT INTO employee VALUES newEmp;
END@

CREATE PROCEDURE NEW_HIRE (IN newName VARCHAR(10))
BEGIN
    DECLARE newEmp empRow;
    DECLARE maxID INT;

    -- Find the current maximum ID;
    SELECT MAX(id) INTO maxID FROM employee;

    SET (newEmp.id, newEmp.name, newEmp.salary)
        = (maxID + 1, newName, 30000);

    -- Call a procedure to insert the new employee
    CALL ADD_EMP (newEmp);
END@

CREATE PROCEDURE FIRE_EMP (IN empID INT)
BEGIN
    DECLARE emp empRow;

    -- SELECT INTO a row variable
    SELECT * INTO emp FROM employee WHERE id = empID;

    DELETE FROM employee WHERE id = empID;

    INSERT INTO former_employee VALUES (emp.id, emp.name);
END@

CALL NEW_HIRE('Adam')@

CALL FIRE_EMP(1)@

SELECT * FROM employee@

SELECT * FROM former_employee@
```

The following is the output of running the script from the CLP in verbose mode:

```
CREATE TABLE employee (id INT, name VARCHAR(10), salary DECIMAL(9,2))
DB20000I The SQL command completed successfully.

INSERT INTO employee VALUES (1, 'Mike', 35000), (2, 'Susan', 35000)
DB20000I The SQL command completed successfully.

CREATE TABLE former_employee (id INT, name VARCHAR(10))
DB20000I The SQL command completed successfully.
```

```

CREATE TYPE empRow AS ROW ANCHOR ROW OF employee
DB20000I The SQL command completed successfully.

CREATE PROCEDURE ADD_EMP (IN newEmp empRow)
BEGIN
    INSERT INTO employee VALUES newEmp;
END
DB20000I The SQL command completed successfully.

CREATE PROCEDURE NEW_HIRE (IN newName VARCHAR(10))
BEGIN
    DECLARE newEmp empRow;
    DECLARE maxID INT;

    -- Find the current maximum ID;
    SELECT MAX(id) INTO maxID FROM employee;

    SET (newEmp.id, newEmp.name, newEmp.salary) = (maxID + 1, newName, 30000);

    -- Call a procedure to insert the new employee
    CALL ADD_EMP (newEmp);
END
DB20000I The SQL command completed successfully.

CREATE PROCEDURE FIRE_EMPLOYEE (IN empID INT)
BEGIN
    DECLARE emp empRow;

    -- SELECT INTO a row variable
    SELECT * INTO emp FROM employee WHERE id = empID;

    DELETE FROM employee WHERE id = empID;

    INSERT INTO former_employee VALUES (emp.id, emp.name);
END
DB20000I The SQL command completed successfully.

CALL NEW_HIRE('Adam')

Return Status = 0

CALL FIRE_EMPLOYEE(1)

Return Status = 0

SELECT * FROM employee

ID          NAME          SALARY
-----
          2 Susan          35000.00
          3 Adam           30000.00

2 record(s) selected.

SELECT * FROM former_employee

ID          NAME
-----
          1 Mike

1 record(s) selected.

```

Example: Row data type use in an SQL function

Row data types can be used in SQL functions to construct, store, or modify record data.

Variables based on row data types can be used as a simple way to hold a row value that has the same format as a table. When used in this way, it is helpful to initialize the row variable upon its first use.

The following is an example of a DB2 CLP script that contains SQL statements that create a table, a row data type, and a function that includes the declaration of a row variable, a row reference and an invocation of the UDF:

```
CREATE TABLE t1 (deptNo VARCHAR(3),
                 reportNo VARCHAR(3),
                 deptName VARCHAR(29),
                 mgrNo VARCHAR (8),
                 location VARCHAR(128))@

INSERT INTO t1 VALUES ('123', 'MM1', 'Sales-1', '0112345', 'Miami')@
INSERT INTO t1 VALUES ('456', 'MM2', 'Sales-2', '0221345', 'Chicago')@
INSERT INTO t1 VALUES ('789', 'MM3', 'Marketing-1', '0331299', 'Toronto')@

CREATE TYPE deptRow AS ROW (r_deptNo VARCHAR(3),
                            r_reportNo VARCHAR(3),
                            r_depTName VARCHAR(29),
                            r_mgrNo VARCHAR (8),
                            r_location VARCHAR(128))@

CREATE FUNCTION getLocation(theDeptNo VARCHAR(3),
                           reportNo VARCHAR(3),
                           theName VARCHAR(29))

RETURNS VARCHAR(128)
BEGIN

    -- Declare a row variable
    DECLARE dept deptRow;

    -- Assign values to the fields of the row variable
    SET dept.r_deptno = theDeptNo;
    SET dept.r_reportNo = reportNo;
    SET dept.r_deptname = theName;
    SET dept.r_mgrno = '';
    SET dept.r_location = '';

    RETURN
        (SELECT location FROM t1 WHERE deptNo = dept.r_deptno);

END@

VALUES (getLocation ('789', 'MM3','Marketing-1'))@
```

When executed this CLP script creates a table, inserts rows into the table, creates a row data type, and a UDF.

The function getLocation is an SQL UDF that declares a row variable and assigns values to its fields using the input parameter values. It references one of the fields in the row variable within the SELECT statement that defines the scalar value returned by the function.

When the VALUES statement is executed at the end of the script, the UDF is invoked and the scalar return value is returned.

The following is the output of running this script from the CLP:

```

CREATE TABLE t1 (deptNo VARCHAR(3), reportNo VARCHAR(3),
  deptName VARCHAR(29), mgrNo VARCHAR (8), location VARCHAR(128))
DB20000I The SQL command completed successfully.

INSERT INTO t1 VALUES ('123', 'MM1', 'Sales-1', '0112345', 'Miami')
DB20000I The SQL command completed successfully.

INSERT INTO t1 VALUES ('456', 'MM2', 'Sales-2', '0221345', 'Chicago')
DB20000I The SQL command completed successfully.

INSERT INTO t1 VALUES ('789', 'MM3', 'Marketing-1', '0331299', 'Toronto')
DB20000I The SQL command completed successfully.

CREATE TYPE deptRow AS ROW (r_deptNo VARCHAR(3), r_reportNo VARCHAR(3), r_deptName
me VARCHAR(29), r_mgrNo VARCHAR (8), r_location VARCHAR(128))
DB20000I The SQL command completed successfully.

CREATE FUNCTION getLocation(theDeptNo VARCHAR(3),
                           reportNo VARCHAR(3),
                           theName VARCHAR(29))

RETURNS VARCHAR(128)
BEGIN
  DECLARE dept deptRow;
  SET dept.r_deptno = theDeptNo;
  SET dept.r_reportNo = reportNo;
  SET dept.r_deptname = theName;
  SET dept.r_mgrno = '';
  SET dept.r_location = '';
  RETURN
    (SELECT location FROM t1 WHERE deptNo = dept.r_deptno);
END
DB20000I The SQL command completed successfully.

VALUES (getLocation ('789', 'MM3', 'Marketing-1'))

1

-----
-----
Toronto

1 record(s) selected.

```

Array types

An array type is a user-defined data type consisting of an ordered set of elements of a single data type.

An *ordinary* array type has a defined upper bound on the number of elements and uses the ordinal position as the array index.

An *associative* array type has no specific upper bound on the number of elements and each element has an associated index value. The data type of the index value can be an integer or a character string but is the same data type for the entire array.

An array type can be used as the type for global variables, SQL variables, and SQL parameters in SQL PL to provide flexible manipulation of a collection of values of a single data type.

Comparison of arrays and associative arrays

Simple arrays and associative arrays differ in multiple ways. Understanding the differences can help you to choose the right data type to use.

The following table highlights the differences between arrays and associative arrays:

Table 1. Comparison of arrays and associative arrays

Arrays	Associative arrays
The maximum cardinality of a simple array is defined when the simple array is defined. When a value is assigned to index N, the elements with indices between the current cardinality of the array and N are implicitly initialized to NULL.	There is no user-specified maximum cardinality and no elements are initialized when an associative array variable is declared. The maximum cardinality is limited by the available free memory.
The index data type for a simple array must be an integer value.	The index type for an associative array can be one of a set of supported data types.
The index values in a simple array must be a contiguous set of integer values.	In an associative array the index values can be sparse.
The CREATE TYPE statement for a simple array does not require the specification of the array cardinality. For example, in this statement, no cardinality is specified: <code>CREATE TYPE simple AS INTEGER ARRAY[];</code>	In the CREATE TYPE statement for an associative array, instead of requiring a specification of the array cardinality, the index data type is required. For example, in this statement, the cardinality for the index data type is specified as INTEGER: <code>CREATE TYPE assoc AS INTEGER ARRAY[INTEGER];</code>
A first assignment to a simple array results in the initialization of array elements with index values between 1 and the index value assigned to the array. The following compound SQL (compiled) statement contains the declaration of a simple array variable and the assignment of a value to the variable: <code>BEGIN DECLARE mySimpleA simple; SET mySimpleA[100] = 123;</code> <code>END</code> After the execution of the assignment statement, the cardinality of mySimpleA is 100; the elements with indices with values 1 to 99 are implicitly initialized to NULL.	A first assignment to an associative array results in the initialization of a single element with a single index value. The following compound SQL (compiled) statement contains the declaration of an associative array variable and the assignment of a value to the variable: <code>BEGIN DECLARE myAssocA assoc; SET myAssocA[100] = 123;</code> <code>END</code> After the execution of the assignment statement, the cardinality of the array is 1.

Example

Ordinary array data type

An ordinary array data type is a structure that contains an ordered collection of data elements in which each element can be referenced by its ordinal position in the collection.

If N is the cardinality (number of elements) in an array, the ordinal position associated with each element, called the index, is an integer value greater than or equal to 1 and less than or equal to N. All elements in an array have the same data type.

Features of the array data type

The many features of the array data type make it ideal for use in SQL PL logic.

An array type is a data type that is defined as an array of another data type.

Every array type has a maximum cardinality, which is specified on the CREATE TYPE statement. If A is an array type with maximum cardinality M, the cardinality of a value of type A can be any value between 0 and M, inclusive. Unlike the maximum cardinality of arrays in programming languages such as C, the maximum cardinality of SQL arrays is not related to their physical representation. Instead, the maximum cardinality is used by the system at run time to ensure that subscripts are within bounds. The amount of memory required to represent an array value is usually proportional to its cardinality, and not to the maximum cardinality of its type.

When an array is being referenced, all of the values in the array are stored in main memory. Therefore, arrays that contain a large amount of data will consume large amounts of main memory.

Array element values can be retrieved by specifying the element's corresponding index value.

Array data types are useful when you want to store a set of values of a single data type. This set of values can be used to greatly simplify the passing of values to routines, because a single array value can be passed instead of multiple, possibly numerous, individual parameters.

Array data types differ from associative array data types. Whereas array data types are a simple collection of values, associative arrays are conceptually like an array of arrays. That is associative arrays are ordered arrays that contain zero or more subarray elements, such that the array elements are accessed by a primary index and the subarray elements are accessed by a subindex.

Restrictions on the array data type

It is important to note the restrictions on the array data type before you use it or when troubleshooting problems with their declaration or use.

The following restrictions apply to the array data type:

- Use of the array data type in dynamic compound statements is not supported.
- Use of the ARRAY_AGG function outside of SQL procedures is not supported.
- Use of the UNNEST function outside of SQL procedures is not supported.
- Use of parameters of the array data type in external procedures other than Java™ procedures is not supported.
- The casting of an array to any data type other than a user-defined arrays data type is not supported.
- The containment of elements of any data type other than that specified for the array is not supported.
- The casting of an array with a cardinality larger than that of the target array is not supported.
- The use of arrays as parameters or return types in methods is not supported.
- The use of arrays as parameters or return types in sourced or template functions is not supported.

- The use of arrays as parameters or return types in external scalar or external table functions is not supported.
- The use of arrays as parameters or return types in SQL scalar functions, SQL table functions, or SQL row functions is not supported.
- The assignment or casting of the result value of a TRIM_ARRAY function to any data type other than an array is not supported.
- The assignment or casting of the result value of an ARRAY constructor or an ARRAY_AGG function to any data type other than an array is not supported.
-

Array variables

Array variables are variables based on user-defined array data types. Array variables can be declared, assigned a value, set to another value, or passed as a parameter to and from SQL procedures.

Array variables inherit the properties of the array data types upon which they are based. Array variables are used to hold a set of data of the same data type.

Local array variables can be declared within SQL procedures using the DECLARE statement.

Global array variables can be created using the CREATE VARIABLE statement.

Creating array variables

To create array variables you must first create the array type and then declare the local array variable or create the global array variable.

Creating an array data type (CREATE TYPE statement):

Creating an array data type is a task that you would perform as a prerequisite to creating a variable of the array data type.

Before you begin

Before you create an array data type, ensure that you have the privileges required to execute the CREATE TYPE statement.

About this task

Array data types can only be created in SQL PL contexts where execution of the CREATE TYPE statement is supported.

Restrictions

See: “Restrictions on the array data type” on page 33

Procedure

1. Define the CREATE TYPE statement
 - a. Specify a name for the array data type.
 - b. Specify the AS keyword followed by the keyword name for the data type of the array element. For example, INTEGER, VARCHAR.

- c. Specify the ARRAY keyword and the domain of the subindices in the array. For example, if you specify 100, the valid indices will be from 1 to 100. This number is the same as the cardinality of the array - the number of elements in the array.
2. Execute the CREATE TYPE statement from a supported interface.

Results

The CREATE type statement should execute successfully and the array type should be created.

Example

Example 1:

```
CREATE TYPE simpleArray AS INTEGER ARRAY[100];
```

This array data type can contain up to 100 integer values indexed by integer values ranging from 1 to 100.

Example 2:

```
CREATE TYPE id_Phone AS VARCHAR(20) ARRAY[100];
```

This array data type can contain up to 100 phone values stored as VARCHAR(20) data type values indexed by integer values ranging from 1 to 100.

What to do next

After creating the array data type you can declare an array variable.

Declaring local variables of type array:

Declaring array data type variables is a task that you perform after creating array data types if you want to be able to temporarily store or pass array data type values.

Before you begin

Before you create a local variable of type row:

- Read: Array data types
- Read: “Restrictions on the array data type” on page 33
- Read: “Creating an array data type (CREATE TYPE statement)” on page 34
- Ensure that you have the privileges required to execute the DECLARE statement.

About this task

Declaring array data types can be done in supported contexts including within: SQL procedures, SQL functions, and triggers.

Procedure

1. Define the DECLARE statement.
 - a. Specify a name for the array data type variable.

- b. Specify the name of the array data type that you used when you created the array data type.

If the array data type was declared using the following CREATE TYPE statement:

```
CREATE TYPE simpleArray AS INTEGER ARRAY[10];
```

You would declare a variable of this data type as follows:

```
DECLARE myArray simpleArray;
```

If the array data type was declared using the following CREATE TYPE statement:

```
CREATE TYPE id_Phone AS VARCHAR(20) ARRAY[100];
```

You would create a variable of this data type as follows:

```
DECLARE id_Phone_Toronto_List id_Phone;
```

This array can contain up to 100 phone values stored as VARCHAR(20) data type values indexed by integer values ranging from 1 to 100. The variable name indicates that the phone values are Toronto phone numbers.

2. Include the DECLARE statement within a supported context. This can be within a CREATE PROCEDURE, CREATE FUNCTION, or CREATE TRIGGER statement.
3. Execute the statement which contains the DECLARE statement.

Results

The statement should execute successfully.

If the statement does not execute successfully due to an error with the DECLARE statement:

- Verify the SQL statement syntax of the DECLARE statement and execute the statement again.
- Verify that no other variable with the same name has already been declared within the same context.
- Verify that the array data type was created successfully.

What to do next

After declaring associative array variables, you might want to assign values to them.

Assigning values to arrays

Values can be assigned to arrays in multiple ways.

Assigning array values using the subindex and literal values:

Values can be assigned to associative arrays using subindices and literal values.

Before you begin

- Read: “Ordinary array data type” on page 32
- Read: “Restrictions on the array data type” on page 33
- Privileges required to execute the SET statement

About this task

You would perform this task before performing SQL PL that is conditional on the variable having an assigned value or before passing the variable as a parameter to a routine.

Procedure

1. Define a SET statement.
 - a. Specify the array variable name.
 - b. Specify the assignment symbol, '='.
 - c. Specify the ARRAY keyword and specify within the required brackets sets of paired values.
2. Execute the SET statement.

Example

The following is an example of how to assign element values to an array named, myArray:

```
SET myArray[1]   = 123;  
SET myArray[2]   = 124;  
...  
SET myArray[100] = 223;
```

What to do next

If the SET statements execute successfully, the array elements have been defined successfully. To validate that the array was created you can attempt to retrieve values from the array.

If the SET statement failed to execute successfully:

- Verify the SQL statement syntax of the SET statement and execute the statement again.
- Verify that the data type was created successfully.

Retrieving array values

Retrieving array values can be done in multiple ways.

Retrieving array values using an index:

Retrieving array element values can be done directly by referencing the array and specifying a sub-index value.

Before you begin

The following are prerequisites to this task:

- Read: "Ordinary array data type" on page 32
- Read: "Restrictions on the array data type" on page 33
- Privileges required to execute the SET statement or any SQL statement that contains the array reference

About this task

You would perform this task within SQL PL code in order to access values stored within an array. You might access the array element value as part of an assignment

(SET) statement or directly within an expression.

Procedure

1. Define a SET statement.
 - a. Specify a variable name of the same data type as the array element.
 - b. Specify the assignment symbol, "=".
 - c. Specify the name of the array, square brackets, and within the square brackets an index value.
2. Execute the SET statement.

Example

The following is an example of a SET statement that retrieves an array value:

```
SET myLocalVar = myArray[1];
```

What to do next

If the SET statement executes successfully, the local variable should contain the array element value.

If the SET statement failed to execute successfully:

- Verify the SQL statement syntax of the SET statement and execute the statement again.
- Verify that the variable is of the same data type as the array element.
- Verify that the array was created successfully and currently exists.

Retrieving the number of array elements:

Retrieving the number of array elements in a simple array can most easily be done by using the CARDINALITY function and retrieving the maximum allowed size of an array can be done using the MAX_CARDINALITY function.

Before you begin

- Read: "Ordinary array data type" on page 32
- Read: "Restrictions on the array data type" on page 33
- Privileges required to execute the SET statement

About this task

You would perform this task within SQL PL code in order to access a count value of the number of elements in an array. You might access the array element value as part of an assignment (SET) statement or access the value directly within an expression.

Procedure

1. Define a SET statement.
 - a. Declare and specify a variable name of type integer that will hold the cardinality value.
 - b. Specify the assignment symbol, '='.
 - c. Specify the name of the CARDINALITY or MAX_CARDINALITY function and within the required brackets, the name of the array.
2. Execute the SET statement.

Results

If the SET statement executes successfully, the local variable should contain the count value of the number of elements in the array.

Example

The following is an example of two SET statements that demonstrate these assignments:

```
SET card = CARDINALITY(arrayName);  
SET maxcard = MAX_CARDINALITY(arrayName);
```

What to do next

If the SET statement failed to execute successfully:

- Verify the SQL statement syntax of the SET statement and execute the statement again.
- Verify that the local variable is of the integer data type.
- Verify that the array was created successfully and currently exists.

Retrieving the first and last array elements (FIRST, LAST functions):

Retrieving the first and last elements in a simple array can most easily be done by using the FIRST and LAST functions.

Before you begin

- Read: “Ordinary array data type” on page 32
- Read: “Restrictions on the array data type” on page 33
- Privileges required to execute the SET statement

About this task

You would perform this task within SQL PL code in order to quickly access the first element in an array.

Procedure

Define a SET statement:

1. Declare and specify a variable that is of the same type as the array element.
2. Specify the assignment symbol, '='.
3. Specify the name of the FIRST or LAST function and within the required brackets, the name of the array.

Results

If the SET statement executes successfully, the local variable should contain the value of the first or last (as appropriate) index value in the array.

Example

For an array of phone numbers defined as:

```
firstPhone index    0          1          2          3  
phone    '416-223-2233' '416-933-9333' '416-887-8887' '416-722-7227'
```

If the following SQL statement is executed:

```
SET firstPhoneIx = FIRST(phones);
```

The variable `firstPhoneIx` will have the value 0. This would be true even if the element value in this position was NULL.

The following SET statement accesses the element value in the first position in the array:

```
SET firstPhone = A[FIRST(A)]
```

What to do next

If the SET statement failed to execute successfully:

- Verify the SQL statement syntax of the SET statement and execute the statement again.
- Verify that the local variable is of the correct data type.
- Verify that the array was created successfully and currently exists.

Retrieving the next and previous array elements:

Retrieving the next or previous elements in a simple array can most easily be done by using the PREV and NEXT functions.

Before you begin

- Read: “Ordinary array data type” on page 32
- Read: “Restrictions on the array data type” on page 33
- Privileges required to execute the SET statement

About this task

You would perform this task within SQL PL code in order to quickly access the immediately adjacent element value in an array.

Procedure

1. Define a SET statement:
 - a. Declare and specify a variable that is of the same type as the array element.
 - b. Specify the assignment symbol, '='.
 - c. Specify the name of the NEXT or PREV function and within the required brackets, the name of the array.
2. Execute the SET statement.

Example

For an array of phone numbers defined as:

```
firstPhone index 0          1          2          3
phone '416-223-2233' '416-933-9333' '416-887-8887' '416-722-7227'
```

The following SQL statement sets the variable `firstPhone` to the value 0..

```
SET firstPhone = FIRST(phones);
```

The following SQL statement sets the variable `nextPhone` to the value 1.

```
SET nextPhone = NEXT(phones, firstPhone);
```

The following SQL statement sets the variable `phoneNumber` to the value of the phone number at the next position in the array after `nextPhone`. This is the array element value at index value position 2.

```
SET phoneNumber = phones[NEXT(phones, nextPhone)];
```

What to do next

If the SET statement failed to execute successfully:

- Verify the SQL statement syntax of the SET statement and execute the statement again.
- Verify that the local variable is of the correct data type.
- Verify that the array was created successfully and currently exists.

Trimming the array (TRIM_ARRAY function)

Trimming an array is a task that you would perform using the `TRIM_ARRAY` function when you want to remove unnecessary array elements from the end of an array.

Before you begin

- Read: Array data types
- Read: Restrictions on array data types
- Privileges required to execute the SET statement

About this task

You would perform this task within SQL PL code in order to quickly remove array elements from the end of an array.

Procedure

1. Define a SET statement:
 - a. Declare and specify an array variable that is of the same type as the array to be modified, or re-use the same array variable.
 - b. Specify the assignment symbol, '='.
 - c. Specify the name of the `TRIM_ARRAY` function and within the required brackets, the name of the array and the number of elements to be trimmed.
2. Execute the SET statement.

Results

If the SET statement executes successfully, the array `phones` should contain the updated value.

Example

For an array of phone numbers defined as:

```
phones index 0      1      2      3
         phone '416-223-2233' '416-933-9333' '416-887-8887' '416-722-7227'
```

After executing the following:

```
SET phones = TRIM_ARRAY ( phones, 2 );
```

The array, `phones`, will be defined as:

```
phones index 0      1
        phone '416-223-2233' '416-933-9333'
```

What to do next

If the SET statement failed to execute successfully:

- Verify the SQL statement syntax of the SET statement and execute the statement again.
- Verify that the local variable is of the correct data type.
- Verify that the array was created successfully and currently exists.

Deleting an array element (ARRAY_DELETE)

Deleting an element permanently from an array can be done using the ARRAY_DELETE function.

Before you begin

- Read: Array data types
- Read: Restrictions on array data types
- Privileges required to execute the SET statement

About this task

You would perform this task within SQL PL code in order to delete an element in an array.

Procedure

1. Define a SET statement:
 - a. Declare and specify a variable that is of the same type as the array element.
 - b. Specify the assignment symbol, '='.
 - c. Specify the name of the ARRAY_DELETE function and within the required brackets, the name of the array, and the subindices that define the range of the elements to be deleted.
2. Execute the SET statement.

Results

If the SET statement executes successfully, the array phones should contain the updated value.

Example

For an array of phone numbers defined as:

```
phones index 0      1      2      3
        phone '416-223-2233' '416-933-9333' '416-887-8887' '416-722-7227'
```

After executing the following SQL statement:

```
SET phones = ARRAY_DELETE ( phones, 1, 2 );
```

The array, phones, will be defined as:

```
phones index 0      3
        phone '416-223-2233' '416-722-7227'
```

What to do next

If the SET statement failed to execute successfully:

- Verify the SQL statement syntax of the SET statement and execute the statement again.
- Verify that the local variable is of the correct data type.
- Verify that the array was created successfully and currently exists.

Determining if an array element exists

Determining if an array element exists and has a value is a task that can be done using the ARRAY_EXISTS function.

Before you begin

- Read: “Ordinary array data type” on page 32
- Read: “Restrictions on the array data type” on page 33
- Privileges required to execute the IF statement or any SQL statement in which the ARRAY_EXISTS function is referenced.

About this task

You would perform this task within SQL PL code in order to determine if an array element exists within an array.

Procedure

1. Define an IF statement:
 - a. Define a condition that includes the ARRAY_EXISTS function.
 - b. Specify the THEN clause and include any logic that you want to have performed if the condition is true and add any ELSE clause values you want.
 - c. Close the IF statement with the END IF clause.
2. Execute the IF statement.

Example

For an array of phone numbers defined as:

```
phones index 0          1          2          3
         phone '416-223-2233' '416-933-9333' '416-887-8887' '416-722-7227'
```

After executing the following, the variable x will be set to 1.

```
IF (ARRAY_EXISTS(phones, 2)) THEN
  SET x = 1;
END IF;
```

What to do next

If the SET statement failed to execute successfully:

- Verify the SQL statement syntax of the SET statement and execute the statement again.
- Verify that the local variable is of the correct data type.
- Verify that the array was created successfully and currently exists.

Array support in SQL procedures

SQL procedures support parameters and variables of array types. Arrays are a convenient way of passing transient collections of data between an application and a stored procedure or between two stored procedures.

Within SQL stored procedures, arrays can be manipulated as arrays in conventional programming languages. Furthermore, arrays are integrated within the relational model in such a way that data represented as an array can be easily converted into a table and data in a table column can be aggregated into an array. The following examples illustrate several operations on arrays. Both examples are command line processor (CLP) scripts that use the percentage character (%) as a statement terminator.

Example 1

This example shows two procedures, `sub` and `main`. Procedure `main` creates an array of 6 integers using an array constructor. It then passes the array to procedure `sum`, which computes the sum of all the elements in the input array and returns the result to `main`. Procedure `sum` illustrates the use of array subindexing and of the `CARDINALITY` function, which returns the number of elements in an array.

```
create type intArray as integer array[100] %

create procedure sum(in numList intArray, out total integer)
begin
declare i, n integer;

set n = CARDINALITY(numList);

set i = 1;
set total = 0;

while (i <= n) do
set total = total + numList[i];
set i = i + 1;
end while;

end %

create procedure main(out total integer)
begin
declare numList intArray;

set numList = ARRAY[1,2,3,4,5,6];

call sum(numList, total);

end %
```

Example 2

In this example, we use two array data types (`intArray` and `stringArray`), and a `persons` table with two columns (`id` and `name`). Procedure `processPersons` adds three additional persons to the table, and returns an array with the person names that contain letter 'o', ordered by `id`. The `ids` and `name` of the three persons to be added are represented as two arrays (`ids` and `names`). These arrays are used as arguments to the `UNNEST` function, which turns the arrays into a two-column table, whose elements are then inserted into the `persons` table. Finally, the last `set` statement in the procedure uses the `ARRAY_AGG` aggregate function to compute the value of the output parameter.

```

create type intArray as integer array[100] %
create type stringArray as varchar(10) array[100] %

create table persons (id integer, name varchar(10)) %
insert into persons values(2, 'Tom') %
insert into persons values(4, 'Jill') %
insert into persons values(1, 'Joe') %
insert into persons values(3, 'Mary') %

create procedure processPersons(out witho stringArray)
begin
declare ids intArray;
declare names stringArray;

set ids = ARRAY[5,6,7];
set names = ARRAY['Bob', 'Ann', 'Sue'];

insert into persons(id, name)
(select T.i, T.n from UNNEST(ids, names) as T(i, n));

set witho = (select array_agg(name order by id)
from persons
where name like '%o%');
end %

```

Associative array data type

An associative array data type is a data type used to represent a generalized array with no predefined cardinality. Associative arrays contain an ordered set of zero or more elements of the same data type, where each element is ordered by and can be referenced by an index value.

The index values of associative arrays are unique, are of the same data type, and do not have to be contiguous.

The following topics provide more information about the associative array data type:

Features of associative arrays

The associative array data type is used to represent associative arrays. It has many features which contribute to its utility.

The associative array data type supports the following associative array properties:

- No predefined cardinality is specified for associative arrays. This enables you to continue adding elements to the array without concern for a maximum size which is useful if you do not know in advance how many elements will constitute a set.
- The array index value can be a non integer data type. VARCHAR and INTEGER are supported index values for the associative array index.
- Index values do not have to be contiguous. In contrast to a conventional array which is indexed by position, an associative array is an array that is indexed by values of another data type and there are not necessarily index elements for all possible index values between the lowest and highest. This is useful if for example you want to create a set that stores names and phone numbers. Pairs of data can be added to the set in any order and be sorted using which ever data item in the pair is defined as the index.
- The elements in an associative array are sorted in ascending order of index values. The insertion order of elements does not matter.

- Associative array data can be accessed and set using direct references or by using a set of available scalar functions.
- Associative arrays are supported in SQL PL contexts.
- Associative arrays can be used to manage and pass sets of values of the same kind in the form of a collection instead of having to:
 - Reduce the data to scalar values and use one-element-at-a-time processing which can cause network traffic problems.
 - Use cursors passed as parameters.
 - Reduce the data into scalar values and reconstitute them as a set using a VALUES clause.

Restrictions on associative array data types

It is important to note the restrictions on the array data type before you use it or when troubleshooting problems with their declaration or use.

The following restrictions apply to the array data type:

- An associative array can only be declared, created, or referenced in SQL PL contexts. The following is a list of SQL PL contexts in which this data type can be used:
 - Parameter to an SQL function that is defined in a module.
 - Parameter to an SQL function that is not defined in a module, but that has a compound SQL (compiled) statement as function body not defined in a module.
 - Return type from an SQL functions that is defined in a module.
 - Return type from an SQL function that is not defined in a module, but that has a compound SQL (compiled) statement as function body.
 - Parameter to an SQL procedure.
 - Local variable declared in an SQL function that is defined in a module.
 - Local variable declared in an SQL function that is not defined in a module, but that has a compound SQL (compiled) statement as function body.
 - Local variable declared in an SQL procedure.
 - Local variable declared in a trigger with a compound SQL (compiled) statement as trigger body.
 - Expressions in SQL statements within compound compiled (SQL) statements.
 - Expressions in SQL statements in SQL PL contexts.
 - Global variable.

Any use outside of one of the previously listed SQL PL contexts is not valid.

- Associative arrays cannot be the type of a table column.
- NULL is not permitted as an index value.
- The maximum size of an associative array is limited by system resources.
- Associative arrays can not be input to the TRIM_ARRAY function. Associative array values cannot be stored in table columns.
- The MAX_CARDINALITY function is supported for use with associative arrays, but always returns null because associative arrays do not have a specified maximum size.

Creating an associative array data type

Creating an associative array data type is a task that you would perform as a prerequisite to creating a variable of the associative array data type. Associative array data types are created by executing the CREATE TYPE (array) statement.

Before you begin

Ensure you have the privileges required to execute the CREATE TYPE statement.

About this task

Associative array data types can only be used in certain contexts.

Procedure

1. Define the CREATE TYPE statement:
 - a. Specify a name for the associative array data type. A good name is one that clearly specifies the type of data stored in the array. For example: Products might be a good name for an array that contains information about products where the array index is the product identifier. As another example, the name y_coordinate might be a good name for an array where the array index is the x coordinate value in a graph function.
 - a. Specify the AS keyword followed by the keyword name for the data type of the array elements (e.g. INTEGER).
 - b. Specify the ARRAY keyword. Within the square brackets of the ARRAY clause, specify the data type of the array index. Note: With associative arrays, there is no explicit limit on the number of elements or on the domain of the array index values.
2. Execute the CREATE TYPE statement from a supported interface.

Example

Example 1:

The following is an example of a CREATE TYPE statement that creates an array named assocArray with 20 elements and a array index of type VARCHAR.

```
CREATE TYPE assocArray AS INTEGER ARRAY[VARCHAR(20)];
```

Example 2:

The following is an example of a basic associative array definition that uses the names of provinces for indices and where the elements are capital cities:

```
CREATE TYPE capitalsArray AS VARCHAR(12) ARRAY[VARCHAR(16)];
```

What to do next

If the statement executes successfully the array data type is created in the database and the array data type can be referenced..

After creating the array data type you might want to create an associative array variable.

Declaring associative array variables

Declaring associative array variables is a task that you perform after creating associative array data types to be able to temporarily store or pass associative array data type values. Local variables are declared using the DECLARE statement. Global variables are created using the CREATE VARIABLE statement.

Before you begin

- Read: Associative array data types
- Read: Restrictions on associative array data types
- Read: Creating the associative array data type

- For global variables, you require the privilege to execute the CREATE VARIABLE statement. For local variables, no privileges required to execute the DECLARE statement

About this task

Associative array variables can be declared and used in supported contexts to store sets of row data.

Procedure

1. Define the DECLARE statement for a local variable or the CREATE TYPE statement for a global variable:
 - a. Specify a name for the associative array data type.
 - b. Specify the name of the associative array data type that you used when you created the associative array data type.
2. Execute the CREATE TYPE statement from a supported interface.

Example

Example 1:

Consider an associative array data type defined as:

```
CREATE TYPE Representative_Location AS VARCHAR(20) ARRAY[VARCHAR(30)];
```

To declare a variable of this data type you would use the DECLARE statement as follows:

```
DECLARE RepsByCity Representative_Location;
```

This array can contain up to the maximum number of associative array element values stored as VARCHAR(20) data type values indexed by unique variable character data type values. The variable name indicates that a set of names of sales representatives is indexed by the name of the city that they represent. In this array, no two sales representative names can be represented by the same city which is the array index value.

Example 2:

Consider an associative array data type defined to store as element values, the names of capital cities, where the indices are province names:

```
CREATE TYPE capitalsArray AS VARCHAR(12) ARRAY[VARCHAR(16)];
```

To create a variable of this data type you would use the CREATE VARIABLE statement as follows:

```
CREATE VARIABLE capitals capitalsArray;
```

This array can contain up to the maximum number of associative array element values stored as VARCHAR(20) data type values indexed by unique variable character data type values. The variable name indicates that a set of names of sales representatives is indexed by the name of the city that they represent. In this array, no two sales representative names can be represented by the same city which is the array index value.

What to do next

If the DECLARE statement or CREATE VARIABLE statement executes successfully, the array data type will have been defined successfully and can be referenced. To

validate that the associative array variables was created you can assign values to the array or attempt to reference values in the array.

If the DECLARE statement or CREATE VARIABLE statement failed to execute successfully, verify the SQL statement syntax of the DECLARE statement and execute the statement again. See the DECLARE statement.

Assigning values to arrays using subindices and literal values

Once an associative array variable has been created or declared, values can be assigned to it. One way of assigning values to associative arrays is by direct assignment.

Before you begin

- Read: Associative array data types
- Read: Restrictions on associative array data types
- Ensure that an associative array variable is in the current scope of use.

About this task

Assigning values to associative array variable elements can be done by using the assignment statement in which the array is named, the index value is specified and the corresponding element value is assigned.

Procedure

1. Define the assignment statement for an associative array variable.
 - Specify the variable name, the index value, and the element value.
 - Specify another associative array variable.
2. Execute the assignment statement from a supported interface.

Example

Example 1:

The following is an example of a variable declaration and a series of assignment statements that define values in the array:

```
DECLARE capitals capitalsArray;

SET capitals['British Columbia'] = 'Victoria';
SET capitals['Alberta'] = 'Edmonton';
SET capitals['Manitoba'] = 'Winnipeg';
SET capitals['Ontario'] = 'Toronto';
SET capitals['Nova Scotia'] = 'Halifax';
```

In the capitals array, the array index values are province names and the associated array element values are the names of the corresponding capital cities. Associative arrays are sorted in ascending order of index value. The order in which values are assigned to associative array elements does not matter.

Example 2:

An associative array variable can also be assigned an associative array variable value of the same associative array data type. This can be done using the assignment statement. For example, consider two associative array variables, capitalsA and capitalsB defined as:

```
DECLARE capitalsA capitalsArray;
DECLARE capitalsB capitalsArray;
```

```
SET capitalsA['British Columbia'] = 'Victoria';
SET capitalsA['Alberta'] = 'Edmonton';
SET capitalsA['Manitoba'] = 'Winnipeg';
SET capitalsA['Ontario'] = 'Toronto';
SET capitalsA['Nova Scotia'] = 'Halifax';
```

The variable capitalsB can be assigned the value of the variable capitalsA by executing the following assignment statement:

```
SET capitalsB = capitalsA;
```

Once executed, capitalsB will have the same value as capitalsA.

What to do next

If the assignment statement executes successfully, the value has been successfully assigned and the new variable value can be referenced.

If the statement failed to execute successfully, verify and correct the SQL statement syntax and verify that the variables named are defined before executing the statement again.

Cursor types

A cursor type can be the built-in data type CURSOR or a user-defined type that is based on the built-in CURSOR data type. A user-defined cursor type can also be defined with a specific row type to restrict the attributes of the result row of the associated cursor.

When a cursor type is associated with a row data structure (specified by a row), it is called a strongly typed cursor. Only result sets that match the definition can be assigned to and stored in a variable of a strongly typed cursor data type. When no result set definition is associated with a cursor data type definition, the cursor data type is said to be weakly typed. Any result set can be stored in a variable of a weakly typed cursor data type.

The cursor data type is only supported for use with SQL PL. It is primarily used to create cursor type definitions that can be used for cursor variable declarations.

This data type can be used to:

- Define cursor variable declarations.
- Simplify the coding of logic within SQL Procedural Language applications. For example, database applications process sets of records called result sets and in some cases the same result set might need to be referenced and processed in different contexts. Passing defined result sets between interfaces can require complex logic. A cursor data type permits the creation of cursor variables which can be used to store result sets, process result sets, and pass result sets as parameters.
- Facilitate the porting to DB2 SQL PL of code which has a similar data type.

Cursor data types must be created using the CREATE TYPE statement. Once this is done variables of this data type can be declared and referenced. Cursor variables can be assigned a row data structure definition, opened, closed, assigned a set of rows from another cursor variable, or be passed as a parameter from SQL procedures.

Overview of cursor data types

This overview of cursor data types introduces the types of cursor data types, the scope in which they can be used, as well as provides information about the restrictions and privileges that pertain to their use.

Types of cursor data types

There are two main types of cursor data types: weakly-typed cursor data types and strongly-typed cursor data types. The property of being strongly or weakly typed is defined when the data type is created. This property is maintained in variables created of each type.

The characteristics of strongly-typed cursor data types and weakly typed cursor data types are provided here:

Strongly-typed cursor data types

A strongly-typed cursor data type is one that is created with a result set definition specified by a row data structure. These data types are called strongly typed, because when result set values are assigned to them the data types of the result sets can be checked. Cursor data type result set definitions can be defined by providing a row type definition. Only result sets that match the definition can be assigned to and stored in a strongly typed cursor data type. Strong type checking is performed at assignment time and if there are any data type mismatches, an error is raised.

Result set definitions for strongly-typed cursor data types can be provided by a row data type definition or an SQL statement definition.

The following is an example of a cursor data type definition that is defined to return a result set with the same row format as the rowType data type:

```
CREATE TYPE cursorType AS rowType CURSOR@
```

Only result sets that contain columns of data with the same data type definition as the rowType row definition can be successfully assigned to variables declared to be of the cursorType cursor data type.

The following is an example of a cursor data type definition that is defined to return a result set with the same row format as that which defines table T1:

```
CREATE TABLE T1 (C1 INT)

CREATE TYPE cursorType AS ANCHOR ROW OF t1 CURSOR;
```

Only result sets that contain columns of data with the same data type definition as the column definition for the table t1 can be successfully assigned to variables declared to be of the cursorType cursor data type.

The row definition associated with a strongly typed cursor can be referenced as the definition of an anchored data type. The following example illustrates this:

```
CREATE TYPE r1 AS ROW (C1 INT);
CREATE TYPE c1 AS RTEST CURSOR;

DECLARE c1 CTEST;
DECLARE r1 ANCHOR ROW OF CV1;
```

A row data type named r1 is defined, a cursor type named c1 associated with the row definition of r1 is defined. The subsequent SQL statements are examples of variable declarations might appear in an SQL procedure.

The second variable declaration is for a variable named `r1` which is defined to be of the anchored data type - it is anchored to the row type that was used to define the cursor `cv1`.

Weakly-typed cursor data types

A weakly typed cursor type is not associated with any row data type definition. No type checking is performed when values are assigned to weakly typed cursor variables.

There is a built-in weakly typed cursor data type named `CURSOR` that can be used to declare weakly typed cursor variables or parameters. The following is an example of a weakly typed cursor variable declaration based on the built-in weakly typed cursor data type `CURSOR`:

```
DECLARE cv1 CURSOR;
```

Weakly typed cursor variables are useful when you must store a result set with an unknown row definition.

To return a weakly typed cursor variable as an output parameter, the cursor must be opened.

In this version, variables based on weakly typed cursor data types cannot be referenced as anchored data types.

User-defined weakly typed cursor data types can be defined.

All other characteristics of cursor variables are common for each type of cursor variable.

Restrictions on cursor data types

Restrictions on cursor data types and cursor variables limit cursor variable functionality as well as where cursor variables can be defined and referenced.

The restrictions on cursor data types and variables are important to note before implementing them. The restrictions can be important in determining whether a cursor variable is appropriate for your needs and can be useful to review when troubleshooting errors related to cursor data type and variable use.

The following restrictions apply to cursor data types in this version:

- Cursor data types can only be created as local types in SQL procedures.

The following restrictions apply to cursor variables in this version:

- Cursor variables are not supported for use in applications. Cursor variables can only be declared and referenced in SQL PL contexts.
- Cursor variables are read-only cursors.
- Rows accessed through the use of a cursor variable are not updatable.
- Cursor variables are not scrollable cursors.
- Strongly typed cursor variable columns cannot be referenced as anchored data types.
- There is no support for global cursor variables.
- XML columns cannot be referenced in cursor variable definitions.
- XQuery language statements cannot be used to define strongly-typed cursor result sets.

Privileges related to cursor data type use

Specific privileges related to cursor data types and variables exist to restrict and control who can create them.

To create cursor data types, you require the following privilege:

- Privilege to execute the CREATE TYPE statement to create a cursor data type.

To declare cursor variables based on existing cursor data types, no privileges are required.

To initialize cursor variables, to open the cursor referenced by a cursor variable, or to fetch values from an opened cursor variable reference, you require the same privileges as are required to execute the DECLARE CURSOR statement.

Cursor variables

Cursor variables are cursors based on predefined cursor data type. Cursor variables can be un-initialized, initialized, assigned a value, set to another value, or passed as a parameter from SQL procedures. Cursor variables inherit the properties of the cursor data types upon which they are based. Cursor variables can be strongly-typed or weakly-typed. Cursor variables hold a reference to the context of the cursor defined by the cursor data type.

Cursor variables can be declared within SQL procedures using the DECLARE statement.

Cursor predicates

Cursor predicates are SQL keywords that can be used to determine the state of a cursor defined within the current scope. They provide a means for easily referencing whether a cursor is open, closed or if there are rows associated with the cursor.

Cursor predicates can be referenced in SQL and SQL PL statements wherever the status of a cursor can be used as a predicate condition. The cursor predicates that can be used include:

IS OPEN

This predicate can be used to determine if the cursor is in an open state. This can be a useful predicate in cases where cursors are passed as parameters to functions and procedures. Before attempting to open the cursor, this predicate can be used to determine if the cursor is already open.

IS NOT OPEN

This predicate can be used to determine if the cursor is closed. Its value is the logical inverse of IS OPEN. This predicate can be useful to determine whether a cursor is closed before attempting to actually close the cursor.

IS FOUND

This predicate can be used to determine if the cursor contains rows after the execution of a FETCH statement. If the last FETCH statement executed was successful, the IS FOUND predicate value is true. If the last FETCH statement executed resulted in a condition where rows were not found, the result is false. The result is unknown when:

- the value of cursor-variable-name is null
- the underlying cursor of cursor-variable-name is not open
- the predicate is evaluated before the first FETCH action was performed on the underlying cursor
- the last FETCH action returned an error

The IS FOUND predicate can be useful within a portion of SQL PL logic that loops and performs a fetch with each iteration. The predicate can be used to determine if rows remain to be fetched. It provides an efficient alternative to using a condition handler that checks for the error condition that is raised when no more rows remain to be fetched.

An alternative to using IS FOUND is to use IS NOT FOUND which has the opposite value.

Example

The following script defines an SQL procedure that contains references to these predicates as well as the prerequisite objects required to successfully compile and call the procedure:

```
CREATE TABLE T1 (c1 INT, c2 INT, c3 INT)@
insert into t1 values (1,1,1),(2,2,2),(3,3,3) @
CREATE TYPE myRowType AS ROW(c1 INT, c2 INT, c3 INT)@
CREATE TYPE myCursorType AS myRowType CURSOR@

CREATE PROCEDURE p(OUT count INT)
LANGUAGE SQL
BEGIN
  DECLARE C1 cursor;
  DECLARE lvarInt INT;

  SET count = -1;
  SET c1 = CURSOR FOR SELECT c1 FROM t1;

  IF (c1 IS NOT OPEN) THEN
    OPEN c1;
  ELSE
    set count = -2;
  END IF;

  set count = 0;
  IF (c1 IS OPEN) THEN

    FETCH c1 into lvarInt;

    WHILE (c1 IS FOUND) DO
      SET count = count + 1;
      FETCH c1 INTO lvarInt;
    END WHILE;
  ELSE
    SET count = 0;
  END IF;

END@

CALL p()@
```

Creating cursor variables

To create cursor variables you must first create a cursor type and then create a cursor variable based on the type.

Creating cursor data types using the CREATE TYPE statement

Creating a cursor data type is a prerequisite to creating a cursor variable. Cursor data types are created using the CREATE TYPE (cursor) statement.

Before you begin

To perform this task you require:

- Privileges to execute the CREATE TYPE (cursor) statement.
- If creating a strongly typed cursor data type, you must either prepare a row specification or base it on an existing row from a table, view, or cursor.

The CREATE TYPE (cursor) statement defines a cursor data type that can be used in SQL PL to declare parameters and local variables of the cursor data type. A strongly typed cursor data type is created if the row-type-name clause is specified in the CREATE TYPE (cursor) statement. A weakly defined cursor data type is created when the row-type-name clause is omitted.

As an alternative to creating a weakly defined cursor data type, the built-in weakly defined cursor data type CURSOR can be used when declaring cursor variables.

```
CREATE TYPE weakCursorType AS CURSOR@
```

If you want to create a strongly-typed cursor data type, a row data type definition must exist that will define the result set that can be associated with the cursor. A row data type definition can be derived from an explicitly defined row data type, a table or view, or strongly typed cursor. The following is an example of a row type definition:

```
CREATE TYPE empRow AS ROW (name varchar(128), ID varchar(8))@
```

The following is an example of a table definition from which a row type definition can be derived:

```
CREATE TABLE empTable AS ROW (name varchar(128), ID varchar(8))@
```

About this task

To define a strongly-typed cursor data type within a database you must successfully execute the CREATE TYPE (CURSOR) statement from any DB2 interface that supports the execution of SQL statements.

Procedure

1. Formulate a CREATE TYPE (CURSOR) statement:
 - a. Specify a name for the type.
 - b. Specify a row definition by doing one of: referencing the name of a row data type, specifying that the type should be anchored to a table or view, or anchored to the result set definition associated with an existing strong cursor type.
2. Execute the CREATE TYPE statement from a supported DB2 interface.

Results

If the CREATE TYPE statement executes successfully, the cursor data type is created in the database.

Example

The following is an example of how to create a weakly typed cursor data type that can be associated with result sets with the same format as the empRow row data type:

```
CREATE TYPE cursorType AS empRow CURSOR@
```

The following is an example of how to create a cursor data type that can be associated with result sets with the same format as the table empTable :

```
CREATE TYPE cursorType AS ANCHOR ROW OF empTable@
```

What to do next

Once the cursor data type is created, cursor variables can be declared based on this data type.

Declaring local variables of type cursor

Local variables of type cursor can be declared once a cursor data type has been created.

Before you begin

A cursor data type definition must exist in the database. Cursor data types are created by successfully executing the CREATE TYPE (CURSOR) statement. The following is an example of a strongly-typed cursor type definition:

```
CREATE TYPE cursorType AS empRow CURSOR;
```

About this task

In this version, cursor variables can only be declared as local variables within SQL procedures. Both strongly-typed and weakly-typed cursor variables can be declared.

Procedure

1. Formulate a DECLARE statement:
 - a. Specify a name for the variable.
 - b. Specify the cursor data type that will define the variable. If the cursor variable is to be weakly-typed, a user-defined weakly typed cursor data type must be specified or the built-in weakly-typed cursor data type CURSOR. If the cursor variable is to be based on a strongly-typed cursor data type, you can initialize the variable immediately.

The following is an example of how to formulate a DECLARE statement that will define a cursor variable of type cursorType that is not initialized:

```
DECLARE Cv1 cursorType@
```

The following is an example of how to formulate a DECLARE statement that will define a cursor variable Cv2 with a type that is anchored to the type of the existing cursor variable named Cv1:

```
DECLARE Cv2 ANCHOR DATA TYPE TO Cv1@
```

The following is an example of how to formulate a DECLARE statement that will define a weakly-typed cursor variable:

```
DECLARE Cv1 CURSOR@
```

2. Execute the DECLARE statement within a supported context.

Results

If execution of the DECLARE statement is successful, the cursor variable is created.

What to do next

Once this cursor variable is created, the cursor variable can be assigned values, referenced, or passed as a parameter.

Assigning values to cursor variables

Result sets can be assigned to cursor variables at different times and in multiple ways using the SET statement.

About this task

Assigning a query result set to a cursor variable

A result set of a select query can be assigned to a cursor variable by using the SET statement and the CURSOR FOR keywords. The following is an example of how the result set associated with a query on a table named T is assigned to a cursor variable named c1 that has an identical row definition as the table.

If T is defined as:

```
CREATE TABLE T (C1 INT, C2 INT, C3 INT);
```

If C1 is a strongly-typed cursor variable that was defined as:

```
CREATE TYPE simpleRow AS ROW (c1 INT, c2 INT, c3 INT);  
CREATE TYPE simpleCur AS CURSOR RETURNS simpleRow;  
DECLARE c1 simpleCur;
```

The assignment can be done as follows:

```
SET c1 = CURSOR FOR SELECT * FROM T;
```

The strong type checking will be successful since c1 has a compatible definition to table T. If c1 was a weakly-typed cursor this assignment would also be successful, because no data type checking would be performed.

Assigning literal values to a cursor variable

A result set of a select query can be assigned to a cursor variable by using the SET statement and the CURSOR FOR keywords. The following is an example of how the result set associated with a query on a table named T is assigned to a cursor variable named c1 that has an identical row definition as the table.

Let T be a table defined as:

```
CREATE TABLE T (C1 INT, C2 INT, C3 INT);
```

Let simpleRow be a row type and simpleCur be a cursor type that are respectively created as:

```
CREATE TYPE simpleRow AS ROW (c1 INT, c2 INT, c3 INT);  
CREATE TYPE simpleCur AS CURSOR RETURNS simpleRow;
```

Let c1 be a strongly-typed cursor variable that is declared within a procedure as:

```
DECLARE c1 simpleCur;
```

The assignment of literal values to cursor c1 can be done as follows:

```
SET c1 = CURSOR FOR VALUES (1, 2, 3);
```

The strong type checking will be successful since the literal values are compatible with the cursor definition. The following is an example of an

assignment of literal values that will fail, because the literal data types are incompatible with the cursor type definition:

```
SET c1 = CURSOR FOR VALUES ('a', 'b', 'c');
```

Assigning cursor variable values to cursor variable values

A cursor variable value can be assigned to another cursor variable only if the cursor variables have identical result set definitions. For example:

If c1 and c2 are strongly-typed cursor variable that was defined as:

```
CREATE TYPE simpleRow AS ROW (c1 INT, c2 INT, c3 INT);
```

```
CREATE TYPE simpleCur AS CURSOR RETURNS simpleRow
```

```
DECLARE c1 simpleCur;
```

```
DECLARE c2 simpleCur;
```

If c2 has been assigned values as follows:

```
SET c2 = CURSOR FOR VALUES (1, 2, 3);
```

The assignment of the result set of c2 to cursor variable c1 can be done as follows:

```
SET c1 = c2;
```

Once cursor variables have been assigned values, the cursor variables and cursor variables field values can be assigned and referenced.

Referencing cursor variables

Cursor variables can be referenced in multiple ways as part of cursor operations related to retrieving and accessing a result set or when calling a procedure and passing cursor variables as parameters.

About this task

The following statements can be used to reference cursor variables within an SQL PL context:

- CALL
- SET
- OPEN
- FETCH
- CLOSE

The OPEN, FETCH, and CLOSE statements are most often used together when accessing the result set associated with a cursor variable. The OPEN statement is used to initialize the result set associated with the cursor variable. Upon successful execution of this statement, the cursor variable is associated with the result set and the rows in the result set can be accessed. The FETCH statement is used to specifically retrieve the column values in the current row being accessed by the cursor variable. The CLOSE statement is used to end the processing of the cursor variable.

The following is an example of a created row data type definition and an SQL procedure definition that contains a cursor variable definition. Use of the OPEN, FETCH, and CLOSE statements with the cursor variable are demonstrated within the SQL procedure:

```

CREATE TYPE simpleRow AS ROW (c1 INT, c2 INT, c3 INT);

CREATE PROCEDURE P(OUT p1 INT, OUT p2 INT, PUT p3 INT, OUT pRow simpleRow)
LANGUAGE SQL
BEGIN

    CREATE TYPE simpleCur AS CURSOR RETURNS simpleRow
    DECLARE c1 simpleCur;
    DECLARE localVar1 INTEGER;
    DECLARE localVar2 INTEGER;
    DECLARE localVar3 INTEGER;
    DECLARE localRow simpleRow;

    SET c1 = CURSOR FOR SELECT * FROM T;

    OPEN C1;

    FETCH c1 INTO localVar1, localVar2, localVar3;

    FETCH c1 into localRow;

    SET p1 = localVar1;

    SET p2 = localVar2;

    SET p3 = localVar3;

    SET pRow = localRow;

    CLOSE c1;

END;

```

Cursor variables can also be referenced as parameters in the CALL statement. As with other parameters, cursor variable parameters are simply referenced by name. The following is an example of a CALL statement within an SQL procedure that references a cursor variable named curVar which is an output parameter:

```
CALL P2(curVar);
```

Determining the number of fetched rows for a cursor

Determining the number of rows associated with a cursor can be efficiently done by using the cursor_rowCount scalar function which takes a cursor variable as a parameter and returns an integer value as an output corresponding to the number of rows that have been fetched since the cursor was opened.

Before you begin

The following prerequisites must be met before you use the cursor_rowCount function:

- A cursor data type must be created.
- A cursor variable of the cursor data type must be declared.
- An OPEN statement referencing the cursor must have been executed.

About this task

You can use the cursor_rowCount function within SQL PL contexts and would perform this task whenever in your procedural logic it is necessary to access the count of the number of rows that have been fetched for a cursor so far or the total count of rows fetched. The use of the cursor_rowCount function simplifies

accessing the fetched row count which otherwise might require that within looping procedural logic you maintain the count with a declared variable and a repeatedly executed SET statement.

Restrictions

The cursor_rowCount function can only be used in SQL PL contexts.

Procedure

1. Formulate an SQL statement with a reference to the cursor_rowCount scalar function. The following is an example of a SET statement that assigns the output of the cursor_rowCount scalar function to a local variable named rows_fetched:

```
SET rows_fetched = CURSOR_ROWCOUNT(curEmp)
```
2. Include the SQL statement containing the cursor_rowCount function reference within a supported SQL PL context. This might be, for example, within a CREATE PROCEDURE statement or a CREATE FUNCTION statement and compile the statement.
- 3.

Results

The statement should compile successfully.

Example

The following is an example of an SQL procedure that includes a reference to the cursor_rowCount function:

```
connect to sample %  
  
set serveroutput on %  
  
create or replace procedure rowcount_test()  
language sql  
begin  
  declare rows_fetched bigint;  
  declare Designers cursor;  
  declare first anchor to employee.firstnme;  
  declare last anchor to employee.lastname;  
  
  set Designers = cursor for select firstnme, lastname  
    from employee where job = 'DESIGNER' order by empno asc;  
  
  open Designers;  
  
  fetch Designers into first, last;  
  call dbms_output.put_line(last || ', ' || first);  
  fetch Designers into first, last;  
  call dbms_output.put_line(last || ', ' || first);  
  
  set rows_fetched = CURSOR_ROWCOUNT(Designers);  
  call dbms_output.put_line(rows_fetched || ' rows fetched.');
```

```
  close Designers;  
end %  
  
call rowcount_test() %  
  
connect reset %  
terminate %
```

What to do next

Execute the SQL procedure or invoke the SQL function.

Example: Cursor variable use

Referencing examples of cursor variable use can be useful when designing and implementing cursor variables.

Cursor variable use within an SQL procedure

Referencing examples that demonstrate cursor variable use is a good way to learn how and where you can use cursor variables.

This example shows the following:

- CREATE TYPE statement to create a ROW data type
- CREATE TYPE statement to create a strongly-typed cursor based on a row data type specification
- CREATE PROCEDURE statement to create a procedure that has an output cursor parameter
- CREATE PROCEDURE statement to create a procedure that calls another procedure and passes a cursor as an input parameter

A prerequisite to running this example is that the SAMPLE database must exist. To create the sample database, issue the following command from a DB2 Command Window:

```
db2samp1;
```

The following is an example CLP script that demonstrates the core features of cursor variable use within SQL procedures. The script contains a row data type definition, a cursor type definition and two SQL procedure definitions. The procedure P_CALLER contains a cursor variable definition and a call to a procedure named P. The procedure P defines a cursor, opens the cursor and passes the cursor as an output parameter value. The procedure P_CALLER receives the cursor parameter, fetches the cursor value into a local variable, and then sets two output parameter values named edlevel and lastname based on the local variable value.

```
--#SET TERMINATOR @
update command options using c off @
connect to sample @

CREATE TYPE myRowType AS ROW (edlevel SMALLINT, name VARCHAR(128))@

CREATE TYPE myCursorType AS myRowType CURSOR@

CREATE PROCEDURE P(IN pempNo VARCHAR(8), OUT pcv1 SYSCURSOR)
LANGUAGE SQL
BEGIN
    SET pcv1 = CURSOR FOR SELECT edlevel, lastname FROM employee WHERE empNo = pempNo;
    OPEN pcv1;

END@

CREATE PROCEDURE P_CALLER( IN pempNo VARCHAR(8) ,
                           OUT edlevel SMALLINT,
                           OUT lastname VARCHAR(128))

LANGUAGE SQL
BEGIN
    DECLARE rv1 myRowType;
    DECLARE c1 SYSCURSOR;
```

```

CALL P (pempNo,c1);
FETCH c1 INTO rv1;
CLOSE c1;

SET edlevel = rv1.edlevel;
SET lastname = rv1.name;

END @

CALL P_CALLER('000180',?,?) @

```

When this script is run, the following output is generated:

```

update command options using c off
DB20000I The UPDATE COMMAND OPTIONS command completed successfully.

```

connect to sample

Database Connection Information

```

Database server      = DB2/LINUX8664 9.7.0
SQL authorization ID = REGRESS5
Local database alias = SAMPLE

```

```

CREATE TYPE myRowType AS ROW (edlevel SMALLINT, name VARCHAR(128))
DB20000I The SQL command completed successfully.

```

```

CREATE TYPE myCursorType AS CURSOR RETURNS myRowType
DB20000I The SQL command completed successfully.

```

```

CREATE PROCEDURE P(IN pempNo VARCHAR(8),OUT pcv1 SYSCURSOR)
LANGUAGE SQL
BEGIN
  SET pcv1 = CURSOR FOR SELECT edlevel, lastname FROM employee WHERE empNo = pempNo;
  OPEN pcv1;

```

```

END
DB20000I The SQL command completed successfully.

```

```

CREATE PROCEDURE P_CALLER( IN pempNo VARCHAR(8) ,
                           OUT edlevel SMALLINT,
                           OUT lastname VARCHAR(128))

```

```

LANGUAGE SQL
BEGIN
  DECLARE rv1 myRowType;
  DECLARE c1 SYSCURSOR;

  CALL P (pempNo,c1);
  FETCH c1 INTO rv1;
  CLOSE c1;

  SET EDLEVEL = rv1.edlevel;
  SET LASTNAME = rv1.name;

```

```

END
DB20000I The SQL command completed successfully.

```

```

CALL P_CALLER('000180',?,?)

```

```

Value of output parameters
-----
Parameter Name : EDLEVEL
Parameter Value : 17

```

Parameter Name : LASTNAME
Parameter Value : SCOUTTEN

Return Status = 0

Boolean data type

The BOOLEAN type is a built-in data type that can only be used for local variables, global variables, parameters, or return types in compound SQL (compiled) statements. A Boolean value represents a truth value of TRUE or FALSE. A Boolean expression or predicate can result in a value of unknown, which is represented as the null value.

Restrictions on the Boolean data type

It is important to note the restrictions on the Boolean data type before you use it or when troubleshooting problems with their use.

The following restrictions apply to the boolean data type:

- The Boolean data type can only be referenced as:
 - Local variables declared in SQL functions
 - Local variables declared in SQL procedures
 - Local variables declared in triggers with a compound SQL (compiled) statement as trigger body
 - Parameter to SQL functions with a compound SQL (compiled) statement as function body
 - Parameter to SQL procedure with a compound SQL (compiled) statement as procedure body
 - Return type
 - Global variable in a module
- The Boolean data type cannot be used to define the data type of a column in a table or view.
- The keywords TRUE and FALSE cannot be referenced as values to be inserted into a table.
- The Boolean data type cannot be referenced in external routines or client applications.
- The Boolean data type cannot be cast to other data types.
- The Boolean data type cannot be returned as a return code value from an SQL procedure.
- Variables of the Boolean data type can only be assigned one of the following values: TRUE, FALSE, or NULL. Numeric or other data type assignments are not supported.
- Selecting or fetching values into variables of the Boolean data type is not supported.
- The Boolean data type cannot be returned in a result set.
- A Boolean variable cannot be used as a predicate. For example, the following SQL clause is not supported:
IF (gb) THEN ...

Use of predicates is only supported in the SET statement and RETURN statement from a UDF.

If these restrictions prevent you from using this data type consider using an integer data type instead and assign it values such as 1 for TRUE, 0 for FALSE, and -1 for NULL.

Chapter 6. SQL routines

SQL routines are routines that have logic implemented with only SQL statements, including SQL Procedural Language (SQL PL) statements.

They are characterized by having their routine-body logic contained within the CREATE statement that is used to create them. This is in contrast with external routines that have their routine logic implemented in a library built form programming source code. In general SQL routines can contain and execute fewer SQL statements than external routines; however they can be every bit as powerful and high performing when implemented according to best practices.

You can create SQL procedures, SQL functions, and SQL methods. Although they are all implemented in SQL, each routine functional type has different features.

Overview of SQL routines

SQL routines are routines that have logic implemented with only SQL statements, including SQL Procedural Language (SQL PL) statements.

SQL routines are characterized by having their routine-body logic contained within the CREATE statement that is used to create them. You can create SQL procedures, SQL functions, and SQL methods. Although they are all implemented in SQL, each routine functional type has different features.

Before deciding to implement a SQL routine, it is important that you first understand what SQL routines are, how they are implemented, and used by reading an "Overview of routines". With that knowledge you can then learn more about SQL routine from the following concept topics so that you can make informed decisions about when and how to use them in your database environment:

- SQL procedures
- SQL functions
- Tools for developing SQL routines
- SQL Procedural Language (SQL PL)
- Comparison of SQL PL and inline SQL PL
- SQL PL statements and features
- Supported inline SQL PL statements and features
- Determining when to use SQL procedures or SQL functions
- Restrictions on SQL routines

After having learned about SQL routines, you might want to do one of the following tasks:

- Develop SQL procedures
- Develop SQL functions
- Develop SQL methods

CREATE statements for SQL routines

SQL routines are created by executing the appropriate CREATE statement for the routine type. In the CREATE statement you also specify the routine body, which for an SQL routine must be composed only of SQL or SQL PL statements.

You can use the IBM® DB2 Development Center to help you create, debug, and run SQL procedures. SQL procedures, functions, and methods can also be created using the DB2 command line processor.

SQL procedures, functions, and methods each have a respective CREATE statement. Although the syntax for these statements is different, there are some common elements to them. In each you must specify the routine name, and parameters if there are to be any as well as a return type. You can also specify additional keywords that provide DB2 with information about the logic contained in the routine. DB2 uses the routine prototype and the additional keywords to identify the routine at invocation time, and to execute the routine with the required feature support and best performance possible.

For specific information on creating SQL procedures in the DB2 Development Center or from the Command Line Processor, or on creating functions and methods, refer to the related topics.

Determining when to use SQL routines or external routines

When implementing routine logic you can choose to implement SQL routines or external routines. There are reasons for choosing each of these two implementations.

About this task

To determine when to choose to implement an SQL routine or an external routine, read the following to determine what if any factors might limit your choice.

Procedure

- Choose to implement SQL routines if:
 - SQL PL and SQL statements provide adequate support to implement the logic that you require.
 - The routine logic consists primarily of SQL statements that query or modify data and performance is a concern. Logic that contains a relatively small amount of control-flow logic relative to the number of SQL statements that query or modify database data will generally perform better with an SQL routine implementation. SQL PL is intended to be used for implementing procedural logic around database operations and not primarily for programming complex logic.
 - The SQL statements that you need to execute can be executed in an external routine implementation.
 - You want to make the modules highly portable between operating system environments and minimize the dependency on programming language code compilers and script interpreters.
 - You want to implement the logic quickly and easily using a high level programming language.
 - You are more comfortable working with SQL than with scripting or programming languages.
 - You want to secure the logic within the database management system.

- You want to minimize routine maintenance and routine package maintenance upon release upgrades or operating system upgrades.
- You want to minimize the amount of code required to implement the logic.
- You want to maximize the safety of the code that is implemented by minimizing the risk of memory management, pointer manipulation, or other common programming pitfalls.
- You want to benefit from special SQL caching support made available when SQL PL is used.
- Choose to implement an external procedure if:
 - If the routine logic is very complex and consists of few SQL statements and routine performance is a concern. Logic such as a complex math algorithm, that involves a large amount of string manipulation, or that does not access the database will generally perform better with an external routine implementation.
 - If the SQL statements that you need to execute can be executed in an external routine implementation.
 - The routine logic will make operating system calls - this can only be done with external routines.
 - The routine logic must read from or write to files - this can only be done with external routines.
 - Write to the server file system. Do this only with caution.
 - Invoke an application or script that resides on the database server.
 - Issue particular SQL statements that are not supported in SQL procedures.
 - You are more comfortable programming in a programming language other than SQL PL.

Results

By default if SQL routines can meet your needs, use them. Generally it is a requirement to implement complex logic or to access files or scripts on the database server that motivates the decision to use external routines. Particularly since SQL PL is fast and easy to learn and implement.

Determining when to use SQL procedures or SQL functions

When faced with the choice of implementing logic with SQL PL in an SQL procedure or an SQL function, there are reasons for choosing each of these two implementations.

About this task

When faced with the choice of implementing logic with SQL PL in an SQL procedure or an SQL function, there are reasons for choosing each of these two implementations.

Procedure

Read the following to determine when to choose to use an SQL procedure or an SQL function.

Choose to implement an SQL function if:

- Functional requirements can be met by an SQL function and you don't anticipate later requiring the features provided by an SQL procedure.

- Performance is a priority and the logic to be contained in the routine consists only of queries or returns only a single result set.

When they only contain queries or the return of a single result set an SQL function performs better than a logically equivalent SQL procedure, because of how SQL functions are compiled.

In SQL procedures, static queries in the form of SELECT statements and full-select statements are compiled individually, such that each query becomes a section of a query access plan in a package when the SQL procedure is created. There is no recompilation of this package until the SQL procedure is recreated or the package is rebound to the database. This means that the performance of the queries is determined based on information available to the database manager at a time earlier than the SQL procedure execution time and hence might not be optimal. Also with an SQL procedure there is also a small overhead entailed when the database manager transfers between executing procedural flow statements and SQL statements that query or modify data.

SQL functions however are expanded and compiled within the SQL statement that references them which means that they are compiled each time that SQL statement is compiled which depending on the statement might happen dynamically. Because SQL functions are not directly associated with a package, there is no overhead entailed when the database manager transfers between executing procedural flow statements and SQL statements that query or modify data.

Choose to implement an SQL procedure if:

- SQL PL features that are only supported in SQL procedures are required. This includes: output parameter support, use of a cursor, the ability to return multiple result sets to the caller, full condition handling support, transaction and savepoint control, or other features.
- You want to execute non-SQL PL statements that can only be executed in SQL procedures.
- You want to modify data and modifying data is not supported for the type of function you need.

Results

Although it isn't always obvious, you can often easily re-write SQL procedures as SQL functions that perform equivalent logic. This can be an effective way to maximize performance when every little performance improvement counts.

Determining when to use SQL routines or dynamically prepared compound SQL statements

When determining how to implement an atomic block of SQL PL and other SQL statements you might be faced with a choice between using SQL routines or dynamically prepared compound SQL statements.

Although SQL routines internally make use of compound SQL statements, the choice of which to use might depend on other factors.

Performance

If a dynamically prepared compound SQL statement can functionally meet your needs, using one is preferable, because the SQL statements that appear in

dynamically prepared compound SQL statements are compiled and executed as a single block. Also these statements generally perform better than CALL statements to logically equivalent SQL procedures.

At SQL procedure creation time, the procedure is compiled and a package is created. The package contains the best execution path for accessing data as of the SQL procedure compile time. Dynamically prepared compound SQL statements are compiled when they are executed. The best execution path for accessing data for these statements is determined using the most up to date database information which can mean that their access plan can be better than that of a logically equivalent SQL procedure that was created at an earlier time which means that they might perform better.

Complexity of the required logic

If the logic is quite simple and the number of SQL statements is relatively small, consider using inline SQL PL in a dynamically prepared compound SQL statement (specifying ATOMIC) or in an SQL function. SQL procedures can also handle simple logic, but use of SQL procedures incurs some overhead, such as creating the procedure and calling it, that, if not required, is best avoided.

Number of SQL statements to be executed

In cases where only one or two SQL statements are to be executed, there might be no benefit in using an SQL procedure. This might actually negatively impact the total performance required to execute these statements. In such a case, it is better to use inline SQL PL in a dynamically prepared compound SQL statement.

Atomicity and transaction control

Atomicity is another consideration. A compound SQL (inlined) statement must be atomic. Commits and rollbacks are not supported in compound SQL (inlined) statements. If transaction control is required or if support for rollback to a savepoint is required, SQL procedures must be used.

Security

Security can also be a consideration. SQL procedures can only be executed by users with EXECUTE privilege on the procedure. This can be useful if you need to limit who can execute a particular piece of logic. The ability to execute a dynamically prepared compound SQL statement can also be managed. However SQL procedure execution authorization provides an extra layer of security control.

Feature support

If you need to return one or more result sets, you must use SQL procedures.

Modularity, longevity, and re-use

SQL procedures are database objects that are persistently stored in the database and can be consistently referenced by multiple applications or scripts. Dynamically prepared compound SQL statements are not stored in the database and therefore the logic they contain cannot be readily re-used.

If SQL procedures can meet your needs, use them. Generally it is a requirement to implement complex logic or to use the features supported by SQL procedures, but not available to dynamically prepared compound SQL statements that motivates the decision to use SQL procedures.

Rewriting SQL procedures as SQL user-defined functions

To maximize performance in a database management system, if possible, it can sometimes be beneficial to rewrite simple SQL procedures as SQL functions.

About this task

Procedures and functions share the fact that their routine-bodies are implemented with a compound block that can contain SQL PL. In both, the same SQL PL statements are included within compound blocks bounded by BEGIN and END keywords.

Procedure

There are some things to note when translating an SQL procedure into an SQL function:

- The primary and only reason to do this is to improve routine performance when the logic only queries data.
- In a scalar function you might have to declare variables to hold the return value to get around the fact that you cannot directly assign a value to any output parameter of the function. The output value of a user-defined scalar function is only specified in the RETURN statement for the function.
- If an SQL function is going to modify data, it must be explicitly created using the MODIFIES SQL clause so that it can contain SQL statements that modify data.

Example

In the example that follows an SQL procedure and an SQL scalar function that are logically equivalent are shown. These two routines functionally provide the same output value given the same input values, however they are implemented and invoked in slightly different ways.

```
CREATE PROCEDURE GetPrice (IN Vendor CHAR(20),
                          IN Pid INT,
                          OUT price DECIMAL(10,3))

LANGUAGE SQL
BEGIN

    IF Vendor = 'Vendor 1'
    THEN SET price = (SELECT ProdPrice FROM V1Table WHERE Id = Pid);
    ELSE IF Vendor = 'Vendor 2'
    THEN SET price = (SELECT Price FROM V2Table
                     WHERE Pid = GetPrice.Pid);

    END IF;
END
```

This procedure takes in two input parameter values and returns an output parameter value that is conditionally determined based on the input parameter values. It uses the IF statement. This SQL procedure is invoked by executing the CALL statement. For example from the CLP, you might execute the following:

```
CALL GetPrice( 'Vendor 1', 9456, ?)
```

The SQL procedure can be rewritten as a logically-equivalent SQL table-function as follows:

```
CREATE FUNCTION GetPrice (Vendor CHAR(20), Pid INT)
  RETURNS DECIMAL(10,3)
  LANGUAGE SQL MODIFIES SQL
  BEGIN
    DECLARE price DECIMAL(10,3);

    IF Vendor = 'Vendor 1'
      THEN SET price = (SELECT ProdPrice FROM V1Table WHERE Id = Pid);
    ELSE IF Vendor = 'Vendor 2'
      THEN SET price = (SELECT Price FROM V2Table
        WHERE Pid = GetPrice.Pid);
    END IF;

    RETURN price;
  END
```

This function takes in two input parameters and returns a single scalar value, conditionally based on the input parameter values. It requires the declaration and use of a local variable named `price` to hold the value to be returned until the function returns whereas the SQL procedure can use the output parameter as a variable. Functionally these two routines are performing the same logic.

Now, of course the execution interface for each of these routines is different. Instead of simply calling the SQL procedure with the `CALL` statement, the SQL function must be invoked within an SQL statement where an expression is allowed. In most cases this isn't a problem and might actually be beneficial if the intention is to immediately operate on the data returned by the routine. Here are two examples of how the SQL function can be invoked.

It can be invoked using the `VALUES` statement:

```
VALUES (GetPrice('Vendor 1', 9456))
```

It can also be invoked in a `SELECT` statement that for example might select values from a table and filter rows based on the result of the function:

```
SELECT VName FROM Vendors WHERE GetPrice(Vname, Pid) < 10
```

SQL procedures

SQL procedures are procedures implemented completely with SQL that can be used to encapsulate logic that can be invoked like a programming sub-routine.

There are many useful applications of SQL procedures within a database or database application architecture. SQL procedures can be used to create simple scripts for quickly querying transforming, and updating data or for generating basic reports, for improving application performance, for modularizing applications, and for improving overall database design, and database security.

There are many features of SQL procedures which make them powerful routine options.

Before deciding to implement a SQL procedure, it is important that you understand what SQL procedures are in the context of SQL routines, how they are implemented, and how they can be used, by first learning about routines and then by referring to the topic, "Overview of SQL procedures".

Features of SQL procedures

SQL procedures are characterized by many features. When implemented according to best practices, they can play an essential role in database architecture, database application design, and in database system performance.

SQL procedures are characterized by many features. SQL procedures:

- Can contain SQL Procedural Language statements and features which support the implementation of control-flow logic around traditional static and dynamic SQL statements.
- Are supported in the entire DB2 family brand of database products in which many if not all of the features supported in DB2 Version 9 are supported.
- Are easy to implement, because they use a simple high-level, strongly typed language.
- SQL procedures are more reliable than equivalent external procedures.
- Adhere to the SQL99 ANSI/ISO/IEC SQL standard.
- Support input, output, and input-output parameter passing modes.
- Support a simple, but powerful condition and error-handling model.
- Allow you to return multiple result sets to the caller or to a client application.
- Allow you to easily access the SQLSTATE and SQLCODE values as special variables.
- Reside in the database and are automatically backed up and restored.
- Can be invoked wherever the CALL statement is supported.
- Support nested procedure calls to other SQL procedures or procedures implemented in other languages.
- Support recursion.
- Support savepoints and the rolling back of executed SQL statements to provide extensive transaction control.
- Can be called from triggers.

SQL procedures provide extensive support not limited to the features listed previously. When implemented according to best practices, they can play an essential role in database architecture, database application design, and in database system performance.

Designing SQL procedures

Designing SQL procedures requires an understanding of your requirements, SQL procedure features, how to use the SQL features, and knowledge of any restrictions that might impede your design.

Parts of SQL procedures

To understand SQL procedures, it helps to understand the parts of an SQL procedure.

To understand SQL procedures, it helps to understand the parts of an SQL procedure. The following are just some of the parts of SQL procedures:

- Structure of SQL procedures
- Parameters in SQL procedures
- Variables in SQL procedures
- SQLCODE and SQLSTATE in SQL procedures
- Atomic blocks and scope of variables in SQL procedures

- Cursors in SQL procedures
- Logic elements in SQL PL
- Condition and error handlers in SQL procedures
- SQL statements that can be executed in SQL procedures

Structure of SQL procedures

SQL procedures consist of several logic parts and SQL procedure development requires you to implement these parts according to a structured format.

The format is quite straight-forward and easy to follow and is intended to simplify the design and semantics of routines.

The core of an SQL procedure is a compound statement. Compound statements are bounded by the keywords BEGIN and END. These statements can be ATOMIC or NOT ATOMIC. By default they are NOT ATOMIC.

Within a compound statement, multiple optional SQL PL objects can be declared and referenced with SQL statements. The following diagram illustrates the structured format of a compound statement within SQL procedures:

```

label: BEGIN
  Variable declarations
  Condition declarations
  Cursor declarations
  Condition handler declarations
  Assignment, flow of control, SQL statements and other compound statements
END label

```

The diagram shows that SQL procedures can consist of one or more optionally atomic compound statements (or blocks) and that these blocks can be nested or serially introduced within a single SQL procedure. Within each of these atomic blocks there is a prescribed order for the optional variable, condition, and handler declarations. These must precede the introduction of procedural logic implemented with SQL-control statements and other SQL statements and cursor declarations. Cursors can be declared anywhere with the set of SQL statements contained in the SQL procedure body.

To clarify control-flow, SQL procedure atomic blocks can be labeled as can many of the SQL control-statements contained within them. This makes it easier to be precise when referencing variables and transfer of control statement references.

Here is an example of an SQL procedure that demonstrates each of the elements listed previously:

```

CREATE PROCEDURE DEL_INV_FOR_PROD (IN prod INT, OUT err_buffer VARCHAR(128))
LANGUAGE SQL
DYNAMIC RESULT SETS 1
BEGIN

  DECLARE SQLSTATE CHAR(5) DEFAULT '00000';
  DECLARE SQLCODE integer DEFAULT 0;
  DECLARE NO_TABLE CONDITION FOR SQLSTATE '42704';
  DECLARE cur1 CURSOR WITH RETURN TO CALLER
    FOR SELECT * FROM Inv;

  A: BEGIN ATOMIC
    DECLARE EXIT HANDLER FOR NO_TABLE
    BEGIN
      SET ERR_BUFFER='Table Inv does not exist';
    END;

```

```

        SET err_buffer = '';

        IF (prod < 200)
            DELETE FROM Inv WHERE product = prod;
        ELSE IF (prod < 400)
            UPDATE Inv SET quantity = 0 WHERE product = prod;
        ELSE
            UPDATE Inv SET quantity = NULL WHERE product = prod;
        END IF;
    END A;

B: OPEN cur1;

END

```

NOT ATOMIC compound statements in SQL procedures

The previous example illustrated a NOT ATOMIC compound statement and is the default type used in SQL procedures. If an unhandled error condition occurs within the compound statement, any work that is completed before the error will not be rolled back, but will not be committed either. The group of statements can only be rolled back if the unit of work is explicitly rolled back using ROLLBACK or ROLLBACK TO SAVEPOINT statements. You can also use the COMMIT statement to commit successful statements if it makes sense to do so.

Here is an example of an SQL procedure with a NOT ATOMIC compound statement:

```

CREATE PROCEDURE not_atomic_proc ()
LANGUAGE SQL
SPECIFIC not_atomic_proc
nap: BEGIN NOT ATOMIC

INSERT INTO c1_sched (class_code, day)
VALUES ('R11:TAA', 1);

SIGNAL SQLSTATE '70000';

INSERT INTO c1_sched (class_code, day)
VALUES ('R22:TBB', 1);

END nap

```

When the SIGNAL statement is executed it explicitly raises an error that is not handled. The procedure returns immediately afterwards. After the procedure returns, although an error occurred, the first INSERT statement did successfully execute and inserted a row into the c1_sched table. The procedure neither committed, nor rolled back the row insert and this remains to be done for the complete unit of work in which the SQL procedure was called.

ATOMIC compound statements in SQL procedures

As the name suggests, ATOMIC compound statements, can be thought of as a singular whole. If any unhandled error conditions arise within it, all statements that have executed up to that point are considered to have failed as well and are therefore rolled back.

Atomic compound statements cannot be nested inside other ATOMIC compound statements.

You cannot use the SAVEPOINT statement, the COMMIT statement, or the ROLLBACK statement from within an ATOMIC compound statement. These are only supported in NOT ATOMIC compound statements within SQL procedures.

Here is an example of an SQL procedure with an ATOMIC compound statement:

```
CREATE PROCEDURE atomic_proc ()
LANGUAGE SQL
SPECIFIC atomic_proc

ap: BEGIN ATOMIC

    INSERT INTO c1_sched (class_code, day)
    VALUES ('R33:TCC', 1);

    SIGNAL SQLSTATE '70000';

    INSERT INTO c1_sched (class_code, day)
    VALUES ('R44:TDD', 1);

END ap
```

When the SIGNAL statement is executed it explicitly raises an error that is not handled. The procedure returns immediately afterwards. The first INSERT statement is rolled back despite successfully executing resulting in a table with no inserted rows for this procedure.

Labels and SQL procedure compound statements

Labels can optionally be used to name any executable statement in an SQL procedure, including compound statements and loops. By referencing labels in other statements you can force the flow of execution to jump out of a compound statement or loop or additionally to jump to the beginning of a compound statement or loop. Labels can be referenced by the GOTO, ITERATE, and LEAVE statements.

Optionally you can supply a corresponding label for the END of a compound statement. If an ending label is supplied, it must be same as the label used at its beginning.

Each label must be unique within the body of an SQL procedure.

Labels can also be used to avoid ambiguity if a variable with the same name has been declared in more than one compound statement in the stored procedure. A label can be used to qualify the name of an SQL variable.

Parameters in SQL procedures

SQL procedures support parameters for the passing of SQL values into and out of procedures.

Parameters can be useful in SQL procedures when implementing logic that is conditional on a particular input or set of input scalar values or when you need to return one or more output scalar values and you do not want to return a result set.

It is good to understand the features of and limitations of parameters in SQL procedures when designing or creating SQL procedures.

- DB2 supports the optional use of a large number of input, output, and input-output parameters in SQL procedures. The keywords IN, OUT, and INOUT in the routine signature portion of CREATE PROCEDURE statements

indicate the mode or intended use of the parameter. IN and OUT parameters are passed by value, and INOUT parameters are passed by reference.

- When multiple parameters are specified for a procedure they must each have a unique name.
- If a variable is to be declared within the procedure with the same name as a parameter, the variable must be declared within a labeled atomic block nested within the procedure. Otherwise DB2 will detect what would otherwise be an ambiguous name reference.
- Parameters to SQL procedures cannot be named either of SQLSTATE or SQLCODE regardless of the data type for the parameter.

Refer to the CREATE PROCEDURE (SQL) statement for complete details about parameter references in SQL procedures.

The following SQL procedure named myparams illustrates the use of IN, INOUT, and OUT parameter modes. Let us say that SQL procedure is defined in a CLP file named myfile.db2 and that we are using the command line.

```
CREATE PROCEDURE myparams (IN p1 INT, INOUT p2 INT, OUT p3 INT)
LANGUAGE SQL
BEGIN
    SET p2 = p1 + 1;
    SET p3 = 2 * p2;
END@
```

Parameter markers

A parameter marker, often denoted by a question mark (?) or a colon followed by a variable name (:var1), is a place holder in an SQL statement whose value is obtained during statement execution.

An application associates parameter markers to application variables. During the execution of the statement, the values of these variables replace each respective parameter marker. Data conversion might take place during the process.

Benefits of parameter markers

For SQL statements that need to be executed many times, it is often beneficial to prepare the SQL statement once, and reuse the query plan by using parameter markers to substitute the input values during runtime. In DB2® 9, a parameter marker is represented in one of two ways:

- The first style, with a "?" character, is used in dynamic SQL execution (dynamic Embedded SQL, CLI, Perl, etc).
- The second style represents the embedded SQL standard construction where the name of the variable is prefixed with a colon (:var1). This style is used in static SQL execution and is commonly referred to as a host variable.

Use of either style indicates where an application variable is to be substituted inside an SQL statement. Parameter markers are referenced by number, and are numbered sequentially from left to right, starting at one. Before the SQL statement is executed, the application must bind a variable storage area to each parameter marker specified in the SQL statement. In addition, the bound variables must be a valid storage area, and must contain input data values when the prepared statement is executed against the database.

The following example illustrates an SQL statement containing two parameter markers.

```
SELECT * FROM customers WHERE custid = ? AND lastname = ?
```

Supported types

DB2 supports untyped parameter markers, which can be used in selected locations of an SQL statement. Table 1 lists the restrictions on parameter marker usage.

Table 2. Restrictions on parameter marker usage

Untyped parameter marker location	Data type
Expression: Alone in a select list	Error
Expression: Both operands of an arithmetic operator	Error
Predicate: Left-hand side operand of an IN predicate	Error
Predicate: Both operands of a relational operator	Error
Function: Operand of an aggregation function	Error

Examples

DB2® provides a rich set of standard interfaces including CLI/ODBC, JDBC, and ADO.NET to access data efficiently. The following code snippets show the use of prepared statement with parameter markers for each data access API.

Consider the following table schema for table t1, where column c1 is the primary key for table t1.

Table 3. Example table schema

Column name	DB2 data type	Nullable
c1	INTEGER	false
c2	SMALLINT	true
c3	CHAR(20)	true
c4	VARCHAR(20)	true
c5	DECIMAL(8,2)	true
c6	DATE	true
c7	TIME	true
c8	TIMESTAMP	true
c9	BLOB(30)	true

The following examples illustrate how to insert a row into table t1 using a prepared statement.

CLI Example

```
void parameterExample1(void)
{
    SQLHENV henv;
    SQLHDBC hdbc;
    SQLHSTMT hstmt;
    SQLRETURN rc;
    TCHAR server[] = _T("C:\\mysample\\");
```

```

TCHAR uid[] = _T("db2e");
TCHAR pwd[] = _T("db2e");
long p1 = 10;
short p2 = 100;
TCHAR p3[100];
TCHAR p4[100];
TCHAR p5[100];
TCHAR p6[100];
TCHAR p7[100];
TCHAR p8[100];
char p9[100];
long len = 0;

_tcscpy(p3, _T("data1"));
_tcscpy(p4, _T("data2"));
_tcscpy(p5, _T("10.12"));
_tcscpy(p6, _T("2003-06-30"));
_tcscpy(p7, _T("12:12:12"));
_tcscpy(p8, _T("2003-06-30-17.54.27.710000"));

memset(p9, 0, sizeof(p9));
p9[0] = 'X';
p9[1] = 'Y';
p9[2] = 'Z';

rc = SQLA1locEnv(&henv);
// check return code ...

rc = SQLA1locConnect(henv, &hdbc);
// check return code ...

rc = SQLConnect(hdbc, (SQLTCHAR*)server, SQL_NTS,
(SQLTCHAR*)uid, SQL_NTS, (SQLTCHAR*)pwd, SQL_NTS);
// check return code ...

rc = SQLA1locStmt(hdbc, &hstmt);
// check return code ...

// prepare the statement
rc = SQLPrepare(hstmt, _T("INSERT INTO t1 VALUES (?, ?, ?, ?, ?, ?, ?, ?)"), SQL_NTS);
// check return code ...

// bind input parameters
rc = SQLBindParameter(hstmt, (unsigned short)1, SQL_PARAM_INPUT,
SQL_C_LONG, SQL_INTEGER, 4, 0, &p1, sizeof(p1), &len);
// check return code ...

rc = SQLBindParameter(hstmt, (unsigned short)2, SQL_PARAM_INPUT, SQL_C_LONG,
SQL_SMALLINT, 2, 0, &p2, sizeof(p2), &len);
// check return code ...

len = SQL_NTS;
rc = SQLBindParameter(hstmt, (unsigned short)3, SQL_PARAM_INPUT, SQL_C_TCHAR,
SQL_CHAR, 0, 0, &p3[0], 100, &len);
// check return code ...

rc = SQLBindParameter(hstmt, (unsigned short)4, SQL_PARAM_INPUT, SQL_C_TCHAR,
SQL_VARCHAR, 0, 0, &p4[0], 100, &len);
// check return code ...

rc = SQLBindParameter(hstmt, (unsigned short)5, SQL_PARAM_INPUT, SQL_C_TCHAR,
SQL_DECIMAL, 8, 2, &p5[0], 100, &len);
// check return code ...

rc = SQLBindParameter(hstmt, (unsigned short)6, SQL_PARAM_INPUT, SQL_C_TCHAR,
SQL_TYPE_DATE, 0, 0, &p6[0], 100, &len);
// check return code ...

```



```

rc = SQLBindParameter(hstmt, (unsigned short)7, SQL_PARAM_INPUT, SQL_C_TCHAR,
    SQL_TYPE_TIME, 0, 0, &p7[0], 100, &len);
// check return code ...

rc = SQLBindParameter(hstmt, (unsigned short)8, SQL_PARAM_INPUT, SQL_C_TCHAR,
    SQL_TYPE_TIMESTAMP, 0, 0, &p8[0], 100, &len);
// check return code ...

len = 3;
rc = SQLBindParameter(hstmt, (unsigned short)9, SQL_PARAM_INPUT, SQL_C_BINARY,
    SQL_BINARY, 0, 0, &p9[0], 100, &len);
// check return code ...

// execute the prepared statement
rc = SQLExecute(hstmt);
// check return code ...

rc = SQLFreeStmt(hstmt, SQL_DROP);
// check return code ...

rc = SQLDisconnect(hdbc);
// check return code ...

rc = SQLFreeConnect(hdbc);
// check return code ...

rc = SQLFreeEnv(henv);
// check return code ...

```

C Example

```

EXEC SQL BEGIN DECLARE SECTION;
    char hostVarStmt1[50];
    short hostVarDeptnumb;
EXEC SQL END DECLARE SECTION;

/* prepare the statement with a parameter marker */
strcpy(hostVarStmt1, "DELETE FROM org WHERE deptnumb = ?");
EXEC SQL PREPARE Stmt1 FROM :hostVarStmt1;

/* execute the statement for hostVarDeptnumb = 15 */
hostVarDeptnumb = 15;
EXEC SQL EXECUTE Stmt1 USING :hostVarDeptnumb;

```

JDBC Example

```

public static void parameterExample1() {

    String driver = "com.ibm.db2e.jdbc.DB2eDriver";
    String url    = "jdbc:db2e:mysample";
    Connection conn = null;
    PreparedStatement pstmt = null;

    try
    {
        Class.forName(driver);

        conn = DriverManager.getConnection(url);

        // prepare the statement
        pstmt = conn.prepareStatement("INSERT INTO t1 VALUES
                                     (?, ?, ?, ?, ?, ?, ?, ?, ?)");

        // bind the input parameters
        pstmt.setInt(1, 1);
        pstmt.setShort(2, (short)2);
        pstmt.setString(3, "data1");
    }
}

```

```

pstmt.setString(4, "data2");
pstmt.setBigDecimal(5, new java.math.BigDecimal("12.34"));
pstmt.setDate(6, new java.sql.Date(System.currentTimeMillis() ));
pstmt.setTime(7, new java.sql.Time(System.currentTimeMillis() ));
pstmt.setTimestamp(8, new java.sql.Timestamp(System.currentTimeMillis() ));
pstmt.setBytes(9, new byte[] { (byte)'X', (byte)'Y', (byte)'Z' });

// execute the statement
pstmt.execute();

pstmt.close();

conn.close();
}
catch (SQLException sqlEx)
{
    while(sqlEx != null)
    {
        System.out.println("SQLERROR: \n" + sqlEx.getErrorCode() +
            ", SQLState: " + sqlEx.getSQLState() +
            ", Message: " + sqlEx.getMessage() +
            ", Vendor: " + sqlEx.getErrorCode() );
        sqlEx = sqlEx.getNextException();
    }
}
catch (Exception ex)
{
    ex.printStackTrace();
}
}

```

ADO.NET Example [C#]

```

public static void ParameterExample1()
{
    DB2eConnection conn = null;
    DB2eCommand cmd = null;
    String connString = @"database=.\; uid=db2e; pwd=db2e";
    int i = 1;

    try
    {
        conn = new DB2eConnection(connString);

        conn.Open();

        cmd = new DB2eCommand("INSERT INTO t1 VALUES
            (?, ?, ?, ?, ?, ?, ?, ?, ?)", conn);

        // prepare the command
        cmd.Prepare();

        // bind the input parameters
        DB2eParameter p1 = new DB2eParameter("@p1", DB2eType.Integer);
        p1.Value = ++i;
        cmd.Parameters.Add(p1);

        DB2eParameter p2 = new DB2eParameter("@p2", DB2eType.SmallInt);
        p2.Value = 100;
        cmd.Parameters.Add(p2);

        DB2eParameter p3 = new DB2eParameter("@p3", DB2eType.Char);
        p3.Value = "data1";
        cmd.Parameters.Add(p3);

        DB2eParameter p4 = new DB2eParameter("@p4", DB2eType.VarChar);
        p4.Value = "data2";
    }
}

```

```

cmd.Parameters.Add(p4);

DB2eParameter p5 = new DB2eParameter("@p5", DB2eType.Decimal);
p5.Value = 20.25;
cmd.Parameters.Add(p5);

DB2eParameter p6 = new DB2eParameter("@p6", DB2eType.Date);
p6.Value = DateTime.Now;
cmd.Parameters.Add(p6);

DB2eParameter p7 = new DB2eParameter("@p7", DB2eType.Time);
p7.Value = new TimeSpan(23, 23, 23);
cmd.Parameters.Add(p7);

DB2eParameter p8 = new DB2eParameter("@p8", DB2eType.Timestamp);
p8.Value = DateTime.Now;
cmd.Parameters.Add(p8);

byte [] barr = new byte[3];
barr[0] = (byte)'X';
barr[1] = (byte)'Y';
barr[2] = (byte)'Z';

DB2eParameter p9 = new DB2eParameter("@p9", DB2eType.Blob);
p9.Value = barr;
cmd.Parameters.Add(p9);

// execute the prepared command
cmd.ExecuteNonQuery();
}
catch (DB2eException e1)
{
    for (int i=0; i < e1.Errors.Count; i++)
    {
        Console.WriteLine("Error #" + i + "\n" +
            "Message: " + e1.Errors[i].Message + "\n" +
            "Native: " + e1.Errors[i].NativeError.ToString() + "\n" +
            "SQL: " + e1.Errors[i].SQLState + "\n");
    }
}
catch (Exception e2)
{
    Console.WriteLine(e2.Message);
}
finally
{
    if (conn != null && conn.State != ConnectionState.Closed)
    {
        conn.Close();
        conn = null;
    }
}
}
}

```

Variables in SQL procedures (DECLARE, SET statements)

Local variable support in SQL procedures allows you to assign and retrieve SQL values in support of SQL procedure logic.

Variables in SQL procedures are defined by using the DECLARE statement.

Values can be assigned to variables using the SET statement or the SELECT INTO statement or as a default value when the variable is declared. Literals, expressions, the result of a query, and special register values can be assigned to variables.

Variable values can be assigned to SQL procedure parameters, other variables in the SQL procedure, and can be referenced as parameters within SQL statements that executed within the routine.

The following example demonstrates various methods for assigning and retrieving variable values.

```
CREATE PROCEDURE proc_vars()
  SPECIFIC proc_vars
  LANGUAGE SQL
  BEGIN

  DECLARE v_rcount INTEGER;

  DECLARE v_max DECIMAL (9,2);

  DECLARE v_adata, v_another DATE;

  DECLARE v_total INTEGER DEFAULT 0;           -- (1)

  DECLARE v_rowsChanged BOOLEAN DEFAULT FALSE; -- (2)

  SET v_total = v_total + 1;                   -- (3)

  SELECT MAX(salary)                           -- (4)
    INTO v_max FROM employee;

  VALUES CURRENT_DATE INTO v_date;           -- (5)

  SELECT CURRENT_DATE, CURRENT_DATE           -- (6)
    INTO v_adata, v_another
  FROM SYSIBM.SYSDUMMY1;

  DELETE FROM T;
  GET DIAGNOSTICS v_rcount = ROW_COUNT;       -- (7)

  IF v_rcount > 0 THEN                         -- (8)
    SET is_done = TRUE;
  END IF;
END
```

When declaring a variable, you can specify a default value using the DEFAULT clause as in line (1). Line (2) shows the declaration of a variable of the Boolean data type with a default value of FALSE. Line (3) shows that a SET statement can be used to assign a single variable value. Variables can also be set by executing a SELECT or FETCH statement in combination with the INTO clause as shown in line (4). Lines (5) and (6) show how the VALUES INTO statement can be used to evaluate a function or special register and assign the value to a variable or to multiple variables.

You can also assign the result of a GET DIAGNOSTICS statement to a variable. GET DIAGNOSTICS can be used to get a handle on the number of affected rows (updated for an UPDATE statement, DELETE for a DELETE statement) or to get the return status of a just executed SQL statement. Line (7) shows how the number of rows modified by the just previously executed DELETE statement can be assigned to a variable.

Line (8) demonstrates how a piece of logic can be used to determine the value to be assigned to a variable. In this case, if rows were changed as part of the earlier DELETE statement and the GET DIAGNOSTICS statement execution resulted in the variable v_rcount being assigned a value greater than zero, the variable is_done is assigned the value TRUE.

SQLCODE and SQLSTATE variables in SQL procedures

To perform error handling or to help you debug your SQL procedures, you might find it useful to test the value of the SQLCODE or SQLSTATE values, return these values as output parameters or as part of a diagnostic message string, or insert these values into a table to

provide basic tracing support.

To use the SQLCODE and SQLSTATE values within SQL procedures, you must declare the following SQL variables in the SQL procedure body:

```
DECLARE SQLCODE INTEGER DEFAULT 0;
DECLARE SQLSTATE CHAR(5) DEFAULT '00000';
```

DB2 implicitly sets these variables whenever a statement is executed. If a statement raises a condition for which a handler exists, the values of the SQLSTATE and SQLCODE variables are available at the beginning of the handler execution. However, the variables are reset as soon as the first statement in the handler is executed. Therefore, it is common practice to copy the values of SQLSTATE and SQLCODE into local variables in the first statement of the handler. In the following example, a CONTINUE handler for any condition is used to copy the SQLCODE variable into another variable named `retcode`. The variable `retcode` can then be used in the executable statements to control procedural logic, or pass the value back as an output parameter.

```
BEGIN
  DECLARE SQLCODE INTEGER DEFAULT 0;
  DECLARE retcode INTEGER DEFAULT 0;

  DECLARE CONTINUE HANDLER FOR SQLEXCEPTION, SQLWARNING, NOT FOUND
    SET retcode = SQLCODE;

  executable-statements
END
```

Note: When you access the SQLCODE or SQLSTATE variables in an SQL procedure, DB2 sets the value of SQLCODE to 0 and SQLSTATE to '00000' for the subsequent statement.

Compound statements and scope of variables in SQL procedures

SQL procedures can contain one or more compound statements. They can be introduced in serial or can be nested within another compound statement. Each compound statement introduces a new scope in which variables might or might not be available for use.

The use of labels to identify a compound statement is important as the label can be used to qualify and uniquely identify variables declared within the compound statement. This is particularly important when referencing of variables in different compound statements or in nested compound statements.

In the following example there are two declarations of the variable *a*. One instance of it is declared in the outer compound statement that is labelled by *lab1*, and the second instance is declared in the inner compound statement labelled by *lab2*. As it is written, DB2 will presume that the reference to *a* in the assignment-statement is the one which is in the local scope of the compound block, labelled by *lab2*. However, if the intended instance of the variable *a* is the one declared in the compound statement block labeled with *lab1*, then to correctly reference it in the

innermost compound block, the variable should be qualified with the label of that block. That is, it should be qualified as: *lab1.a*.

```
CREATE PROCEDURE P1 ()
LANGUAGE SQL
lab1: BEGIN
  DECLARE a INT DEFAULT 100;
  lab2: BEGIN
    DECLARE a INT DEFAULT NULL;

    SET a = a + lab1.a;

    UPDATE T1
    SET T1.b = 5
    WHERE T1.b = a; -- Variable a refers to lab2.a
                    unless qualified otherwise

  END lab2;
END lab1
```

The outermost compound statement in an SQL procedure can be declared to be atomic, by adding the keyword `ATOMIC` after the `BEGIN` keyword. If any error occurs in the execution of the statements that comprise the atomic compound statement, then the entire compound statement is rolled back.

Cursors in SQL procedures

In SQL procedures, a cursor make it possible to define a result set (a set of data rows) and perform complex logic on a row by row basis.

In SQL procedures, a cursor make it possible to define a result set (a set of data rows) and perform complex logic on a row by row basis. By using the same mechanics, an SQL procedure can also define a result set and return it directly to the caller of the SQL procedure or to a client application.

A cursor can be viewed as a pointer to one row in a set of rows. The cursor can only reference one row at a time, but can move to other rows of the result set as needed.

To use cursors in SQL procedures, you need to do the following:

1. Declare a cursor that defines a result set.
2. Open the cursor to establish the result set.
3. Fetch the data into local variables as needed from the cursor, one row at a time.
4. Close the cursor when done

To work with cursors you must use the following SQL statements:

- `DECLARE CURSOR`
- `OPEN`
- `FETCH`
- `CLOSE`

The following example demonstrates the basic use of a read-only cursor within an SQL procedure:

```
CREATE PROCEDURE sum_salaries(OUT sum INTEGER)
LANGUAGE SQL
BEGIN
  DECLARE p_sum INTEGER;
  DECLARE p_sal INTEGER;
  DECLARE c_CURSOR FOR SELECT SALARY FROM EMPLOYEE;
```

```

DECLARE SQLSTATE CHAR(5) DEFAULT '00000';

SET p_sum = 0;

OPEN c;

FETCH FROM c INTO p_sal;

WHILE(SQLSTATE = '00000') DO
    SET p_sum = p_sum + p_sal;
    FETCH FROM c INTO p_sal;
END WHILE;

CLOSE c;

SET sum = p_sum;

END%

```

SQL PL logic elements in the SQL-procedure body

SQL PL provides support for variables and flow of control statements that can be used to control the sequence of statement execution.

Sequential execution is the most basic path that program execution can take. With this method, the program starts execution at the first line of the code, followed by the next, and continues until the final statement in the code has been executed. This approach works fine for very simple tasks, but tends to lack usefulness because it can only handle one situation. Programs often need to be able to decide what to do in response to changing circumstances. By controlling a code's execution path, a specific piece of code can then be used to intelligently handle more than one situation.

SQL PL provides support for variables and flow of control statements that can be used to control the sequence of statement execution. Statements such as IF and CASE are used to conditionally execute blocks of SQL PL statements, while other statements, such as WHILE and REPEAT, are typically used to execute a set of statements repetitively until a task is complete.

Although there are many types of SQL PL statements, there are a few categories into which these can be sorted:

- Variable related statements
- Conditional statements
- Loop statements
- Transfer of control statements

Variable related statements in SQL procedures:

Variable related SQL statements are used to declare variables and to assign values to variables. These statements provide the necessary support required to make use of the other types of SQL PL statements and SQL statements that will make use of variable values.

Variable related SQL statements are used to declare variables and to assign values to variables. There are a few types of variable related statements:

- DECLARE <variable> statement in SQL procedures
- DECLARE <condition> statement in SQL procedures
- DECLARE <condition handler> statement in SQL procedures

- DECLARE CURSOR in SQL procedures
- SET (assignment-statement) in SQL procedures

These statements provide the necessary support required to make use of the other types of SQL PL statements and SQL statements that will make use of variable values.

Conditional statements in SQL procedures:

Conditional statements are used to define what logic is to be executed based on the status of some condition being satisfied.

Conditional statements are used to define what logic is to be executed based on the status of some condition being satisfied. There are two types of conditional statements supported in SQL procedures:

- CASE
- IF

These statements are similar; however the CASE statements extends the IF statement.

CASE statement in SQL procedures:

CASE statements can be used to conditionally enter into some logic based on the status of a condition being satisfied.

CASE statements can be used to conditionally enter into some logic based on the status of a condition being satisfied. There are two types of CASE statements:

- Simple case statement: used to enter into some logic based on a literal value
- Searched case statement: used to enter into some logic based on the value of an expression

The WHEN clause of the CASE statement defines the value that when satisfied determines the flow of control.

Here is an example of an SQL procedure with a CASE statement with a simple-case-statement-when-clause:

```
CREATE PROCEDURE UPDATE_DEPT (IN p_workdept)
LANGUAGE SQL
BEGIN

    DECLARE v_workdept CHAR(3);
    SET v_workdept = p_workdept;

    CASE v_workdept
        WHEN 'A00' THEN
            UPDATE department SET deptname = 'D1';
        WHEN 'B01' THEN
            UPDATE department SET deptname = 'D2';
        ELSE
            UPDATE department SET deptname = 'D3';
        END CASE

    END
```

Here is an example of CASE statement with a searched-case-statement-when-clause:

```

CREATE PROCEDURE UPDATE_DEPT (IN p_workdept)
LANGUAGE SQL
BEGIN

    DECLARE v_workdept CHAR(3);
    SET v_workdept = p_workdept;

    CASE
        WHEN v_workdept = 'A00' THEN
            UPDATE department SET deptname = 'D1';
        WHEN v_workdept = 'B01' THEN
            UPDATE department SET deptname = 'D2';
        ELSE
            UPDATE department SET deptname = 'D3';
    END CASE

END

```

The previous two examples are logically equivalent, however it is important to note that CASE statements with a searched-case-statement-when-clause can be very powerful. Any supported SQL expression can be used here. These expressions can contain references to variables, parameters, special registers, and more.

IF statement in SQL procedures:

IF statements can be used to conditionally enter into some logic based on the status of a condition being satisfied.

The IF statement is logically equivalent to a CASE statements with a searched-case-statement-when clause.

The IF statement supports the use of optional ELSE IF clauses and a default ELSE clause. An END IF clause is required to indicate the end of the statement.

Here is an example of procedure that contains an IF statement:

```

CREATE PROCEDURE UPDATE_SAL (IN empNum CHAR(6),
                             INOUT rating SMALLINT)
LANGUAGE SQL
BEGIN
    IF rating = 1 THEN
        UPDATE employee
        SET salary = salary * 1.10, bonus = 1000
        WHERE empno = empNum;
    ELSEIF rating = 2 THEN
        UPDATE employee
        SET salary = salary * 1.05, bonus = 500
        WHERE empno = empNum;
    ELSE
        UPDATE employee
        SET salary = salary * 1.03, bonus = 0
        WHERE empno = empNum;
    END IF;
END

```

Looping statements in SQL procedures:

Looping statements provide support for repeatedly executing some logic until a condition is met.

Looping statements provide support for repeatedly executing some logic until a condition is met. The following looping statements are supported in SQL PL:

- FOR
- LOOP
- REPEAT
- WHILE

The FOR statement is distinct from the others, because it is used to iterate over rows of a defined result set, whereas the others are using for iterating over a series of SQL statements until for each a condition is satisfied.

Labels can be defined for all loop-control-statements to identify them.

FOR statement in SQL procedures:

FOR statements are a special type of looping statement, because they are used to iterate over rows in a defined read-only result set.

When a FOR statement is executed a cursor is implicitly declared such that for each iteration of the FOR-loop the next row is the result set if fetched. Looping continues until there are no rows left in the result set.

The FOR statement simplifies the implementation of a cursor and makes it easy to retrieve a set of column values for a set of rows upon which logical operations can be performed.

Here is an example of an SQL procedure that contains only a simple FOR statement:

```
CREATE PROCEDURE P()
LANGUAGE SQL
BEGIN ATOMIC
  DECLARE fullname CHAR(40);

  FOR v AS cur1 CURSOR FOR
      SELECT firstme, midinit, lastname FROM employee
  DO
    SET fullname = v.lastname || ',' || v.firstme
      || ' ' || v.midinit;
    INSERT INTO tnames VALUES (fullname);
  END FOR;
END
```

Note: Logic such as is shown in this example would be better implemented using the CONCAT function. The simple example serves to demonstrate the syntax.

The for-loop-name specifies a label for the implicit compound statement generated to implemented the FOR statement. It follows the rules for the label of a compound statement. The for-loop-name can be used to qualify the column names in the result set as returned by the select-statement.

The cursor-name simply names the cursor that is used to select the rows from the result set. If it is not specified, the DB2 database manager will automatically generate a unique cursor name internally.

The column names of the select statement must be unique and a FROM clause specifying a table (or multiple tables if doing some kind of JOIN or UNION) is required. The tables and columns referenced must exist prior to the loop being executed. Global temporary tables and declared temporary tables can be referenced.

Positioned updates and deletes, and searched updates and deletes are supported in the FOR loop. To ensure correct results, the FOR loop cursor specification must include a FOR UPDATE clause.

The cursor that is created in support of the FOR statement cannot be referenced outside of the FOR loop.

LOOP statement in SQL procedures:

The LOOP statement is a special type of looping statement, because has no terminating condition clause.

It defines a series of statements that are executed repeatedly until another piece of logic, generally a transfer of control statement, forces the flow of control to jump to some point outside of the loop.

The LOOP statement is generally used in conjunction with one of the following statements: LEAVE, GOTO, ITERATE, or RETURN. These statements can force control to just after the loop, to a specified location in the SQL procedure, to the start of the loop to begin another iteration of the loop, or to exit the SQL procedure. To indicate where to pass flow to when using these statements, labels are used.

The LOOP statement is useful when you have complicated logic in a loop which you might need to exit in more than one way, however it should be used with care to avoid instances of infinite loops.

If the LOOP statement is used alone without a transfer of control statement, the series of statements included in the loop will be executed indefinitely or until a database condition occurs that raises a condition handler that forces a change in the control flow or a condition occurs that is not handled that forces the return of the SQL procedure.

Here is an example of an SQL procedure that contains a LOOP statement. It also uses the ITERATE and LEAVE statements.

```
CREATE PROCEDURE ITERATOR()
LANGUAGE SQL
BEGIN
  DECLARE v_deptno CHAR(3); DECLARE v_deptname VARCHAR(29);
  DECLARE at_end INTEGER DEFAULT 0;
  DECLARE not_found CONDITION FOR SQLSTATE '02000';

  DECLARE c1 CURSOR FOR SELECT deptno, deptname
                        FROM department ORDER BY deptno;
  DECLARE CONTINUE HANDLER FOR not_found SET at_end = 1;
  OPEN c1;

  ins_loop: LOOP

    FETCH c1 INTO v_deptno, v_deptname;

    IF at_end = 1 THEN
      LEAVE ins_loop;
    ELSEIF v_dept = 'D11' THEN
      ITERATE ins_loop;
    END IF;

    INSERT INTO department (deptno, deptname)
      VALUES ('NEW', v_deptname);
```

```

        END LOOP;

        CLOSE c1;
    END

```

WHILE statement in SQL procedures:

The WHILE statement defines a set of statements to be executed until a condition that is evaluated at the beginning of the WHILE loop is false.

The while-loop-condition (an expression) is evaluated before each iteration of the loop.

Here is an example of an SQL procedure with a simple WHILE loop:

```

CREATE PROCEDURE sum_mn (IN p_start INT
                        ,IN p_end INT
                        ,OUT p_sum INT)

SPECIFIC sum_mn
LANGUAGE SQL
smn: BEGIN

    DECLARE v_temp INTEGER DEFAULT 0;
    DECLARE v_current INTEGER;

    SET v_current = p_start;

    WHILE (v_current <= p_end) DO
        SET v_temp = v_temp + v_current;
        SET v_current = v_current + 1;
    END WHILE;
    p_sum = v_current;
END smn;

```

Note: Logic such as is shown in this example would be better implemented using a mathematical formula. The simple example serves to demonstrate the syntax.

REPEAT statement in SQL procedures:

The REPEAT statement defines a set of statements to be executed until a condition that is evaluated at the end of the REPEAT loop is true.

The repeat-loop-condition is evaluated at the completion of each iteration of the loop.

With a WHILE statement, the loop is not entered if the while-loop-condition is false at 1st pass. The REPEAT statement is useful alternative; however it is noteworthy that while-loop logic can be rewritten as a REPEAT statement.

Here is an SQL procedure that includes a REPEAT statement:

```

CREATE PROCEDURE sum_mn2 (IN p_start INT
                        ,IN p_end INT
                        ,OUT p_sum INT)

SPECIFIC sum_mn2
LANGUAGE SQL
smn2: BEGIN

    DECLARE v_temp INTEGER DEFAULT 0;
    DECLARE v_current INTEGER;

    SET v_current = p_start;

```

```

REPEAT
  SET v_temp = v_temp + v_current;
  SET v_current = v_current + 1;
UNTIL (v_current > p_end)
END REPEAT;
END

```

Transfer of control statements in SQL procedures:

Transfer of control statements are used to redirect the flow of control within an SQL procedure.

This unconditional branching can be used to cause the flow of control to jump from one point to another point, which can either precede or follow the transfer of control statement. The supported transfer of control statements in SQL procedures are:

- GOTO
- ITERATE
- LEAVE
- RETURN

Transfer of control statements can be used anywhere within an SQL procedure, however ITERATE and LEAVE are generally used in conjunction with a LOOP statement or other looping statements.

GOTO statement in SQL procedures:

The GOTO statement is a straightforward and basic flow of control statement that causes an unconditional change in the flow of control.

It is used to branch to a specific user-defined location using labels defined in the SQL procedure.

Use of the GOTO statement is generally considered to be poor programming practice and is not recommended. Extensive use of GOTO tends to lead to unreadable code especially when procedures grow long. Besides, GOTO is not necessary because there are better statements available to control the execution path. There are no specific situations that require the use of GOTO; instead it is more often used for convenience.

Here is an example of an SQL procedure that contains a GOTO statement:

```

CREATE PROCEDURE adjust_salary ( IN p_empno CHAR(6),
                                IN p_rating INTEGER,
                                OUT p_adjusted_salary DECIMAL (8,2) )
LANGUAGE SQL
BEGIN
  DECLARE new_salary DECIMAL (9,2);
  DECLARE service DATE; -- start date

  SELECT salary, hiredate INTO v_new_salary, v_service
  FROM employee
  WHERE empno = p_empno;

  IF service > (CURRENT DATE - 1 year) THEN
    GOTO exit;
  END IF;

  IF p_rating = 1 THEN
    SET new_salary = new_salary + (new_salary * .10);

```

```

END IF;

UPDATE employee SET salary = new_salary WHERE empno = p_empno;

exit:
SET p_adjusted_salary = v_new_salary;

END

```

This example demonstrates what of the good uses of the GOTO statement: skipping almost to the end of a procedure or loop so as not to execute some logic, but to ensure that some other logic does still get executed.

You should be aware of a few additional scope considerations when using the GOTO statement:

- If the GOTO statement is defined in a FOR statement, the label must be defined inside the same FOR statement, unless it is in a nested FOR statement or nested compound statement.
- If the GOTO statement is defined in a compound statement, the label must be defined inside the same compound statement, unless it is in a nested FOR statement or nested compound statement.
- If the GOTO statement is defined in a handler, the label must be defined in the same handler, following the other scope rules.
- If the GOTO statement is defined outside of a handler, the label must not be defined within a handler.
- If the label is not defined within a scope that the GOTO statement can reach, an error is returned (SQLSTATE 42736).

ITERATE statement in SQL procedures:

The ITERATE statement is used to cause the flow of control to return to the beginning of a labeled LOOP statement.

The ITERATE statement is used to cause the flow of control to return to the beginning of a labeled LOOP statement.

Here is an example of an SQL procedure that contains an ITERATE statement:

```

CREATE PROCEDURE ITERATOR()
LANGUAGE SQL
BEGIN
  DECLARE v_deptno CHAR(3); DECLARE v_deptname VARCHAR(29);
  DECLARE at_end INTEGER DEFAULT 0;
  DECLARE not_found CONDITION FOR SQLSTATE '02000';

  DECLARE c1 CURSOR FOR SELECT deptno, deptname
                        FROM department ORDER BY deptno;
  DECLARE CONTINUE HANDLER FOR not_found SET at_end = 1;
  OPEN c1;

  ins_loop: LOOP
    FETCH c1 INTO v_deptno, v_deptname;
    IF at_end = 1 THEN
      LEAVE ins_loop;
    ELSEIF v_dept = 'D11' THEN
      ITERATE ins_loop;
    END IF;

    INSERT INTO department (deptno, deptname)
    VALUES ('NEW', v_deptname);

```

```

END LOOP;

CLOSE c1;

END

```

In the example, the ITERATE statement is used to return the flow of control to the LOOP statement defined with label ins_loop when a column value in a fetched row matches a certain value. The position of the ITERATE statement ensures that no values are inserted into the department table.

LEAVE statement in SQL procedures:

The LEAVE statement is used to transfer the flow of control out of a loop or compound statement.

The LEAVE statement is used to transfer the flow of control out of a loop or compound statement.

Here is an example of an SQL procedure that contain a LEAVE statement:

```

CREATE PROCEDURE ITERATOR()
LANGUAGE SQL
BEGIN
  DECLARE v_deptno CHAR(3); DECLARE v_deptname VARCHAR(29);
  DECLARE at_end INTEGER DEFAULT 0;
  DECLARE not_found CONDITION FOR SQLSTATE '02000';

  DECLARE c1 CURSOR FOR SELECT deptno, deptname
                        FROM department ORDER BY deptno;
  DECLARE CONTINUE HANDLER FOR not_found SET at_end = 1;

  OPEN c1;

  ins_loop: LOOP

    FETCH c1 INTO v_deptno, v_deptname;

    IF at_end = 1 THEN
      LEAVE ins_loop;
    ELSEIF v_dept = 'D11' THEN
      ITERATE ins_loop;
    END IF;

    INSERT INTO department (deptno, deptname)
    VALUES ('NEW', v_deptname);

  END LOOP;

  CLOSE c1;
END

```

In the example, the LEAVE statement is used to exit the LOOP statement defined with label ins_loop. It is nested within an IF statement and therefore is conditionally executed when the IF-condition is true which becomes true when there are no more rows found in the cursor. The position of the LEAVE statement ensures that no further iterations of the loop are executed once a NOT FOUND error is raised.

RETURN statement in SQL procedures:

The RETURN statement is used to unconditionally and immediately terminate an SQL procedure by returning the flow of control to the caller of the stored procedure.

It is mandatory that when the RETURN statement is executed that it return an integer value. If the return value is not provided, the default is 0. The value is typically used to indicate success or failure of the procedure's execution. The value can be a literal, variable, or an expression that evaluates to an integer value.

You can use one or more RETURN statements in a stored procedure. The RETURN statement can be used anywhere after the declaration blocks within the SQL-procedure-body.

To return multiple output values, parameters can be used instead. Parameter values must be set prior to the RETURN statement being executed.

Here is an example of an SQL procedure that uses the RETURN statement:

```
CREATE PROCEDURE return_test (IN p_empno CHAR(6),
                             IN p_emplastname VARCHAR(15) )
LANGUAGE SQL
SPECIFIC return_test
BEGIN

    DECLARE v_lastname VARCHAR (15);

    SELECT lastname INTO v_lastname
    FROM employee
    WHERE empno = p_empno;

    IF v_lastname = p_emplastname THEN
        RETURN 1;
    ELSE
        RETURN -1;
    END IF;

END rt
```

In the example, if the parameter *p_emplastname* matches the value stored in table employee, the procedure returns 1. If it does not match, it returns -1.

Condition handlers in SQL procedures:

Condition handlers determine the behavior of your SQL procedure when a condition occurs. You can declare one or more condition handlers in your SQL procedure for general conditions, named conditions, or specific SQLSTATE values.

If a statement in your SQL procedure raises an SQLWARNING or NOT FOUND condition, and you have declared a handler for the respective condition, DB2 passes control to the corresponding handler. If you have not declared a handler for such a condition, DB2 passes control to the next statement in the SQL procedure body. If the SQLCODE and SQLSTATE variables have been declared, they will contain the corresponding values for the condition.

If a statement in your SQL procedure raises an SQLEXCEPTION condition, and you declared a handler for the specific SQLSTATE or the SQLEXCEPTION condition, DB2 passes control to that handler. If the SQLSTATE and SQLCODE variables have been declared, their values after the successful execution of a handler will be '00000' and 0 respectively.

If a statement in your SQL procedure raises an `SQLSTATE` or the `SQLSTATE` condition, DB2 terminates the SQL procedure and returns to the caller.

The handler declaration syntax for condition handlers is described in Compound SQL (Procedure) statement.

Returning result sets from SQL procedures

In SQL procedures, cursors can be used to do more than iterate through rows of a result set. They can also be used to return result sets to the calling program.

Result sets can be retrieved by SQL procedures (in the case of a nested procedure calls) or client applications programmed in C using the CLI application programming interface, Java, CLI, or .NET CLR languages.

Before you begin

You must have the authority to create an SQL procedure.

Procedure

To return a result set from an SQL procedure:

1. Specify the `DYNAMIC RESULT SETS` clause in the `CREATE PROCEDURE` statement
2. `DECLARE` the cursor using the `WITH RETURN` clause
3. Open the cursor in the SQL procedure
4. Keep the cursor open for the client application - do not close it

Example

Here is an example of an SQL procedure that only returns a single result set:

```
CREATE PROCEDURE read_emp()  
SPECIFIC read_emp  
LANGUAGE SQL  
DYNAMIC RESULT SETS 1  
  
Re: BEGIN  
  
    DECLARE c_emp CURSOR WITH RETURN FOR  
        SELECT salary, bonus, comm.  
        FROM employee  
        WHERE job != 'PRES';  
  
    OPEN c_emp;  
  
END Re
```

If the cursor is closed using the `CLOSE` statement prior to the return of the SQL procedure, the cursor result set will not be returned to the caller or client application.

Multiple result sets can be returned from an SQL procedure by using multiple cursors. To return multiple cursors the following must be done:

- Specify the DYNAMIC RESULT SETS clause in the CREATE PROCEDURE statement. Specify the maximum possible number of result sets likely to be returned. The number of results sets actually returned must not exceed this number.
- Declare cursors for each of the result sets to be returned that specify the WITH RETURN clause.
- Open the cursors to be returned.
- Keep the cursor open for the client application - do not close them.

One cursor is required per result set that is to be returned.

Result sets are returned to the caller in the order in which they are opened.

Once you have created the SQL procedure that returns a result set you might want to call it and retrieve the result set.

Multiple result sets can also be returned by enabling multiple instances of a same cursor. You must DECLARE the cursor using the WITH RETURN TO CLIENT.

An example to enable multiple instances of an open cursor using the WITH RETURN TO CLIENT:

```
CREATE PROCEDURE PROC(IN a INT)
BEGIN
  DECLARE index INTEGER DEFAULT 1;
  WHILE index < a DO
    BEGIN
      DECLARE cur CURSOR WITH RETURN TO CLIENT FOR SELECT * FROM T WHERE pk = index;
      OPEN cur;
      SET index = index + 1;
    END;
  END WHILE;
END
@
```

Receiving procedure result sets in SQL routines

You can receive result sets from procedures you invoke from within an SQL-bodied routine.

Before you begin

You must know how many result sets the invoked procedure will return. For each result set that the invoking routine receives, a result set must be declared.

Procedure

To accept procedure result sets from within an SQL-bodied routine:

1. DECLARE result set locators for each result set that the procedure will return.

For example:

```
DECLARE result1 RESULT_SET_LOCATOR VARYING;
DECLARE result2 RESULT_SET_LOCATOR VARYING;
DECLARE result3 RESULT_SET_LOCATOR VARYING;
```

2. Invoke the procedure. For example:

```
CALL targetProcedure();
```

3. ASSOCIATE the result set locator variables (defined previously) with the invoked procedure. For example:

```
ASSOCIATE RESULT SET LOCATORS(result1, result2, result3)
WITH PROCEDURE targetProcedure;
```

4. ALLOCATE the result set cursors passed from the invoked procedure to the result set locators. For example:

```
ALLOCATE rsCur CURSOR FOR RESULT SET result1;
```

5. FETCH rows from the result sets. For example:

```
FETCH rsCur INTO ...
```

Creating SQL procedures

Creating SQL procedures is similar to creating any database object in that it consists of executing a DDL SQL statement.

SQL procedures are created by executing the CREATE PROCEDURE statement.

About this task

The CREATE PROCEDURE statement can be executed using graphical development environment tools or by directly executing the statement from the DB2 Command Line Processor (CLP), a DB2 Command Window, or another DB2 interface.

When creating SQL procedures, you can specify how the precompiler and binder should generate the procedure package, what authorization ID should be used to set the SQL procedure definer in the DB2 catalog views, and to set other package options.

Creating SQL procedures from the command line

Before you begin, the user must have the privileges required to execute the CREATE PROCEDURE statement for an SQL procedure.

Before you begin

- The user must have the privileges required to execute the CREATE PROCEDURE statement for an SQL procedure.
- Privileges to execute all of the SQL statements included within the SQL-procedure-body of the procedure.
- Any database objects referenced in the CREATE PROCEDURE statement for the SQL procedure must exist prior to the execution of the statement.

Procedure

- Select an alternate terminating character for the Command Line Processor (DB2 CLP) other than the default terminating character, which is a semicolon (;), to use in the script that you will prepare in the next step.

This is required so that the CLP can distinguish the end of SQL statements that appear within the body of a routine's CREATE statement from the end of the CREATE PROCEDURE statement itself. The semicolon character must be used to terminate SQL statements within the SQL routine body and the chosen alternate terminating character should be used to terminate the CREATE statement and any other SQL statements that you might contain within your CLP script.

For example, in the following CREATE PROCEDURE statement, the '@;' sign ('@') is used as the terminating character for a DB2 CLP script named myCLPscript.db2:

```
CREATE PROCEDURE UPDATE_SALARY_IF
(IN employee_number CHAR(6), IN rating SMALLINT)
LANGUAGE SQL
```

```

BEGIN
  DECLARE not_found CONDITION FOR SQLSTATE '02000';
  DECLARE EXIT HANDLER FOR not_found
    SIGNAL SQLSTATE '20000' SET MESSAGE_TEXT = 'Employee not found';

  IF (rating = 1)
    THEN UPDATE employee
      SET salary = salary * 1.10, bonus = 1000
      WHERE empno = employee_number;
  ELSEIF (rating = 2)
    THEN UPDATE employee
      SET salary = salary * 1.05, bonus = 500
      WHERE empno = employee_number;
  ELSE UPDATE employee
      SET salary = salary * 1.03, bonus = 0
      WHERE empno = employee_number;
  END IF;
END
@

```

- Run the DB2 CLP script containing the CREATE PROCEDURE statement for the procedure from the command line, using the following CLP command:

```
db2 -td terminating-character -vf CLP-script-name
```

where *terminating-character* is the terminating character used in the CLP script file *CLP-script-name* that is to be run.

The DB2 CLP option **-td** indicates that the CLP terminator default is to be reset with *terminating-character*. The **-vf** indicates that the CLP's optional verbose (**-v**) option is to be used, which will cause each SQL statement or command in the script to be displayed to the screen as it is run, along with any output that results from its execution. The **-f** option indicates that the target of the command is a file.

To run the specific script shown in the first step, issue the following command from the system command prompt:

```
db2 -td@ -vf myCLPscript.db2
```

Customizing precompile and bind options for compiled SQL objects

The precompile and bind options for SQL procedures, compiled functions, compiled triggers and compound SQL (compiled) statements can be customized via a DB2 registry variable or some SQL procedure routines.

About this task

To customize precompile and bind options for compiled SQL objects, set the instance-wide DB2 registry variable, **DB2_SQLROUTINE_PREPOPTS**. For example:

```
db2set DB2_SQLROUTINE_PREPOPTS=options
```

The options can be changed at the procedure level with the SET_ROUTINE_OPTS stored procedure. The values of the options set for the creation of SQL procedures in the current session can be obtained with the GET_ROUTINE_OPTS function.

The options used to compile a given routine are stored in the system catalog table ROUTINES.PRECOMPILE_OPTIONS, in the row corresponding to the routine. If the routine is revalidated, those stored options are also used during the revalidation.

After a routine is created, the compile options can be altered using the SYSPROC.ALTER_ROUTINE_PACKAGE and

SYSPROC.REBIND_ROUTINE_PACKAGE procedures. The altered options are reflected in the ROUTINES_PRECOMPILE_OPTIONS system catalog table.

Note: Cursor blocking is disabled in SQL procedures for cursors referenced in FETCH statements and for implicit cursors in FOR statements. Regardless of the value specified for the BLOCKING bind option, data will be retrieved one row at a time in an optimized, highly efficient manner.

Example

The SQL procedures used in this example will be defined in following CLP scripts. These scripts are not in the sqlp1 samples directory, but you can easily create these files by cutting-and-pasting the CREATE procedure statements into your own files.

The examples use a table named "expenses", which you can create in the sample database as follows:

```
db2 connect to sample
db2 CREATE TABLE expenses(amount DOUBLE, date DATE)
db2 connect reset
```

To begin, specify the use of ISO format for dates as an instance-wide setting:

```
db2set DB2_SQLROUTINE_PREOPTS="DATETIME ISO"
db2stop
db2start
```

Stopping and restarting the DB2 instance is necessary for the change to take affect.

Then connect to the database:

```
db2 connect to sample
```

The first procedure is defined in CLP script maxamount.db2 as follows:

```
CREATE PROCEDURE maxamount(OUT maxamnt DOUBLE)
BEGIN
  SELECT max(amount) INTO maxamnt FROM expenses;
END @
```

It will be created with options **DATETIME ISO** and **ISOLATION UR**:

```
db2 "CALL SET_ROUTINE_OPTS(GET_ROUTINE_OPTS() || ' ISOLATION UR')"
db2 -td@ -vf maxamount.db2
```

The next procedure is defined in CLP script fullamount.db2 as follows:

```
CREATE PROCEDURE fullamount(OUT fullamnt DOUBLE)
BEGIN
  SELECT sum(amount) INTO fullamnt FROM expenses;
END @
```

It will be created with option **ISOLATION CS** (note that it is not using the instance-wide **DATETIME ISO** setting in this case):

```
CALL SET_ROUTINE_OPTS(' ISOLATION CS')
db2 -td@ -vf fullamount.db2
```

The last procedure in the example is defined in CLP script perday.db2 as follows:

```
CREATE PROCEDURE perday()
BEGIN
  DECLARE cur1 CURSOR WITH RETURN FOR
  SELECT date, sum(amount)
  FROM expenses
```

```
GROUP BY date;

OPEN cur1;
END @
```

The last SET_ROUTINE_OPTS call uses the NULL value as the argument. This restores the global setting specified in the **DB2_SQLROUTINE_PREPOPTS** registry, so the last procedure will be created with option **DATETIME ISO**:

```
CALL SET_ROUTINE_OPTS(NULL)
db2 -td@ -vf perday.db2
```

Improving the performance of SQL procedures

When an SQL procedure is created, DB2 separates the SQL queries in the procedure body from the procedural logic. To maximize performance, the SQL queries are statically compiled into sections in a package. For a statically compiled query, a section consists mainly of the access plan

selected by the DB2 optimizer for that query

Overview of how DB2 compiles SQL PL and inline SQL PL

Before discussing how to improve the performance of SQL procedures we should discuss how DB2 compiles them upon the execution of the CREATE PROCEDURE statement.

When an SQL procedure is created, DB2 separates the SQL queries in the procedure body from the procedural logic. To maximize performance, the SQL queries are statically compiled into sections in a package. For a statically compiled query, a section consists mainly of the access plan selected by the DB2 optimizer for that query. A package is a collection of sections. For more information on packages and sections, please refer to the DB2 SQL Reference. The procedural logic is compiled into a dynamically linked library.

During the execution of a procedure, every time control flows from the procedural logic to an SQL statement, there is a "context switch" between the DLL and the DB2 engine. As of DB2 Version 8.1, SQL procedures run in "unfenced mode". That is they run in the same addressing space as the DB2 engine. Therefore the context switch we refer to here is not a full context switch at the operating system level, but rather a change of layer within DB2. Reducing the number of context switches in procedures that are invoked very often, such as procedures in an OLTP application, or that process large numbers of rows, such as procedures that perform data cleansing, can have a noticeable impact on their performance.

Whereas an SQL procedure containing SQL PL is implemented by statically compiling its individual SQL queries into sections in a package, an inline SQL PL function is implemented, as the name suggests, by inlining the body of the function into the query that uses it. Queries in SQL functions are compiled together, as if the function body were a single query. The compilation occurs every time a statement that uses the function is compiled. Unlike what happens in SQL procedures, procedural statements in SQL functions are not executed in a different layer than dataflow statements. Therefore, there is no context switch every time control flows from a procedural to a dataflow statement or vice versa.

If there are no side-effects in your logic use an SQL function instead

Because of the difference in compilation between SQL PL in procedures and inline SQL PL in functions, it is reasonable to presume that a piece of procedural code will execute faster in a function than in a procedure if it only queries SQL data and does no data modifications - that is it has no side-effects on the data in the database or external to the database.

That is only good news if all the statements that you need to execute are supported in SQL functions. SQL functions can not contain SQL statements that modify the database. As well, only a subset of SQL PL is available in the inline SQL PL of functions. For example, you cannot execute CALL statements, declare cursors, or return result sets in SQL functions.

Here is an example of an SQL procedure containing SQL PL that was a good candidate for conversion to an SQL function to maximize performance:

```
CREATE PROCEDURE GetPrice (IN Vendor CHAR(20),
                          IN Pid INT, OUT price DECIMAL(10,3))
LANGUAGE SQL
BEGIN
  IF Vendor eq; ssq;Vendor 1ssq;
    THEN SET price eq; (SELECT ProdPrice
                       FROM V1Table
                       WHERE Id = Pid);
  ELSE IF Vendor eq; ssq;Vendor 2ssq;
    THEN SET price eq; (SELECT Price FROM V2Table
                       WHERE Pid eq; GetPrice.Pid);
  END IF;
END
```

Here is the rewritten SQL function:

```
CREATE FUNCTION GetPrice (Vendor CHAR(20), Pid INT)
RETURNS DECIMAL(10,3)
LANGUAGE SQL
BEGIN
  DECLARE price DECIMAL(10,3);
  IF Vendor = 'Vendor 1'
    THEN SET price = (SELECT ProdPrice
                     FROM V1Table
                     WHERE Id = Pid);
  ELSE IF Vendor = 'Vendor 2'
    THEN SET price = (SELECT Price FROM V2Table
                     WHERE Pid = GetPrice.Pid);
  END IF;
  RETURN price;
END
```

Remember that the invocation of a function is different than a procedure. To invoke the function, use the VALUES statement or invoke the function where an expression is valid, such as in a SELECT or SET statement. Any of the following are valid ways of invoking the new function:

```
VALUES (GetPrice('IBM', 324))

SELECT VName FROM Vendors WHERE GetPrice(Vname, Pid) < 10

SET price = GetPrice(Vname, Pid)
```

Avoid multiple statements in an SQL PL procedure when just one is sufficient

Although it is generally a good idea to write concise SQL, it is very easy to forget to do this in practice. For example the following SQL statements:

```
INSERT INTO tab_comp VALUES (item1, price1, qty1);
INSERT INTO tab_comp VALUES (item2, price2, qty2);
INSERT INTO tab_comp VALUES (item3, price3, qty3);
```

can be rewritten as a single statement:

```
INSERT INTO tab_comp VALUES (item1, price1, qty1),
                             (item2, price2, qty2),
                             (item3, price3, qty3);
```

The multi-row insert will require roughly one third of the time required to execute the three original statements. Isolated, this improvement might seem negligible, but if the code fragment is executed repeatedly, for example in a loop or in a trigger body, the improvement can be significant.

Similarly, a sequence of SET statements like:

```
SET A = expr1;
SET B = expr2;
SET C = expr3;
```

can be written as a single VALUES statement:

```
VALUES expr1, expr2, expr3 INTO A, B, C;
```

This transformation preserves the semantics of the original sequence if there are no dependencies between any two statements. To illustrate this, consider:

```
SET A = monthly_avg * 12;
SET B = (A / 2) * correction_factor;
```

Converting the previous two statements to:

```
VALUES (monthly_avg * 12, (A / 2) * correction_factor) INTO A, B;
```

does not preserve the original semantics because the expressions before the INTO keyword are evaluated 'in parallel'. This means that the value assigned to *B* is not based on the value assigned to *A*, which was the intended semantics of the original statements.

Reduce multiple SQL statements to a single SQL expression

Like other programming languages, the SQL language provides two types of conditional constructs: procedural (IF and CASE statements) and functional (CASE expressions). In most circumstances where either type can be used to express a computation, using one or the other is a matter of taste. However, logic written using CASE expressions is not only more compact, but also more efficient than logic written using CASE or IF statements.

Consider the following fragment of SQL PL code:

```
IF (Price <= MaxPrice) THEN
  INSERT INTO tab_comp(Id, Val) VALUES(0id, Price);
ELSE
  INSERT INTO tab_comp(Id, Val) VALUES(0id, MaxPrice);
END IF;
```

The condition in the IF clause is only being used to decide what value is inserted in the `tab_comp.Val` column. To avoid the context switch between the procedural and the dataflow layers, the same logic can be expressed as a single INSERT with a CASE expression:

```
INSERT INTO tab_comp(Id, Val)
VALUES(0id,
CASE
WHEN (Price <= MaxPrice) THEN Price
ELSE MaxPrice
END);
```

It's worth noting that CASE expressions can be used in any context where a scalar value is expected. In particular, they can be used on the right-hand side of assignments. For example:

```
IF (Name IS NOT NULL) THEN
SET ProdName = Name;
ELSEIF (NameStr IS NOT NULL) THEN
SET ProdName = NameStr;
ELSE
SET ProdName = DefaultName;
END IF;
```

can be rewritten as:

```
SET ProdName = (CASE
WHEN (Name IS NOT NULL) THEN Name
WHEN (NameStr IS NOT NULL) THEN NameStr
ELSE DefaultName
END);
```

In fact, this particular example admits an even better solution:

```
SET ProdName = COALESCE(Name, NameStr, DefaultName);
```

Don't underestimate the benefit of taking the time to analyze and consider rewriting your SQL. The performance benefits will pay you back many times over for the time invested in analyzing and rewriting your procedure.

Exploit the set-at-a-time semantics of SQL

Procedural constructs such as loops, assignment and cursors allow us to express computations that would not be possible to express using just SQL DML statements. But when we have procedural statements at our disposal, there is a risk that we could turn to them even when the computation at hand can, in fact, be expressed using just SQL DML statements. As we've mentioned earlier, the performance of a procedural computation can be orders of magnitude slower than the performance of an equivalent computation expressed using DML statements. Consider the following fragment of code:

```
DECLARE cur1 CURSOR FOR SELECT col1, col2 FROM tab_comp;
OPEN cur1;
FETCH cur1 INTO v1, v2;
WHILE SQLCODE <> 100 DO
IF (v1 > 20) THEN
INSERT INTO tab_sel VALUES (20, v2);
ELSE
INSERT INTO tab_sel VALUES (v1, v2);
END IF;
FETCH cur1 INTO v1, v2;
END WHILE;
```

To begin with, the loop body can be improved by applying the transformation discussed in the last section - "Reduce multiple SQL statements to a single SQL expression":

```
DECLARE cur1 CURSOR FOR SELECT col1, col2 FROM tab_comp;
OPEN cur1;
FETCH cur1 INTO v1, v2;
WHILE SQLCODE <> 100 DO
    INSERT INTO tab_sel VALUES (CASE
                                WHEN v1 > 20 THEN 20
                                ELSE v1
                                END, v2);
    FETCH cur1 INTO v1, v2;
END WHILE;
```

But upon closer inspection, the whole block of code can be written as an INSERT with a sub-SELECT:

```
INSERT INTO tab_sel (SELECT (CASE
                            WHEN col1 > 20 THEN 20
                            ELSE col1
                            END),
                    col2
                    FROM tab_comp);
```

In the original formulation, there was a context switch between the procedural and the dataflow layers for each row in the SELECT statements. In the last formulation, there is no context switch at all, and the optimizer has a chance to globally optimize the full computation.

On the other hand, this dramatic simplification would not have been possible if each of the INSERT statements targeted a different table, as shown in the following example:

```
DECLARE cur1 CURSOR FOR SELECT col1, col2 FROM tab_comp;
OPEN cur1;
FETCH cur1 INTO v1, v2;
WHILE SQLCODE <> 100 DO
    IF (v1 > 20) THEN
        INSERT INTO tab_default VALUES (20, v2);
    ELSE
        INSERT INTO tab_sel VALUES (v1, v2);
    END IF;
    FETCH cur1 INTO v1, v2;
END WHILE;
```

However, the set-at-a-time nature of SQL can also be exploited here:

```
INSERT INTO tab_sel (SELECT col1, col2
                    FROM tab_comp
                    WHERE col1 <= 20);
INSERT INTO tab_default (SELECT col1, col2
                        FROM tab_comp
                        WHERE col1 > 20);
```

When looking at improving the performance of existing procedural logic, any time spent in eliminating cursor loops will likely pay off.

Keep the DB2 optimizer informed

When a procedure is created, its individual SQL queries are compiled into sections in a package. The DB2 optimizer chooses an execution plan for a query based, among other things, on table statistics (for example, table sizes or the relative frequency of data values in a column) and indexes available at the time the query

is compiled. When tables suffer significant changes, it may be a good idea to let DB2 collect statistics on these tables again. And when statistics are updated or new indexes are created, it may also be a good idea to rebind the packages associated with SQL procedures that use the tables, to let DB2 create plans that exploit the latest statistics and indexes.

Table statistics can be updated using the **RUNSTATS** command. To rebind the package associated with an SQL procedure, you can use the **REBIND_ROUTINE_PACKAGE** built-in procedure that is available in DB2 Version 8.1. For example, the following command can be used to rebind the package for procedure **MYSHEMA.MYPROC**:

```
CALL SYSPROC.REBIND_ROUTINE_PACKAGE('P', 'MYSHEMA.MYPROC', 'ANY')
```

where 'P' indicates that the package corresponds to a procedure and 'ANY' indicates that any of the functions and types in the SQL path are considered for function and type resolution. See the Command Reference entry for the **REBIND** command for more details.

Use arrays

You can use arrays to efficiently pass collections of data between applications and stored procedures and to store and manipulate transient collections of data within SQL procedures without having to use relational tables. Operators on arrays available within SQL procedures allow for the efficient storage and retrieval of data. Applications that create arrays of moderate size will experience significantly better performance than applications that create very large arrays (on the scale of multiple megabytes), as the entire array is stored in main memory. See *Related links* section for additional information.

SQL functions

SQL functions are functions implemented completely with SQL that can be used to encapsulate logic that can be invoked like a programming sub-routine. You can create SQL scalar functions and SQL table functions.

There are many useful applications for SQL functions within a database or database application architecture. SQL functions can be used to create operators on column data, for extending the support of built-in functions, for making application logic more modular, and for improving overall database design, and database security.

The following topics provide more information about SQL functions:

Features of SQL functions

SQL functions are characterized by many general features:

SQL functions:

- Can contain SQL Procedural Language statements and features which support the implementation of control-flow logic around traditional static and dynamic SQL statements.
- Are supported in the entire DB2 family brand of database products in which many if not all of the features supported in DB2 Version 9 are supported.
- Are easy to implement, because they use a simple high-level, strongly typed language.

- SQL functions are more reliable than equivalent external functions.
- Support input parameters.
- SQL scalar functions return a scalar value.
- SQL table functions return a table result set.
- Support a simple, but powerful condition and error-handling model.
- Allow you to easily access the SQLSTATE and SQLCODE values as special variables.
- Reside in the database and are automatically backed up and restored as part of backup and restore operations.
- Can be invoked wherever expressions in an SQL statement are supported.
- Support nested functions calls to other SQL functions or functions implemented in other languages.
- Support recursion (when dynamic SQL is used in compiled functions).
- Can be invoked from triggers.
- Many SQL statements can be included within SQL functions, however there are exceptions. For the complete list of SQL statements that can be included and executed in SQL functions, see: SQL statements that can be executed in routines

SQL functions provide extensive support not limited to what is listed previously. When implemented according to best practices, they can play an essential role in database architecture, database application design, and in database system performance.

Designing SQL functions

Designing SQL functions is a task that you perform before creating SQL functions in a database.

To design SQL functions it is important to be familiar with the features of SQL functions. The following topics provide more information about SQL function design concepts:

Inlined SQL functions and compiled SQL functions

There are two implementation types for SQL functions: inlined SQL functions and compiled SQL functions.

Inlined SQL functions typically produce the best performance. However, they do not support some SQL PL language features and data types that compiled SQL functions support. These features include:

- the CASE statement
- the REPEAT statement
- Cursor processing
- Dynamic SQL
- Condition handlers

SQL functions that are declared in SQL PL modules are always compiled.

PL/SQL functions are always compiled. While inlined functions can be referenced in PL/SQL code, they cannot be declared using PL/SQL. They must be declared using SQL PL.

For all other cases, the syntax of the CREATE FUNCTION statement determines whether an SQL function is inlined or compiled.

- An SQL PL function with an atomic body is an inlined function. An SQL function is atomic if it contains a single RETURN statement, or consists of a compound statement that begins with the keywords BEGIN ATOMIC.
- An SQL PL function that is non-atomic is a compiled function. An SQL PL function is non-atomic if it contains a compound statement that begins with the keywords BEGIN or BEGIN NOT ATOMIC.

Examples

- Inlined functions

```
create function F1 (N integer)
returns integer
deterministic
no external action
contains sql
return N * 10
@
```

```
create function F2 (N integer)
returns integer
deterministic
no external action
contains sql
begin atomic
  if N < 5 then
    return N * 10
  else
    return N * 20
  end if;
end
@
```

- Compiled functions

```
create function F3 (N integer)
returns integer
deterministic
no external action
contains sql
begin
  if N < 5 then
    return N * 10
  else
    return N * 20
  end if;
end
@
```

```
create function F4 (N integer)
returns integer
deterministic
no external action
contains sql
begin not atomic
  if N < 5 then
    return N * 10
  else
    return N * 20
  end if;
end
@
```

Restrictions on SQL functions

Be aware of the restrictions on SQL functions before creating them or when troubleshooting problems related to their implementation and use.

The following restrictions apply to SQL functions:

- SQL table functions cannot contain compiled compound statements.
- SQL scalar functions containing compiled compound statements cannot be invoked in partitioned database environments.
- By definition, SQL functions cannot contain cursors defined with the WITH RETURN clause.
- Compiled SQL scalar functions cannot be invoked in partitioned database environments.
- The following data types are not supported within compiled SQL functions: structured data types, LONG VARCHAR data type, and LONG VARGRAPHIC data type. The XML data type is not supported in Version 10.1. The support for XML data type starts in Version 10.1 Fix Pack 1.
- In this version, use of the DECLARE TYPE statement within compiled SQL functions is not supported.

Creating SQL scalar functions

Creating SQL scalar functions is a task that you would perform when designing a database or when developing applications. SQL scalar functions are generally created when there is an identifiable benefit in encapsulating a piece of reusable logic so that it can be referenced within SQL statements in multiple applications or within database objects.

Before you begin

Before you create an SQL function:

- Read: “SQL functions” on page 105
- Read: “Features of SQL functions” on page 105
- Ensure that you have the privileges required to execute the CREATE FUNCTION (scalar) statement.

About this task

Restrictions

See: “Restrictions on SQL functions” on page 107

Procedure

1. Define the CREATE FUNCTION (scalar) statement:
 - a. Specify a name for the function.
 - b. Specify a name and data type for each input parameter.
 - c. Specify the RETURNS keyword and the data type of the scalar return value.
 - d. Specify the BEGIN keyword to introduce the function-body. Note: Use of the BEGIN ATOMIC keyword is not recommended for new functions.
 - e. Specify the function body. Specify the RETURN clause and a scalar return value or variable.
 - f. Specify the END keyword.
2. Execute the CREATE FUNCTION (scalar) statement from a supported interface.

Results

The CREATE FUNCTION (scalar) statement should execute successfully and the scalar function should be created.

Example

Example 1

The following is an example of a compiled SQL function:

```
CREATE FUNCTION GetPrice (Vendor CHAR(20), Pid INT)
  RETURNS DECIMAL(10,3)
  LANGUAGE SQL
  MODIFIES SQL
  BEGIN
    DECLARE price DECIMAL(10,3);

    IF Vendor = 'Vendor 1'
      THEN SET price = (SELECT ProdPrice FROM V1Table WHERE Id = Pid);
    ELSE IF Vendor = 'Vendor 2'
      THEN SET price = (SELECT Price
                        FROM V2Table
                        WHERE Pid = GetPrice.Pid);
    END IF;

    RETURN price;
  END
```

This function takes in two input parameters and returns a single scalar value, conditionally based on the input parameter values. It requires the declaration and use of a local variable named price to hold the value to be returned until the function returns.

Example 2

The following example demonstrates a compiled SQL function definition containing a cursor, condition handler statement, and a REPEAT statement:

```
CREATE FUNCTION exit_func(a INTEGER)
  SPECIFIC exit_func
  LANGUAGE SQL
  RETURNS INTEGER
  BEGIN
    DECLARE val INTEGER DEFAULT 0;

    DECLARE myint INTEGER DEFAULT 0;

    DECLARE cur2 CURSOR FOR
      SELECT c2 FROM udfd1
      WHERE c1 <= a
      ORDER BY c1;

    DECLARE EXIT HANDLER FOR NOT FOUND
      BEGIN
        SIGNAL SQLSTATE '70001'
        SET MESSAGE_TEXT =
          'Exit handler for not found fired!';
      END;

    OPEN cur2;

    REPEAT
      FETCH cur2 INTO val;
      SET myint = myint + val;
    UNTIL (myint >= a)
    END REPEAT;

    CLOSE cur2;

    RETURN myint;
  ENDE@
```

What to do next

After creating the scalar function you might want to invoke the function to test it.

Creating SQL table functions

The task of creating SQL table functions can be done at any time.

Before you begin

Before you create an SQL table function, ensure that you have the privileges required to execute the CREATE FUNCTION (table) statement.

Restrictions

See: “Restrictions on SQL functions” on page 107

Procedure

1. Define the CREATE FUNCTION (table) statement:
 - a. Specify a name for the function.
 - b. Specify a name and data type for each input parameter.
 - c. Specify the routine attributes.
 - d. Specify the RETURNS TABLE keyword.
 - e. Specify the BEGIN ATOMIC keyword to introduce the function-body.
 - f. Specify the function body.
 - g. Specify the RETURN clause with brackets in which you specify a query that defines the result set to be returned.
 - h. Specify the END keyword.
2. Execute the CREATE FUNCTION (table) statement from a supported interface.

Results

The CREATE FUNCTION (table) statement should execute successfully and the table function should be created.

Example

Example 1

The following is an example of an SQL table function that is used to track and audit updates made to employee salary data:

```
CREATE FUNCTION update_salary (updEmpNum CHAR(4), amount INTEGER)
RETURNS TABLE (emp_lastname VARCHAR(10),
                emp_firstname VARCHAR(10),
                newSalary INTEGER)
LANGUAGE SQL
MODIFIES SQL DATA
NO EXTERNAL ACTION
NOT DETERMINISTIC
BEGIN ATOMIC

INSERT INTO audit_table(user, table, action, time)
VALUES (USER, 'EMPLOYEE',
        'Salary update. Values: ' || updEmpNum || ' ' || char(amount), CURRENT_TIMESTAMP);
```



```

RETURN (SELECT lastname, firstname, salary
        FROM FINAL TABLE(UPDATE employee SET salary = salary + amount WHERE employee.empnum = updEmpNum));
END

```

This function updates the salary of an employee specified by `updEmpNum`, by the amount specified by `amount`, and also records in an audit table named `audit_table`, the user that invoked the routine, the name of the table that was modified, and the type of modification made by the user. A `SELECT` statement that references a data change statement in the `FROM` clause is used to get back the updated row values.

Example 2

The following is an example of an SQL table function:

```

CREATE TABLE t1(pk INT)
CREATE TABLE t1_archive LIKE T1%
CREATE FUNCTION archive_tbl_t1(ppk INT)
  RETURNS TABLE(pk INT, c1 INT, date)
  LANGUAGE SQL
  MODIFIES SQL DATA
  BEGIN ATOMIC
  DECLARE c1 INT;
  DECLARE date DATE;
  SET (c1, date) = (SELECT * FROM OLD TABLE(DELETE FROM t1 WHERE t1.pk = ppk));
  INSERT INTO T1_ARCHIVE VALUES (ppk, c1, date);
  RETURN VALUES (pk, c1, date);
END%

```

What to do next

After creating the table function, you might want to invoke the function to test it.

Chapter 7. Compound statements

A compound statement groups other statements together into an executable block. Compound statements can be executed independently or be included in the definitions of database objects such as procedures, functions, methods, and triggers. There are different SQL statements for these because there are unique differences and restrictions that apply to each.

Compound statements can be either inline compound statements (formerly called dynamic compound statements) or compiled compound statements. The differences between these two statements are shown in the following paragraphs.

Inline compound statements

Inline compound statements are atomic and are defined with the BEGIN ATOMIC and END keywords, between which other SQL statements can be defined and executed. Inline compound statements can contain variable declarations, SQL statements and the subset of SQL PL statements known as inline SQL PL statements.

Compiled compound statements

Compiled compound statements are not atomic and are defined with the BEGIN and END keywords, between which other SQL statements can be defined and executed. Compiled compound statements can contain SQL statements and all SQL PL statements.

You would choose to use a compiled compound statement instead of an inline compound statement if you want to make use of the additional features available with compiled compound statements.

Compound statements are primarily useful for creating short scripts that can be executed from the DB2 Command Line Processor. They are also used to define the body of a routine or trigger.

Creating compound statements

Creating and executing compound statements is a task that you would perform when you need to run a script consisting of SQL statements.

Before you begin

Before you create a compound statement:

- Read: Chapter 7, “Compound statements”
- Ensure that you have the privileges required to execute the Compound statement.

Procedure

1. Define a compound SQL statement.
2. Execute the compound SQL statement from a supported interface.

Results

If executed dynamically, the SQL statement should execute successfully.

Example

The following is an example of an inlined compound SQL statement that contains SQL PL:

```
BEGIN
  FOR row AS
    SELECT pk, c1, discretize(c1) AS v FROM source
  DO
    IF row.v is NULL THEN
      INSERT INTO except VALUES(row.pk, row.c1);
    ELSE
      INSERT INTO target VALUES(row.pk, row.d);
    END IF;
  END FOR;
END
```

The compound statement is bounded by the keywords BEGIN and END. It includes use of both the FOR and IF/ELSE control-statements that are part of SQL PL. The FOR statement is used to iterate through a defined set of rows. For each row a column's value is checked and conditionally, based on the value, a set of values is inserted into another table.

Part 2. PL/SQL support

PL/SQL (Procedural Language/Structured Query Language) statements can be compiled and executed using DB2 interfaces. This support reduces the complexity of enabling existing PL/SQL solutions so that they will work with the DB2 data server.

The supported interfaces include:

- DB2 command line processor (CLP)
- DB2 CLPPlus
- IBM Data Studio client

PL/SQL statement execution is not enabled from these interfaces by default. PL/SQL statement execution support must be enabled on the DB2 data server.

Chapter 8. PL/SQL features

PL/SQL statements and scripts can be compiled and executed using DB2 interfaces.

You can execute the following PL/SQL statements:

- Anonymous blocks; for example, DECLARE...BEGIN...END
- CREATE OR REPLACE FUNCTION statement
- CREATE OR REPLACE PACKAGE statement
- CREATE OR REPLACE PACKAGE BODY statement
- CREATE OR REPLACE PROCEDURE statement
- CREATE OR REPLACE TRIGGER statement
- CREATE OR REPLACE TYPE statement
- DROP PACKAGE statement
- DROP PACKAGE BODY statement

PL/SQL procedures and functions can be invoked from other PL/SQL statements or from DB2 SQL PL statements. You can call a PL/SQL procedure from SQL PL by using the CALL statement.

The following statements and language elements are supported in PL/SQL contexts:

- Type declarations:
 - Associative arrays
 - Record types
 - VARRAY types
- Subtype declarations
- Variable declarations:
 - %ROWTYPE
 - %TYPE
- Basic statements, clauses, and statement attributes:
 - Assignment statement
 - NULL statement
 - RETURNING INTO clause
 - Statement attributes, including SQL%FOUND, SQL%NOTFOUND, and SQL%ROWCOUNT
- Control statements and structures:
 - CASE statements:
 - Simple CASE statement
 - Searched CASE statement
 - Exception handling
 - EXIT statement
 - FOR statement
 - GOTO statement
 - IF statement

- LOOP statement
- PIPE ROW statement
- RETURN statement
- WHILE statement
- Static cursors:
 - CLOSE statement
 - Cursor FOR loop statement
 - FETCH statement (including FETCH INTO a %ROWTYPE variable)
 - OPEN statement
 - Parameterized cursors
 - Cursor attributes
- REF CURSOR support:
 - Variables and parameters of type REF CURSOR
 - Strong REF CURSORs
 - OPEN FOR statement
 - Returning REF CURSORs to JDBC applications
- Error support:
 - RAISE_APPLICATION_ERROR procedure
 - RAISE statement
 - SQLCODE function
 - SQLERRM function

Chapter 9. Creating PL/SQL procedures and functions from a CLP script

You can create PL/SQL procedures and functions from a DB2 command line processor (CLP) script.

Procedure

1. Formulate PL/SQL procedure or function definitions within a CLP script file. Terminate each statement with a new line and a forward slash character (/). Other statement termination characters are also supported.
2. Save the file. In this example, the file name is `script.db2`.
3. Execute the script from the CLP. If a forward slash character or a semicolon was used to terminate statements, issue the following command:

```
db2 -td/ -vf script.db2
```

If another statement termination character (for example, the @ character) was used in the script file, you must specify that character in the command string. For example:

```
db2 -td@ -vf script.db2
```

Results

The CLP script should execute successfully if there are no syntax errors.

Example

The following example of a CLP script creates a PL/SQL function and procedure, and then calls the PL/SQL procedure.

```
CONNECT TO mydb
/

CREATE TABLE emp (
    name          VARCHAR2(10),
    salary        NUMBER,
    comm          NUMBER,
    tot_comp      NUMBER
)
/

INSERT INTO emp VALUES ('Larry', 1000, 50, 0)
/
INSERT INTO emp VALUES ('Curly', 200, 5, 0)
/
INSERT INTO emp VALUES ('Moe', 10000, 1000, 0)
/

CREATE OR REPLACE FUNCTION emp_comp (
    p_sal        NUMBER,
    p_comm       NUMBER )
RETURN NUMBER
IS
BEGIN
    RETURN (p_sal + NVL(p_comm, 0)) * 24;
END emp_comp
/
```

```

CREATE OR REPLACE PROCEDURE update_comp(p_name IN VARCHAR) AS
BEGIN
    UPDATE emp SET tot_comp = emp_comp(salary, comm)
        WHERE name = p_name;
END update_comp
/

CALL update_comp('Curly')
/

SELECT * FROM emp
/

CONNECT RESET
/

```

This script produces the following sample output:

```
CALL update_comp('Curly')
```

```
Return Status = 0
```

```
SELECT * FROM emp
```

NAME	SALARY	COMM	TOT_COMP
Larry	1000	50	0
Curly	200	5	4920
Moe	10000	1000	0

```
3 record(s) selected.
```

What to do next

Test your new procedures or functions by invoking them. For procedures, use the CALL statement. For functions, execute queries or other SQL statements that contain references to those functions.

Chapter 10. Restrictions on PL/SQL support

It is important to note the restrictions on PL/SQL compilation support before performing PL/SQL compilation, or when troubleshooting PL/SQL compilation or runtime problems.

In this version:

- PL/SQL procedures, functions, triggers, and packages can only be created from the catalog partition in a partitioned database environment.
- The NCLOB data type is not supported for use in PL/SQL statements or in PL/SQL contexts when the database is not defined as a Unicode database. In Unicode databases, the NCLOB data type is mapped to a DB2 DBCLOB data type.
- The XMLTYPE data type is not supported.

Chapter 11. PL/SQL sample schema

Most of the PL/SQL examples are based on a PL/SQL sample schema that represents employees in an organization.

The following script (plsql_sample.sql) defines that PL/SQL sample schema.

```
--
-- Script that creates the 'sample' tables, views, procedures,
-- functions, triggers, and so on.
--
-- Create and populate tables used in the documentation examples.
--
-- Create the 'dept' table
--
CREATE TABLE dept (
  deptno      NUMBER(2) NOT NULL CONSTRAINT dept_pk PRIMARY KEY,
  dname       VARCHAR2(14) NOT NULL CONSTRAINT dept_dname_uq UNIQUE,
  loc         VARCHAR2(13)
);
--
-- Create the 'emp' table
--
CREATE TABLE emp (
  empno       NUMBER(4) NOT NULL CONSTRAINT emp_pk PRIMARY KEY,
  ename       VARCHAR2(10),
  job         VARCHAR2(9),
  mgr         NUMBER(4),
  hiredate    DATE,
  sal         NUMBER(7,2) CONSTRAINT emp_sal_ck CHECK (sal > 0),
  comm        NUMBER(7,2),
  deptno      NUMBER(2) CONSTRAINT emp_ref_dept_fk
              REFERENCES dept(deptno)
);
--
-- Create the 'jobhist' table
--
CREATE TABLE jobhist (
  empno       NUMBER(4) NOT NULL,
  startdate   DATE NOT NULL,
  enddate     DATE,
  job         VARCHAR2(9),
  sal         NUMBER(7,2),
  comm        NUMBER(7,2),
  deptno      NUMBER(2),
  chgdesc     VARCHAR2(80),
  CONSTRAINT jobhist_pk PRIMARY KEY (empno, startdate),
  CONSTRAINT jobhist_ref_emp_fk FOREIGN KEY (empno)
              REFERENCES emp(empno) ON DELETE CASCADE,
  CONSTRAINT jobhist_ref_dept_fk FOREIGN KEY (deptno)
              REFERENCES dept (deptno) ON DELETE SET NULL,
  CONSTRAINT jobhist_date_chk CHECK (startdate <= enddate)
);
--
-- Create the 'salemp' view
--
CREATE OR REPLACE VIEW salemp AS
  SELECT empno, ename, hiredate, sal, comm FROM emp WHERE job = 'SALESMAN';
--
-- Sequence to generate values for function 'new_empno'
--
CREATE SEQUENCE next_empno START WITH 8000 INCREMENT BY 1;
--
```

```

-- Issue PUBLIC grants
--
GRANT ALL ON emp TO PUBLIC;
GRANT ALL ON dept TO PUBLIC;
GRANT ALL ON jobhist TO PUBLIC;
GRANT ALL ON salesemp TO PUBLIC;
--
-- Load the 'dept' table
--
INSERT INTO dept VALUES (10,'ACCOUNTING','NEW YORK');
INSERT INTO dept VALUES (20,'RESEARCH','DALLAS');
INSERT INTO dept VALUES (30,'SALES','CHICAGO');
INSERT INTO dept VALUES (40,'OPERATIONS','BOSTON');
--
-- Load the 'emp' table
--
INSERT INTO emp VALUES (7369,'SMITH','CLERK',7902,'17-DEC-80',800,NULL,20);
INSERT INTO emp VALUES (7499,'ALLEN','SALESMAN',7698,'20-FEB-81',1600,300,30);
INSERT INTO emp VALUES (7521,'WARD','SALESMAN',7698,'22-FEB-81',1250,500,30);
INSERT INTO emp VALUES (7566,'JONES','MANAGER',7839,'02-APR-81',2975,NULL,20);
INSERT INTO emp VALUES (7654,'MARTIN','SALESMAN',7698,'28-SEP-81',1250,1400,30);
INSERT INTO emp VALUES (7698,'BLAKE','MANAGER',7839,'01-MAY-81',2850,NULL,30);
INSERT INTO emp VALUES (7782,'CLARK','MANAGER',7839,'09-JUN-81',2450,NULL,10);
INSERT INTO emp VALUES (7788,'SCOTT','ANALYST',7566,'19-APR-87',3000,NULL,20);
INSERT INTO emp VALUES (7839,'KING','PRESIDENT',NULL,'17-NOV-81',5000,NULL,10);
INSERT INTO emp VALUES (7844,'TURNER','SALESMAN',7698,'08-SEP-81',1500,0,30);
INSERT INTO emp VALUES (7876,'ADAMS','CLERK',7788,'23-MAY-87',1100,NULL,20);
INSERT INTO emp VALUES (7900,'JAMES','CLERK',7698,'03-DEC-81',950,NULL,30);
INSERT INTO emp VALUES (7902,'FORD','ANALYST',7566,'03-DEC-81',3000,NULL,20);
INSERT INTO emp VALUES (7934,'MILLER','CLERK',7782,'23-JAN-82',1300,NULL,10);
--
-- Load the 'jobhist' table
--
INSERT INTO jobhist VALUES (7369,'17-DEC-80',NULL,'CLERK',800,NULL,20,
    'New Hire');
INSERT INTO jobhist VALUES (7499,'20-FEB-81',NULL,'SALESMAN',1600,300,30,
    'New Hire');
INSERT INTO jobhist VALUES (7521,'22-FEB-81',NULL,'SALESMAN',1250,500,30,
    'New Hire');
INSERT INTO jobhist VALUES (7566,'02-APR-81',NULL,'MANAGER',2975,NULL,20,
    'New Hire');
INSERT INTO jobhist VALUES (7654,'28-SEP-81',NULL,'SALESMAN',1250,1400,30,
    'New Hire');
INSERT INTO jobhist VALUES (7698,'01-MAY-81',NULL,'MANAGER',2850,NULL,30,
    'New Hire');
INSERT INTO jobhist VALUES (7782,'09-JUN-81',NULL,'MANAGER',2450,NULL,10,
    'New Hire');
INSERT INTO jobhist VALUES (7788,'19-APR-87','12-APR-88','CLERK',1000,NULL,20,
    'New Hire');
INSERT INTO jobhist VALUES (7788,'13-APR-88','04-MAY-89','CLERK',1040,NULL,20,
    'Raise');
INSERT INTO jobhist VALUES (7788,'05-MAY-90',NULL,'ANALYST',3000,NULL,20,
    'Promoted to Analyst');
INSERT INTO jobhist VALUES (7839,'17-NOV-81',NULL,'PRESIDENT',5000,NULL,10,
    'New Hire');
INSERT INTO jobhist VALUES (7844,'08-SEP-81',NULL,'SALESMAN',1500,0,30,
    'New Hire');
INSERT INTO jobhist VALUES (7876,'23-MAY-87',NULL,'CLERK',1100,NULL,20,
    'New Hire');
INSERT INTO jobhist VALUES (7900,'03-DEC-81','14-JAN-83','CLERK',950,NULL,10,
    'New Hire');
INSERT INTO jobhist VALUES (7900,'15-JAN-83',NULL,'CLERK',950,NULL,30,
    'Changed to Dept 30');
INSERT INTO jobhist VALUES (7902,'03-DEC-81',NULL,'ANALYST',3000,NULL,20,
    'New Hire');
INSERT INTO jobhist VALUES (7934,'23-JAN-82',NULL,'CLERK',1300,NULL,10,
    'New Hire');

```

```

SET SQLCOMPAT PLSQL;
--
-- Procedure that lists all employees' numbers and names
-- from the 'emp' table using a cursor
--
CREATE OR REPLACE PROCEDURE list_emp
IS
    v_empno      NUMBER(4);
    v_ename      VARCHAR2(10);
    CURSOR emp_cur IS
        SELECT empno, ename FROM emp ORDER BY empno;
BEGIN
    OPEN emp_cur;
    DBMS_OUTPUT.PUT_LINE('EMPNO   ENAME');
    DBMS_OUTPUT.PUT_LINE('-----  -----');
    LOOP
        FETCH emp_cur INTO v_empno, v_ename;
        EXIT WHEN emp_cur%NOTFOUND;
        DBMS_OUTPUT.PUT_LINE(v_empno || '   ' || v_ename);
    END LOOP;
    CLOSE emp_cur;
END;
/
--
-- Procedure that selects an employee row given the employee
-- number and displays certain columns
--
CREATE OR REPLACE PROCEDURE select_emp (
    p_empno      IN NUMBER
)
IS
    v_ename      emp.ename%TYPE;
    v_hiredate   emp.hiredate%TYPE;
    v_sal        emp.sal%TYPE;
    v_comm       emp.comm%TYPE;
    v_dname      dept.dname%TYPE;
    v_disp_date  VARCHAR2(10);
BEGIN
    SELECT ename, hiredate, sal, NVL(comm, 0), dname
        INTO v_ename, v_hiredate, v_sal, v_comm, v_dname
        FROM emp e, dept d
        WHERE empno = p_empno
            AND e.deptno = d.deptno;
    v_disp_date := TO_CHAR(v_hiredate, 'YYYY/MM/DD');
    DBMS_OUTPUT.PUT_LINE('Number   : ' || p_empno);
    DBMS_OUTPUT.PUT_LINE('Name     : ' || v_ename);
    DBMS_OUTPUT.PUT_LINE('Hire Date : ' || v_disp_date);
    DBMS_OUTPUT.PUT_LINE('Salary   : ' || v_sal);
    DBMS_OUTPUT.PUT_LINE('Commission: ' || v_comm);
    DBMS_OUTPUT.PUT_LINE('Department: ' || v_dname);
EXCEPTION
    WHEN NO_DATA_FOUND THEN
        DBMS_OUTPUT.PUT_LINE('Employee ' || p_empno || ' not found');
    WHEN OTHERS THEN
        DBMS_OUTPUT.PUT_LINE('The following is SQLERRM:');
        DBMS_OUTPUT.PUT_LINE(SQLERRM);
        DBMS_OUTPUT.PUT_LINE('The following is SQLCODE:');
        DBMS_OUTPUT.PUT_LINE(SQLCODE);
END;
/
--
-- Procedure that queries the 'emp' table based on
-- department number and employee number or name. Returns
-- employee number and name as IN OUT parameters and job,
-- hire date, and salary as OUT parameters.
--

```

```

CREATE OR REPLACE PROCEDURE emp_query (
    p_deptno      IN      NUMBER,
    p_empno       IN OUT NUMBER,
    p_ename       IN OUT VARCHAR2,
    p_job         OUT   VARCHAR2,
    p_hiredate    OUT   DATE,
    p_sal         OUT   NUMBER
)
IS
BEGIN
    SELECT empno, ename, job, hiredate, sal
    INTO p_empno, p_ename, p_job, p_hiredate, p_sal
    FROM emp
    WHERE deptno = p_deptno
        AND (empno = p_empno
            OR ename = UPPER(p_ename));
END;
/
--
-- Procedure to call 'emp_query_caller' with IN and IN OUT
-- parameters. Displays the results received from IN OUT and
-- OUT parameters.
--
CREATE OR REPLACE PROCEDURE emp_query_caller
IS
    v_deptno      NUMBER(2);
    v_empno       NUMBER(4);
    v_ename       VARCHAR2(10);
    v_job         VARCHAR2(9);
    v_hiredate    DATE;
    v_sal         NUMBER;
BEGIN
    v_deptno := 30;
    v_empno  := 0;
    v_ename  := 'Martin';
    emp_query(v_deptno, v_empno, v_ename, v_job, v_hiredate, v_sal);
    DBMS_OUTPUT.PUT_LINE('Department : ' || v_deptno);
    DBMS_OUTPUT.PUT_LINE('Employee No: ' || v_empno);
    DBMS_OUTPUT.PUT_LINE('Name       : ' || v_ename);
    DBMS_OUTPUT.PUT_LINE('Job       : ' || v_job);
    DBMS_OUTPUT.PUT_LINE('Hire Date : ' || v_hiredate);
    DBMS_OUTPUT.PUT_LINE('Salary   : ' || v_sal);
EXCEPTION
    WHEN TOO_MANY_ROWS THEN
        DBMS_OUTPUT.PUT_LINE('More than one employee was selected');
    WHEN NO_DATA_FOUND THEN
        DBMS_OUTPUT.PUT_LINE('No employees were selected');
END;
/
--
-- Function to compute yearly compensation based on semimonthly
-- salary
--
CREATE OR REPLACE FUNCTION emp_comp (
    p_sal      NUMBER,
    p_comm     NUMBER
) RETURN NUMBER
IS
BEGIN
    RETURN (p_sal + NVL(p_comm, 0)) * 24;
END;
/
--
-- After statement-level triggers that display a message after
-- an insert, update, or deletion to the 'emp' table. One message
-- per SQL command is displayed.
--

```



```

CREATE OR REPLACE TRIGGER user_ins_audit_trig
  AFTER INSERT ON emp
  FOR EACH ROW
DECLARE
  v_action          VARCHAR2(24);
BEGIN
  v_action := ' added employee(s) on ';
  DBMS_OUTPUT.PUT_LINE('User ' || USER || v_action ||
    TO_CHAR(SYSDATE, 'YYYY-MM-DD'));
END;
/
CREATE OR REPLACE TRIGGER user_upd_audit_trig
  AFTER UPDATE ON emp
  FOR EACH ROW
DECLARE
  v_action          VARCHAR2(24);
BEGIN
  v_action := ' updated employee(s) on ';
  DBMS_OUTPUT.PUT_LINE('User ' || USER || v_action ||
    TO_CHAR(SYSDATE, 'YYYY-MM-DD'));
END;
/
CREATE OR REPLACE TRIGGER user_del_audit_trig
  AFTER DELETE ON emp
  FOR EACH ROW
DECLARE
  v_action          VARCHAR2(24);
BEGIN
  v_action := ' deleted employee(s) on ';
  DBMS_OUTPUT.PUT_LINE('User ' || USER || v_action ||
    TO_CHAR(SYSDATE, 'YYYY-MM-DD'));
END;
/
--
-- Before row-level triggers that display employee number and
-- salary of an employee that is about to be added, updated,
-- or deleted in the 'emp' table
--
CREATE OR REPLACE TRIGGER emp_ins_sal_trig
  BEFORE INSERT ON emp
  FOR EACH ROW
DECLARE
  sal_diff          NUMBER;
BEGIN
  DBMS_OUTPUT.PUT_LINE('Inserting employee ' || :NEW.empno);
  DBMS_OUTPUT.PUT_LINE('..New salary: ' || :NEW.sal);
END;
/
CREATE OR REPLACE TRIGGER emp_upd_sal_trig
  BEFORE UPDATE ON emp
  FOR EACH ROW
DECLARE
  sal_diff          NUMBER;
BEGIN
  sal_diff := :NEW.sal - :OLD.sal;
  DBMS_OUTPUT.PUT_LINE('Updating employee ' || :OLD.empno);
  DBMS_OUTPUT.PUT_LINE('..Old salary: ' || :OLD.sal);
  DBMS_OUTPUT.PUT_LINE('..New salary: ' || :NEW.sal);
  DBMS_OUTPUT.PUT_LINE('..Raise      : ' || sal_diff);
END;
/
CREATE OR REPLACE TRIGGER emp_del_sal_trig
  BEFORE DELETE ON emp
  FOR EACH ROW
DECLARE
  sal_diff          NUMBER;
BEGIN

```

```

        DBMS_OUTPUT.PUT_LINE('Deleting employee ' || :OLD.empno);
        DBMS_OUTPUT.PUT_LINE('..Old salary: ' || :OLD.sal);
    END;
/
--
-- Package specification for the 'emp_admin' package
--
CREATE OR REPLACE PACKAGE emp_admin
IS
    FUNCTION get_dept_name (
        p_deptno      NUMBER
    ) RETURN VARCHAR2;
    FUNCTION update_emp_sal (
        p_empno       NUMBER,
        p_raise        NUMBER
    ) RETURN NUMBER;
    PROCEDURE hire_emp (
        p_empno       NUMBER,
        p_ename        VARCHAR2,
        p_job          VARCHAR2,
        p_sal          NUMBER,
        p_hiredate     DATE,
        p_comm         NUMBER,
        p_mgr          NUMBER,
        p_deptno       NUMBER
    );
    PROCEDURE fire_emp (
        p_empno        NUMBER
    );
END emp_admin;
/
--
-- Package body for the 'emp_admin' package
--
CREATE OR REPLACE PACKAGE BODY emp_admin
IS
    --
    -- Function that queries the 'dept' table based on the department
    -- number and returns the corresponding department name
    --
    FUNCTION get_dept_name (
        p_deptno      IN NUMBER
    ) RETURN VARCHAR2
    IS
        v_dname        VARCHAR2(14);
    BEGIN
        SELECT dname INTO v_dname FROM dept WHERE deptno = p_deptno;
        RETURN v_dname;
    EXCEPTION
        WHEN NO_DATA_FOUND THEN
            DBMS_OUTPUT.PUT_LINE('Invalid department number ' || p_deptno);
            RETURN '';
    END;
    --
    -- Function that updates an employee's salary based on the
    -- employee number and salary increment/decrement passed
    -- as IN parameters. Upon successful completion the function
    -- returns the new updated salary.
    --
    FUNCTION update_emp_sal (
        p_empno       IN NUMBER,
        p_raise        IN NUMBER
    ) RETURN NUMBER
    IS
        v_sal          NUMBER := 0;
    BEGIN
        SELECT sal INTO v_sal FROM emp WHERE empno = p_empno;

```

```

        v_sal := v_sal + p_raise;
        UPDATE emp SET sal = v_sal WHERE empno = p_empno;
        RETURN v_sal;
EXCEPTION
    WHEN NO_DATA_FOUND THEN
        DBMS_OUTPUT.PUT_LINE('Employee ' || p_empno || ' not found');
        RETURN -1;
    WHEN OTHERS THEN
        DBMS_OUTPUT.PUT_LINE('The following is SQLERRM:');
        DBMS_OUTPUT.PUT_LINE(SQLERRM);
        DBMS_OUTPUT.PUT_LINE('The following is SQLCODE:');
        DBMS_OUTPUT.PUT_LINE(SQLCODE);
        RETURN -1;
END;
--
-- Procedure that inserts a new employee record into the 'emp' table
--
PROCEDURE hire_emp (
    p_empno    NUMBER,
    p_ename    VARCHAR2,
    p_job      VARCHAR2,
    p_sal      NUMBER,
    p_hiredate DATE,
    p_comm     NUMBER,
    p_mgr      NUMBER,
    p_deptno   NUMBER
)
AS
BEGIN
    INSERT INTO emp(empno, ename, job, sal, hiredate, comm, mgr, deptno)
        VALUES(p_empno, p_ename, p_job, p_sal,
            p_hiredate, p_comm, p_mgr, p_deptno);
END;
--
-- Procedure that deletes an employee record from the 'emp' table based
-- on the employee number
--
PROCEDURE fire_emp (
    p_empno    NUMBER
)
AS
BEGIN
    DELETE FROM emp WHERE empno = p_empno;
END;
END;
/

SET SQLCOMPAT DB2;

```

Chapter 12. Obfuscation

Obfuscation encodes the body of the DDL statements for database objects such as routines, triggers, views, and PL/SQL packages. Obfuscating your code helps protect your intellectual property because users cannot read the code, but DB2 for Linux, UNIX, and Windows can still understand it.

The DBMS_DDL module provides two routines for obfuscating your routines, triggers, views, or your PL/SQL packages:

WRAP function

Takes a routine, trigger, PL/SQL package, or PL/SQL package body definition as an argument and produces a string containing the initial header followed by an obfuscated version of the rest of the statement. For example, input like:

```
CREATE PROCEDURE P(a INT)
BEGIN
  INSERT INTO T1 VALUES (a);
END
```

using the DBMS_DDL.WRAP function might result in:

```
CREATE PROCEDURE P(a INT) WRAPPED SQL09072
aBcDefg12AbcasHGJG6JKHhgkjFGHHkkk1j1jk878979HJHui99
```

The obfuscated portion of the DDL statement contains codepage invariant characters, ensuring that it is valid for any codepage.

CREATE_WRAPPED procedure

Takes the same input as the WRAP function described previously, but instead of returning the obfuscated text, an object is created in the database. Internally the object is not obfuscated so that it can be processed by the compiler, but in catalog views like SYSCAT.ROUTINES or SYSCAT.TRIGGERS the content of the TEXT column is obfuscated.

An obfuscated statement can be used in CLP scripts and can be submitted as dynamic SQL using other client interfaces.

Obfuscation is available for the following statements:

- **db2look** by using the **-wrap** option
- CREATE FUNCTION
- CREATE PACKAGE
- CREATE PACKAGE BODY
- CREATE PROCEDURE
- CREATE TRIGGER
- CREATE VIEW
- ALTER MODULE

The **db2look** tool obfuscates all the preceding statements when the **-wrap** option is used.

Chapter 13. Blocks (PL/SQL)

PL/SQL block structures can be included within PL/SQL procedure, function, or trigger definitions or executed independently as an anonymous block statement.

PL/SQL block structures and the anonymous block statement contain one or more of the following sections:

- An optional declaration section
- A mandatory executable section
- An optional exception section

These sections can include SQL statements, PL/SQL statements, data type and variable declarations, or other PL/SQL language elements.

Anonymous block statement (PL/SQL)

The PL/SQL anonymous block statement is an executable statement that can contain PL/SQL control statements and SQL statements. It can be used to implement procedural logic in a scripting language. In PL/SQL contexts, this statement can be compiled and executed by the DB2 data server.

The anonymous block statement, which does not persist in the database, can consist of up to three sections: an optional declaration section, a mandatory executable section, and an optional exception section.

The optional declaration section, which can contain the declaration of variables, cursors, and types that are to be used by statements within the executable and exception sections, is inserted before the executable BEGIN-END block.

The optional exception section can be inserted near the end of the BEGIN-END block. The exception section must begin with the keyword `EXCEPTION`, and continues until the end of the block in which it appears.

Invocation

This statement can be executed from an interactive tool or command line interface such as the CLP. This statement can also be embedded within a PL/SQL procedure definition, function definition, or trigger definition. Within these contexts, the statement is called a block structure instead of an anonymous block statement.

Authorization

No privileges are required to invoke an anonymous block. However, the privileges held by the authorization ID of the statement must include all necessary privileges to invoke the SQL statements that are embedded within the anonymous block.

Syntax

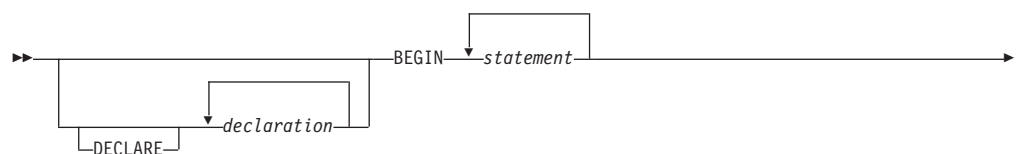

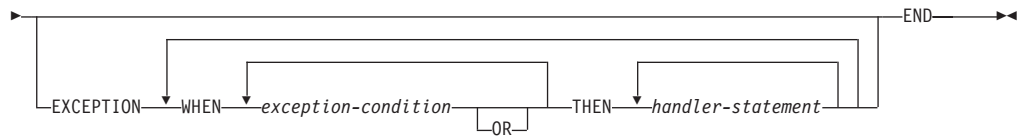

Description

DECLARE

An optional keyword that starts the DECLARE statement, which can be used to declare data types, variables, or cursors. The use of this keyword depends upon the context in which the block appears.

declaration

Specifies a data type, variable, cursor, exception, or procedure declaration whose scope is local to the block. Each declaration must be terminated by a semicolon.

BEGIN

A mandatory keyword that introduces the executable section, which can include one or more SQL or PL/SQL statements. A BEGIN-END block can contain nested BEGIN-END blocks.

statement

Specifies a PL/SQL or SQL statement. Each statement must be terminated by a semicolon.

EXCEPTION

An optional keyword that introduces the exception section.

WHEN *exception-condition*

Specifies a conditional expression that tests for one or more types of exceptions.

THEN *handler-statement*

Specifies a PL/SQL or SQL statement that is executed if a thrown exception matches an exception in *exception-condition*. Each statement must be terminated by a semicolon.

END

A mandatory keyword that ends the block.

Examples

The following example shows the simplest possible anonymous block statement that the DB2 data server can compile:

```
BEGIN
  NULL;
END;
```

The following example shows an anonymous block that you can enter interactively through the DB2 CLP:

```
SET SERVEROUTPUT ON;

BEGIN
  dbms_output.put_line( 'Hello' );
END;
```

The following example shows an anonymous block with a declaration section that you can enter interactively through the DB2 CLP:

```
SET SERVEROUTPUT ON;

DECLARE
    current_date DATE := SYSDATE;
BEGIN
    dbms_output.put_line( current_date );
END;
```

Chapter 14. Procedures (PL/SQL)

The DB2 data server supports the compilation and execution of PL/SQL procedures. PL/SQL procedures are database objects that contain PL/SQL procedural logic and SQL statements that can be invoked in contexts where the CALL statement or procedure references are valid.

PL/SQL procedures are created by executing the PL/SQL CREATE PROCEDURE statement. Such procedures can be dropped from the database by using the DB2 SQL DROP statement. If you want to replace the implementation for a procedure, you do not need to drop it. You can use the CREATE PROCEDURE statement and specify the OR REPLACE option to replace the procedure implementation.

CREATE PROCEDURE statement (PL/SQL)

The CREATE PROCEDURE statement defines a procedure that is stored in the database.

Invocation

This statement can be executed from the DB2 command line processor (CLP), any supported interactive SQL interface, an application, or a routine.

Authorization

The privileges held by the authorization ID of the statement must include at least one of the following:

- If the schema name of the procedure does not exist, IMPLICIT_SCHEMA authority on the database
- If the schema name of the procedure refers to an existing schema, CREATEIN privilege on the schema
- DBADM authority

The privileges held by the authorization ID of the statement must also include all of the privileges necessary to invoke the SQL statements that are specified in the procedure body.

The authorization ID of the statement must be the owner of the matched procedure if OR REPLACE is specified (SQLSTATE 42501).

Syntax

→ CREATE OR REPLACE PROCEDURE →

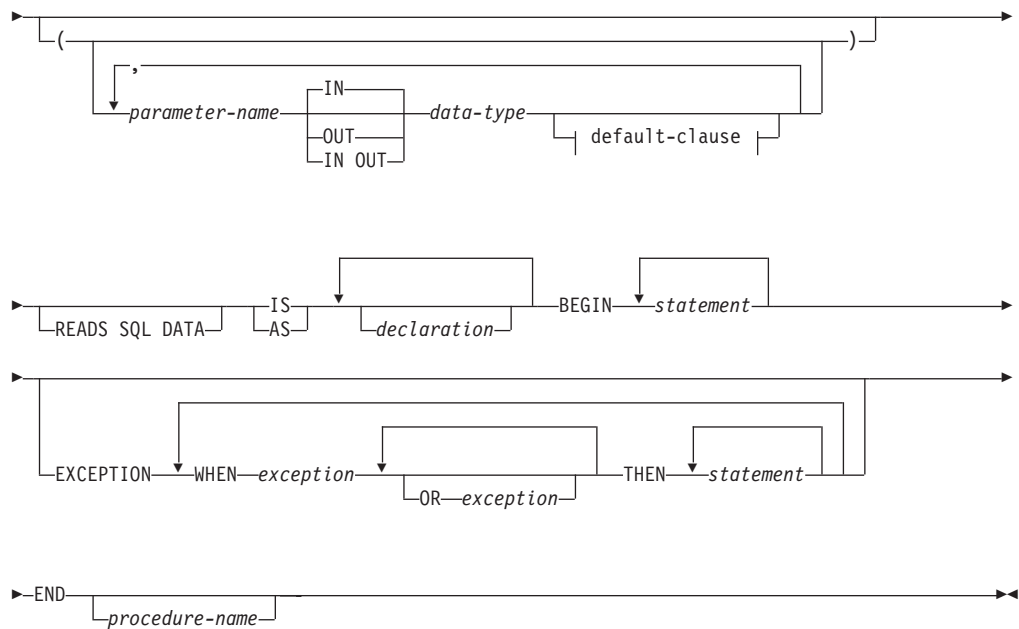

Description

PROCEDURE *procedure-name*

Specifies an identifier for the procedure. The unqualified form of *procedure-name* is an SQL identifier with a maximum length of 128. In dynamic SQL statements, the value of the CURRENT SCHEMA special register is used to qualify an unqualified object name. In static SQL statements, the QUALIFIER precompile or bind option implicitly specifies the qualifier for unqualified object names. The qualified form of *procedure-name* is a schema name followed by a period character and an SQL identifier. If a two-part name is specified, the schema name cannot begin with 'SYS'; otherwise, an error is returned (SQLSTATE 42939).

The name (including an implicit or explicit qualifier), together with the number of parameters, must not identify a procedure that is described in the catalog (SQLSTATE 42723). The unqualified name, together with the number of parameters, is unique within its schema, but does not need to be unique across schemas.

parameter-name

Specifies the name of a parameter. The parameter name must be unique for this procedure (SQLSTATE 42734).

data-type

Specifies one of the supported PL/SQL data types.

READS SQL DATA

Indicates that SQL statements that do not modify SQL data can be included in the procedure. This clause is a DB2 extension.

IS or AS

Introduces the procedure body definition.

declaration

Specifies one or more variable, cursor, or REF CURSOR type declarations.

BEGIN

Introduces the executable block. The BEGIN-END block can contain an EXCEPTION section.

statement

Specifies a PL/SQL or SQL statement. The statement must be terminated by a semicolon.

EXCEPTION

An optional keyword that introduces the exception section.

WHEN *exception-condition*

Specifies a conditional expression that tests for one or more types of exceptions.

statement

Specifies a PL/SQL or SQL statement. The statement must be terminated by a semicolon.

END

A mandatory keyword that ends the block. You can optionally specify the name of the procedure.

Notes

The CREATE PROCEDURE statement can be submitted in obfuscated form. In an obfuscated statement, only the procedure name is readable. The rest of the statement is encoded in such a way that it is not readable, but can be decoded by the database server. Obfuscated statements can be produced by calling the DBMS_DDL.WRAP function.

Examples

The following example shows a simple procedure that takes no parameters:

```
CREATE OR REPLACE PROCEDURE simple_procedure
IS
BEGIN
    DBMS_OUTPUT.PUT_LINE('That''s all folks!');
END simple_procedure;
```

The following example shows a procedure that takes an IN and an OUT parameter, and that has GOTO statements whose labels are of the standard PL/SQL form (<<label>>):

```
CREATE OR REPLACE PROCEDURE test_goto
( p1 IN INTEGER, out1 OUT VARCHAR2(30) )
IS
BEGIN
    <<LABEL2ABOVE>>
    IF p1 = 1 THEN
        out1 := out1 || 'one';
        GOTO LABEL1BELOW;
    END IF;
    if out1 IS NULL THEN
        out1 := out1 || 'two';
        GOTO LABEL2ABOVE;
    END IF;

    out1 := out1 || 'three';
```

```

<<LABEL1BELOW>>
out1 := out1 || 'four';

END test_goto;

```

Procedure references (PL/SQL)

Invocation references to PL/SQL procedures within PL/SQL contexts can be compiled by the DB2 data server.

A valid PL/SQL procedure reference consists of the procedure name followed by its parameters, if any.

Syntax

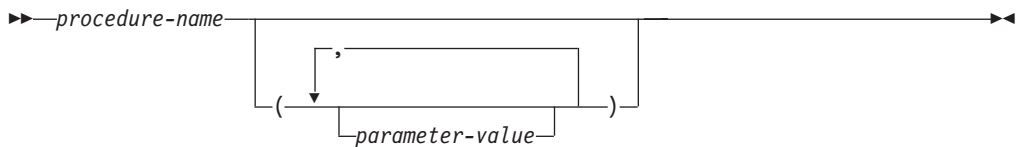

Description

procedure-name

Specifies an identifier for the procedure.

parameter-value

Specifies a parameter value. If no parameters are to be passed, the procedure can be called either with or without parentheses.

Example

The following example shows how to call a PL/SQL procedure within a PL/SQL context:

```

BEGIN
    simple_procedure;
END;

```

After a PL/SQL procedure has been created in a DB2 database, it can also be called using the CALL statement, which is supported in DB2 SQL contexts and applications using supported DB2 application programming interfaces.

Function invocation syntax support (PL/SQL)

A number of procedures support function invocation syntax in a PL/SQL assignment statement.

These procedures include:

- DBMS_SQL.EXECUTE
- DBMS_SQL.EXECUTE_AND_FETCH
- DBMS_SQL.FETCH_ROWS
- DBMS_SQL.IS_OPEN
- DBMS_SQL.LAST_ROW_COUNT
- DBMS_SQL.OPEN_CURSOR
- UTL_SMTP.CLOSE_DATA

- UTL_SMTP.COMMAND
- UTL_SMTP.COMMAND_REPLIES
- UTL_SMTP.DATA
- UTL_SMTP.EHLO
- UTL_SMTP.HELO
- UTL_SMTP.HELP
- UTL_SMTP.MAIL
- UTL_SMTP.NOOB
- UTL_SMTP.OPEN_DATA
- UTL_SMTP.QUIT
- UTL_SMTP.RCPT
- UTL_SMTP.RSET
- UTL_SMTP.VRFY

Examples

```

DECLARE
    cursor1 NUMBER;
    rowsProcessed NUMBER;
BEGIN
    cursor1 := DBMS_SQL.OPEN_CURSOR;
    DBMS_SQL.PARSE(cursor1, 'INSERT INTO T1 VALUES (10)', DBMS_SQL.NATIVE);
    rowsProcessed := DBMS_SQL.EXECUTE(cursor1);
    DBMS_SQL.CLOSE_CURSOR(cursor1);
END;
/

DECLARE
    v_connection UTL_SMTP.CONNECTION;
    v_reply UTL_SMTP.REPLY;
BEGIN
    UTL_SMTP.OPEN_CONNECTION('127.0.0.1', 25, v_connection, 10, v_reply);
    UTL_SMTP.HELO(v_connection, '127.0.0.1');
    UTL_SMTP.MAIL(v_connection, 'sender1@ca.ibm.com');
    UTL_SMTP.RCPT(v_connection, 'receiver1@ca.ibm.com');
    v_reply := UTL_SMTP.OPEN_DATA (v_connection);
    UTL_SMTP.WRITE_DATA (v_connection, 'Test message');
    UTL_SMTP.CLOSE_DATA (v_connection);
    UTL_SMTP.QUIT(v_connection);
END;
/

```

Chapter 15. Functions (PL/SQL)

The DB2 data server supports the compilation and execution of scalar and pipelined PL/SQL functions. Scalar PL/SQL functions can be invoked in contexts where expressions are valid. When evaluated, a scalar PL/SQL function returns a value that is substituted within the expression in which the function is embedded. Pipelined PL/SQL functions can be invoked in the FROM clause of SELECT statements and compute a table one row at a time.

PL/SQL functions are created by executing the CREATE FUNCTION statement. Such functions can be dropped from the database by using the DB2 SQL DROP statement. If you want to replace the implementation for a function, you do not need to drop it. You can use the CREATE FUNCTION statement and specify the OR REPLACE option to replace the function implementation.

CREATE FUNCTION statement (PL/SQL)

The CREATE FUNCTION statement defines a scalar or pipelined function that is stored in the database.

Invocation

A scalar function returns a single value each time it is invoked, and is generally valid wherever an SQL expression is valid. A pipelined function computes a table one row at a time and can be referenced in the FROM clause of SELECT statements.

This statement can be executed from the DB2 command line processor, any supported interactive SQL interface, an application, or routine.

Authorization

The privileges held by the authorization ID of the statement must include at least one of the following:

- If the schema name of the function does not exist, IMPLICIT_SCHEMA authority on the database
- If the schema name of the function refers to an existing schema, CREATEIN privilege on the schema
- DBADM authority

The privileges held by the authorization ID of the statement must also include all of the privileges necessary to invoke the SQL statements that are specified in the function body.

The authorization ID of the statement must be the owner of the matched function if OR REPLACE is specified (SQLSTATE 42501).

Syntax

```
→ CREATE [OR REPLACE] FUNCTION name →
```

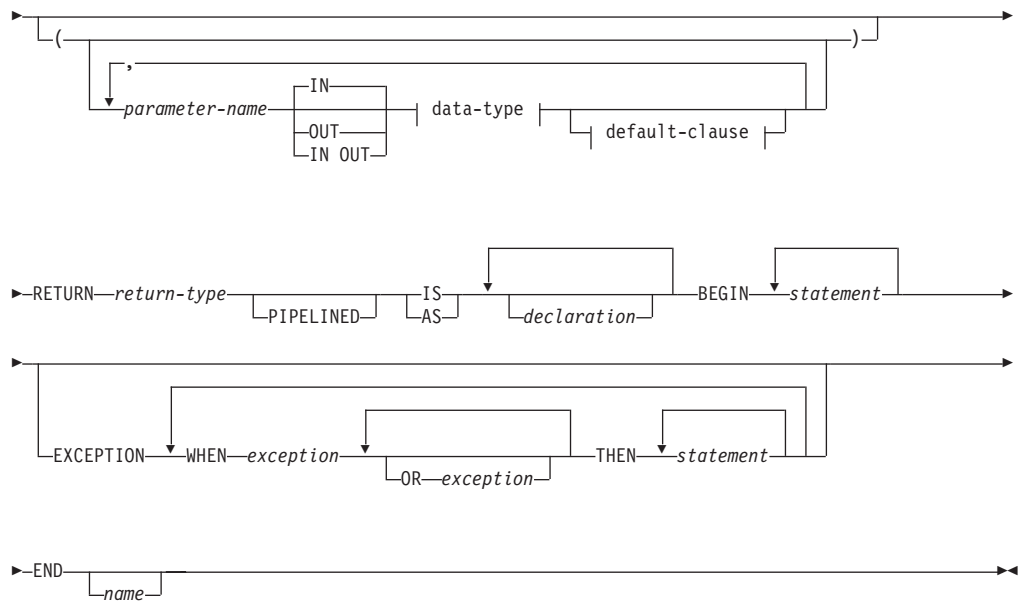

Description

The CREATE FUNCTION statement specifies the name of the function, the optional parameters, the return type of the function, and the body of the function. The body of the function is a block that is enclosed by the BEGIN and END keywords. It can contain an optional EXCEPTION section that defines an action to be taken when a defined exception condition occurs.

OR REPLACE

Indicates that if a function with the same name already exists in the schema, the new function is to replace the existing one. If this option is not specified, the new function cannot replace an existing one with the same name in the same schema.

FUNCTION *name*

Specifies an identifier for the function.

parameter-name

Specifies the name of a parameter. The name cannot be the same as any other parameter-name in the parameter list (SQLSTATE 42734).

data-type

Specifies one of the supported PL/SQL data types.

RETURN *return-type*

Specifies the data type of the scalar value that is returned by the function.

PIPELINED

Specifies that the function being created is a pipelined function.

IS or AS

Introduces the block that defines the function body.

declaration

Specifies one or more variable, cursor, or REF CURSOR type declarations.

statement

Specifies one or more PL/SQL program statements. Each statement must be terminated by a semicolon.

exception

Specifies an exception condition name.

Notes

A PL/SQL function cannot take any action that changes the state of an object that the database manager does not manage.

The CREATE FUNCTION statement can be submitted in obfuscated form. In an obfuscated statement, only the function name is readable. The rest of the statement is encoded in such a way that it is not readable, but can be decoded by the database server. Obfuscated statements can be produced by calling the DBMS_DDL.WRAP function.

Examples

The following example shows a basic function that takes no parameters:

```
CREATE OR REPLACE FUNCTION simple_function
  RETURN VARCHAR2
IS
BEGIN
  RETURN 'That''s All Folks!';
END simple_function;
```

The following example shows a function that takes two input parameters:

```
CREATE OR REPLACE FUNCTION emp_comp (
  p_sal          NUMBER,
  p_comm         NUMBER )
RETURN NUMBER
IS
BEGIN
  RETURN (p_sal + NVL(p_comm, 0)) * 24;
END emp_comp;
```

The following example shows a pipelined function that returns a table with two rows:

```
CREATE TYPE row_typ as OBJECT(f1 NUMBER, f2 VARCHAR2(10))

CREATE TYPE arr_typ as TABLE OF row_typ

CREATE FUNCTION pipe_func
RETURN arr_typ
PIPELINED
IS
BEGIN
  PIPE ROW (1, 'one');
  PIPE ROW (2, 'two');
  RETURN;
END pipe_func;
```

Function references (PL/SQL)

Scalar PL/SQL functions can be referenced wherever an expression is supported. Pipelined PL/SQL functions can be referenced in the FROM clause of SELECT statements.

Syntax

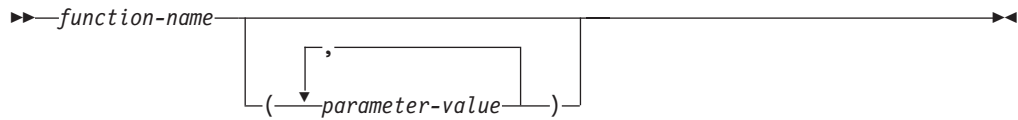

Description

function-name

Specifies an identifier for the function.

parameter-value

Specifies a value for a parameter.

Examples

The following example shows how a function named `SIMPLE_FUNCTION`, defined in the PL/SQL sample schema, can be called from a PL/SQL anonymous block:

```
BEGIN
  DBMS_OUTPUT.PUT_LINE(simple_function);
END;
```

The following example shows how a scalar function and a pipelined function can be used within an SQL statement:

```
SELECT
  emp.empno, emp.ename, emp.sal, emp.comm,
  emp_comp(sal, comm)+bon.bonus "YEARLY COMPENSATION"
FROM emp, TABLE(bonuses()) as bon(category, bonus)
WHERE bon.category = emp.category
```

Chapter 16. Collection, record, and object types (PL/SQL)

The use of PL/SQL collections is supported by the DB2 data server. A PL/SQL *collection* is a set of ordered data elements with the same data type. Individual data items in the set can be referenced by using subscript notation within parentheses.

In PL/SQL contexts, the DB2 server supports varrays, associative arrays, and record types. The DB2 server accepts the syntax for the creation of PL/SQL nested tables and object types, but maps nested tables to associative arrays and object types to records.

VARRAY collection type declaration (PL/SQL)

A VARRAY is a type of collection in which each element is referenced by a positive integer called the *array index*. The maximum cardinality of the VARRAY is specified in the type definition.

The TYPE IS VARRAY statement is used to define a VARRAY collection type.

Syntax

```
► TYPE varraytype IS VARRAY (n) OF datatype; ◀
```

Description

varraytype

An identifier that is assigned to the array type.

n The maximum number of elements in the array type.

datatype

A supported data type, such as NUMBER, VARCHAR2, RECORD, VARRAY, or associative array type. The %TYPE attribute and the %ROWTYPE attribute are also supported.

Example

The following example reads employee names from the EMP table, stores the names in an array variable of type VARRAY, and then displays the results. The EMP table contains one column named ENAME. The code is executed from a DB2 script (script.db2). The following commands should be issued from the DB2 command window before executing the script (db2 -tvf script.db2):

```
db2set DB2_COMPATIBILITY_VECTOR=FFF
db2stop
db2start
```

The script contains the following code:

```
SET SQLCOMPAT PLSQL;

connect to mydb
/

CREATE PACKAGE foo
AS
    TYPE emp_arr_typ IS VARRAY(5) OF VARCHAR2(10);
```

```

END;
/

SET SERVEROUTPUT ON
/

DECLARE
    emp_arr          foo.emp_arr_typ;
    CURSOR emp_cur IS SELECT ename FROM emp WHERE ROWNUM <= 5;
    i                INTEGER := 0;
BEGIN
    FOR r_emp IN emp_cur LOOP
        i := i + 1;
        emp_arr(i) := r_emp.ename;
    END LOOP;
    FOR j IN 1..5 LOOP
        DBMS_OUTPUT.PUT_LINE(emp_arr(j));
    END LOOP;
END;
/

DROP PACKAGE foo
/

connect reset
/

```

This script produces the following sample output:

```

Curly
Larry
Moe
Shemp
Joe

```

CREATE TYPE (VARRAY) statement (PL/SQL)

The CREATE TYPE (VARRAY) statement defines a VARRAY data type.

Invocation

This statement can be executed from the DB2 command line processor (CLP), any supported interactive SQL interface, an application, or a routine.

Authorization

The privileges held by the authorization ID of the statement must include at least one of the following:

- If the schema name of the VARRAY type does not exist, IMPLICIT_SCHEMA authority on the database
- If the schema name of the VARRAY type refers to an existing schema, CREATEIN privilege on the schema
- DBADM authority

Syntax

```

▶▶ CREATE OR REPLACE TYPE varraytype IS AS VARRAY (—n—)

```

Description

OR REPLACE

Indicates that if a user-defined data type with the same name already exists in the schema, the new data type is to replace the existing one. If this option is not specified, the new data type cannot replace an existing one with the same name in the same schema.

varraytype

Specifies an identifier for the VARRAY type. The unqualified form of *varraytype* is an SQL identifier with a maximum length of 128. The value of the CURRENT SCHEMA special register is used to qualify an unqualified object name. The qualified form of *varraytype* is a schema name followed by a period character and an SQL identifier. If a two-part name is specified, the schema name cannot begin with 'SYS'; otherwise, an error is returned (SQLSTATE 42939). The name (including an implicit or explicit qualifier) must not identify a user-defined data type that is described in the catalog (SQLSTATE 42723). The unqualified name is unique within its schema, but does not need to be unique across schemas.

- n* Specifies the maximum number of elements in the array type. The maximum cardinality of an array on a given system is limited by the total amount of memory that is available to DB2 applications. As such, although arrays of large cardinalities (up to 2,147,483,647) can be created, not all elements might be available for use.

datatype

A supported data type, such as NUMBER, VARCHAR2, RECORD, VARRAY, or associative array type. The %TYPE attribute and the %ROWTYPE attribute are also supported.

Example

The following example creates a VARRAY data type with a maximum of 10 elements, where each element has the data type NUMBER:

```
CREATE TYPE NUMARRAY1 AS VARRAY (10) OF NUMBER
```

CREATE TYPE (Nested table) statement (PL/SQL)

The CREATE TYPE (Nested table) statement defines an associative array indexed by INTEGER data type.

Invocation

This statement can be executed from the DB2 command line processor (CLP), any supported interactive SQL interface, an application, or a routine.

Authorization

The privileges held by the authorization ID of the statement must include at least one of the following:

- If the schema name of the nested table type does not exist, IMPLICIT_SCHEMA authority on the database

- If the schema name of the nested table type refers to an existing schema, CREATEIN privilege on the schema
- DBADM authority

Syntax

```

▶▶ CREATE _____ TYPE assocarray _____ IS _____ TABLE OF datatype _____
    |_____|
    OR REPLACE
    |_____|
    AS
  
```

Description

OR REPLACE

Indicates that if a user-defined data type with the same name already exists in the schema, the new data type is to replace the existing one. If this option is not specified, the new data type cannot replace an existing one with the same name in the same schema.

assocarray

Specifies an identifier for the associative array type.

datatype

Specifies a supported data type, such as NUMBER, VARCHAR2, RECORD, VARRAY, or associative array type.

Example

The following example reads the first ten employee names from the EMP table, stores them in a nested table, and then displays its contents:

```

SET SERVEROUTPUT ON
/

CREATE OR REPLACE TYPE emp_arr_typ IS TABLE OF VARCHAR2(10)
/

DECLARE
    emp_arr          emp_arr_typ;
    CURSOR emp_cur IS SELECT ename FROM emp WHERE ROWNUM <= 10;
    i                INTEGER := 0;
BEGIN
    FOR r_emp IN emp_cur LOOP
        i := i + 1;
        emp_arr(i) := r_emp.ename;
    END LOOP;
    FOR j IN 1..10 LOOP
        DBMS_OUTPUT.PUT_LINE(emp_arr(j));
    END LOOP;
END
/
  
```

Records (PL/SQL)

A record type is a composite data type that consists of one or more identifiers and their corresponding data types.

You can create user-defined record types by using the TYPE IS RECORD statement within a package or by using the CREATE TYPE (Object) statement.

Dot notation is used to reference fields in a record. For example, record.field.

Syntax

```
» TYPE rectype IS RECORD ( field datatype )
```

Description

TYPE *rectype* IS RECORD

Specifies an identifier for the record type.

field

Specifies an identifier for a field of the record type.

datatype

Specifies the corresponding data type of the *field*. The %TYPE attribute, RECORD, VARRAY, associative array types, and the %ROWTYPE attributes are supported.

Example

The following example shows a package that references a user-defined record type:

```
CREATE OR REPLACE PACKAGE pkg7a
IS
TYPE t1_typ IS RECORD (
  c1 T1.C1%TYPE,
  c2 VARCHAR(10)
);
END;
```

CREATE TYPE (Object) statement (PL/SQL)

The CREATE TYPE (Object) statement defines a record data type.

Invocation

This statement can be executed from the DB2 command line processor (CLP), any supported interactive SQL interface, an application, or a routine.

Authorization

The privileges held by the authorization ID of the statement must include at least one of the following:

- If the schema name of the object type does not exist, IMPLICIT_SCHEMA authority on the database
- If the schema name of the object type refers to an existing schema, CREATEIN privilege on the schema
- DBADM authority

Syntax

```
» CREATE [OR REPLACE] TYPE objecttype
```

► AS OBJECT ((*field* *datatype*))

Description

OR REPLACE

Indicates that if a user-defined data type with the same name already exists in the schema, the new data type is to replace the existing one. If this option is not specified, the new data type cannot replace an existing one with the same name in the same schema.

objecttype

Specifies an identifier for the record type.

field

Specifies an identifier for a field of the record type.

datatype

Specifies a supported data type, such as NUMBER, VARCHAR2, RECORD, VARRAY, or associative array type.

Example

The following example shows a the definition of a record type with two fields:

```
CREATE TYPE objtyp AS OBJECT
(
  c1    NUMBER
  c2    VARCHAR2(10)
):
END
```

Associative arrays (PL/SQL)

A PL/SQL associative array is a collection type that associates a unique key with a value.

An associative array has the following characteristics:

- An associative array type must be defined before array variables of that array type can be declared. Data manipulation occurs in the array variable.
- The array does not need to be initialized; simply assign values to array elements.
- There is no defined limit on the number of elements in the array; it grows dynamically as elements are added.
- The array can be *sparse*; there can be gaps in the assignment of values to keys.
- An attempt to reference an array element that has not been assigned a value results in an exception.

Use the TYPE IS TABLE OF statement to define an associative array type.

Syntax

►► TYPE *assoctype* IS TABLE OF *datatype* INDEX BY (*BINARY_INTEGER* | *PLS_INTEGER* | *VARCHAR2*(-*n*-))

Description

TYPE *assoctype*

Specifies an identifier for the array type.

datatype

Specifies a supported data type, such as VARCHAR2, NUMBER, RECORD, VARRAY, or associative array type. The %TYPE attribute and the %ROWTYPE attribute are also supported.

INDEX BY

Specifies that the associative array is to be indexed by one of the data types introduced by this clause.

BINARY_INTEGER

Integer numeric data.

PLS_INTEGER

Integer numeric data.

VARCHAR2 (*n*)

A variable-length character string of maximum length *n*. The %TYPE attribute is also supported if the object to which the %TYPE attribute is being applied is of the BINARY_INTEGER, PLS_INTEGER, or VARCHAR2 data type.

To declare a variable with an associative array type, specify *array-name assoctype*, where *array-name* represents an identifier that is assigned to the associative array, and *assoctype* represents the identifier for a previously declared array type.

To reference a particular element of the array, specify *array-name(n)*, where *array-name* represents the identifier for a previously declared array, and *n* represents a value of INDEX BY data type of *assoctype*. If the array is defined from a record type, the reference becomes *array-name(n).field*, where *field* is defined within the record type from which the array type is defined. To reference the entire record, omit *field*.

Examples

The following example reads the first ten employee names from the EMP table, stores them in an array, and then displays the contents of the array.

```
SET SERVEROUTPUT ON
/

CREATE OR REPLACE PACKAGE pkg_test_type1
IS
    TYPE emp_arr_typ IS TABLE OF VARCHAR2(10) INDEX BY BINARY_INTEGER;
END pkg_test_type1
/

DECLARE
    emp_arr          pkg_test_type1.emp_arr_typ;
    CURSOR emp_cur IS SELECT ename FROM emp WHERE ROWNUM <= 10;
    i                INTEGER := 0;
BEGIN
    FOR r_emp IN emp_cur LOOP
        i := i + 1;
        emp_arr(i) := r_emp.ename;
    END LOOP;
    FOR j IN 1..10 LOOP
```

```

        DBMS_OUTPUT.PUT_LINE(emp_arr(j));
    END LOOP;
END
/

```

This code generates the following sample output:

```

SMITH
ALLEN
WARD
JONES
MARTIN
BLAKE
CLARK
SCOTT
KING
TURNER

```

The example can be modified to use a record type in the array definition.

```

SET SERVEROUTPUT ON
/

CREATE OR REPLACE PACKAGE pkg_test_type2
IS
    TYPE emp_rec_typ IS RECORD (
        empno    INTEGER,
        ename    VARCHAR2(10)
    );
END pkg_test_type2
/

CREATE OR REPLACE PACKAGE pkg_test_type3
IS
    TYPE emp_arr_typ IS TABLE OF pkg_test_type2.emp_rec_typ INDEX BY BINARY_INTEGER;
END pkg_test_type3
/

DECLARE
    emp_arr          pkg_test_type3.emp_arr_typ;
    CURSOR emp_cur IS SELECT empno, ename FROM emp WHERE ROWNUM <= 10;
    i                INTEGER := 0;
BEGIN
    DBMS_OUTPUT.PUT_LINE('EMPNO    ENAME');
    DBMS_OUTPUT.PUT_LINE('-----    -----');
    FOR r_emp IN emp_cur LOOP
        i := i + 1;
        emp_arr(i).empno := r_emp.empno;
        emp_arr(i).ename := r_emp.ename;
    END LOOP;
    FOR j IN 1..10 LOOP
        DBMS_OUTPUT.PUT_LINE(emp_arr(j).empno || '    ' ||
            emp_arr(j).ename);
    END LOOP;
END
/

```

The modified code generates the following sample output:

```

EMPNO    ENAME
-----    -----
1001     SMITH
1002     ALLEN
1003     WARD
1004     JONES
1005     MARTIN
1006     BLAKE

```

```

1007    CLARK
1008    SCOTT
1009    KING
1010    TURNER

```

This example can be further modified to use the emp%ROWTYPE attribute to define emp_arr_typ, instead of using the emp_rec_typ record type.

```

SET SERVEROUTPUT ON
/

CREATE OR REPLACE PACKAGE pkg_test_type4
IS
    TYPE emp_arr_typ IS TABLE OF emp%ROWTYPE INDEX BY BINARY_INTEGER;
END pkg_test_type4
/

DECLARE
    emp_arr          pkg_test_type4.emp_arr_typ;
    CURSOR emp_cur IS SELECT empno, ename FROM emp WHERE ROWNUM <= 10;
    i                INTEGER := 0;
BEGIN
    DBMS_OUTPUT.PUT_LINE('EMPNO    ENAME');
    DBMS_OUTPUT.PUT_LINE('-----    -----');
    FOR r_emp IN emp_cur LOOP
        i := i + 1;
        emp_arr(i).empno := r_emp.empno;
        emp_arr(i).ename := r_emp.ename;
    END LOOP;
    FOR j IN 1..10 LOOP
        DBMS_OUTPUT.PUT_LINE(emp_arr(j).empno || '    ' ||
            emp_arr(j).ename);
    END LOOP;
END
/

```

In this case, the sample output is identical to that of the previous example.

Finally, instead of assigning each field of the record individually, a record-level assignment can be made from r_emp to emp_arr:

```

SET SERVEROUTPUT ON
/

CREATE OR REPLACE PACKAGE pkg_test_type5
IS
    TYPE emp_rec_typ IS RECORD (
        empno    INTEGER,
        ename    VARCHAR2(10)
    );
END pkg_test_type5
/

CREATE OR REPLACE PACKAGE pkg_test_type6
IS
    TYPE emp_arr_typ IS TABLE OF pkg_test_type5.emp_rec_typ INDEX BY BINARY_INTEGER;
END pkg_test_type6
/

DECLARE
    emp_arr          pkg_test_type6.emp_arr_typ;
    CURSOR emp_cur IS SELECT empno, ename FROM emp WHERE ROWNUM <= 10;
    i                INTEGER := 0;
BEGIN
    DBMS_OUTPUT.PUT_LINE('EMPNO    ENAME');
    DBMS_OUTPUT.PUT_LINE('-----    -----');
    FOR r_emp IN emp_cur LOOP

```

```

        i := i + 1;
        emp_arr(i) := r_emp;
    END LOOP;
    FOR j IN 1..10 LOOP
        DBMS_OUTPUT.PUT_LINE(emp_arr(j).empno || ' ' ||
            emp_arr(j).ename);
    END LOOP;
END
/

```

Collection methods (PL/SQL)

Collection methods can be used to obtain information about collections or to modify collections.

The following commands should be executed before attempting to run the examples in Table 4.

```

db2set DB2_COMPATIBILITY_VECTOR=ORA
db2stop
db2start
db2 connect to mydb

```

The MYDB database has one table, EMP, which has one column, ENAME (defined as VARCHAR(10)):

```
db2 select * from emp
```

```

ENAME
-----
Curly
Larry
Moe
Shemp
Joe

```

5 record(s) selected.

Table 4. Collection methods that are supported (or tolerated) by the DB2 data server in a PL/SQL context

Collection method	Description	Example
COUNT	Returns the number of elements in a collection.	<pre> CREATE PACKAGE foo AS TYPE sparse_arr_typ IS TABLE OF NUMBER INDEX BY BINARY_INTEGER; END; / SET SERVEROUTPUT ON / DECLARE sparse_arr foo.sparse_arr_typ; BEGIN sparse_arr(-10) := -10; sparse_arr(0) := 0; sparse_arr(10) := 10; DBMS_OUTPUT.PUT_LINE('COUNT: ' sparse_arr.COUNT); END; / </pre>

Table 4. Collection methods that are supported (or tolerated) by the DB2 data server in a PL/SQL context (continued)

Collection method	Description	Example
DELETE	Removes all elements from a collection.	<pre> CREATE PACKAGE foo AS TYPE names_typ IS TABLE OF VARCHAR2(10) INDEX BY BINARY_INTEGER; END; / SET SERVEROUTPUT ON / DECLARE actor_names foo.names_typ; BEGIN actor_names(1) := 'Chris'; actor_names(2) := 'Steve'; actor_names(3) := 'Kate'; actor_names(4) := 'Naomi'; actor_names(5) := 'Peter'; actor_names(6) := 'Philip'; actor_names(7) := 'Michael'; actor_names(8) := 'Gary'; DBMS_OUTPUT.PUT_LINE('COUNT: ' actor_names.COUNT); actor_names.DELETE(2); DBMS_OUTPUT.PUT_LINE('COUNT: ' actor_names.COUNT); actor_names.DELETE(3, 5); DBMS_OUTPUT.PUT_LINE('COUNT: ' actor_names.COUNT); actor_names.DELETE; DBMS_OUTPUT.PUT_LINE('COUNT: ' actor_names.COUNT); END; / </pre>
DELETE (<i>n</i>)	Removes element <i>n</i> from an associative array. You cannot delete individual elements from a VARRAY collection type.	See "DELETE".
DELETE (<i>n1</i> , <i>n2</i>)	Removes all elements from <i>n1</i> to <i>n2</i> from an associative array. You cannot delete individual elements from a VARRAY collection type.	See "DELETE".

Table 4. Collection methods that are supported (or tolerated) by the DB2 data server in a PL/SQL context (continued)

Collection method	Description	Example
EXISTS (<i>n</i>)	Returns TRUE if the specified element exists.	<pre> CREATE PACKAGE foo AS TYPE emp_arr_typ IS VARRAY(5) OF VARCHAR2(10); END; / SET SERVEROUTPUT ON / DECLARE emp_arr foo.emp_arr_typ; CURSOR emp_cur IS SELECT ename FROM emp WHERE ROWNUM <= 5; i INTEGER := 0; BEGIN FOR r_emp IN emp_cur LOOP i := i + 1; emp_arr.EXTEND; emp_arr(i) := r_emp.ename; END LOOP; emp_arr.TRIM; FOR j IN 1..5 LOOP IF emp_arr.EXISTS(j) = true THEN DBMS_OUTPUT.PUT_LINE(emp_arr(j)); ELSE DBMS_OUTPUT.PUT_LINE('THIS ELEMENT HAS BEEN DELETED'); END IF; END LOOP; END; / </pre>
EXTEND	Appends a single NULL element to a collection.	See “EXISTS (<i>n</i>)”.
EXTEND (<i>n</i>)	Appends <i>n</i> NULL elements to a collection.	See “EXISTS (<i>n</i>)”.
EXTEND (<i>n1</i> , <i>n2</i>)	Appends <i>n1</i> copies of the <i>n2</i> th element to a collection.	See “EXISTS (<i>n</i>)”.

Table 4. Collection methods that are supported (or tolerated) by the DB2 data server in a PL/SQL context (continued)

Collection method	Description	Example
FIRST	Returns the smallest index number in a collection.	<pre> CREATE PACKAGE foo AS TYPE emp_arr_typ IS VARRAY(5) OF VARCHAR2(10); END; / SET SERVEROUTPUT ON / DECLARE emp_arr foo.emp_arr_typ; CURSOR emp_cur IS SELECT ename FROM emp WHERE ROWNUM <= 5; i INTEGER := 0; k INTEGER := 0; l INTEGER := 0; BEGIN FOR r_emp IN emp_cur LOOP i := i + 1; emp_arr(i) := r_emp.ename; END LOOP; -- Use FIRST and LAST to specify the lower and -- upper bounds of a loop range: FOR j IN emp_arr.FIRST..emp_arr.LAST LOOP DBMS_OUTPUT.PUT_LINE(emp_arr(j)); END LOOP; -- Use NEXT(n) to obtain the subscript of -- the next element: k := emp_arr.FIRST; WHILE k IS NOT NULL LOOP DBMS_OUTPUT.PUT_LINE(emp_arr(k)); k := emp_arr.NEXT(k); END LOOP; -- Use PRIOR(n) to obtain the subscript of -- the previous element: l := emp_arr.LAST; WHILE l IS NOT NULL LOOP DBMS_OUTPUT.PUT_LINE(emp_arr(l)); l := emp_arr.PRIOR(l); END LOOP; DBMS_OUTPUT.PUT_LINE('COUNT: ' emp_arr.COUNT); emp_arr.TRIM; DBMS_OUTPUT.PUT_LINE('COUNT: ' emp_arr.COUNT); emp_arr.TRIM(2); DBMS_OUTPUT.PUT_LINE('COUNT: ' emp_arr.COUNT); DBMS_OUTPUT.PUT_LINE('Max. no. elements = ' emp_arr.LIMIT); END; / </pre>
LAST	Returns the largest index number in a collection.	See "FIRST".

Table 4. Collection methods that are supported (or tolerated) by the DB2 data server in a PL/SQL context (continued)

Collection method	Description	Example
LIMIT	Returns the maximum number of elements for a VARRAY, or NULL for nested tables.	See "FIRST".
NEXT (<i>n</i>)	Returns the index number of the element immediately following the specified element.	See "FIRST".
PRIOR (<i>n</i>)	Returns the index number of the element immediately prior to the specified element.	See "FIRST".
TRIM	Removes a single element from the end of a collection. You cannot trim elements from an associative array collection type.	See "FIRST".
TRIM (<i>n</i>)	Removes <i>n</i> elements from the end of a collection. You cannot trim elements from an associative array collection type.	See "FIRST".

Chapter 17. Variables (PL/SQL)

Variables must be declared before they are referenced.

Variables that are used in a block must generally be defined in the declaration section of the block unless they are global variables or package-level variables. The declaration section contains the definitions of variables, cursors, and other types that can be used in PL/SQL statements within the block. A variable declaration consists of a name that is assigned to the variable and the data type of the variable. Optionally, the variable can be initialized to a default value within the variable declaration.

Procedures and functions can have parameters for passing input values. Procedures can also have parameters for passing output values, or parameters for passing both input and output values.

PL/SQL also includes variable data types to match the data types of existing columns, rows, or cursors using the %TYPE and %ROWTYPE qualifiers.

Variable declarations (PL/SQL)

Variables that are used in a block must generally be defined in the declaration section of the block unless they are global variables or package-level variables. A variable declaration consists of a name that is assigned to the variable and the data type of the variable. Optionally, the variable can be initialized to a default value within the variable declaration.

Syntax

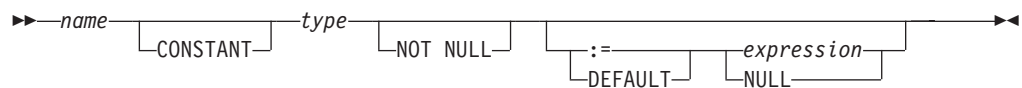

Description

name

Specifies an identifier that is assigned to the variable.

CONSTANT

Specifies that the variable value is constant. A default expression must be assigned, and a new value cannot be assigned to the variable within the application program.

type

Specifies a data type for the variable.

NOT NULL

Currently ignored by DB2. Routines that specify NOT NULL for variable declarations compile successfully. However, such routines behave as though NOT NULL has not been specified. No run-time checking is performed to disallow null values in variables declared NOT NULL. See the following example, if your application needs to restrict null values in PL/SQL variables.

DEFAULT

Specifies a default value for the variable. This default is evaluated every time

that the block is entered. For example, if SYSDATE has been assigned to a variable of type DATE, the variable resolves to the current invocation time, not to the time at which the procedure or function was precompiled.

- :=** The assignment operator is a synonym for the DEFAULT keyword. However, if this operator is specified without *expression*, the variable is initialized to the value NULL.

expression

Specifies the initial value that is to be assigned to the variable when the block is entered.

NULL

Specifies the SQL value NULL, which has a null value.

Examples

1. The following procedure shows variable declarations that utilize defaults consisting of string and numeric expressions:

```
CREATE OR REPLACE PROCEDURE dept_salary_rpt (  
    p_deptno      NUMBER  
)  
IS  
    todays_date   DATE := SYSDATE;  
    rpt_title     VARCHAR2(60) := 'Report For Department # ' || p_deptno  
        || ' on ' || todays_date;  
    base_sal      INTEGER := 35525;  
    base_comm_rate NUMBER := 1.33333;  
    base_annual   NUMBER := ROUND(base_sal * base_comm_rate, 2);  
BEGIN  
    DBMS_OUTPUT.PUT_LINE(rpt_title);  
    DBMS_OUTPUT.PUT_LINE('Base Annual Salary: ' || base_annual);  
END;
```

The following sample output was obtained by calling this procedure:

```
CALL dept_salary_rpt(20);
```

```
Report For Department # 20 on 10-JUL-07 16:44:45  
Base Annual Salary: 47366.55
```

2. The following example restricts null values by adding explicit checks using IS NULL or IS NOT NULL and handles error cases as required:

```
create table T(coll integer);  
insert into T values null;  
  
declare  
    N integer not null := 0;  
    null_variable exception;  
begin  
    select coll into N from T;  
    if N is null then  
        raise null_variable;  
    end if;  
exception  
    when null_variable then  
        -- Handle error condition here.  
        dbms_output.put_line('Null variable detected');  
end;
```

Parameter modes (PL/SQL)

PL/SQL procedure parameters can have one of three possible modes: IN, OUT, or IN OUT. PL/SQL function parameters can only be IN.

- An IN formal parameter is initialized to the actual parameter with which it was called, unless it was explicitly initialized with a default value. The IN parameter can be referenced within the called program; however, the called program cannot assign a new value to the IN parameter. After control returns to the calling program, the actual parameter always contains the value to which it was set prior to the call.
- An OUT formal parameter is initialized to the actual parameter with which it was called. The called program can reference and assign new values to the formal parameter. If the called program terminates without an exception, the actual parameter takes on the value to which the formal parameter was last set. If a handled exception occurs, the actual parameter takes on the last value to which the formal parameter was set. If an unhandled exception occurs, the value of the actual parameter remains what it was prior to the call.
- Like an IN parameter, an IN OUT formal parameter is initialized to the actual parameter with which it was called. Like an OUT parameter, an IN OUT formal parameter is modifiable by the called program, and the last value of the formal parameter is passed to the calling program's actual parameter if the called program terminates without an exception. If a handled exception occurs, the actual parameter takes on the last value to which the formal parameter was set. If an unhandled exception occurs, the value of the actual parameter remains what it was prior to the call.

Table 5 summarizes this behavior.

Table 5. Parameter modes

Mode property	IN	IN OUT	OUT
Formal parameter initialized to:	Actual parameter value	Actual parameter value	Actual parameter value
Formal parameter modifiable by the called program?	No	Yes	Yes
After normal termination of the called program, actual parameter contains:	Original actual parameter value prior to the call	Last value of the formal parameter	Last value of the formal parameter
After a handled exception in the called program, actual parameter contains:	Original actual parameter value prior to the call	Last value of the formal parameter	Last value of the formal parameter
After an unhandled exception in the called program, actual parameter contains:	Original actual parameter value prior to the call	Original actual parameter value prior to the call	Original actual parameter value prior to the call

Data types (PL/SQL)

The DB2 data server supports a wide range of data types that can be used to declare variables in a PL/SQL block.

Table 6. Supported scalar data types that are available in PL/SQL

PL/SQL data type	DB2 SQL data type	Description
BINARY_INTEGER	INTEGER	Integer numeric data
BLOB	BLOB (4096)	Binary data
BLOB (<i>n</i>)	BLOB (<i>n</i>) <i>n</i> = 1 to 2 147 483 647	Binary large object data
BOOLEAN	BOOLEAN	Logical Boolean (true or false)
CHAR	CHAR (1)	Fixed-length character string data of length 1
CHAR (<i>n</i>)	CHAR (<i>n</i>) <i>n</i> = 1 to 254	Fixed-length character string data of length <i>n</i>
CHAR VARYING (<i>n</i>)	VARCHAR (<i>n</i>)	Variable-length character string data of maximum length <i>n</i>
CHARACTER	CHARACTER (1)	Fixed-length character string data of length 1
CHARACTER (<i>n</i>)	CHARACTER (<i>n</i>) <i>n</i> = 1 to 254	Fixed-length character string data of length <i>n</i>
CHARACTER VARYING (<i>n</i>)	VARCHAR (<i>n</i>) <i>n</i> = 1 to 32 672	Variable-length character string data of maximum length <i>n</i>
CLOB	CLOB (1M)	Character large object data
CLOB (<i>n</i>)	CLOB (<i>n</i>) <i>n</i> = 1 to 2 147 483 647	Fixed-length long character string data of length <i>n</i>
DATE	DATE ¹	Date and time data (expressed to the second)
DEC	DEC (9, 2)	Decimal numeric data
DEC (<i>p</i>)	DEC (<i>p</i>) <i>p</i> = 1 to 31	Decimal numeric data of precision <i>p</i>
DEC (<i>p</i> , <i>s</i>)	DEC (<i>p</i> , <i>s</i>) <i>p</i> = 1 to 31; <i>s</i> = 1 to 31	Decimal numeric data of precision <i>p</i> and scale <i>s</i>
DECIMAL	DECIMAL (9, 2)	Decimal numeric data
DECIMAL (<i>p</i>)	DECIMAL (<i>p</i>) <i>p</i> = 1 to 31	Decimal numeric data of precision <i>p</i>
DECIMAL (<i>p</i> , <i>s</i>)	DECIMAL (<i>p</i> , <i>s</i>) <i>p</i> = 1 to 31; <i>s</i> = 1 to 31	Decimal numeric data of precision <i>p</i> and scale <i>s</i>
DOUBLE	DOUBLE	Double precision floating-point number
DOUBLE PRECISION	DOUBLE PRECISION	Double precision floating-point number
FLOAT	FLOAT	Float numeric data
FLOAT (<i>n</i>) <i>n</i> = 1 to 24	REAL	Real numeric data

Table 6. Supported scalar data types that are available in PL/SQL (continued)

PL/SQL data type	DB2 SQL data type	Description
FLOAT (<i>n</i>) <i>n</i> = 25 to 53	DOUBLE	Double numeric data
INT	INT	Signed four-byte integer numeric data
INTEGER	INTEGER	Signed four-byte integer numeric data
LONG	CLOB (32760)	Character large object data
LONG RAW	BLOB (32760)	Binary large object data
LONG VARCHAR	CLOB (32760)	Character large object data
NATURAL	INTEGER	Signed four-byte integer numeric data
NCHAR	GRAPHIC (127)	Fixed-length graphic string data
NCHAR (<i>n</i>) <i>n</i> = 1 to 2000	GRAPHIC (<i>n</i>) <i>n</i> = 1 to 127	Fixed-length graphic string data of length <i>n</i>
NCLOB ²	DBCLOB (1M)	Double-byte character large object data
NCLOB (<i>n</i>)	DBCLOB (2000)	Double-byte long character string data of maximum length <i>n</i>
NVARCHAR2	VARGRAPHIC (2048)	Variable-length graphic string data
NVARCHAR2 (<i>n</i>)	VARGRAPHIC (<i>n</i>)	Variable-length graphic string data of maximum length <i>n</i>
NUMBER	NUMBER ³	Exact numeric data
NUMBER (<i>p</i>)	NUMBER (<i>p</i>) ³	Exact numeric data of maximum precision <i>p</i>
NUMBER (<i>p</i> , <i>s</i>)	NUMBER (<i>p</i> , <i>s</i>) ³ <i>p</i> = 1 to 31	Exact numeric data of maximum precision <i>p</i> and scale <i>s</i>
NUMERIC	NUMERIC (9.2)	Exact numeric data
NUMERIC (<i>p</i>)	NUMERIC (<i>p</i>) <i>p</i> = 1 to 31	Exact numeric data of maximum precision <i>p</i>
NUMERIC (<i>p</i> , <i>s</i>)	NUMERIC (<i>p</i> , <i>s</i>) <i>p</i> = 1 to 31; <i>s</i> = 0 to 31	Exact numeric data of maximum precision <i>p</i> and scale <i>s</i>
PLS_INTEGER	INTEGER	Integer numeric data
RAW	BLOB (32767)	Binary large object data
RAW (<i>n</i>)	BLOB (<i>n</i>) <i>n</i> = 1 to 32 767	Binary large object data
SMALLINT	SMALLINT	Signed two-byte integer data
TIMESTAMP (0)	TIMESTAMP (0)	Date data with timestamp information
TIMESTAMP (<i>p</i>)	TIMESTAMP (<i>p</i>)	Date and time data with optional fractional seconds and precision <i>p</i>

Table 6. Supported scalar data types that are available in PL/SQL (continued)

PL/SQL data type	DB2 SQL data type	Description
VARCHAR	VARCHAR (4096)	Variable-length character string data with a maximum length of 4096 characters
VARCHAR (<i>n</i>)	VARCHAR (<i>n</i>)	Variable-length character string data with a maximum length of <i>n</i> characters
VARCHAR2 (<i>n</i>)	VARCHAR2 (<i>n</i>) ⁴	Variable-length character string data with a maximum length of <i>n</i> characters
<ol style="list-style-type: none"> 1. When the DB2_COMPATIBILITY_VECTOR registry variable is set for the DATE data type, DATE is equivalent to TIMESTAMP (0). 2. For restrictions on the NCLOB data type in certain database environments, see "Restrictions on PL/SQL support". 3. This data type is supported when the number_compat database configuration parameter set to ON. 4. This data type is supported when the varchar2_compat database configuration parameter set to ON. 		

In addition to the scalar data types described in Table 6 on page 164, the DB2 data server also supports collection types, record types, and REF CURSOR types.

%TYPE attribute in variable declarations (PL/SQL)

The %TYPE attribute, used in PL/SQL variable and parameter declarations, is supported by the DB2 data server. Use of this attribute ensures that type compatibility between table columns and PL/SQL variables is maintained.

A qualified column name in dot notation or the name of a previously declared variable must be specified as a prefix to the %TYPE attribute. The data type of this column or variable is assigned to the variable being declared. If the data type of the column or variable changes, there is no need to modify the declaration code.

The %TYPE attribute can also be used with formal parameter declarations.

Syntax

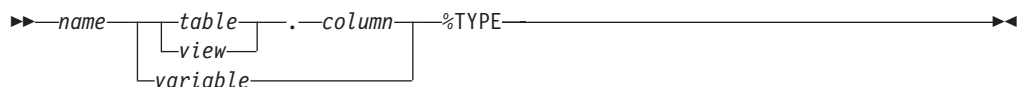

Description

name

Specifies an identifier for the variable or formal parameter that is being declared.

table

Specifies an identifier for the table whose column is to be referenced.

view

Specifies an identifier for the view whose column is to be referenced.

column

Specifies an identifier for the table or view column that is to be referenced.

variable

Specifies an identifier for a previously declared variable that is to be referenced. The variable does not inherit any other column attributes, such as, for example, the nullability attribute.

Example

The following example shows a procedure that queries the EMP table using an employee number, displays the employee's data, finds the average salary of all employees in the department to which the employee belongs, and then compares the chosen employee's salary with the department average.

```
CREATE OR REPLACE PROCEDURE emp_sal_query (
    p_empno      IN NUMBER
)
IS
    v_ename      VARCHAR2(10);
    v_job        VARCHAR2(9);
    v_hiredate   DATE;
    v_sal        NUMBER(7,2);
    v_deptno     NUMBER(2);
    v_avgsal     NUMBER(7,2);
BEGIN
    SELECT ename, job, hiredate, sal, deptno
        INTO v_ename, v_job, v_hiredate, v_sal, v_deptno
        FROM emp WHERE empno = p_empno;
    DBMS_OUTPUT.PUT_LINE('Employee # : ' || p_empno);
    DBMS_OUTPUT.PUT_LINE('Name       : ' || v_ename);
    DBMS_OUTPUT.PUT_LINE('Job         : ' || v_job);
    DBMS_OUTPUT.PUT_LINE('Hire Date  : ' || v_hiredate);
    DBMS_OUTPUT.PUT_LINE('Salary     : ' || v_sal);
    DBMS_OUTPUT.PUT_LINE('Dept #    : ' || v_deptno);

    SELECT AVG(sal) INTO v_avgsal
        FROM emp WHERE deptno = v_deptno;
    IF v_sal > v_avgsal THEN
        DBMS_OUTPUT.PUT_LINE('Employee's salary is more than the department '
            || 'average of ' || v_avgsal);
    ELSE
        DBMS_OUTPUT.PUT_LINE('Employee's salary does not exceed the department '
            || 'average of ' || v_avgsal);
    END IF;
END;
```

This procedure could be rewritten without explicitly coding the EMP table data types in the declaration section.

```
CREATE OR REPLACE PROCEDURE emp_sal_query (
    p_empno      IN emp.empno%TYPE
)
IS
    v_ename      emp.ename%TYPE;
    v_job        emp.job%TYPE;
    v_hiredate   emp.hiredate%TYPE;
    v_sal        emp.sal%TYPE;
    v_deptno     emp.deptno%TYPE;
    v_avgsal     v_sal%TYPE;
BEGIN
    SELECT ename, job, hiredate, sal, deptno
        INTO v_ename, v_job, v_hiredate, v_sal, v_deptno
        FROM emp WHERE empno = p_empno;
    DBMS_OUTPUT.PUT_LINE('Employee # : ' || p_empno);
    DBMS_OUTPUT.PUT_LINE('Name       : ' || v_ename);
```

```

DBMS_OUTPUT.PUT_LINE('Job      : ' || v_job);
DBMS_OUTPUT.PUT_LINE('Hire Date : ' || v_hiredate);
DBMS_OUTPUT.PUT_LINE('Salary   : ' || v_sal);
DBMS_OUTPUT.PUT_LINE('Dept #   : ' || v_deptno);

SELECT AVG(sal) INTO v_avgsal
  FROM emp WHERE deptno = v_deptno;
IF v_sal > v_avgsal THEN
  DBMS_OUTPUT.PUT_LINE('Employee's salary is more than the department '
    || 'average of ' || v_avgsal);
ELSE
  DBMS_OUTPUT.PUT_LINE('Employee's salary does not exceed the department '
    || 'average of ' || v_avgsal);
END IF;
END;

```

The `p_empno` parameter is an example of a formal parameter that is defined using the `%TYPE` attribute. The `v_avgsal` variable is an example of the `%TYPE` attribute referring to another variable instead of a table column.

The following sample output is generated by a call to the `EMP_SAL_QUERY` procedure:

```
CALL emp_sal_query(7698);
```

```

Employee # : 7698
Name       : BLAKE
Job        : MANAGER
Hire Date  : 01-MAY-81 00:00:00
Salary     : 2850.00
Dept #     : 30
Employee's salary is more than the department average of 1566.67

```

SUBTYPE definitions (PL/SQL)

A *subtype* is a definition of a type based on a built-in type.

Subtypes provide a layer of abstraction between variables and parameters and the data types that they use. This layer allows you to concentrate any changes to the data types in one location. You can add constraints to subtypes so that they cannot be nullable or limited to a specific range of values.

Subtypes can be defined in:

- CREATE PACKAGE statement (PL/SQL)
- CREATE PACKAGE BODY statement (PL/SQL)
- CREATE PROCEDURE (PL/SQL)
- CREATE FUNCTION (PL/SQL)
- CREATE TRIGGER (PL/SQL)
- Anonymous block (PL/SQL)

Syntax

```

▶▶ SUBTYPE type-name IS built-in-type

```

RANGE *start-value* .. *end-value*
NOT NULL

Description

SUBTYPE *type-name*

Specifies an identifier for the subtype.

built-in-type

Specifies the built-in data type that the subtype is based on.

RANGE *start-value* .. *end-value*

Optionally defines a range of values within the domain of the subtype that is valid for the subtype.

NOT NULL

Optionally defines that the subtype is not nullable.

Example

The following example shows a package that defines a subtype for small integers:

```
CREATE OR REPLACE PACKAGE math
IS
SUBTYPE tinyint IS INTEGER RANGE -256 .. 255 NOT NULL
END;
```

%ROWTYPE attribute in record type declarations (PL/SQL)

The %ROWTYPE attribute, used to declare PL/SQL variables of type record with fields that correspond to the columns of a table or view, is supported by the DB2 data server. Each field in a PL/SQL record assumes the data type of the corresponding column in the table.

A *record* is a named, ordered collection of fields. A *field* is similar to a variable; it has an identifier and a data type, but it also belongs to a record, and must be referenced using dot notation, with the record name as a qualifier.

Syntax

►► *record* — $\left\{ \begin{array}{l} \textit{table} \\ \textit{view} \end{array} \right.$ — %ROWTYPE —►►

Description

record

Specifies an identifier for the record.

table

Specifies an identifier for the table whose column definitions will be used to define the fields in the record.

view

Specifies an identifier for the view whose column definitions will be used to define the fields in the record.

%ROWTYPE

Specifies that the record field data types are to be derived from the column data types that are associated with the identified table or view. Record fields do not inherit any other column attributes, such as, for example, the nullability attribute.

Example

The following example shows how to use the %ROWTYPE attribute to create a record (named r_emp) instead of declaring individual variables for the columns in the EMP table.

```
CREATE OR REPLACE PROCEDURE emp_sal_query (
    p_empno          IN emp.empno%TYPE
)
IS
    r_emp            emp%ROWTYPE;
    v_avgsal         emp.sal%TYPE;
BEGIN
    SELECT ename, job, hiredate, sal, deptno
        INTO r_emp.ename, r_emp.job, r_emp.hiredate, r_emp.sal, r_emp.deptno
        FROM emp WHERE empno = p_empno;
    DBMS_OUTPUT.PUT_LINE('Employee # : ' || p_empno);
    DBMS_OUTPUT.PUT_LINE('Name       : ' || r_emp.ename);
    DBMS_OUTPUT.PUT_LINE('Job       : ' || r_emp.job);
    DBMS_OUTPUT.PUT_LINE('Hire Date : ' || r_emp.hiredate);
    DBMS_OUTPUT.PUT_LINE('Salary    : ' || r_emp.sal);
    DBMS_OUTPUT.PUT_LINE('Dept #    : ' || r_emp.deptno);

    SELECT AVG(sal) INTO v_avgsal
        FROM emp WHERE deptno = r_emp.deptno;
    IF r_emp.sal > v_avgsal THEN
        DBMS_OUTPUT.PUT_LINE('Employee's salary is more than the department '
            || 'average of ' || v_avgsal);
    ELSE
        DBMS_OUTPUT.PUT_LINE('Employee's salary does not exceed the department '
            || 'average of ' || v_avgsal);
    END IF;
END;
```

Chapter 18. Basic statements (PL/SQL)

The programming statements that can be used in a PL/SQL application include: assignment, DELETE, EXECUTE IMMEDIATE, INSERT, NULL, SELECT INTO, and UPDATE.

NULL statement (PL/SQL)

The NULL statement is an executable statement that does nothing. The NULL statement can act as a placeholder whenever an executable statement is required, but no SQL operation is wanted; for example, within a branch of the IF-THEN-ELSE statement.

Syntax

►►—NULL—◄◄

Examples

The following example shows the simplest valid PL/SQL program that the DB2 data server can compile:

```
BEGIN
  NULL;
END;
```

The following example shows the NULL statement within an IF..THEN..ELSE statement:

```
CREATE OR REPLACE PROCEDURE divide_it (
  p_numerator    IN NUMBER,
  p_denominator  IN NUMBER,
  p_result       OUT NUMBER
)
IS
BEGIN
  IF p_denominator = 0 THEN
    NULL;
  ELSE
    p_result := p_numerator / p_denominator;
  END IF;
END;
```

Assignment statement (PL/SQL)

The assignment statement sets a previously-declared variable or formal OUT or IN OUT parameter to the value of an expression.

Syntax

►►—*variable* := *expression*—◄◄

Description

variable

Specifies an identifier for a previously-declared variable, OUT formal parameter, or IN OUT formal parameter.

expression

Specifies an expression that evaluates to a single value. The data type of this value must be compatible with the data type of *variable*.

Example

The following example shows assignment statements in the executable section of a procedure:

```
CREATE OR REPLACE PROCEDURE dept_salary_rpt (
  p_deptno      IN  NUMBER,
  p_base_annual OUT  NUMBER
)
IS
  todays_date   DATE;
  rpt_title     VARCHAR2(60);
  base_sal      INTEGER;
  base_comm_rate NUMBER;
BEGIN
  todays_date := SYSDATE;
  rpt_title := 'Report For Department # ' || p_deptno || ' on '
    || todays_date;
  base_sal := 35525;
  base_comm_rate := 1.33333;
  p_base_annual := ROUND(base_sal * base_comm_rate, 2);

  DBMS_OUTPUT.PUT_LINE(rpt_title);
  DBMS_OUTPUT.PUT_LINE('Base Annual Salary: ' || p_base_annual);
END
/
```

EXECUTE IMMEDIATE statement (PL/SQL)

The EXECUTE IMMEDIATE statement prepares an executable form of an SQL statement from a character string form of the statement and then executes the SQL statement. EXECUTE IMMEDIATE combines the basic functions of the PREPARE and EXECUTE statements.

Invocation

This statement can only be specified in a PL/SQL context.

Authorization

The authorization rules are those defined for the specified SQL statement.

The authorization ID of the statement might be affected by the DYNAMICRULES bind option.

Syntax

►► EXECUTE IMMEDIATE *sql-expression* ►►

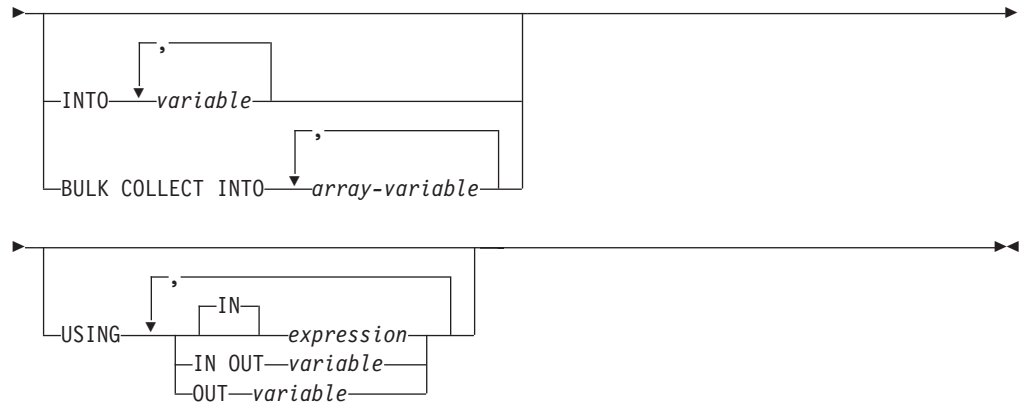

Description

sql-expression

An expression returning the statement string to be executed. The expression must return a character-string type that is less than the maximum statement size of 2 097 152 bytes. Note that a CLOB(2097152) can contain a maximum size statement, but a VARCHAR cannot.

The statement string must be one of the following SQL statements:

- ALTER
- CALL
- COMMENT
- COMMIT
- Compound SQL (compiled)
- Compound SQL (inlined)
- CREATE
- DECLARE GLOBAL TEMPORARY TABLE
- DELETE
- DROP
- EXPLAIN
- FLUSH EVENT MONITOR
- FLUSH PACKAGE CACHE
- GRANT
- INSERT
- LOCK TABLE
- MERGE
- REFRESH TABLE
- RELEASE SAVEPOINT
- RENAME
- REVOKE
- ROLLBACK
- SAVEPOINT
- SELECT (only when the EXECUTE IMMEDIATE statement also specifies the BULK COLLECT INTO clause)
- SET COMPILATION ENVIRONMENT
- SET CURRENT DECFLOAT ROUNDING MODE

- SET CURRENT DEFAULT TRANSFORM GROUP
- SET CURRENT DEGREE
- SET CURRENT FEDERATED ASYNCHRONY
- SET CURRENT EXPLAIN MODE
- SET CURRENT EXPLAIN SNAPSHOT
- SET CURRENT IMPLICIT XMLPARSE OPTION
- SET CURRENT ISOLATION
- SET CURRENT LOCALE LC_TIME
- SET CURRENT LOCK TIMEOUT
- SET CURRENT MAINTAINED TABLE TYPES FOR OPTIMIZATION
- SET CURRENT MDC ROLLOUT MODE
- SET CURRENT OPTIMIZATION PROFILE
- SET CURRENT QUERY OPTIMIZATION
- SET CURRENT REFRESH AGE
- SET CURRENT SQL_CCFLAGS
- SET ROLE (only if DYNAMICRULES run behavior is in effect for the package)
- SET ENCRYPTION PASSWORD
- SET EVENT MONITOR STATE (only if DYNAMICRULES run behavior is in effect for the package)
- SET INTEGRITY
- SET PASSTHRU
- SET PATH
- SET SCHEMA
- SET SERVER OPTION
- SET SESSION AUTHORIZATION
- SET variable
- TRANSFER OWNERSHIP (only if DYNAMICRULES run behavior is in effect for the package)
- TRUNCATE (only if DYNAMICRULES run behavior is in effect for the package)
- UPDATE

The statement string must not contain a statement terminator, with the exception of compound SQL statements which can contain semicolons (;) to separate statements within the compound block. A compound SQL statement is used within some CREATE and ALTER statements which, therefore, can also contain semicolons.

When an EXECUTE IMMEDIATE statement is executed, the specified statement string is parsed and checked for errors. If the SQL statement is invalid, it is not executed, and an exception is thrown.

INTO *variable*

Specifies the name of a variable that is to receive an output value from the corresponding parameter marker.

BULK COLLECT INTO *array-variable*

Identifies one or more variables with an array data type. Each row of the query is assigned to an element in each array in the order of the result set, with the array index assigned in sequence.

- If exactly one *array-variable* is specified:
 - If the data type of the *array-variable* element is not a record type, the SELECT list must have exactly one column and the column data type must be assignable to the array element data type.
 - If the data type of the *array-variable* element is a record type, the SELECT list must be assignable to the record type.
- If multiple array variables are specified:
 - The data type of the *array-variable* element must not be a record type.
 - There must be an *array-variable* for each column in the SELECT list.
 - The data type of each column in the SELECT list must be assignable to the array element data type of the corresponding *array-variable*.

If the data type of *array-variable* is an ordinary array, the maximum cardinality must be greater than or equal to the number of rows that are returned by the query.

This clause can only be used if the *sql-expression* is a SELECT statement.

USING

IN *expression*

Specifies a value that is passed to an input parameter marker. IN is the default.

IN OUT *variable*

Specifies the name of a variable that provides an input value to, or receives an output value from the corresponding parameter marker. This option is not supported when the INTO or BULK COLLECT INTO clause is used.

OUT *variable*

Specifies the name of a variable that receives an output value from the corresponding parameter marker. This option is not supported when the INTO or BULK COLLECT INTO clause is used.

The number and order of evaluated expressions or variables must match the number and order of—and be type-compatible with—the parameter markers in *sql-expression*.

Notes

- Statement caching affects the behavior of an EXECUTE IMMEDIATE statement.

Example

```
CREATE OR REPLACE PROCEDURE proc1( p1 IN NUMBER, p2 IN OUT NUMBER, p3 OUT NUMBER )
IS
BEGIN
  p3 := p1 + 1;
  p2 := p2 + 1;
END;
/

EXECUTE IMMEDIATE 'BEGIN proc1( :1, :2, :3 ); END' USING IN p1 + 10, IN OUT p3,
  OUT p2;

EXECUTE IMMEDIATE 'BEGIN proc1( :1, :2, :3 ); END' INTO p3, p2 USING p1 + 10, p3;
```

SQL statements (PL/SQL)

SQL statements that are supported within PL/SQL contexts can be used to modify data or to specify the manner in which statements are to be executed.

Table 7 lists these statements. The behavior of these statements when executed in PL/SQL contexts is equivalent to the behavior of the corresponding DB2 SQL statements.

Table 7. SQL statements that can be executed by the DB2 server within PL/SQL contexts

Command	Description
DELETE	Deletes rows from a table
INSERT	Inserts rows into a table
MERGE	Updates a target (a table or view) using data from a source (result of a table reference)
SELECT INTO	Retrieves rows from a table
UPDATE	Updates rows in a table

BULK COLLECT INTO clause (PL/SQL)

A SELECT INTO statement with the optional BULK COLLECT keywords preceding the INTO keyword retrieves multiple rows into an array.

Syntax

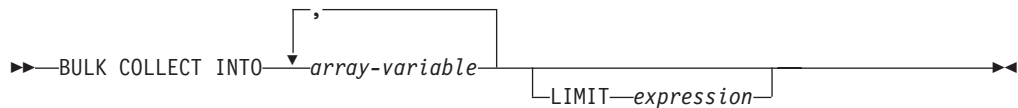

Description

BULK COLLECT INTO *array-variable*

Identifies one or more variables with an array data type. Each row of the result is assigned to an element in each array in the order of the result set, with the array index assigned in sequence.

- If exactly one *array-variable* is specified:
 - If the data type of the *array-variable* element is not a record type, the SELECT list must have exactly one column, and the column data type must be assignable to the array element data type.
 - If the data type of the *array-variable* element is a record type, the SELECT list must be assignable to the record type.
- If multiple array variables are specified:
 - The data type of the *array-variable* element must not be a record type.
 - There must be an *array-variable* for each column in the SELECT list.
 - The data type of each column in the SELECT list must be assignable to the array element data type of the corresponding *array-variable*.

If the data type of *array-variable* is an ordinary array, the maximum cardinality must be greater than or equal to the number of rows that are returned by the query.

LIMIT expression

Provides an upper bound for how many rows are being fetched. The expression can be a numeric literal, a variable, or a complex expression, but it cannot depend on any column from the select statement.

Notes

- Variations of the BULK COLLECT INTO clause are also supported with the FETCH statement and the EXECUTE IMMEDIATE statement.

Example

The following example shows a procedure that uses the BULK COLLECT INTO clause to return an array of rows from the procedure. The procedure and the type for the array are defined in a package.

```
CREATE OR REPLACE PACKAGE bci_sample
IS
  TYPE emps_array IS VARRAY (30) OF VARCHAR2(6);

  PROCEDURE get_dept_empno (
    dno      IN  emp.deptno%TYPE,
    emps_dno OUT emps_array
  );
END bci_sample;

CREATE OR REPLACE PACKAGE BODY bci_sample
IS
  PROCEDURE get_dept_empno (
    dno      IN  emp.deptno%TYPE,
    emps_dno OUT emps_array
  )
  IS
  BEGIN
    SELECT empno BULK COLLECT INTO emps_dno
    FROM emp
    WHERE deptno=dno;
  END get_dept_empno;
END bci_sample;
```

RETURNING INTO clause (PL/SQL)

INSERT, UPDATE, and DELETE statements that are appended with the optional RETURNING INTO clause can be compiled by the DB2 data server. When used in PL/SQL contexts, this clause captures the newly added, modified, or deleted values from executing INSERT, UPDATE, or DELETE statements, respectively.

Syntax

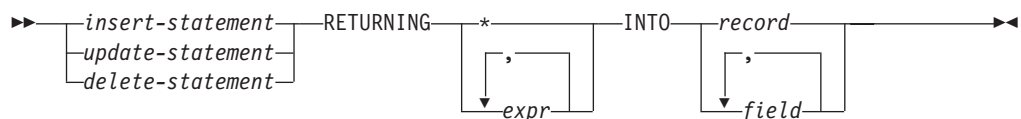

Description

insert-statement

Specifies a valid INSERT statement. An exception is raised if the INSERT statement returns a result set that contains more than one row.

update-statement

Specifies a valid UPDATE statement. An exception is raised if the UPDATE statement returns a result set that contains more than one row.

delete-statement

Specifies a valid DELETE statement. An exception is raised if the DELETE statement returns a result set that contains more than one row.

RETURNING *

Specifies that all of the values from the row that is affected by the INSERT, UPDATE, or DELETE statement are to be made available for assignment.

RETURNING *expr*

Specifies an expression to be evaluated against the row that is affected by the INSERT, UPDATE, or DELETE statement. The evaluated results are assigned to a specified record or fields.

INTO *record*

Specifies that the returned values are to be stored in a record with compatible fields and data types. The fields must match in number, order, and data type those values that are specified with the RETURNING clause. If the result set contains no rows, the fields in the record are set to the null value.

INTO *field*

Specifies that the returned values are to be stored in a set of variables with compatible fields and data types. The fields must match in number, order, and data type those values that are specified with the RETURNING clause. If the result set contains no rows, the fields are set to the null value.

Examples

The following example shows a procedure that uses the RETURNING INTO clause:

```
CREATE OR REPLACE PROCEDURE emp_comp_update (
    p_empno      IN emp.empno%TYPE,
    p_sal        IN emp.sal%TYPE,
    p_comm       IN emp.comm%TYPE
)
IS
    v_empno      emp.empno%TYPE;
    v_ename      emp.ename%TYPE;
    v_job        emp.job%TYPE;
    v_sal        emp.sal%TYPE;
    v_comm       emp.comm%TYPE;
    v_deptno     emp.deptno%TYPE;
BEGIN
    UPDATE emp SET sal = p_sal, comm = p_comm WHERE empno = p_empno
    RETURNING
        empno,
        ename,
        job,
        sal,
        comm,
        deptno
    INTO
        v_empno,
        v_ename,
        v_job,
        v_sal,
        v_comm,
        v_deptno;

    IF SQL%FOUND THEN
```

```

        DBMS_OUTPUT.PUT_LINE('Updated Employee # : ' || v_empno);
        DBMS_OUTPUT.PUT_LINE('Name                : ' || v_ename);
        DBMS_OUTPUT.PUT_LINE('Job                 : ' || v_job);
        DBMS_OUTPUT.PUT_LINE('Department      : ' || v_deptno);
        DBMS_OUTPUT.PUT_LINE('New Salary     : ' || v_sal);
        DBMS_OUTPUT.PUT_LINE('New Commission  : ' || v_comm);
    ELSE
        DBMS_OUTPUT.PUT_LINE('Employee # ' || p_empno || ' not found');
    END IF;
END;
```

This procedure returns the following sample output:

```
EXEC emp_comp_update(9503, 6540, 1200);
```

```

Updated Employee # : 9503
Name                : PETERSON
Job                 : ANALYST
Department         : 40
New Salary         : 6540.00
New Commission     : 1200.00
```

The following example shows a procedure that uses the RETURNING INTO clause with record types:

```

CREATE OR REPLACE PROCEDURE emp_delete (
    p_empno      IN emp.empno%TYPE
)
IS
    r_emp        emp%ROWTYPE;
BEGIN
    DELETE FROM emp WHERE empno = p_empno
    RETURNING
        *
    INTO
        r_emp;

    IF SQL%FOUND THEN
        DBMS_OUTPUT.PUT_LINE('Deleted Employee # : ' || r_emp.empno);
        DBMS_OUTPUT.PUT_LINE('Name                : ' || r_emp.ename);
        DBMS_OUTPUT.PUT_LINE('Job                 : ' || r_emp.job);
        DBMS_OUTPUT.PUT_LINE('Manager             : ' || r_emp.mgr);
        DBMS_OUTPUT.PUT_LINE('Hire Date          : ' || r_emp.hiredate);
        DBMS_OUTPUT.PUT_LINE('Salary             : ' || r_emp.sal);
        DBMS_OUTPUT.PUT_LINE('Commission         : ' || r_emp.comm);
        DBMS_OUTPUT.PUT_LINE('Department         : ' || r_emp.deptno);
    ELSE
        DBMS_OUTPUT.PUT_LINE('Employee # ' || p_empno || ' not found');
    END IF;
END;
```

This procedure returns the following sample output:

```
EXEC emp_delete(9503);
```

```

Deleted Employee # : 9503
Name                : PETERSON
Job                 : ANALYST
Manager            : 7902
Hire Date          : 31-MAR-05 00:00:00
Salary             : 6540.00
Commission         : 1200.00
Department         : 40
```

Statement attributes (PL/SQL)

SQL%FOUND, SQL%NOTFOUND, and SQL%ROWCOUNT are PL/SQL attributes that can be used to determine the effect of an SQL statement.

- The SQL%FOUND attribute has a Boolean value that returns TRUE if at least one row was affected by an INSERT, UPDATE, or DELETE statement, or if a SELECT INTO statement retrieved one row. The following example shows an anonymous block in which a row is inserted and a status message is displayed.

```
BEGIN
  INSERT INTO emp (empno,ename,job,sal,deptno)
    VALUES (9001, 'JONES', 'CLERK', 850.00, 40);
  IF SQL%FOUND THEN
    DBMS_OUTPUT.PUT_LINE('Row has been inserted');
  END IF;
END;
```

- The SQL%NOTFOUND attribute has a Boolean value that returns TRUE if no rows were affected by an INSERT, UPDATE, or DELETE statement, or if a SELECT INTO statement did not retrieve a row. For example:

```
BEGIN
  UPDATE emp SET hiredate = '03-JUN-07' WHERE empno = 9000;
  IF SQL%NOTFOUND THEN
    DBMS_OUTPUT.PUT_LINE('No rows were updated');
  END IF;
END;
```

- The SQL%ROWCOUNT attribute has an integer value that represents the number of rows that were affected by an INSERT, UPDATE, or DELETE statement. For example:

```
BEGIN
  UPDATE emp SET hiredate = '03-JUN-07' WHERE empno = 9001;
  DBMS_OUTPUT.PUT_LINE('# rows updated: ' || SQL%ROWCOUNT);
END;
```

Chapter 19. Control statements (PL/SQL)

Control statements are the programming statements that make PL/SQL a full procedural complement to SQL.

A number of PL/SQL control statements can be compiled by the DB2 data server.

IF statement (PL/SQL)

Use the IF statement within PL/SQL contexts to execute SQL statements on the basis of certain criteria.

The four forms of the IF statement are:

- IF...THEN...END IF
- IF...THEN...ELSE...END IF
- IF...THEN...ELSE IF...END IF
- IF...THEN...ELSIF...THEN...ELSE...END IF

IF...THEN...END IF

The syntax of this statement is:

```
IF boolean-expression THEN
  statements
END IF;
```

IF...THEN statements are the simplest form of IF. The statements between THEN and END IF are executed only if the condition evaluates to TRUE. In the following example, an IF...THEN statement is used to test for and to display those employees who have a commission.

```
DECLARE
  v_empno      emp.empno%TYPE;
  v_comm       emp.comm%TYPE;
  CURSOR emp_cursor IS SELECT empno, comm FROM emp;
BEGIN
  OPEN emp_cursor;
  DBMS_OUTPUT.PUT_LINE('EMPNO   COMM');
  DBMS_OUTPUT.PUT_LINE('-----   -----');
  LOOP
    FETCH emp_cursor INTO v_empno, v_comm;
    EXIT WHEN emp_cursor%NOTFOUND;
  --
  -- Test whether or not the employee gets a commission
  --
    IF v_comm IS NOT NULL AND v_comm > 0 THEN
      DBMS_OUTPUT.PUT_LINE(v_empno || ' ' ||
        TO_CHAR(v_comm, '$99999.99'));
    END IF;
  END LOOP;
  CLOSE emp_cursor;
END;
```

This program generates the following sample output:

```

EMPNO    COMM
-----  -
7499    $300.00
7521    $500.00
7654    $1400.00

```

IF...THEN...ELSE...END IF

The syntax of this statement is:

```

IF boolean-expression THEN
  statements
ELSE
  statements
END IF;

```

IF...THEN...ELSE statements specify an alternative set of statements that should be executed if the condition evaluates to FALSE. In the following example, the previous example is modified so that an IF...THEN...ELSE statement is used to display the text “Non-commission” if an employee does not have a commission.

```

DECLARE
  v_empno      emp.empno%TYPE;
  v_comm       emp.comm%TYPE;
  CURSOR emp_cursor IS SELECT empno, comm FROM emp;
BEGIN
  OPEN emp_cursor;
  DBMS_OUTPUT.PUT_LINE('EMPNO    COMM');
  DBMS_OUTPUT.PUT_LINE('-----  -----');
  LOOP
    FETCH emp_cursor INTO v_empno, v_comm;
    EXIT WHEN emp_cursor%NOTFOUND;
  --
  -- Test whether or not the employee gets a commission
  --
    IF v_comm IS NOT NULL AND v_comm > 0 THEN
      DBMS_OUTPUT.PUT_LINE(v_empno || ' ' ||
        TO_CHAR(v_comm, '$99999.99'));
    ELSE
      DBMS_OUTPUT.PUT_LINE(v_empno || ' ' || 'Non-commission');
    END IF;
  END LOOP;
  CLOSE emp_cursor;
END;

```

This program generates the following sample output:

```

EMPNO    COMM
-----  -
7369    Non-commission
7499    $   300.00
7521    $   500.00
7566    Non-commission
7654    $  1400.00
7698    Non-commission
7782    Non-commission
7788    Non-commission
7839    Non-commission
7844    Non-commission
7876    Non-commission
7900    Non-commission
7902    Non-commission
7934    Non-commission

```

IF...THEN...ELSE IF...END IF

The syntax of this statement is:

```
IF boolean-expression THEN
  IF boolean-expression THEN
    statements
ELSE
  IF boolean-expression THEN
    statements
END IF;
```

You can nest IF statements so that alternative IF statements are invoked, depending on whether the conditions of an outer IF statement evaluate to TRUE or FALSE. In the following example, the outer IF...THEN...ELSE statement tests whether or not an employee has a commission. The inner IF...THEN...ELSE statements subsequently test whether the employee's total compensation exceeds or is less than the company average. When you use this form of the IF statement, you are actually nesting an IF statement inside of the ELSE part of an outer IF statement. You therefore need one END IF for each nested IF and one for the parent IF...ELSE. (Note that the logic in this program can be simplified considerably by calculating each employee's yearly compensation using an NVL function within the SELECT statement of the cursor declaration; however, the purpose of this example is to demonstrate how IF statements can be used.)

```
DECLARE
  v_empno          emp.empno%TYPE;
  v_sal            emp.sal%TYPE;
  v_comm           emp.comm%TYPE;
  v_avg            NUMBER(7,2);
  CURSOR emp_cursor IS SELECT empno, sal, comm FROM emp;
BEGIN
  --
  -- Calculate the average yearly compensation
  --
  SELECT AVG((sal + NVL(comm,0)) * 24) INTO v_avg FROM emp;
  DBMS_OUTPUT.PUT_LINE('Average Yearly Compensation: ' ||
    TO_CHAR(v_avg, '$999,999.99'));
  OPEN emp_cursor;
  DBMS_OUTPUT.PUT_LINE('EMPNO   YEARLY COMP');
  DBMS_OUTPUT.PUT_LINE('-----   -----');
  LOOP
    FETCH emp_cursor INTO v_empno, v_sal, v_comm;
    EXIT WHEN emp_cursor%NOTFOUND;
  --
  -- Test whether or not the employee gets a commission
  --
    IF v_comm IS NOT NULL AND v_comm > 0 THEN
  --
  -- Test whether the employee's compensation with commission exceeds
  -- the company average
  --
      IF (v_sal + v_comm) * 24 > v_avg THEN
        DBMS_OUTPUT.PUT_LINE(v_empno || ' ' ||
          TO_CHAR((v_sal + v_comm) * 24, '$999,999.99') ||
          ' Exceeds Average');
      ELSE
        DBMS_OUTPUT.PUT_LINE(v_empno || ' ' ||
          TO_CHAR((v_sal + v_comm) * 24, '$999,999.99') ||
          ' Below Average');
      END IF;
    ELSE
  --
  -- Test whether the employee's compensation without commission exceeds
  -- the company average
```

```

--
        IF v_sal * 24 > v_avg THEN
            DBMS_OUTPUT.PUT_LINE(v_empno || ' ' ||
                TO_CHAR(v_sal * 24, '$999,999.99') || ' Exceeds Average');
        ELSE
            DBMS_OUTPUT.PUT_LINE(v_empno || ' ' ||
                TO_CHAR(v_sal * 24, '$999,999.99') || ' Below Average');
        END IF;
    END IF;
END LOOP;
CLOSE emp_cursor;
END;

```

This program generates the following sample output:

```

Average Yearly Compensation: $ 53,528.57
EMPNO  YEARLY COMP
-----  -
7369  $ 19,200.00 Below Average
7499  $ 45,600.00 Below Average
7521  $ 42,000.00 Below Average
7566  $ 71,400.00 Exceeds Average
7654  $ 63,600.00 Exceeds Average
7698  $ 68,400.00 Exceeds Average
7782  $ 58,800.00 Exceeds Average
7788  $ 72,000.00 Exceeds Average
7839  $ 120,000.00 Exceeds Average
7844  $ 36,000.00 Below Average
7876  $ 26,400.00 Below Average
7900  $ 22,800.00 Below Average
7902  $ 72,000.00 Exceeds Average
7934  $ 31,200.00 Below Average

```

IF...THEN...ELSIF...THEN...ELSE...END IF

The syntax of this statement is:

```

IF boolean-expression THEN
    statements
[ ELSIF boolean-expression THEN
    statements
[ ELSIF boolean-expression THEN
    statements ] ...]
[ ELSE
    statements ]
END IF;

```

IF...THEN...ELSIF...ELSE statements provide the means for checking many alternatives in one statement. Formally, this statement is equivalent to nested IF...THEN...ELSE...IF...THEN statements, but only one END IF is needed. The following example uses an IF...THEN...ELSIF...ELSE statement to count the number of employees by compensation, in steps of \$25,000.

```

DECLARE
    v_empno          emp.empno%TYPE;
    v_comp           NUMBER(8,2);
    v_lt_25K        SMALLINT := 0;
    v_25K_50K       SMALLINT := 0;
    v_50K_75K       SMALLINT := 0;
    v_75K_100K      SMALLINT := 0;
    v_ge_100K       SMALLINT := 0;
CURSOR emp_cursor IS SELECT empno, (sal + NVL(comm,0)) * 24 FROM emp;
BEGIN
    OPEN emp_cursor;
    LOOP
        FETCH emp_cursor INTO v_empno, v_comp;
        EXIT WHEN emp_cursor%NOTFOUND;

```

```

        IF v_comp < 25000 THEN
            v_lt_25K := v_lt_25K + 1;
        ELSIF v_comp < 50000 THEN
            v_25K_50K := v_25K_50K + 1;
        ELSIF v_comp < 75000 THEN
            v_50K_75K := v_50K_75K + 1;
        ELSIF v_comp < 100000 THEN
            v_75K_100K := v_75K_100K + 1;
        ELSE
            v_ge_100K := v_ge_100K + 1;
        END IF;
    END LOOP;
    CLOSE emp_cursor;
    DBMS_OUTPUT.PUT_LINE('Number of employees by yearly compensation');
    DBMS_OUTPUT.PUT_LINE('Less than 25,000 : ' || v_lt_25K);
    DBMS_OUTPUT.PUT_LINE('25,000 - 49,9999 : ' || v_25K_50K);
    DBMS_OUTPUT.PUT_LINE('50,000 - 74,9999 : ' || v_50K_75K);
    DBMS_OUTPUT.PUT_LINE('75,000 - 99,9999 : ' || v_75K_100K);
    DBMS_OUTPUT.PUT_LINE('100,000 and over : ' || v_ge_100K);
END;
```

This program generates the following sample output:

```

Number of employees by yearly compensation
Less than 25,000 : 2
25,000 - 49,9999 : 5
50,000 - 74,9999 : 6
75,000 - 99,9999 : 0
100,000 and over : 1
```

CASE statement (PL/SQL)

The CASE statement executes a set of one or more statements when a specified search condition is true. CASE is a standalone statement that is distinct from the CASE expression, which must appear as part of an expression.

There are two forms of the CASE statement: the simple CASE statement and the searched CASE statement.

Simple CASE statement (PL/SQL)

The simple CASE statement attempts to match an expression (known as the *selector*) to another expression that is specified in one or more WHEN clauses. A match results in the execution of one or more corresponding statements.

Syntax

►►—CASE—*selector-expression*—►►

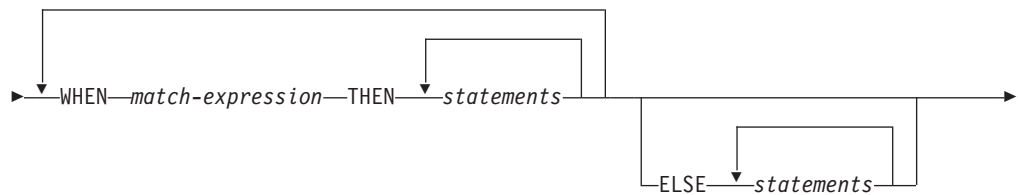

Description

CASE *selector-expression*

Specifies an expression whose value has a data type that is compatible with each *match-expression*. If the value of *selector-expression* matches the first *match-expression*, the statements in the corresponding THEN clause are executed. If there are no matches, the statements in the corresponding ELSE clause are executed. If there are no matches and there is no ELSE clause, an exception is thrown.

WHEN *match-expression*

Specifies an expression that is evaluated within the CASE statement. If *selector-expression* matches a *match-expression*, the statements in the corresponding THEN clause are executed.

THEN

A keyword that introduces the statements that are to be executed when the corresponding Boolean expression evaluates to TRUE.

statements

Specifies one or more SQL or PL/SQL statements, each terminated with a semicolon.

ELSE

A keyword that introduces the default case of the CASE statement.

Example

The following example uses a simple CASE statement to assign a department name and location to a variable that is based upon the department number.

```

DECLARE
    v_empno      emp.empno%TYPE;
    v_ename      emp.ename%TYPE;
    v_deptno     emp.deptno%TYPE;
    v_dname      dept.dname%TYPE;
    v_loc        dept.loc%TYPE;
    CURSOR emp_cursor IS SELECT empno, ename, deptno FROM emp;
BEGIN
    OPEN emp_cursor;
    DBMS_OUTPUT.PUT_LINE('EMPNO      ENAME      DEPTNO      DNAME      '
        || '      LOC');
    DBMS_OUTPUT.PUT_LINE('-----      -
        -----      -
        -----      -
        || '      -----');
    LOOP
        FETCH emp_cursor INTO v_empno, v_ename, v_deptno;
        EXIT WHEN emp_cursor%NOTFOUND;
        CASE v_deptno
            WHEN 10 THEN v_dname := 'Accounting';
                       v_loc   := 'New York';
            WHEN 20 THEN v_dname := 'Research';
                       v_loc   := 'Dallas';
            WHEN 30 THEN v_dname := 'Sales';
                       v_loc   := 'Chicago';
            WHEN 40 THEN v_dname := 'Operations';
                       v_loc   := 'Boston';
            ELSE v_dname := 'unknown';
               v_loc   := '';
        END CASE;
    END LOOP;
END;

```

```

        END CASE;
        DBMS_OUTPUT.PUT_LINE(v_empno || ' ' || RPAD(v_ename, 10) ||
            ' ' || v_deptno || ' ' || RPAD(v_dname, 14) || ' ' ||
            v_loc);
    END LOOP;
    CLOSE emp_cursor;
END;
```

This program returns the following sample output:

EMPNO	ENAME	DEPTNO	DNAME	LOC
7369	SMITH	20	Research	Dallas
7499	ALLEN	30	Sales	Chicago
7521	WARD	30	Sales	Chicago
7566	JONES	20	Research	Dallas
7654	MARTIN	30	Sales	Chicago
7698	BLAKE	30	Sales	Chicago
7782	CLARK	10	Accounting	New York
7788	SCOTT	20	Research	Dallas
7839	KING	10	Accounting	New York
7844	TURNER	30	Sales	Chicago
7876	ADAMS	20	Research	Dallas
7900	JAMES	30	Sales	Chicago
7902	FORD	20	Research	Dallas
7934	MILLER	10	Accounting	New York

Searched CASE statement (PL/SQL)

A searched CASE statement uses one or more Boolean expressions to determine which statements to execute.

Syntax



Description

CASE

A keyword that introduces the first WHEN clause in the CASE statement.

WHEN *boolean-expression*

Specifies an expression that is evaluated when control flow enters the WHEN clause in which the expression is defined. If *boolean-expression* evaluates to TRUE, the statements in the corresponding THEN clause are executed. If *boolean-expression* does not evaluate to TRUE, the statements in the corresponding ELSE clause are executed.

THEN

A keyword that introduces the statements that are to be executed when the corresponding Boolean expression evaluates to TRUE.

statements

Specifies one or more SQL or PL/SQL statements, each terminated with a semicolon.

ELSE

A keyword that introduces the default case of the CASE statement.

Example

The following example uses a searched CASE statement to assign a department name and location to a variable that is based upon the department number.

```
DECLARE
    v_empno      emp.empno%TYPE;
    v_ename      emp.ename%TYPE;
    v_deptno     emp.deptno%TYPE;
    v_dname      dept.dname%TYPE;
    v_loc        dept.loc%TYPE;
    CURSOR emp_cursor IS SELECT empno, ename, deptno FROM emp;
BEGIN
    OPEN emp_cursor;
    DBMS_OUTPUT.PUT_LINE('EMPNO      ENAME      DEPTNO      DNAME      '
        || '      LOC');
    DBMS_OUTPUT.PUT_LINE('-----      - - - - -      - - - - -      - - - - -'
        || '      - - - - -');
    LOOP
        FETCH emp_cursor INTO v_empno, v_ename, v_deptno;
        EXIT WHEN emp_cursor%NOTFOUND;
        CASE
            WHEN v_deptno = 10 THEN v_dname := 'Accounting';
                                     v_loc := 'New York';
            WHEN v_deptno = 20 THEN v_dname := 'Research';
                                     v_loc := 'Dallas';
            WHEN v_deptno = 30 THEN v_dname := 'Sales';
                                     v_loc := 'Chicago';
            WHEN v_deptno = 40 THEN v_dname := 'Operations';
                                     v_loc := 'Boston';
            ELSE v_dname := 'unknown';
                 v_loc := '';
        END CASE;
        DBMS_OUTPUT.PUT_LINE(v_empno || '      ' || RPAD(v_ename, 10) ||
            '      ' || v_deptno || '      ' || RPAD(v_dname, 14) || '      ' ||
            v_loc);
    END LOOP;
    CLOSE emp_cursor;
END;
```

This program returns the following sample output:

EMPNO	ENAME	DEPTNO	DNAME	LOC
7369	SMITH	20	Research	Dallas
7499	ALLEN	30	Sales	Chicago
7521	WARD	30	Sales	Chicago
7566	JONES	20	Research	Dallas
7654	MARTIN	30	Sales	Chicago
7698	BLAKE	30	Sales	Chicago
7782	CLARK	10	Accounting	New York
7788	SCOTT	20	Research	Dallas
7839	KING	10	Accounting	New York
7844	TURNER	30	Sales	Chicago
7876	ADAMS	20	Research	Dallas
7900	JAMES	30	Sales	Chicago
7902	FORD	20	Research	Dallas
7934	MILLER	10	Accounting	New York

Loops (PL/SQL)

Use the EXIT, FOR, LOOP, and WHILE statements to repeat a series of commands in your PL/SQL program.

FOR (cursor variant) statement (PL/SQL)

The cursor FOR loop statement opens a previously declared cursor, fetches all rows in the cursor result set, and then closes the cursor.

Use this statement instead of separate SQL statements to open a cursor, define a loop construct to retrieve each row of the result set, test for the end of the result set, and then finally close the cursor.

Invocation

This statement can be invoked within a PL/SQL procedure, function, trigger, or anonymous block.

Authorization

No specific authorization is required to reference a row expression within an SQL statement; however, for successful statement execution, all other authorization requirements for processing a cursor are required.

Syntax

```
►►—FOR—record—IN—cursor—LOOP—statements—END LOOP—◄◄
```

Description

FOR

Introduces the condition that must be true if the FOR loop is to proceed.

record

Specifies an identifier that was assigned to an implicitly declared record with definition `cursor%ROWTYPE`.

IN *cursor*

Specifies the name of a previously declared cursor.

LOOP and END LOOP

Starts and ends the loop containing SQL statements that are to be executed during each iteration through the loop.

statements

One or more PL/SQL statements. A minimum of one statement is required.

Example

The following example shows a procedure that contains a cursor FOR loop:

```
CREATE OR REPLACE PROCEDURE cursor_example
IS
  CURSOR emp_cur_1 IS SELECT * FROM emp;
BEGIN
  DBMS_OUTPUT.PUT_LINE('EMPNO      ENAME');
  DBMS_OUTPUT.PUT_LINE('-----      -');
  FOR v_emp_rec IN emp_cur_1 LOOP
    DBMS_OUTPUT.PUT_LINE(v_emp_rec.empno || '      ' || v_emp_rec.ename);
  END LOOP;
END;
```

FOR (integer variant) statement (PL/SQL)

Use the FOR statement to execute a set of SQL statements more than once.

Invocation

This statement can be embedded within a PL/SQL procedure, function, or anonymous block statement.

Authorization

No privileges are required to invoke the FOR statement; however, the authorization ID of the statement must hold the necessary privileges to invoke the SQL statements that are embedded in the FOR statement.

Syntax

```
▶▶FOR integer-variable IN REVERSE expression1 .. expression2▶▶
▶LOOP statements END LOOP▶▶
```

Description

integer-variable

An automatically defined integer variable that is used during loop processing. The initial value of *integer-variable* is *expression1*. After the initial iteration, the value of *integer-variable* is incremented at the beginning of each subsequent iteration. Both *expression1* and *expression2* are evaluated when entering the loop, and loop processing stops when *integer-variable* is equal to *expression2*.

IN Introduces the optional REVERSE keyword and expressions that define the range of integer variables for the loop.

REVERSE

Specifies that the iteration is to proceed from *expression2* to *expression1*. Note that *expression2* must have a higher value than *expression1*, regardless of whether the REVERSE keyword is specified, if the statements in the loop are to be processed.

expression1

Specifies the initial value of the range of integer variables for the loop. If the REVERSE keyword is specified, *expression1* specifies the end value of the range of integer variables for the loop.

expression2

Specifies the end value of the range of integer variables for the loop. If the REVERSE keyword is specified, *expression2* specifies the initial value of the range of integer variables for the loop.

statements

Specifies the PL/SQL and SQL statements that are executed each time that the loop is processed.

Examples

The following example shows a basic FOR statement within an anonymous block:

```
BEGIN
  FOR i IN 1 .. 10 LOOP
    DBMS_OUTPUT.PUT_LINE('Iteration # ' || i);
  END LOOP;
END;
```

This example generates the following output:

```
Iteration # 1
Iteration # 2
Iteration # 3
Iteration # 4
Iteration # 5
Iteration # 6
Iteration # 7
Iteration # 8
Iteration # 9
Iteration # 10
```

If the start value is greater than the end value, the loop body is not executed at all, but no error is returned, as shown by the following example:

```
BEGIN
  FOR i IN 10 .. 1 LOOP
    DBMS_OUTPUT.PUT_LINE('Iteration # ' || i);
  END LOOP;
END;
```

This example generates no output, because the loop body is never executed.

The following example uses the REVERSE keyword:

```
BEGIN
  FOR i IN REVERSE 1 .. 10 LOOP
    DBMS_OUTPUT.PUT_LINE('Iteration # ' || i);
  END LOOP;
END;
```

This example generates the following output:

```
Iteration # 10
Iteration # 9
Iteration # 8
Iteration # 7
Iteration # 6
Iteration # 5
Iteration # 4
Iteration # 3
Iteration # 2
Iteration # 1
```

FORALL statement (PL/SQL)

The FORALL statement executes a data change statement for all elements of an array or for a range of elements of an array.

Invocation

This statement can only be specified in a PL/SQL block.

Authorization

The privileges held by the authorization ID of the statement must include all of the privileges necessary to invoke the data change statement that is specified in the FORALL statement.

Syntax

```
▶▶—FORALL—index-variable—IN—lower-bound—..—upper-bound—  
    └──INDICES OF—indexing-array—  
    └──VALUES OF—indexing-array—
```



Description

index-variable

Identifies a name to be used as an array index. It is implicitly declared as an INTEGER and it can only be referenced in the FORALL statement.

lower-bound .. upper-bound

Identifies a range of index values that are assignable to the *index-variable* with *lower-bound* less than *upper-bound*. The range represents every integer value starting with *lower-bound* and incrementing by 1 up to and including *upper-bound*.

INDICES OF *indexing-array*

Identifies the set of array index values of the array identified by *indexing-array*. If *indexing-array* is an associative array, array index values must be assignable to *index-variable* and could be a sparse set.

VALUES OF *indexing-array*

Identifies the set of element values of the array identified by *indexing-array*. The element values must be assignable to *index-variable* and could be an unordered sparse set.

insert-statement

Specifies an INSERT statement that is effectively executed for each *index-variable* value.

searched-delete-statement

Specifies a searched DELETE statement that is effectively executed for each *index-variable* value.

searched-update-statement

Specifies a searched UPDATE statement that is effectively executed for each *index-variable* value.

execute-immediate-statement

Specifies an EXECUTE IMMEDIATE statement that is effectively executed for each *index-variable* value.

Notes

- FORALL statement processing is not atomic. If an error occurs while iterating in the FORALL statement, any data change operations that have already been processed are not implicitly rolled back. An application can use a ROLLBACK statement to roll back the entire transaction when an error occurs in the FORALL statement.

Example

The following example shows a basic FORALL statement:

```
FORALL x
  IN in_customer_list.FIRST..in_customer_list.LAST
  DELETE FROM customer
    WHERE cust_id IN in_customer_list(x);
```

EXIT statement (PL/SQL)

The EXIT statement terminates execution of a loop within a PL/SQL code block.

Invocation

This statement can be embedded within a FOR, LOOP, or WHILE statement in a PL/SQL procedure, function, or anonymous block.

Authorization

No privileges are required to invoke the EXIT statement. However, the authorization ID of the statement must hold the necessary privileges to invoke the SQL statements that are embedded within the FOR, LOOP, or WHILE statement.

Syntax

▶▶—EXIT—◀◀

Example

The following example shows a basic LOOP statement with an EXIT statement within an anonymous block:

```
DECLARE
  sum PLS_INTEGER := 0;
BEGIN
  LOOP
    sum := sum + 1;
    IF sum > 10 THEN
      EXIT;
    END IF;
  END LOOP;
END
```

LOOP statement (PL/SQL)

The LOOP statement executes a sequence of statements within a PL/SQL code block multiple times.

Invocation

This statement can be embedded in a PL/SQL procedure, function, or anonymous block statement.

Authorization

No privileges are required to invoke the LOOP statement. However, the authorization ID of the statement must hold the necessary privileges to invoke the SQL statements that are embedded within the LOOP statement.

Syntax

▶▶—LOOP—*statements*—END—LOOP—◀◀

Description

statements

Specifies one or more PL/SQL or SQL statements. These statements are executed during each iteration of the loop.

Example

The following example shows a basic LOOP statement within an anonymous block:

```
DECLARE
  sum INTEGER := 0;
BEGIN
  LOOP
    sum := sum + 1;
    IF sum > 10 THEN
      EXIT;
    END IF;
  END LOOP;
END
```

WHILE statement (PL/SQL)

The WHILE statement repeats a set of SQL statements as long as a specified expression is true. The condition is evaluated immediately before each entry into the loop body.

Invocation

This statement can be embedded within a PL/SQL procedure, function, or anonymous block statement.

Authorization

No privileges are required to invoke the WHILE statement; however, the authorization ID of the statement must hold the necessary privileges to invoke the SQL statements that are embedded in the WHILE statement.

Syntax

▶▶—WHILE—*expression*—LOOP—*statements*—END LOOP—▶▶

Description

expression

Specifies an expression that is evaluated immediately before each entry into the loop body to determine whether or not the loop is to be executed. If the expression is logically true, the loop is executed. If the expression is logically false, loop processing ends. An EXIT statement can be used to terminate the loop while the expression is true.

statements

Specifies the PL/SQL and SQL statements that are executed each time that the loop is processed.

Example

The following example shows a basic WHILE statement within an anonymous block:

```
DECLARE
  sum INTEGER := 0;
BEGIN
  WHILE sum < 11 LOOP
    sum := sum + 1;
  END LOOP;
END
```

The WHILE statement within this anonymous block executes until *sum* is equal to 11; loop processing then ends, and processing of the anonymous block proceeds to completion.

CONTINUE statement (PL/SQL)

The CONTINUE statement terminates the current iteration of a loop within a PL/SQL code block, and moves to the next iteration of the loop.

Invocation

This statement can be embedded within a FOR, LOOP, or WHILE statement, or within a PL/SQL procedure, function, or anonymous block statement.

Authorization

No privileges are required to invoke the CONTINUE statement. However, the authorization ID of the statement must hold the necessary privileges to invoke the SQL statements that are embedded within the FOR, LOOP, or WHILE statement.

Syntax

▶▶—CONTINUE—◀◀

Example

The following example shows a basic LOOP statement with an CONTINUE statement within an anonymous block:

```
BEGIN
  FOR i IN 1 .. 5 LOOP
    IF i = 3 THEN
      CONTINUE;
    END IF;
    DBMS_OUTPUT.PUT_LINE('Iteration # ' || i);
  END LOOP;
END;
```

This example generates the following output:

```
Iteration # 1
Iteration # 2
Iteration # 4
Iteration # 5
```

Exception handling (PL/SQL)

By default, any error encountered in a PL/SQL program stops execution of the program. You can trap and recover from errors by using an EXCEPTION section.

The syntax for exception handlers is an extension of the syntax for a BEGIN block.

Syntax

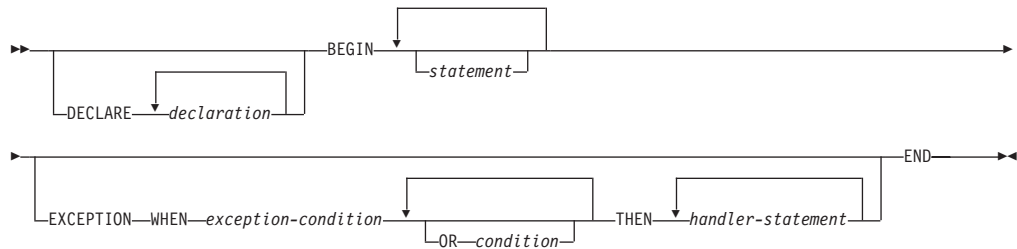

If no error occurs, the block simply executes *statement*, and control passes to the statement after END. However, if an error occurs while executing a *statement*, further processing of the *statement* is abandoned, and control passes to the EXCEPTION section. The WHEN clauses are searched for the first exception matching the error that occurred. If a match is found, the corresponding *handler-statement* is executed, and control passes to the statement after END. If no match is found, the program stops executing.

If a new error occurs during execution of the *handler-statement*, it can only be caught by a surrounding EXCEPTION clause.

Exceptions in a WHEN clause can be either user-defined or built-in. User-defined exceptions can be defined in the DECLARE section of either the current block or its surrounding block, or in the DECLARE section of a PL/SQL package. The syntax PRAGMA EXCEPTION_INIT or PRAGMA DB2_EXCEPTION_INIT can be used immediately after the definition of an exception, specifying the Oracle sqlcode or DB2 sqlstate that corresponds to the user-defined exception.

In the following example, the DECLARE section contains the definitions of three named exceptions. The body of the block is a call to procedure MyApp.Main. The EXCEPTION section contains handlers for the three exceptions:

1. exception1 is not associated with an Oracle sqlcode or a DB2 sqlstate.
2. exception2 is associated with Oracle sqlcode -942 (Undefined name).
3. exception3 is associated with DB2 sqlstate 42601 (syntax error).

```
DECLARE
    exception1 EXCEPTION;
    exception2 EXCEPTION;
    PRAGMA EXCEPTION_INIT(exception2,-942);
    exception3 EXCEPTION;
    PRAGMA DB2_EXCEPTION_INIT(exception3,'42601');
BEGIN
    MyApp.Main(100);
EXCEPTION
    WHEN exception1 THEN
        DBMS_OUTPUT.PUT_LINE('User-defined exception1 caught');
    WHEN exception2 THEN
```

```

        DBMS_OUTPUT.PUT_LINE('User-defined exception2 (Undefined name) caught');
    WHEN exception3 THEN
        DBMS_OUTPUT.PUT_LINE('User-defined exception3 (Syntax error) caught');
END

```

Note: A limited number of Oracle sqlcodes are accepted by DB2 as arguments to PRAGMA EXCEPTION_INIT. Refer to “Oracle-DB2 error mapping (PL/SQL)” on page 200 for the full list.

When an exception initialized with PRAGMA EXCEPTION_INIT is caught, the value returned by the SQLCODE function is the DB2 sqlcode associated with the exception, not the Oracle value. In the previous example, when exception2 is caught, the value returned by SQLCODE will be -204, which is the DB2 sqlcode corresponding to Oracle sqlcode -942. If the Oracle sqlcode specified in PRAGMA EXCEPTION_INIT is not listed in the Oracle-DB2 error mapping table, then compilation fails. You can avoid this by replacing PRAGMA EXCEPTION_INIT with PRAGMA DB2_EXCEPTION_INIT and specifying the DB2 sqlstate corresponding to the error that you want identified.

Table 8 summarizes the built-in exceptions that you can use. The special exception name OTHERS matches every exception. Condition names are not case sensitive.

Table 8. Built-in exception names

Exception name	Description
CASE_NOT_FOUND	None of the cases in a CASE statement evaluates to "true", and there is no ELSE condition.
CURSOR_ALREADY_OPEN	An attempt was made to open a cursor that is already open.
DUP_VAL_ON_INDEX	There are duplicate values for the index key.
INVALID_CURSOR	An attempt was made to access an unopened cursor.
INVALID_NUMBER	The numeric value is invalid.
LOGIN_DENIED	The user name or password is invalid.
NO_DATA_FOUND	No rows satisfied the selection criteria.
NOT_LOGGED_ON	A database connection does not exist.
OTHERS	For any exception that has not been caught by a prior condition in the exception section.
SUBSCRIPT_BEYOND_COUNT	An array index is out of range or does not exist.
SUBSCRIPT_OUTSIDE_LIMIT	The data type of an array index expression is not assignable to the array index type.
TOO_MANY_ROWS	More than one row satisfied the selection criteria, but only one row is allowed to be returned.
VALUE_ERROR	The value is invalid.
ZERO_DIVIDE	Division by zero was attempted.

Raise application error (PL/SQL)

The `RAISE_APPLICATION_ERROR` procedure raises an exception based on a user-provided error code and message. This procedure is only supported in PL/SQL contexts.

Syntax

```
▶▶ RAISE_APPLICATION_ERROR(—error-number—, —message—, keeperrorstack false)—;▶▶
```

Description

error-number

A vendor-specific number that is mapped to a DB2 error code before it is stored in a variable named `SQLCODE`. The `RAISE_APPLICATION_ERROR` procedure accepts user-defined *error-number* values from -20000 to -20999. The `SQLCODE` that is returned in the error message is `SQL0438N`. The `SQLSTATE` contains class 'UD' plus three characters that correspond to the last three digits of the *error-number* value.

message

A user-defined message with a maximum length of 70 bytes.

keeperrorstack

An optional boolean value indicating whether the error stack should be preserved. Currently, only the default value of *false* is supported.

Example

The following example uses the `RAISE_APPLICATION_ERROR` procedure to display error codes and messages that are specific to missing employee information:

```
CREATE OR REPLACE PROCEDURE verify_emp (
    p_empno      NUMBER
)
IS
    v_ename      emp.ename%TYPE;
    v_job        emp.job%TYPE;
    v_mgr        emp.mgr%TYPE;
    v_hiredate   emp.hiredate%TYPE;
BEGIN
    SELECT ename, job, mgr, hiredate
        INTO v_ename, v_job, v_mgr, v_hiredate FROM emp
        WHERE empno = p_empno;
    IF v_ename IS NULL THEN
        RAISE_APPLICATION_ERROR(-20010, 'No name for ' || p_empno);
    END IF;
    IF v_job IS NULL THEN
        RAISE_APPLICATION_ERROR(-20020, 'No job for' || p_empno);
    END IF;
    IF v_mgr IS NULL THEN
        RAISE_APPLICATION_ERROR(-20030, 'No manager for ' || p_empno);
    END IF;
    IF v_hiredate IS NULL THEN
        RAISE_APPLICATION_ERROR(-20040, 'No hire date for ' || p_empno);
    END IF;
    DBMS_OUTPUT.PUT_LINE('Employee ' || p_empno ||
        ' validated without errors');
EXCEPTION
    WHEN OTHERS THEN
```



```

        DBMS_OUTPUT.PUT_LINE('SQLCODE: ' || SQLCODE);
        DBMS_OUTPUT.PUT_LINE('SQLERRM: ' || SQLERRM);
END;

CALL verify_emp(7839);

SQLCODE: -438
SQLERRM: SQL0438N Application raised error or warning with
diagnostic text: "No manager for 7839". SQLSTATE=UD030

```

RAISE statement (PL/SQL)

The RAISE statement raises a previously-defined exception.

Syntax

►►—RAISE—*exception*—◄◄

Description

exception

Specifies a previously-defined exception.

Example

The following example shows a procedure that raises an exception of oddno or evenno based on the value provided as argument in the invocation::

```

CREATE OR REPLACE PROCEDURE raise_demo (inval NUMBER) IS
    evenno EXCEPTION;
    oddno EXCEPTION;
BEGIN
    IF MOD(inval, 2) = 1 THEN
        RAISE oddno;
    ELSE
        RAISE evenno;
    END IF;
EXCEPTION
    WHEN evenno THEN
        dbms_output.put_line(TO_CHAR(inval) || ' is even');
    WHEN oddno THEN
        dbms_output.put_line(TO_CHAR(inval) || ' is odd');
END raise_demo;
/

SET SERVEROUTPUT ON
/

CALL raise_demo (11)
/

```

The output of the CALL statement would be:

```

CALL raise_demo (11)

Return Status = 0

11 is odd

```

Oracle-DB2 error mapping (PL/SQL)

PL/SQL error codes and exception names have corresponding DB2 error codes and SQLSTATE values.

These error codes, exception names, and SQLSTATE values are summarized in Table 9.

Table 9. Mapping of PL/SQL error codes and exception names to DB2 error codes and SQLSTATE values

plsqlCode	plsqlName	db2Code	db2State
-1	DUP_VAL_ON_INDEX	-803	23505
+100	NO_DATA_FOUND	+100	02000
-1012	NOT_LOGGED_ON	-1024	08003
-1017	LOGIN_DENIED	-30082	08001
-1476	ZERO_DIVIDE	-801	22012
-1722	INVALID_NUMBER	-420	22018
-1001	INVALID_CURSOR	-501	24501
-1422	TOO_MANY_ROWS	-811	21000
-6502	VALUE_ERROR	-433	22001
-6511	CURSOR_ALREADY_OPEN	-502	24502
-6532	SUBSCRIPT_OUTSIDE_LIMIT	-20439	428H1
-6533	SUBSCRIPT_BEYOND_COUNT	-20439	2202E
-6592	CASE_NOT_FOUND	-773	20000
-54		-904	57011
-60		-911	40001
-310		-206	42703
-595		-390	42887
-597		-303	42806
-598		-407	23502
-600		-30071	58015
-603		-119	42803
-604		-119	42803
-610		-20500	428HR
-611		-117	42802
-612		-117	42802
-613		-811	21000
-615		-420	22018
-616		-420	22018
-617		-418	42610
-618		-420	22018
-619		-418	42610
-620		-171	42815
-622		-304	22003

Table 9. Mapping of PL/SQL error codes and exception names to DB2 error codes and SQLSTATE values (continued)

plsqlCode	plsqlName	db2Code	db2State
-623		-604	42611
-904		-206	42703
-911		-7	42601
-942		-204	42704
-955		-601	42710
-996		-1022	57011
-1119		-292	57047
-1002		+231	02000
-1403		-100	02000
-1430		-612	42711
-1436		-20451	560CO
-1438		-413	22003
-1450		-614	54008
-1578		-1007	58034
-2112		-811	21000
-2261		+605	01550
-2291		-530	23503
-2292		-532	23001
-3113		-30081	08001
-3114		-1024	08003
-3214		-20170	57059
-3297		-20170	57059
-4061		-727	56098
-4063		-727	56098
-4091		-723	09000
-6502		-304	22003
-6508		-440	42884
-6550		-104	42601
-6553		-104	42601
-14028		-538	42830
-19567		-1523	55039
-30006		-904	57011
-30041		-1139	54047

Chapter 20. Cursors (PL/SQL)

A *cursor* is a named control structure used by an application program to point to and select a row of data from a result set. Instead of executing a query all at once, you can use a cursor to read and process the query result set one row at a time.

A cursor in a PL/SQL context is treated as a WITH HOLD cursor. For more information about WITH HOLD cursors, see “DECLARE CURSOR statement”.

The DB2 data server supports both PL/SQL static cursors and cursor variables.

Static cursors (PL/SQL)

A *static cursor* is a cursor whose associated query is fixed at compile time. Declaring a cursor is a prerequisite to using it. Declarations of static cursors using PL/SQL syntax within PL/SQL contexts are supported by the DB2 server.

Syntax

```
►►—CURSOR—cursor-name—IS—query—◄◄
```

Description

cursor-name

Specifies an identifier for the cursor that can be used to reference the cursor and its result set.

query

Specifies a SELECT statement that determines a result set for the cursor.

Example

The following example shows a procedure that contains multiple static cursor declarations:

```
CREATE OR REPLACE PROCEDURE cursor_example
IS
    CURSOR emp_cur_1 IS SELECT * FROM emp;

    CURSOR emp_cur_2 IS SELECT empno, ename FROM emp;

    CURSOR emp_cur_3 IS SELECT empno, ename
                        FROM emp
                        WHERE deptno = 10
                        ORDER BY empno;
BEGIN
    OPEN emp_cur_1;
    ...
END;
```

Parameterized cursors (PL/SQL)

Parameterized cursors are static cursors that can accept passed-in parameter values when they are opened.

The following example includes a parameterized cursor. The cursor displays the name and salary of each employee in the EMP table whose salary is less than that specified by a passed-in parameter value.

```

DECLARE
    my_record      emp%ROWTYPE;
    CURSOR c1 (max_wage NUMBER) IS
        SELECT * FROM emp WHERE sal < max_wage;
BEGIN
    OPEN c1(2000);
    LOOP
        FETCH c1 INTO my_record;
        EXIT WHEN c1%NOTFOUND;
        DBMS_OUTPUT.PUT_LINE('Name = ' || my_record.ename || ', salary = '
            || my_record.sal);
    END LOOP;
    CLOSE c1;
END;

```

If 2000 is passed in as the value of *max_wage*, only the name and salary data for those employees whose salary is less than 2000 is returned:

```

Name = SMITH, salary = 800.00
Name = ALLEN, salary = 1600.00
Name = WARD, salary = 1250.00
Name = MARTIN, salary = 1250.00
Name = TURNER, salary = 1500.00
Name = ADAMS, salary = 1100.00
Name = JAMES, salary = 950.00
Name = MILLER, salary = 1300.00

```

Opening a cursor (PL/SQL)

The result set that is associated with a cursor cannot be referenced until the cursor has been opened.

Syntax

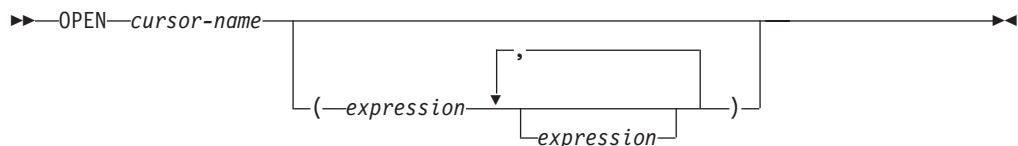

Description

cursor-name

Specifies an identifier for a cursor that was previously declared within a PL/SQL context. The specified cursor cannot already be open.

expression

When *cursor-name* is a parameterized cursor, specifies one or more optional actual parameters. The number of actual parameters must match the number of corresponding formal parameters.

Example

The following example shows an OPEN statement for a cursor that is part of the CURSOR_EXAMPLE procedure:

```

CREATE OR REPLACE PROCEDURE cursor_example
IS
    CURSOR emp_cur_3 IS SELECT empno, ename

```

```

FROM emp
WHERE deptno = 10
ORDER BY empno;

BEGIN
  OPEN emp_cur_3;
  ...
END;

```

Fetching rows from a cursor (PL/SQL)

The FETCH statement that is required to fetch rows from a PL/SQL cursor is supported by the DB2 data server in PL/SQL contexts.

Syntax

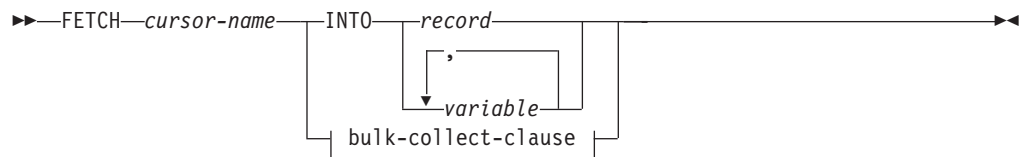

bulk-collect-clause:

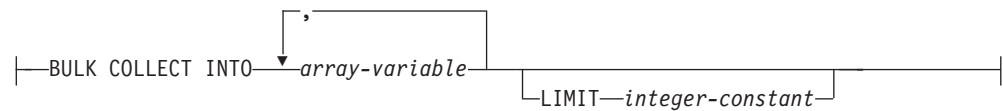

Description

cursor-name

Name of a static cursor or cursor variable.

record

Identifier for a previously-defined record. This can be a user-defined record or a record definition that is derived from a table using the `%ROWTYPE` attribute.

variable

A PL/SQL variable that will hold the field data from the fetched row. One or more variables can be defined, but they must match in order and number the fields that are returned in the select list of the query that was specified in the cursor declaration. The data types of the fields in the select list must match or be implicitly convertible to the data types of the fields in the record or the data types of the variables.

The variable data types can be defined explicitly or by using the `%TYPE` attribute.

BULK COLLECT INTO *array-variable*

Identifies one or more variables with an array data type. Each row of the result is assigned to an element in each array in the order of the result set, with the array index assigned in sequence.

- If exactly one *array-variable* is specified:
 - If the data type of the *array-variable* element is not a record type, the result row of the cursor must have exactly one column, and the column data type must be assignable to the array element data type.

- If the data type of the *array-variable* element is a record type, the result row of the cursor must be assignable to the record type.
- If multiple array variables are specified:
 - The data type of the *array-variable* element must not be a record type.
 - There must be an *array-variable* for each column in the result row of the cursor.
 - The data type of each column in the result row of the cursor must be assignable to the array element data type of the corresponding *array-variable*.

If the data type of *array-variable* is an ordinary array, the maximum cardinality must be greater than or equal to the number of rows that are returned by the query, or greater than or equal to the *integer-constant* that is specified in the LIMIT clause.

LIMIT *integer-constant*

Identifies a limit for the number of rows stored in the target array. The cursor position is moved forward *integer-constant* rows or to the end of the result set.

Example

The following example shows a procedure that contains a FETCH statement.

```
CREATE OR REPLACE PROCEDURE cursor_example
IS
    v_empno      NUMBER(4);
    v_ename      VARCHAR2(10);
    CURSOR emp_cur_3 IS SELECT empno, ename FROM emp WHERE deptno = 10
                        ORDER BY empno;
BEGIN
    OPEN emp_cur_3;
    FETCH emp_cur_3 INTO v_empno, v_ename;
    ...
END;
```

If the %TYPE attribute is used to define the data type of a target variable, the target variable declaration in a PL/SQL application program does not need to change if the data type of the database column changes. The following example shows a procedure with variables that are defined using the %TYPE attribute.

```
CREATE OR REPLACE PROCEDURE cursor_example
IS
    v_empno      emp.empno%TYPE;
    v_ename      emp.ename%TYPE;
    CURSOR emp_cur_3 IS SELECT empno, ename FROM emp WHERE deptno = 10
                        ORDER BY empno;
BEGIN
    OPEN emp_cur_3;
    FETCH emp_cur_3 INTO v_empno, v_ename;
    ...
END;
```

If all of the columns in a table are retrieved in the order in which they are defined, the %ROWTYPE attribute can be used to define a record into which the FETCH statement will place the retrieved data. Each field within the record can then be accessed using dot notation. The following example shows a procedure with a record definition that uses %ROWTYPE. This record is used as the target of the FETCH statement.

```
CREATE OR REPLACE PROCEDURE cursor_example
IS
    v_emp_rec     emp%ROWTYPE;
```



```

        CURSOR emp_cur_1 IS SELECT * FROM emp;
BEGIN
    OPEN emp_cur_1;
    FETCH emp_cur_1 INTO v_emp_rec;
    DBMS_OUTPUT.PUT_LINE('Employee Number: ' || v_emp_rec.empno);
    DBMS_OUTPUT.PUT_LINE('Employee Name : ' || v_emp_rec.ename);
END;

```

Closing a cursor (PL/SQL)

After all rows have been retrieved from the result set that is associated with a cursor, the cursor must be closed. The result set cannot be referenced after the cursor has been closed.

However, the cursor can be reopened and the rows of the new result set can be fetched.

Syntax

```

▶▶—CLOSE—cursor-name—▶▶

```

Description

cursor-name

Specifies an identifier for an open cursor that was previously declared within a PL/SQL context.

Example

The following example shows a CLOSE statement for a cursor that is part of the CURSOR_EXAMPLE procedure:

```

CREATE OR REPLACE PROCEDURE cursor_example
IS
    v_emp_rec      emp%ROWTYPE;
    CURSOR emp_cur_1 IS SELECT * FROM emp;
BEGIN
    OPEN emp_cur_1;
    FETCH emp_cur_1 INTO v_emp_rec;
    DBMS_OUTPUT.PUT_LINE('Employee Number: ' || v_emp_rec.empno);
    DBMS_OUTPUT.PUT_LINE('Employee Name : ' || v_emp_rec.ename);
    CLOSE emp_cur_1;
END;

```

Using %ROWTYPE with cursors (PL/SQL)

The %ROWTYPE attribute is used to define a record with fields corresponding to all of the columns that are fetched from a cursor or cursor variable. Each field assumes the data type of its corresponding column.

The %ROWTYPE attribute is prefixed by a cursor name or a cursor variable name. The syntax is record cursor%ROWTYPE, where *record* is an identifier that is assigned to the record, and *cursor* is an explicitly declared cursor within the current scope.

The following example shows how to use a cursor with the %ROWTYPE attribute to retrieve department information about each employee in the EMP table.

```

CREATE OR REPLACE PROCEDURE emp_info
IS
    CURSOR empcur IS SELECT ename, deptno FROM emp;
    myvar      empcur%ROWTYPE;

```

```

BEGIN
  OPEN empcur;
  LOOP
    FETCH empcur INTO myvar;
    EXIT WHEN empcur%NOTFOUND;
    DBMS_OUTPUT.PUT_LINE( myvar.ename || ' works in department '
      || myvar.deptno );
  END LOOP;
  CLOSE empcur;
END;
```

A call to this procedure (CALL emp_info;) returns the following sample output:

```

SMITH works in department 20
ALLEN works in department 30
WARD works in department 30
JONES works in department 20
MARTIN works in department 30
BLAKE works in department 30
CLARK works in department 10
SCOTT works in department 20
KING works in department 10
TURNER works in department 30
ADAMS works in department 20
JAMES works in department 30
FORD works in department 20
MILLER works in department 10
```

Cursor attributes (PL/SQL)

Each cursor has a set of attributes that enables an application program to test the state of the cursor.

These attributes are %ISOPEN, %FOUND, %NOTFOUND, and %ROWCOUNT.

%ISOPEN

This attribute is used to determine whether a cursor is in the open state. When a cursor is passed as a parameter to a function or procedure, it is useful to know (before attempting to open the cursor) whether the cursor is already open.

%FOUND

This attribute is used to determine whether a cursor contains rows after the execution of a FETCH statement. If FETCH statement execution was successful, the %FOUND attribute has a value of true. If FETCH statement execution was not successful, the %FOUND attribute has a value of false. The result is unknown when:

- The value of *cursor-variable-name* is null
- The underlying cursor of *cursor-variable-name* is not open
- The %FOUND attribute is evaluated before the first FETCH statement was executed against the underlying cursor
- FETCH statement execution returns an error

The %FOUND attribute provides an efficient alternative to using a condition handler that checks for the error that is returned when no more rows remain to be fetched.

%NOTFOUND

This attribute is the logical opposite of the %FOUND attribute.

%ROWCOUNT

This attribute is used to determine the number of rows that have been fetched since a cursor was opened.

Table 10 summarizes the attribute values that are associated with certain cursor events.

Table 10. Summary of cursor attribute values

Cursor attribute	%ISOPEN	%FOUND	%NOTFOUND	%ROWCOUNT
Before OPEN	False	Undefined	Undefined	"Cursor not open" exception
After OPEN and before 1st FETCH	True	Undefined	Undefined	0
After 1st successful FETCH	True	True	False	1
After <i>n</i> th successful FETCH (last row)	True	True	False	<i>n</i>
After <i>n</i> +1st FETCH (after last row)	True	False	True	<i>n</i>
After CLOSE	False	Undefined	Undefined	"Cursor not open" exception

Cursor variables (PL/SQL)

A *cursor variable* is a cursor that contains a pointer to a query result set. The result set is determined by execution of the OPEN FOR statement using the cursor variable.

A cursor variable, unlike a static cursor, is not associated with a particular query. The same cursor variable can be opened a number of times with separate OPEN FOR statements containing different queries. A new result set is created each time and made available through the cursor variable.

SYS_REFCURSOR cursor variables (PL/SQL)

The DB2 server supports the declaration of cursor variables of the SYS_REFCURSOR built-in data type, which can be associated with any result set.

The SYS_REFCURSOR data type is known as a weakly-typed REF CURSOR type. Strongly-typed cursor variables of the REF CURSOR type require a result set specification.

Syntax

```
▶▶—DECLARE—cursor-variable-name—SYS_REFCURSOR—▶▶
```

Description

cursor-variable-name

Specifies an identifier for the cursor variable.

SYS_REFCURSOR

Specifies that the data type of the cursor variable is the built-in SYS_REFCURSOR data type.

Example

The following example shows a SYS_REFCURSOR variable declaration:

```
DECLARE emprefcur SYS_REFCURSOR;
```

User-defined REF CURSOR type variables (PL/SQL)

The DB2 server supports the user-defined REF CURSOR data type and cursor variable declarations.

The user-defined REF CURSOR type can be defined by executing the TYPE declaration in a PL/SQL context. After the type has been defined, you can declare a cursor variable of that type.

Syntax

```
▶▶ TYPE cursor-type-name IS REF CURSOR RETURN return-type ◀◀
```

Description

TYPE *cursor-type-name*

Specifies an identifier for the cursor data type.

IS REF CURSOR

Specifies that the cursor is of a user-defined REF CURSOR data type.

RETURN *return-type*

Specifies the return type that is associated with the cursor. If a *return-type* is specified, this REF CURSOR type is strongly typed; otherwise, it is weakly typed.

Example

The following example shows a cursor variable declaration in the DECLARE section of an anonymous block:

```
DECLARE
  TYPE emp_cur_type IS REF CURSOR RETURN emp%ROWTYPE;
  my_rec emp_cur_type;
BEGIN
  ...
END
```

Dynamic queries with cursor variables (PL/SQL)

The DB2 data server supports dynamic queries through the OPEN FOR statement in PL/SQL contexts.

Syntax

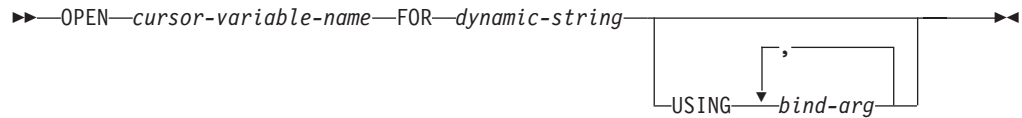

Description

OPEN *cursor-variable-name*

Specifies an identifier for a cursor variable that was previously declared within a PL/SQL context.

FOR *dynamic-string*

Specifies a string literal or string variable that contains a SELECT statement (without the terminating semicolon). The statement can contain named parameters, such as, for example, *:param1*.

USING *bind-arg*

Specifies one or more bind arguments whose values are substituted for placeholders in *dynamic-string* when the cursor opens.

Examples

The following example shows a dynamic query that uses a string literal:

```
CREATE OR REPLACE PROCEDURE dept_query
IS
    emp_refcur    SYS_REFCURSOR;
    v_empno       emp.empno%TYPE;
    v_ename       emp.ename%TYPE;
BEGIN
    OPEN emp_refcur FOR 'SELECT empno, ename FROM emp WHERE deptno = 30' ||
        ' AND sal >= 1500';
    DBMS_OUTPUT.PUT_LINE('EMPNO    ENAME');
    DBMS_OUTPUT.PUT_LINE('-----  -----');
    LOOP
        FETCH emp_refcur INTO v_empno, v_ename;
        EXIT WHEN emp_refcur%NOTFOUND;
        DBMS_OUTPUT.PUT_LINE(v_empno || '    ' || v_ename);
    END LOOP;
    CLOSE emp_refcur;
END;
```

The following example output is generated by the DEPT_QUERY procedure:

```
CALL dept_query;
```

```
EMPNO    ENAME
-----  -----
7499     ALLEN
7698     BLAKE
7844     TURNER
```

The query in the previous example can be modified with bind arguments to pass the query parameters:

```
CREATE OR REPLACE PROCEDURE dept_query (
    p_deptno       emp.deptno%TYPE,
    p_sal          emp.sal%TYPE
)
IS
    emp_refcur     SYS_REFCURSOR;
    v_empno        emp.empno%TYPE;
```

```

        v_ename          emp.ename%TYPE;
BEGIN
    OPEN emp_refcur FOR 'SELECT empno, ename FROM emp WHERE deptno = :dept'
        || ' AND sal >= :sal' USING p_deptno, p_sal;
    DBMS_OUTPUT.PUT_LINE('EMPNO      ENAME');
    DBMS_OUTPUT.PUT_LINE('-----      -');
    LOOP
        FETCH emp_refcur INTO v_empno, v_ename;
        EXIT WHEN emp_refcur%NOTFOUND;
        DBMS_OUTPUT.PUT_LINE(v_empno || '      ' || v_ename);
    END LOOP;
    CLOSE emp_refcur;
END;

```

The following CALL statement generates the same output that was generated in the previous example:

```
CALL dept_query(30, 1500);
```

A string variable to pass the SELECT statement provides the most flexibility:

```

CREATE OR REPLACE PROCEDURE dept_query (
    p_deptno          emp.deptno%TYPE,
    p_sal             emp.sal%TYPE
)
IS
    emp_refcur        SYS_REFCURSOR;
    v_empno           emp.empno%TYPE;
    v_ename           emp.ename%TYPE;
    p_query_string    VARCHAR2(100);
BEGIN
    p_query_string := 'SELECT empno, ename FROM emp WHERE ' ||
        'deptno = :dept AND sal >= :sal';
    OPEN emp_refcur FOR p_query_string USING p_deptno, p_sal;
    DBMS_OUTPUT.PUT_LINE('EMPNO      ENAME');
    DBMS_OUTPUT.PUT_LINE('-----      -');
    LOOP
        FETCH emp_refcur INTO v_empno, v_ename;
        EXIT WHEN emp_refcur%NOTFOUND;
        DBMS_OUTPUT.PUT_LINE(v_empno || '      ' || v_ename);
    END LOOP;
    CLOSE emp_refcur;
END;

```

This version of the DEPT_QUERY procedure generates the following example output:

```
CALL dept_query(20, 1500);
```

```

EMPNO      ENAME
-----      -
7566      JONES
7788      SCOTT
7902      FORD

```

Example: Returning a REF CURSOR from a procedure (PL/SQL)

This example demonstrates how to define and open a REF CURSOR variable, and then pass it as a procedure parameter.

The cursor variable is specified as an IN OUT parameter so that the result set is made available to the caller of the procedure:

```

CREATE OR REPLACE PROCEDURE emp_by_job (
    p_job          VARCHAR2,
    p_emp_refcur   IN OUT SYS_REFCURSOR
)
IS
BEGIN
    OPEN p_emp_refcur FOR SELECT empno, ename FROM emp WHERE job = p_job;
END;

```

The EMP_BY_JOB procedure is invoked in the following anonymous block by assigning the procedure's IN OUT parameter to a cursor variable that was declared in the anonymous block's declaration section. The result set is fetched using this cursor variable.

```

DECLARE
    v_empno      emp.empno%TYPE;
    v_ename      emp.ename%TYPE;
    v_job        emp.job%TYPE := 'SALESMAN';
    v_emp_refcur SYS_REFCURSOR;
BEGIN
    DBMS_OUTPUT.PUT_LINE('EMPLOYEES WITH JOB ' || v_job);
    DBMS_OUTPUT.PUT_LINE('EMPNO   ENAME');
    DBMS_OUTPUT.PUT_LINE('-----');
    emp_by_job(v_job, v_emp_refcur);
    LOOP
        FETCH v_emp_refcur INTO v_empno, v_ename;
        EXIT WHEN v_emp_refcur%NOTFOUND;
        DBMS_OUTPUT.PUT_LINE(v_empno || '   ' || v_ename);
    END LOOP;
    CLOSE v_emp_refcur;
END;

```

The following example output is generated when the anonymous block executes:

```

EMPLOYEES WITH JOB SALESMAN
EMPNO   ENAME
-----
7499    ALLEN
7521    WARD
7654    MARTIN
7844    TURNER

```

Example: Modularizing cursor operations (PL/SQL)

This example demonstrates how various operations on cursor variables can be modularized into separate programs or PL/SQL components.

The following example shows a procedure that opens a cursor variable whose query retrieves all rows in the EMP table:

```

CREATE OR REPLACE PROCEDURE open_all_emp (
    p_emp_refcur   IN OUT SYS_REFCURSOR
)
IS
BEGIN
    OPEN p_emp_refcur FOR SELECT empno, ename FROM emp;
END;

```

In the next example, a procedure opens a cursor variable whose query retrieves all rows for a given department:

```

CREATE OR REPLACE PROCEDURE open_emp_by_dept (
    p_emp_refcur   IN OUT SYS_REFCURSOR,
    p_deptno       emp.deptno%TYPE
)
IS

```

```

BEGIN
    OPEN p_emp_refcur FOR SELECT empno, ename FROM emp
        WHERE deptno = p_deptno;
END;

```

The following example shows a procedure that opens a cursor variable whose query retrieves all rows in the DEPT table:

```

CREATE OR REPLACE PROCEDURE open_dept (
    p_dept_refcur IN OUT SYS_REFCURSOR
)
IS
BEGIN
    OPEN p_dept_refcur FOR SELECT deptno, dname FROM dept;
END;

```

In the next example, a procedure fetches and displays a cursor variable result set consisting of employee number and name:

```

CREATE OR REPLACE PROCEDURE fetch_emp (
    p_emp_refcur IN OUT SYS_REFCURSOR
)
IS
    v_empno emp.empno%TYPE;
    v_ename emp.ename%TYPE;
BEGIN
    DBMS_OUTPUT.PUT_LINE('EMPNO ENAME');
    DBMS_OUTPUT.PUT_LINE('-----');
    LOOP
        FETCH p_emp_refcur INTO v_empno, v_ename;
        EXIT WHEN p_emp_refcur%NOTFOUND;
        DBMS_OUTPUT.PUT_LINE(v_empno || ' ' || v_ename);
    END LOOP;
END;

```

The following example shows a procedure that fetches and displays a cursor variable result set consisting of department number and name:

```

CREATE OR REPLACE PROCEDURE fetch_dept (
    p_dept_refcur IN SYS_REFCURSOR
)
IS
    v_deptno dept.deptno%TYPE;
    v_dname dept.dname%TYPE;
BEGIN
    DBMS_OUTPUT.PUT_LINE('DEPT DNAME');
    DBMS_OUTPUT.PUT_LINE('-----');
    LOOP
        FETCH p_dept_refcur INTO v_deptno, v_dname;
        EXIT WHEN p_dept_refcur%NOTFOUND;
        DBMS_OUTPUT.PUT_LINE(v_deptno || ' ' || v_dname);
    END LOOP;
END;

```

The following example shows a procedure that closes a cursor variable:

```

CREATE OR REPLACE PROCEDURE close_refcur (
    p_refcur IN OUT SYS_REFCURSOR
)
IS
BEGIN
    CLOSE p_refcur;
END;

```

The following example shows an anonymous block that executes these procedures:

```

DECLARE
    gen_refcur      SYS_REFCURSOR;
BEGIN
    DBMS_OUTPUT.PUT_LINE('ALL EMPLOYEES');
    open_all_emp(gen_refcur);
    fetch_emp(gen_refcur);
    DBMS_OUTPUT.PUT_LINE('*****');

    DBMS_OUTPUT.PUT_LINE('EMPLOYEES IN DEPT #10');
    open_emp_by_dept(gen_refcur, 10);
    fetch_emp(gen_refcur);
    DBMS_OUTPUT.PUT_LINE('*****');

    DBMS_OUTPUT.PUT_LINE('DEPARTMENTS');
    open_dept(gen_refcur);
    fetch_dept(gen_refcur);
    DBMS_OUTPUT.PUT_LINE('*****');

    close_refcur(gen_refcur);
END;
```

The following example output is generated when the anonymous block executes:

```

ALL EMPLOYEES
EMPNO      ENAME
-----
7369      SMITH
7499      ALLEN
7521      WARD
7566      JONES
7654      MARTIN
7698      BLAKE
7782      CLARK
7788      SCOTT
7839      KING
7844      TURNER
7876      ADAMS
7900      JAMES
7902      FORD
7934      MILLER
*****
EMPLOYEES IN DEPT #10
EMPNO      ENAME
-----
7782      CLARK
7839      KING
7934      MILLER
*****
DEPARTMENTS
DEPT      DNAME
-----
10      ACCOUNTING
20      RESEARCH
30      SALES
40      OPERATIONS
*****
```

Chapter 21. Triggers (PL/SQL)

A PL/SQL trigger is a named database object that encapsulates and defines a set of actions that are to be performed in response to an insert, update, or delete operation against a table. Triggers are created using the PL/SQL CREATE TRIGGER statement.

Types of triggers (PL/SQL)

The DB2 data server supports row-level and statement-level triggers within a PL/SQL context.

A *row-level trigger* fires once for each row that is affected by a triggering event. For example, if deletion is defined as a triggering event for a particular table, and a single DELETE statement deletes five rows from that table, the trigger fires five times, once for each row.

A *statement-level trigger* fires only once for each statement. Using the previous example, if deletion is defined as a triggering event for a particular table, and a single DELETE statement deletes five rows from that table, the trigger fires once. Statement-level trigger granularity cannot be specified for BEFORE triggers or INSTEAD OF triggers.

The trigger code block is executed either before or after each row is affected by the triggering statement, except for INSTEAD OF triggers which execute the trigger code block instead of affecting each row based on the activating statement.

Trigger variables (PL/SQL)

NEW and OLD are special variables that you can use with PL/SQL triggers without explicitly defining them.

- NEW is a pseudo-record name that refers to the new table row for insert and update operations in row-level triggers. Its usage is :NEW.column, where *column* is the name of a column in the table on which the trigger is defined.
 - When used in a *before row-level trigger*, the initial content of :NEW.column is the column value in the new row that is to be inserted or in the row that is to replace the old row.
 - When used in an *after row-level trigger*, the new column value has already been stored in the table.
 - When a trigger is activated by a DELETE operation, the :NEW.column used in that trigger is null.

In the trigger code block, :NEW.column can be used like any other variable. If a value is assigned to :NEW.column in the code block of a before row-level trigger, the assigned value is used in the inserted or updated row.

- OLD is a pseudo-record name that refers to the old table row for update and delete operations in row-level triggers. Its usage is :OLD.column, where *column* is the name of a column in the table on which the trigger is defined.
 - When used in a *before row-level trigger*, the initial content of :OLD.column is the column value in the row that is to be deleted or in the old row that is to be replaced by the new row.

- When used in an *after row-level trigger*, the old column value is no longer stored in the table.
- When a trigger is activated by an INSERT operation, the `:OLD.column` used in that trigger is null.

In the trigger code block, `:OLD.column` can be used like any other variable. If a value is assigned to `:OLD.column` in the code block of a before row-level trigger, the assigned value has no affect on the action of the trigger.

Trigger event predicates (PL/SQL)

The trigger event predicates, `UPDATING`, `DELETING`, and `INSERTING` can only be used in a trigger to identify the event that activated the trigger.



DELETING

True if the trigger was activated by a delete operation. False otherwise.

INSERTING

True if the trigger was activated by an insert operation. False otherwise.

UPDATING

True if the trigger was activated by an update operation. False otherwise.

These predicates can be specified as a single search condition, or as a boolean factor within a complex search condition in a `WHEN` clause or PL/SQL statement.

Transactions and exceptions (PL/SQL)

A trigger is always executed as part of the same transaction within which the triggering statement is executing.

If no exceptions occur within the trigger code block, the effects of data manipulation language (DML) within the trigger are committed only if the transaction that contains the triggering statement commits. If the transaction is rolled back, the effects of DML within the trigger are also rolled back.

A DB2 rollback can only occur within an atomic block or by using an `UNDO` handler. The triggering statement itself is not rolled back unless the application forces a rollback of the encapsulating transaction.

If an unhandled exception occurs within the trigger code block, the calling statement is rolled back.

CREATE TRIGGER statement (PL/SQL)

The `CREATE TRIGGER` statement defines a PL/SQL trigger in the database.

Syntax

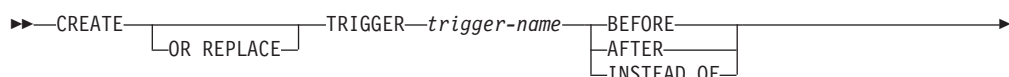

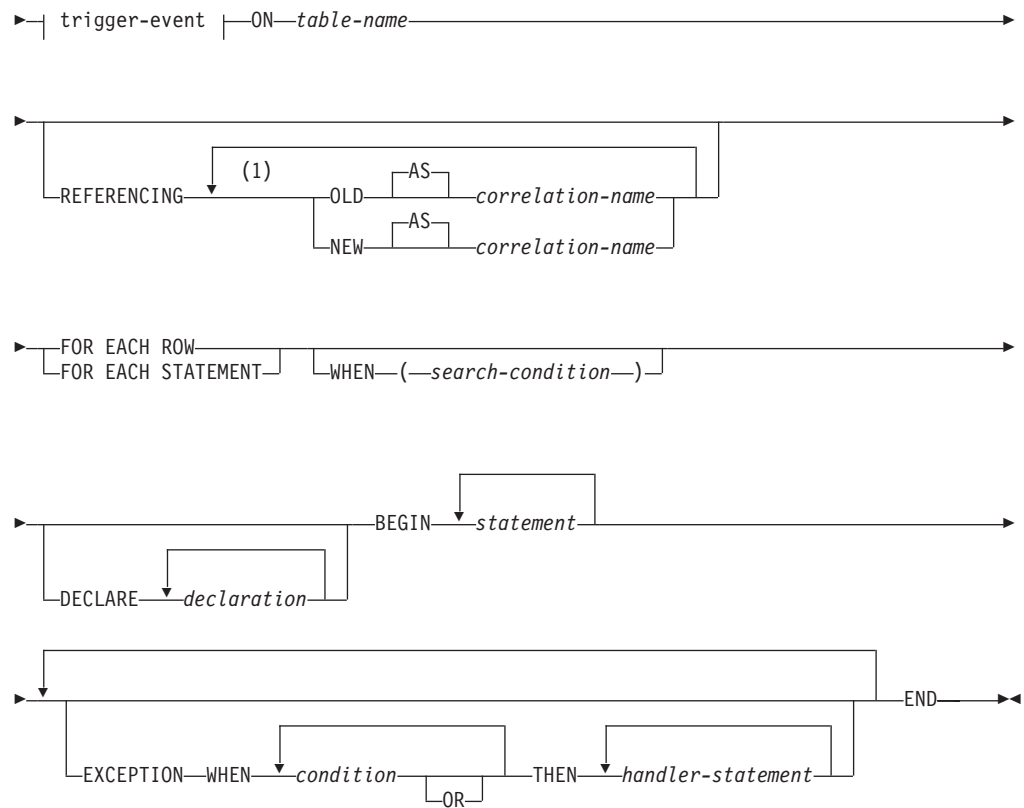

trigger-event:

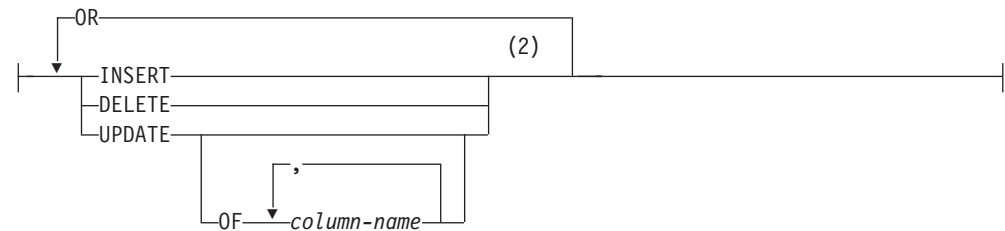

Notes:

- 1 OLD and NEW can only be specified once each.
- 2 A trigger event must not be specified more than once for the same operation. For example, INSERT OR DELETE is allowed, but INSERT OR INSERT is not allowed.

Description

OR REPLACE

Specifies to replace the definition for the trigger if one exists at the current server. The existing definition is effectively dropped before the new definition is replaced in the catalog. This option is ignored if a definition for the trigger does not exist at the current server.

trigger-name

Names the trigger. The name, including the implicit or explicit schema name,

must not identify a trigger already described in the catalog (SQLSTATE 42710). If a two-part name is specified, the schema name cannot begin with 'SYS' (SQLSTATE 42939).

BEFORE

Specifies that the associated triggered action is to be applied before any changes caused by the actual update of the subject table are applied to the database.

AFTER

Specifies that the associated triggered action is to be applied after the changes caused by the actual update of the subject table are applied to the database.

INSTEAD OF

Specifies that the associated triggered action replaces the action against the subject view.

trigger-event

Specifies that the triggered action associated with the trigger is to be executed whenever one of the events is applied to the subject table. Any combination of the events can be specified, but each event (INSERT, DELETE, and UPDATE) can only be specified once (SQLSTATE 42613).

INSERT

Specifies that the triggered action associated with the trigger is to be executed whenever an INSERT operation is applied to the subject table.

DELETE

Specifies that the triggered action associated with the trigger is to be executed whenever a DELETE operation is applied to the subject table.

UPDATE

Specifies that the triggered action associated with the trigger is to be executed whenever an UPDATE operation is applied to the subject table, subject to the columns specified or implied.

If the optional *column-name* list is not specified, every column of the table is implied. Therefore, omission of the *column-name* list implies that the trigger will be activated by the update of any column of the table.

OF *column-name*, ...

Each *column-name* specified must be a column of the base table (SQLSTATE 42703). If the trigger is a BEFORE trigger, the *column-name* specified cannot be a generated column other than the identity column (SQLSTATE 42989). No *column-name* can appear more than once in the *column-name* list (SQLSTATE 42711). The trigger will only be activated by the update of a column that is identified in the *column-name* list. This clause cannot be specified for an INSTEAD OF trigger (SQLSTATE 42613).

ON *table-name*

Designates the subject table of the BEFORE trigger or AFTER trigger definition. The name must specify a base table or an alias that resolves to a base table (SQLSTATE 42704 or 42809). The name must not specify a catalog table (SQLSTATE 42832), a materialized query table (SQLSTATE 42997), a created temporary table, a declared temporary table (SQLSTATE 42995), or a nickname (SQLSTATE 42809).

REFERENCING

Specifies the correlation names for the *transition variables*. Correlation names identify a specific row in the set of rows affected by the triggering SQL

operation. Each row affected by the triggering SQL operation is available to the triggered action by qualifying columns with *correlation-names* specified as follows.

OLD AS *correlation-name*

Specifies a correlation name that identifies the row state prior to the triggering SQL operation. If the trigger event is INSERT, the values in the row are null values.

NEW AS *correlation-name*

Specifies a correlation name that identifies the row state as modified by the triggering SQL operation and by any SET statement in a BEFORE trigger that has already executed. If the trigger event is DELETE, the values in the row are null values.

If the REFERENCING clause is not invoked, then trigger variables NEW and OLD can optionally be used without explicitly defining them.

FOR EACH ROW

Specifies that the triggered action is to be applied once for each row of the subject table that is affected by the triggering SQL operation.

FOR EACH STATEMENT

Specifies that the triggered action is to be applied only once for the whole statement.

WHEN

(search-condition)

Specifies a condition that is true, false, or unknown. The *search-condition* provides a capability to determine whether or not a certain triggered action should be executed. The associated action is performed only if the specified search condition evaluates as true.

declaration

Specifies a variable declaration.

statement or handler-statement

Specifies a PL/SQL program statement. The trigger body can contain nested blocks.

condition

Specifies an exception condition name, such as NO_DATA_FOUND.

Example

The following example shows a before row-level trigger that calculates the commission of every new employee belonging to department 30 before a record for that employee is inserted into the EMP table. It also records any salary increases that exceed 50% in an exception table:

```
CREATE TABLE emp (  
    name          VARCHAR2(10),  
    deptno       NUMBER,  
    sal          NUMBER,  
    comm        NUMBER  
)  
/  
  
CREATE TABLE exception (  
    name          VARCHAR2(10),  
    old_sal       NUMBER,  
    new_sal      NUMBER
```

```

)
/

CREATE OR REPLACE TRIGGER emp_comm_trig
  BEFORE INSERT OR UPDATE ON emp
  FOR EACH ROW
BEGIN
  IF (:NEW.deptno = 30 and INSERTING) THEN
    :NEW.comm := :NEW.sal * .4;
  END IF;

  IF (UPDATING and (:NEW.sal - :OLD.sal) > :OLD.sal * .5) THEN
    INSERT INTO exception VALUES (:NEW.name, :OLD.sal, :NEW.sal);
  END IF;
END
/

```

Dropping triggers (PL/SQL)

You can remove a trigger from the database by using the DROP TRIGGER statement.

Syntax

```

▶▶—DROP TRIGGER—trigger-name—◀◀

```

Description

trigger-name

Specifies the name of the trigger that is to be dropped.

Examples: Triggers (PL/SQL)

PL/SQL trigger definitions can be compiled by the DB2 data server. These examples will help you to create valid triggers and to troubleshoot PL/SQL trigger compilation errors.

Before row-level triggers

The following example shows a before row-level trigger that calculates the commission of every new employee belonging to department 30 before a record for that employee is inserted into the EMP table:

```

CREATE OR REPLACE TRIGGER emp_comm_trig
  BEFORE INSERT ON emp
  FOR EACH ROW
BEGIN
  IF :NEW.deptno = 30 THEN
    :NEW.comm := :NEW.sal * .4;
  END IF;
END;

```

The trigger computes the commissions for two new employees and inserts those values as part of the new employee rows:

```

INSERT INTO emp VALUES (9005, 'ROBERS', 'SALESMAN', 7782, SYSDATE, 3000.00, NULL, 30);
INSERT INTO emp VALUES (9006, 'ALLEN', 'SALESMAN', 7782, SYSDATE, 4500.00, NULL, 30);
SELECT * FROM emp WHERE empno IN (9005, 9006);

```

EMPNO	ENAME	JOB	MGR	HIREDATE	SAL	COMM	DEPTNO
-------	-------	-----	-----	----------	-----	------	--------

9005	ROBERS	SALESMAN	7782	01-APR-05	3000	1200	30
9006	ALLEN	SALESMAN	7782	01-APR-05	4500	1800	30

After row-level triggers

The following example shows three after row-level triggers.

- When a new employee row is inserted into the EMP table, one trigger (EMP_INS_TRIG) adds a new row to the JOBHIST table for that employee and adds a row to the EMPCHGLOG table with a description of the action.
- When an existing employee row is updated, the second trigger (EMP_CHG_TRIG) sets the ENDDATE column of the latest JOBHIST row (assumed to be the one with a null ENDDATE) to the current date and inserts a new JOBHIST row with the employee's new information. This trigger also adds a row to the EMPCHGLOG table with a description of the action
- When an employee row is deleted from the EMP table, the third trigger (EMP_DEL_TRIG) adds a row to the EMPCHGLOG table with a description of the action.

```

CREATE TABLE empchglog (
  chg_date      DATE,
  chg_desc      VARCHAR2(30)
);
CREATE OR REPLACE TRIGGER emp_ins_trig
  AFTER INSERT ON emp
  FOR EACH ROW
DECLARE
  v_empno      emp.empno%TYPE;
  v_deptno     emp.deptno%TYPE;
  v_dname      dept.dname%TYPE;
  v_action     VARCHAR2(7);
  v_chgdesc    jobhist.chgdesc%TYPE;
BEGIN
  v_action := 'Added';
  v_empno := :NEW.empno;
  v_deptno := :NEW.deptno;
  INSERT INTO jobhist VALUES (:NEW.empno, SYSDATE, NULL,
    :NEW.job, :NEW.sal, :NEW.comm, :NEW.deptno, 'New Hire');

  INSERT INTO empchglog VALUES (SYSDATE,
    v_action || ' employee # ' || v_empno);
END;

CREATE OR REPLACE TRIGGER emp_chg_trig
  AFTER UPDATE ON emp
  FOR EACH ROW
DECLARE
  v_empno      emp.empno%TYPE;
  v_deptno     emp.deptno%TYPE;
  v_dname      dept.dname%TYPE;
  v_action     VARCHAR2(7);
  v_chgdesc    jobhist.chgdesc%TYPE;
BEGIN
  v_action := 'Updated';
  v_empno := :NEW.empno;
  v_deptno := :NEW.deptno;
  v_chgdesc := '';
  IF NVL(:OLD.ename, '-null-') != NVL(:NEW.ename, '-null-') THEN
    v_chgdesc := v_chgdesc || 'name, ';
  END IF;
  IF NVL(:OLD.job, '-null-') != NVL(:NEW.job, '-null-') THEN
    v_chgdesc := v_chgdesc || 'job, ';
  END IF;
  IF NVL(:OLD.sal, -1) != NVL(:NEW.sal, -1) THEN

```

```

        v_chgdesc := v_chgdesc || 'salary, ';
    END IF;
    IF NVL(:OLD.comm, -1) != NVL(:NEW.comm, -1) THEN
        v_chgdesc := v_chgdesc || 'commission, ';
    END IF;
    IF NVL(:OLD.deptno, -1) != NVL(:NEW.deptno, -1) THEN
        v_chgdesc := v_chgdesc || 'department, ';
    END IF;
    v_chgdesc := 'Changed ' || RTRIM(v_chgdesc, ' ');
    UPDATE jobhist SET enddate = SYSDATE WHERE empno = :OLD.empno
        AND enddate IS NULL;
    INSERT INTO jobhist VALUES (:NEW.empno, SYSDATE, NULL,
        :NEW.job, :NEW.sal, :NEW.comm, :NEW.deptno, v_chgdesc);

    INSERT INTO empchglog VALUES (SYSDATE,
        v_action || ' employee # ' || v_empno);
END;

CREATE OR REPLACE TRIGGER emp_del_trig
AFTER DELETE ON emp
FOR EACH ROW
DECLARE
    v_empno          emp.empno%TYPE;
    v_deptno         emp.deptno%TYPE;
    v_dname          dept.dname%TYPE;
    v_action         VARCHAR2(7);
    v_chgdesc        jobhist.chgdesc%TYPE;
BEGIN
    v_action := 'Deleted';
    v_empno := :OLD.empno;
    v_deptno := :OLD.deptno;

    INSERT INTO empchglog VALUES (SYSDATE,
        v_action || ' employee # ' || v_empno);
END;

```

In the following example, two employee rows are added using two separate INSERT statements, and then both rows are updated using a single UPDATE statement. The JOBHIST table shows the action of the trigger for each affected row: two new hire entries for the two new employees and two changed commission records. The EMPCHGLOG table also shows that the trigger was fired a total of four times, once for each action against the two rows.

```

INSERT INTO emp VALUES (9003,'PETERS','ANALYST',7782,SYSDATE,5000.00,NULL,40);
INSERT INTO emp VALUES (9004,'AIKENS','ANALYST',7782,SYSDATE,4500.00,NULL,40);

UPDATE emp SET comm = sal * 1.1 WHERE empno IN (9003, 9004);

SELECT * FROM jobhist WHERE empno IN (9003, 9004);

```

EMPNO	STARTDATE	ENDDATE	JOB	SAL	COMM	DEPTNO	CHGDESC
9003	31-MAR-05	31-MAR-05	ANALYST	5000		40	New Hire
9004	31-MAR-05	31-MAR-05	ANALYST	4500		40	New Hire
9003	31-MAR-05		ANALYST	5000	5500	40	Changed commission
9004	31-MAR-05		ANALYST	4500	4950	40	Changed commission

```

SELECT * FROM empchglog;

CHG_DATE  CHG_DESC
-----
31-MAR-05 Added employee # 9003
31-MAR-05 Added employee # 9004
31-MAR-05 Updated employee # 9003
31-MAR-05 Updated employee # 9004

```

After both employees are deleted with a single DELETE statement, the EMPCHGLOG table shows that the trigger was fired twice, once for each deleted employee:

```
DELETE FROM emp WHERE empno IN (9003, 9004);
```

```
SELECT * FROM empchglog;
```

```
CHG_DATE  CHG_DESC  
-----  
31-MAR-05 Added employee # 9003  
31-MAR-05 Added employee # 9004  
31-MAR-05 Updated employee # 9003  
31-MAR-05 Updated employee # 9004  
31-MAR-05 Deleted employee # 9003  
31-MAR-05 Deleted employee # 9004
```

Chapter 22. Packages (PL/SQL)

PL/SQL package definitions are supported by the DB2 data server. A PL/SQL package is a named collection of functions, procedures, variables, cursors, user-defined types, and records that are referenced using a common qualifier, the package name.

Packages have the following characteristics:

- Packages provide a convenient way of organizing the functions and procedures that have a related purpose. Permission to use the package functions and procedures is dependent upon one privilege that is granted to the entire package.
- Certain items in a package can be declared public. Public entities are visible and can be referenced by other programs that hold the EXECUTE privilege on the package. In the case of public functions and procedures, only their signatures are visible. The PL/SQL code for these function and procedures is not accessible to others; therefore, applications that utilize such a package are dependent upon only the information that is available in the signatures.
- Other items in a package can be declared private. Private entities can be referenced and used by functions and procedures within the package, but not by external applications.

Package components (PL/SQL)

Packages consist of two main components: the package specification and the package body.

- The *package specification* is the public interface, comprising the elements that can be referenced outside of the package. A package specification is created by executing the CREATE PACKAGE statement.
- The *package body* contains the actual implementation of all of the procedures and functions that are declared within the package specification, as well as any declaration of private types, variables, and cursors. A package body is created by executing the CREATE PACKAGE BODY statement.

Creating packages (PL/SQL)

Creating a package specification enables you to encapsulate related data type, procedure, and function definitions within a single context in the database.

Packages are extensions of schemas that provide namespace support for the objects that they reference. They are repositories in which executable code can be defined. Using a package involves referencing or executing objects that are defined in the package specification and implemented within the package.

Creating package specifications (PL/SQL)

A package specification establishes which package objects can be referenced from outside of the package. Objects that can be referenced from outside of a package are called the public elements of that package.

The following example shows how to create a package specification named EMP_ADMIN, consisting of two functions and two stored procedures.

```

CREATE OR REPLACE PACKAGE emp_admin
IS
    FUNCTION get_dept_name (
        p_deptno      NUMBER DEFAULT 10
    )
    RETURN VARCHAR2;
    FUNCTION update_emp_sal (
        p_empno       NUMBER,
        p_raise        NUMBER
    )
    RETURN NUMBER;
    PROCEDURE hire_emp (
        p_empno        NUMBER,
        p_ename         VARCHAR2,
        p_job           VARCHAR2,
        p_sal           NUMBER,
        p_hiredate      DATE DEFAULT sysdate,
        p_comm          NUMBER DEFAULT 0,
        p_mgr           NUMBER,
        p_deptno        NUMBER DEFAULT 10
    );
    PROCEDURE fire_emp (
        p_empno         NUMBER
    );
END emp_admin;

```

CREATE PACKAGE statement (PL/SQL)

The CREATE PACKAGE statement creates a package specification, which defines the interface to a package.

Syntax

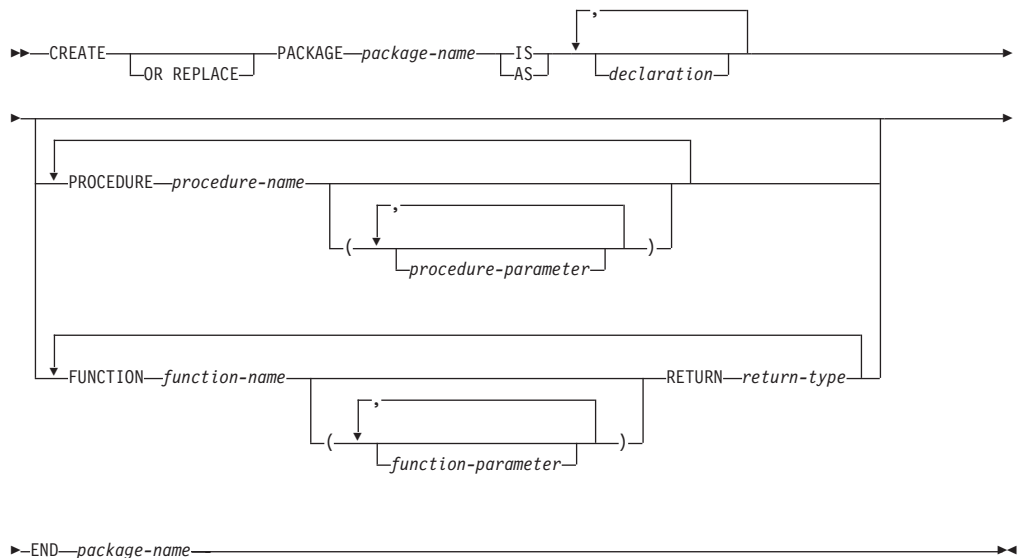

Description

package-name
Specifies an identifier for the package.

declaration

Specifies an identifier for a public item. The public item can be accessed from outside of the package using the syntax *package-name.item-name*. There can be zero or more public items. Public item declarations must come before procedure or function declarations. The *declaration* can be any of the following:

- Collection declaration
- EXCEPTION declaration
- Record declaration
- REF CURSOR and cursor variable declaration
- TYPE definition for a collection, record, or REF CURSOR type variable
- SUBTYPE definition
- Variable declaration

procedure-name

Specifies an identifier for a public procedure. The public procedure can be invoked from outside of the package using the syntax *package-name.procedure-name()*.

procedure-parameter

Specifies an identifier for a formal parameter of the procedure.

function-name

Specifies an identifier for a public function. The public function can be invoked from outside of the package using the syntax *package-name.function-name()*.

function-parameter

Specifies an identifier for a formal parameter of the function. Input (IN mode) parameters can be initialized with a default value.

return-type

Specifies a data type for the value that is returned by the function.

Notes

The CREATE PACKAGE statement can be submitted in obfuscated form. In an obfuscated statement, only the package name is readable. The rest of the statement is encoded in such a way that it is not readable, but can be decoded by the database server. Obfuscated statements can be produced by calling the DBMS_DDL.WRAP function.

Creating the package body (PL/SQL)

A package body contains the implementation of all of the procedures and functions that are declared within the package specification.

The following example shows how to create a package body for the EMP_ADMIN package specification.

```
--
-- Package body for the 'emp_admin' package.
--
CREATE OR REPLACE PACKAGE BODY emp_admin
IS
  --
  -- Function that queries the 'dept' table based on the department
  -- number and returns the corresponding department name.
  --
  FUNCTION get_dept_name (
    p_deptno      IN NUMBER DEFAULT 10
  )
```

```

RETURN VARCHAR2
IS
    v_dname          VARCHAR2(14);
BEGIN
    SELECT dname INTO v_dname FROM dept WHERE deptno = p_deptno;
    RETURN v_dname;
EXCEPTION
    WHEN NO_DATA_FOUND THEN
        DBMS_OUTPUT.PUT_LINE('Invalid department number ' || p_deptno);
        RETURN '';
END;
--
-- Function that updates an employee's salary based on the
-- employee number and salary increment/decrement passed
-- as IN parameters. Upon successful completion the function
-- returns the new updated salary.
--
FUNCTION update_emp_sal (
    p_empno          IN NUMBER,
    p_raise          IN NUMBER
)
RETURN NUMBER
IS
    v_sal            NUMBER := 0;
BEGIN
    SELECT sal INTO v_sal FROM emp WHERE empno = p_empno;
    v_sal := v_sal + p_raise;
    UPDATE emp SET sal = v_sal WHERE empno = p_empno;
    RETURN v_sal;
EXCEPTION
    WHEN NO_DATA_FOUND THEN
        DBMS_OUTPUT.PUT_LINE('Employee ' || p_empno || ' not found');
        RETURN -1;
    WHEN OTHERS THEN
        DBMS_OUTPUT.PUT_LINE('The following is SQLERRM:');
        DBMS_OUTPUT.PUT_LINE(SQLERRM);
        DBMS_OUTPUT.PUT_LINE('The following is SQLCODE:');
        DBMS_OUTPUT.PUT_LINE(SQLCODE);
        RETURN -1;
END;
--
-- Procedure that inserts a new employee record into the 'emp' table.
--
PROCEDURE hire_emp (
    p_empno          NUMBER,
    p_ename          VARCHAR2,
    p_job            VARCHAR2,
    p_sal            NUMBER,
    p_hiredate       DATE    DEFAULT sysdate,
    p_comm           NUMBER  DEFAULT 0,
    p_mgr            NUMBER,
    p_deptno        NUMBER  DEFAULT 10
)
AS
BEGIN
    INSERT INTO emp(empno, ename, job, sal, hiredate, comm, mgr, deptno)
        VALUES(p_empno, p_ename, p_job, p_sal,
            p_hiredate, p_comm, p_mgr, p_deptno);
END;
--
-- Procedure that deletes an employee record from the 'emp' table based
-- on the employee number.
--
PROCEDURE fire_emp (
    p_empno          NUMBER
)
AS

```



```

BEGIN
  DELETE FROM emp WHERE empno = p_empno;
END;
END;

```

CREATE PACKAGE BODY statement (PL/SQL)

The CREATE PACKAGE BODY statement creates a package body, which contains the implementation of all of the procedures and functions that are declared within the package specification, as well as any declaration of private types, variables, and cursors.

Syntax

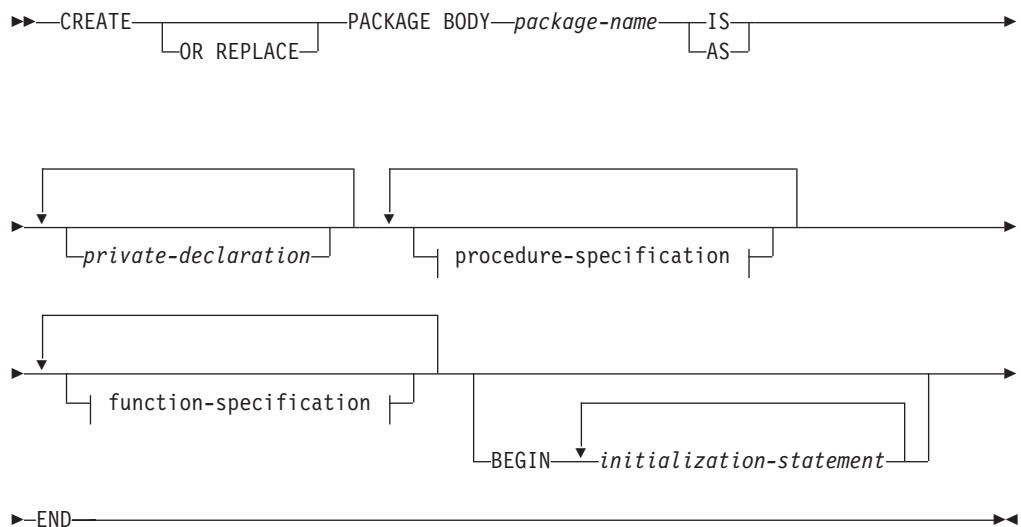

procedure-specification:

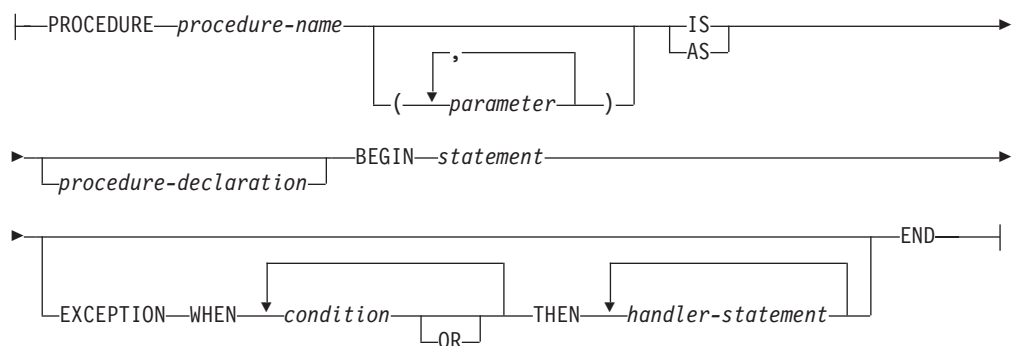

function-specification:

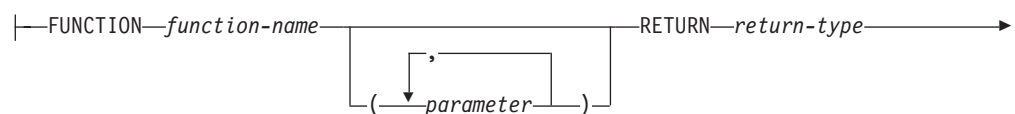

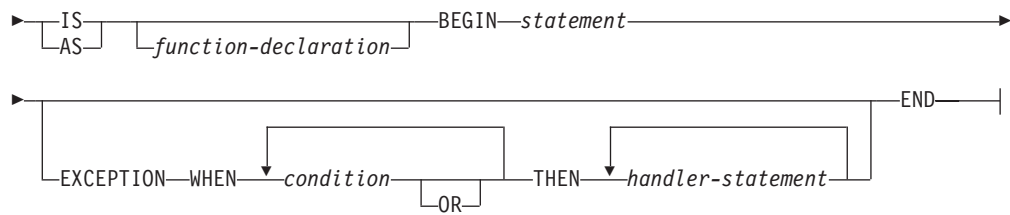

Description

package-name

Specifies the name of the package whose body is to be created. A package specification with the same name must exist.

private-declaration

Specifies the name of a private object that can be accessed by any procedure or function within the package. There can be zero or more private variables. The *private-declaration* can be any of the following:

- Variable declaration
- Record declaration
- Collection declaration
- REF CURSOR and cursor variable declaration
- TYPE definitions for records, collections, or variables of the REF CURSOR type
- SUBTYPE definition over a base type

procedure-name

Specifies the name of a public procedure that is declared in the package specification and its signature. The signature can specify any one of the following: the formal parameter names, data types, parameter modes, the order of the formal parameters, or the number of formal parameters. When the procedure name and package specification exactly match the signature of the public procedure's declaration, *procedure-name* defines the body of this public procedure.

If none of these conditions is true, *procedure-name* defines a new private procedure.

parameter

Specifies a formal parameter of the procedure.

procedure-declaration

Specifies a declaration that can be accessed only from within procedure *procedure-name*. This is a PL/SQL statement.

statement

Specifies a PL/SQL program statement.

function-name

Specifies the name of a public function that is declared in the package specification and its signature. The signature can specify any one of the following: the formal parameter names, data types, parameter modes, the order of the formal parameters, or the number of formal parameters. When the function name and package specification exactly match the signature of the public function's declaration, *function-name* defines the body of this public function.

If none of these conditions is true, *function-name* defines a new private function.

parameter

Specifies a formal parameter of the function.

return-type

Specifies the data type of the value that is returned by the function.

function-declaration

Specifies a declaration that can be accessed only from within function *function-name*. This is a PL/SQL statement.

statement

Specifies a PL/SQL program statement.

initialization-statement

Specifies a statement in the initialization section of the package body. The initialization section, if specified, must contain at least one statement. The statements in the initialization section are executed once per user session when the package is first referenced.

Notes

The CREATE PACKAGE BODY statement can be submitted in obfuscated form. In an obfuscated statement, only the package name is readable. The rest of the statement is encoded in such a way that it is not readable, but can be decoded by the database server. Obfuscated statements can be produced by calling the DBMS_DDL.WRAP function.

Referencing package objects (PL/SQL)

References to objects that are defined within a package must sometimes be qualified with the package name.

To reference the objects that are declared in a package specification, specify the package name, a period character, and then the name of the object. If the package is not defined in the current schema, specify the schema name as well. For example:

```
package_name.type_name  
package_name.item_name  
package_name.subprogram_name  
schema.package_name.subprogram_name
```

Example

The following example contains a reference to a function named GET_DEPT_NAME that is defined in a package named EMP_ADMIN:

```
select emp_admin.get_dept_name(10) from dept
```

Packages with user-defined types (PL/SQL)

User-defined types can be declared and referenced in packages.

The following example shows a package specification for the EMP_RPT package. This definition includes the following declarations:

- A publicly accessible record type, EMPREC_TYP
- A publicly accessible weakly-typed REF CURSOR type, EMP_REFCUR

- A publicly accessible subtype, DEPT_NUM, restricted to the range of values from 1 to 99
- Two functions, GET_DEPT_NAME and OPEN_EMP_BY_DEPT; both functions have an input parameter of the subtype DEPT_NUM; the latter function returns the REF CURSOR type EMP_REFCUR
- Two procedures, FETCH_EMP and CLOSE_REFCUR; both declare a weakly-typed REF CURSOR type as a formal parameter

```
CREATE OR REPLACE PACKAGE emp_rpt
IS
    TYPE emprec_typ IS RECORD (
        empno      NUMBER(4),
        ename      VARCHAR(10)
    );
    TYPE emp_refcur IS REF CURSOR;
    SUBTYPE dept_num IS dept.deptno%TYPE RANGE 1..99;

    FUNCTION get_dept_name (
        p_deptno   IN dept_num
    ) RETURN VARCHAR2;
    FUNCTION open_emp_by_dept (
        p_deptno   IN dept_num
    ) RETURN EMP_REFCUR;
    PROCEDURE fetch_emp (
        p_refcur   IN OUT SYS_REFCURSOR
    );
    PROCEDURE close_refcur (
        p_refcur   IN OUT SYS_REFCURSOR
    );
END emp_rpt;
```

The definition of the associated package body includes the following private variable declarations:

- A static cursor, DEPT_CUR
- An associative array type, DEPTTAB_TYP
- An associative array variable, T_DEPT
- An integer variable, T_DEPT_MAX
- A record variable, R_EMP

```
CREATE OR REPLACE PACKAGE BODY emp_rpt
IS
    CURSOR dept_cur IS SELECT * FROM dept;
    TYPE depttab_typ IS TABLE OF dept%ROWTYPE
        INDEX BY BINARY_INTEGER;
    t_dept          DEPTTAB_TYP;
    t_dept_max      INTEGER := 1;
    r_emp           EMPREC_TYP;

    FUNCTION get_dept_name (
        p_deptno   IN dept_num
    ) RETURN VARCHAR2
    IS
    BEGIN
        FOR i IN 1..t_dept_max LOOP
            IF p_deptno = t_dept(i).deptno THEN
                RETURN t_dept(i).dname;
            END IF;
        END LOOP;
        RETURN 'Unknown';
    END;

    FUNCTION open_emp_by_dept (
        p_deptno   IN dept_num
```

```

) RETURN EMP_REFCUR
IS
    emp_by_dept EMP_REFCUR;
BEGIN
    OPEN emp_by_dept FOR SELECT empno, ename FROM emp
        WHERE deptno = p_deptno;
    RETURN emp_by_dept;
END;

PROCEDURE fetch_emp (
    p_refcur    IN OUT SYS_REFCURSOR
)
IS
BEGIN
    DBMS_OUTPUT.PUT_LINE('EMPNO    ENAME');
    DBMS_OUTPUT.PUT_LINE('-----  -----');
    LOOP
        FETCH p_refcur INTO r_emp;
        EXIT WHEN p_refcur%NOTFOUND;
        DBMS_OUTPUT.PUT_LINE(r_emp.empno || '    ' || r_emp.ename);
    END LOOP;
END;

PROCEDURE close_refcur (
    p_refcur    IN OUT SYS_REFCURSOR
)
IS
BEGIN
    CLOSE p_refcur;
END;
BEGIN
    OPEN dept_cur;
    LOOP
        FETCH dept_cur INTO t_dept(t_dept_max);
        EXIT WHEN dept_cur%NOTFOUND;
        t_dept_max := t_dept_max + 1;
    END LOOP;
    CLOSE dept_cur;
    t_dept_max := t_dept_max - 1;
END emp_rpt;

```

This package contains an initialization section that loads the private associative array variable T_DEPT, using the private static cursor DEPT_CUR. T_DEPT serves as a department name lookup table in function GET_DEPT_NAME. The function OPEN_EMP_BY_DEPT returns a REF CURSOR variable for the result set of employee numbers and names for a given department. This REF CURSOR variable can then be passed to procedure FETCH_EMP to retrieve and list the individual rows of the result set. Finally, procedure CLOSE_REFCUR can be used to close the REF CURSOR variable that is associated with this result set.

The following anonymous block runs the package functions and procedures. The declaration section includes the declaration of a scalar variable V_DEPTNO, using the public SUBTYPE DEPT_NUM and a cursor variable V_EMP_CUR, using the public REF CURSOR type, EMP_REFCUR. V_EMP_CUR contains a pointer to the result set that is passed between the package function and procedures.

```

DECLARE
    v_deptno      emp_rpt.DEPT DEFAULT 30;
    v_emp_cur     emp_rpt.EMP_REFCUR;
BEGIN
    v_emp_cur := emp_rpt.open_emp_by_dept(v_deptno);
    DBMS_OUTPUT.PUT_LINE('EMPLOYEES IN DEPT #' || v_deptno ||
        ' : ' || emp_rpt.get_dept_name(v_deptno));
    emp_rpt.fetch_emp(v_emp_cur);

```

```

        DBMS_OUTPUT.PUT_LINE('*****');
        DBMS_OUTPUT.PUT_LINE(v_emp_cur%ROWCOUNT || ' rows were retrieved');
        emp_rpt.close_refcur(v_emp_cur);
END;
```

This anonymous block produces the following sample output:

```

EMPLOYEES IN DEPT #30: SALES
EMPNO      ENAME
-----
7499      ALLEN
7521      WARD
7654      MARTIN
7698      BLAKE
7844      TURNER
7900      JAMES
*****
6 rows were retrieved
```

The following anonymous block shows another way of achieving the same result. Instead of using the package procedures `FETCH_EMP` and `CLOSE_REFCUR`, the logic is coded directly into the anonymous block. Note the declaration of record variable `R_EMP`, using the public record type `EMPREC_TYP`.

```

DECLARE
    v_deptno      emp_rpt.DEPT DEFAULT 30;
    v_emp_cur     emp_rpt.EMP_REFCUR;
    r_emp         emp_rpt.EMPREC_TYP;
BEGIN
    v_emp_cur := emp_rpt.open_emp_by_dept(v_deptno);
    DBMS_OUTPUT.PUT_LINE('EMPLOYEES IN DEPT #' || v_deptno ||
        ' : ' || emp_rpt.get_dept_name(v_deptno));
    DBMS_OUTPUT.PUT_LINE('EMPNO      ENAME');
    DBMS_OUTPUT.PUT_LINE('-----      -----');
    LOOP
        FETCH v_emp_cur INTO r_emp;
        EXIT WHEN v_emp_cur%NOTFOUND;
        DBMS_OUTPUT.PUT_LINE(r_emp.empno || '      ' ||
            r_emp.ename);
    END LOOP;
    DBMS_OUTPUT.PUT_LINE('*****');
    DBMS_OUTPUT.PUT_LINE(v_emp_cur%ROWCOUNT || ' rows were retrieved');
    CLOSE v_emp_cur;
END;
```

This anonymous block produces the following sample output:

```

EMPLOYEES IN DEPT #30: SALES
EMPNO      ENAME
-----
7499      ALLEN
7521      WARD
7654      MARTIN
7698      BLAKE
7844      TURNER
7900      JAMES
*****
6 rows were retrieved
```

Dropping packages (PL/SQL)

You can drop a package if it is no longer needed. Alternatively, if you want to reuse the package, you have the option to drop only the package body.

Syntax

► DROP PACKAGE BODY *package-name* ►

Description

BODY

Specifies that only the package body is to be dropped. If this keyword is omitted, both the package specification and the package body are dropped.

package-name

Specifies the name of a package.

Examples

The following example shows how to drop only the body of a package named EMP_ADMIN:

```
DROP PACKAGE BODY emp_admin
```

The following example shows how to drop both the specification and the body of the package:

```
DROP PACKAGE emp_admin
```

Part 3. Built-in modules

The built-in modules provide an easy-to-use programmatic interface for performing a variety of useful operations.

For example, you can use built-in modules to perform the following functions:

- Send and receive messages and alerts across connections.
- Write to and read from files and directories on the operating system's file system.
- Generate reports containing a variety of monitor information.

Built-in modules can be invoked from an SQL-based application, a DB2 command line, or a command script.

Built-in modules transform string data according to the database code page setting.

Built-in modules are not supported for the following product editions:

- DB2 Express-C

Chapter 23. DBMS_ALERT module

The DBMS_ALERT module provides a set of procedures for registering for alerts, sending alerts, and receiving alerts.

Alerts are stored in SYSTOOLS.DBMS_ALERT_INFO, which is created in the SYSTOOLSPACE when you first reference this module for each database.

The schema for this module is SYSIBMADM.

The DBMS_ALERT module includes the following built-in routines.

Table 11. Built-in routines available in the DBMS_ALERT module

Routine name	Description
REGISTER procedure	Registers the current session to receive a specified alert.
REMOVE procedure	Removes registration for a specified alert.
REMOVEALL procedure	Removes registration for all alerts.
SIGNAL procedure	Signals the occurrence of a specified alert.
SET_DEFAULTS procedure	Sets the polling interval for the WAITONE and WAITANY procedures.
WAITANY procedure	Waits for any registered alert to occur.
WAITONE procedure	Waits for a specified alert to occur.

Usage notes

The procedures in the DBMS_ALERT module are useful when you want to send an alert for a specific event. For example, you might want to send an alert when a trigger is activated as the result of changes to one or more tables.

The DBMS_ALERT module requires that the database configuration parameter CUR_COMMIT is set to ON

Example

When a trigger, TRIG1, is activated, send an alert from connection 1 to connection 2. First, create the table and the trigger.

```
CREATE TABLE T1 (C1 INT)@

CREATE TRIGGER TRIG1
AFTER INSERT ON T1
REFERENCING NEW AS NEW
FOR EACH ROW
BEGIN ATOMIC
CALL DBMS_ALERT.SIGNAL( 'trig1', NEW.C1 );
END@
```

From connection 1, issue an INSERT statement.

```
INSERT INTO T1 values (10)@
-- Commit to send messages to the listeners (required in early program)
CALL DBMS_ALERT.COMMIT()@
```

From connection 2, register to receive the alert called trig1 and wait for the alert.

```
CALL DBMS_ALERT.REGISTER('trig1')@
CALL DBMS_ALERT.WAITONE('trig1', ?, ?, 5)@
```

This example results in the following output:

```
Value of output parameters
-----
Parameter Name : MESSAGE
Parameter Value : -

Parameter Name : STATUS
Parameter Value : 1

Return Status = 0
```

REGISTER procedure - Register to receive a specified alert

The REGISTER procedure registers the current session to receive a specified alert.

Syntax

```
▶▶ DBMS_ALERT.REGISTER(—name—) ◀◀
```

Procedure parameters

name

An input argument of type VARCHAR(128) that specifies the name of the alert.

Authorization

EXECUTE privilege on the DBMS_ALERT module.

Example

Use the REGISTER procedure to register for an alert named alert_test, and then wait for the signal.

```
SET SERVEROUTPUT ON@
```

```
CREATE PROCEDURE proc1()
BEGIN
  DECLARE v_name    VARCHAR(30) DEFAULT 'alert_test';
  DECLARE v_msg     VARCHAR(80);
  DECLARE v_status  INTEGER;
  DECLARE v_timeout INTEGER DEFAULT 5;
  CALL DBMS_ALERT.REGISTER(v_name);
  CALL DBMS_OUTPUT.PUT_LINE('Waiting for signal...');
  CALL DBMS_ALERT.WAITONE(v_name , v_msg , v_status , v_timeout);
  CALL DBMS_OUTPUT.PUT_LINE('Alert name   : ' || v_name);
  CALL DBMS_OUTPUT.PUT_LINE('Alert status : ' || v_status);
  CALL DBMS_ALERT.REMOVE(v_name);
END@

CALL proc1@
```

This example results in the following output:

```
Waiting for signal...
Alert name   : alert_test
Alert status : 1
```

REMOVE procedure - Remove registration for a specified alert

The REMOVE procedure removes registration from the current session for a specified alert.

Syntax

```
▶▶—DBMS_ALERT.REMOVE—(—name—)—————▶▶
```

Procedure parameters

name

An input argument of type VARCHAR(128) that specifies the name of the alert.

Authorization

EXECUTE privilege on the DBMS_ALERT module.

Example

Use the REMOVE procedure to remove an alert named alert_test.

```
SET SERVEROUTPUT ON@
```

```
CREATE PROCEDURE proc1()
BEGIN
  DECLARE v_name    VARCHAR(30) DEFAULT 'alert_test';
  DECLARE v_msg     VARCHAR(80);
  DECLARE v_status  INTEGER;
  DECLARE v_timeout INTEGER DEFAULT 5;
  CALL DBMS_ALERT.REGISTER(v_name);
  CALL DBMS_OUTPUT.PUT_LINE('Waiting for signal...');
  CALL DBMS_ALERT.WAITONE(v_name , v_msg , v_status , v_timeout);
  CALL DBMS_OUTPUT.PUT_LINE('Alert name   : ' || v_name);
  CALL DBMS_OUTPUT.PUT_LINE('Alert status : ' || v_status);
  CALL DBMS_ALERT.REMOVE(v_name);
END@

CALL proc1@
```

This example results in the following output:

```
Waiting for signal...
Alert name   : alert_test
Alert status : 1
```

REMOVEALL procedure - Remove registration for all alerts

The REMOVEALL procedure removes registration from the current session for all alerts.

Syntax

```
▶▶—DBMS_ALERT.REMOVEALL—————▶▶
```

Authorization

EXECUTE privilege on the DBMS_ALERT module.

Example

Use the REMOVEALL procedure to remove registration for all alerts.

```
CALL DBMS_ALERT.REMOVEALL@
```

SET_DEFAULTS - Set the polling interval for WAITONE and WAITANY

The SET_DEFAULTS procedure sets the polling interval that is used by the WAITONE and WAITANY procedures.

Syntax

```
▶▶—DBMS_ALERT.SET_DEFAULTS—(—sensitivity—)—————▶▶
```

Procedure parameters

sensitivity

An input argument of type INTEGER that specifies an interval in seconds for the WAITONE and WAITANY procedures to check for signals. If a value is not specified, then the interval is 1 second by default.

Authorization

EXECUTE privilege on the DBMS_ALERT module.

Example

Use the SET_DEFAULTS procedure to specify the polling interval for the WAITONE and WAITANY procedures.

```
SET SERVEROUTPUT ON@
```

```
CREATE PROCEDURE proc1()
BEGIN
  DECLARE v_name    VARCHAR(30) DEFAULT 'alert_test';
  DECLARE v_msg     VARCHAR(80);
  DECLARE v_status  INTEGER;
  DECLARE v_timeout INTEGER DEFAULT 20;
  DECLARE v_polling INTEGER DEFAULT 3;
  CALL DBMS_ALERT.REGISTER(v_name);
  CALL DBMS_OUTPUT.PUT_LINE('Waiting for signal...');
  CALL DBMS_ALERT.SET_DEFAULTS(v_polling);
  CALL DBMS_OUTPUT.PUT_LINE('Polling interval: ' || v_polling);
  CALL DBMS_ALERT.WAITONE(v_name , v_msg , v_status , v_timeout);
  CALL DBMS_ALERT.REMOVE(v_name);
END@

CALL proc1@
```

This example results in the following output:

```
Polling interval : 3
```

SIGNAL procedure - Signal occurrence of a specified alert

The SIGNAL procedure signals the occurrence of a specified alert. The signal includes a message that is passed with the alert. The message is distributed to the listeners (processes that have registered for the alert) when the SIGNAL call is issued.

Syntax

►► DBMS_ALERT.SIGNAL(*—name—*,*—message—*)◄◄

Procedure parameters

name

An input argument of type VARCHAR(128) that specifies the name of the alert.

message

An input argument of type VARCHAR(32672) that specifies the information to pass with this alert. This message can be returned by the WAITANY or WAITONE procedures when an alert occurs.

Authorization

EXECUTE privilege on the DBMS_ALERT module.

Example

Use the SIGNAL procedure to signal the occurrence of an alert named alert_test.

```
SET SERVEROUTPUT ON@
```

```
CREATE PROCEDURE proc1()
BEGIN
  DECLARE v_name VARCHAR(30) DEFAULT 'alert_test';
  CALL DBMS_ALERT.SIGNAL(v_name,'This is the message from ' || v_name);
  CALL DBMS_OUTPUT.PUT_LINE('Issued alert for ' || v_name);
END@

CALL proc1@
```

This example results in the following output:

```
Issued alert for alert_test
```

WAITANY procedure - Wait for any registered alerts

The WAITANY procedure waits for any registered alerts to occur.

Syntax

►► DBMS_ALERT.WAITANY(*—name—*,*—message—*,*—status—*,*—timeout—*)◄◄

Procedure parameters

name

An output argument of type VARCHAR(128) that contains the name of the alert.

message

An output argument of type VARCHAR(32672) that contains the message sent by the SIGNAL procedure.

status

An output argument of type INTEGER that contains the status code returned by the procedure. The following values are possible

0 An alert occurred.

1 A timeout occurred.

timeout

An input argument of type INTEGER that specifies the amount of time in seconds to wait for an alert.

Authorization

EXECUTE privilege on the DBMS_ALERT module.

Example

From one connection, run a CLP script called `waitany.clp` to receive any registered alerts.

`waitany.clp`:

```
SET SERVEROUTPUT ON@

CREATE PROCEDURE proc1()
BEGIN
  DECLARE v_name    VARCHAR(30);
  DECLARE v_msg     VARCHAR(80);
  DECLARE v_status  INTEGER;
  DECLARE v_timeout INTEGER DEFAULT 20;
  CALL DBMS_ALERT.REGISTER('alert_test');
  CALL DBMS_ALERT.REGISTER('any_alert');
  CALL DBMS_OUTPUT.PUT_LINE('Registered for alert alert_test and any_alert');
  CALL DBMS_OUTPUT.PUT_LINE('Waiting for signal...');
  CALL DBMS_ALERT.WAITANY(v_name , v_msg , v_status , v_timeout);
  CALL DBMS_OUTPUT.PUT_LINE('Alert name : ' || v_name);
  CALL DBMS_OUTPUT.PUT_LINE('Alert msg : ' || v_msg);
  CALL DBMS_OUTPUT.PUT_LINE('Alert status : ' || v_status);
  CALL DBMS_OUTPUT.PUT_LINE('Alert timeout: ' || v_timeout || ' seconds');
  CALL DBMS_ALERT.REMOVEALL;
END@

call proc1@
```

From another connection, run a script called `signal.clp` to issue a signal for an alert named `any_alert`.

`signal.clp`:

```
SET SERVEROUTPUT ON@

CREATE PROCEDURE proc2
  BEGIN
    DECLARE v_name VARCHAR(30) DEFAULT 'any_alert';
    CALL DBMS_ALERT.SIGNAL(v_name,'This is the message from ' || v_name);
    CALL DBMS_OUTPUT.PUT_LINE('Issued alert for ' || v_name);
  END@

CALL proc2@
```

The script `signal.clp` results in the following output:

```
Issued alert for any_alert
```

The script `waitany.clp` results in the following output:

```
Registered for alert alert_test and any_alert
Waiting for signal...
Alert name : any_alert
Alert msg : This is the message from any_alert
Alert status : 0
Alert timeout: 20 seconds
```

Usage notes

If no alerts are registered when the WAITANY procedure is called, the procedure returns SQL0443N.

WAITONE procedure - Wait for a specified alert

The WAITONE procedure waits for a specified alert to occur.

Syntax

```
►►—DBMS_ALERT.WAITONE—(—name—, —message—, —status—, —timeout—)—————►►
```

Procedure parameters

name

An input argument of type VARCHAR(128) that specifies the name of the alert.

message

An output argument of type VARCHAR(32672) that contains the message sent by the SIGNAL procedure.

status

An output argument of type INTEGER that contains the status code returned by the procedure. The following values are possible

0 An alert occurred.

1 A timeout occurred.

timeout

An input argument of type INTEGER that specifies the amount of time in seconds to wait for the specified alert.

Authorization

EXECUTE privilege on the DBMS_ALERT module.

Example

Run a CLP script named waitone.clp to receive an alert named alert_test.

waitone.clp:

```
SET SERVEROUTPUT ON@

CREATE PROCEDURE proc1()
BEGIN
  DECLARE v_name     VARCHAR(30) DEFAULT 'alert_test';
  DECLARE v_msg     VARCHAR(80);
  DECLARE v_status   INTEGER;
  DECLARE v_timeout INTEGER DEFAULT 20;
  CALL DBMS_ALERT.REGISTER(v_name);
  CALL DBMS_OUTPUT.PUT_LINE('Waiting for signal...');
  CALL DBMS_ALERT.WAITONE(v_name , v_msg , v_status , v_timeout);

```

```

CALL DBMS_OUTPUT.PUT_LINE('Alert name : ' || v_name);
CALL DBMS_OUTPUT.PUT_LINE('Alert msg : ' || v_msg);
CALL DBMS_OUTPUT.PUT_LINE('Alert status : ' || v_status);
CALL DBMS_OUTPUT.PUT_LINE('Alert timeout: ' || v_timeout || ' seconds');
CALL DBMS_ALERT.REMOVE(v_name);
END@

```

```
CALL proc1@
```

From a different connection, run a script named `signalalert.clp` to issue a signal for an alert named `alert_test`.

`signalalert.clp`:

```
SET SERVEROUTPUT ON@
```

```

CREATE PROCEDURE proc2
BEGIN
  DECLARE v_name VARCHAR(30) DEFAULT 'alert_test';
  CALL DBMS_ALERT.SIGNAL(v_name,'This is the message from ' || v_name);
  CALL DBMS_OUTPUT.PUT_LINE('Issued alert for ' || v_name);
END@

```

```
CALL proc2@
```

The script `signalalert.clp` results in the following output:

```
Issued alert for alert_test
```

The script `waitone.clp` results in the following output:

```

Waiting for signal...
Alert name : alert_test
Alert msg : This is the message from alert_test
Alert status : 0
Alert timeout: 20 seconds

```

Chapter 24. DBMS_DDL module

The DBMS_DDL module provides the capability to obfuscate DDL objects such as routines, triggers, views or PL/SQL packages. Obfuscation allows the deployment of SQL objects to a database without exposing the procedural logic.

The DDL statements for these objects are obfuscated both in vendor-provided install scripts as well as in the DB2 catalogs.

The schema for this module is SYSIBMADM.

The DBMS_DDL module includes the following routines.

Table 12. Built-in routines available in the DBMS_DDL module

Routine name	Description
WRAP function	Produces an obfuscated version of the DDL statement provided as argument.
CREATE_WRAPPED procedure	Deploys a DDL statement in the database in an obfuscated format.

WRAP function - Obfuscate a DDL statement

The **WRAP** function transforms a readable DDL statement into an obfuscated DDL statement.

Syntax

In an obfuscated DDL statement, the procedural logic and embedded SQL statements are scrambled in such a way that any intellectual property in the logic cannot be easily extracted. If the DDL statement corresponds to an external routine definition, the portion following the parameter list is encoded.

►►—DBMS_DDL.WRAP—(—*object-definition-string*—)—————►►

Parameters

object-definition-string

A string of type CLOB(2M) containing a DDL statement text which can be one of the following (SQLSTATE 5UA00):

- create procedure
- create function
- create package (PL/SQL)
- create package body (PL/SQL)
- create trigger
- create view
- alter module add function
- alter module publish function
- alter module add procedure
- alter module publish procedure

The result is a string of type CLOB(2M) which contains an encoded version of the input statement. The encoding consists of a prefix of the original statement up to and including the routine signature or the trigger, view or package name, followed by the keyword WRAPPED. This keyword is followed by information about the application server that executes the function. The information has the form *pppvrrm*, where:

- *ppp* identifies the product as DB2 Database for Linux[®], UNIX[®], and Windows[®] using the letters SQL
- *vv* is a two-digit version identifier, such as '09'
- *rr* is a two-digit release identifier, such as '07'
- *m* is a one-character modification level identifier, such as '0'.

For example, Fixpack 2 of Version 9.7 is identified as 'SQL09072'. This application server information is followed by a string of letters (a-z, and A-Z), digits (0-9), underscores and colons. No syntax checking is done on the input statement beyond the prefix that remains readable after obfuscation.

The encoded DDL statement is typically longer than the plain text form of the statement. If the result exceeds the maximum length for SQL statements an error is raised (SQLSTATE 54001).

Note: The encoding of the statement is meant to obfuscate the content and should not be considered as a form of strong encryption.

Authorization

EXECUTE privilege on the DBMS_DDL module

Example

- Produce an obfuscated version of a function that computes a yearly salary from an hourly wage given a 40 hour workweek

```
VALUES(DBMS_DDL.WRAP('CREATE FUNCTION ' ||
                    'salary(wage DECFLOAT) ' ||
                    'RETURNS DECFLOAT ' ||
                    'RETURN wage * 40 * 52'))
```

The result of the previous statement would be something of the form:

```
CREATE FUNCTION salary(wage DECFLOAT) WRAPPED SQL09072 obfuscated-text
```

- Produce an obfuscated form of a trigger setting a complex default

```
VALUES(DBMS_DDL.WRAP('CREATE OR REPLACE TRIGGER ' ||
                    'trg1 BEFORE INSERT ON emp ' ||
                    'REFERENCING NEW AS n ' ||
                    'FOR EACH ROW ' ||
                    'WHEN (n.bonus IS NULL) ' ||
                    'SET n.bonus = n.salary * .04'))
```

The result of the previous statement would be something of the form:

```
CREATE OR REPLACE TRIGGER trg1 WRAPPED SQL09072 obfuscated-text
```

CREATE_WRAPPED procedure - Deploy an obfuscated object

The **CREATE_WRAPPED** procedure transforms a plain text DDL object definition into an obfuscated DDL object definition and then deploys the object in the database.

Syntax

In an obfuscated DDL statement, the procedural logic and embedded SQL statements are encoded in such a way that any intellectual property in the logic cannot be easily extracted.

►►—DBMS_DDL.CREATE_WRAPPED—(—*object-definition-string*—)—————►►

Parameters

object-definition-string

A string of type CLOB(2M) containing a DDL statement text which can be one of the following (SQLSTATE 5UA00):

- create procedure
- create function
- create package (PL/SQL)
- create package body (PL/SQL)
- create trigger
- create view
- alter module add function
- alter module publish function
- alter module add procedure
- alter module publish procedure

The procedure transforms the input into an obfuscated DDL statement string and then dynamically executes that DDL statement. Special register values such as PATH and CURRENT SCHEMA in effect at invocation as well as the current invoker's rights are being used.

The encoding consists of a prefix of the original statement up to and including the routine signature or the trigger, view or package name, followed by the keyword **WRAPPED**. This keyword is followed by information about the application server that executes the procedure. The information has the form "*pppvrrm*," where:

- *ppp* identifies the product as DB2 Database for Linux[®], UNIX[®], and Windows[®] using the letters SQL
- *vv* is a two-digit version identifier, such as '09'
- *rr* is a two-digit release identifier, such as '07'
- *m* is a one-character modification level identifier, such as '0'.

For example, Fixpack 2 of Version 9.7 is identified as 'SQL09072'. This application server information is followed by a string of letters (a-z, and A-Z), digits (0-9), underscores and colons. No syntax checking is done on the input statement beyond the prefix that remains readable after obfuscation.

The encoded DDL statement is typically longer than the plain text form of the statement. If the result exceeds the maximum length for SQL statements an error is raised (SQLSTATE 54001).

Note: The encoding of the statement is meant to obfuscate the content and should not be considered as a form of strong encryption.

Authorization

EXECUTE privilege on the DBMS_DDL module.

Example

- Create an obfuscated function computing a yearly salary from an hourly wage given a 40 hour workweek

```
CALL DBMS_DDL.CREATE_WRAPPED('CREATE FUNCTION ' ||
                              'salary(wage DECFLOAT) ' ||
                              'RETURNS DECFLOAT ' ||
                              'RETURN wage * 40 * 52');
SELECT text FROM SYSCAT.ROUTINES
WHERE routinename = 'SALARY'
   AND routineschema = CURRENT SCHEMA;
```

Upon successful execution of the CALL statement, The SYSCAT.ROUTINES.TEXT column for the row corresponding to routine 'SALARY' would be something of the form:

```
CREATE FUNCTION salary(wage DECFLOAT) WRAPPED SQL09072 obfuscated-text
```

- Create an obfuscated trigger setting a complex default

```
CALL DBMS_DDL.CREATE_WRAPPED('CREATE OR REPLACE TRIGGER ' ||
                              'trg1 BEFORE INSERT ON emp ' ||
                              'REFERENCING NEW AS n ' ||
                              'FOR EACH ROW ' ||
                              'WHEN (n.bonus IS NULL) ' ||
                              'SET n.bonus = n.salary * .04');
SELECT text FROM SYSCAT.TRIGGERS
WHERE trigname = 'TRG1'
   AND trigschema = CURRENT SCHEMA;
```

Upon successful execution of the CALL statement, The SYSCAT.TRIGGERS.TEXT column for the row corresponding to trigger 'TRG1' would be something of the form:

```
CREATE OR REPLACE TRIGGER trg1 WRAPPED SQL09072 obfuscated-text
```

Chapter 25. DBMS_JOB module

The DBMS_JOB module provides procedures for the creation, scheduling, and managing of jobs.

The DBMS_JOB module provides an alternate interface for the Administrative Task Scheduler (ATS). A job is created by adding a task to the ATS. The actual task name is constructed by concatenating the DBMS_JOB.TASK_NAME_PREFIX procedure name with the assigned job identifier, such as SAMPLE_JOB_TASK_1 where 1 is the job identifier.

A job runs a stored procedure which has been previously stored in the database. The SUBMIT procedure is used to create and store a job definition. A job identifier is assigned to every job, along with its associated stored procedure and the attributes describing when and how often the job is run.

On first run of the SUBMIT procedure in a database, the SYSTOOLSPACE table space is created if necessary.

To enable job scheduling for the DBMS_JOB routines, run:

```
db2set DB2_ATS_ENABLE=1
```

When and how often a job runs depends upon two interacting parameters - **next_date** and **interval**. The **next_date** parameter is a datetime value that specifies the next date and time when the job is to be executed. The **interval** parameter is a string that contains a date function that evaluates to a datetime value. Just prior to any execution of the job, the expression in the **interval** parameter is evaluated, and the resulting value replaces the **next_date** value stored with the job. The job is then executed. In this manner, the expression in **interval** is re-evaluated prior to each job execution, supplying the **next_date** date and time for the next execution.

The first run of a scheduled job, as specified by the **next_date** parameter, should be set at least 5 minutes after the current time, and the interval between running each job should also be at least 5 minutes.

The schema for this module is SYSIBMADM.

The DBMS_JOB module includes the following built-in routines.

Table 13. Built-in routines available in the DBMS_JOB module

Routine name	Description
BROKEN procedure	Specify that a given job is either broken or not broken.
CHANGE procedure	Change the parameters of the job.
INTERVAL procedure	Set the execution frequency by means of a date function that is recalculated each time the job runs. This value becomes the next date and time for execution.
NEXT_DATE procedure	Set the next date and time when the job is to be run.

Table 13. Built-in routines available in the DBMS_JOB module (continued)

Routine name	Description
REMOVE procedure	Delete the job definition from the database.
RUN procedure	Force execution of a job even if it is marked as broken.
SUBMIT procedure	Create a job and store the job definition in the database.
WHAT procedure	Change the stored procedure run by a job.

Table 14. Built-in constants available in the DBMS_JOB module

Constant name	Description
ANY_INSTANCE	The only supported value for the instance argument for the DBMS_JOB routines.
TASK_NAME_PREFIX	This constant contains the string that is used as the prefix for constructing the task name for the administrative task scheduler.

Usage notes

When the first job is submitted through the DBMS_JOB module for each database, the Administrative Task Scheduler setup is performed:

1. Create the SYSTOOLSPACE table space if it does not exist;
2. Create the ATS table and views, such as SYSTOOLS.ADMIN_TASK_LIST.

To list the scheduled jobs, run:

```
db2 SELECT * FROM systools.admin_task_list
      WHERE name LIKE DBMS_JOB.TASK_NAME_PREFIX || '_%'
```

To view the status of the job execution, run:

```
db2 SELECT * FROM systools.admin_task_status
      WHERE name LIKE DBMS_JOB.TASK_NAME_PREFIX || '_%'
```

Examples

Example 1: The following example uses the stored procedure, job_proc. This stored procedure simply inserts a timestamp into the jobrun table, which contains a single VARCHAR column.

```
CREATE TABLE jobrun (
  runtime          VARCHAR(40)
)@

CREATE OR REPLACE PROCEDURE job_proc
BEGIN
  INSERT INTO jobrun VALUES ('job_proc run at ' || TO_CHAR(SYSDATE,
    'yyyy-mm-dd hh24:mi:ss'));
END@
```

This example results in the following output:

```
CREATE TABLE jobrun ( runtime          VARCHAR(40) )
DB20000I The SQL command completed successfully.
```

```
CREATE OR REPLACE PROCEDURE job_proc
BEGIN
  INSERT INTO jobrun VALUES ('job_proc run at ' || TO_CHAR(SYSDATE,
```



```
'yyyy-mm-dd hh24:mi:ss');  
END  
DB20000I The SQL command completed successfully.
```

BROKEN procedure - Set the state of a job to either broken or not broken

The BROKEN procedure sets the state of a job to either broken or not broken.

A broken job cannot be executed except by using the RUN procedure.

Syntax

```
▶▶ DBMS_JOB.BROKEN(—job—,—broken—,—next_date—)▶▶
```

Parameters

job

An input argument of type DECIMAL(20) that specifies the identifier of the job to be set as broken or not broken.

broken

An input argument of type BOOLEAN that specifies the job status. If set to "true", the job state is set to broken. If set to "false", the job state is set to not broken. Broken jobs cannot be run except through the RUN procedure.

next_date

An optional input argument of type DATE that specifies the date and time when the job runs. The default is SYSDATE.

Authorization

EXECUTE privilege on the DBMS_JOB module.

Examples

Example 1: Set the state of a job with job identifier 104 to broken:

```
CALL DBMS_JOB.BROKEN(104,true);
```

Example 2: Change the state back to not broken:

```
CALL DBMS_JOB.BROKEN(104,false);
```

CHANGE procedure - Modify job attributes

The CHANGE procedure modifies certain job attributes, including the executable SQL statement, the next date and time the job is run, and how often it is run.

Syntax

```
▶▶ DBMS_JOB.CHANGE(—job—,—what—,—next_date—,—interval—)▶▶
```

Parameters

job

An input argument of type DECIMAL(20) that specifies the identifier of the job with the attributes to modify.

what

An input argument of type VARCHAR(1024) that specifies the executable SQL statement. Set this argument to NULL if the existing value is to remain unchanged.

next_date

An input argument of type TIMESTAMP(0) that specifies the next date and time when the job is to run. Set this argument to NULL if the existing value is to remain unchanged.

interval

An input argument of type VARCHAR(1024) that specifies the date function that, when evaluated, provides the next date and time the job is to run. Set this argument to NULL if the existing value is to remain unchanged.

Authorization

EXECUTE privilege on the DBMS_JOB module.

Examples

Example 1: Change the job to run next on December 13, 2009. Leave other parameters unchanged.

```
CALL DBMS_JOB.CHANGE(104,NULL,TO_DATE('13-DEC-09','DD-MON-YY'),NULL);
```

INTERVAL procedure - Set run frequency

The INTERVAL procedure sets the frequency of how often a job is run.

Syntax

```
▶▶—DBMS_JOB.INTERVAL—(—job—,—interval—)—————▶▶
```

Parameters

job

An input argument of type DECIMAL(20) that specifies the identifier of the job whose frequency is being changed.

interval

An input argument of type VARCHAR(1024) that specifies the date function that, when evaluated, provides the next date and time the job is to run.

Authorization

EXECUTE privilege on the DBMS_JOB module.

Examples

Example 1: Change the job to run once a week:

```
CALL DBMS_JOB.INTERVAL(104,'SYSDATE + 7');
```

NEXT_DATE procedure - Set the date and time when a job is run

The NEXT_DATE procedure sets the next date and time of when the job is to run.

Syntax

►► DBMS_JOB.NEXT_DATE(—*job*—, —*next_date*—) ◀◀

Parameters

job

An input argument of type DECIMAL(20) that specifies the identifier of the job whose next run date is to be modified.

next_date

An input argument of type TIMESTAMP(0) that specifies the date and time when the job is to be run next.

Authorization

EXECUTE privilege on the DBMS_JOB module.

Examples

Example 1: Change the job to run next on December 14, 2009:

```
CALL DBMS_JOB.NEXT_DATE(104, TO_DATE('14-DEC-09', 'DD-MON-YY'));
```

REMOVE procedure - Delete the job definition from the database

The REMOVE procedure deletes the specified job from the database.

In order to have it executed again in the future, the job must be resubmitted using the SUBMIT procedure.

Note: The stored procedure associated with the job is not deleted when the job is removed.

Syntax

►► DBMS_JOB.REMOVE(—*job*—) ◀◀

Parameters

job

An input argument of type DECIMAL(20) that specifies the identifier of the job to be removed from the database.

Authorization

EXECUTE privilege on the DBMS_JOB module.

Examples

Example 1: Remove a job from the database:

```
CALL DBMS_JOB.REMOVE(104);
```

RUN procedure - Force a broken job to run

The RUN procedure forces a job to run, even if it has a broken state.

Syntax

►► DBMS_JOB.RUN(—*job*—)◄◄

Parameters

job

An input argument of type DECIMAL(20) that specifies the identifier of the job to run.

Authorization

EXECUTE privilege on the DBMS_JOB module.

Examples

Example 1: Force a job to run.

```
CALL DBMS_JOB.RUN(104);
```

SUBMIT procedure - Create a job definition and store it in the database

The SUBMIT procedure creates a job definition and stores it in the database.

A job consists of a job identifier, the stored procedure to be executed, when the job is first executed, and a date function that calculates the next date and time for the job to be run.

Syntax

►► DBMS_JOB.SUBMIT(—*job*—, —*what*—
◄◄
 [, —*next_date*—]
 [, —*interval*—]
 [, —*no_parse*—])

Parameters

job

An output argument of type DECIMAL(20) that specifies the identifier assigned to the job.

what

An input argument of type VARCHAR(1024) that specifies the name of the dynamically executable SQL statement.

next_date

An optional input argument of type TIMESTAMP(0) that specifies the next date and time when the job is to be run. The default is SYSDATE.

interval

An optional input argument of type VARCHAR(1024) that specifies a date

function that, when evaluated, provides the date and time of the execution after the next execution. If *interval* is set to NULL, then the job is run only once. NULL is the default.

no_parse

An optional input argument of type BOOLEAN. If set to true, do not syntax-check the SQL statement at job creation; instead, perform syntax checking only when the job first executes. If set to false, syntax check the SQL statement at job creation. The default is false.

Authorization

EXECUTE privilege on the DBMS_JOB module.

Examples

Example 1: The following example creates a job using the stored procedure, `job_proc`. The job will first execute in about 5 minutes, and runs once a day thereafter as set by the *interval* argument, `SYSDATE + 1`.

```
SET SERVEROUTPUT ON@
```

```
BEGIN
  DECLARE jobid          INTEGER;
  CALL DBMS_JOB.SUBMIT(jobid,'CALL job_proc();',SYSDATE + 5 minutes, 'SYSDATE + 1');
  CALL DBMS_OUTPUT.PUT_LINE('jobid: ' || jobid);
END@
```

The output from this command is as follows:

```
SET SERVEROUTPUT ON
```

```
DB20000I The SET SERVEROUTPUT command completed successfully.
```

```
BEGIN
  DECLARE jobid          INTEGER;
  CALL DBMS_JOB.SUBMIT(jobid,'CALL job_proc();',SYSDATE + 5 minutes, 'SYSDATE + 1');
  CALL DBMS_OUTPUT.PUT_LINE('jobid: ' || jobid);
END
DB20000I The SQL command completed successfully.
```

```
jobid: 1
```

WHAT procedure - Change the SQL statement run by a job

The WHAT procedure changes the SQL statement run by a specified job.

Syntax

```
►► DBMS_JOB.WHAT (—job—, —what—) ◀◀
```

Parameters

job

An input argument of type DECIMAL(20) that specifies the job identifier for which the dynamically executable SQL statement is to be changed.

what

An input argument of type VARCHAR(1024) that specifies the dynamically executed SQL statement.

Authorization

EXECUTE privilege on the DBMS_JOB module.

Examples

Example 1: Change the job to run the list_emp procedure:

```
CALL DBMS_JOB.WHAT(104,'list_emp;');
```

Chapter 26. DBMS_LOB module

The DBMS_LOB module provides the capability to operate on large objects.

In the following sections describing the individual procedures and functions, lengths and offsets are measured in bytes if the large objects are BLOBs. Lengths and offsets are measured in characters if the large objects are CLOBs.

The DBMS_LOB module supports LOB data up to 10M bytes.

The schema for this module is SYSIBMADM.

The DBMS_LOB module includes the following routines which can contain BLOB and CLOB versions (for example, the OPEN procedure has an OPEN_BLOB and OPEN_CLOB implementation).

Table 15. Built-in routines available in the DBMS_LOB module

Routine Name	Description
APPEND procedure	Appends one large object to another.
CLOSE procedure	Close an open large object.
COMPARE function	Compares two large objects.
CONVERTTOBLOB procedure	Converts character data to binary.
CONVERTTOCLOB procedure	Converts binary data to character.
COPY procedure	Copies one large object to another.
ERASE procedure	Erase a large object.
GET_STORAGE_LIMIT function	Get the storage limit for large objects.
GETLENGTH function	Get the length of the large object.
INSTR function	Get the position of the nth occurrence of a pattern in the large object starting at offset.
ISOPEN function	Check if the large object is open.
OPEN procedure	Open a large object.
READ procedure	Read a large object.
SUBSTR function	Get part of a large object.
TRIM procedure	Trim a large object to the specified length.
WRITE procedure	Write data to a large object.
WRITEAPPEND procedure	Write data from the buffer to the end of a large object.

Note: In partitioned database environments, you will receive an error if you execute any of the following routines inside a WHERE clause of a SELECT statement:

- dbms_lob.compare
- dbms_lob.get_storage_limit
- dbms_lob.get_length
- dbms_lob.instr
- dbms_lob.isopen

- `dbms_lob.substr`

The following table lists the public variables available in the module.

Table 16. *DBMS_LOB public variables*

Public variables	Data type	Value
<code>lob_readonly</code>	INTEGER	0
<code>lob_readwrite</code>	INTEGER	1

APPEND procedures - Append one large object to another

The APPEND procedures provide the capability to append one large object to another.

Note: Both large objects must be of the same type.

Syntax

```
▶▶ DBMS_LOB.APPEND_BLOB(dest_lob, src_lob)
```

```
▶▶ DBMS_LOB.APPEND_CLOB(dest_lob, src_lob)
```

Parameters

dest_lob

An input or output argument of type BLOB(10M) or CLOB(10M) that specifies the large object locator for the destination object. Must be the same data type as *src_lob*.

src_lob

An input argument of type BLOB(10M) or CLOB(10M) that specifies the large object locator for the source object. Must be the same data type as *dest_lob*.

Authorization

EXECUTE privilege on the DBMS_LOB module.

CLOSE procedures - Close an open large object

The CLOSE procedures are a no-op.

Syntax

```
▶▶ DBMS_LOB.CLOSE_BLOB(lob_loc)
```

```
▶▶ DBMS_LOB.CLOSE_CLOB(lob_loc)
```

Parameters

lob_loc

An input or output argument of type BLOB(10M) or CLOB(10M) that specifies the large object locator of the large object to be closed.

Authorization

EXECUTE privilege on the DBMS_LOB module.

COMPARE function - Compare two large objects

The COMPARE function performs an exact byte-by-byte comparison of two large objects for a given length at given offsets.

The function returns:

- Zero if both large objects are exactly the same for the specified length for the specified offsets
- Non-zero if the objects are not the same
- Null if *amount*, *offset_1*, or *offset_2* are less than zero.

Note: The large objects being compared must be the same data type.

Syntax

```
DBMS_LOB.COMPARE(lob_1, lob_2,  
                [amount],  
                [offset_1],  
                [offset_2])
```

Parameters

lob_1

An input argument of type BLOB(10M) or CLOB(10M) that specifies the large object locator of the first large object to be compared. Must be the same data type as *lob_2*.

lob_2

An input argument of type BLOB(10M) or CLOB(10M) that specifies the large object locator of the second large object to be compared. Must be the same data type as *lob_1*.

amount

An optional input argument of type INTEGER. If the data type of the large objects is BLOB, then the comparison is made for *amount* bytes. If the data type of the large objects is CLOB, then the comparison is made for *amount* characters. The default is the maximum size of a large object.

offset_1

An optional input argument of type INTEGER that specifies the position within the first large object to begin the comparison. The first byte (or character) is offset 1. The default is 1.

offset_2

An optional input argument of type INTEGER that specifies the position within the second large object to begin the comparison. The first byte (or character) is offset 1. The default is 1.

Authorization

EXECUTE privilege on the DBMS_LOB module.

CONVERTTLOB procedure - Convert character data to binary

The CONVERTTLOB procedure provides the capability to convert character data to binary.

Syntax

```
►► DBMS_LOB.CONVERTTLOB(—dest_lob—,—src_clob—,—amount—,——————►  
►—dest_offset—,—src_offset—,—blob_csid—,—lang_context—,—warning—)————►◄
```

Parameters

dest_lob

An input or output argument of type BLOB(10M) that specifies the large object locator into which the character data is to be converted.

src_clob

An input argument of type CLOB(10M) that specifies the large object locator of the character data to be converted.

amount

An input argument of type INTEGER that specifies the number of characters of *src_clob* to be converted.

dest_offset

An input or output argument of type INTEGER that specifies the position (in bytes) in the destination BLOB where writing of the source CLOB should begin. The first byte is offset 1.

src_offset

An input or output argument of type INTEGER that specifies the position (in characters) in the source CLOB where conversion to the destination BLOB should begin. The first character is offset 1.

blob_csid

An input argument of type INTEGER that specifies the character set ID of the destination BLOB. This value must match the database codepage.

lang_context

An input argument of type INTEGER that specifies the language context for the conversion. This value must be 0.

warning

An output argument of type INTEGER that always returns 0.

Authorization

EXECUTE privilege on the DBMS_LOB module.

CONVERTTOCLOB procedure - Convert binary data to character

The CONVERTTOCLOB procedure provides the capability to convert binary data to character.

Syntax

```
► DBMS_LOB.CONVERTTOCLOB(—dest_lob—, —src_blob—, —amount—, —————►  
► —dest_offset—, —src_offset—, —blob_csid—, —lang_context—, —warning—) —————►
```

Parameters

dest_lob

An input or output argument of type CLOB(10M) that specifies the large object locator into which the binary data is to be converted.

src_blob

An input argument of type BLOB(10M) that specifies the large object locator of the binary data to be converted.

amount

An input argument of type INTEGER that specifies the number of characters of *src_blob* to be converted.

dest_offset

An input or output argument of type INTEGER that specifies the position (in characters) in the destination CLOB where writing of the source BLOB should begin. The first byte is offset 1.

src_offset

An input or output argument of type INTEGER that specifies the position (in bytes) in the source BLOB where conversion to the destination CLOB should begin. The first character is offset 1.

blob_csid

An input argument of type INTEGER that specifies the character set ID of the source BLOB. This value must match the database codepage.

lang_context

An input argument of type INTEGER that specifies the language context for the conversion. This value must be 0.

warning

An output argument of type INTEGER that always returns 0.

Authorization

EXECUTE privilege on the DBMS_LOB module.

COPY procedures - Copy one large object to another

The COPY procedures provide the capability to copy one large object to another.

Note: The source and destination large objects must be the same data type.

Syntax

```
▶▶ DBMS_LOB.COPY_BLOB(—dest_lob—, —src_lob—, —amount—  
▶▶ )  
▶▶ [—dest_offset—  
▶▶ [—src_offset—
```



```
▶▶ DBMS_LOB.COPY_CLOB(—dest_lob—, —src_lob—, —amount—  
▶▶ )  
▶▶ [—dest_offset—  
▶▶ [—src_offset—
```

Parameters

dest_lob

An input or output argument of type BLOB(10M) or CLOB(10M) that specifies the large object locator of the large object to which *src_lob* is to be copied. Must be the same data type as *src_lob*.

src_lob

An input argument of type BLOB(10M) or CLOB(10M) that specifies the large object locator of the large object from which *dest_lob* is to be copied. Must be the same data type as *dest_lob*.

amount

An input argument of type INTEGER that specifies the number of bytes or characters of *src_lob* to be copied.

dest_offset

An optional input argument of type INTEGER that specifies the position in the destination large object where writing of the source large object should begin. The first position is offset 1. The default is 1.

src_offset

An optional input argument of type INTEGER that specifies the position in the source large object where copying to the destination large object should begin. The first position is offset 1. The default is 1.

Authorization

EXECUTE privilege on the DBMS_LOB module.

ERASE procedures - Erase a portion of a large object

The ERASE procedures provide the capability to erase a portion of a large object.

To erase a large object means to replace the specified portion with zero-byte fillers for BLOBs or with spaces for CLOBs. The actual size of the large object is not altered.

Syntax

```
▶▶ DBMS_LOB.ERASE_BLOB(—lob_loc—, —amount— [—offset—])
```

►► DBMS_LOB.ERASE_CLOB (—lob_loc—, —amount—, —offset—) ►►

Parameters

lob_loc

An input or output argument of type BLOB(10M) or CLOB(10M) that specifies the large object locator of the large object to be erased.

amount

An input or output argument of type INTEGER that specifies the number of bytes or characters to be erased.

offset

An optional input argument of type INTEGER that specifies the position in the large object where erasing is to begin. The first byte or character is at position 1. The default is 1.

Authorization

EXECUTE privilege on the DBMS_LOB module.

GET_STORAGE_LIMIT function - Return the limit on the largest allowable large object

The GET_STORAGE_LIMIT function returns the limit on the largest allowable large object.

The function returns an INTEGER value that reflects the maximum allowable size of a large object in this database.

Syntax

►► DBMS_LOB.GET_STORAGE_LIMIT (—) ►►

Authorization

EXECUTE privilege on the DBMS_LOB module.

GETLENGTH function - Return the length of the large object

The GETLENGTH function returns the length of a large object.

The function returns an INTEGER value that reflects the length of the large object in bytes (for a BLOB) or characters (for a CLOB).

Syntax

►► DBMS_LOB.GETLENGTH (—lob_loc—) ►►

Parameters

lob_loc

An input argument of type BLOB(10M) or CLOB(10M) that specifies the large object locator of the large object whose length is to be obtained.

Authorization

EXECUTE privilege on the DBMS_LOB module.

INSTR function - Return the location of the *n*th occurrence of a given pattern

The INSTR function returns the location of the *n*th occurrence of a given pattern within a large object.

The function returns an INTEGER value of the position within the large object where the pattern appears for the *n*th time, as specified by *n*th. This value starts from the position given by *offset*.

Syntax

```
DBMS_LOB.INSTR(lob_loc, pattern, offset, nth)
```

Parameters

lob_loc

An input argument of type BLOB or CLOB that specifies the large object locator of the large object in which to search for the *pattern*.

pattern

An input argument of type BLOB(32767) or VARCHAR(32672) that specifies the pattern of bytes or characters to match against the large object. Note that *pattern* must be BLOB if *lob_loc* is a BLOB; and *pattern* must be VARCHAR if *lob_loc* is a CLOB.

offset

An optional input argument of type INTEGER that specifies the position within *lob_loc* to start searching for the *pattern*. The first byte or character is at position 1. The default value is 1.

nth

An optional argument of type INTEGER that specifies the number of times to search for the *pattern*, starting at the position given by *offset*. The default value is 1.

Authorization

EXECUTE privilege on the DBMS_LOB module.

ISOPEN function - Test if the large object is open

The ISOPEN function always returns an INTEGER value of 1..

Syntax

▶▶ DBMS_LOB.ISOPEN(*lob_loc*)

Parameters

lob_loc

An input argument of type BLOB(10M) or CLOB(10M) that specifies the large object locator of the large object to be tested by the function.

Authorization

EXECUTE privilege on the DBMS_LOB module.

OPEN procedures - Open a large object

The OPEN procedures are a no-op.

Syntax

▶▶ DBMS_LOB.OPEN_BLOB(*lob_loc*, *open_mode*)

▶▶ DBMS_LOB.OPEN_CLOB(*lob_loc*, *open_mode*)

Parameters

lob_loc

An input or output argument of type BLOB(10M) or CLOB(10M) that specifies the large object locator of the large object to be opened.

open_mode

An input argument of type INTEGER that specifies the mode in which to open the large object. Set to 0 (*lob_readonly*) for read-only mode. Set to 1 (*lob_readwrite*) for read-write mode.

Authorization

EXECUTE privilege on the DBMS_LOB module.

READ procedures - Read a portion of a large object

The READ procedures provide the capability to read a portion of a large object into a buffer.

Syntax

▶▶ DBMS_LOB.READ_BLOB(*lob_loc*, *amount*, *offset*, *buffer*)

▶▶ DBMS_LOB.READ_CLOB(*lob_loc*, *amount*, *offset*, *buffer*)

Parameters

lob_loc

An input argument of type BLOB(10M) or CLOB(10M) that specifies the large object locator of the large object to be read.

amount

An input or output argument of type INTEGER that specifies the number of bytes or characters to read.

offset

An input argument of type INTEGER that specifies the position to begin reading. The first byte or character is at position 1.

buffer

An output argument of type BLOB(32762) or VARCHAR(32762) that specifies the variable to receive the large object. If *lob_loc* is a BLOB, then *buffer* must be BLOB. If *lob_loc* is a CLOB, then *buffer* must be VARCHAR.

Authorization

EXECUTE privilege on the DBMS_LOB module.

SUBSTR function - Return a portion of a large object

The SUBSTR function provides the capability to return a portion of a large object.

The function returns a BLOB(32767) (for a BLOB) or VARCHAR (for a CLOB) value for the returned portion of the large object read by the function.

Syntax

►► DBMS_LOB.SUBSTR(—*lob_loc*—, —*amount*—, —*offset*—)

Parameters

lob_loc

An input argument of type BLOB(10M) or CLOB(10M) that specifies the large object locator of the large object to be read.

amount

An optional input argument of type INTEGER that specifies the number of bytes or characters to be returned. The default value is 32,767.

offset

An optional input argument of type INTEGER that specifies the position within the large object to begin returning data. The first byte or character is at position 1. The default value is 1.

Authorization

EXECUTE privilege on the DBMS_LOB module.

TRIM procedures - Truncate a large object to the specified length

The TRIM procedures provide the capability to truncate a large object to the specified length.

Syntax

▶▶—DBMS_LOB.TRIM_BLOB—(*—lob_loc—*,*—newlen—*)—————▶▶

▶▶—DBMS_LOB.TRIM_CLOB—(*—lob_loc—*,*—newlen—*)—————▶▶

Parameters

lob_loc

An input or output argument of type BLOB(10M) or CLOB(10M) that specifies the large object locator of the large object to be trimmed.

newlen

An input argument of type INTEGER that specifies the new number of bytes or characters to which the large object is to be trimmed.

Authorization

EXECUTE privilege on the DBMS_LOB module.

WRITE procedures - Write data to a large object

The WRITE procedures provide the capability to write data into a large object.

Any existing data in the large object at the specified offset for the given length is overwritten by data given in the buffer.

Syntax

▶▶—DBMS_LOB.WRITE_BLOB—(*—lob_loc—*,*—amount—*,*—offset—*,*—buffer—*)—————▶▶

▶▶—DBMS_LOB.WRITE_CLOB—(*—lob_loc—*,*—amount—*,*—offset—*,*—buffer—*)—————▶▶

Parameters

lob_loc

An input or output argument of type BLOB(10M) or CLOB(10M) that specifies the large object locator of the large object to be written.

amount

An input argument of type INTEGER that specifies the number of bytes or characters in *buffer* to be written to the large object.

offset

An input argument of type INTEGER that specifies the offset in bytes or characters from the beginning of the large object for the write operation to begin. The start value of the large object is 1.

buffer

An input argument of type BLOB(32767) or VARCHAR(32672) that contains the data to be written to the large object. If *lob_loc* is a BLOB, then *buffer* must be BLOB. If *lob_loc* is a CLOB, then *buffer* must be VARCHAR.

Authorization

EXECUTE privilege on the DBMS_LOB module.

WRITEAPPEND procedures - Append data to the end of a large object

The WRITEAPPEND procedures provide the capability to add data to the end of a large object.

Syntax

▶▶ DBMS_LOB.WRITEAPPEND_BLOB(*lob_loc*, *amount*, *buffer*)

▶▶ DBMS_LOB.WRITEAPPEND_CLOB(*lob_loc*, *amount*, *buffer*)

Parameters

lob_loc

An input or output argument of type BLOB or CLOB that specifies the large object locator of the large object to which data is to be appended.

amount

An input argument of type INTEGER that specifies the number of bytes or characters from *buffer* to be appended to the large object.

buffer

An input argument of type BLOB(32767) or VARCHAR(32672) that contains the data to be appended to the large object. If *lob_loc* is a BLOB, then *buffer* must be BLOB. If *lob_loc* is a CLOB, then *buffer* must be VARCHAR.

Authorization

EXECUTE privilege on the DBMS_LOB module.

Chapter 27. DBMS_OUTPUT module

The DBMS_OUTPUT module provides a set of procedures for putting messages (lines of text) in a message buffer and getting messages from the message buffer. These procedures are useful during application debugging when you need to write messages to standard output.

The schema for this module is SYSIBMADM.

The DBMS_OUTPUT module includes the following built-in routines.

Table 17. Built-in routines available in the DBMS_OUTPUT module

Routine name	Description
DISABLE procedure	Disables the message buffer.
ENABLE procedure	Enables the message buffer
GET_LINE procedure	Gets a line of text from the message buffer.
GET_LINES procedure	Gets one or more lines of text from the message buffer and places the text into a collection
NEW_LINE procedure	Puts an end-of-line character sequence in the message buffer.
PUT procedure	Puts a string that includes no end-of-line character sequence in the message buffer.
PUT_LINE procedure	Puts a single line that includes an end-of-line character sequence in the message buffer.

The procedures in this module allow you to work with the message buffer. Use the command line processor (CLP) command SET SERVEROUTPUT ON to redirect the output to standard output.

DISABLE and ENABLE procedures are not supported inside autonomous procedures.

An autonomous procedure is a procedure that, when called, executes inside a new transaction independent of the original transaction.

Example

In proc1 use the PUT and PUT_LINE procedures to put a line of text in the message buffer. When proc1 runs for the first time, SET SERVEROUTPUT ON is specified, and the line in the message buffer is printed to the CLP window. When proc1 runs a second time, SET SERVEROUTPUT OFF is specified, and no lines from the message buffer are printed to the CLP window.

```
CREATE PROCEDURE proc1( P1 VARCHAR(10) )
BEGIN
  CALL DBMS_OUTPUT.PUT( 'P1 = ' );
  CALL DBMS_OUTPUT.PUT_LINE( P1 );
END@

SET SERVEROUTPUT ON@
```

```
CALL proc1( '10' )@
SET SERVEROUTPUT OFF@
CALL proc1( '20' )@
```

The example results in the following output:

```
CALL proc1( '10' )
    Return Status = 0
P1 = 10
SET SERVEROUTPUT OFF
DB20000I The SET SERVEROUTPUT command completed successfully.
CALL proc1( '20' )
    Return Status = 0
```

DISABLE procedure - Disable the message buffer

The DISABLE procedure disables the message buffer.

After this procedure runs, any messages that are in the message buffer are discarded. Calls to the PUT, PUT_LINE, or NEW_LINE procedures are ignored, and no error is returned to the sender.

Syntax

```
►►—DBMS_OUTPUT.DISABLE—◄◄
```

Authorization

EXECUTE privilege on the DBMS_OUTPUT module.

Example

The following example disables the message buffer for the current session:

```
CALL DBMS_OUTPUT.DISABLE@
```

Usage notes

To send and receive messages after the message buffer has been disabled, use the ENABLE procedure.

ENABLE procedure - Enable the message buffer

The ENABLE procedure enables the message buffer. During a single session, applications can put messages in the message buffer and get messages from the message buffer.

Syntax

```
►►—DBMS_OUTPUT.ENABLE—(—buffer_size—)◄◄
```

Procedure parameters

buffer_size

An input argument of type INTEGER that specifies the maximum length of the message buffer in bytes. If you specify a value of less than 2000 for *buffer_size*, the buffer size is set to 2000. If the value is NULL, then the default buffer size is 20000.

Authorization

EXECUTE privilege on the DBMS_OUTPUT module.

Example

The following example enables the message buffer:

```
CALL DBMS_OUTPUT.ENABLE( NULL )@
```

Usage notes

You can call the ENABLE procedure to increase the size of an existing message buffer. Any messages in the old buffer are copied to the enlarged buffer.

GET_LINE procedure - Get a line from the message buffer

The GET_LINE procedure gets a line of text from the message buffer. The text must be terminated by an end-of-line character sequence.

Tip: To add an end-of-line character sequence to the message buffer, use the PUT_LINE procedure, or, after a series of calls to the PUT procedure, use the NEW_LINE procedure.

Syntax

```
▶▶—DBMS_OUTPUT.GET_LINE—(—line—,—status—)—▶▶
```

Procedure parameters

line

An output argument of type VARCHAR(32672) that returns a line of text from the message buffer.

status

An output argument of type INTEGER that indicates whether a line was returned from the message buffer:

- 0 indicates that a line was returned
- 1 indicates that there was no line to return

Authorization

EXECUTE privilege on the DBMS_OUTPUT module.

Example

Use the GET_LINE procedure to get a line of text from the message buffer. In this example, proc1 puts a line of text in the message buffer. proc3 gets the text from the message buffer and inserts it into a table named messages. proc2 then runs, but

because the message buffer is disabled, no text is added to the message buffer. When the select statement runs, it returns only the text added by proc1.

```
CALL DBMS_OUTPUT.ENABLE( NULL )@

CREATE PROCEDURE proc1()
BEGIN
  CALL DBMS_OUTPUT.PUT_LINE( 'PROC1 put this line in the message buffer.' );
END@

CREATE PROCEDURE proc2()
BEGIN
  CALL DBMS_OUTPUT.PUT_LINE( 'PROC2 put this line in the message buffer.' );
END@

CREATE TABLE messages ( msg VARCHAR(100) )@

CREATE PROCEDURE proc3()
BEGIN
  DECLARE line VARCHAR(32672);
  DECLARE status INT;

  CALL DBMS_OUTPUT.GET_LINE( line, status );
  while status = 0 do
    INSERT INTO messages VALUES ( line );
    CALL DBMS_OUTPUT.GET_LINE( line, status );
  end while;
END@

CALL proc1@

CALL proc3@

CALL DBMS_OUTPUT.DISABLE@

CALL proc2@

CALL proc3@

SELECT * FROM messages@
```

This example results in the following output:

```
MSG
-----
PROC1 put this line in the message buffer.

1 record(s) selected.
```

GET_LINES procedure - Get multiple lines from the message buffer

The GET_LINES procedure gets one or more lines of text from the message buffer and stores the text in a collection. Each line of text must be terminated by an end-of-line character sequence.

Tip: To add an end-of-line character sequence to the message buffer, use the PUT_LINE procedure, or, after a series of calls to the PUT procedure, use the NEW_LINE procedure.

Syntax

```
▶▶—DBMS_OUTPUT.GET_LINES—(—lines—,—numlines—)—▶▶
```

Procedure parameters

lines

An output argument of type DBMS_OUTPUT.CHARARR that returns the lines of text from the message buffer. The type DBMS_OUTPUT.CHARARR is internally defined as a VARCHAR(32672) ARRAY[2147483647] array.

numlines

An input and output argument of type INTEGER. When used as input, specifies the number of lines to retrieve from the message buffer. When used as output, indicates the actual number of lines that were retrieved from the message buffer. If the output value of *numlines* is less than the input value, then there are no more lines remaining in the message buffer.

Authorization

EXECUTE privilege on the DBMS_OUTPUT module.

Example

Use the GET_LINES procedure to get lines of text from the message buffer and store the text in an array. The text in the array can be inserted into a table and queried.

```
CALL DBMS_OUTPUT.ENABLE( NULL )@

CREATE PROCEDURE proc1()
BEGIN
  CALL DBMS_OUTPUT.PUT_LINE( 'PROC1 put this line in the message buffer.' );
  CALL DBMS_OUTPUT.PUT_LINE( 'PROC1 put this line in the message buffer.' );
END@

CREATE PROCEDURE proc2()
BEGIN
  CALL DBMS_OUTPUT.PUT_LINE( 'PROC2 put this line in the message buffer.' );
END@

CREATE TABLE messages ( msg VARCHAR(100) )@

CREATE PROCEDURE proc3()
BEGIN
  DECLARE lines DBMS_OUTPUT.CHARARR;
  DECLARE numlines INT;
  DECLARE i INT;

  CALL DBMS_OUTPUT.GET_LINES( lines, numlines );
  SET i = 1;
  WHILE i <= numlines DO
    INSERT INTO messages VALUES ( lines[i] );
    SET i = i + 1;
  END WHILE;
END@

CALL proc1@

CALL proc3@

CALL DBMS_OUTPUT.DISABLE@

CALL proc2@

CALL proc3@

SELECT * FROM messages@
```

This example results in the following output:

```
MSG
-----
PROC1 put this line in the message buffer.
PROC1 put this line in the message buffer

      2 record(s) selected.
```

NEW_LINE procedure - Put an end-of-line character sequence in the message buffer

The NEW_LINE procedure puts an end-of-line character sequence in the message buffer.

Syntax

```
►►—DBMS_OUTPUT.NEW_LINE—◄◄
```

Authorization

EXECUTE privilege on the DBMS_OUTPUT module.

Example

Use the NEW_LINE procedure to write an end-of-line character sequence to the message buffer. In this example, the text that is followed by an end-of-line character sequence displays as output because SET SERVEROUTPUT ON is specified. However, the text that is in the message buffer, but is not followed by an end-of-line character, does not display.

```
SET SERVEROUTPUT ON@

CREATE PROCEDURE proc1()
BEGIN
  CALL DBMS_OUTPUT.PUT( 'T' );
  CALL DBMS_OUTPUT.PUT( 'h' );
  CALL DBMS_OUTPUT.PUT( 'i' );
  CALL DBMS_OUTPUT.PUT( 's' );
  CALL DBMS_OUTPUT.NEW_LINE;
  CALL DBMS_OUTPUT.PUT( 'T' );
  CALL DBMS_OUTPUT.PUT( 'h' );
  CALL DBMS_OUTPUT.PUT( 'a' );
  CALL DBMS_OUTPUT.PUT( 't' );
END@

CALL proc1@

SET SERVEROUTPUT OFF@
```

This example results in the following output:

```
This
```

PUT procedure - Put a partial line in the message buffer

The PUT procedure puts a string in the message buffer. No end-of-line character sequence is written at the end of the string.

Syntax

►►—DBMS_OUTPUT.PUT—(*—item—*)—►►

Procedure parameters

item

An input argument of type VARCHAR(32672) that specifies the text to write to the message buffer.

Authorization

EXECUTE privilege on the DBMS_OUTPUT module.

Example

Use the PUT procedure to put a partial line in the message buffer. In this example, the NEW_LINE procedure adds an end-of-line character sequence to the message buffer. When proc1 runs, because SET SERVEROUTPUT ON is specified, a line of text is returned.

```
SET SERVEROUTPUT ON@

CREATE PROCEDURE proc1()
BEGIN
  CALL DBMS_OUTPUT.PUT( 'H' );
  CALL DBMS_OUTPUT.PUT( 'e' );
  CALL DBMS_OUTPUT.PUT( 'l' );
  CALL DBMS_OUTPUT.PUT( 'l' );
  CALL DBMS_OUTPUT.PUT( 'o' );
  CALL DBMS_OUTPUT.PUT( '.' );
  CALL DBMS_OUTPUT.NEW_LINE;
END@

CALL proc1@

SET SERVEROUTPUT OFF@
```

This example results in the following output:

```
Hello.
```

Usage notes

After using the PUT procedure to add text to the message buffer, use the NEW_LINE procedure to add an end-of-line character sequence to the message buffer. Otherwise, the text is not returned by the GET_LINE and GET_LINES procedures because it is not a complete line.

PUT_LINE procedure - Put a complete line in the message buffer

The PUT_LINE procedure puts a single line that includes an end-of-line character sequence in the message buffer.

Syntax

►►—DBMS_OUTPUT.PUT_LINE—(*—item—*)—►►

Procedure parameters

item

An input argument of type VARCHAR(32672) that specifies the text to write to the message buffer.

Authorization

EXECUTE privilege on the PUT_LINE procedure.

Example

Use the PUT_LINE procedure to write a line that includes an end-of-line character sequence to the message buffer.

```
SET SERVEROUTPUT ON@

CREATE PROCEDURE PROC1()
BEGIN
    CALL DBMS_OUTPUT.PUT( 'a' );
    CALL DBMS_OUTPUT.NEW_LINE;
    CALL DBMS_OUTPUT.PUT_LINE( 'b' );
END@

CALL PROC1@

SET SERVEROUTPUT OFF@
```

This example results in the following output:

```
a
b
```

Chapter 28. DBMS_PIPE module

The DBMS_PIPE module provides a set of routines for sending messages through a pipe within or between sessions that are connected to databases within the same DB2 instance.

The schema for this module is SYSIBMADM.

The DBMS_PIPE module includes the following built-in routines.

Table 18. Built-in routines available in the DBMS_PIPE module

Routine name	Description
CREATE_PIPE function	Explicitly creates a private or public pipe.
NEXT_ITEM_TYPE function	Determines the data type of the next item in a received message.
PACK_MESSAGE function	Puts an item in the session's local message buffer.
PACK_MESSAGE_RAW procedure	Puts an item of type RAW in the session's local message buffer.
PURGE procedure	Removes unreceived messages in the specified pipe.
RECEIVE_MESSAGE function	Gets a message from the specified pipe.
REMOVE_PIPE function	Deletes an explicitly created pipe.
RESET_BUFFER procedure	Resets the local message buffer.
SEND_MESSAGE procedure	Sends a message on the specified pipe.
UNIQUE_SESSION_NAME function	Returns a unique session name.
UNPACK_MESSAGE procedures	Retrieves the next data item from a message and assigns it to a variable.

Usage notes

Pipes are created either implicitly or explicitly during procedure calls. An *implicit pipe* is created when a procedure call contains a reference to a pipe name that does not exist. For example, if a pipe named "mailbox" is passed to the SEND_MESSAGE procedure and that pipe does not already exist, a new pipe named "mailbox" is created. An *explicit pipe* is created by calling the CREATE_PIPE function and specifying the name of the pipe.

Pipes can be private or public. A *private pipe* can only be accessed by the user who created the pipe. Even an administrator cannot access a private pipe that was created by another user. A *public pipe* can be accessed by any user who has access to the DBMS_PIPE module. To specify the access level for a pipe, use the CREATE_PIPE function and specify a value for the *private* parameter: "false" specifies that the pipe is public; "true" specifies that the pipe is private. If no value is specified, the default is to create a private pipe. All implicit pipes are private.

To send a message through a pipe, call the `PACK_MESSAGE` function to put individual data items (lines) in a local message buffer that is unique to the current session. Then, call the `SEND_MESSAGE` procedure to send the message through the pipe.

To receive a message, call the `RECEIVE_MESSAGE` function to get a message from the specified pipe. The message is written to the receiving session's local message buffer. Then, call the `UNPACK_MESSAGE` procedure to retrieve the next data item from the local message buffer and assign it to a specified program variable. If a pipe contains multiple messages, the `RECEIVE_MESSAGE` function gets the messages in FIFO (first-in-first-out) order.

Each session maintains separate message buffers for messages that are created by the `PACK_MESSAGE` function and messages that are retrieved by the `RECEIVE_MESSAGE` function. The separate message buffers allow you to build and receive messages in the same session. However, when consecutive calls are made to the `RECEIVE_MESSAGE` function, only the message from the last `RECEIVE_MESSAGE` call is preserved in the local message buffer.

Example

In connection 1, create a pipe that is named `pipe1`. Put a message in the session's local message buffer, and send the message through `pipe1`.

```
BEGIN
  DECLARE status INT;
  SET status = DBMS_PIPE.CREATE_PIPE( 'pipe1' );
  SET status = DBMS_PIPE.PACK_MESSAGE('message1');
  SET status = DBMS_PIPE.SEND_MESSAGE( 'pipe1' );
END@
```

In connection 2, receive the message, unpack it, and display it to standard output.

```
SET SERVEROUTPUT ON@

BEGIN
  DECLARE status    INT;
  DECLARE int1      INTEGER;
  DECLARE date1     DATE;
  DECLARE raw1      BLOB(100);
  DECLARE varchar1  VARCHAR(100);
  DECLARE itemType  INTEGER;

  SET status = DBMS_PIPE.RECEIVE_MESSAGE( 'pipe1' );
  IF( status = 0 ) THEN
    SET itemType = DBMS_PIPE.NEXT_ITEM_TYPE();
    CASE itemType
      WHEN 6 THEN
        CALL DBMS_PIPE.UNPACK_MESSAGE_INT( int1 );
        CALL DBMS_OUTPUT.PUT_LINE( 'int1: ' || int1 );
      WHEN 9 THEN
        CALL DBMS_PIPE.UNPACK_MESSAGE_CHAR( varchar1 );
        CALL DBMS_OUTPUT.PUT_LINE( 'varchar1: ' || varchar1 );
      WHEN 12 THEN
        CALL DBMS_PIPE.UNPACK_MESSAGE_DATE( date1 );
        CALL DBMS_OUTPUT.PUT_LINE( 'date1:' || date1 );
      WHEN 23 THEN
        CALL DBMS_PIPE.UNPACK_MESSAGE_RAW( raw1 );
        CALL DBMS_OUTPUT.PUT_LINE( 'raw1: ' || VARCHAR(raw1) );
      ELSE
        CALL DBMS_OUTPUT.PUT_LINE( 'Unexpected value' );
    END CASE;
  END IF;
END
```

```

        END CASE;
    END IF;
    SET status = DBMS_PIPE.REMOVE_PIPE( 'pipe1' );
END@

```

This example results in the following output:

```

varchar1: message1

```

CREATE_PIPE function - Create a pipe

The CREATE_PIPE function explicitly creates a public or private pipe with the specified name.

For more information about explicit public and private pipes, see the topic about the DBMS_PIPE module.

Syntax

```

▶▶ DBMS_PIPE.CREATE_PIPE(—pipename—, —maxpipesize—, —private—)▶▶

```

Return value

This function returns the status code 0 if the pipe is created successfully.

Function parameters

pipename

An input argument of type VARCHAR(128) that specifies the name of the pipe. For more information about pipes, see Chapter 28, “DBMS_PIPE module,” on page 281.

maxpipesize

An optional input argument of type INTEGER that specifies the maximum capacity of the pipe in bytes. The default is 8192 bytes.

private

An optional input argument that specifies the access level of the pipe:

For non-partitioned database environments

A value of "0" or "FALSE" creates a public pipe.

A value of "1" or "TRUE" creates a private pipe. This is the default.

In a partitioned database environment

A value of "0" creates a public pipe.

A value of "1" creates a private pipe. This is the default.

Authorization

EXECUTE privilege on the DBMS_PIPE module.

Example

Example 1: Create a private pipe that is named messages:

```

SET SERVEROUTPUT ON@

```

```

CREATE PROCEDURE proc1()

```

```

BEGIN
  DECLARE v_status          INTEGER;
  SET v_status = DBMS_PIPE.CREATE_PIPE('messages');
  DBMS_OUTPUT.PUT_LINE('CREATE_PIPE status: ' || v_status);
END@

```

```
CALL proc1@
```

This example results in the following output:

```
CREATE_PIPE status: 0
```

Example 2: Create a public pipe that is named mailbox:

```
SET SERVEROUTPUT ON@
```

```

CREATE PROCEDURE proc2()
BEGIN
  DECLARE v_status INTEGER;
  SET v_status = DBMS_PIPE.CREATE_PIPE('mailbox',0);
  DBMS_OUTPUT.PUT_LINE('CREATE_PIPE status: ' || v_status);
END@

```

```
CALL proc2@
```

This example results in the following output:

```
CREATE_PIPE status: 0
```

NEXT_ITEM_TYPE function - Return the data type code of the next item

The NEXT_ITEM_TYPE function returns an integer code that identifies the data type of the next data item in a received message.

The received message is stored in the session's local message buffer. Use the UNPACK_MESSAGE procedure to move each item off of the local message buffer, and then use the NEXT_ITEM_TYPE function to return the data type code for the next available item. A code of 0 is returned when there are no more items left in the message.

Syntax

```
▶▶—DBMS_PIPE.NEXT_ITEM_TYPE—▶▶
```

Return value

This function returns one of the following codes that represents a data type.

Table 19. NEXT_ITEM_TYPE data type codes

Type code	Data type
0	No more data items
6	INTEGER
9	VARCHAR
12	DATE
23	BLOB

Authorization

EXECUTE privilege on the DBMS_PIPE module.

Example

In proc1, pack and send a message. In proc2, receive the message and then unpack it by using the NEXT_ITEM_TYPE function to determine its type.

```
SET SERVEROUTPUT ON@

CREATE PROCEDURE proc1()
BEGIN
  DECLARE status INT;
  SET status = DBMS_PIPE.CREATE_PIPE( 'pipe1' );
  SET status = DBMS_PIPE.PACK_MESSAGE('message1');
  SET status = DBMS_PIPE.SEND_MESSAGE( 'pipe1' );
END@

CREATE PROCEDURE proc2()
BEGIN
  DECLARE status    INT;
  DECLARE num1     DECFLOAT;
  DECLARE date1    DATE;
  DECLARE raw1     BLOB(100);
  DECLARE varchar1 VARCHAR(100);
  DECLARE itemType INTEGER;

  SET status = DBMS_PIPE.RECEIVE_MESSAGE( 'pipe1' );
  IF( status = 0 ) THEN
    SET itemType = DBMS_PIPE.NEXT_ITEM_TYPE();
    CASE itemType
      WHEN 6 THEN
        CALL DBMS_PIPE.UNPACK_MESSAGE_NUMBER( num1 );
        CALL DBMS_OUTPUT.PUT_LINE( 'num1: ' || num1 );
      WHEN 9 THEN
        CALL DBMS_PIPE.UNPACK_MESSAGE_CHAR( varchar1 );
        CALL DBMS_OUTPUT.PUT_LINE( 'varchar1: ' || varchar1 );
      WHEN 12 THEN
        CALL DBMS_PIPE.UNPACK_MESSAGE_DATE( date1 );
        CALL DBMS_OUTPUT.PUT_LINE( 'date1: ' || date1 );
      WHEN 23 THEN
        CALL DBMS_PIPE.UNPACK_MESSAGE_RAW( raw1 );
        CALL DBMS_OUTPUT.PUT_LINE( 'raw1: ' || VARCHAR(raw1) );
      ELSE
        CALL DBMS_OUTPUT.PUT_LINE( 'Unexpected value' );
    END CASE;
  END IF;
  SET status = DBMS_PIPE.REMOVE_PIPE( 'pipe1' );
END@

CALL proc1@

CALL proc2@
```

This example results in the following output:

```
varchar1: message1
```

PACK_MESSAGE function - Put a data item in the local message buffer

The PACK_MESSAGE function puts a data item in the session's local message buffer.

Syntax

►►—DBMS_PIPE.PACK_MESSAGE—(—*item*—)—————►►

Procedure parameters

item

An input argument of type VARCHAR(4096), DATE, or DECFLOAT that contains an expression. The value returned by this expression is added to the local message buffer of the session.

Tip: To put data items of type RAW in the local message buffer, use the PACK_MESSAGE_RAW procedure.

Authorization

EXECUTE privilege on the DBMS_PIPE module.

Example

Use the PACK_MESSAGE function to put a message for Sujata in the local message buffer, and then use the SEND_MESSAGE procedure to send the message on a pipe.

```
SET SERVEROUTPUT ON@
```

```
CREATE PROCEDURE proc1()
BEGIN
  DECLARE    v_status    INTEGER;
  DECLARE    status      INTEGER;
  SET status = DBMS_PIPE.PACK_MESSAGE('Hi, Sujata');
  SET status = DBMS_PIPE.PACK_MESSAGE('Can you attend a meeting at 3:00, today?');
  SET status = DBMS_PIPE.PACK_MESSAGE('If not, is tomorrow at 8:30 ok with you?');
  SET v_status = DBMS_PIPE.SEND_MESSAGE('pipe');
  CALL DBMS_OUTPUT.PUT_LINE('SEND_MESSAGE status: ' || v_status);
END@

CALL proc1@
```

This example results in the following output:

```
SEND_MESSAGE status: 0
```

Usage notes

The PACK_MESSAGE function or PACK_MESSAGE_RAW procedure must be called at least once before issuing a SEND_MESSAGE call.

PACK_MESSAGE_RAW procedure - Put a data item of type RAW in the local message buffer

The PACK_MESSAGE_RAW procedure puts a data item of type RAW in the session's local message buffer.

Syntax

►►—DBMS_PIPE.PACK_MESSAGE_RAW—(—*item*—)—————►►

Procedure parameters

item

An input argument of type BLOB(4096) that specifies an expression. The value returned by this expression is added to the session's local message buffer.

Authorization

EXECUTE privilege on the DBMS_PIPE module.

Example

Use the PACK_MESSAGE_RAW procedure to put a data item of type RAW in the local message buffer.

```
SET SERVEROUTPUT ON@
```

```
CREATE PROCEDURE proc1()
BEGIN
  DECLARE v_raw          BLOB(100);
  DECLARE v_raw2        BLOB(100);
  DECLARE v_status      INTEGER;
  SET v_raw = BLOB('21222324');
  SET v_raw2 = BLOB('30000392');
  CALL DBMS_PIPE.PACK_MESSAGE_RAW(v_raw);
  CALL DBMS_PIPE.PACK_MESSAGE_RAW(v_raw2);
  SET v_status = DBMS_PIPE.SEND_MESSAGE('datatypes');
  CALL DBMS_OUTPUT.PUT_LINE('SEND_MESSAGE status: ' || v_status);
END@
```

```
CALL proc1@
```

This example results in the following output:

```
SEND_MESSAGE status: 0
```

Usage notes

The PACK_MESSAGE function or PACK_MESSAGE_RAW procedure must be called at least once before issuing a SEND_MESSAGE call.

PURGE procedure - Remove unreceived messages from a pipe

The PURGE procedure removes unreceived messages in the specified implicit pipe.

Tip: Use the REMOVE_PIPE function to delete an explicit pipe.

Syntax

```
►►—DBMS_PIPE.PURGE—(—pipename—)—————►►
```

Procedure parameters

pipename

An input argument of type VARCHAR(128) that specifies the name of the implicit pipe.

Authorization

EXECUTE privilege on the DBMS_PIPE module.

Example

In proc1 send two messages on a pipe: Message #1 and Message #2. In proc2, receive the first message, unpack it, and then purge the pipe. When proc3 runs, the call to the RECEIVE_MESSAGE function times out and returns the status code 1 because no message is available.

```
SET SERVEROUTPUT ON@

CREATE PROCEDURE proc1()
BEGIN
    DECLARE v_status      INTEGER;
    DECLARE status        INTEGER;
    SET status = DBMS_PIPE.PACK_MESSAGE('Message #1');
    SET v_status = DBMS_PIPE.SEND_MESSAGE('pipe');
    CALL DBMS_OUTPUT.PUT_LINE('SEND_MESSAGE status: ' || v_status);
    SET status = DBMS_PIPE.PACK_MESSAGE('Message #2');
    SET v_status = DBMS_PIPE.SEND_MESSAGE('pipe');
    CALL DBMS_OUTPUT.PUT_LINE('SEND_MESSAGE status: ' || v_status);
END@

CREATE PROCEDURE proc2()
BEGIN
    DECLARE v_item        VARCHAR(80);
    DECLARE v_status      INTEGER;
    SET v_status = DBMS_PIPE.RECEIVE_MESSAGE('pipe',1);
    CALL DBMS_OUTPUT.PUT_LINE('RECEIVE_MESSAGE status: ' || v_status);
    CALL DBMS_PIPE.UNPACK_MESSAGE_CHAR(v_item);
    CALL DBMS_OUTPUT.PUT_LINE('Item: ' || v_item);
    CALL DBMS_PIPE.PURGE('pipe');
END@

CREATE PROCEDURE proc3()
BEGIN
    DECLARE v_item        VARCHAR(80);
    DECLARE v_status      INTEGER;
    SET v_status = DBMS_PIPE.RECEIVE_MESSAGE('pipe',1);
    CALL DBMS_OUTPUT.PUT_LINE('RECEIVE_MESSAGE status: ' || v_status);
END@

CALL proc1@

CALL proc2@

CALL proc3@
```

This example results in the following output.

From proc1:

```
SEND_MESSAGE status: 0
SEND_MESSAGE status: 0
```

From proc2:

```
RECEIVE_MESSAGE status: 0
Item: Hi, Sujata
```

From proc3:

```
RECEIVE_MESSAGE status: 1
```

RECEIVE_MESSAGE function - Get a message from a specified pipe

The RECEIVE_MESSAGE function gets a message from a specified pipe.

Syntax

```
DBMS_PIPE.RECEIVE_MESSAGE(—pipename— [,—timeout—])
```

Return value

The RECEIVE_MESSAGE function returns one of the following status codes of type INTEGER.

Table 20. RECEIVE_MESSAGE status codes

Status code	Description
0	Success
1	Time out

Function parameters

pipename

An input argument of type VARCHAR(128) that specifies the name of the pipe. If the specified pipe does not exist, the pipe is created implicitly. For more information about pipes, see Chapter 28, “DBMS_PIPE module,” on page 281.

timeout

An optional input argument of type INTEGER that specifies the wait time in seconds. The default is 86400000 (1000 days).

Authorization

EXECUTE privilege on the DBMS_PIPE module.

Example

In proc1, send a message. In proc2, receive and unpack the message. Timeout if the message is not received within 1 second.

```
SET SERVEROUTPUT ON@
```

```
CREATE PROCEDURE proc1()
BEGIN
  DECLARE status INTEGER;
  SET status = DBMS_PIPE.CREATE_PIPE( 'pipe1' );
  SET status = DBMS_PIPE.PACK_MESSAGE('message1');
  SET status = DBMS_PIPE.SEND_MESSAGE( 'pipe1' );
END@

CREATE PROCEDURE proc2()
BEGIN
  DECLARE v_item          VARCHAR(80);
  DECLARE v_status       INTEGER;
  SET v_status = DBMS_PIPE.RECEIVE_MESSAGE('pipe1',1);
  CALL DBMS_OUTPUT.PUT_LINE('RECEIVE_MESSAGE status: ' || v_status);
  CALL DBMS_PIPE.UNPACK_MESSAGE(v_item);
  CALL DBMS_OUTPUT.PUT_LINE('Item: ' || v_item);
END@

CALL proc1@
CALL proc2@
```

This example results in the following output:

RECEIVE_MESSAGE status: 0
Item: message1

REMOVE_PIPE function - Delete a pipe

The REMOVE_PIPE function deletes an explicitly created pipe. Use this function to delete any public or private pipe that was created by the CREATE_PIPE function.

Syntax

►► DBMS_PIPE.REMOVE_PIPE(—*pipename*—) ◀◀

Return value

This function returns one of the following status codes of type INTEGER.

Table 21. REMOVE_PIPE status codes

Status code	Description
0	Pipe successfully removed or does not exist
NULL	An exception is thrown

Function parameters

pipename

An input argument of type VARCHAR(128) that specifies the name of the pipe.

Authorization

EXECUTE privilege on the DBMS_PIPE module.

Example

In proc1 send two messages on a pipe: Message #1 and Message #2. In proc2, receive the first message, unpack it, and then delete the pipe. When proc3 runs, the call to the RECEIVE_MESSAGE function times out and returns the status code 1 because the pipe no longer exists.

```
SET SERVEROUTPUT ON@
```

```
CREATE PROCEDURE proc1()
BEGIN
  DECLARE v_status INTEGER;
  DECLARE status INTEGER;
  SET v_status = DBMS_PIPE.CREATE_PIPE('pipe1');
  CALL DBMS_OUTPUT.PUT_LINE('CREATE_PIPE status: ' || v_status);

  SET status = DBMS_PIPE.PACK_MESSAGE('Message #1');
  SET v_status = DBMS_PIPE.SEND_MESSAGE('pipe1');
  CALL DBMS_OUTPUT.PUT_LINE('SEND_MESSAGE status: ' || v_status);

  SET status = DBMS_PIPE.PACK_MESSAGE('Message #2');
  SET v_status = DBMS_PIPE.SEND_MESSAGE('pipe1');
  CALL DBMS_OUTPUT.PUT_LINE('SEND_MESSAGE status: ' || v_status);
END@

CREATE PROCEDURE proc2()
BEGIN
  DECLARE v_item VARCHAR(80);
```

```

DECLARE    v_status      INTEGER;
DECLARE    status        INTEGER;
SET v_status = DBMS_PIPE.RECEIVE_MESSAGE('pipe1',1);
CALL DBMS_OUTPUT.PUT_LINE('RECEIVE_MESSAGE status: ' || v_status);
CALL DBMS_PIPE.UNPACK_MESSAGE(v_item);
CALL DBMS_OUTPUT.PUT_LINE('Item: ' || v_item);
SET status = DBMS_PIPE.REMOVE_PIPE('pipe1');
END@

CREATE PROCEDURE proc3()
BEGIN
  DECLARE    v_item      VARCHAR(80);
  DECLARE    v_status    INTEGER;
  SET v_status = DBMS_PIPE.RECEIVE_MESSAGE('pipe1',1);
  CALL DBMS_OUTPUT.PUT_LINE('RECEIVE_MESSAGE status: ' || v_status);
END@

CALL proc1@

CALL proc2@

CALL proc3@

```

This example results in the following output.

From proc1:

```

CREATE_PIPE status : 0
SEND_MESSAGE status: 0
SEND_MESSAGE status: 0

```

From proc2:

```

RECEIVE_MESSAGE status: 0
Item: Message #1

```

From proc3:

```

RECEIVE_MESSAGE status: 1

```

RESET_BUFFER procedure - Reset the local message buffer

The RESET_BUFFER procedure resets a pointer to the session's local message buffer back to the beginning of the buffer. Resetting the buffer causes subsequent PACK_MESSAGE calls to overwrite any data items that existed in the message buffer prior to the RESET_BUFFER call.

Syntax

```

▶▶—DBMS_PIPE.RESET_BUFFER—▶▶

```

Authorization

EXECUTE privilege on the DBMS_PIPE module.

Example

In proc1, use the PACK_MESSAGE function to put a message for an employee named Sujata in the local message buffer. Call the RESET_BUFFER procedure to replace the message with a message for Bing, and then send the message on a pipe. In proc2, receive and unpack the message for Bing.

```

SET SERVEROUTPUT ON@

CREATE PROCEDURE proc1()
BEGIN
  DECLARE    v_status      INTEGER;
  DECLARE    status        INTEGER;
  SET status = DBMS_PIPE.PACK_MESSAGE('Hi, Sujata');
  SET status = DBMS_PIPE.PACK_MESSAGE('Can you attend a meeting at 3:00, today?');
  SET status = DBMS_PIPE.PACK_MESSAGE('If not, is tomorrow at 8:30 ok with you?');
  CALL DBMS_PIPE.RESET_BUFFER;
  SET status = DBMS_PIPE.PACK_MESSAGE('Hi, Bing');
  SET status = DBMS_PIPE.PACK_MESSAGE('Can you attend a meeting at 9:30, tomorrow?');
  SET v_status = DBMS_PIPE.SEND_MESSAGE('pipe');
  CALL DBMS_OUTPUT.PUT_LINE('SEND_MESSAGE status: ' || v_status);
END@

CREATE PROCEDURE proc2()
BEGIN
  DECLARE    v_item        VARCHAR(80);
  DECLARE    v_status      INTEGER;
  SET v_status = DBMS_PIPE.RECEIVE_MESSAGE('pipe',1);
  CALL DBMS_OUTPUT.PUT_LINE('RECEIVE_MESSAGE status: ' || v_status);
  CALL DBMS_PIPE.UNPACK_MESSAGE_CHAR(v_item);
  CALL DBMS_OUTPUT.PUT_LINE('Item: ' || v_item);
  CALL DBMS_PIPE.UNPACK_MESSAGE(v_item);
  CALL DBMS_OUTPUT.PUT_LINE('Item: ' || v_item);
END@

CALL proc1@

CALL proc2@

```

This example results in the following output:

From proc1:

SEND_MESSAGE status: 0

From proc2:

RECEIVE_MESSAGE status: 0

Item: Hi, Bing

Item: Can you attend a meeting at 9:30, tomorrow?

SEND_MESSAGE procedure - Send a message to a specified pipe

The SEND_MESSAGE procedure sends a message from the session's local message buffer to a specified pipe.

Syntax

```

▶▶ DBMS_PIPE.SEND_MESSAGE (—pipename— [—timeout—] [—maxpipesize—]) ▶▶

```

Return value

This procedure returns one of the following status codes of type INTEGER.

Table 22. SEND_MESSAGE status codes

Status code	Description
0	Success
1	Time out

Procedure parameters

pipename

An input argument of type VARCHAR(128) that specifies the name of the pipe. If the specified pipe does not exist, the pipe is created implicitly. For more information about pipes, see Chapter 28, “DBMS_PIPE module,” on page 281.

timeout

An optional input argument of type INTEGER that specifies the wait time in seconds. The default is 86400000 (1000 days).

maxpipesize

An optional input argument of type INTEGER that specifies the maximum capacity of the pipe in bytes. The default is 8192 bytes.

Authorization

EXECUTE privilege on the DBMS_PIPE module.

Example

In proc1, send a message. In proc2, receive and unpack the message. Timeout if the message is not received within 1 second.

```
SET SERVEROUTPUT ON@
```

```
CREATE PROCEDURE proc1()
BEGIN
  DECLARE status INTEGER;
  SET status = DBMS_PIPE.CREATE_PIPE( 'pipe1' );
  SET status = DBMS_PIPE.PACK_MESSAGE('message1');
  SET status = DBMS_PIPE.SEND_MESSAGE( 'pipe1' );
END@
```

```
CREATE PROCEDURE proc2()
BEGIN
  DECLARE v_item          VARCHAR(80);
  DECLARE v_status        INTEGER;
  SET v_status = DBMS_PIPE.RECEIVE_MESSAGE('pipe1',1);
  CALL DBMS_OUTPUT.PUT_LINE('RECEIVE_MESSAGE status: ' || v_status);
  CALL DBMS_PIPE.UNPACK_MESSAGE(v_item);
  CALL DBMS_OUTPUT.PUT_LINE('Item: ' || v_item);
END@
```

```
CALL proc1@
CALL proc2@
```

This example results in the following output:

```
RECEIVE_MESSAGE status: 0
Item: message1
```

UNIQUE_SESSION_NAME function - Return a unique session name

The UNIQUE_SESSION_NAME function returns a unique name for the current session.

You can use this function to create a pipe that has the same name as the current session. To create this pipe, pass the value returned by the UNIQUE_SESSION_NAME function to the SEND_MESSAGE procedure as the pipe name. An implicit pipe is created that has the same name as the current session.

Syntax

▶▶—DBMS_PIPE.UNIQUE_SESSION_NAME—▶▶

Return value

This function returns a value of type VARCHAR(128) that represents the unique name for the current session.

Authorization

EXECUTE privilege on the DBMS_PIPE module.

Example

Create a pipe that has the same name as the current session.

```
SET SERVEROUTPUT ON@

CREATE PROCEDURE proc1()
BEGIN
  DECLARE    status          INTEGER;
  DECLARE    v_session       VARCHAR(30);
  SET v_session = DBMS_PIPE.UNIQUE_SESSION_NAME;
  SET status = DBMS_PIPE.PACK_MESSAGE('message1');
  SET status = DBMS_PIPE.SEND_MESSAGE(v_session);
  CALL DBMS_OUTPUT.PUT_LINE('Sent message on pipe ' || v_session);
END@

CALL proc1@
```

This example results in the following output:

```
Sent message on pipe *LOCAL.myschema.080522010048
```

UNPACK_MESSAGE procedures - Get a data item from the local message buffer

The UNPACK_MESSAGE procedures retrieve the next data item from a message and assign it to a variable.

Before calling one of the UNPACK_MESSAGE procedures, use the RECEIVE_MESSAGE procedure to place the message in the local message buffer.

Syntax

▶▶—DBMS_PIPE.UNPACK_MESSAGE_NUMBER—(*item*)—▶▶

▶▶—DBMS_PIPE.UNPACK_MESSAGE_CHAR—(*item*)—▶▶

▶▶—DBMS_PIPE.UNPACK_MESSAGE_DATE—(*item*)—▶▶

▶▶—DBMS_PIPE.UNPACK_MESSAGE_RAW—(*item*)—▶▶

Procedure parameters

item

An output argument of one of the following types that specifies a variable to receive data items from the local message buffer.

Routine	Data type
UNPACK_MESSAGE_NUMBER	DECFLOAT
UNPACK_MESSAGE_CHAR	VARCHAR(4096)
UNPACK_MESSAGE_DATE	DATE
UNPACK_MESSAGE_RAW	BLOB(4096)

Authorization

EXECUTE privilege on the DBMS_PIPE module.

Example

In `proc1`, pack and send a message. In `proc2`, receive the message, unpack it using the appropriate procedure based on the item's type, and display the message to standard output.

```
SET SERVEROUTPUT ON@
```

```
CREATE PROCEDURE proc1()
BEGIN
  DECLARE status INT;
  SET status = DBMS_PIPE.CREATE_PIPE( 'pipe1' );
  SET status = DBMS_PIPE.PACK_MESSAGE('message1');
  SET status = DBMS_PIPE.SEND_MESSAGE( 'pipe1' );
END@

CREATE PROCEDURE proc2()
BEGIN
  DECLARE status INT;
  DECLARE num1 DECFLOAT;
  DECLARE date1 DATE;
  DECLARE raw1 BLOB(100);
  DECLARE varchar1 VARCHAR(100);
  DECLARE itemType INTEGER;

  SET status = DBMS_PIPE.RECEIVE_MESSAGE( 'pipe1' );
  IF( status = 0 ) THEN
    SET itemType = DBMS_PIPE.NEXT_ITEM_TYPE();
    CASE itemType
      WHEN 6 THEN
        CALL DBMS_PIPE.UNPACK_MESSAGE_NUMBER( num1 );
        CALL DBMS_OUTPUT.PUT_LINE( 'num1: ' || num1 );
      WHEN 9 THEN
        CALL DBMS_PIPE.UNPACK_MESSAGE_CHAR( varchar1 );
        CALL DBMS_OUTPUT.PUT_LINE( 'varchar1: ' || varchar1 );
      WHEN 12 THEN
        CALL DBMS_PIPE.UNPACK_MESSAGE_DATE( date1 );
        CALL DBMS_OUTPUT.PUT_LINE( 'date1: ' || date1 );
      WHEN 23 THEN
        CALL DBMS_PIPE.UNPACK_MESSAGE_RAW( raw1 );
        CALL DBMS_OUTPUT.PUT_LINE( 'raw1: ' || VARCHAR(raw1) );
      ELSE
        CALL DBMS_OUTPUT.PUT_LINE( 'Unexpected value' );
    END CASE;
  END IF;
  SET status = DBMS_PIPE.REMOVE_PIPE( 'pipe1' );
END@
```

```
END@
```

```
CALL proc1@
```

```
CALL proc2@
```

This example results in the following output:

```
varchar1: message1
```

Chapter 29. DBMS_SQL module

The DBMS_SQL module provides a set of procedures for executing dynamic SQL, and therefore supports various data manipulation language (DML) or data definition language (DDL) statement.

The schema for this module is SYSIBMADM.

The DBMS_SQL module includes the following built-in routines.

Table 23. Built-in routines available in the DBMS_SQL module

Procedure name	Description
BIND_VARIABLE_BLOB procedure	Provides the input BLOB value for the IN or INOUT parameter; and defines the data type of the output value to be BLOB for the INOUT or OUT parameter.
BIND_VARIABLE_CHAR procedure	Provides the input CHAR value for the IN or INOUT parameter; and defines the data type of the output value to be CHAR for the INOUT or OUT parameter.
BIND_VARIABLE_CLOB procedure	Provides the input CLOB value for the IN or INOUT parameter; and defines the data type of the output value to be CLOB for the INOUT or OUT parameter.
BIND_VARIABLE_DATE procedure	Provides the input DATE value for the IN or INOUT parameter; and defines the data type of the output value to be DATE for the INOUT or OUT parameter.
BIND_VARIABLE_DOUBLE procedure	Provides the input DOUBLE value for the IN or INOUT parameter; and defines the data type of the output value to be DOUBLE for the INOUT or OUT parameter.
BIND_VARIABLE_INT procedure	Provides the input INTEGER value for the IN or INOUT parameter; and defines the data type of the output value to be INTEGER for the INOUT or OUT parameter.
BIND_VARIABLE_NUMBER procedure	Provides the input DECFLOAT value for the IN or INOUT parameter; and defines the data type of the output value to be DECFLOAT for the INOUT or OUT parameter.
BIND_VARIABLE_RAW procedure	Provides the input BLOB(32767) value for the IN or INOUT parameter; and defines the data type of the output value to be BLOB(32767) for the INOUT or OUT parameter.
BIND_VARIABLE_TIMESTAMP procedure	Provides the input TIMESTAMP value for the IN or INOUT parameter; and defines the data type of the output value to be TIMESTAMP for the INOUT or OUT parameter.

Table 23. Built-in routines available in the DBMS_SQL module (continued)

Procedure name	Description
BIND_VARIABLE_VARCHAR procedure	Provides the input VARCHAR value for the IN or INOUT parameter; and defines the data type of the output value to be VARCHAR for the INOUT or OUT parameter.
CLOSE_CURSOR procedure	Closes a cursor.
COLUMN_VALUE_BLOB procedure	Retrieves the value of column of type BLOB.
COLUMN_VALUE_CHAR procedure	Retrieves the value of column of type CHAR.
COLUMN_VALUE_CLOB procedure	Retrieves the value of column of type CLOB.
COLUMN_VALUE_DATE procedure	Retrieves the value of column of type DATE.
COLUMN_VALUE_DOUBLE procedure	Retrieves the value of column of type DOUBLE.
COLUMN_VALUE_INT procedure	Retrieves the value of column of type INTEGER.
COLUMN_VALUE_LONG procedure	Retrieves the value of column of type CLOB(32767).
COLUMN_VALUE_NUMBER procedure	Retrieves the value of column of type DECFLOAT.
COLUMN_VALUE_RAW procedure	Retrieves the value of column of type BLOB(32767).
COLUMN_VALUE_TIMESTAMP procedure	Retrieves the value of column of type TIMESTAMP
COLUMN_VALUE_VARCHAR procedure	Retrieves the value of column of type VARCHAR.
DEFINE_COLUMN_BLOB procedure	Defines the data type of the column to be BLOB.
DEFINE_COLUMN_CHAR procedure	Defines the data type of the column to be CHAR.
DEFINE_COLUMN_CLOB procedure	Defines the data type of the column to be CLOB.
DEFINE_COLUMN_DATE procedure	Defines the data type of the column to be DATE.
DEFINE_COLUMN_DOUBLE procedure	Defines the data type of the column to be DOUBLE.
DEFINE_COLUMN_INT procedure	Defines the data type of the column to be INTEGER.
DEFINE_COLUMN_LONG procedure	Defines the data type of the column to be CLOB(32767).
DEFINE_COLUMN_NUMBER procedure	Defines the data type of the column to be DECFLOAT.
DEFINE_COLUMN_RAW procedure	Defines the data type of the column to be BLOB(32767).
DEFINE_COLUMN_TIMESTAMP procedure	Defines the data type of the column to be TIMESTAMP.
DEFINE_COLUMN_VARCHAR procedure	Defines the data type of the column to be VARCHAR.

Table 23. Built-in routines available in the DBMS_SQL module (continued)

Procedure name	Description
DESCRIBE_COLUMNS procedure	Return a description of the columns retrieved by a cursor.
DESCRIBE_COLUMNS2 procedure	Identical to DESCRIBE_COLUMNS, but allows for column names greater than 32 characters.
EXECUTE procedure	Executes a cursor.
EXECUTE_AND_FETCH procedure	Executes a cursor and fetch one row.
FETCH_ROWS procedure	Fetches rows from a cursor.
IS_OPEN procedure	Checks if a cursor is open.
LAST_ROW_COUNT procedure	Returns the total number of rows fetched.
OPEN_CURSOR procedure	Opens a cursor.
PARSE procedure	Parses a DDL statement.
VARIABLE_VALUE_BLOB procedure	Retrieves the value of INOUT or OUT parameters as BLOB.
VARIABLE_VALUE_CHAR procedure	Retrieves the value of INOUT or OUT parameters as CHAR.
VARIABLE_VALUE_CLOB procedure	Retrieves the value of INOUT or OUT parameters as CLOB.
VARIABLE_VALUE_DATE procedure	Retrieves the value of INOUT or OUT parameters as DATE.
VARIABLE_VALUE_DOUBLE procedure	Retrieves the value of INOUT or OUT parameters as DOUBLE.
VARIABLE_VALUE_INT procedure	Retrieves the value of INOUT or OUT parameters as INTEGER.
VARIABLE_VALUE_NUMBER procedure	Retrieves the value of INOUT or OUT parameters as DECFLOAT.
VARIABLE_VALUE_RAW procedure	Retrieves the value of INOUT or OUT parameters as BLOB(32767).
VARIABLE_VALUE_TIMESTAMP procedure	Retrieves the value of INOUT or OUT parameters as TIMESTAMP.
VARIABLE_VALUE_VARCHAR procedure	Retrieves the value of INOUT or OUT parameters as VARCHAR.

The following table lists the built-in types and constants available in the DBMS_SQL module.

Table 24. DBMS_SQL built-in types and constants

Name	Type or constant	Description
DESC_REC	Type	A record of column information.
DESC_REC2	Type	A record of column information.
DESC_TAB	Type	An array of records of type DESC_REC.
DESC_TAB2	Type	An array of records of type DESC_REC2.

Table 24. DBMS_SQL built-in types and constants (continued)

Name	Type or constant	Description
NATIVE	Constant	The only value supported for language_flag parameter of the PARSE procedure.

Usage notes

The routines in the DBMS_SQL module are useful when you want to construct and run dynamic SQL statements. For example, you might want execute DDL or DML statements such as "ALTER TABLE" or "DROP TABLE", construct and execute SQL statements on the fly, or call a function which uses dynamic SQL from within a SQL statement.

BIND_VARIABLE_BLOB procedure - Bind a BLOB value to a variable

The BIND_VARIABLE_BLOB procedure provides the capability to associate a BLOB value with an IN, INOUT, or OUT argument in an SQL command.

Syntax

```
▶▶ DBMS_SQL.BIND_VARIABLE_BLOB ( c, name, value ) ▶▶
```

Parameters

c An input argument of type INTEGER that specifies the cursor ID for the SQL command with bind variables.

name

An input argument of type VARCHAR(128) that specifies the name of the bind variable in the SQL command.

value

An input argument of type BLOB(2G) that specifies the value to be assigned.

Authorization

EXECUTE privilege on the DBMS_SQL module.

BIND_VARIABLE_CHAR procedure - Bind a CHAR value to a variable

The BIND_VARIABLE_CHAR procedure provides the capability to associate a CHAR value with an IN, INOUT, or OUT argument in an SQL command.

Syntax

```
▶▶ DBMS_SQL.BIND_VARIABLE_CHAR ( c, name, value, out_value_size ) ▶▶
```

Parameters

c An input argument of type INTEGER that specifies the cursor ID for the SQL command with bind variables.

name

An input argument of type VARCHAR(128) that specifies the name of the bind variable in the SQL command.

value

An input argument of type CHAR(254) that specifies the value to be assigned.

out_value_size

An optional input argument of type INTEGER that specifies the length limit for the IN or INOUT argument, and the maximum length of the output value for the INOUT or OUT argument. If it is not specified, the length of *value* is assumed.

Authorization

EXECUTE privilege on the DBMS_SQL module.

BIND_VARIABLE_CLOB procedure - Bind a CLOB value to a variable

The BIND_VARIABLE_CLOB procedure provides the capability to associate a CLOB value with an IN, INOUT, or OUT argument in an SQL command.

Syntax

►► DBMS_SQL.BIND_VARIABLE_CLOB(—*c*—, —*name*—, —*value*—) ►►

Parameters

c An input argument of type INTEGER that specifies the cursor ID for the SQL command with bind variables.

name

An input argument of type VARCHAR(128) that specifies the name of the bind variable in the SQL command.

value

An input argument of type CLOB(2G) that specifies the value to be assigned.

Authorization

EXECUTE privilege on the DBMS_SQL module.

BIND_VARIABLE_DATE procedure - Bind a DATE value to a variable

The BIND_VARIABLE_DATE procedure provides the capability to associate a DATE value with an IN, INOUT, or OUT argument in an SQL command.

Syntax

►► DBMS_SQL.BIND_VARIABLE_DATE(—*c*—, —*name*—, —*value*—) ►►

Parameters

c An input argument of type INTEGER that specifies the cursor ID for the SQL command with bind variables.

name

An input argument of type VARCHAR(128) that specifies the name of the bind variable in the SQL command.

value

An input argument of type DATE that specifies the value to be assigned.

Authorization

EXECUTE privilege on the DBMS_SQL module.

BIND_VARIABLE_DOUBLE procedure - Bind a DOUBLE value to a variable

The BIND_VARIABLE_DOUBLE procedure provides the capability to associate a DOUBLE value with an IN, INOUT, or OUT argument in an SQL command.

Syntax

►►DBMS_SQL.BIND_VARIABLE_DOUBLE(—*c*—,—*name*—,—*value*—)◄◄

Parameters

c An input argument of type INTEGER that specifies the cursor ID for the SQL command with bind variables.

name

An input argument of type VARCHAR(128) that specifies the name of the bind variable in the SQL command.

value

An input argument of type DOUBLE that specifies the value to be assigned.

Authorization

EXECUTE privilege on the DBMS_SQL module.

BIND_VARIABLE_INT procedure - Bind an INTEGER value to a variable

The BIND_VARIABLE_INT procedure provides the capability to associate an INTEGER value with an IN or INOUT bind variable in an SQL command.

Syntax

►►DBMS_SQL.BIND_VARIABLE_INT(—*c*—,—*name*—,—*value*—)◄◄

Parameters

c An input argument of type INTEGER that specifies the cursor ID for the SQL command with bind variables.

name

An input argument of type VARCHAR(128) that specifies the name of the bind variable in the SQL command.

value

An input argument of type INTEGER that specifies the value to be assigned.

Authorization

EXECUTE privilege on the DBMS_SQL module.

BIND_VARIABLE_NUMBER procedure - Bind a NUMBER value to a variable

The BIND_VARIABLE_NUMBER procedure provides the capability to associate a NUMBER value with an IN, INOUT, or OUT argument in an SQL command.

Syntax

```
▶▶ DBMS_SQL.BIND_VARIABLE_NUMBER(c, name, value)▶▶
```

Parameters

c An input argument of type INTEGER that specifies the cursor ID for the SQL command with bind variables.

name

An input argument of type VARCHAR(128) that specifies the name of the bind variable in the SQL command.

value

An input argument of type DECFLOAT that specifies the value to be assigned.

Authorization

EXECUTE privilege on the DBMS_SQL module.

BIND_VARIABLE_RAW procedure - Bind a RAW value to a variable

The BIND_VARIABLE_RAW procedure provides the capability to associate a RAW value with an IN, INOUT, or OUT argument in an SQL command.

Syntax

```
▶▶ DBMS_SQL.BIND_VARIABLE_RAW(c, name, value [out_value_size])▶▶  
▶▶ )▶▶
```

Parameters

c An input argument of type INTEGER that specifies the cursor ID for the SQL command with bind variables.

name

An input argument of type VARCHAR(128) that specifies the name of the bind variable in the SQL command.

value

An input argument of type BLOB(32767) that specifies the value to be assigned.

out_value_size

An optional input argument of type INTEGER that specifies the length limit

for the IN or INOUT argument, and the maximum length of the output value for the INOUT or OUT argument. If it is not specified, the length of *value* is assumed.

Authorization

EXECUTE privilege on the DBMS_SQL module.

BIND_VARIABLE_TIMESTAMP procedure - Bind a TIMESTAMP value to a variable

The BIND_VARIABLE_TIMESTAMP procedure provides the capability to associate a TIMESTAMP value with an IN, INOUT, or OUT argument in an SQL command.

Syntax

```
▶▶ DBMS_SQL.BIND_VARIABLE_TIMESTAMP(—c—, —name—, —value—)▶▶
```

Parameters

c An input argument of type INTEGER that specifies the cursor ID for the SQL command with bind variables.

name

An input argument of type VARCHAR(128) that specifies the name of the bind variable in the SQL command.

value

An input argument of type TIMESTAMP that specifies the value to be assigned.

Authorization

EXECUTE privilege on the DBMS_SQL module.

BIND_VARIABLE_VARCHAR procedure - Bind a VARCHAR value to a variable

The BIND_VARIABLE_VARCHAR procedure provides the capability to associate a VARCHAR value with an IN, INOUT, or OUT argument in an SQL command.

Syntax

```
▶▶ DBMS_SQL.BIND_VARIABLE_VARCHAR(—c—, —name—, —value—▶▶  
▶▶ [—out_value_size—] )▶▶
```

Parameters

c An input argument of type INTEGER that specifies the cursor ID for the SQL command with bind variables.

name

An input argument of type VARCHAR(128) that specifies the name of the bind variable in the SQL command.

value

An input argument of type VARCHAR(32672) that specifies the value to be assigned.

out_value_size

An input argument of type INTEGER that specifies the length limit for the IN or INOUT argument, and the maximum length of the output value for the INOUT or OUT argument. If it is not specified, the length of *value* is assumed.

Authorization

EXECUTE privilege on the DBMS_SQL module.

CLOSE_CURSOR procedure - Close a cursor

The CLOSE_CURSOR procedure closes an open cursor. The resources allocated to the cursor are released and it cannot no longer be used.

Syntax

►► DBMS_SQL.CLOSE_CURSOR(—*c*—) ◀◀

Parameters

c An input argument of type INTEGER that specifies the cursor ID of the cursor to be closed.

Authorization

EXECUTE privilege on the DBMS_SQL module.

Examples

Example 1: This example illustrates closing a previously opened cursor.

```
DECLARE
    curid          INTEGER;
BEGIN
    curid := DBMS_SQL.OPEN_CURSOR;
    .
    .
    .
    DBMS_SQL.CLOSE_CURSOR(curid);
END;
```

COLUMN_VALUE_BLOB procedure - Return a BLOB column value into a variable

The COLUMN_VALUE_BLOB procedure defines a variable that will receive a BLOB value from a cursor.

Syntax

►► DBMS_SQL.COLUMN_VALUE_BLOB(—*c*—, —*position*—, —*value*—) ◀◀

Parameters

c An input argument of type INTEGER that specifies the cursor ID of the cursor that is returning data to the variable being defined.

position

An input argument of type INTEGER that specifies the position of the returned data within the cursor. The first value in the cursor is position 1.

value

An output argument of type BLOB(2G) that specifies the variable receiving the data returned by the cursor in a prior fetch call.

Authorization

EXECUTE privilege on the DBMS_SQL module.

COLUMN_VALUE_CHAR procedure - Return a CHAR column value into a variable

The COLUMN_VALUE_CHAR procedure defines a variable to receive a CHAR value from a cursor.

Syntax

```
▶▶ DBMS_SQL.COLUMN_VALUE_CHAR( ( c , position , value ) )  
▶▶ ( column_error , actual_length )
```

Parameters

c An input argument of type INTEGER that specifies the cursor ID of the cursor that is returning data to the variable being defined.

position

An input argument of type INTEGER that specifies the position of the returned data within the cursor. The first value in the cursor is position 1.

value

An output argument of type CHAR that specifies the variable receiving the data returned by the cursor in a prior fetch call.

column_error

An optional output argument of type INTEGER that returns the SQLCODE, if any, associated with the column.

actual_length

An optional output argument of type INTEGER that returns the actual length of the data, prior to any truncation.

Authorization

EXECUTE privilege on the DBMS_SQL module.

COLUMN_VALUE_CLOB procedure - Return a CLOB column value into a variable

The COLUMN_VALUE_CLOB procedure defines a variable that will receive a CLOB value from a cursor.

Syntax

```
▶▶ DBMS_SQL.COLUMN_VALUE_CLOB( ( c , position , value ) )▶▶
```

Parameters

c An input argument of type INTEGER that specifies the cursor ID of the cursor that is returning data to the variable being defined.

position

An input argument of type INTEGER that specifies the position of the returned data within the cursor. The first value in the cursor is position 1.

value

An output argument of type CLOB(2G) that specifies the variable receiving the data returned by the cursor in a prior fetch call.

Authorization

EXECUTE privilege on the DBMS_SQL module.

COLUMN_VALUE_DATE procedure - Return a DATE column value into a variable

The COLUMN_VALUE_DATE procedure defines a variable that will receive a DATE value from a cursor.

Syntax

```
▶▶ DBMS_SQL.COLUMN_VALUE_DATE( ( c , position , value ) )▶▶  
▶▶ [ column_error ] [ actual_length ] )▶▶
```

Parameters

c An input argument of type INTEGER that specifies the cursor ID of the cursor that is returning data to the variable being defined.

position

An input argument of type INTEGER that specifies the position of the returned data within the cursor. The first value in the cursor is position 1.

value

An output argument of type DATE that specifies the variable receiving the data returned by the cursor in a prior fetch call.

column_error

An output argument of type INTEGER that returns the SQLCODE, if any, associated with the column.

actual_length

An output argument of type INTEGER that returns the actual length of the data, prior to any truncation.

Authorization

EXECUTE privilege on the DBMS_SQL module.

COLUMN_VALUE_DOUBLE procedure - Return a DOUBLE column value into a variable

The COLUMN_VALUE_DOUBLE procedure defines a variable that will receive a DOUBLE value from a cursor.

Syntax

```
DBMS_SQL.COLUMN_VALUE_DOUBLE(c, position, value,  
, column_error, actual_length)
```

Parameters

c An input argument of type INTEGER that specifies the cursor ID of the cursor that is returning data to the variable being defined.

position

An input argument of type INTEGER that specifies the position of the returned data within the cursor. The first value in the cursor is position 1.

value

An output argument of type DOUBLE that specifies the variable receiving the data returned by the cursor in a prior fetch call.

column_error

An output argument of type INTEGER that returns the SQLCODE, if any, associated with the column.

actual_length

An output argument of type INTEGER that returns the actual length of the data, prior to any truncation.

Authorization

EXECUTE privilege on the DBMS_SQL module.

COLUMN_VALUE_INT procedure - Return an INTEGER column value into a variable

The COLUMN_VALUE_INT procedure defines a variable that will receive a INTEGER value from a cursor.

Syntax

```

▶▶ DBMS_SQL.COLUMN_VALUE_INT ( ( c , position , value )
▶▶ ( column_error , actual_length ) )

```

Parameters

- c* An input argument of type INTEGER that specifies the cursor ID of the cursor that is returning data to the variable being defined.
- position*
An input argument of type INTEGER that specifies the position of the returned data within the cursor. The first value in the cursor is position 1.
- value*
An output argument of type INTEGER that specifies the variable receiving the data returned by the cursor in a prior fetch call.
- column_error*
An output argument of type INTEGER that returns the SQLCODE, if any, associated with the column.
- actual_length*
An output argument of type INTEGER that returns the actual length of the data, prior to any truncation.

Authorization

EXECUTE privilege on the DBMS_SQL module.

COLUMN_VALUE_LONG procedure - Return a LONG column value into a variable

The COLUMN_VALUE_LONG procedure defines a variable that will receive a portion of a LONG value from a cursor.

Syntax

```

▶▶ DBMS_SQL.COLUMN_VALUE_LONG ( ( c , position , length ,
▶▶ offset , value , value_length ) )

```

Parameters

- c* An input argument of type INTEGER that specifies the cursor ID of the cursor that is returning data to the variable being defined.
- position*
An input argument of type INTEGER that specifies the position of the returned data within the cursor. The first value in the cursor is position 1.
- length*
An input argument of type INTEGER that specifies the desired number of bytes of the LONG data to retrieve beginning at *offset*.

offset

An input argument of type INTEGER that specifies the position within the LONG value to start data retrieval.

value

An output argument of type CLOB(32760) that specifies the variable receiving the data returned by the cursor in a prior fetch call.

value_length

An output argument of type INTEGER that returns the actual length of the data returned.

Authorization

EXECUTE privilege on the DBMS_SQL module.

COLUMN_VALUE_NUMBER procedure - Return a DECFLOAT column value into a variable

The COLUMN_VALUE_NUMBER procedure defines a variable that will receive a DECFLOAT value from a cursor.

Syntax

```
▶▶ DBMS_SQL.COLUMN_VALUE_NUMBER ( ( c , position , value )  
▶▶ ( column_error , actual_length ) )
```

Parameters

c An input argument of type INTEGER that specifies the cursor ID of the cursor that is returning data to the variable being defined.

position

An input argument of type INTEGER that specifies the position of the returned data within the cursor. The first value in the cursor is position 1.

value

An output argument of type DECFLOAT that specifies the variable receiving the data returned by the cursor in a prior fetch call.

column_error

An optional output argument of type INTEGER that returns the SQLCODE, if any, associated with the column.

actual_length

An optional output argument of type INTEGER that returns the actual length of the data, prior to any truncation.

Authorization

EXECUTE privilege on the DBMS_SQL module.

COLUMN_VALUE_RAW procedure - Return a RAW column value into a variable

The COLUMN_VALUE_RAW procedure defines a variable that will receive a RAW value from a cursor.

Syntax

```
▶▶ DBMS_SQL.COLUMN_VALUE_RAW ( c , position , value )  
▶▶ ( column_error , actual_length )
```

Parameters

c An input argument of type INTEGER that specifies the cursor ID of the cursor that is returning data to the variable being defined.

position

An input argument of type INTEGER that specifies the position of the returned data within the cursor. The first value in the cursor is position 1.

value

An output argument of type BLOB(32767) that specifies the variable receiving the data returned by the cursor in a prior fetch call.

column_error

An optional output argument of type INTEGER that returns the SQLCODE, if any, associated with the column.

actual_length

An optional output argument of type INTEGER that returns the actual length of the data, prior to any truncation.

Authorization

EXECUTE privilege on the DBMS_SQL module.

COLUMN_VALUE_TIMESTAMP procedure - Return a TIMESTAMP column value into a variable

The COLUMN_VALUE_TIMESTAMP procedure defines a variable that will receive a TIMESTAMP value from a cursor.

Syntax

```
▶▶ DBMS_SQL.COLUMN_VALUE_TIMESTAMP ( c , position , value )  
▶▶ ( column_error , actual_length )
```

Parameters

c An input argument of type INTEGER that specifies the cursor ID of the cursor that is returning data to the variable being defined.

position

An input argument of type INTEGER that specifies the position of the returned data within the cursor. The first value in the cursor is position 1.

value

An output argument of type TIMESTAMP that specifies the variable receiving the data returned by the cursor in a prior fetch call.

column_error

An output argument of type INTEGER that returns the SQLCODE, if any, associated with the column.

actual_length

An output argument of type INTEGER that returns the actual length of the data, prior to any truncation.

Authorization

EXECUTE privilege on the DBMS_SQL module.

COLUMN_VALUE_VARCHAR procedure - Return a VARCHAR column value into a variable

The COLUMN_VALUE_VARCHAR procedure defines a variable that will receive a VARCHAR value from a cursor.

Syntax

```
▶▶ DBMS_SQL.COLUMN_VALUE_VARCHAR ( ( c , position , value )  
▶▶ ( , column_error , actual_length )
```

Parameters

c An input argument of type INTEGER that specifies the cursor ID of the cursor that is returning data to the variable being defined.

position

An input argument of type INTEGER that specifies the position of the returned data within the cursor. The first value in the cursor is position 1.

value

An output argument of type VARCHAR(32672) that specifies the variable receiving the data returned by the cursor in a prior fetch call.

column_error

An output argument of type INTEGER that returns the SQLCODE, if any, associated with the column.

actual_length

An output argument of type INTEGER that returns the actual length of the data, prior to any truncation.

Authorization

EXECUTE privilege on the DBMS_SQL module.

DEFINE_COLUMN_BLOB- Define a BLOB column in the SELECT list

The DEFINE_COLUMN_BLOB procedure defines a BLOB column or expression in the SELECT list that is to be returned and retrieved in a cursor.

Syntax

```
▶▶—DBMS_SQL.DEFINE_COLUMN_BLOB—(—c—,—position—,—column—)—▶▶
```

Parameters

c An input argument of type INTEGER that specifies the cursor handle associated with the SELECT command.

position

An input argument of type INTEGER that specifies the position of the column or expression in the SELECT list that is being defined.

column

An input argument of type BLOB(2G).

Authorization

EXECUTE privilege on the DBMS_SQL module.

DEFINE_COLUMN_CHAR procedure - Define a CHAR column in the SELECT list

The DEFINE_COLUMN_CHAR procedure defines a CHAR column or expression in the SELECT list that is to be returned and retrieved in a cursor.

Syntax

```
▶▶—DBMS_SQL.DEFINE_COLUMN_CHAR—(—c—,—position—,—column—,—column_size—)—▶▶
```

Parameters

c An input argument of type INTEGER that specifies the cursor handle associated with the SELECT command.

position

An input argument of type INTEGER that specifies the position of the column or expression in the SELECT list that is being defined.

column

An input argument of type CHAR(254).

column_size

An input argument of type INTEGER that specifies the maximum length of the returned data. Returned data exceeding *column_size* is truncated to *column_size* characters.

Authorization

EXECUTE privilege on the DBMS_SQL module.

DEFINE_COLUMN_CLOB - Define a CLOB column in the SELECT list

The DEFINE_COLUMN_CLOB procedure defines a CLOB column or expression in the SELECT list that is to be returned and retrieved in a cursor.

Syntax

```
▶▶ DBMS_SQL.DEFINE_COLUMN_CLOB(—c—, —position—, —column—)▶▶
```

Parameters

c An input argument of type INTEGER that specifies the cursor handle associated with the SELECT command.

position

An input argument of type INTEGER that specifies the position of the column or expression in the SELECT list that is being defined.

column

An input argument of type CLOB(2G).

Authorization

EXECUTE privilege on the DBMS_SQL module.

DEFINE_COLUMN_DATE - Define a DATE column in the SELECT list

The DEFINE_COLUMN_DATE procedure defines a DATE column or expression in the SELECT list that is to be returned and retrieved in a cursor.

Syntax

```
▶▶ DBMS_SQL.DEFINE_COLUMN_DATE(—c—, —position—, —column—)▶▶
```

Parameters

c An input argument of type INTEGER that specifies the cursor handle associated with the SELECT command.

position

An input argument of type INTEGER that specifies the position of the column or expression in the SELECT list that is being defined.

column

An input argument of type DATE.

Authorization

EXECUTE privilege on the DBMS_SQL module.

DEFINE_COLUMN_DOUBLE - Define a DOUBLE column in the SELECT list

The DEFINE_COLUMN_DOUBLE procedure defines a DOUBLE column or expression in the SELECT list that is to be returned and retrieved in a cursor.

Syntax

```
►►—DBMS_SQL.DEFINE_COLUMN_DOUBLE—(—c—,—position—,—column—)—————►►
```

Parameters

c An input argument of type INTEGER that specifies the cursor handle associated with the SELECT command.

position

An input argument of type INTEGER that specifies the position of the column or expression in the SELECT list that is being defined.

column

An input argument of type DOUBLE.

Authorization

EXECUTE privilege on the DBMS_SQL module.

DEFINE_COLUMN_INT- Define an INTEGER column in the SELECT list

The DEFINE_COLUMN_INT procedure defines an INTEGER column or expression in the SELECT list that is to be returned and retrieved in a cursor.

Syntax

```
►►—DBMS_SQL.DEFINE_COLUMN_INT—(—c—,—position—,—column—)—————►►
```

Parameters

c An input argument of type INTEGER that specifies the cursor handle associated with the SELECT command.

position

An input argument of type INTEGER that specifies the position of the column or expression in the SELECT list that is being defined.

column

An input argument of type INTEGER.

Authorization

EXECUTE privilege on the DBMS_SQL module.

DEFINE_COLUMN_LONG procedure - Define a LONG column in the SELECT list

The DEFINE_COLUMN_LONG procedure defines a LONG column or expression in the SELECT list that is to be returned and retrieved in a cursor.

Syntax

►►DBMS_SQL.DEFINE_COLUMN_LONG(—*c*—,—*position*—)◄◄

Parameters

c An input argument of type INTEGER that specifies the cursor handle associated with the SELECT command.

position

An input argument of type INTEGER that specifies the position of the column or expression in the SELECT list that is being defined.

Authorization

EXECUTE privilege on the DBMS_SQL module.

DEFINE_COLUMN_NUMBER procedure - Define a DECFLOAT column in the SELECT list

The DEFINE_COLUMN_NUMBER procedure defines a DECFLOAT column or expression in the SELECT list that is to be returned and retrieved in a cursor.

Syntax

►►DBMS_SQL.DEFINE_COLUMN_NUMBER(—*c*—,—*position*—,—*column*—)◄◄

Parameters

c An input argument of type INTEGER that specifies the cursor handle associated with the SELECT command.

position

An input argument of type INTEGER that specifies the position of the column or expression in the SELECT list that is being defined.

column

An input argument of type DECFLOAT.

Authorization

EXECUTE privilege on the DBMS_SQL module.

DEFINE_COLUMN_RAW procedure - Define a RAW column or expression in the SELECT list

The DEFINE_COLUMN_RAW procedure defines a RAW column or expression in the SELECT list that is to be returned and retrieved in a cursor.

Syntax

►►DBMS_SQL.DEFINE_COLUMN_RAW(—*c*—,—*position*—,—*column*—,—*column_size*—)◄◄

Parameters

c An input argument of type INTEGER that specifies the cursor handle associated with the SELECT command.

position

An input argument of type INTEGER that specifies the position of the column or expression in the SELECT list that is being defined.

column

An input argument of type BLOB(32767).

column_size

An input argument of type INTEGER that specifies the maximum length of the returned data. Returned data exceeding *column_size* is truncated to *column_size* characters.

Authorization

EXECUTE privilege on the DBMS_SQL module.

DEFINE_COLUMN_TIMESTAMP - Define a TIMESTAMP column in the SELECT list

The DEFINE_COLUMN_TIMESTAMP procedure defines a TIMESTAMP column or expression in the SELECT list that is to be returned and retrieved in a cursor.

Syntax

►►—DBMS_SQL.DEFINE_COLUMN_TIMESTAMP—(*c*—,—*position*—,—*column*—)—►►

Parameters

c An input argument of type INTEGER that specifies the cursor handle associated with the SELECT command.

position

An input argument of type INTEGER that specifies the position of the column or expression in the SELECT list that is being defined.

column

An input argument of type TIMESTAMP.

Authorization

EXECUTE privilege on the DBMS_SQL module.

DEFINE_COLUMN_VARCHAR procedure - Define a VARCHAR column in the SELECT list

The DEFINE_COLUMN_VARCHAR procedure defines a VARCHAR column or expression in the SELECT list that is to be returned and retrieved in a cursor.

Syntax

►►—DBMS_SQL.DEFINE_COLUMN_VARCHAR—(*c*—,—*position*—,—*column*—,—*column_size*—)—►►

Parameters

c An input argument of type INTEGER that specifies the cursor handle associated with the SELECT command.

position

An input argument of type INTEGER that specifies the position of the column or expression in the SELECT list that is being defined.

column

An input argument of type VARCHAR(32672).

column_size

An input argument of type INTEGER that specifies the maximum length of the returned data. Returned data exceeding *column_size* is truncated to *column_size* characters.

Authorization

EXECUTE privilege on the DBMS_SQL module.

DESCRIBE_COLUMNS procedure - Retrieve a description of the columns in a SELECT list

The DESCRIBE_COLUMNS procedure provides the capability to retrieve a description of the columns in a SELECT list from a cursor.

Syntax

```
▶▶ DBMS_SQL.DESCRIBE_COLUMNS(c, col_cnt, desc_tab) ▶▶
```

Parameters

c An input argument of type INTEGER that specifies the cursor ID of the cursor whose columns are to be described.

col_cnt

An output argument of type INTEGER that returns the number of columns in the SELECT list of the cursor.

desc_tab

An output argument of type DESC_TAB that describes the column metadata. The DESC_TAB array provides information on each column in the specified cursor.

Authorization

EXECUTE privilege on the DBMS_SQL module.

Usage notes

This procedure requires a user temporary table space with a page size of 4K; otherwise it returns an SQL0286N error. You can create the user temporary table space with this command:

```
CREATE USER TEMPORARY TABLESPACE DBMS_SQL_TEMP_TBS
```

DESC_TAB is an array of DESC_REC records of column information:

Table 25. DESC_TAB definition through DESC_REC records

Record name	Description
col_type	SQL data type as defined in Supported SQL data types in C and C++ embedded SQL applications.
col_max_len	Maximum length of the column.
col_name	Column name.
col_name_len	Length of the column name.
col_schema	Always NULL.
col_schema_name_len	Always NULL.
col_precision	Precision of the column as defined in the database. If col_type denotes a graphic or DBCLOB SQL data type, then this variable indicates the maximum number of double-byte characters the column can hold.
col_scale	Scale of the column as defined in the database (only applies to DECIMAL, NUMERIC, TIMESTAMP).
col_charsetid	Always NULL.
col_charsetform	Always NULL.
col_null_ok	Nullable indicator. This has a value of 1 if the column is nullable, otherwise, 0.

```
ALTER MODULE SYSIBMADM.DBMS_SQL PUBLISH TYPE DESC_REC AS ROW
(
  col_type INTEGER,
  col_max_len INTEGER,
  col_name VARCHAR(128),
  col_name_len INTEGER,
  col_schema_name VARCHAR(128),
  col_schema_name_len INTEGER,
  col_precision INTEGER,
  col_scale INTEGER,
  col_charsetid INTEGER,
  col_charsetform INTEGER,
  col_null_ok INTEGER
);
```

```
ALTER MODULE SYSIBMADM.DBMS_SQL PUBLISH TYPE DESC_TAB AS DESC_REC ARRAY[INTEGER];
```

Examples

Example 1: The following example describes the empno, ename, hiredate, and sal columns from the "EMP" table.

```
SET SERVEROUTPUT ON@

BEGIN
  DECLARE handle INTEGER;
  DECLARE col_cnt INTEGER;
  DECLARE col DBMS_SQL.DESC_TAB;
  DECLARE i INTEGER DEFAULT 1;
  DECLARE CUR1 CURSOR FOR S1;

  CALL DBMS_SQL.OPEN_CURSOR( handle );
  CALL DBMS_SQL.PARSE( handle,
    'SELECT empno, firstame, lastname, salary
     FROM employee', DBMS_SQL.NATIVE );
```

```

CALL DBMS_SQL.DESCRIBE_COLUMNS( handle, col_cnt, col );

IF col_cnt > 0 THEN
  CALL DBMS_OUTPUT.PUT_LINE( 'col_cnt = ' || col_cnt );
  CALL DBMS_OUTPUT.NEW_LINE();
  fetchLoop: LOOP
    IF i > col_cnt THEN
      LEAVE fetchLoop;
    END IF;

    CALL DBMS_OUTPUT.PUT_LINE( 'i = ' || i );
    CALL DBMS_OUTPUT.PUT_LINE( 'col[i].col_name = ' || col[i].col_name );
    CALL DBMS_OUTPUT.PUT_LINE( 'col[i].col_name_len = ' ||
      NVL(col[i].col_name_len, 'NULL') );
    CALL DBMS_OUTPUT.PUT_LINE( 'col[i].col_schema_name = ' ||
      NVL( col[i].col_schema_name, 'NULL' ) );

    IF col[i].col_schema_name_len IS NULL THEN
      CALL DBMS_OUTPUT.PUT_LINE( 'col[i].col_schema_name_len = NULL' );
    ELSE
      CALL DBMS_OUTPUT.PUT_LINE( 'col[i].col_schema_name_len = ' ||
        col[i].col_schema_name_len );
    END IF;

    CALL DBMS_OUTPUT.PUT_LINE( 'col[i].col_type = ' || col[i].col_type );
    CALL DBMS_OUTPUT.PUT_LINE( 'col[i].col_max_len = ' || col[i].col_max_len );
    CALL DBMS_OUTPUT.PUT_LINE( 'col[i].col_precision = ' || col[i].col_precision );
    CALL DBMS_OUTPUT.PUT_LINE( 'col[i].col_scale = ' || col[i].col_scale );

    IF col[i].col_charsetid IS NULL THEN
      CALL DBMS_OUTPUT.PUT_LINE( 'col[i].col_charsetid = NULL' );
    ELSE
      CALL DBMS_OUTPUT.PUT_LINE( 'col[i].col_charsetid = ' || col[i].col_charsetid );
    END IF;

    IF col[i].col_charsetform IS NULL THEN
      CALL DBMS_OUTPUT.PUT_LINE( 'col[i].col_charsetform = NULL' );
    ELSE
      CALL DBMS_OUTPUT.PUT_LINE( 'col[i].col_charsetform = ' || col[i].col_charsetform );
    END IF;

    CALL DBMS_OUTPUT.PUT_LINE( 'col[i].col_null_ok = ' || col[i].col_null_ok );
    CALL DBMS_OUTPUT.NEW_LINE();
    SET i = i + 1;
  END LOOP;
END IF;
END@

```

Output:

col_cnt = 4

```

i = 1
col[i].col_name = EMPNO
col[i].col_name_len = 5
col[i].col_schema_name = NULL
col[i].col_schema_name_len = NULL
col[i].col_type = 452
col[i].col_max_len = 6
col[i].col_precision = 6
col[i].col_scale = 0
col[i].col_charsetid = NULL
col[i].col_charsetform = NULL
col[i].col_null_ok = 0

```

```

i = 2
col[i].col_name = FIRSTNME
col[i].col_name_len = 8

```

```

col[i].col_schema_name = NULL
col[i].col_schema_name_len = NULL
col[i].col_type = 448
col[i].col_max_len = 12
col[i].col_precision = 12
col[i].col_scale = 0
col[i].col_charsetid = NULL
col[i].col_charsetform = NULL
col[i].col_null_ok = 0

i = 3
col[i].col_name = LASTNAME
col[i].col_name_len = 8
col[i].col_schema_name = NULL
col[i].col_schema_name_len = NULL
col[i].col_type = 448
col[i].col_max_len = 15
col[i].col_precision = 15
col[i].col_scale = 0
col[i].col_charsetid = NULL
col[i].col_charsetform = NULL
col[i].col_null_ok = 0

i = 4
col[i].col_name = SALARY
col[i].col_name_len = 6
col[i].col_schema_name = NULL
col[i].col_schema_name_len = NULL
col[i].col_type = 484
col[i].col_max_len = 5
col[i].col_precision = 9
col[i].col_scale = 2
col[i].col_charsetid = NULL
col[i].col_charsetform = NULL
col[i].col_null_ok = 1

```

DESCRIBE_COLUMNS2 procedure - Retrieve a description of column names in a SELECT list

The DESCRIBE_COLUMNS2 procedure provides the capability to retrieve a description of the columns in a SELECT list from a cursor.

Syntax

```

▶▶—DBMS_SQL.DESCRIBE_COLUMNS—(—c—,—col_cnt—,—desc_tab2—)—▶▶

```

Parameters

c An input argument of type INTEGER that specifies the cursor ID of the cursor whose columns are to be described.

col_cnt

An output argument of type INTEGER that returns the number of columns in the SELECT list of the cursor.

desc_tab

An output argument of type DESC_TAB2 that describes the column metadata. The DESC_TAB2 array provides information on each column in the specified cursor

Authorization

EXECUTE privilege on the DBMS_SQL module.

Usage notes

This procedure requires a user temporary table space with a page size of 4K; otherwise it returns an SQL0286N error. You can create the user temporary table space with this command:

```
CREATE USER TEMPORARY TABLESPACE DBMS_SQL_TEMP_TBS
```

DESC_TAB2 is an array of DESC_REC2 records of column information:

Table 26. DESC_TAB2 definition through DESC_REC2 records

Record name	Description
col_type	SQL data type as defined in Supported SQL data types in C and C++ embedded SQL applications.
col_max_len	Maximum length of the column.
col_name	Column name.
col_name_len	Length of the column name.
col_schema	Always NULL.
col_schema_name_len	Always NULL.
col_precision	Precision of the column as defined in the database. If col_type denotes a graphic or DBCLOB SQL data type, then this variable indicates the maximum number of double-byte characters the column can hold.
col_scale	Scale of the column as defined in the database (only applies to DECIMAL, NUMERIC, TIMESTAMP).
col_charsetid	Always NULL.
col_charsetform	Always NULL.
col_null_ok	Nullable indicator. This has a value of 1 if the column is nullable, otherwise, 0.

```
ALTER MODULE SYSIBMADM.DBMS_SQL PUBLISH TYPE DESC_REC2 AS ROW
(
col_type INTEGER,
col_max_len INTEGER,
col_name VARCHAR(128),
col_name_len INTEGER,
col_schema_name VARCHAR(128),
col_schema_name_len INTEGER,
col_precision INTEGER,
col_scale INTEGER,
col_charsetid INTEGER,
col_charsetform INTEGER,
col_null_ok INTEGER
);
```

```
ALTER MODULE SYSIBMADM.DBMS_SQL PUBLISH TYPE DESC_TAB2 AS DESC_REC2 ARRAY[INTEGER];
```

EXECUTE procedure - Run a parsed SQL statement

The EXECUTE function executes a parsed SQL statement.

Syntax

►►—DBMS_SQL.EXECUTE—(—*c*—,—*ret*—)—————►►

Parameters

c An input argument of type INTEGER that specifies the cursor ID of the parsed SQL statement to be executed.

ret

An output argument of type INTEGER that returns the number of rows processed if the SQL command is DELETE, INSERT, or UPDATE; otherwise it returns 0.

Authorization

EXECUTE privilege on the DBMS_SQL module.

Usage notes

This procedure can be invoked using function invocation syntax in a PL/SQL assignment statement.

Examples

Example 1: The following anonymous block inserts a row into the "DEPT" table.

```
SET SERVEROUTPUT ON@

CREATE TABLE dept (
  deptno DECIMAL(2) NOT NULL CONSTRAINT dept_pk PRIMARY KEY,
  dname  VARCHAR(14) NOT NULL,
  loc    VARCHAR(13),
  CONSTRAINT dept_dname_uq UNIQUE( deptno, dname )
)@

BEGIN
  DECLARE curid INTEGER;
  DECLARE v_sql VARCHAR(50);
  DECLARE v_status INTEGER;

  CALL DBMS_SQL.OPEN_CURSOR(curid);
  SET v_sql = 'INSERT INTO dept VALUES (50, ''HR'', ''LOS ANGELES'')';
  CALL DBMS_SQL.PARSE(curid, v_sql, DBMS_SQL.native);
  CALL DBMS_SQL.EXECUTE(curid, v_status);
  CALL DBMS_OUTPUT.PUT_LINE('Number of rows processed: ' || v_status);
  CALL DBMS_SQL.CLOSE_CURSOR(curid);
END@
```

This example results in the following output:

```
SET SERVEROUTPUT ON
DB200001 The SET SERVEROUTPUT command completed successfully.

CREATE TABLE dept
( deptno DECIMAL(2) NOT NULL CONSTRAINT dept_pk PRIMARY KEY,
  dname  VARCHAR(14) NOT NULL,
  loc    VARCHAR(13),
```

```

        CONSTRAINT dept_dname_uq UNIQUE( deptno, dname ) )
DB20000I The SQL command completed successfully.

BEGIN
  DECLARE curid INTEGER;
  DECLARE v_sql VARCHAR(50);
  DECLARE v_status INTEGER;

  CALL DBMS_SQL.OPEN_CURSOR(curid);
  SET v_sql = 'INSERT INTO dept VALUES (50, 'HR', 'LOS ANGELES)';
  CALL DBMS_SQL.PARSE(curid, v_sql, DBMS_SQL.native);
  CALL DBMS_SQL.EXECUTE(curid, v_status);
  CALL DBMS_OUTPUT.PUT_LINE('Number of rows processed: ' || v_status);
  CALL DBMS_SQL.CLOSE_CURSOR(curid);
END
DB20000I The SQL command completed successfully.

Number of rows processed: 1

```

EXECUTE_AND_FETCH procedure - Run a parsed SELECT command and fetch one row

The EXECUTE_AND_FETCH procedure executes a parsed SELECT command and fetches one row.

Syntax

```

▶▶ DBMS_SQL.EXECUTE_AND_FETCH ( c [ , exact ] , ret )

```

Parameters

c An input argument of type INTEGER that specifies the cursor id of the cursor for the SELECT command to be executed.

exact

An optional argument of type INTEGER. If set to 1, an exception is thrown if the number of rows in the result set is not exactly equal to 1. If set to 0, no exception is thrown. The default is 0. A NO_DATA_FOUND (SQL0100W) exception is thrown if *exact* is set to 1 and there are no rows in the result set. A TOO_MANY_ROWS (SQL0811N) exception is thrown if *exact* is set to 1 and there is more than one row in the result set.

ret

An output argument of type INTEGER that returns 1 if a row was fetched successfully, 0 if there are no rows to fetch.

Authorization

EXECUTE privilege on the DBMS_SQL module.

Usage notes

This procedure can be invoked using function invocation syntax in a PL/SQL assignment statement.

Examples

Example 1: The following stored procedure uses the EXECUTE_AND_FETCH function to retrieve one employee using the employee's name. An exception will be thrown if the employee is not found, or there is more than one employee with the same name.

```
SET SERVEROUTPUT ON@

CREATE TABLE emp (
  empno    DECIMAL(4) NOT NULL CONSTRAINT emp_pk PRIMARY KEY,
  ename    VARCHAR(10),
  job      VARCHAR(9),
  mgr      DECIMAL(4),
  hiredate TIMESTAMP(0),
  sal      DECIMAL(7,2) CONSTRAINT emp_sal_ck CHECK (sal > 0),
  comm     DECIMAL(7,2) )@

INSERT INTO emp VALUES (7369,'SMITH','CLERK',7902,'1980-12-17',800,NULL)@
INSERT INTO emp VALUES (7499,'ALLEN','SALESMAN',7698,'1981-02-20',1600,300)@
INSERT INTO emp VALUES (7521,'WARD','SALESMAN',7698,'1981-02-22',1250,500)@
INSERT INTO emp VALUES (7566,'JONES','MANAGER',7839,'1981-04-02',2975,NULL)@
INSERT INTO emp VALUES (7654,'MARTIN','SALESMAN',7698,'1981-09-28',1250,1400)@

CREATE OR REPLACE PROCEDURE select_by_name(
  IN p_ename ANCHOR TO emp.ename)
BEGIN
  DECLARE curid INTEGER;
  DECLARE v_empno ANCHOR TO emp.empno;
  DECLARE v_hiredate ANCHOR TO emp.hiredate;
  DECLARE v_sal ANCHOR TO emp.sal;
  DECLARE v_comm ANCHOR TO emp.comm;
  DECLARE v_disp_date VARCHAR(10);
  DECLARE v_sql VARCHAR(120);
  DECLARE v_status INTEGER;
  SET v_sql = 'SELECT empno, hiredate, sal, NVL(comm, 0)
    FROM emp e WHERE ename = :p_ename ';
  CALL DBMS_SQL.OPEN_CURSOR(curid);
  CALL DBMS_SQL.PARSE(curid, v_sql, DBMS_SQL.native);
  CALL DBMS_SQL.BIND_VARIABLE_VARCHAR(curid, ':p_ename', UPPER(p_ename));
  CALL DBMS_SQL.DEFINE_COLUMN_NUMBER(curid, 1, v_empno);
  CALL DBMS_SQL.DEFINE_COLUMN_DATE(curid, 2, v_hiredate);
  CALL DBMS_SQL.DEFINE_COLUMN_NUMBER(curid, 3, v_sal);
  CALL DBMS_SQL.DEFINE_COLUMN_NUMBER(curid, 4, v_comm);
  CALL DBMS_SQL.EXECUTE_AND_FETCH(curid, 1 /*True*/, v_status);
  CALL DBMS_SQL.COLUMN_VALUE_NUMBER(curid, 1, v_empno);
  CALL DBMS_SQL.COLUMN_VALUE_DATE(curid, 2, v_hiredate);
  CALL DBMS_SQL.COLUMN_VALUE_NUMBER(curid, 3, v_sal);
  CALL DBMS_SQL.COLUMN_VALUE_NUMBER(curid, 4, v_comm);
  SET v_disp_date = TO_CHAR(v_hiredate, 'MM/DD/YYYY');
  CALL DBMS_OUTPUT.PUT_LINE('Number   : ' || v_empno);
  CALL DBMS_OUTPUT.PUT_LINE('Name     : ' || UPPER(p_ename));
  CALL DBMS_OUTPUT.PUT_LINE('Hire Date : ' || v_disp_date);
  CALL DBMS_OUTPUT.PUT_LINE('Salary   : ' || v_sal);
  CALL DBMS_OUTPUT.PUT_LINE('Commission: ' || v_comm);
  CALL DBMS_SQL.CLOSE_CURSOR(curid);
END@

CALL select_by_name( 'MARTIN' )@
```

This example results in the following output:

```
SET SERVEROUTPUT ON
DB20000I The SET SERVEROUTPUT command completed successfully.

CREATE TABLE emp
( empno    DECIMAL(4) NOT NULL CONSTRAINT emp_pk PRIMARY KEY,
```

```

        ename    VARCHAR(10),
        job      VARCHAR(9),
        mgr      DECIMAL(4),
        hiredate  TIMESTAMP(0),
        sal      DECIMAL(7,2) CONSTRAINT emp_sal_ck CHECK (sal > 0),
        comm     DECIMAL(7,2) )
DB20000I The SQL command completed successfully.

INSERT INTO emp VALUES (7369,'SMITH','CLERK',7902,'1980-12-17',800,NULL)
DB20000I The SQL command completed successfully.

INSERT INTO emp VALUES (7499,'ALLEN','SALESMAN',7698,'1981-02-20',1600,300)
DB20000I The SQL command completed successfully.

INSERT INTO emp VALUES (7521,'WARD','SALESMAN',7698,'1981-02-22',1250,500)
DB20000I The SQL command completed successfully.

INSERT INTO emp VALUES (7566,'JONES','MANAGER',7839,'1981-04-02',2975,NULL)
DB20000I The SQL command completed successfully.

INSERT INTO emp VALUES (7654,'MARTIN','SALESMAN',7698,'1981-09-28',1250,1400)
DB20000I The SQL command completed successfully.

CREATE OR REPLACE PROCEDURE select_by_name(
IN p_ename ANCHOR TO emp.ename)
BEGIN
    DECLARE curid INTEGER;
    DECLARE v_empno ANCHOR TO emp.empno;
    DECLARE v_hiredate ANCHOR TO emp.hiredate;
    DECLARE v_sal ANCHOR TO emp.sal;
    DECLARE v_comm ANCHOR TO emp.comm;
    DECLARE v_disp_date VARCHAR(10);
    DECLARE v_sql VARCHAR(120);
    DECLARE v_status INTEGER;
    SET v_sql = 'SELECT empno, hiredate, sal, NVL(comm, 0)
        FROM emp e WHERE ename = :p_ename ';
    CALL DBMS_SQL.OPEN_CURSOR(curid);
    CALL DBMS_SQL.PARSE(curid, v_sql, DBMS_SQL.native);
    CALL DBMS_SQL.BIND_VARIABLE_VARCHAR(curid, ':p_ename', UPPER(p_ename));
    CALL DBMS_SQL.DEFINE_COLUMN_NUMBER(curid, 1, v_empno);
    CALL DBMS_SQL.DEFINE_COLUMN_DATE(curid, 2, v_hiredate);
    CALL DBMS_SQL.DEFINE_COLUMN_NUMBER(curid, 3, v_sal);
    CALL DBMS_SQL.DEFINE_COLUMN_NUMBER(curid, 4, v_comm);
    CALL DBMS_SQL.EXECUTE_AND_FETCH(curid, 1 /*True*/, v_status);
    CALL DBMS_SQL.COLUMN_VALUE_NUMBER(curid, 1, v_empno);
    CALL DBMS_SQL.COLUMN_VALUE_DATE(curid, 2, v_hiredate);
    CALL DBMS_SQL.COLUMN_VALUE_NUMBER(curid, 3, v_sal);
    CALL DBMS_SQL.COLUMN_VALUE_NUMBER(curid, 4, v_comm);
    SET v_disp_date = TO_CHAR(v_hiredate, 'MM/DD/YYYY');
    CALL DBMS_OUTPUT.PUT_LINE('Number      : ' || v_empno);
    CALL DBMS_OUTPUT.PUT_LINE('Name        : ' || UPPER(p_ename));
    CALL DBMS_OUTPUT.PUT_LINE('Hire Date   : ' || v_disp_date);
    CALL DBMS_OUTPUT.PUT_LINE('Salary      : ' || v_sal);
    CALL DBMS_OUTPUT.PUT_LINE('Commission: ' || v_comm);
    CALL DBMS_SQL.CLOSE_CURSOR(curid);
END
DB20000I The SQL command completed successfully.

CALL select_by_name( 'MARTIN' )

Return Status = 0

Number      : 7654
Name        : MARTIN
Hire Date   : 09/28/1981
Salary      : 1250.00
Commission: 1400.00

```

FETCH_ROWS procedure - Retrieve a row from a cursor

The FETCH_ROWS function retrieves a row from a cursor

Syntax

▶—DBMS_SQL.FETCH_ROWS—(—*c*—,—*ret*—)—————▶

Parameters

c An input argument of type INTEGER that specifies the cursor ID of the cursor from which to fetch a row.

ret

An output argument of type INTEGER that returns 1 if a row was fetched successfully, 0 if there are no rows to fetch.

Authorization

EXECUTE privilege on the DBMS_SQL module.

Usage notes

This procedure can be invoked using function invocation syntax in a PL/SQL assignment statement.

Examples

Example 1: The following examples fetches the rows from the "EMP" table and displays the results.

```
SET SERVEROUTPUT ON@
```

```
CREATE TABLE emp (  
  empno    DECIMAL(4) NOT NULL CONSTRAINT emp_pk PRIMARY KEY,  
  ename    VARCHAR(10),  
  job      VARCHAR(9),  
  mgr      DECIMAL(4),  
  hiredate TIMESTAMP(0),  
  sal      DECIMAL(7,2) CONSTRAINT emp_sal_ck CHECK (sal > 0),  
  comm     DECIMAL(7,2) )@
```

```
INSERT INTO emp VALUES (7369,'SMITH','CLERK',7902,'1980-12-17',800,NULL)@  
INSERT INTO emp VALUES (7499,'ALLEN','SALESMAN',7698,'1981-02-20',1600,300)@  
INSERT INTO emp VALUES (7521,'WARD','SALESMAN',7698,'1981-02-22',1250,500)@  
INSERT INTO emp VALUES (7566,'JONES','MANAGER',7839,'1981-04-02',2975,NULL)@  
INSERT INTO emp VALUES (7654,'MARTIN','SALESMAN',7698,'1981-09-28',1250,1400)@
```

```
BEGIN
```

```
  DECLARE curid INTEGER;  
  DECLARE v_empno DECIMAL(4);  
  DECLARE v_ename VARCHAR(10);  
  DECLARE v_hiredate DATE;  
  DECLARE v_sal DECIMAL(7, 2);  
  DECLARE v_comm DECIMAL(7, 2);  
  DECLARE v_sql VARCHAR(50);  
  DECLARE v_status INTEGER;  
  DECLARE v_rowcount INTEGER;
```

```
  SET v_sql = 'SELECT empno, ename, hiredate, sal, ' || 'comm FROM emp';
```

```
  CALL DBMS_SQL.OPEN_CURSOR(curid);
```

```

CALL DBMS_SQL.PARSE(curid, v_sql, DBMS_SQL.native);
CALL DBMS_SQL.DEFINE_COLUMN_NUMBER(curid, 1, v_empno);
CALL DBMS_SQL.DEFINE_COLUMN_VARCHAR(curid, 2, v_ename, 10);
CALL DBMS_SQL.DEFINE_COLUMN_DATE(curid, 3, v_hiredate);
CALL DBMS_SQL.DEFINE_COLUMN_NUMBER(curid, 4, v_sal);
CALL DBMS_SQL.DEFINE_COLUMN_NUMBER(curid, 5, v_comm);
CALL DBMS_SQL.EXECUTE(curid, v_status);
CALL DBMS_OUTPUT.PUT_LINE('EMPNO  ENAME          HIREDATE    SAL
                           COMM');
CALL DBMS_OUTPUT.PUT_LINE('-----  -----  -----  -----
                           ' || '-----');

FETCH_LOOP: LOOP
  CALL DBMS_SQL.FETCH_ROWS(curid, v_status);

  IF v_status = 0 THEN
    LEAVE FETCH_LOOP;
  END IF;

  CALL DBMS_SQL.COLUMN_VALUE_NUMBER(curid, 1, v_empno);
  CALL DBMS_SQL.COLUMN_VALUE_VARCHAR(curid, 2, v_ename);
  CALL DBMS_SQL.COLUMN_VALUE_DATE(curid, 3, v_hiredate);
  CALL DBMS_SQL.COLUMN_VALUE_NUMBER(curid, 4, v_sal);
  CALL DBMS_SQL.COLUMN_VALUE_NUMBER(curid, 5, v_comm);
  CALL DBMS_OUTPUT.PUT_LINE(v_empno || ' ' || ' ' ||
    RPAD(v_ename, 10) || ' ' || ' ' || TO_CHAR(v_hiredate,
    'yyyy-mm-dd') || ' ' || ' ' || TO_CHAR(v_sal,
    '9,999.99') || ' ' || ' ' || TO_CHAR(NVL(v_comm, 0),
    '9,999.99'));
END LOOP FETCH_LOOP;

CALL DBMS_SQL.CLOSE_CURSOR(curid);
END@

```

This example results in the following output:

```

SET SERVEROUTPUT ON
DB20000I The SET SERVEROUTPUT command completed successfully.

CREATE TABLE emp (empno DECIMAL(4) NOT NULL CONSTRAINT emp_pk PRIMARY KEY,
  ename VARCHAR(10), job VARCHAR(9), mgr DECIMAL(4),
  hiredate TIMESTAMP(0),
  sal DECIMAL(7,2) CONSTRAINT emp_sal_ck CHECK (sal > 0),
  comm DECIMAL(7,2) )
DB20000I The SQL command completed successfully.

INSERT INTO emp VALUES (7369,'SMITH','CLERK',7902,'1980-12-17',800,NULL)
DB20000I The SQL command completed successfully.

INSERT INTO emp VALUES (7499,'ALLEN','SALESMAN',7698,'1981-02-20',1600,300)
DB20000I The SQL command completed successfully.

INSERT INTO emp VALUES (7521,'WARD','SALESMAN',7698,'1981-02-22',1250,500)
DB20000I The SQL command completed successfully.

INSERT INTO emp VALUES (7566,'JONES','MANAGER',7839,'1981-04-02',2975,NULL)
DB20000I The SQL command completed successfully.

INSERT INTO emp VALUES (7654,'MARTIN','SALESMAN',7698,'1981-09-28',1250,1400)
DB20000I The SQL command completed successfully.

BEGIN
  DECLARE curid INTEGER;
  DECLARE v_empno DECIMAL(4);
  DECLARE v_ename VARCHAR(10);
  DECLARE v_hiredate DATE;
  DECLARE v_sal DECIMAL(7, 2);

```

```

DECLARE v_comm DECIMAL(7, 2);
DECLARE v_sql VARCHAR(50);
DECLARE v_status INTEGER;
DECLARE v_rowcount INTEGER;

SET v_sql = 'SELECT empno, ename, hiredate, sal, ' || 'comm FROM emp';

CALL DBMS_SQL.OPEN_CURSOR(curid);
CALL DBMS_SQL.PARSE(curid, v_sql, DBMS_SQL.native);
CALL DBMS_SQL.DEFINE_COLUMN_NUMBER(curid, 1, v_empno);
CALL DBMS_SQL.DEFINE_COLUMN_VARCHAR(curid, 2, v_ename, 10);
CALL DBMS_SQL.DEFINE_COLUMN_DATE(curid, 3, v_hiredate);
CALL DBMS_SQL.DEFINE_COLUMN_NUMBER(curid, 4, v_sal);
CALL DBMS_SQL.DEFINE_COLUMN_NUMBER(curid, 5, v_comm);
CALL DBMS_SQL.EXECUTE(curid, v_status);
CALL DBMS_OUTPUT.PUT_LINE('EMPNO  ENAME          HIREDATE    SAL
COMM');
CALL DBMS_OUTPUT.PUT_LINE('-----  -----  -----  -----
' || '-----');

FETCH_LOOP: LOOP
CALL DBMS_SQL.FETCH_ROWS(curid, v_status);

IF v_status = 0 THEN
LEAVE FETCH_LOOP;
END IF;

CALL DBMS_SQL.COLUMN_VALUE_NUMBER(curid, 1, v_empno);
CALL DBMS_SQL.COLUMN_VALUE_VARCHAR(curid, 2, v_ename);
CALL DBMS_SQL.COLUMN_VALUE_DATE(curid, 3, v_hiredate);
CALL DBMS_SQL.COLUMN_VALUE_NUMBER(curid, 4, v_sal);
CALL DBMS_SQL.COLUMN_VALUE_NUMBER(curid, 5, v_comm);
CALL DBMS_OUTPUT.PUT_LINE(v_empno || ' ' || RPAD(v_ename,
10) || ' ' || TO_CHAR(v_hiredate,
'yyyy-mm-dd') || ' ' || TO_CHAR(v_sal,
'9,999.99') || ' ' || TO_CHAR(NVL(v_comm,
0), '9,999.99'));
END LOOP FETCH_LOOP;

CALL DBMS_SQL.CLOSE_CURSOR(curid);
END
DB20000I The SQL command completed successfully.

```

EMPNO	ENAME	HIREDATE	SAL	COMM
7369	SMITH	1980-12-17	800.00	0.00
7499	ALLEN	1981-02-20	1,600.00	300.00
7521	WARD	1981-02-22	1,250.00	500.00
7566	JONES	1981-04-02	2,975.00	0.00
7654	MARTIN	1981-09-28	1,250.00	1,400.00

IS_OPEN procedure - Check if a cursor is open

The IS_OPEN function provides the capability to test if the given cursor is open.

Syntax

```

▶▶ DBMS_SQL.IS_OPEN(—c—, —ret—) ◀◀

```

Parameters

- c* An input argument of type INTEGER that specifies the cursor ID of the cursor to be tested.

ret

An output argument of type BOOLEAN that indicates if the specified file is open (TRUE) or closed (FALSE).

Authorization

EXECUTE privilege on the DBMS_SQL module.

Usage notes

This procedure can be invoked using function invocation syntax in a PL/SQL assignment statement.

LAST_ROW_COUNT procedure - return the cumulative number of rows fetched

The LAST_ROW_COUNT procedure returns the number of rows that have been fetched.

Syntax

►►—DBMS_SQL.LAST_ROW_COUNT—(—*ret*—)—————►►

Parameters

ret

An output argument of type INTEGER that returns the number of rows that have been fetched so far in the current session. A call to DBMS_SQL.PARSE resets the counter.

Authorization

EXECUTE privilege on the DBMS_SQL module.

Usage notes

This procedure can be invoked using function invocation syntax in a PL/SQL assignment statement.

Examples

Example 1: The following example uses the LAST_ROW_COUNT procedure to display the total number of rows fetched in the query.

```
SET SERVEROUTPUT ON@
```

```
CREATE TABLE emp (  
  empno    DECIMAL(4) NOT NULL CONSTRAINT emp_pk PRIMARY KEY,  
  ename    VARCHAR(10),  
  job      VARCHAR(9),  
  mgr      DECIMAL(4),  
  hiredate TIMESTAMP(0),  
  sal      DECIMAL(7,2) CONSTRAINT emp_sal_ck CHECK (sal > 0),  
  comm     DECIMAL(7,2) )@
```

```
INSERT INTO emp VALUES (7369, 'SMITH', 'CLERK', 7902, '1980-12-17', 800, NULL)@  
INSERT INTO emp VALUES (7499, 'ALLEN', 'SALESMAN', 7698, '1981-02-20', 1600, 300)@  
INSERT INTO emp VALUES (7521, 'WARD', 'SALESMAN', 7698, '1981-02-22', 1250, 500)@
```

```

INSERT INTO emp VALUES (7566,'JONES','MANAGER',7839,'1981-04-02',2975,NULL)@
INSERT INTO emp VALUES (7654,'MARTIN','SALESMAN',7698,'1981-09-28',1250,1400)@

```

```

BEGIN
  DECLARE curid INTEGER;
  DECLARE v_empno DECIMAL(4);
  DECLARE v_ename VARCHAR(10);
  DECLARE v_hiredate DATE;
  DECLARE v_sal DECIMAL(7, 2);
  DECLARE v_comm DECIMAL(7, 2);
  DECLARE v_sql VARCHAR(50);
  DECLARE v_status INTEGER;
  DECLARE v_rowcount INTEGER;

  SET v_sql = 'SELECT empno, ename, hiredate, sal, ' || 'comm FROM emp';

  CALL DBMS_SQL.OPEN_CURSOR(curid);
  CALL DBMS_SQL.PARSE(curid, v_sql, DBMS_SQL.native);
  CALL DBMS_SQL.DEFINE_COLUMN_NUMBER(curid, 1, v_empno);
  CALL DBMS_SQL.DEFINE_COLUMN_VARCHAR(curid, 2, v_ename, 10);
  CALL DBMS_SQL.DEFINE_COLUMN_DATE(curid, 3, v_hiredate);
  CALL DBMS_SQL.DEFINE_COLUMN_NUMBER(curid, 4, v_sal);
  CALL DBMS_SQL.DEFINE_COLUMN_NUMBER(curid, 5, v_comm);
  CALL DBMS_SQL.EXECUTE(curid, v_status);
  CALL DBMS_OUTPUT.PUT_LINE('EMPNO  ENAME          HIREDATE    SAL
  COMM');
  CALL DBMS_OUTPUT.PUT_LINE('-----  -----  -----  -----
  ' || '-----');

  FETCH_LOOP: LOOP
    CALL DBMS_SQL.FETCH_ROWS(curid, v_status);

    IF v_status = 0 THEN
      LEAVE FETCH_LOOP;
    END IF;

    CALL DBMS_SQL.COLUMN_VALUE_NUMBER(curid, 1, v_empno);
    CALL DBMS_SQL.COLUMN_VALUE_VARCHAR(curid, 2, v_ename);
    CALL DBMS_SQL.COLUMN_VALUE_DATE(curid, 3, v_hiredate);
    CALL DBMS_SQL.COLUMN_VALUE_NUMBER(curid, 4, v_sal);
    CALL DBMS_SQL.COLUMN_VALUE_NUMBER(curid, 5, v_comm);
    CALL DBMS_OUTPUT.PUT_LINE(v_empno || ' ' || RPAD(v_ename,
    10) || ' ' || TO_CHAR(v_hiredate,
    'yyyy-mm-dd') || ' ' || TO_CHAR(v_sal,
    '9,999.99') || ' ' || TO_CHAR(NVL(v_comm,
    0), '9,999.99'));
  END LOOP FETCH_LOOP;

  CALL DBMS_SQL.LAST_ROW_COUNT( v_rowcount );
  CALL DBMS_OUTPUT.PUT_LINE('Number of rows: ' || v_rowcount);
  CALL DBMS_SQL.CLOSE_CURSOR(curid);
END@

```

This example results in the following output:

```

SET SERVEROUTPUT ON
DB20000I The SET SERVEROUTPUT command completed successfully.

CREATE TABLE emp ( empno    DECIMAL(4) NOT NULL CONSTRAINT emp_pk PRIMARY KEY,
  ename    VARCHAR(10), job    VARCHAR(9),
  mgr      DECIMAL(4),
  hiredate  TIMESTAMP(0),
  sal      DECIMAL(7,2) CONSTRAINT emp_sal_ck CHECK (sal > 0),
  comm     DECIMAL(7,2) )
DB20000I The SQL command completed successfully.

INSERT INTO emp VALUES (7369,'SMITH','CLERK',7902,'1980-12-17',800,NULL)

```

```

DB20000I The SQL command completed successfully.

INSERT INTO emp VALUES (7499,'ALLEN','SALESMAN',7698,'1981-02-20',1600,300)
DB20000I The SQL command completed successfully.

INSERT INTO emp VALUES (7521,'WARD','SALESMAN',7698,'1981-02-22',1250,500)
DB20000I The SQL command completed successfully.

INSERT INTO emp VALUES (7566,'JONES','MANAGER',7839,'1981-04-02',2975,NULL)
DB20000I The SQL command completed successfully.

INSERT INTO emp VALUES (7654,'MARTIN','SALESMAN',7698,'1981-09-28',1250,1400)
DB20000I The SQL command completed successfully.

```

```

BEGIN
  DECLARE curid INTEGER;
  DECLARE v_empno DECIMAL(4);
  DECLARE v_ename VARCHAR(10);
  DECLARE v_hiredate DATE;
  DECLARE v_sal DECIMAL(7, 2);
  DECLARE v_comm DECIMAL(7, 2);
  DECLARE v_sql VARCHAR(50);
  DECLARE v_status INTEGER;
  DECLARE v_rowcount INTEGER;

  SET v_sql = 'SELECT empno, ename, hiredate, sal, ' || 'comm FROM emp';

  CALL DBMS_SQL.OPEN_CURSOR(curid);
  CALL DBMS_SQL.PARSE(curid, v_sql, DBMS_SQL.native);
  CALL DBMS_SQL.DEFINE_COLUMN_NUMBER(curid, 1, v_empno);
  CALL DBMS_SQL.DEFINE_COLUMN_VARCHAR(curid, 2, v_ename, 10);
  CALL DBMS_SQL.DEFINE_COLUMN_DATE(curid, 3, v_hiredate);
  CALL DBMS_SQL.DEFINE_COLUMN_NUMBER(curid, 4, v_sal);
  CALL DBMS_SQL.DEFINE_COLUMN_NUMBER(curid, 5, v_comm);
  CALL DBMS_SQL.EXECUTE(curid, v_status);
  CALL DBMS_OUTPUT.PUT_LINE('EMPNO  ENAME      HIREDATE    SAL
  COMM');
  CALL DBMS_OUTPUT.PUT_LINE('-----  -
  ' || '-----');

  FETCH_LOOP: LOOP
    CALL DBMS_SQL.FETCH_ROWS(curid, v_status);

    IF v_status = 0 THEN
      LEAVE FETCH_LOOP;
    END IF;

    CALL DBMS_SQL.COLUMN_VALUE_NUMBER(curid, 1, v_empno);
    CALL DBMS_SQL.COLUMN_VALUE_VARCHAR(curid, 2, v_ename);
    CALL DBMS_SQL.COLUMN_VALUE_DATE(curid, 3, v_hiredate);
    CALL DBMS_SQL.COLUMN_VALUE_NUMBER(curid, 4, v_sal);
    CALL DBMS_SQL.COLUMN_VALUE_NUMBER(curid, 5, v_comm);
    CALL DBMS_OUTPUT.PUT_LINE(
      v_empno || ' ' || RPAD(v_ename, 10) || ' ' || TO_CHAR(v_hiredate,
      'yyyy-mm-dd') || ' ' || TO_CHAR(v_sal,
      '9,999.99') || ' ' || TO_CHAR(NVL(v_comm,
      0), '9,999.99'));
  END LOOP FETCH_LOOP;

  CALL DBMS_SQL.LAST_ROW_COUNT( v_rowcount );
  CALL DBMS_OUTPUT.PUT_LINE('Number of rows: ' || v_rowcount);
  CALL DBMS_SQL.CLOSE_CURSOR(curid);
END
DB20000I The SQL command completed successfully.

```

```

EMPNO  ENAME      HIREDATE    SAL    COMM
-----  -

```

7369	SMITH	1980-12-17	800.00	0.00
7499	ALLEN	1981-02-20	1,600.00	300.00
7521	WARD	1981-02-22	1,250.00	500.00
7566	JONES	1981-04-02	2,975.00	0.00
7654	MARTIN	1981-09-28	1,250.00	1,400.00

Number of rows: 5

OPEN_CURSOR procedure - Open a cursor

The OPEN_CURSOR procedure creates a new cursor.

A cursor must be used to parse and execute any dynamic SQL statement. Once a cursor has been opened, it can be used again with the same or different SQL statements. The cursor does not have to be closed and reopened in order to be used again.

Syntax

►► DBMS_SQL.OPEN_CURSOR(—c—) ◀◀

Parameters

c An output argument of type INTEGER that specifies the cursor ID of the newly created cursor.

Authorization

EXECUTE privilege on the DBMS_SQL module.

Usage notes

This procedure can be invoked using function invocation syntax in a PL/SQL assignment statement.

Examples

Example 1: The following example creates a new cursor:

```
DECLARE
    curid          INTEGER;
BEGIN
    curid := DBMS_SQL.OPEN_CURSOR;
    .
    .
    .
END;
```

PARSE procedure - Parse an SQL statement

The PARSE procedure parses an SQL statement.

If the SQL command is a DDL command, it is immediately executed and does not require running the EXECUTE procedure.

Syntax

►► DBMS_SQL.PARSE(—c—, —statement—, —language_flag—) ◀◀

Parameters

c An input argument of type INTEGER that specifies the cursor ID of an open cursor.

statement

The SQL statement to be parsed.

language_flag

This argument is provided for Oracle syntax compatibility. Use a value of 1 or DBMS_SQL.native.

Authorization

EXECUTE privilege on the DBMS_SQL module.

Usage notes

This procedure can be invoked using function invocation syntax in a PL/SQL assignment statement.

Examples

Example 1: The following anonymous block creates a table named job. Note that DDL statements are executed immediately by the PARSE procedure and do not require a separate EXECUTE step.

```
SET SERVEROUTPUT ON@

BEGIN
  DECLARE curid INTEGER;
  CALL DBMS_SQL.OPEN_CURSOR(curid);
  CALL DBMS_SQL.PARSE(curid, 'CREATE TABLE job (jobno DECIMAL(3),
    ' || 'jname VARCHAR(9))', DBMS_SQL.native);
  CALL DBMS_SQL.CLOSE_CURSOR(curid);
END@
```

This example results in the following output:

```
SET SERVEROUTPUT ON
DB20000I The SET SERVEROUTPUT command completed successfully.

BEGIN
  DECLARE curid INTEGER;
  CALL DBMS_SQL.OPEN_CURSOR(curid);
  CALL DBMS_SQL.PARSE(curid, 'CREATE TABLE job (jobno DECIMAL(3), ' ||
    'jname VARCHAR(9))', DBMS_SQL.native);
  CALL DBMS_SQL.CLOSE_CURSOR(curid);
END
DB20000I The SQL command completed successfully.
```

Example 2: The following inserts two rows into the job table.

```
BEGIN
  DECLARE curid INTEGER;
  DECLARE v_sql VARCHAR(50);
  DECLARE v_status INTEGER;

  CALL DBMS_SQL.OPEN_CURSOR(curid);
  SET v_sql = 'INSERT INTO job VALUES (100, 'ANALYST')';
  CALL DBMS_SQL.PARSE(curid, v_sql, DBMS_SQL.native);
  CALL DBMS_SQL.EXECUTE(curid, v_status);
  CALL DBMS_OUTPUT.PUT_LINE('Number of rows processed: ' || v_status);
  SET v_sql = 'INSERT INTO job VALUES (200, 'CLERK')';
  CALL DBMS_SQL.PARSE(curid, v_sql, DBMS_SQL.native);
```



```

CALL DBMS_SQL.EXECUTE(curid, v_status);
CALL DBMS_OUTPUT.PUT_LINE('Number of rows processed: ' || v_status);
CALL DBMS_SQL.CLOSE_CURSOR(curid);
END@

```

This example results in the following output:

```

BEGIN
  DECLARE curid INTEGER;
  DECLARE v_sql VARCHAR(50);
  DECLARE v_status INTEGER;

  CALL DBMS_SQL.OPEN_CURSOR(curid);
  SET v_sql = 'INSERT INTO job VALUES (100, 'ANALYST')';
  CALL DBMS_SQL.PARSE(curid, v_sql, DBMS_SQL.native);
  CALL DBMS_SQL.EXECUTE(curid, v_status);
  CALL DBMS_OUTPUT.PUT_LINE('Number of rows processed: ' || v_status);
  SET v_sql = 'INSERT INTO job VALUES (200, 'CLERK')';
  CALL DBMS_SQL.PARSE(curid, v_sql, DBMS_SQL.native);
  CALL DBMS_SQL.EXECUTE(curid, v_status);
  CALL DBMS_OUTPUT.PUT_LINE('Number of rows processed: ' || v_status);
  CALL DBMS_SQL.CLOSE_CURSOR(curid);
END
DB20000I The SQL command completed successfully.

Number of rows processed: 1
Number of rows processed: 1

```

Example 3: The following anonymous block uses the DBMS_SQL module to execute a block containing two INSERT statements. Note that the end of the block contains a terminating semicolon, whereas in the prior examples, the individual INSERT statements did not have a terminating semicolon.

```

BEGIN
  DECLARE curid INTEGER;
  DECLARE v_sql VARCHAR(100);
  DECLARE v_status INTEGER;

  CALL DBMS_SQL.OPEN_CURSOR(curid);
  SET v_sql = 'BEGIN ' || 'INSERT INTO job VALUES (300, 'MANAGER'); '
            || 'INSERT INTO job VALUES (400, 'SALESMAN'); ' || 'END;';
  CALL DBMS_SQL.PARSE(curid, v_sql, DBMS_SQL.native);
  CALL DBMS_SQL.CLOSE_CURSOR(curid);
END@

```

This example results in the following output:

```

BEGIN
  DECLARE curid INTEGER;
  DECLARE v_sql VARCHAR(100);
  DECLARE v_status INTEGER;

  CALL DBMS_SQL.OPEN_CURSOR(curid);
  SET v_sql = 'BEGIN ' || 'INSERT INTO job VALUES (300, 'MANAGER'); ' ||
            'INSERT INTO job VALUES (400, 'SALESMAN'); ' || 'END;';
  CALL DBMS_SQL.PARSE(curid, v_sql, DBMS_SQL.native);
  CALL DBMS_SQL.CLOSE_CURSOR(curid);
END
DB20000I The SQL command completed successfully.

```

VARIABLE_VALUE_BLOB procedure - Return the value of a BLOB INOUT or OUT parameter

The VARIABLE_VALUE_BLOB procedure provides the capability to return the value of a BLOB INOUT or OUT parameter.

Syntax

►► DBMS_SQL.VARIABLE_VALUE_BLOB (—*c*—, —*name*—, —*value*—) ◀◀

Parameters

c An input argument of type INTEGER that specifies the cursor ID of the cursor returning a bind variable.

name

An input argument that specifies the name of the bind variable.

value

An output argument of type BLOB(2G) that specifies the variable receiving the value.

Authorization

EXECUTE privilege on the DBMS_SQL module.

VARIABLE_VALUE_CHAR procedure - Return the value of a CHAR INOUT or OUT parameter

The VARIABLE_VALUE_CHAR procedure provides the capability to return the value of a CHAR INOUT or OUT parameter.

Syntax

►► DBMS_SQL.VARIABLE_VALUE_CHAR (—*c*—, —*name*—, —*value*—) ◀◀

Parameters

c An input argument of type INTEGER that specifies the cursor ID of the cursor returning a bind variable.

name

An input argument that specifies the name of the bind variable.

value

An output argument of type CHAR(254) that specifies the variable receiving the value.

Authorization

EXECUTE privilege on the DBMS_SQL module.

VARIABLE_VALUE_CLOB procedure - Return the value of a CLOB INOUT or OUT parameter

The VARIABLE_VALUE_CLOB procedure provides the capability to return the value of a CLOB INOUT or OUT parameter.

Syntax

▶▶—DBMS_SQL.VARIABLE_VALUE_CLOB—(—*c*—,—*name*—,—*value*—)————▶▶

Parameters

c An input argument of type INTEGER that specifies the cursor ID of the cursor returning a bind variable.

name

An input argument that specifies the name of the bind variable.

value

An output argument of type CLOB(2G) that specifies the variable receiving the value.

Authorization

EXECUTE privilege on the DBMS_SQL module.

VARIABLE_VALUE_DATE procedure - Return the value of a DATE INOUT or OUT parameter

The VARIABLE_VALUE_DATE procedure provides the capability to return the value of a DATE INOUT or OUT parameter.

Syntax

▶▶—DBMS_SQL.VARIABLE_VALUE_DATE—(—*c*—,—*name*—,—*value*—)————▶▶

Parameters

c An input argument of type INTEGER that specifies the cursor ID of the cursor returning a bind variable.

name

An input argument that specifies the name of the bind variable.

value

An output argument of type DATE that specifies the variable receiving the value.

Authorization

EXECUTE privilege on the DBMS_SQL module.

VARIABLE_VALUE_DOUBLE procedure - Return the value of a DOUBLE INOUT or OUT parameter

The VARIABLE_VALUE_DOUBLE procedure provides the capability to return the value of a DOUBLE INOUT or OUT parameter.

Syntax

▶▶—DBMS_SQL.VARIABLE_VALUE_DOUBLE—(—*c*—,—*name*—,—*value*—)————▶▶

Parameters

c An input argument of type INTEGER that specifies the cursor ID of the cursor returning a bind variable.

name

An input argument that specifies the name of the bind variable.

value

An output argument of type DOUBLE that specifies the variable receiving the value.

Authorization

EXECUTE privilege on the DBMS_SQL module.

VARIABLE_VALUE_INT procedure - Return the value of an INTEGER INOUT or OUT parameter

The VARIABLE_VALUE_INT procedure provides the capability to return the value of a INTEGER INOUT or OUT parameter.

Syntax

▶▶ DBMS_SQL.VARIABLE_VALUE_INT(—*c*—,—*name*—,—*value*—)▶▶

Parameters

c An input argument of type INTEGER that specifies the cursor ID of the cursor returning a bind variable.

name

An input argument that specifies the name of the bind variable.

value

An output argument of type INTEGER that specifies the variable receiving the value.

Authorization

EXECUTE privilege on the DBMS_SQL module.

VARIABLE_VALUE_NUMBER procedure - Return the value of a DECFLOAT INOUT or OUT parameter

The VARIABLE_VALUE_NUMBER procedure provides the capability to return the value of a DECFLOAT INOUT or OUT parameter.

Syntax

▶▶ DBMS_SQL.VARIABLE_VALUE_NUMBER(—*c*—,—*name*—,—*value*—)▶▶

Parameters

c An input argument of type INTEGER that specifies the cursor ID of the cursor returning a bind variable.

name

An input argument that specifies the name of the bind variable.

value

An output argument of type DECFLOAT that specifies the variable receiving the value.

Authorization

EXECUTE privilege on the DBMS_SQL module.

VARIABLE_VALUE_RAW procedure - Return the value of a BLOB(32767) INOUT or OUT parameter

The VARIABLE_VALUE_RAW procedure provides the capability to return the value of a BLOB(32767) INOUT or OUT parameter.

Syntax

►► DBMS_SQL.VARIABLE_VALUE_RAW(—*c*—, —*name*—, —*value*—) ►►

Parameters

c An input argument of type INTEGER that specifies the cursor ID of the cursor returning a bind variable.

name

An input argument that specifies the name of the bind variable.

value

An output argument of type BLOB(32767) that specifies the variable receiving the value.

Authorization

EXECUTE privilege on the DBMS_SQL module.

VARIABLE_VALUE_TIMESTAMP procedure - Return the value of a TIMESTAMP INOUT or OUT parameter

The VARIABLE_VALUE_TIMESTAMP procedure provides the capability to return the value of a TIMESTAMP INOUT or OUT parameter.

Syntax

►► DBMS_SQL.VARIABLE_VALUE_TIMESTAMP(—*c*—, —*name*—, —*value*—) ►►

Parameters

c An input argument of type INTEGER that specifies the cursor ID of the cursor returning a bind variable.

name

An input argument that specifies the name of the bind variable.

value

An output argument of type `TIMESTAMP` that specifies the variable receiving the value.

Authorization

EXECUTE privilege on the `DBMS_SQL` module.

VARIABLE_VALUE_VARCHAR procedure - Return the value of a VARCHAR INOUT or OUT parameter

The `VARIABLE_VALUE_VARCHAR` procedure provides the capability to return the value of a `VARCHAR INOUT` or `OUT` parameter.

Syntax

```
▶▶ DBMS_SQL.VARIABLE_VALUE_VARCHAR(—c—, —name—, —value—) ▶▶
```

Parameters

c An input argument of type `INTEGER` that specifies the cursor ID of the cursor returning a bind variable.

name

An input argument that specifies the name of the bind variable.

value

An output argument of type `VARCHAR(32672)` that specifies the variable receiving the value.

Authorization

EXECUTE privilege on the `DBMS_SQL` module.

Chapter 30. DBMS_UTILITY module

The DBMS_UTILITY module provides various utility programs.

The schema for this module is SYSIBMADM.

The DBMS_UTILITY module includes the following routines.

Table 27. Built-in routines available in the DBMS_UTILITY module

Routine Name	Description
ANALYZE_DATABASE procedure	Analyze database tables, clusters, and indexes.
ANALYZE_PART_OBJECT procedure	Analyze a partitioned table or partitioned index.
ANALYZE_SCHEMA procedure	Analyze schema tables, clusters, and indexes.
CANONICALIZE procedure	Canonicalizes a string (for example, strips off white space).
COMMA_TO_TABLE procedure	Convert a comma-delimited list of names to a table of names.
COMPILE_SCHEMA procedure	Compile programs in a schema.
DB_VERSION procedure	Get the database version.
EXEC_DDL_STATEMENT procedure	Execute a DDL statement.
GET_CPU_TIME function	Get the current CPU time.
GET_DEPENDENCY procedure	Get objects that depend on the given object.
GET_HASH_VALUE function	Compute a hash value.
GET_TIME function	Get the current time.
NAME_RESOLVE procedure	Resolve the given name.
NAME_TOKENIZE procedure	Parse the given name into its component parts.
TABLE_TO_COMMA procedure	Convert a table of names to a comma-delimited list.
VALIDATE procedure	Make an invalid database object valid.

The following table lists the built-in variables and types available in the DBMS_UTILITY module.

Table 28. DBMS_UTILITY public variables

Public variables	Data type	Description
lname_array	TABLE	For lists of long names.
uncl_array	TABLE	For lists of users and names.

The LNAME_ARRAY is for storing lists of long names including fully-qualified names.

```
ALTER MODULE SYSIBMADM.DBMS_UTILITY PUBLISH TYPE LNAME_ARRAY AS VARCHAR(4000) ARRAY[];
```

The UNCL_ARRAY is for storing lists of users and names.

```
ALTER MODULE SYSIBMADM.DBMS_UTILITY PUBLISH TYPE UNCL_ARRAY AS VARCHAR(227) ARRAY[];
```

ANALYZE_DATABASE procedure - Gather statistics on tables, clusters, and indexes

The ANALYZE_DATABASE procedure provides the capability to gather statistics on tables, clusters, and indexes in the database.

Syntax

```
DBMS_UTILITY.ANALYZE_DATABASE( ( method )
                                ( estimate_rows )
                                ( estimate_percent )
                                ( method_opt ) )
```

Parameters

method

An input argument of type VARCHAR(128) that specifies the type of analyze functionality to perform. Valid values are:

- ESTIMATE - gather estimated statistics based upon on either a specified number of rows in *estimate_rows* or a percentage of rows in *estimate_percent*;
- COMPUTE - compute exact statistics; or
- DELETE - delete statistics from the data dictionary.

estimate_rows

An optional input argument of type INTEGER that specifies the number of rows on which to base estimated statistics. One of *estimate_rows* or *estimate_percent* must be specified if the *method* is ESTIMATE. The default value is NULL.

estimate_percent

An optional input argument of type INTEGER that specifies the percentage of rows upon which to base estimated statistics. One of *estimate_rows* or *estimate_percent* must be specified if the *method* is ESTIMATE. The default value is NULL.

method_opt

An optional input argument of type VARCHAR(1024) that specifies the object types to be analyzed. Any combination of the following keywords are valid:

- [FOR TABLE]
- [FOR ALL [INDEXED] COLUMNS] [SIZE n]
- [FOR ALL INDEXES]

The default is NULL.

Authorization

EXECUTE privilege on the DBMS_UTILITY module.

ANALYZE_PART_OBJECT procedure - Gather statistics on a partitioned table or partitioned index

The ANALYZE_PART_OBJECT procedure provides the capability to gather statistics on a partitioned table or index.

Syntax

```
DBMS_UTILITY.ANALYZE_PART_OBJECT( ( schema, object_name )
    [, object_type
    [, command_type
    [, command_opt
    [, sample_clause ] ] ] ] )
```

Parameters

schema

An input argument of type VARCHAR(128) that specifies the schema name of the schema whose objects are to be analyzed.

object_name

An input argument of type VARCHAR(128) that specifies the name of the partitioned object to be analyzed.

object_type

An optional input argument of type CHAR that specifies the type of object to be analyzed. Valid values are:

- T - table;
- I - index.

The default is T.

command_type

An optional input argument of type CHAR that specifies the type of analyze functionality to perform. Valid values are:

- E - gather estimated statistics based upon on a specified number of rows or a percentage of rows in the *sample_clause* clause;
- C - compute exact statistics; or
- V - validate the structure and integrity of the partitions.

The default value is E.

command_opt

An optional input argument of type VARCHAR(1024) that specifies the options for the statistics calculation. For *command_type* E or C, this argument can be any combination of:

- [FOR TABLE]
- [FOR ALL COLUMNS]
- [FOR ALL LOCAL INDEXES]

For *command_type* V, this argument can be CASCADE if *object_type* is T. The default value is NULL.

sample_clause

An optional input argument of type VARCHAR(128). If *command_type* is E, this argument contains the following clause to specify the number of rows or percentage of rows on which to base the estimate.

SAMPLE n { ROWS | PERCENT }

The default value is SAMPLE 5 PERCENT.

Authorization

EXECUTE privilege on the DBMS_UTILITY module.

ANALYZE_SCHEMA procedure - Gather statistics on schema tables, clusters, and indexes

The ANALYZE_SCHEMA procedure provides the capability to gather statistics on tables, clusters, and indexes in the specified schema.

Syntax

```
DBMS_UTILITY.ANALYZE_SCHEMA( ( schema , method )
( estimate_rows , estimate_percent , method_opt ) )
```

Parameters

schema

An input argument of type VARCHAR(128) that specifies the schema name of the schema whose objects are to be analyzed.

method

An input argument of type VARCHAR(128) that specifies the type of analyze functionality to perform. Valid values are:

- ESTIMATE - gather estimated statistics based upon on either a specified number of rows in *estimate_rows* or a percentage of rows in *estimate_percent*;
- COMPUTE - compute exact statistics; or
- DELETE - delete statistics from the data dictionary.

estimate_rows

An optional input argument of type INTEGER that specifies the number of rows on which to base estimated statistics. One of *estimate_rows* or *estimate_percent* must be specified if the *method* is ESTIMATE. The default value is NULL.

estimate_percent

An optional input argument of type INTEGER that specifies the percentage of rows upon which to base estimated statistics. One of *estimate_rows* or *estimate_percent* must be specified if the *method* is ESTIMATE. The default value is NULL.

method_opt

An optional input argument of type VARCHAR(1024) that specifies the object types to be analyzed. Any combination of the following keywords are valid:

- [FOR TABLE]
- [FOR ALL [INDEXED] COLUMNS] [SIZE n]
- [FOR ALL INDEXES]

The default is NULL.

Authorization

EXECUTE privilege on the DBMS_UTILITY module.

CANONICALIZE procedure - Canonicalize a string

The CANONICALIZE procedure performs various operations on an input string.

The CANONICALIZE procedure performs the following operations on an input string:

- If the string is not double-quoted, verifies that it uses the characters of a legal identifier. If not, an exception is thrown. If the string is double-quoted, all characters are allowed.
- If the string is not double-quoted and does not contain periods, puts all alphabetic characters into uppercase and eliminates leading and trailing spaces.
- If the string is double-quoted and does not contain periods, strips off the double quotes.
- If the string contains periods and no portion of the string is double-quoted, puts each portion of the string into uppercase and encloses each portion in double quotes.
- If the string contains periods and portions of the string are double-quoted, returns the double-quoted portions unchanged, including the double quotes, and returns the non-double-quoted portions in uppercase and enclosed in double quotes.

Syntax

```
▶▶—DBMS_UTILITY.CANONICALIZE—(—name—,—canon_name—,—canon_len—)—▶▶
```

Parameters

name

An input argument of type VARCHAR(1024) that specifies the string to be canonicalized.

canon_name

An output argument of type VARCHAR(1024) that returns the canonicalized string.

canon_len

An input argument of type INTEGER that specifies the number of bytes in *name* to canonicalize starting from the first character.

Authorization

EXECUTE privilege on the DBMS_UTILITY module.

Examples

Example 1: The following procedure applies the CANONICALIZE procedure on its input parameter and displays the results.

```

SET SERVEROUTPUT ON@

CREATE OR REPLACE PROCEDURE canonicalize(
  IN p_name VARCHAR(4096),
  IN p_length INTEGER DEFAULT 30)
BEGIN
  DECLARE v_canon VARCHAR(100);

  CALL DBMS_UTILITY.CANONICALIZE(p_name, v_canon, p_length);
  CALL DBMS_OUTPUT.PUT_LINE('Canonicalized name ==>' || v_canon || '<==');
  CALL DBMS_OUTPUT.PUT_LINE('Length: ' || LENGTH(v_canon));
END@

CALL canonicalize('Identifier')@
CALL canonicalize('"Identifier"')@
CALL canonicalize('_+142%')@
CALL canonicalize('abc.def.ghi')@
CALL canonicalize('"abc.def.ghi"')@
CALL canonicalize('"abc".def."ghi"')@
CALL canonicalize('"abc.def".ghi')@

```

This example results in the following output:

```

SET SERVEROUTPUT ON
DB20000I The SET SERVEROUTPUT command completed successfully.

CREATE OR REPLACE PROCEDURE canonicalize(
  IN p_name VARCHAR(4096),
  IN p_length INTEGER DEFAULT 30)
BEGIN
  DECLARE v_canon VARCHAR(100);

  CALL DBMS_UTILITY.CANONICALIZE(p_name, v_canon, p_length);
  CALL DBMS_OUTPUT.PUT_LINE('Canonicalized name ==>' || v_canon || '<==');
  CALL DBMS_OUTPUT.PUT_LINE('Length: ' || LENGTH(v_canon));
END
DB20000I The SQL command completed successfully.

CALL canonicalize('Identifier')

Return Status = 0

Canonicalized name ==>IDENTIFIER<==
Length: 10

CALL canonicalize('"Identifier"')

Return Status = 0

Canonicalized name ==>Identifier<==
Length: 10

CALL canonicalize('_+142%')

Return Status = 0

Canonicalized name ==>_+142%<==
Length: 6

CALL canonicalize('abc.def.ghi')

Return Status = 0

Canonicalized name ==>"ABC"."DEF"."GHI"<==
Length: 17

CALL canonicalize('"abc.def.ghi"')

```

```

Return Status = 0

Canonicalized name ==>abc.def.ghi<==
Length: 11

CALL canonicalize("abc".def."ghi")

Return Status = 0

Canonicalized name ==>"abc"."DEF"."ghi"<==
Length: 17

CALL canonicalize('"abc.def".ghi')

Return Status = 0

Canonicalized name ==>"abc.def"."GHI"<==
Length: 15

```

COMMA_TO_TABLE procedures - Convert a comma-delimited list of names into a table of names

The COMMA_TO_TABLE procedure converts a comma-delimited list of names into an array of names. Each entry in the list becomes an element in the array.

Note: The names must be formatted as valid identifiers.

Syntax

```

▶▶—DBMS_UTILITY.COMMA_TO_TABLE_LNAME—(—list—,—tablen—,—tab—)————▶▶

▶▶—DBMS_UTILITY.COMMA_TO_TABLE_UNCL—(—list—,—tablen—,—tab—)————▶▶

```

Parameters

list

An input argument of type VARCHAR(32672) that specifies a comma-delimited list of names.

tablen

An output argument of type INTEGER that specifies the number of entries in *tab*.

tab

An output argument of type LNAME_ARRAY or UNCL_ARRAY that contains a table of the individual names in *list*. See LNAME_ARRAY or UNCL_ARRAY for a description of *tab*.

Authorization

EXECUTE privilege on the DBMS_UTILITY module.

Examples

Example 1: The following procedure uses the COMMA_TO_TABLE_LNAME procedure to convert a list of names to a table. The table entries are then displayed.

```

SET SERVEROUTPUT ON@

CREATE OR REPLACE PROCEDURE comma_to_table(
  IN p_list VARCHAR(4096))
BEGIN
  DECLARE r_lname DBMS_UTILITY.LNAME_ARRAY;
  DECLARE v_length INTEGER;
  CALL DBMS_UTILITY.COMMA_TO_TABLE_LNAME(p_list, v_length, r_lname);
  BEGIN
    DECLARE i INTEGER DEFAULT 1;
    DECLARE loop_limit INTEGER;

    SET loop_limit = v_length;
    WHILE i <= loop_limit DO
      CALL DBMS_OUTPUT.PUT_LINE(r_lname[i]);
      SET i = i + 1;
    END WHILE;
  END;
END@

CALL comma_to_table('sample_schema.dept,sample_schema.emp,sample_schema.jobhist')@

```

This example results in the following output:

```

SET SERVEROUTPUT ON
DB20000I The SET SERVEROUTPUT command completed successfully.

CREATE OR REPLACE PROCEDURE comma_to_table(
  IN p_list VARCHAR(4096))
BEGIN
  DECLARE r_lname DBMS_UTILITY.LNAME_ARRAY;
  DECLARE v_length INTEGER;
  CALL DBMS_UTILITY.COMMA_TO_TABLE_LNAME(p_list, v_length, r_lname);
  BEGIN
    DECLARE i INTEGER DEFAULT 1;
    DECLARE loop_limit INTEGER;

    SET loop_limit = v_length;
    WHILE i <= loop_limit DO
      CALL DBMS_OUTPUT.PUT_LINE(r_lname[i]);
      SET i = i + 1;
    END WHILE;
  END;
END
DB20000I The SQL command completed successfully.

CALL comma_to_table('sample_schema.dept,sample_schema.emp,sample_schema.jobhist')

Return Status = 0

sample_schema.dept
sample_schema.emp
sample_schema.jobhist

```

COMPILE_SCHEMA procedure - Compile all functions, procedures, triggers, and packages in a schema

The COMPILE_SCHEMA procedure provides the capability to recompile all functions, procedures, triggers, and packages in a schema.

Syntax

```
▶▶ DBMS_UTILITY.COMPILE_SCHEMA(—schema—, —compile_all—, —reuse_settings—)
```

Parameters

schema

An input argument of type VARCHAR(128) that specifies the schema in which the programs are to be recompiled.

compile_all

An optional input argument of type BOOLEAN that must be set to false, meaning that the procedure only recompiles programs currently in invalid state.

reuse_settings

An optional input argument of type BOOLEAN that must be set to false, meaning that the procedure uses the current session settings.

Authorization

EXECUTE privilege on the DBMS_UTILITY module.

DB_VERSION procedure - Retrieve the database version

The DB_VERSION procedure returns the version number of the database.

Syntax

```
▶▶ DBMS_UTILITY.DB_VERSION(—version—, —compatibility—)
```

Parameters

version

An output argument of type VARCHAR(1024) that returns the database version number.

compatibility

An output argument of type VARCHAR(1024) that returns the compatibility setting of the database.

Authorization

EXECUTE privilege on the DBMS_UTILITY module.

Examples

Example 1: The following anonymous block displays the database version information.

```
SET SERVEROUTPUT ON@  
  
BEGIN  
  DECLARE v_version VARCHAR(80);  
  DECLARE v_compat VARCHAR(80);
```

```

CALL DBMS_UTILITY.DB_VERSION(v_version, v_compat);
CALL DBMS_OUTPUT.PUT_LINE('Version: ' || v_version);
CALL DBMS_OUTPUT.PUT_LINE('Compatibility: ' || v_compat);
END@

```

This example results in the following output:

```

SET SERVEROUTPUT ON
DB20000I The SET SERVEROUTPUT command completed successfully.

```

```

BEGIN
  DECLARE v_version VARCHAR(80);
  DECLARE v_compat VARCHAR(80);

  CALL DBMS_UTILITY.DB_VERSION(v_version, v_compat);
  CALL DBMS_OUTPUT.PUT_LINE('Version: ' || v_version);
  CALL DBMS_OUTPUT.PUT_LINE('Compatibility: ' || v_compat);
END
DB20000I The SQL command completed successfully.

```

```

Version: DB2 v9.7.0.0
Compatibility: DB2 v9.7.0.0

```

EXEC_DDL_STATEMENT procedure - Run a DDL statement

The EXEC_DDL_STATEMENT procedure provides the capability to execute a DDL command.

Syntax

```

▶▶ DBMS_UTILITY.EXEC_DDL_STATEMENT(—parse_string—)▶▶

```

Parameters

parse_string

An input argument of type VARCHAR(1024) that specifies the DDL command to execute.

Authorization

EXECUTE privilege on the DBMS_UTILITY module.

Examples

Example 1: The following anonymous block creates the job table.

```

BEGIN
  CALL DBMS_UTILITY.EXEC_DDL_STATEMENT(
    'CREATE TABLE job (' ||
    'jobno DECIMAL(3), ' ||
    'jname VARCHAR(9)) ');
END@

```

GET_CPU_TIME function - Retrieve the current CPU time

The GET_CPU_TIME function returns the CPU time in hundredths of a second from some arbitrary point in time.

Syntax

►►—DBMS_UTILITY.GET_CPU_TIME—(—)—————►►

Authorization

EXECUTE privilege on the DBMS_UTILITY module.

Examples

Example 1: The following SELECT command retrieves the current CPU time.

```
SELECT DBMS_UTILITY.GET_CPU_TIME FROM DUAL;
```

```
get_cpu_time
-----
           603
```

Example 2: Calculate the elapsed time by obtaining difference between two CPU time values.

```
SET SERVEROUTPUT ON@
```

```
CREATE OR REPLACE PROCEDURE proc1()
```

```
  BEGIN
    DECLARE cpuTime1 BIGINT;
    DECLARE cpuTime2 BIGINT;
    DECLARE cpuTimeDelta BIGINT;
    DECLARE i INTEGER;

    SET cpuTime1 = DBMS_UTILITY.GET_CPU_TIME();

    SET i = 0;
    loop1: LOOP
      IF i > 10000 THEN
        LEAVE loop1;
      END IF;
      SET i = i + 1;
    END LOOP;

    SET cpuTime2 = DBMS_UTILITY.GET_CPU_TIME();

    SET cpuTimeDelta = cpuTime2 - cpuTime1;

    CALL DBMS_OUTPUT.PUT_LINE( 'cpuTimeDelta = ' || cpuTimeDelta );
  END
  @
```

```
CALL proc1@
```

GET_DEPENDENCY procedure - List objects dependent on the given object

The GET_DEPENDENCY procedure provides the capability to list all objects that are dependent upon the given object.

Syntax

►►—DBMS_UTILITY.GET_DEPENDENCY—(—type—,—schema—,—name—)—————►►

Parameters

type

An input argument of type VARCHAR(128) that specifies the object type of *name*. Valid values are FUNCTION, INDEX, LOB, PACKAGE, PACKAGE BODY, PROCEDURE, SEQUENCE, TABLE, TRIGGER, and VIEW.

schema

An input argument of type VARCHAR(128) that specifies the name of the schema in which *name* exists.

name

An input argument of type VARCHAR(128) that specifies the name of the object for which dependencies are to be obtained.

Authorization

EXECUTE privilege on the DBMS_UTILITY module.

Examples

Example 1: The following anonymous block finds dependencies on the table T1, and the function FUNC1.

```
SET SERVEROUTPUT ON@

CREATE TABLE SCHEMA1.T1 (C1 INTEGER)@

CREATE OR REPLACE FUNCTION SCHEMA2.FUNC1( parm1 INTEGER )
SPECIFIC FUNC1
RETURNS INTEGER
BEGIN
    RETURN parm1;
END@

CREATE OR REPLACE FUNCTION SCHEMA3.FUNC2()
SPECIFIC FUNC2
RETURNS INTEGER
BEGIN
    DECLARE retVal INTEGER;
    SELECT SCHEMA2.FUNC1(1) INTO retVal FROM SCHEMA1.T1;
END@

CALL DBMS_UTILITY.GET_DEPENDENCY('FUNCTION', 'SCHEMA2', 'FUNC1')@
CALL DBMS_UTILITY.GET_DEPENDENCY('TABLE', 'SCHEMA1', 'T1')@
```

This example results in the following output:

```
SET SERVEROUTPUT ON
DB20000I The SET SERVEROUTPUT command completed successfully.

CREATE TABLE SCHEMA1.T1 (C1 INTEGER)
DB20000I The SQL command completed successfully.

CREATE OR REPLACE FUNCTION SCHEMA2.FUNC1( parm1 INTEGER )
SPECIFIC FUNC1
RETURNS INTEGER
BEGIN
    RETURN parm1;
END
DB20000I The SQL command completed successfully.

CREATE OR REPLACE FUNCTION SCHEMA3.FUNC2()
SPECIFIC FUNC2
RETURNS INTEGER
```

```

BEGIN
  DECLARE retVal INTEGER;
  SELECT SCHEMA2.FUNC1(1) INTO retVal FROM SCHEMA1.T1;
END
DB20000I The SQL command completed successfully.

CALL DBMS_UTILITY.GET_DEPENDENCY('FUNCTION', 'SCHEMA2', 'FUNC1')

  Return Status = 0

DEPENDENCIES ON SCHEMA2.FUNC1
-----
*FUNCTION SCHEMA2.FUNC1()
*  FUNCTION SCHEMA3 .FUNC2()

CALL DBMS_UTILITY.GET_DEPENDENCY('TABLE', 'SCHEMA1', 'T1')

  Return Status = 0

DEPENDENCIES ON SCHEMA1.T1
-----
*TABLE SCHEMA1.T1()
*  FUNCTION SCHEMA3 .FUNC2()

```

GET_HASH_VALUE function - Compute a hash value for a given string

The GET_HASH_VALUE function provides the capability to compute a hash value for a given string.

The function returns a generated hash value of type INTEGER, and the value is platform-dependent.

Syntax

```

▶▶—DBMS_UTILITY.GET_HASH_VALUE—(—name—,—base—,—hash_size—)—▶▶

```

Parameters

name

An input argument of type VARCHAR(32672) that specifies the string for which a hash value is to be computed.

base

An input argument of type INTEGER that specifies the starting value at which hash values are to be generated.

hash_size

An input argument of type INTEGER that specifies the number of hash values for the desired hash table.

Authorization

EXECUTE privilege on the DBMS_UTILITY module.

Examples

Example 1: The following example returns hash values for two strings. The starting value for the hash values is 100, with a maximum of 1024 distinct values.

```

SELECT DBMS_UTILITY.GET_HASH_VALUE('Peter',100,1024) AS HASH_VALUE
      FROM SYSIBM.SYSDUMMY1@
SELECT DBMS_UTILITY.GET_HASH_VALUE('Mary',100,1024) AS HASH_VALUE
      FROM SYSIBM.SYSDUMMY1@

```

This example results in the following output:

```

SELECT DBMS_UTILITY.GET_HASH_VALUE('Peter',100,1024) AS HASH_VALUE
      FROM SYSIBM.SYSDUMMY1

```

```

HASH_VALUE
-----
                343

```

1 record(s) selected.

```

SELECT DBMS_UTILITY.GET_HASH_VALUE('Mary',100,1024) AS HASH_VALUE
      FROM SYSIBM.SYSDUMMY1

```

```

HASH_VALUE
-----
                760

```

1 record(s) selected.

GET_TIME function - Return the current time

The GET_TIME function provides the capability to return the current time in hundredths of a second.

Syntax

```

▶▶—DBMS_UTILITY.GET_TIME—(—)—————▶▶

```

Authorization

EXECUTE privilege on the DBMS_UTILITY module.

Examples

Example 1: The following example shows calls to the GET_TIME function.

```

SELECT DBMS_UTILITY.GET_TIME FROM DUAL;

```

```

get_time
-----
1555860

```

```

SELECT DBMS_UTILITY.GET_TIME FROM DUAL;

```

```

get_time
-----
1556037

```

NAME_RESOLVE procedure - Obtain the schema and other membership information for a database object

The NAME_RESOLVE procedure provides the capability to obtain the schema and other membership information of a database object. Synonyms are resolved to their base objects.

Syntax

```
►► DBMS_UTILITY.NAME_RESOLVE (—name—, —context—, —schema—, —part1—, —————►  
► —part2—, —dblink—, —part1_type—, —object_number—) —————►◄
```

Parameters

name

An input argument of type VARCHAR(1024) that specifies the name of the database object to resolve. Can be specified in the format:

[[a.]b.]c[@dblink]

context

An input argument of type INTEGER. Set to the following values:

- 1 - to resolve a function, procedure, or module name;
- 2 - to resolve a table, view, sequence, or synonym name; or
- 3 - to resolve a trigger name.

schema

An output argument of type VARCHAR(128) that specifies the name of the schema containing the object specified by *name*.

part1

An output argument of type VARCHAR(128) that specifies the name of the resolved table, view, sequence, trigger, or module.

part2

An output argument of type VARCHAR(128) that specifies the name of the resolved function or procedure (including functions and procedures within a module).

dblink

An output argument of type VARCHAR(128) that specifies name of the database link (if @dblink is specified in *name*).

part1_type

An output argument of type INTEGER. Returns the following values:

- 2 - resolved object is a table;
- 4 - resolved object is a view;
- 6 - resolved object is a sequence;
- 7 - resolved object is a stored procedure;
- 8 - resolved object is a stored function;
- 9 - resolved object is a module or a function or procedure within a module;
- or
- 12 - resolved object is a trigger.

object_number

An output argument of type INTEGER that specifies the object identifier of the resolved database object.

Authorization

EXECUTE privilege on the DBMS_UTILITY module.

Examples

Example 1: The following stored procedure is used to display the returned values of the NAME_RESOLVE procedure for various database objects.

```
SET SERVEROUTPUT ON@

CREATE OR REPLACE PROCEDURE name_resolve(
  IN p_name VARCHAR(4096),
  IN p_context DECFLOAT )
BEGIN
  DECLARE v_schema VARCHAR(30);
  DECLARE v_part1 VARCHAR(30);
  DECLARE v_part2 VARCHAR(30);
  DECLARE v_dblink VARCHAR(30);
  DECLARE v_part1_type DECFLOAT;
  DECLARE v_objectid DECFLOAT;

  CALL DBMS_UTILITY.NAME_RESOLVE(p_name, p_context, v_schema, v_part1, v_part2,
    v_dblink, v_part1_type, v_objectid);
  CALL DBMS_OUTPUT.PUT_LINE('name      : ' || p_name);
  CALL DBMS_OUTPUT.PUT_LINE('context  : ' || p_context);
  CALL DBMS_OUTPUT.PUT_LINE('schema   : ' || v_schema);
  IF v_part1 IS NULL THEN
    CALL DBMS_OUTPUT.PUT_LINE('part1    : NULL');
  ELSE
    CALL DBMS_OUTPUT.PUT_LINE('part1    : ' || v_part1);
  END IF;
  IF v_part2 IS NULL THEN
    CALL DBMS_OUTPUT.PUT_LINE('part2    : NULL');
  ELSE
    CALL DBMS_OUTPUT.PUT_LINE('part2    : ' || v_part2);
  END IF;
  IF v_dblink IS NULL THEN
    CALL DBMS_OUTPUT.PUT_LINE('dblink   : NULL');
  ELSE
    CALL DBMS_OUTPUT.PUT_LINE('dblink   : ' || v_dblink);
  END IF;
  CALL DBMS_OUTPUT.PUT_LINE('part1 type: ' || v_part1_type);
  CALL DBMS_OUTPUT.PUT_LINE('object id : ' || v_objectid);
END@

DROP TABLE S1.T1@
CREATE TABLE S1.T1 (C1 INT)@

CREATE OR REPLACE PROCEDURE S2.PROC1
BEGIN
END@

CREATE OR REPLACE MODULE S3.M1@
ALTER MODULE S3.M1 PUBLISH FUNCTION F1() RETURNS BOOLEAN
BEGIN
  RETURN TRUE;
END@

CALL NAME_RESOLVE( 'S1.T1', 2 )@
CALL NAME_RESOLVE( 'S2.PROC1', 2 )@
CALL NAME_RESOLVE( 'S2.PROC1', 1 )@
CALL NAME_RESOLVE( 'PROC1', 1 )@
CALL NAME_RESOLVE( 'M1', 1 )@
CALL NAME_RESOLVE( 'S3.M1.F1', 1 )@
```

This example results in the following output:

```
SET SERVEROUTPUT ON
DB200001 The SET SERVEROUTPUT command completed successfully.
```

```

CREATE OR REPLACE PROCEDURE name_resolve(
  IN p_name VARCHAR(4096),
  IN p_context DECFLOAT )
BEGIN
  DECLARE v_schema VARCHAR(30);
  DECLARE v_part1 VARCHAR(30);
  DECLARE v_part2 VARCHAR(30);
  DECLARE v_dblink VARCHAR(30);
  DECLARE v_part1_type DECFLOAT;
  DECLARE v_objectid DECFLOAT;

  CALL DBMS_UTILITY.NAME_RESOLVE(p_name, p_context, v_schema, v_part1, v_part2,
    v_dblink, v_part1_type, v_objectid);
  CALL DBMS_OUTPUT.PUT_LINE('name      : ' || p_name);
  CALL DBMS_OUTPUT.PUT_LINE('context  : ' || p_context);
  CALL DBMS_OUTPUT.PUT_LINE('schema   : ' || v_schema);
  IF v_part1 IS NULL THEN
    CALL DBMS_OUTPUT.PUT_LINE('part1    : NULL');
  ELSE
    CALL DBMS_OUTPUT.PUT_LINE('part1    : ' || v_part1);
  END IF;
  IF v_part2 IS NULL THEN
    CALL DBMS_OUTPUT.PUT_LINE('part2    : NULL');
  ELSE
    CALL DBMS_OUTPUT.PUT_LINE('part2    : ' || v_part2);
  END IF;
  IF v_dblink IS NULL THEN
    CALL DBMS_OUTPUT.PUT_LINE('dblink   : NULL');
  ELSE
    CALL DBMS_OUTPUT.PUT_LINE('dblink   : ' || v_dblink);
  END IF;
  CALL DBMS_OUTPUT.PUT_LINE('part1 type: ' || v_part1_type);
  CALL DBMS_OUTPUT.PUT_LINE('object id : ' || v_objectid);
END
DB20000I The SQL command completed successfully.

DROP TABLE S1.T1
DB20000I The SQL command completed successfully.

CREATE TABLE S1.T1 (C1 INT)
DB20000I The SQL command completed successfully.

CREATE OR REPLACE PROCEDURE S2.PROC1
BEGIN
END
DB20000I The SQL command completed successfully.

CREATE OR REPLACE MODULE S3.M1
DB20000I The SQL command completed successfully.

ALTER MODULE S3.M1 PUBLISH FUNCTION F1() RETURNS BOOLEAN
BEGIN
  RETURN TRUE;
END
DB20000I The SQL command completed successfully.

CALL NAME_RESOLVE( 'S1.T1', 2 )

  Return Status = 0

name      : S1.T1
context   : 2
schema    : S1
part1     : T1
part2     : NULL
dblink    : NULL
part1 type: 2

```

```

object id : 8

CALL NAME_RESOLVE( 'S2.PROC1', 2 )
SQL0204N "S2.PROC1" is an undefined name.  SQLSTATE=42704

CALL NAME_RESOLVE( 'S2.PROC1', 1 )

    Return Status = 0

name      : S2.PROC1
context   : 1
schema    : S2
part1     : PROC1
part2     : NULL
dblink    : NULL
part1 type: 7
object id : 66611

CALL NAME_RESOLVE( 'PROC1', 1 )

    Return Status = 0

name      : PROC1
context   : 1
schema    : S2
part1     : NULL
part2     : PROC1
dblink    : NULL
part1 type: 7
object id : 66611

CALL NAME_RESOLVE( 'M1', 1 )

    Return Status = 0

name      : M1
context   : 1
schema    : S3
part1     : NULL
part2     : M1
dblink    : NULL
part1 type: 9
object id : 16

CALL NAME_RESOLVE( 'S3.M1.F1', 1 )

    Return Status = 0

name      : S3.M1.F1
context   : 1
schema    : S3
part1     : M1
part2     : F1
dblink    : NULL
part1 type: 9
object id : 16

```

Example 2: Resolve a table accessed by a database link. Note that NAME_RESOLVE does not check the validity of the database object on the remote database. It merely echoes back the components specified in the *name* argument.

```

BEGIN
    name_resolve('sample_schema.emp@sample_schema_link',2);
END;

name      : sample_schema.emp@sample_schema_link
context   : 2

```



```

schema      : SAMPLE_SCHEMA
part1       : EMP
part2       :
dblink      : SAMPLE_SCHEMA_LINK
part1 type: 0
object id : 0

```

NAME_TOKENIZE procedure - Parse the given name into its component parts

The NAME_TOKENIZE procedure parses a name into its component parts. Names without double quotes are put into uppercase, and double quotes are stripped from names with double quotes.

Syntax

```

▶▶—DBMS_UTILITY.NAME_TOKENIZE—(—name—,—a—,—b—,—c—,—dblink—,—nextpos—)————▶▶

```

Parameters

name

An input argument of type VARCHAR(1024) that specifies the string containing a name in the following format:

```
a[.b[.c]][@dblink ]
```

- a* An output argument of type VARCHAR(128) that returns the leftmost component.
- b* An output argument of type VARCHAR(128) that returns the second component, if any.
- c* An output argument of type VARCHAR(128) that returns the third component, if any.

dblink

An output argument of type VARCHAR(32672) that returns the database link name.

nextpos

An output argument of type INTEGER that specifies the position of the last character parsed in *name*.

Authorization

EXECUTE privilege on the DBMS_UTILITY module.

Examples

Example 1: The following stored procedure is used to display the returned values of the NAME_TOKENIZE procedure for various names.

```

SET SERVEROUTPUT ON@

CREATE OR REPLACE PROCEDURE name_tokenize(
  IN p_name VARCHAR(100) )
BEGIN
  DECLARE v_a VARCHAR(30);
  DECLARE v_b VARCHAR(30);
  DECLARE v_c VARCHAR(30);
  DECLARE v_dblink VARCHAR(30);
  DECLARE v_nextpos INTEGER;

```

```

CALL DBMS_UTILITY.NAME_TOKENIZE(p_name, v_a, v_b, v_c, v_dblink, v_nextpos);
CALL DBMS_OUTPUT.PUT_LINE('name : ' || p_name);
IF v_a IS NULL THEN
  CALL DBMS_OUTPUT.PUT_LINE('a : NULL');
ELSE
  CALL DBMS_OUTPUT.PUT_LINE('a : ' || v_a);
END IF;
IF v_b IS NULL THEN
  CALL DBMS_OUTPUT.PUT_LINE('b : NULL');
ELSE
  CALL DBMS_OUTPUT.PUT_LINE('b : ' || v_b);
END IF;
IF v_c IS NULL THEN
  CALL DBMS_OUTPUT.PUT_LINE('c : NULL');
ELSE
  CALL DBMS_OUTPUT.PUT_LINE('c : ' || v_c);
END IF;
IF v_dblink IS NULL THEN
  CALL DBMS_OUTPUT.PUT_LINE('dblink : NULL');
ELSE
  CALL DBMS_OUTPUT.PUT_LINE('dblink : ' || v_dblink);
END IF;
IF v_nextpos IS NULL THEN
  CALL DBMS_OUTPUT.PUT_LINE('nextpos: NULL');
ELSE
  CALL DBMS_OUTPUT.PUT_LINE('nextpos: ' || v_nextpos);
END IF;
END@

CALL name_tokenize( 'b' )@
CALL name_tokenize( 'a.b' )@
CALL name_tokenize( 'a".b.c' )@
CALL name_tokenize( 'a.b.c@d' )@
CALL name_tokenize( 'a.b."c"@d"' )@

```

This example results in the following output:

```

SET SERVEROUTPUT ON
DB20000I The SET SERVEROUTPUT command completed successfully.

```

```

CREATE OR REPLACE PROCEDURE name_tokenize(
  IN p_name VARCHAR(100) )
BEGIN
  DECLARE v_a VARCHAR(30);
  DECLARE v_b VARCHAR(30);
  DECLARE v_c VARCHAR(30);
  DECLARE v_dblink VARCHAR(30);
  DECLARE v_nextpos INTEGER;

  CALL DBMS_UTILITY.NAME_TOKENIZE(p_name, v_a, v_b, v_c, v_dblink, v_nextpos);
  CALL DBMS_OUTPUT.PUT_LINE('name : ' || p_name);
  IF v_a IS NULL THEN
    CALL DBMS_OUTPUT.PUT_LINE('a : NULL');
  ELSE
    CALL DBMS_OUTPUT.PUT_LINE('a : ' || v_a);
  END IF;
  IF v_b IS NULL THEN
    CALL DBMS_OUTPUT.PUT_LINE('b : NULL');
  ELSE
    CALL DBMS_OUTPUT.PUT_LINE('b : ' || v_b);
  END IF;
  IF v_c IS NULL THEN
    CALL DBMS_OUTPUT.PUT_LINE('c : NULL');
  ELSE
    CALL DBMS_OUTPUT.PUT_LINE('c : ' || v_c);
  END IF;
END;

```

```

IF v_dblink IS NULL THEN
  CALL DBMS_OUTPUT.PUT_LINE('dblink : NULL');
ELSE
  CALL DBMS_OUTPUT.PUT_LINE('dblink : ' || v_dblink);
END IF;
IF v_nextpos IS NULL THEN
  CALL DBMS_OUTPUT.PUT_LINE('nextpos: NULL');
ELSE
  CALL DBMS_OUTPUT.PUT_LINE('nextpos: ' || v_nextpos);
END IF;
END
DB20000I The SQL command completed successfully.

```

```
CALL name_tokenize( 'b' )
```

```
Return Status = 0
```

```

name  : b
a     : B
b     : NULL
c     : NULL
dblink : NULL
nextpos: 1

```

```
CALL name_tokenize( 'a.b' )
```

```
Return Status = 0
```

```

name  : a.b
a     : A
b     : B
c     : NULL
dblink : NULL
nextpos: 3

```

```
CALL name_tokenize( '"a".b.c' )
```

```
Return Status = 0
```

```

name  : "a".b.c
a     : a
b     : B
c     : C
dblink : NULL
nextpos: 7

```

```
CALL name_tokenize( 'a.b.c@d' )
```

```
Return Status = 0
```

```

name  : a.b.c@d
a     : A
b     : B
c     : C
dblink : D
nextpos: 7

```

```
CALL name_tokenize( 'a.b."c"@d' )
```

```
Return Status = 0
```

```

name  : a.b."c"@d
a     : A
b     : B
c     : C
dblink : d
nextpos: 11

```

TABLE_TO_COMMA procedures - Convert a table of names into a comma-delimited list of names

The TABLE_TO_COMMA procedures convert an array of names into a comma-delimited list of names. Each array element becomes a list entry.

Note: The names must be formatted as valid identifiers.

Syntax

```
►► DBMS_UTILITY.TABLE_TO_COMMA_LNAME(—tab—,—tablen—,—list—)◄◄
```

```
►► DBMS_UTILITY.TABLE_TO_COMMA_UNCL(—tab—,—tablen—,—list—)◄◄
```

Parameters

tab

An input argument of type LNAME_ARRAY or UNCL_ARRAY that specifies the array containing names. See LNAME_ARRAY or UNCL_ARRAY for a description of *tab*.

tablen

An output argument of type INTEGER that returns the number of entries in *list*.

list

An output argument of type VARCHAR(32672) that returns the comma-delimited list of names from *tab*.

Authorization

EXECUTE privilege on the DBMS_UTILITY module.

Examples

Example 1: The following example first uses the COMMA_TO_TABLE_LNAME procedure to convert a comma-delimited list to a table. The TABLE_TO_COMMA_LNAME procedure then converts the table back to a comma-delimited list which is displayed.

```
SET SERVEROUTPUT ON@

CREATE OR REPLACE PROCEDURE table_to_comma(
  IN p_list VARCHAR(100))
BEGIN
  DECLARE r_lname DBMS_UTILITY.LNAME_ARRAY;
  DECLARE v_length INTEGER;
  DECLARE v_listlen INTEGER;
  DECLARE v_list VARCHAR(80);

  CALL DBMS_UTILITY.COMMA_TO_TABLE_LNAME(p_list, v_length, r_lname);
  CALL DBMS_OUTPUT.PUT_LINE('Table Entries');
  CALL DBMS_OUTPUT.PUT_LINE('-----');
  BEGIN
    DECLARE i INTEGER DEFAULT 1;
    DECLARE LOOP_LIMIT INTEGER;
    SET LOOP_LIMIT = v_length;

    WHILE i <= LOOP_LIMIT DO
```

```

        CALL DBMS_OUTPUT.PUT_LINE(r_lname(i));
        SET i = i + 1;
    END WHILE;
END;
CALL DBMS_OUTPUT.PUT_LINE('-----');
CALL DBMS_UTILITY.TABLE_TO_COMMA_LNAME(r_lname, v_listlen, v_list);
CALL DBMS_OUTPUT.PUT_LINE('Comma-Delimited List: ' || v_list);
END@

CALL table_to_comma('sample_schema.dept,sample_schema.emp,sample_schema.jobhist')@

```

This example results in the following output:

```

SET SERVEROUTPUT ON
DB20000I The SET SERVEROUTPUT command completed successfully.

CREATE OR REPLACE PROCEDURE table_to_comma(
    IN p_list VARCHAR(100))
BEGIN
    DECLARE r_lname DBMS_UTILITY.LNAME_ARRAY;
    DECLARE v_length INTEGER;
    DECLARE v_listlen INTEGER;
    DECLARE v_list VARCHAR(80);

    CALL DBMS_UTILITY.COMMA_TO_TABLE_LNAME(p_list, v_length, r_lname);
    CALL DBMS_OUTPUT.PUT_LINE('Table Entries');
    CALL DBMS_OUTPUT.PUT_LINE('-----');
    BEGIN
        DECLARE i INTEGER DEFAULT 1;
        DECLARE LOOP_LIMIT INTEGER;
        SET LOOP_LIMIT = v_length;

        WHILE i <= LOOP_LIMIT DO
            CALL DBMS_OUTPUT.PUT_LINE(r_lname(i));
            SET i = i + 1;
        END WHILE;
    END;
    CALL DBMS_OUTPUT.PUT_LINE('-----');
    CALL DBMS_UTILITY.TABLE_TO_COMMA_LNAME(r_lname, v_listlen, v_list);
    CALL DBMS_OUTPUT.PUT_LINE('Comma-Delimited List: ' || v_list);
END
DB20000I The SQL command completed successfully.

CALL table_to_comma('sample_schema.dept,sample_schema.emp,sample_schema.jobhist')

    Return Status = 0

Table Entries
-----
sample_schema.dept
sample_schema.emp
sample_schema.jobhist
-----
Comma-Delimited List: sample_schema.dept,sample_schema.emp,sample_schema.jobhist

```

VALIDATE procedure - Change an invalid routine into a valid routine

The VALIDATE procedure provides the capability to change the state of an invalid routine to valid.

Syntax

```

▶▶—DBMS_UTILITY.VALIDATE—(—object_id—)—▶▶

```

Parameters

object_id

An input argument of type INTEGER that specifies the identifier of the routine to be changed to a valid state. The ROUTINEID column of the SYSCAT.ROUTINES view contains all the routine identifiers.

Authorization

EXECUTE privilege on the DBMS_UTILITY module.

Chapter 31. MONREPORT module

The MONREPORT module provides a set of procedures for retrieving a variety of monitoring data and generating text reports.

The schema for this module is SYSIBMADM.

The MONREPORT module includes the following built-in routines.

Table 29. Built-in routines available in the MONREPORT module

Routine name	Description
CONNECTION procedure	The Connection report presents monitor data for each connection.
CURRENTAPPS procedure	The Current Applications report presents the current instantaneous state of processing of units of work, agents, and activities for each connection. The report starts with state information summed across connections, followed by a section for details for each connection.
CURRENTSQL procedure	The Current SQL report lists the top activities currently running, as measured by various metrics.
DBSUMMARY procedure	The Summary report contains in-depth monitor data for the entire database, as well as key performance indicators for each connection, workload, service class, and database member.
LOCKWAIT procedure	The Lock Waits report contains information about each lock wait currently in progress. Details include lock holder and requestor details, plus characteristics of the lock held and the lock requested.
PKGCACHE procedure	The Package Cache report lists the top statements accumulated in the package cache as measured by various metrics.

Usage notes

Monitor element names are displayed in upper case (for example, TOTAL_CPU_TIME). To find out more information about a monitor element, search the *DB2 Information Center* for the monitor name.

For reports with a *monitoring_interval* input, negative values in a report are inaccurate. This may occur during a rollover of source data counters. To determine accurate values, re-run the report after the rollover is complete.

Note: The reports are implemented using SQL procedures within modules, and as such can be impacted by the package cache configuration. If you observe slow performance when running the reports, inspect your package cache configuration to ensure it is sufficient for your workload. For further information, see “pckcachesz - Package cache size configuration parameter”.

The following examples demonstrate various ways to call the MONREPORT routines. The examples show the MONREPORT.CONNECTION(*monitoring_interval*, *application_handle*) procedure. You can handle optional parameters for which you do not want to enter a value in the following ways:

- You can always specify null or DEFAULT.
- For character inputs, you can specify an empty string (' ').
- If it is the last parameter, you can omit it.

To generate a report that includes a section for each connection, with the default monitoring interval of 10 seconds, make the following call to the MONREPORT.CONNECTION procedure:

```
call monreport.connection()
```

To generate a report that includes a section only for the connection with application handle 32, with the default monitoring interval of 10 seconds, you can make either of the following calls to the MONREPORT.CONNECTION procedure:

```
call monreport.connection(DEFAULT, 32)
```

```
call monreport.connection(10, 32)
```

To generate a report that includes a section for each connection, with a monitoring interval of 60 seconds, you can make either of the following calls to the MONREPORT.CONNECTION procedure:

```
call monreport.connection(60)
```

```
call monreport.connection(60, null)
```

By default, the reports in this module are generated in English. To change the language in which the reports are generated, change the CURRENT LOCALE LC_MESSAGES special register. For example, to generate the CONNECTION report in French, issue the following commands:

```
SET CURRENT LOCALE LC_MESSAGES = 'CLDR 1.5:fr_FR'  
CALL MONREPORT.CONNECTION
```

Ensure that the language in which the reports are generated is supported by the database code page. If the database code page is Unicode, you can generate the reports in any language.

CONNECTION procedure - Generate a report on connection metrics

The CONNECTION procedure gathers monitor data for each connection and produces a text-formatted report.

Syntax

```
►►—MONREPORT.CONNECTION—(—monitoring_interval—,—application_handle—)————►
```

Parameters

monitoring_interval

An optional input argument of type INTEGER that specifies the duration in seconds that monitoring data is collected before it is reported. For example, if you specify a monitoring interval of 30, the routine calls table functions, waits 30 seconds and calls the table functions again. The routine then calculates the difference, which reflects changes during the interval. If the *monitoring_interval*

argument is not specified (or if null is specified), the default value is 10. The range of valid inputs are the integer values 0-3600 (that is, up to 1 hour).

application_handle

An optional input argument of type BIGINT that specifies an application handle that identifies a connection. If the *application_handle* argument is not specified (or if null is specified), the report includes a section for each connection. The default is null.

Authorization

The following privilege is required:

- EXECUTE privilege on the MONREPORT module

Examples

The following examples demonstrate various ways to call the CONNECTION procedure.

This example produces a report for all connections, with data displayed corresponding to an interval of 30 seconds:

```
call monreport.connection(30);
```

This example produces a report for a connection with an application handle of 34. Data is displayed based on absolute totals accumulated in the source table functions (rather than based on the current interval):

```
call monreport.connection(0, 34);
```

This next example produces a report for a connection with an application handle of 34. Data is displayed corresponding to an interval of 10 seconds.

```
call monreport.connection(DEFAULT, 34);
```

The final example produces the default report: for all connections, with data displayed corresponding to an interval of 10 seconds:

```
call monreport.connection;
```

Here is an example of the report output for the default procedure call (all connections, 10 second interval):

```
Result set 1
```

```
-----
```

```
TEXT
```

```
-----
```

```
Monitoring report - connection
```

```
-----
```

```
Database:          SAMPLE
Generated:         04/06/2010 13:36:52
Interval monitored: 10
-- Command options --
APPLICATION_HANDLE: A11
```

```
=====
```

```
Part 1 - Summary of connections
```

```
-----
```

#	APPLICATION_HANDLE	TOTAL_CPU_TIME	TOTAL_ACT_TIME	ACT_COMPLETED_TOTAL	TOTAL_WAIT_TIME	CLIENT_IDLE_WAIT_TIME
---	--------------------	----------------	----------------	---------------------	-----------------	-----------------------

```
-----
```

```

1   180          0          0          0          0          0
2   65711       116307      675          1          410         9884
3   131323     116624      679          1          717        12895

```

=====
Part 2 - Details for each connection

connection #:1

--Connection identifiers--

Application identifiers
APPLICATION_HANDLE = 180
APPLICATION_NAME = db2bp
APPLICATION_ID = *N0.jwr.100406173420

Authorization IDs
SYSTEM_AUTHID = JWR
SESSION_AUTHID = JWR

Client attributes
CLIENT_ACCTNG =
CLIENT_USERID =
CLIENT_APPLNAME =
CLIENT_WRKSTNNAME =
CLIENT_PID = 29987
CLIENT_PRDID = SQL09081
CLIENT_PLATFORM = LINUXX8664
CLIENT_PROTOCOL = LOCAL

-- Other connection details --
CONNECTION_START_TIME = 2010-04-06-13.34.20.635181
NUM_LOCKS_HELD = 9

Work volume and throughput

	Per second	Total
TOTAL_APP_COMMITS	0	0
ACT_COMPLETED_TOTAL	0	0
APP_RQSTS_COMPLETED_TOTAL	0	0

TOTAL_CPU_TIME = 0
TOTAL_CPU_TIME per request = 0

Row processing
ROWS_READ/ROWS_RETURNED = 0 (0/0)
ROWS_MODIFIED = 0

Wait times

-- Wait time as a percentage of elapsed time --

	%	Wait time/Total time
For requests	0	0/0
For activities	0	0/0

-- Time waiting for next client request --

CLIENT_IDLE_WAIT_TIME = 0
CLIENT_IDLE_WAIT_TIME per second = 0

-- Detailed breakdown of TOTAL_WAIT_TIME --

	%	Total
TOTAL_WAIT_TIME	100	3434

```

I/O wait time
  POOL_READ_TIME          23  805
  POOL_WRITE_TIME         8  280
  DIRECT_READ_TIME        3  131
  DIRECT_WRITE_TIME       3  104
  LOG_DISK_WAIT_TIME     10  344
LOCK_WAIT_TIME           0   18
AGENT_WAIT_TIME          0   0
Network and FCM
  TCP/IP SEND WAIT TIME   0   0
  TCP/IP RECV WAIT TIME  0   0
  IPC SEND WAIT TIME      0   0
  IPC RECV WAIT TIME      0   0
  FCM SEND WAIT TIME      0   0
  FCM RECV WAIT TIME      6  212
WLM_QUEUE_TIME_TOTAL     0   0
CF_WAIT_TIME             32  1101
RECLAIM_WAIT_TIME        2   98
SMP_RECLAIM_WAIT_TIME    3  118

```

Component times

-- Detailed breakdown of processing time --

	%	Total
	-----	-----
Total processing	100	0
Section execution		
TOTAL_SECTION_PROC_TIME	0	0
TOTAL_SECTION_SORT_PROC_TIME	0	0
Compile		
TOTAL_COMPILE_PROC_TIME	0	0
TOTAL_IMPLICIT_COMPILE_PROC_TIME	0	0
Transaction end processing		
TOTAL_COMMIT_PROC_TIME	0	0
TOTAL_ROLLBACK_PROC_TIME	0	0
Utilities		
TOTAL_RUNSTATS_PROC_TIME	0	0
TOTAL_REORGS_PROC_TIME	0	0
TOTAL_LOAD_PROC_TIME	0	0

Buffer pool

Buffer pool hit ratios

Type	Ratio	Reads (Logical/Physical)
-----	-----	-----
Data	84	1545/246
Index	73	1824/491
XDA	0	0/0
Temp data	0	0/0
Temp index	0	0/0
Temp XDA	0	0/0
GBP Data	94	(259 - 246)/259
GBP Index	96	(507 - 491)/507
GBP XDA	88	(1402 - 1366)/1776
LBP Data	18	(1268 - 4)/1545
LBP Index	29	(1287 - 0)/1824
LBP XDA	22	(1299 - 3)/1492

I/O

Buffer pool writes
 POOL_DATA_WRITES = 0
 POOL_XDA_WRITES = 0
 POOL_INDEX_WRITES = 0

```

Direct I/O
  DIRECT_READS          = 0
  DIRECT_READ_REQS     = 0
  DIRECT_WRITES        = 0
  DIRECT_WRITE_REQS    = 0
Log I/O
  LOG_DISK_WAITS_TOTAL = 0

```

Locking

```

-----
                Per activity          Total
                -----
LOCK_WAIT_TIME    0                    0
LOCK_WAITS        0                    0
LOCK_TIMEOUTS    0                    0
DEADLOCKS        0                    0
LOCK_ESCALS      0                    0

```

Routines

```

-----
                Per activity          Total
                -----
TOTAL_ROUTINE_INVOCATIONS  0                    0
TOTAL_ROUTINE_TIME        0                    0

```

```
TOTAL_ROUTINE_TIME per invocation = 0
```

Sort

```

-----
TOTAL_SORTS              = 0
SORT_OVERFLOWS           = 0
POST_THRESHOLD_SORTS    = 0
POST_SHRTHRESHOLD_SORTS = 0

```

Network

```

-----
Communications with remote clients
TCPIP_SEND_VOLUME per send    = 0          (0/0)
TCPIP_RECV_VOLUME per receive = 0          (0/0)

Communications with local clients
IPC_SEND_VOLUME per send      = 0          (0/0)
IPC_RECV_VOLUME per receive   = 0          (0/0)

Fast communications manager
FCM_SEND_VOLUME per send     = 0          (0/0)
FCM_RECV_VOLUME per receive  = 0          (0/0)

```

Other

```

-----
Compilation
  TOTAL_COMPILATIONS          = 0
  PKG_CACHE_INSERTS          = 0
  PKG_CACHE_LOOKUPS          = 0
Catalog cache
  CAT_CACHE_INSERTS          = 0
  CAT_CACHE_LOOKUPS          = 0
Transaction processing
  TOTAL_APP_COMMITS          = 0
  INT_COMMITS                = 0
  TOTAL_APP_ROLLBACKS        = 0
  INT_ROLLBACKS              = 0
Log buffer
  NUM_LOG_BUFFER_FULL        = 0
Activities aborted/rejected
  ACT_ABORTED_TOTAL          = 0
  ACT_REJECTED_TOTAL          = 0

```

```

Workload management controls
  WLM_QUEUE_ASSIGNMENTS_TOTAL = 0
  WLM_QUEUE_TIME_TOTAL        = 0

```

DB2 utility operations

```

-----
TOTAL_RUNSTATS          = 0
TOTAL_REORGS            = 0
TOTAL_LOADS             = 0

```

connection #:2

--Connection identifiers--

Application identifiers

```

APPLICATION_HANDLE      = 65711
APPLICATION_NAME        = db2bp
APPLICATION_ID          = *N1.jwr.100406173430

```

Authorization IDs

```

SYSTEM_AUTHID          = JWR
SESSION_AUTHID         = JWR

```

Client attributes

```

CLIENT_ACCTNG          =
CLIENT_USERID          =
CLIENT_APPLNAME        =
CLIENT_WRKSTNNAME      =
CLIENT_PID             = 30044
CLIENT_PRDID           = SQL09081
CLIENT_PLATFORM        = LINUXX8664
CLIENT_PROTOCOL        = LOCAL

```

-- Other connection details --

```

CONNECTION_START_TIME  = 2010-04-06-13.34.31.058344
NUM_LOCKS_HELD         = 0

```

Work volume and throughput

```

-----
                                     Per second      Total
-----
TOTAL_APP_COMMITS              0                1
ACT_COMPLETED_TOTAL            0                1
APP_RQSTS_COMPLETED_TOTAL      0                2

TOTAL_CPU_TIME                  = 116307
TOTAL_CPU_TIME per request      = 58153

Row processing
  ROWS_READ/ROWS_RETURNED       = 0 (8/0)
  ROWS_MODIFIED                  = 5

```

Wait times

-- Wait time as a percentage of elapsed time --

```

                                     %      Wait time/Total time
-----
For requests                        58    410/696
For activities                       58    398/675

```

-- Time waiting for next client request --

```

CLIENT_IDLE_WAIT_TIME          = 9884
CLIENT_IDLE_WAIT_TIME per second = 988

```

-- Detailed breakdown of TOTAL_WAIT_TIME --

```

%      Total

```

```

TOTAL_WAIT_TIME          --- -----
                        100 410

I/O wait time
  POOL_READ_TIME         5   23
  POOL_WRITE_TIME        28  116
  DIRECT_READ_TIME       0   1
  DIRECT_WRITE_TIME      0   4
  LOG_DISK_WAIT_TIME     11  48
  LOCK_WAIT_TIME         2   11
  AGENT_WAIT_TIME        0   0
Network and FCM
  TCPIP_SEND_WAIT_TIME   0   0
  TCPIP_RECV_WAIT_TIME   0   0
  IPC_SEND_WAIT_TIME     0   1
  IPC_RECV_WAIT_TIME     0   0
  FCM_SEND_WAIT_TIME     0   0
  FCM_RECV_WAIT_TIME     1   5
WLM_QUEUE_TIME_TOTAL    0   0
CF_WAIT_TIME             17  73
RECLAIM_WAIT_TIME       23  96
SMP_RECLAIM_WAIT_TIME   4   20

```

Component times

-- Detailed breakdown of processing time --

	%	Total
	-----	-----
Total processing	100	286
Section execution		
TOTAL_SECTION_PROC_TIME	96	276
TOTAL_SECTION_SORT_PROC_TIME	0	0
Compile		
TOTAL_COMPILE_PROC_TIME	0	2
TOTAL_IMPLICIT_COMPILE_PROC_TIME	0	0
Transaction end processing		
TOTAL_COMMIT_PROC_TIME	1	4
TOTAL_ROLLBACK_PROC_TIME	0	0
Utilities		
TOTAL_RUNSTATS_PROC_TIME	0	0
TOTAL_REORGS_PROC_TIME	0	0
TOTAL_LOAD_PROC_TIME	0	0

Buffer pool

Buffer pool hit ratios

Type	Ratio	Reads (Logical/Physical)
-----	-----	-----
Data	91	72/6
Index	100	46/0
XDA	0	0/0
Temp data	0	0/0
Temp index	0	0/0
Temp XDA	0	0/0
GBP Data	60	(10 - 6)/10
GBP Index	0	(8 - 0)/8
LBP Data	52	(34 - 0)/72
LBP Index	0	(46 - 0)/46

I/O

Buffer pool writes
 POOL_DATA_WRITES = 36
 POOL_XDA_WRITES = 0

```

    POOL_INDEX_WRITES      = 0
Direct I/O
    DIRECT_READS           = 1
    DIRECT_READ_REQS       = 1
    DIRECT_WRITES          = 4
    DIRECT_WRITE_REQS      = 1
Log I/O
    LOG_DISK_WAITS_TOTAL   = 13

```

Locking

	Per activity	Total
LOCK_WAIT_TIME	11	11
LOCK_WAITS	100	1
LOCK_TIMEOUTS	0	0
DEADLOCKS	0	0
LOCK_ESCALS	0	0

Routines

	Per activity	Total
TOTAL_ROUTINE_INVOCATIONS	0	0
TOTAL_ROUTINE_TIME	0	0

TOTAL_ROUTINE_TIME per invocation = 0

Sort

TOTAL_SORTS	= 0
SORT_OVERFLOWS	= 0
POST_THRESHOLD_SORTS	= 0
POST_SHRTHRESHOLD_SORTS	= 0

Network

Communications with remote clients		
TCPIP_SEND_VOLUME per send	= 0	(0/0)
TCPIP_RECV_VOLUME per receive	= 0	(0/0)
Communications with local clients		
IPC_SEND_VOLUME per send	= 54	(108/2)
IPC_RECV_VOLUME per receive	= 69	(138/2)
Fast communications manager		
FCM_SEND_VOLUME per send	= 0	(0/0)
FCM_RECV_VOLUME per receive	= 432	(2592/6)

Other

Compilation	
TOTAL_COMPILATIONS	= 1
PKG_CACHE_INSERTS	= 2
PKG_CACHE_LOOKUPS	= 2
Catalog cache	
CAT_CACHE_INSERTS	= 3
CAT_CACHE_LOOKUPS	= 8
Transaction processing	
TOTAL_APP_COMMITS	= 1
INT_COMMITS	= 0
TOTAL_APP_ROLLBACKS	= 0
INT_ROLLBACKS	= 0
Log buffer	
NUM_LOG_BUFFER_FULL	= 0
Activities aborted/rejected	
ACT_ABORTED_TOTAL	= 0

```

ACT_REJECTED_TOTAL          = 0
Workload management controls
WLM_QUEUE_ASSIGNMENTS_TOTAL = 0
WLM_QUEUE_TIME_TOTAL        = 0

```

DB2 utility operations

```

-----
TOTAL_RUNSTATS              = 0
TOTAL_REORGS                = 0
TOTAL_LOADS                  = 0

```

connection #:3

--Connection identifiers--

```

Application identifiers
APPLICATION_HANDLE          = 131323
APPLICATION_NAME            = db2bp
APPLICATION_ID              = *N2.jwr.100406173452
Authorization IDs
SYSTEM_AUTHID              = JWR
SESSION_AUTHID             = JWR

```

Client attributes

```

CLIENT_ACCTNG              =
CLIENT_USERID              =
CLIENT_APPLNAME            =
CLIENT_WRKSTNNAME         =
CLIENT_PID                 = 30510
CLIENT_PRDID               = SQL09081
CLIENT_PLATFORM           = LINUX8664
CLIENT_PROTOCOL            = LOCAL

```

-- Other connection details --

```

CONNECTION_START_TIME      = 2010-04-06-13.34.52.398427
NUM_LOCKS_HELD             = 0

```

Work volume and throughput

```

-----
                                     Per second          Total
-----
TOTAL_APP_COMMITS                0                   1
ACT_COMPLETED_TOTAL              0                   1
APP_RQSTS_COMPLETED_TOTAL        0                   2

```

```

TOTAL_CPU_TIME                   = 116624
TOTAL_CPU_TIME per request       = 58312

```

Row processing

```

ROWS_READ/ROWS_RETURNED         = 0 (18/0)
ROWS_MODIFIED                    = 4

```

Wait times

-- Wait time as a percentage of elapsed time --

```

                                     %      Wait time/Total time
-----
For requests                          82    717/864
For activities                          80    549/679

```

-- Time waiting for next client request --

```

CLIENT_IDLE_WAIT_TIME           = 12895
CLIENT_IDLE_WAIT_TIME per second = 1289

```

-- Detailed breakdown of TOTAL_WAIT_TIME --

	%	Total

TOTAL_WAIT_TIME	100	717
I/O wait time		
POOL_READ_TIME	2	16
POOL_WRITE_TIME	18	136
DIRECT_READ_TIME	0	3
DIRECT_WRITE_TIME	0	2
LOG_DISK_WAIT_TIME	10	77
LOCK_WAIT_TIME	3	27
AGENT_WAIT_TIME	0	0
Network and FCM		
TCPIP_SEND_WAIT_TIME	0	0
TCPIP_RECV_WAIT_TIME	0	0
IPC_SEND_WAIT_TIME	0	0
IPC_RECV_WAIT_TIME	0	0
FCM_SEND_WAIT_TIME	0	0
FCM_RECV_WAIT_TIME	21	157
WLM_QUEUE_TIME_TOTAL	0	0
CF_WAIT_TIME	9	66
RECLAIM_WAIT_TIME	12	92
SMP_RECLAIM_WAIT_TIME	16	119

Component times

 -- Detailed breakdown of processing time --

	%	Total

Total processing	100	147
Section execution		
TOTAL_SECTION_PROC_TIME	89	131
TOTAL_SECTION_SORT_PROC_TIME	0	0
Compile		
TOTAL_COMPILE_PROC_TIME	4	6
TOTAL_IMPLICIT_COMPILE_PROC_TIME	0	0
Transaction end processing		
TOTAL_COMMIT_PROC_TIME	1	2
TOTAL_ROLLBACK_PROC_TIME	0	0
Utilities		
TOTAL_RUNSTATS_PROC_TIME	0	0
TOTAL_REORGS_PROC_TIME	0	0
TOTAL_LOAD_PROC_TIME	0	0

Buffer pool

 Buffer pool hit ratios

Type	Ratio	Reads (Logical/Physical)

Data	91	47/4
Index	100	78/0
XDA	0	0/0
Temp data	0	0/0
Temp index	0	0/0
Temp XDA	0	0/0
GBP Data	26	(15 - 4)/15
GBP Index	0	(9 - 0)/9
LBP Data	6	(44 - 0)/47
LBP Index	48	(40 - 0)/78

I/O

 Buffer pool writes
 POOL_DATA_WRITES = 3

```

POOL_XDA_WRITES      = 0
POOL_INDEX_WRITES    = 35
Direct I/O
DIRECT_READS         = 15
DIRECT_READ_REQS     = 4
DIRECT_WRITES        = 6
DIRECT_WRITE_REQS    = 1
Log I/O
LOG_DISK_WAITS_TOTAL = 18

```

Locking

	Per activity	Total
LOCK_WAIT_TIME	27	27
LOCK_WAITS	200	2
LOCK_TIMEOUTS	0	0
DEADLOCKS	0	0
LOCK_ESCALS	0	0

Routines

	Per activity	Total
TOTAL_ROUTINE_INVOCATIONS	0	0
TOTAL_ROUTINE_TIME	0	0

TOTAL_ROUTINE_TIME per invocation = 0

Sort

```

TOTAL_SORTS          = 1
SORT_OVERFLOW        = 0
POST_THRESHOLD_SORTS = 0
POST_SHRTHRESHOLD_SORTS = 0

```

Network

```

Communications with remote clients
TCPIP_SEND_VOLUME per send      = 0      (0/0)
TCPIP_RECV_VOLUME per receive   = 0      (0/0)

Communications with local clients
IPC_SEND_VOLUME per send        = 54     (108/2)
IPC_RECV_VOLUME per receive     = 73     (146/2)

Fast communications manager
FCM_SEND_VOLUME per send        = 0      (0/0)
FCM_RECV_VOLUME per receive     = 1086   (10864/10)

```

Other

```

Compilation
TOTAL_COMPILATIONS      = 1
PKG_CACHE_INSERTS      = 2
PKG_CACHE_LOOKUPS       = 2
Catalog cache
CAT_CACHE_INSERTS      = 0
CAT_CACHE_LOOKUPS       = 9
Transaction processing
TOTAL_APP_COMMITS      = 1
INT_COMMITS             = 0
TOTAL_APP_ROLLBACKS    = 0
INT_ROLLBACKS          = 0
Log buffer
NUM_LOG_BUFFER_FULL    = 0
Activities aborted/rejected

```

```

ACT_ABORTED_TOTAL           = 0
ACT_REJECTED_TOTAL          = 0
Workload management controls
WLM_QUEUE_ASSIGNMENTS_TOTAL = 0
WLM_QUEUE_TIME_TOTAL        = 0

```

DB2 utility operations

```

-----
TOTAL_RUNSTATS              = 0
TOTAL_REORGS                = 0
TOTAL_LOADS                  = 0

```

628 record(s) selected.

Return Status = 0

CURRENTAPPS procedure - Generate a report of point-in-time application processing metrics

The CURRENTAPPS procedure gathers information about the current instantaneous state of processing of units or work, agents, and activities for each connection.

Syntax

```

▶▶—MONREPORT.CURRENTAPPS—(—)—▶▶

```

Authorization

The following privilege is required:

- EXECUTE privilege on the MONREPORT module

The following examples demonstrate ways to call the CURRENTAPPS procedure:

```

call monreport.currentapps;
call monreport.currentapps();

```

CURRENTSQL procedure - Generate a report that summarizes activities

The CURRENTSQL procedure generates a text-formatted report that summarizes currently running activities.

Syntax

```

▶▶—MONREPORT.CURRENTSQL—(—member—)—▶▶

```

Parameters

member

An input argument of type SMALLINT that determines whether to show data for a particular member or partition, or to show data summed across all members. If this argument is not specified (or if null is specified), the report shows values summed across all members. If a valid member number is specified, the report shows values for that member.

Authorization

The following privilege is required:

- EXECUTE privilege on the MONREPORT module

The following examples demonstrate various ways to call the CURRENTSQL procedure. The first example produces a report that shows activity metrics aggregated across all members:

```
call monreport.currentsql;
```

The next example produces a report that shows activity metrics specific to the activity performance on member number 4.

```
call monreport.currentsql(4);
```

DBSUMMARY procedure - Generate a summary report of system and application performance metrics

The DBSUMMARY procedure generates a text-formatted monitoring report that summarizes system and application performance metrics.

The DB Summary report contains in-depth monitor data for the entire database as well as key performance indicators for each connection, workload, service class, and database member.

Syntax

```
►►—MONREPORT.DBSUMMARY—(—monitoring_interval—)—————►►
```

Parameters

monitoring_interval

An optional input argument of type INTEGER that specifies the duration in seconds that monitoring data is collected before it is reported. For example, if you specify a monitoring interval of 30, the routine calls the table functions, waits 30 seconds and then calls the table functions again. The DBSUMMARY procedure then calculates the difference, which reflects changes during the interval. If the *monitoring_interval* argument is not specified (or if null is specified), the default value is 10. The range of valid inputs are the integer values 0-3600 (that is, up to 1 hour).

Authorization

The following privilege is required:

- EXECUTE privilege on the MONREPORT module

Examples

The following examples demonstrate various ways to call the DBSUMMARY procedure.

The first example produces a report that displays data corresponding to an interval of 30 seconds.

```
call monreport.dbsummary(30);
```

The next example produces a report that displays data corresponding to an interval of 10 seconds (the default value):

```
call monreport.dbsummary;
```

This procedure call returns the following output:

```
Result set 1
-----

TEXT
-----
Monitoring report - database summary
-----
Database:                SAMPLE
Generated:               04/06/2010 13:35:24
Interval monitored:     10

=====
Part 1 - System performance

Work volume and throughput
-----

```

	Per second	Total
TOTAL_APP_COMMITS	0	2
ACT_COMPLETED_TOTAL	0	9
APP_RQSTS_COMPLETED_TOTAL	0	6
TOTAL_CPU_TIME	= 2649800	
TOTAL_CPU_TIME per request	= 441633	
Row processing		
ROWS_READ/ROWS_RETURNED	= 97 (685/7)	
ROWS_MODIFIED	= 117	

```

Wait times
-----
-- Wait time as a percentage of elapsed time --

```

	%	Wait time/Total time
For requests	19	3434/17674
For activities	10	1203/11613

```

-- Time waiting for next client request --

CLIENT_IDLE_WAIT_TIME      = 70566
CLIENT_IDLE_WAIT_TIME per second = 7056

-- Detailed breakdown of TOTAL_WAIT_TIME --

```

	%	Total
TOTAL_WAIT_TIME	100	3434
I/O wait time		
POOL_READ_TIME	23	805
POOL_WRITE_TIME	8	280
DIRECT_READ_TIME	3	131
DIRECT_WRITE_TIME	3	104
LOG_DISK_WAIT_TIME	10	344
LOCK_WAIT_TIME	0	18
AGENT_WAIT_TIME	0	0
Network and FCM		
TCPIP_SEND_WAIT_TIME	0	0

```

TCPIP_RECV_WAIT_TIME      0    0
IPC_SEND_WAIT_TIME       0    0
IPC_RECV_WAIT_TIME       0    0
FCM_SEND_WAIT_TIME      0    0
FCM_RECV_WAIT_TIME      6   212
WLM_QUEUE_TIME_TOTAL     0    0
CF_WAIT_TIME             32  1101
RECLAIM_WAIT_TIME        2    98
SMP_RECLAIM_WAIT_TIME    3   118

```

Component times

-- Detailed breakdown of processing time --

	%	Total

Total processing	100	14240
Section execution		
TOTAL_SECTION_PROC_TIME	2	365
TOTAL_SECTION_SORT_PROC_TIME	0	0
Compile		
TOTAL_COMPILE_PROC_TIME	0	17
TOTAL_IMPLICIT_COMPILE_PROC_TIME	2	294
Transaction end processing		
TOTAL_COMMIT_PROC_TIME	0	36
TOTAL_ROLLBACK_PROC_TIME	0	0
Utilities		
TOTAL_RUNSTATS_PROC_TIME	0	0
TOTAL_REORGS_PROC_TIME	0	0
TOTAL_LOAD_PROC_TIME	0	0

Buffer pool

Buffer pool hit ratios

Type	Ratio	Reads (Logical/Physical)

Data	84	1545/246
Index	73	1824/491
XDA	0	0/0
Temp data	0	0/0
Temp index	0	0/0
Temp XDA	0	0/0
GBP Data	94	(259 - 246)/259
GBP Index	96	(507 - 491)/507
GBP XDA	88	(1402 - 1366)/1776
LBP Data	18	(1268 - 4)/1545
LBP Index	29	(1287 - 0)/1824
Temp XDA	22	(1299 - 3)/1492

I/O

Buffer pool writes
 POOL_DATA_WRITES = 39
 POOL_XDA_WRITES = 0
 POOL_INDEX_WRITES = 35
Direct I/O
 DIRECT_READS = 1006
 DIRECT_READ_REQS = 131
 DIRECT_WRITES = 484
 DIRECT_WRITE_REQS = 28
Log I/O
 LOG_DISK_WAITS_TOTAL = 63

Locking

	Per activity	Total
LOCK_WAIT_TIME	2	18
LOCK_WAITS	22	2
LOCK_TIMEOUTS	0	0
DEADLOCKS	0	0
LOCK_ESCALS	0	0

Routines

	Per activity	Total
TOTAL_ROUTINE_INVOCATIONS	0	1
TOTAL_ROUTINE_TIME	1117	10058

TOTAL_ROUTINE_TIME per invocation = 10058

Sort

TOTAL_SORTS	= 5
SORT_OVERFLOWS	= 0
POST_THRESHOLD_SORTS	= 0
POST_SHRTHRESHOLD_SORTS	= 0

Network

Communications with remote clients

TCPIP_SEND_VOLUME per send	= 0	(0/0)
TCPIP_RECV_VOLUME per receive	= 0	(0/0)

Communications with local clients

IPC_SEND_VOLUME per send	= 137	(1101/8)
IPC_RECV_VOLUME per receive	= 184	(1106/6)

Fast communications manager

FCM_SEND_VOLUME per send	= 3475	(31277/9)
FCM_RECV_VOLUME per receive	= 2433	(131409/54)

Other

Compilation

TOTAL_COMPILATIONS	= 4
PKG_CACHE_INSERTS	= 11
PKG_CACHE_LOOKUPS	= 13

Catalog cache

CAT_CACHE_INSERTS	= 74
CAT_CACHE_LOOKUPS	= 112

Transaction processing

TOTAL_APP_COMMITS	= 2
INT_COMMITS	= 2
TOTAL_APP_ROLLBACKS	= 0
INT_ROLLBACKS	= 0

Log buffer

NUM_LOG_BUFFER_FULL	= 0
---------------------	-----

Activities aborted/rejected

ACT_ABORTED_TOTAL	= 0
ACT_REJECTED_TOTAL	= 0

Workload management controls

WLM_QUEUE_ASSIGNMENTS_TOTAL	= 0
WLM_QUEUE_TIME_TOTAL	= 0

DB2 utility operations

TOTAL_RUNSTATS	= 0
TOTAL_REORGS	= 0
TOTAL_LOADS	= 0

=====
 Part 2 - Application performance drill down

Application performance database-wide

TOTAL_CPU_TIME per request	TOTAL_ WAIT_TIME %	TOTAL_APP_ COMMITTS	ROWS_READ + ROWS_MODIFIED
441633	19	2	802

Application performance by connection

APPLICATION_ HANDLE	TOTAL_CPU_TIME per request	TOTAL_ WAIT_TIME %	TOTAL_APP_ COMMITTS	ROWS_READ + ROWS_MODIFIED
180	0	0	0	0
65711	495970	46	1	566
131323	324379	43	1	222

Application performance by service class

SERVICE_ CLASS_ID	TOTAL_CPU_TIME per request	TOTAL_ WAIT_TIME %	TOTAL_APP_ COMMITTS	ROWS_READ + ROWS_MODIFIED
11	0	0	0	0
12	0	0	0	0
13	440427	19	2	802

Application performance by workload

WORKLOAD_ NAME	TOTAL_CPU_TIME per request	TOTAL_ WAIT_TIME %	TOTAL_APP_ COMMITTS	ROWS_READ + ROWS_MODIFIED
SYSDEFAULTM	0	0	0	0
SYSDEFAULTUSE	410174	45	2	788

=====
 Part 3 - Member level information

- I/O wait time is
 (POOL_READ_TIME + POOL_WRITE_TIME + DIRECT_READ_TIME + DIRECT_WRITE_TIME).

MEMBER	TOTAL_CPU_TIME per request	TOTAL_ WAIT_TIME %	RQSTS_COMPLETED_ TOTAL	I/O wait time
0	17804	0	9	10
1	108455	47	14	866
2	74762	41	13	441

237 record(s) selected.

Return Status = 0

LOCKWAIT procedure - Generate a report of current lock waits

The Lock Waits report contains information about each lock wait currently in progress. Details include information about the lock holder and requestor and characteristics of the lock held and the lock requested.

Syntax

►►—MONREPORT.LOCKWAIT—(—)—◄◄

Authorization

The following privilege is required:

- EXECUTE privilege on the MONREPORT module

The following examples demonstrate various ways to call the LOCKWAIT procedure:

```
call monreport.lockwait;  
call monreport.lockwait();
```

```
-----  
-----  
Monitoring report - current lock waits  
-----  
Database:          SAMPLE  
Generated:         08/28/2009 07:16:26  
  
=====
```

Part 1 - Summary of current lock waits

```
-----  
-----
```

#	REQ_APPLICATION HANDLE	LOCK_MODE REQUESTED	HLD_APPLICATION _HANDLE	LOCK_ MODE	LOCK_OBJECT_TYPE
1	26	U	21	U	ROW
2	25	U	21	U	ROW
3	24	U	21	U	ROW
4	23	U	21	U	ROW
5	22	U	21	U	ROW
6	27	U	21	U	ROW

```
-----  
-----  
  
...  
  
390 record(s) selected.  
  
Return Status = 0
```

Figure 1. Sample MONREPORT.LOCKWAIT output - summary section

```

=====
Part 2: Details for each current lock wait

lock wait #:1
-----

-- Lock details --

LOCK_NAME           = 04000500040000000000000052
LOCK_WAIT_START_TIME = 2009-08-28-07.15.31.013802
LOCK_OBJECT_TYPE    = ROW
TABSCHEMA           = TRIPATHY
TABNAME             = INVENTORY
ROWID               = 4
LOCK_STATUS         = W
LOCK_ATTRIBUTES     = 0000000000000000
ESCALATION          = N

-- Requestor and holder application details --

Attributes          Requestor          Holder
-----
APPLICATION_HANDLE  26
APPLICATION_ID      *LOCAL.tripathy.09082811531
APPLICATION_NAME    java
SESSION_AUTHID     TRIPATHY
MEMBER             0
LOCK_MODE          -
LOCK_MODE_REQUESTED U

-- Lock holder current agents --

AGENT_TID          = 41
REQUEST_TYPE       = FETCH
EVENT_STATE        = IDLE
EVENT_OBJECT       = REQUEST
EVENT_TYPE         = WAIT
ACTIVITY_ID        =
UOW_ID            =

-- Lock holder current activities --

ACTIVITY_ID        = 1
UOW_ID            = 1
LOCAL_START_TIME   = 2009-08-28-07.14.31.079757
ACTIVITY_TYPE      = READ_DML
ACTIVITY_STATE     = IDLE

STMT_TEXT          =
select * from inventory for update

-- Lock requestor waiting agent and activity --

AGENT_TID          = 39
REQUEST_TYPE       = FETCH
ACTIVITY_ID        = 1
UOW_ID            = 1
LOCAL_START_TIME   = 2009-08-28-07.15.31.012935
ACTIVITY_TYPE      = READ_DML
ACTIVITY_STATE     = EXECUTING

STMT_TEXT          =
select * from inventory for update

```

Figure 2. Sample MONREPORT.LOCKWAIT output - details section

PKGDCACHE procedure - Generate a summary report of package cache metrics

The Package Cache Summary report lists the top statements accumulated in the package cache as measured by various metrics.

Syntax

```
►►—MONREPORT.PKGCACHE—(—cache_interval—,—section_type—,—member—)————►►
```

Parameters

cache_interval

An optional input argument of type INTEGER that specifies the report should only include data for package cache entries that have been updated in the past number of minutes specified by the *cache_interval* value. For example a *cache_interval* value of 60 produces a report based on package cache entries that have been updated in the past 60 minutes. Valid values are integers between 0 and 10080, which supports an interval of up to 7 days. If the argument is not specified (or if null is specified), the report includes data for package cache entries regardless of when they were added or updated.

section_type

An optional input argument of type CHAR(1) that specifies whether the report should include data for static SQL, dynamic SQL, or both. If the argument is not specified (or if null is specified), the report includes data for both types of SQL. Valid values are: d or D (for dynamic) and s or S (for static).

member

An optional input argument of type SMALLINT that determines whether to show data for a particular member or partition, or to show data summed across all members. If this argument is not specified (or if null is specified), the report shows values summed across all members. If a valid member number is specified, the report shows values for that member.

Authorization

The following privilege is required:

- EXECUTE privilege on the MONREPORT module

The following examples demonstrate various ways to call the PKGCACHE procedure. The first example produces a report based on all statements in the package cache, with data aggregated across all members:

```
call monreport.pkgcache;
```

The next example produces a report based on both dynamic and static statements in the package cache for which metrics have been updated within the last 30 minutes, with data aggregated across all members:

```
call monreport.pkgcache(30);
```

The next example produces a report based on all dynamic statements in the package cache, with data aggregated across all members:

```
call monreport.pkgcache(DEFAULT, 'd');
```

The next example produces a report based on both dynamic and static statements in the package cache for which metrics have been updated within the last 30 minutes, with data specific to a member number 4:

```
call db2monreport.pkgcache(30, DEFAULT, 4);
```

Chapter 32. UTL_DIR module

The UTL_DIR module provides a set of routines for maintaining directory aliases that are used with the UTL_FILE module.

Note: The UTL_DIR module does not issue any direct operating system calls, for example, the `mkdir` or `rmdir` commands. Maintenance of the physical directories is outside the scope of this module.

The schema for this module is SYSIBMADM.

The UTL_DIR module includes the following built-in routines.

Table 30. Built-in routines available in the UTL_DIR module

Routine name	Description
CREATE_DIRECTORY procedure	Creates a directory alias for the specified path.
CREATE_OR_REPLACE_DIRECTORY procedure	Creates or replaces a directory alias for the specified path.
DROP_DIRECTORY procedure	Drops the specified directory alias.
GET_DIRECTORY_PATH procedure	Gets the corresponding path for the specified directory alias.

CREATE_DIRECTORY procedure - Create a directory alias

The CREATE_DIRECTORY procedure creates a directory alias for the specified path.

Directory information is stored in SYSTOOLS.DIRECTORIES, which is created in the SYSTOOLSPACE when you first reference this module for each database.

Syntax

►►—UTL_DIR.CREATE_DIRECTORY—(—*alias*—,—*path*—)—————►►

Procedure parameters

alias

An input argument of type VARCHAR(128) that specifies the directory alias.

path

An input argument of type VARCHAR(1024) that specifies the path.

Authorization

EXECUTE privilege on the UTL_DIR module.

Example

Create a directory alias, and use it in a call to the UTL_FILE.FOPEN function.

```

SET SERVEROUTPUT ON@

CREATE OR REPLACE PROCEDURE proc1()
BEGIN
  DECLARE v_filehandle  UTL_FILE.FILE_TYPE;
  DECLARE isOpen        BOOLEAN;
  DECLARE v_filename    VARCHAR(20) DEFAULT 'myfile.csv';
  CALL UTL_DIR.CREATE_DIRECTORY('mydir', '/home/user/temp/mydir');
  SET v_filehandle = UTL_FILE.FOPEN('mydir',v_filename,'w');
  SET isOpen = UTL_FILE.IS_OPEN( v_filehandle );
  IF isOpen != TRUE THEN
    RETURN -1;
  END IF;
  CALL DBMS_OUTPUT.PUT_LINE('Opened file: ' || v_filename);
  CALL UTL_FILE.FCLOSE(v_filehandle);
END@

CALL proc1@

```

This example results in the following output:

```
Opened file: myfile.csv
```

CREATE_OR_REPLACE_DIRECTORY procedure - Create or replace a directory alias

The CREATE_OR_REPLACE_DIRECTORY procedure creates or replaces a directory alias for the specified path.

Directory information is stored in SYSTOOLS.DIRECTORIES, which is created in the SYSTOOLSPACE when you first reference this module for each database.

Syntax

```
▶▶—UTL_DIR.CREATE_OR_REPLACE_DIRECTORY—(—alias—,—path—)————▶▶
```

Procedure parameters

alias

An input argument of type VARCHAR(128) that specifies the directory alias.

path

An input argument of type VARCHAR(1024) that specifies the path.

Authorization

EXECUTE privilege on the UTL_DIR module.

Example

Example 1: Create a directory alias. Because the directory already exists, an error occurs.

```
CALL UTL_DIR.CREATE_DIRECTORY('mydir', 'home/user/temp/empdir')@
```

This example results in the following output:

```
SQL0438N Application raised error or warning with diagnostic text: "directory
alias already defined".  SQLSTATE=23505
```

Example 2: Create or replace a directory alias.

```
CALL UTL_DIR.CREATE_OR_REPLACE_DIRECTORY('mydir', 'home/user/temp/empdir')@
```

This example results in the following output:

```
Return Status = 0
```

DROP_DIRECTORY procedure - Drop a directory alias

The DROP_DIRECTORY procedure drops the specified directory alias.

Syntax

```
▶▶—UTL_DIR.DROP_DIRECTORY—(—alias—)—————▶▶
```

Procedure parameters

alias

An input argument of type VARCHAR(128) that specifies the directory alias.

Authorization

EXECUTE privilege on the UTL_DIR module.

Example

Drop the specified directory alias.

```
CALL UTL_DIR.DROP_DIRECTORY('mydir')@
```

This example results in the following output:

```
Return Status = 0
```

GET_DIRECTORY_PATH procedure - Get the path for a directory alias

The GET_DIRECTORY_PATH procedure returns the corresponding path for a directory alias.

Syntax

```
▶▶—UTL_DIR.GET_DIRECTORY_PATH—(—alias—,—path—)—————▶▶
```

Procedure parameters

alias

An input argument of type VARCHAR(128) that specifies the directory alias.

path

An output argument of type VARCHAR(1024) that specifies the path that is defined for a directory alias.

Authorization

EXECUTE privilege on the UTL_DIR module.

Example

Get the path that is defined for a directory alias.

```
CALL UTL_DIR.GET_DIRECTORY_PATH('mydir', ? )@
```

This example results in the following output:

Value of output parameters

Parameter Name : PATH

Parameter Value : home/rhoda/temp/mydir

Return Status = 0

Chapter 33. UTL_FILE module

The UTL_FILE module provides a set of routines for reading from and writing to files on the database server's file system.

The schema for this module is SYSIBMADM.

The UTL_FILE module includes the following built-in routines and types.

Table 31. Built-in routines available in the UTL_FILE module

Routine name	Description
FCLOSE procedure	Closes a specified file.
FCLOSE_ALL procedure	Closes all open files.
FCOPY procedure	Copies text from one file to another.
FFLUSH procedure	Flushes unwritten data to a file
FOPEN function	Opens a file.
FREMOVE procedure	Removes a file.
FRENAME procedure	Renames a file.
GET_LINE procedure	Gets a line from a file.
IS_OPEN function	Determines whether a specified file is open.
NEW_LINE procedure	Writes an end-of-line character sequence to a file.
PUT procedure	Writes a string to a file.
PUT_LINE procedure	Writes a single line to a file.
PUTF procedure	Writes a formatted string to a file.
UTL_FILE.FILE_TYPE	Stores a file handle.

The following is a list of named conditions (these are called "exceptions" by Oracle) that an application can receive.

Table 32. Named conditions for an application

Condition Name	Description
access_denied	Access to the file is denied by the operating system.
charsetmismatch	A file was opened using FOPEN_NCHAR, but later I/O operations used non-CHAR functions such as PUTF or GET_LINE.
delete_failed	Unable to delete file.
file_open	File is already open.
internal_error	Unhandled internal error in the UTL_FILE module.
invalid_filehandle	File handle does not exist.
invalid_filename	A file with the specified name does not exist in the path.

Table 32. Named conditions for an application (continued)

Condition Name	Description
invalid_maxlinesize	The MAX_LINESIZE value for FOPEN is invalid. It must be between 1 and 32672.
invalid_mode	The open_mode argument in FOPEN is invalid.
invalid_offset	The ABSOLUTE_OFFSET argument for FSEEK is invalid. It must be greater than 0 and less than the total number of bytes in the file.
invalid_operation	File could not be opened or operated on as requested.
invalid_path	The specified path does not exist or is not visible to the database
read_error	Unable to read the file.
rename_failed	Unable to rename the file.
write_error	Unable to write to the file.

Usage notes

To reference directories on the file system, use a directory alias. You can create a directory alias by calling the UTL_DIR.CREATE_DIRECTORY or UTL_DIR.CREATE_OR_REPLACE_DIRECTORY procedures. For example, CALL UTL_DIR.CREATE_DIRECTORY('mydir', 'home/user/temp/mydir')@.

The UTL_FILE module executes file operations by using the DB2 instance ID. Therefore, if you are opening a file, verify that the DB2 instance ID has the appropriate operating system permissions.

The UTL_FILE module is supported only in a non-partitioned database environment.

FCLOSE procedure - Close an open file

The FCLOSE procedure closes a specified file.

Syntax

```
▶▶ UTL_FILE.FCLOSE(file) ◀◀
```

Procedure parameters

file

An input or output argument of type UTL_FILE.FILE_TYPE that contains the file handle. When the file is closed, this value is set to 0.

Authorization

EXECUTE privilege on the UTL_FILE module.

Example

Open a file, write some text to the file, and then close the file.

```
SET SERVEROUTPUT ON@

CREATE OR REPLACE PROCEDURE proc1()
BEGIN
    DECLARE v_filehandle    UTL_FILE.FILE_TYPE;
    DECLARE isOpen          BOOLEAN;
    DECLARE v_dirAlias      VARCHAR(50) DEFAULT 'mydir';
    DECLARE v_filename      VARCHAR(20) DEFAULT 'myfile.csv';
    CALL UTL_DIR.CREATE_OR_REPLACE_DIRECTORY('mydir', '/tmp');
    SET v_filehandle = UTL_FILE.FOPEN(v_dirAlias,v_filename,'w');
    SET isOpen = UTL_FILE.IS_OPEN( v_filehandle );
    IF isOpen != TRUE THEN
        RETURN -1;
    END IF;
    CALL UTL_FILE.PUT_LINE(v_filehandle,'Some text to write to the file. ');
    CALL UTL_FILE.FCLOSE(v_filehandle);
    SET isOpen = UTL_FILE.IS_OPEN( v_filehandle );
    IF isOpen != TRUE THEN
        CALL DBMS_OUTPUT.PUT_LINE('Closed file: ' || v_filename);
    END IF;
END@

CALL proc1@
```

This example results in the following output:

```
Closed file: myfile.csv
```

FCLOSE_ALL procedure - Close all open files

The FCLOSE_ALL procedure closes all open files. The procedure runs successfully even if there are no open files to close.

Syntax

```
▶▶—UTL_FILE.FCLOSE_ALL—◀◀
```

Authorization

EXECUTE privilege on the UTL_FILE module.

Example

Open a couple of files, write some text to the files, and then close all open files.

```
SET SERVEROUTPUT ON@

CREATE OR REPLACE PROCEDURE proc1()
BEGIN
    DECLARE v_filehandle    UTL_FILE.FILE_TYPE;
    DECLARE v_filehandle2   UTL_FILE.FILE_TYPE;
    DECLARE isOpen          BOOLEAN;
    DECLARE v_dirAlias      VARCHAR(50) DEFAULT 'mydir';
    DECLARE v_filename      VARCHAR(20) DEFAULT 'myfile.csv';
    DECLARE v_filename2     VARCHAR(20) DEFAULT 'myfile2.csv';
    CALL UTL_DIR.CREATE_OR_REPLACE_DIRECTORY('mydir', '/tmp');
    SET v_filehandle = UTL_FILE.FOPEN(v_dirAlias,v_filename,'w');
    SET isOpen = UTL_FILE.IS_OPEN( v_filehandle );
    IF isOpen != TRUE THEN
```

```

        RETURN -1;
    END IF;
    CALL UTL_FILE.PUT_LINE(v_filehandle,'Some text to write to a file. ');
    SET v_filehandle2 = UTL_FILE.FOPEN(v_dirAlias,v_filename2,'w');
    SET isOpen = UTL_FILE.IS_OPEN( v_filehandle2 );
    IF isOpen != TRUE THEN
        RETURN -1;
    END IF;
    CALL UTL_FILE.PUT_LINE(v_filehandle2,'Some text to write to another file. ');
    CALL UTL_FILE.FCLOSE_ALL;
    SET isOpen = UTL_FILE.IS_OPEN( v_filehandle );
    IF isOpen != TRUE THEN
        CALL DBMS_OUTPUT.PUT_LINE(v_filename || ' is now closed. ');
    END IF;
    SET isOpen = UTL_FILE.IS_OPEN( v_filehandle2 );
    IF isOpen != TRUE THEN
        CALL DBMS_OUTPUT.PUT_LINE(v_filename2 || ' is now closed. ');
    END IF;
END@

CALL proc1@

```

This example results in the following output:

```

myfile.csv is now closed.
myfile2.csv is now closed.

```

FCOPY procedure - Copy text from one file to another

The FCOPY procedure copies text from one file to another.

Syntax

```

▶▶▶ UTL_FILE.FCOPY( (location, filename, dest_dir, dest_file)
▶▶▶ (start_line, end_line) )

```

Procedure parameters

location

An input argument of type VARCHAR(128) that specifies the alias of the directory that contains the source file.

filename

An input argument of type VARCHAR(255) that specifies the name of the source file.

dest_dir

An input argument of type VARCHAR(128) that specifies the alias of the destination directory.

dest_file

An input argument of type VARCHAR(255) that specifies the name of the destination file.

start_line

An optional input argument of type INTEGER that specifies the line number of the first line of text to copy in the source file. The default is 1.

end_line

An optional input argument of type INTEGER that specifies the line number of

the last line of text to copy in the source file. If this argument is omitted or null, the procedure continues copying all text through the end of the file.

Authorization

EXECUTE privilege on the UTL_FILE module.

Example

Make a copy of a file, empfile.csv, that contains a comma-delimited list of employees from the emp table.

```
SET SERVEROUTPUT ON@
```

```
CREATE PROCEDURE proc1()
BEGIN
  DECLARE v_empfile UTL_FILE.FILE_TYPE;
  DECLARE v_dirAlias VARCHAR(50) DEFAULT 'empdir';
  DECLARE v_src_file VARCHAR(20) DEFAULT 'empfile.csv';
  DECLARE v_dest_file VARCHAR(20) DEFAULT 'empcopy.csv';
  DECLARE v_empline VARCHAR(200);
  CALL UTL_FILE.FCOPY(v_dirAlias,v_src_file,v_dirAlias,v_dest_file);
END@
```

```
CALL proc1@
```

This example results in the following output:

```
Return Status = 0
```

The file copy, empcopy.csv, contains the following data:

```
10,CHRISTINE,I,HAAS,A00,3978,1/1/1965,PRES,18,F,8/24/1933,52750,1000,4220
20,MICHAEL,L,THOMPSON,B01,3476,10/10/1973,MANAGER,18,M,2/2/1948,41250,800,3300
30,SALLY,A,KWAN,C01,4738,4/5/1975,MANAGER,20,F,5/11/1941,38250,800,3060
50,JOHN,B,GEYER,E01,6789,8/17/1949,MANAGER,16,M,9/15/1925,40175,800,3214
60,IRVING,F,STERN,D11,6423,9/14/1973,MANAGER,16,M,7/7/1945,32250,500,2580
70,EVA,D,PULASKI,D21,7831,9/30/1980,MANAGER,16,F,5/26/1953,36170,700,2893
90,EILEEN,W,HENDERSON,E11,5498,8/15/1970,MANAGER,16,F,5/15/1941,29750,600,2380
100,THEODORE,Q,SPENSER,E21,972,6/19/1980,MANAGER,14,M,12/18/1956,26150,500,2092
```

FFLUSH procedure - Flush unwritten data to a file

The FFLUSH procedure forces unwritten data in the write buffer to be written to a file.

Syntax

```
▶▶—UTL_FILE.FFLUSH—(—file—)————▶▶
```

Procedure parameters

file

An input argument of type UTL_FILE.FILE_TYPE that contains the file handle.

Authorization

EXECUTE privilege on the UTL_FILE module.

Example

Flush each line after calling the NEW_LINE procedure.

```

SET SERVEROUTPUT ON@

CREATE PROCEDURE proc1()
BEGIN
  DECLARE v_empfile_src UTL_FILE.FILE_TYPE;
  DECLARE v_empfile_tgt UTL_FILE.FILE_TYPE;
  DECLARE v_dirAlias VARCHAR(50) DEFAULT 'empdir';
  DECLARE v_src_file VARCHAR(20) DEFAULT 'empfile.csv';
  DECLARE v_dest_file VARCHAR(20) DEFAULT 'empfilenew.csv';
  DECLARE v_empline VARCHAR(200);
  DECLARE SQLCODE INTEGER DEFAULT 0;
  DECLARE SQLSTATE CHAR(5) DEFAULT '00000';
  DECLARE SQLSTATE1 CHAR(5) DEFAULT '00000';
  DECLARE CONTINUE HANDLER FOR SQLSTATE '02000' SET SQLSTATE1 = SQLSTATE;

  SET v_empfile_src = UTL_FILE.FOPEN(v_dirAlias,v_src_file,'r');
  SET v_empfile_tgt = UTL_FILE.FOPEN(v_dirAlias,v_dest_file,'w');

  loop1: LOOP
    CALL UTL_FILE.GET_LINE(v_empfile_src,v_empline);
    IF SQLSTATE1 = '02000' THEN -- NO DATA FOUND
      LEAVE loop1;
    END IF;
    CALL UTL_FILE.PUT(v_empfile_tgt,v_empline);
    CALL UTL_FILE.NEW_LINE(v_empfile_tgt);
    CALL UTL_FILE.FFLUSH(v_empfile_tgt);
  END LOOP;
  CALL DBMS_OUTPUT.PUT_LINE('Updated file: ' || v_dest_file);
  CALL UTL_FILE.FCLOSE_ALL;
END@

CALL proc1@

```

This example results in the following output:

```
Updated file: empfilenew.csv
```

The updated file, empfilenew.csv, contains the following data:

```

10,CHRISTINE,I,HAAS,A00,3978,1/1/1965,PRES,18,F,8/24/1933,52750,1000,4220
20,MICHAEL,L,THOMPSON,B01,3476,10/10/1973,MANAGER,18,M,2/2/1948,41250,800,3300
30,SALLY,A,KWAN,C01,4738,4/5/1975,MANAGER,20,F,5/11/1941,38250,800,3060
50,JOHN,B,GEYER,E01,6789,8/17/1949,MANAGER,16,M,9/15/1925,40175,800,3214
60,IRVING,F,STERN,D11,6423,9/14/1973,MANAGER,16,M,7/7/1945,32250,500,2580
70,EVA,D,PULASKI,D21,7831,9/30/1980,MANAGER,16,F,5/26/1953,36170,700,2893
90,EILEEN,W,HENDERSON,E11,5498,8/15/1970,MANAGER,16,F,5/15/1941,29750,600,2380
100,THEODORE,Q,SPENSER,E21,972,6/19/1980,MANAGER,14,M,12/18/1956,26150,500,2092

```

FOPEN function - Open a file

The FOPEN function opens a file for I/O.

Syntax

```

▶▶ UTL_FILE.FOPEN(—location—,—filename—,—open_mode—, —max_linesize—)

```

Return value

This function returns a value of type `UTL_FILE.FILE_TYPE` that indicates the file handle of the opened file.

Function parameters

location

An input argument of type `VARCHAR(128)` that specifies the alias of the directory that contains the file.

filename

An input argument of type `VARCHAR(255)` that specifies the name of the file.

open_mode

An input argument of type `VARCHAR(10)` that specifies the mode in which the file is opened:

a append to file

r read from file

w write to file

max_linesize

An optional input argument of type `INTEGER` that specifies the maximum size of a line in characters. The default value is 1024 bytes. In read mode, an exception is thrown if an attempt is made to read a line that exceeds *max_linesize*. In write and append modes, an exception is thrown if an attempt is made to write a line that exceeds *max_linesize*. End-of-line character(s) do not count towards the line size.

Authorization

EXECUTE privilege on the `UTL_FILE` module.

Example

Open a file, write some text to the file, and then close the file.

```
SET SERVEROUTPUT ON@

CREATE OR REPLACE PROCEDURE proc1()
BEGIN
  DECLARE v_filehandle  UTL_FILE.FILE_TYPE;
  DECLARE isOpen       BOOLEAN;
  DECLARE v_dirAlias   VARCHAR(50) DEFAULT 'mydir';
  DECLARE v_filename   VARCHAR(20) DEFAULT 'myfile.csv';
  CALL UTL_DIR.CREATE_OR_REPLACE_DIRECTORY('mydir', '/tmp');
  SET v_filehandle = UTL_FILE.FOPEN(v_dirAlias,v_filename,'w');
  SET isOpen = UTL_FILE.IS_OPEN( v_filehandle );
  IF isOpen != TRUE THEN
    RETURN -1;
  END IF;
  CALL DBMS_OUTPUT.PUT_LINE('Opened file: ' || v_filename);
  CALL UTL_FILE.PUT_LINE(v_filehandle,'Some text to write to the file.');
```

```
CALL UTL_FILE.FCLOSE(v_filehandle);
END@

CALL proc1@
```

This example results in the following output.

```
Opened file: myfile.csv
```

FREMOVE procedure - Remove a file

The FREMOVE procedure removes a specified file from the system. If the file does not exist, this procedure throws an exception.

Syntax

►►—UTL_FILE.FREMOVE—(—*location*—,—*filename*—)—————►►

Procedure parameters

location

An input argument of type VARCHAR(128) that specifies the alias of the directory that contains the file.

filename

An input argument of type VARCHAR(255) that specifies the name of the file.

Authorization

EXECUTE privilege on the UTL_FILE module.

Example

Remove the file myfile.csv from the system.

```
SET SERVEROUTPUT ON@
```

```
CREATE PROCEDURE proc1()
BEGIN
  DECLARE v_dirAlias    VARCHAR(50) DEFAULT 'mydir';
  DECLARE v_filename   VARCHAR(20) DEFAULT 'myfile.csv';
  CALL UTL_FILE.FREMOVE(v_dirAlias,v_filename);
  CALL DBMS_OUTPUT.PUT_LINE('Removed file: ' || v_filename);
END@
```

```
CALL proc1@
```

This example results in the following output:

```
Removed file: myfile.csv
```

FRENAME procedure - Rename a file

The FRENAME procedure renames a specified file. Renaming a file effectively moves a file from one location to another.

Syntax

►►—UTL_FILE.FRENAME—(—*location*—,—*filename*—,—*dest_dir*—,—*dest_file*—[,—*replace*—])—————►►

Procedure parameters

location

An input argument of type VARCHAR(128) that specifies the alias of the directory that contains the file that you want to rename.

filename

An input argument of type VARCHAR(255) that specifies the name of the file that you want to rename.

dest_dir

An input argument of type VARCHAR(128) that specifies the alias of the destination directory.

dest_file

An input argument of type VARCHAR(255) that specifies the new name of the file.

replace

An optional input argument of type INTEGER that specifies whether to replace the file *dest_file* in the directory *dest_dir* if the file already exists:

1 Replaces existing file.

0 Throws an exception if the file already exists. This is the default if no value is specified for *replace*.

Authorization

EXECUTE privilege on the UTL_FILE module.

Example

Rename a file, empfile.csv, that contains a comma-delimited list of employees from the emp table.

```
SET SERVEROUTPUT ON@
```

```
CREATE PROCEDURE proc1()
BEGIN
  DECLARE v_dirAlias VARCHAR(50) DEFAULT 'empdir';
  DECLARE v_src_file VARCHAR(20) DEFAULT 'oldemp.csv';
  DECLARE v_dest_file VARCHAR(20) DEFAULT 'newemp.csv';
  DECLARE v_replace INTEGER DEFAULT 1;
  CALL UTL_FILE.FRENAME(v_dirAlias,v_src_file,v_dirAlias,
    v_dest_file,v_replace);
  CALL DBMS_OUTPUT.PUT_LINE('The file ' || v_src_file ||
    ' has been renamed to ' || v_dest_file);
END@

CALL proc1@
```

This example results in the following output:

```
The file oldemp.csv has been renamed to newemp.csv
```

GET_LINE procedure - Get a line from a file

The GET_LINE procedure gets a line of text from a specified file. The line of text does not include the end-of-line terminator. When there are no more lines to read, the procedure throws a NO_DATA_FOUND exception.

Syntax

```
►►—UTL_FILE.GET_LINE—(—file—,—buffer—)—◄◄
```

Procedure parameters

file

An input argument of type UTL_FILE.FILE_TYPE that contains the file handle of the opened file.

buffer

An output argument of type VARCHAR(32672) that contains a line of text from the file.

Authorization

EXECUTE privilege on the UTL_FILE module.

Example

Read through and display the records in the file empfile.csv.

```
SET SERVEROUTPUT ON@
```

```
CREATE PROCEDURE proc1()
BEGIN
  DECLARE v_empfile UTL_FILE.FILE_TYPE;
  DECLARE v_dirAlias VARCHAR(50) DEFAULT 'empdir';
  DECLARE v_filename VARCHAR(20) DEFAULT 'empfile.csv';
  DECLARE v_empline VARCHAR(200);
  DECLARE v_count INTEGER DEFAULT 0;
  DECLARE SQLCODE INTEGER DEFAULT 0;
  DECLARE SQLSTATE CHAR(5) DEFAULT '00000';
  DECLARE SQLSTATE1 CHAR(5) DEFAULT '00000';
  DECLARE CONTINUE HANDLER FOR SQLSTATE '02000' SET SQLSTATE1 = SQLSTATE;

  SET v_empfile = UTL_FILE.FOPEN(v_dirAlias,v_filename,'r');

  loop1: LOOP
    CALL UTL_FILE.GET_LINE(v_empfile, v_empline);
    IF SQLSTATE1 = '02000' THEN -- NO DATA FOUND
      LEAVE loop1;
    END IF;
    CALL DBMS_OUTPUT.PUT_LINE(v_empline);
    SET v_count = v_count + 1;
  END LOOP;
  CALL DBMS_OUTPUT.PUT_LINE('End of file ' || v_filename || ' - ' || v_count
    || ' records retrieved');
  CALL UTL_FILE.FCLOSE(v_empfile);
END@

CALL proc1@
```

This example results in the following output:

```
10,CHRISTINE,I,HAAS,A00,3978,1/1/1965,PRES,18,F,8/24/1933,52750,1000,4220
20,MICHAEL,L,THOMPSON,B01,3476,10/10/1973,MANAGER,18,M,2/2/1948,41250,800,3300
30,SALLY,A,KWAN,C01,4738,4/5/1975,MANAGER,20,F,5/11/1941,38250,800,3060
50,JOHN,B,GEYER,E01,6789,8/17/1949,MANAGER,16,M,9/15/1925,40175,800,3214
60,IRVING,F,STERN,D11,6423,9/14/1973,MANAGER,16,M,7/7/1945,32250,500,2580
70,EVA,D,PULASKI,D21,7831,9/30/1980,MANAGER,16,F,5/26/1953,36170,700,2893
90,EILEEN,W,HENDERSON,E11,5498,8/15/1970,MANAGER,16,F,5/15/1941,29750,600,2380
100,THEODORE,Q,SPENSER,E21,972,6/19/1980,MANAGER,14,M,12/18/1956,26150,500,2092
End of file empfile.csv - 8 records retrieved
```

Syntax

►► UTL_FILE.NEW_LINE(—*file*— [,—*lines*])

Procedure parameters

file

An input argument of type UTL_FILE.FILE_TYPE that contains the file handle.

lines

An optional input argument of type INTEGER that specifies the number of end-of-line character sequences to write to the file. The default is 1.

Authorization

EXECUTE privilege on the UTL_FILE module.

Example

Write a file that contains a triple-spaced list of employee records.

```
SET SERVEROUTPUT ON@
```

```
CREATE PROCEDURE proc1()
BEGIN
  DECLARE v_empfile_src UTL_FILE.FILE_TYPE;
  DECLARE v_empfile_tgt UTL_FILE.FILE_TYPE;
  DECLARE v_dirAlias VARCHAR(50) DEFAULT 'empdir';
  DECLARE v_src_file VARCHAR(20) DEFAULT 'empfile.csv';
  DECLARE v_dest_file VARCHAR(20) DEFAULT 'empfilenew.csv';
  DECLARE v_empline VARCHAR(200);
  DECLARE SQLCODE INTEGER DEFAULT 0;
  DECLARE SQLSTATE CHAR(5) DEFAULT '00000';
  DECLARE SQLSTATE1 CHAR(5) DEFAULT '00000';
  DECLARE CONTINUE HANDLER FOR SQLSTATE '02000' SET SQLSTATE1 = SQLSTATE;

  SET v_empfile_src = UTL_FILE.FOPEN(v_dirAlias,v_src_file,'r');
  SET v_empfile_tgt = UTL_FILE.FOPEN(v_dirAlias,v_dest_file,'w');

  loop1: LOOP
    CALL UTL_FILE.GET_LINE(v_empfile_src,v_empline);
    IF SQLSTATE1 = '02000' THEN -- NO DATA FOUND
      LEAVE loop1;
    END IF;
    CALL UTL_FILE.PUT(v_empfile_tgt,v_empline);
    CALL UTL_FILE.NEW_LINE(v_empfile_tgt, 2);
  END LOOP;

  CALL DBMS_OUTPUT.PUT_LINE('Wrote to file: ' || v_dest_file);
  CALL UTL_FILE.FCLOSE_ALL;
END@

CALL proc1@
```

This example results in the following output:

```
Wrote to file: empfilenew.csv
```

The file that is updated, empfilenew.csv, contains the following data:

```
10,CHRISTINE,I,HAAS,A00,3978,1/1/1965,PRES,18,F,8/24/1933,52750,1000,4220
```

```

20,MICHAEL,L,THOMPSON,B01,3476,10/10/1973,MANAGER,18,M,2/2/1948,41250,800,3300

30,SALLY,A,KWAN,C01,4738,4/5/1975,MANAGER,20,F,5/11/1941,38250,800,3060

50,JOHN,B,GEYER,E01,6789,8/17/1949,MANAGER,16,M,9/15/1925,40175,800,3214

60,IRVING,F,STERN,D11,6423,9/14/1973,MANAGER,16,M,7/7/1945,32250,500,2580

70,EVA,D,PULASKI,D21,7831,9/30/1980,MANAGER,16,F,5/26/1953,36170,700,2893

90,EILEEN,W,HENDERSON,E11,5498,8/15/1970,MANAGER,16,F,5/15/1941,29750,600,2380

100,THEODORE,Q,SPENSER,E21,972,6/19/1980,MANAGER,14,M,12/18/1956,26150,500,2092

```

PUT procedure - Write a string to a file

The PUT procedure writes a string to a specified file. No end-of-line character sequence is written at the end of the string.

Syntax

```
▶▶ UTL_FILE.PUT(—file—,—buffer—)▶▶
```

Procedure parameters

file

An input argument of type UTL_FILE.FILE_TYPE that contains the file handle.

buffer

An input argument of type VARCHAR(32672) that specifies the text to write to the file.

Authorization

EXECUTE privilege on the UTL_FILE module.

Example

Use the PUT procedure to add a string to a file and then use the NEW_LINE procedure to add an end-of-line character sequence.

```

SET SERVEROUTPUT ON@

CREATE PROCEDURE procl()
BEGIN
  DECLARE v_empfile_src UTL_FILE.FILE_TYPE;
  DECLARE v_empfile_tgt UTL_FILE.FILE_TYPE;
  DECLARE v_dirAlias VARCHAR(50) DEFAULT 'empdir';
  DECLARE v_src_file VARCHAR(20) DEFAULT 'empfile.csv';
  DECLARE v_dest_file VARCHAR(20) DEFAULT 'empfilenew.csv';
  DECLARE v_empline VARCHAR(200);
  DECLARE SQLCODE INTEGER DEFAULT 0;
  DECLARE SQLSTATE CHAR(5) DEFAULT '00000';
  DECLARE SQLSTATE1 CHAR(5) DEFAULT '00000';
  DECLARE CONTINUE HANDLER FOR SQLSTATE '02000' SET SQLSTATE1 = SQLSTATE;

```

```

SET v_empfile_src = UTL_FILE.FOPEN(v_dirAlias,v_src_file,'r');
SET v_empfile_tgt = UTL_FILE.FOPEN(v_dirAlias,v_dest_file,'w');

loop1: LOOP
  CALL UTL_FILE.GET_LINE(v_empfile_src,v_empline);
  IF SQLSTATE1 = '02000' THEN -- NO DATA FOUND
    LEAVE loop1;
  END IF;
  CALL UTL_FILE.PUT(v_empfile_tgt,v_empline);
  CALL UTL_FILE.NEW_LINE(v_empfile_tgt, 2);
END LOOP;

CALL DBMS_OUTPUT.PUT_LINE('Wrote to file: ' || v_dest_file);
CALL UTL_FILE.FCLOSE_ALL;
END@

CALL proc1@

```

This example results in the following output:

Wrote to file: empfilenew.csv

The updated file, empfilenew.csv, contains the following data:

```

10,CHRISTINE,I,HAAS,A00,3978,1/1/1965,PRES,18,F,8/24/1933,52750,1000,4220

20,MICHAEL,L,THOMPSON,B01,3476,10/10/1973,MANAGER,18,M,2/2/1948,41250,800,3300

30,SALLY,A,KWAN,C01,4738,4/5/1975,MANAGER,20,F,5/11/1941,38250,800,3060

50,JOHN,B,GEYER,E01,6789,8/17/1949,MANAGER,16,M,9/15/1925,40175,800,3214

60,IRVING,F,STERN,D11,6423,9/14/1973,MANAGER,16,M,7/7/1945,32250,500,2580

70,EVA,D,PULASKI,D21,7831,9/30/1980,MANAGER,16,F,5/26/1953,36170,700,2893

90,EILEEN,W,HENDERSON,E11,5498,8/15/1970,MANAGER,16,F,5/15/1941,29750,600,2380

100,THEODORE,Q,SPENSER,E21,972,6/19/1980,MANAGER,14,M,12/18/1956,26150,500,2092

```

Usage notes

After using the PUT procedure to add a string to a file, use the NEW_LINE procedure to add an end-of-line character sequence to the file.

PUT_LINE procedure - Write a line of text to a file

The PUT_LINE procedure writes a line of text, including an end-of-line character sequence, to a specified file.

Syntax

```

▶▶—UTL_FILE.PUT_LINE—(—file—,—buffer—)—▶▶

```

Procedure parameters

file

An input argument of type UTL_FILE.FILE_TYPE that contains the file handle of file to which the line is to be written.

buffer

An input argument of type VARCHAR(32672) that specifies the text to write to the file.

Authorization

EXECUTE privilege on the UTL_FILE module.

Example

Use the PUT_LINE procedure to write lines of text to a file.

```
CALL proc1@
SET SERVEROUTPUT ON@

CREATE PROCEDURE proc1()
BEGIN
  DECLARE v_empfile_src UTL_FILE.FILE_TYPE;
  DECLARE v_empfile_tgt UTL_FILE.FILE_TYPE;
  DECLARE v_dirAlias VARCHAR(50) DEFAULT 'empdir';
  DECLARE v_src_file VARCHAR(20) DEFAULT 'empfile.csv';
  DECLARE v_dest_file VARCHAR(20) DEFAULT 'empfilenew2.csv';
  DECLARE v_empline VARCHAR(200);
  DECLARE v_count INTEGER DEFAULT 0;
  DECLARE SQLCODE INTEGER DEFAULT 0;
  DECLARE SQLSTATE CHAR(5) DEFAULT '00000';
  DECLARE SQLSTATE1 CHAR(5) DEFAULT '00000';
  DECLARE CONTINUE HANDLER FOR SQLSTATE '02000' SET SQLSTATE1 = SQLSTATE;

  SET v_empfile_src = UTL_FILE.FOPEN(v_dirAlias,v_src_file,'r');
  SET v_empfile_tgt = UTL_FILE.FOPEN(v_dirAlias,v_dest_file,'w');

  loop1: LOOP
    CALL UTL_FILE.GET_LINE(v_empfile_src,v_empline);
    IF SQLSTATE1 = '02000' THEN -- NO DATA FOUND
      LEAVE loop1;
    END IF;
    SET v_count = v_count + 1;
    CALL UTL_FILE.PUT(v_empfile_tgt,'Record ' || v_count || ' : ');
    CALL UTL_FILE.PUT_LINE(v_empfile_tgt,v_empline);
  END LOOP;
  CALL DBMS_OUTPUT.PUT_LINE('End of file ' || v_src_file || ' - ' || v_count
  || ' records retrieved');
  CALL UTL_FILE.FCLOSE_ALL;
END@

CALL proc1@
```

This example results in the following output:

End of file empfile.csv - 8 records retrieved

The file that is updated, empfilenew2.csv, contains the following data:

```
Record 1: 10,CHRISTINE,I,HAAS,A00,3978,1/1/1965,PRES,18,F,8/24/1933,52750,1000,4220
Record 2: 20,MICHAEL,L,THOMPSON,B01,3476,10/10/1973,MANAGER,18,M,2/2/1948,41250,800,3300
Record 3: 30,SALLY,A,KWAN,C01,4738,4/5/1975,MANAGER,20,F,5/11/1941,38250,800,3060
Record 4: 50,JOHN,B,GEYER,E01,6789,8/17/1949,MANAGER,16,M,9/15/1925,40175,800,3214
```

Record 5: 60,IRVING,F,STERN,D11,6423,9/14/1973,MANAGER,16,M,7/7/1945,32250,500,2580
 Record 6: 70,EVA,D,PULASKI,D21,7831,9/30/1980,MANAGER,16,F,5/26/1953,36170,700,2893
 Record 7: 90,EILEEN,W,HENDERSON,E11,5498,8/15/1970,MANAGER,16,F,5/15/1941,29750,600,2380
 Record 8: 100,THEODORE,Q,SPENSER,E21,972,6/19/1980,MANAGER,14,M,12/18/1956,26150,500,2092

PUTF procedure - Write a formatted string to a file

The PUTF procedure writes a formatted string to a specified file.

Syntax

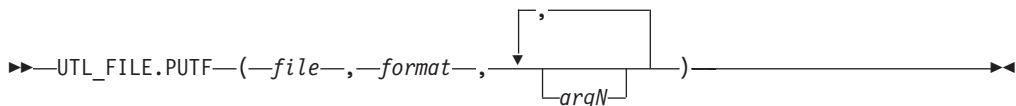

Procedure parameters

file

An input argument of type UTL_FILE.FILE_TYPE that contains the file handle.

format

An input argument of type VARCHAR(1024) that specifies the string to use for formatting the text. The special character sequence, *%s*, is substituted by the value of *argN*. The special character sequence, *\n*, indicates a new line.

argN

An optional input argument of type VARCHAR(1024) that specifies a value to substitute in the format string for the corresponding occurrence of the special character sequence *%s*. Up to five arguments, *arg1* through *arg5*, can be specified. *arg1* is substituted for the first occurrence of *%s*, *arg2* is substituted for the second occurrence of *%s*, and so on.

Authorization

EXECUTE privilege on the UTL_FILE module.

Example

Format employee data.

```
SET SERVEROUTPUT ON@
```

```
CREATE PROCEDURE proc1()
BEGIN
  DECLARE v_filehandle    UTL_FILE.FILE_TYPE;
  DECLARE v_dirAlias     VARCHAR(50) DEFAULT 'mydir';
  DECLARE v_filename     VARCHAR(20) DEFAULT 'myfile.csv';
  DECLARE v_format       VARCHAR(200);
  SET v_format = '%s %s, %s\nSalary: $%s Commission: $%s\n\n';
  CALL UTL_DIR.CREATE_OR_REPLACE_DIRECTORY('mydir', '/tmp');
  SET v_filehandle = UTL_FILE.FOPEN(v_dirAlias,v_filename,'w');
  CALL UTL_FILE.PUTF(v_filehandle,v_format,'000030','SALLY','KWAN','40175','3214');
  CALL DBMS_OUTPUT.PUT_LINE('Wrote to file: ' || v_filename);
  CALL UTL_FILE.FCLOSE(v_filehandle);
END@

CALL proc1@
```

This example results in the following output:

```
Wrote formatted text to file: myfile.csv
```

The formatted file, myfile.csv, contains the following data:

```
000030 SALLY, KWAN  
Salary: $40175 Commission: $3214
```

UTL_FILE.FILE_TYPE

UTL_FILE.FILE_TYPE is a file handle type that is used by routines in the UTL_FILE module.

Example

Declare a variable of type UTL_FILE.FILE_TYPE.

```
DECLARE v_filehandle UTL_FILE.FILE_TYPE;
```

Chapter 34. UTL_MAIL module

The UTL_MAIL module provides the capability to send e-mail.

The schema for this module is SYSIBMADM.

The UTL_MAIL module includes the following routines.

Table 33. Built-in routines available in the UTL_MAIL module

Routine name	Description
SEND procedure	Packages and sends an e-mail to an SMTP server.
SEND_ATTACH_RAW procedure	Same as the SEND procedure, but with BLOB attachments.
SEND_ATTACH_VARCHAR2	Same as the SEND procedure, but with VARCHAR attachments

Usage notes

In order to successfully send an e-mail using the UTL_MAIL module, the database configuration parameter SMTP_SERVER must contain one or more valid SMTP server addresses.

Examples

Example 1: To set up a single SMTP server with the default port 25:

```
db2 update db cfg using smtp_server 'smtp.ibm.com'
```

Example 2: To set up a single SMTP server that uses port 2000, rather than the default port 25:

```
db2 update db cfg using smtp_server 'smtp2.ibm.com:2000'
```

Example 3: To set a list of SMTP servers:

```
db2 update db cfg using smtp_server  
'smtp.example.com,smtp1.example.com:23,smtp2.example.com:2000'
```

Note: The e-mail is sent to each of the SMTP servers, in the order listed, until a successful reply is received from one of the SMTP servers.

SEND procedure - Send an e-mail to an SMTP server

The SEND procedure provides the capability to send an e-mail to an SMTP server.

Syntax

```
►► UTL_MAIL.SEND(—sender—, —recipients—, —cc—, —bcc—, —subject—, —————►
```

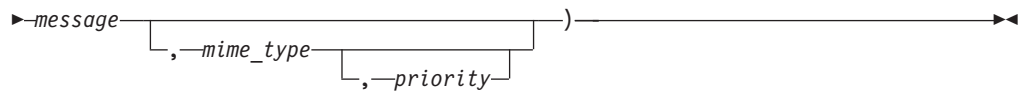

Parameters

sender

An input argument of type VARCHAR(256) that specifies the e-mail address of the sender.

recipients

An input argument of type VARCHAR(32672) that specifies the comma-separated e-mail addresses of the recipients.

cc An input argument of type VARCHAR(32672) that specifies the comma-separated e-mail addresses of copy recipients.

bcc

An input argument of type VARCHAR(32672) that specifies the comma-separated e-mail addresses of blind copy recipients.

subject

An input argument of type VARCHAR(32672) that specifies the subject line of the e-mail.

message

An input argument of type VARCHAR(32672) that specifies the body of the e-mail.

mime_type

An optional input argument of type VARCHAR(1024) that specifies the MIME type of the message. The default is 'text/plain; charset=us-ascii'.

priority

An optional argument of type INTEGER that specifies the priority of the e-mail. The default value is 3.

Authorization

EXECUTE privilege on the UTL_MAIL module.

Examples

Example 1: The following anonymous block sends a simple e-mail message.

```
BEGIN
  DECLARE v_sender VARCHAR(30);
  DECLARE v_recipients VARCHAR(60);
  DECLARE v_subj VARCHAR(20);
  DECLARE v_msg VARCHAR(200);

  SET v_sender = 'kkent@mycorp.com';
  SET v_recipients = 'bwayne@mycorp.com,pparker@mycorp.com';
  SET v_subj = 'Holiday Party';
  SET v_msg = 'This year''s party is scheduled for Friday, Dec. 21 at ' ||
    '6:00 PM. Please RSVP by Dec. 15th.';
  CALL UTL_MAIL.SEND(v_sender, v_recipients, NULL, NULL, v_subj, v_msg);
END@
```

This example results in the following output:

```

BEGIN
  DECLARE v_sender VARCHAR(30);
  DECLARE v_recipients VARCHAR(60);
  DECLARE v_subj VARCHAR(20);
  DECLARE v_msg VARCHAR(200);

  SET v_sender = 'kkent@mycorp.com';
  SET v_recipients = 'bwayne@mycorp.com,pparker@mycorp.com';
  SET v_subj = 'Holiday Party';
  SET v_msg = 'This year''s party is scheduled for Friday, Dec. 21 at ' ||
    '6:00 PM. Please RSVP by Dec. 15th.';
  CALL UTL_MAIL.SEND(v_sender, v_recipients, NULL, NULL, v_subj, v_msg);
END
DB20000I The SQL command completed successfully.

```

SEND_ATTACH_RAW procedure - Send an e-mail with a BLOB attachment to an SMTP server

The SEND_ATTACH_RAW procedure provides the capability to send an e-mail to an SMTP server with a binary attachment.

Syntax

```

▶▶ UTL_MAIL.SEND_ATTACH_RAW( ( sender, recipients, cc, bcc, subject,
▶ message, mime_type, priority, attachment
▶ ( att_inline, att_mime_type, att_filename ) ) )

```

Parameters

sender

An input argument of type VARCHAR(256) that specifies the e-mail address of the sender.

recipients

An input argument of type VARCHAR(32672) that specifies the comma-separated e-mail addresses of the recipients.

cc An input argument of type VARCHAR(32672) that specifies the comma-separated e-mail addresses of copy recipients.

bcc

An input argument of type VARCHAR(32672) that specifies the comma-separated e-mail addresses of blind copy recipients.

subject

An input argument of type VARCHAR(32672) that specifies the subject line of the e-mail.

message

An input argument of type VARCHAR(32672) that specifies the body of the e-mail.

mime_type

An input argument of type VARCHAR(1024) that specifies the MIME type of the message. The default is 'text/plain; charset=us-ascii'.

priority

An input argument of type INTEGER that specifies the priority of the e-mail. The default value is 3.

attachment

An input argument of type BLOB(10M) that contains the attachment.

att_inline

An optional input argument of type BOOLEAN that specifies whether the attachment is viewable inline. If set to "true", then the attachment is viewable inline, "false" otherwise. The default value is "true".

att_mime_type

An optional input argument of type VARCHAR(1024) that specifies the MIME type of the attachment. The default value is application/octet.

att_filename

An optional input argument of type VARCHAR(512) that specifies the file name containing the attachment. The default value is NULL.

Authorization

EXECUTE privilege on the UTL_MAIL module.

SEND_ATTACH_VARCHAR2 procedure - Send an e-mail with a VARCHAR attachment to an SMTP server

The SEND_ATTACH_VARCHAR2 procedure provides the capability to send an e-mail to an SMTP server with a text attachment.

Syntax

```
▶▶ UTL_MAIL.SEND_ATTACH_VARCHAR2( ( sender, recipients, cc, bcc, subject, message, mime_type, priority, attachment, att_inline, att_mime_type, att_filename ) )
```

Parameters

sender

An input argument of type VARCHAR(256) that specifies the e-mail address of the sender.

recipients

An input argument of type VARCHAR(32672) that specifies the comma-separated e-mail addresses of the recipients.

cc

An input argument of type VARCHAR(32672) that specifies the comma-separated e-mail addresses of copy recipients.

bcc

An input argument of type VARCHAR(32672) that specifies the comma-separated e-mail addresses of blind copy recipients.

subject

An input argument of type VARCHAR(32672) that specifies the subject line of the e-mail.

message

An input argument of type VARCHAR(32672) that specifies the body of the e-mail.

mime_type

An input argument of type VARCHAR(1024) that specifies the MIME type of the message. The default is 'text/plain; charset=us-ascii'.

priority

An input argument of type INTEGER that specifies the priority of the e-mail. The default value is 3.

attachment

An input argument of type VARCHAR(32000) that contains the attachment.

att_inline

An optional input argument of type BOOLEAN that specifies whether the attachment is viewable inline. If set to "true", then the attachment is viewable inline, "false" otherwise. The default value is "true".

att_mime_type

An optional input argument of type VARCHAR(1024) that specifies the MIME type of the attachment. The default value is 'text/plain; charset=us-ascii'.

att_filename

An optional input argument of type VARCHAR(512) that specifies the file name containing the attachment. The default value is NULL.

Authorization

EXECUTE privilege on the UTL_MAIL module.

Chapter 35. UTL_SMTP module

The UTL_SMTP module provides the capability to send e-mail over the Simple Mail Transfer Protocol (SMTP).

The UTL_SMTP module includes the following routines.

Table 34. Built-in routines available in the UTL_SMTP module

Routine Name	Description
CLOSE_DATA procedure	Ends an e-mail message.
COMMAND procedure	Execute an SMTP command.
COMMAND_REPLIES procedure	Execute an SMTP command where multiple reply lines are expected.
DATA procedure	Specify the body of an e-mail message.
EHLO procedure	Perform initial handshaking with an SMTP server and return extended information.
HELO procedure	Perform initial handshaking with an SMTP server.
HELP procedure	Send the HELP command.
MAIL procedure	Start a mail transaction.
NOOP procedure	Send the null command.
OPEN_CONNECTION function	Open a connection.
OPEN_CONNECTION procedure	Open a connection.
OPEN_DATA procedure	Send the DATA command.
QUIT procedure	Terminate the SMTP session and disconnect.
RCPT procedure	Specify the recipient of an e-mail message.
RSET procedure	Terminate the current mail transaction.
VERFY procedure	Validate an e-mail address.
WRITE_DATA procedure	Write a portion of the e-mail message.
WRITE_RAW_DATA procedure	Write a portion of the e-mail message consisting of RAW data.

The following table lists the public variables available in the module.

Table 35. Built-in types available in the UTL_SMTP module

Public variable	Data type	Description
connection	RECORD	Description of an SMTP connection.
reply	RECORD	SMTP reply line.

The CONNECTION record type provides a description of an SMTP connection.

```
ALTER MODULE SYSIBMADM.UTL_SMTP PUBLISH TYPE connection AS ROW
(
  /* name or IP address of the remote host running SMTP server */
  host VARCHAR(255),
  /* SMTP server port number */
```

```

        port INTEGER,
        /* transfer timeout in seconds */
        tx_timeout INTEGER,
    );

```

The REPLY record type provides a description of an SMTP reply line. REPLIES is an array of SMTP reply lines.

```

ALTER MODULE SYSIBMADM.UTL_SMTP PUBLISH TYPE reply AS ROW
(
    /* 3 digit reply code received from the SMTP server */
    code INTEGER,
    /* the text of the message received from the SMTP server */
    text VARCHAR(508)
);

```

Examples

Example 1: The following procedure constructs and sends a text e-mail message using the UTL_SMTP module.

```

CREATE OR REPLACE PROCEDURE send_mail(
    IN p_sender VARCHAR(4096),
    IN p_recipient VARCHAR(4096),
    IN p_subj VARCHAR(4096),
    IN p_msg VARCHAR(4096),
    IN p_mailhost VARCHAR(4096))
SPECIFIC send_mail
LANGUAGE SQL
BEGIN
    DECLARE v_conn UTL_SMTP.CONNECTION;
    DECLARE v_crlf VARCHAR(2);
    DECLARE v_port INTEGER CONSTANT 25;

    SET v_crlf = CHR(13) || CHR(10);
    SET v_conn = UTL_SMTP.OPEN_CONNECTION(p_mailhost, v_port, 10);
    CALL UTL_SMTP.HELO(v_conn, p_mailhost);
    CALL UTL_SMTP.MAIL(v_conn, p_sender);
    CALL UTL_SMTP.RCPT(v_conn, p_recipient);
    CALL UTL_SMTP.DATA(
        v_conn,
        'Date: ' || TO_CHAR(SYSDATE, 'Dy, DD Mon YYYY HH24:MI:SS') || v_crlf ||
        'From: ' || p_sender || v_crlf ||
        'To: ' || p_recipient || v_crlf ||
        'Subject: ' || p_subj || v_crlf ||
        p_msg);
    CALL UTL_SMTP.QUIT(v_conn);
END@

CALL send_mail('bwayne@mycorp.com', 'pparker@mycorp.com', 'Holiday Party',
'Are you planning to attend?', 'smtp.mycorp.com')@

```

Example 2: The following example uses the OPEN_DATA, WRITE_DATA, and CLOSE_DATA procedures instead of the DATA procedure.

```

CREATE OR REPLACE PROCEDURE send_mail_2(
    IN p_sender VARCHAR(4096),
    IN p_recipient VARCHAR(4096),
    IN p_subj VARCHAR(4096),
    IN p_msg VARCHAR(4096),
    IN p_mailhost VARCHAR(4096))
SPECIFIC send_mail_2
LANGUAGE SQL
BEGIN
    DECLARE v_conn UTL_SMTP.CONNECTION;
    DECLARE v_crlf VARCHAR(2);
    DECLARE v_port INTEGER CONSTANT 25;

```

```

SET v_crlf = CHR(13) || CHR(10);
SET v_conn = UTL_SMTP.OPEN_CONNECTION(p_mailhost, v_port, 10);
CALL UTL_SMTP.HELO(v_conn, p_mailhost);
CALL UTL_SMTP.MAIL(v_conn, p_sender);
CALL UTL_SMTP.RCPT(v_conn, p_recipient);
CALL UTL_SMTP.OPEN_DATA(v_conn);
CALL UTL_SMTP.WRITE_DATA(v_conn, 'From: ' || p_sender || v_crlf);
CALL UTL_SMTP.WRITE_DATA(v_conn, 'To: ' || p_recipient || v_crlf);
CALL UTL_SMTP.WRITE_DATA(v_conn, 'Subject: ' || p_subj || v_crlf);
CALL UTL_SMTP.WRITE_DATA(v_conn, v_crlf || p_msg);
CALL UTL_SMTP.CLOSE_DATA(v_conn);
CALL UTL_SMTP.QUIT(v_conn);
END@

CALL send_mail_2('bwayne@mycorp.com', 'pparker@mycorp.com', 'Holiday Party',
'Are you planning to attend?', 'smtp.mycorp.com')@

```

CLOSE_DATA procedure - End an e-mail message

The CLOSE_DATA procedure terminates an e-mail message

The procedure terminates an e-mail message by sending the following sequence:

```
<CR><LF>.<CR><LF>
```

This is a single period at the beginning of a line.

Syntax

```

▶▶ UTL_SMTP.CLOSE_DATA ( ( c [ , reply ] ) )

```

Parameters

c An input or output argument of type CONNECTION that specifies the SMTP connection to be closed.

reply

An optional output argument of type REPLY that returns a single reply line from the SMTP server. It is the last reply line if multiple reply lines are returned by the SMTP server.

Authorization

EXECUTE privilege on the UTL_SMTP module.

Usage notes

This procedure can be invoked using function invocation syntax in a PL/SQL assignment statement.

COMMAND procedure - Run an SMTP command

The COMMAND procedure provides the capability to execute an SMTP command.

Note: Use COMMAND_REPLIES if multiple reply lines are expected to be returned.

Syntax

```
▶▶ UTL_SMTP.COMMAND ( c , cmd , arg , reply ) ▶▶
```

Parameters

c An input or output argument of type CONNECTION that specifies the SMTP connection to which the command is to be sent.

cmd

An input argument of type VARCHAR(510) that specifies the SMTP command to process.

arg

An optional input argument of type VARCHAR(32672) that specifies an argument to the SMTP command. The default is NULL.

reply

An optional output argument of type REPLY that returns a single reply line from the SMTP server. It is the last reply line if multiple reply lines are returned by the SMTP server.

Authorization

EXECUTE privilege on the UTL_SMTP module.

Usage notes

This procedure can be invoked using function invocation syntax in a PL/SQL assignment statement.

COMMAND_REPLIES procedure - Run an SMTP command where multiple reply lines are expected

The COMMAND_REPLIES function processes an SMTP command that returns multiple reply lines.

Note: Use COMMAND if only a single reply line is expected.

Syntax

```
▶▶ UTL_SMTP.COMMAND_REPLIES ( c , cmd , arg , replies ) ▶▶
```

Parameters

c An input or output argument of type CONNECTION that specifies the SMTP connection to which the command is to be sent.

cmd

An input argument of type VARCHAR(510) that specifies the SMTP command to process.

arg

An optional input argument of type VARCHAR(32672) that specifies an argument to the SMTP command. The default is NULL.

replies

An optional output argument of type REPLIES that returns multiple reply lines from the SMTP server.

Authorization

EXECUTE privilege on the UTL_SMTP module.

Usage notes

This procedure can be invoked using function invocation syntax in a PL/SQL assignment statement.

DATA procedure - Specify the body of an e-mail message

The DATA procedure provides the capability to specify the body of the e-mail message.

The message is terminated with a <CR><LF>.<CR><LF> sequence.

Syntax

```
▶▶ UTL_SMTP.DATA ( c , body [ , reply ] )
```

Parameters

c An input or output argument of type CONNECTION that specifies the SMTP connection to which the command is to be sent.

body

An input argument of type VARCHAR(32000) that specifies the body of the e-mail message to be sent.

reply

An optional output argument of type REPLY that returns a single reply line from the SMTP server. It is the last reply line if multiple reply lines are returned by the SMTP server.

Authorization

EXECUTE privilege on the UTL_SMTP module.

Usage notes

This procedure can be invoked using function invocation syntax in a PL/SQL assignment statement.

EHLO procedure - Perform initial handshaking with an SMTP server and return extended information

The EHLO procedure performs initial handshaking with the SMTP server after establishing the connection.

The EHLO procedure allows the client to identify itself to the SMTP server. The HELO procedure performs the equivalent functionality, but returns less information about the server.

Syntax

```
▶▶UTL SMTP.EHLO(—c—,—domain—  
                  └,—replies┘—)▶▶
```

Parameters

c An input or output argument of type CONNECTION that specifies the connection to the SMTP server over which to perform handshaking.

domain

An input argument of type VARCHAR(255) that specifies the domain name of the sending host.

replies

An optional output argument of type REPLIES that return multiple reply lines from the SMTP server.

Authorization

EXECUTE privilege on the UTL SMTP module.

Usage notes

This procedure can be invoked using function invocation syntax in a PL/SQL assignment statement.

HELO procedure - Perform initial handshaking with an SMTP server

The HELO procedure performs initial handshaking with the SMTP server after establishing the connection.

The HELO procedure allows the client to identify itself to the SMTP server. The EHLO procedure performs the equivalent functionality, but returns more information about the server.

Syntax

```
▶▶UTL SMTP.HELO(—c—,—domain—  
                  └,—reply┘—)▶▶
```

Parameters

c An input or output argument of type CONNECTION that specifies the connection to the SMTP server over which to perform handshaking.

domain

An input argument of type VARCHAR(255) that specifies the domain name of the sending host.

reply

An optional output argument of type REPLY that returns a single reply line from the SMTP server. It is the last reply line if multiple reply lines are returned by the SMTP server.

Authorization

EXECUTE privilege on the UTL_SMTP module.

Usage notes

This procedure can be invoked using function invocation syntax in a PL/SQL assignment statement.

HELP procedure - Send the HELP command

The HELP function provides the capability to send the HELP command to the SMTP server.

Syntax

```
▶▶ UTL_SMTP.HELP ( ( c [command, replies] ) )
```

Parameters

c An input or output argument of type CONNECTION that specifies the SMTP connection to which the command is to be sent.

command

An optional input argument of type VARCHAR(510) that specifies the command about which help is requested.

replies

An optional output argument of type REPLIES that returns multiple reply lines from the SMTP server.

Authorization

EXECUTE privilege on the UTL_SMTP module.

Usage notes

This procedure can be invoked using function invocation syntax in a PL/SQL assignment statement.

MAIL procedure - Start a mail transaction

This procedure can be invoked using function invocation syntax in a PL/SQL assignment statement.

Syntax

```
▶▶ UTL_SMTP.MAIL ( ( c, sender [parameters, reply] ) )
```

Parameters

c An input or output argument of type CONNECTION that specifies the connection to the SMTP server on which to start a mail transaction.

sender

An input argument of type VARCHAR(256) that specifies the e-mail address of the sender.

parameters

An optional input argument of type VARCHAR(32672) that specifies the optional mail command parameters in the format key=value.

reply

An optional output argument of type REPLY that returns a single reply line from the SMTP server. It is the last reply line if multiple reply lines are returned by the SMTP server.

Authorization

EXECUTE privilege on the UTL_SMTP module.

Usage notes

This procedure can be invoked using function invocation syntax in a PL/SQL assignment statement.

NOOP procedure - Send the null command

The NOOP procedure sends a null command to the SMTP server. The NOOP has no effect on the server except to obtain a successful response.

Syntax

```
▶▶ UTL_SMTP.NOOP ( c [ , reply ] ) ▶▶
```

Parameters

c An input or output argument of type CONNECTION that specifies the SMTP connection on which to send the command.

reply

An optional output argument of type REPLY that returns a single reply line from the SMTP server. It is the last reply line if multiple reply lines are returned by the SMTP server.

Authorization

EXECUTE privilege on the UTL_SMTP module.

Usage notes

This procedure can be invoked using function invocation syntax in a PL/SQL assignment statement.

OPEN_CONNECTION function - Return a connection handle to an SMTP server

The OPEN_CONNECTION function returns a connection handle to an SMTP server.

The function returns a connection handle to the SMTP server.

Syntax

```
▶▶—UTL_SMTP.OPEN_CONNECTION—(—host—,—port—,—tx_timeout—)————▶▶
```

Parameters

host

An input argument of type VARCHAR(255) that specifies the name of the SMTP server.

port

An input argument of type INTEGER that specifies the port number on which the SMTP server is listening.

tx_timeout

An input argument of type INTEGER that specifies the time out value, in seconds. To instruct the procedure not to wait, set this value to 0. To instruct the procedure to wait indefinitely, set this value to NULL.

Authorization

EXECUTE privilege on the UTL_SMTP module.

OPEN_CONNECTION procedure - Open a connection to an SMTP server

The OPEN_CONNECTION procedure opens a connection to an SMTP server.

Syntax

```
▶▶—UTL_SMTP.OPEN_CONNECTION—(—host—,—port—,—connection—,—tx_timeout—,—reply—)————▶▶
```

Parameters

host

An input argument of type VARCHAR(255) that specifies the name of the SMTP server.

port

An input argument of type INTEGER that specifies the port number on which the SMTP server is listening.

connection

An output argument of type CONNECTION that returns a connection handle to the SMTP server.

tx_timeout

An optional input argument of type INTEGER that specifies the time out

value, in seconds. To instruct the procedure not to wait, set this value to 0. To instruct the procedure to wait indefinitely, set this value to NULL.

reply

An output argument of type REPLY that returns a single reply line from the SMTP server. It is the last reply line if multiple reply lines are returned by the SMTP server.

Authorization

EXECUTE privilege on the UTL_SMTP module.

OPEN_DATA procedure - Send the DATA command to the SMTP server

The OPEN_DATA procedure sends the DATA command to the SMTP server.

Syntax

```
▶▶ UTL_SMTP.OPEN_DATA ( ( c [ , -reply ] ) )
```

Parameters

c An input argument of type CONNECTION that specifies the SMTP connection on which to send the command

reply

An optional output argument of type REPLY that returns a single reply line from the SMTP server. It is the last reply line if multiple reply lines are returned by the SMTP server.

Authorization

EXECUTE privilege on the UTL_SMTP module.

Usage notes

This procedure can be invoked using function invocation syntax in a PL/SQL assignment statement.

QUIT procedure - Close the session with the SMTP server

The QUIT procedure closes the session with an SMTP server.

Syntax

```
▶▶ UTL_SMTP.QUIT ( ( c [ , -reply ] ) )
```

Parameters

c An input or output argument of type CONNECTION that specifies the SMTP connection to terminate.

reply

An optional output argument of type REPLY that returns a single reply line from the SMTP server. It is the last reply line if multiple reply lines are returned by the SMTP server.

Authorization

EXECUTE privilege on the UTL_SMTP module.

Usage notes

This procedure can be invoked using function invocation syntax in a PL/SQL assignment statement.

RCPT procedure - Provide the e-mail address of the recipient

The RCPT procedure provides the e-mail address of the recipient.

Note: To schedule multiple recipients, invoke the RCPT procedure multiple times.

Syntax

```
▶▶ UTL_SMTP.RCPT(c, recipient [, parameters [, reply ]])▶▶
```

Parameters

c An input or output argument of type CONNECTION that specifies the SMTP connection on which to add a recipient.

recipient

An input argument of type VARCHAR(256) that specifies the e-mail address of the recipient.

parameters

An optional input argument of type VARCHAR(32672) that specifies the mail command parameters in the format key=value.

reply

An optional output argument of type REPLY that returns a single reply line from the SMTP server. It is the last reply line if multiple reply lines are returned by the SMTP server.

Authorization

EXECUTE privilege on the UTL_SMTP module.

Usage notes

This procedure can be invoked using function invocation syntax in a PL/SQL assignment statement.

RSET procedure - End the current mail transaction

The RSET procedure provides the capability to terminate the current mail transaction.

Syntax

```
▶▶ UTL_SMTP.RSET ( ( c [ , reply ] ) ) ▶▶
```

Parameters

c An input or output argument of type CONNECTION that specifies the SMTP connection on which to cancel the mail transaction.

reply

An optional output argument of type REPLY that returns a single reply line from the SMTP server. It is the last reply line if multiple reply lines are returned by the SMTP server.

Authorization

EXECUTE privilege on the UTL_SMTP module.

Usage notes

This procedure can be invoked using function invocation syntax in a PL/SQL assignment statement.

VRFY procedure - Validate and verify the recipient's e-mail address

The VRFY function provides the capability to validate and verify a recipient e-mail address. If valid, the recipient's full name and fully qualified mailbox is returned.

Syntax

```
▶▶ UTL_SMTP.VRFY ( ( c , recipient , reply ) ) ▶▶
```

Parameters

c An input or output argument of type CONNECTION that specifies the SMTP connection on which to verify the e-mail address.

recipient

An input argument of type VARCHAR(256) that specifies the e-mail address to be verified.

reply

An output argument of type REPLY that returns a single reply line from the SMTP server. It is the last reply line if multiple reply lines are returned by the SMTP server.

Authorization

EXECUTE privilege on the UTL_SMTP module.

Usage notes

This procedure can be invoked using function invocation syntax in a PL/SQL assignment statement.

WRITE_DATA procedure - Write a portion of an e-mail message

The WRITE_DATA procedure provides the capability to add data to an e-mail message. The WRITE_DATA procedure may be called repeatedly to add data.

Syntax

▶▶—UTL SMTP.WRITE_DATA—(—*c*—,—*data*—)————▶▶

Parameters

c An input or output argument of type CONNECTION that specifies the SMTP connection on which to add data.

data

An input argument of type VARCHAR(32000) that specifies the data to be added to the e-mail message.

Authorization

EXECUTE privilege on the UTL SMTP module.

WRITE_RAW_DATA procedure - Add RAW data to an e-mail message

The WRITE_RAW_DATA procedure provides the capability to add data to an e-mail message. The WRITE_RAW_DATA procedure may be called repeatedly to add data.

Syntax

▶▶—UTL SMTP.WRITE_RAW_DATA—(—*c*—,—*data*—)————▶▶

Parameters

c An input or output argument of type CONNECTION that specifies the SMTP connection on which to add data.

data

An input argument of type BLOB(15M) that specifies the data to be added to the e-mail message.

Authorization

EXECUTE privilege on the UTL SMTP module.

Part 4. DB2 compatibility features

Chapter 36. DB2 compatibility features introduction

The DB2 product provides a number of features that reduce the time and complexity of enabling some applications that were written for relational database products other than the DB2 product to run on a DB2 system.

Some of these features, including the following ones, are enabled by default.

- Implicit casting (weak typing), which reduces the number of SQL statements that you must modify to enable applications to run on the DB2 product.
- New built-in scalar functions. For details, see Built-in functions (see *SQL Reference Volume 1*).
- Improvements to the `TIMESTAMP_FORMAT` and `VARCHAR_FORMAT` scalar functions. The `TIMESTAMP_FORMAT` function returns a timestamp for an input string, using a specified format. The `VARCHAR_FORMAT` function returns a string representation of an input expression that has been formatted according to a specified character template. `TO_DATE` and `TO_TIMESTAMP` are synonyms for `TIMESTAMP_FORMAT`, and `TO_CHAR` is a synonym for `VARCHAR_FORMAT`.
- The lifting of several SQL restrictions, resulting in more compatible syntax between products. For example, the use of correlation names in subqueries and table functions is now optional.
- Synonyms for syntax that is used by other database products. Examples are as follows:
 - `UNIQUE` is a synonym for `DISTINCT` in the column functions and the select list of a query.
 - `MINUS` is a synonym for the `EXCEPT` set operator
 - You can use `seqname.NEXTVAL` in place of the SQL standard syntax `NEXT VALUE FOR seqname`. You can also use `seqname.CURRVAL` in place of the SQL standard syntax `PREVIOUS VALUE FOR seqname`.
- Global variables, which you can use to easily map package variables, emulate `@@nested`, `@@level` or `@errorlevel` global variables, or pass information from DB2 applications to triggers, functions, or procedures.
- An `ARRAY` collection data type that you use to easily map to `VARRAY` constructs in SQL procedures.
- Increased identifier length limits.
- The pseudocolumn `ROWID`, which you can use to refer to the `RID`. An unqualified `ROWID` reference is equivalent to `RID_BIT()`, and a qualified `ROWID` reference, such as `EMPLOYEE.ROWID`, is equivalent to `RID_BIT(EMPLOYEE)`.

You can optionally enable the following other features by setting the **DB2_COMPATIBILITY_VECTOR** registry variable. These features are disabled by default.

- An implementation of hierarchical queries using `CONNECT BY PRIOR` syntax.
- Support for outer joins using the outer join operator, which is the plus sign (+).
- Use of the `DATE` data type as `TIMESTAMP(0)`, a combined date and time value.
- Syntax and semantics to support the `NUMBER` data type.
- Syntax and semantics to support the `VARCHAR2` data type.

- The ROWNUM pseudocolumn, which is a synonym for ROW_NUMBER() OVER(). However, the ROWNUM pseudocolumn is allowed in the SELECT list and in the WHERE clause of the SELECT statement.
- A dummy table named DUAL, which provides a capability that is similar to that of the SYSIBM.SYSDUMMY1 table.
- Alternative semantics for the TRUNCATE statement, such that IMMEDIATE is an optional keyword that is assumed to be the default if not specified. An implicit commit operation is performed before the TRUNCATE statement executes if the TRUNCATE statement is not the first statement in the logical unit of work.
- Support for assigning the CHAR or GRAPHIC data type instead of the VARCHAR or VARGRAPHIC data type to character and graphic string constants whose byte lengths are less than or equal to 254.
- Use of collection methods to perform operations on arrays, such as FIRST, LAST, NEXT, and previous.
- Support for creating Oracle data dictionary-compatible views.
- Support for compiling and executing PL/SQL statements and other language elements.
- Support for making cursors insensitive to subsequent statements by materializing the cursors at OPEN time.
- Support for INOUT parameters in procedures that you define with defaults and can invoke without specifying the arguments for those parameters.

Additional resources

For more information about compatibility features, see DB2 Viper 2 compatibility features.

For information about the IBM Migration Toolkit (MTK), see Migrate Now!.

For information about the DB2 Oracle database compatibility features, see Oracle to DB2 Conversion Guide: Compatibility Made Easy.

Chapter 37. DB2_COMPATIBILITY_VECTOR registry variable

The **DB2_COMPATIBILITY_VECTOR** registry variable enables one or more DB2 compatibility features. These features ease the task of migrating applications that were written for relational database products other than the DB2 product to DB2 Version 9.5 or later.

This registry variable is supported on Linux, UNIX, and Windows operating systems.

You can enable individual DB2 compatibility features by specify a hexadecimal value for the registry variable. Each bit in the variable value enables a different feature. Values are as follows:

- NULL (default)
- 0000 - FFFF
- ORA, to take full advantage of the DB2 compatibility features for Oracle applications
- SYB, to take full advantage of the DB2 compatibility features for Sybase applications
- MYS, to take full advantage of the DB2 compatibility features for MySQL applications

A value setting of ORA, SYB, or MYS is recommended.

Important: Enable these features only if you require them for a specific compatibility purpose. If you enable DB2 compatibility features, some SQL behavior changes from what is documented in the SQL reference information. To determine the potential effects of a compatibility feature on your SQL applications, see the documentation that is associated with the compatibility feature.

Registry variable settings

The following table specifies the setting required to enable each compatibility feature.

Table 36. DB2_COMPATIBILITY_VECTOR registry variable values

Bit position (hexadecimal value)	Compatibility feature	Description
1 (0x01)	ROWNUM pseudocolumn	Enables the use of ROWNUM as a synonym for ROW_NUMBER() OVER() and permits ROWNUM to appear in the WHERE clause of SQL statements.
2 (0x02)	DUAL table	Resolves unqualified references to the DUAL table as SYSIBM.DUAL.
3 (0x04)	Outer join operator	Enables support for the outer join operator, which is the plus sign (+).
4 (0x08)	Hierarchical queries	Enables support for hierarchical queries using the CONNECT BY clause.

Table 36. DB2_COMPATIBILITY_VECTOR registry variable values (continued)

Bit position (hexadecimal value)	Compatibility feature	Description
5 (0x10)	NUMBER data type ¹	Enables support for the NUMBER data type and associated numeric processing. When you create a database with this support enabled, the number_compat database configuration parameter is set to ON.
6 (0x20)	VARCHAR2 data type ¹	Enables support for the VARCHAR2 and NVARCHAR2 data types and associated character string processing. When you create a database with this support enabled, the varchar2_compat database configuration parameter is set to ON.
7 (0x40)	DATE data type ¹	Enables the interpretation of the DATE data type as the TIMESTAMP(0) data type, a combined date and time value. For example, "VALUES CURRENT DATE" in date compatibility mode returns a value such as 2011-02-17-10.43.55. When you create a database with this support enabled, the date_compat database configuration parameter is set to ON.
8 (0x80)	TRUNCATE TABLE	Enables alternative semantics for the TRUNCATE statement, under which IMMEDIATE is an optional keyword that is assumed to be the default if not specified. An implicit commit operation is performed before the TRUNCATE statement executes if the TRUNCATE statement is not the first statement in the logical unit of work.
9 (0x100)	Character literals	Enables the assignment of the CHAR or GRAPHIC data type, instead of the VARCHAR or VARGRAPHIC data type, to character and graphic string constants whose byte lengths are less than or equal to 254.
10 (0x200)	Collection methods	Enables the use of methods to perform operations on arrays, such as first, last, next, and previous. Also enables the use of parentheses in place of square brackets in references to specific elements in an array, for example, array1(<i>i</i>) refers to element <i>i</i> of array1.
11 (0x400)	Oracle data dictionary-compatible views ¹	Enables the creation of Oracle data dictionary-compatible views.
12 (0x800)	PL/SQL compilation ²	Enables the compilation and execution of PL/SQL statements and language elements.

Table 36. DB2_COMPATIBILITY_VECTOR registry variable values (continued)

Bit position (hexadecimal value)	Compatibility feature	Description
13 (0x1000)	Insensitive cursors	Enables cursors that are defined with WITH RETURN to be insensitive if the select-statement does not explicitly specify FOR UPDATE.
14 (0x2000)	Chapter 48, "INOUT parameters," on page 477	Enables the specification of DEFAULT for INOUT parameter declarations.
15 (0x8000)	LIMIT and OFFSET clauses	Enables the use of the MySQL- and PostgreSQL-compatible LIMIT and OFFSET clauses on fullselect, UPDATE, and DELETE statements.
17 (0x10000)	Chapter 41, "SQL data-access-level enforcement," on page 453	Enables routines to enforce SQL data-access levels at run time.
18 (0x20000)	Chapter 51, "Oracle database link syntax," on page 483	Enables Oracle database link syntax for accessing objects in other databases.
<p>1. This feature is applicable only during database creation. Enabling or disabling this feature after creating a database affects only subsequently created databases.</p> <p>2. See "Restrictions on PL/SQL support" .</p>		

Usage

You set and update the **DB2_COMPATIBILITY_VECTOR** registry variable by using the **db2set** command.

- To enable all of the supported Oracle compatibility features, set the registry variable to the value ORA (equivalent to the hexadecimal value 10FFF).
- To enable all of the supported Sybase compatibility features, set the registry variable to the value SYB (equivalent to the hexadecimal value 3004).
- Currently, the only supported MySQL compatibility feature is enablement of the LIMIT and OFFSET clauses (0x8000).

A new setting for the registry variable does not take effect until after you stop and restart the instance. Also, you must rebind DB2 packages for the change to take effect. Packages that you do not rebind explicitly will pick up the change at the next implicit rebind.

If you set the **DB2_COMPATIBILITY_VECTOR** registry variable, create databases as Unicode databases.

Example 1

This example shows how to set the registry variable to enable all of the supported Oracle compatibility features:

```
db2set DB2_COMPATIBILITY_VECTOR=ORA
db2stop
db2start
```

Example 2

This example shows how to set the registry variable to enable both ROWNUM (0x01) and DUAL (0x02):

```
db2set DB2_COMPATIBILITY_VECTOR=03
db2stop
db2start
```

Example 3

This example shows how to disable all compatibility features by resetting the **DB2_COMPATIBILITY_VECTOR** registry variable:

```
db2set DB2_COMPATIBILITY_VECTOR=
db2stop
db2start
```

If you create a database when any of the following features are enabled, the database will still be enabled for these features after this **db2set** command executes:

- The NUMBER data type
- The VARCHAR2 data type
- The DATE data type as TIMESTAMP(0)
- Creation of Oracle data dictionary-compatible views

Chapter 38. Setting up the DB2 environment for Oracle application enablement

You can reduce the time and complexity of enabling Oracle applications to work with DB2 data servers if you set up the DB2 environment appropriately.

Before you begin

- A DB2 data server product must be installed.
- You require SYSADM and the appropriate operating system authority to issue the **db2set** command.
- You require SYSADM or SYSCTRL authority to issue the **CREATE DATABASE** command.

About this task

The DB2 product can support many commonly referenced features from other database products. This task is a prerequisite for executing PL/SQL statements or SQL statements that reference Oracle data types from DB2 interfaces or for using any other SQL compatibility features. You enable DB2 compatibility features at the database level; you cannot disable them.

Procedure

To enable Oracle applications to work with DB2 data servers:

1. In a DB2 command window, start the DB2 database manager by issuing the following command:

```
db2start
```

2. Set the **DB2_COMPATIBILITY_VECTOR** registry variable to one of the following values:

- The hexadecimal value that enables the specific compatibility feature that you want to use.

- To take advantage of all the DB2 compatibility features, **ORA**, as shown in the following command. This is the recommended setting.

```
db2set DB2_COMPATIBILITY_VECTOR=ORA
```

3. Enable deferred prepare support by setting the **DB2_DEFERRED_PREPARE_SEMANTICS** registry variable to **YES**, as shown:

```
db2set DB2_DEFERRED_PREPARE_SEMANTICS=YES
```

If you set the **DB2_COMPATIBILITY_VECTOR** registry variable to **ORA** and do not set the **DB2_DEFERRED_PREPARE_SEMANTICS** registry variable, a default value of **YES** is used. However, it is recommended that you explicitly set the **DB2_DEFERRED_PREPARE_SEMANTICS** registry variable to **YES**.

4. Stop the database manager by issuing the **db2stop** command:

```
db2stop
```

5. Start the database manager by issuing the **db2start** command:

```
db2start
```

6. Create your DB2 database by issuing the **CREATE DATABASE** command. By default, databases are created as Unicode databases (this is also the preferred setting). For example, to create a database that is named DB, issue the following command:

```
db2 CREATE DATABASE DB
```

7. Optional: Run a Command Line Processor Plus (CLPPlus) or command line processor (CLP) script (for example, `script.sql`) to verify that the database supports PL/SQL statements and data types. The following CLPPlus script creates and then calls a simple procedure:

```
CONNECT user@hostname:port/dbname;

CREATE TABLE t1 (c1 NUMBER);

CREATE OR REPLACE PROCEDURE testdb(num IN NUMBER, message OUT VARCHAR2)
AS
BEGIN
  INSERT INTO t1 VALUES (num);

  message := 'The number you passed is: ' || TO_CHAR(num);
END;
/

CALL testdb(100, ?);

DISCONNECT;
EXIT;
```

To run the CLPPlus script, issue the following command:

```
clpplus @script.sql
```

The following example shows the CLP version of the same script. This script uses the **SET SQLCOMPAT PLSQL** command to enable recognition of the forward slash character (/) on a new line as a PL/SQL statement termination character.

```
CONNECT TO DB;

SET SQLCOMPAT PLSQL;

-- Semicolon is used to terminate
-- the CREATE TABLE statement:
CREATE TABLE t1 (c1 NUMBER);

-- Forward slash on a new line is used to terminate
-- the CREATE PROCEDURE statement:
CREATE OR REPLACE PROCEDURE testdb(num IN NUMBER, message OUT VARCHAR2)
AS
BEGIN
  INSERT INTO t1 VALUES (num);

  message := 'The number you passed is: ' || TO_CHAR(num);
END;
/

CALL testdb(100, ?);

SET SQLCOMPAT DB2;

CONNECT RESET;
```

To run the CLP script, issue the following command:

```
db2 -tvf script.sql
```

Results

The DB2 database that you created is enabled for Oracle applications. You can now use the compatibility features that you enabled. Only databases created after the **DB2_COMPATIBILITY_VECTOR** registry variable is set are enabled for Oracle applications.

What to do next

- Start using the CLPPlus interface.
- Execute PL/SQL scripts and statements.
- Transfer database object definitions.
- Enable database applications.

Chapter 39. Data types

DATE data type based on TIMESTAMP(0)

The DATE data type supports applications that use the Oracle DATE data type and expect that the DATE values include time information (for example, '2009-04-01-09.43.05').

Enablement

You enable DATE as TIMESTAMP(0) support at the database level, before creating the database where you require the support. To enable the support, set the **DB2_COMPATIBILITY_VECTOR** registry variable to hexadecimal value 0x40 (bit position 7), and then stop and restart the instance to have the new setting take effect.

```
db2set DB2_COMPATIBILITY_VECTOR=40
db2stop
db2start
```

To take full advantage of the DB2 compatibility features for Oracle applications, the recommended setting for the **DB2_COMPATIBILITY_VECTOR** is ORA, which sets all of the compatibility bits.

After you create a database with DATE as TIMESTAMP(0) support enabled, the **date_compat** database configuration parameter is set to ON.

If you create a database with DATE as TIMESTAMP(0) support enabled, you cannot disable that support for that database, even if you reset the **DB2_COMPATIBILITY_VECTOR** registry variable. Similarly, if you create a database with DATE as TIMESTAMP(0) support disabled, you cannot enable that support for that database later, even by setting the **DB2_COMPATIBILITY_VECTOR** registry variable.

Effects

The **date_compat** database configuration parameter indicates whether the DATE compatibility semantics associated with the TIMESTAMP(0) data type are applied to the connected database. The effects of setting **date_compat** to ON are as follows.

When the DATE data type is explicitly encountered in SQL statements, it is implicitly mapped to TIMESTAMP(0) in most cases. An exception is the specification of SQL DATE in the *xml-index-specification* clause of a CREATE INDEX statement. As a result of the implicit mapping, messages refer to the TIMESTAMP data type instead of DATE, and any operations that describe data types for columns or routines return TIMESTAMP instead of DATE.

Datetime literal support is changed as follows:

- The value of an explicit DATE literal is a TIMESTAMP(0) value in which the time portion is all zeros. For example, DATE '2008-04-28' represents the timestamp value '2008-04-28-00.00.00'.
- The database manager supports two additional formats for the string representation of a date, which correspond to 'DD-MON-YYYY' and 'DD-MON-RR'. Only English abbreviations of the month are supported. For example, '28-APR-2008' or '28-APR-08' can be used as string representations of a date, which represents the TIMESTAMP(0) value '2008-04-28-00.00.00'.

Starting from Version 9.7 Fix Pack 6, the database manager also supports the following formats for the string representation of a date in English only:

- 'DDMONYYYY' or 'DDMONRR'
- 'DD-MONYYYY' or 'DD-MONRR'
- 'DDMON-YYYY' or 'DDMON-RR'

For example, the following strings all represent the `TIMESTAMP(0)` value '2008-04-28-00.00.00':

- '28APR2008' or '28APR08'
- '28-APR2008' or '28-APR08'
- '28APR-2008' or '28APR-08'

For a description of the format elements, see `TIMESTAMP_FORMAT` scalar function (see *SQL Reference Volume 1*).

The `CURRENT_DATE` (also known as `CURRENT DATE`) special register returns a `TIMESTAMP(0)` value that is the same as the `CURRENT_TIMESTAMP(0)` value.

When you add a numeric value to a `TIMESTAMP` value or subtract a numeric value from a `TIMESTAMP` value, it is assumed that the numeric value represents a number of days. The numeric value can have any numeric data type, and any fractional value is considered to be a fractional portion of a day. For example, `TIMESTAMP '2008-03-28 12:00:00' + 1.3` adds 1 day, 7 hours, and 12 minutes to the `TIMESTAMP` value, resulting in '2008-03-29 19:12:00'. If you are using expressions for partial days, such as 1/24 (1 hour) or 1/24/60 (1 minute), ensure that the `number_compat` database configuration parameter is set to 0N so that the division is performed using `DECFLOAT` arithmetic.

The results of some functions change:

- If you pass a string argument to the `ADD_MONTHS` scalar function, it returns a `TIMESTAMP(0)` value.
- The `DATE` scalar function returns a `TIMESTAMP(0)` value for all input types.
- If you pass a string argument to the `LAST_DAY` scalar function, it returns a `TIMESTAMP(0)` value.
- If you pass a `DATE()` argument to the `ADD_MONTHS`, `LAST_DAY`, `NEXT_DAY`, `ROUND`, or `TRUNCATE` scalar function, the function returns a `TIMESTAMP(0)` value.
- The adding of one date value to another returns `TIMESTAMP(0)` value.
- The subtracting of one timestamp value from another returns `DECFLOAT(34)`, representing the difference as a number of days. Similarly, subtracting one date value from another returns `DECFLOAT(34)`, that represents a number of days.
- The second parameter in the `TIMESTAMPDIFF` scalar function does not represent a timestamp duration. Rather it represents the difference between two timestamps as a number of days. The returned estimate may vary by a number of days. For example, if the number of months (interval 64) is requested for the difference between '2010-03-31-00.00.00.000000' and '2010-03-01-00.00.00.000000', the result is 1. This is because the difference between the timestamps is 30 days, and the assumption of 30 days in a month applies. The following table shows how the returned value is determined for each interval.

Table 37. *TIMESTAMPDIFF* computations

Result interval	Computation using the difference between two timestamps as a number of days
Years	integer value of (days/365)
Quarters	integer value of (days/90)
Months	integer value of (days/30)
Weeks	integer value of (days/7)
Days	integer value of days
Hours	integer value of (days*24)
Minutes (the absolute value of the number of days must not exceed 1491308.0888888888888882)	integer value of (days*24*60)
Seconds (the absolute value of the number of days must be less than 24855.1348148148148148)	integer value of (days*24*60*60)
Microseconds (the absolute value of the number of days must be less than 0.02485513481481481)	integer value of (days*24*60*60*1000000)

If you use the import or load utility to input data into a DATE column, you must use the timestampformat file type modifier instead of the dateformat file type modifier.

NUMBER data type

The NUMBER data type supports applications that use the Oracle NUMBER data type.

Enablement

You enable NUMBER support at the database level, before creating the database where you require the support. To enable the support, set the **DB2_COMPATIBILITY_VECTOR** registry variable to hexadecimal value 0x10 (bit position 5), and then stop and restart the instance to have the new setting take effect.

```
db2set DB2_COMPATIBILITY_VECTOR=10
db2stop
db2start
```

To take full advantage of the DB2 compatibility features for Oracle applications, the recommended setting for the **DB2_COMPATIBILITY_VECTOR** is ORA, which sets all of the compatibility bits.

When you create a database with NUMBER support enabled, the **number_compat** database configuration parameter is set to ON.

If you create a database with NUMBER support enabled, you cannot disable NUMBER support for that database, even if you reset the **DB2_COMPATIBILITY_VECTOR** registry variable. Similarly, if you create a database with NUMBER support disabled, you cannot enable NUMBER support for that database later, even by setting the **DB2_COMPATIBILITY_VECTOR** registry variable.

Effects

The effects of setting the `number_compat` database configuration parameter to ON are as follows.

When the NUMBER data type is explicitly encountered in SQL statements, the data type is implicitly mapped as follows:

- If you specify NUMBER without precision and scale attributes, it is mapped to DECFLOAT(16).
- If you specify NUMBER(*p*), it is mapped to DECIMAL(*p*).
- If you specify NUMBER(*p,s*), it is mapped to DECIMAL(*p,s*).

The maximum supported precision is 31, and the scale must be a positive value that is no greater than the precision. Also, a result of the implicit mapping, messages refer to data types DECFLOAT and DECIMAL instead of NUMBER. In addition, any operations that describe data types for columns or routines return either DECIMAL or DECFLOAT instead of NUMBER.

Tip: The DECFLOAT(16) data type provides a lower maximum precision than that of the Oracle NUMBER data type. If you need more than 16 digits of precision for storing numbers in columns, then explicitly define those columns as DECFLOAT(34).

Numeric literal support is unchanged: the rules for integer, decimal, and floating-point constants continue to apply. These rules limit decimal literals to 31 digits and floating-point literals to the range of binary double-precision floating-point values. If necessary, you can use a string-to-DECFLOAT(34) cast, using the CAST specification or the DECFLOAT function, for values beyond the range of DECIMAL or DOUBLE up to the range of DECFLOAT(34). There is currently no support for a numeric literal that ends in either D, representing 64-bit binary floating-point values, or F, representing 32-bit binary floating-point values. A numeric literal that includes an E has the data type of DOUBLE, which you can cast to REAL using the CAST specification or the cast function REAL.

If you cast NUMBER data values to character strings, using either the CAST specification or the VARCHAR or CHAR scalar function, all leading zeros are stripped from the result.

The default data type that is used for a sequence value in the CREATE SEQUENCE statement is DECIMAL(27) instead of INTEGER.

All arithmetic operations and arithmetic or mathematical functions involving DECIMAL or DECFLOAT data types are effectively performed using decimal floating-point arithmetic and return a value with a data type of DECFLOAT(34). This type of performance also applies to arithmetic operations where both operands have a DECIMAL or DECFLOAT(16) data type, which differs from the description of decimal arithmetic in the “Expressions with arithmetic operators” section of Expressions (see *SQL Reference Volume 1*). Additionally, all division operations involving only integer data types (SMALLINT, INTEGER, or BIGINT) are effectively performed using decimal floating-point arithmetic. These operations return a value with a data type of DECFLOAT(34) instead of an integer data type. Division by zero with integer operands returns infinity and a warning instead of an error.

In some cases function resolution is also changed, such that an argument of data type DECIMAL is considered to be a DECFLOAT value during the resolution

process. Also functions with arguments that correspond to the NUMBER(*p*[,*s*]) data type are effectively treated as if the argument data types were NUMBER. However, this change in function resolution does not apply to the set of functions that have a variable number of arguments and base their result data types on the set of data types of the arguments. The functions included in this set are as follows:

- COALESCE
- DECODE
- GREATEST
- LEAST
- MAX (scalar)
- MIN (scalar)
- NVL
- VALUE

In addition to the general changes to numeric functions, a special consideration also applies to the MOD function; if the second argument in the MOD function is zero, then the function returns the value of the first argument.

The rules for result data types (see *SQL Reference Volume 1*) are extended to make DECFLOAT(34) the result data type if the precision of a DECIMAL result data type would have exceeded 31. These rules also apply to the following items:

- Corresponding columns in set operations: UNION, EXCEPT(MINUS), and INTERSECT
- Expression values in the IN list of an IN predicate
- Corresponding expressions of a multiple row VALUES clause

The rounding mode that is used for assignments and casts depends on the data types that are involved. In some cases, truncation is used. In cases where the target is a binary floating-point (REAL or DOUBLE) value, round-half-even is used, as usual. In other cases, usually involving a DECIMAL or DECFLOAT value, the rounding is based on the value of the **decflt_rounding** database configuration parameter. The value of this parameter defaults to round-half-even, but you can set it to round-half-up to match the Oracle rounding mode. The following table summarizes the rounding that is used for various numeric assignments and casts.

Table 38. Rounding for numeric assignments and casts

Source data type	Target data type			
	Integer types	DECIMAL	DECFLOAT	REAL/DOUBLE
Integer types	not applicable	not applicable	decflt_rounding	round_half_even
DECIMAL	decflt_rounding	decflt_rounding	decflt_rounding	round_half_even
DECFLOAT	decflt_rounding	decflt_rounding	decflt_rounding	round_half_even
REAL/DOUBLE	truncate	decflt_rounding	decflt_rounding	round_half_even
String (cast only)	not applicable	decflt_rounding	decflt_rounding	round_half_even

The DB2 decimal floating-point values are based on the IEEE 754R standard. Retrieval of DECFLOAT data and casting of DECFLOAT data to character strings removes any trailing zeros after the decimal point.

Client-server compatibility

Client applications working with a DB2 database server that you enable for NUMBER data type support never receive a NUMBER data type from the server. Any column or expression that would report NUMBER from an Oracle server report either DECIMAL or DECFLOAT from a DB2 server.

Because an Oracle environment expects the rounding mode to be round-half-up, it is important that the client rounding mode match the server rounding mode. This means that the `db2cli.ini` file setting must match the value of the **deflt_rounding** database configuration parameter. To most closely match the Oracle rounding mode, you should specify `ROUND_HALF_UP` for the database configuration parameter.

Restrictions

NUMBER data type support has the following restrictions:

- There is no support for the following items:
 - A precision attribute greater than 31
 - A precision attribute of asterisk (*)
 - A scale attribute that exceeds the precision attribute
 - A negative scale attribute

There is no corresponding DECIMAL precision and scale support for NUMBER data type specifications.

- You cannot invoke the trigonometric functions or the DIGITS scalar function with arguments of data type NUMBER without a precision (DECFLOAT).
- You cannot create a distinct type with the name NUMBER.

VARCHAR2 and NVARCHAR2 data types

The VARCHAR2 and NVARCHAR2 data types support applications that use the Oracle VARCHAR2 and NVARCHAR2 data types.

Enablement

You enable VARCHAR2 and NVARCHAR2 (subsequently jointly referred to as VARCHAR2) support at the database level, before creating the database where you require support. To enable the support, set the **DB2_COMPATIBILITY_VECTOR** registry variable to hexadecimal value 0x20 (bit position 6), and then stop and restart the instance to have the new setting take effect.

```
db2set DB2_COMPATIBILITY_VECTOR=20
db2stop
db2start
```

To take full advantage of the DB2 compatibility features for Oracle applications, the recommended setting for the **DB2_COMPATIBILITY_VECTOR** is `ORA`, which sets all of the compatibility bits.

When you create a database with VARCHAR2 support enabled, the **varchar2_compat** database configuration parameter is set to `ON`.

If you create a database with VARCHAR2 support enabled, you cannot disable VARCHAR2 support for that database, even if you reset the **DB2_COMPATIBILITY_VECTOR** registry variable. Similarly, if you create a database with

VARCHAR2 support disabled, you cannot enable VARCHAR2 support for that database later, even by setting the **DB2_COMPATIBILITY_VECTOR** registry variable.

To use the NVARCHAR2 data type, a database must be a Unicode database.

Effects

The effects of setting the **varchar2_compat** database configuration parameter to ON are as follows.

When the VARCHAR2 data type is explicitly encountered in SQL statements, it is implicitly mapped to the VARCHAR data type. The maximum length for VARCHAR2 is the same as the maximum length for VARCHAR: 32, 672. Similarly, when the NVARCHAR2 data type is explicitly encountered in SQL statements, it is implicitly mapped to the VARGRAPHIC data type. The maximum length for NVARCHAR2 is the same as the maximum length for VARGRAPHIC: 16, 336.

Character string literals up to 254 bytes in length have a data type of CHAR. Character string literals longer than 254 bytes have a data type of VARCHAR.

Comparisons involving varying-length string types use non-padded comparison semantics, and comparisons with only fixed-length string types continue to use blank-padded comparison semantics, with two exceptions:

- Comparisons involving string column information from catalog views always use the IDENTITY collation with blank-padded comparison semantics, regardless of the database collation.
- String comparisons involving a data type with the FOR BIT DATA attribute always use the IDENTITY collation with blank-padded comparison semantics.

IN list expressions are treated as having a varying-length string data type if both of the following conditions are true:

- The result type for the IN list of an IN predicate would resolve to a fixed-length string data type
- The left operand of the IN predicate is a varying-length string data type

Character string values (other than LOB values) with a length of zero are generally treated as null values. An assignment or cast of an empty string value to CHAR, NCHAR, VARCHAR, or NVARCHAR produces a null value.

Functions that return character string arguments, or that are based on parameters with character string data types, also treat empty string CHAR, NCHAR, VARCHAR, or NVARCHAR values as null values. Special considerations apply for some functions when the **varchar2_compat** database configuration parameter is set to ON, as follows:

- CONCAT function and the concatenation operator. A null or empty string value is ignored in the concatenated result. The result type of the concatenation is shown in the following table.

Table 39. Data Type and lengths of concatenated operands

Operands	Combined length attributes	Result
CHAR(A) CHAR(B)	<255	CHAR(A+B)
CHAR(A) CHAR(B)	>254	VARCHAR(A+B)

Table 39. Data Type and lengths of concatenated operands (continued)

Operands	Combined length attributes	Result
CHAR(A) VARCHAR(B)	-	VARCHAR(MIN(A+B,32672))
VARCHAR(A) VARCHAR(B)	-	VARCHAR(MIN(A+B,32672))
CLOB(A) CHAR(B)	-	CLOB(MIN(A+B, 2G))
CLOB(A) VARCHAR(B)	-	CLOB(MIN(A+B, 2G))
CLOB(A) CLOB(B)		CLOB(MIN(A+B, 2G))
GRAPHIC(A) GRAPHIC(B)	<128	GRAPHIC(A+B)
GRAPHIC(A) GRAPHIC(B)	>128	VARGRAPHIC(A+B)
GRAPHIC(A) VARGRAPHIC(B)	-	VARGRAPHIC(MIN(A+B,16336))
VARGRAPHIC(A) VARGRAPHIC(B)	-	VARGRAPHIC(MIN(A+B,16336))
DBCLOB(A) CHAR(B)	-	DBCLOB(MIN(A+B, 1G))
DBCLOB(A) VARCHAR(B)	-	DBCLOB(MIN(A+B, 1G))
DBCLOB(A) CLOB(B)		DBCLOB(MIN(A+B, 1G))
BLOB(A) BLOB(B)	-	BLOB(MIN(A+B, 2G))

- INSERT function. A null value or empty string as the fourth argument results in deletion of the number of bytes indicated by the third argument, beginning at the byte position indicated by the second argument from the first argument.
- LENGTH function. The value returned by the LENGTH function is the number of bytes in the character string. An empty string value returns the null value.
- REPLACE function. If all of the argument values have a data type of CHAR, VARCHAR, GRAPHIC, or VARGRAPHIC, then:
 - A null value or empty string as the second argument is treated as an empty string, and consequently the first argument is returned as the result
 - A null value or empty string as the third argument is treated as an empty string, and nothing replaces the string that is removed from the source string by the second argument.

If any argument value has a data type of CLOB or BLOB and any argument is the null value, the result is the null value. All three arguments of the REPLACE function must be specified.

- SUBSTR function. References to SUBSTR which have a character string input for the first argument will be replaced with an invocation to SUBSTRB. References to SUBSTR which have a national character (graphic) string input for the first argument will be replaced with an invocation to SUBSTR2.
- TRANSLATE function. The *from-string-exp* is the second argument, and the *to-string-exp* is the third argument. If the *to-string-exp* is shorter than the *from-string-exp*, the extra characters in the *from-string-exp* that are found in the *char-string-exp* (the first argument) are removed; that is, the default *pad-char* argument is effectively an empty string, unless a different pad character is specified in the fourth argument.
- TRIM function. If the trim character argument of a TRIM function invocation is a null value or an empty string, the function returns a null value.

In the ALTER TABLE statement or the CREATE TABLE statement, when a DEFAULT clause is specified without an explicit value for a column defined with the VARCHAR or the VARGRAPHIC data type, the default value is a blank character.

Empty strings are converted to a blank character when the database configuration parameter **varchar2_compat** is set to ON. For example:

- SYSCAT.DATAPARTITIONS.STATUS has a single blank character when the data partition is visible.
- SYSCAT.PACKAGES.PKGVERSION has a single blank character when the package version has not been explicitly set.
- SYSCAT.ROUTINES.COMPILE_OPTIONS has a null value when compile options have not been set.

If SQL statements use parameter markers, a data type conversion that affects VARCHAR2 usage can occur. For example, if the input value is a VARCHAR of length zero and it is converted to a LOB, the result will be a null value. However, if the input value is a LOB of length zero and it is converted to a LOB, the result will be a LOB of length zero. The data type of the input value can be affected by deferred prepare.

Restrictions

The VARCHAR2 data type and associated character string processing support have the following restrictions:

- The VARCHAR2 length attribute qualifier CHAR is not accepted.
- The LONG VARCHAR and LONG VARGRAPHIC data types are not supported (but are not explicitly blocked) when the **varchar2_compat** database configuration parameter is set to ON.

Chapter 40. Character and graphic constant handling

Implicit casting (or weak typing) is an alternative way to parse character or graphic constants to support applications that expect these constants to be assigned the data types CHAR and GRAPHIC.

Enablement

To enable character and graphic constant handling support, set the **DB2_COMPATIBILITY_VECTOR** registry variable to hexadecimal value 0x100 (bit position 9), and then stop and restart the instance to have the new setting take effect.

```
db2set DB2_COMPATIBILITY_VECTOR=100
db2stop
db2start
```

To take full advantage of the DB2 compatibility features for Oracle applications, the recommended setting for the **DB2_COMPATIBILITY_VECTOR** is ORA, which sets all of the compatibility bits.

Prior to character or graphic constant support, an application that used weak typing in its SQL would have failed to compile against the DB2 product. With implicit casting, strings and numbers can be compared, assigned, and operated on in a very flexible fashion. After character or graphic constant support is enabled, character or graphic string constants whose length is less than or equal to 254 bytes have a data type of CHAR or GRAPHIC, respectively. Character or graphic string constants whose length is greater than 254 bytes have a data type of VARCHAR or VARGRAPHIC, respectively. Because this data type assignment can change the result types of some SQL statements, it is strongly recommended that this registry variable setting for a database not be toggled.

Effects

After you enable the support, constants are handled as follows:

- Character string constants whose lengths are less than or equal to 254 bytes have a data type of CHAR.
- Graphic string constants whose lengths are less than or equal to 254 bytes have a data type of GRAPHIC.
- Character string constants whose lengths are greater than 254 bytes have a data type of VARCHAR.
- Graphic string constants whose lengths are greater than 254 bytes have a data type of VARGRAPHIC.

Because these data type assignments can change the result types of some SQL statements, do not toggle this registry variable setting.

Chapter 41. SQL data-access-level enforcement

The degree to which a routine (stored procedure or user-defined function) can execute SQL statements is determined by its SQL-access-level.

There are four SQL data-access-levels:

- NO SQL
- CONTAINS SQL
- READS SQL DATA
- MODIFIES SQL DATA

By default, SQL PL and PL/SQL routines enforce data-access levels at compile time. If a routine contains an SQL statement that requires a data-access level that exceeds that of the routine, an error is returned when you create the routine. Similarly, if a routine invokes another routine whose data-access level exceeds that of the calling routine, an error is returned when you create the first routine. Additionally, if you define a compiled user-defined function as MODIFIES SQL DATA, you can use it only as the sole element on the right side of an assignment statement within a compound SQL (compiled) statement. This check is also performed when you compile the statement.

Starting with Version 9.7 Fix Pack 3, you can have SQL PL and PL/SQL routines enforce data-access levels at run time instead of at compile time by setting the **DB2_COMPATIBILITY_VECTOR** registry variable. To enable the support, set the registry variable to hexadecimal value 0x10000 (bit position 17), and then stop and restart the instance to have the new setting take effect.

```
db2set DB2_COMPATIBILITY_VECTOR=10000
db2stop
db2start
```

To take full advantage of the DB2 compatibility features for Oracle applications, the recommended setting for the DB2_COMPATIBILITY_VECTOR is ORA, which sets all of the compatibility bits.

The enforcement is now performed at run-time at the statement level. An error is returned when a statement that exceeds the current SQL data access level is performed. If a routine invokes another routine defined with a more restrictive SQL data-access level, the called routine inherits the data-access level of its parent. Additionally, if you define a compiled user-defined function as MODIFIES SQL DATA and it is not the sole element on the right side of an assignment statement within a compound SQL (compiled) statement, an error is returned only if the function issues an SQL statement that modifies SQL data.

In addition, starting with Version 9.7 Fix Pack 6, COMMIT and ROLLBACK statements are allowed in a compiled PL/SQL user-defined function and a compiled language SQL user-defined function that has been defined with the MODIFIES SQL DATA clause in a CREATE FUNCTION statement.

Chapter 42. Outer join operator

When you set the **DB2_COMPATIBILITY_VECTOR** registry variable to support the outer join operator (+), queries can use this operator as alternative syntax within predicates of the **WHERE** clause.

A join is the process of combining data from two or more tables based on some common domain of information. Rows from one table are paired with rows from another table when information in the corresponding rows match on the basis of the joining criterion. An outer join returns all rows that satisfy the join condition and also returns some or all of the rows from one or both tables for which no rows satisfy the join condition. You should use the outer join syntax of **RIGHT OUTER JOIN**, **LEFT OUTER JOIN**, or **FULL OUTER JOIN** wherever possible. You should use the outer join operator only when enabling applications from database products other than the DB2 product to run on a DB2 database system.

Enablement

You enable outer join operator support by setting the **DB2_COMPATIBILITY_VECTOR** registry variable to hexadecimal value 0x04 (bit position 3), and then stop and restart the instance to have the new setting take effect.

```
db2set DB2_COMPATIBILITY_VECTOR=04
db2stop
db2start
```

To take full advantage of the DB2 compatibility features for Oracle applications, the recommended setting for the **DB2_COMPATIBILITY_VECTOR** is **ORA**, which sets all of the compatibility bits.

Examples

You apply the outer join operator (+) in parentheses following a column name within predicates that refer to columns from two tables, as shown in the following examples:

- The following query performs a left outer join of tables T1 and T2. Include both tables in the **FROM** clause, separated by a comma. Apply the outer join operator to all columns of T2 in predicates that also reference T1.

```
SELECT * FROM T1
LEFT OUTER JOIN T2 ON T1.PK1 = T2.FK1
AND T1.PK2 = T2.FK2
```

The previous query is equivalent to the following one, which uses the outer join operator:

```
SELECT * FROM T1, T2
WHERE T1.PK1 = T2.FK1(+)
AND T1.PK2 = T2.FK2(+)
```

- The following query performs a right outer join of tables T1 and T2. Include both tables in the **FROM** clause, separated by a comma, and apply the outer join operator to all columns of T1 in predicates that also reference T2.

```
SELECT * FROM T1
RIGHT OUTER JOIN T2 ON T1.FK1 = T2.PK1
AND T1.FK2 = T2.PK2
```

The previous query is equivalent to the following one, which uses the outer join operator:

```
SELECT * FROM T1, T2
WHERE T1.FK1(+) = T2.PK1
AND T1.FK2(+) = T2.PK2
```

A table that has columns marked with the outer join operator is sometimes referred to as a *NULL-producer*.

A set of predicates that are separated by AND operators is known as an *AND-factor*. If there are no AND operators in a WHERE clause, the set of predicates in the WHERE clause is considered to be the only AND-factor.

Rules

The following rules apply to the outer join operator:

- Predicates
 - The WHERE predicate is considered on a granularity of ANDed Boolean factors.
 - Local predicates such as $T1.A(+) = 5$ can exist, but they are executed with the join. A local predicate without (+) is executed after the join.
- Boolean
 - Each Boolean term can refer to at most two tables, for example, $T1.C11 + T2.C21 = T3.C3(+)$ is not allowed.
 - Correlation for outer join Boolean terms is not allowed.
- Outer join operator
 - You cannot specify the outer join operator in the same subselect as the explicit JOIN syntax
 - You can specify the outer join operator only in the WHERE clause on columns that are associated with tables that you specify in the FROM clause of the same subselect.
 - You cannot apply the outer join operator to an entire expression. Within an AND-factor, each column reference from the same table must be followed by the outer join operator, for example, $T1.COL1 (+) - T1.COL2 (+) = T2.COL1$.
 - You can specify the outer join operator only in the WHERE clause on columns that are associated with tables that you specify in the FROM clause of the same subselect.
- NULL-producer
 - Each table can be the NULL-producer with respect to at most one other table. If a table is joined to a third table, it must be the outer table.
 - You can use a table only once as the NULL-producer for one other table within a query.
 - You cannot use the same table as both the outer table and the NULL-producer in separate outer joins that form a cycle. A cycle can be formed across multiple joins when the chain of predicates comes back to an earlier table.
For example, the following query starts with T1 as the outer table in the first predicate and then cycles back to T1 in the third predicate. T2 is used as both the NULL-producer in the first predicate and the outer table in the second predicate, but this usage is not itself a cycle.

```

SELECT ... FROM T1,T2,T3
  WHERE T1.a1 = T2.b2(+)
        AND T2.b2 = T3.c3(+)
        AND T3.c3 = T1.a1(+)  -- invalid cycle

```

- AND-factor
 - An AND-factor can have only one table as a NULL-producer. Each column reference that is followed by the outer join operator must be from the same table.
 - An AND-factor that includes an outer join operator can reference at most two tables.
 - If you require multiple AND-factors for the outer join between two tables, you must specify the outer join operator in all of these AND-factors. If an AND-factor does not specify the outer join operator, it is processed on the result of the outer join.
 - An AND-factor with predicates that involve only one table can specify the outer join operator if there is at least one other AND-factor that meets the following criteria:
 - The AND-factor must involve the same table as the NULL-producer.
 - The AND-factor must involve another table as the outer table.
 - An AND-factor with predicates involving only one table and without an outer join operator is processed on the result of the join.
 - An AND-factor that includes an outer join operator must follow the rules for a join-condition of an ON clause that is defined under a joined-table.

Chapter 43. Hierarchical queries

A hierarchical query is a form of recursive query that retrieves a hierarchy, such as a bill of materials, from relational data by using a `CONNECT BY` clause.

Enablement

You enable hierarchical query support by setting the `DB2_COMPATIBILITY_VECTOR` registry variable to hexadecimal value `0x08` (bit position 4), and then stop and restart the instance to have the new setting take effect.

```
db2set DB2_COMPATIBILITY_VECTOR=08
db2stop
db2start
```

To take full advantage of the DB2 compatibility features for Oracle applications, the recommended setting for the `DB2_COMPATIBILITY_VECTOR` is `ORA`, which sets all of the compatibility bits.

You can then use `CONNECT BY` syntax, including pseudocolumns, unary operators, and the `SYS_CONNECT_BY_PATH` scalar function.

A hierarchical query contains a `CONNECT BY` clause that defines the join conditions between parent and child elements. Connect-by recursion uses the same subquery for the seed (`START WITH` clause) and the recursive step (`CONNECT BY` clause). This combination provides a concise method of representing recursions such as bills-of-material, reports-to-chains, or email threads.

Connect-by recursion returns an error if a cycle occurs. A *cycle* occurs when a row produces itself, either directly or indirectly. By using the optional `CONNECT BY NOCYCLE` clause, you can direct the recursion to ignore the duplicated row, thus avoiding both the cycle and the error. Hierarchical queries or connect-by recursion differs from DB2 recursion. For more information about the differences, see `Port CONNECT BY to DB2`.

hierarchical-query-clause

A subselect that includes a *hierarchical-query-clause* is called a hierarchical query.

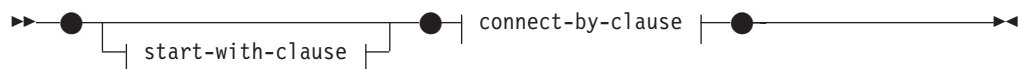

start-with-clause:

```
|—START WITH—search-condition—|
```

connect-by-clause:

```
|—CONNECT BY—| search-condition —|  
          └─NOCYCLE─┘
```

start-with-clause

START WITH denotes the seed of the recursion. The *start-with-clause* specifies the intermediate result table H_1 for the hierarchical query. Table H_1 consists of those rows of R for which the *search-condition* is true. If you do not specify the *start-with-clause*, H_1 is the entire intermediate result table R. The rules for the *search-condition* within the *start-with-clause* are the same as those within the WHERE clause.

connect-by-clause

CONNECT BY describes the recursive step. The *connect-by-clause* produces the intermediate result table H_{n+1} from H_n by joining H_n with R, using the search condition. If you specify the NOCYCLE keyword, the repeated row is not included in the intermediate result table H_{n+1} . An error is not returned. The rules for the *search-condition* within the *connect-by-clause* are the same as those within the WHERE clause, except that OLAP specifications cannot be specified (SQLSTATE 42903).

After a first intermediate result table H_1 is established, subsequent intermediate result tables H_2 , H_3 , and so forth are generated. The subsequently created intermediate result tables are generated by joining H_n with table R using the *connect-by-clause* as a join condition to produce H_{n+1} . R is the result of the FROM clause of the subselect and any join predicates in the WHERE clause. The process stops when H_{n+1} yields an empty result table. The result table H of the *hierarchical-query-clause* is the result as if UNION ALL were applied for every intermediate result table..

You can use the unary operator PRIOR to distinguish column references to H_n , the previous recursive step or parent, from column references to R. Consider the following example:

```
CONNECT BY MGRID = PRIOR EMPID
```

MGRID is resolved with R, and EMPID is resolved within the columns of the previous intermediate result table H_n .

Rules

- If the intermediate result table H_{n+1} would return a row from R for a hierarchical path that is the same as a row from R that is already in that hierarchical path, an error is returned (SQLSTATE 560CO).
- If the NOCYCLE keyword is specified, an error is not returned, but the repeated row is not included in the intermediate result table H_{n+1} .
- A maximum of 64 levels of recursion is supported (SQLSTATE 54066).
- A subselect that is a hierarchical query returns the intermediate result set in a partial order, unless you destroy that order by using an explicit ORDER BY clause, a GROUP BY or HAVING clause, or a DISTINCT keyword in the select list. The partial order returns rows such that rows produced in H_{n+1} for a particular hierarchy immediately follow the row in H_n that produced them. You can use the ORDER SIBLINGS BY clause to enforce order within a set of rows produced by the same parent.
- A hierarchical query is not supported for a materialized query table (SQLSTATE 428EC).
- You cannot use the CONNECT BY clause with XML functions or XQuery (SQLSTATE 428H4).
- You cannot specify a NEXT VALUE expression for a sequence in the following places (SQLSTATE 428F9):

- The parameter list of the CONNECT_BY_ROOT operator or a SYS_CONNECT_BY_PATH function
- START WITH and CONNECT BY clauses

Notes

- Hierarchical query support affects the subselect in the following ways:
 - The clauses of the subselect are processed in the following sequence:
 1. FROM clause
 2. *hierarchical-query-clause*
 3. WHERE clause
 4. GROUP BY clause
 5. HAVING clause
 6. SELECT clause
 7. ORDER BY clause
 8. FETCH FIRST clause
 - Special rules apply to the order of processing the predicates in the WHERE clause. The *search-condition* is factored into predicates along with its AND conditions (conjunctions). If a predicate is an implicit join predicate (that is, it references more than one table in the FROM clause), the predicate is applied before the *hierarchical-query-clause* is applied. Any predicate referencing at most one table in the FROM clause is applied to the intermediate result table of the *hierarchical-query-clause*.
If you write a hierarchical query involving joins, use explicit joined tables with an ON clause to avoid confusion about the application of WHERE clause predicates.
 - You can specify the ORDER SIBLINGS BY clause. This clause specifies that the ordering applies only to siblings within the hierarchies.
- A *pseudocolumn* is a qualified or unqualified identifier that has meaning in a specific context and shares the same namespace as columns and variables. If an unqualified identifier does not identify a column or a variable, the identifier is checked to see whether it identifies a pseudocolumn.
LEVEL is a pseudocolumn for use in hierarchical queries. The LEVEL pseudocolumn returns the recursive step in the hierarchy at which a row was produced. All rows that are produced by the START WITH clause return the value 1. Rows that are produced by applying the first iteration of the CONNECT BY clause return 2, and so on. The data type of the column is INTEGER NOT NULL.
You must specify LEVEL in the context of a hierarchical query. You cannot specify LEVEL in the START WITH clause, as an argument of the CONNECT_BY_ROOT operator, or as an argument of the SYS_CONNECT_BY_PATH function (SQLSTATE 428H4).
- Unary operators that support hierarchical queries are CONNECT_BY_ROOT and PRIOR.
- A functions that supports hierarchical queries is the SYS_CONNECT_BY_PATH scalar function.

Examples

- The following reports-to-chain example illustrates connect-by recursion. The example is based on a table named MY_EMP, which is created and populated with data as follows:

```

CREATE TABLE MY_EMP(
  EMPID  INTEGER NOT NULL PRIMARY KEY,
  NAME   VARCHAR(10),
  SALARY DECIMAL(9, 2),
  MGRID  INTEGER);

INSERT INTO MY_EMP VALUES ( 1, 'Jones', 30000, 10);
INSERT INTO MY_EMP VALUES ( 2, 'Hall', 35000, 10);
INSERT INTO MY_EMP VALUES ( 3, 'Kim', 40000, 10);
INSERT INTO MY_EMP VALUES ( 4, 'Lindsay', 38000, 10);
INSERT INTO MY_EMP VALUES ( 5, 'McKeough', 42000, 11);
INSERT INTO MY_EMP VALUES ( 6, 'Barnes', 41000, 11);
INSERT INTO MY_EMP VALUES ( 7, 'O'Neil', 36000, 12);
INSERT INTO MY_EMP VALUES ( 8, 'Smith', 34000, 12);
INSERT INTO MY_EMP VALUES ( 9, 'Shoeman', 33000, 12);
INSERT INTO MY_EMP VALUES (10, 'Monroe', 50000, 15);
INSERT INTO MY_EMP VALUES (11, 'Zander', 52000, 16);
INSERT INTO MY_EMP VALUES (12, 'Henry', 51000, 16);
INSERT INTO MY_EMP VALUES (13, 'Aaron', 54000, 15);
INSERT INTO MY_EMP VALUES (14, 'Scott', 53000, 16);
INSERT INTO MY_EMP VALUES (15, 'Mills', 70000, 17);
INSERT INTO MY_EMP VALUES (16, 'Goyal', 80000, 17);
INSERT INTO MY_EMP VALUES (17, 'Urbassek', 95000, NULL);

```

The following query returns all employees working for Goyal, as well as some additional information, such as the reports-to-chain:

```

1 SELECT NAME,
2     LEVEL,
3     SALARY,
4     CONNECT_BY_ROOT NAME AS ROOT,
5     SUBSTR(SYS_CONNECT_BY_PATH(NAME, ':'), 1, 25) AS CHAIN
6 FROM MY_EMP
7 START WITH NAME = 'Goyal'
8 CONNECT BY PRIOR EMPID = MGRID
9 ORDER SIBLINGS BY SALARY;

```

NAME	LEVEL	SALARY	ROOT	CHAIN
Goyal	1	80000.00	Goyal	:Goyal
Henry	2	51000.00	Goyal	:Goyal:Henry
Shoeman	3	33000.00	Goyal	:Goyal:Henry:Shoeman
Smith	3	34000.00	Goyal	:Goyal:Henry:Smith
O'Neil	3	36000.00	Goyal	:Goyal:Henry:O'Neil
Zander	2	52000.00	Goyal	:Goyal:Zander
Barnes	3	41000.00	Goyal	:Goyal:Zander:Barnes
McKeough	3	42000.00	Goyal	:Goyal:Zander:McKeough
Scott	2	53000.00	Goyal	:Goyal:Scott

Lines 7 and 8 comprise the core of the recursion: The optional START WITH clause describes the WHERE clause that is to be used on the source table to seed the recursion. In this case, only the row for employee Goyal is selected. If the START WITH clause is omitted, the entire source table is used to seed the recursion. The CONNECT BY clause describes how, given the existing rows, the next set of rows is to be found. The unary operator PRIOR is used to distinguish values in the previous step from those in the current step. PRIOR identifies EMPID as the employee ID of the previous recursive step, and MGRID as originating from the current recursive step.

The LEVEL pseudocolumn in line 2 indicates the current level of recursion. CONNECT_BY_ROOT is a unary operator that always returns the value of its argument as it was during the first recursive step; that is, the values that are returned by an explicit or implicit START WITH clause.

SYS_CONNECT_BY_PATH() is a binary function that prepends the second argument to the first and then appends the result to the value that it produced in the previous recursive step. The arguments must be character types.

Unless explicitly overridden, connect-by recursion returns a result set in a partial order; that is, the rows that are produced by a recursive step always follow the row that produced them. Siblings at the same level of recursion have no specific order. The ORDER SIBLINGS BY clause in line 9 defines an order for these siblings, which further refines the partial order, potentially into a total order.

- Return the organizational structure of the DEPARTMENT table. Use the level of the department to visualize the hierarchy.

```
SELECT LEVEL, CAST(SPACE((LEVEL - 1) * 4) || '/' || DEPTNAME
AS VARCHAR(40)) AS DEPTNAME
FROM DEPARTMENT
START WITH DEPTNO = 'A00'
CONNECT BY NOCYCLE PRIOR DEPTNO = ADMRDEPT
```

The query returns:

LEVEL	DEPTNAME
1	/SPIFFY COMPUTER SERVICE DIV.
2	/PLANNING
2	/INFORMATION CENTER
2	/DEVELOPMENT CENTER
3	/MANUFACTURING SYSTEMS
3	/ADMINISTRATION SYSTEMS
2	/SUPPORT SERVICES
3	/OPERATIONS
3	/SOFTWARE SUPPORT
3	/BRANCH OFFICE F2
3	/BRANCH OFFICE G2
3	/BRANCH OFFICE H2
3	/BRANCH OFFICE I2
3	/BRANCH OFFICE J2

CONNECT_BY_ROOT unary operator

The CONNECT_BY_ROOT unary operator is for use only in hierarchical queries. For every row in the hierarchy, this operator returns the expression for the root ancestor of the row.

►►—CONNECT_BY_ROOT—*expression*—◄◄

expression

An expression that does not contain a NEXT VALUE expression, a hierarchical query construct (such as the LEVEL pseudocolumn), the SYS_CONNECT_BY_PATH function, or an OLAP function. If you specify any of these items, SQLSTATE 428H4 is returned.

Usage

The result type of the operator is the result type of the expression.

The following rules apply to the CONNECT_BY_ROOT operator:

- A CONNECT_BY_ROOT operator has a higher precedence than that of any infix operator, such as the plus sign (+) or double vertical bar (||). Therefore, to pass an expression with infix operators as an argument, you must use parentheses. For example, the following expression returns the FIRSTNAME value of the root ancestor row concatenated with the LASTNAME value of the actual row in the hierarchy:

```
CONNECT_BY_ROOT FIRSTNAME || LASTNAME
```

That expression is equivalent to the first one in the following list but not the second one:

```
(CONNECT_BY_ROOT FIRSTNME) || LASTNAME
CONNECT_BY_ROOT (FIRSTNME || LASTNAME)
```

- A CONNECT_BY_ROOT operator cannot be specified in the START WITH clause or the CONNECT BY clause of a hierarchical query (SQLSTATE 428H4).
- A CONNECT_BY_ROOT operator cannot be specified as an argument to the SYS_CONNECT_BY_PATH function (SQLSTATE 428H4).

The following query returns the hierarchy of departments and their root departments in the DEPARTMENT table:

```
SELECT CONNECT_BY_ROOT DEPTNAME AS ROOT, DEPTNAME
FROM DEPARTMENT START WITH DEPTNO IN ('B01','C01','D01','E01')
CONNECT BY PRIOR DEPTNO = ADMRDEPT
```

This query returns the following results:

ROOT	DEPTNAME
PLANNING	PLANNING
INFORMATION CENTER	INFORMATION CENTER
DEVELOPMENT CENTER	DEVELOPMENT CENTER
DEVELOPMENT CENTER	MANUFACTURING SYSTEMS
DEVELOPMENT CENTER	ADMINISTRATION SYSTEMS
SUPPORT SERVICES	SUPPORT SERVICES
SUPPORT SERVICES	OPERATIONS
SUPPORT SERVICES	SOFTWARE SUPPORT
SUPPORT SERVICES	BRANCH OFFICE F2
SUPPORT SERVICES	BRANCH OFFICE G2
SUPPORT SERVICES	BRANCH OFFICE H2
SUPPORT SERVICES	BRANCH OFFICE I2
SUPPORT SERVICES	BRANCH OFFICE J2

PRIOR unary operator

The PRIOR unary operator is for use only in the CONNECT BY clause of hierarchical queries. To get all subordinates over all levels, the PRIOR operator must be added to the CONNECT BY clause of the hierarchical query.

►►—PRIOR—*expression*—◄◄

expression

Any expression that does not contain a NEXT VALUE expression, an hierarchical query construct (such as the LEVEL pseudocolumn), the SYS_CONNECT_BY_PATH function, or an OLAP function. If you specify any of these items, SQLSTATE 428H4 is returned.

Usage

The CONNECT BY clause performs an inner join between the intermediate result table H_n of a hierarchical query and the source result table that you specify in the FROM clause. All column references to tables that are referenced in the FROM clause and that are arguments to the PRIOR operator are considered to range over table H_n .

The result data type of the operator is the result data type of the expression.

As shown in the following example, you typically join the primary key of the intermediate result table H_n to the foreign keys of the source result table to recursively traverse the hierarchy:

```
CONNECT BY PRIOR T.PK = T.FK
```

If the primary key is a composite key, prefix each column with PRIOR, as shown in the following example:

```
CONNECT BY PRIOR T.PK1 = T.FK1 AND PRIOR T.PK2 = T.FK2
```

A PRIOR operator has a higher precedence than any infix operator, such as the plus sign (+) or double vertical bar (||). Therefore, to pass an expression with infix operators as an argument, you must use parentheses. The parentheses surrounding groups of operands and operators are necessary to indicate the intended order in which operations are to be performed. For example, the following expression returns the FIRSTNAME value of the prior row concatenated with the LASTNAME value of the actual row in the hierarchy:

```
PRIOR FIRSTNAME || LASTNAME
```

That expression is equivalent to the first one in the following list but not the second one:

```
(PRIOR FIRSTNAME) || LASTNAME
PRIOR (FIRSTNAME || LASTNAME)
```

If you specify the PRIOR operator outside a CONNECT BY clause of a hierarchical query, SQLSTATE 428H4 is returned.

Example

- The following query returns the hierarchy of departments in the DEPARTMENT table:

```
SELECT LEVEL, DEPTNAME
FROM DEPARTMENT START WITH DEPTNO = 'A00'
CONNECT BY NOCYCLE PRIOR DEPTNO = ADMRDEPT
```

This query returns the following results:

LEVEL	DEPTNAME
1	SPIFFY COMPUTER SERVICE DIV.
2	PLANNING
2	INFORMATION CENTER
2	DEVELOPMENT CENTER
3	MANUFACTURING SYSTEMS
3	ADMINISTRATION SYSTEMS
2	SUPPORT SERVICES
3	OPERATIONS
3	SOFTWARE SUPPORT
3	BRANCH OFFICE F2
3	BRANCH OFFICE G2
3	BRANCH OFFICE H2
3	BRANCH OFFICE I2
3	BRANCH OFFICE J2

SYS_CONNECT_BY_PATH

The SYS_CONNECT_BY_PATH function builds a string representing a path from the root to a node in hierarchical queries.

►►SYS_CONNECT_BY_PATH(—string-expression1—,—string-expression2—)◄◄

The schema is SYSIBM.

string-expression1

A character string expression that identifies the row. The expression must not include any of the items in the following list; otherwise, the SQLSTATE in parentheses is returned:

- A NEXT VALUE expression for a sequence (SQLSTATE 428F9)
- Any hierarchical query construct, such as the LEVEL pseudocolumn or the CONNECT_BY_ROOT operator (SQLSTATE 428H4)
- An OLAP function (SQLSTATE 428H4)
- An aggregate function (SQLSTATE 428H4)

string-expression2

A constant string that serves as a separator. The expression must not include any of the items in the following list; otherwise, the SQLSTATE in parentheses is returned:

- A NEXT VALUE expression for a sequence (SQLSTATE 428F9)
- Any hierarchical query construct, such as the LEVEL pseudocolumn or the CONNECT_BY_ROOT operator (SQLSTATE 428H4)
- An OLAP function (SQLSTATE 428H4)
- An aggregate function (SQLSTATE 428H4)

The result is a varying-length character string. The length attribute of the result data type is the greater of 1000 and the length attribute of *string-expression1*.

The string for a particular row at pseudocolumn LEVEL *n* is built as follows:

- Step 1 (using the values of the root row from the first intermediate result table H_1):

$path_1 := string-expression2 || string-expression1$

- Step *n* (based on the row from the intermediate result table H_n):

$path_n := path_{n-1} || string-expression2 || string-expression1$

The following rules apply to the SYS_CONTEXT_BY_PATH function:

- If you specify the function outside the context of a hierarchical query, SQLSTATE 428H4 is returned.
- If you use the function in a START WITH clause or a CONNECT BY clause, SQLSTATE 428H4 is returned.

The following example returns the hierarchy of departments in the DEPARTMENT table:

```
SELECT CAST(SYS_CONNECT_BY_PATH(DEPTNAME, '/')
           AS VARCHAR(76)) AS ORG
FROM DEPARTMENT START WITH DEPTNO = 'A00'
CONNECT BY NOCYCLE PRIOR DEPTNO = ADMRDEPT
```

This query returns the following results:

```
ORG
-----
/SPIFFY COMPUTER SERVICE DIV.
/SPIFFY COMPUTER SERVICE DIV./PLANNING
/SPIFFY COMPUTER SERVICE DIV./INFORMATION CENTER
/SPIFFY COMPUTER SERVICE DIV./DEVELOPMENT CENTER
```

```
/SPIFFY COMPUTER SERVICE DIV./DEVELOPMENT CENTER/MANUFACTURING SYSTEMS
/SPIFFY COMPUTER SERVICE DIV./DEVELOPMENT CENTER/ADMINISTRATION SYSTEMS
/SPIFFY COMPUTER SERVICE DIV./SUPPORT SERVICES
/SPIFFY COMPUTER SERVICE DIV./SUPPORT SERVICES/OPERATIONS
/SPIFFY COMPUTER SERVICE DIV./SUPPORT SERVICES/SOFTWARE SUPPORT
/SPIFFY COMPUTER SERVICE DIV./SUPPORT SERVICES/BRANCH OFFICE F2
/SPIFFY COMPUTER SERVICE DIV./SUPPORT SERVICES/BRANCH OFFICE G2
/SPIFFY COMPUTER SERVICE DIV./SUPPORT SERVICES/BRANCH OFFICE H2
/SPIFFY COMPUTER SERVICE DIV./SUPPORT SERVICES/BRANCH OFFICE I2
/SPIFFY COMPUTER SERVICE DIV./SUPPORT SERVICES/BRANCH OFFICE J2
```

Chapter 44. Compatibility database configuration parameters

You can use database configuration parameters to indicate whether the compatibility semantics associated with the certain data types are applied to the connected database.

The compatibility parameters that can be checked are:

date_compat

Indicates whether the DATE data type compatibility semantics that are associated with the TIMESTAMP(0) data type are applied to the connected database.

number_compat

Indicates whether the compatibility semantics that are associated with the NUMBER data type are applied to the connected database.

varchar2_compat

Indicates whether the compatibility semantics that are associated with the VARCHAR2 data type are applied to the connected database.

The value of each of these parameters is determined at database creation time, and is based on the setting of the **DB2_COMPATIBILITY_VECTOR** registry variable. You cannot change the value.

Chapter 45. ROWNUM pseudocolumn

Any unresolved and unqualified column reference to the ROWNUM pseudocolumn is converted to the OLAP specification ROW_NUMBER() OVER().

Enablement

You enable ROWNUM pseudocolumn support by setting the **DB2_COMPATIBILITY_VECTOR** registry variable to hexadecimal value 0x01 (bit position 1), and then stop and restart the instance to have the new setting take effect.

```
db2set DB2_COMPATIBILITY_VECTOR=01
db2stop
db2start
```

To take full advantage of the DB2 compatibility features for Oracle applications, the recommended setting for the DB2_COMPATIBILITY_VECTOR is ORA, which sets all of the compatibility bits.

ROWNUM numbers the records in a result set. The first record that meets the WHERE clause criteria in a SELECT statement is given a row number of 1, and every subsequent record meeting that same criteria increases the row number.

Both ROWNUM and ROW_NUMBER() OVER() are allowed in the WHERE clause of a subselect and are useful for restricting the size of a result set. If you use ROWNUM in the WHERE clause and there is an ORDER BY clause in the same subselect, the ordering is applied before the ROWNUM predicate is evaluated. Similarly, if you use the ROW_NUMBER() OVER() function in the WHERE clause and there is an ORDER BY clause in the same subselect, the ordering is applied before the ROW_NUMBER() OVER() function is evaluated. If you use the ROW_NUMBER() OVER() function in the WHERE clause, you cannot specify a window-order-clause or a window-partition-clause.

Before translating an unqualified reference to 'ROWNUM' as ROW_NUMBER() OVER() function, DB2 attempts to resolve the reference to one of the following items:

- A column within the current SQL query
- A local variable
- A routine parameter
- A global variable

Avoid using 'ROWNUM' as a column name or a variable name while ROWNUM pseudocolumn support is enabled.

Example

Assuming that ROWNUM pseudocolumn support is enabled for the connected database, retrieve the 20th to the 40th rows of a result set that is stored in a temporary table.

```
SELECT TEXT FROM SESSION.SEARCHRESULTS
WHERE ROWNUM BETWEEN 20 AND 40
ORDER BY ID
```

Note that ROWNUM is affected by the ORDER BY clause.

Chapter 46. DUAL table

The DB2 data server resolves any unqualified reference to the DUAL table as a built-in view that returns one row and one column that is named DUMMY, whose value is 'X'.

Enablement

You enable DUAL table support by setting of the **DB2_COMPATIBILITY_VECTOR** registry variable to hexadecimal value 0x02 (bit position 2), and then stop and restart the instance to have the new setting take effect.

```
db2set DB2_COMPATIBILITY_VECTOR=02
db2stop
db2start
```

To take full advantage of the DB2 compatibility features for Oracle applications, the recommended setting for the DB2_COMPATIBILITY_VECTOR is ORA, which sets all of the compatibility bits.

Unqualified table references to the DUAL table are resolved as SYSIBM.DUAL.

If a user-defined table named DUAL exists, the DB2 server resolves a table reference to the user-defined table only if the reference is explicitly qualified.

Example 1

Generate a random number by selecting from DUAL.

```
SELECT RAND() AS RANDOM_NUMBER FROM DUAL
```

Example 2

Retrieve the value of the CURRENT SCHEMA special register.

```
SET SCHEMA = MYSCHEMA;
SELECT CURRENT SCHEMA AS CURRENT_SCHEMA FROM DUAL;
```

Chapter 47. Insensitive cursor

You can make cursors insensitive to subsequent statements by materializing the cursor at OPEN time. Statements that are executed while the cursor is open do not affect the result table once all the rows have been materialized in the temporary copy of the result table.

Enablement

You enable insensitive cursors by setting the **DB2_COMPATIBILITY_VECTOR** registry variable to hexadecimal value 0x1000 (bit position 13), and then stop and restart the instance to have the new setting take effect.

```
db2set DB2_COMPATIBILITY_VECTOR=1000
db2stop
db2start
```

To take full advantage of the DB2 compatibility features for Oracle applications, the recommended setting for the **DB2_COMPATIBILITY_VECTOR** is **ORA**, which sets all of the compatibility bits.

When the result set is materialized at OPEN time, the cursor behaves as a read only cursor. All cursors defined as **WITH RETURN** are **INSENSITIVE** as long as they are not explicitly marked as **FOR UPDATE**. If you do not enable insensitive cursor support, there is no guarantee that DB2 cursors will be materialized at OPEN time. Therefore, the result sets that are generated when you run the same query against a DB2 database and a relational database that immediately materializes cursors might be different. For example, Sybase TSQL includes the capability of issuing a query from a batch statement or a procedure that produces a result set for the invoker. The query is materialized immediately. Other statements in the block expect that they cannot affect the result and issue statements, such as **DELETE**, against the same table that was referenced in the query. When a similar scenario is run without an insensitive cursor, the result set from that cursor will be different from the Sybase result.

Insensitive cursors are supported as follows:

- You can define a cursor as **INSENSITIVE** in a **DECLARE CURSOR** statement that is used in a compound SQL (compiled) statement.
- If you bind a package with the **STATICREADONLY INSENSITIVE** parameter of the **BIND** command, all read-only and ambiguous cursors are insensitive.
- If you specify the **STATICREADONLY INSENSITIVE** option for the **DB2_SQLROUTINE_PREPOPTS** registry variable or the **SET_ROUTINE_OPTS** procedure, at OPEN time, SQL routines materialize all-read only and ambiguous cursors that are issued as static SQL.

Restrictions

The **INSENSITIVE** keyword is not supported by any of the precompilers. CLI and JDBC do not provide support for identifying insensitive nonscrollable cursors (either cursor attributes or result set attributes).

Example

This code returns the entire result set of the SELECT statement to the client before executing the DELETE statement.

```
BEGIN
  DECLARE res INSENSITIVE CURSOR WITH RETURN TO CLIENT FOR
    SELECT * FROM T;
  OPEN T;
  DELETE FROM T;
END
```

Chapter 48. INOUT parameters

You can define the INOUT parameter for a procedure to have a default value, by using the DEFAULT keyword.

Enablement

You enable INOUT parameter support by setting the **DB2_COMPATIBILITY_VECTOR** registry variable to hexadecimal value 0x2000 (bit position 14), and then stop and restart the instance to have the new setting take effect.

```
db2set DB2_COMPATIBILITY_VECTOR=2000
db2stop
db2start
```

To take full advantage of the DB2 compatibility features for Oracle applications, the recommended setting for the DB2_COMPATIBILITY_VECTOR is ORA, which sets all of the compatibility bits.

An INOUT parameter is both an input and an output parameter. You can use the DEFAULT keyword to define the default value for an INOUT parameter as either an expression or NULL. If you then invoke the procedure by specifying DEFAULT or no argument for the parameter, the default value that you defined for the parameter is used to initialize it. No value is returned for this parameter when the procedure exits.

Restrictions

The DEFAULT keyword is not supported for INOUT parameters in functions.

Example

The following code creates a procedure with optional INOUT parameters:

```
CREATE OR REPLACE PROCEDURE paybonus
  (IN empid INTEGER,
  IN percentbonus DECIMAL(2, 2),
  INOUT budget DECFLOAT DEFAULT NULL)
  ...
```

The procedure computes the amount of bonus from the employee's salary, issues the bonus, and then deducts the bonus from the departmental budget. If no budget is specified for the procedure, then the deduction portion is ignored. Examples of how to invoke the procedure follow:

```
CALL paybonus(12, 0.05, 50000);
CALL paybonus(12, 0.05, DEFAULT);
CALL paybonus(12, 0.05);
```

Chapter 49. Currently committed semantics

Under *currently committed* semantics, only committed data is returned to readers. However, readers do not wait for writers to release row locks. Instead, readers return data that is based on the currently committed version of data: that is, the version of the data before the start of the write operation.

Lock timeouts and deadlocks can occur under the cursor stability (CS) isolation level with row-level locking, especially with applications that are not designed to prevent such problems. Some high-throughput database applications cannot tolerate waiting on locks that are issued during transaction processing. Also, some applications cannot tolerate processing uncommitted data but still require non-blocking behavior for read transactions.

Currently committed semantics are turned on by default for new databases. You do not have to make application changes to take advantage of the new behavior. To override the default behavior, set the **cur_commit** database configuration parameter to **DISABLED**. Overriding the behavior might be useful, for example, if applications require the blocking of writers to synchronize internal logic. During database upgrade from V9.5 or earlier, the **cur_commit** configuration parameter is set to **DISABLED** to maintain the same behavior as in previous releases. If you want to use currently committed on cursor stability scans, you need to set the **cur_commit** configuration parameter to **ON** after the upgrade.

Currently committed semantics apply only to read-only scans that do not involve catalog tables and internal scans that are used to evaluate or enforce constraints. Because currently committed semantics are decided at the scan level, the access plan of a writer might include currently committed scans. For example, the scan for a read-only subquery can involve currently committed semantics.

Because currently committed semantics obey isolation level semantics, applications running under currently committed semantics continue to respect isolation levels.

Currently committed semantics require increased log space for writers. Additional space is required for logging the first update of a data row during a transaction. This data is required for retrieving the currently committed image of the row. Depending on the workload, this can have an insignificant or measurable impact on the total log space used. The requirement for additional log space does not apply when **cur_commit** database configuration parameter is set to **DISABLED**.

Restrictions

The following restrictions apply to currently committed semantics:

- The target table object in a section that is to be used for data update or deletion operations does not use currently committed semantics. Rows that are to be modified must be lock protected to ensure that they do not change after they have satisfied any query predicates that are part of the update operation.
- A transaction that makes an uncommitted modification to a row forces the currently committed reader to access appropriate log records to determine the currently committed version of the row. Although log records that are no longer in the log buffer can be physically read, currently committed semantics do not support the retrieval of log files from the log archive. This affects only databases that you configure to use infinite logging.

- The following scans do not use currently committed semantics:
 - Catalog table scans
 - Scans that are used to enforce referential integrity constraints
 - Scans that reference LONG VARCHAR or LONG VARGRAPHIC columns
 - Range-clustered table (RCT) scans
 - Scans that use spatial or extended indexes

Example

Consider the following scenario, in which deadlocks are avoided by using currently committed semantics. In this scenario, two applications update two separate tables, as shown in step 1, but do not yet commit. Each application then attempts to use a read-only cursor to read from the table that the other application updated, as shown in step 2. These applications are running under the CS isolation level.

Step	Application A	Application B
1	update T1 set col1 = ? where col2 = ?	update T2 set col1 = ? where col2 = ?
2	select col1, col3, col4 from T2 where col2 >= ?	select col1, col5, from T1 where col5 = ? and col2 = ?
3	commit	commit

Without currently committed semantics, these applications running under the cursor stability isolation level might create a deadlock, causing one of the applications to fail. This happens when each application must read data that is being updated by the other application.

Under currently committed semantics, if one of the applications that is running a query in step 2 requires the data that is being updated by the other application, the first application does not wait for the lock to be released. As a result, a deadlock is impossible. The first application locates and uses the previously committed version of the data instead.

Chapter 50. Oracle data dictionary-compatible views

When you set the **DB2_COMPATIBILITY_VECTOR** registry variable to support Oracle data dictionary-compatible views, the views are automatically created when you create a database.

You enable Oracle data dictionary-compatible view support by setting the **DB2_COMPATIBILITY_VECTOR** registry variable to hexadecimal value 0x400 (bit position 11), and then stop and restart the instance to have the new setting take effect.

```
db2set DB2_COMPATIBILITY_VECTOR=400
db2stop
db2start
```

To take full advantage of the DB2 compatibility features for Oracle applications, the recommended setting for the **DB2_COMPATIBILITY_VECTOR** is **ORA**, which sets all of the compatibility bits.

The data dictionary is a repository for database metadata. The data dictionary views are self-describing. The **DICTIONARY** view returns a listing of all data dictionary views with comments that describe the content of each view. The **DICT_COLUMNS** view returns a list of all columns in all data dictionary views. With these two views, you can determine what information is available and how to access it.

There are three different versions of each data dictionary view, and each version is identified by the prefix of the view name.

- **ALL_*** views return information about objects to which the current user has access.
- **DBA_*** views return information about all objects in the database, regardless of who owns them.
- **USER_*** views return information about objects that are owned by the current database user.

Not all versions apply to each view.

The data dictionary definition includes **CREATE VIEW**, **CREATE PUBLIC SYNONYM**, and **COMMENT** statements for each view that is compatible with the Oracle data dictionary. The views, which are created in the **SYSIBMADM** schema, are listed in Table 40.

Table 40. Oracle data dictionary-compatible views

Category	Defined views
General	DICTIONARY, DICT_COLUMNS USER_CATALOG, DBA_CATALOG, ALL_CATALOG USER_DEPENDENCIES, DBA_DEPENDENCIES, ALL_DEPENDENCIES USER_OBJECTS, DBA_OBJECTS, ALL_OBJECTS USER_SEQUENCES, DBA_SEQUENCES, ALL_SEQUENCES USER_TABLESPACES, DBA_TABLESPACES

Table 40. Oracle data dictionary-compatible views (continued)

Category	Defined views
Tables or views	USER_CONSTRAINTS, DBA_CONSTRAINTS, ALL_CONSTRAINTS USER_CONS_COLUMNS, DBA_CONS_COLUMNS, ALL_CONS_COLUMNS USER_INDEXES, DBA_INDEXES, ALL_INDEXES USER_IND_COLUMNS, DBA_IND_COLUMNS, ALL_IND_COLUMNS USER_TAB_PARTITIONS, DBA_TAB_PARTITIONS, ALL_TAB_PARTITIONS USER_PART_TABLES, DBA_PART_TABLES, ALL_PART_TABLES USER_PART_KEY_COLUMNS, DBA_PART_KEY_COLUMNS, ALL_PART_KEY_COLUMNS USER_SYNONYMS, DBA_SYNONYMS, ALL_SYNONYMS USER_TABLES, DBA_TABLES, ALL_TABLES USER_TAB_COMMENTS, DBA_TAB_COMMENTS, ALL_TAB_COMMENTS USER_TAB_COLUMNS, DBA_TAB_COLUMNS, ALL_TAB_COLUMNS USER_COL_COMMENTS, DBA_COL_COMMENTS, ALL_COL_COMMENTS USER_TAB_COL_STATISTICS, DBA_TAB_COL_STATISTICS, ALL_TAB_COL_STATISTICS USER_VIEWS, DBA_VIEWS, ALL_VIEWS USER_VIEW_COLUMNS, DBA_VIEW_COLUMNS, ALL_VIEW_COLUMNS
Programming objects	USER_PROCEDURES, DBA_PROCEDURES, ALL_PROCEDURES USER_SOURCE, DBA_SOURCE, ALL_SOURCE USER_TRIGGERS, DBA_TRIGGERS, ALL_TRIGGERS USER_ERRORS, DBA_ERRORS, ALL_ERRORS USER_ARGUMENTS, DBA_ARGUMENTS, ALL_ARGUMENTS
Security	USER_ROLE_PRIVS, DBA_ROLE_PRIVS, ROLE_ROLE_PRIVS SESSION_ROLES USER_SYS_PRIVS, DBA_SYS_PRIVS, ROLE_SYS_PRIVS SESSION_PRIVS USER_TAB_PRIVS, DBA_TAB_PRIVS, ALL_TAB_PRIVS, ROLE_TAB_PRIVS USER_TAB_PRIVS_MADE, ALL_TAB_PRIVS_MADE USER_TAB_PRIVS_RECD, ALL_TAB_PRIVS_RECD DBA_ROLES

Examples

The following examples show how to enable, get information about, and use data dictionary-compatible views for a database that is named MYDB:

- Enable the creation of data dictionary-compatible views:

```
db2set DB2_COMPATIBILITY_VECTOR=ORA
db2stop
db2start
db2 create db mydb
```
- Determine what data dictionary-compatible views are available:

```
connect to mydb
select * from dictionary
```
- Use the USER_SYS_PRIVS view to show all the system privileges that the current user has been granted:

```
connect to mydb
select * from user_sys_privs
```
- Determine the column definitions for the DBA_TABLES view:

```
connect to mydb
describe select * from dba_tables
```

Chapter 51. Oracle database link syntax

When you set the `DB2_COMPATIBILITY_VECTOR` registry variable to support Oracle database link syntax, you can connect with a remote database, table, or view.

Enablement

You enable Oracle database link syntax support by setting the `DB2_COMPATIBILITY_VECTOR` registry variable to hexadecimal value `0x20000` (bit position 18), and then stop and restart the instance to have the new setting take effect.

```
db2set DB2_COMPATIBILITY_VECTOR=20000
db2stop
db2start
```

To take full advantage of the DB2 compatibility features for Oracle applications, the recommended setting for the `DB2_COMPATIBILITY_VECTOR` is `ORA`, which sets all of the compatibility bits.

The database link syntax uses the `@` (at sign) to indicate an in or membership condition. For example, to access a remote object `pencils` under schema `user` using a database link to `stock`, you can use:

```
SELECT * FROM user.pencils@stock;
```

Note: The DB2 system supports the use of the `@` character as a valid character in an ordinary identifier. For example, you can create a table with `pencils@stock` as its name. When database link support is enabled, the `@` character is treated as a special delimiter in table, view, and column references. If you want to use `@` in database object names when link support is enabled, you must enclose the name with double quotes.

Example

Remote object references are formatted as:

```
<schema_name>,<object_name>@<server_name>
```

Column references can also be included:

```
<schema_name>,<object_name>,<column_name>@<server_name>
```

The following `SELECT` statements query a remote table named `EMPLOYEE`:

```
SELECT birthdate FROM rschema.employee@sudb WHERE firstname='SAM'
SELECT rschema.employee.birthdate@sudb FROM rschema.employee@sudb
WHERE rschema.employee.firstname@sudb ='SAM'
```

You can also issue `UPDATE`, `INSERT`, and `DELETE` statements against a remote table:

```
UPDATE rschema.employee@sudb SET firstname='MARY'
INSERT INTO rschema.employee@sudb VALUES ('Bob')
DELETE FROM rschema.employee@sudb
```

Chapter 52. Terminology mapping: Oracle to DB2 products

Because Oracle applications can be enabled to work with DB2 data servers when the DB2 environment is set up appropriately, it is important to understand how certain Oracle concepts map to DB2 concepts.

This section provides an overview of the data management concepts used by Oracle, and the similarities or differences between these concepts and those used by the DB2 product. Table 41 provides a concise summary of commonly used Oracle terms and their DB2 equivalents.

Table 41. Mapping of common Oracle concepts to DB2 concepts

Oracle concept	DB2 concept	Notes
active log	active log	The concepts are the same.
actual parameter	argument	The concepts are the same.
alert log	db2diag log files and administration notification log	The db2diag log files are primarily intended for use by IBM Software Support for troubleshooting. The administration notification log is primarily intended for use by database and system administrators for troubleshooting. Administration notification log messages are also logged in the db2diag log files, using a standardized message format.
archive log	offline archive log	The concepts are the same.
archive log mode	log archiving	The concepts are the same.
background_dump_dest	diagpath	The concepts are the same.
created global temporary table	created global temporary table	The concepts are the same.
cursor sharing	statement concentrator	The concepts are the same.
data block	data page	The concepts are the same.
data buffer cache	buffer pool	The concepts are the same. However, in the DB2 product, you can have as many buffer pools as you like, of any page size.

Table 41. Mapping of common Oracle concepts to DB2 concepts (continued)

Oracle concept	DB2 concept	Notes
data dictionary	system catalog	The DB2 system catalog contains metadata in the form of tables and views. The database manager creates and maintains two sets of system catalog views that are defined on the base system catalog tables: SYSCAT views Read-only views. SYSSTAT views Updatable views that contain statistical information that is used by the optimizer.
data dictionary cache	catalog cache	The concepts are the same.
data file	container	DB2 data is physically stored in containers, which contain objects.
database link	nickname	A nickname is an identifier that refers to an object at a remote data source, that is, a federated database object.
dual table	dual table	The concepts are the same.
dynamic performance views	snapshot monitor SQL administrative views	Snapshot monitor SQL administrative views, which use schema SYSIBMADM, return monitor data about a specific area of the database system. For example, the SYSIBMADM.SNAPBP SQL administrative view provides a snapshot of buffer pool information.
extent	extent	A DB2 extent is made up of a set of contiguous data pages.
formal parameter	parameter	The concepts are the same.
global index	nonpartitioned index	The concepts are the same.
inactive log	online archive log	The concepts are the same.

Table 41. Mapping of common Oracle concepts to DB2 concepts (continued)

Oracle concept	DB2 concept	Notes
init.ora file and Server Parameter File (SPFILE)	database manager configuration file and database configuration file	A DB2 instance can contain multiple databases. Therefore, configuration parameters and their values are stored at both the instance level, in the database manager configuration file, and at the database level, in the database configuration file. You manage the database manager configuration file through the GET DBM CFG or UPDATE DBM CFG command. You manage the database configuration file through the GET DB CFG or UPDATE DB CFG command.
instance	instance or database manager	An instance is a combination of background processes and shared memory. A DB2 instance is also known as a database manager.
large pool	utility heap	The utility heap is used by the backup, restore, and load utilities.
library cache	package cache	The package cache, which is allocated from database shared memory, is used to cache sections for static and dynamic SQL and XQuery statements executed on a database.
local index	partitioned index	This is the same concept.
materialized view	materialized query table (MQT)	An MQT is a table whose definition is based on the results of a query and can help improve performance. The DB2 SQL compiler determines whether a query would run more efficiently against an MQT than it would against the base table on which the MQT is based.
noarchive log mode	circular logging	The concepts are the same.

Table 41. Mapping of common Oracle concepts to DB2 concepts (continued)

Oracle concept	DB2 concept	Notes
Oracle Call Interface (OCI) Oracle Call Interface (OCI)	DB2CI	DB2CI is a C and C++ application programming interface that uses function calls to connect to DB2 databases, manage cursors, and perform SQL statements. See Chapter 53, "IBM Data Server Driver for DB2CI," on page 493 for a list of OCI APIs supported by the DB2CI driver.
Oracle Call Interface (OCI) Oracle Call Interface (OCI)	Call Level Interface (CLI)	CLI is a C and C++ application programming interface that uses function calls to pass dynamic SQL statements as function arguments. In most cases, you can replace an OCI function with a CLI function and relevant changes to the supporting program code.
ORACLE_SID environment variable	DB2INSTANCE environment variable	The concepts are the same.
partitioned tables	partitioned tables	The concepts are the same.
Procedural Language/Structured Query Language (PL/SQL)	SQL Procedural Language (SQL PL)	SQL PL is an extension of SQL that consists of statements and other language elements. SQL PL provides statements for declaring variables and condition handlers, assigning values to variables, and implementing procedural logic. SQL PL is a subset of the SQL/Persistent Stored Modules (SQL/PSM) language standard. You can use DB2 interfaces to compile and execute Oracle PL/SQL statements.
program global area (PGA)	application shared memory and agent private memory	Application shared memory stores information that is shared between a database and a particular application: primarily, rows of data that are passed to or from the database. Agent private memory stores information that is used to service a particular application, such as sort heaps, cursor information, and session contexts.

Table 41. Mapping of common Oracle concepts to DB2 concepts (continued)

Oracle concept	DB2 concept	Notes
redo log	transaction log	The transaction log records database transactions. You can use it for recovery.
role	role	The concepts are the same.
segment	storage object	The concepts are the same.
session	session; database connection	The concepts are the same.
startup nomount command	db2start command	The command used to start the instance.
synonym	alias	An alias is an alternative name for a table, a view, a nickname, or another alias. The term <i>synonym</i> can be specified instead of <i>alias</i> . Aliases are not used to control what version of a DB2 procedure or user-defined function is used by an application. To control the version, use the SET PATH statement to add the required schema to the value of the CURRENT PATH special register.
system global area (SGA)	instance shared memory and database shared memory	The instance shared memory stores all of the information for a particular instance, such as lists of all active connections and security information. The database shared memory stores information for a particular database, such as package caches, log buffers, and buffer pools.
SYSTEM table space	SYSCATSPACE table space	The SYSCATSPACE table space contains the system catalog. This table space is created by default when you create a database.
table space	table space	The concepts are the same.
user global area (UGA)	application global memory	Application global memory comprises application shared memory and application-specific memory.

Part 5. DB2CI application development

DB2CI is a callable SQL interface to the DB2 Version 9.7 database servers. It is a 'C' and 'C++' application programming interface for DB2 database access that uses function calls to connect to databases, manage cursors, and perform SQL statements.

Starting with Version 9.7 Fix Pack 1, you can use the DB2CI interface to access databases on DB2 Version 9.7 servers on any of the supported operating systems.

The DB2CI interface provides support for a number of Oracle Call Interface (OCI) APIs. This support reduces the complexity of enabling existing OCI applications so that they work with DB2 databases. The IBM Data Server Driver for DB2CI is the driver for the DB2CI interface.

Chapter 53. IBM Data Server Driver for DB2CI

The IBM Data Server Driver for DB2CI provides support for DB2CI application development.

The IBM Data Server Client includes the DB2CI driver. You need to install this client to install the DB2CI driver.

The DB2CI driver provides support for calls to the following OCI APIs.

Table 42. DB2CI driver support

Supported OCI APIs

OCIAttrGet	OCILobGetLength	OCINumberTan
OCIAttrSet	OCILobIsEqual	OCINumberToInt
OCIBindArrayOfStruct	OCILobIsTemporary	OCINumberToReal
OCIBindByName	OCILobIsOpen	OCINumberToRealArray
OCIBindByPos	OCILobLocatorAssign	OCINumberToText
OCIBindDynamic	OCILobLocatorIsInit	OCINumberTrunc
OCIBreak	OCILobRead	OCIParmGet
OCIClientVersion	OCILobTrim	OCIParmSet
OCIDateAddDays	OCILobWrite	OCIPasswordChange
OCIDateAddMonths	OCILogoff	OCIPing
OCIDateAssign	OCILogon	OCIRawAllocSize
OCIDateCheck	OCILogon2	OCIRawAssignBytes
OCIDateCompare	OCINumberAbs	OCIRawAssignRaw
OCIDateDaysBetween	OCINumberAdd	OCIRawPtr
OCIDateFromText	OCINumberArcCos	OCIRawResize
OCIDateLastDay	OCINumberArcSin	OCIRawSize
OCIDateNextDay	OCINumberArcTan	OCIReset
OCIDateSysDate	OCINumberArcTan2	OCIResultSetToStmt
OCIDateToText	OCINumberAssign	OCIServerAttach
OCIDefineArrayOfStruct	OCINumberCeil	OCIServerDetach
OCIDefineByPos	OCINumberCmp	OCIServerVersion
OCIDefineDynamic	OCINumberCos	OCISessionBegin
OCIDescribeAny	OCINumberDec	OCISessionEnd
OCIDescriptorAlloc	OCINumberDiv	OCISessionGet
OCIDescriptorFree	OCINumberExp	OCISessionRelease
OCIEnvCreate	OCINumberFloor	OCISstmtExecute
OCIEnvInit	OCINumberFromInt	OCISstmtFetch
OCIErrorGet	OCINumberFromReal	OCISstmtFetch2
OCIFileClose	OCINumberFromText	OCISstmtGetBindInfo
OCIFileExists	OCINumberHypCos	OCISstmtGetPieceInfo

Table 42. DB2CI driver support (continued)

Supported OCI APIs		
OCIFileFlush	OCINumberHypSin	OCIStmtPrepare
OCIFileGetLength	OCINumberHypTan	OCIStmtPrepare2
OCIFileInit	OCINumberInc	OCIStmtRelease
OCIFileOpen	OCINumberIntPower	OCIStmtSetPieceInfo
OCIFileRead	OCINumberIsInt	OCIStringAllocSize
OCIFileSeek	OCINumberIsZero	OCIStringAssign
OCIFileTerm	OCINumberLn	OCIStringAssignText
OCIFileWrite	OCINumberLog	OCIStringPtr
OCIHandleAlloc	OCINumberMod	OCIStringResize
OCIHandleFree	OCINumberMul	OCIStringSize
OCIInitialize	OCINumberNeg	OCITerminate
OCILobAppend	OCINumberPower	OCITransCommit
OCILobAssign	OCINumberPrec	OCITransDetach
OCILobClose	OCINumberRound	OCITransForget
OCILobCopy	OCINumberSetPi	OCITransMultiPrepare
OCILobCreateTemporary	OCINumberSetZero	OCITransPrepare
OCILobDisableBuffering	OCINumberShift	OCITransRollback
OCILobEnableBuffering	OCINumberSign	OCITransStart
OCILobErase	OCINumberSin	xaoEnv
OCILobFreeTemporary	OCINumberSqrt	xaosterr
OCILobFlushBuffer	OCINumberSub	xaoSvcCtx

Chapter 54. Building DB2CI applications

You can build DB2CI applications using an existing Oracle Call Interface (OCI) application and the **bldapp** script file.

Before you begin

- You must have a DB2 database with the same structure as the Oracle database used by your existing OCI application.
- You must have installed the IBM Data Server Client.

About this task

DB2 samples provides a script called **bldapp** for compiling and linking applications that use OCI functions supported by the IBM Data Server Driver for DB2CI. It is located in the *DB2DIR\samples\db2ci* or *DB2DIR/samples/db2ci* directories, along with sample programs. *DB2DIR* represents the location where your DB2 copy is installed.

The **bldapp** script file takes up to four parameters. The first parameter, \$1, specifies the name of your source file. The additional parameters are only required to build embedded SQL programs that requires a connection to the database: the second parameter, \$2, specifies the name of the database to which you want to connect; the third parameter, \$3, specifies the user ID for the database, and \$4 specifies the password. If the program contains embedded SQL, indicated by the `.sql` extension, then the **embprep** script is called to precompile the program, producing a program file with a `.c` extension.

Restriction

- Ensure that your existing OCI application only has calls to OCI functions supported by the DB2CI driver. See Chapter 53, “IBM Data Server Driver for DB2CI,” on page 493 for a complete list of supported OCI functions.

Procedure

1. If you are building your DB2CI application using an existing OCI application, ensure that you specify the `db2ci.h` include file.
2. Build your DB2CI application with the **bldapp** script file. The following example shows how to build the sample program `tbinfo` from the source file `tbinfo.c` on Linux and UNIX operating systems:

```
cd $INSTHOME/sqllib/samples/db2ci
bldapp tbinfo
```

The result is an executable file, `tbinfo`.

3. Run the executable file generated in the previous step by entering the executable name as follows:

```
tbinfo
```

DB2CI application compile and link options (AIX)

The compile and link options in this topic are recommended for building DB2CI applications with the AIX® IBM C compiler.

You can find the following options in the *DB2DIR/samples/cli/bldapp* batch file, where *DB2DIR* is the location where your DB2 copy is installed.

Compile options:

- x1c** The IBM C compiler.
- \$EXTRA_CFLAG**
Contains the value "-q64" for 64-bit environments; otherwise, contains no value.
- I\$DB2PATH/include**
Specify the location of the DB2 include files. For example:
\$HOME/sql1lib/include
- c** Perform compile only; no link. This script has separate compile and link steps.

Link options:

- x1c** Use the compiler as a front end for the linker.
- \$EXTRA_CFLAG**
Contains the value "-q64" for 64-bit environments; otherwise, contains no value.
- o \$1** Specify the executable program.
- \$1.o** Specify the object file.
- utilci.o**
Include the utility object file for error checking.
- L\$DB2PATH/\$LIB**
Specify the location of the DB2 runtime shared libraries. For example: \$HOME/sql1lib/\$LIB. If you do not specify the -L option, the compiler assumes the following path: /usr/lib:/lib.
- ldb2ci**
Link with the DB2CI library.

DB2CI application compile and link options (HP-UX)

The compile and link options in this topic are recommended for building DB2CI applications with the HP-UX C compiler.

You can find the following options in the *DB2DIR/samples/db2ci/bldapp* batch file, where *DB2DIR* is the location where your DB2 copy is installed.

Compile options:

- cc** Use the C compiler.
- \$EXTRA_CFLAG**
If the HP-UX platform is IA64 and 64-bit support is enabled, this flag contains the value **+DD64**; if 32-bit support is enabled, it contains the value **+DD32**. If the HP-UX platform is PA-RISC and 64-bit support is enabled, it contains the value **+DA2.0W**. For 32-bit support on a PA-RISC platform, this flag contains the value **+DA2.0N**.
 - +DD64** Must be used to generate 64-bit code for HP-UX on IA64.
 - +DD32** Must be used to generate 32-bit code for HP-UX on IA64.

+DA2.0W

Must be used to generate 64-bit code for HP-UX on PA-RISC.

+DA2.0N

Must be used to generate 32-bit code for HP-UX on PA-RISC.

-Ae Enables HP ANSI extended mode.

-I\$DB2PATH/include

Specify the location of the DB2 include files. For example:
\$HOME/sql1lib/include

-c Perform compile only; no link. Compile and link are separate steps.

Link options:

cc Use the compiler as a front end for the linker.

\$EXTRA_CFLAG

If the HP-UX platform is IA64 and 64-bit support is enabled, this flag contains the value **+DD64**; if 32-bit support is enabled, it contains the value **+DD32**. If the HP-UX platform is PA-RISC and 64-bit support is enabled, it contains the value **+DA2.0W**. For 32-bit support on a PA-RISC platform, this flag contains the value **+DA2.0N**.

+DD64 Must be used to generate 64-bit code for HP-UX on IA64.

+DD32 Must be used to generate 32-bit code for HP-UX on IA64.

+DA2.0W

Must be used to generate 64-bit code for HP-UX on PA-RISC.

+DA2.0N

Must be used to generate 32-bit code for HP-UX on PA-RISC.

-o \$1 Specify the executable program.

\$1.o Specify the object file.

utilci.o

Include the utility object file for error checking.

\$EXTRA_LFLAG

Specify the runtime path. If set, for 32-bit it contains the value **-Wl,+b\$HOME/sql1lib/lib32**, and for 64-bit: **-Wl,+b\$HOME/sql1lib/lib64**. If not set, it contains no value.

-L\$DB2PATH/\$LIB

Specify the location of the DB2 runtime shared libraries. For 32-bit: **\$HOME/sql1lib/lib32**; for 64-bit: **\$HOME/sql1lib/lib64**.

-ldb2ci

Link with the DB2CI library.

DB2CI application compile and link options (Linux)

The compile and link options in this topic are recommended for building DB2CI applications with the GNU/Linux gcc compiler.

You can find the following options in the *DB2DIR/samples/db2ci/bldapp* batch file, where *DB2DIR* is the location where your DB2 copy is installed.

Compile options:

gcc The C compiler.

\$EXTRA_C_FLAGS

Contains one of the following:

- **-m31** on Linux for zSeries® only, to build a 32-bit library;
- **-m32** on Linux for x86, x64 and POWER®, to build a 32-bit library;
- **-m64** on Linux for zSeries, POWER, x64, to build a 64-bit library; or
- No value on Linux for IA64, to build a 64-bit library.

-I\$DB2PATH/include

Specify the location of the DB2 include files. For example:
`$HOME/sql1lib/include`

-c Perform compile only; no link. Compile and link are separate steps.

Link options:

gcc Use the compiler as a front end for the linker.

\$EXTRA_C_FLAGS

Contains one of the following:

- **-m31** on Linux for zSeries only, to build a 32-bit library;
- **-m32** on Linux for x86, x64 and POWER, to build a 32-bit library;
- **-m64** on Linux for zSeries, POWER, x64, to build a 64-bit library; or
- No value on Linux for IA64, to build a 64-bit library.

-o \$1 Specify the executable.

\$1.o Include the program object file.

utilci.o

Include the utility object file for error checking.

\$EXTRA_LFLAG

For 32-bit it contains the value `"-Wl,-rpath,$DB2PATH/lib32"`, and for 64-bit it contains the value `"-Wl,-rpath,$DB2PATH/lib64"`.

-L\$DB2PATH/\$LIB

Specify the location of the DB2 static and shared libraries at link-time. For example, for 32-bit: `$HOME/sql1lib/lib32`, and for 64-bit: `$HOME/sql1lib/lib64`.

-ldb2ci

Link with the DB2CI library.

DB2CI application compile and link options (Solaris)

The compile and link options in this topic are recommended for building DB2CI applications with the the Solaris C compiler.

You can find the following options in the *DB2DIR/samples/db2ci/bldapp* batch file, where *DB2DIR* is the location where your DB2 copy is installed.

Compile options:

- cc** Use the C compiler.
- xarch=\$CFLAG_ARCH**
This option ensures that the compiler will produce valid executables when linking with libdb2.so. The value for \$CFLAG_ARCH is set as follows:
- "v8plusa" for 32-bit applications on Solaris SPARC
 - "v9" for 64-bit applications on Solaris SPARC
 - "sse2" for 32-bit applications on Solaris x64
 - "amd64" for 64-bit applications on Solaris x64
- I\$DB2PATH/include**
Specify the location of the DB2 include files. For example:
\$HOME/sql1lib/include
- c** Perform compile only; no link. This script has separate compile and link steps.

Link options:

- cc** Use the compiler as a front end for the linker.
- xarch=\$CFLAG_ARCH**
This option ensures that the compiler will produce valid executables when linking with libdb2.so. The value for \$CFLAG_ARCH is set to either "v8plusa" for 32-bit, or "v9" for 64-bit.
- mt** Link in multi-thread support to prevent problems calling fopen.
- Note:** If POSIX threads are used, DB2 applications also have to link with -lpthread, whether or not they are threaded.
- o \$1** Specify the executable program.
- \$1.o** Include the program object file.
- utilci.o**
Include the utility object file for error checking.
- L\$DB2PATH/\$LIB**
Specify the location of the DB2 static and shared libraries at link-time. For example, for 32-bit: \$HOME/sql1lib/lib32, and for 64-bit: \$HOME/sql1lib/lib64
- \$EXTRA_LFLAG**
Specify the location of the DB2 shared libraries at run-time. For 32-bit it contains the value "-R\$DB2PATH/lib32", and for 64-bit it contains the value "-R\$DB2PATH/lib64".
- ldb2ci**
Link with the DB2CI library.

DB2CI application compile and link options (Windows)

The compile and link options in this topic are recommended for building DB2CI applications with the Microsoft Visual C++ compiler.

You can find the following options in the *DB2DIR*\samples\db2ci\bl1dapp.bat batch file, where *DB2DIR* is the location where your DB2 copy is installed.

Compile options:

%BLDCOMP%

Variable for the compiler. The default is `cl`, the Microsoft Visual C++ compiler. It can be also set to `icl`, the Intel C++ Compiler for 32-bit and 64-bit applications, or `ec1`, the Intel C++ Compiler for Itanium 64-bit applications.

-Zi Enable debugging information.

-Od Disable optimizations. It is easier to use a debugger with optimization off.

-c Perform compile only; no link.

-W2 Set warning level.

-DWIN32

Compiler option necessary for Windows operating systems.

Link options:

link Use the linker.

-debug Include debugging information.

-out:%1.exe
Specify the executable.

%1.obj Include the object file.

db2ci.lib or db2ci64.lib

Link to the DB2CI library. For Windows 32-bit operating systems, use `db2ci.lib`. For Windows 64-bit operating systems, use `db2ci64.lib`.

Refer to your compiler documentation for additional compiler options.

Part 6. Appendixes

Appendix A. Overview of the DB2 technical information

DB2 technical information is available in multiple formats that can be accessed in multiple ways.

DB2 technical information is available through the following tools and methods:

- DB2 Information Center
 - Topics (Task, concept and reference topics)
 - Sample programs
 - Tutorials
- DB2 books
 - PDF files (downloadable)
 - PDF files (from the DB2 PDF DVD)
 - printed books
- Command-line help
 - Command help
 - Message help

Note: The DB2 Information Center topics are updated more frequently than either the PDF or the hardcopy books. To get the most current information, install the documentation updates as they become available, or refer to the DB2 Information Center at ibm.com.

You can access additional DB2 technical information such as technotes, white papers, and IBM Redbooks® publications online at [ibm.com](http://www.ibm.com). Access the DB2 Information Management software library site at <http://www.ibm.com/software/data/sw-library/>.

Documentation feedback

We value your feedback on the DB2 documentation. If you have suggestions for how to improve the DB2 documentation, send an email to db2docs@ca.ibm.com. The DB2 documentation team reads all of your feedback, but cannot respond to you directly. Provide specific examples wherever possible so that we can better understand your concerns. If you are providing feedback on a specific topic or help file, include the topic title and URL.

Do not use this email address to contact DB2 Customer Support. If you have a DB2 technical issue that the documentation does not resolve, contact your local IBM service center for assistance.

DB2 technical library in hardcopy or PDF format

The following tables describe the DB2 library available from the IBM Publications Center at www.ibm.com/e-business/linkweb/publications/servlet/pbi.wss. English and translated DB2 Version 10.1 manuals in PDF format can be downloaded from www.ibm.com/support/docview.wss?rs=71&uid=swg27009474.

Although the tables identify books available in print, the books might not be available in your country or region.

The form number increases each time a manual is updated. Ensure that you are reading the most recent version of the manuals, as listed below.

Note: The *DB2 Information Center* is updated more frequently than either the PDF or the hard-copy books.

Table 43. DB2 technical information

Name	Form Number	Available in print	Last updated
<i>Administrative API Reference</i>	SC27-3864-00	Yes	April, 2012
<i>Administrative Routines and Views</i>	SC27-3865-01	No	January, 2013
<i>Call Level Interface Guide and Reference Volume 1</i>	SC27-3866-01	Yes	January, 2013
<i>Call Level Interface Guide and Reference Volume 2</i>	SC27-3867-01	Yes	January, 2013
<i>Command Reference</i>	SC27-3868-01	Yes	January, 2013
<i>Database Administration Concepts and Configuration Reference</i>	SC27-3871-01	Yes	January, 2013
<i>Data Movement Utilities Guide and Reference</i>	SC27-3869-01	Yes	January, 2013
<i>Database Monitoring Guide and Reference</i>	SC27-3887-01	Yes	January, 2013
<i>Data Recovery and High Availability Guide and Reference</i>	SC27-3870-01	Yes	January, 2013
<i>Database Security Guide</i>	SC27-3872-01	Yes	January, 2013
<i>DB2 Workload Management Guide and Reference</i>	SC27-3891-01	Yes	January, 2013
<i>Developing ADO.NET and OLE DB Applications</i>	SC27-3873-01	Yes	January, 2013
<i>Developing Embedded SQL Applications</i>	SC27-3874-01	Yes	January, 2013
<i>Developing Java Applications</i>	SC27-3875-01	Yes	January, 2013
<i>Developing Perl, PHP, Python, and Ruby on Rails Applications</i>	SC27-3876-00	No	April, 2012
<i>Developing RDF Applications for IBM Data Servers</i>	SC27-4462-00	Yes	January, 2013
<i>Developing User-defined Routines (SQL and External)</i>	SC27-3877-01	Yes	January, 2013
<i>Getting Started with Database Application Development</i>	GI13-2046-01	Yes	January, 2013

Table 43. DB2 technical information (continued)

Name	Form Number	Available in print	Last updated
<i>Getting Started with DB2 Installation and Administration on Linux and Windows</i>	GI13-2047-00	Yes	April, 2012
<i>Globalization Guide</i>	SC27-3878-00	Yes	April, 2012
<i>Installing DB2 Servers</i>	GC27-3884-01	Yes	January, 2013
<i>Installing IBM Data Server Clients</i>	GC27-3883-00	No	April, 2012
<i>Message Reference Volume 1</i>	SC27-3879-01	No	January, 2013
<i>Message Reference Volume 2</i>	SC27-3880-01	No	January, 2013
<i>Net Search Extender Administration and User's Guide</i>	SC27-3895-01	No	January, 2013
<i>Partitioning and Clustering Guide</i>	SC27-3882-01	Yes	January, 2013
<i>Preparation Guide for DB2 10.1 Fundamentals Exam 610</i>	SC27-4540-00	No	January, 2013
<i>Preparation Guide for DB2 10.1 DBA for Linux, UNIX, and Windows Exam 611</i>	SC27-4541-00	No	January, 2013
<i>pureXML Guide</i>	SC27-3892-01	Yes	January, 2013
<i>Spatial Extender User's Guide and Reference</i>	SC27-3894-00	No	April, 2012
<i>SQL Procedural Languages: Application Enablement and Support</i>	SC27-3896-01	Yes	January, 2013
<i>SQL Reference Volume 1</i>	SC27-3885-01	Yes	January, 2013
<i>SQL Reference Volume 2</i>	SC27-3886-01	Yes	January, 2013
<i>Text Search Guide</i>	SC27-3888-01	Yes	January, 2013
<i>Troubleshooting and Tuning Database Performance</i>	SC27-3889-01	Yes	January, 2013
<i>Upgrading to DB2 Version 10.1</i>	SC27-3881-01	Yes	January, 2013
<i>What's New for DB2 Version 10.1</i>	SC27-3890-01	Yes	January, 2013
<i>XQuery Reference</i>	SC27-3893-01	No	January, 2013

Table 44. DB2 Connect-specific technical information

Name	Form Number	Available in print	Last updated
<i>DB2 Connect Installing and Configuring DB2 Connect Personal Edition</i>	SC27-3861-00	Yes	April, 2012

Table 44. DB2 Connect-specific technical information (continued)

Name	Form Number	Available in print	Last updated
DB2 Connect Installing and Configuring DB2 Connect Servers	SC27-3862-01	Yes	January, 2013
DB2 Connect User's Guide	SC27-3863-01	Yes	January, 2013

Displaying SQL state help from the command line processor

DB2 products return an SQLSTATE value for conditions that can be the result of an SQL statement. SQLSTATE help explains the meanings of SQL states and SQL state class codes.

Procedure

To start SQL state help, open the command line processor and enter:

```
? sqlstate or ? class code
```

where *sqlstate* represents a valid five-digit SQL state and *class code* represents the first two digits of the SQL state.

For example, ? 08003 displays help for the 08003 SQL state, and ? 08 displays help for the 08 class code.

Accessing different versions of the DB2 Information Center

Documentation for other versions of DB2 products is found in separate information centers on ibm.com[®].

About this task

For DB2 Version 10.1 topics, the *DB2 Information Center* URL is <http://publib.boulder.ibm.com/infocenter/db2luw/v10r1>.

For DB2 Version 9.8 topics, the *DB2 Information Center* URL is <http://publib.boulder.ibm.com/infocenter/db2luw/v9r8/>.

For DB2 Version 9.7 topics, the *DB2 Information Center* URL is <http://publib.boulder.ibm.com/infocenter/db2luw/v9r7/>.

For DB2 Version 9.5 topics, the *DB2 Information Center* URL is <http://publib.boulder.ibm.com/infocenter/db2luw/v9r5>.

For DB2 Version 9.1 topics, the *DB2 Information Center* URL is <http://publib.boulder.ibm.com/infocenter/db2luw/v9/>.

For DB2 Version 8 topics, go to the *DB2 Information Center* URL at: <http://publib.boulder.ibm.com/infocenter/db2luw/v8/>.

Updating the DB2 Information Center installed on your computer or intranet server

A locally installed DB2 Information Center must be updated periodically.

Before you begin

A DB2 Version 10.1 Information Center must already be installed. For details, see the “Installing the DB2 Information Center using the DB2 Setup wizard” topic in *Installing DB2 Servers*. All prerequisites and restrictions that applied to installing the Information Center also apply to updating the Information Center.

About this task

An existing DB2 Information Center can be updated automatically or manually:

- Automatic updates update existing Information Center features and languages. One benefit of automatic updates is that the Information Center is unavailable for a shorter time compared to during a manual update. In addition, automatic updates can be set to run as part of other batch jobs that run periodically.
- Manual updates can be used to update existing Information Center features and languages. Automatic updates reduce the downtime during the update process, however you must use the manual process when you want to add features or languages. For example, a local Information Center was originally installed with both English and French languages, and now you want to also install the German language; a manual update will install German, as well as, update the existing Information Center features and languages. However, a manual update requires you to manually stop, update, and restart the Information Center. The Information Center is unavailable during the entire update process. In the automatic update process the Information Center incurs an outage to restart the Information Center after the update only.

This topic details the process for automatic updates. For manual update instructions, see the “Manually updating the DB2 Information Center installed on your computer or intranet server” topic.

Procedure

To automatically update the DB2 Information Center installed on your computer or intranet server:

1. On Linux operating systems,
 - a. Navigate to the path where the Information Center is installed. By default, the DB2 Information Center is installed in the `/opt/ibm/db2ic/V10.1` directory.
 - b. Navigate from the installation directory to the `doc/bin` directory.
 - c. Run the `update-ic` script:

```
update-ic
```
2. On Windows operating systems,
 - a. Open a command window.
 - b. Navigate to the path where the Information Center is installed. By default, the DB2 Information Center is installed in the `<Program Files>\IBM\DB2 Information Center\Version 10.1` directory, where `<Program Files>` represents the location of the Program Files directory.
 - c. Navigate from the installation directory to the `doc\bin` directory.
 - d. Run the `update-ic.bat` file:

```
update-ic.bat
```

Results

The DB2 Information Center restarts automatically. If updates were available, the Information Center displays the new and updated topics. If Information Center updates were not available, a message is added to the log. The log file is located in `doc\eclipse\configuration` directory. The log file name is a randomly generated number. For example, `1239053440785.log`.

Manually updating the DB2 Information Center installed on your computer or intranet server

If you have installed the DB2 Information Center locally, you can obtain and install documentation updates from IBM.

About this task

Updating your locally installed *DB2 Information Center* manually requires that you:

1. Stop the *DB2 Information Center* on your computer, and restart the Information Center in stand-alone mode. Running the Information Center in stand-alone mode prevents other users on your network from accessing the Information Center, and allows you to apply updates. The Workstation version of the DB2 Information Center always runs in stand-alone mode. .
2. Use the Update feature to see what updates are available. If there are updates that you must install, you can use the Update feature to obtain and install them

Note: If your environment requires installing the *DB2 Information Center* updates on a machine that is not connected to the internet, mirror the update site to a local file system by using a machine that is connected to the internet and has the *DB2 Information Center* installed. If many users on your network will be installing the documentation updates, you can reduce the time required for individuals to perform the updates by also mirroring the update site locally and creating a proxy for the update site.

If update packages are available, use the Update feature to get the packages. However, the Update feature is only available in stand-alone mode.

3. Stop the stand-alone Information Center, and restart the *DB2 Information Center* on your computer.

Note: On Windows 2008, Windows Vista (and higher), the commands listed later in this section must be run as an administrator. To open a command prompt or graphical tool with full administrator privileges, right-click the shortcut and then select **Run as administrator**.

Procedure

To update the *DB2 Information Center* installed on your computer or intranet server:

1. Stop the *DB2 Information Center*.
 - On Windows, click **Start > Control Panel > Administrative Tools > Services**. Then right-click **DB2 Information Center** service and select **Stop**.
 - On Linux, enter the following command:

```
/etc/init.d/db2icdv10 stop
```
2. Start the Information Center in stand-alone mode.
 - On Windows:
 - a. Open a command window.

- b. Navigate to the path where the Information Center is installed. By default, the *DB2 Information Center* is installed in the *Program_Files\IBM\DB2 Information Center\Version 10.1* directory, where *Program_Files* represents the location of the Program Files directory.
- c. Navigate from the installation directory to the *doc\bin* directory.
- d. Run the *help_start.bat* file:

```
help_start.bat
```
- On Linux:
 - a. Navigate to the path where the Information Center is installed. By default, the *DB2 Information Center* is installed in the */opt/ibm/db2ic/V10.1* directory.
 - b. Navigate from the installation directory to the *doc/bin* directory.
 - c. Run the *help_start* script:

```
help_start
```

The systems default Web browser opens to display the stand-alone Information Center.

3. Click the **Update** button (🔄). (JavaScript must be enabled in your browser.) On the right panel of the Information Center, click **Find Updates**. A list of updates for existing documentation displays.
4. To initiate the installation process, check that the selections you want to install, then click **Install Updates**.
5. After the installation process has completed, click **Finish**.
6. Stop the stand-alone Information Center:
 - On Windows, navigate to the *doc\bin* directory within the installation directory, and run the *help_end.bat* file:

```
help_end.bat
```

Note: The *help_end* batch file contains the commands required to safely stop the processes that were started with the *help_start* batch file. Do not use **Ctrl-C** or any other method to stop *help_start.bat*.
 - On Linux, navigate to the *doc/bin* directory within the installation directory, and run the *help_end* script:

```
help_end
```

Note: The *help_end* script contains the commands required to safely stop the processes that were started with the *help_start* script. Do not use any other method to stop the *help_start* script.
7. Restart the *DB2 Information Center*.
 - On Windows, click **Start > Control Panel > Administrative Tools > Services**. Then right-click **DB2 Information Center** service and select **Start**.
 - On Linux, enter the following command:

```
/etc/init.d/db2icdv10 start
```

Results

The updated *DB2 Information Center* displays the new and updated topics.

DB2 tutorials

The DB2 tutorials help you learn about various aspects of DB2 database products. Lessons provide step-by-step instructions.

Before you begin

You can view the XHTML version of the tutorial from the Information Center at <http://publib.boulder.ibm.com/infocenter/db2luw/v10r1/>.

Some lessons use sample data or code. See the tutorial for a description of any prerequisites for its specific tasks.

DB2 tutorials

To view the tutorial, click the title.

"pureXML®" in pureXML Guide

Set up a DB2 database to store XML data and to perform basic operations with the native XML data store.

DB2 troubleshooting information

A wide variety of troubleshooting and problem determination information is available to assist you in using DB2 database products.

DB2 documentation

Troubleshooting information can be found in the *Troubleshooting and Tuning Database Performance* or the Database fundamentals section of the *DB2 Information Center*, which contains:

- Information about how to isolate and identify problems with DB2 diagnostic tools and utilities.
- Solutions to some of the most common problem.
- Advice to help solve other problems you might encounter with your DB2 database products.

IBM Support Portal

See the IBM Support Portal if you are experiencing problems and want help finding possible causes and solutions. The Technical Support site has links to the latest DB2 publications, TechNotes, Authorized Program Analysis Reports (APARs or bug fixes), fix packs, and other resources. You can search through this knowledge base to find possible solutions to your problems.

Access the IBM Support Portal at http://www.ibm.com/support/entry/portal/Overview/Software/Information_Management/DB2_for_Linux,_UNIX_and_Windows

Terms and conditions

Permissions for the use of these publications are granted subject to the following terms and conditions.

Applicability: These terms and conditions are in addition to any terms of use for the IBM website.

Personal use: You may reproduce these publications for your personal, noncommercial use provided that all proprietary notices are preserved. You may not distribute, display or make derivative work of these publications, or any portion thereof, without the express consent of IBM.

Commercial use: You may reproduce, distribute and display these publications solely within your enterprise provided that all proprietary notices are preserved. You may not make derivative works of these publications, or reproduce, distribute or display these publications or any portion thereof outside your enterprise, without the express consent of IBM.

Rights: Except as expressly granted in this permission, no other permissions, licenses or rights are granted, either express or implied, to the publications or any information, data, software or other intellectual property contained therein.

IBM reserves the right to withdraw the permissions granted herein whenever, in its discretion, the use of the publications is detrimental to its interest or, as determined by IBM, the above instructions are not being properly followed.

You may not download, export or re-export this information except in full compliance with all applicable laws and regulations, including all United States export laws and regulations.

IBM MAKES NO GUARANTEE ABOUT THE CONTENT OF THESE PUBLICATIONS. THE PUBLICATIONS ARE PROVIDED "AS-IS" AND WITHOUT WARRANTY OF ANY KIND, EITHER EXPRESSED OR IMPLIED, INCLUDING BUT NOT LIMITED TO IMPLIED WARRANTIES OF MERCHANTABILITY, NON-INFRINGEMENT, AND FITNESS FOR A PARTICULAR PURPOSE.

IBM Trademarks: IBM, the IBM logo, and ibm.com are trademarks or registered trademarks of International Business Machines Corp., registered in many jurisdictions worldwide. Other product and service names might be trademarks of IBM or other companies. A current list of IBM trademarks is available on the Web at www.ibm.com/legal/copytrade.shtml

Appendix B. Notices

This information was developed for products and services offered in the U.S.A. Information about non-IBM products is based on information available at the time of first publication of this document and is subject to change.

IBM may not offer the products, services, or features discussed in this document in other countries. Consult your local IBM representative for information about the products and services currently available in your area. Any reference to an IBM product, program, or service is not intended to state or imply that only that IBM product, program, or service may be used. Any functionally equivalent product, program, or service that does not infringe any IBM intellectual property right may be used instead. However, it is the user's responsibility to evaluate and verify the operation of any non-IBM product, program, or service.

IBM may have patents or pending patent applications covering subject matter described in this document. The furnishing of this document does not grant you any license to these patents. You can send license inquiries, in writing, to:

IBM Director of Licensing
IBM Corporation
North Castle Drive
Armonk, NY 10504-1785
U.S.A.

For license inquiries regarding double-byte character set (DBCS) information, contact the IBM Intellectual Property Department in your country or send inquiries, in writing, to:

Intellectual Property Licensing
Legal and Intellectual Property Law
IBM Japan, Ltd.
1623-14, Shimotsuruma, Yamato-shi
Kanagawa 242-8502 Japan

The following paragraph does not apply to the United Kingdom or any other country/region where such provisions are inconsistent with local law:

INTERNATIONAL BUSINESS MACHINES CORPORATION PROVIDES THIS PUBLICATION "AS IS" WITHOUT WARRANTY OF ANY KIND, EITHER EXPRESS OR IMPLIED, INCLUDING, BUT NOT LIMITED TO, THE IMPLIED WARRANTIES OF NON-INFRINGEMENT, MERCHANTABILITY, OR FITNESS FOR A PARTICULAR PURPOSE. Some states do not allow disclaimer of express or implied warranties in certain transactions; therefore, this statement may not apply to you.

This information could include technical inaccuracies or typographical errors. Changes are periodically made to the information herein; these changes will be incorporated in new editions of the publication. IBM may make improvements, changes, or both in the product(s) and/or the program(s) described in this publication at any time without notice.

Any references in this information to websites not owned by IBM are provided for convenience only and do not in any manner serve as an endorsement of those

websites. The materials at those websites are not part of the materials for this IBM product and use of those websites is at your own risk.

IBM may use or distribute any of the information you supply in any way it believes appropriate without incurring any obligation to you.

Licenses of this program who wish to have information about it for the purpose of enabling: (i) the exchange of information between independently created programs and other programs (including this one) and (ii) the mutual use of the information that has been exchanged, should contact:

IBM Canada Limited
U59/3600
3600 Steeles Avenue East
Markham, Ontario L3R 9Z7
CANADA

Such information may be available, subject to appropriate terms and conditions, including, in some cases, payment of a fee.

The licensed program described in this document and all licensed material available for it are provided by IBM under terms of the IBM Customer Agreement, IBM International Program License Agreement, or any equivalent agreement between us.

Any performance data contained herein was determined in a controlled environment. Therefore, the results obtained in other operating environments may vary significantly. Some measurements may have been made on development-level systems, and there is no guarantee that these measurements will be the same on generally available systems. Furthermore, some measurements may have been estimated through extrapolation. Actual results may vary. Users of this document should verify the applicable data for their specific environment.

Information concerning non-IBM products was obtained from the suppliers of those products, their published announcements, or other publicly available sources. IBM has not tested those products and cannot confirm the accuracy of performance, compatibility, or any other claims related to non-IBM products. Questions on the capabilities of non-IBM products should be addressed to the suppliers of those products.

All statements regarding IBM's future direction or intent are subject to change or withdrawal without notice, and represent goals and objectives only.

This information may contain examples of data and reports used in daily business operations. To illustrate them as completely as possible, the examples include the names of individuals, companies, brands, and products. All of these names are fictitious, and any similarity to the names and addresses used by an actual business enterprise is entirely coincidental.

COPYRIGHT LICENSE:

This information contains sample application programs in source language, which illustrate programming techniques on various operating platforms. You may copy, modify, and distribute these sample programs in any form without payment to IBM, for the purposes of developing, using, marketing or distributing application programs conforming to the application programming interface for the operating

platform for which the sample programs are written. These examples have not been thoroughly tested under all conditions. IBM, therefore, cannot guarantee or imply reliability, serviceability, or function of these programs. The sample programs are provided "AS IS", without warranty of any kind. IBM shall not be liable for any damages arising out of your use of the sample programs.

Each copy or any portion of these sample programs or any derivative work must include a copyright notice as follows:

© (*your company name*) (*year*). Portions of this code are derived from IBM Corp. Sample Programs. © Copyright IBM Corp. *_enter the year or years_*. All rights reserved.

Trademarks

IBM, the IBM logo, and ibm.com are trademarks or registered trademarks of International Business Machines Corp., registered in many jurisdictions worldwide. Other product and service names might be trademarks of IBM or other companies. A current list of IBM trademarks is available on the web at "Copyright and trademark information" at www.ibm.com/legal/copytrade.shtml.

The following terms are trademarks or registered trademarks of other companies

- Linux is a registered trademark of Linus Torvalds in the United States, other countries, or both.
- Java and all Java-based trademarks and logos are trademarks or registered trademarks of Oracle, its affiliates, or both.
- UNIX is a registered trademark of The Open Group in the United States and other countries.
- Intel, Intel logo, Intel Inside, Intel Inside logo, Celeron, Intel SpeedStep, Itanium, and Pentium are trademarks or registered trademarks of Intel Corporation or its subsidiaries in the United States and other countries.
- Microsoft, Windows, Windows NT, and the Windows logo are trademarks of Microsoft Corporation in the United States, other countries, or both.

Other company, product, or service names may be trademarks or service marks of others.

Index

A

- actual parameter 485
- alert log 485
- ANALYZE_DATABASE procedure 342
- ANALYZE_PART_OBJECT procedure 343
- ANALYZE_SCHEMA procedure 344
- anchored data types
 - declaring variables 14, 15
 - details 13
 - examples 15, 16
 - restrictions 14
- anonymous block statement
 - PL/SQL 133
- anonymous blocks 133
- APPEND procedure 262
- application development
 - DB2CI 491
- archive log 485
- archive log mode 485
- array data types
 - associative array
 - creating 47
 - declaring local variables 47
 - overview 45
 - restrictions 46
 - creating 34
 - elements
 - deleting 42
 - determining whether exist 43
 - retrieving number 38
 - ordinary 32
 - overview 31, 33
 - restrictions 33
 - trimming 41
 - values
 - assigning 36
 - retrieving 37, 40
 - variables
 - creating 34
 - declaring 35
 - overview 34
- arrays
 - assigning values 36, 49
 - associative 152
 - element retrieval 39
 - type comparison 32
- assignment statement
 - PL/SQL 171
- ASSOCIATE RESULT SET LOCATOR statement 96
- associative array data types
 - creating 47
 - declaring local variables 47
 - overview 45
 - restrictions 46
- associative arrays
 - comparison to simple arrays 32
 - overview 45, 49, 152
- attributes
 - cursor 208
 - PL/SQL
 - %ROWTYPE 169

- attributes (*continued*)
 - PL/SQL (*continued*)
 - %TYPE 166
 - statement
 - PL/SQL 180

B

- bdump directory 485
- BIND_VARIABLE_BLOB procedure 300
- BIND_VARIABLE_CHAR procedure 300
- BIND_VARIABLE_CLOB procedure 301
- BIND_VARIABLE_DATE procedure 301
- BIND_VARIABLE_DOUBLE procedure 302
- BIND_VARIABLE_INT procedure 302
- BIND_VARIABLE_NUMBER procedure 303
- BIND_VARIABLE_RAW procedure 303
- BIND_VARIABLE_TIMESTAMP procedure 304
- BIND_VARIABLE_VARCHAR procedure 304
- binding
 - compiled functions 98
 - compiled triggers 98
 - SQL procedures 98
 - SQL statements 98
- blocks
 - PL/SQL 133
- Boolean data type
 - details 63
- BROKEN procedure 255
- BULK COLLECT INTO clause 176

C

- C language
 - building DB2CI applications 495
- C/C++ language
 - building DB2CI applications 495
- CANONICALIZE procedure 345
- CASE statement
 - PL/SQL 185
 - searched 187
 - simple 185
 - SQL procedures 86
- CHANGE procedure 255
- character constants 451
- CLOSE procedures 262
- CLOSE statement
 - closing cursors 207
- CLOSE_CURSOR procedure 305
- CLOSE_DATA procedure 417
- collections
 - associative arrays 152
 - methods 156
 - overview 147
 - VARRAY type 147
- COLUMN_VALUE_BLOB procedure 305
- COLUMN_VALUE_CHAR procedure 306
- COLUMN_VALUE_CLOB procedure 307
- COLUMN_VALUE_DATE procedure 307
- COLUMN_VALUE_DOUBLE procedure 308

COLUMN_VALUE_INT procedure 308
 COLUMN_VALUE_LONG procedure 309
 COLUMN_VALUE_NUMBER procedure 310
 COLUMN_VALUE_RAW procedure 311
 COLUMN_VALUE_TIMESTAMP procedure 311
 COLUMN_VALUE_VARCHAR procedure 312
 COMMA_TO_TABLE procedure 347
 command line processor (CLP)
 terminating character 97
 COMMAND procedure 417
 COMMAND_REPLIES procedure 418
 COMPARE function 263
 compatibility
 features summary 431
 COMPILE_SCHEMA procedure 349
 compiled functions
 bind options 98
 precompile options 98
 compiled SQL functions
 overview 106
 compiled triggers
 bind options 98
 precompile options 98
 compiler options
 AIX
 DB2CI applications 496
 HP-UX
 DB2CI applications 496
 Linux
 DB2CI applications 498
 Solaris
 DB2CI applications 498
 Windows
 DB2CI applications 499
 compound SQL statements
 creating 113
 overview 113
 SQL procedures 83
 concurrency
 improving 479
 condition handlers
 SQL procedures 94
 configuration parameters
 date_compat 441, 469
 number_compat 443, 469
 varchar2_compat 446, 469
 CONNECT BY clause 459
 CONNECT_BY_ROOT unary operator 463
 CONNECTION procedure 366
 constants
 handling 451
 CONTINUE statement 195
 control statements
 PL/SQL
 CONTINUE 195
 EXIT 193
 list 181
 LOOP 193
 CONVERTTOBLOB procedure 264
 CONVERTTOCLOB procedure 265
 COPY procedure 265
 CREATE FUNCTION statement
 PL/SQL 143
 CREATE PACKAGE BODY statement 231
 CREATE PACKAGE statement 228
 CREATE PROCEDURE statement
 creating SQL procedures 97
 CREATE PROCEDURE statement (*continued*)
 PL/SQL 137
 CREATE TRIGGER statement 218
 CREATE TYPE (Nested table) statement
 PL/SQL 149
 CREATE TYPE (Object) statement
 PL/SQL 151
 CREATE TYPE (VARRAY) statement
 PL/SQL 148
 CREATE_DIRECTORY procedure 387
 CREATE_OR_REPLACE_DIRECTORY procedure 388
 CREATE_PIPE function 283
 CREATE_WRAPPED procedure 251
 cur_commit database configuration parameter
 overview 479
 CURRENTAPPS procedure 377
 CURRENTSQL procedure 377
 cursor data types
 creating 55
 overview 50, 51
 privileges 53
 restrictions 52
 types 51
 cursor predicates
 details 53
 cursor sharing 485
 cursor variables
 assigning values 57
 creating 54, 56
 details 53, 209
 example 61, 213
 opening 211
 referencing 58
 restrictions 52
 ROWTYPE attribute 207
 SQL procedures 61
 SYS_REFCURSOR 209
 cursor_rowCount function 59
 cursors
 insensitive 475
 parameterized 204
 PL/SQL
 attributes 208
 closing 207
 declaring 203
 details 203
 fetching rows 205
 opening 204
 processing result sets 189
 SQL procedures 84

D

data
 access levels 453
 data block 485
 data buffer cache 485
 data dictionaries
 DB2-Oracle terminology mapping 485
 Oracle
 compatible views 481
 data dictionary cache 485
 data file 485
 DATA procedure 419
 data types
 anchored
 overview 14

- data types *(continued)*
 - associative array
 - creating 47
 - overview 45
 - BOOLEAN 63
 - cursor
 - overview 50
 - DATE 441
 - FILE_TYPE 407
 - NUMBER 443
 - NVARCHAR2 446
 - PL/SQL 150, 164, 168
 - REF CURSOR 210
 - row 17, 19
 - VARCHAR2 446
- data-access levels
 - routines 453
 - stored procedures 453
 - user-defined functions 453
- database applications
 - DB2CI 491
- database links
 - syntax 483
 - terminology mapping 485
- database objects
 - creating 108
- DATE data type
 - based on TIMESTAMP(0) 441
- date_compat database configuration parameter
 - DATE based on TIMESTAMP(0) 441
 - overview 469
- DB_VERSION procedure 349
- DB2 Information Center
 - updating 507, 508
 - versions 506
- DB2_COMPATIBILITY_VECTOR registry variable
 - details 433
- DB2CI
 - AIX
 - application compiler options 496
 - application development 491
 - HP-UX
 - application compiler options 496
 - IBM Data Server Driver for DB2CI 493
 - Linux
 - application compiler options 498
 - Solaris
 - application compiler options 498
 - Windows
 - application compiler options 499
- DB2CI applications
 - building 495
- DBMS_ALERT module 241
- DBMS_DDL module 249
- DBMS_JOB module
 - BROKEN procedure 255
 - CHANGE procedure 255
 - INTERVAL procedure 256
 - NEXT_DATE procedure 257
 - overview 253
 - REMOVE procedure 257
 - RUN procedure 258
 - SUBMIT procedure 258
 - WHAT procedure 259
- DBMS_LOB module
 - APPEND procedures 262
 - CLOSE procedures 262
- DBMS_LOB module *(continued)*
 - COMPARE function 263
 - CONVERTTOBLOB procedure 264
 - CONVERTTOCLOB procedure 265
 - COPY procedures 265
 - ERASE procedures 266
 - GET_STORAGE_LIMIT function 267
 - GETLENGTH function 267
 - INSTR function 268
 - ISOPEN function 269
 - OPEN procedures 269
 - overview 261
 - READ procedures 269
 - SUBSTR function 270
 - TRIM procedures 271
 - WRITE procedures 271
 - WRITEAPPEND procedures 272
- DBMS_OUTPUT module 273
- DBMS_PIPE module 281
- DBMS_SQL module
 - BIND_VARIABLE_BLOB procedure 300
 - BIND_VARIABLE_CHAR procedure 300
 - BIND_VARIABLE_CLOB procedure 301
 - BIND_VARIABLE_DATE procedure 301
 - BIND_VARIABLE_DOUBLE procedure 302
 - BIND_VARIABLE_INT procedure 302
 - BIND_VARIABLE_NUMBER procedure 303
 - BIND_VARIABLE_RAW procedure 303
 - BIND_VARIABLE_TIMESTAMP procedure 304
 - BIND_VARIABLE_VARCHAR procedure 304
 - CLOSE_CURSOR procedure 305
 - COLUMN_VALUE_BLOB procedure 305
 - COLUMN_VALUE_CHAR procedure 306
 - COLUMN_VALUE_CLOB procedure 307
 - COLUMN_VALUE_DATE procedure 307
 - COLUMN_VALUE_DOUBLE procedure 308
 - COLUMN_VALUE_INT procedure 308
 - COLUMN_VALUE_LONG procedure 309
 - COLUMN_VALUE_NUMBER procedure 310
 - COLUMN_VALUE_RAW procedure 311
 - COLUMN_VALUE_TIMESTAMP procedure 311
 - COLUMN_VALUE_VARCHAR procedure 312
 - DEFINE_COLUMN_BLOB procedure 313
 - DEFINE_COLUMN_CHAR procedure 313
 - DEFINE_COLUMN_CLOB procedure 314
 - DEFINE_COLUMN_DATE procedure 314
 - DEFINE_COLUMN_DOUBLE procedure 315
 - DEFINE_COLUMN_INT procedure 315
 - DEFINE_COLUMN_LONG procedure 316
 - DEFINE_COLUMN_NUMBER procedure 316
 - DEFINE_COLUMN_RAW procedure 316
 - DEFINE_COLUMN_TIMESTAMP procedure 317
 - DEFINE_COLUMN_VARCHAR procedure 317
 - DESCRIBE_COLUMNS procedure 318
 - DESCRIBE_COLUMNS2 procedure 321
 - EXECUTE procedure 323
 - EXECUTE_AND_FETCH procedure 324
 - FETCH_ROWS procedure 327
 - IS_OPEN procedure 329
 - LAST_ROW_COUNT procedure 330
 - OPEN_CURSOR procedure 333
 - overview 297
 - PARSE procedure 333
 - VARIABLE_VALUE_BLOB procedure 336
 - VARIABLE_VALUE_CHAR procedure 336
 - VARIABLE_VALUE_CLOB procedure 336
 - VARIABLE_VALUE_DATE procedure 337

- DBMS_SQL module (*continued*)
 - VARIABLE_VALUE_DOUBLE procedure 337
 - VARIABLE_VALUE_INT procedure 338
 - VARIABLE_VALUE_NUMBER procedure 338
 - VARIABLE_VALUE_RAW procedure 339
 - VARIABLE_VALUE_TIMESTAMP procedure 339
 - VARIABLE_VALUE_VARCHAR procedure 340
- DBMS_UTILITY module
 - ANALYZE_DATABASE procedure 342
 - ANALYZE_PART_OBJECT procedure 343
 - ANALYZE_SCHEMA procedure 344
 - CANONICALIZE procedure 345
 - COMMA_TO_TABLE procedures 347
 - COMPILE_SCHEMA procedure 349
 - DB_VERSION procedure 349
 - EXEC_DDL_STATEMENT procedure 350
 - GET_CPU_TIME function 351
 - GET_DEPENDENCY procedure 351
 - GET_HASH_VALUE function 353
 - GET_TIME function 354
 - NAME_RESOLVE procedure 355
 - NAME_TOKENIZE procedure 359
 - overview 341
 - TABLE_TO_COMMA procedures 362
 - VALIDATE procedure 363
- DBSUMMARY procedure 378
- deadlocks
 - avoiding 479
- DECLARE statements
 - SQL procedures
 - condition handlers 85
 - conditions 85
 - cursors 85
 - variables 81, 85
- DEFINE_COLUMN_BLOB procedure 313
- DEFINE_COLUMN_CHAR procedure 313
- DEFINE_COLUMN_CLOB procedure 314
- DEFINE_COLUMN_DATE procedure 314
- DEFINE_COLUMN_DOUBLE procedure 315
- DEFINE_COLUMN_INT procedure 315
- DEFINE_COLUMN_LONG procedure 316
- DEFINE_COLUMN_NUMBER procedure 316
- DEFINE_COLUMN_RAW procedure 316
- DEFINE_COLUMN_TIMESTAMP procedure 317
- DEFINE_COLUMN_VARCHAR procedure 317
- DESCRIBE_COLUMNS procedure 318
- DESCRIBE_COLUMNS2 procedure 321
- DISABLE procedure 274
- documentation
 - overview 503
 - PDF files 503
 - printed 503
 - terms and conditions of use 510
- DROP_DIRECTORY procedure 389
- DUAL table 473
- dynamic performance views 485
- dynamic SQL
 - SQL procedures comparison 68

E

- EHLO procedure 420
- elements
 - retrieving 39
- ENABLE procedure 274
- ERASE procedure 266

- errors
 - DB2-Oracle mapping 200
 - mapping 200
 - PL/SQL applications 198
- examples
 - anchored data types 15, 16
 - cursor variables 61
 - PL/SQL schema 123
 - PL/SQL triggers 222
 - row data types 27
- exceptions
 - PL/SQL
 - handling 196
 - transactions 218
- EXEC_DDL_STATEMENT procedure 350
- EXECUTE IMMEDIATE statement
 - PL/SQL 172
- EXECUTE procedure 323
- EXECUTE_AND_FETCH procedure 324
- EXIT statement 193
- external routines
 - SQL routines comparison 66

F

- FCLOSE procedure 392
- FCLOSE_ALL procedure 393
- FCOPY procedure 394
- FETCH statement
 - PL/SQL 205
- FETCH_ROWS procedure 327
- FFLUSH procedure 395
- FILE_TYPE data type 407
- FIRST function 39
- FOPEN function 396
- FOR (cursor variant) statement 189
- FOR (integer variant) statement 190
- FOR statement 88
- FORALL statement
 - PL/SQL 191
- formal parameter 485
- FOUND cursor attribute 208
- FREMOVE procedure 398
- FRENAME procedure 398
- functions
 - CREATE_PIPE 283
 - FOPEN 396
 - invocation syntax support in PL/SQL 140
 - IS_OPEN 401
 - modules 239
 - NEXT_ITEM_TYPE 284
 - PACK_MESSAGE 286
 - parameter modes 163
 - PL/SQL
 - overview 143
 - references 146
 - RECEIVE_MESSAGE 289
 - REMOVE_PIPE 290
- scalar
 - CONCAT 446
 - INSERT 446
 - LENGTH 446
 - REPLACE 446
 - SUBSTR 446
 - SYS_CONNECT_BY_PATH 465
 - TRANSLATE 446
 - TRIM 446

functions (*continued*)
UNIQUE_SESSION_NAME 293

G

GET_CPU_TIME procedure 351
GET_DEPENDENCY procedure 351
GET_DIRECTORY_PATH procedure 389
GET_HASH_VALUE function 353
GET_LINE procedure
files 399
message buffers 275
GET_LINES procedure 276
GET_STORAGE_LIMIT function 267
GET_TIME function 354
GETLENGTH function 267
global index 485
GOTO statement
details 91
graphic data
constants
handling 451

H

HELO procedure 420
help
SQL statements 506
HELP procedure 421
hierarchical queries 459

I

IBM Data Server Driver for DB2CI
supported OCI APIs 493
IF statement
PL/SQL 181
SQL 86, 87
inactive log 485
init.ora 485
inlined SQL functions 106
INOUT parameters 477
insensitive cursors 475
INSTR function 268
INTERVAL procedure 256
IS_OPEN function 401
IS_OPEN procedure 329
ISOPEN attribute 208
ISOPEN function 269
ITERATE statement
example 92

L

large pool 485
LAST function 39
LAST_ROW_COUNT procedure 330
LEAVE statement
SQL procedures 93
LEVEL pseudocolumn 459
library cache 485
literals
handling 451
local index 485

locks
timeouts
avoiding 479
LOCKWAIT procedure 382
LOOP statement
PL/SQL 193
SQL procedures 89
loops
PL/SQL 189

M

MAIL procedure 421
materialized view 485
methods
collection 156
modules
DBMS_ALERT 241
DBMS_DDL 249
DBMS_JOB 253
DBMS_LOB 261
DBMS_OUTPUT 273
DBMS_PIPE 281
DBMS_SQL 297
DBMS_UTILITY 341
MONREPORT 365
overview 239
UTL_DIR 387
UTL_FILE 391
UTL_MAIL 409
UTL_SMTP 415
MONREPORT module
CONNECTION procedure 366
CURRENTAPPS procedure 377
CURRENTSQL procedure 377
DBSUMMARY procedure 378
details 365
LOCKWAIT procedure 382
PKGCACHE procedure 385

N

NAME_RESOLVE procedure 355
NAME_TOKENIZE procedure 359
NEW trigger variable 217
NEW_LINE procedure 278, 402
NEXT_DATE procedure 257
NEXT_ITEM_TYPE function 284
noarchive log mode 485
NOOP procedure 422
NOTFOUND attribute 208
notices 513
NULL
statement 171
NULL-producer 455
NUMBER data type
details 443
number_compat database configuration parameter
effect 443
overview 469
NVARCHAR2 data type
details 446

O

- obfuscation
 - PL/SQL 131
 - SQL PL 131
- objects
 - packages 233
- OCI APIs
 - IBM Data Server Driver for OCI 493
- OLAP
 - specification 471
- OLD trigger variable 217
- OPEN FOR statement 211
- OPEN procedure 269
- OPEN statement
 - PL/SQL 204
- OPEN_CONNECTION function 423
- OPEN_CONNECTION procedure 423
- OPEN_CURSOR procedure 333
- OPEN_DATA procedure 424
- operators
 - CONNECT_BY_ROOT 463
 - outer join 455
 - PRIOR 464
 - unary 459
- Oracle
 - application enablement 437
 - data dictionary--compatible views 481
 - database link syntax 483
 - DB2-Oracle terminology mapping 485
- Oracle Call Interface (OCI) 485
- ORACLE_SID environment variable 485
- ordinary array data type 32

P

- PACK_MESSAGE function 286
- PACK_MESSAGE_RAW procedure 286
- packages
 - bodies 229
 - objects 233
 - PL/SQL
 - components 227
 - creating 227
 - creating package bodies 229, 231
 - creating package specifications 227
 - dropping 237
 - overview 227
 - user-defined types 233
- parameter markers
 - examples 76
 - overview 76
- parameter modes 163
- parameterized cursors 204
- parameters
 - INOUT 477
 - SQL procedures 75
- PARSE procedure 333
- performance
 - SQL procedures 100
- PKGCACHE procedure 385
- PL/SQL
 - blocks 133
 - collection methods 156
 - collections
 - associative arrays 152
 - overview 147

- PL/SQL (continued)
 - collections (continued)
 - VARRAY type 147
 - control statements
 - CONTINUE 195
 - EXIT 193
 - FOR (cursor variant) 189
 - FOR (integer variant) 190
 - FORALL 191
 - LOOP 193
 - overview 181
 - WHILE 194
 - cursor variables
 - opening 211
 - overview 209
 - ROWTYPE attribute 207
 - SYS_REFCURSOR built-in data type 209
 - cursors
 - attributes 208
 - closing 207
 - declaring 203
 - fetching rows from 205
 - opening 204
 - overview 203
 - parameterized 204
 - data types
 - list 164
 - record 150, 169
 - subtype 168
 - dynamic queries 211
 - event predicates 218
 - exception handling 196
 - function invocation syntax support 140
 - functions
 - creating 119
 - overview 143
 - references to 146
 - loops 189
 - modularizing cursor operations example 213
 - obfuscation 131
 - Oracle application enablement 437
 - overview 115, 117
 - packages
 - components 227
 - creating 227
 - creating package body 229
 - creating package specifications 227
 - dropping 237
 - overview 227
 - package specifications 228
 - referencing objects 233
 - user-defined types 233
 - parameters
 - %TYPE attribute 166
 - procedures
 - creating 119
 - overview 137
 - references to 140
 - raising exceptions 198
 - REF CURSOR data type 210
 - REF CURSOR example 212
 - restrictions 121
 - sample schema 123
 - statement attributes 180
 - statements
 - anonymous block 133
 - assignment 171

- PL/SQL *(continued)*
 - statements *(continued)*
 - basic 171
 - BULK COLLECT INTO clause 176
 - CASE 185
 - CREATE FUNCTION 143
 - CREATE PACKAGE 228
 - CREATE PACKAGE BODY 231
 - CREATE PROCEDURE 137
 - CREATE TRIGGER 218
 - CREATE TYPE (Nested table) 149
 - CREATE TYPE (Object) 151
 - CREATE TYPE (VARRAY) 148
 - EXECUTE IMMEDIATE 172
 - IF 181
 - NULL 171
 - RAISE 199
 - RETURNING INTO clause 177
 - searched CASE 187
 - simple CASE 185
 - SQL 176
 - SYS_REFCURSOR data type 209
 - triggers
 - commits 218
 - dropping 222
 - examples 222
 - overview 217
 - rollbacks 218
 - row-level 217
 - trigger event predicates 218
 - trigger variables 217
 - variables
 - %TYPE attribute 166
 - declaring 161
 - overview 161
 - record 150
- precompilation
 - compiled functions 98
 - compiled triggers 98
 - SQL procedures 98
 - SQL statements 98
- predicates
 - IS FOUND 53
 - IS NOT FOUND 53
 - IS NOT OPEN 53
 - IS OPEN 53
 - trigger event (PL/SQL) 218
- PRIOR unary operator 464
- privileges
 - cursor data types 53
- problem determination
 - information available 510
 - tutorials 510
- procedures
 - CREATE_DIRECTORY 387
 - CREATE_OR_REPLACE_DIRECTORY 388
 - CREATE_WRAPPED 251
 - DISABLE 274
 - DROP_DIRECTORY 389
 - ENABLE 274
 - FCLOSE 392
 - FCLOSE_ALL 393
 - FCOPY 394
 - FFLUSH 395
 - FREMOVE 398
 - FRENAME 398
 - GET_DIRECTORY_PATH 389

- procedures *(continued)*
 - GET_LINE 275, 399
 - GET_LINES 276
 - NEW_LINE 278, 402
 - PACK_MESSAGE_RAW 286
 - PL/SQL
 - overview 137
 - parameter modes 163
 - references to 140
 - PURGE 287
 - PUT 279, 403
 - PUT_LINE 279, 404
 - PUTF 406
 - REGISTER 242
 - REMOVE 243
 - REMOVEALL 243
 - RESET_BUFFER 291
 - result sets
 - SQL routines 96
 - SEND_MESSAGE 292
 - SET_DEFAULTS 244
 - SIGNAL 245
 - SQL
 - array support 44
 - components 72
 - compound statements 83
 - condition handlers 94
 - conditional statements 86
 - control flow statements 85, 86, 87
 - designing 72
 - features 72
 - looping statements 87
 - overview 71
 - parameters 75
 - structure 73
 - transfer of control statements 91
 - uses 71
 - variables 81, 83
 - UNPACK_MESSAGE 294
 - WAITANY 245
 - WAITONE 247
- program global area (PGA) 485
- pseudocolumns
 - LEVEL 459
 - ROWNUM 471
- PURGE procedure 287
- PUT procedure
 - put partial line in message buffer 279
 - write string to file 403
- PUT_LINE procedure
 - put complete line in message buffer 279
 - write text to file 404
- PUTF procedure 406

Q

- queries
 - hierarchical 459
- QUIT procedure 424

R

- RAISE statement 199
- RCPT procedure 425
- READ procedure 269
- RECEIVE_MESSAGE function 289

- records
 - types
 - user-defined 150
 - variables 150
- redo log 485
- REF CURSOR data type 210
- REF CURSOR variables 212
- REGISTER procedure 242
- registry variables
 - DB2_COMPATIBILITY_VECTOR 433
- REMOVE procedure
 - delete job definition from database 257
 - remove registration for specified alert 243
- REMOVE_PIPE function 290
- REMOVEALL procedure 243
- REPEAT statement
 - SQL procedures 90
- RESET_BUFFER procedure 291
- result sets
 - receiving
 - SQL routines 96
 - returning
 - SQL procedures 95
- RETURN statement
 - SQL procedures 94
- RETURNING INTO clause 177
- rounding 443
- routines
 - comparison
 - SQL and external 66
 - data-access levels 453
 - external
 - comparison to SQL 66
 - issuing CREATE statements 97
 - modules 239
 - receiving result sets 96
 - SQL
 - comparison to external 66
 - creating 66
 - overview 65
 - performance 100
- row data types
 - assigning values 19, 21
 - creating 18
 - details 17
 - dropping 25
 - examples 25, 27, 30
 - overview 17
 - restrictions 17
 - variables 19
- row values
 - assigning 21
 - referencing 22
- row variables
 - assigning values 19
 - comparing 22
 - creating 18
 - overview 18
 - referencing
 - fields 23
 - INSERT statements 24
 - overview 22
- ROW_NUMBER
 - function 471
- ROWCOUNT attribute 208
- ROWNUM pseudocolumn 471

- rows
 - passing as routine parameters 24
- ROWTYPE attribute 169, 207
- RSET procedure 426
- RUN procedure 258

S

- samples
 - PL/SQL schema 123
- scalar functions
 - creating 108
- schemas
 - sample 123
- searched CASE statement
 - PL/SQL 187
- segment 485
- SEND procedure 409
- SEND_ATTACH_RAW procedure 411
- SEND_ATTACH_VARCHAR2 procedure 412
- SEND_MESSAGE procedure 292
- Server Parameter File (SPFILE) 485
- session 485
- SET statement
 - row variables 21
 - variables in SQL procedures 81
- SET_DEFAULTS procedure 244
- SIGNAL procedure 245
- specifications
 - packages 227, 228
- SQL
 - table functions
 - creating 110
 - SQL functions
 - comparison to SQL procedures 67
 - compiled 106
 - creating
 - scalar 108
 - designing 106
 - features 105
 - inlined 106
 - overview 105
 - restrictions 107
 - scalar
 - creating 108
 - SQL PL
 - obfuscation 131
 - SQL Procedural Language (SQL PL)
 - array data types 31
 - control flow statements 85
 - cursor data types 55
 - data types
 - Boolean 63
 - inline
 - executing 7
 - overview 3
 - overview 1
 - performance 100
 - SQL procedures 5
 - SQL procedures
 - ATOMIC compound statements 73
 - bind options 98
 - comparison to dynamic compound SQL 68
 - comparison to SQL functions 67
 - components 72
 - condition handlers
 - overview 94

- SQL procedures (*continued*)
 - conditional statements 86
 - control flow statements 85, 86, 87
 - creating 97
 - cursors 84
 - designing 72
 - features 72
 - labels 73
 - looping statements
 - FOR 88
 - LOOP 89
 - overview 87
 - REPEAT 90
 - WHILE 90
 - NOT ATOMIC compound statements 73
 - overview 71
 - parameters 75
 - performance 100
 - precompile options 98
 - returning result sets 95
 - rewriting as SQL UDFs 70
 - SQLCODE variables 83
 - SQLSTATE variables 83
 - structure 73
 - transfer of control statements
 - GOTO 91
 - ITERATE 92
 - LEAVE 93
 - overview 91
 - RETURN 94
 - uses 71
 - variables 81
- SQL routines
 - comparison to external routines 66
 - creating 66
 - overview 65
- SQL statements
 - bind options 98
 - compound 113
 - CREATE TYPE (Nested table) 149
 - CREATE TYPE (Object) 151
 - help
 - displaying 506
 - looping statements 87
 - PL/SQL 176
 - precompile options 98
 - related to variables 85
 - transfer of control statements 91
- SQL%FOUND statement attribute 180
- SQL%NOTFOUND statement attribute 180
- SQL%ROWCOUNT statement attribute 180
- SQLCA
 - error location 9
- SQLCODE
 - variables in SQL procedures 83
- SQLSTATE
 - variables in SQL procedures 83
- START WITH clause 459
- startup nomount 485
- statement attributes
 - PL/SQL 180
- statements
 - PL/SQL
 - anonymous block 133
 - assignment 171
 - basic 171
 - BULK COLLECT INTO clause 176

- statements (*continued*)
 - PL/SQL (*continued*)
 - CASE 185
 - CLOSE 207
 - CONTINUE 195
 - control 181
 - CREATE FUNCTION 143
 - CREATE PACKAGE 228
 - CREATE PACKAGE BODY 231
 - CREATE PROCEDURE 137
 - CREATE TRIGGER 218
 - CREATE TYPE (Nested table) 149
 - CREATE TYPE (Object) 151
 - CREATE TYPE (VARRAY) 148
 - EXECUTE IMMEDIATE 172
 - EXIT 193
 - FETCH 205
 - FOR (cursor variant) 189
 - FOR (integer variant) 190
 - FORALL 191
 - IF 181
 - LOOP 193
 - NULL 171
 - OPEN 204
 - OPEN FOR 211
 - RAISE 199
 - RETURNING INTO clause 177
 - searched CASE 187
 - simple CASE 185
 - WHILE 194
 - stored procedures
 - data-access levels 453
 - strings
 - semantics 446
 - subindexes 36
 - SUBMIT procedure 258
 - SUBSTR scalar function
 - details 270
 - subtype
 - types
 - user-defined 168
 - synonyms
 - DB2-Oracle terminology mapping 485
 - SYS_CONNECT_BY_PATH scalar function 465
 - system global area (SGA) 485
 - SYSTEM table space 485

T

- TABLE_TO_COMMA procedure 362
- tables
 - DUAL 473
- terminology mapping
 - DB2-Oracle 485
- terms and conditions
 - publications 510
- TIMESTAMP(0) data type
 - DATE data type based on 441
- transactions
 - PL/SQL 218
- triggers
 - event predicates 218
 - PL/SQL 218
 - commits 218
 - creating 218
 - dropping 222
 - examples 222

- triggers (*continued*)
 - PL/SQL (*continued*)
 - overview 217
 - rollbacks 218
 - row-level 217
 - trigger variables 217
- TRIM procedure 271
- troubleshooting
 - online information 510
 - tutorials 510
- tutorials
 - list 510
 - problem determination 510
 - pureXML 510
 - troubleshooting 510
- TYPE attribute 166

U

- UDFs
 - rewriting SQL procedures as UDFs 70
 - scalar
 - creating 108
- UDTs
 - associative array 45
 - ordinary array 32
- unary operators
 - CONNECT_BY_ROOT 459, 463
 - PRIOR 464
- UNIQUE_SESSION_NAME function 293
- UNPACK_MESSAGE procedure 294
- updates
 - DB2 Information Center 507, 508
- user global area (UGA) 485
- user-defined functions
 - data-access levels 453
- user-defined types (UDTs)
 - PL/SQL packages 233
- UTL_DIR module 387
- UTL_FILE module 391
- UTL_MAIL module
 - overview 409
 - SEND 409
 - SEND_ATTACH_RAW 411
 - SEND_ATTACH_VARCHAR2 412
- UTL_SMTP module
 - CLOSE 417
 - COMMAND 417
 - COMMAND_REPLIES 418
 - DATA 419
 - EHLO 420
 - HELO 420
 - HELP 421
 - MAIL 421
 - NOOP 422
 - OPEN_CONNECTION function 423
 - OPEN_CONNECTION procedure 423
 - OPEN_DATA 424
 - overview 415
 - QUIT 424
 - RCPT 425
 - RSET 426
 - VERB 426
 - WRITE_DATA 427
 - WRITE_RAW_DATA 427

V

- VALIDATE procedure 363
- VARCHAR2 data type
 - details 446
- varchar2_compat database configuration parameter
 - overview 469
 - VARCHAR2 data type 446
- VARIABLE_VALUE_BLOB procedure 336
- VARIABLE_VALUE_CHAR procedure 336
- VARIABLE_VALUE_CLOB procedure 336
- VARIABLE_VALUE_DATE procedure 337
- VARIABLE_VALUE_DOUBLE procedure 337
- VARIABLE_VALUE_INT procedure 338
- VARIABLE_VALUE_NUMBER procedure 338
- VARIABLE_VALUE_RAW procedure 339
- VARIABLE_VALUE_TIMESTAMP procedure 339
- VARIABLE_VALUE_VARCHAR procedure 340
- variables
 - array data types 34
 - cursor data types 209
 - local
 - anchored data types 14
 - array data types 35
 - cursor data types 56
 - PL/SQL
 - declaring 161
 - overview 161
 - record 150
 - REF CURSOR 210
 - row data types 19
 - SQL procedures 81, 85
 - trigger 217
- VARRAY collection type 147
- views
 - Oracle data dictionary compatibility 481
- VERB procedure 426

W

- WAITANY procedure 245
- WAITONE procedure 247
- WHAT procedure 259
- WHILE statement
 - SQL procedures 90
- WRAP function 249
- WRITE procedure 271
- WRITE_DATA procedure 427
- WRITE_RAW_DATA procedure 427
- WRITEAPPEND procedure 272



Printed in USA

SC27-3896-01



Spine information:

IBM DB2 10.1 for Linux, UNIX, and Windows

SQL Procedural Languages: Application Enablement and Support

