



IBM Software Group

# 2004 WDI / WBIC Customer Conference

*Global Business Transformation*

## WebSphere Business Integration Connect - Where does it Connect?

**WebSphere.** software



Lyle Larson  
Consulting IT Specialist, WBI-Connect  
lylel@us.ibm.com



© 2004 IBM Corporation

## Objectives

- **Explain the Trading Partner Community approach**
- **Give a technical overview of WBI Connect**
- **Show how WBI Connect can be customized**
- **Run a live demonstration of WBI Connect**

# Building Trading Partner Communities

# Community Integration Total Cost of Ownership

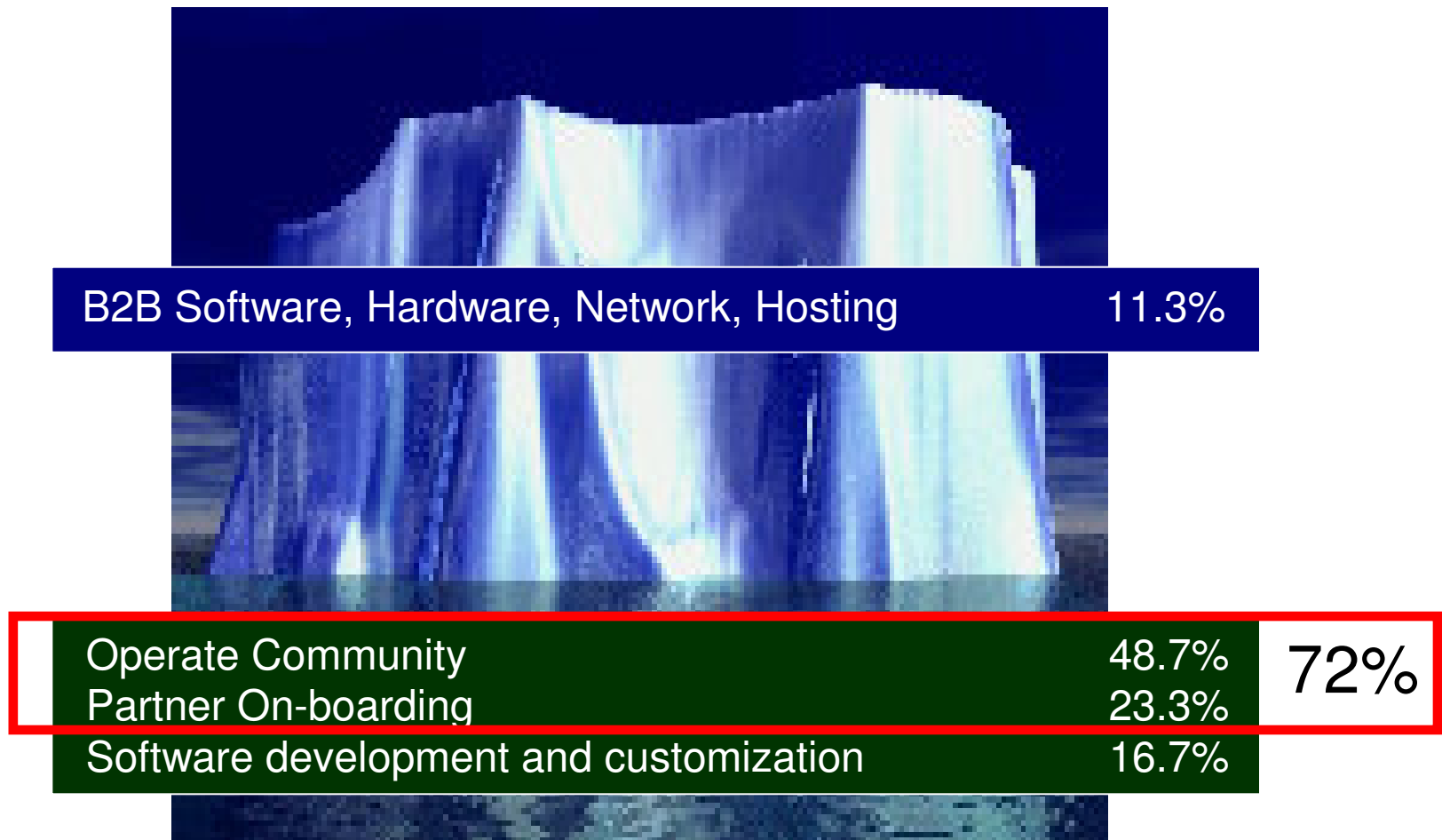

## Strengths of Community Integration versus B2B

**Creating sufficient links between partners such that all participants of the community gain value from the relationship**

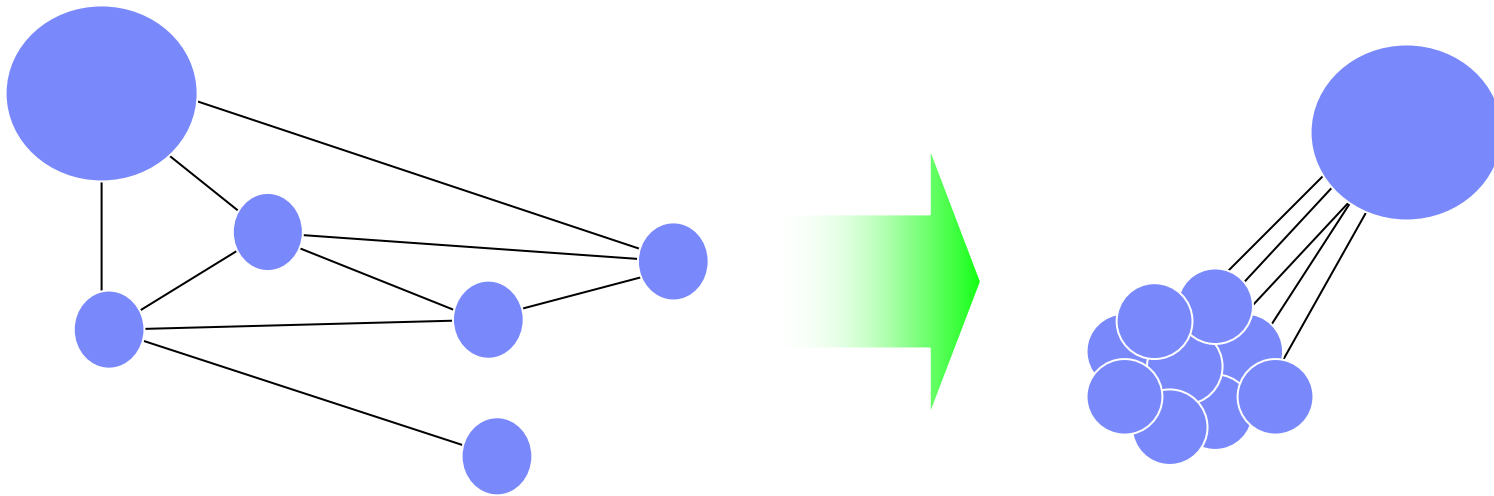

- **Shared visibility of participants**
- **Alignment of business objectives via Community-wide SLAs**
- **Facilitation of the integration of a critical mass of participants**
- **Repeatable and scalable management of Community Integration lifecycle**

# WebSphere Business Integration Connect Technical Overview

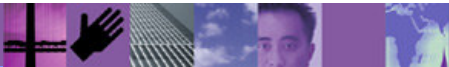

WebSphere Business Integration Connect – Reference Architecture

## Business Integration Capabilities and Qualities

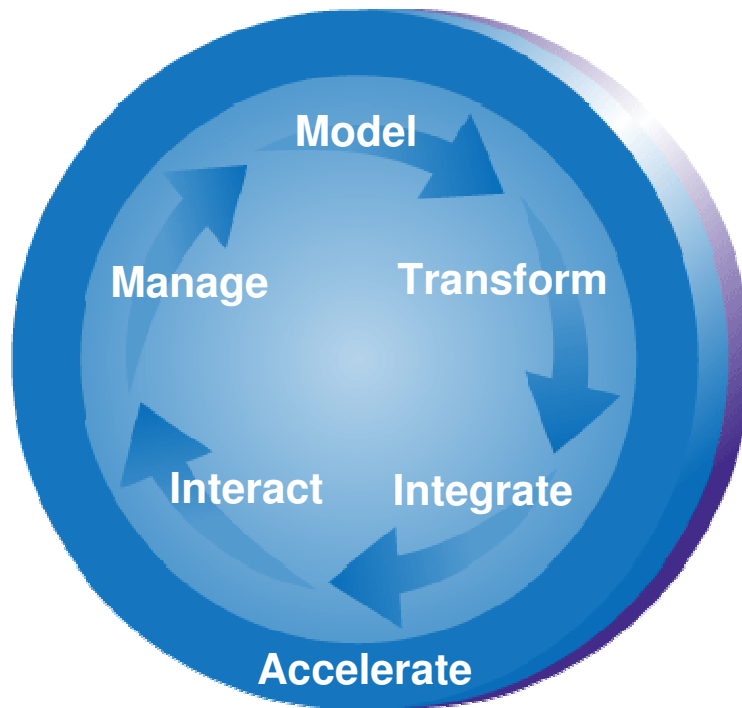

- **Model** business functions and processes
- **Transform** applications, processes & data
- **Integrate** islands of applications and information

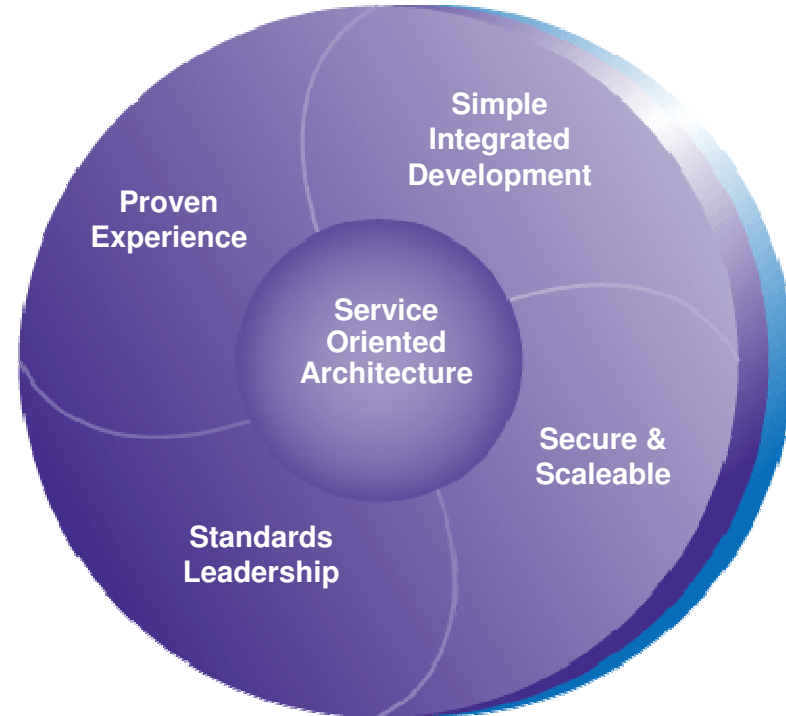

- **Interact** with people and resources anytime, anywhere, with any device
- **Manage** performance against business objectives
- **Accelerate** the implementation of intelligent processes

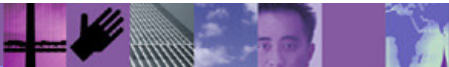

# Business Integration Reference Architecture

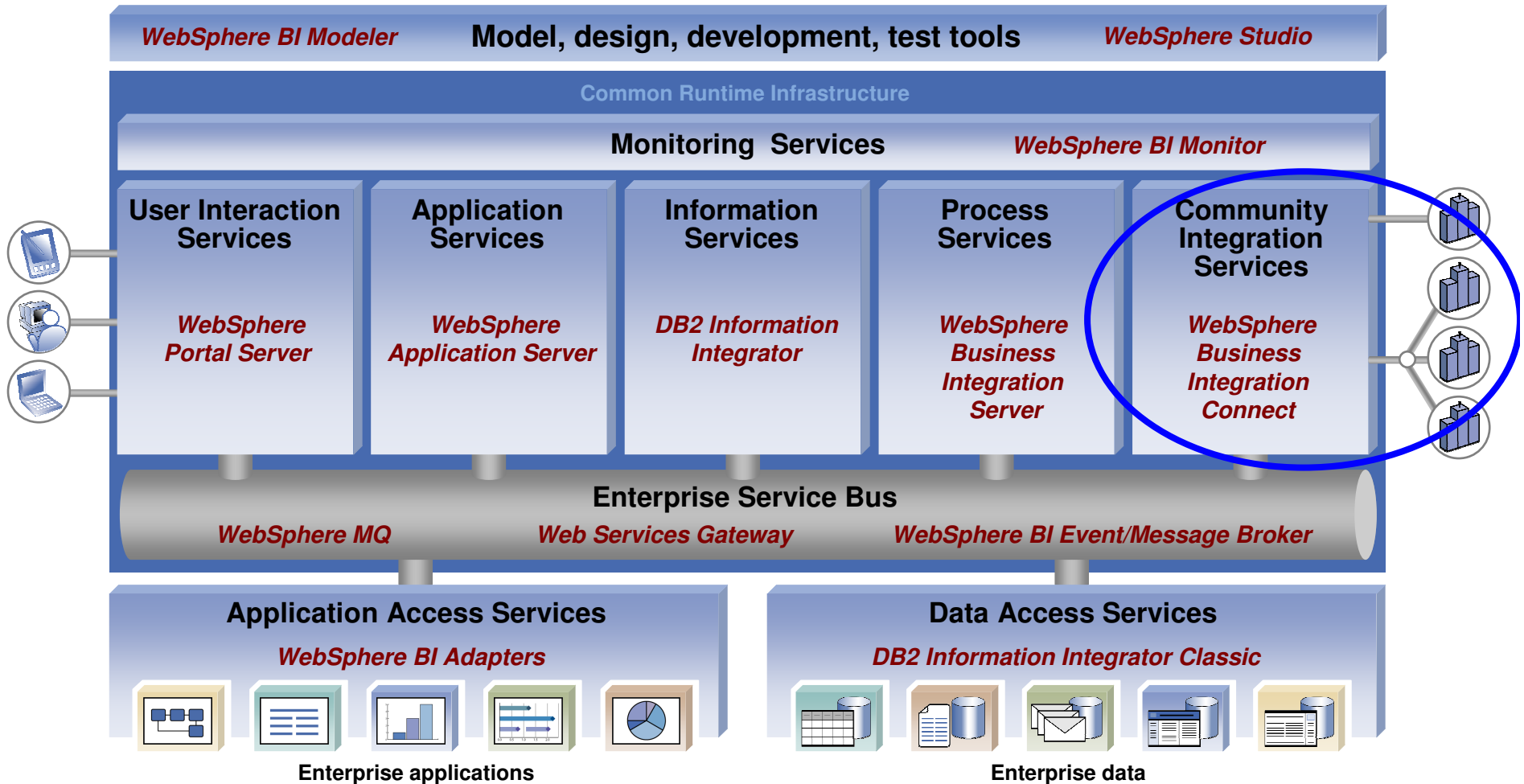



# WebSphere Business Integration Connect extends your On Demand business to business partners

## Requirements:

- **Connects partners within a value chain**
- **Reduces cost and improves productivity with B2B transactions**
- **Allows reuse of internal business processes with trading partners**

## Benefits:

### Business:

- **Takes cost out** of the business
- Business **processes extended** to include partners
- **Visibility** across the entire value-chain
- **Improve and automate** value-chain management
- **Strengthen Partner Relationships** through tighter business linkages

### IT:

- **Eases participation** in and adoption of widely used market standards
- **Standardize business processes** behind and across the firewalls
- **Quickly respond** to changing value-chain requirements

**Software that allows business-to-business process integration and data sharing among partners of all sizes**

# Key elements of WebSphere Business Integration Connect V4.2

## *Enterprise/Advanced Technology*

- Central Repository for reuse and visibility
- Highly scalable architecture
- Supports large communities
- Supports multiple protocols and formats
- Based on Standards and IBM products
- Two licensing options
- Single and double byte international support

## *Express Technology*

- Stand-alone lightweight implementation
- AS/2 and HTTP(S) only
- Single and double byte international support
- Multiple platforms: Windows, Linux, iSeries
- Maximum 5 connections per license

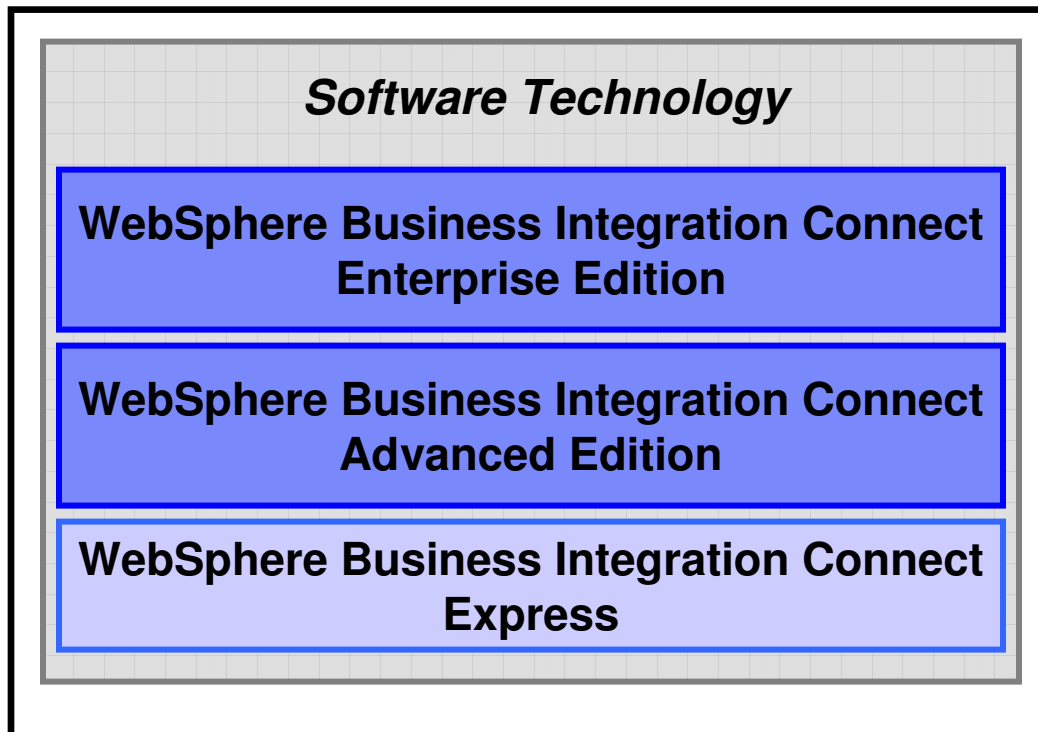

# Community Roles

**Principle Business Partner -  
system administration**

**External Business Partners**

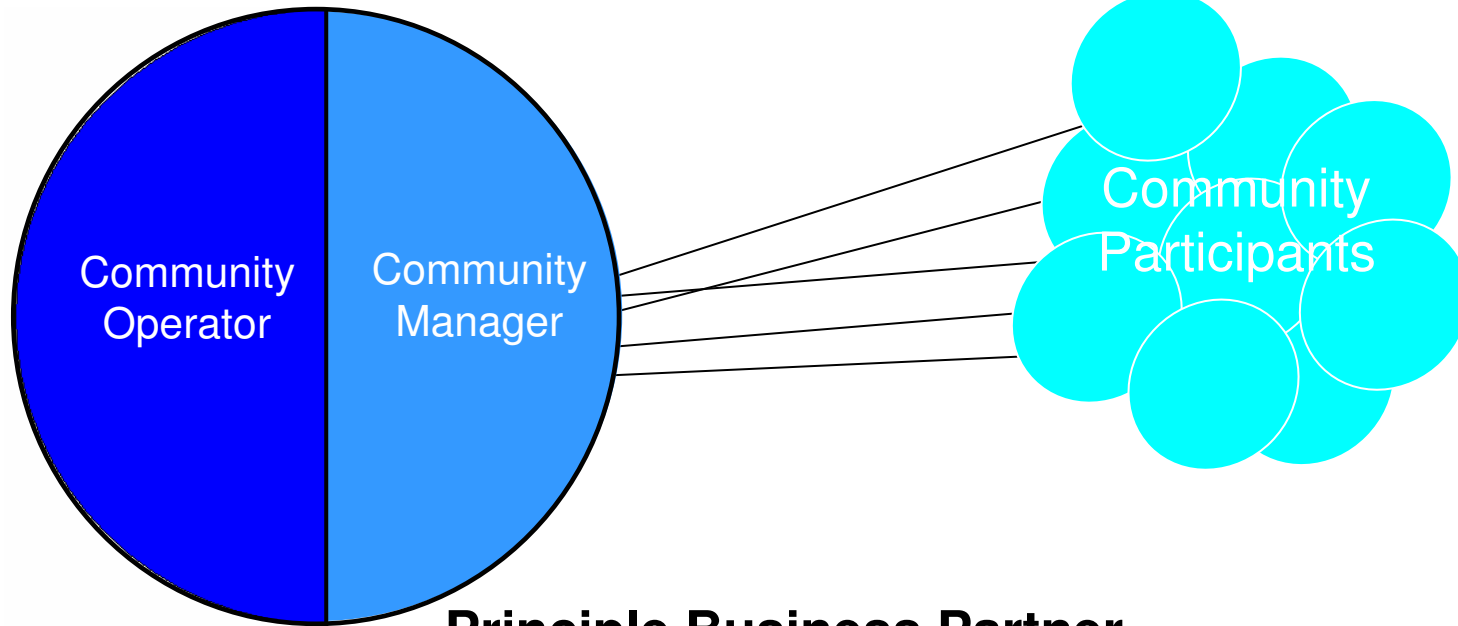

**Principle Business Partner -  
operations**

**Hub**

**Spokes**

## 3 Participant Roles



Community Participant

- External business partners to the B2B gateway
- Can be as many defined as desired
- Each one is a single connection to the B2B gateway



Community Manager

- Also a participant, but is the principle one
- Can only be one for a single B2B Gateway
- Operational manager for the community



Community Operator

- Pre-defined – cannot be deleted
- “sysadmin” for the B2B Gateway
- Defines and maintains the B2B Gateway’s capabilities
- Typically does NOT send or receive documents

# 3 Views of System Data



Community Participant Console

Reports		Tools	
Volume	Exceptions	Document Analysis	Original Document
Processes	Document Status	Partner Connection	Data Validation
Viewers		Administration	
Event Viewer		User Management	Profile Management
		Alerts	
		Exception Alerts	
		Volume Alerts	

+



Community Manager Console

Viewers		Tools	
Community Events		Post Test Message	
		Administration	
		Participant Connection Mgmt	

+



Community Operator Console

Viewers		Hub Administration	
Activity Viewer		Console Branding Mgmt	Target Mgmt
Gateway Queue		Password Policy Mgmt	Partner Mgmt
		Document Flow Mgmt	Interaction Mgmt

# Example Interactions

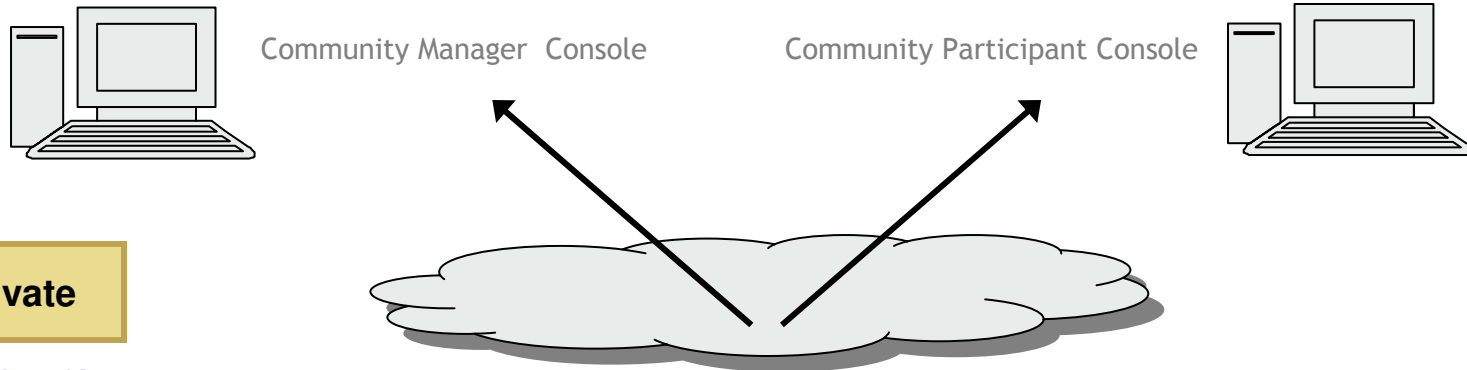

**Activate**

Configure capabilities to enable flows

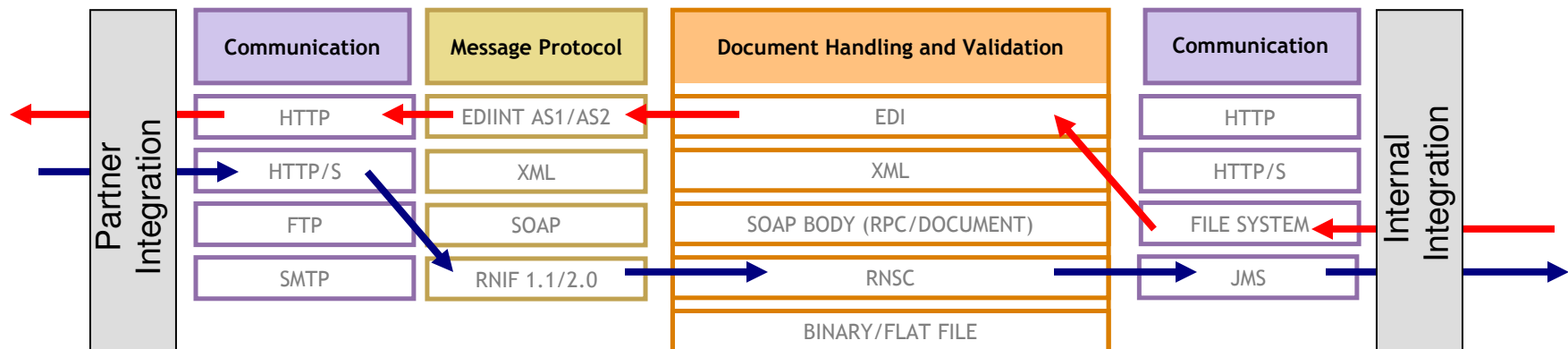
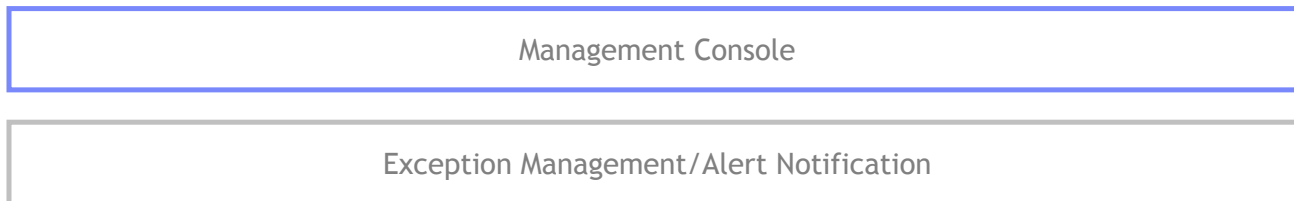

# WebSphere Business Integration Connect – Architecture Software Components

- Target (TAR)
- Document Manager (DOC)
  - State Engine (STE)
  - Document Processing Engine (DPE)
  - Delivery Manager (DM)
- Community Console (CON)
- WAS provides container management for components

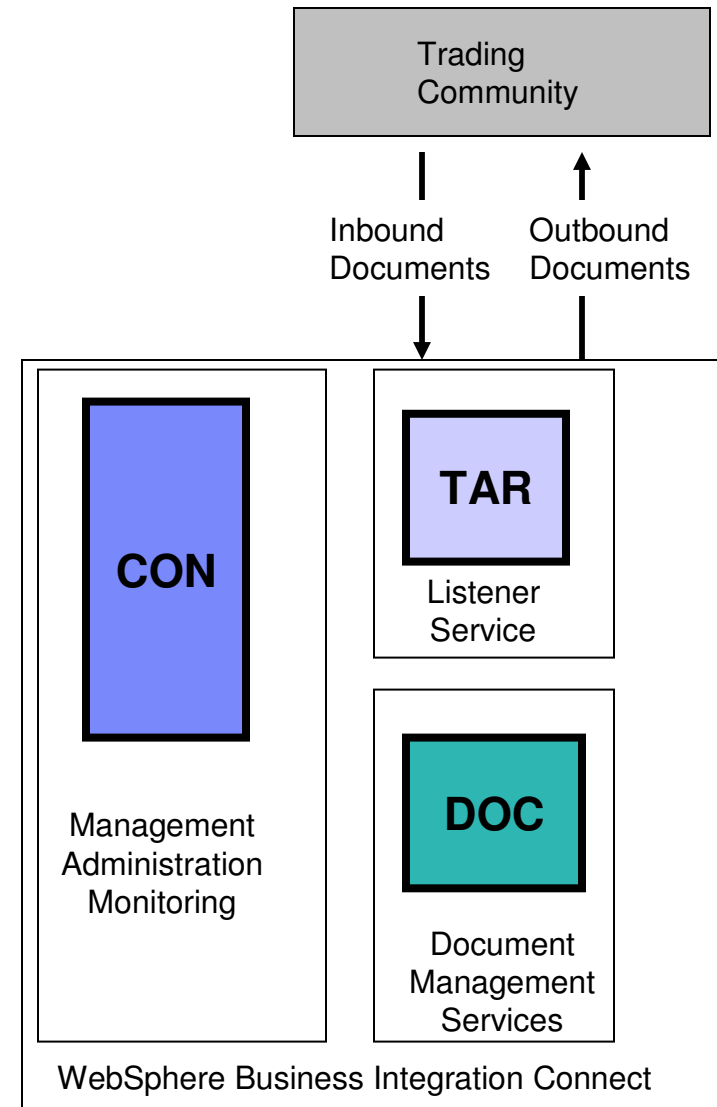

WebSphere Business Integration Connect – Architecture  
**Infrastructure Architecture**

- Shared Storage
  - Role: Document Storage
  - Components Access Same File System
  - NAS/NFS Recommended
  
- Database
  - Role: Metadata Storage
  - Oracle 9i (9.2)
  - DB2 8.1.2
  
- Messaging Queue
  - Role: Event Management
  - JMS/WebSphere MQ 5.3

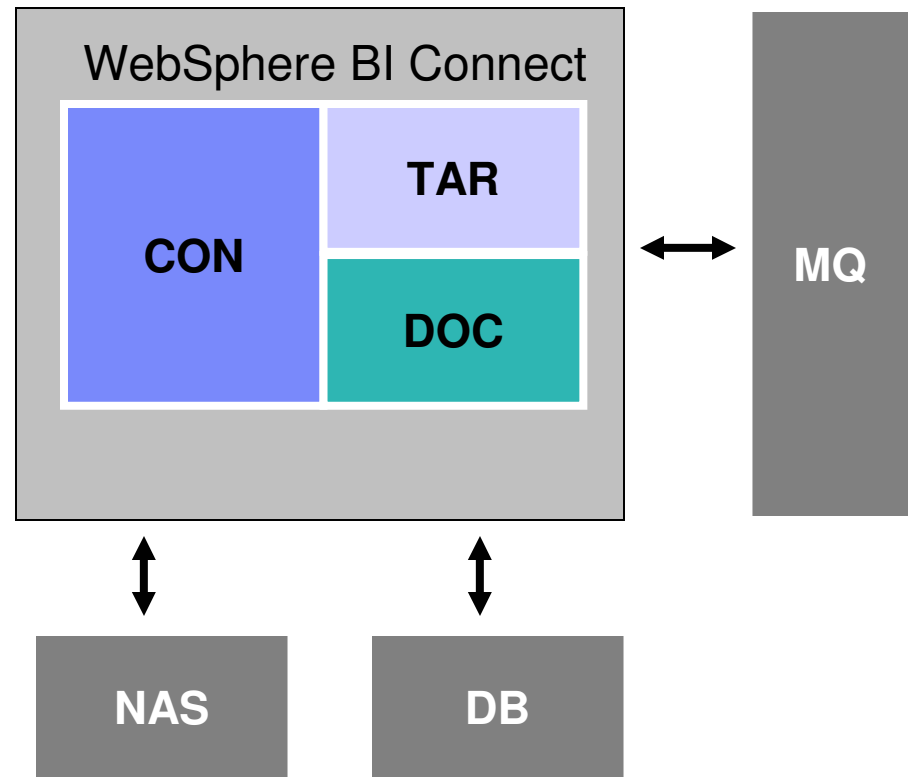



# Representative Deployment Configuration

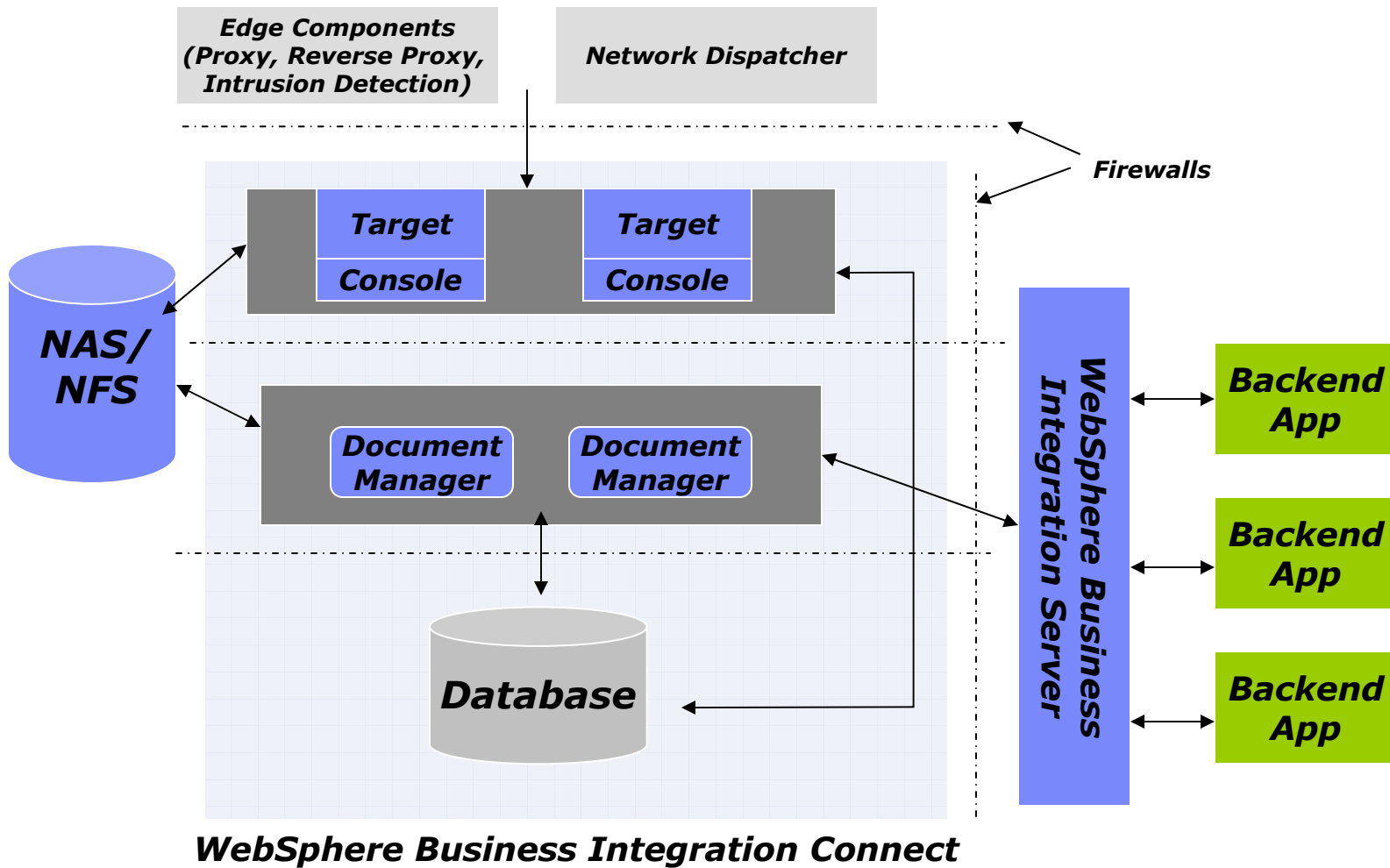

WebSphere Business Integration Connect – Architecture

# Component Interactions

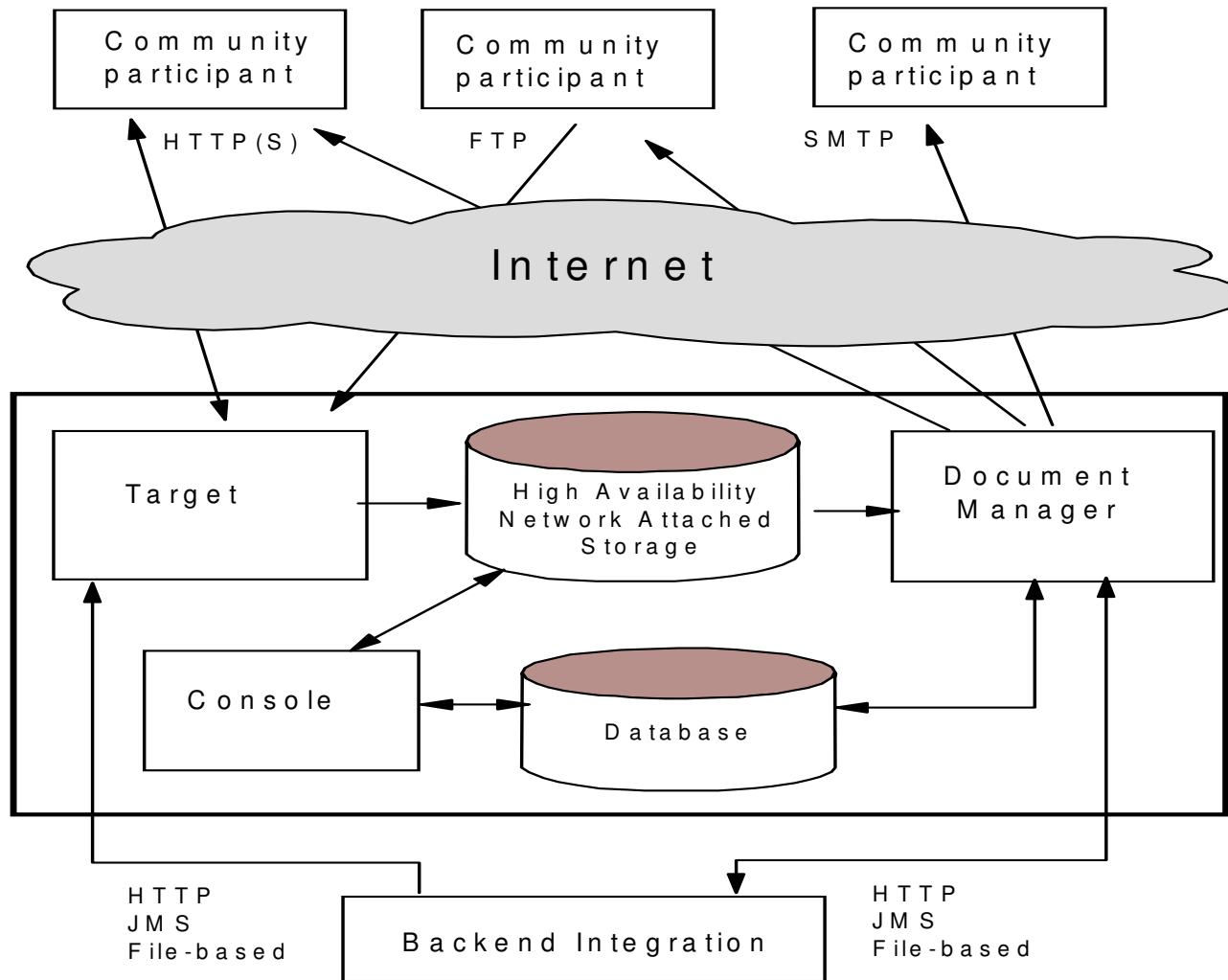

# Protocol Support as of 4.2.2

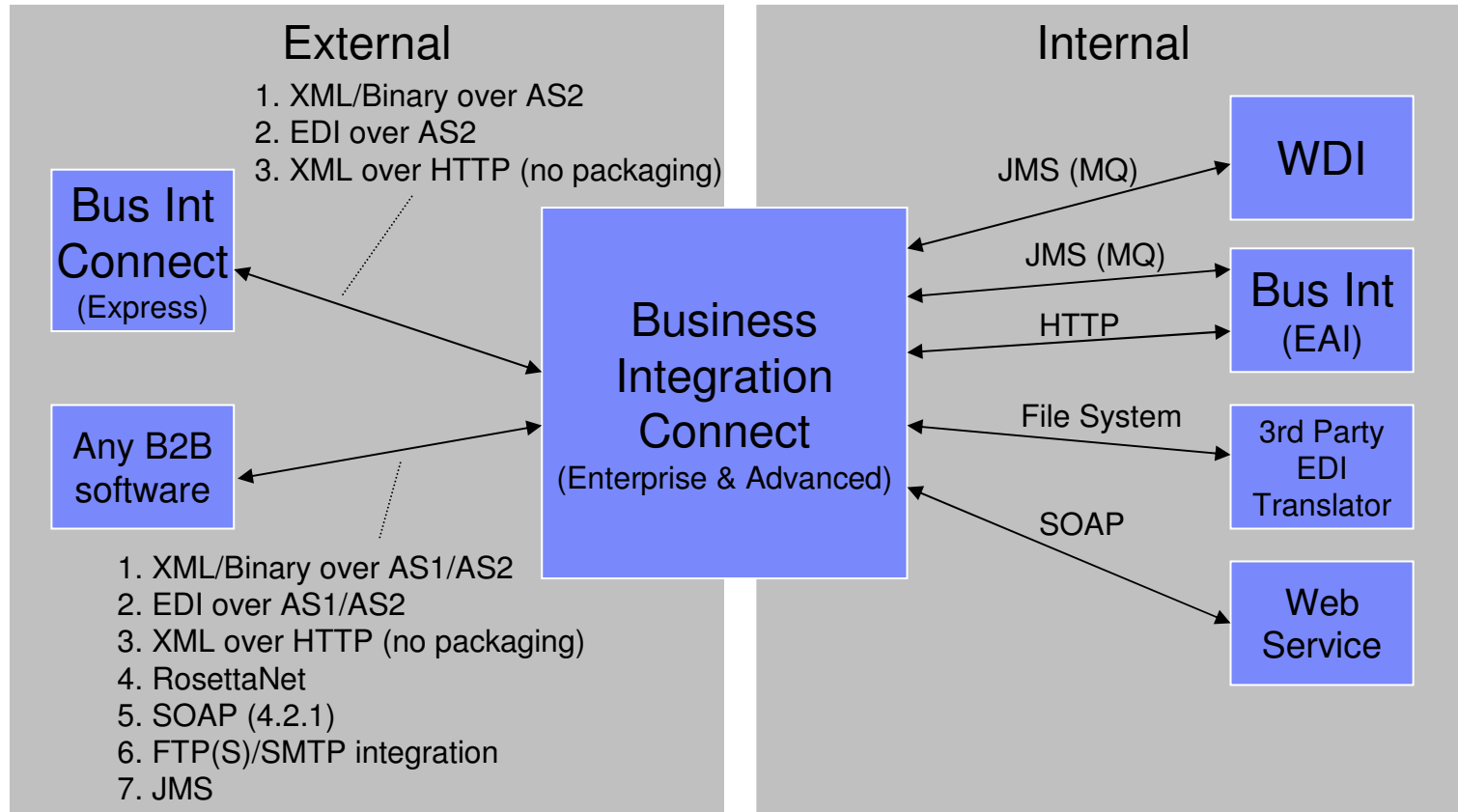

# WebSphere Business Integration Connect Customization

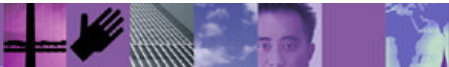

# Extensible Architecture

- Pluggable Protocols and Packagers
  - Provide interface to create and ‘plug-in’ protocols
  - Documented for Customers, Services and Partners
    - Establish Business Partner Program
  - WBI Connect to leverage framework for supported protocols

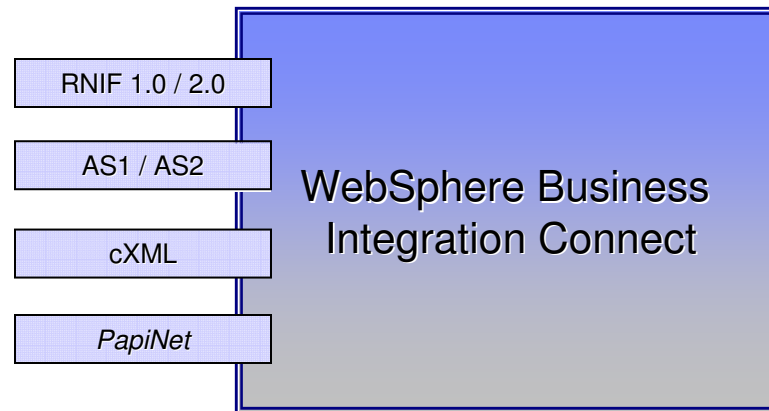

# Extensible Architecture

- User Exits: Validation and Transformation
  - Provide interface to perform custom functions on documents via 'exits'  
Encryption/decryption, validation, transformation
  - Documented for Customers, Services and Partners

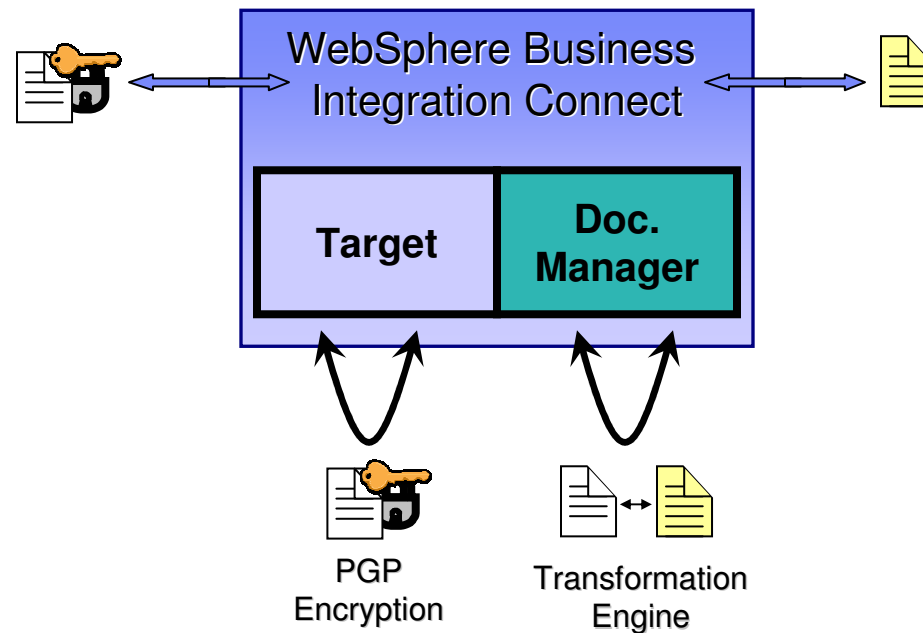

# WebSphere Business Integration Connect Demonstration Slides



# Event Viewer

**WebSphere Business Integration Connect Community Console**

Account Admin | **Viewers** | Tools | Hub Admin | Community Participant Simulator | Logout | Help

**Event Viewer** | AS1/AS2 Viewer | RosettaNet Viewer | Document Viewer | Gateway Queue

**Event Viewer Search** [Help](#)

Start Date: 12/01/2003 \*      End Date: 1/4/2004 \*

Start Time: 19:40:43 \*      End Time: 19:50:43 \*

Participants: All | Hub Operator | hubmgr \*

Event Type:  Debug  Info  Warning  Error  Critical

Event Code: All

Event Location: All

Source IP:

Event ID:

Sort By: TimeStamp Descend      Results Per Page: 10

Refresh:  off      Refresh Rate: 20 seconds

**Search** Reset



# Event Viewer

Event Viewer | AS1/AS2 Viewer | RcsettaNet Viewer | Document viewer | Gateway Queue

Debug
  Info
  Warning
  Error
  Critical

Event Viewer Show Criteria

Page 1 of 2

First Pg    << Prev 10    < Prev    1 2    Next >    Next 10 >>    Total La

Event Code	Event Name	TimeStamp	Type	Location	Source IP	Source Participant	Target Particip
210001	Connection Not Found	2003-12-15 23:03:15.576	Error	Unknown	127.0.0.1	partner1	hubmgr
210001	Connection Not Found	2003-12-15 22:45:25.245	Error	Unknown	127.0.0.1	partner1	hubmgr
101003	Connection Already Exists	2003-12-15 22:40:16.346	Warning	Unknown	-	Hub Operator	
210013	Connection Not Fully Configured	2003-12-15 19:55:05.896	Error	Unknown	127.0.0.1	partner1	hubmgr
210066	Package and Content Business Id's map to different partners.	2003-12-15 19:52:00.584	Error	Unknown	127.0.0.1	hubmgr	partner:
210013	Connection Not Fully Configured	2003-12-15 19:49:12.532	Error	Unknown	127.0.0.1	partner1	hubmgr
210013	Connection Not Fully Configured	2003-12-15 19:42:54.582	Error	Unknown	127.0.0.1	partner1	hubmgr

# Event Viewer

### Document Details

[List](#)   [Help](#)

**Reference Id:** 10715179196930010A486E79F0024623750900BEAF320FB  
**Document ID:** 000000001

Doc Time Stamp	Gateway Type	Connection Document Flow	Status
961007-2013	Unknown		

	Source	In Time Stamp	Source Business ID	Source Document Flow
( 2.06 kb)	hubmgr	12-15-2003 19:51:59:000	987654321	EDI-X12 ALL: A.L ALL
	Target	End State Time Stamp	Target Business ID	Target Document Flow
	partner1		123456789	- - - -

### Document Events

[Help](#)

Event Filter:

Debug
 Information
 Warning
 Error
 Critical

Total Event Count: 2

Event Name	TimeStamp	Type	Event Code	Location	Source IP
▼ Package and Content Business Id's map to different partners.	2003-12-15 19:52:00.584	Error	210066	Unknown	127.0.0.1

#### Event Details

From Partner ID = 21,22,22,21, To Partner ID = , From Package Partner ID = , To Package Partner ID =

26
Global Business Transformation
© 2004 IBM Corporation



# Event Alert Definition

Account Admin | Viewers | Tools | Hub Admin | Community Participant Simulator

Profiles | Participant Connections | Exclusion List | **Alerts**

Define | Notify

**Alert: Events**

**Alert type:**  Volume Alert  Event Alert

**Alert Name:**

**Alert Owner:**

**Participant:**

**Event Type:**

**Event Name:**

**Alert Status:**

- 123456 Participant Name Already Exists
- 200014 Community Manager Provided RN Process-Instance-ID Warning
- 200016 Community Manager Provided RosettaNet Global Usage Code Warnin
- 210018 User Defined Duplicate Check Field(s) not Found
- 210030 Not all Files Present for Document
- 230008 Validation Warning**
- 240072 MIME Structure Validation Warning
- 240425 MDN Not Signed
- 250003 Delivery Scheduler Warning