

System Automation for z/OS



Defining Automation Policy

Version 2 Release 3

System Automation for z/OS



Defining Automation Policy

Version 2 Release 3

Note!

Before using this information and the product it supports, be sure to read the general information under "Notices" on page xiii.

Eighth Edition (June 2004)

This edition applies to Tivoli System Automation for z/OS (Program Number 5645-006) Version 2, Release 3, an IBM licensed program, and to all subsequent releases and modifications until otherwise indicated in new editions or technical newsletters.

Order publications through your IBM representative or the IBM branch office serving your locality. Publications are not stocked at the address given below.

IBM welcomes your comments. A form for readers' comments appears at the back of this publication. If the form has been removed, address your comments to:

IBM Deutschland Entwicklung GmbH
Department 3248
Schoenaicher Strasse 220
D-71032 Boeblingen
Federal Republic of Germany

If you prefer to send comments electronically, use one of the following methods:

FAX (Germany): 07031 + 16-3456
FAX (Other Countries): (+49)+7031-16-3456
Internet: s390id@de.ibm.com

When you send information to IBM, you grant IBM a nonexclusive right to use or distribute the information in any way it believes appropriate without incurring any obligation to you.

© Copyright International Business Machines Corporation 1996, 2004. All rights reserved.

US Government Users Restricted Rights – Use, duplication or disclosure restricted by GSA ADP Schedule Contract with IBM Corp.

Contents

Figures vii

Tables xi

Notices xiii

Web Site Disclaimer xiii
Programming Interface Information xiii
Trademarks xiv

About This Book xv

Who Should Use This Book xv
Notes on Terminology. xv
Where to Find More Information xv
 The System Automation for z/OS Library xv
 Related Product Information xvi
 Using LookAt to look up message explanations xviii
 Accessing z/OS licensed documents on the
 Internet xviii

Chapter 1. Overview 1

How to Define Automation Policy: An Outline 2
| The Customization Dialog Primary Menu. 2
Entry Type Introduction 3
 Policy Objects and Policy Items 7
Considerations for the SA z/OS Graphical Interface 8
 Grouping Resources Logically 8
Considerations for Automation 9
Building and Distributing SA z/OS Automation
Policy 10

**Chapter 2. Using the Customization
Dialog 11**

How to Start the Customization Dialog 12
How to Navigate in the Customization Dialog. 13
 How to Use a Fast Path 13
 Concurrent User Access 14
 How to Cancel Input on a Panel 14
How to Create New Policy Objects 14
| How to Rename a Policy Object 15
Delete Option on All Entry Name Selection Panels 16
Common Policy Items 18
 Policy Item DESCRIPTION 18
 Policy Item COPY 19
 Policy Item WHERE USED 20

Chapter 3. Automation Concepts 23

Goal Driven Automation 23
 Grouping Support 23
 A Grouping Scenario 24
Automatic Calculation of Schedules (Service
Periods) 28
 Adaptive Scheduling 28
Relationship Support 28
How SA z/OS Uses Error Thresholds 31

 Setting up a Threshold 31
Automation Flags 34
 Types of Automation Flags 35
 Setting Automation Flags. 37
 Automation Manager Flags 38
 Relationship Between Automation Flags and
 Resource Status 38
 Automation Flags and Minor Resource Flags 39
Event and Trigger Support 39
Assigning System Automation Symbols
(AOCLONE) 42
 Using System Symbols and System Automation
 Symbols 43

**Chapter 4. Scenarios on How to Use
the Customization Dialog. 45**

How to Work with Resources 45
 Step 1: How to Create the Policy Objects that
 Make Up the Sysplex 45
 Step 2: How to Create the Applications 47
 Step 3: How to Create the Application Groups. 48
How to Use Schedules (Service Periods). 69
 Schedule Override 69
 Early Start. 70
How to Use Triggers and Events 70
How to Use User E-T Pairs 72
 Step 1: Specifying User Data in the
 Customization Dialog 72
 Step 2: Access the User Data. 73
How to Implement Message Processing with
User-Defined Data 74
 Step 1: How to Specify the User-Defined Data. 74
 Step 2: How to Specify the Commands 75
 Step 3: How to Update the NetView Automation
 Table 76
 Step 4: How to Write the REXX Exec 78

Chapter 5. Defining Automation Policy 81

Enterprise Policy Object 82
 Policy Items for an Enterprise 82
 More about Policy Item SEND COMMAND
 OPERS 83
 More about Policy Item INGSSEND PARMS. 85
 More about Policy Item PROCESSOR OPS INFO 86
 More about Policy Item AUTO MSG CLASSES 87
 More about Policy Item SYMBOL DESCRIPTION 88
 More about Policy Item MPF DEFINITIONS 89
Group Policy Object 90
 Creating a New Group 90
 Policy Items for Standard Groups 92
 Policy Items for Sysplex Groups 92
 More about Policy Item GROUP INFO 94
 More about Policy Item SUBGROUPS 94
 More about Policy Item SYSTEMS. 95
 More about Policy Item SYSPLEX 95

	More about Policy Item NMC DEFINITIONS . . .	98	Policy Items for JES3 Subsystems	194
	More about Policy Item APPLICATION GROUPS	99	Policy Items for CICS Subsystems	199
	More about Policy Item LOCAL PAGE DATA		Policy Items for DB2 Subsystems	204
	SET	99	Policy Items for IMS Subsystems	208
	More about Policy Item JOB DEFINITIONS . . .	100	Policy Items for OPC Subsystems.	217
	More about Policy Item JOB/ASID		Policy Items for USS Subsystems	218
	DEFINITIONS	101	Defining VTAM Application Subsystems . . .	220
	More about Policy Item RESOURCE		Events Policy Object	221
	DEFINITIONS	102	Creating a New Event	221
	More about Policy Item IEADMCxx SYMBOLS	103	Policy Items for Events	222
	SubGroup Policy Object	103	More about Policy Item CONDITION	223
	Creating a New SubGroup	103	Service Periods Policy Object	223
	Policy Items for SubGroup	104	More about Policy Item SERVICE WINDOW	224
	System Policy Object	105	Triggers Policy Object	226
	Creating a New System	105	More about Policy Item CONDITION	227
	Policy Items for Systems.	108	Processor Policy Object	229
	More about Policy Item SYSTEM INFO. . . .	113	Creating a New Processor	229
	More about Policy Item AUTOMATION		Policy Items for Processors	230
	SYMBOLS	114	Policy Items for PSM Processors	234
	More about Policy Item NETVIEW	115	Monitor Resource Policy Object	237
	More about Policy Item AUTOMATION		More about Policy Item MONITOR INFO . . .	238
	CONSOLE	116	More about Policy Item HEALTHSTATE . . .	239
	More about Policy Item AUTOMATION SETUP	117	More about Policy Item SERVICE PERIOD . .	241
	More about Policy Item PROCESSOR	120	Product Automation Policy Object	241
	More about Policy Item TARGET SYSTEM INFO	121	Defining Automation for DB2 Components .	242
	More about Policy Item IPL INFO	122	Defining Automation for CICS Components .	243
	ApplicationGroup Policy Object	125	Defining Automation for IMS Components .	247
	Creating a New ApplicationGroup	125	Defining Automation for OPC Components .	251
	Policy Items for ApplicationGroups	128	Timers Policy Object	256
	More about Policy Item APPLGROUP INFO . .	130	Timeout Settings Policy Object.	258
	More about Policy Item APPLICATIONS . . .	130	Tape Attendance Policy Object.	260
	More about Policy Item TRIGGER	131	MVS Component Policy Object	262
	More about Policy Item SERVICE PERIOD . .	131	More about the THRESHOLD Policy Items .	264
	More about Policy Item RELATIONSHIPS. . .	132	More about the WTOBUF RECOVERY Policy	265
	More about Policy Item RESOURCES	139	Item	265
	More about Policy Item GENERATED		More about Policy Item MESSAGES/USER	
	RESOURCES	143	DATA	268
	More about Policy Item MEMBER OF	144	More about Policy Item MINOR RESOURCE	
	Application Policy Object	145	FLAGS	269
	Creating a New Application	145	MVSCOMP Defaults Policy Object	269
	Policy Items for Applications	151	System Defaults Policy Object	270
	More about Policy Item APPLICATION INFO	154	More about Policy Item AUTOMATION	
	More about Policy Item AUTOMATION INFO	157	OPTIONS	271
	More about Policy Item AUTOMATION FLAGS	162	More about Policy Item ENVIRONMENT . . .	272
	More about Policy Item TRIGGER	164	Application Defaults Policy Object	272
	More about Policy Item SERVICE PERIOD . .	164	Auto Operators Policy Object	273
	More about Policy Item RELATIONSHIPS. . .	165	More about the OPERATORS Policy Item . .	274
	More about Policy Item MESSAGES/USER		Structure of AOFWRKxx Operators	278
	DATA	165	Notify Operators Policy Object	279
	More about Policy Item STARTUP	175	Network Policy Object	282
	More about Policy Item SHUTDOWN	179	NNT Sessions Policy Object	286
	More about Policy Item THRESHOLDS.	185	Resident CLISTs Policy Object.	288
	More about Policy Item MINOR RESOURCE		Status Details Policy Object.	289
	FLAGS	186	More about Policy Item SDF DETAILS	290
	More about Policy Item SYSTEM		Includes Policy Object	292
	ASSOCIATION.	187	User E-T Pairs Policy Object	292
	More about Policy Item GENERATED		More about Policy Item E-T DATA	293
	RESOURCES	188		
	More about Policy Item MEMBER OF for			
	Applications.	189		
	Policy Items for JES2 Subsystems.	190		

Chapter 6. Policy Database Maintenance 295
 Policy Database Selection List 295

Creating a New Policy Database	297	Defining a MOVE Group for Automatic Restart Manager	354
Using Sample SA z/OS Policy Databases	300		
Specifying Settings for Policy Databases	301		
Logging Policy Database Modifications	303		
Chapter 7. Creating Reports about Policy Databases	307	Chapter 12. Conversion Function	355
Chapter 8. Building and Distributing Control Files.	313	Moved and Restructured Data	355
How to Define Data Sets for Build Processing	314	Initial Policy Database Conversion	355
How to Build the Configuration Files	314	Converted Data	357
Building the Processor Control File	315	Selective Policy Database Conversion	363
Usage Notes.	316	Generating a Job for Batch Conversion	364
Building the System Operations Configuration Files	317		
System Operations Configuration Files Build Options	318	Appendix A. Concurrent Customization by Multiple Users	365
Distributing the System Operations Configuration Files	324	Concurrent User Access Capabilities.	365
Generating a Job for Batch Build	326	Policy Definitions Usage.	365
		Policy Database Selection	365
		Entry Type Selection	366
		Entry Name Selection	366
		Changing Links	366
		Automated NetView Automation Table Build.	367
Chapter 9. Data Management.	327	Appendix B. More about Using the Customization Dialog	369
Panel Interaction	327	Getting Help	369
Importing Policy Database Data	327	Changing Your Customization Dialog Environment	369
Migrating the Automation Control File	329	Extending Policy Definitions	371
Entry Name Creation.	336	Defining Data Sets for Batch Processing	375
Migration of Include Files and Product Automation Definitions	339	Define ISPF Temporary Data Sets for Batch Build	376
Generating a Job for Batch Migrate	345	User-written Functions	377
		Alternate Configuration Support	378
		How to Define Alternate Configurations for Systems	378
		How to Build Alternate Configurations.	379
		Restrictions	379
Chapter 10. Automating Networks	347	Appendix C. Message Definitions That Do Not Create AT Entries	381
Automation Network Definition Process	347		
Defining an SDF Focal Point System.	348	Glossary	383
Defining Gateway Sessions	349		
Defining Automatically-Initiated TAF Full-Screen Sessions	350	Index	403
Chapter 11. How System Operations Coordinates with Automatic Restart Manager	353		
Defining an ARM Element Name.	353		

Figures

1. Customization Dialog Primary Menu	2	44. Select Resources Panel for DWHAPG with	Valid APG-Resources	64
2. Entry Type Selection Panel	7	45. Select Resources Panel for DWHAPG with	Selected Preferences.	66
3. Entry Name Selection Panel for Groups	7	46. Select Resources Panel for DWHAPG with	Converted Preferences	66
4. Policy Selection Panel for Sysplex Groups	8	47. Define New Entry Input Panel for WBSRVAPG		68
5. Customization Dialog Primary Menu	12	48. Final Select Resources Panel for WBSRVAPG		69
6. Define New Entry Panel for an Application	15	49. Scenario with Triggers, Events and Service	Period	72
7. Sample Generic Define New Entry Panel	15	50. UET Entry-Type Selection Panel.		72
8. Entry Name Selection Panel: Rename Action	16	51. UET Keyword-Data Specification Panel		73
9. Entry Name Rename Popup Panel	16	52. Message Processing Panel.		74
10. Delete Error Panel	17	53. User Defined Data Panel		75
11. Where Used Panel	17	54. CMD Processing Panel.		76
12. Requesting a List of Instances	18	55. Message Processing Panel.		76
13. Links of Application Class to Instances	18	56. Automation Processing Panel		77
14. Sample Description Policy Item Panel.	19	57. Automation Processing Panel		77
15. Where Used Panel	21	58. Entry Type Selection Panel		81
16. Example of Aggregating Applications into		59. Policy Selection Panel for Enterprises		82
Application Groups	24	60. Operator Profile for Sending Commands Panel		84
17. Application Groups	26	61. INGSND Command Parms Panel.		85
18. Grouping of Applications into Nested		62. Processor Operations Information Panel		87
ApplicationGroups	27	63. AUTO MSG CLASSES Panel		88
19. Relationships and Conditions	29	64. System Automation Symbols (AOCLONEx)	Description Panel	89
20. The HASPARENT Relationship	29	65. MPF Header and Trailer Definition Panel		89
21. Relationship in a Sysplex	30	66. Define New Entry Panel for a Sysplex Group		91
22. Relationship between Applications and		67. Policy Selection Panel for Standard Groups		92
Application Groups	31	68. Policy Selection Panel for Sysplex Groups		93
23. Thresholds Specification Panel	32	69. Group Information Panel for Standard Groups		94
24. Thresholds Definition Panel	33	70. Subgroups Panel for Standard Groups		95
25. Component Definition: MVSDUMP Panel	34	71. Systems Panel for Standard Groups		95
26. Flag Automation Specification Panel	35	72. Sysplex Policy Definition Panel for Sysplex	Groups	96
27. How a Trigger Uses Events	40	73. NMC Definitions Panel for Sysplex Groups		98
28. Triggers, Events and Conditions.	41	74. Group Information Panel for Standard Groups		99
29. Current Configuration with Sysplex		75. Local Page Data Set Recovery		100
Application Group CICS/AOR	51	76. Job Definitions for Local Page Data Set	Recovery	101
30. Current Configuration with Applications		77. JOB/ASID Definitions		101
CICS/AOR1 through CICS/AOR3.	52	78. Long Running ENQ Resource Definitions		102
31. Resources for the CICS/AOR Sysplex		79. Long Running ENQ IEADMCxx Symbols		103
Application Group	53	80. Define New Entry Panel for a Subgroup		104
32. Current Configuration with Application Group		81. Policy Selection Panel for Subgroups		104
DB2	55	82. Define New Entry Panel for a System		105
33. Current Configuration with Applications		83. Policy Selection Panel for Systems		109
Linked to DB2	56	84. SYSTEM INFO Panel		113
34. Select System Panel for DB2 Application group	56	85. Automation Symbols Panel		114
35. Select Resources Panel for DB2 Application		86. NetView Information Panel		115
Group	57	87. Environment Definition: CONSOLE (Route	Codes) Panel.	116
36. Grouping Resources.	58	88. Environment Setup Panel		117
37. Resources for the CICS Sysplex Application		89. Select Target Hardware for System Panel		120
Group	58	90. Target System Information Panel		121
38. Current Configuration with Applications		91. MVS Target System IPL Information Panel		123
Linked to DB2	59			
39. Select Resources Panel for Application Group				
NET	59			
40. Select Resources Panel for DWHAPG with				
valid APG-Resources	61			
41. Select Resources Panel for DWHAPG2	62			
42. Select Resources Panel for DWHAPG2	63			
43. Select Resources Panel for DWHAPG3	63			

92. VM Target System IPL Information Panel	124		145. CICS Link for Application Panel	203
93. Define New Entry Panel for a Sysplex Application Group	126		146. CICS State/Action for Application Panel	203
94. Policy Selection Panel for System Application Groups	128		147. CICS Resource Thresholds Selection Panel	204
95. Application Group Information Panel	130		148. Policy Selection Panel for DB2 Subsystems	205
96. Applications for ApplicationGroup Panel for System Application Groups	130		149. DB2 Control Entries Panel	206
97. Trigger for ApplicationGroup Panel	131		150. DB2 Resource Thresholds Selection Panel	207
98. Applications for ApplicationGroup Panel for System Application Groups	131		151. Policy Selection Panel for IMS Subsystems	208
99. Relationship Selection List Panel	132		152. IMS Control Region Specifications Panel for subtype CTL	210
100. Define Relationship Panel	133		153. IMS Dependent Region Specifications Panel	216
101. Example for Strong Chaining	137		154. Policy Selection Panel for OPC Subsystems	217
102. Select Resources for ApplicationGroup Panel	139		155. OPC control specifications Panel	218
103. Generated Resources Panel	144		156. Policy Selection Panel for USS Subsystems	219
104. Member of Panel for ApplicationGroups	144		157. USS Control Specification Panel	219
105. Define New Entry Panel for Applications	145		158. Entry Name Selection Panel for Events	222
106. Applications Defined as Instance Objects and of Type STANDARD	151		159. Define New Event Panel	222
107. Application Information Panel	155		160. Policy Selection Panel for Events	222
108. Application Automation Definition Panel	157		161. Unset Condition Panel for Events	223
109. Flag Automation Specification Panel	162		162. Policy Selection Panel for Service Periods	224
110. Trigger for Application Panel	164		163. Service Windows Panel for Service Periods	225
111. Service Period for Application Panel	164		164. Policy Selection Panel for Triggers	227
112. Relationship Selection List Panel	165		165. Trigger Conditions Panel	228
113. Message Processing Panel	166		166. STARTUP Condition for Trigger Panel	229
114. CMD Processing Panel	168		167. Defining a New SA z/OS Processor Entry	230
115. Reply Processing Panel	170		168. Policy Selection Panel for Processor	230
116. Code Processing Panel	171		169. Processor Information Panel	231
117. User Defined Data Panel	173		170. LPAR Definitions Panel	233
118. Message Type Selection Panel	174		171. Policy Selection Panel for PSM Processors	234
119. Automation Processing Panel	174		172. ProcOps Service Machine Information Panel	234
120. Using STARTUP Policy	176		173. GUEST Definitions Panel	236
121. Subsystem Startup Processing Panel	176		174. Policy Selection for Monitor Resource	237
122. Startup Command Processing Panel	178		175. Monitor Resource Information Panel	238
123. Subsystem Shutdown Processing Panel	179		176. Healthstate Processing Panel	240
124. Shutdown Command Processing Panel for INIT and FINAL	181		177. Service Period for Monitor Resource Panel	241
125. Shutdown Command Processing Panel for NORM, IMMED, and FORCE	182		178. Entry Type Selections for Product Automation Panel	242
126. Shutdown Reply Processing Panel for NORM, IMMED and FORCE	184		179. Policy Selection Panel for DB2 System Defaults	242
127. Shutdown Reply Processing Panel for INIT	185		180. Policy Selection Panel for CICS State/Action Tables	243
128. Thresholds Definition Panel	185		181. CICS State/Action Tables Panel	244
129. Minor Resource Selection Panel	186		182. Policy Selection Panel for CICS Link Definitions	244
130. System Association Panel	187		183. CICS Connection Links Panel	245
131. Generated Resources Panel	189		184. Policy Selection Panel for CICS Link Monitor Periods	246
132. Member of Panel for Applications	189		185. Link Monitoring Service Period Panel	247
133. Policy Selection Panel for JES2 Subsystems	190		186. Policy Selection Panel for IMS State/Action Table	248
134. SPOOLFULL Processing Panel	191		187. IMS State Action Tables Panel	248
135. SPOOLFULL Processing Panel for JES2	192		188. Policy Selection Panel for IMS XRF Status File	249
136. SPOOLSHORT Processing Panel	193		189. IMS Status File Specification Panel	249
137. JES2 DRAIN Processing Panel	193		190. Policy Selection Panel for IMS XRF Resource	250
138. Policy Selection Panel for JES3 Subsystems	194		191. IMS Resource Names Panel	251
139. JES3 SPOOLFULL Processing Panel	195		192. Policy Selection Panel for OPC System Detail	252
140. JES3 SPOOLSHORT Processing Panel	195		193. OPC System Details Panel	252
141. JES3 Monitor Definition Panel	196		194. Policy Selection Panel for OPC Controller Details	253
142. JES3 Thresholds Specification Panel	198		195. OPC Controller Details Panel	254
143. Policy Selection Panel for CICS Subsystems	199		196. Policy Selection Panel for OPC Special Resources	255
144. CICS Control Specifications Panel	200			

197. OPC Special Resource Definitions Panel	255		236. Settings for Policy Data Base Panel	302
198. Policy Selection Panel for OPC Workstation Domain	256		237. Example of an Activity Log	305
199. Policy Selection Panel for Timers	257		238. SA z/OS Report Selection Menu	307
200. Timer Specification Panel	257		239. Policy Data Base Report Parameters Panel	308
201. Policy Selection Panel for Timeout Settings	258		240. Example of Report Output Format FLAT	309
202. Environment Definition: TIMEOUT Panel	259		241. List of Generated Resources.	310
203. Policy Selection Panel for Tape Attendance	261		242. Unreferenced Member Report	311
204. Environment Definition: TAPES Panel	261		243. Command Progress Display for the Status Messages Report	312
205. Policy Selection Panel for MVS Components	263		244. Example Status Messages Report (Excerpt)	313
206. Environment Definition: WTOBUF Overflow Panel	265		245. Build Functions Menu Panel	314
207. WTOBUF Recovery Passes Panel for MVS Component	266		246. Processor Operations Control File Build Panel	315
208. Console Mode After WTOBUF Recovery Panel	267		247. Build Parameters Panel	319
209. Message Processing Panel	268		248. SA z/OS Automation Configuration	325
210. Minor Resource Selection Panel	269		249. Data Management Select Panel.	327
211. Policy Selection Panel for MVSCOMP Defaults	270		250. Policy Data Base Import Panel.	328
212. Policy Selection Panel for System Defaults	271		251. Entry Name Selection Panel for Import Policy Data	329
213. System Automation Options Panel	272		252. Confirm Selected Entry Names For Import Panel	329
214. Subsystem Defaults Panel	272		253. System Migration Definitions Panel	331
215. Policy Selection Panel for Application Defaults	273		254. System Object Migration Panel.	334
216. Policy Selection Panel for Auto Operators	274		255. Entry Name Migration Panel	335
217. Automation Operator Definition Panel	276		256. UET Keyword-Data Specification for Entry Name HSMMAIL	339
218. Automation Operator NetView Userids Panel	277		257. ACF Definitions for CICS	340
219. Automation Operator: MVSCONS Panel	278		258. Monitoring Service Period	344
220. Policy Selection Panel for Notify Operators	279		259. Focal Point Forwarding Definitions for Systems	348
221. Operator Notification Panel.	280		260. Notification Forwarding Panel for CHI02	348
222. Operator Notification Message Classes Panel	281		261. Notification Forwarding Panel for ATL01 and ATL02	348
223. Policy Selection Panel for Network	283		262. Automation Operator Definitions Panel	349
224. Policy Selection Panel for NNT Sessions	287		263. Automation Operator NetView Userids Panel	350
225. NNT Sessions Definition Panel.	287		264. Fullscreen TAF Application Definition Panel	351
226. NNT Sessions Definition Panel.	287		265. PDB Convert Option Panel	356
227. Policy Selection Panel for Resident CLISTs	289		266. SA z/OS Customization Dialog Settings Menu	370
228. Policy Selection Panel for Status Details	290		267. Entry Type Selection Panel	371
229. Status Display Facility Details Panel	290		268. Edit Policy Selections Panel.	372
230. Policy Selection Panel for User E-T Pairs	293		269. Define Policy Selection Panel	373
231. UET Entry-Type Selection Panel	293		270. SA z/OS Data Set Customization Details Panel	375
232. UET Keyword-Data Specification Panel	294		271. Send Policy Data Base Panel	378
233. Policy Data Base Selection Panel	295			
234. Policy Data Base Selection Panel	297			
235. Create a New Policy Database Panel	298			

Tables

1. System Automation for z/OS Library	xvi	8. SA z/OS Mapping of NetView Automation Operator to SA z/OS Automated Function	. 274
2. Related Products Books	xvi	9. SA z/OS Message Classes 281
3. System Symbols and System Automation Symbols.	43	10. Creation of Entry Names. 336
4. System Symbols	44	11. Cross Reference of SA OS/390 1.3 Feature Keywords to SA z/OS 2.3 Dialog Entries 361
5. System Automation Symbols.	44	12. Policy Selection Filter Attributes 374
6. Relationship Conditions	138		
7. Preference Value Scenarios	142		

Notices

References in this publication to IBM products, programs, or services do not imply that IBM intends to make these available in all countries in which IBM operates. Any reference to an IBM product, program, or service is not intended to state or imply that only IBM product, program, or service may be used. Subject to IBM's valid intellectual property or other legally protectable rights, any functionally equivalent product, program, or service may be used instead of the IBM product, program, or service. The evaluation and verification of operation in conjunction with other products, except those expressly designated by IBM, are the responsibility of the user.

IBM may have patents or pending patent applications covering subject matter in this document. The furnishing of this document does not give you any license to these patents. You can send license inquiries, in writing, to:

IBM Director of Licensing
IBM Corporation
North Castle Drive
Armonk, NY 10504-1785
USA

Licensees of this program who wish to have information about it for the purpose of enabling: (i) the exchange of information between independently created programs and other programs (including this one) and (ii) the mutual use of the information which has been exchanged, should contact:

IBM Deutschland Entwicklung GmbH
Department 3248
Schoenaicher Strasse 220
D-71032 Boeblingen
Federal Republic of Germany

Such information may be available, subject to appropriate terms and conditions, including in some cases, payment of a fee.

Web Site Disclaimer

Any pointers in this publication to non-IBM Web sites are provided for convenience only and do not in any manner serve as an endorsement. IBM accepts no responsibility for the content or use of non-IBM Web sites specifically mentioned in this publication or accessed through an IBM Web site that is mentioned in this publication.

Programming Interface Information

This publication documents information that is NOT intended to be used as a Programming Interface of System Automation for z/OS.

Trademarks

The following terms are trademarks or service marks of the IBM Corporation in the United States or other countries or both:

ACF/VTAM	APPN
CICS	DB2
DFSMS/MVS	ESCON
FICON	IBM
IMS	Library Reader
Micro Channel	WebSphere MQ
Multiprise	MVS
MVS/ESA	Netfinity
Netfinity Manager	NetView
OpenEdition	OS/2
OS/390	Parallel Sysplex
RACF	RMF
Sysplex Timer	System/390
Tivoli	Tivoli Enterprise Console
VM/ESA	VSE/ESA
VTAM	z/OS
zSeries	

The following terms are trademarks of other companies:

HeathKit

Heath Co., St. Joseph, MO

Spectracom

Spectracom Corp., Rochester, NY

Windows

Microsoft Corporation

Windows NT

Microsoft Corporation

Java Sun Microsystems, Inc.

UNIX UNIX is a registered trademark of The Open Group in the United States and other countries.

LINUX

LINUX is a registered trademark of Linus Torvalds and others.

About This Book

This book describes Tivoli[®] System Automation for z/OS[®] (SA z/OS). This product plays a key role in supplying high-end automation solutions whereas Tivoli Systems (Tivoli Management Environment, Tivoli) delivers integrated cross-platform management functions. This book contains information about how to enable SA z/OS's automation.

Who Should Use This Book

This book is primarily intended for automation programmers responsible for defining and maintaining the automation policy.

Notes on Terminology

MVS[™]

References in this book to *MVS* refer either to the MVS/ESA[™] product or to the MVS element of z/OS.

NetView[®]

The term *NetView* used in this documentation stands for IBM[®] Tivoli NetView for OS/390[®].

OPC

References in this book to *OPC* refer to Tivoli Workload Scheduler (TWS).

Resources, Applications, and Subsystems

These three terms are used in the SA z/OS library to designate automated entities. The correct term to be used depends on the context. Refer to the *Introduction* chapter in *System Automation for z/OS Operator's Commands* for the definition of these terms.

Where to Find More Information

The System Automation for z/OS Library

The following table shows the information units in the System Automation for z/OS library:

Table 1. System Automation for z/OS Library

Title	Order Number
<i>System Automation for z/OS Planning and Installation</i>	SC33-7038
<i>System Automation for z/OS Customizing and Programming</i>	SC33-7035
<i>System Automation for z/OS Defining Automation Policy</i>	SC33-7039
<i>System Automation for z/OS User's Guide</i>	SC33-7040
<i>System Automation for z/OS Messages and Codes</i>	SC33-7041
<i>System Automation for z/OS Operator's Commands</i>	SC33-7042
<i>System Automation for z/OS Programmer's Reference</i>	SC33-7043
<i>System Automation for z/OS CICS Automation Programmer's Reference and Operator's Guide</i>	SC33-7044
<i>System Automation for z/OS IMS Automation Programmer's Reference and Operator's Guide</i>	SC33-7045
<i>System Automation for z/OS OPC Automation Programmer's Reference and Operator's Guide</i>	SC23-7046
<i>System Automation for z/OS Licensed Program Specifications</i>	SC33-7037

The System Automation for z/OS books are also available on CD-ROM as part of the following collection kit:

IBM Online Library z/OS Software Products Collection (SK3T-4270)

SA z/OS Home Page

For the latest news on SA z/OS, visit the SA z/OS home page at <http://www.ibm.com/servers/eserver/zseries/software/sa>

Related Product Information

The following table shows the books in the related product libraries that you may find useful for support of the SA z/OS base program.

Table 2. Related Products Books

Title	Order Number
<i>ISPF User's Guide</i>	SC34-4484
<i>ISPF Dialog Management Guide and Reference</i>	SC34-4266
<i>MVS/ESA MVS Configuration Program Guide and Reference</i>	GC28-1817
<i>MVS/ESA Planning: Dynamic I/O Configuration</i>	GC28-1674
<i>MVS/ESA Support for the Enterprise Systems Connection</i>	GC28-1140
<i>MVS/ESA Planning: APPC Management</i>	GC28-1110
<i>MVS/ESA Application Development Macro Reference</i>	GC28-1822
<i>OS/390: MVS System Commands</i>	GC28-1781
<i>MVS/ESA SPL Application Development Macro Reference</i>	GC28-1857
<i>OS/390 Hardware Configuration Definition: User's Guide</i>	SC28-1848
<i>OS/390 Information Roadmap</i>	GC28-1727
<i>OS/390 Information Transformation</i>	GC28-1985
<i>OS/390 Introduction and Release Guide</i>	GC28-1725

Table 2. Related Products Books (continued)

Title	Order Number
<i>OS/390 JES Commands Summary</i>	GX22-0041
<i>OS/390 Licensed Program Specifications</i>	GC28-1728
<i>OS/390 Printing Softcopy Books</i>	S544-5354
<i>OS/390 Starting Up a Sysplex</i>	GC28-1779
<i>OS/390 Up and Running!</i>	GC28-1726
<i>Planning for the 9032 Model 3 and 9033 Enterprise Systems Connection Director</i>	SA26-6100
<i>Resource Access Control Facility (RACF) Command Language Reference</i>	SC28-0733
<i>S/390 MVS Sysplex Overview -- An Introduction to Data Sharing and Parallelism</i>	GC23-1208
<i>S/390 MVS Sysplex Systems Management</i>	GC23-1209
<i>S/390 Sysplex Hardware and Software Migration</i>	GC23-1210
<i>S/390 MVS Sysplex Application Migration</i>	GC23-1211
<i>S/390 Managing Your Processors</i>	GC38-0452
<i>Tivoli/Enterprise Console User's Guide Volume I</i>	GC31-8334
<i>Tivoli/Enterprise Console User's Guide Volume II</i>	GC31-8335
<i>Tivoli/Enterprise Console Event Integration Facility Guide</i>	GC31-8337
<i>Tivoli NetView for OS/390 Administration Reference</i>	SC31-8222
<i>Tivoli NetView for OS/390 Application Programming Guide</i>	SC31-8223
<i>Tivoli NetView for OS/390 APPN Topology and Accounting Agent</i>	SC31-8224
<i>Tivoli NetView for OS/390 Automation Guide</i>	SC31-8225
<i>Tivoli NetView for OS/390 AON Customization Guide</i>	SC31-8662
<i>Tivoli NetView for OS/390 AON User's Guide</i>	GC31-8661
<i>Tivoli NetView for OS/390 Bridge Implementation</i>	SC31-8238
<i>Tivoli NetView for OS/390 Command Reference Vol. 1</i>	SC31-8227
<i>Tivoli NetView for OS/390 Command Reference Vol. 2</i>	SC31-8735
<i>Tivoli NetView for OS/390 Customization Guide</i>	SC31-8228
<i>Tivoli NetView for OS/390 Customization: Using Assembler</i>	SC31-8229
<i>Tivoli NetView for OS/390 Customization: Using Pipes</i>	SC31-8248
<i>Tivoli NetView for OS/390 Customization: Using PL/I and C</i>	SC31-8230
<i>Tivoli NetView for OS/390 Customization: Using REXX and CLIST Language</i>	SC31-8231
<i>Tivoli NetView for OS/390 Data Mode Reference</i>	SC31-8232
<i>Tivoli NetView for OS/390 Installation: Getting Started</i>	SC31-8767
<i>Tivoli NetView for OS/390 Installation: Migration Guide</i>	SC31-8768
<i>Tivoli NetView for OS/390 Installation: Configuring Graphical Components</i>	SC31-8770
<i>Tivoli NetView for OS/390 Installation: Configuring Additional Components</i>	SC31-8769
<i>Tivoli NetView for OS/390 Messages and Codes</i>	SC31-8237
<i>Tivoli NetView for OS/390 MultiSystem Manager User's Guide</i>	SC31-8607

Table 2. Related Products Books (continued)

Title	Order Number
<i>Tivoli NetView for OS/390 NetView Management Console User's Guide</i>	GC31-8665
<i>Tivoli NetView for OS/390 User's Guide</i>	SC31-8241
<i>Tivoli NetView for OS/390 RODM and GMFHS Programming Guide</i>	SC31-8233
<i>Tivoli NetView for OS/390 Security Reference</i>	SC31-8606
<i>Tivoli NetView for OS/390 SNA Topology Manager and APPN Accounting Manager Implementation Guide</i>	SC31-8239
<i>Tivoli Management Platform Reference Guide</i>	GC31-8324
<i>TSO/E REXX/MVS User's Guide</i>	SC28-1882
<i>TSO/E REXX/MVS Reference</i>	SC28-1883
<i>VM/XA SP GCS Command and Macro Reference</i>	SC23-0433
<i>VSE/SP Unattended Node Support</i>	SC33-6412
<i>VTAM Messages and Codes</i>	SC31-6493
<i>VTAM Network Implementation Guide</i>	SC31-6404
<i>VTAM Network Implementation Guide</i>	SC31-6434

Using LookAt to look up message explanations

LookAt is an online facility that lets you look up explanations for most messages you encounter, as well as for some system abends and codes. Using LookAt to find information is faster than a conventional search because in most cases LookAt goes directly to the message explanation.

You can access LookAt from the Internet at:

<http://www.ibm.com/eserver/zseries/zos/bkserv/lookat/> or from anywhere in z/OS or z/OS.e where you can access a TSO/E command line (for example, TSO/E prompt, ISPF, z/OS UNIX System Services running OMVS).

The LookAt Web site also features a mobile edition of LookAt for devices such as Pocket PCs, Palm OS, or Linux-based handhelds. So, if you have a handheld device with wireless access and an Internet browser, you can now access LookAt message information from almost anywhere.

To use LookAt as a TSO/E command, you must have LookAt installed on your host system. You can obtain the LookAt code for TSO/E from a disk on your z/OS *Collection* (SK3T-4269) or from the LookAt Web site's **Download** link.

Accessing z/OS licensed documents on the Internet

z/OS licensed documentation is available on the Internet in PDF format at the IBM Resource Link™ Web site at:

<http://www.ibm.com/servers/resourceLink>

Licensed documents are available only to customers with a z/OS license. Access to these documents requires an IBM Resource Link user ID and password, and a key code. With your z/OS order you received a Memo to Licensees, (GI10-0671), that includes this key code. ¹

1. z/OS.e™ customers received a Memo to Licensees, (GI10-0684) that includes this key code.

To obtain your IBM Resource Link user ID and password, log on to:
<http://www.ibm.com/servers/resourceLink>

To register for access to the z/OS licensed documents:

1. Sign in to Resource Link using your Resource Link user ID and password.
2. Select **User Profiles** located on the left-hand navigation bar.

Note: You cannot access the z/OS licensed documents unless you have registered for access to them and received an e-mail confirmation informing you that your request has been processed.

Printed licensed documents are not available from IBM.

You can use the PDF format on either **z/OS Licensed Product Library CD-ROM** or IBM Resource Link to print licensed documents.

Chapter 1. Overview

Before you can use SA z/OS to automate, monitor, and control the resources in your enterprise, you must define your enterprise's automation policy. For this purpose you use the SA z/OS customization dialog to provide information to SA z/OS such as:

- Which resources (such as systems or applications) you want to automate, monitor and control
- How resources are to be associated (grouped) with each other for automation
- The dependencies between resources and groups of resources
- How and what automation, such as automatic startup or shutdown, is to be applied to these resources
- Conditions under which automated actions should occur, and what actions should be performed
- When automation is active, and how it handles certain tasks and events during system operation

The customization dialog leads the SA z/OS policy administrator through the process of defining resources and automation for the enterprise. SA z/OS automatically extracts the required information from this to display resources graphically on the NMC workstation.

Before you begin to use the customization dialog to define your enterprise automation policy, you need to determine how you want SA z/OS to work within your enterprise. Making this determination is part of the process of planning to use SA z/OS. There are many considerations for planning to use SA z/OS of which you should be aware. For this purpose, also refer to the planning instructions given in *System Automation for z/OS Planning and Installation*.

Note:

Do not use the customization dialogs on a Kanji terminal as they will not work. If you have your terminal defined as a 3278KN terminal, you can circumvent the Kanji restriction by going into ISPF option 0.1 (panel ID ISPOPT1) and redefining the TERMINAL TYPE to 3278.

The remainder of this chapter deals with the following topics:

- "How to Define Automation Policy: An Outline" on page 2 gives an outline of the process of creating enterprise automation policy.
- "The Customization Dialog Primary Menu" on page 2 introduces the *Customization Dialog Primary Menu*.
- "Entry Type Introduction" on page 3 introduces all entry types.
- "Considerations for the SA z/OS Graphical Interface" on page 8 provides some information on how to customize the monitoring aspect of SA z/OS.
- "Considerations for Automation" on page 9 provides some information on how to customize the automation aspect of SA z/OS.
- "Building and Distributing SA z/OS Automation Policy" on page 10 introduces what you need to do once you have entered your policy information (both for monitoring and automation) into the policy database using the customization dialog.

How to Define Automation Policy: An Outline

The process of defining automation policy comprises the following steps:

1. At the configuration focal point, where you have the customization dialog installed, create the information in the policy database using the ISPF input panels of the customization dialog.
2. Then use the BUILD function of the customization dialog to produce the required output, the system operations configuration files: Automation Control File (ACF), Automation Manager Configuration File (AMC), NetView Automation Table (AT), and the MPFLSTSA file.
3. Then you distribute the generated output to the sysplexes or standalone systems that you want to automate.

Refer to Chapter 8, “Building and Distributing Control Files,” on page 313 and Figure 248 on page 325 for more information on building and distributing the generated output files.

The Customization Dialog Primary Menu

Once you have started the customization dialog, you are presented with the *Customization Dialog Primary Menu*, as shown in Figure 1.

```
-----
MENU  OPTIONS  HELP
-----
AOFGPRM  SA z/OS 2.3 Customization Dialog Primary Menu
Option ==> _____

  0 Settings          User parameters

  1 Open              Work with the Policy Data Base
  2 Build             Build functions for Policy Data Base
  3 Report            Generate reports from Policy Data Base
  4 Policies          Maintain Policy Data Base list
  5 Data Management  Import policies/Migrate files into a Policy Data Base
  U User              User-defined selections

  X Exit              Terminate Customization Dialog

To switch to another Policy Data Base, specify the Policy Data Base name
in the following field, or specify a ? to get a selection list.
Current Policy Data Base. . . RESOURCE_PDB _____

                          Licensed Materials - Property of IBM
                    5645-006 (C) Copyright IBM Corp. 1990, 2004 All Rights Reserved.
```

Figure 1. Customization Dialog Primary Menu

You can select the following options:

0 Settings

This option displays the *Customization Dialog Settings Menu*, see “Changing Your Customization Dialog Environment” on page 369.

1 Open

With this option, you open the policy database of your choice, see “How to Start the Customization Dialog” on page 12.

2 Build

This option displays the *Build Functions Menu*, see Chapter 8, “Building and Distributing Control Files,” on page 313.

3 Report

This option displays the *Report Selection Menu*, see Chapter 7, “Creating Reports about Policy Databases,” on page 307.

4 Policies

This option displays the *Policy Data Base Selection* panel with the list of existing policy databases, see “Creating a New Policy Database” on page 297.

5 Data Management

This option displays the *Data Management Select* panel, see “Migrating the Automation Control File” on page 329.

U User

This option invokes the *User-written Functions Selection Menu*. This menu allows you to add installation-specific functions to the customization dialog. For more information refer to “User-written Functions” on page 377.

X Exit Use this option to exit the customization dialog

Entry Type Introduction

All resources in your enterprise, such as systems or applications, or other objects that you use to automate your enterprise data processing, such as components of your z/OS operating system, are called *entry types*. A complete list of SA z/OS entry types is listed on the *Entry Type Selection* panel (see Figure 2 on page 7), which is the first panel you see after you have decided which enterprise or policy database you are going to work with.

For each entry type you can invoke a series of panels to create, modify, or delete entries of a certain entry type. A single instance of a certain entry type is called a *policy object*. These entries are referred to by their *entry name*.

When you select an object via its name, you get a list of *policy items* specific for the entry type you are working with. For example, the *Timers* entry type may consist of several named sets of timer definitions, each containing a number of timers. These named sets are selected and linked to a particular system as required. Each set can be linked to an arbitrary number of systems and any number of sets can be linked to any particular system.

The numbers and letters in parentheses in the following list indicate the entry type’s index on the *Entry Type Selection* panel. You can use either numbers or letters to select the appropriate entry type. The alphanumeric index is used in other panels of the customization dialog to identify a certain entry type.

Detailed information and scenarios on how to automate the resources (applications and application groups) and make them available on certain systems are described in Chapter 4, “Scenarios on How to Use the Customization Dialog,” on page 45.

(1/ENT) Enterprise

An Enterprise is the top level of your SA z/OS structure. It comprises enterprise wide data for the complete policy database, including:

- the definition of an operator profile for sending commands
- the definition of INGSND command parameters
- Processor operations focal point information

Entry Type Introduction

(2/GRP) Group

A group is the largest subdivision of an SA z/OS enterprise. An SA z/OS enterprise may have several groups, each consisting of systems or subgroups, or both.

A sysplex group can be used to represent a physical sysplex (systems within the same XCF group ID). A standard group can be used to represent a logical sysplex (systems with different XCF group IDs). The definition of groups is a prerequisite for sysplex-wide automation.

(3/SBG) Subgroup

Like groups, subgroups are collections of systems. You define a subgroup by selecting the member systems and assigning a name to the subgroup. Subgroups can be collected into groups. They offer a finer level of structuring groups.

(4/SYS) System

A system is an image of an operating system running on a host processor monitored by SA z/OS. The system may be MVS, VM, VSE, LINUX, or CF (coupling facility). A system definition includes for example:

- links to other objects associated with the system, for example, links to application groups
- Application defaults
- System defaults
- Clone specifications

(5/APG) ApplicationGroup

An application group is a set of applications to which you assign a name. You can define two types of application groups: System Application Groups and Sysplex Application Groups. You assign System Application Groups to one or more systems and Sysplex Application Groups to one sysplex group.

(6/APL) Application

An application is a z/OS subsystem or job that runs on a system in the SA z/OS enterprise. SA z/OS monitors applications through the messages they issue to the system, MVS commands, and SA z/OS-provided services. An application can belong to more than one application group. An application definition includes:

- Subsystem name and the name of the procedure that runs the job
- Warning and alert thresholds
- Start and Stop specifications
- individual automation flags

(7/EVT) Events

Events are used for external dependencies where they represent a process that the automation cannot handle. For example, an operator needs to manually edit a file before the application can continue. SA z/OS remembers which events are SET (have occurred) and can be told when to forget them (by defining an UNSET condition).

(8/SVP) Service Periods

Define the availability of applications. A service period is a set of time intervals (service windows) during which an application should be active or inactive.

(9/TRG) Triggers

In combination with events and service periods, triggers are used to control the starting and stopping of applications.

(10/PRO) Processor

A processor is the physical or physically partitioned hardware on which a system runs. To monitor VM guest systems, a "logical" processor, called the *ProcOps Service Machine* (PSM), has been introduced.

The OCF-based processors supported by SA z/OS are zSeries® and 390-CMOS processors, excluding the 9221 processor. An OCF-based processor is a processor that uses an operations command facility (OCF) to interact with human operators or external programs to perform operations management functions on the processor. The OCF accepts and processes operations management commands, which SA z/OS sends from the focal point system. The processor operations commands are described in *System Automation for z/OS Operator's Commands*.

(11/MTR) Monitor Resource

The Monitor Resource Policy Object enables you to monitor the performance and health of an application. That is, a separate status informs you about the application's health. This health status can be used by the automation manager to make decisions and, if necessary, trigger automation for the subject application. This monitoring can be used to make the currently available JES3 monitoring obsolete.

(20/PRD) Product Automation

With this policy object, you can define automation policy for the following products:

- CICS
- DB2
- IMS
- OPC

(30/TMR) Timers

Automation timer definitions. This object is used to schedule automation tasks which are periodic, or which must run at a particular time.

(31/TMO) Timeout Settings

The timeout values for responses to MVS commands and cross-domain commands. This entry type enables you to create sets of timeout definitions. Each timeout definition can specify timeout values for:

- System, NetView, or SA z/OS commands
- Cross-domain logon requests
- Your own timeout variables

If the time limit is exceeded, then it is assumed that an error condition exists and an appropriate action is taken.

(32/TPA) Tape Attendance

Specifies the time during which tape drives are either attended or unattended. This entry type also allows you to specify whether or not you want to monitor tape mounts on this system. If you do want to monitor tape mounts, you must enter warning and alert thresholds (in minutes and seconds) indicating how long a wait is allowed in mounting a tape before the response is considered unsatisfactory.

(33/MVC) MVS Component

This entry type allows you to apply automation to various z/OS data sets, resources and facilities.

Entry Type Introduction

(34/MDF) MVSCOMP Defaults

Sets defaults for z/OS component (entry type MVS Component) automation.

(35/SDF) System Defaults

This entry type allows you to set various defaults that are used throughout the system. The values set here may be overridden by other entry types, such as Application, Application Defaults, or MVSCOMP Defaults, or by setting appropriate values in individual applications or MVS Component objects.

(36/ADF) Application Defaults

This entry type specifies default values for automation flags and error threshold settings. These values will be used as the default for any Application object on the system to which the Application Defaults set is attached.

(37/AOP) Auto Operators

Maps automation functions to automation operators. *Automation operators* are automated operator tasks, or *autotasks*, that can respond to operating system, application, and network messages without requiring a human operator. Sets of automation operators can be linked to a system. Each automation operator takes actions similar to those of a human operator, such as monitoring the system and handling and coordinating recovery and shutdown operations.

Automation operators are assigned specific messages on which to act.

(38/NFY) Notify Operators

Defines NetView operators who receive notification messages.

(39/NTW) Network

Defines Gateway, adjacent NetView domains (downlevel only), and SDF focal points.

(40/NNT) NNT Sessions

Defines NetView to NetView sessions (user IDs, passwords, NetView domains).

Note:

From SA z/OS 2.3 onwards, this entry type is no longer being supported. Use this function only to maintain systems with SA OS/390 releases up to 2.2 or for cleanup.

(41/RES) Resident CLISTs

Automation CLISTs that must be preloaded to improve performance.

(42/SCR) Status Details

Defines NetView Status Display facility (SDF) settings.

(98/ICL) Includes

Entry type ICL is no longer supported by SA z/OS Version 2. Use this function only to maintain systems with releases up to SA OS/390 1.3 and for cleanup.

(99/UET) User E-T Pairs

User-defined entry/type data for the automation control file. Used for user-defined extensions to automation policy.

Policy Objects and Policy Items

Each policy object has a number of policy items associated with it. To define policy, you enter data for the policy items of each policy object in the SA z/OS enterprise.

For example, if you choose option 2 on the *Entry Type Selection* panel (Figure 2) to specify *Group* policy, Figure 3 is displayed. (The labels, for example, AOFGETYP, AOFGENAM, are the panel IDs that are displayed after you enter the command PANELID on the command line.)

```

MENU  OPTIONS  HELP
-----
AOFGETYP                      Entry Type Selection
Option ==>> _____

  1 ENT      Enterprise          30 TMR      Timers
  2 GRP      Group              31 TMO      Timeout Settings
  3 SBG      SubGroup           32 TPA      Tape Attendance
  4 SYS      System             33 MVC      MVS Component
  5 APG      ApplicationGroup (*) 34 MDF      MVSCOMP Defaults
  6 APL      Application         (*) 35 SDF      System Defaults
  7 EVT      Events             36 ADF      Application Defaults
  8 SVP      Service Periods    37 AOP      Auto Operators
  9 TRG      Triggers           38 NFY      Notify Operators
 10 PRO      Processor          39 NTW      Network
 11 MTR      Monitor Resource (*) 40 NNT      NNT Sessions
                                     41 RES      Resident CLISTS
 20 PRD      Product Automation 42 SCR      Status Details
                                     98 ICL      Includes
                                     99 UET      User E-T Pairs

(*) Multi-User-Capable

```

Figure 2. Entry Type Selection Panel

Figure 3 shows the *Group* policy objects *SYSPLEX1* and *SYSPLEX2*.

```

COMMANDS  ACTIONS  VIEW  HELP
-----
AOFGENAM                      Entry Name Selection          Row 1 to 2 of 2
Command ==>> _____          SCROLL==>> PAGE

Entry Type : Group              PolicyDB Name   : DATABASE_NAME
                                Enterprise Name  : YOUR_ENTERPRISE

Action      Entry Name          C Short Description
S _____ SYSPLEX1           Sysplex with SYSTEM1, SYSTEM2, SYSTEM3
           SYS1SYS2           Sysplex with SYS1 and SYS2
***** Bottom of data *****

```

Figure 3. Entry Name Selection Panel for Groups

If you select an existing group, the *Policy Selection* panel is displayed, as shown in Figure 4 on page 8. This panel gives you a list of the policy items for a group. You can enter S for SELECT next to any policy item, to display the appropriate policy input panel. Figure 4 on page 8 shows the *Policy Selection* panel for groups, listing the policy items for the selected policy object *SYSPLEX1*.

Considerations for the SA z/OS Graphical Interface

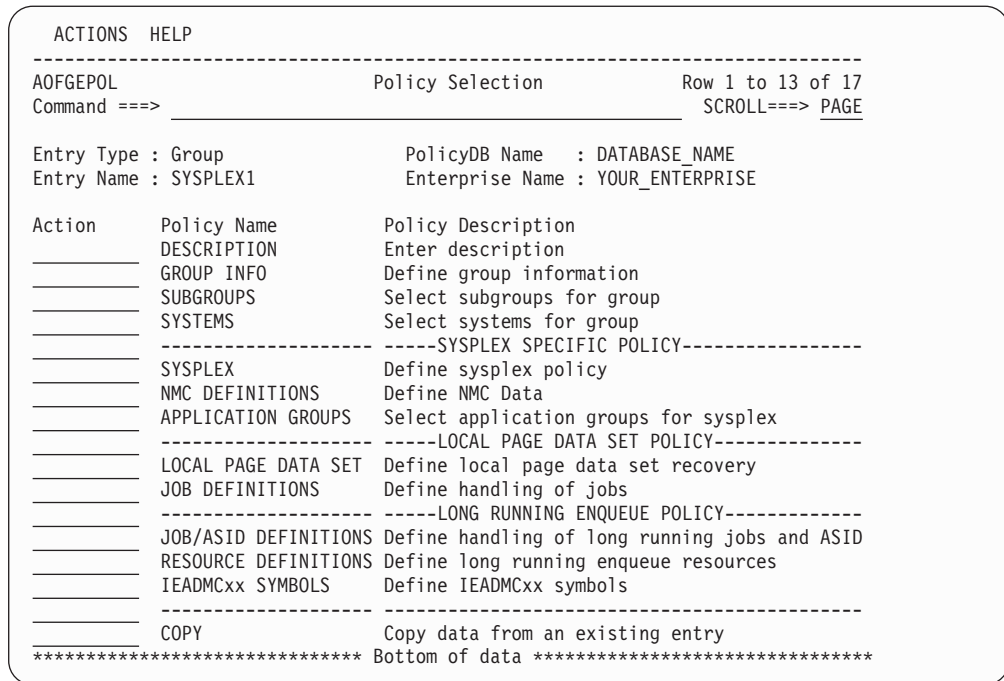

Figure 4. Policy Selection Panel for Sysplex Groups

Considerations for the SA z/OS Graphical Interface

The customization dialog leads the SA z/OS policy administrator through several panels to define the systems and other automated resources of the enterprise. The resulting *enterprise policy* provides the information that SA z/OS uses to provide objects for the displays on the NMC workstation.

The objects visible on the NMC workstation are based on the resources that are defined in the customization dialog and therefore known to SA z/OS. The automation manager component of SA z/OS monitors the resources and their status. SA z/OS permanently puts information about the resources and their status into the focal point RODM from where it is retrieved by the NMC workstation.

Grouping Resources Logically

To provide the hierarchy required for graphical representation on the NMC workstation, you need to define your enterprise in terms of the relationships between the resources. The reason for grouping your enterprise resources within SA z/OS is to simplify the representation of the status information that can be generated by your enterprise. The decisions you make on how to group your resources have a great impact on how powerful the graphic interface on the NMC workstation is for you. Each group (of systems or applications) can be represented by a single icon in the NMC workstation displays. SA z/OS monitoring acts as a filtering mechanism for the status data generated by the components of these groups. The status of the group is determined by the statuses of its members using an algorithm defined independently for each grouping of resources in your SA z/OS enterprise.

The grouping of resources allowed by SA z/OS is flexible. For example, systems may be grouped by geographical region or use or type. You may decide to place all high priority jobs in one application group and specify that the status of the group will be "degraded" if only one of its subsidiary applications has an unsatisfactory status.

For information on how to set up the graphical interface on the NMC workstation refer to *System Automation for z/OS Planning and Installation*. For information on how to use this graphical interface refer to *System Automation for z/OS User's Guide*.

Considerations for Automation

While information for monitoring of resources is defined at the enterprise level, automation of resources and applications is defined at the system level. Each system in an SA z/OS enterprise uses SA z/OS routines to automate operator functions for its own applications and z/OS components. The programs that automate these functions are called *SA z/OS automation procedures*. *SA z/OS automation procedures* invoke SA z/OS provided *common routines* and *generic routines*. You can customize your automation by writing your own *automation procedures* which can also invoke the SA z/OS provided routines.

SA z/OS provides automation procedures that are internally invoked according to the NetView automation table and that manage, for example, the following:

- WebSphere® Application Server
- SAP
- TCP/IP
- HTTP Server
- Job Entry Subsystem/2 (JES2)
- Job Entry Subsystem/3 (JES3)
- Time Sharing Option/Extensions (TSO/E)
- APPC
- ASCH
- Resource Measurement Facility (RMF)
- Virtual Telecommunication Access Method (VTAM®)
- NetView
- Transient jobs
- Non-z/OS resources
- Any other applications
- Special automation functions are also provided to manage CICS®, IMS™, DB2™, and to integrate with OPC

SA z/OS provides automation procedures that enable recovery of the following z/OS components and data sets:

- SYSLOG data sets
- LOGREC data sets
- System Management Facility (SMF) data sets
- Write-to-operator (WTO) buffers
- JES spools
- z/OS dump data sets
- Action Message Retention Facility (AMRF) buffers
- sysplex resources, for example, coupling facility

With SA z/OS you can also define policies for the automated startup and shutdown of processors and for the automated IPL and shutdown of operating systems.

The above lists represent applications and z/OS components for which SA z/OS provides automation, but you are not limited to these. You can extend automation by adding new applications, and you can create your own automation procedures.

The SA z/OS policy administrator uses the customization dialog to set the way in which enterprise resources are to be handled by SA z/OS when predefined

Considerations for Automation

conditions are met. In addition to invoking provided automation procedures, SA z/OS can be used to trigger user-written automation procedures.

Building and Distributing SA z/OS Automation Policy

After you have entered all data necessary to define your enterprise monitoring and automation policy in the policy database, you use the BUILD function of the customization dialog to build the files needed by SA z/OS. These include:

- The automation control files for the automation agent (ACF) and automation manager (AMC).
- The processor operations control file and a sample NetView operation definition file.
- NetView automation tables and the MPFLSTSA member.

The automation configuration definitions are needed if you want to use system operations automation functions. If you want to use processor operations automation functions (for example, monitoring processors), the processor operations control file must be built, and the corresponding NetView operator definitions must be provided.

Refer to Chapter 8, “Building and Distributing Control Files,” on page 313 for more information on the SA z/OS build function.

The automation configuration files must be distributed to each system in the SA z/OS enterprise where SA z/OS system operations functions are to run. In general, this is all of the z/OS systems in the SA z/OS enterprise. In a sysplex, the data set name of the automation control file must be equal on all systems in the sysplex.

However, it is highly recommended to use a shared data set in a sysplex, and if possible, to use a shared data set for the whole enterprise.

Chapter 2. Using the Customization Dialog

The SA z/OS customization dialog runs under Interactive System Productivity Facility (ISPF) Dialog Manager, which operates under Time Sharing Option/Extended (TSO/E). For information on installing the customization dialog and sample policy databases on the focal point system, refer to *System Automation for z/OS Planning and Installation*.

The customization dialog provides panels on which you create and work with SA z/OS automation policy definitions. The task of defining and building automation policy is performed on the SA z/OS configuration focal point system from where it is distributed to the systems and sysplexes that you want to automate (see also Figure 248 on page 325).

The combined definition of all the resources is called an *enterprise definition* or also an *automation configuration*. SA z/OS enterprise definition data entered in the customization dialog is stored in an z/OS data set called a *policy database*. You can define more than one enterprise, each with its own policy database, or you can store the automation policy of an enterprise in more than one policy database, however, the policy for all systems of a sysplex must be in the same policy database.

Your first step in defining automation policy will be to create a new policy database, using one of the sample databases as a model. SA z/OS provides sample policy databases containing sample enterprise definitions. These are described in “Using Sample SA z/OS Policy Databases” on page 300.

To do this, you should create an empty policy database using the *EMPTY sample database, and then use the *IMPORT* function to import policy definitions from either the other sample databases that are supplied with SA z/OS, or from your own policy databases. For more details about importing policy databases, see “Importing Policy Database Data” on page 327. You should note that this is now the preferred method for creating new policy databases.

You can create many different SA z/OS enterprise definitions. However, SA z/OS uses only one enterprise definition at a time. Each SA z/OS enterprise definition is stored in a different policy database. The customization dialog enables you to edit, copy, delete, and build SA z/OS enterprise definitions after you create them.

You select entry types from the list shown on the *Entry Type Selection* panel (Figure 2 on page 7) and certain objects from these entry types to specify the way enterprise resources are to be handled by SA z/OS when predefined conditions are met. You can link automation policies to individual systems as required to meet your automation needs.

You can monitor systems and resources using the NMC workstation that are defined to SA z/OS even if you have not defined special automation policy for these resources. Conversely, you may automate your enterprise without monitoring it using the NMC workstation. If you want to use SA z/OS for automation only you must still use the customization dialog to create policy for the resources you want to automate.

How to Start the Customization Dialog

To start the customization dialog:

1. Log on to TSO/E using a logon procedure that will make the customization dialog available to you. Refer to *System Automation for z/OS Planning and Installation* for instructions on how to create an appropriate logon procedure.
2. Select the customization dialog from the ISPF menu on which they have been installed. SA z/OS displays the *Customization Dialog Primary Menu* as shown in Figure 5.

Note:

The installation can use the keyword INITSEL for the startup exec INGDLG to automatically provide an initial selection on the *Customization Dialog Primary Menu*. If this keyword is specified, you will not see the *Customization Dialog Primary Menu* as the first panel when invoking the customization dialog, but for example, the *Entry Name Selection* panel for a frequently used entry type.

```
-----
MENU  OPTIONS  HELP
-----
AOFGPRM      SA z/OS 2.3 Customization Dialog Primary Menu
Option ==>> _____

  0 Settings          User parameters

  1 Open              Work with the Policy Data Base
  2 Build             Build functions for Policy Data Base
  3 Report            Generate reports from Policy Data Base
  4 Policies          Maintain Policy Data Base list
  5 Data Management  Import policies/Migrate files into a Policy Data Base
  U User              User-defined selections

  X Exit              Terminate Customization Dialog

To switch to another Policy Data Base, specify the Policy Data Base name
in the following field, or specify a ? to get a selection list.
Current Policy Data Base. . . RESOURCE_PDB

                          Licensed Materials - Property of IBM
                          5645-006 (C) Copyright IBM Corp. 1990, 2004 All Rights Reserved.
```

Figure 5. Customization Dialog Primary Menu

To start the customization dialog for a policy database of your choice, you can:

- Select option 1 *Open* and type the name of your desired policy database into the *Current Policy Data Base* field (if not filled in from a previous invocation). This will lead you directly to the *Entry Type Selection* panel shown in Figure 2 on page 7.
- Type a '?' in the *Current Policy Data Base* field to get a selection of available policy databases in the *Policy Data Base Selection* panel as shown in Figure 234 on page 297. From this panel then you select your desired policy database.
- You can also reach the *Policy Data Base Selection* panel by selecting option 4 *Policies*.

If there are no policy databases displayed when you start the customization dialog, you must either create a policy database (see “Creating a New Policy Database” on page 297) or add an existing policy database to your display list.

If other users want to view the policy database you have just created, they must add it to their PolicyDB list using the ADD command.

How to Navigate in the Customization Dialog

Many characteristics of the customization dialog are ISPF facilities. See *ISPF User's Guide* for details. You need to know the following characteristics of the customization dialog:

- For panels that display a list from which you are required to select one or more entries and specify an action against that entry, you can:
 - Enter “*action entry name*” on the command line, for example, *OPEN entry name*
 - Enter the action in the *Action* column next to the appropriate entry, for example, enter *OPEN* in the *Action* column next to entry name.
 - Select the entry by entering *S* or *SELECT* in the *Action* column next to the entry. Move the cursor to the *ACTIONS* menu bar entry, press *ENTER*, and enter the number corresponding to the action you want to take. For example, place an *S* in the *Action* column next to “entry name” and select 1 (*OPEN*) from the Action menu.

The action most likely to be used on a certain panel is always the first action listed in the *ACTIONS* pull-down menu. When you enter *S* or *SELECT* in the *Action* column and press the *ENTER* key, this default action is used. For example, entering *S* under *Action* for “*MY_ENTERPRISE*” in the *Policy Data Base Selection* panel opens the *MY_ENTERPRISE* database.

Some panels display a list from which you can select only one entry. If you attempt to select more than one entry from such a list, only one selection is accepted. If one entry is already selected and you select another one, this new selection becomes active and the previous selection is removed.

From a list of policy items, you can select multiple items. Then they are processed sequentially. Pressing the *END* (*PF3*) key takes you to the next selected item to be processed without returning to the selection panel.

- The *COMMANDS* pull-down menu lists all commands that can be entered at the command line.
- The *ACTIONS* pull-down menu lists all actions that can be entered in the *Action* column for panels displaying entry lists.
- The *VIEW* pull-down menu lists the different levels of detail that can be displayed for the entries in an entry list. For example, in many entry lists you can display just the entry name and short description, or you can also display a detailed description for each entry.

Sample panels shown in this documentation may look different on your system depending on the selected view.

- On data entry panels, the *END* (*PF3*) key verifies input, saves the data, and exits the current panel.
- Pressing the *ENTER* key verifies input and redisplayes the current panel.

How to Use a Fast Path

If the policy database that you want to work with, is already displayed in the field *Current Policy Data Base* of the *Customization Dialog Primary Menu*, you can use the entry type abbreviation as a fast path:

- You can directly type the code for the entry type that you want to work with. For example, to reach the *Entry Name Selection* panel for *Applications*, just type:
APL

How to Navigate in the Customization Dialog

- If you want to start with defining a new application group for example, just type:
APG; NEW application_group_name
- From every panel within the customization dialog, if you want to reach a certain entry type and you already know the name of the object, you want to edit, you can type, for example, to reach the APPC application:

=APL; S APPC

or to reach application group CICS_APG:

=APG; S CICS_APG

or to just reach the *Entry Name Selection* panel for *Applications*:

=APL

Concurrent User Access

As you may have separate administrators for different areas, for example, *JES* or *VTAM*, who should be able to do their updates independently, the customization dialog allows concurrent update for entry types *APL*, *APG*, and *MTR*. For other entry types, only one user at a time can access a policy database. See also Appendix A, “Concurrent Customization by Multiple Users,” on page 365 for further information.

How to Cancel Input on a Panel

To cancel your input on the current panel, type the CANCEL (or C) at the Command prompt. CANCEL can be used to disregard data entered on the panel, whether or not you have pressed the ENTER key. However, once the message POLICY SAVED

is displayed when leaving a panel, the data entered has been saved and cannot be canceled. To delete input after this message is displayed, you must go back to that panel and type over existing values.

How to Create New Policy Objects

The process of creating a new policy object is the same for all types of policy objects, as follows:

1. From the *Entry Type Selection* panel, you select the desired policy object’s entry type. For example, if you want to create a new Application object, enter option 6 or *APL* at the command line.
2. SA z/OS displays the *Entry Name Selection* panel for the selected entry type. You can either select action NEW from the COMMANDS pull-down or enter the command `new entry_type_name` at the panel’s command line. The entry type name is optional for this command.
3. SA z/OS displays the *Define New Entry* panel (an example for defining a new Application is shown in Figure 6 on page 15) for the selected entry type, where you now specify the required information. See Chapter 5, “Defining Automation Policy,” on page 81 for more information about how to create new policy objects.

```

COMMANDS  HELP
-----
AOFGDYN3                                Define New Entry
Command ==> _____
More: +

Define new entry of type Application

Name . . . . . _____

Subsystem Name . . . . . _____
Object Type . . . . . INSTANCE (CLASS INSTANCE)
Application Type . . . . . STANDARD (STANDARD IMAGE JES2 JES3 CICS IMS DB2
                                     OPC USS)
Subtype . . . . . _____ (For CICS, IMS, DB2, OPC only)
Job Type . . . . . _____ (MVS NONMVS TRANSIENT)
Job Name . . . . . _____
Transient Rerun . . . . . _____ (YES NO)
Scheduling Subsystem . . . . . _____ (MSTR, JES Subsystem, or blank)
JCL Procedure Name . . . . . _____
    
```

Figure 6. Define New Entry Panel for an Application

4. If you specify an entry name and press Enter, the subsystem name and job name are defaulted to the entry name, if possible. This is also true for all other entry types where the entry name could be used as a default for further qualifications

Throughout Chapter 5, “Defining Automation Policy,” on page 81, if there is no extra information given about creating a particular policy object, then it is created using a generic panel, as shown in Figure 7.

```

COMMANDS  HELP
-----
AOFGDYN2                                Define New Entry
Command ==> _____

Define new entry of type Monitor Resource

Name . . . . . _____

Short description . . . . . _____
Long description . . . . . _____
Long description . . . . . _____
Long description . . . . . _____
Long description . . . . . _____
Long description . . . . . _____
    
```

Figure 7. Sample Generic Define New Entry Panel

How to Rename a Policy Object

The process of renaming an existing policy object is the same for all types of policy object. From the *Entry Name Selection* panel, type r or rename in the *Action* field in front of the entry you want to rename, as shown in Figure 8 on page 16.

How to Rename a Policy Object

```
COMMANDS  ACTIONS  VIEW  HELP
-----
AOFGENAM          Entry Name Selection          Row 1 to 5 of 5
Command ==>>>          SCROLL==>>> PAGE

Entry Type : Application          PolicyDB Name : DATABASE_NAME
                                   Enterprise Name : YOUR_ENTERPRISE

Action      Entry Name          C Short Description
-----
r           APPC              APPC/MVS automation policy
           ASCH              ASCH automation policy
           CICS_SA_PPI_RCV    CICS SA PPI Receiver
           CICS1H            CICS TS V1.3 FOC1 with TCP/IP
           CICS1H_PPI        CICS1H PPI Receiver
***** Bottom of data *****
```

Figure 8. Entry Name Selection Panel: Rename Action

The sample screen shows a list of applications with command *r* in the action field of entry name *ASCH*. Pressing the ENTER key will display a rename popup panel where you can enter the new entry name, as shown in Figure 9.

```
Entry Rename

Description : ASCH automation policy
Old Name   : ASCH

New Name   . . _____

Press ENTER to rename member.
Press CANCEL to cancel rename.
```

Figure 9. Entry Name Rename Popup Panel

Pressing ENTER will start the renaming process; if the name you entered already exists or is invalid you will be required to enter a different name. After completion, the newly sorted *Entry Name Selection* panel will be displayed with the renamed entry as the top row. If there are multiple rename requests, the last renamed entry is shown as top row.

You can leave the rename popup panel using END or CANCEL without renaming the policy object.

Notes:

- The rename function is implemented for all entry types except for Includes (ICL).
- To modify the Enterprise name, edit the policy database and then simply overwrite the name, see “Specifying Settings for Policy Databases” on page 301.

Delete Option on All Entry Name Selection Panels

To delete a policy object select it from the *Entry Name Selection* panel, and either select *Delete* from the ACTIONS pull-down menu or type *d* in the **Action** column. A popup panel will ask you to confirm your deletion request.

Delete Option on All Entry Name Selection Panels

If you want to delete an object that is selected by other objects, a panel is displayed that informs you of this fact and offers you to display a list of the referencing objects and, optionally, remove the links.

Examples:

- An application is linked to one or more application groups.
- An application class has links to instances.
- An application group is linked to a system.

Example 1:

For applications that are members of application groups, the *Delete Error* panel offers the following possibility:

```
COMMANDS  HELP
-----
Delete Error
Command ==> _____

Entry Type : Application      PolicyDB Name  : DATABASE_NAME
Entry Name  : CICS            Enterprise Name : YOUR_ENTERPRISE

The delete request cannot be completed because the
entry selected is currently referenced by one or more
entries.

You can use the WHEREUSED function to list all the
referencing entries and, optionally, remove this
entry from each of them.

Display WHEREUSED list. . . YES 1      YES      NO
```

Figure 10. Delete Error Panel

Entering YES on this panel (**1**) displays the panel shown in Figure 11 where you can remove the application to be deleted from the application groups where it is contained.

```
COMMANDS  ACTIONS  VIEW  HELP
-----
AOFGXWHU      Where Used                      Row 1 to 9 of 9
Command ==> _____          SCROLL==> PAGE

Entry Type : Application      PolicyDB Name  : DATABASE_NAME
Entry Name  : CICS            Enterprise Name : YOUR_ENTERPRISE

Action      Status      Entry Name      Entry Type
-----
          SELECTED  APG_FOC1        APG
          SELECTED  CICS_APG        APG
          SELECTED  CICS_APG2       APG
          COPY_APG   APG
          DEFAULTS  APG
          OPERATIONS APG
          SAG_APPL  APG
          SYSTAPG   APG
          SYSTEM    APG
***** Bottom of data *****
```

Figure 11. Where Used Panel

Example 2:

Delete Option on All Entry Name Selection Panels

For application classes that have links to applications, the Delete Error panel offers the following possibility:

```
COMMANDS  HELP
-----
A0FGM0C5          Delete Error

Entry Type : Application      PolicyDB Name  : DATABASE_NAME
Entry Name  : APL_CLASS       Enterprise Name : YOUR_ENTERPRISE

The delete request cannot be completed because the Class
selected is currently referenced by one or more Instances.

You can use the LINK TO INSTANCES function to list all the
referencing Instances and, optionally, remove them.

Display list of INSTANCES. . . YES 2      YES      NO
Command ==> _____
```

Figure 12. Requesting a List of Instances

Entering YES on this panel, (**2**), displays the panel shown in Figure 13.

```
COMMANDS  ACTIONS  VIEW  HELP
-----
A0FGXC2I          Link Class to Instances

Entry Type : Application      PolicyDB Name  : DATABASE_NAME
Entry Name  : APL_CLASS       Enterprise Name : YOUR_ENTERPRISE

Action      Status      Entry Name
-----
           SELECTED    ABC_INST
           SELECTED    DEF_INST
           SELECTED    GHI_INST
```

Figure 13. Links of Application Class to Instances

This panel (Figure 13) allows you to scroll through the list of all links and to remove them, if appropriate. If all links are removed, then the deletion of the application class can be continued by confirming your deletion request.

Common Policy Items

The following policy items are found on many policy definitions:

- DESCRIPTION
- COPY
- WHERE USED

Policy Item DESCRIPTION

Figure 14 on page 19 shows an example of a Description policy item panel (in this case for the SYSTEM entry type)

```

COMMANDS  HELP
-----
          Description
Command ==> _____

Entry Type : System          PolicyDB Name  : DATABASE_NAME
Entry Name  : SAMPLE_SYSTEM_01 Enterprise Name : YOUR_ENTERPRISE

Enter or update the entry description:

Short Description . . . Focal Point system
Long Description . . . _____
Long Description . . . _____
Long Description . . . _____
Long Description . . . _____
Long Description . . . _____

```

Figure 14. Sample Description Policy Item Panel

Both types of description (short and long) can be displayed in the customization dialog, depending on which VIEW option you choose.

Short Description

This is optional and can be up to forty characters in length. The short description is also used by the NMC workstation, DISPSTAT, and INGLIST.

Long Description

This is optional and can consist of up to five lines of up to fifty characters in length. The extended description is part of the DISPINFO display for applications.

Policy Item COPY

While creating a new policy object, you can use this policy item to copy policy information from an existing object to the created object. This function displays a list of all other entries of the same entry type in the SA z/OS enterprise that are eligible to be used as the source of a copy function.

The following list outlines the process to use an object's Copy policy item while creating a new object.

1. Select an entry type from the *Entry Type Selection* panel. The *Entry Name Selection* panel is displayed.
2. Enter new (N) on the command line to create a new object. SA z/OS will display the *Define New Entry* panel for the policy object that you want create.
3. Enter information for the new object as prompted by its *Define New Entry* panel. Exit the panel (END command).
4. The *Policy Selection* panel for the new object is displayed. Select its Copy policy item.
5. A panel listing all currently defined objects from the same entry type is displayed. Select the concrete policy object from which you want to copy policy information.
6. When the copy is complete, you return to the *Policy Selection* panel for the new object. The **Copy complete** message shows that the copy has been successful. If you copy groups or processors, you may receive message *partial copy complete*, which means that not all entries could have been copied. The help function shows details about the data that was not copied.
7. Complete the new application definition by performing any necessary modifications to the information that has been copied.

Common Policy Items

1 The following list shows which information items are or are not copied by the Copy policy item:

1. All data of the source object is copied to the target object for all entry types with two exceptions:
 - Data which has to be entered during the 'NEW' processing on the related *Define New Entry* panel for the target object is not copied from the source object.
 - The short and extended description which is also offered on the *Define New Entry* panel is copied from the source object whenever there is not already data specified in the target object.
2. All links to other objects down the hierarchy of objects are copied from the source to the target. For example, if you copy an application group with linked applications, then the links of the source application group are copied to the target application group.
3. All links to other objects up the hierarchy of objects are NOT copied from the source to the target. For example, if you copy an application that is linked to an application group, then the copied target application is NOT linked to that application group.
4. Groups of type SYSPLEX can only be copied from groups of type SYSPLEX and groups of type STANDARD can only be copied from groups of type STANDARD (see "Creating a New Group" on page 90).
5. Sysplex Application Groups can only be copied from Sysplex Application Groups and System Application Groups can only be copied from System Application Groups (see "ApplicationGroup Policy Object" on page 125).
6. Links to members of sysplex groups (that is, links to subgroups, systems and Sysplex Application Groups) are NOT copied, to avoid conflicts like having the same system defined in more than one sysplex.
7. Links from systems to processors are not copied to avoid conflicts having the same system defined in more than one processor.
8. Resource links of Application Groups are not copied.

Policy Item WHERE USED

When you select this option for a certain resource, SA z/OS displays a list of all resources from a higher level which currently do include or possibly may include this resource into their hierarchy. You can add or remove the lower level resource to or from the hierarchy of the higher level resource.

For example, if you select this policy item from the *Policy Selection* panel for a system (entry type *System*), SA z/OS displays a list of all groups and subgroups in the SA z/OS enterprise, indicating which groups and subgroups include this system. You can add the system to a group or subgroup, or remove the system from a group or subgroup.

Or, if you select this policy item for an application, you get a list of existing application groups. The word SELECTED in the *Status* column indicates in which application group the application currently is included (see Figure 15 on page 21).

Other examples for the usage of this policy item are:

- for *Service Periods*: to which applications are they linked?
- for *System Defaults*: which z/OS systems in the enterprise make use of this system defaults set.

```

COMMANDS  ACTIONS  VIEW  HELP
-----
A0FGXWHU          Where Used          Row 1 to 9 of 9
Command ==> _____ SCROLL==> PAGE

Entry Type : Application      PolicyDB Name : DATABASE_NAME
Entry Name : CICS             Enterprise Name : YOUR_ENTERPRISE

Action      Status      Entry Name      Entry Type
-----
_____    SELECTED    APG_FOC1        APG
_____    SELECTED    CICS_APG        APG
_____    _____    CICS_APG2       APG
_____    _____    COPY_APG        APG
_____    _____    DEFAULTS        APG
_____    _____    OPERATIONS      APG
_____    _____    SAG_APPL        APG
_____    _____    SYSTAPG        APG
_____    _____    SYSTEM          APG
***** Bottom of data *****

```

Figure 15. Where Used Panel

Common Policy Items

Chapter 3. Automation Concepts

This chapter describes various SA z/OS concepts that you should read before using the customization dialog to define automation policy for your enterprise. The following topics are discussed:

- “Goal Driven Automation”
- “Relationship Support” on page 28
- “How SA z/OS Uses Error Thresholds” on page 31
- “Automation Flags” on page 34
- “Event and Trigger Support” on page 39

Goal Driven Automation

SA z/OS implements goal driven automation.

One flavor of goal driven automation in SA z/OS are events and triggers on the one hand and service periods on the other hand (see “Event and Trigger Support” on page 39 and “Automatic Calculation of Schedules (Service Periods)” on page 28). They basically allow you to define goals for applications, application groups, or monitor resources (to be available or unavailable) and to specify external events that, in addition to the defined goals, need to be satisfied before an application, application group, or monitor resource can be really started or stopped.

In SA z/OS you can define the applications, application groups, and monitor resources to be resources (application resources, application group resources and monitor resources) that you want to automate.

Another flavor of goal driven automation is that automation programmers define the default behavior or state of resources using the customization dialog so that SA z/OS tries to keep the resource in the specified state during specified schedules under specified prerequisites.

If operators want to change the goal of a resource, they may issue or remove a request to start or stop it using the INGREQ or INGSET command with appropriate startup or shutdown parameters. A request is executed by SA z/OS only if it does not conflict with requests of higher priority. Otherwise, as requests are persistent, they only take effect when conflicting requests of higher priority are resolved. Operators must remove obsolete requests from SA z/OS.

Note:

INGREQ requests are persistent. They are remembered across session boundaries until they are explicitly revoked.

You can find more details on the concepts of goal driven automation later in this chapter or you can also refer to *System Automation for z/OS User's Guide*.

Grouping Support

Modern applications are often composed of many components, such as data servers, networking and security components. Examples are client/server applications where the application logic is distributed between a client and one or

Goal Driven Automation

more servers and where the data can also be distributed between two and more servers. These components are often spread among the various systems in the sysplex.

In SA z/OS you can automate a complete application group. If you want to have all members (for example, all applications) of an application group available, you just tell SA z/OS to have the application group available.

Figure 16 presents a grouping example. Complex applications that are made of individual application components are denoted with $G1 \dots G3$ (G stands for group). The application-components are denoted with A_n and B_n . For example, the complex application group $G2$ comprises application group $G1$ and the single applications $A4, A5$. Application group $G1$ in turn consists of three applications $A1, A2, A3$. Also, application groups may comprise applications that may or may not be contained in other application groups. $G3$ is such an example.

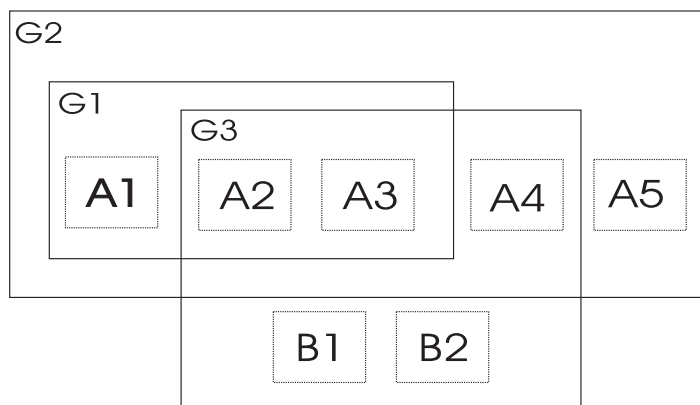

Figure 16. Example of Aggregating Applications into Application Groups

A Grouping Scenario

The following scenario shows how grouping is performed on the conceptual level. For information on how to enter such a grouping policy into the customization dialog, refer to “How to Work with Resources” on page 45.

Grouping applications and nesting application groups is a process that can be logically divided into multiple steps:

- “Step 1: Identify Resources”
- “Step 2: Group the Resources” on page 25
- “Step 3: Nest the Groups” on page 26
- “Step 4: Match Resources to Systems” on page 27

Note:

Applications and application groups are also referred to with the general term *resources*.

Step 1: Identify Resources

Imagine a scenario with two application groups representing a data warehouse and a web server.

- The data warehouse requires the following resources: VTAM, TCP/IP, DB2 (consisting of components DB2MAIN, DB2IRLM), CICS (consisting of components CICSMAIN, CICSAOR1, CICSAOR2, CICSAOR3, CICSTOR, CICSFOR), and DWH.
- The web server requires the following resources: VTAM, TCP/IP, DB2 (DB2MAIN, DB2IRLM), and WBSRV.

Step 2: Group the Resources

Some of the needed resources identified in the previous step are candidates for aggregation:

- Resources that are made of multiple components; in our example, these are:
 - CICSAOR1, CICSAOR2 and CICSAOR3 which could be aggregated into a group called CICSAOR, so that they can be automated as a unit.
 - group CICS, which will contain resources CICSMAIN, CICSTOR, CICSFOR and the aggregated CICSAOR group.
 - group DB2, which will contain resources DB2MAIN and DB2IRLM.
- Resources that are used by multiple exploiters; in our example, these are:
 - VTAM and TCP/IP, which are used by the data warehouse and the web server; so we will aggregate them into a group called NET.
 - DB2MAIN and DB2IRLM, which are used by the data warehouse and the web server; so we will aggregate them into a group called DB2.
- Finally we conceive the data warehouse as group DWHAPG and the web server as group WBSRVAPG for later nesting the other groups into them as required (see “Step 3: Nest the Groups” on page 26).

Figure 17 on page 26 shows a possible aggregation of all components into groups.

|

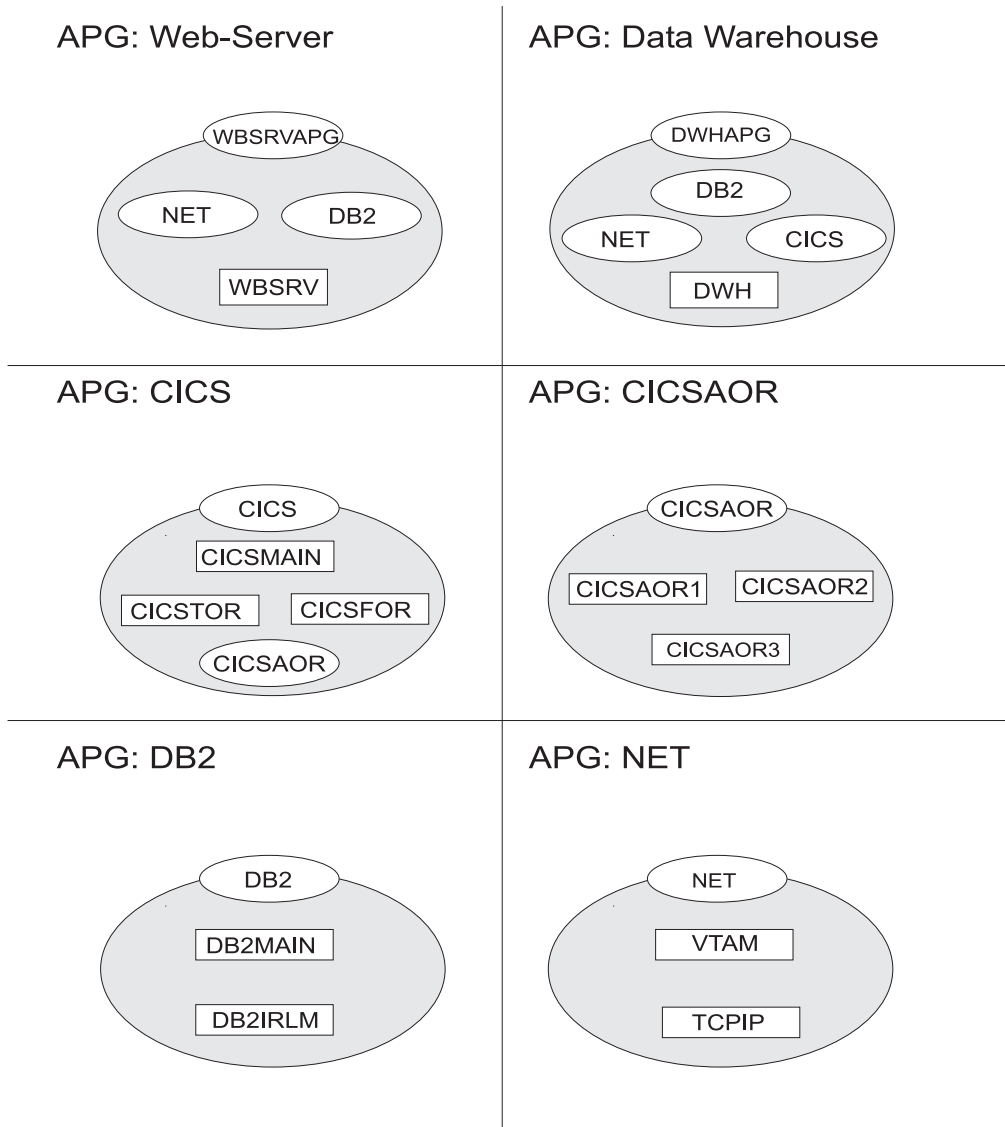

Figure 17. Application Groups

In Figure 17, oval labels represent application groups, rectangle labels represent applications. For example, application group CICS contains applications CICSMAIN, CICSTOR, CICSFOR and the nested application group CICSAOR.

Step 3: Nest the Groups

Figure 18 on page 27 shows how the application groups are nested in this environment. From an operator’s point of view, a start request against WBSRVAPG should start all imbedded components in a reasonable order. The same is true for requests against all other groups such as, for example, NET and DB2.

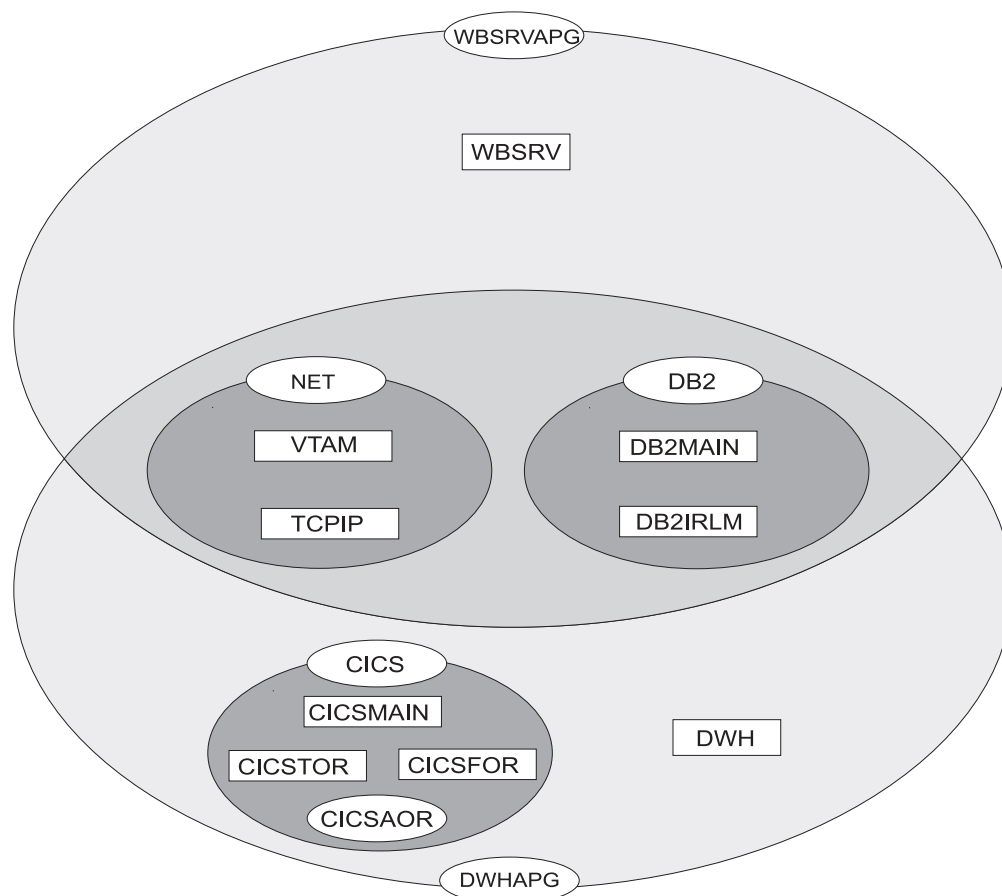

Figure 18. Grouping of Applications into Nested ApplicationGroups

Step 4: Match Resources to Systems

In a next step, system administrators must decide on which systems and in which sysplexes these groups and applications should run. Assume that in our scenario we have an environment of three z/OS systems SYSTEM1, SYSTEM2, SYSTEM3 that are members in sysplex SYSPLEX1.

In our example, a possible decision could be:

- The web server group WBSRVAPG should run on SYSTEM1.
- The data warehouse group DWHAPG should run on SYSTEM2 and - if SYSTEM2 is not available - on SYSTEM3.
- The DB2 group, containing applications DB2MAIN, DB2IRLM should run on SYSTEM2 and on SYSTEM3.
- The NET group, containing applications VTAM, TCPIP should run in the entire sysplex.
- The CICS group, containing applications CICSMAIN, CICSFOR, CICSTOR and the application group CICSAOR should run on SYSTEM2 and on SYSTEM3.

Refer to “How to Work with Resources” on page 45 for detailed information on how to implement this scenario using the customization dialog.

Automatic Calculation of Schedules (Service Periods)

Service periods allow users to schedule the availability of applications, application groups, or monitor resources. A service period is a set of service windows during which a resource (application, application group, or monitor resource) should be active or inactive. So with service periods, you can specify both the up and down times for a resource.

Service periods set the desired status of the applications, application groups and monitor resources that they are linked to.

During the process of evaluating operator requests, SA z/OS calculates schedules for the availability of resources. This means that if you have a resource, say a database, that is supporting two applications, you can configure things so that the database will automatically be made available when either one of the two applications should be available, and to be unavailable otherwise.

If, for example, application *A* should be up from 7am to 7pm, and application *B* should be up from 9am to 3pm and 5pm to 9pm, then simply setting these schedules for the applications and giving them a start dependency upon the database is sufficient to have SA z/OS calculate a schedule for the database of 7am until 9pm. Note that this inference is done dynamically at runtime and will also take into account operator requests and schedule overrides.

Adaptive Scheduling

When defining the sysplex policy, the automation programmer can specify that certain resources are backups for other resources. In order to meet and/or maintain application availability, SA z/OS will activate these resources (if no other requests or policy definitions are opposed). This means that if an application's normal configuration is unavailable, SA z/OS will start an alternate configuration which will provide the same service. This can be configured so that no operator intervention is required.

This feature works best when the automation programmer sets schedules on a group level, rather than on an individual resource level. Applications need to be defined in groups, as it is the selective request propagation by the group resources that achieves the effect.

Relationship Support

One of the most effective automation capabilities of SA z/OS is the concept of *dependency relationships*. You define relationships between *dependent* resources and *supporting* resources.

In the customization dialog you always define relationships from the point of view of the dependent resource, and specify the name of the supporting resource.

Relationships can be specified together with a *condition* that must be satisfied for the *supporting resource*, before the specified action can be processed for the dependent resource.

Examples for relationships are *MAKEAVAILABLE* or *MAKEUNAVAILABLE*.
Examples for conditions are *WhenAvailable* or *WhenDown*.

A typical dependency relationship that you might define for a dependent resource, *RES_DEP*, would be: *MAKEAVAILABLE/WhenAvailable*, where the condition *WhenAvailable* applies to a supporting resource *RES_SUP* (see Figure 19).

So the relationship defined in Figure 19 would read: Only if the desired state for the dependent resource *RES_DEP* is available, make it available as soon as the supporting resource *RES_SUP* is available.



Figure 19. Relationships and Conditions

In the example shown in Figure 19, a request to become available is issued for *RES_DEP*. *RES_DEP* cannot be made available, unless *RES_SUP* is available. SA z/OS implements the concept of a request propagation. A request will be propagated along the dependency graph, so that finally the original request can be fulfilled. In this example, the request to *RES_DEP* will be propagated to *RES_SUP*, which can make itself available, because it is not depending on anything else. Then, after *RES_SUP* is available, *RES_DEP* will become available. Thus the original request is persistent until it is withdrawn.

Another example: assume that *RES_DEP* has its relationship with the supporting resource *RES_SUP* defined as *HASPASSIVEPARENT* and a request to become available is issued for *RES_DEP*. This request will not be propagated along the dependency graph. A separate request must be issued for *RES_SUP* to make the resource *RES_DEP* available.

There is a special relationship, *HASPARENT*, that has been introduced to simplify relationship specifications. It is equivalent to a *MAKEAVAILABLE/WhenAvailable* dependency between the dependent and supporting resource and a *MAKEUNAVAILABLE/WhenDown* dependency from the supporting resource to the dependent resource, as shown in Figure 20.



Figure 20. The HASPARENT Relationship

Relationships may be defined between any two resources within the same sysplex. The resources may be on different systems or may be Sysplex Application Groups. Figure 21 on page 30 presents an example of relationships across system boundaries.

Relationship Support

Note:

An application group can also be either a supporting resource or a dependent resource. It can even be simultaneously a supporting resource and a dependent resource, as shown in Figure 21.

Be careful not to define loops.

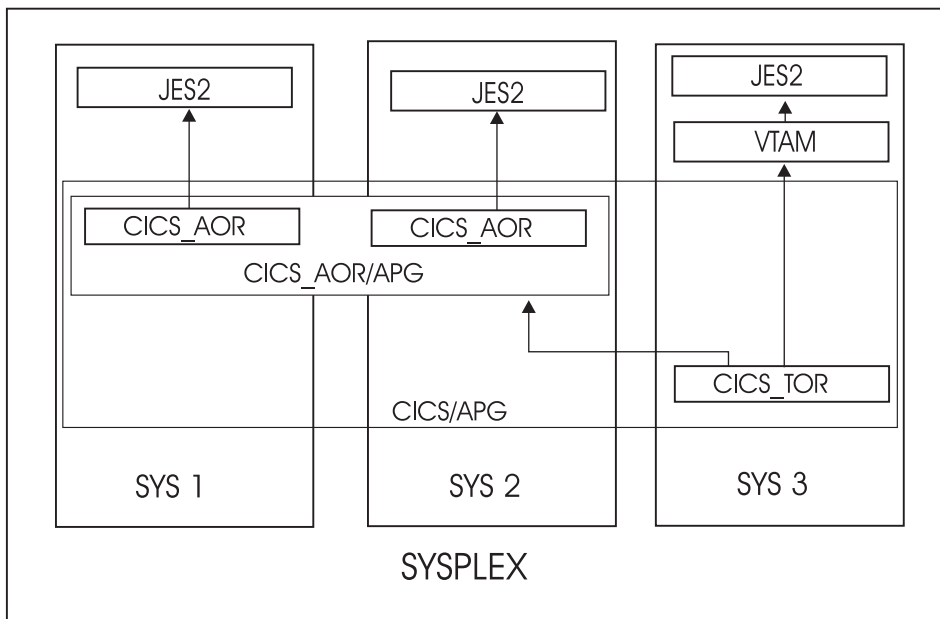

Figure 21. Relationship in a Sysplex

Figure 21 shows an example of grouping and relationships defined across a sysplex consisting of the systems *SYS1*, *SYS2* and *SYS3*.

In this figure, the arrows denote *HASPARENT* relationships. For example, *CICS_TOR* will be started as soon as one member of application group *CICS_AOR/APG* is available and *VTAM* is available.

If a group is a dependent resource, then all *MAKEAVAILABLE* relationships apply to the members of the group as well as to the group as a whole, for example, in Figure 22 on page 31, resource *APL* will not start before the resources *CICS*, *VTAM*, and *JES2* are available.

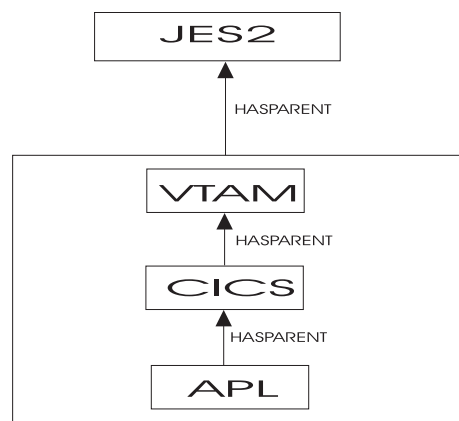

Figure 22. Relationship between Applications and Application Groups

For information on how to define relationships refer to “More about Policy Item RELATIONSHIPS” on page 132. During automation in your enterprise, conflicting relationships and requests could possibly occur. *System Automation for z/OS User’s Guide* describes such a scenario and informs the operator how to handle such a situation.

How SA z/OS Uses Error Thresholds

Error thresholds influence whether SA z/OS recovers from an error situation or not. These are a number of error conditions within a certain time interval, such as five error conditions requiring restart within one hour. During a condition requiring restart, SA z/OS checks whether the number of occurrences of the condition reaches the critical threshold. If it is reached, SA z/OS does not attempt restarting a resource. For applications, you can define a critical threshold for restarting these applications.

For z/OS components, such as dump data sets or log data sets, you can define thresholds to limit the frequency of how often they may be deleted after they ran full without an action being taken or a notification being sent to the operator.

Error thresholds also determine when you should be alerted to problems. The primary use of error thresholds is to track subsystem abends and ensure that the abend and restart cycle does not become an infinite loop, but they may also be customized for other uses.

The following sections inform you how to define error thresholds. Information on how to display threshold settings and occurrences, and to interactively set thresholds (by using the command `INGTHRES`) is provided in *System Automation for z/OS User’s Guide*.

Setting up a Threshold

SA z/OS uses error thresholds to determine when to stop recovering from an error situation. You can define error thresholds to track errors for MVS components and applications. You can set error thresholds by selecting policy item `THRESHOLDS` for the following policy objects:

- System Defaults, see Figure 23 on page 32
- Application Defaults, you get a panel similar to Figure 23 on page 32
- MVSCOMP Defaults, you get a panel similar to Figure 23 on page 32
- Application, see Figure 24 on page 33

How SA z/OS Uses Error Thresholds

- MVS Component, see “Thresholds for MVS Components” on page 34

Thresholds can be displayed and modified using the INGTHRES command (see *System Automation for z/OS Operator’s Commands*).

To set error thresholds for all MVSCOMP resources, choose *MVSCOMP Defaults* from the *Entry Type Selection* panel. To set error thresholds for all applications, choose *Application Defaults* from the *Entry Type Selection* panel. If you do not specify error threshold defaults for MVS components or applications, SA z/OS uses the error thresholds for all monitored resources, which are defined in the *System Defaults* objects.

Thresholds are defined by specifying the number of errors in a particular time interval, for example three times in one hour. Figure 23 shows the *Thresholds Specification* panel for the System Defaults object.

Note:

Setting a *critical threshold* to 1 will disable the recovery process already with the first occurrence of the error. This is valid independently from the specified time interval.

```

COMMANDS  HELP
-----
AOFPTH1          Thresholds Specification
Command ==>>> _____

Entry Type : System Defaults      PolicyDB Name : DATABASE_NAME
Entry Name  : SYSTEM_DEFAULTS    Enterprise Name : YOUR_ENTERPRISE

Resource: System wide defaults

Specify the number of times an event must occur to define a particular level.

----- Levels -----
Resource          Critical   Frequent   Infrequent
                  Number  Interval  Number  Interval  Number  Interval
                  (hh:mm) (hh:mm)   (hh:mm) (hh:mm)   (hh:mm) (hh:mm)
System wide defaults  4     01:00    3     02:00    2     12:00
  
```

Figure 23. Thresholds Specification Panel

There are three levels of threshold defined:

- Infrequent: Issues a warning message and restart processing is done
- Frequent: Issues a warning message, but restart processing is still done
- Critical: Sets the resource to a status of BROKEN, stops the restart automation and issues a message

When the number of occurrences of a situation reaches the infrequent and frequent error thresholds, SA z/OS notifies the operator and logs a message in the NetView log. When the number of occurrences of a situation reaches the critical threshold, SA z/OS stops to recover from that abend situation.

Once processing has stopped, operator intervention is required to restart it. This is because the critical error threshold is used as a trigger to stop SA z/OS from attempting to restart the application. After the operator has restarted the

application, the thresholds will next be analyzed when the application next abnormally ends. If this occurs within the time interval specified for the critical threshold, it may result in the critical threshold being reached again. The error density will decrease with time, but this will not cause SA z/OS to restart the application.

For example, an application has a critical error threshold of two per hour defined.

- The application will be restarted if it abnormally ends at 10:30.
- The application will be restarted if it abnormally ends again at 12:20.
- The application will not be restarted by SA z/OS if it abnormally ends again at 12:45. Operator intervention is required to restart the application.
- If an operator restarts the application at 13:05 and the application abnormally ends at 13:15, the error count will again reach two per hour and the application will not be restarted by SA z/OS.
- If the operator restarts the application at 15:00, the error count within the last hour will be zero again. The application will have to abnormally end twice within the hour in order to reach the critical error threshold again.

The primary use of error thresholds in SA z/OS automated operations is to track application abnormal ends and ensure that the abend-and-restart cycle does not continue indefinitely. You can also set error thresholds for events other than the occurrence of errors. For example, you can set thresholds to act as counters of specified events on your system.

Thresholds for Applications

Error threshold definitions for an application define how many abend errors can occur before a message is logged or restart processing is stopped. You define such a threshold using the *THRESHOLDS* policy item, of an *Application* policy object. SA z/OS will display a panel as shown in Figure 24.

If no error thresholds are set here, the application uses the thresholds defined in the *Application Defaults* policy object. Determine whether existing default threshold values are appropriate for this application. If they are not appropriate, create a unique threshold entry for the application.

```

COMMANDS  HELP
-----
AOFPIZTH                               Thresholds Definition
Command ==>

Entry Type : Application                PolicyDB Name : DATABASE_NAME
Entry Name : APPC                       Enterprise Name : YOUR_ENTERPRISE

Resource:   APPC
Description: APPC/MVS automation policy

Specify the number of times an event must occur to define a particular level.

----- Levels -----
Resource      Critical      Frequent      Infrequent
              Number  Interval    Number  Interval    Number  Interval
              (hh:mm) (hh:mm)      (hh:mm) (hh:mm)      (hh:mm)
APPC          4      01:00       3      02:00       2      12:00

```

Figure 24. Thresholds Definition Panel

Thresholds for MVS Components

You can define thresholds for components or functions of z/OS:

- MVSDUMP: for z/OS dump data sets
- SMFDUMP: for SMF dump data sets
- LOGREC: for SYS1.LOGREC data sets
- SYSLOG: for system log data sets

For example, a threshold for an z/OS dump data set specifies, how often a full dump data set should be recovered in which time interval, before the operator gets a message, specifying that something is supposed to go permanently wrong.

```
COMMANDS  HELP
-----
AOFPIVD   Component Definition: MVSDUMP
Command ==> _____

Entry Type : MVS Component      PolicyDB Name  : DATABASE_NAME
Entry Name  : MVS_COMPONENT     Enterprise Name : YOUR_ENTERPRISE

Specify the number of times an event must occur to define a particular level.

----- Threshold Levels -----
Resource      Critical      Frequent      Infrequent
              Number  Interval  Number  Interval  Number  Interval
              (hh:mm)  (hh:mm)  (hh:mm)  (hh:mm)
MVSDUMP       03      01:00      02      01:00      01      01:00
```

Figure 25. Component Definition: MVSDUMP Panel

Thresholds can be set that let the operator know if certain errors are occurring infrequently, frequently or have reached a critical stage where the recovery process should be ended (to avoid endless loops). This is done by specifying how many times an error must happen in a certain time period for each error situation.

In our example from Figure 25, if a certain error occurs once per hour, it is considered to be infrequent. However, if an z/OS dump (MVSDUMP) runs full more often than three times an hour, the critical stage is reached. In such a case, SA z/OS will no longer recover the dump, but will notify the operator of this occurrence.

Automation Flags

One of the main tasks of customizing SA z/OS system operations involves setting automation flags. You can access *Flag Automation Specification* panels when defining *Applications* (individual applications or application classes), *Application Defaults* sets, *MVS Component* sets, *System Defaults* sets and *MVSCOMP Defaults* sets.

The *Flag Automation Specification* panels of the customization dialog define the cumulative effects of your automation flag settings, including:

- When automation is active
- Resources to which automation applies
- The types of automation mode you want SA z/OS to handle, such as starting and shutting down applications.
- Any exceptions to the defined automation

- Whether any automated operator function will operate in *assist mode*, an SA z/OS option allowing a human operator to monitor and verify the flow of an automated operation.

SA z/OS automation flags control whether automation occurs for a resource and, if so, when. Using the customization dialog, you can set default automation flags for all systems and applications or you can override automation flags for specific systems or applications.

The following topics are discussed:

- “Types of Automation Flags”
- “Setting Automation Flags” on page 37
- “Automation Manager Flags” on page 38
- “Relationship Between Automation Flags and Resource Status” on page 38
- “Automation Flags and Minor Resource Flags” on page 39

For more information on how to use automation flags and when SA z/OS checks automation flags, refer to *System Automation for z/OS Customizing and Programming*.

Types of Automation Flags

Figure 26 shows an example of a *Flag Automation Specification* panel that is displayed when the AUTOMATION FLAGS policy item for an *Application* is selected (refer to Figure 106 on page 151).

```

COMMANDS  ACTIONS  HELP
-----
A0FGFAS1          Flag Automation Specification
Command ==> _____

Entry Type : Application          PolicyDB Name : DATABASE_NAME
Entry Name : APPC                Enterprise Name : YOUR_ENTERPRISE
                                   More:      +

Resource: APPC
Enter level of automation desired.

Automation Flags: Y = Yes      N = No      E = Exits
Assist Flags:     D = Display  L = Log     N = None

Actions  Flag      Auto      Assist  Exits
-----  -
Automation . _____ _____ 0
Recovery . . _____ _____ 0
Start. . . . _____ _____ 1
ShutDown . . _____ _____ 0
Initstart. . _____ _____ 2
Restart. . . _____ _____ 0

Enter or Display times to disable automation . . NO _____ Yes No

```

Figure 26. Flag Automation Specification Panel

There is one flag that controls all the other flags:

- **Automation**

Automation is the controlling flag for resource automation. During automated operations, SA z/OS first checks the Automation flag when determining whether automation is on or off for a resource and which operator functions are automated. If the setting for this flag is YES, SA z/OS checks specific flag settings for that resource. If the setting for this flag is NO, automation is completely turned off for the resource, and SA z/OS does not check any other flags.

Automation Flags

The other flags which apply to each resource are:

- **Recovery**

This flag determines if SA z/OS monitors a resource for predefined situations requiring recovery activity and takes necessary corrective actions when these situations occur. Some examples of situations requiring recovery activities include write-to-operator buffer (WTOBUF) shortages and full MVS system maintenance data sets, such as LOGREC, SYSLOG, and MVS dump, that require offloading. By automatically responding to error conditions, SA z/OS can prevent resource outages, thereby increasing system availability.

- **Start**

This setting manages the startup process for an application by ensuring appropriate actions are taken, completely initializing the application, and bringing the application to an up or ready state (when the application issues an UP message, indicating that it is ready for use).

For resources that have a startup process consisting of issuing several commands and handling several replies, you can use the Start flag to determine how much of the startup process is automated. For example, if you want to automate initial startup process for a resource but have an operator handle the rest of the startup process you can set the Initstart flag to YES, and the Start flag to NO. The resource start phase then requires operator intervention. You might want to set your flags like this for situations when you do not want to use the automated, predefined startup procedures but want to issue unique startup commands.

- **Shutdown**

This flag determines if a shutdown command can be accepted and processed for an application. It also determines if secondary automation will be processed if a manual shutdown is issued.

Note:

If you use the override parameter on INGREQ to force an automated shutdown when the Shutdown flag is off, secondary automation will not occur as a result of the shutdown. This setting manages the shutdown process for an application by ensuring that actions are taken to stop the application in an orderly fashion, such as issuing shutdown commands and replies.

- **Initstart**

This setting controls the initial startup process for an application following an SA z/OS initial status determination cycle. SA z/OS conducts status determination cycles when:

- SA z/OS is initialized after an IPL.
- SA z/OS is initialized when its host NetView is restarted.
- The automation control file is reloaded.
- The RESYNC command is issued.

Those applications found to be inactive during the first SA z/OS initialization after an IPL are assigned an initial status of DOWN, if the status prior to the IPL and the various other options permit.

Following SA z/OS initialization, those applications that have a status of DOWN will be started if the Initstart flag setting is YES. SA z/OS will ensure that the application is started in the order specified in automation policy and that any prerequisite applications are functional.

For some resources, the activities controlled by the Initstart setting completely start up an application. That is, the MVS START command is sufficient to bring

the resource to a STARTED state. For other resources, the startup process is more involved, with additional commands issued and replies handled. For such resources, you can use the Start automation flag to automate the rest of the startup process or indicate that an operator will handle the rest of the process.

- **Restart**

The setting of this flag controls the restarting of an application, either when it ends abnormally (an *abend* condition), when automation shuts it down, or when it shuts down outside the control of SA z/OS. By automatically responding to the application requiring a restart, SA z/OS automation decreases the time and system resources required to get an application up and running again.

Error thresholds influence whether SA z/OS restarts resources. During a condition requiring restart, SA z/OS checks whether the number of occurrences of the condition exceeds the critical threshold defined in the automation policy. If the critical threshold is exceeded, SA z/OS does not attempt restarting a resource. See “How SA z/OS Uses Error Thresholds” on page 31 for more information.

The *Exits* column displays the number of exits defined. Automation exit data is added to the Automation Control File (ACF) whenever there are any additional definitions for that flag. This additional data may be, for example, automation disable times.

If you want to enable automation, but specify times when it should be disabled, you can enter YES in the input field at the bottom of the screen. Another panel will be displayed where you can specify one or more time ranges specifying the times when automation will be disabled.

Setting Automation Flags

You can set automation flags for:

- *System Defaults* (using their AUTOMATION FLAGS policy item)
- *Application Defaults* (using their AUTOMATION FLAGS policy item)
- *MVSCOMP Defaults* (using their AUTOMATION FLAGS policy item)
- *Applications* (using their AUTOMATION FLAGS policy item)
- *MVS Components* (using their MINOR RESOURCE FLAGS policy item)

Note:

For MVS components, only the Automation and Recovery flags apply.

Performance Recommendation

It is recommended that you consider carefully which flags are defined explicitly in this manner. In order to improve runtime performance, the effective flag value for each resource (Automation, Initstart, Startup, Recovery, Shutdown, and Restart) is resolved during initialization processing. This can have a noticeable impact on the time required for SA z/OS to initialize.

Since flags have inherited values, it is not necessary to define them all explicitly. Specific resources need only have flags defined if they differ from the values inherited from the defaults.

Automation Flags

A common step during automated handling of events is to check the automation flags to determine whether automation is on or off and whether automated handling of an event can continue.

The AOCQRY common routine performs this automation flag check. See *System Automation for z/OS Programmer's Reference* for more information.

The benefit of this automation hierarchy is that you can customize SA z/OS to automate as many activities and resources as necessary in the z/OS environment. You can choose to have SA z/OS handle all phases of startup, monitoring, recovery, and shutdown for all resources or have a human operator control some phases for some resources. You can control all automation by setting just one flag (the Automation flag) on one panel and then setting exceptions. The simplest way to automate your resources is to use the Automation flag.

Periods for which automation is not to apply can be specified.

There are several commands to display automation flag settings, for example, DISPFLGS. The INGAUTO command dialog can be used to set or override automation flags.

SA z/OS provides an exit capability for automation flag processing. See *System Automation for z/OS Customizing and Programming* for more information.

Automation Manager Flags

There are two automation flags that are not set in the customization dialog, but are set either by an operator command or when the automation agents are initialized. These are:

- the *global automation flag*:

Using the INGLIST or the INGSET command (see *System Automation for z/OS User's Guide* or *System Automation for z/OS Operator's Commands*) you can set an automation flag for the individual resources, which is checked by the automation manager before it sends any order to the automation agent to start or stop the specific resource.

The purpose of this flag is to prevent (if flag is set to NO) or enable (YES) the starting or stopping of resources. This can be done for resources that reside on systems that are currently inactive, for example, to prevent the startup of the resource at IPL time of the system.

- the *hold flag*:

This flag can be set with the INGSET command but it is set automatically by SA z/OS in the following way:

- If you initialize the automation agents you get the WTOR message AOF603D where you can select the NOSTART option. If you select this option, SA z/OS internally sets the hold flag for every resource, so that no resource (subsystem) is automatically started until this flag is overridden by an operator's explicit INGREQ request.

The purpose of this flag is to enable the startup of manually selected subsystems instead of starting all subsystems at a time.

Relationship Between Automation Flags and Resource Status

From initialization through normal operation to shutdown, a resource can have several automation modes, such as being started, in an up state, abending, and shutting down. SA z/OS uses *resource states* to track these automation modes for

monitored resources. A resource must have a particular status for certain automated actions to occur. The effect of these actions may, in turn, change the resource status from one value to another.

Understanding how SA z/OS typically uses resource states and automation flags is important when planning and writing your own automation procedures. For more details on automation flags, resource states, and their use in automation procedures, see *System Automation for z/OS Customizing and Programming* and *System Automation for z/OS User's Guide*.

SA z/OS provides an exit for processing state changes. Refer to *System Automation for z/OS Customizing and Programming* for more information.

Resource States and the Status Display Facility

SA z/OS also uses resource states in status information forwarded to the status display facility (SDF). This status information results in status changes being reflected on SDF panels.

Automation Flags and Minor Resource Flags

In addition to the automation flag settings for the entire application, you can set flags for minor resources (MINOR RESOURCE FLAGS policy item) that control responses to specific situations. The advanced automation option AOFMINORCHECK (described in *System Automation for z/OS Customizing and Programming*) determines whether flags for minor resources are checked. Typical minor resources include message IDs and states.

For example, JES2 is defined as application JES. You have defined a reply to message \$HASP099 on the MESSAGE policy item of the Application policy object for JES2. You can change the reply to \$HASP099 by:

- Turning the Shutdown flag for JES off. This means you have to shutdown JES manually.
- Turning the Shutdown flag for minor resource JES.\$HASP099 off. This allows SA z/OS to shutdown JES normally. When the \$HASP099 message is issued, shutdown processing will wait for a manual response.

Event and Trigger Support

This section informs you about the concepts of events and triggers and how you can use them. This information is useful to understand how to define these automation policies using the customization dialog.

How events and triggers are defined is described in sections:

- “Events Policy Object” on page 221
- “Triggers Policy Object” on page 226

Simply spoken, these facilities allow you to specify external conditions when certain applications on certain systems should either be automatically started or stopped.

Events are used to represent processes outside of automation. You can use the INGEVENT command to let SA z/OS know that an event has occurred. One or more events are part of a trigger condition. You can define a condition to be either a *startup condition* or a *shutdown condition*.

Event and Trigger Support

Events are used to decide whether the goal for a resource should be realized. Even if all dependency relationships and conditions are fulfilled, but a resource's startup condition is not fulfilled, because not all events of the startup condition are set, then the resource will not be started.

An event can be in one of two states: set or unset. The state of an event is changed with an INGEVENT command. For more information on the INGEVENT command refer to *System Automation for z/OS Operator's Commands*. The state of an event is set by the user (or a procedure) and memorized throughout the system. Each time, an event is set, SA z/OS checks all triggers defined in your environment or in your sysplex to find out whether applications need to be started or shut down according to the new conditions.

Triggers are connected to applications, application groups, or monitor resources. They act as inhibitors for the requested action. For an application to be started, its desired status must be AVAILABLE and its startup trigger must be satisfied. For an application to be stopped, its desired status must be UNAVAILABLE and its shutdown trigger must be satisfied.

If a trigger is connected to an application group then, if the trigger startup condition for the application group is not satisfied, none of its members can be started. Also, if the trigger shutdown condition is not satisfied, then none of the group members can be stopped. So the trigger is kind of inherited to the members of the application group. This is also valid if the group contains nested groups. Then the trigger is also inherited to the members of the nested group.

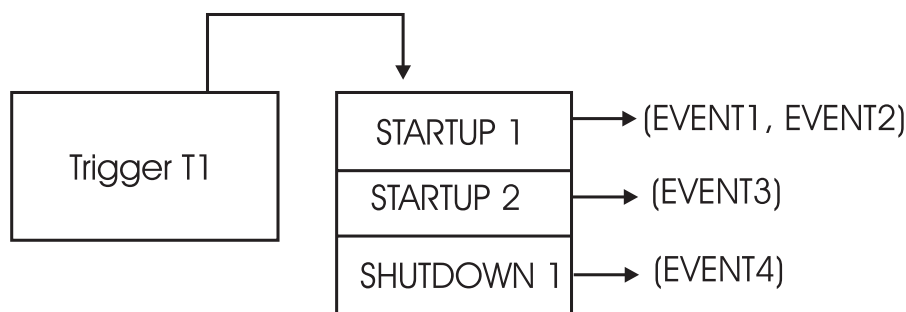

Figure 27. How a Trigger Uses Events

In Figure 27 the application connected to *Trigger T1* would be started if either *EVENT1* and *EVENT2* are set or if *EVENT3* is set, assuming the desired goal of the application is: available. The application would be stopped, if *EVENT4* is set and the desired goal of the application is: unavailable.

Triggers are used to control the starting and stopping of applications in a single system or a Parallel Sysplex[®]. So the trigger must be linked to one or more applications and has a list of conditions attached to it.

A trigger's condition list consists of up to 10 startup conditions and up to 10 shutdown conditions, each having up to 20 events. Each condition is either a startup or a shutdown condition. All events within a condition must have the status *SET* to meet the condition. If more than one condition of the same type, *STARTUP* or *SHUTDOWN*, is specified, **only one** of that type has to be met to satisfy the trigger.

Triggers and Traffic Lights

A trigger is a kind of a traffic light that controls whether a running application should stop, or whether an application with goal *MAKEAVAILABLE* should really drive away from a traffic light that switched to green, just like a ready-to start resource may only run if the trigger's startup conditions are satisfied. You see that the goal, or the request to start a resource must be there in order that a trigger with fulfilled startup conditions has an effect, just as a green traffic light is of no importance if there are no cars around the street.

However, a trigger with fulfilled shutdown conditions does not work like a red traffic light. Instead, a shutdown trigger (the red traffic light) stops the application only if the application's goal is *MAKEUNAVAILABLE* (while a red traffic light stops a running car anyhow). And, an application with goal *MAKEUNAVAILABLE* is only stopped, if a connected shutdown trigger is set.

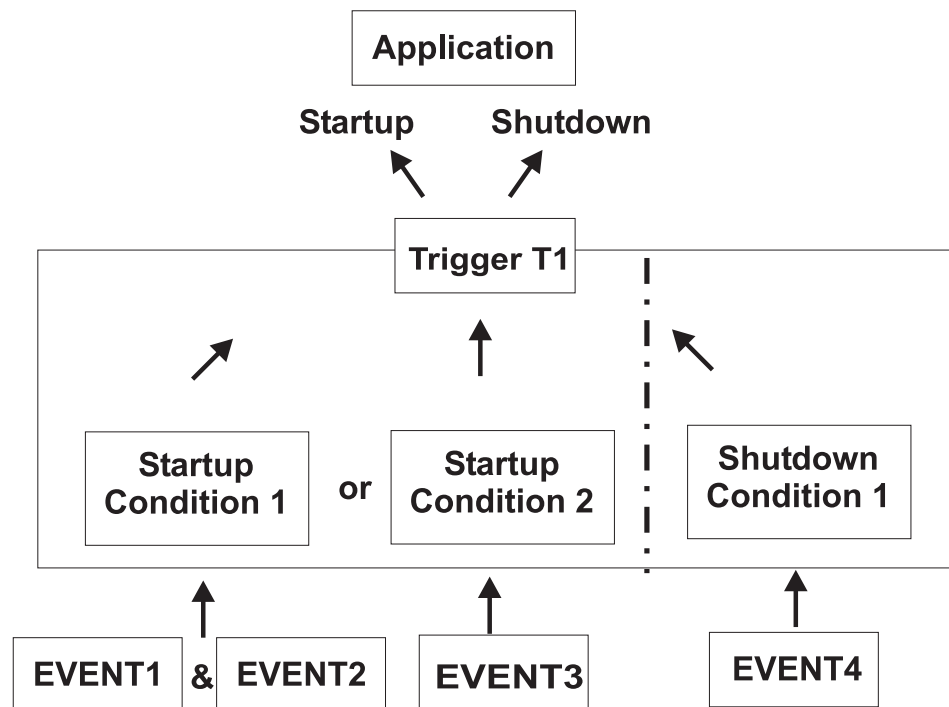

Figure 28. Triggers, Events and Conditions

Figure 28 shows another scenario, how triggers, events and conditions work together: for example, if *EVENT1* and *EVENT2* are set, then *Startup Condition 1* is true and *Trigger T1* starts the application - provided that the application's goal is being available. If *EVENT4* is set, then *Shutdown Condition 1* is true and *Trigger T1* stops the application - provided that the application's goal is being unavailable.

A startup condition is satisfied, when all events of the condition are set (and, for SA OS/390 1.3, the current time is within the service window for an eventually connected service period). A shutdown condition is satisfied, when all its events are set (and, for SA OS/390 1.3, the current time is outside of any service window for an eventually connected service period).

Event and Trigger Support

Where no real dependency exists between the applications it is more appropriate to use events and triggers to control the STARTUP and SHUTDOWN.

Assigning System Automation Symbols (AOCCLONE)

You can assign up to 36 system automation symbols to each system (for example, &AOCCLONE., ~, &AOCCLONE1. through &AOCCLONE9., and &AOCCLONEA. through &AOCCLONEZ.). When you use a system automation symbol in a job name, each system can run with a unique job name while the application or subsystem shares a single automation policy across systems. The substitution can occur anywhere within the job name. Any of the 36 available system automation symbols can be used. You may specify more than one system automation symbol.

Note:

Be careful when cloning applications controlled by Automatic Restart Manager. In most cases, the applications should be defined to Automatic Restart Manager as restart-in-place only. If you allow cross-system restarts for cloned applications, they may be restarted more than once on the same system.

The usage of system automation symbols is not limited to sysplexes. In addition to qualifying the job name, you can use system automation symbols for substitution anywhere within a defined literal, such as a shutdown command. The value of system automation symbols is also available for your automation through the NetView AOFAOCCCLONE common global variables (1 to 9, and A to Z). The AOFAOCCCLONE and each AOFAOCCCLONEn variable contains the value of the corresponding AOCCLONE variable.

SA z/OS also supports the specification of a procname in addition to a job name. The standard startup command is:

```
MVS S jobname
```

but if a procname is specified, SA z/OS issues:

```
MVS S procname,JOBNAME=jobname
```

Note:

The job name is the result of the substitution of any applicable &AOCCLONE. value and will be the name that is used for the whole automation of the application.

To define an identical application with different job names, follow these steps:

1. Define your system, optionally assigning values to one or more of the system automation symbols.
2. Link the application through an application group to the system.
3. Build the automation policy for the system. The system automation symbols are written to the automation control file as part of the system definition.
4. Build the application policy. If system automation symbols are used in the job name, they are replaced with the appropriate &AOCCLONE. values.
5. Load the automation control file. The system automation symbols are replaced with the appropriate values.

Using System Symbols and System Automation Symbols

You can specify system symbols as well as system automation symbols (AOCCLONE variables) in the following fields in the customization dialog:

Table 3. System Symbols and System Automation Symbols

Field Name	Policy Item
Description (Short and Long) ¹	Policy DESCRIPTION of all entry types
ARM element name	Policy APPLICATION INFO of entry type APL
WLM resource name	Policy APPLICATION INFO of entry type APL
Job name	Policy APPLICATION INFO of entry type APL
JCL procedure name	Policy APPLICATION INFO of entry type APL
Command prefix	Policy AUTOMATION of entry type APL
IMS Control Region Name	Policy IMS CONTROL of entry type APL
IMS Subsystem ID	Policy IMS CONTROL of entry type APL
DB2 Subsystem name	Policy DB2 CONTROL of entry type APL
DB2 Active Log Dataset Name	Policy DB2 CONTROL of entry type APL
CICS Major Node Name	Policy CICS CONTROL of entry type APL
CICS APPLID	Policy CICS CONTROL of entry type APL
Minor resource names ²	Policy MINOR RESOURCE FLAGS of entry type APL and MVC
Message ID	Policy MESSAGES/USER DATA of entry type APL and MVC
Command text ¹	Policy MESSAGES/USER DATA (type CMD), STARTUP, SHUTDOWN, JES2/3 SPOOLFULL, JES2/3 SPOOLSHORT, JES3 MONITOR of entry type APL, policy MESSAGES/USER DATA of entry type MVC, policy TIMERS of entry type TMR
Reply text ¹	Policy MESSAGES/USER DATA (type REPLY), SHUTDOWN of entry type APL, policy MESSAGES/USER DATA of entry type MVC
Code1/2/3, Value Returned ¹	Policy MESSAGES/USER DATA (type CODE) of entry type APL and MVC
Data ¹	Policy MESSAGES/USER DATA (type USER) of entry type APL and MVC
Data	Policy E-T DATA of entry type UET
Temporary Data Set HLQ	Policy SYSPLEX of entry type GRP
Monitoring Command ¹	Policy USS CONTROL of entry type APL
Command/Path ¹	Policy USS CONTROL of entry type APL
File Name ¹	Policy USS CONTROL of entry type APL
User ID	Policy USS CONTROL of entry type APL
Console Name	Policy AUTOMATION CONSOLE of entry type SYS
UNIX Installation Path ¹	Policy AUTOMATION SETUP of entry type SYS
Activate command ¹	Policy MONITOR INFO of entry type MTR
Deactivate command ¹	Policy MONITOR INFO of entry type MTR
Monitor command ¹	Policy MONITOR INFO of entry type MTR

Assigning System Automation Symbols (AOCCLONE)

Table 3. System Symbols and System Automation Symbols (continued)

1. If you are using system automation symbols in fields that are not automatically translated to uppercase, these variables must be entered in uppercase.
2. The ending period of a system automation symbol for minor resource names must be followed by at least one character, for example, DAT&AOCCLONE2.A

Table 4 lists the fields in the customization dialog where you can only specify system symbols.

Table 4. System Symbols

Field Name	Policy Name
Automation Operators	policy OPERATORS of entry type AOP
NetView Operators	policy OPERATORS of entry type AOP
Console Name	policy OPERATORS of entry type AOP

Table 5 lists the field in the customization dialog where you can only specify system automation symbols (AOCCLONE variables).

Table 5. System Automation Symbols

Field Name	Policy Name
Supporting Resource Name	Policy RELATIONSHIPS of entry type APL and APG

Chapter 4. Scenarios on How to Use the Customization Dialog

This chapter provides a series of scenarios on how to use the customization dialog to implement the appropriate automation policy:

This section discusses the following scenarios:

- “How to Work with Resources”
- “How to Use Schedules (Service Periods)” on page 69
- “How to Use Triggers and Events” on page 70
- “How to Use User E-T Pairs” on page 72
- “How to Implement Message Processing with User-Defined Data” on page 74

How to Work with Resources

This chapter contains a scenario on how to group resources for applications in a complex configuration. This scenario is based on the grouping scenario from “A Grouping Scenario” on page 24.

Some background information about resources will be given where required.

The complete process of grouping resources is divided into three steps:

- “Step 1: How to Create the Policy Objects that Make Up the Sysplex”
- “Step 2: How to Create the Applications” on page 47
- “Step 3: How to Create the Application Groups” on page 48

Step 1: How to Create the Policy Objects that Make Up the Sysplex

You start on the *Entry Type Selection* panel. It is assumed that the policy database is empty.

Creating a sysplex consists of:

- creating the systems
- creating the sysplex group
- link the systems to the sysplex group

Step 1.1: How to Create the Systems

In this substep, you create the systems *SYSTEM1*, *SYSTEM2* and *SYSTEM3*. You may want to read the information in “Creating a New System” on page 105 to see some sample panels of the customization dialog before you continue this scenario.

1. On the *Entry Type Selection* panel enter option 4 or SYS to get to the *Entry Name Selection* panel for systems which displays an empty list.
2. Enter NEW SYSTEM1 into the command line.
The *Define New Entry* panel for systems is displayed; the *Name* field is already filled with *SYSTEM1*.
3. Enter SYSTEM1 into the *MVS SYSNAME* field and press the PF3 (END) key twice to leave this panel.

Note:

To leave this panel, you have to press PF3 twice because the first PF3 prompts you for the ProcOps name, which is defaulted to the MVS SYSNAME if you do not change it.

Background:

What is a Resource?

The MVS SYSNAME name will be part of the resource names that have a system scope.

This name usually consists of three parts:

- an 11 character identifier
- the entry type from which it was derived
- and usually the System it runs on (that is, the specified MVS SYSNAME for that system).

For sysplex-wide resources (for example, Sysplex Application Groups), the system identifier is omitted.

Resources of type APL, APG, or MTR are automatically generated when applications, application groups, or monitor resources are linked to systems. Resources of other types are generated dynamically when the system operations configuration files are built.

Within the customization dialog, resources of type APL, APG, or MTR can be viewed and they can be linked via special policy items.

The *Policy Selection* panel for systems is displayed, showing a message indicating that the system is created.

4. Press PF3 or enter END to return to the *Entry Name Selection* panel showing *SYSTEM1* in the list.
5. Repeat the previous steps to create *SYSTEM2* and *SYSTEM3*. Now you have three systems in the list on the *Entry Name Selection* panel. Press PF3 to return to the *Entry Type Selection* panel.

Step 1.2: How to Create the Sysplex

You may want to read the information in “Creating a New Group” on page 90 to see some sample panels of the customization dialog before you continue with the scenario.

1. On the *Entry Type Selection* panel, enter option 2 or GRP to get to the *Entry Name Selection* panel for groups which displays an empty list.
2. Enter NEW SYSPLEX1 into the command line.
The *Define New Entry* panel for groups is displayed; the *Name* field is already filled with *SYSPLEX1*.
3. Change the *Group Type* field to SYSPLEX as you want to create a sysplex group. Press PF3 to exit this panel. The *Policy Selection* panel for Groups is displayed, showing a message that the group is created.

4. On the *Policy Selection* panel, select policy item SYSTEMS. The *Systems for Group* panel is displayed showing the three systems defined in "Step 1.1: How to Create the Systems" on page 45.
5. Select all three systems with an 'S' and press PF3 twice.
Now your environment contains a sysplex with three z/OS systems.

Background:

Ways to Build a Sysplex

A sysplex consists of z/OS systems within an XCF group with the same group ID. In the customization dialog such a sysplex can be built by creating a sysplex group and linking its systems.

This happens either "bottom-up" (from a system to a group, with the system's WHERE USED policy item) or "top-down" (from a group to a system, with the group's SYSTEM policy item).

For the "bottom-up" approach you must go into the SYS entry type, select all systems you want in the Sysplex, select each system's WHERE USED policy item where you get a list of sysplex groups and subgroups to which you can link the system.

You can also link groups with systems indirectly. This happens if you create *SubGroup* objects (SBG entry type) and link these subgroups "bottom-up" to groups AND "top-down" to Systems.

Sysplex-Groups usually consist of multiple systems; however, systems only can be linked into one sysplex group (either directly or indirectly).

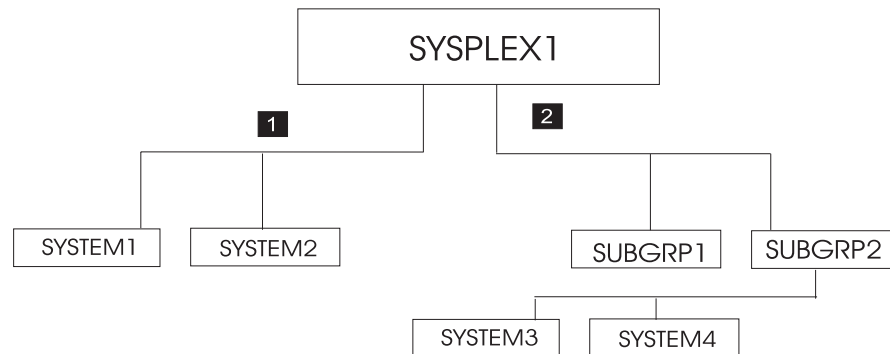

The previous figure describes how you can create a sysplex:

- 1** *SYSTEM1* and *SYSTEM2* are linked directly to sysplex *SYSPLEX1*.
- 2** *SYSTEM3* and *SYSTEM4* are linked to subgroup *SUBGRP2* and this subgroup is linked to *SYSPLEX1*.

Step 2: How to Create the Applications

In this step, you create all required application subsystems.

You may want to read the information in "Creating a New Application" on page 145 to see some sample panels of the customization dialog before you continue with the scenario.

How to Work with Resources

1. On the *Entry Type Selection* panel enter option 6 or APL to get to the *Entry Name Selection* panel for applications, which is displayed with an empty list.
2. Enter NEW VTAM into the command line.
The *Define New Entry* panel for applications is displayed; the *Name* field is already filled with VTAM.
3. Enter VTAM into the *Subsystem Name* field. You must also enter a *Jobname*. This field is mandatory and you can use VTAM, too.

Background:

Application Resource Name

The Subsystem Name is used as first part of the application's resource name. It is recommended to use the same name for the application entry name and subsystem name for better identification of applications and resources that will be derived from applications.

4. Then press the PF3 to leave this panel. The *Policy Selection* panel is displayed, showing a message that the application is created.
5. On the *Policy Selection* panel for applications press PF3 again to return to the *Entry Name Selection* panel. It now shows VTAM in the list.
6. Repeat the previous steps for the rest of the applications:

WBSRV (Web Server)
DWH (Data Warehouse)
CICSMAIN
CICSTOR
CICSFOR
CICSAOR1
CICSAOR2
CICSAOR3
DB2MAIN
DB2IRLM
TCPIP

Now all subsystems (applications) are defined to your environment and the *Entry Name Selection* panel shows 12 applications.

Step 3: How to Create the Application Groups

In this step, you create all required application groups and define the behavior of their members.

According to the example from "A Grouping Scenario" on page 24, the groups should run on the following systems:

- WBSRVAPG should run on SYSTEM1.
- DWHAPG should run on SYSTEM2 and alternatively on SYSTEM3.
- DB2 should run on SYSTEM2 and SYSTEM3.
- NET should run in the entire sysplex.
- CICS should run on SYSTEM2 and on SYSTEM3.

Background:*Sysplex Application Groups and System Application Groups*

The application group type (*SYSTEM* or *SYSPLEX*) sets the boundaries for the automation of the application group and its members.

- Sysplex Application Groups may reside on multiple systems within one or more sysplexes.
- System Application Groups reside on single systems.

Use Sysplex Application Groups for DWHAPG, NET, and CICS. System Application Groups will be used for WBSRVAPG and DB2.

Step 3.1: Create Sysplex Application Group CICSAOR

You start with the creation of CICSAOR because CICSAOR contains only applications (CICSAOR1, CICSAOR2, CICSAOR3) that already have been defined. Then you create the application group with a nature of BASIC.

You may want to read the information in “Creating a New ApplicationGroup” on page 125 to see some sample panels of the customization dialog before you continue this scenario.

1. On the *Entry Type Selection* panel enter option 5 or APG . The *Entry Name Selection* panel is displayed with an empty list.
2. On the *Entry Name Selection* panel enter NEW CICSAOR into the command line. The *Define New Entry* panel for application groups is displayed; the *Name* field is already filled with CICSAOR.
3. Check that the *Application Group Type* field contains SYSPLEX.
4. Enter BASIC into the *Nature* field.

Background:

Nature of an Application group

SA z/OS knows three natures:

BASIC

In a BASIC application group *all* of its components must be available before the group is considered to be available.

MOVE

In a MOVE application group exactly one of its components must be available before the Group is considered to be available. In MOVE groups you can specify alternative components to start if its primary component fails to start.

SERVER

In a SERVER application group any number of components can be specified that must be available before the group is considered to be available. In SERVER groups you can specify what should happen if its components fails to start.

The nature of an application group can be changed later on. However be careful with such a change, because the role of the application group will change too (and definitions made for example for a MOVE group may not be appropriate for a SERVER group).

In the example, the application group consists of three applications, (CICSAOR1, CICSAOR2, and CICSAOR3) which all should be available. You should therefore decide to take a BASIC Group.

5. Enter *CICSAOR* into the *Automation Name* field.

Background:

Application group Resource name

The *Automation Name* will be used as the first part of this application group's resource name. It is recommended to use the same name as the application group entry name and the Automation name for better identification of application groups and resources that will be derived from them.

If no Automation Name is specified, no resource will be generated for the application group. Nevertheless, the application resources for all applications linked to this application group are created and will become available for automation.

6. Press PF3 to exit the panel. The *Policy Selection* panel for Groups is displayed showing a message that the application group is created.
7. On the *Policy Selection* panel select the WHERE USED policy item. The *Where Used* panel is displayed with sysplex group *SYSPLEX1*.
8. Select the sysplex group and press PF3. For a moment, you can see the *Command Progress Display* popup window telling you that the resource has

been created. This popup is just a quick information that will disappear automatically. You can see the generated resources under the corresponding policy item of the application group.

Finally, you are back on the *Policy Selection* panel for CICSOR.

Background:

Generating Sysplex Application Group Resources

A Sysplex Application Group resource is created automatically if:

- there is an Automation Name for the application group, and
- there is a link to a sysplex group.

Only one resource will be created (not one resource per system) and the resource name has no system identifier.

CICSAOR has got an Automation Name; therefore a resource for this application group will be generated.

The current configuration with application group CICSAOR is now:

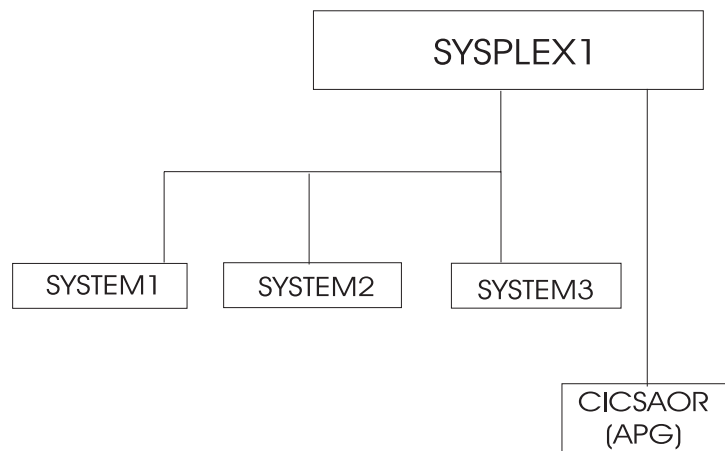

Figure 29. Current Configuration with Sysplex Application Group CICSAOR

9. On the *Policy Selection* panel for CICSAOR select the APPLICATIONS policy item.

The *Applications for ApplicationGroup* panel will be displayed with all twelve applications.

10. Select all of

CICSAOR1
CICSAOR2
CICSAOR3

and press PF3 (END).

You are now back on the *Policy Selection* panel for CICSAOR.

Background:

Generating Application Resources

Application Resources are generated when Applications are linked to Systems. This now is the case for CICSAOR1, CICSAOR2, CICSAOR3: all now are linked to CICSAOR, and indirectly via sysplex SYSPLEX1 they are linked to SYSTEM1, SYSTEM2 and SYSTEM3.

For each linked system, one resource is generated.

Again, you can see the *Command Progress Display* popup window telling you that the resources have been created. For example, for CICSAOR1, the following resources have been generated:

```
CICSAOR1/APL/SYSTEM1  
CICSAOR1/APL/SYSTEM2  
CICSAOR1/APL/SYSTEM3
```

For each application three resources are generated and linked to the application group resource.

Note: These Application Resources are deleted when:

- either the application is deleted,
- or the application group CICSAOR is deleted,
- or if other parts of the link chain APL-APG-GRP-SYS are deleted or de-linked (that is, if SYSPLEX1 or Systems SYSTEM1...3 or links between them are deleted).

The current links are:

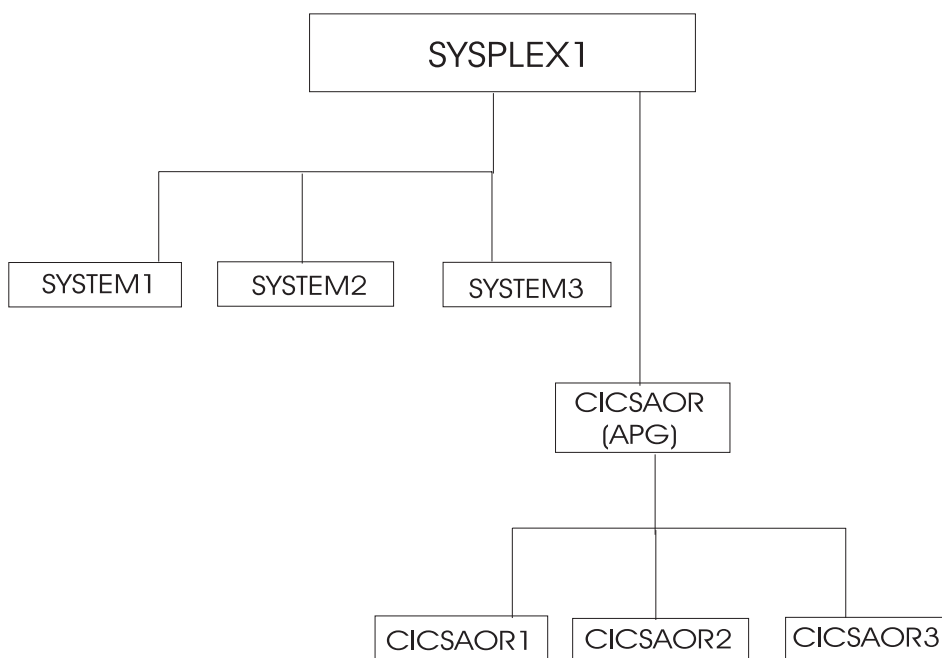

Figure 30. Current Configuration with Applications CICSAOR1 through CICSAOR3

- On the *Policy Selection* panel for CICS/AOR select the RESOURCES policy item. The *Select Resources* panel is displayed with 9 application resources selected. You can see this panel in Figure 31.

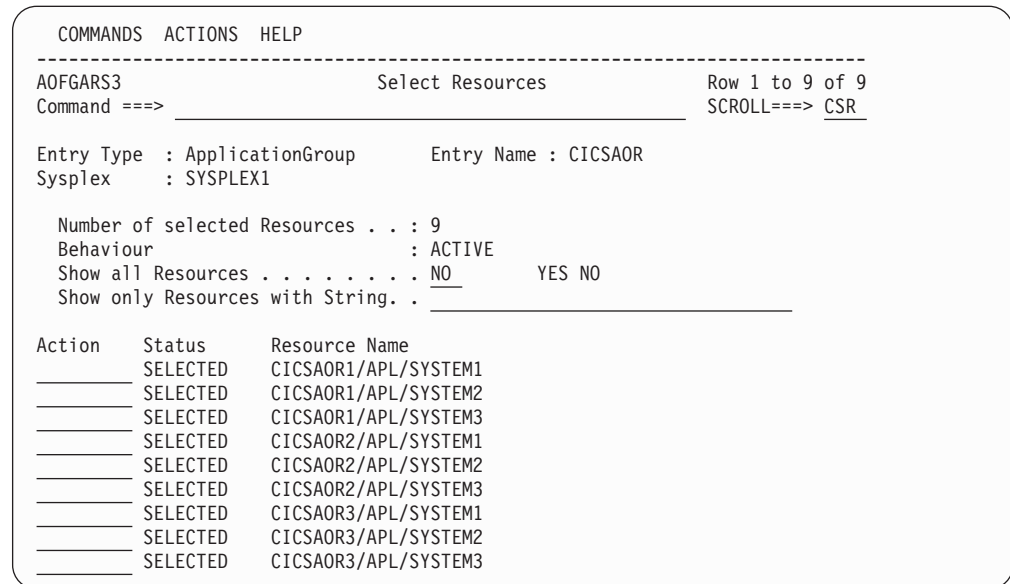

Figure 31. Resources for the CICS/AOR Sysplex Application Group

- On the *Select Resources* panel for CICS/AOR, deselect the three resources on SYSTEM1, because CICS should not run on SYSTEM1. Type an M (which is the action code for REMOVE) into the *Action* column in front of each resource that you want to remove from the group.
When you press ENTER, the field *Number of selected Resources* now shows a 6.
- Press PF3 (END) to return to the *Policy Selection* panel for CICS/AOR.
- Select policy item APPLGROUP INFO to get to the *Application Group Information* panel for CICS/AOR.
- Change the field *Automatically link Application-Resources* to NO.
Reason: Application group definitions are complete now. Further modifications within the sysplex should not affect this completed resource selections on panel *Select Resources*.

Background:*Automatically link Application-Resources*

Set this input field to NO if the definition of an application group resource (with its linked applications, its nature and its behavior and so on) is complete. This prevents possible changes in the automation policy, like changed system links or application links, from having an influence on this application group resource.

If this field is set to YES, the application group resource will be changed if system links or application links occur, namely, the number of generated application resources, the number of linked application resources and possibly the behavior of the application group resource will change.

For example, if you link another system to SYSPLEX1, you would get three more resources into your application group CICSOR, one for each linked application.

Later on, you will specify preference values for application resources, where automatically generated resources with their default preferences could adversely affect your complete application group definition.

16. Press PF3 until you are back on the *Entry Type Selection* panel.

Now application group CICSOR is complete: if a start request is issued against CICSOR, also start requests to CICSOR1, CICSOR2 and CICSOR3 are automatically issued on SYSTEM2 and SYSTEM3.

Step 3.2: Create System Application Group DB2

The application group DB2 runs on two specific systems, so you define it as a System Application Group.

1. On the *Entry Type Selection* panel, enter option 5 or APG.

The *Entry Name Selection* panel is displayed with the application group CICSOR.

2. Enter 'NEW DB2'.

The *Define New Entry* panel for application groups is displayed; the *Name* field is already filled with DB2.

3. In the scenario you decided to let DB2 permanently run only on two out of the three systems of SYSPLEX1, namely on SYSTEM2 and SYSTEM3. Thus you type "SYSTEM" into the *Application Group Type* field.

You merely want DB2 be started with all of its components, without specific backup considerations. Thus you leave its *Nature* field at "BASIC".

For resource generation, enter DB2 into the *Automation Name* field.

4. Press PF3 to reach the *Policy Selection* panel.

Note:

No resource is created for the APG at this point in time, because the application group is not yet linked to one or more systems.

The *Policy Selection* panel is displayed indicating that the application group is created.

5. Select the WHERE USED policy item. The *Where Used* panel is displayed with the three systems.
6. DB2 should only run on SYSTEM2 and SYSTEM3. Thus select SYSTEM2 and SYSTEM3 and press PF3 (END). You will see the *Command Progress Display* popup window telling you that two resources have been created:
DB2/APG/SYSTEM2
DB2/APG/SYSTEM3

Background:

Generating System Application Group Resources

A System Application Group resource is automatically generated

- if there is an Automation Name for the application group, and
- if there is link to a system.

For each linked system, one resource is generated.

There are two ways to link a System Application Group to a system:

- For the application group use the WHERE USED policy item on the *Policy Selection* panel or the WHEREUSED (W) command on the *Entry Name Selection* panel to get to the list of systems, and then select at least one system.
- If you are on the *Policy Selection* panel for a system, select the APPLICATION GROUPS policy item and then select an application group.

The current configuration is shown in Figure 32.

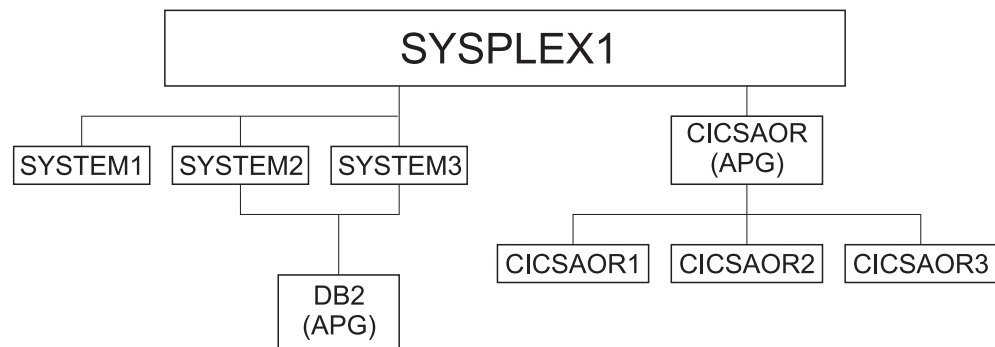

Figure 32. Current Configuration with Application Group DB2

7. On the *Policy Selection* panel for DB2, select the APPLICATIONS policy item to link the required applications.
The *Applications for ApplicationGroup* panel is displayed with all twelve applications.
8. Select DB2MAIN and DB2IRLM and press PF3 (END) to return to the *Policy Selection* panel.
Now DB2MAIN and DB2IRLM are linked to two systems via the application group DB2. For the application group, the field *Automatically link Application-Resources into APG* is set to YES, which is the default.

How to Work with Resources

One resource is generated for each system-link of each application. The *Command Progress Display* popup window indicates that the following four resources are generated:

```
DB2IRLM/APL/SYSTEM2
DB2IRLM/APL/SYSTEM3
DB2MAIN/APL/SYSTEM2
DB2MAIN/APL/SYSTEM3
```

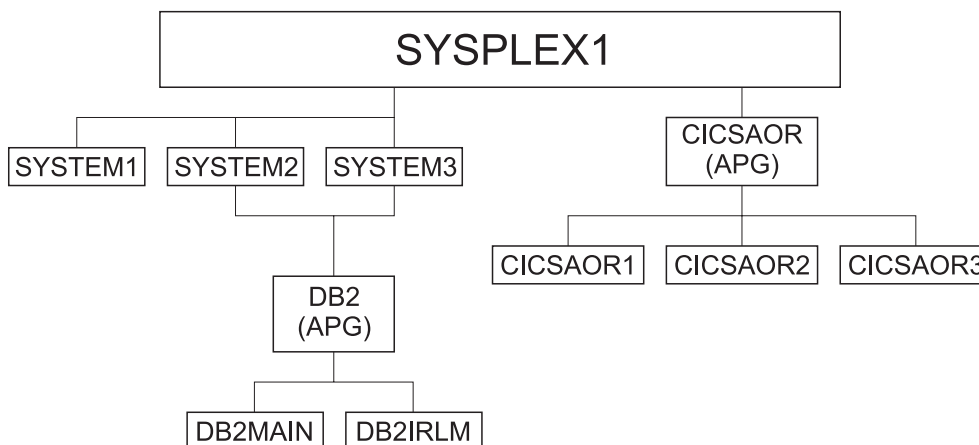

Figure 33. Current Configuration with Applications Linked to DB2

- On the *Policy Selection* panel for application group DB2, select the RESOURCES policy item.

The *Select System* panel with an indication of the number of resources selected for each system is shown. You can compare the resulting panel on your system with Figure 34.

COMMANDS	ACTIONS	HELP

AOFGARS1	Select System	Row 1 to 2 of 2
Command ==>		SCROLL==> PAGE
Entry Type : ApplicationGroup	PolicyDB Name : DATABASE_NAME	
Entry Name : DB2	Enterprise Name : YOUR_ENTERPRISE	
Action	System	Selected Resources
	SYSTEM2	2
	SYSTEM3	2
***** Bottom of data *****		

Figure 34. Select System Panel for DB2 Application group

A System Application Group can be linked to several systems which generates application resources for those systems. So to work with the resource links, you have to specify first which system you want to get the resources for. This is done on the *Select System* panel by selecting one of the systems.

- On the *Select System* panel, select either of the SYS Resources SYSTEM2 or SYSTEM3 and press ENTER.

The *Select Resources* panel with, for example, the two APL Resources for SYSTEM2 is displayed. You can compare the resulting panel on your system with Figure 35 on page 57.

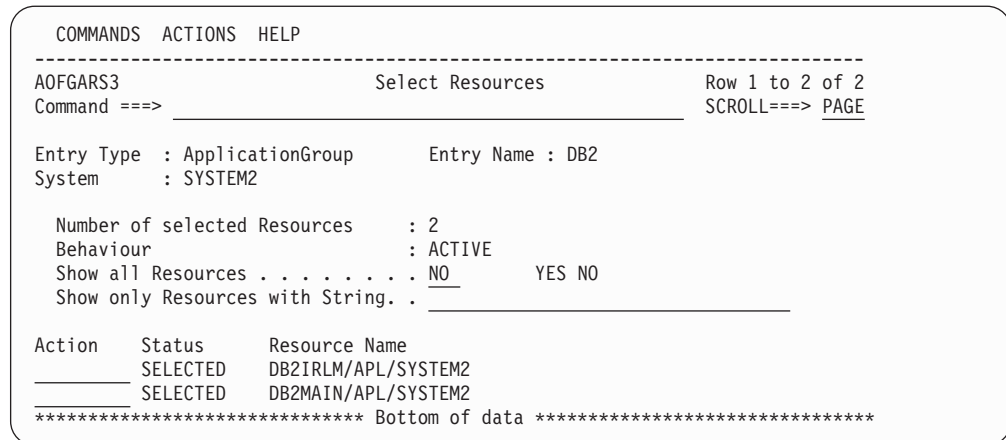

Figure 35. Select Resources Panel for DB2 Application Group

Both applications should be started, thus no change on this panel is required.

11. On the *Select Resources* panel, Press PF3 (END) or CANCEL. This returns you to the *Select System* panel, from where you can view the *Select Resources* panel for the APL resources in SYSTEM3.
12. On the *Select Resources* panel with APL Resources for SYSTEM3, press PF3 (END) twice now to return to the *Policy Selection* panel for application group DB2.
13. Select policy item APPLGROUP INFO to reach the *Application Group Information* panel. Change the field *Automatically link Application-Resources into APG* to NO.
The DB2 application group is now complete.
14. Now press PF3 until you are back at the *Entry Type Selection* panel.
15. Now the application group DB2 is complete: if a start request is issued against DB2 on SYSTEM2, start requests to the application resources DB2MAIN and DB2IRLM are also automatically issued for SYSTEM2. A start request against application group DB2 on SYSTEM3 does the same for SYSTEM3.

Step 3.3: Create System Application Group CICS

You will create this application group with the nature of BASIC and with links to three applications (CICSMAIN, CICSTOR, CICSFOR). These applications are already defined.

1. On the *Entry Type Selection* panel, enter option 5 or APG. To create the CICS System Application Group you have to repeat steps 2 through 10 of “Step 3.2: Create System Application Group DB2” on page 54 accordingly.
On the *Applications for ApplicationGroup* panel, select applications
CICSMAIN
CICSTOR
CICSFOR
2. The *Select System* panel is displayed as shown in Figure 36 on page 58.

How to Work with Resources

```

COMMANDS  ACTIONS  HELP
-----
A0FGARS1          Select System          Row 1 to 2 of 2
Command ==> _____ SCROLL==> PAGE

Entry Type : ApplicationGroup      PolicyDB Name : DATABASE_NAME
Entry Name : CICS                  Enterprise Name : YOUR_ENTERPRISE

Action      System              Selected Resources
-----
           SYSTEM2              2
           SYSTEM3              2
***** Bottom of data *****

```

Figure 36. Grouping Resources

Select SYSTEM2. A panel is displayed similar to the one shown in Figure 37.

```

COMMANDS  ACTIONS  HELP
-----
A0FGARS3          Select Resources      Row 1 to 3 of 3
Command ==> _____ SCROLL==> PAGE

Entry Type : ApplicationGroup      Entry Name : CICS
System      : SYSTEM2

Number of selected Resources      : 3
Behaviour                          : ACTIVE
Show all Resources . . . . . NO    YES NO
Show only Resources with String. . _____

Action  Status      Resource Name
-----
        SELECTED  CICSFOR/APL/SYSTEM2
        SELECTED  CICSMAIN/APL/SYSTEM2
        SELECTED  CICSTOR/APL/SYSTEM2
***** Bottom of data *****

```

Figure 37. Resources for the CICS Sysplex Application Group

Check the created links for SYSTEM3 too. The selected links should be the same.

3. Press PF3 to get back to the *Policy Selection* panel and select policy item APPLGROUP INFO. Once again, change the field *Automatically link Application-Resources* to NO.
4. Press PF3 until you are back on the *Entry Type Selection* panel.

Now application group CICS is complete: if a start request is issued against CICS, start requests are also issued to application resources CICSFOR, CICSMAIN, CICSTOR (on SYSTEM2 and SYSTEM3).

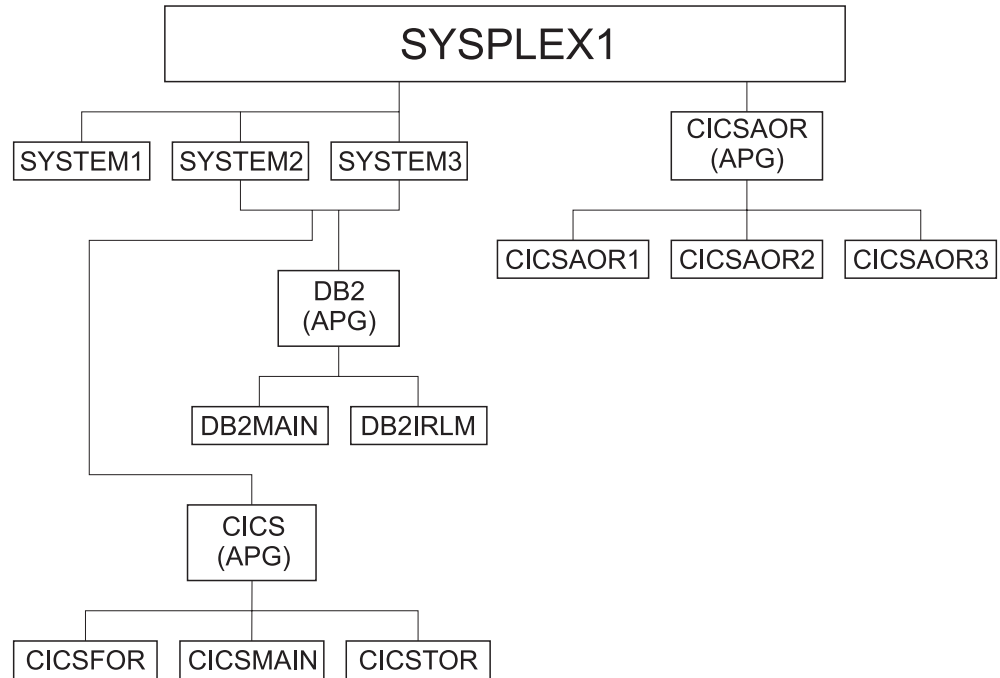

Figure 38. Current Configuration with Applications Linked to DB2

Step 3.4: Create Sysplex Application Group NET

The creation of Sysplex Application Group NET follows the previous examples, therefore, no detailed description of the required steps is contained here.

The Sysplex Application Group NET should run in the entire SYSplex1, and the applications VTAM and TCP/IP should be linked to it.

After your definitions are complete, the *Select Resources* panel for the NET application group should look like Figure 39.

```

COMMANDS  ACTIONS  HELP
-----
AOFGARS3          Select Resources          Row 1 to 6 of 6
Command ==>          SCROLL==> PAGE

Entry Type : ApplicationGroup      Entry Name : NET
Sysplex    : SYSplex1

Number of selected Resources      : 6
Behaviour                               : ACTIVE
Show all Resources . . . . . NO      YES NO
Show only Resources with String. . .

Action  Status      Resource Name
-----  -----      -
SELECTED TCPIP/APL/SYSTEM1
SELECTED TCPIP/APL/SYSTEM2
SELECTED TCPIP/APL/SYSTEM3
SELECTED VTAM/APL/SYSTEM1
SELECTED VTAM/APL/SYSTEM2
SELECTED VTAM/APL/SYSTEM3
***** Bottom of data *****
    
```

Figure 39. Select Resources Panel for Application Group NET

Step 3.5: Create MOVE Group DWHAPG

The Data Warehouse Group DWHAPG should run on one system (SYSTEM2) and, if something goes wrong on SYSTEM2, alternatively on SYSTEM3. This application group is created with nature MOVE.

Background:

What are Move Groups?

All previous application groups were of nature BASIC: BASIC means that all of its components are peers and all of them need to be available before the application group is considered to be available.

A MOVE Group, as a contrast, is designed for backup solutions. A MOVE Group can have many components, but exactly one is supposed to be active. All other components are for backup only. Thus MOVE Groups usually contain members of one kind (where one application can replace the others).

The applications needed for the DWHAPG application group are available. Thus no additional preparation seem to be needed (an error, as you will see).

1. On the *Entry Type Selection* panel, enter option 5 or APG. The *Entry Name Selection* panel is displayed with four application groups: CICS, CICSAOR, DB2, NET.
2. Enter NEW DWHAPG into the command line. The *Define New Entry* panel is displayed; the *Name* field is already filled with DWHAPG.
3. The application group DWHAPG should run alternatively on two out of the three systems. Thus leave the *Application Group Type* field as "SYSPLEX".
You want to start the components of DWHAPG exactly once, but with backups. Thus you change its nature to "MOVE".
For resource generation you need an automation name. Therefore enter DWHAPG in the *Automation Name* field.
4. Press PF3 to exit the panel. The *Policy Selection* panel for Groups is displayed showing a message that the application group has been created.
5. On the *Policy Selection* panel select the WHERE USED policy item. The *Where Used* panel is displayed with sysplex group SYSPLEX1.
6. Select the sysplex group and press PF3.
You will see the *Command Progress Display* panel telling you that the DWHAPG/APG resource has been created.
7. Select the RESOURCES policy item. You will see the *Select Resources* panel with an empty list of resources. The reason why no resource seems to be available is that you did not link any applications to the application group - thus no application resources were generated.
Note that the Availability Target is 1 (exactly 1 resource is supposed to be up in a MOVE Group). You cannot change this value.
8. Change the field *Show all Resources* to YES.

The *Select Resources* panel is displayed with all valid application group resources. Valid application group resources are Sysplex Application Group resources on the same sysplex (CICSAOR/APG, NET/APG) and System Application Group resources on one of the systems in the Sysplex (CICS/APG/SYSTEM2, CICS/APG/SYSTEM3, DB2/APG/SYSTEM2 and DB2/APG/SYSTEM3). Figure 40 on page 61 shows this panel.

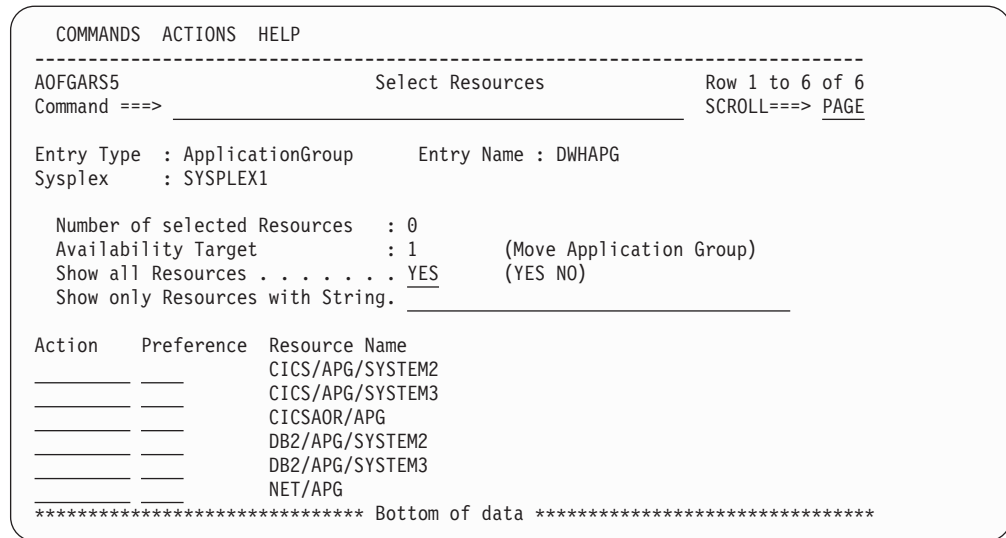

Figure 40. Select Resources Panel for DWHAPG with valid APG-Resources

However, the resulting panel shown in Figure 40 is not yet what you wanted: The target of your group was to start all of these components plus the DWH Application on either SYSTEM2 or SYSTEM3.

The target, to start the whole package alternatively on SYSTEM2 or SYSTEM3 cannot be reached with the described definitions.

Solution: You have to define two additional application groups with the same contents - one with focus on SYSTEM2 and one with focus on SYSTEM3.

Their names will be DWHAPG2 and DWHAPG3. DWHAPG will have these two APGs as member and start them alternatively.

However, you must define these groups as System Application Groups because they must have the System Application Group CICS on SYSTEM2 and SYSTEM3.

9. Press PF3 until you are back on panel *Entry Name Selection* and enter NEW DWHAPG2 on the command line.
Or, as a fast path, specify =APG;NEW DWHAPG2.
The *Define New Entry* panel is displayed, with DWHAPG2 already filled in the *Name* field.
10. DWHAPG2 should run on a single system. Therefore, select type SYSTEM on the *Define New Entry* panel.
As you want to start all of DWHAPG2's components, select BASIC.
For resource generation you need an automation name. Type DWHAPG2 in the related field and press PF3 to exit the panel.
11. On the *Policy Selection* panel select the WHERE USED policy item and on the *Where Used* panel select sysplex group SYSTEM2.
12. Press PF3 to exit the panel. The *Command Progress Display* panel is displayed, showing that the resource DWHAPG2/APG/SYSTEM2 has been generated.
13. Select policy item APPLICATIONS. From the displayed list, select application DWH. Press PF3 to exit the panel.
As a result, the application resource DWH/APL/SYSTEM2 is generated and linked to the application group resource DWHAPG2.
14. Select the RESOURCES policy item. The *Select Resources* panel with the APL Resource DWH/APL/SYSTEM2 is displayed.
15. Select this APL Resource, if it is not already selected.

How to Work with Resources

16. Change the *Show all Resources* field to YES. As a result, two application group resources are displayed together with the one application resource, as shown in Figure 41.

```

COMMANDS  ACTIONS  HELP
-----
A0FGARS3          Select Resources          Row 1 to 3 of 3
Command ==> _____ SCROLL==> PAGE

Entry Type : ApplicationGroup      Entry Name : DWHAPG2
System    : SYSTEM2

Number of selected Resources      : 1
Behaviour      : ACTIVE
Show all Resources . . . . . YES   YES NO
Show only Resources with String. . _____

Action   Status   Resource Name
-----
          SELECTED DB2/APG/SYSTEM2
          DWH/APL/SYSTEM2
***** Bottom of data *****

```

Figure 41. Select Resources Panel for DWHAPG2

17. You want to use DWHAPG2 to start the application groups CICS and DB2 on SYSTEM2.
- Select CICS on SYSTEM2 (that is, resource CICS/APG/SYSTEM2), DB2 on SYSTEM2 (that is, resource DB2/APG/SYSTEM2) and DWH on SYSTEM2 (see Figure 41).

Background:

Defining Loops in Groups

The application group CICS is now linked to DWHAPG2. However, when you are using the resource selection panel for CICS, be careful not to link DWHAPG2 to CICS, because this would result in a loop.



18. Change the field *Show selected Resources only* to YES to check the result. The *Select Resources* panel with one application resource and two application group resources selected is displayed, as shown in Figure 42 on page 63).

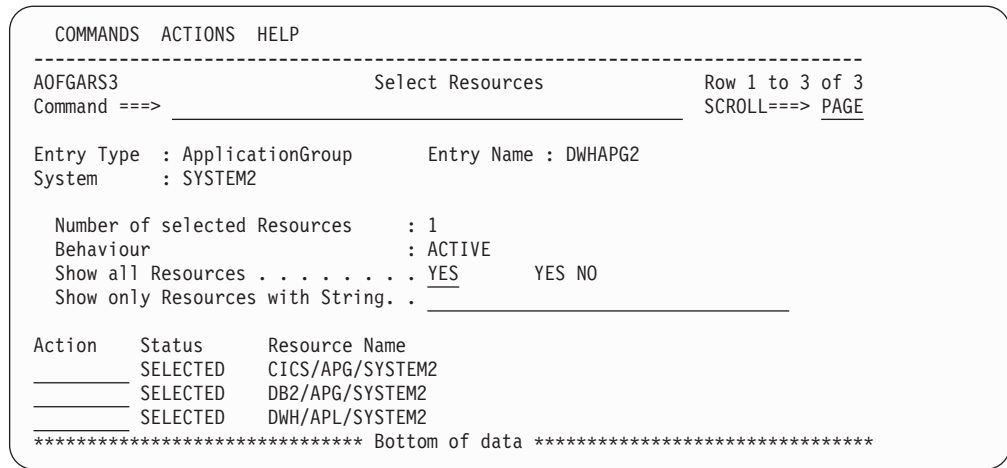

Figure 42. Select Resources Panel for DWHAPG2

19. Press PF3 until you return to the *Entry Name Selection* panel.
20. Now create application group DWHAPG3 in the same way as application group DWHAPG2, as described in steps 9 on page 61 to 12 on page 61, and link it to System SYSTEM3.
21. For application group DWHAPG3, you want the same application members as you already defined for DWHAPG2, but with focus on SYSTEM3. For this purpose, you select the COPY policy item and in the subsequent *Select Entry for Copy* panel, you select DWHAPG2.
 You should be aware that COPY only copies parts of source-objects data and only parts of the links. For more information, see “Common Policy Items” on page 18.
 After copying and pressing PF3, you are now back on the *Policy Selection* panel for DWHAPG3.
22. Select the RESOURCES policy item and link the resources for SYSTEM3. The result should look like the panel shown in Figure 43.

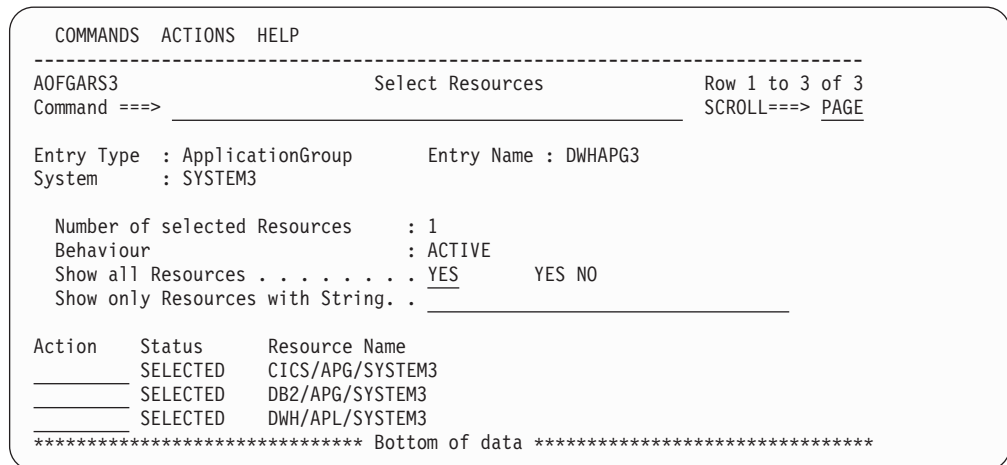

Figure 43. Select Resources Panel for DWHAPG3

- Press PF3 until you are back on the *Entry Name Selection* panel.
23. Now you have all components for your Move Group DWHAPG, and you can select DWHAPG on the *Entry Name Selection* panel. Select its RESOURCES policy item.

How to Work with Resources

24. The *Select Resources* panel for DWHAPG is displayed.

Change the *Show all Resources* field to YES.

The *Select Resources* panel with eight APG-Resources is displayed (see Figure 44).

```
COMMANDS  ACTIONS  HELP
-----
A0FGARS5          Select Resources          Row 1 to 8 of 8
Command ==> _____ SCROLL==> PAGE

Entry Type : ApplicationGroup      Entry Name : DWHAPG
Sysplex    : SYSPLEX1

Number of selected Resources : 0
Availability Target          : 1      (Move Application Group)
Show all Resources . . . . . YES      (YES NO)
Show only Resources with String.

Action   Preference  Resource Name
-----  -
_____  _____  CICS/APG/SYSTEM2
_____  _____  CICS/APG/SYSTEM3
_____  _____  CICSAOR/APG
_____  _____  DB2/APG/SYSTEM2
_____  _____  DB2/APG/SYSTEM3
_____  _____  DWHAPG2/APG/SYSTEM2
_____  _____  DWHAPG3/APG/SYSTEM3
_____  _____  NET/APG
***** Bottom of data *****
```

Figure 44. *Select Resources Panel for DWHAPG with Valid APG-Resources*

Background:

Using Preferences to Define Specific Roles

The Resources panel for MOVE groups looks slightly different than the panels for BASIC groups. It has an additional field (*Availability Target*) that cannot be modified, and the second column in the scrollable part of the panel is called *Preferences*.

Preferences are used to define specific roles of the resources linked to a group. You want DWHAPG2 on SYSTEM2 be started first and, if this fails, you want to start DWHAPG3 on SYSTEM3. To define this, start with preference values 700 and 500. They have the following meaning:

700 Resource is started when the group is started. The resource is not stopped unless a very high preference (greater than 950) alternative becomes available. (Use for the resource that normally runs).

500 Resource is started when the higher preference alternative becomes unavailable. It continues running when normal Preference (700) alternatives become available again. It stops at next (scheduled) outage. (Use for the backup resource).

For more details about preference values, refer to “More about Policy Item RESOURCES” on page 139.

The SECON(D)ARY command sets a preference of 400, which has the following meaning:

400 Resource is started when the higher preference alternative becomes unavailable. The difference to preference 500 is that the resource is stopped when the normal Preference (700) alternative becomes available again.

25. Set the preferences: Select the DWHAPG2 group on SYSTEM2 as primary (using action *P* in the *Action* column) and the DWHAPG3 group on SYSTEM3 as secondary (using preference value 500 in the *Preference* column). Figure 45 on page 66 shows the *Select Resources* panel with the selections made and Figure 46 on page 66 shows the *Select Resources* panel after you pressed ENTER: with the action *P* converted to the corresponding numeric value 700.

Note:

You can either set preferences directly in *Preference* column or use the *Action* column for important values:

- PRIMARY...(P) - Sets "primary" preference of 700.
- SECONDARY.(D) - Sets "secondary" preference of 400.

How to Work with Resources

```

COMMANDS  ACTIONS  HELP
-----
A0FGARS5          Select Resources          Row 1 to 8 of 8
Command ==> _____ SCROLL==> PAGE

Entry Type : ApplicationGroup      Entry Name : DWHAPG
Sysplex    : SYSPLEX1

Number of selected Resources : 0
Availability Target          : 1      (Move Application Group)
Show all Resources . . . . . YES    (YES NO)
Show only Resources with String.

Action  Preference  Resource Name
-----  -
_____  _____  CICS/APG/SYSTEM2
_____  _____  CICS/APG/SYSTEM3
_____  _____  CICSAOR/APG
_____  _____  DB2/APG/SYSTEM2
_____  _____  DB2/APG/SYSTEM3
P_____  _____  DWHAPG2/APG/SYSTEM2
_____  500_____  DWHAPG3/APG/SYSTEM3
_____  _____  NET/APG
***** Bottom of data *****

```

Figure 45. Select Resources Panel for DWHAPG with Selected Preferences

```

COMMANDS  ACTIONS  HELP
-----
A0FGARS5          Select Resources          Row 1 to 8 of 8
Command ==> _____ SCROLL==> PAGE

Entry Type : ApplicationGroup      Entry Name : DWHAPG
Sysplex    : SYSPLEX1

Number of selected Resources : 0
Availability Target          : 1      (Move Application Group)
Show all Resources . . . . . YES    (YES NO)
Show only Resources with String.

Action  Preference  Resource Name
-----  -
_____  _____  CICS/APG/SYSTEM2
_____  _____  CICS/APG/SYSTEM3
_____  _____  CICSAOR/APG
_____  _____  DB2/APG/SYSTEM2
_____  _____  DB2/APG/SYSTEM3
_____  700_____  DWHAPG2/APG/SYSTEM2
_____  500_____  DWHAPG3/APG/SYSTEM3
_____  _____  NET/APG
***** Bottom of data *****

```

Figure 46. Select Resources Panel for DWHAPG with Converted Preferences

Press PF3 to return to the *Policy Selection* panel for DWHAPG.

26. Select policy item APPLGROUP INFO and change the field *Automatically link Application-Resources* to NO.
27. Now press PF3 until you are back on the *Entry Type Selection* panel.

Application group DWHAPG is complete now: if a start request is issued against DWHAPG, its primary resource DWHAPG2 is started. If this fails, a start vote is issued against DWHAPG3.

Step 3.6: Create Sysplex Application Group WBSRVAPG

You will create the Sysplex Application Group WBSRVAPG as a SERVER group.

Background:

What is a SERVER Group?

SERVER groups are created when not all but only a certain number of its linked resources need to be available in order to consider the application group as being available.

Thus a SERVER group with an *Availability Target* of 1 and the preference values set accordingly can behave like a MOVE group.

On the other hand, a SERVER group with Availability Target set to *ALL and all the Preferences of its members set to 700, will act like a BASIC group.

The Web server group WBSRVAPG should run only on SYSTEM1. The WBSRV application and the NET application group are essential parts that must be up. In contrast, the DB2 application group is not necessarily needed.

1. On the *Entry Type Selection* panel, enter 5 or APG.

The *Entry Name Selection* panel is displayed and shows seven application groups.

2. Enter NEW WBSRVAPG at the command line.

The *Define New Entry* panel is displayed; the *Name* field is already filled with WBSRVAPG.

3. The application group WBSRVAPG runs mainly on SYSTEM1. But WBSRVAPG will have some members that run on other systems from the sysplex. Thus you leave the *Application Group Type* field at "SYSPLEX".

WBSRVAPG should start with all of its components, but it is acceptable if DB2 cannot be started. Thus you change the nature of the WBSRVAPG group to "SERVER".

On the same panel, in the field *Default Preference*, change the default preference to 444 as the initial value for all resources that will be linked automatically.

For resource generation you need an automation name; enter WBSRVAPG into the *Automation Name* field.

The input in the *Define New Entry* panel should now look similar to Figure 47 on page 68.

```

COMMANDS  HELP
-----
AOFGDYN3                               Define New Entry
Command ==> _____ More: +

Define new entry of type ApplicationGroup

Name . . . . . WBSRVAPG

Type . . . . . SYSPLEX (SYSTEM SYSPLEX)
Nature . . . . . SERVER (BASIC MOVE SERVER)
Default Preference . . . 444 (0 to 3200, *DEF)
Automation Name . . . WBSRVAPG
Automatically link . . . YES (for Application-Resources)
Behaviour . . . . . ACTIVE (ACTIVE PASSIVE)

Short description . . . _____
Long description . . . _____
Long description . . . _____
Long description . . . _____
Long description . . . _____
Long description . . . _____

```

Figure 47. Define New Entry Input Panel for WBSRVAPG

4. Press PF3 to create WBSRVAPG. The *Policy Selection* panel for WBSRVAPG is displayed with a message indicating that the application group has been created.
5. On the *Policy Selection* panel select the WHERE USED policy item. The *Where Used* panel is displayed with sysplex group *SYSPLEX1*.
6. Select the sysplex group and press PF3. You will see the *Command Progress Display* popup window telling you that the resource WBSRVAPG/APG has been created.
7. Select policy item APPLICATIONS of WBSRVAPG and link application WBSRV. Press PF3 to return to the *Policy Selection* panel for WBSRVAPG. You will be notified that the following resources have been generated:

```

WBSRV/APL/SYSTEM1
WBSRV/APL/SYSTEM2
WBSRV/APL/SYSTEM3

```

8. Select the RESOURCES policy item of WBSRVAPG to get to the *Select Resources* panel for WBSRVAPG.

As you can see, the Preference for the linked resources is the value you entered on the *Define New Entry* panel for application groups.

You can use the *Preference* column to fine-tune the automatic linking of application resources into an application group.

By setting the *Show all Resources* field to YES, you get the complete list of (twelve) selectable resources.

Change the preferences so that the WBSRVAPG application group is started on SYSTEM1 with WBSRV and NET as mandatory components and DB2 as not-mandatory. To achieve this:

- Set the Availability Target to "2"
- Select mandatory components (WBSRV/APL/SYSTEM1 and NET/APG) with a preference value of 1000.
- Deselect WBSRV/APL/SYSTEM2 and WBSRV/APL/SYSTEM3 (action *m*).
- Select DB2 (DB2/APG/SYSTEM2 and DB2/APG/SYSTEM3) with a preference value between 501 and 999.

When the application group is started, all selected members with at least Preference 600 will also be started, but members with Preference 1000 are mandatory.

If you change the *Show all Resources* field to NO, your definitions should look like the sample screen shown in Figure 48.

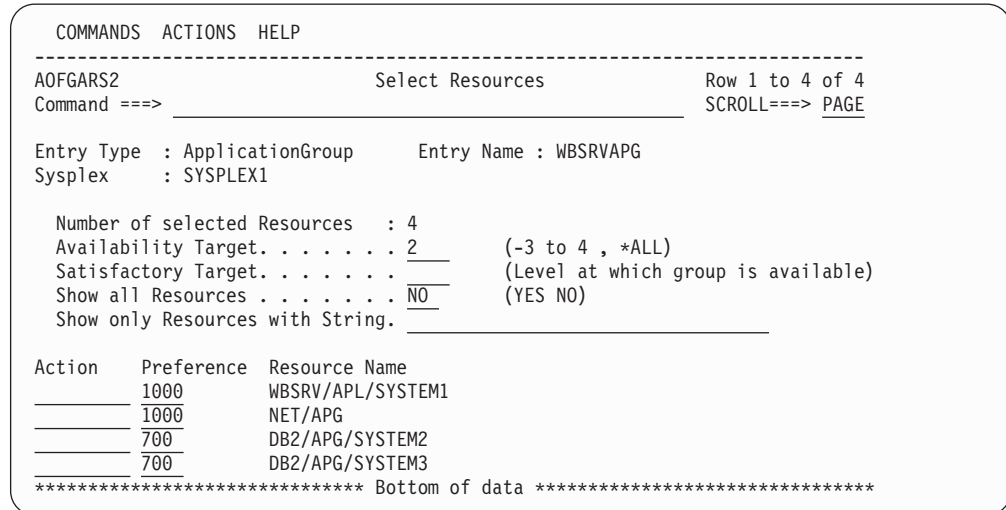

Figure 48. Final Select Resources Panel for WBSRVAPG

- The WBSRVAPG application group is now complete. Therefore, press PF3 in the *Select Resources* panel, select policy item APPLGROUP INFO in the *Policy Selection* panel and once again change the field *Automatically link Application-Resources into APG* to NO on the upcoming *Application Group Information* panel.

Now the application group WBSRVAPG is complete: if a start request is issued against WBSRVAPG, at least WBSRV and NET must be successfully started to make WBSRVAPG available.

How to Use Schedules (Service Periods)

Have a look at the scenario described in “A Grouping Scenario” on page 24. You extend this scenario using service periods that automatically control the startup and shutdown of the resources: the data warehouse application is to be available from 9am to 10pm, the web server is to be available from 4am through to 11pm.

Three service periods are needed:

- SWBSRV linked to the WBSRVAPG (web server) application group
- SDWH linked to the DWHAPG (data warehouse) application group
- SDB2DWN linked to the DB2 application group

The SDB2DWN service period should be for the resource to be down 24 hours a day, seven days a week. This will serve to shutdown DB2 and CICS when they are not needed to support an application (WBSRV or DWH or anything else that is dependent upon them).

Schedule Override

The web server needs to be available until midnight. So the operator just needs to override the SWBSRV service period (changing 11pm to 12am). An appropriate action would be the only one required to reverse the override.

How to Use Schedules (Service Periods)

If you do not want to use service periods, you could just issue a high priority request for WBSRVAPG to be available sometime before 11pm. To remove this request at midnight, you could either use INGREQ command with the expiration time parameter, which will automatically remove the request. Or, at 12am, you could use the INGVOTE command to remove this request.

Early Start

At 3am the web server application needs to be started.

The operator simply creates an override for SWBSRV that says to start the web server at 3am and keep it up until 11pm. Everything will then happen automatically. This can be done several hours (or even days) in advance.

If the operator does not want to use service periods to achieve this, he or she just needs to issue a start command against the WBSRVAPG application group and all the required resources will be made available (and kept available) until the operator removes their request (if this is after 4am, the resources will not be stopped as the desired status of the resource will not change. The requested AVAILABLE from the operator will be replaced with a requested AVAILABLE from the schedule).

How to Use Triggers and Events

This chapter contains a scenario on how to define automatic start and stop based either on fixed time intervals (service periods) or on special conditions (events).

Scenario:

Let us assume you have a group of three CICS applications: two *application owning regions*: one AOR running on SYS1, one AOR running on SYS2 and one *terminal only region TOR* running on SYS3. These need to be available between 7:00 AM and 6:00 PM during the weekdays and between 8:00 AM and 2:00 PM on Saturdays.

But before the three systems can be started, a backup of some related data sets is required.

You can have NetView trap the successful completion of the backup process. Now the two *application owning regions* can be started.

Once either of the AORs is up, SA z/OS is able to start the TOR on SYS3.

In emergency situations the systems need to be automatically stopped in a controlled way.

So to enable the automatic startup and shutdown of the systems and applications when required, the system administrator must specify certain conditions and definitions described in the following list. These conditions are checked by the system, and if met, the CICS applications are started. If for any reason some of these applications are already available, then no new startup is triggered by SA z/OS.

To implement the scenario, perform the following steps:

- Define applications AOR and TOR.
- Define a Sysplex Application Group AOR_MOVE of nature MOVE for the sysplex consisting of SYS1 and SYS2. This will generate the resource

AOR_MOVE/APG

- Link application *AOR* to this MOVE-group. This will generate the resources
AOR/APL/SYS1
AOR/APL/SYS2
- Define a System Application Group *TOR_GRP* of nature BASIC. This will generate the resource
TOR_GRP/APG
- Connect system *SYS3* to *TOR_GRP* and put application *TOR* into this group. This will generate the resource
TOR/APL/SYS3
- Define a *HasParent* relationship between *TOR/APL/SYS3* and *AOR_MOVE/APG* (with *AOR_MOVE/APG* being the parent of *TOR/APL/SYS3*). This will make *TOR/APL/SYS3* available as soon as its parent is available.
- Create application group resource *CICS_APL/APG* of nature BASIC and let the application group resource *TOR_GRP/APG* and *AOR_MOVE/APG* be members in this group.
- Define an *EVENT1*: This event, if set, will signal to the system that the backup is successfully performed and the applications *AOR* can be started on their systems *SYS1* and *SYS2*. The administrator can have SA z/OS automatically set this event by trapping message *IEF404I* from the backup process. You can set events using the *INGEVENT* command.

For each event you also define when SA z/OS should unset the event. In the scenario, you could specify that *EVENT1* should be unset if the applications are up.

- Define a trigger *TRIGGER1* and link it to the resources *AOR/APL/SYS1* and *AOR/APL/SYS2*. This trigger specifies that the linked applications are to be started if *EVENT1* is set.

How to define triggers and to determine their condition lists is described in “Triggers Policy Object” on page 226.

How to link a trigger to an application is described in chapter “Policy Items for Applications” on page 151 under policy item *TRIGGER*.

- Define a service period *SERV1* that specifies that the applications should be started on weekdays and on Saturdays as specified in the scenario. Link this service period to *CICS_APL/APG*.

How to define service periods is described in “Service Periods Policy Object” on page 223.

Now you are done. The definitions are illustrated in Figure 49 on page 72.

1. If the time of day is within the time frame defined by the service period *SERV1*, SA z/OS will start *CICS_APL/APG*.
2. This in turn will start *TOR_GRP/APG* and *AOR_MOVE/APG*. *AOR_MOVE/APG* is available, as soon as one of its members *AOR/APL/SYS1* or *AOR/APL/SYS2* is available. Availability of these two resources is controlled by event/trigger condition.
3. As soon as *AOR_MOVE/APG* is available, SA z/OS will start *TOR/APL/SYS3* because its parent is available.

How to Use User E-T Pairs

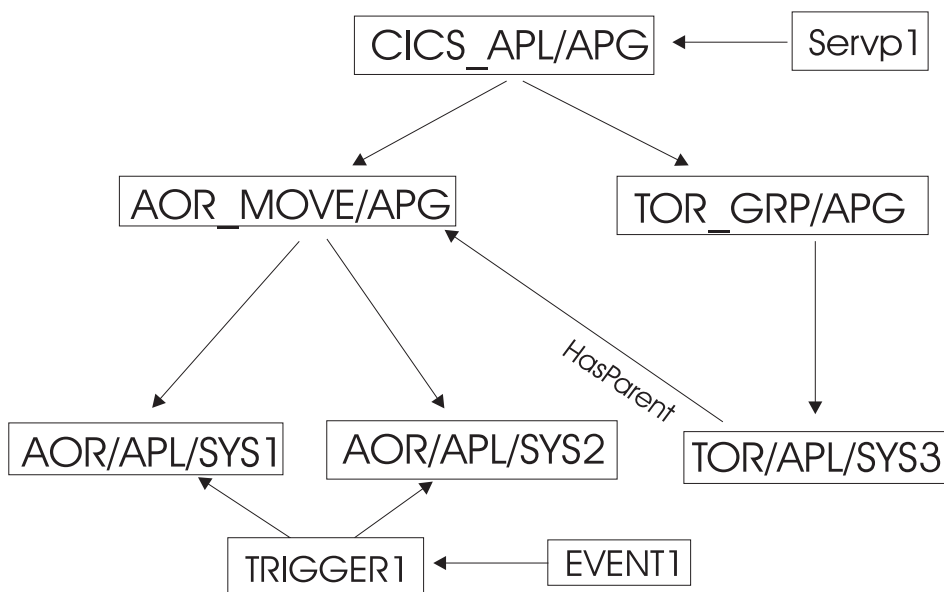

Figure 49. Scenario with Triggers, Events and Service Period

How to Use User E-T Pairs

This chapter describes how user-specified data, that does not fit into one of the standard entry types (for example, APL, APG, or SYS) can be entered into a policy database and retrieved later on by the automation.

In this example, the data for a job card shall be modified.

Step 1: Specifying User Data in the Customization Dialog

Select entry type *User E-T Pairs* (99) from the *Entry Type Selection* panel. In the example, assume that an entry JOBCARDS for a set of jobcards has already been created. Select this entry now.

If you select policy item *E-T DATA* from the *Policy Selection* panel for the JOBCARDS *User E-T Pairs*, The *UET Entry-Type Selection* panel similar to Figure 50 is displayed.

COMMANDS	ACTIONS	VIEW	HELP

AOFGUET	UET Entry-Type Selection		Row 8d from 13
Command ==>			SCROLL==> PAGE
Entry Type : User E-T Pairs		PolicyDB Name : DATABASE_NAME	
Entry Name : JOBCARDS		Enterprise Name : YOUR_ENTERPRISE	
Action	Entry Name	Type	
E	JOBCARD	DEFAULTS	
_____	JOBCARD	ICKDSF	
_____	JOBCARD	IDCAMS	
_____	JOBCARD	IMSFUND	
_____	JOBCARD	SENDMAIL	
***** Bottom of data *****			

Figure 50. UET Entry-Type Selection Panel

Now enter an E for Edit in the *Action* column for the *User E-T Pairs* pair that you want to edit. In the example, you want to edit *JOBCARD DEFAULTS*. SA z/OS

displays the *UET Keyword-Data Specification* panel into which you can enter the keywords and user data for each Entry-Type pair data as shown in Figure 51.

A keyword is an identifier for the data that follows it. The set of keyword/data pairs may be null, and each keyword does not have to be unique; that is, each keyword may have multiple sets of data assigned to it.

```

COMMANDS  ACTIONS  HELP
-----
AOFGUKD          UET Keyword-Data Specification          Row 48 from 130
Command ==>> _____          SCROLL==>> PAGE

Entry Type : User E-T Pairs          PolicyDB Name : DATABASE_NAME
Entry Name : JOBCARDS                Enterprise Name : YOUR_ENTERPRISE
UET Entry  : JOBCARD                 UET Type      : DEFAULTS

Action  Keyword/Data(partial)
-----  -----
        JOBNAME
        HAIIOC3*
        CLASS
        A
        MSGCLASS
        N
        MSGLEVEL
        (1,1)
        REGION
        4096K
***** Bottom of data *****

```

Figure 51. UET Keyword-Data Specification Panel

Step 2: Access the User Data

In a NetView session, you can use the command DISPACF to retrieve the data from the automation control file.

You can also retrieve the data using ACFFQRY from within a REXX exec as shown in the following example:

```

Get_keyword: /* name of a subroutine in the REXX ecec */
  Arg keyword .
  len = Length(keyword)
  /* get the data within a pipe */
  'PIPE NetView ACFFQRY JOBCARD DEFAULTS | STEM ALL_DATA.',
  '| SEPARATE | LOCATE 1.' || len' /'|keyword|'|/|',
  '| STEM KEY.'
  If all_data.0 < 1 Then
    Call Terminal_Error 'PIPE 1 Failed'
  If all_data.1 <> 'ACFFQRY:0' Then
    Return
  If key.0 = 0 Then
    Say 'No Match for 'keyword
  Else Do i = 1 to key.0
    Say 'Match! 'key.i
  End

Return

```

This method returns the following data in the pipe:

```

| IPSNO
ACFFQRY:0
JOBCARD DEFAULTS
JOBNAME=HAIIOC3*

```

How to Use User E-T Pairs

```
CLASS=A
MSGCLASS=N
MSGLEVEL=(1,1)
REGION=4096K
```

After this processing, the data is available in the key. stem variable and you can use it for further processing.

How to Implement Message Processing with User-Defined Data

This section describes how user-defined data is used to automatically execute commands if an application issues a certain message.

Example:

The HSM application issues the ARC0909E message that indicates the utilization percentage of the journal data set. You now want to automate the recovery of the HSM journal data set if it is more than 97% full. For this purpose, you want SA z/OS to automatically issue two commands to HSM that will perform the recovery:

HOLD ALL

To stop all further activities for HSM.

BACKVOL CDS

To create a backup of the full journal data set and allocate a new one.

To implement this scenario, perform the steps described in the following sections.

Step 1: How to Specify the User-Defined Data

Select the application for which you want to automate the recovery and then select its policy item MESSAGES/USER DATA. This will lead you to panel *Message Processing* where you enter the message ID ARC0909E as shown in Figure 52.

```

  ACTIONS  HELP
-----
AOFMSGX           Message Processing           Row 1 to 4 of 20
Command ==> _____ SCROLL==> PAGE

Entry Type : Application           PolicyDB Name : DATABASE_NAME
Entry Name  : HSM                   Enterprise Name : YOUR_ENTERPRISE

Define message IDs and their automation actions.
CMD = Command  REP = Reply  CODE = CODE  USER = User Data
AUTO = AT Actions      OVR = AT Override

Action  Message ID           Cmd Rep Code User Auto Ovr
        Description
USER    ARC0909E
        HSM journal data set utilization
        _____
        _____
        _____
        _____
        _____
        _____
        _____
        _____
```

Figure 52. Message Processing Panel

How to Implement Message Processing with User-Defined Data

To specify your user-defined data, type USER in the *Action* column of the *Message Processing* panel shown in Figure 52 on page 74. Pressing ENTER will lead you to the *User Defined Data* panel where you specify your input as shown in Figure 53.

```
COMMANDS  HELP
-----
AOFMSGU           User Defined Data           Row 1 to 3 of 20
Command ==> _____ SCROLL==> PAGE

Entry Name : HSM           Message ID : ARC0909E

To change keyword-data pair, specify the following:

Keyword
Data
LIMIT
97%
_____
_____
_____
_____
_____
_____
```

Figure 53. User Defined Data Panel

In the REXX exec that you will write in “Step 4: How to Write the REXX Exec” on page 78, you will compare the percentage value returned from the ARC0909E message with the value specified here, and, if it exceeds your specified value, you will cause SA z/OS to issue the commands specified in “Step 3: How to Update the NetView Automation Table” on page 76. If you later decide to start recovery if 95% usage is exceeded, you need not edit your REXX exec, but only your customization dialog input and then rebuild your system operations configuration files.

Pressing PF3 will store your input and bring you back to the *Message Processing* panel.

Step 2: How to Specify the Commands

In the *Message Processing* panel (Figure 52 on page 74) now enter CMD in the *Action* column for message ARC0909E. This leads to the *CMD Processing* panel where you specify your input as shown in Figure 54 on page 76.

How to Implement Message Processing with User-Defined Data

```

COMMANDS  HELP
-----
AOFMSGC          CMD Processing          Row 1 to 2 of 20
Command ==> _____ SCROLL==> PAGE

Entry Name : HSM          Message ID : ARC0909E

Enter commands to be executed when resource issues the selected message.
or define this message as status message.

Status . . . _____ ('?' for selection list)

Pass/Selection Automated Function/'*'
Command Text

MVS F &SUBSJOB, HOLD ALL
_____

MVS F &SUBSJOB, BACKVOL CDS
_____

```

Figure 54. CMD Processing Panel

Step 3: How to Update the NetView Automation Table

You need to specify a NetView automation table entry to trigger a REXX exec called YOUR_CLIST, which you will create in “Step 4: How to Write the REXX Exec” on page 78.

The AT entry can be specified by using the *Automation Processing* panel to override the predefined AT entry. To do this, enter OVR in the *Action* column for message ARC0909E in the *Message Processing* panel, as shown in Figure 55.

```

ACTIONS  HELP
-----
AOFMSGGX          Message Processing          Row 1 to 4 of 20
Command ==> _____ SCROLL==> PAGE

Entry Type : Application          PolicyDB Name : DATABASE_NAME
Entry Name : HSM                  Enterprise Name : YOUR_ENTERPRISE

Define message IDs and their automation actions.
CMD = Command  REP = Reply  CODE = CODE  USER = User Data
AUTO = AT Actions          OVR = AT Override

Action  Message ID          Cmd Rep Code User Auto Ovr
Description
OVR    ARC0909E              2      1
      HSM journal data set utilization
_____
_____
_____
_____
_____

```

Figure 55. Message Processing Panel

This leads to the *Automation Processing* panel, as shown in Figure 56 on page 77. This shows the default values for the message.

How to Implement Message Processing with User-Defined Data

```
COMMANDS  HELP
-----
AOFMSGGA          Automation Processing
Command ==> _____

Entry Name : HSM          Message ID : ARC0909E          More:  +
NetView AT source . . . . . DEFAULT          (DEFAULT USER)

NetView AT condition. . . . .
MSGID = 'ARC0909E'

NetView AT action 1 . . . . .
EXEC(CMD('ISSUECMD ')ROUTE(ONE %AOFOPGSSOPER%))

NetView AT action 2 . . . . .
```

Figure 56. Automation Processing Panel

The definitions that are needed to create an AT entry are as shown in the action fields in Figure 57. Pressing Enter will save your override and the fields are highlighted in a different color, and the *NetView AT source* field is changed to USER to indicate the override.

```
COMMANDS  HELP
-----
AOFMSGGA          Automation Processing
Command ==> _____

Entry Name : HSM          Message ID : ARC0909E          More:  +
NetView AT source . . . . . USER          (DEFAULT USER)

NetView AT condition. . . . .
MSGID = 'ARC0909E'

NetView AT action 1 . . . . .
EXEC(CMD('YOUR_CLIST') ROUTE(ONE *));

NetView AT action 2 . . . . .
```

Figure 57. Automation Processing Panel

Alternatively, you can manually specify this automation table entry either in INGMMSGU1 (which is empty, but already included in INGMMSG01), or in your own automation table, which then needs to be specified in the AUTOMATION SETUP policy for entry type SYS.

This entry should look like the following:

```
IF MSGID = 'ACR0909E'
THEN EXEC(CMD('YOUR_CLIST') ROUTE(ONE *));
```

Step 4: How to Write the REXX Exec

The value specified on the *User Defined Data* panel (Figure 53 on page 75) is accessed in the PIPE statement using the ACFFQRY command and stored in the variable limit (**1**).

To issue the commands specified on the *CMD Processing* panel (Figure 54 on page 76), the ACFCMD command is used (**2**).

```
/* REXX */

/* debugging ... */
.....

lrc = 0

/* Get the message from the safe */
"GETMLINE txt 1"

svmsgid = msgid()
svjobname = jobname()
Parse Var txt . type . ' IS ABOUT ' usage '% ' .

/* This sample recovers just type JRNL */
If type \= 'JRNL' Then Exit 0

/* Check the RECOVERY automation flag */
"AOCQRY "svjobname"."svmsgid" RECOVERY"
lrc = rc

Select
  /* Automation allowed */
  When lrc = 0 Then Do
    /* Get TGlobal variable from AOCQRY */
    "GLOBALV GETT SUBSAPPL"

    /* Get the user-data from the ACF */
    "PIPE (STAGESEP | NAME GETUDATA)" ,
      "NETV ACFFQRY "subsappl","svmsgid" , 1
      "| SEPARATE" ,
      "| LOCATE 1.6 /LIMIT=" ,
      "| EDIT 7.2 1" ,
      "| VAR limit"

    /* If no limit was defined use default */
    If symbol('limit') = 'LIT' Then limit = '95'

    /* Check if limit is exceeded. If so, issue commands */
    If usage >= limit Then Do
      "ACFCMD MSGTYP="svmsgid" 2
      lrc = rc

      /* Error occurred ? */
      If lrc \= 0 Then Do
        ...
      End
    End
  /* Automation not allowed */
  When lrc < 3 Then Do
    ...
  End
  /* Resource not known to SA */
  When lrc = 3 Then Nop
  /* Error occurred */
  Otherwise Do
    ...
  End
End
```

How to Implement Message Processing with User-Defined Data

```
End  
End  
Exit 1rc
```

How to Implement Message Processing with User-Defined Data

Chapter 5. Defining Automation Policy

This chapter describes how to define SA z/OS policy objects. They are described in the following sections in the order they appear on the *Entry Type Selection* panel shown in Figure 58.

MENU OPTIONS HELP			

AOFGETYP		Entry Type Selection	
Option ==>			
1	ENT	Enterprise	30 TMR Timers
2	GRP	Group	31 TMO Timeout Settings
3	SBG	SubGroup	32 TPA Tape Attendance
4	SYS	System	33 MVC MVS Component
5	APG	ApplicationGroup (*)	34 MDF MVSCOMP Defaults
6	APL	Application (*)	35 SDF System Defaults
7	EVT	Events	36 ADF Application Defaults
8	SVP	Service Periods	37 AOP Auto Operators
9	TRG	Triggers	38 NFY Notify Operators
10	PRO	Processor	39 NTW Network
11	MTR	Monitor Resource (*)	40 NNT NNT Sessions
			41 RES Resident CLISTS
20	PRD	Product Automation	42 SCR Status Details
			98 ICL Includes
			99 UET User E-T Pairs

(*) Multi-User-Capable

Figure 58. Entry Type Selection Panel

This chapter discusses the following policy objects:

- “Enterprise Policy Object” on page 82
- “Group Policy Object” on page 90
- “SubGroup Policy Object” on page 103
- “System Policy Object” on page 105
- “ApplicationGroup Policy Object” on page 125
- “Application Policy Object” on page 145
- “Events Policy Object” on page 221
- “Service Periods Policy Object” on page 223
- “Triggers Policy Object” on page 226
- “Processor Policy Object” on page 229
- “Monitor Resource Policy Object” on page 237
- “Product Automation Policy Object” on page 241
- “Timers Policy Object” on page 256
- “Timeout Settings Policy Object” on page 258
- “Tape Attendance Policy Object” on page 260
- “MVS Component Policy Object” on page 262
- “MVSCOMP Defaults Policy Object” on page 269
- “System Defaults Policy Object” on page 270
- “Application Defaults Policy Object” on page 272
- “Auto Operators Policy Object” on page 273
- “Notify Operators Policy Object” on page 279

- “Network Policy Object” on page 282
- “NNT Sessions Policy Object” on page 286
- “Resident CLISTs Policy Object” on page 288
- “Status Details Policy Object” on page 289
- “Includes Policy Object” on page 292
- “User E-T Pairs Policy Object” on page 292

Enterprise Policy Object

You can define one enterprise for each policy database. An enterprise definition includes:

- Enterprise description
- operator profile and command parameters for INGSEND
- Processor operations focal point information

Policy Items for an Enterprise

Figure 59 shows the policy items that are displayed when *Enterprise* is selected from the *Entry Type Selection* panel.

```

ACTIONS  HELP
-----
AOFGEPOL          Policy Selection          Row 1 to 7 of 7
Command ==> _____ SCROLL==> PAGE

Entry Type : Enterprise          PolicyDB Name : USER_PDB
Entry Name : MY_NEW_ENTERPRISE  Enterprise Name : MY_NEW_ENTERPRISE

Action      Policy Name      Policy Description
-----
            DESCRIPTION  Enter description
            SEND COMMAND OPERS  Define Operator Profile for sending commands
            INGSEND PARMS      Define INGSEND Command Parms
            PROCESSOR OPS INFO  Define processor operations focal point info
            AUTO MSG CLASSES    Define Auto Msg Classes
            SYMBOL DESCRIPTION  Enter system automation symbol description
            MPF DEFINITIONS     Define MPF header and trailer information
***** Bottom of data *****

```

Figure 59. Policy Selection Panel for Enterprises

The policy items for Enterprises are:

SEND COMMAND OPERS

This policy item allows you to define default RMTCMD autotasks for operators sending commands to target domains, so that they do not have to remember which target operator ID to use for a particular domain. This gives you more flexibility than the RMTCMD default of taking the task ID of the issuing operator.

These definitions are also used for cross domain command routing to systems that are outside the local sysplex. This is valid for all operator commands supporting the TARGET parameter.

For more information, see “More about Policy Item SEND COMMAND OPERS” on page 83.

INGSEND PARMS

This policy item allows you to define default parameters for the INGSEND command.

It also allows you to specify the CRM to be used by INGSSEND when communicating with target domains. A wildcard character, *, can be used for NETID. Additionally, NETID is optional and may be left blank. Your last entry in this policy definition will probably be * * ROUTE until you have migrated your entire enterprise to the current SA z/OS release and have changed your INGSSEND usage to be based entirely on RMTCMD.

RMTCMD-based INGSSEND exploits NetView PIPES for some invocations. You can define a value to be used on the CORRWAIT PIPE stage if you need a shorter or longer CORRWAIT value than the SA z/OS default of ten seconds. CORRWAIT only applies if your command routing mechanism is RMTCMD.

For more information refer to “More about Policy Item INGSSEND PARMs” on page 85.

PROCESSOR OPS INFO

This policy item allows you to certain enterprise-wide processor operations data. For more information, refer to “More about Policy Item PROCESSOR OPS INFO” on page 86.

AUTO MSG CLASSES

This policy item allows you to define your own message classes. Message classes that are defined here can be assigned to operators by using policy NOTIFY OPERATORS of the entry type NFY. For more information, see “More about Policy Item AUTO MSG CLASSES” on page 87

SYMBOL DESCRIPTION

This policy item allows you to enter system automation symbol descriptions. For more information, see “More about Policy Item SYMBOL DESCRIPTION” on page 88

MPF DEFINITIONS

This policy item allows you to define MPF header and trailer information. For more information, see “More about Policy Item MPF DEFINITIONS” on page 89

More about Policy Item SEND COMMAND OPERS

Figure 60 on page 84 shows the panel that is displayed when the SEND COMMAND OPERS policy item is selected.

Enterprise Policy Object

```
COMMANDS  HELP
-----
A0FGOPR          Operator Profile for sending commands  Row 1 to 12 of 20
Command ==>          SCROLL==> PAGE

Entry Type : Enterprise      PolicyDB Name : DATABASE_NAME
Entry Name  : YOUR_ENTERPRISE Enterprise Name : YOUR_ENTERPRISE

  ORIGIN  ORIGIN  ORIGIN  TARGET  TARGET  TARGET
  NETID   DOMAIN  OPER   NETID   DOMAIN  OPER
  *       IPSFO  JACKY  *       IPSFM  USERID1
  *       IPSFP  JACKY  *       IPSFM  USERID2
  _____
  _____
  _____
  _____
  _____
  _____
  _____
  _____
  _____
  _____
  _____
```

Figure 60. Operator Profile for Sending Commands Panel

This policy item allows you to define default RMTCMD autotasks for operators sending commands to target domains, so that they do not have to remember which target operator ID to use for a particular domain. This gives you more flexibility than the RMTCMD default of taking the task ID of the issuing operator.

These definitions are also used for cross domain command routing to systems that are outside the local sysplex. This is valid for all operator commands supporting the TARGET parameter.

This policy item is intended to help you migrate your cross domain command routing to RMTCMD, by allowing you to use any naming scheme for RMTCMD autotasks. By default, RMTCMD uses the operator ID of the invoking task to determine the RMTCMD autotask to which to issue a command. Use the *Operator Profile for Sending Commands* panel to define an association between an origin operator and a target RMTCMD autotask. The INGSSEND command uses predefined RMTCMD associations to resolve the OPER keyword (target operator ID to execute the routed command), if it has not been specified on an invocation. If INGSSEND does not find an RMTCMD association for the invoking operator to the target domain in the automation control file, the RMTCMD default will be used to resolve the target operator ID. For more information on INGSSEND, refer to *System Automation for z/OS User's Guide* and *System Automation for z/OS Operator's Commands*. For more information on RMTCMD, refer to *Tivoli NetView for OS/390 Command Reference Volume 1*.

The definitions you enter here apply to all systems in the enterprise. They are included in the automation control file built for each system. At run time, INGSSEND on each origin domain will use only the information intended for that particular origin Netid.Domain.

On the *Operator Profile for Sending Commands* panel (Figure 60), the following fields are defined for both origin and target:

NETID

The Network ID is optional. The maximum length is eight characters. The first character must be alphanumeric. The rest must be either alphanumeric or national characters.

DOMAIN

The NetView Domain ID is optional. The maximum length is five characters. The first character must be alphanumeric. The rest must be either alphanumeric or national characters.

OPER The Origin Operator ID is required. The maximum length is eight characters.

The Target Operator ID is optional. If entered, it must be eight characters or less. If the field is left blank, it will resolve to the ORIGIN OPER value.

The operator ID you define here should have matching OPERATOR statements in the relevant DSIOPF for each origin and target domain.

Note:
For TARGET OPER, PPT or target domain concatenated with PPT is not allowed.

A wildcard character, *, can be used for NETID and DOMAIN. All fields are optional except for ORIGIN OPER. TARGET OPER will resolve to ORIGIN OPER if it is not entered. This is the NetView default.

More about Policy Item INGSEND PARMS

If you select policy item INGSEND PARMS from the Policy Selection panel for enterprises, a panel similar to Figure 61 is shown.

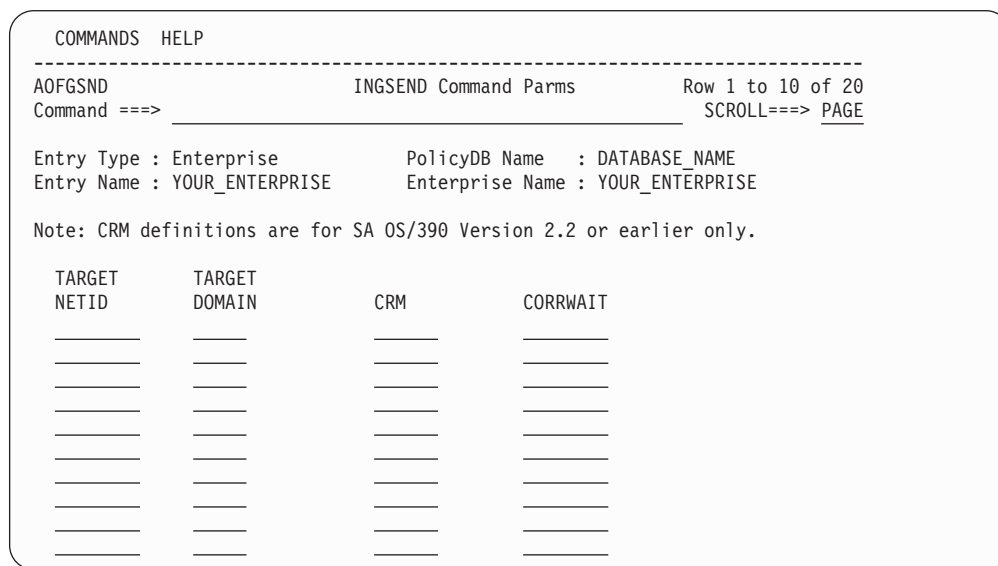

Figure 61. INGSEND Command Params Panel

The System Operations INGSEND command is used to route commands across domains. Only one command routing mechanism is supported: the NetView RMTCMD command.

To ensure compatibility with systems running SA OS/390 2.2 or earlier the specification for the NetView ROUTE command is still allowed.

RMTCMD-based INGSEND invocations can involve usage of the NetView PIPE command. Since RMTCMD produces asynchronous command output, it is

Enterprise Policy Object

necessary to use the CORRWAIT Pipe stage to trap the asynchronous messages. You can customize the CORRWAIT time that INGSEND uses per target domain.

Use wildcards for target netid and domain to specify the predominant CRM in your enterprise.

TARGET NETID

The Target Network ID is optional and, if entered, must be eight or less characters. The first character must be alphanumeric. The rest must be either alphanumeric or national characters. If left blank, it will default to '*'.

Note:

Wildcard value of '*' is allowed. This field can only be blank or '*' for a CRM of ROUTE.

TARGET DOMAIN

The Target Domain is optional and, if entered, must be five or less characters. The first character must be alphanumeric. The rest must be either alphanumeric or national characters. If left blank, it will default to '*'.

Note:

Wildcard value of '*' is allowed.

CRM The Command Routing Mechanism is optional. This can be either RMTCMD or ROUTE. If left blank, it will default to RMTCMD.

Note:

The value of this field will only be interpreted on systems running SA OS/390 2.2 or earlier. For newer SA z/OS releases the value is ignored as only RMTCMD is supported.

CORRWAIT

The corrwait value is optional. This value is used by INGSEND for the NetView PIPE CORRWAIT stage. If left blank, it will default to 10 seconds.

Note:

This field is only allowed for a CRM of RMTCMD.

More about Policy Item PROCESSOR OPS INFO

A panel as shown in Figure 62 on page 87 is displayed if you select policy item PROCESSOR OPS INFO from the *Policy Selection* panel for enterprises.

```

COMMANDS  HELP
-----
ISQDPD02          Processor Operations Information
Command ==>

Entry Type : Enterprise          PolicyDB Name : DATABASE_NAME
Entry Name : YOUR_ENTERPRISE    Enterprise Name : YOUR_ENTERPRISE

Enter the configuration information:
Primary Processor Operations focal point name . . ____
Backup Processor Operations focal point name . . . ____

Enter the data set names for the Processor Control file and Control file log:
Control file. . . . . MULTISYS.POCNTL
Control file log. . . MULTISYS.POLOG

```

Figure 62. Processor Operations Information Panel

The panel contains the following fields:

Focal point name (primary or backup)

Enter the NetView domain name of the NetView that is the name of the focal point for your SA z/OS configuration. Names can contain 5 characters, starting with an alphabetic character, #, \$, or @. This field is required if you are using SA z/OS processor operations functions. The customization dialog does not verify your entry.

Control file

Identifies the data set containing configuration information by processor operations under NetView.

Control file log

Identifies the data set containing information about errors in the configuration definition. When you generate a control file, this error file contains the errors or messages created during the generation procedure. Check this file after each control file generation.

More about Policy Item AUTO MSG CLASSES

A panel as shown in Figure 63 on page 88 is displayed if you select policy item AUTO MSG CLASSES on the *Policy Selection* panel for enterprises.

Enterprise Policy Object

```
COMMANDS  HELP
-----
AOFPIEM0      User Auto Messages Classes      Row 1 to 8 of 20
Command ==>>                                SCROLL==>> PAGE

Entry Type : Enterprise      PolicyDB Name  : DATABASE_NAME
Entry Name  : YOUR_ENTERPRISE Enterprise Name : YOUR_ENTERPRISE

Define message classes by entering the class and its description.
Do not use any of the pre-defined SA z/OS message classes.

  Message   Description
  Class

  ---      _____
  ---      _____
  ---      _____
  ---      _____
  ---      _____
  ---      _____
  ---      _____
  ---      _____
```

Figure 63. AUTO MSG CLASSES Panel

This panel defines the user message classes that are available to be assigned to notify operators by using policy NOTIFY OPERATORS of entry type NFY. The *Auto Msg Classes* policy object allows you to define your own message classes.

You can also enter a short description of each message class. Message classes must consist of an alpha and a numeric character. All double numeric message classes are reserved for use by IBM. See “Notify Operators Policy Object” on page 279 for more information on the message classes that SA z/OS defines.

Notes: _____

Notes:

1. No duplicate message classes are allowed.
2. Message classes used within any Notify Operators cannot be deleted.

For details about the definition restrictions of message classes, refer to the online help of SA z/OS.

More about Policy Item SYMBOL DESCRIPTION

If you select policy item SYMBOL DESCRIPTION from the Policy Selection panel for enterprises, a panel similar to Figure 64 on page 89 is shown.

```

COMMANDS  HELP
-----
AOFGSYMD      System Automation Symbols (AOCCLONEx) Description
Command ==> _____

Entry Type : Enterprise      PolicyDB Name : DATABASE_NAME
Entry Name : YOUR_ENTERPRISE Enterprise Name : YOUR_ENTERPRISE
More:      +

Symbolname  Description
AOCCLONE    Used for VTAM startlist suffix
AOCCLONE1  _____
AOCCLONE2  _____
AOCCLONE3  _____
AOCCLONE4  _____
AOCCLONE5  _____
AOCCLONE6  _____
AOCCLONE7  _____
AOCCLONE8  _____
AOCCLONE9  _____
AOCCLONEA  _____
AOCCLONEB  _____
AOCCLONEC  _____

```

Figure 64. System Automation Symbols (AOCCLONEx) Description Panel

This panel allows you to enter or update a description for all system automation symbols.

Description

This allows you to specify a description for each system automation symbol. This description will be shown for the system automation symbols on all systems in the policy DB.

More about Policy Item MPF DEFINITIONS

If you select policy item MPF DEFINITIONS from the Policy Selection panel for enterprises, a panel similar to Figure 65 is shown.

```

COMMANDS  HELP
-----
AOFGMPP      MPF Header and Trailer Definition
Command ==> _____

Entry Type : Enterprise      PolicyDB Name : DATABASE_NAME
Entry Name : YOUR_ENTERPRISE Enterprise Name : YOUR_ENTERPRISE

MPF Header Lines
.NO_ENTRY,SUP(NO),RETAIN(YES),AUTO(NO)
.DEFAULT,SUP(YES),RETAIN(YES),AUTO(YES)
_____

MPF Trailer Lines
.MSGCOLR  URGATTN(R,R),IMEDACTN(B,R),EVETACTN(P,R)
.MSGCOLR  GENMSG(P,R),PPMSG(Y,R),SELPEN(B,R)
.MSGCOLR  INSTRERR(W,R),ENTRYARA(T,R),WARNLGEN(B,R)
_____

```

Figure 65. MPF Header and Trailer Definition Panel

This panel allows you to enter or update definitions which will be included in the MPFLSTSA member during MPF build.

MPF Header Lines

Allows you to specify up to 3 MPF statements that will be included at the top of the MPFLSTSA member, for example:

```
.NO_ENTRY,SUP(NO),RETAIN(I,CE),AUTO(YES)
```

Enterprise Policy Object

or

.DEFAULT,SUP(YES),RETAIN(I,CE),AUTO(NO)

MPF Trailer Lines

Allows you to specify up to 3 MPF statements that will be included at the bottom of the MPFLSTSA member.

Note:

Changes in MPF header and trailer lines are taken into account during the *next* build of NetView automation tables when the MPF member is also rebuilt.

Group Policy Object

A group is the largest subdivision of an SA z/OS enterprise. It is a set of systems, or subgroups, or both, that you want to associate with one another for purposes of automation, monitoring on the NMC workstation or that you want to use with the SA z/OS processor operations functions. An SA z/OS enterprise may have many groups, each consisting of one or more systems and subgroups. You define a group by assigning a name to it and by selecting the member systems and subgroups.

The status of a group depends on the status of the systems or applications of which it is comprised. The status of a group is indicated by appropriate colors on the NMC workstation. You specify the number of systems or applications of a group that must be in an unsatisfactory state to cause SA z/OS to change the color of a group in the graphic display.

Creating a New Group

How to create new policy objects in general, is described in “How to Create New Policy Objects” on page 14.

Groups can be defined as either *standard groups* or *sysplex groups*. A standard group contains any combination of systems and subgroups. A sysplex group contains only systems or subgroups that belong to the same XCF group. For a sysplex group, there are additional policy items to describe certain sysplex-specific resources. A sysplex group may also have Sysplex Application Groups connected to it. Sysplex Application Groups are groups of applications that can reside on more than one system in the sysplex. A group must be defined as either a sysplex group or a standard group when it is created. Figure 66 on page 91 is an example of the *Define New Entry* panel for groups.

A system may belong to many standard groups, but can belong to only one sysplex group.

If you want to monitor your newly created sysplex group on the NMC workstation, you need to specify an entry for this sysplex in the INGTOPOF file (see *System Automation for z/OS Planning and Installation*).

```

COMMANDS  HELP
-----
AOFGDYN2                                Define New Entry
Command ==> _____

Define new entry of type Group

Name . . . . .

Group Type . . . . . SYSPLEX      (STANDARD SYSPLEX)
ProcOps Commands . . . . NO      (YES NO)

Short description . . . _____
Long description . . . _____
Long description . . . _____
Long description . . . _____
Long description . . . _____
Long description . . . _____

```

Figure 66. Define New Entry Panel for a Sysplex Group

The unique fields are:

Name This is the name of the entry as used by the SA z/OS dialogs. Each Group must be assigned a unique, non-blank name. The name must be unique among the names of all groups, subgroups, systems (including both the entry names and the Image/ProcOps names), and processors in the current policy database.

Group type

Use this field to specify the type of group you want to create. You can create either a Sysplex group if the group is to be associated with a sysplex, or a Standard group. Each type of group has specific policy items and restrictions associated with it. The value you enter here cannot be changed after the group is created.

The available values are:

SYSPLEX

If the Group is being used to represent a logical sysplex (a group of systems within the same XCF group ID).

STANDARD

For all other Groups, for example, to represent a physical sysplex (a group of systems within different XCF group IDs, such as a GDPS site).

ProcOps Commands

Indicates whether processor operations commands issued against this group are to be accepted for processing. The default is NO. See *System Automation for z/OS Operator's Commands* for information about the processor operations commands.

Note:

If you specify YES, then a processor operations command directed to that group will affect all systems in that group, even if those systems are associated with a subgroup of the group and that subgroup is **not** enabled for processor operations commands.

Policy Items for Standard Groups

Figure 67 shows the policy items that are displayed for a standard group.

```

ACTIONS  HELP
-----
AOFGEPOL          Policy Selection          Row 1 to 7 of 7
Command ==>>>          SCROLL==>> PAGE

Entry Type : Group          PolicyDB Name  : DATABASE_NAME
Entry Name  : STANDARD_GROUP Enterprise Name : YOUR_ENTERPRISE

Action      Policy Name      Policy Description
          DESCRIPTION  Enter description
          GROUP INFO   Define group information
          SUBGROUPS    Select subgroups for group
          SYSTEMS      Select systems for group
-----
          COPY          Copy data from an existing entry
***** Bottom of data *****

```

Figure 67. Policy Selection Panel for Standard Groups

The unique policy items for groups are:

GROUP INFO

This displays the type of group that was specified when the group was created. This can be either standard or sysplex. It also displays and allows you to update the current value of the processor operations commands indicator.

For more information, see “More about Policy Item GROUP INFO” on page 94.

SUBGROUPS

When you select this policy item, a list of all subgroups in the SA z/OS enterprise is displayed. Those subgroups that are related to the current group are marked with SELECT. You can add subgroups to the group, or remove subgroups from the group.

For more information, see “More about Policy Item SUBGROUPS” on page 94.

SYSTEMS

When you select this policy item, a list of all systems in the SA z/OS enterprise is displayed, indicating by SELECTED which are related to this group. You can add systems to the group, or remove systems from the group.

For more information, see “More about Policy Item SYSTEMS” on page 95.

Policy Items for Sysplex Groups

You define a sysplex group when creating a new group object by specifying “sysplex” in the group type field of the *Define New Entry* panel. There are certain restrictions for sysplex groups:

- A system can be linked to only one sysplex group. The same system can be linked to other standard groups. This applies if the system is linked directly to the system group, or indirectly through a subgroup.
- A subgroup may be linked to only one sysplex group.

Figure 68 is an example of the *Policy Selection* panel for Sysplex groups.

```

ACTIONS  HELP
-----
AOFGEPOL                               Policy Selection                               Row 1 to 17 of 17
Command ==>> _____                SCROLL==>> PAGE

Entry Type : Group                      PolicyDB Name : DATABASE_NAME
Entry Name : SYSPLEX_GROUP_01          Enterprise Name : YOUR_ENTERPRISE

Action   Policy Name      Policy Description
-----
DESCRIPTION      Enter description
GROUP INFO       Define group information
SUBGROUPS        Select subgroups for group
SYSTEMS          Select systems for group
-----
SYSPLEX          Define sysplex policy
NMC DEFINITIONS Define NMC Data
APPLICATION GROUPS Select application groups for sysplex
-----
LOCAL PAGE DATA SET Define local page data set recovery
JOB DEFINITIONS  Define handling of jobs
-----
JOB/ASID DEFINITIONS Define handling of long running jobs and ASID
RESOURCE DEFINITIONS Define long running enqueue resources
IEADMCxx SYMBOLS Define IEADMCxx symbols
-----
COPY            Copy data from an existing entry
*****
***** Bottom of data *****

```

Figure 68. Policy Selection Panel for Sysplex Groups

The policy items for sysplex groups are the same as those for standard groups with the following additions:

SYSPLEX

This policy item allows you to describe certain resources associated with the sysplex. For more information, see “More about Policy Item SYSPLEX” on page 95.

NMC DEFINITIONS

This policy item allows you to make NMC definitions for the primary and secondary NMC Focal Point Domains. For more information, see “More about Policy Item NMC DEFINITIONS” on page 98.

APPLICATION GROUPS

This policy item displays a list of all Sysplex Application Groups, indicating which application groups are selected for this sysplex. For more information, see “More about Policy Item APPLICATION GROUPS” on page 99.

LOCAL PAGE DATA SET

With this policy item you can predefine local page data sets that are used in recovery situations to prevent auxiliary storage shortage outages. For more information, see “More about Policy Item LOCAL PAGE DATA SET” on page 99.

JOB DEFINITIONS

With this policy item you can define the jobs that can or cannot be cancelled (KEEP/CANCEL), in case the job is responsible for the shortage condition. For more information, see “More about Policy Item JOB DEFINITIONS” on page 100.

JOB/ASID DEFINITIONS

With this policy item you can define the jobs and address space IDs that

Group Policy Object

can or cannot be cancelled. You can specify KEEP if the job must not be cancelled, DUMP to dump the job after the wait time has expired, or NODUMP to suppress the dump before the job is cancelled.

For more information, see “More about Policy Item JOB/ASID DEFINITIONS” on page 101.

RESOURCE DEFINITIONS

With this policy item you can define the major and minor resource names together with their wait time (30-999 seconds) after which an ENQ is treated as a long running ENQ.

For more information, see “More about Policy Item RESOURCE DEFINITIONS” on page 102.

IEADMCxx SYMBOLS

With this policy item you can define the IEADMCxx symbols together with their substitution value for selective jobs or address space IDs. For more information, see “More about Policy Item IEADMCxx SYMBOLS” on page 103.

More about Policy Item GROUP INFO

A panel as shown in Figure 69 is displayed if you select policy item GROUP INFO on the *Policy Selection* panel for standard groups. (If the group type was defined as sysplex, this is reflected in the panel.)

```
COMMANDS  HELP
-----
A0FGGPA0          Group Information
Command ==> _____

Entry Type : Group          PolicyDB Name : DATABASE_NAME
Entry Name : STANDARD_GROUP Enterprise Name : YOUR_ENTERPRISE

The following field was specified when the Group was defined
and cannot be modified:
Group Type : STANDARD

ProcOps Commands . . . . NO (YES NO)
```

Figure 69. Group Information Panel for Standard Groups

This panel displays the following information:

Group Type

This field cannot be changed; it was set when this group was created. For more details, see “Group Type” on page 91.

ProcOps Commands

For more details, see “ProcOps Commands ” on page 91.

More about Policy Item SUBGROUPS

A panel as shown in Figure 70 on page 95 is displayed if you select policy item SUBGROUPS on the *Policy Selection* panel for standard groups. (If the group type was defined as sysplex, this is reflected in the panel.)

```

COMMANDS ACTIONS VIEW HELP
-----
A0FGXC4E          SubGroups for Group          Row 1 to 2 of 2
Command ==>>>          SCROLL==>> PAGE

Entry Type : Group          PolicyDB Name : DATABASE_NAME
Entry Name : STANDARD_GROUP Enterprise Name : YOUR_ENTERPRISE

Action      Status          SubGroup
-----
          _____          FOCAL_POINT_SUBGROUP
          _____          TARGET_SUBGROUP
***** Bottom of data *****

```

Figure 70. Subgroups Panel for Standard Groups

This panel allows you to manage the links between the current Group entry and the SubGroups entries. From this panel you can:

- Add a link between the entries with the ADD (A) command in the Action column.
- Remove a link between the entries with the REMOVE (M) command in the Action column.

More about Policy Item SYSTEMS

A panel as shown in Figure 71 is displayed if you select policy item SYSTEMS on the *Policy Selection* panel for standard groups. (If the group type was defined as sysplex, this is reflected in the panel.)

```

COMMANDS ACTIONS VIEW HELP
-----
A0FGXC4E          Systems for Group          Row 1 to 4 of 4
Command ==>>>          SCROLL==>> PAGE

Entry Type : Group          PolicyDB Name : DATABASE_NAME
Entry Name : STANDARD_GROUP Enterprise Name : YOUR_ENTERPRISE

Action      Status          System
-----
          _____          SAMPLE_SYSTEM_01
          _____          SAMPLE_SYSTEM_02
          _____          SAMPLE_SYSTEM_03
          _____          SAMPLE_SYSTEM_04
***** Bottom of data *****

```

Figure 71. Systems Panel for Standard Groups

This panel allows you to manage the links between the current Group entry and the Systems entries. From this panel you can:

- Add a link between the entries with the ADD (A) command in the Action column.
- Remove a link between the entries with the REMOVE (M) command in the Action column.

More about Policy Item SYSPLEX

A panel as shown in Figure 72 on page 96 is displayed if you select policy item SYSPLEX on the *Policy Selection* panel for sysplexes.

```

COMMANDS  HELP
-----
A0FGGPB0          Sysplex Policy Definition
Command ==> _____

Entry Type : Group          PolicyDB Name : DATABASE_NAME
Entry Name : SYSPLEX_GROUP_01 Enterprise Name : YOUR_ENTERPRISE

Sysplex Name. . . . . _____
Sysplex Timer Monitoring. . . . . YES YES NO
Number Monitored Sysplex Timers . . . . . 2 1 2
Temporary Data Set HLQ. . . . . _____
                                           Data set HLQ (max. 17 chars)

Started Task Job Name . . . . . _____
Couple Data Set HLQ . . . . . _____

CDS type   Alternate volumes          Desired monitoring
(SYSPLEX) (PRIMARY ALTERNATE NONE)
Sysplex   _____ PRIMARY
ARM       _____ PRIMARY
CFRM      _____ PRIMARY
LOGR      _____ PRIMARY
SFM       _____ PRIMARY
WLM       _____ PRIMARY

Logical SYSPLEX Group ID. . . . . _____ Unique ID for this logical sysplex
(SA OS/390 1.3 only)
    
```

Figure 72. Sysplex Policy Definition Panel for Sysplex Groups

The fields on the *Sysplex Policy Definition* panel are as follows:

Sysplex Name

Defines the name of the sysplex.

Sysplex Timer Monitoring

If you have one or more sysplex timers in your sysplex and you want them monitored by the NMC workstation, enter YES and specify the number of monitored sysplex timers in the next field. Enter NO, if you do not want monitoring. This is the default.

Number Monitored Sysplex Timers

Enter '2' if you are using the sysplex timer with the Expanded Availability Option and you want to have two sysplex timers monitored by the NMC workstation. Enter '1', if you only want one sysplex timer monitored.

Temporary Data Set HLQ

Defines the high level qualifier to be used to assemble a data set name for allocating temporary data sets needed by programs running as started tasks. The qualifier can consist of up to 17 characters according to the z/OS data set naming rules (hlq1.hlq2.hlq3). Specify the name without quotes.

Started Task Job Name

Defines the job name to be used for programs running as started tasks. The name can consist of up to 8 characters according to the z/OS job naming rules.

Couple Data Set HLQ

Specify the high level qualifier to be used for the allocation of alternate couple data sets (CDS). The qualifier can consist of up to three parts according to the z/OS data set naming rules. When allocating an alternate

CDS, this qualifier is appended with the type (for example, SYSPLEX) and CDS0*n*, where *n* is a sequence number.

CDS type - Alternate volumes - Desired monitoring

Specify the types of couple data sets to be used, and the monitoring to be done.

The types of supported couple data sets are:

Sysplex

Contains the policy and status for basic sysplex functions and points to the other couple data sets.

ARM Contains the policy for automatic restart management.

CFRM Contains the policy for coupling facility resource management.

LOGR Contains an inventory for the sysplex logger function.

SFM Contains the policy for sysplex failure management.

WLM Contains the policy for the workload manager.

In the column *Alternate volumes* you can enter up to 8 volume names for allocating alternate couple data sets for types Sysplex, ARM, CFRM, LOGR and SFM. For WLM, no alternate volumes can be specified. The names must be in accordance to the z/OS volume naming rules. In case of allocating alternate couple data sets, the allocation starts on the first specified volume and continues in the specified order.

The information you enter in column *Desired monitoring*, determines when the NMC workstation of SA z/OS displays the associated icon for a couple data set as satisfactory or unsatisfactory. For example, if you have a couple data set QUAL1.ARM.CDS0, which you want to be monitored as PRIMARY, but currently this data set is not available because the operator had to switch to an alternate ARM CDS, then the icon for QUAL1.ARM.CDS0 is marked as being unsatisfactory (colored red).

You specify the monitoring that is to be done for each type of couple data set as follows:

ALTERNATE

Indicates that you want to monitor both the primary and the alternate data set. In this case, when either the primary or the alternate fails, the related icon will turn red.

PRIMARY

Indicates that you want to monitor only the primary couple data set. In this case, there is only one icon (for the primary CDS) on the NMC workstation and the operator will only see when the primary itself is unavailable, no matter whether an alternate CDS is available to take over.

NONE

Indicates that none of the couple data sets are monitored. This is the default for all types of CDSs, except for the sysplex CDS. The default for the sysplex CDS is PRIMARY.

Logical Sysplex Group ID

Note:

The logical SYSPLEX Group ID is for SA OS/390 1.3 only. For newer versions, it must be specified in the HSAPRMxx member.

A logical sysplex group ID may be specified to indicate that a subset of the members of an actual z/OS sysplex is defined in this sysplex group. If specified, the ID may contain 1 or 2 characters. Valid characters are A-Z, 0-9, and the national characters (\$, # and @).

If a logical sysplex group ID is specified, it will be prefixed with the string INGXSG to construct the XCF group name used for cross system synchronization, for example, INGXSGxy.

If no logical sysplex group ID is specified, the default group name INGXSG will be used.

This group needs to be associated to an appropriate XCF transport class by the person responsible for the sysplex setup (refer to the manual *z/OS MVS Setting Up a Sysplex*).

More about Policy Item NMC DEFINITIONS

A panel as shown in Figure 73 is displayed if you select policy item NMC DEFINITIONS on the *Policy Selection* panel for sysplexes.

```

COMMANDS  HELP
-----
AOFGNMC          NMC Definitions          Row 1 to 8 of 20
Command ==>>>          SCROLL==>> PAGE

Entry Type : Group          PolicyDB Name : USER_PDB
Entry Name : SYSPLEX_GROUP_01      Enterprise Name : MY_NEW_ENTERPRISE

NMC Focal Point Domains
  Primary. . . . DOMS1
  Secondary. . . . DOMS2

Anchor  Description
-----  -----
WTOR    NMC anchor for WTORS
TAPE    NMC anchor for tape mount requests
SYSPLEX NMC anchor for sysplex related events
CRITMSG NMC anchor for critical messages
-----  -----
-----  -----
-----  -----
-----  -----
-----  -----

```

Figure 73. NMC Definitions Panel for Sysplex Groups

Anchors are special objects that exist in RODM. They are displayed as icons on the NMC topology client. They are not automated by the automation manager. They play the role of major resources and serve these purposes:

- Anchors are used to display and group minor resources that derive from events such as WTORS and tape mount requests.
- Lost&Found anchors are used to display minor resources for which either the specified major resource or sysplex anchor does not exist in RODM.

- Couple data sets (CDSs), coupling facilities (CFs) and external timer references (ETRs) are displayed as minor resources and are attached to the sysplex anchor.
- It is possible to attach a minor resource to a user-defined anchor with the INGPOST command. The major resource specified to INGPOST can be a regular resource (for example, APL, APG, SYS, etc.) or an anchor.
- Heartbeats (minor resources) are attached to a heartbeat anchor.

Specify the name of an anchor on this panel for these cases:

- To enable the display of WTORS and tape mount requests in the NMC topology client, the anchor names that must be specified are: WTOR and TAPE
- To define a sysplex anchor for 'homeless' minor resources or to display CDSs, CFs, and ETRs, the name of the sysplex anchor is: SYSPLEX
- To display minor resources that are created with INGPOST. The name used for the resource= parameter should be the name of the anchor that is specified here. For example, with resource=ANCHOR/MJR/CRITMSG the name of the anchor is: CRITMSG

Do *not* specify an anchor on this panel for:

- Heartbeats. The anchor is automatically created by SA z/OS.
- Lost&Found anchors.

More about Policy Item APPLICATION GROUPS

A panel as shown in Figure 74 is displayed if you select policy item APPLICATION GROUPS on the *Policy Selection* panel for sysplex groups.

```

COMMANDS  ACTIONS  VIEW  HELP
-----
A0FGXC4E          Sysplex ApplGroups for Sysplex          Row 1 to 10 of 10
Command ==>>>          SCROLL==>>> PAGE

Entry Type : Group          PolicyDB Name : DATABASE_NAME
Entry Name : SYSPLEX_GROUP_01      Enterprise Name : YOUR_ENTERPRISE

Action      Status          Sysplex ApplGroup
-----
          SELECTED      APPL_GROUP_MOVE
          SELECTED      APPL_GROUP_NAME
          SELECTED      APPLGR_DB531
          SELECTED      APPLGR_SGPLEX
          SELECTED      DB2_GROUP
          SELECTED      IMS7_XRF
          SELECTED      IMS711_GRP
          SELECTED      IMS721_GRP
          SELECTED      OPC_OBSERVER
          SELECTED      SYSPLEX_APPLGROUP
***** Bottom of data *****

```

Figure 74. Group Information Panel for Standard Groups

This panel allows you to manage the links between the current Sysplex entry and the Sysplex ApplGroups entries.

More about Policy Item LOCAL PAGE DATA SET

With the automation of local page data sets, SA z/OS prevents auxiliary storage shortage outages, by dynamically allocating spare local page data sets when needed.

Group Policy Object

```
COMMANDS  HELP
-----
AOFGLCLP          Local Page Data Set Recovery          Row 1 to 6 of 20
Command ==> _____          SCROLL==> PAGE

Entry Type : Group          PolicyDB Name   : DATABASE_NAME
Entry Name  : SYSPL1       Enterprise Name : YOUR_ENTERPRISE

Page Data Set HLQ . . . . . _____
                               Data set HLQ (max. 23 chars)
Number of Cylinders . . . . . 400    100-999

Page Data Set Volumes . . . . . _____
                               _____
                               _____
                               _____

Data Set Names for Spare Page Data Sets
_____
_____
_____
_____
_____
```

Figure 75. Local Page Data Set Recovery

Fill in the following fields:

Page Data Set HLQ

Defines a high level qualifier which is used to assemble a data set name for creating and allocating a page data. The qualifier can consist of up to 23 characters and must follow the naming conventions of MVS data sets (hlq.hlq2.hlq3). The high level qualifier must point to the master catalog and must not be SMS managed.

Number of Cylinders

Defines the maximum number of cylinders (100 to 999) used for the dynamic allocation of a local page data set. The default value is 400. Note, that on a 3390 DASD, 100 cylinders are adequate to 70 MB and the formatting process takes approximately 20 seconds for this amount of space.

Page Data Set Volumes

Defines a list of volume IDs which are eligible when the automation is creating and allocating a new page data set. The volumes must be shared by all systems in the sysplex.

Data Set Names for Spare Page Data Sets

Defines the pre-formatted spare page data set to be used in the recovery situation. Specify the names without quotes. You may include system symbols and system automation symbols (see "Assigning System Automation Symbols (AOCCLONE)" on page 42). The data sets must be allocated on a volume shared by all systems in the sysplex and must be catalogued in the master catalog. In case the systems in the sysplex do not share the master catalog, the page data set must be re-catalogued on each system except the one which created the data set using the following IDCAMS statement:

```
DEF PAGESPACE(NAME(lpdsn) VOLUME(volume) RECATALOG)
```

More about Policy Item JOB DEFINITIONS

You can customize the automation to cancel or keep jobs that are blocking a resource.

```

COMMANDS  HELP
-----
AOFGLCLJ      Local Page Data Set Recovery Job Definition Row 1 to 8 of 20
Command ==> _____ SCROLL==> PAGE

Entry Type : Group          PolicyDB Name  : DATABASE_NAME
Entry Name  : SYSPL1        Enterprise Name : YOUR_ENTERPRISE

Define the jobs which can or cannot be cancelled (KEEP/CANCEL) in case the job
is one of those jobs responsible for the shortage condition.
A default specification with Job Name=* must exist.

Job Name/*  Handling
            (KEEP/CANCEL)

_____  _____
_____  _____
_____  _____
_____  _____
_____  _____
_____  _____

```

Figure 76. Job Definitions for Local Page Data Set Recovery

Job Name

Defines the jobs which can or cannot be cancelled in case they are one of those jobs responsible for the shortage condition.

Handling

Specify KEEP if the job cannot be cancelled. Otherwise specify CANCEL. You can also specify a wildcard character (*). You must define a default with Job Name=* and either KEEP if all jobs not explicitly defined cannot be cancelled, or CANCEL if all jobs can be cancelled.

More about Policy Item JOB/ASID DEFINITIONS

If you want to automate long running ENQs, you can specify dump options, a title for each dump being taken, and job names or address space IDs of the jobs that are kept or cancelled.

```

COMMANDS  HELP
-----
AOFGENQJ      Long Running ENQ Job/ASID Definitions Row 1 to 3 of 20
Command ==> _____ SCROLL==> PAGE

Entry Type : Group          PolicyDB Name  : DATABASE_NAME
Entry Name  : SYSPL1        Enterprise Name : YOUR_ENTERPRISE

Dump Options . . . _____
Dump Title . . . . _____
_____

Define the jobs and address space IDs which can or cannot be cancelled with or
without dump (KEEP/NODUMP/DUMP) or their dump IDs in case the job/ASID is one
of those responsible for the long running ENQ.
A default specification with Job Name/ASID=* must exist.

Job Name/  Handling
ASID/*    (KEEP/NODUMP/DUMP/dumpids)

_____  _____
_____  _____
_____  _____

```

Figure 77. JOB/ASID Definitions

Group Policy Object

Fill in the following fields:

Dump Options

Defines the DUMP option that is used for the SDATA parameter on the dump command. The following options are allowed: ALLNUC, COUPLE, CSA, GRSQ, LPA, LSQA, NOPSA, NOSQA, NOSUM, NUC, PSA, RGN, SERVERS, SQA, SUM, SWA, TRT, WLM and XESDATA. This value applies only to jobs or ASIDs defined with DUMP in the following list.

Dump Title

Defines the title of each dump taken with the default dump options.

Job Name/ASID

Defines the jobs and address space IDs that can or cannot be cancelled in case they are one of those responsible for the long running ENQ.

- Specify KEEP if the job or ASID cannot be cancelled.
- Specify NODUMP if the job or ASID can be cancelled without a dump.
- Specify DUMP if the job or ASID can be cancelled with a dump using the default dump options, otherwise specify the dump IDs if the job or ASID can be cancelled using the IEADMCxx PARMLIB members.

Specification of a trailing wildcard (*) is allowed. You must define a default with Job name/ASID=* together with the handling which will be appropriate for all jobs and ASIDs not explicitly defined.

More about Policy Item RESOURCE DEFINITIONS

You can specify which resources you want to monitor and define a value for the maximum time a job can lock a resource while other jobs are waiting for the resource. If the amount of time is exceeded, the recovery takes place.

```
COMMANDS  HELP
-----
AOFGENQR          Long Running ENQ Resource Definition      Row 1 to 7 of 20
Command ==>>>          SCROLL==>>> PAGE

Entry Type : Group          PolicyDB Name : DATABASE_NAME
Entry Name : SYSPL1        Enterprise Name : YOUR_ENTERPRISE

Define the major and minor resource names together with the elapsed execution
time (30-999 sec) after that an ENQ is treated as a long running ENQ.
If resources are excluded a default specification with Major Resource/Minor
Resources=* must exist.

Major      Minor          Time/EXCL
Resource/* Resource/*      (30-999 s)
-----
_____
_____
_____
_____
_____
_____
_____
_____
_____
_____
```

Figure 78. Long Running ENQ Resource Definitions

Major Resource Name

Defines the major resource name of the resource to be checked for long running enqueues.

Minor Resource Name

Defines the minor resource name of the resource to be checked for long running enqueues.

SubGroup Policy Object

Figure 80 is an example of the *Define New Entry* panel for subgroups.

```

COMMANDS  HELP
-----
A0FGDYN2          Define New Entry
Command ==> _____

Define new entry of type SubGroup

Name . . . . . _____

ProcOps Commands . . . . NO  (YES NO)

Short description . . . _____
Long description . . . _____
Long description . . . _____
Long description . . . _____
Long description . . . _____
Long description . . . _____

```

Figure 80. Define New Entry Panel for a Subgroup

The unique field on this panel is:

ProcOps Commands

Indicates whether processor operations commands issued against this subgroup are to be accepted for processing. The default is NO.

Note:

If a group with which this subgroup is associated is enabled for processor operations commands, then a processor operations command directed to that group will affect all systems in the group even if this subgroup is *not* enabled for processor operations commands.

Policy Items for SubGroups

Figure 81 shows the policy items that are displayed when a subgroup is selected from the *Entry Name Selection* panel.

```

ACTIONS  HELP
-----
A0FGEPOL          Policy Selection
Command ==> _____          SCROLL==> PAGE

Entry Type : SubGroup          PolicyDB Name : DATABASE_NAME
Entry Name : TARGET_SUBGROUP   Enterprise Name : YOUR_ENTERPRISE

Action   Policy Name      Policy Description
DESCRIPTION      Enter description
SUBGROUP INFO    Display Subgroup information
SYSTEMS          Select Systems for SubGroup
-----
WHERE USED      List Groups linked to this entry
COPY            Copy data from an existing entry

```

Figure 81. Policy Selection Panel for Subgroups

The unique policy items for subgroups are:

SUBGROUP INFO

When you select this policy item, information about subgroups is displayed for verification and updating.

SYSTEMS

When you select this policy item, a list of all systems in the SA z/OS enterprise is displayed, indicating those systems that are related to this subgroup. You can add systems to the subgroup, or remove systems from the subgroup.

System Policy Object

A system is any host system in the SA z/OS enterprise. The operating systems can be either MVS or non-MVS. For system operations, the system must be MVS. For processor operations functions, the system can be MVS, VM, VSE, LINUX, or CF (coupling facility). A system definition includes:

- The operating system type
- Processor operations information
- Details of which IBM automation products are operating on the system
- Member application groups
- NetView and z/OS-related information
- Automation policy for the system (optional)

The information you supply here will determine what automation policy set objects are included in your system and how your system is automated.

Creating a New System

How to create new policy objects in general, is described in “How to Create New Policy Objects” on page 14.

Figure 82 shows the panel that is displayed when you create a new system from the *Entry Name Selection* panel for systems.

If you want to monitor your newly created system as a standalone system on the NMC workstation, you need to specify an entry for this sysplex in the INGTOPOF file (see *System Automation for z/OS Planning and Installation*).

```

COMMANDS  HELP
-----
AOFGDYN2          Define New Entry
Command ==> _____ More: +

Define new entry of type System

  Name . . . . . _____

  Operating system . . . MVS_      (MVS VM VSE LINUX CF)
  MVS system name . . . _____ (MVS systems only)
  Image/ProcOps name . . . _____

Specify information for NMC Focal Point Communication (MVS systems only):
Heartbeat Interval . . . . . 5      (1 - 60 minutes)
Missing Heartbeat Delay . . . 30_   (1 - 3600 seconds)

Short description . . . _____
Long description . . . _____
Long description . . . _____
Long description . . . _____
Long description . . . _____

```

Figure 82. Define New Entry Panel for a System

The fields are:

System Policy Object

Name This required name gives a unique name to the system you are defining. Valid characters are any alphabetic or numeric character or any of @, #, \$, ?, or _ (underscore), with the first character being alphabetic, numeric, or @, #, or \$. The entry name must be unique among the names of all groups, subgroups, systems, or processors, defined in the current policy database. It must also be unique among processor operations names, with the exception that this system's processor operations name may match this system's entry name.

Operating system

A required identifier of the operating system to be run on the system. The allowed values are MVS, VM, VSE, LINUX, or CF. The supported default is MVS.

CF indicates the coupling facility control code. LINUX identifies the Linux for zSeries operating system.

MVS SYSNAME

Required for MVS systems, this value *must match* the system name (SYSID) as specified in the IEASYSxx member of SYS1.PARMLIB. Valid characters are any alphabetic or numeric character or any of @, #, or \$.

Note:

The first three characters of MVS SYSNAME must not be A0F because these are reserved for internal SA z/OS processing.

To support an alternate configuration of a system, special notation with a trailing 'plus-sign' is allowed. This trailing character will be removed when the automation files are built. If you are going to enable automation for IXC102A/IXC402D the MVS SYSNAME must not start with a numeric character. For more information see *System Automation for z/OS Customizing and Programming*.

Image/ProcOps name

Specifies the name of the system for hardware related functions, for example, processor operations functions.

Like the system's Entry name, this name must be unique among the names of all groups, subgroups, systems, processors and image names defined in the current policy database. For MVS systems the name is defaulted to the MVS SYSNAME but can be changed.

Valid characters are any alphabetic or numeric character or any of @, # or \$. The name may start with a numeric character except for systems of type CF.

Heartbeat Interval

This specifies the time interval at which the SA z/OS system operations functions sends a generic alert from this system to the NMC focal point system. The SA z/OS system operations functions on the NMC focal point system use heartbeat alerts to verify the status forwarding path from each sysplex or single remote system. For more information see "The SA z/OS Heartbeat Function" on page 107. The heartbeat interval is a required field in the range 1 to 60 minutes that defaults to 5 minutes. Heartbeat information is relevant for z/OS systems only.

The smaller the heartbeat interval, the faster SA z/OS can detect a status forwarding path failure. For example, if you define an interval of two

minutes then, on average, SA z/OS will take one minute, plus the missing heartbeat delay time, to detect a failure in the status forwarding path.

Missing Heartbeat Delay

This specifies the time that the SA z/OS system operations functions on the NMC focal point system will wait after a heartbeat was expected. If this time expires without receiving the heartbeat, the system operations functions will begin missing heartbeat processing for the remote system. The field is provided as a way to buffer against temporary network delays. For more information see “The SA z/OS Heartbeat Function.” The missing heartbeat delay is a required field in the range 1 to 3600 seconds that defaults to 30 seconds. Heartbeat information is relevant for z/OS systems only.

The smaller the missing heartbeat delay, the more sensitive SA z/OS is to temporary status forwarding path delays. The longer the delay, the slower SA z/OS will be to react to a missing heartbeat. Again, you will have to balance these two considerations.

Consideration must be given to the number of systems and subsystems being monitored in your enterprise. The larger the enterprise being monitored, the larger the delay should be. This is to ensure that at resync time with high status forwarding to the focal point, any delays due to this do not cause unnecessary missing heartbeat processing.

The SA z/OS Heartbeat Function

The heartbeat function validates the path between remote systems and the focal point system. This path is known as the status forwarding path.

SA z/OS validates the status forwarding path by sending an alert, called the heartbeat alert, from each single remote system or from a designated system in the sysplex at a regular interval.

If the heartbeat is missing from the designated sysplex system, the SA z/OS topology manager tries to connect to another system in the sysplex. Only if all systems are not responding, SA z/OS invokes the missing heartbeat processing.

SA z/OS on the NMC focal point system expects heartbeats from each remote system at the interval defined for each system, but it expects a heartbeat only from one system in the sysplex. This interval is known as the heartbeat interval. Receiving a heartbeat on the NMC focal point system indicates that the status forwarding path from the remote system is up, and hence status for resources associated with that system can be considered to be current.

If SA z/OS on the NMC focal point system does not detect an expected heartbeat, it waits to allow for temporary network slowdowns, or any other temporary problems in the status forwarding path that may have delayed the heartbeat. The wait period is known as the missing heartbeat delay. When the missing heartbeat delay time expires, (or for a sysplex, when the missing heartbeat delay time expires for all systems in the sysplex) SA z/OS invokes its missing heartbeat processing for the remote system or the sysplex and changes the status of all associated resources to Unknown because SA z/OS is no longer able to receive status updates for those resources.

When setting the missing heartbeat delay period, consideration must be given to the number of sysplexes or single systems, and subsystems being monitored in your enterprise. The larger the enterprise being monitored, the larger the delay should be.

System Policy Object

When SA z/OS detects that heartbeats from a remote system have resumed, it resynchronizes the NMC workstation status displayed for resources associated with the system by requesting that the remote system should resend all status information.

You can define both the heartbeat interval and the missing heartbeat delay for each MVS system in your enterprise.

Policy Items for Systems

Figure 83 on page 109 shows the z/OS policy items that are displayed when an MVS system is selected from the *Entry Name Selection* panel.

Notes:

- Not all policies are displayed on one screen. Scroll down to see the second part of this panel.
- Several of the policy items available from this panel allow you to select and manage the links between the system and a variety of entry types. The panels associated with these policy items are all very similar and straightforward to use and are not covered in this section.

```

ACTIONS  HELP
-----
AOFGEPOL          Policy Selection          Row 1 to 36 of 36
Command ==>      SCROLL==> PAGE

Entry Type : System          PolicyDB Name : DATABASE_NAME
Entry Name  : SAMPLE_SYSTEM_01 Enterprise Name : YOUR_ENTERPRISE

Action  Policy Name      Policy Description
-----  -
DESCRIPTION      Enter description
SYSTEM INFO      Enter and display system information
AUTOMATION SYMBOLS Define system automation symbols (AOCCLOEx)
NETVIEW          Enter NetView-related information
AUTOMATION CONSOLE Enter MVS route codes for notifications
AUTOMATION SETUP  Define system environment for automation
APPLICATION GROUPS Select applicationgroups for system
MONITOR RESOURCES Select monitor resources for system
AUTOMATION TIMERS Select timers for system
NNT SESSIONS     Select NNT sessions for system
USER E-T PAIRS   Select user entry-type pairs for system
AUTOMATION TIMEOUT Select timeout settings for system
RESIDENT CLISTS  Select resident clists for system
TAPE ATTENDANCE  Select tape attendance for system
APPLICATION DEFAULTS Select application defaults for system
SYSTEM DEFAULTS  Select system defaults for system
MVSCOMP DEFAULTS Select MVS Component Defaults for system
MVS COMPONENT    Select MVS Components for system
NETWORK          Select network for system
AUTO OPERATORS   Select automation operators for system
SCREENS          Select screen status definitions
NOTIFY OPERATORS Select notify operators
DB2 SYSTEM DEFAULTS Select DB2 system defaults for system
IMS XRF RESOURCES Select IMS XRF resource names for system
IMS XRF STATUS FILES Select IMS XRF Status files for system
OPC SYSTEM DETAILS Select OPC system details for system
CONTROLLER DETAILS Select OPC controller details for system
WORKSTATION DOMAINS Select OPC Workstation domains for system
INCLUDES         Select include members for System
-----
PROCESSOR        Select processor or partition
TARGET SYSTEM INFO Basics, time zones, and interested operators
IPL INFO         Define IPL information
-----
WHERE USED       List groups/subgroups linked to this entry
COPY            Copy data from existing entry
***** Bottom of data *****

```

Figure 83. Policy Selection Panel for Systems

The policy items for systems are:

SYSTEM INFO

This displays and allows you to update the operating system type for this system definition.

You can also use this option to change the heartbeat interval and the missing heartbeat delay times. Refer to “System Policy Object” on page 105 for more information.

AUTOMATION SYMBOLS

You can enter or update system automation symbols that can be set to various system-specific values. These can then be substituted into several values, like MVS automatic restart management element names, MVS workload manager resource names, job names, user specified commands and others. Refer to “More about Policy Item AUTOMATION SYMBOLS” on page 114 for more information.

NETVIEW

This policy item lets you enter the following details required for interacting

System Policy Object

with NetView. This information is required only if you are using enterprise monitoring. For more information on this policy item see “More about Policy Item NETVIEW” on page 115.

AUTOMATION CONSOLE

The automation console definitions are used when SA z/OS notification messages are to be sent as write-to-operator (WTO) messages to the MVS consoles. This policy item defines the route codes and MCSFLAGS necessary for this process. WTO messages are sent to the Automation Console when none of the notification operators defined in the *Notify Operators* policy item are logged on or when SYSOP is defined as a notification operator.

For more information on this policy item refer to “More about Policy Item AUTOMATION CONSOLE” on page 116.

AUTOMATION SETUP

This policy item is used to enter details of your operating environment. For more information refer to “More about Policy Item AUTOMATION SETUP” on page 117.

APPLICATION GROUPS

When you select this policy item, a list of all System Application Groups is displayed, indicating which are related to this system. You can add application groups to the system or remove application groups from the system.

MONITOR RESOURCES

This policy option allows you to manage the links from the current System entry to the Monitor Resource entries. Refer to “Monitor Resource Policy Object” on page 237 for more information.

AUTOMATION TIMERS

This policy item displays a list of defined Automation Timer sets and allows you to choose which sets are to be associated with this system object. See “Timers Policy Object” on page 256 for more information.

NNT SESSIONS

This policy item displays a list of defined NNT Session sets and allows you to choose which sets are to be associated with this system object. See “NNT Sessions Policy Object” on page 286 for more information.

Note:

The *NNT Sessions* entry type is provided for downlevel SA OS/390 systems only and will no longer be supported.

USER E-T PAIRS

This policy item displays a list of defined User E-T Pairs sets and allows you to choose which sets are to be associated with this system object. See “User E-T Pairs Policy Object” on page 292 for more information.

AUTOMATION TIMEOUT

This policy item displays a list of defined Automation Timeout sets and allows you to choose which sets are to be associated with this system object. See “Timeout Settings Policy Object” on page 258 for more information.

RESIDENT CLISTS

This policy item displays a list of defined Resident CLIST sets and allows

you to choose which sets are to be associated with this system object. See “Resident CLISTs Policy Object” on page 288 for more information.

TAPE ATTENDANCE

This policy item displays a list of defined Tape Attendance sets and allows you to choose which sets are to be associated with this system object. See “Tape Attendance Policy Object” on page 260 for more information.

APPLICATION DEFAULTS

This policy item displays a list of defined Application Defaults sets and allows you to choose a set to be associated with this system object. If an application belongs to an application class, the class inheritance takes precedence. See “Application Defaults Policy Object” on page 272 for more information.

SYSTEM DEFAULTS

This policy item displays a list of defined system defaults sets and allows you to choose a set to be associated with this system object. If an application belongs to an application class, the class inheritance takes precedence. See “System Defaults Policy Object” on page 270 for more information.

MVSCOMP DEFAULTS

This policy item displays a list of defined MVSCOMP Defaults sets and allows you to choose a set to be associated with this system object. See “MVSCOMP Defaults Policy Object” on page 269 for more information.

MVS COMPONENT

This policy item displays a list of defined MVS Component sets and allows you to choose which sets are to be associated with this system object. See “MVS Component Policy Object” on page 262 for more information.

NETWORK

This policy item displays a list of defined Network sets and allows you to choose which sets are to be associated with this system object. See “Network Policy Object” on page 282 for more information.

AUTO OPERATORS

This policy item displays a list of defined Auto Operator sets and allows you to choose which sets are to be associated with this system object. See “Auto Operators Policy Object” on page 273 for more information.

SCREENS

This policy item displays a list of defined SDF Status Definition sets and allows you to choose which sets are to be associated with this system object. See “Status Details Policy Object” on page 289 for more information.

NOTIFY OPERATORS

This policy item displays a list of defined notification operator sets who receive SA z/OS notification messages.

See “Notify Operators Policy Object” on page 279 for more information.

DB2 SYSTEM DEFAULTS

If you select this policy item, SA z/OS will display a list of DB2 system defaults which previously have been defined as described in “DB2 System Defaults” on page 242. From this list you can link one DB2 system default entry to the current system. Or you can also remove such a link and link a different entry to the system. Only one such entry should be linked to a system, otherwise multiple entries will be built with SA z/OS only loading the last one processed.

System Policy Object

IMS XRF RESOURCES

If you select this policy item, SA z/OS will display a list of Extended Recovery Facility (XRF) resources which previously have been defined as described in “IMS XRF Resources” on page 250. From this list you can link one or more XRF resources to the current system. Or you can also remove such links and link different resources to the system.

IMS XRF STATUS FILES

If you select this policy item, SA z/OS will display a list of Extended Recovery Facility (XRF) status files which previously have been defined as described in “IMS XRF Status Files” on page 249. From this list you can link one or more XRF status files to the current system. Or you can also remove such links and link different status files to the system.

OPC SYSTEM DETAILS

If you select this policy item, SA z/OS will display a list of OPC system details which have been previously defined as described in “OPC System Details” on page 252. From this list you can link one such OPC system detail entry to the current system. Or you can also remove such a link and link a different entry to the system. Only one such entry should be linked to a system, otherwise multiple entries will be built with SA z/OS only loading the last one processed.

CONTROLLER DETAILS

If you select this policy item, SA z/OS will display a list of OPC controller details which have been previously defined as described in “Controller Details” on page 253. From this list you can link one such OPC controller detail entry to the current system. Or you can also remove such a link and link a different entry to the system. Only one such entry should be linked to a system, otherwise multiple entries will be built with SA z/OS only loading the last one processed.

WORKSTATION DOMAINS

If you select this policy item, SA z/OS will display a list of workstation domain IDs which have been previously defined as described in “Workstation Domains” on page 256. From this list you can link one such workstation domain to the current system. Or you can also remove such a link and link a different entry to the system. Only one such entry should be linked to a system, otherwise multiple entries will be built with SA z/OS only loading the last one processed.

INCLUDES

If you select this policy item, SA z/OS will display the *Includes for System* panel. This panel displays the entries that are defined via the *Includes* entry type. So with this policy item, you can manage the links between the current *System* entry and the *Includes* entries.

From the *Includes for System* panel you can:

- Add a link between the entries.
- Remove a link between the entries.

Note:

The *Includes* entry type is provided for downlevel SA z/OS systems only and will no longer be supported.

PROCESSOR

Selection of this policy item displays a panel that lists all processors and

partitions defined in the enterprise. You can select one processor or partition on which the system should run.

TARGET SYSTEM INFO

This policy item displays basic information about the target system, for example, time zones, operators receiving messages from the system and operator consoles.

IPL INFO

With this policy item you can define IPL information for the MVS or VM target system.

More about Policy Item SYSTEM INFO

The panel shown in Figure 84 is displayed when you select policy item SYSTEM INFO on the *Policy Selection* panel for Systems (Figure 83 on page 109).

```

COMMANDS  HELP
-----
A0FGSPD0          System Information
Command ==> _____

Entry Type : System          PolicyDB Name : DATABASE_NAME
Entry Name : SYSTEM_01      Enterprise Name : YOUR_ENTERPRISE

  Operating system . . . . . MVS          (MVS VM VSE LINUX CF)
  MVS SYSNAME. . . . . FOC1          (MVS systems only)
  Image/ProcOps name . . . . FOC1

Specify information for NMC Focal Point Communication (MVS systems only):
  Heartbeat Interval . . . . 5          (1 - 60 minutes)
  Missing Heartbeat Delay. . 30        (1 - 3600 seconds)

```

Figure 84. SYSTEM INFO Panel

The following information can be entered:

Operating system

Identifies the operating system that runs on the system. Valid values are MVS, VM, VSE, LINUX and CF. CF indicates the coupling facility control code for the coupling facility in a Parallel Sysplex. LINUX indicates the Linux for zSeries operating system distributed for 390-CMOS and zSeries processors. This field is required and its default value is MVS.

MVS SYSNAME

This is required for MVS systems. This value *must match* the system name (SYSID) as specified in the IEASYSxx member of SYS1.PARMLIB. Valid characters are any alphabetic or numeric character or any of @, # or \$. Note that the first three characters of the MVS SYSNAME must not be "AOF", as these are reserved for internal SA z/OS processing. To define a system for an alternate configuration, it must be marked with a trailing "+" in its MVS SYSNAME. This trailing character will be removed when the automation files are built.

If you are going to enable automation for IXC102A/IXC402D the MVS SYSNAME must not start with a numeric character. For more information see *System Automation for z/OS Customizing and Programming*.

Image/ProcOps name

Specifies the name of the system for hardware related functions, for example, processor operations functions. As the entry name for the system, this name must be unique among the names of all groups, subgroups,

System Policy Object

systems, processors, and image names defined in the current policy database. For MVS systems, the name is defaulted to the MVS SYSNAME but it can be changed. Valid characters are any alphabetic or numeric character, or any of @, # or \$.

Heartbeat Interval

Specifies the time interval at which the SA z/OS system operations functions will send a generic alert from this system to the NMC Focal Point. The SA z/OS system operations functions on the NMC Focal Point use heartbeat alerts to verify the status forwarding path from each remote system. The heartbeat interval is a required field in the range of 1 to 60 minutes. The default is 5 minutes. Heartbeat information is only needed for MVS systems.

Missing Heartbeat Delay

Specifies the time that the SA z/OS system operations functions on the NMC Focal Point will wait after a heartbeat was expected. If this time expires without receiving the heartbeat, system operations will begin missing heartbeat processing for the remote system. The field is provided as a way to buffer against temporary network delays. The missing heartbeat delay is a required field in the range of 1 to 3600 seconds. 30 seconds is the default. Heartbeat information is only needed for MVS systems.

More about Policy Item AUTOMATION SYMBOLS

The panel shown in Figure 85 is displayed when you select policy item AUTOMATION SYMBOLS from the *Policy Selection* panel for Systems (Figure 83 on page 109).

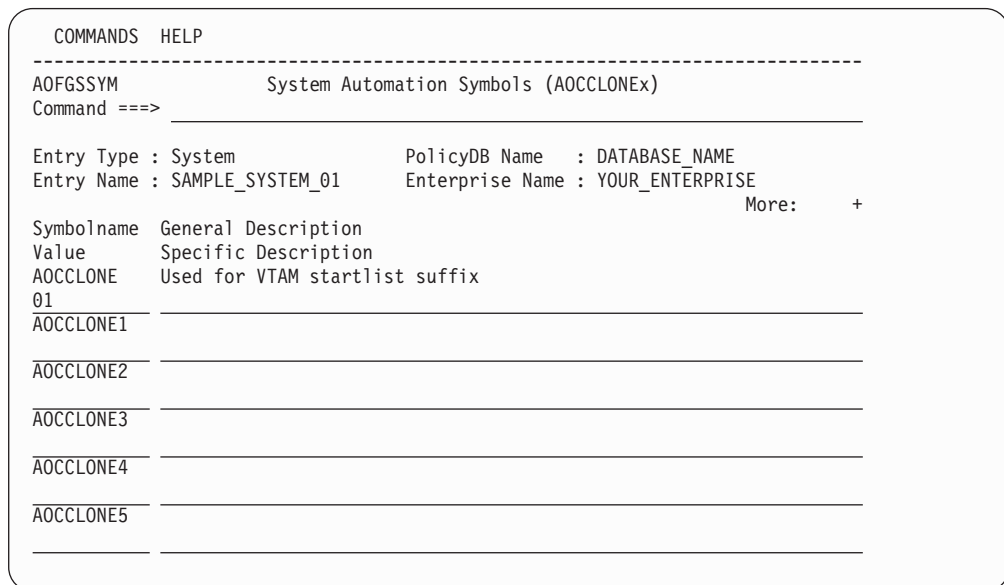

COMMANDS HELP

A0FGSSYM System Automation Symbols (AOCCLONEx)
Command ==> _____

Entry Type : System PolicyDB Name : DATABASE_NAME
Entry Name : SAMPLE_SYSTEM_01 Enterprise Name : YOUR_ENTERPRISE
More: +

Symbolname	General Description
Value	Specific Description
AOCCLONE	Used for VTAM startlist suffix
01	
AOCCLONE1	_____
AOCCLONE2	_____
AOCCLONE3	_____
AOCCLONE4	_____
AOCCLONE5	_____

Figure 85. Automation Symbols Panel

This panel allows you to enter or update system automation symbols that can be set to various system-specific values. These can then be substituted into several values, such as MVS automatic restart management element names, MVS workload manager resource names, job names, user specified commands and others.

To specify that AOCCLONE value *x* is to be substituted, enter &AOCCLONEx. at the appropriate point in the field. You must specify both the leading ampersand (&) and the trailing period (.).

You may, additionally, specify the tilde (~) to get the 0th (unnumbered) AOCCLONE value substituted. For more details refer to “Using System Symbols and System Automation Symbols” on page 43.

This panel has the following fields:

General Description

This shows the general description of the system automation symbol for all systems in the policy database. It can be defined in the entry type ENT using the policy item SYMBOL DESCRIPTION, see “More about Policy Item SYMBOL DESCRIPTION” on page 88.

Value This allows you to specify the value of the system automation symbol (&AOCCLONEx variable)

Specific Description

This allows you to specify a specific description of the automation symbol for this system only.

More about Policy Item NETVIEW

The panel shown in Figure 86 is displayed when you select policy item NETVIEW from the *Policy Selection* panel for Systems (Figure 83 on page 109).

```

COMMANDS  HELP
-----
A0FGSPG0          NetView Information
Command ==>>>

Entry Type : System          PolicyDB Name  : DATABASE_NAME
Entry Name  : SYSTEM_01      Enterprise Name : YOUR_ENTERPRISE

Specify NetView-related information about this system.

SA NetView Domain . . . . . _____ Name of the NetView domain
                                         under which SA z/OS functions run
SA NetView Network. . . . . _____ Network name for SA z/OS
                                         NetView domain
Network NetView Domain. . . _____ Name of the NetView domain
                                         under which network automation runs

```

Figure 86. NetView Information Panel

The following information can be entered:

SA NetView Domain

This field is optional. It allows you to enter the NetView domain name of the NetView under which the SA z/OS functions run on this system. This information is applicable only if you are using a dual NetView setup. The SA z/OS NetView name can be up to five characters long.

SA NetView Network Name

This name is required only if you are using enterprise monitoring. It specifies the network on which the system operations NetView domain resides. It can be up to eight characters long.

Network NetView Domain

This field is optional. It identifies the NetView domain that runs network

automation. It can be up to five characters long. When the automation control file is loaded, this value is assigned to the common global variable AOF_NETWORK_DOMAIN_ID.

More about Policy Item AUTOMATION CONSOLE

The panel shown in Figure 87 is displayed when you select policy item AUTOMATION CONSOLE from the *Policy Selection* panel for Systems (Figure 83 on page 109).

```
COMMANDS  HELP
-----
AOFPIEC0      Environment Definition: CONSOLE (Route Codes)
Command ==> _____

Entry Type : System          PolicyDB Name  : DATABASE_NAME
Entry Name  : SAMPLE_SYSTEM_01 Enterprise Name : YOUR_ENTERPRISE

Enter information and select S the route codes for SA z/OS notifications.
Console ID ==> 01  or Console Name ==> _____

A Code      Definition
*  1  Master console action
-  2  Master console information
-  3  Tape pool
-  4  Direct access pool
-  5  Tape library
-  6  Disk library
-  7  Unit record pool
-  8  Teleprocessing control
-  9  System security
-  9  System security
- 10  System error, maintenance
- 11  Programmer information
- 12  Emulators
- 13
- 14
- 15
- 16  User

Press ENTER to define MCSFLAGS
```

Figure 87. Environment Definition: CONSOLE (Route Codes) Panel

In order to define an automation console, you need to specify:

Console ID

This parameter defines the logical console ID of the MVS console that is to receive the WTO messages. The logical console ID can be found by entering an MVS Display Console command from the console that is to receive the messages. The default is 01.

Console Name

This parameter defines the 1-8 alphanumeric console name specified in the CONSOLEnn member of the z/OS PARMLIB. The system console name *MASTER* or *ANY* can also be used. Otherwise the first character must be alphabetic. If a console name is specified, the *Console ID* field must remain blank.

Route Codes

The appropriate z/OS route codes can be selected from this panel. These route codes define which kind of messages the automation console is to receive. Each notification message has already been defined as one of these kinds of WTOs. The console can also be defined to receive all of the

notification messages regardless of how they have been defined. The last four codes on the panel are reserved for user-defined codes.

The default routing code is 1 (only messages that appear as Master Console Action WTOs are displayed on the console). Further information on the route codes can be found in *z/OS MVS Routing and Descriptor Codes*.

MCSFLAGS

The appropriate MVS MCSFLAG codes can be selected from the *Environment Definition: CONSOLE (MCSFLAGS)* panel which you reach by pressing ENTER in the *Environment Definition: CONSOLE (Route Codes)* panel. In this panel, you simply place an S in the A column beside the desired selection. The MCSFLAG codes are used to provide additional information for the WTO messages (for example, if flag 6 is set, the time is not included with the WTO).

If flag 1 is set, the messages are queued to the console defined in Console ID (ignoring the route codes).

Further information on the MCSFLAG codes can be found in *Tivoli NetView for z/OS Customization: Using REXX and the NetView Command List Language*

More about Policy Item AUTOMATION SETUP

The panel shown in Figure 88 is displayed when you select policy item AUTOMATION SETUP from the *Policy Selection* panel for Systems (Figure 83 on page 109).

```

COMMANDS  HELP
-----
AOFPIES0          Environment Setup
Command ==> _____

Entry Type : System          PolicyDB Name : DATABASE_NAME
Entry Name : SAMPLE_SYSTEM_01 Enterprise Name : YOUR_ENTERPRISE

Primary JES. . . . . JES2      Primary JES2/JES3 subsystem name
System Monitor Time. . . 00:30 Time between SYSTEM monitoring
                             cycles (hh:mm or NONE)
Gateway Monitor Time . . NONE   Time between GATEWAY monitoring
                             cycles (hh:mm or NONE)
Monitor Option . . . . . INGPJMON Default routine used to monitor
                             application status
Automation Table . . . . . INGMMSG01
-----
MVS SYSNAME       : FOC1      NetView automation table members
SDF Root Name. . . . . FOC1    The MVS SYSID in SYS1.PARMLIB
Exit name(s) . . . . .         Root of this system's SDF tree
                             Environment setup user exit names
UNIX install path. . . . .
-----
                             System Automation UNIX installation path

```

Figure 88. Environment Setup Panel

You can enter the following data:

Primary JES

The name of the primary Job Entry Subsystem as specified for a JES2 or JES3 subsystem. The named subsystem is the default scheduling subsystem.

System Policy Object

System Monitor Time

The time between system monitoring cycles. The default is every 59 minutes. Monitoring may be suspended by specifying NONE.

Gateway Monitor Time

The time between gateway monitoring cycles. The default is 15 minutes. Monitoring may be suspended by specifying NONE.

Monitor Option

The name of the default routine used to monitor application status. Such routines are referred to as *application monitor routines*. The default application monitor routine if Monitor Option is left blank is INGPJMON. If an application belongs to an application class, inheritance from class overrides the default. Or, if an application has specified an individual monitor routine (see “More about Policy Item AUTOMATION INFO” on page 157), then this routine overrides what you specify here. The following application monitor routines are valid:

AOFADMON

This routine determines the status of an application by issuing the MVS D A, *jobname* command. The job name used is the job name defined in the customization dialog for the application.

Possible values for the application monitor status as determined by this routine are Active, Starting, Inactive.

You should avoid using this routine.

AOFAPMON

This routine determines the status of a program-to-program interface (PPI) receiver. It calls DISPPI and checks if a specific PPI receiver is active.

AOFATMON

This routine is used to determine the status of a task operating within the NetView environment. The task status is determined by issuing the NetView LIST *taskname* command. Note that if this routine monitor is to be used for an application, when the application is defined using the customization dialog, the application’s job name must be defined to be the NetView task name.

Possible values for the application monitor status as determined by this routine are Active, Starting, Inactive.

Note:

If the NetView LIST *taskname* command indicates that the task is not known, this condition maps to Inactive status.

AOFCPSM

This routine is a dedicated routine used to monitor the status of the SA z/OS processor operations applications using the ISQCHK service.

Possible values for the application monitor status as determined by this routine are Active, Inactive.

AOFUXMON

This routine determines the status of a resource with application type USS. This resource can either be an z/OS UNIX process, a file

in the UNIX filesystem (HFS), or a TCP port. Depending on the nature of the resource (process, file, or port) AOFUXMON decides which internal monitoring method to use.

INGPJMON

This routine determines the status of an application by running a routine that searches the MVS address space control blocks (ASCBs) for address spaces with a particular job name. The job name used is the job name defined in the customization dialog for the application.

Possible values for the application monitor status as determined by this routine are Active, Starting, Inactive.

INGMTSYS

With this routine, IMAGE applications for BCPII usage can be monitored.

ISQMTSYS

With this routine, a processor operations target system resource represented by its proxy can be monitored. You can find examples of how to use a proxy definition in *System Automation for z/OS Customizing and Programming*. Active operator console connections are mandatory and will be used for sending a z/OS command (for example, d t) and receiving the related response.

NONE

No application monitor routine is to be used (unless overridden in the *Application Automation Definition* panel)

user-name

A user-defined and created application monitor routine

Automation Table

You may specify multiple automation tables that are loaded and used for message automation. The automation tables are activated in the sequence as specified. The sequence of the automation tables is not changed during a configuration refresh (INGAMS REFRESH).

The first automation table of the list defined here replaces the SA z/OS initial automation table INGMMSG00 that was loaded during initialization. The default is INGMMSG01.

MVS Sysname

The name used by SA z/OS for the system name for purposes of automation.

The MVS SYSNAME for each system under SA z/OS control:

- Must be the same as the system name defined in the IEASYSxx member of the SYS1.PARMLIB data set used to IPL the system.
- May have numeric or national characters in any position.

MVS SYSNAME is also used by SA z/OS to map to the master include file built for the system. When SA z/OS is initialized, it looks for the automation control file that maps to the SYSNAME of the system it is running on. See *System Automation for z/OS Planning and Installation* for more information on how SA z/OS determines the default automation control file.

System Policy Object

SDF Root Name

The name used by SDF for the system name. The system name entered in the *MVS Sysname* field is the default.

Exit name(s)

An installation exit or exits invoked to perform additional environment setup. This item is optional. Refer to *System Automation for z/OS Customizing and Programming* for more information.

UNIX install path

Defines the path where SA z/OS can find its UNIX System Services programs.

More about Policy Item PROCESSOR

The panel shown in Figure 89 is displayed when you select policy item PROCESSOR on the *Policy Selection* panel for Systems (Figure 83 on page 109).

```
COMMANDS  ACTIONS  HELP
-----
A0FGXWLU      Select Target Hardware for System      Row 1 to 10 of 10
Command ==>>                                SCROLL==>> PAGE

Entry Type : System          PolicyDB Name : DATABASE_NAME
Entry Name : SAMPLE_SYSTEM_01 Enterprise Name : YOUR_ENTERPRISE

Action      Status      Processor  CPC Name      LPAR Name
-----
           _____ PRLPR01    PSN7411_     LP01
           _____ PRLPR01    PSN7412_     LP02
           _____ PRLPR01    PSN7413_     LP03
           _____ PRLPR01    PSN7414_     LP04
           _____ RALESA     PSN00000
           _____ RAL007     XF9672C1     R071
           _____ RAL007     XF9672C2     R072
           _____ TST001     LPT1
           _____ TST001     PTST9        LPT2
           _____ TST001     LPT3
***** Bottom of data *****
```

Figure 89. Select Target Hardware for System Panel

This panel allows you to link a system to the target hardware; it displays a list of:

- All processors together with their LPARs.
- All processors in basic mode.

The panel has the following unique fields:

Processor

Shows the processor entry name.

CPC Name

Shows the CPC Name/NAU as specified on the Processor Information panel. This field may be blank, if data for the Processor Information policy has not yet been specified.

LPAR Name

Shows the name of the logical partition as specified on the LPAR Definitions panel. For basic processors, this field is empty.

More about Policy Item TARGET SYSTEM INFO

The panel shown in Figure 90 is displayed when you select policy item TARGET SYSTEM INFO on the *Policy Selection* panel for Systems (Figure 83 on page 109).

```

COMMANDS  HELP
-----
A0FGPOTS          Target System Basic Characteristics
Command ==> _____

Entry Type : System          PolicyDB Name  : DATABASE_NAME
Entry Name  : SAMPLE_SYSTEM_01 Enterprise Name : YOUR_ENTERPRISE

Enter basic information:
  Initialized target system . . YES          (YES, NO)
  Load Profile Name . . . . . _____ (Activate Load Profile)

Enter target system time zones:
  Target time same as host . . YES          (YES or blank)
  Target time earlier . . . . . _____ (1 to 23, or blank)
  Target time later . . . . . _____ (1 to 23, or blank)

Enter operators who are to receive messages from console:
  System Console . . . . . SYSOP1 SYSOP2 SYSOP3 _____
  Operator Console . . . . . SYSOP4 _____

```

Figure 90. Target System Information Panel

Initialized Target System

Enter YES to indicate that the target system is automatically initialized when SA z/OS processor operations starts. Otherwise, enter NO.

Note:

If you choose to initialize the target system automatically, be aware that when you start SA z/OS, the ISQSTART command may be completed before the target system is initialized.

Load Profile Name

Enter the load profile name defined at the support element. The name you choose must correspond with the load profile defined at the support element. Leave this field blank to take the default defined at the support element.

Note:

This profile name can contain only the characters A to Z and 0 to 9.

Target time same as host

If the target system is in the same time zone as the focal-point system, type YES or Y. If not, leave this field blank. For systems that run as guest systems under VM this field must be set to YES.

Target time earlier

Enter the number of hours that the target system is earlier than the focal point system. (A target system in Los Angeles is three hours earlier than a focal-point system in New York.)

System Policy Object

| **Target time later**
| Enter the number of hours that the target system is later than the focal
| point system. (A target system in New York is three hours later than a
| focal point system in Los Angeles.)

Enter operators to receive messages from console

Enter the user IDs of the operators you want to receive system console and operator console messages. You can enter any valid NetView user ID.

System Console

Enter the user IDs of the operators you want to receive system console messages. The operators listed receive messages only from the system console. You can enter any valid NetView user ID. This field is optional.

Operator Console

Enter the user IDs of the operators you want to receive operator console messages. You can enter any valid NetView user ID. This field is optional.

Notes:

1. For OCF-based systems using only console integration, the operating system messages are forwarded to the system console interested operator list.
2. Operators not on these lists do not see messages from these consoles unless their user IDs are added using the ISQXMON command when SA z/OS is running.

More about Policy Item IPL INFO

The panels you can use to define your target system IPL information depends on the operating system you are running.

MVS Target System IPL Information

The panel shown in Figure 91 on page 123 is displayed when you select policy item IPL INFO on the *Policy Selection* panel for Systems (Figure 83 on page 109) for MVS.

```

COMMANDS  HELP
-----
AOFGP0MI          MVS Target System IPL Information
Command ==>>>

Entry Type : System           PolicyDB Name : DATABASE_NAME
Entry Name  : AOC4            Enterprise Name : YOUR_ENTERPRISE

Enter responses to the following messages for the target system.

IEA101A specify system parameters
-----
IEA347A specify master catalog parameter
-----
IEA213A or IEA214A DUPLICATE VOLUME
-----
-----
-----
-----
-----
-----
-----
-----
-----
-----

```

Figure 91. MVS Target System IPL Information Panel

Use this panel to define responses used during the MVS or z/OS target IPL process.

During the start process, the target system requests information from the operator. By providing the responses at this panel, the operator enables SA z/OS to respond to these messages. Target systems using VSE, LINUX, or CF do not request information from the operator during startup.

IEA101A specify system parameters

Enter the desired response to the IEA101A message. All IEA101A message responses begin with the characters R 0. You do not have to begin your response with these characters, they are provided by SA z/OS automation. Quotation marks are not necessary. The customization dialog does not verify your entry.

IEA347A SPECIFY MASTER CATALOG PARAMETER

ENTER THE DESIRED RESPONSE TO THE IEA347A MESSAGE. THE customization dialog DOES NOT VERIFY YOUR ENTRY.

IEA212A or IEA213A/IEA214A duplicate volume

Specify the device addresses to be kept online if duplicate DASD volumes exist on a z/OS system at IPL time. You have 24 entries to specify real or generic DASD device addresses. Example for a generic device address: 012*. This indicates that all addresses from 0120 to 012F must remain online.

This entry works in conjunction with the automatic response selection.

Provide default response when neither device is specified. Specify YES or NO to indicate if a default response is required if neither or both of the devices in the IEA213A/IEA214A message match those identified as required devices. For IEA214A messages, the current IPL (SYSRES) device is considered as being implicitly defined. If YES is selected, an automated response will always be provided. For a SYSRES device, the device shown in the message is demounted. Otherwise the following applies:

- If neither device is in the reply list, the first device is demounted.
- If only one device is in the reply list, the remaining device is demounted.

System Policy Object

- If both devices are in the reply list, the first device in the list as scanned from left to right remains mounted and the other device is demounted.
- If both devices are in the reply list due to the same generic device mask in the list as scanned from left to right, the second device is demounted.

A selection of NO will result in a response allowing the IPL to continue only if one and only one device is identified as being required. Otherwise, message ISQ1203 will be issued and the IPL process will be suspended. In such a case, the operator needs to react to system message ISQ1203.

A selection of NO and a generic device address of **** will always stop the IPL process if a duplicate volume is detected.

Notes:

1. For valid responses, see *z/OS MVS System Messages, Vol 3 (ASB-BPX)*.
2. Responses to IEA101A, IEA347A, IEA212A, and IEA213A can be changed without generating and loading a new SA z/OS processor control file by the use of the host ISQXOPT command before IPLing the target system. However, these changes are not saved if SA z/OS processor is stopped or restarted.
3. You receive either message IEA212A or IEA213A depending on the level of your MVS system.
4. All message responses begin with the characters R 0. You do not have to begin your response with these characters; SA z/OS automation provides them. Quotation marks are also not necessary.

VM Target System IPL Information

To define the response to the VM IPL START message, use the panel shown in Figure 92. During the start process, the target system requests information from the operator. By providing the responses at this panel, the operator enables SA z/OS to respond to these messages.

```
COMMANDS  HELP
-----
A0FGPOVI          VM Target System IPL Information
Command ==>>> _____

Entry Type : System          PolicyDB Name  : DATABASE_NAME
Entry Name  : VM1            Enterprise Name : YOUR_ENTERPRISE

Enter message for the target system.

VM IPL START message response
```

Figure 92. VM Target System IPL Information Panel

VM IPL START message response

Enter the desired response to the VM IPL START message. The customization dialog does not verify your entry.

Note:

The VM IPL START message response field can be changed without generating and loading a new processor operations control file. You can do this by issuing the host ISQXOPT command before you IPL the target system. However, these changes are not saved if processor operations or SA z/OS is stopped or restarted.

ApplicationGroup Policy Object

An application group is a set of applications to which you assign a name. There are two types of ApplicationGroups:

1. *System Application Groups* - application groups that are associated with particular systems.
2. *Sysplex Application Groups* - application groups that are associated with sysplexes.

A *Sysplex Application Group* is a special type of application group that is associated with one sysplex. Sysplex Application Groups are used to monitor and automate applications and application groups that can run on multiple systems in a sysplex. Using Sysplex Application Groups means you do not need to connect the application group to each system of the sysplex. Instead, all applications of this Sysplex Application Group are known on all systems of the sysplex. You can then monitor the group at the sysplex level, rather than at system level.

The SA z/OS customization dialog allows concurrent user access capability for entry type *ApplicationGroup*. See also Appendix A, "Concurrent Customization by Multiple Users," on page 365 for further information.

Creating a New ApplicationGroup

How to create new policy objects in general, is described in "How to Create New Policy Objects" on page 14.

Figure 93 on page 126 shows the panel that is displayed when you create a new application group with the *New* command from the *Entry Name Selection* panel for application groups.

ApplicationGroup Policy Object

```

COMMANDS  HELP
-----
AOFGDYN2          Define New Entry
Command ==> _____ More: +

Define new entry of type ApplicationGroup

Name . . . . . _____

Type . . . . . SYSPLEX (SYSTEM SYSPLEX)
Nature . . . . . BASIC (BASIC MOVE SERVER)
Default Preference . . . *DEF (0 to 3200, *DEF)
Automation Name . . . . . _____
Automatically link . . . YES (for Application-Resources)
Behaviour . . . . . ACTIVE (ACTIVE PASSIVE)

Short description . . . _____
Long description . . . _____
Long description . . . _____
Long description . . . _____
Long description . . . _____
Long description . . . _____

```

Figure 93. Define New Entry Panel for a Sysplex Application Group

The unique fields are:

Name This is the name of the application group. It must be unique within the policy database. Valid names may contain up to twenty alphanumeric characters.

Application Group Type

This indicates whether the Application Group will be used for Systems or for a Sysplex. This attribute sets the boundaries for the selection of Resource members of the Application Group, and should be set as follows:

SYSPLEX

Use this type if the Application Group is being used to define sets of Applications and Resources that may reside on multiple systems within a sysplex.

SYSTEM

Use this type if the Application Group is being used to define sets of Applications and Resources that reside on single systems.

Application Group Types cannot be changed after this panel has been left.

Nature

In this field you can define the availability behavior of application groups and applications. You can specify one of the following attributes:

BASIC

The group is available when all of its resource members are available.

MOVE

The group is available when one of its resource members is available.

All members should be instances of the same application.

To avoid the following conflict, you should not define an application to be a member in two MOVE groups: Assume that resource *RES1* is a member in two MOVE groups. One of the MOVE groups starts a member which is not shared by the other MOVE group. This implies that *RES1* should be down for this

MOVE group, because only one member should be available. The second MOVE group now starts the shared member *RES1*. This causes the first MOVE group to run with two applications. If you want to assure that only one group member of a MOVE group is available, you need to insert the relationship *MAKEAVAILABLE/WhenObservedDown* (passive) between all group members and the group resource.

SERVER

This is like a move group. Additionally, you need to define an *availability target* which determines how many of its members should be available to define the server group as being available.

All members should be instances of the same application.

Depending on your selection for the *Nature* field, your process of entering resources into a group will be different, as described in "How to Work with Resources" on page 45. Refer to this chapter for examples on how to use the different natures appropriately.

Default Preference

This entry field specifies what preference should be used for application resources when automatically linking applications into ApplicationGroups (note that the *Automatically link Application-Resources into APG* entry field below must be set to YES for automatic linking; also note that preference values are only used for SERVER and MOVE ApplicationGroups). *DEF preference corresponds to default preference 700. This is the default for this field. For information about preference values and their meanings refer to "More about Policy Item RESOURCES" on page 139 and to page 65. Or, if you want to read how an operator can override preference values, refer to *System Automation for z/OS User's Guide*.

Automation Name

If you want to automate and monitor the current application group, then you need to specify an automation name in this field.

At the time the application group is created, it is not yet known as to which systems you want to link it. So you need to use its *WHERE USED* policy item to connect it to the systems you want. Let us suppose, you created a System Application Group called SYST_APG and linked it to systems SYSTEM1 (with the same MVS SYSNAME) and SYSTEM2 (with the same MVS SYSNAME). After pressing the END key, SA z/OS generates the following resources:

```
SYST_APG/APG/SYSTEM1  
SYST_APG/APG/SYSTEM2
```

Automatically link

This entry field specifies whether applications that will later be linked to the current ApplicationGroup should automatically be linked as resources too. This field defaults to YES. This field should be changed to NO if no more resources should automatically be added in case additional systems become linked to the ApplicationGroup (for System Application Groups) or to associated Sysplex-Group (for Sysplex Application Groups).

Behavior

With this field you can define whether requests to the application group should be propagated to the group members or not. With this option you can avoid having a resource unintentionally stopped if it is required for some other process outside the group.

ApplicationGroup Policy Object

ACTIVE

Propagates requests to all members of the application group according to the application group's nature, for example, a start request to a BASIC group is propagated to all members, as a BASIC group is considered to be available when all members are available. A start request to a MOVE group is forwarded to the member with the highest preference, as a MOVE group is considered to be available when exactly one member is available.

ACTIVE is the default.

PASSIVE

Does not propagate the requests to the group members. This enables monitoring and disables the automation of the application group.

Policy Items for ApplicationGroups

As described in "Creating a New ApplicationGroup" on page 125, there are two types of application groups:

- System Application Groups
- Sysplex Application Groups

Figure 94 shows the policy items that are displayed when a System Application Group is selected from the *Entry Name Selection* panel.

```

  ACTIONS  HELP
-----
A0FGEPOL          Policy Selection          Row 1 to 13 of 13
Command ===> _____ SCROLL===> PAGE

Entry Type : ApplicationGroup      PolicyDB Name : DATABASE_NAME
Entry Name  : APPL_GROUP_NAME     Enterprise Name : YOUR_ENTERPRISE

Action      Policy Name      Policy Description
-----
            DESCRIPTION    Enter description
            APPLGROUP INFO  Define applicationgroup information
            APPLICATIONS    Select applications for sysplex APG
            TRIGGER         Select trigger
            SERVICE PERIOD   Select service period
            RELATIONSHIPS    Define relationships
            -----RESOURCES-----
            RESOURCES       Select resources and set preferences
            GENERATED RESOURCES List resources generated for this entry
            MEMBER OF       List resources where this entry is a member
            -----
            WHERE USED      List sysplex groups linked to this entry
            COPY            Copy data from existing entry

```

Figure 94. Policy Selection Panel for System Application Groups

The unique policy items for application groups are:

APPLGROUP INFO

This policy item displays information about the Application Group, as specified when creating the application group. The panel is very similar to the one used for creating the application group. You may update indicated values in this panel. See "More about Policy Item APPLGROUP INFO" on page 130 for more information.

APPLICATIONS

When you select this policy item, a list of all applications in the SA z/OS enterprise is displayed, indicating which, if any, are associated with this

application group. You can add applications to the application group or remove applications from the application group. If the current application group has a resource name, then the appropriate APL-resources are generated. According to the application group's settings, the application resources (APL-resources) are linked as members into the application group resource (APG-resource). See "More about Policy Item APPLICATIONS" on page 130 for more information on this policy item.

TRIGGER

Each application group may be linked to one trigger. With this policy item, you can use the *Trigger for ApplicationGroup* panel to link the application group to a trigger so that all of its applications will be started or stopped depending on the defined trigger conditions.

SERVICE PERIOD

With this policy item, you can use the *Service Period for ApplicationGroup* panel to link a service period to the application group. Its resources are then automatically started up or shut down in the time frame specified by the service period.

RELATIONSHIPS

This policy item has the same functionality for entry types *Application*, *ApplicationGroup*, and *Monitor Resource*. For each application, application group, or monitor resource you may specify several relationships. They will be used to automate the startup or stopping of those applications, application groups, and monitor resources. If you select this policy item, in the *Relationship Selection List* panel, you can view existing relationships or define new relationships for the current application, application group, or monitor resource.

You define relationships between dependent resources and supporting resources. In the customization dialog you define relationships always from the point of view of the dependent resource. So the resource that you have currently selected will become the dependent resource, when you define a new relationship.

Refer to "More about Policy Item RELATIONSHIPS" on page 132 for more information on viewing existing or defining new dependency relationships.

RESOURCES

This policy item allows you to select Resources for current ApplicationGroup and set their preferences or name.

The panels displayed look different depending on the nature of the current application group. Refer to Chapter 4, "Scenarios on How to Use the Customization Dialog," on page 45 and "More about Policy Item RESOURCES" on page 139 for information on how to work with these different panels.

GENERATED RESOURCES

This policy item displays a list of all resources that have been generated for the current application group and for the applications that are linked to this application group. See "More about Policy Item GENERATED RESOURCES" on page 143 for a description of the *Generated Resources* panel.

MEMBER OF

As resources derived from application groups can be members of other APG-resources, this policy item lets you see those resources of which the

ApplicationGroup Policy Object

current application group resource is a member. Refer to panel *Member of* in “More about Policy Item MEMBER OF” on page 144 for more details.

More about Policy Item APPLGROUP INFO

A panel like Figure 95 will be displayed if you select policy item APPLGROUP INFO from the Policy Selection Panel for Application Groups.

```
COMMANDS  HELP
-----
A0FGAPA0      Application Group Information
Command ==> _____

Entry Type : ApplicationGroup      PolicyDB Name  : DATABASE_NAME
Entry Name  : APPL_GROUP_NAME     Enterprise Name : YOUR_ENTERPRISE

The following field was specified when the Application Group was
defined and cannot be modified:
  Application Group Type : SYSPLEX

Nature . . . . . BASIC           (BASIC MOVE SERVER)
Default Preference . . . *DEF     (0 to 3200, *DEF)
Automation Name . . . . .
Behaviour. . . . . ACTIVE       (ACTIVE PASSIVE)
Owner. . . . . _____

Automatically link Application-Resources
into APG . . . . . YES         (YES NO)
```

Figure 95. Application Group Information Panel

All of the fields apart from *Owner* on this panel are explained in “Creating a New ApplicationGroup” on page 125. You can update the values shown in the lower part of this panel.

Owner

Specifies who the operator should contact if there is an error.

More about Policy Item APPLICATIONS

If you select an application group’s policy item *APPLICATIONS*, you reach the *Applications for ApplicationGroup* panel. Figure 96 shows an example.

```
COMMANDS  ACTIONS  VIEW  HELP
-----
A0FGXC4E      Applications for ApplicationGroup      Row 1 to 13 of 106
Command ==> _____      SCROLL==> PAGE

Entry Type : ApplicationGroup      PolicyDB Name  : SCENARIO
Entry Name  : NET                  Enterprise Name : SCENARIO

Action      Status      Application
-----
_____      SELECTED  CICSAOR1
_____      _____ CICSAOR2
_____      _____ CICSAOR3
_____      _____ CICSFOR
_____      _____ CICSMAIN
_____      _____ CICSTOR
_____      _____ DB2IRLM
_____      _____ DB2MAIN
_____      _____ DWH
_____      SELECTED  TCPIP
_____      SELECTED  VTAM
_____      _____ WBSRV
```

Figure 96. Applications for ApplicationGroup Panel for System Application Groups

Here you can add or remove applications from an application group. If you add an application to an application group which is already linked to a system, then SA z/OS will generate a resource for this application. If you previously set the option *Automatically link Application-Resources* to YES when creating the application group, SA z/OS will also add the new resource into this application group. Otherwise, you simply have an independent application resource that you can start, stop, or automate as required.

More about Policy Item TRIGGER

If you select an application group’s TRIGGER policy item, you reach the Trigger for ApplicationGroup panel. Figure 97 shows an example. For more details about triggers, refer to “Event and Trigger Support” on page 39.

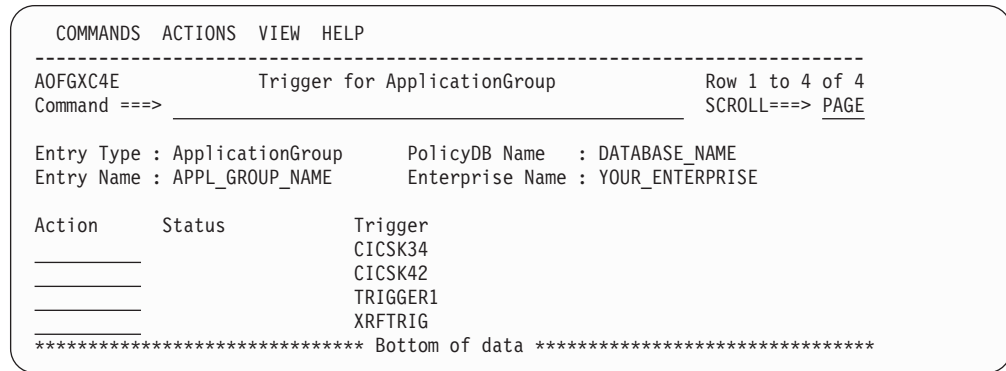

Figure 97. Trigger for ApplicationGroup Panel

Here you can add triggers to or remove them from an application group.

More about Policy Item SERVICE PERIOD

If you select an application group’s SERVICE PERIOD policy item, you reach the Service Period for ApplicationGroup panel. Figure 98 shows an example.

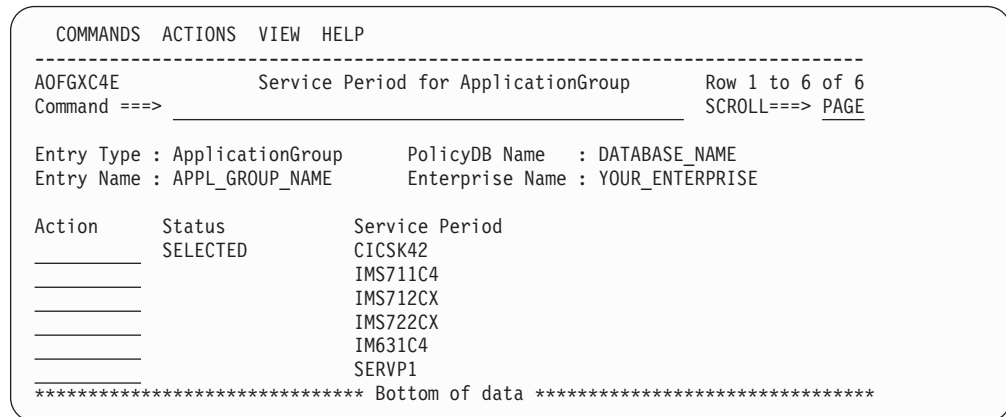

Figure 98. Applications for ApplicationGroup Panel for System Application Groups

Here you can add service periods to or remove them from an application group.

More about Policy Item RELATIONSHIPS

The *Relationship Selection List* panel (Figure 99) is displayed if you select policy item RELATIONSHIPS from the *Policy Selection* panel for application groups. It shows information about existing relationships and allows you to define new relationships.

The ACTION pull-down choice offers actions to edit and delete selected relationships. The Delete command immediately deletes the relationship. The Edit command leads to the *Define Relationship* panel (as shown in Figure 99).

```

COMMANDS  ACTIONS  VIEW  HELP
-----
A0FGXREL          Relationship Selection List
Command ==> _____

Entry Type : ApplicationGroup      PolicyDB Name   : DATABASE_NAME
Entry Name  : APPL_GROUP_NAME     Enterprise Name  : YOUR_ENTERPRISE

Action #   Type                Supporting Resource      Auto   Chain
-----  -  -
   1     HASPARENT              VTAM/APG/=
   _     MAKEAVAILABLE          S/APG/=                  ACTIVE  WEAK
***** Bottom of data *****

```

Figure 99. Relationship Selection List Panel

This panel displays information about existing relationships. In all of the relationships for the current resource, this resource is the dependent resource. The columns have the same meaning as described in “Defining Relationships.”

Entering the *NEW* command from this panel to define new relationships takes you to the *Define Relationship* panel described in “Defining Relationships.”

Defining Relationships

You define relationships between dependent resources and supporting resources. In the customization dialog you always define relationships from the point of view of the dependent resource. So the resource that you are currently editing will become the dependent resource for the relationship dependency being defined. If you select this policy item, in the upcoming *Define Relationship* panel, (Figure 100 on page 133) you will specify the name of the supporting resource (in field *Supporting Resource*).

```

COMMANDS  HELP
-----
                                Define Relationship
Command ==> _____

Entry Type : ApplicationGroup      PolicyDB Name : DATABASE_NAME
Entry Name : APPL_GROUP_NAME      Enterprise Name : YOUR_ENTERPRISE

Autoname   :      APPL_GRP_01      More:      +
Description . . . . _____

Relationship Type. . HASPARENT      MAKEAVAILABLE MAKEUNAVAILABLE
PREPAVAILABLE PREPUNAVAILABLE
FORCEDOWN EXTERNALLY HASMONITOR
HASPARENT HASPASSIVEPARENT

Supporting Resource. VTAM/APG/=
Sequence Number. . . 1             Resource Name
Sequence Number (1-99,blank)

Automation . . . . _____      ACTIVE PASSIVE
Chaining . . . . _____        STRONG WEAK
Condition . . . . _____        Satisfy condition
(? for list of possible values)
    
```

Figure 100. Define Relationship Panel

This panel shows either the automation name (*Autoname*) for *ApplicationGroups* or the subsystem name (*Subsystem*) for *Applications*.

This panel contains the following fields that can be filled in:

Description

You can enter a forty-character text to describe the relationship.

Relationship Type

Here you define the relationship between the application group, referred to as the dependent resource, with any other resource referred to as the supporting resource. The supporting resource can either be an application or an application group.

All relationships and conditions are only observed by automation if the requested goal of the involved resources allow them. Dependencies are only checked if they are of importance for the existing desired goal.

Select one of the following values:

MAKEAVAILABLE

The dependent resource cannot be started until the specified *Condition* has been fulfilled for the supporting resource. So for example, if you specify *WhenAvailable* as the relationship condition, then SA z/OS will start the dependent resource as soon as the supporting resource itself is available, if no request or goal contradicts.

Note:

If no goal is explicitly specified, then the default goal is: make the resource available.

MAKEUNAVAILABLE

The dependent resource cannot be stopped until the specified *Condition* has been fulfilled for the supporting resource.

PREPAVAILABLE

If the desired goal of the resource is *MAKEAVAILABLE*, then the *PRESTART* commands for the dependent resource are issued as soon as the specified *Condition* has been satisfied for the supporting resource.

PREPUNAVAILABLE

If the desired goal of the resource is *MAKEUNAVAILABLE*, then the *SHUTINIT* commands for the dependent resource are issued as soon as the specified *Condition* has been satisfied for the supporting resource.

FORCEDOWN

To force a shutdown in case the supporting resource has reached the specified satisfactory condition.

EXTERNALLY

The supporting resource will, at certain times, perform various automated actions for the dependent resource. These actions are specified through the relationships condition. For example, with this selection you specify that an external resource is responsible for starting or stopping the current (dependent) resource.

HASMONITOR

For relationships defining connections between application or application group resources and monitor resources.

Note:

This relationship type can only be used for applications (APLs) and application groups (APGs).

HASPARENT

With this selection you specify that the current application or application group has a parent. The parent is the supporting resource that you specify in the *Supporting Resource* entry field (see “Supporting Resource” on page 135).

The dependent resource cannot be started until the supporting resource is available.

The supporting resource cannot be stopped before the dependent resource is unavailable.

The supporting resource will, at certain times, perform various automated actions for the dependent resource. These actions are specified through the relationships condition (see “Condition” on page 137). For example, if you specify *StartsMe* as the relationship condition, then the supporting resource will start the dependent resource whenever the supporting resource is started.

A request to start the dependent resource results in issuing a start request against the supporting resource if the supporting resource is down.

Note:

This relationship type implements the parent/child relationship from earlier SA z/OS releases. Those are converted into HASPARENT, when HASPARENT is specified in the *APL Relationship Type* field on the *PDB Convert Options* panel (see “Initial Policy Database Conversion” on page 355).

HASPASSIVEPARENT

The only difference between the HasPassiveParent and HasParent relationship is that a request to start the dependent resource will not result in the issuing of a start request against the supporting resource if the supporting resource is down. A start request must be issued against the supporting resource before the start request for the dependent resource is processed.

Note:

This relationship type implements the parent/child relationship from earlier SA z/OS releases. Those are converted into HASPASSIVEPARENT when HASPASSIVEPARENT is specified in the *APL Relationship Type* field in the *PDB Convert Options* panel (see “Initial Policy Database Conversion” on page 355).

Supporting Resource

Here you enter the name of the resource that the dependent resource has the previously defined relationship with. This name consists of two or three parts, separated by slashes, where the last part shows the system name. You can use the equal sign '=' which then stands for the local system of the dependent resource. The syntax for valid formats is similar to the syntax for generated resources:

APG-AutomationName/APG	(for sysplex APG)
APG-AutomationName/APG/MVSSysname	(for system APG)
APG-AutomationName/APG/=	(for system APG)
SubSystemName/APL/MVSSysname	(for APL)
SubSystemName/APL/=	(for APL)
MonitorName/MTR/MVSSysname	(for MTR)
MonitorName/MTR/=	(for MTR)

Note:

If the supporting resource is an APL resource, a MTR resource, or a system APG resource, one system automation symbol (&AOCCLONE., ~ or &AOCCLONEx. with x=1 through 9, A through Z) can be specified in the name. System symbols cannot be specified.

For MVSSysname the special notation with a trailing 'plus-sign' is allowed.

Sequence Number

This number is used when the automation control file is built. Each relationship that has been assigned a number will be put into the ACF

ApplicationGroup Policy Object

PARENT=(.) field. The position within the list is determined by this number. Valid values are 1 through 99 and blank.

The first entry in the list that is defined in the current sysplex is used for AOCQRY and for ACF compatibility with prior SA z/OS releases. The position within the list is given by this number. All relationships with the same number are sorted within their sequence number according to their type and alphabetically.

Note:

The number is forced to blank for relationships where the supporting resource is an APG or MTR resource.

Automation

Defines the processing of SA z/OS in order to satisfy the relationship:

ACTIVE

Specifies that SA z/OS will attempt to bring the resource to the desired condition to satisfy the dependency. This is the default for MAKEAVAILABLE and MAKEUNAVAILABLE.

PASSIVE

Specifies that SA z/OS will wait until the resource is in the desired condition to satisfy the dependency. That is, the request to bring the resource into the desired condition needs to come from outside, such as an operator command.

This field is forced to blank for HASMONITOR, HASPARENT, HASPASSIVEPARENT, EXTERNALLY, and FORCEDOWN relationships. This field is forced to PASSIVE for WhenGroupHasNotFailed, WhenHardDown or any WhenObserved... condition.

Chaining

Defines whether the status of the supporting resource, or of the attached subtree is to be considered:

STRONG

Specifies that SA z/OS considers the status of the attached subtree.

WEAK

Specifies that SA z/OS considers just the status of the supporting resource (this is the default for MAKEAVAILABLE and MAKEUNAVAILABLE).

This field is forced to blank for HASMONITOR, HASPARENT, HASPASSIVEPARENT, EXTERNALLY, and FORCEDOWN relationships. This field is forced to WEAK for PREPAVAILABLE and MAKEAVAILABLE relationships with a WhenGroupHasNotFailed condition.

Strong chaining causes SA z/OS to check all relationships of the involved resources along the attached subtree. Weak chaining simply requires that the action is permitted on the dependent resource.

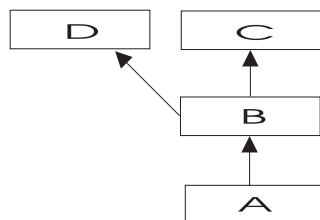

Figure 101. Example for Strong Chaining

In the example shown in Figure 101 for strong chaining, SA z/OS will also consider the dependency between resources B and C and B and D. So A will only be started if B, C and D are up. Or C will only be stopped if A and B are down.

Condition

Defines the condition the supporting resource must have in order to satisfy the relationship. Enter a '?' to get to the *Relationship Condition Selection* panel from where you can select an appropriate value.

Refer to "Relationship Conditions" for more information on available condition values and the context in which they may be used. If no value is given for this field the following default values will be set:

blank for HASPARENT

StartsMe
for EXTERNALLY

WhenAvailable
for MAKEAVAILABLE and PREPAVAILABLE

WhenDown
for MAKEUNAVAILABLE and PREPUNAVAILABLE

WhenObservedDown
for FORCEDOWN

This field is forced to blank for HASMONITOR relationships.

Relationship Conditions: The relationship conditions that are available depend on the relationship.

The relationship conditions for HASPARENT, HASPASSIVEPARENT, and EXTERNALLY are:

StartsMe
The dependent resource will be started whenever the supporting resource is started.

StopsMe
The dependent resource will be stopped whenever the supporting resource is stopped.

StartsAndStopsMe
The supporting resource will start the dependent resource whenever it is started itself. The supporting resource will stop the dependent resource whenever it is stopped itself.

Relationship conditions valid for Prepare/Make/Available/Unavailable are summarized in Table 6 on page 138.

ApplicationGroup Policy Object

Observed status means the observed status for the supporting resource. *Desired status* means the desired status for the supporting resource.

Read this table as in the following examples:

- For the condition *WhenAvailable*, the action specified by the *Relationship Type* may be taken when the supporting resource's observed status is *Available* and its desired status is also *Available*.
- For the condition *WhenRunning*, the action specified in *Relationship Type* may be taken when the supporting resource's observed status is *Available* or *Degraded* and its desired status is *Available*.

Table 6. Relationship Conditions

Condition	Observed Status	Desired Status	Passive Only
WhenAvailable	Available, WasAvailable	Available	
WhenRunning	Available, WasAvailable, Degraded	Available	
WhenSoftDown	SoftDown	Unavailable	
WhenHardDown	HardDown	Unavailable	Yes
WhenDown	SoftDown, HardDown, SysGone	Unavailable	
WhenAssumedDown	SoftDown, HardDown, SysGone, Unknown	Unavailable	
WhenAvailableOrStarting	Available, WasAvailable OR Softdown, Unknown AND start dependency satisfied	Available	
WhenRunningOrStarting	Available, WasAvailable, Degraded OR Softdown, Unknown AND start dependency satisfied	Available	
WhenDownOrStopping	Stopping, SoftDown, HardDown, SysGone	Unavailable	
WhenAssumedDownOrStopping	Stopping, SoftDown, HardDown, SysGone, Unknown	Unavailable	
WhenStoppableOrSoftDown	SoftDown OR Available, WasAvailable, Degraded, Starting, Stopping, Problem AND stop dependency satisfied	Unavailable	
WhenStoppableOrDown	SoftDown, HardDown, SysGone OR Available, WasAvailable, Degraded, Starting, Stopping, Problem AND stop dependency satisfied	Unavailable	
WhenStoppableOrAssumedDown	SoftDown, HardDown, SysGone, Unknown OR Available, WasAvailable, Degraded, Starting, Stopping, Problem AND stop dependency satisfied	Unavailable	
WhenObservedDown	HardDown, SoftDown, SysGone	n/a	
WhenObservedAssumedDown	HardDown, SoftDown, SysGone, Unknown	n/a	

Table 6. Relationship Conditions (continued)

Condition	Observed Status	Desired Status	Passive Only
WhenObservedSoftDown	SoftDown	n/a	
WhenObservedHardDown	HardDown	n/a	Yes
WhenObservedAvailable	Available	n/a	
WhenObservedRunning	Available, Degraded	n/a	
WhenObservedWasAvailable	WasAvailable	n/a	
WhenObservedWasAvailableUnknownOrSysgone	WasAvailable, Unknown, Sysgone	n/a	
WhenGroupHasNotFailed	Group/Failed flag not set	n/a	Yes

Any of these conditions can be used with any of the action relationships (PrepareAvailable, MakeAvailable, PrepareUnavailable, MakeUnavailable).

More about Policy Item RESOURCES

When you select policy item RESOURCES, you will first be presented with a selection panel if the application group is linked to more than one system or sysplex. There are three different panels depending on whether the application group is of type Server, Move, or Basic. The panel shown in Figure 102 is for an application group of type Server.

If you want to add resource members into an application group of nature MOVE or SERVER, you can attach preference values to these resources (see the *Preference* column in Figure 102).

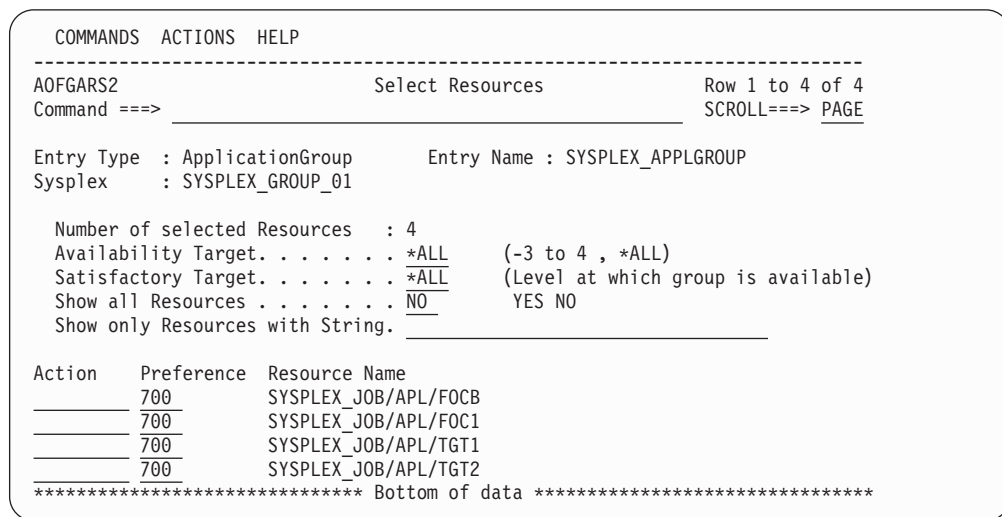

Figure 102. Select Resources for ApplicationGroup Panel

This panel has the following fields (unless stated, the fields apply to all application group types):

Number of selected Resources

This shows the current number of selected Resources.

Availability Target

This *Availability Target* is different depending on the type of application group:

ApplicationGroup Policy Object

Server Valid values for Server application groups are:

***ALL** This means that all selected Resources must be *available* before the current application group-derived Resource is considered as *available*.

number

This (positive) *number* is the number of selected Resources that must be *available* before the current application group-derived Resource is considered as *available*. This number must be less than or equal to the value in the *Number of selected Resources* field.

If the value entered is greater, it will be changed to the maximum allowed when you leave the panel.

-number

This (negative) *number* is the number of selected Resources *less than* the total that must be *available* before the current application group-derived Resource is considered as *available*. This number must be less than the value in the *Number of selected Resources* field.

If the value entered is less than or equal to the minimum value that is allowed, it will be changed to the minimum when you leave the panel.

Move The *Availability Target* is always 1.

Basic The *Availability Target* is not applicable.

Satisfactory Target

The *Satisfactory Target* is only applicable to Server application groups. It specifies the number of members in the group that must be active before the automation manager treats the group as being in a satisfactory state.

Valid values for server application groups are the same as for the Availability Target.

The Satisfactory Target may be less than, or equal to the Availability Target, but cannot be higher.

If the Satisfactory Target is of type *-number* then it is treated relative to the adjusted Availability Target.

Show all Resources

This can be:

YES

Shows all selectable Resources.

NO

Only shows *selected* Resources.

Show only Resources with String

If you enter a string in this field, only matching Resources are listed. No wildcards are supported.

Action

The following Actions are valid from the ACTIONS menu and Action prompt:

(P)PRIMARY

Sets preference value to 700.

SECON(D)ARY

Sets preference value to 400.

(A)DD

Sets preference value to 700.

RE(M)OVE

Removes preference value.

(S)ELECT

Sets preference value to 700.

Preference

A Resource becomes SELECTED when a positive number is entered to this field. The preference value says what "role" the selected Resource has. The maximum valid value is 3200. Any value greater than 3200 will be changed to that valid maximum.

The following roles are related to the preference values given:

>2600

The resource always selected regardless of its state. Use this value if the APL- or APG-Resource must run.

>2000

The resource always selected unless the observed status of the resource is SYSGONE or HARDDOWN. It is only selected when no other viable member exists. A viable member is a resource that can be started and that is allowed to be started. In principle, the observed status is one of the following: Softdown, Starting, Degraded, Available or WasAvailable.

1000

The resource always started, other resources stopped. (Use if you really want the APL- or APG-Resource to run).

700

The resource is selected for startup after an IPL and after recovery situations. Members with preference 300 will be stopped in favour of this group. It is not stopped unless a very high preference alternative becomes available. This value is the default. Use it in a MOVE group for a resource that normally runs.

600

Used as a threshold. A resource with a preference of 600 and lower will not be selected at group startup.

500

This resource is not selected for startup after IPL but it is started as a backup after failure and continues running even though normal preference (700) alternatives become available. It is stopped at the next (scheduled) outage. Use this value in a MOVE group for the backup resource.

300

Like 200, but a move to an alternate backup (Preference 500) would only occur at a (scheduled) outage.

200

Resource started as backup, stopped as soon as better alternative (Preference 450 and greater) becomes available. (Use where you can have a backup, but you don't really want one).

ApplicationGroup Policy Object

- 1 This means that the member will always be deselected and will always have a MakeUnavailable vote propagated to it. This can be useful if you want complete manual control of the move process.
- 0 This means that the member is a passive member and will never get a vote propagated to it by the group. If a member has its preference changed so it becomes passive, any votes that have been propagated to it from the group will be withdrawn.

Preferences other than those listed are accepted. You can find more information on the meaning of preferences in *System Automation for z/OS User's Guide*. Various scenarios are described in Table 7.

Table 7. Preference Value Scenarios

Scenario	Description
Absolute manual control	<p>Member to be activated gets preference 3200, all others get preference 1.</p> <p>The member with the 3200 preference will be selected. All others will always have a MakeUnavailable vote propagated to them.</p> <p>This does not change even if the system with the selected member leaves the sysplex.</p>
Move only after system failure	<p>Primary member defined preference 2800, backups preference 500.</p> <p>As long as the primary is not SYSGONE it will be selected. If the primary is SYSGONE, its preference drops to 2575 (2800 - 400 + 175), allowing an alternative viable member to be selected.</p> <p>The backups will only be viable if the resource was previously active because of the groups recovery mode.</p>
Move only if system down	<p>Primary member defined preference 2800, backups preference 700.</p> <p>As long as the primary member is not SYSGONE it will be selected. If the primary member is SYSGONE, its preference drops to 2575 (2800 - 400 + 175), allowing an alternative viable resource to be selected.</p> <p>The backups are always viable.</p>
Sticky move only after system down	<p>Primary member defined preference 2801, backups preference 2800.</p> <p>As long as the primary member is not SYSGONE, it will be selected. If the primary becomes SYSGONE, its preference drops to 2576 (2801 - 400 + 175), allowing one of the backups to be selected. The sticky bonus raises its preference to 2975 (2800 + 175), meaning that even when the primary returns the selected backup system will remain selected.</p> <p>It will only be deselected if it goes to SYSGONE, in which case the primary will be re-selected if it is available otherwise another backup would be picked.</p>

Table 7. Preference Value Scenarios (continued)

Scenario	Description
Move only after system or application failure	<p>Primary member defined with preference 2400, backups preference 500.</p> <p>As long as the primary member is not SYSGONE or HARDDOWN it remains selected. If it is HARDDOWN or SYSGONE its preference is still <2600, so a viable alternative can be selected.</p> <p>The backups are only viable if you are in recovery mode (that is, the member was active when the failure occurred).</p>
Move only if system down or application failure	<p>Primary member defined with preference 2400, backups preference 700.</p> <p>As long as the primary member is not SYSGONE or HARDDOWN it remains selected. If it is HARDDOWN or SYSGONE its preference is still <2600, so a viable alternative can be selected.</p>
Sticky move if system down, move after application failure	<p>Primary member defined with preference 2401, backups preference 2400.</p> <p>As long as the primary is not SYSGONE or HARDDOWN it remains selected. If it is SYSGONE or HARDDOWN its preference is <2600, so a viable alternative may be chosen.</p> <p>The sticky bonus raises the preference of the selected member to 2575 (2400 + 175), so it will remain selected until gets to a state of SYSGONE or HARDDOWN, at which point another viable alternative will be selected, with the primary member having preference.</p> <p>The individual shutdown of the active member will not trigger a move.</p>
Sticky move group, unless member stopped	<p>Primary member defined with preference 701, backups preference 700.</p> <p>As long as the primary member is startable, it remains selected. If it becomes non-startable, another member is selected and that remains selected as long as it is startable.</p> <p>Individually stopping the active member will trigger a move. If the members were defined with preferences >1500, the bonus would be 175 points rather than 25 points.</p>
Sticky move group, until told otherwise	<p>Primary member defined with preference 3200, backups with preference 1600.</p> <p>With base preferences of 3200, you get it picking a member when the sysplex is IPLd and retaining that one until an operator uses INGGROUP to make it pick another one.</p> <p>Beware of timing problems as the first system with a member to register will probably get it.</p>

More about Policy Item GENERATED RESOURCES

The *Generated Resources* panel appears if you select policy item *GENERATED RESOURCES* from the *Policy Selection* panel for *ApplicationGroups*. This panel shows all resources that are generated by SA z/OS for the application group itself and all

ApplicationGroup Policy Object

the resources for the applications that are members of this application group. This panel is for information only. No actions are allowed.

```

COMMANDS  HELP
-----
A0FGXRSG          Generated Resources          Row 1 to 8 of 8
Command ==>>>          SCROLL==>>> PAGE

Entry Type : ApplicationGroup      PolicyDB Name : DATABASE_NAME
Entry Name : NET                   Enterprise Name : YOUR_ENTERPRISE

Resource Name          Generated by link to
Resources for THIS entry:
NET/APG/SYSTEM1       SYSTEM1
NET/APG/SYSTEM2       SYSTEM2
Resources for APPLICATIONS (generated by links to this entry):
TCPIP/APL/SYSTEM1     NET
TCPIP/APL/SYSTEM2     NET
VTAM/APL/SYSTEM1      NET
VTAM/APL/SYSTEM2      NET
***** Bottom of data *****

```

Figure 103. Generated Resources Panel

This panel displays the following information:

Resources for THIS entry

Shows the resources generated for the application group. The display is different for application groups of type SYSPLEX or SYSTEM: No system information is shown for Sysplex Application Groups, as several systems can be part of the sysplex.

Resources for APPLICATIONS (generated by links to this entry)

Shows the resources generated for applications that are linked to the application group.

More about Policy Item MEMBER OF

The *Member of* panel appears if you select policy item *MEMBER OF* from the *Policy Selection* panel for application groups.

```

COMMANDS  HELP
-----
Command ==>>>          Member of          SCROLL==>>> PAGE

Entry Type : ApplicationGroup      PolicyDB Name : DATABASE_NAME
Entry Name : APPL_GROUP_NAME      Enterprise Name : YOUR_ENTERPRISE

Own Resource...          ...is a member of          Preference Nature
NET/APG/SYSTEM1         WBSRVAPG/APG              700          MOVE/SERVER
NET/APG/SYSTEM2         WBSRVAPG/APG              700          MOVE/SERVER
***** Bottom of data *****

```

Figure 104. Member of Panel for ApplicationGroups

This panel lists all Resources, where this ApplicationGroup is a member "resource-wise"; that is, it lists all relations from Resources that have been derived from the current ApplicationGroup to other Resources. This panel is for information only. No data can be changed.

A "Member of" relation can be added or removed in the RESOURCES policy of the entry in the list's "member of" column (that is in the RESOURCES policy of the APG Entry Name, from which the "member of" Resource was derived).

If the owning ("is a member of") APG resource is of nature SERVER or MOVE, then column *Preference* shows the preference value that was set for the current resource in the RESOURCES policy item of the owning resource. If the owning resource's nature is BASIC, it shows "SELECTED". For more details about available preference values see "Creating a New ApplicationGroup" on page 125.

In our example from Figure 104 on page 144, the resource *NET/APG/SYSTEM1* in turn is a member of resource *WBSRVAPG/APG*.

Application Policy Object

An *application* is a z/OS subsystem, started task, application, batch job, or non-MVS resource that runs on a system in the SA z/OS enterprise. SA z/OS monitors applications through the messages they issue to the operator. Application is also used to refer to a subsystem or process on an SNMP-capable machine. Note that SA z/OS does not provide automation for applications on non-MVS systems.

An application cannot be linked to a system directly. It must be defined as part of an application group, and it may belong to more than one application group. If a system is assigned multiple application groups containing the same application, SA z/OS ensures that the application is defined only once in the automation control file.

The SA z/OS customization dialog allow concurrent user access capability for entry type *Application*. See also Appendix A, "Concurrent Customization by Multiple Users," on page 365 for further information.

Creating a New Application

How to create new policy objects in general is described in "How to Create New Policy Objects" on page 14.

Figure 105 shows the panel that is displayed when you create a new application from the *Entry Name Selection* panel for applications.

```

COMMANDS  HELP
-----
AOFGDYN2          Define New Entry
Command ==> _____ More: +

Define new entry of type Application

Name . . . . . _____

Subsystem Name . . . . .
Object Type . . . . . INSTANCE (CLASS INSTANCE)
Application Type . . . . . STANDARD (STANDARD IMAGE JES2 JES3 CICS IMS DB2
                                OPC USS)
Subtype . . . . . _____ (For CICS, IMS, DB2, OPC only)
Job Type . . . . . _____ (MVS NONMVS TRANSIENT)
Job Name . . . . . _____
Transient Rerun . . . . . _____ (YES NO)
Scheduling Subsystem . . . . . _____ (MSTR, JES Subsystem, or blank)
JCL Procedure Name . . . . . _____
    
```

Figure 105. Define New Entry Panel for Applications

When you define a new application, you provide the following information:

Name This field is required. It assigns a unique twenty-character name to the application you are defining. It is often convenient to use the same name

Application Policy Object

for both the subsystem name and the application name. In some cases, however, it may be useful to have multiple applications with the same subsystem name. This enables you to have a standard "tree" of subsystems but to drop the right characteristics of an application on a specific system. The first character of the application name may not be numeric.

Subsystem Name

The Subsystem Name is required. This gives a unique, eleven-character name to the Application you are defining. This name is used by SA z/OS automation. You may have multiple applications with the same subsystem name. However, you should take care to ensure that only one of them is linked to any given system. Although the same subsystem name can be allocated to an instance and a linked class, this should be avoided as the policy inheritance can produce unpredictable results. Valid characters are any alphanumeric character or any of @, #, \$, ? or _ (underscore), with the first character being alphanumeric or one of @, #, \$ or ?.

When defining applications on SNMP target systems, it is recommended that the subsystem name be the same as the name of the process or subsystem on the SNMP target system.

The subsystem name of an existing application can be modified by overtyping the field subsystem name in the Application Information policy panel.

Notes:

1. When renaming a subsystem, the new name will be checked to be unique within your policy database, no matter which system the application is linked to. If you want to change the subsystem name to a name that already exists, you need to unlink the application from all application groups first.
2. The following values are reserved for SA z/OS and cannot be used:

\$\$\$OPCA	@EXTCOND	@SERVICE	@TRIGGER
ABCODEPROG	ABCODESYSTEM	ABCODETRAN	ADJNETV
ALL	APPLGROUP	APPLICATION	ASSOCIATION
AUTOMATION	AUTOOPS	CICSCNTL	CONNECTION
DB2CNTL	ENTERPRISE	ENVIRON	EXTEND
FORWARD	FULLSESS	GATEWAY	GROUP
HEALTHCHK	IMAGECNTL	IMSCNTL	IMSRSENM
INITSTART	LISTSHUT	MONITOR	MVSCOMP
MVSESA	NNT*	NONE	NTFYOP
OPCAPARM	OPCCNTL	PROCESSOR	RCVRAUTO
RCVRSOS	RCVRTRAN	RCVRVIOL	RECOVERY
RESIDENT	RESTART	SDF	SENDCMD
SERVICE	START	STSFILE	SUBGROUP
SUBSYSDEF	SUBSYSTEM	SYSTEM	TERMINATE
THRESHOLDS	TIMER	TRIGGER	

Object Type**CLASS**

If the entry represents common policy to be inherited by one or more other application entries defined as INSTANCES, select this object type. CLASSES are used only to define inherited policy; they do not represent applications that are managed by SA z/OS.

INSTANCE

If the entry represents an application to be managed by SA z/OS, select this object type. If you link an application defined as an INSTANCE to an application defined as a CLASS you can omit policy items from the INSTANCE which allows that policy to be inherited from the specified CLASS.

Use of the object type CLASS allows you to define a common policy for multiple applications. This is advisable if these applications share common characteristics and functions. It decreases effort during:

- Initial definition.
- Administrative changes (using the customization dialog).
- Run time changes (using the SA z/OS automation engine).

An application instance is linked to a class using the LINK TO CLASS or LINK TO INSTANCES policy item. If a policy item is not specified for the instance, it is then inherited from the class. Conversely, a policy item specified for an instance overrides any class specification.

Flag definitions for classes or defaults cannot be merged with specific resource definitions. For example specifying a RESTART flag with an exit at class level and a RESTART flag with a NOAUTO period at resource level will not result in a resource definition with both. The presence of any definition at resource level will take precedence over those at class and default level. Likewise a class definition will take precedence over a default. The definitions for a specific flag type will not be merged.

The inheritance of policy from an application class occurs during SA z/OS initialization. If an application policy item is not specified in either the application instance or the class, then defaults are used from the application defaults, system defaults, and environment setup objects. Some policy items are required to be specified for an application instance. Except for job name, these same items need to be specified for an application class, but note they will never be inherited.

SA z/OS supports run time changes to application class. If the ACF command is used to change a policy item for a class, all those instances belonging to the class and inheriting that policy item are also updated.

Application Type

The application type is required. The default type value is STANDARD. The value STANDARD can be changed once, all other values cannot be changed after the application is created. Other type values are:

- JES2 if the application represents a JES2 application, see “Policy Items for JES2 Subsystems” on page 190.
- JES3 if the application represents a JES3 application, see “Policy Items for JES3 Subsystems” on page 194.
- DB2 if the application represents a DB2 application, see “Policy Items for CICS Subsystems” on page 199.

Application Policy Object

- CICS if the application represents a CICS application, see “Policy Items for DB2 Subsystems” on page 204.
- IMS if the application represents an IMS application, see “Policy Items for IMS Subsystems” on page 208.
- OPC if the application represents an OPC application, see “Policy Items for OPC Subsystems” on page 217.
- USS if the application represents an USS application, see “Policy Items for USS Subsystems” on page 218.
- IMAGE if the application represents a system image (to enable the enhanced Parallel Sysplex functions). For details, see *System Automation for z/OS Customizing and Programming*.

Not specifying STANDARD causes some additional policy options, specific to the automation of those applications, to be displayed on the SA z/OS *Policy Selection* panel. Note that once you have specified the value and created the Application entry, the value cannot be changed. Only the value STANDARD can be changed afterwards.

Subtype

Specifies the region subtype for CICS, DB2 and IMS or the controller type for OPC applications. The following values may be specified:

- CICS: AOR TOR FOR DOR QOR
- DB2: MSTR SPAS IRLM DBM1 DIST WLMS
- IMS: CTL TP DBRC DLS FP BMP
- OPC: CONTROLLER TRACKER SERVER DATASERVER

For other applications the value is forced to blank.

JobType

This may be one of:

MVS This is the standard MVS job type that SA z/OS normally handles. It is typically monitored using the ASCB checker. This job type can be specified explicitly with a JOBTYP= MVS for an application but is the assumed default if the JobType entry is omitted from the definition of the application.

NONMVS

This is a type of resource that may be started by SA z/OS but which cannot be monitored using an ASCB check or using the MVS D A method. For this type of resource to be monitored, if the AOFATMON routine cannot be used, either a user-provided application monitor routine is required or the message automation table must be correctly set up to maintain the job status accurately. This status is the only way of monitoring this class of job. NONMVS jobs must have STARTUP and SHUTDOWN commands defined.

TRANSIENT

This is a type of job that may be started by SA z/OS but terminates without the intervention of SA z/OS. It is a short running job that will generally, but not necessarily, terminate before SA z/OS does. It can be monitored using an ASCB check.

A TRANSIENT job, as far as monitoring is concerned, is treated as an z/OS job, but it has special properties: Transient jobs must START and END before their dependent applications are started.

Transient jobs can have shutdown passes specified if there is a possibility that they may need to be shut down by SA z/OS. These passes are optional.

Job Name

The job name is required. This gives a unique name to the application to be run. An MVS job name is defined by MVS. There is a one-to-one mapping between the MVS job name and the subsystem name. SA z/OS automation interprets messages from MVS by taking the MVS job name and mapping it to the subsystem name.

The job name may be up to eight alphanumeric and national characters, including @, #, and \$, after clone resolution, provided the first character is not numeric.

If the job type is NONMVS you can also use _ and ?.

You may include system symbols and system automation symbols (see "Assigning System Automation Symbols (AOCCLONE)" on page 42).

The special value *MASTER* is allowed for applications of type STANDARD. If the object type is CLASS then a Job Name is not allowed. See also the JCL Procedure Name if you are using replicated applications.

You may have multiple applications with the same job name but you must ensure that only one of them is linked to a certain system. Duplicates are ignored by the BUILD function.

The job name defaults to the subsystem name if possible (eight character name length and character restrictions apply).

For applications of type IMAGE the value is forced to the subsystem name.

Transient Rerun

This field specifies whether or not a transient job may be rerun within the lifetime of an SA z/OS. The Transient Rerun option introduces the concept of the *one-shot transient job*.

YES The job will be rerun as appropriate, depending on the flag settings and the IPL/RECYCLE options. SETSTATE can then be used to set it to RESTART status, and it can be part of a SHUTDOWN request with the RESTART option set to YES.

NO The job will only be run once in the lifecycle of a particular z/OS.

Note:

The job will also be rerun if the automation status file is deleted.

A NO setting can be overridden by the RECYCLEOPT=START option. If RECYCLEOPT=START is specified, then the transient job will be rerun when SA z/OS is recycled. If this is not desired, then the SA z/OS default can be enforced by omission of the RECYCLEOPT entry.

A value of NO affects the processing of the SETSTATE and INGREQ commands. NO is the default value for transient jobs.

Important Note

The following feature applies to all SA z/OS-controlled jobs, but has particular significance for one-shot transients.

On an initial automation control file load, such as at initialization, a one-shot transient will run, terminate and go to ENDED status. If a SETSTATE or INGREQ with restart is attempted it will be rejected because the status is ENDED, as the value for a one-shot is always NO.

The status information for a job can be lost if an automation control file that does not contain the job is loaded. The status information is deleted from the automation status file because the automation control file does not contain it. If the original automation control file contains a one-shot transient job then it will be restarted due to the lack of previous data in the automation status file.

If you have a job that **MUST** not run more than once, then you must take care with automation control file reloads. They must either be limited, or they must never be without the one-shot job entries.

When a one-shot job terminates and goes to ENDED status, it remains in that state across shutdowns. It also remains in ENDED state across an SA z/OS recycle if the START ON RECYCLE option is 'NO'. In this case, children may be started.

An automation control file reload causes status information about applications that are not defined in the automation control file to be forgotten. If a later reload is used to redefine the application to automation, the application status is set to DOWN. Note also that some transient statuses (such as BREAKING, ABENDING, or STOPPING) may be collapsed to their final, static state (STOPPED or BROKEN) if the application address space is not active when the status determination phase of the reload runs.

Scheduling Subsystem

This is optional. It is the name of the subsystem that is to schedule this application, as follows:

MSTR Indicating that the application is scheduled directly by the MVS/ESA master scheduler.

blank Indicating that the application is scheduled by the primary JES.

other Indicating that the application is scheduled by another scheduling subsystem. The value entered is the name of that subsystem. The subsystem specified must be defined as being type JES2 or JES3.

For applications of type IMAGE the value is forced to blank.

JCL Procedure Name

The JCL Procedure Name is optional. This specifies the name of the JCL procedure used to create this instance of the application. If specified, the default start command for the application will be:

```
MVS S procname,JOBNAME=jobname
```

where *procname* is the JCL Procedure Name and *jobname* is the Job Name specified above. If no JCL Procedure Name is specified, the default start command is:

MVS S *jobname*

You may include system symbols and system automation symbols (see “Assigning System Automation Symbols (AOCCLONE)” on page 42).

For applications of type IMAGE the value is forced to blank.

Policy Items for Applications

Figure 106 shows the policy items that are displayed when an Application is selected from the *Entry Name Selection* panel.

Some of the policy items may be set for all application automation on a certain system. As an example, *Thresholds* can be set to a default value for all applications. If the definition of an application has no value specified for Thresholds, the value specified as the *Application Defaults* is used. If no value is specified in the *Application Defaults* any value specified in *System Defaults* is used. See also “Application Defaults Policy Object” on page 272 and “System Defaults Policy Object” on page 270.

```

ACTIONS  HELP
-----
AOFGEPOL                Policy Selection                Row 1 to 20 of 20
Command ==>>>          SCROLL==>>> PAGE

Entry Type : Application      PolicyDB Name  : DATABASE_NAME
Entry Name  : APPL1          Enterprise Name : YOUR_ENTERPRISE

Action      Policy Name      Policy Description
-----
LINK TO CLASS      LINK TO CLASS      Link instance to class
APPLICATION INFO   APPLICATION INFO   Define application information
AUTOMATION INFO   AUTOMATION INFO   Define application automation information
AUTOMATION FLAGS  AUTOMATION FLAGS  Define application automation flags
TRIGGER           TRIGGER           Select trigger
SERVICE PERIOD   SERVICE PERIOD    Select service period
RELATIONSHIPS     RELATIONSHIPS     Define relationships
MESSAGES/USER DATA  MESSAGES/USER DATA  Define application messages and user data
STARTUP           STARTUP           Define startup procedures
SHUTDOWN          SHUTDOWN          Define shutdown procedures
THRESHOLDS        THRESHOLDS        Define error thresholds
MINOR RESOURCE FLAGS  MINOR RESOURCE FLAGS  Define application sub-component flags
SYSTEM ASSOCIATION  SYSTEM ASSOCIATION  Define primary and secondary associations
-----RESOURCES-----
GENERATED RESOURCES  GENERATED RESOURCES  List resources generated for this entry
MEMBER OF           MEMBER OF           List resources where this entry is a member
-----
WHERE USED          WHERE USED          List application groups linked to this entry
COPY               COPY               Copy data from an existing entry
***** Bottom of data *****

```

Figure 106. Applications Defined as Instance Objects and of Type STANDARD

The unique policy items for Applications are:

LINK TO CLASS

This field is displayed if the application was defined as an INSTANCE (refer to “Creating a New Application” on page 145). It lists all entries that were defined as resource classes and allows you to select one class to which this resource instance should be linked.

Application Policy Object

LINK TO INSTANCES

This policy item is displayed if the application was defined as a CLASS (refer to “Creating a New Application” on page 145). It lists all instance entries with the instances that are currently linked to this class displayed with SELECTED under the status column. You can add or remove instances linked to this class.

APPLICATION INFO

This policy item displays the *Application Information* panel, which shows the policy for the current application as entered when it was created. You can edit a part of the policy information on this panel. The fields that contain policy information that you must not modify are read-only. To change read-only information, you must delete and recreate the application. Refer to “More about Policy Item APPLICATION INFO” on page 154 for more information.

AUTOMATION INFO

This policy item is used to define the application to SA z/OS automation. Refer to “More about Policy Item AUTOMATION INFO” on page 157 for an example and the description of the panel that is displayed when the AUTOMATION INFO policy item is selected.

AUTOMATION FLAGS

Automation flags allow you to enable and disable automation. You can disable automation for specific time periods or turn it off entirely. You can also enable or disable automation for specific automation phases, such as Initstart, Start, Recovery, Shutdown, and Restart, and for responses to specific messages and status changes within these phases.

Determine whether the automation flags currently set for your system at the system wide defaults and application levels are appropriate for this application. If they are not, define one or more application automation flags in either the application instance or class policy object. For more information, refer to “More about Policy Item AUTOMATION FLAGS” on page 162 and “Automation Flags” on page 34.

TRIGGER

Each application may be linked to one trigger. This policy item allows you to link the current application to a trigger. Only one trigger can be selected.

Triggers are used to control the starting and stopping of applications in a single system or a Parallel Sysplex. They determine the behavior of the requested action. For an application to be started, its desired status must be AVAILABLE and its startup trigger must be satisfied.

For an application to be stopped, its desired status must be UNAVAILABLE and its shutdown trigger must be satisfied. For more information on how to use triggers, refer to “More about Policy Item TRIGGER” on page 164 and “Event and Trigger Support” on page 39.

SERVICE PERIOD

Service periods allow users to schedule the availability of applications, application groups, or monitor resources. With this policy item you can link a service period to the application so that it is automatically started up or shut down in the time frame specified with the service period. For more information, refer to “More about Policy Item SERVICE PERIOD” on page 164.

RELATIONSHIPS

Relationships are used to define dependencies between resources that are

used to perform in a controlled way startup or shutdown actions of dependent and supporting applications, application groups, and monitor resources.

This policy item has the same functionality for entry types *Application*, *ApplicationGroup*, and *Monitor Resource*. For each application, application group, or monitor resource you may specify several relationships. If you select this policy item, in the upcoming *Relationship Selection List* panel, you can view existing or define new relationships for the current application, application group, or monitor resource.

You define relationships between dependent resources and supporting resources. In the customization dialog you define relationships always from the point of view of the dependent resource. So the resource that you have currently selected will become the dependent resource, when you define a new relationship.

Refer to “More about Policy Item RELATIONSHIPS” on page 132 for more information on viewing or defining dependency relationships.

MESSAGES/USER DATA

This policy item allows you to specify automated actions, such as the issuing of a command or reply, to be taken in response to a message issued by the application.

You can also specify some of the application statuses as messages to trigger any command of your choice.

How to proceed in specifying this policy item is described in “More about Policy Item MESSAGES/USER DATA” on page 165.

STARTUP

This policy item allows you to add, remove or modify startup procedures for the current application. Refer to “More about Policy Item STARTUP” on page 175 for more information how to specify the startup automation policy.

SHUTDOWN

You must specify NORMAL shutdown commands for any application that you want to automate with SA z/OS. You may also specify INIT, IMMED, FORCE, and FINAL shutdown commands.

Specifying shutdown commands or replies for the application allows the automation to perform application shutdowns. You can specify different shutdown commands or replies to be issued for the different types of shutdown situations. How to achieve this is described in “More about Policy Item SHUTDOWN” on page 179.

THRESHOLDS

Error threshold definitions for an application define how manyabend errors can occur before a message is logged or restart processing is stopped. If no error thresholds are set here, the application uses the thresholds defined in the *Application Defaults* policy object.

Determine whether existing default threshold values are appropriate for this application. If they are not appropriate, create a unique threshold entry for the application. For more information on thresholds, see “How SA z/OS Uses Error Thresholds” on page 31.

MINOR RESOURCE FLAGS

This policy item allows you to define flags for minor resources for the

Application Policy Object

application. Minor resources are any resources specified to be subsidiary to this application, for example, messages and statuses.

The main purposes in defining minor resources are to let you:

- Trigger automation for minor resources
- Override the automation settings of major resources for a single minor resource, or a select number of minor resources

See the description of the policy item MINOR RESOURCE FLAGS in “MVS Component Policy Object” on page 262 for information on how to manage minor resources.

The automation flags associated with minor resources are sometimes called extended automation flags. See “Automation Flags and Minor Resource Flags” on page 39 for information about them.

SYSTEM ASSOCIATION

This policy item allows you to define primary and secondary systems for the application. Primary and secondary categorizations help SA z/OS determine whether or not an application should be started by SA z/OS when SA z/OS is initialized on a system. These categories allow SA z/OS to perform automation, such as monitoring or shut down, on applications that can be moved by an external agent. For a detailed description on how to define system categories with this option refer to “More about Policy Item SYSTEM ASSOCIATION” on page 187.

GENERATED RESOURCES

This policy item lists all resources that were generated for the current application. Application resources are generated when a link between an application and a system occurs. Applications can never be linked directly to systems. This link happens indirectly by linking an application to an application group (either in an application’s WHERE USED policy item or in an application group’s APPLICATIONS policy item.)

The *GENERATED RESOURCES* panel is displayed which looks similar to the one shown in Figure 103 on page 144, however, the part *Resources for THIS entry*, showing the application group resource is missing.

MEMBER OF

This policy item lets you see the APG-Resources of which the current application is a member. Refer to “More about Policy Item MEMBER OF” on page 144 for more details.

More about Policy Item APPLICATION INFO

If you select the APPLICATION INFO policy item from the Policy Selection panel for Applications, the Application Information panel is displayed, as shown in Figure 107 on page 155.

```

COMMANDS  HELP
-----
                                Application Information
Command ==> _____

Entry Type : Application          PolicyDB Name  : DATABASE_NAME
Entry Name  : APPL1              Enterprise Name: YOUR_ENTERPRISE
                                           More:      +
Application Type . . . . . STANDARD (STANDARD IMAGE JES2 JES3
                                       CICS IMS DB2 OPC USS)
                                       (For CICS, IMS, DB2, OPC only)
Subtype . . . . . _____
Subsystem Name . . . . . APPL1
Job Type . . . . . _____ (MVS NONMVS TRANSIENT)
Job Name . . . . . APPL1
Transient Rerun. . . . . _____ (YES NO)
Scheduling Subsystem . . . . . _____ (MSTR, JES Subsystem or blank)
JCL Procedure Name . . . . . _____
Captured Messages Limit. . . . . _____ (0 to 999, or blank)
ARM Element Name . . . . . _____
WLM Resource Names . . . . . _____

Owner. . . . . _____

```

Figure 107. Application Information Panel

This panel displays the following information:

Subsystem Name

Name Gives a unique, eleven character name to the Application you are defining. This name is used by SA z/OS automation. You may have multiple applications with the same subsystem name. However, only one of them can be linked to a system.

You can change the subsystem name by overwriting the existing name. If the application is linked, the name will be checked to be unique within all subsystem names of the policy database. If you want to change the subsystem name to a name that exists already, you need to unlink the application from all application groups first.

If no subsystem name is specified, the default is the value of the Entry name (if this name is not longer than 8 characters for applications of type IMAGE, and not longer than 11 characters for all other application types).

For applications of type IMAGE the subsystem name can only be an 8 character name.

Note:

Certain values are reserved for SA z/OS and cannot be used. Refer to the online help for a complete list.

Object Type

Refer to “Object Type” on page 147 for more details.

Application Type

Refer to “Application Type” on page 147 for more details.

Subtype

Refer to “Subtype” on page 148 for more details.

Job Type

Refer to “Job Type” on page 148 for more details.

Application Policy Object

Job Name

Refer to “Job Name” on page 149 for more details.

Transient Rerun

Refer to “Transient Rerun” on page 149 for more details.

Scheduling Subsystem

Refer to “Scheduling Subsystem” on page 150 for more details.

JCL Procedure Name

Refer to “JCL Procedure Name” on page 150 for more details.

Captured Messages Limit

Specifies the maximum number of ‘captured messages’ which will be saved for the SA z/OS command DISPINFO.

If the field is left blank the value can be inherited from a class or the systems default definition. If neither of them are specified a default value of 0 will be used.

MVS Automatic Restart Management Element Name

An application defined to MVS Automatic Restart Manager must have an element name that is unique within each sysplex where the application runs. Each element name consists of up to 16 alphanumeric and national characters including @,#,\$ and _ (underscore) after clone resolution, provided the first character is not numeric. Clone resolution occurs at automation control file load.

You may include system symbols and system automation symbols. For more details, see “Assigning System Automation Symbols (AOCCLONE)” on page 42.

The element name can be:

Constant

The element name is the same, regardless of which system the application is running on. This is required for applications that are restartable on multiple systems in the sysplex. An application with a constant Automatic Restart Manager element name may at the same time have a cloned job name.

Note:

An application with a cloned job name and a constant Automatic Restart Manager element name can be started on only one system within a sysplex.

For applications of type IMAGE the value is forced to blank.

Cloned

The application has a different element name on each system. The element name is derived from some attribute that is unique to the system on which the application runs. Applications with cloned element names must be defined to MVS Automatic Restart Manager in such a way that MVS will only attempt to restart them on the same system and not move them to other systems in the sysplex.

Applications with cloned element names may have constant job names. This can be useful if you want to have the same application running on multiple systems with Automatic Restart Manager recovery enabled.

For example, you have a USERPROC that runs on all your systems and you want Automatic Restart Manager recovery for it. Automatic restart management requires that USERPROC have a different element name on each system. Defining USERPROC to SA z/OS with a constant job name, but with a cloned element name (and perhaps some parameters to define the element name) allows you to define a single SA z/OS application with a different element name on each system.

WLM Resource Names

These are the names of the WLM Resources that are associated with the application. When the application is in either the UP or ENDED automation status, the resource will be set ON. When the application is in any other status, the resource will be set OFF.

You may include system symbols and system automation symbols, see "Assigning System Automation Symbols (AOCCLONE)" on page 42. A maximum of 3 different WLM resource names may be specified.

For applications of type IMAGE the value is forced to blank.

Owner

This specifies information for the operator about who to contact in case of error.

More about Policy Item AUTOMATION INFO

Panel *Application Automation Definition* is displayed (as shown in Figure 108), if you select the policy item *AUTOMATON INFO* from panel *Policy Selection* for the *Application* entry type.

```

COMMANDS  HELP
-----
Application Automation Definition
Command ==> _____

Entry Type : Application          PolicyDB Name : DATABASE_NAME
Entry Name : APPL1              Enterprise Name : YOUR_ENTERPRISE
                                     More:      +

Command Prefix . . . . . _____
Message Prefix . . . . . _____
Sysname . . . . . _____ (System name)
Enter monitor information:
Monitor Routine. . . . . _____ (name NONE)
Periodic Interval. . . . . _____ (hh:mm NONE)
Enter startup information:
Start on IPL . . . . . _____ (YES NO NONE blank)
Start on Recycle . . . . . _____ (YES NO NONE blank)
Start Timeout . . . . . _____ (time for "UP" status checks, hh:mm:ss)
Start Cycles . . . . . _____ (start timeout checks, 0 to 99)
Restart Option . . . . . _____ (ALWAYS ABENDONLY NEVER)
External Startup . . . . . _____ (INITIAL ALWAYS NEVER blank)
Enter shutdown information:
External Shutdown. . . . . _____ (FINAL ALWAYS NEVER blank)
Shutdown Delay . . . . . _____ (hh:mm:ss)
Cleanup Delay . . . . . _____ (hh:mm:ss)
    
```

Figure 108. Application Automation Definition Panel

This panel contains the following fields:

Application Policy Object

Command Prefix

This is the console prefix character for the application. Many applications, such as JES2, JES3, and NetView support the use of a command prefix character which identifies a command as belonging to that application. If such support is available for this application, enter the corresponding command character.

Any command that would normally be issued at a z/OS console should be prefixed with MVS. NetView commands to control NetView automation do not require the MVS prefix.

You may include system symbols and system automation symbols, see “Assigning System Automation Symbols (AOCCLONE)” on page 42.

Note:

The single quotation character (') is reserved for SA z/OS and should not be used.

Message Prefix

Specifies one or more message prefixes for this application. You only have to specify these message prefix(es) if the application issues messages that do not contain the MVS job name. These message prefixes must be unique for this application.

Sysname

The system name for the subsystem. This is only required for JES subsystems where the Sysname for the subsystem is not the same as the MVS Sysname. If Sysname is not specified, it will default to the name specified in the AUTOMATION SETUP policy item of the *System* policy object.

Monitor Routine

The name of the application monitor routine used to monitor this application’s status. If you leave this field blank, the default application monitor routine is the routine that you may globally specify for a system for all applications that run on this system. You achieve this on the system’s *Environment Setup* panel (see “More about Policy Item AUTOMATION SETUP” on page 117). If an application belongs to an application class, inheritance from the class overrides the *Environment Setup* default. For valid application monitor routines provided by SA z/OS refer to “More about Policy Item AUTOMATION SETUP” on page 117. You can, however, specify a user-written monitor routine, or enter NONE if you do not want this application to be monitored.

The following specifications are valid:

INGPJMON

Monitors status via ASCB checking.

AOFADMON

Monitors status via MVS D A commands. This should be avoided.

AOFATMON

Monitors status of a task in the NetView environment.

AOFUXMON

Routine used to monitor USS applications.

AOFAPMON

Routine used to monitor a PPI receiver.

AOFCPSM

Dedicated routine used to monitor SA z/OS Processor Operations.

INGMTSYS

Dedicated routine used to monitor IMAGE applications for BCPII usage.

ISQMTSYS

Dedicated routine used to monitor SA z/OS processor operations target system resources.

NONE

No monitoring routine is to be used.

username

A user-defined and created monitoring routine.

Note:

If a user-defined routine is not found by automation, the SA z/OS routine INGPJMON is used except for applications of type IMAGE. In this case INGMTSYS is the default.

If this application is linked to an application CLASS entry which has the Monitor Routine specified, the CLASS policy takes precedence over the Environment Setup policy.

Periodic Interval

This is the amount of time between application subsystem monitoring cycles. Monitoring may be suspended by specifying NONE.

Start on IPL

Specifies how SA z/OS determines the initial status of the application on the first occasion that SA z/OS is started after a z/OS IPL or an automation status file reallocation.

Reallocating the automation status file has the same effect as a z/OS IPL because SA z/OS stores the last IPL date and time in the automation status file. When the automation status file is deleted, SA z/OS assumes that the next startup is the first startup following a z/OS IPL.

You can specify four values for Start on IPL:

- YES** The application is always startable when the start dependency is fulfilled. The application status is set to DOWN during initialization. It is recommended that you specify YES for critical applications such as JES, VTAM, and TSO. Replying NOSTART to message AOF603D (specify initialization options) overrides this setting.
- NO** The application is always non-startable. The application status is set to CTLDOWN during initialization, and you must use the SETSTATE command to instruct SA z/OS to restart it.
- blank** The application is startable, depending on the status recorded for it in the automation status file. If the status is STOPPING, STOPPED, BREAKING, BROKEN, or CTLDOWN, it is not changed and the application is not started. Any other status is changed to DOWN during initialization. If the INITSTART automation flag is yes, the

Application Policy Object

application is started when its start dependency is fulfilled. This default setting is indicated as MAYBE on the SA z/OS display for the DISPINFO command.

NONE

This value is the same as blank except that this application, if it is an instance, does not inherit the value from its related application class.

Start on Recycle

The Start on Recycle option specifies how SA z/OS determines the initial status of the application when SA z/OS is re-initialized on a system that has not had an MVS IPL since SA z/OS was shut down.

You can specify four values for Start on Recycle:

YES The application is always startable when the start dependency is fulfilled. The application status is set to DOWN during initialization. It is recommended that you specify YES for critical applications such as JES, VTAM, and TSO. Replying NOSTART to message AOF603D (specify initialization options) overrides this setting.

NO The application is always nonstartable. The application status is set to CTLDOWN during initialization, and you must use the SETSTATE command to instruct SA z/OS to restart it.

blank The application is startable, depending on the status recorded for it in the automation status file. If the status is STOPPING, STOPPED, BREAKING, BROKEN, or CTLDOWN, it is not changed, and the application is not started. Any other status is changed to DOWN during initialization. If the INITSTART automation flag is yes, the application is started when its start dependency is fulfilled.

NONE

This value is the same as blank except that this application does not inherit the value from its related application class.

Start Timeout

The start timeout interval that begins when SA z/OS issues a start command for an application. If the application fails to reach UP status in this time, an application monitor check is performed and the application's status is set to STARTED2 if the application has been started or to INACTIVE if the application is not found. Message AOF571 is issued with a description of the situation. The default value for Start Timeout is 2 minutes.

Start Cycles

Specifies the number of times to cycle the start timeout period before posting the subsystem as a problem. The default value for Start Cycles is 1.

Restart Option

The circumstances under which the application should be restarted. The options are:

Always

The application is restarted if it was terminated without using the INGREQ command. Note that, if the advanced automation option AOFRESTARTALWAYS is set to 0, the application restart thresholds are checked. The application is restarted only if it has not exceeded

the critical threshold. By default the application is restarted every time it is stopped outside the control of SA z/OS.

Abendonly

The application is eligible for restart only if it abnormally ends. The application is restarted only if its critical error threshold has not been exceeded.

Never The application is never eligible for restart by SA z/OS.

You can use this option to force a specific application state. For example, if an application is defined with the restart option set to Always and an operator tries to shut down the application without using the INGREQ command, the application will be restarted when it has completed its shutdown. The AOFRESTARTALWAYS advanced automation option can be used to modify this behavior.

External Startup

Specifies whether the application is started externally or via a specified startup procedure.

INITIAL

The application will only initially be started externally.

ALWAYS

The application will always be started externally.

NEVER

The application will never be started externally.

blank Indicates that the value can be inherited from an application CLASS entry.

| For applications of type IMAGE where the monitor routine is INGMTSYS
| the value is forced to ALWAYS.

External Shutdown

Specifies whether the application is stopped externally or via a specified shutdown procedure.

FINAL

The application will be stopped externally if the external supporting resource (parent) is also being stopped.

ALWAYS

The application will always be stopped externally.

NEVER

The application will never be stopped externally.

blank Indicates that the value can be inherited from an application CLASS entry

| For applications of type IMAGE where the monitor routine is INGMTSYS
| the value is forced to ALWAYS.

Shutdown Delay

The time delay between attempts to perform automated shutdown of an application. Automation can perform multiple passes of shutdown attempts. This value relates to shutdown commands specified for the application. The MDFYSHUT command can be issued on shutdown passes to change the timing between consecutive passes.

Application Policy Object

Cleanup Delay

The delay between application monitoring checks performed by SA z/OS after the final termination message (TERMMSG FINAL=YES) for an application is processed. The termination procedure is as follows:

1. When SA z/OS receives the final termination message for an application, it waits for the period defined in the AOFPAUSE global variable before performing its first application monitoring check. (See *System Automation for z/OS Customizing and Programming* for more information on AOFPAUSE.)
2. If the application monitoring check shows that the application is still active, it will wait for the period specified in Cleanup Delay and try again. This will be repeated if necessary.
3. If, after two checks, an application monitor check still finds the application to be active, the application will be posted to ZOMBIE status and periodically rechecked at increasing intervals.

The default value for the Cleanup Delay is 12 seconds.

More about Policy Item AUTOMATION FLAGS

The Flag Automation Specification panel Figure 109 is displayed if you select policy item AUTOMATION FLAGS from the *Policy Selection* panel for applications. For more details about automation flags, refer to "Automation Flags" on page 34.

```
COMMANDS  ACTIONS  HELP
-----
Flag Automation Specification
Command ==> _____

Entry Type : Application          PolicyDB Name : DATABASE_NAME
Entry Name : APPL1                Enterprise Name : YOUR_ENTERPRISE
                                     More:      +

Resource: APPL1
Enter level of automation desired.

Automation Flags: Y = Yes      N = No      E = Exits
Assist Flags:     D = Display  L = Log    N = None

Actions  Flag      Auto      Assist     Exits
-----  -
Automation . _____ _____ 0
Recovery . . _____ _____ 0
Start. . . . _____ _____ 0
ShutDown . . _____ _____ 0
Initstart. . _____ _____ 0
Restart. . . _____ _____ 0

Enter or Display times to disable automation . . NO _____ Yes No
```

Figure 109. Flag Automation Specification Panel

This panel allows you to specify:

- The types of automation mode.
- Whether any automated operator functions will operate in assist mode.
- Whether user-provided exit routine(s) are to be called to determine whether or not automation is to continue.
- When automation occurs.

There are six types of automation flags supported by SA z/OS:

Automation

Is the general automation flag that must be yes for the remaining flags to be used. If it is 'NO', there is no automation for the resource.

Recovery

Indicates whether recovery of the resource (actions on messages that are neither for the initialization nor the ending of the resource) is allowed.

Start Indicates whether actions or responses to initialization for the resource are allowed.

ShutDown

Indicates whether actions on or responses to ending messages are allowed.

InitStart

Indicates whether a resource can be started when its state is DOWN (controls initial starting of the resource).

Restart

Indicates whether the restarting of a resource that abnormally ended or was automatically shutdown is allowed.

For each flag you may specify:

Action

The Action field is an input field through which you can enter either the full action name or fast key symbol (as denoted in the ACTIONS action bar choice) that you want to perform, or enter 'S' and select the action from the ACTIONS action bar.

The action that can be performed is SELECT (S) - selects the flag to define or delete Exits.

Auto Controls whether particular automated responses are allowed:

YES Indicates that automation is active.

NO Indicates that automation is not active.

EXITS Indicates that there are one or more user-provided exits routines defined.

Note:

If no value is specified the ASSIST and EXITS specifications are *not* built into the ACF.

Assist Defines the operator assist mode for each of the specific automation states:

DISPLAY

Turns on assist mode for the chosen type of automation (for example, START or RECOVERY). The normal actions that should be taken under the chosen type of automation do not occur, but messages describing what would have happened appear in the log and Status Display Facility (SDF) is updated.

LOG Operates in the same way as DISPLAY, except that it only writes to the log (no SDF display).

NONE

Indicates that Assist mode is not operational with this choice; all commands are issued normally.

NONE is the default.

Note:
Assist is not used on the general automation flag. An entry in this field is moved over to all the other specific flags.

The **Exits** field displays the number of exits defined.

If you want to enable automation but specify times when it should be disabled, you can enter YES in the final input field. Another panel will be displayed where you can specify one or more time ranges when automation will be disabled.

More about Policy Item TRIGGER

The Trigger for Application panel Figure 110 is displayed if you select policy item TRIGGER from the *Policy Selection* panel for applications. For more details about triggers, refer to “Event and Trigger Support” on page 39.

```
COMMANDS ACTIONS VIEW HELP
-----
Command ==> Trigger for Application Row 1 to 4 of 4
SCROLL==> PAGE

Entry Type : ApplicationGroup PolicyDB Name : DATABASE_NAME
Entry Name : APPL1 Enterprise Name : YOUR_ENTERPRISE

Action Status Trigger
-----
CICSK34
CICSK42
TRIGGER1
XRFTRIG
***** Bottom of data *****
```

Figure 110. Trigger for Application Panel

Here you can add triggers to or remove them from an application.

More about Policy Item SERVICE PERIOD

If you select an application’s SERVICE PERIOD policy item, you reach the Service Period for Application panel. Figure 111 shows an example.

```
COMMANDS ACTIONS VIEW HELP
-----
Command ==> Service Period for Application Row 1 to 6 of 6
SCROLL==> PAGE

Entry Type : ApplicationGroup PolicyDB Name : DATABASE_NAME
Entry Name : APPL1 Enterprise Name : YOUR_ENTERPRISE

Action Status Service Period
-----
SELECTED
CICSK42
IMS711C4
IMS712CX
IMS722CX
IM631C4
SERVP1
***** Bottom of data *****
```

Figure 111. Service Period for Application Panel

Here you can add service periods to or remove them from an application.

More about Policy Item RELATIONSHIPS

The *Relationship Selection List* panel (Figure 99 on page 132) is displayed if you select policy item RELATIONSHIPS from the *Policy Selection* panel for application groups. It shows information about existing relationships and allows you to define new relationships.

The ACTION pull-down choice offers actions to edit and delete selected relationships. The Delete command immediately deletes the relationship. The Edit command leads to the *Define Relationship* panel (as shown in Figure 112).

```

COMMANDS  ACTIONS  VIEW  HELP
-----
AOFGXREL          Relationship Selection List
Command ==> _____

Entry Type : Application          PolicyDB Name : DATABASE_NAME
Entry Name  : APPL1              Enterprise Name : YOUR_ENTERPRISE

Action #  Type          Supporting Resource          Auto  Chain
-----  -  -
   1     HASPARENT      VTAM/APL/=
   2     MAKEAVAILABLE  S/APG/=                      ACTIVE WEAK
***** Bottom of data *****

```

Figure 112. Relationship Selection List Panel

This panel displays information about existing relationships. In all of the relationships for the current resource, this resource is the dependent resource. The columns have the same meaning as described in “Defining Relationships” on page 132.

Entering the *NEW* command from this panel to define new relationships takes you to the *Define Relationship* panel described in “Defining Relationships” on page 132.

More about Policy Item MESSAGES/USER DATA

If you select policy item MESSAGES/USER DATA from the *Policy Selection* panel for Applications (Figure 106 on page 151), the *Message Processing* panel shown in Figure 113 on page 166 is displayed.

Application Policy Object

ACTIONS HELP		Message Processing		Row 1 to 7 of 25	
Command ==>				SCROLL==> PAGE	
Entry Type :	Application	PolicyDB Name :	DATABASE_NAME		
Entry Name :	APPL1	Enterprise Name :	YOUR_ENTERPRISE		
Define message IDs and their automation actions.					
CMD = Command REP = Reply CODE = CODE USER = User Data					
AUTO = AT Actions OVR = AT Override					
Action	Message ID	Cmd	Rep	Code	User Auto Ovr
cmd	AUTODOWN				*
	Status commands				
	ACORESTART	2			*
	Status commands				
	CTLDOWN	2			*
	Status commands				
	DFS0769I			4	*
	SENDING A MAIL				
	DFS0844I		1	5	
	SENDING A MAIL				
	DFS554A		5	9	
	SENDING A MAIL				
	DFS690A	1			*
	Waiting for IMS CTL-Region				

Figure 113. Message Processing Panel

On the *Message Processing* panel, you specify how SA z/OS should react if the application issues the specified message. You can type one of the following types of message response into the *Action* column. Depending on what you type here, SA z/OS displays a follow-on panel where you further specify SA z/OS's automated reaction to the message.

For each of the automated responses, an entry in the NetView automation table is required that specifies which routine SA z/OS should be used to process your specified action. SA z/OS is able automatically to build the NetView AT entries for all CMD, REPLY, AUTO, and OVR actions as well as for certain USER and CODE actions.

Information about how to manage the NetView automation table is given in *System Automation for z/OS Customizing and Programming*.

The following actions are available:

CMD For issuing commands as a response to a message, see "CMD Processing" on page 168.

REP For issuing replies, see "Reply Processing" on page 169.

CODE If you want check for certain codes within the message. If the codes are contained in the message, you can enter a value that is returned to the calling CLIST, see "Code Processing" on page 170.

USER You can use the associated panel to let SA z/OS perform user-specified actions if the current message requires more specific automation than provided by the generic routines (see "User Defined Data" on page 172).

Using the ACFFQRY common routine from within a CLIST, you can retrieve the keywords entered into this panel and process them as needed. Syntax rules for specifying user data are available in the online help. For

information on how to use ACFFQRY in a CLIST refer to ACFFQRY in *System Automation for z/OS Programmer's Reference*.

AUTO

You can use the associated panel to specify messages that indicate the status of a resource, see "AUTO Processing" on page 173. Once messages have been defined, they are automatically added to the NetView automation table.

OVR This allows you to override a default NetView automation table entry generated for a message, see "Overriding Message Automation" on page 174.

Notes:

1. AUTO cannot be defined in combination with OVR.
2. The AUTO action allows you to define Ignore or Suppress, which will prevent the building of an AT entry for the message.

Reserved Message IDs

With the following message IDs and also with any of the SA z/OS defined keywords you can invoke a special SA z/OS automation:

- AMRFSHORT
- AMRFFULL
- AMRFCLEAR
- CAPMSGs
- VTAMUP
- NODEUP
- ACORESTART (which is associated with action *CMD*)
- WTORS
- MVSDUMPTAKEN
- MVSDUMPRESET
- MVSDUMP
- SMFDUMP
- LOGREC
- SYSLOG
- Any of the system operations statuses

You can also specify a short description of the action that the response performs.

Note:

For product automation (that is, DB2, CICS, IMS, OPC) there are further keywords defined. For details see *System Automation for z/OS CICS Automation Programmer's Reference and Operator's Guide*, *System Automation for z/OS IMS Automation Programmer's Reference and Operator's Guide*, and *System Automation for z/OS OPC Automation Programmer's Reference and Operator's Guide*.

For product automation, the following reserved message IDs exist:

- for CICS:

Application Policy Object

- | - ABCODETRAN (.xxxxx, where xxxxx is the optional transaction name)
| Additional transaction keyword dropped
- | - HEALTHCHK
- | - LISTSHUT
- | - RCVRSOS
- | - RCVRTRAN (.xxxxx, where xxxxx is the optional transaction name)
| Additional transaction keyword dropped
- | • for IMS:
 - | - ABCODETRAN (.xxxxx, where xxxxx is the optional transaction name)
| Additional transaction keyword dropped
 - | - ABCODEPROG (.xxxxx, where xxxxx is the program name) Additional
| program keyword dropped

| For a list of keywords for which no AT entries are built, see App C.

For more information on how to use these various methods of message processing refer to *System Automation for z/OS Customizing and Programming*.

CMD Processing

SA z/OS displays the *CMD Processing* panel if you entered the action code *CMD* into the *Action* column from panel *Message Processing*.

```
COMMANDS  HELP
-----
                                CMD Processing                Row 1 to 2 of 20
Command ==> _____ SCROLL==> PAGE

Entry Name : APPL1                Message ID : AUTODOWN

Enter commands to be executed when resource issues the selected message.
or define this message as status message.

Status . . . _____ ('?' for selection list)

Pass/Selection Automated Function/'*'
Command Text
FREQ
MSG SYSOP '==> JES3ABEND FREQ ALERT <=='
```

```
CRIT
MSG SYSOP '==> JES3ABEND CRIT ALERT <=='
```

Figure 114. *CMD Processing Panel*

Use this panel to enter commands that are executed when the application issues the previously specified message. If you specify one of the SA z/OS provided automation commands (described in *System Automation for z/OS Operator's Commands*), they should be queued using the NetView CMD LOW command. This ensures that TGLOBALs in use by the calling automation procedure are not changed by the calling command.

For a list of TGLOBALs that can be used to be substituted into each command, prior to execution, refer to ACFCMD in *System Automation for z/OS Programmer's Reference*.

The *CMD Processing* panel has a *Status* field that defines a resource status indicated by the Message ID. Valid values are displayed in a selection list if either a question mark or unknown status information is entered.

Any value contained in the selection list can be directly defined in the status field. Alternatively, this field allows you to mark the message to be captured, ignored, or suppressed. If it is to be ignored or suppressed, no NetView Automation Table entry will be generated. No data is accepted in this field if an override (OVR) action exists.

The value entered in the *Pass/Selection* field defines when the command or reply should be issued. The use of this field is as follows:

Pass Enter a number from 1 through 99 or an asterisk (*) in this field in order to specify a Pass value. During the build of the automation control file, this value will be prefixed with 'PASS' to create the selection criteria for the CMD or REP entry.

Selection

An expression other than a Pass is considered a Selection value and will be unaltered during the build process. A Selection value can be blank or any name that does not begin with a number or contain imbedded blanks, commas, quotes, or parentheses.

Automated Function/'**

Enter the name of the automated function under which the command is to run. If the field is left blank, the function defaults to the one currently running the command list. SA z/OS automated functions are mapped to NetView automation operators. This is documented in Table 8 on page 274.

Note:

Entering a '*' enables return code checking for the specified command. This means, processing continues if the command returns a return code of 0, in all other cases the processing is stopped immediately. If running in ASSIST mode, return code checking is disabled.

Command Text

Enter the command or command list to be issued. Any system command must be prefaced with MVS.

Pass or Selection values can be repeated for multiple text entries. Each set of entries with the same pass or selection form a Command Group.

In the NetView automation table the ISSUECMD routine is normally generated to process this kind of message. For more details, see ISSUECMD in *System Automation for z/OS Programmer's Reference*.

Reply Processing

SA z/OS displays the *Reply Processing* panel if you entered the action code REP into the *Action* column from panel *Message Processing*.

Application Policy Object

```
COMMANDS  HELP
-----
                                Reply Processing                                Row 1 to 8 of 20
Command ==> _____                                SCROLL==> PAGE

Entry Name : APPL1                                Message ID : ARC0055A

Enter the replies to be issued when this resource issues the selected message
or define this message as status message.

Status . . . _____ ('?' for selection list)

Pass/      Retry Reply Text
Selection  Count
-----  -  -----
_____  -  _____
_____  -  _____
_____  -  _____
_____  -  _____
_____  -  _____
_____  -  _____
_____  -  _____
```

Figure 115. Reply Processing Panel

Use this panel to enter the replies to be issued when this resource issues the previously specified message.

The REP entry panel has the *Status* field, as described in “CMD Processing” on page 168.

The use of the *Pass* or *Selection* field is similar to that described in “CMD Processing” on page 168. Pass or Selection values can be repeated for multiple text entries. Each set of entries with the same pass or selection forms a Reply Group.

In the NetView automation table the ISSUEREPE routine is normally generated to process this kind of message. For more details, see ISSUEREPE in *System Automation for z/OS Programmer's Reference*.

Additionally, there are the following fields:

Retry Count

Enter a number in the range from 1 to 99 in this field to define the retry attempts to be made before the common routine decides that a reply cannot be issued. A retry occurs when the outstanding reply number is not available. There is a two second time delay between each retry. The default retry count is 0.

Reply Text

Type into this field the actual reply to the message. Enter it in the same format as you would do from an MVS console (without the R and the reply number). To specify a null reply, type NULL in this field.

Code Processing

SA z/OS displays the following panel if you entered the action code *CODE* in the *Action* column from panel *Message Processing*.

```

COMMANDS  HELP
-----
Code Processing                               Row 1 to 10 of 20
Command ==> _____ SCROLL==> PAGE

Entry Name : NETVIEW                          Message ID : WTOR5

Enter the value to be passed to the calling CLIST when this resource
issues the selected message and the following codes are contained in
the message.

Code 1      Code 2      Code 3      Value Returned
-----
DSI802A     *                _____    NORMAL
DSI803A     *                _____    NORMAL
*           *                _____    IMPORTANT SEC
_____
_____
_____
_____
_____
_____

```

Figure 116. Code Processing Panel

Use this panel to enter the value to be passed to the calling CLIST when the resource issues the previously specified message and the codes you specify in this panel are contained in the message. Your CLIST can call the common routine CDEMATCH to compare data with the information placed in the CODE fields. You can use the override action to define the associated AT entry.

For non-predefined message automation use the CDEMATCH routine in the NetView automation table to process this kind of message. For more details, see CDEMATCH in *System Automation for z/OS Programmer's Reference*.

The entry fields in the *Code Processing* panel have the following purpose:

CODE1, 2, 3

Data entered in these fields is compared with data from the user command list (CLIST). The data in the command list is typically pulled from the message. Therefore if the codes defined here match up with codes from the message text, a value is returned to the command list. You need not use all three CODE fields.

Value Returned

If all the CODE fields defined match up with those from the command list, the value placed in this field is returned to the command list to be used for decision making.

For the message ID, if the code matching values are found then the corresponding value is returned.

Example:

Code 1	Code 2	Code 3	Value Returned
ERROR*	\$PJF		STOPPING
ABEND*	SA22		ABENDING

The user command list compares Code 1 and Code 2 to codes it pulled from the message. If the codes match, the corresponding value is returned to the command list. Therefore, if in the example, ABEND* and SA z/OS match with the command list codes, the value ABENDING is given to the command list (which could be used to update a status). More information about this panel is given in the online help.

Application Policy Object

WTO Buffer Shortage Recovery: The definitions can also be used for WTO buffer shortage recovery. To define these use message ID WTOBUF and define the following values:

CODE1

Specifies the name of the job which might or might not be canceled. The job name may be specified with the wildcard character "*" as the last character.

CODE2

Must be WTO, WTOR or * to indicate for which requests the job(s) might or might not be canceled. Use just * to specify WTO and WTOR requests.

CODE3

Must be blank.

Value Returned

Must be CANCEL or KEEP to indicate whether the job(s) might or might not be canceled.

Example:

Code 1	Code 2	Code 3	Value Returned
JOB1	WTOR		KEEP
JOB2*	WTO		KEEP
JOB3*	*		CANCEL
JOB4*	*		KEEP
*	*		KEEP

To set up the default behavior for all jobs not explicitly defined, a specification of CODE1=* and CODE2=* is needed. To indicate that all other jobs might be cancelled specify CANCEL in the VALUE RETURNED field, otherwise specify KEEP.

The job name *MASTER* cannot be entered in the CODE1 field. If your default behavior is setup to cancel all jobs not explicitly defined, a cancel command will be issued against *MASTER* if it is the job name being checked. As *MASTER* is non-cancelable, the cancel command will be refused. The effective result will be as if you had an explicit entry for *MASTER* with a VALUE RETURNED of KEEP.

Each line on the panel contains 4 fields. There is a limit on the total number of non-blank fields from the sixth line onwards. This limit is 254.

User Defined Data

SA z/OS displays the *User Defined Data* panel, as shown in Figure 117 on page 173, if you entered the action code USER into the *Action* column on the *Message Processing* panel.

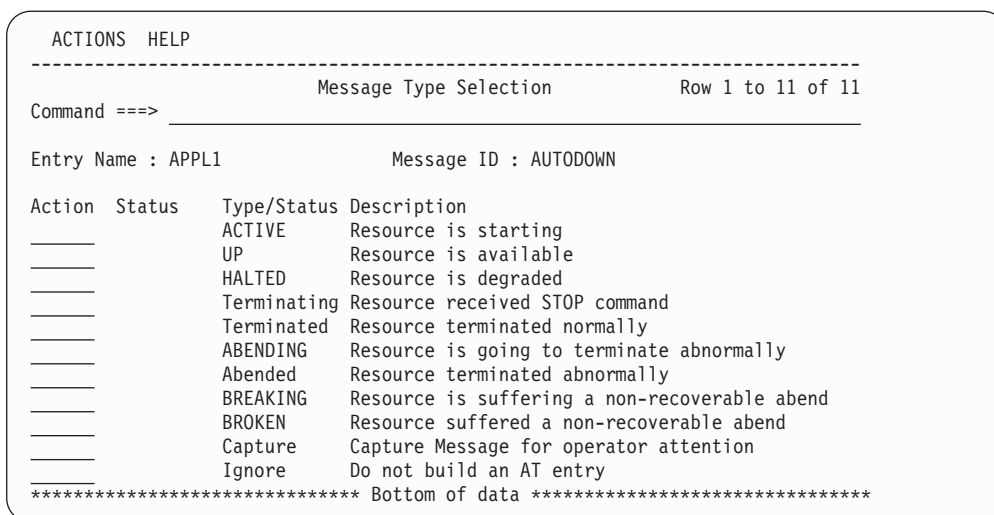

Figure 118. Message Type Selection Panel

On this panel you can select a message type or status that is associated with the message ID.

Overriding Message Automation

If you enter OVR in the *Action* field for a message ID, the *Automation Processing* panel is displayed, as shown in Figure 119.

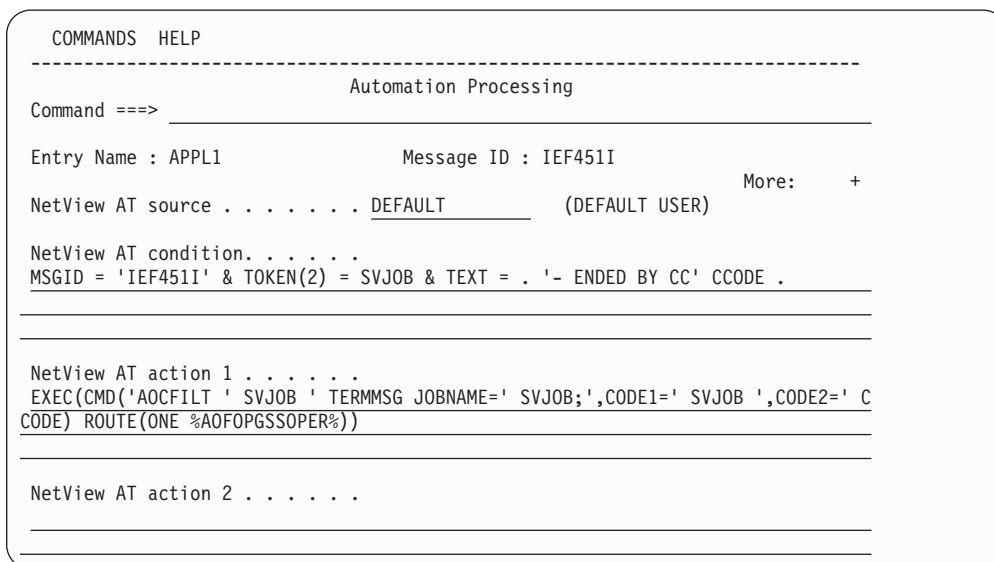

Figure 119. Automation Processing Panel

This panel allows you to either define your own or override predefined NetView Automation Table (AT) entries for a given Entry Name and Message ID. If you override the entry, an asterisk is shown in the OVR column of the *Message Processing* panel. It has the following fields:

NetView AT source

This field may be set to:

DEFAULT

The data displayed in the NetView AT Condition and Action fields are predefined by SA z/OS. This data will be used to build an AT entry unless it is overridden by the user.

USER The data displayed in the NetView AT Condition and Action fields are defined by the user. This data will be used to build an AT entry.

If user data exist you can toggle between user and default data by entering USER or DEFAULT.

NetView AT condition

This field displays the condition as it is used to build an AT entry. The condition field can be overridden.

This data will be enclosed in IF/THEN keywords when building an AT. No IF/THEN keywords should be used in this field. A leading IF and a trailing THEN will be removed.

NetView AT action *x*

These fields display the actions as they are used to build an AT entry. All action fields can be overridden.

A semicolon ';' will be appended to the last action when building an AT. No trailing semicolon should be used in this field. If used, it will be removed.

To delete user data, leave the *Automation Processing* panel using the END key or PF3 while either the *NetView AT source* field is set to DEFAULT or the condition field is blank.

You can view the default values by entering DEFAULT in the *NetView AT source* field. If you then try to exit the panel, a warning message appear telling you that, by leaving the panel, you will delete your AT entry override. You can then either press the END or PF3 key to continue (and delete the entry), or press the ENTER key to keep the override.

Notes:

1. No syntax checks will be done for the AT entry within the customization dialog.
2. Lower case characters are converted to uppercase.
3. Labels defined for certain SA z/OS default AT entries will not be used if the AT entry was overridden.
4. If message automation is neither predefined by SA z/OS nor defined by the user, then no AT entry is generated for the given Entry Name.

More about Policy Item STARTUP

The STARTUP policy item is used to specify scheduling subsystem, JCL procedure name (both of which are also available on policy item APPLICATION INFO), the startup parameters and all the commands necessary to start a subsystem. These commands are issued when SA z/OS is going to start the subsystem.

The STARTUP policy item can be used to define several command sequences which are executed if an application requires certain start types depending upon the circumstances, such as a cold start, warm start or recovery start. By means of the INGREQ command, you can specify which command sequence should be taken.

Application Policy Object

Or, you can use this facility for performance improvements: If for example, as shown in Figure 120, application *A* depends on application *B* and *B* in turn depends on *C* and *A* also has a *PREPAVAILABLE* relation to *C*, then after *C* is started, you can have SA z/OS issue a sequence of prestart commands to *A* while the supporting resource *B* is starting.

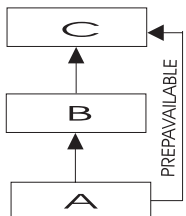

Figure 120. Using *STARTUP* Policy

If you select policy item *STARTUP* from the *Policy Selection* panel for Applications (Figure 106 on page 151), you come to the *Subsystem Startup Processing* panel shown in Figure 121.

```

COMMANDS  ACTIONS  HELP
-----
Subsystem Startup Processing          Row 1 to 3 of 3
Command ==> _____

Entry Type : Application              PolicyDB Name : DATABASE_NAME
Entry Name : APPL1                   Enterprise Name : YOUR_ENTERPRISE

Scheduling Subsystem. . _____ (MSTR, JES Subsystem or blank)
JCL Procedure Name. . . _____
Startup Parameters. . . _____

To specify automated commands when starting this subsystem, select the
appropriate start phase.

Action   Phase   Description                               Cmd
-----
_____ PRESTART Executed before startup is initiated
_____ STARTUP  Executed to initiate the startup
_____ POSTSTART Executed after startup has completed
***** Bottom of data *****
  
```

Figure 121. *Subsystem Startup Processing Panel*

For each application, you can specify a list of commands (startup procedures) which will be used before the application is started, to start the application and also after the application has started. All specified commands will be processed during the different startup phases of the application. The *STARTUP* policy item is used to specify all the necessary commands.

The advantage of this concept is that you can have SA z/OS perform certain actions for the preparation of an application. For example, before starting CICS, you can have the VTAM major node activated.

You can fill in the following fields:

Scheduling Subsystem

This specifies the name of the subsystem that is to schedule the current application, as follows:

MSTR This indicates that the application is scheduled directly by the z/OS master scheduler.

blank This indicates that the application is scheduled by the primary JES.

other This indicates that the application is scheduled by another scheduling subsystem. The value entered is the name of that subsystem. The subsystem specified must be defined as being type JES2 or JES3 (see *Application Type* in the *Define New Entry Panel for Applications* Figure 105 on page 145).

This field is optional.

JCL Procedure Name

Specifies the name of the JCL procedure used to create this instance of the application. If specified, the default start command for the application will be:

```
MVS S procname,JOBNAME=jobname
```

where *procname* is the JCL procedure name and *jobname* is the job name specified above. If no JCL procedure name is specified, the default start command is:

```
MVS S jobname
```

You may include system symbols and system automation symbols. See “Assigning System Automation Symbols (AOCCLONE)” on page 42 for details on using system automation symbols.

Parameters

Specifies the desired subsystem startup parameters. These values are added onto the MVS START command for the subsystem. For example, the desired start command for VTAM may be:

```
S VTAM,,,(LIST=00)
```

Therefore, if this command is to be submitted from SA z/OS, the parameters field should contain:

```
,,,(LIST=00)
```

Whatever is entered in the parameters field is appended directly to the MVS START command for the subsystem. Therefore, the commas preceding (LIST=00) are necessary.

You may include system symbols and system automation symbols. See “Assigning System Automation Symbols (AOCCLONE)” on page 42 for details on using system automation symbols.

You may also include run time variables, such as SUBSAPPL, SUBSJOB, SUBSPROC, SUBSSHUTDLY and others. For a complete list of run time variables, refer to SA z/OS documentation.

You can specify commands for the following startup phases:

PRESTART

Commands entered for this type are issued before the application is started. You can use these to perform some preparations, for example, let SA z/OS issue VTAM commands to activate additional connections.

Application Policy Object

If a PrepAvailable is defined for the resource, the PRESTART commands are executed when the PrepAvailable condition is satisfied, or as soon as the start request becomes winning. Therefore, if the PRESTART commands rely on another resource running, a PreAvailable relationship should be defined.

STARTUP

You should enter only one command. This will be issued to start the application.

If you select this option, you need to specify the complete startup command, otherwise, no automatic startup command is generated from the policy specified in the *APPLICATION INFO* policy item (in entry fields *Job Name* and *JCL Procedure Name*).

POSTSTART

Commands entered for this type are issued immediately after the UP message has been received.

The *CMD* column displays the number of commands that have been entered for a particular startup entry.

For each of these options (PRESTART, STARTUP, and POSTSTART) the *Startup Command Processing* panel is displayed (as shown in Figure 122), where you can enter the startup commands that are specific to the current application.

```
COMMANDS  HELP
-----
Startup Command Processing          Row 1 to 3 of 20
Command ==> _____          SCROLL==> PAGE

Entry Type : Application           PolicyDB Name  : DATABASE_NAME
Entry Name  : APPL1               Enterprise Name: YOUR_ENTERPRISE

Start Phase: POSTSTART            External Startup: NEVER

Type      Automated Function/ '*'
Command text
WARM     NETOPER
VARY NET,ACT, ID=APL&SUBSJOB
-----
WARM     JESOPER
MVS $SI U0-U5
-----
```

Figure 122. Startup Command Processing Panel

This panel shows the selected start phase and the external startup value specified on policy item APPLICATION INFO and it may be used to enter the commands that are particular for this start phase.

It contains the following fields:

External Startup

This shows whether the application is started externally or via the specified startup commands.

Type Enter the condition (for example, COLD) for which the command should be executed.

NORM is a predefined type of SA z/OS.

Leaving this field blank means that the command is executed for any condition.

Automated Function/'*'

Enter the name of the automated function under which the command is to run. If the field is left blank, the function defaults to the one currently running the command list. SA z/OS automated functions are mapped to NetView automation operators. This is documented in Table 8 on page 274.

Note:

Entering an '*' enables return code checking for the specified command. This means, processing continues if the command returns a return code of 0. In all other cases the processing is stopped immediately. If running in ASSIST mode, return code checking is disabled.

Command Text

Enter the command or command list to be issued. Any system command must be prefaced with MVS.

More about Policy Item SHUTDOWN

If you select policy item SHUTDOWN from the *Policy Selection* panel for Applications (Figure 106 on page 151), you come to the *Subsystem Shutdown Processing* panel shown in Figure 123.

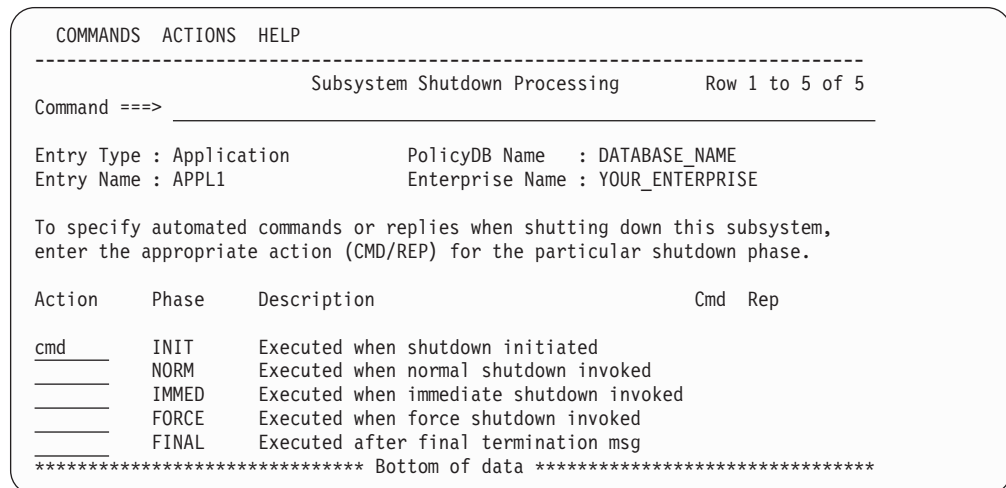

Figure 123. Subsystem Shutdown Processing Panel

The SHUTDOWN option is used to specify all the commands necessary to shutdown a subsystem and follow-on activities.

Because shutdown procedures may involve replies to outstanding messages as well as commands, the **Action** field is used to indicate whether a command or reply is to be specified for a particular phase of shutdown. When either CMD or REP is entered, the user is brought to another panel where the actual commands and replies can be defined, as shown in Figure 124 on page 181, Figure 125 on page 182, and Figure 126 on page 184.

Application Policy Object

Similar to the startup processing of applications described in the previous section, the following commands or replies can be chosen from this panel:

INIT Commands and replies entered under this phase are issued when the shutdown process is initiated (before the subsystem is brought down). Possible entries could be commands to send out warning messages to users or quiescing activities.

If you specified a PREPUNAVAILABLE relationship, then the commands listed under INIT will be executed if the condition is satisfied.

Initial shutdown commands do any necessary processing for an application when shutdown begins. For example, you can use initial shutdown commands to issue a warning to any logged-on users that the application will be shutting down. Or, for the JES2 subsystem, you may wish to stop users on JES2 NJE lines from starting new transmissions or sessions.

The initial shutdown commands should not be used to actually shut the application down as unpredictable results may occur.

NORM

If the NORM option is selected on the INGREQ STOP command, all the commands and replies entered under this phase are issued. These entries should be the commands and replies that perform a normal shutdown of the subsystem.

IMMED

The commands and replies specified here are run when the IMMED option on INGREQ STOP is selected. These entries bring the subsystem down immediately.

FORCE

INGREQ STOP also has a FORCE option that runs the entries specified here if selected. The commands and replies would be the typical ones a user would enter to force a subsystem off the system without any delay.

FINAL

The commands specified here are run after the final termination message has been received.

Note:

For this shutdown phase only commands can be specified.

The **CMD** and **REPLY** fields cannot be filled in, but instead display the number of commands or replies that have been entered for a particular shutdown entry.

SA z/OS will issue an error message when the automation control file is loaded if you have defined any applications for which there are no shutdown commands.

You can use the multiple pass feature to issue one or more groups of shutdown commands or replies for all shutdown types except initial shutdown. Commands or replies with 1 in their corresponding pass fields are the entries that are issued during the first attempt at shutting down the subsystem. If after a specified amount of time (entered in the Shut Delay parameter of the *Application Automation Definition* panel) the subsystem is not yet down, another attempt (or pass) is tried. The next pass runs all entries that have 2 in their pass field. This continues until the subsystem is down. Each pass may consist of zero or more commands and zero

or one reply. Note that issuing multiple replies on a single pass is NOT advisable. Either code secondary replies on subsequent passes or chain them through the automation table and ISSUEREP.

All commands for a given pass are processed before any replies for that pass are processed. After each set of commands and replies is issued, SA z/OS will wait for the amount of time defined in the Shut Delay field on the *Application Automation Definition* panel. After that time, if a call to the application monitor routine shows that the application has not shut down, the commands and/or reply defined for the next pass will be issued. If a call to the application monitor routine shows that the application has shut down, any subsequent shutdown passes will not be processed. If the final termination message is not received within the time specified in AOFSHUTDELAY, SA z/OS assumes that the application is down.

If SA z/OS processes all the shutdown passes defined for an application and the application monitor routine still shows the application as active, a warning is sent to the operator and the application status is set to STUCK.

The next panel displayed depends on the shutdown processing that you specify for the shutdown phases (INIT, NORM, etc.) on the *Subsystem Shutdown Processing* panel. You can specify either command processing *CMD* (C) or reply processing *REP* (R) for all shutdown types (except for FINAL, where you can specify only *CMD*). How to proceed on these follow-on panels is described in the following sections:

- “Command Shutdown Processing for INIT and FINAL”
- “Command Shutdown Processing for NORM, IMMED and FORCE” on page 182
- “Reply Shutdown Processing” on page 183

Command Shutdown Processing for INIT and FINAL

For INIT and FINAL shutdown commands, the *Shutdown Command Processing* panel is displayed, as shown in Figure 124.

```

COMMANDS  HELP
-----
Shutdown Command Processing          Row 1 to 1 of 20
Command ==> _____             SCROLL==> PAGE

Entry Type : Application              PolicyDB Name : DATABASE_NAME
Entry Name : APPL1                   Enterprise Name : YOUR_ENTERPRISE

Subsystem      : VTAM
Shutdown Phase: SHUTINIT             External Shutdown: NEVER

Enter commands to be executed when the selected shutdown phase is invoked
for this subsystem. Type may be NORM, IMMED or FORCE.

Type          Automated Function/'*'
Command text

MVS SEND 'VTAM COMING DOWN SHORTLY'
  
```

Figure 124. Shutdown Command Processing Panel for INIT and FINAL

This panel shows the subsystem name and the external startup value specified on the Application Info policy. It may be used to enter the commands that are particular for the specified shutdown phase, as follows:

Application Policy Object

External Shutdown

This shows whether the application is stopped externally or via the specified shutdown commands.

The following fields can be filled in:

Type Enter the condition for which the command should be executed. NORM, IMMED and FORCE are allowed types and correspond to the shutdown phases SHUTNORM, SHUTIMMED and SHUTFORCE.

Automated Function

Enter the name of the automated function under which the command is to run. If the field is left blank, the function defaults to the one currently running the command list.

Note:

Entering a '*' enables return code checking for the specified command. This means that processing continues if the command returns a return code of 0. In all other cases processing is stopped immediately. If running in ASSIST mode, return code checking is disabled.

Command Text

Enter the command or command list to be issued. Any system command must be prefaced with MVS.

You cannot issue multiple passes of initial shutdown commands, neither should you invoke MDFYSHUT.

Command Shutdown Processing for NORM, IMMED and FORCE

For NORM, IMMED, and FORCE shutdown commands, the *Shutdown Command Processing* panel is displayed, as shown in Figure 125.

```
COMMANDS  HELP
-----
Shutdown Command Processing          Row 1 to 2 of 20
Command ==> _____          SCROLL==> PAGE

Entry Type : Application              PolicyDB Name : DATABASE_NAME
Entry Name : APPL1                   Enterprise Name : YOUR_ENTERPRISE

Subsystem      : APPL1
Shutdown Phase: SHUTNORM              External Shutdown: NEVER

Enter commands to be executed when the selected shutdown phase is invoked
for this subsystem.

Pass      Automated Function/'*'
Command text
1
MVS Z NET,QUICK _____
_____

2
MVS Z NET,CANCEL _____
_____
```

Figure 125. Shutdown Command Processing Panel for NORM, IMMED, and FORCE

This panel shows the subsystem name and the external startup value specified on the Application Info policy. It may be used to enter the commands that are particular for the specified shutdown phase, as follows:

External Shutdown

This shows whether the application is stopped externally or via the specified shutdown commands.

The following fields can be filled in:

Pass Any number between 1 and 99 can be entered in this field. Commands or replies with 1 in their corresponding Pass field are the entries that are issued during the first attempt at shutting down the subsystem.

If after a specified amount of time (entered in the Shut Delay parameter from Subsystem Definition panel) the subsystem is not yet down, another attempt (or pass) is tried. The next pass runs all entries that have 2 in their Pass field. This continues until the subsystem is down. If you do not specify a pass for a command, it will be issued on every pass.

For example, Figure 125 on page 182 defines the normal shutdown commands issued for the VTAM subsystem. This example defines two passes of shutdown commands. On the first pass, the command MVS Z NET,QUICK is issued. On the second pass, the command MVS Z NET,CANCEL is issued.

In another example, MVS P TSO could be a command for pass 1 and MVS C TSO could be the command for pass 2 (which means that if purging TSO fails, it is canceled).

Automated Function

Enter the name of the automated function under which the command is to run. If the field is left blank, the function defaults to the one currently running the command list.

Note:

Entering a '*' enables return code checking for the specified command. This means that processing continues if the command returns a return code of 0. In all other cases processing is stopped immediately. If running in ASSIST mode, return code checking is disabled.

Command Text

Enter the command or command list to be issued. Any system command must be prefaced with MVS.

If you want to use MDFYSHUT to change the shutdown pass processing, you should specify it as a command on one of the passes.

Reply Shutdown Processing

For NORM, IMMED, and FORCE shutdown replies, the *Shutdown Reply Processing* panel is displayed if you enter action code REP, as shown in Figure 126 on page 184.

Application Policy Object

```
COMMANDS  HELP
-----
Shutdown Reply Processing          Row 1 to 6 of 20
Command ==> _____          SCROLL==> PAGE

Entry Type : Application          PolicyDB Name : DATABASE_NAME
Entry Name : APPL1              Enterprise Name : YOUR_ENTERPRISE

Subsystem      : APPL1
Shutdown Phase: SHUTNORM        External Shutdown: NEVER

Enter the replies to be issued when the selected shutdown phase is invoked
for this subsystem.

Pass Retry Reply Text
  Count
 1   9   SHUT
 3   9   I TA
 4   9   I TER ACQ
 5   9   END
  _   _
  _   _
```

Figure 126. Shutdown Reply Processing Panel for NORM, IMMED and FORCE

This panel shows the subsystem name and the external startup value specified on the Application Info policy. It may be used to enter the replies that are particular for the specified shutdown phase, as follows:

External Shutdown

This shows whether the application is stopped externally or via the specified shutdown commands.

The following fields can be filled in:

Pass Any number between 1 and 99 can be entered in this field. Commands or replies with 1 in their corresponding Pass field are the entries that are issued during the first attempt at shutting down the subsystem.

If after a specified amount of time (entered in the Shut Delay parameter from Subsystem Definition panel) the subsystem is not yet down, another attempt (or pass) is tried. The next pass runs all entries that have 2 in their Pass field. This continues until the subsystem is down. A pass number is required for each shutdown reply.

For example, MVS P TSO could be a command for pass 1 and MVS C TSO could be the command for pass 2 (which means that if purging TSO fails, it is canceled).

Retry Count

A number in the range 1 to 99 can be entered in this field to define the retry attempts made before the common routine decides that a reply cannot be issued. A retry occurs when the outstanding reply number is not available. There is a 2-second time delay between each retry. The default retry count is 0.

Reply Text

Enter the reply to be issued when the selected shutdown phase is invoked for this subsystem. For a null reply enter NULL as the reply.

For INIT, you cannot issue multiple passes of initial shutdown replies. Therefore the *Shutdown Reply Processing* panel only contains fields for the reply text, as shown in Figure 127 on page 185.

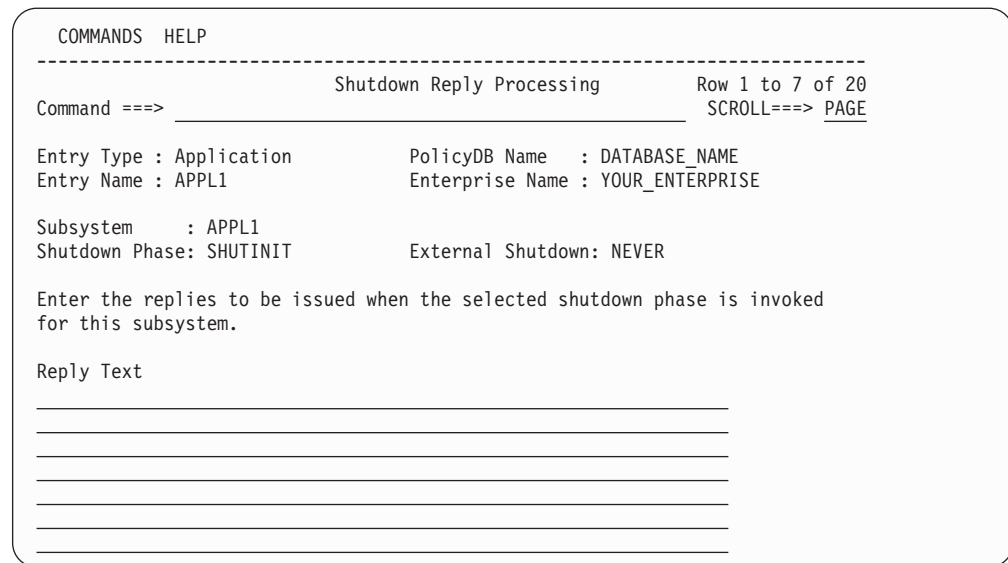

Figure 127. Shutdown Reply Processing Panel for INIT

For FINAL, shutdown reply processing is not allowed.

More about Policy Item THRESHOLDS

The Thresholds Definition panel is displayed if you select policy item THRESHOLDS on the *Policy Selection* panel for applications, as shown in Figure 128.

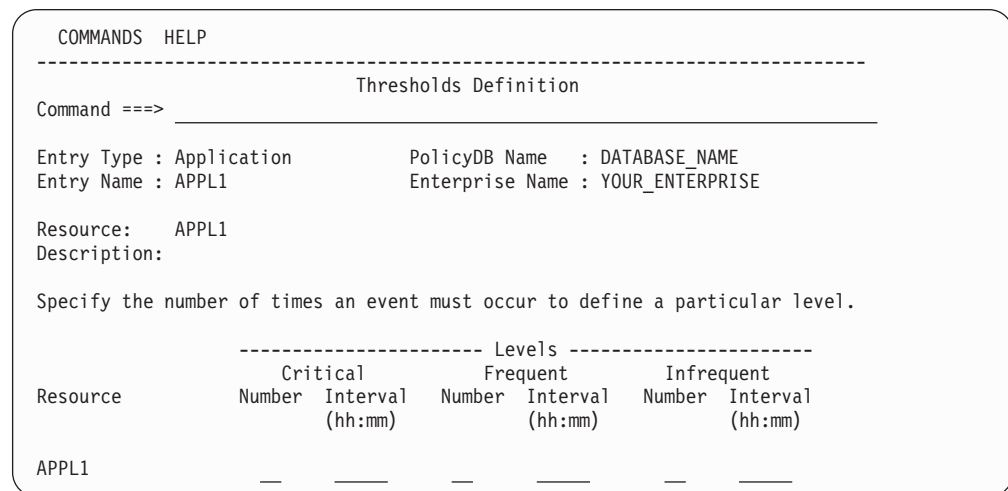

Figure 128. Thresholds Definition Panel

The information provided in the THRESHOLDS dialogs is used to determine when an operator should be notified of an error situation. An attempt at recovering an error (such as an abend of a subsystem) is handled by automation, but an operator may want to know if this error is occurring often.

Thresholds can be set that let the operator know if certain errors are occurring infrequently, frequently or have reached a critical stage where the recovery process should be ended (to avoid endless loops). This is done by specifying how many times an error must happen in a certain time period for each error situation.

Application Policy Object

For more information on setting thresholds refer to “How SA z/OS Uses Error Thresholds” on page 31.

More about Policy Item MINOR RESOURCE FLAGS

The Minor Resource Selection panel is displayed if you select policy item MINOR RESOURCE FLAGS on the *Policy Selection* panel for applications, as shown in Figure 129.

```
COMMANDS  HELP
-----
Minor Resource Selection          Row 1 to 10 of 20
Command ==> _____          SCROLL==> PAGE

Entry Type : Application          PolicyDB Name : DATABASE_NAME
Entry Name : APPL1               Enterprise Name : YOUR_ENTERPRISE

Major Resource: APPL1

Select minor resource option to be altered.

- _____
- _____
- _____
- _____
- _____
- _____
- _____
- _____
```

Figure 129. Minor Resource Selection Panel

This panel allows you to manage your minor resource definitions. From this panel you can do the following:

Add Add a minor resource by entering a name in one of the null entries at the bottom of the list and entering an S in front of the entry to select it and edit the automation flags. The following rules apply to the minor resource names:

- The name cannot contain any of the following characters: comma, single quotation mark, double quotation mark, left or right parenthesis, equal sign or a blank.
- The name cannot start or end with a period.
- The name cannot contain consecutive periods.

Rename

Rename a minor resource by typing the new name over the current name.

Delete Delete a minor resource by blanking out the name. All automation policy for that minor resource will be deleted.

Edit Edit the automation flags for the minor resource by entering an S in the input field before the minor resource name. Note that you can select multiple entries in which case the automation flag panel will be displayed once for each selection, without having to return to this panel between selections.

Note:

If the update to any minor resource results in all of the automation flags being deleted then those minor resources will no longer be found in the ACF created during the next 'build'. This can result from one of the following scenarios:

- Creating a new minor resource name by entering the name in one of the null entries but not entering S to select the entry to define the automation flags.
- Editing an entry and resetting all the automation flags to blank.

More about Policy Item SYSTEM ASSOCIATION

Note:

The following description is only valid if the automation control file (ACF) created is loaded on an SA OS/390 1.3 system. For later SA z/OS releases, these definitions are no longer used for automation. You may use the definitions for your own purpose.

If you select an application group's policy item SYSTEM ASSOCIATION, SA z/OS displays the *System Association* panel.

COMMANDS ACTIONS VIEW HELP			
AOFGLPD0		System Association	
Command ==>>		SCROLL==>> PAGE	
Entry Type : Application		PolicyDB Name : DATABASE_NAME	
Entry Name : APPC		Enterprise Name : YOUR_ENTERPRISE	
Action	Association	System	Sysplex
_____	PRIMARY	SYSTEM_AOCA	SYSPLEX_AOCPLEX
_____	PRIMARY	SYSTEM_AOCB	SYSPLEX_AOCPLEX
_____	PRIMARY	SYSTEM_AOCC	SYSPLEX_AOCPLEX
_____	PRIMARY	SYSTEM_AOCD	SYSPLEX_AOCPLEX
_____	PRIMARY	SYSTEM_KEY6	SYSPLEX_KEY67
_____	PRIMARY	SYSTEM_KEY7	SYSPLEX_KEY67
_____	PRIMARY	SYSTEM_KEY1	SYSPLEX_SYSP

Figure 130. System Association Panel

SA z/OS defines the concept of **primary** and **secondary** systems for applications for your convenience.

The *System Association* panel displays the current system association information for the selected application. System associations help determine whether or not SA z/OS is going to start an application that is linked to the system. There are two types of associations that can exist between a system and an application:

Primary

A system is a primary system for an application if the application is normally meant to be running there. SA z/OS starts the application on all the primary systems defined for it.

Secondary

A system is a secondary system for an application if it is defined to

Application Policy Object

automation on that system, but the application is not normally meant to be running there. Secondary systems are systems to which an application can be moved in the event that one or more of its primary systems are unavailable. SA z/OS does not start the application on its secondary systems.

A system can be a primary system for certain applications and a secondary system for others. Primary or secondary association for a system depends on the relationship between the applications and the system.

If you do not wish an application to be defined to automation on a system, you should remove the linkages between either the system and the application group containing the application or between the application group and the application.

SA z/OS always starts applications on primary systems, and never starts them on secondary systems, but does not provide any other mechanism for coordinating applications between primary and secondary systems. z/OS provides the intersystem coordination for applications which are recovered by Automatic Restart Manager. If you wish to use primary and secondary associations with an application that does not use Automatic Restart Manager or which requires cross splex recovery, you must provide your own coordination mechanism.

If primary or secondary associations are set, then the statuses **MOVED** and **FALLBACK** are applicable. The **MOVED** and **FALLBACK** statuses are defined to deal with the concept of primary and secondary systems. These statuses are different from an **AUTODOWN** or **CTLDOWN** status associations:

- **MOVED** - The application is not running on this (primary) system. It should be active on another system.
- **FALLBACK** - The application is not running on this (secondary) system. It should be active on another system.

Refer to “Automation Flags” on page 34 for more information on automation statuses.

Using **MOVED** and **FALLBACK**

SA z/OS provides two automation statuses, **MOVED** and **FALLBACK**, to handle applications which normally run on one system (the primary) but which can run on an alternative system (the secondary) if the primary is unavailable.

SA z/OS does not provide any logic to actually perform a fallback from a primary to a secondary system. If you want cross-system fallback, you have to provide the coordinating logic yourself.

If you want the application moved automatically you will have to write your own code or define a **MOVE**-group. You can put applications into **MOVED** or **FALLBACK** status either through **SETSTATE** or **AOCUPDT**.

More about Policy Item **GENERATED RESOURCES**

The *Generated Resources* panel appears if you select policy item *GENERATED RESOURCES* from the *Policy Selection* panel for Applications, as shown in Figure 131 on page 189. This panel shows all resources that are generated by SA z/OS for the application. This panel is for information only. No actions are allowed.

Application Resources are generated when a link between an Application and a System occurs. Applications can never be linked directly to Systems.

This link happens indirectly by linking an Application to an Application Group (either in Application's WHERE USED policy or in an Application Group's APPLICATIONS policy.)

```

COMMANDS  HELP
-----
Command ==>          Generated Resources          Row 1 to 8 of 8
                                SCROLL==> PAGE

Entry Type : Application          PolicyDB Name  : DATABASE_NAME
Entry Name  : NET                 Enterprise Name : YOUR_ENTERPRISE

Resource Name          Generated by link to
Resources for THIS entry:
NET/APL/SYSTEM1       SYSTEM1
NET/APL/SYSTEM2       SYSTEM2
***** Bottom of data *****

```

Figure 131. Generated Resources Panel

This panel displays the following information:

Resources for THIS entry

Shows the resources generated for the application.

Generated by link to

This says who the owner of a Resource is. In this case; owners are Application Groups because the current entry is an APL

A link to the owner creates the Resource, unlinking from the owner (or deletion of the owner) deletes the Resource..

More about Policy Item MEMBER OF for Applications

The *Member of* panel is displayed if you select policy item *MEMBER OF* on the *Policy Selection* panel for applications.

```

COMMANDS  HELP
-----
AOFGXMOF          Member of
Command ==>          SCROLL==> PAGE

Entry Type : Application          PolicyDB Name  : DATABASE_NAME
Entry Name  : AOR1                 Enterprise Name : YOUR_ENTERPRISE

Own Resource...      ...is a member of      Preference Nature
AOR1/APL/SYS1       AOR_G/APG              700          MOVE/SERVER
AOR1/APL/SYS2       AOR_G/APG              700          MOVE/SERVER

```

Figure 132. Member of Panel for Applications

This panel lists all Resources, where this ApplicationGroup is a member "resource-wise"; that is, it lists all relations from Resources that have been derived from the current ApplicationGroup to other Resources. This panel is for information only. No data can be changed.

A "Member of" relation can be added or removed in the RESOURCES policy of the entry in the list's "member of" column (that is in the RESOURCES policy of the APG Entry Name, from which the "member of" Resource was derived).

Application Policy Object

In this example, this panel is invoked for application *AOR1* which is a member of a Sysplex Application Group. In such a case, you will see all resources generated for the sysplex.

Policy Items for JES2 Subsystems

Figure 133 is an example of a *Policy Selection* panel for a JES2 subsystem.

```

  ACTIONS  HELP
-----
A0FGEPOL          Policy Selection          Row 14 to 24 of 24
Command ==> _____ SCROLL==> PAGE

Entry Type : Application          PolicyDB Name : DATABASE_NAME
Entry Name : JES2                 Enterprise Name : YOUR_ENTERPRISE

Action      Policy Name          Policy Description
-----
          ...
          -----JES2 SPECIFIC POLICY-----
          JES2 SPOOLFULL         Define JES2 spool full procedures
          JES2 SPOOLSHORT       Define JES2 spool short procedures
          JES2 DRAIN             Define JES2 drain procedures
          ...
***** Bottom of data *****
```

Figure 133. Policy Selection Panel for JES2 Subsystems

See “Policy Items for Applications” on page 151 for descriptions of most policy items on this panel. The additional policy items are:

JES2 SPOOLFULL

Provides for recovery from a JES spool full condition. Figure 134 on page 191 shows the recovery parameters that can be specified for JES2 when this policy item is selected.

JES2 SPOOLSHORT

Provides for recovery from JES spool shortage condition. The recovery parameters available for JES2 spool shortage recovery are the same as for spool full recovery. Refer to “More about Policy Item JES2 SPOOLSHORT” on page 192.

JES2 DRAIN

Allows you to specify which JES resources are to be drained and how they are to be drained in the event that a JES2 shutdown fails.

More about Policy Item JES2 SPOOLFULL

If you select policy item SPOOLFULL for a JES2 subsystem, SA z/OS displays the SPOOLFULL Processing panel.

```

COMMANDS  HELP
-----
                                SPOOLFULL Processing
Command ==> _____

Entry Type : Application          PolicyDB Name  : DATABASE_NAME
Entry Name  : JES2                Enterprise Name : YOUR_ENTERPRISE

Enter SPOOLFULL settings.
Retry Time . . . . _____    Spool recovery attempt interval (hh:mm:ss)
Buffer . . . . . _____      Recovery target below TGWARN (0->50)
Reset Time . . . . _____     Recovery reset interval (hh:mm:ss)

Priority of systems for spool recovery:

CPUID  1  ___  2  ___  3  ___  4  ___  5  ___  6  ___  7  ___  8  ___
        9  ___ 10  ___ 11  ___ 12  ___ 13  ___ 14  ___ 15  ___ 16  ___
       17  ___ 18  ___ 19  ___ 20  ___ 21  ___ 22  ___ 23  ___ 24  ___
       25  ___ 26  ___ 27  ___ 28  ___ 29  ___ 30  ___ 31  ___ 32  ___

Edit Spoolfull Pass Commands . . NO  YES  NO

```

Figure 134. SPOOLFULL Processing Panel

The following parameters can be entered:

Retry Time

The time entered in this field defines the time between attempts at spool recovery. If the first set of recovery commands has been issued and the spool is not recovered after this amount of time, the second set of defined commands is issued. Time range 00:00:00 to 23:59:59. The default is 5 minutes.

Buffer The percentage amount of spool that is to be recovered under the threshold (TGWARN for SPOOLSHORT, 100% for SPOOLFULL). The value must be positive and less than 75% of the threshold value. If invalid or not specified a default of 5 is used. For example, if TGWARN is set to 80 and Buffer is set to 10, SPOOLSHORT recovery will continue until spool utilization is less than 70%.

Reset time

This is the amount of time that must elapse after the spool has been driven below the recovery target before the spool incident is considered to be closed. If the spool exceeds the trigger threshold again before this interval is up, the recovery will begin again with the next pass, rather than restarting from pass 1.

The default is 15 minutes.

CPUID 1st - 32nd

An ordered list of system IDs belonging to the JES2 subsystems sharing the JES spool in a MAS definition. During the recovery the JES2 command D MEMBER,STATUS=ACTIVE,NAME is issued and the first machine in the list that is active on the display response is assumed to be responsible for handling the recovery.

Note:

You must keep the CPUID lists for JES subsystems sharing the spool space in synchronization.

Application Policy Object

If SA z/OS cannot find an active machine in the CPUID list, it will assume responsibility for the recovery itself. This can lead to multiple machines issuing recovery commands if your lists are incomplete.

Edit Spoolfull Pass Commands

Entering YES in this field allows you to edit the recovery commands. Figure 135 shows the *SPOOLFULL Processing* panel on which you can enter commands to be issued during SPOOLFULL processing.

```
COMMANDS  HELP
-----
A0FPISPF          SPOOLFULL Processing          SCROLL==> PAGE
Command ==> _____

Entry Type : Application          PolicyDB Name : DATABASE_NAME
Entry Name : JES2                 Enterprise Name : YOUR_ENTERPRISE

Subsystem   : JES2
Description : JES2 policy definition

Enter the appropriate commands to issue when SPOOL is full.

Pass Automated Function/ '*'
Command Text
 1
MSG SYSOP '=====> SPOOL ALERT <====='
-----
 2
MSG SYSOP ' JES2 SPOOL SPACE IS FULL '
-----
 3
MSG SYSOP ' PERFORM INSTALLATION RECOVERY. '
-----
 4
MSG SYSOP '=====> SPOOL ALERT <====='
-----
```

Figure 135. SPOOLFULL Processing Panel for JES2

Commands are issued by passes, so a command to be issued on every pass should be specified without pass specification. Two substitution variables (EHKVAR1 and EHKVAR2) are available. EHKVAR1 contains the current spool utilization, and EHKVAR2 contains the recovery target.

More about Policy Item JES2 SPOOLSHORT

If you select policy item SPOOLSHORT for a JES2 subsystem, SA z/OS displays the SPOOLSHORT Processing panel, as shown in Figure 136 on page 193.

```

COMMANDS  HELP
-----
                                SPOOLSHORT Processing
Command ==> _____

Entry Type : Application          PolicyDB Name  : DATABASE_NAME
Entry Name  : JES2                Enterprise Name : YOUR_ENTERPRISE

Enter SPOOLSHORT settings.
Retry Time . . . . _____   Spool recovery attempt interval (hh:mm:ss)
Buffer . . . . . _____     Recovery target below TGWARN (0->50)
Reset Time . . . . _____    Recovery reset interval (hh:mm:ss)

Priority of systems for spool recovery:

CPUID  1  ___  2  ___  3  ___  4  ___  5  ___  6  ___  7  ___  8  ___
        9  ___ 10  ___ 11  ___ 12  ___ 13  ___ 14  ___ 15  ___ 16  ___
       17  ___ 18  ___ 19  ___ 20  ___ 21  ___ 22  ___ 23  ___ 24  ___
       25  ___ 26  ___ 27  ___ 28  ___ 29  ___ 30  ___ 31  ___ 32  ___

Edit Spoolshort Pass Commands . . NO  YES  NO

```

Figure 136. SPOOLSHORT Processing Panel

The parameters that can be entered on this panel are similar to those described in “More about Policy Item JES2 SPOOLFULL” on page 190, and the *Spoolshort Processing* panel is similar to the *Spoolfull Processing* panel.

More about Policy Item JES2 DRAIN

If you select policy item DRAIN for a JES2 subsystem, SA z/OS displays the JES2 DRAIN Processing panel, as shown in Figure 137.

```

COMMANDS  HELP
-----
                                JES2 DRAIN Specifications
Command ==> _____

Entry Type : Application          PolicyDB Name  : DATABASE_NAME
Entry Name  : JES2                Enterprise Name : YOUR_ENTERPRISE

Subsystem: JES2
Enter information (Yes or No) for initial drain to bring down JES2 facilities.
LIN . . . . . _____   Drain lines
LOG . . . . . _____   Drain JES2-VTAM interface
OFF . . . . . _____   Drain spool offloaders
PRT . . . . . _____   Drain printers
RDR . . . . . _____   Drain readers
PUN . . . . . _____   Drain punches
Enter information (Command or No) for force drain if normal drain fails.
LIN . . . . . _____   Force drain lines
LOG . . . . . _____   Force drain JES2-VTAM interface
OFF . . . . . _____   Force drain spool offloaders
PRT . . . . . _____   Force drain printers
RDR . . . . . _____   Force drain readers

```

Figure 137. JES2 DRAIN Processing Panel

This panel is used to identify which JES resources are to be drained and how they are to be drained if a JES shutdown is unsuccessful:

Initial drain

Choose the resources that are to be stopped with a JES \$P command. An initial drain occurs either because of a JES shutdown or an operator issued AOFDRAIN. YES indicates that a stop command should be issued for the resource while a NO (the default) does not drain the resource type.

Application Policy Object

Force drain

Define the drain command to be entered for each resource if JES has not successfully shutdown. Possible JES commands could be Restart (\$E), Cancel (\$C) or any other appropriate command. If NO is entered (the default), this resource type does not have any commands issued for it.

Policy Items for JES3 Subsystems

Figure 138 shows a *Policy Selection* panel for a JES3 subsystem.

```

ACTIONS  HELP
-----
A0FGEPOL          Policy Selection          Row 14 to 25 of 25
Command ==> _____ SCROLL==> PAGE

Entry Type : Application          PolicyDB Name  : DATABASE_NAME
Entry Name  : JES2                Enterprise Name : YOUR_ENTERPRISE

Action      Policy Name          Policy Description
-----
          ...
          -----JES3 SPECIFIC POLICY-----
          JES3 SPOOLFULL        Define JES3 spool full procedures
          JES3 SPOOLSHORT      Define JES3 spool short procedures
          JES3 MONITOR          Define JES3 monitoring (SA 2.2 and earlier)
          JES3 ABENDS           Define JES3 abend thresholds
          ...
***** Bottom of data *****
```

Figure 138. Policy Selection Panel for JES3 Subsystems

See “Policy Items for Applications” on page 151 for descriptions of most policy items on this panel. The additional policy items are:

JES3 SPOOLFULL

Allows you to specify recovery from JES spool full condition. For more information refer to “More about Policy Item JES3 SPOOLFULL.”

JES3 SPOOLSHORT

Allows you to specify recovery from JES spool short condition. For more information refer to “More about Policy Item JES3 SPOOLSHORT” on page 195.

JES3 MONITOR

Allows you to define JES3 monitor settings and commands. For more information refer to “More about Policy Item JES3 MONITOR” on page 196.

Note:

Use this policy only to define the JES3 monitor data for SA OS/390 releases prior to SA z/OS version 2.3. For newer SA z/OS releases use monitor resources (entry type MTR).

JES3 ABENDS

Set thresholds for JES3 abends. For more information on setting thresholds refer to “More about Policy Item JES3 ABENDS” on page 198.

More about Policy Item JES3 SPOOLFULL

If you select policy item SPOOLFULL for a JES3 subsystem, SA z/OS displays the SPOOLFULL Processing panel, as shown in Figure 139 on page 195.

```

COMMANDS  HELP
-----
A0FPISPF          SPOOLFULL Processing          Row 1 to 2 of 24
Command ==> _____ SCROLL==> PAGE

Entry Type : Application          PolicyDB Name : DATABASE_NAME
Entry Name : JES3                 Enterprise Name : YOUR_ENTERPRISE

Subsystem   : JES3
Description : JES3 automation policy

Enter the appropriate commands to issue when SPOOL is full.

Pass Automated Function/'*'
Command Text

MSG SYSOP '=====> SPOOL ALERT <====='
_____

MSG SYSOP ' JES3 SPOOL SPACE IS FULL      '
_____

```

Figure 139. JES3 SPOOLFULL Processing Panel

Commands are issued by passes, so a command to be issued on every pass should be specified with an asterisk * for the pass. Two substitution variables (EHKVAR1 and EHKVAR2) are available. EHKVAR1 contains the current spool utilization, and EHKVAR2 contains the recovery target.

More about Policy Item JES3 SPOOLSHORT

If you select policy item SPOOLSHORT for a JES3 subsystem, SA z/OS displays the SPOOLSHORT Processing panel, as shown in Figure 140.

```

COMMANDS  HELP
-----
A0FPISPS          SPOOLSHORT Processing          Row 1 to 2 of 37
Command ==> _____ SCROLL==> PAGE

Entry Type : Application          PolicyDB Name : DATABASE_NAME
Entry Name : JES3                 Enterprise Name : YOUR_ENTERPRISE

Subsystem   : JES3
Description : JES3 automation policy

Enter the appropriate commands to issue when SPOOL is short.

Pass Automated Function/'*'
Command Text

1
MSG SYSOP '=====> SPOOL ALERT <====='
_____

1
MSG SYSOP ' SPOOL SPACE BELOW THRESHOLD      '
_____

```

Figure 140. JES3 SPOOLSHORT Processing Panel

Commands are issued by passes, so a command to be issued on every pass should be specified with an asterisk * for the pass. Two substitution variables (EHKVAR1 and EHKVAR2) are available. EHKVAR1 contains the current spool utilization, and EHKVAR2 contains the recovery target.

More about Policy Item JES3 MONITOR

Note:

Use this policy only to define the JES3 monitor data for SA OS/390 releases prior to SA z/OS version 2.3. For newer SA z/OS releases use monitor resources (entry type MTR). See “Monitor Resource Policy Object” on page 237 and *System Automation for z/OS Customizing and Programming* for more details.

If you select policy item MONITOR for a JES3 subsystem, SA z/OS displays the *JES3 Monitor Definition* panel, as shown in Figure 141.

```

COMMANDS  HELP
-----
AOFPIEJ3          JES3 Monitor Definition
Command ==> _____

Entry Type : Application          PolicyDB Name : DATABASE_NAME
Entry Name : JES3                Enterprise Name : YOUR_ENTERPRISE
                                           More:      +

Important Note: Use this policy only to define the JES3 monitor data
for SA OS/390 releases prior to SA z/OS version 2.3.
For newer SA z/OS releases use the monitor resources (entry type MTR).

Enter threshold value for total jobs in (MDS) setup (1 to 9999):
Total MDS . . . . . _____

Enter threshold values for each MDS queue (1 to 999):
Fetch . . . . . _____ Verify. . . . . _____
Wait Volume . . . . . _____ Error . . . . . _____
Allocate . . . . . _____ Breakdown . . . . . _____
Unavailable . . . . . _____ Restart . . . . . _____
System Select . . . . . _____ System Verify . . . . . _____

Enter the following information (1 to 59 minutes):
MDS monitoring interval . . . . . _____
C/I monitoring interval . . . . . _____
C/I active threshold. . . . . _____
Spool inquiry interval. . . . . _____
Free space threshold. . . . . _____ (1 to 99 percent)
JSM DSP inquiry interval. . . . . _____ (not valid for JES3 Version 3 or higher)

Edit JES3 commands. . NO _____ (YES NO)
    
```

Figure 141. JES3 Monitor Definition Panel

Information used by spool recovery and certain JES3 monitoring routines is defined in this panel. If none of the entries are filled in then monitoring by JES3 is not performed. The data entered here is only valid if the processor is the JES3 global processor.

The following fields can be entered:

Total MDS

A threshold value may be set indicating a limit on the total number of jobs in setup. When an MDS monitor cycle occurs, an action will be taken if the number of jobs in setup is equal to or greater than this threshold value.

MDS queues

For each of the 10 JES3 MDS queues identified, a threshold may be set indicating a limit as to the number of jobs that particular queue may contain. If, for example, the ERROR threshold is set to 5, if 5 or more jobs are pending on the MDS Error queue when an MDS monitor cycle occurs, an action will be attempted.

The actions taken when an MDS threshold is reached are defined in the MESSAGES policy of the APL dialog. In place of the message ID, the following keywords should be entered with CMD in the Action column:

MDSCOUNTQ

Current number of jobs in (MDS) setup.

MDSCOUNTF

MDS Fetch Queue

MDSCOUNTV

MDS Verify Queue

MDSCOUNTW

MDS Wait Volume Queue

MDSCOUNTE

MDS Error Queue

MDSCOUNTA

MDS Allocate Queue

MDSCOUNTB

MDS Breakdown Queue

MDSCOUNTU

MDS Unavailable Queue

MDSCOUNTR

MDS Restart Queue

MDSCOUNTSS

MDS System Select Queue

MDSCOUNTSV

MDS System Verify Queue

MDS monitoring interval

This field defines how often (in minutes) an *I S command is to be issued in order to monitor the MDS queues for any of the MDS thresholds being reached.

C/I monitoring interval

This field defines how often (in minutes) an *I A,D=CI command is issued for converter/interpreter activity monitoring purposes.

C/I active threshold

This field defines the length of time (in minutes) a job may be active in C/I before &ingprods. takes an action. If C/I monitoring shows that a job has been in C/I longer than this threshold, the commands associated with the CITIME keyword are issued. Similar to MDSCOUNTx, CITIME should be entered in the Message ID field of SUBSYSTEM MESSAGES.

Spool inquiry interval

This field defines how often (in minutes) a *I Q S command is issued to monitor the spool space.

Free space threshold

This field defines the amount of free spool space left that causes an action to be taken. If the value given by the *I Q S command is less than the threshold value, the commands entered in the SPOOLSHORT policy of the APL dialog are issued.

Application Policy Object

JSM DSP inquiry interval

This defines how often (in minutes) an *I A,D=JSM command is to be issued to monitor for JSM (JES3 spool maintenance) activity. If monitoring shows that JSM is not active, the commands entered using the NOJSM keyword in the MESSAGES policy for JES3 definition are issued.

Edit automatically issued JES3 commands

The default for this field is NO. Entering YES brings the user to another panel where JES3 commands can be entered that are repeatedly issued at a specified interval.

There are two fields to be filled in on the JES3 Commands panel:

Interval

This defines in minutes how often the command is to be issued.

Command

The JES3 command to be issued should be entered here beside its corresponding interval.

More about Policy Item JES3 ABENDS

If you select policy item ABENDS for a JES3 subsystem, SA z/OS displays the *Thresholds Specification* panel, as shown in Figure 142. For more details about thresholds, see “How SA z/OS Uses Error Thresholds” on page 31.

```
COMMANDS  HELP
-----
A0FPITH1          Thresholds Specification
Command ==> _____

Entry Type : Application          PolicyDB Name  : DATABASE_NAME
Entry Name  : JES3                Enterprise Name: YOUR_ENTERPRISE

Resource: JES3 Abend defaults

Specify the number of times an event must occur to define a particular level.

----- Levels -----
Resource          Critical      Frequent      Infrequent
                  Number Interval Number Interval Number Interval
                  (hh:mm)      (hh:mm)      (hh:mm)
JES3 Abend defaults  _      _      _      _      _      _
```

Figure 142. JES3 Thresholds Specification Panel

The following fields can be entered:

Number

This field is used to define the number of occurrences of an error that creates the particular error level. The range of allowable numbers is 1 to 10.

Interval

The number of errors entered in the previous field must occur in a certain time period in order to create a specific error level. This time period is placed in this field. The format of this field is in hours and minutes. The range for hours is 00 to 99 and minutes 00 to 59. The colon between hours and minutes is optional (can be entered as HH:MM or HHMM).

The values entered in the Number and Interval fields should be such that the threshold levels are reached in a logical manner (a critical threshold should not be reached before a frequent threshold).

Invalid values are flagged if:

1. The critical number is less than or equal to the frequent number, *AND*
2. The critical interval is greater than or equal to the frequent interval.

A similar check is done between the frequent and infrequent values.

Policy Items for CICS Subsystems

Figure 143 shows the *Policy Selection* panel for applications that have been created with application type CICS (see entry field *Application Type* in Figure 105 on page 145). This *Policy Selection* panel contains additional policy items for a CICS subsystem.

Some of these policy items are only applicable to a CICS subsystem defined as an instance. If a subsystem CLASS of type CICS is selected, only the additional policy item RESOURCE THRESHOLDS will be available.

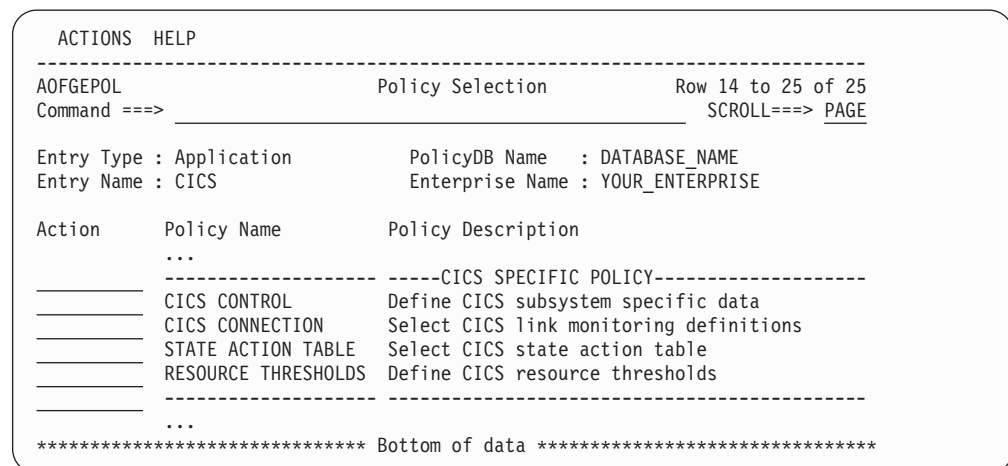

Figure 143. Policy Selection Panel for CICS Subsystems

The CICS specific policy items are:

CICS CONTROL

With this policy item you can define the extended subsystem information required for CICS Automation. You will reach a panel described in “More about Policy Item CICS CONTROL” on page 200 where you can fill in the required information.

CICS CONNECTION

If you select this policy item, the panel *CICS link for Application* will be displayed, showing a list of CICS link definitions previously defined as described in “Link Definitions” on page 244. Use this policy item to connect a CICS link monitoring definition to the current CICS subsystem. This item is described in section CONNECTION of *System Automation for z/OS CICS Automation Programmer’s Reference and Operator’s Guide*. By selecting a link here, SA z/OS creates an entry in the automation control file as follows:

```
CONNECTION subsys.connection_id
```

Application Policy Object

where connection `connection_id` is the entry name specified when creating the entry 40/CCN. You may select multiple connections.

STATE ACTION TABLE

If you select this policy item, SA z/OS will display panel *CICS State/Action for Application* with a list of CICS state/action tables which previously have been defined as described in “CICS State/Action Tables” on page 243.

From this list you can link one state/action table to the current CICS subsystem.

RESOURCE THRESHOLDS

With this policy item you can manage your CICS resource threshold definitions for the specific CICS subsystem. You will reach the panel *CICS Resource thresholds selection* described in “More about Policy Item RESOURCE THRESHOLDS” on page 203 where you can fill in the required information.

More about Policy Item CICS CONTROL

With this policy item you can define the extended subsystem information required for CICS Automation, as shown in Figure 144.

```
COMMANDS  HELP
-----
AOFPCXL          CICS control specifications
Command ==> _____

Entry Type : Application          PolicyDB Name : DATABASE_NAME
Entry Name : CICS                Enterprise Name : YOUR_ENTERPRISE
                                           More:      +

Subsystem : CICSTEST
Subtype   : TOR                  Subtype from APPLICATION INFO policy

Enter or update the following fields:
APPLid. . . . _____
Major node. . _____
Keypoint req. NO          YES NO
SMFid. . . . _____    SMF record number
CMASid. . . . _____
                                           CICSP1ex/SM CMAS region identifier

The following definitions are for SA13 only:
Auto operator _____ Automation operator name
Start timer _____ Startup time (mm:ss)
Cold timer _____ Cold start time (mm:ss)
Warm timer _____ Warm start time (mm:ss)
Emerg. timer _____ Emergency start time (mm:ss)
```

Figure 144. CICS Control Specifications Panel

Fill in the following fields:

Subtype

This parameter describes the controller type. It can be entered on the APPLICATION INFO policy item of the application, or the application class on the *Subtype* field. The value shown is either the one specified on the application or the one specified on the application class to which the application is linked.

APPLid

Use one of the following:

APPLID

If XRF=NO is coded on the SIT for this CICS subsystem, use this

keyword to specify the VTAM application identifier, provided that the name of the VTAM APPL statement and the ACB name specified in it are the same.

(VTAM APPL name,VTAM ACBNAME)

If XRF=NO is coded on the SIT for this CICS, but the name of the VTAM APPL statement is different from the ACBNAME specified in it, code them both in this entry. The VTAM ACBNAME defined must be the same as that used by the CICS application.

(generic-applid,specific-applid)

If XRF=YES is coded on the SIT for this CICS subsystem, generic-applid is the name given to both the active and alternate subsystem and specific-applid is the specific name for this subsystem. The specific-applid defined must be the same as that used by the CICS application.

Major node

The VTAM node for this CICS subsystem. This is used for recovery procedures when the VTAM ACB is not active.

Keypoint req

Determines whether or not a CICS keypoint is required and whether or not Indoubt UOWs can exist. If KEYPOINTREQ=YES is specified, and a keypoint is missed, warning message EVE677 is issued during the shutdown. The status will also be changed to stopping if SA z/OS determines that an immediate restart of CICS is unlikely.

KEYPOINTREQ is applicable to CICS TS and pre-CICS TS systems. When KEYPOINTREQ=YES is specified, and warm keypoint data is not available or UOWs indoubt exists, then SA z/OS forces the next start type of CICS to be AUTO irrespective of what has been specified in the SIT or by the operator. If a CICS start type of AUTO is always specified, either by the SIT or by the operator, then the KEYPOINTREQ parameter is not needed.

At the last shutdown of CICS, if no CICS warm keypoint was taken or if indoubt UOW(s) existed, then if KEYPOINTREQ=YES is defined in the automation control file, a message is issued if you have chosen a non-AUTO start type (that is, INITIAL or COLD). You then have the option of specifying override=UOW to force a COLD or INITIAL start. Note however that if the application is being started via a schedule and start type COLD or INITIAL was set (via say INGSET) and if the above mentioned conditions exist, then automation will start the application with starttype AUTO.

SMFid

A CICS Automation command processor creates SMF records that contain subsystem names, job names, application identifiers, event types, and event data. These records can be used for availability reporting. The SMF record number used is 215. If you don't want record number 215 used, then use this keyword to specify a different record number.

CMASid

Identifies the CICSplex/SM CMAS region for shutdown purposes.

Auto Operator

Note:

This field is for SA OS/390 1.3 only.

Application Policy Object

Identifies the keyword used in the control file entry described in section *AUTOOPS--Automation Operators in System Automation for z/OS CICS Automation Programmer's Reference and Operator's Guide*. That defines the automation operator used for this CICS subsystem.

Start Timer

Note:

This field is for SA OS/390 1.3 only.

The time in which a startup must initiate before an alert is sent to the operator. This is expressed in minutes and seconds (mm:ss). The default is 1 minute.

Cold Timer

Note:

This field is for SA OS/390 1.3 only.

The time in which a cold start must complete before an alert is sent to the operator. This is expressed in minutes and seconds (mm:ss). The default is 8 minutes.

Warm Timer

Note:

This field is for SA OS/390 1.3 only.

The time in which a warm start must complete before an alert is sent to the operator. This is expressed in minutes and seconds (mm:ss). The default is 3 minutes.

Emerg.Timer

Note:

This field is for SA OS/390 1.3 only.

The time in which an emergency start must complete before an alert is sent to the operator. This is expressed in minutes and seconds (mm:ss). The default is 7 minute.

The extended CICS subsystem automation that you define here is also described in section *CICSCNTL of System Automation for z/OS CICS Automation Programmer's Reference and Operator's Guide*.

More about Policy Item CICS CONNECTION

With this policy item you can select CICS link monitoring definitions required for CICS Automation, as shown in Figure 145 on page 203.

```

COMMANDS  ACTIONS  VIEW  HELP
-----
CICS link for Application                               Row 1 to 2 of 2
Command ==> _____ SCROLL==> PAGE

Entry Type : Application      PolicyDB Name : DATABASE_NAME
Entry Name : CICS             Enterprise Name : YOUR_ENTERPRISE

Action      Status      CICS link
-----
            _____ CICK4CCK4C
            _____ EYUMAS1AMS2B
***** Bottom of data *****

```

Figure 145. CICS Link for Application Panel

This panel allows you to manage the links between the current Application entry and the CICS link entries.

More about Policy Item STATE ACTION TABLE

With this policy item you can manage the link from the current application entry to the CICS State/Action entry, as shown in Figure 146. Each application entry may be linked to one CICS State/Action entry.

```

COMMANDS  ACTIONS  VIEW  HELP
-----
CICS State/Action for Application                       Row 1 to 1 of 1
Command ==> _____ SCROLL==> PAGE

Entry Type : Application      PolicyDB Name : DATABASE_NAME
Entry Name : CICS             Enterprise Name : YOUR_ENTERPRISE

Action      Status      CICS State/Action
-----
            _____ CICS
***** Bottom of data *****

```

Figure 146. CICS State/Action for Application Panel

This panel allows you to define a CICS State/Action for the Application. When this policy is selected a list of all CICS State/Action entries is displayed. The CICS State/Action entry that is currently linked to this Application entry is marked as "SELECTED".

More about Policy Item RESOURCE THRESHOLDS

With this policy item you can define CICS resource thresholds.

Application Policy Object

```
COMMANDS  HELP
-----
CICS Resource Thresholds Selection      Row 1 to 10 of 20
Command ==> _____                SCROLL==> PAGE

Entry Type : Application                PolicyDB Name : DATABASE_NAME
Entry Name : CICS                      Enterprise Name : YOUR_ENTERPRISE

Subsystem name: CICS

Select CICS resource thresholds to be altered.

- _____
- _____
- _____
- _____
- _____
- _____
- _____
- _____
- _____
- _____
```

Figure 147. CICS Resource Thresholds Selection Panel

From this panel you can do the following:

- Add a CICS resource threshold definition by entering a name on one blank line and entering an *S* in front of the entry to select it to edit the thresholds. For the rules that apply to the CICS resource threshold names, refer to the panel's online help.

Pressing enter after typing a name and the *S*, brings you to the *Thresholds Definition* panel shown in Figure 24 on page 33 where you can define thresholds.

- Rename CICS resource thresholds by typing the new name over the current name.
- Delete CICS resource thresholds by blanking out the name. All automation policy for that resource threshold will be deleted.
- Edit the thresholds for the CICS resource thresholds by entering an *S* in the input field before the resource name. Note that you can select multiple entries in which case the thresholds panel will be displayed once for each selection, without having to return to this panel between selections.

Note:

If the update to any CICS resource thresholds results in all of the thresholds being deleted then those resources will no longer be found in the ACF created during the next 'build'. This can result from one of the following scenarios:

- Creating a new resource threshold name by entering the name in one of the null entries but not entering *S* to select the entry to define the thresholds.
- Editing an entry and resetting all the thresholds to blank.

Policy Items for DB2 Subsystems

Figure 148 on page 205 shows the *Policy Selection* panel for applications that have been created with application type DB2 (see entry field *Application Type* in Figure 105 on page 145). This *Policy Selection* panel contains additional policy items for a DB2 subsystem.

Some of these policy items are only applicable to a DB2 subsystem defined as an instance. If a subsystem CLASS of type DB2 is selected, only the additional policy item RESOURCE THRESHOLDS will be available.

```

ACTIONS  HELP
-----
A0FGEPOL          Policy Selection          Row 14 to 23 of 23
Command ==> _____ SCROLL==> PAGE

Entry Type : Application      PolicyDB Name  : DATABASE_NAME
Entry Name  : DB2            Enterprise Name : YOUR_ENTERPRISE

Action      Policy Name      Policy Description
-----
          ...
          -----DB2 SPECIFIC POLICY-----
          DB2 CONTROL        Define DB2 Control entries
          RESOURCE THRESHOLDS Define DB2 resource Thresholds
          ...
***** Bottom of data *****

```

Figure 148. Policy Selection Panel for DB2 Subsystems

The DB2 specific policy items are:

DB2 CONTROL

With this policy item you can specify additional data for a DB2 subsystem. For more information refer to “More about Policy Item DB2 CONTROL.”

RESOURCE THRESHOLDS

With this policy item you can manage your DB2 resource threshold definitions for the current DB2 subsystem. These will overwrite the default threshold definition - if any - for DB2 subsystems running on the system where the current DB2 subsystem will run. You will reach the panel *DB2 Resource thresholds selection* which is equivalent to the *CICS Resource thresholds selection* panel shown in Figure 147 on page 204.

More about Policy Item DB2 CONTROL

With this policy item you can specify the additional data for a DB2 subsystem:

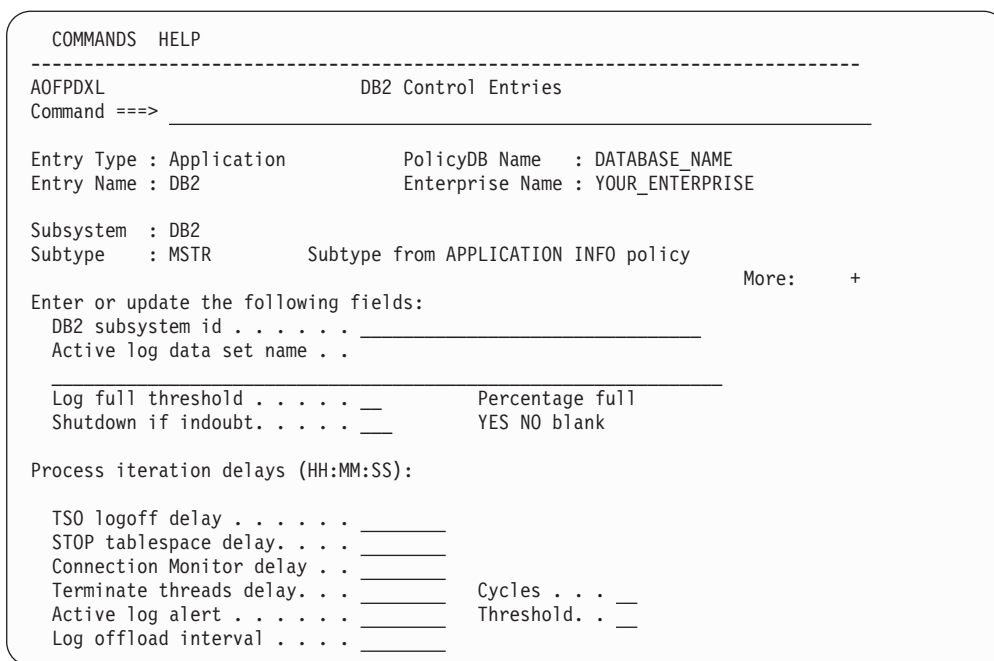

Figure 149. DB2 Control Entries Panel

Subtype

This parameter describes the controller type. It can be entered on the APPLICATION INFO policy item of the application, or the application class on the *Subtype* field. The value shown is either the one specified on the application or the one specified on the application class to which the application is linked.

DB2 subsystem id

This entry must correspond to the DB2 subsystem ID as defined in the system PARMLIB.

Active log data set name

Enter the DSN for the active log data set that is checked before threshold checking is performed. This value will be compared with the DSN which appears in the DSNJ002I message. The final HLQ (.DSnn) is not required. Specify the name without quotes.

Log full threshold

Specify the percentage the active log data set is allowed to become full, before the command corresponding to the DSNJ110E message is issued. 90 percent is the default value.

Shutdown if indoubt

Specify YES or NO to indicate if indoubt threads should be checked before shutting down DB2. If you want shutdown to proceed without checking for indoubt threads, then enter YES. If not, then you can use precheck on the NetView shutdown panel to check for indoubt threads.

Process iteration delays

Enter the following values in the format HHMMSS or HH:MM:SS. Except for cycles and thresholds, which must be a valid 2-digit number.

TSO logoff delay

This is the amount of time that the TSO logoff request should allow for before cancelling a TSO session. This is used, for example, during Thread Termination. 1 minute is the default.

STOP tablespace delay

This is the amount of time to delay between STOP tablespace request cycles. There are up to 3 cycles performed to ensure that the tablespace is shutdown. 2 minutes is the default.

Connection Monitor delay

This is the amount of time to delay between connection monitoring cycles. 30 minutes is the default.

Terminate threads delay

This is the amount of time to delay between thread termination cycles. 2 minutes is the default.

Terminate threads cycles

This is the number of cycles to attempt at terminating threads. 6 attempts is the default.

Active log alert

This is the amount of time to allow between DSNJ111E messages before issuing an alert. 5 minutes is the default.

Active log alert threshold

This is the number of DSNJ111E alerts to allow for, prior to issuing any associated commands from the ACF for the DSNJ111E message entry. 5 alerts is the default.

Log offload interval

This is the amount of time to allow between DSNJ115I messages before issuing an alert plus any associated commands from the ACF for the DSNJ115I message entry. 30 minutes is the default.

More about Policy Item DB2 RESOURCE THRESHOLDS

With this policy item you can define DB2 resource thresholds.

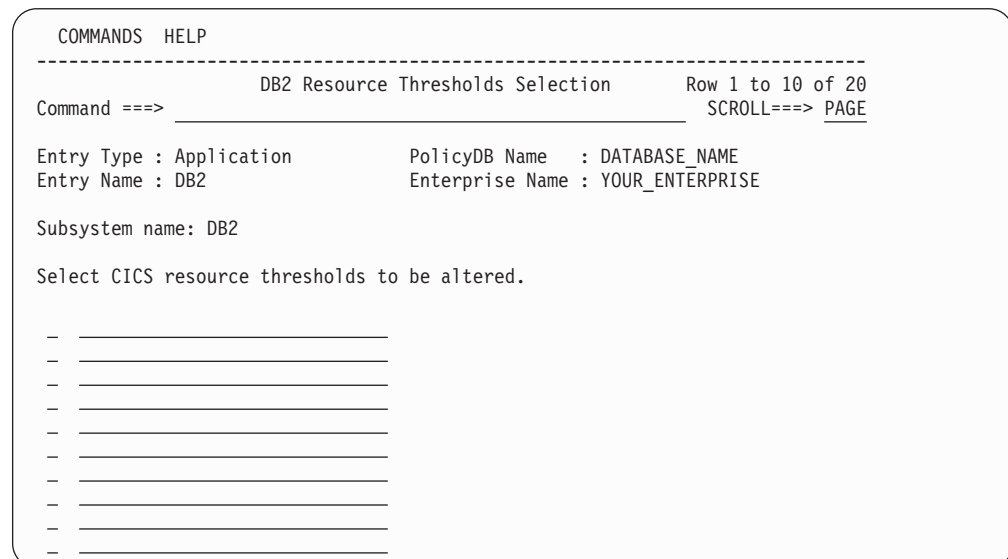

Figure 150. DB2 Resource Thresholds Selection Panel

From this panel you can do the following:

- Add a DB2 resource threshold definition by entering a name on one blank line and entering an S in front of the entry to select it to edit the thresholds. For the rules that apply to the DB2 resource threshold names, refer to the panel's online help.

Application Policy Object

Pressing enter after typing a name and the *S*, brings you to the *Thresholds Definition* panel shown in Figure 24 on page 33 where you can define thresholds.

- Rename DB2 resource thresholds by typing the new name over the current name.
- Delete DB2 resource thresholds by blanking out the name. All automation policy for that resource threshold will be deleted.
- Edit the thresholds for the DB2 resource thresholds by entering an *S* in the input field before the resource name. Note that you can select multiple entries in which case the thresholds panel will be displayed once for each selection, without having to return to this panel between selections.

Note:

If the update to any DB2 resource thresholds results in all of the thresholds being deleted then these resources will no longer be found in the ACF created during the next 'build'. This can result from one of the following scenarios:

- Creating a new resource threshold name by entering the name in one of the null entries but not entering *S* to select the entry to define the thresholds.
- Editing an entry and resetting all the thresholds to blank.

Policy Items for IMS Subsystems

Figure 151 shows the *Policy Selection* panel for applications that have been created with application type IMS (see entry field *Application Type* in Figure 105 on page 145). This *Policy Selection* panel contains additional policy items for an IMS subsystem.

Some of these policy items are only applicable to an IMS subsystem defined as an instance. If a subsystem CLASS of type IMS is selected, only the additional policy items IMS CONTROL and RESOURCE THRESHOLDS will be available.

```

ACTIONS  HELP
-----
AOFGEPOL                Policy Selection                Row 14 to 24 of 24
Command ==> _____ SCROLL==> PAGE

Entry Type : Application      PolicyDB Name  : DATABASE_NAME
Entry Name  : IMS            Enterprise Name : YOUR_ENTERPRISE

Action      Policy Name      Policy Description
-----
...
-----IMS SPECIFIC POLICY-----
-----
IMS CONTROL      Define IMS subsystem specific data
STATE ACTION TABLE  Select IMS state action table
RESOURCE THRESHOLDS Define IMS resource thresholds
...
***** Bottom of data *****
```

Figure 151. Policy Selection Panel for IMS Subsystems

The IMS specific policy items are:

IMS CONTROL

Use this policy item to define additional IMS information for the IMS CONTROL REGION subsystem. This is described in *System Automation for z/OS IMS Automation Programmer's Reference and Operator's Guide* in section

IMSCNTL. This policy item is only defined for an IMS control region. For more information refer to “More about Policy Item IMS CONTROL.”

RESOURCE THRESHOLDS

With this policy item you can manage your resource threshold definitions for this IMS subsystem. It will override any other system default threshold definitions. You will reach the panel *IMS Resource thresholds selection* which is similar to the *CICS Resource thresholds selection* panel shown in Figure 147 on page 204 where you can fill in the required information.

STATE ACTION TABLE

If you select this policy item, SA z/OS will display a list of state/action tables which previously have been defined as described in “IMS State/Action Tables” on page 247. From this list you can link one state/action table to the current IMS subsystem or change or remove an existing link.

More about Policy Item IMS CONTROL

If you select policy item IMS CONTROL from the *Policy Selection* panel for IMS subsystems, and you have specified the subtype CTL, Figure 152 on page 210 where you describe the IMS/DC control region is displayed.

Application Policy Object

```

COMMANDS  HELP
-----
AOFGICTL          IMS Control Region specifications
Command ==> _____

Entry Type : Application          PolicyDB Name  : DATABASE_NAME
Entry Name  : IMS                 Enterprise Name : YOUR_ENTERPRISE

Subsystem   : IMS
Subtype    : CTL                 Subtype from APPLICATION INFO policy
More:      +

Enter or update the following fields:
APPLid. . . . . _____
APPL1 connect . . . . . _____
APPL2 connect . . . . . _____
Default HSBID . . . . . _____ 1 2 or blank
Startup parm1 . . . . . _____
Startup parm2 . . . . . _____
Shutgo. . . . . _____ YES NO
IMS subsystem ID. . . . . _____
Default start type. . . . . _____ AUTO COLD BUILDQ WARMSDBL
Default force . . . . . _____ DUMP NODUMP
Applid connect. . . . . _____ YES NO
Broadcast delay . . . . . _____ Minutes
Force transfer delay. . . . . _____ Minutes
Immed transfer delay. . . . . _____ Minutes
Region recovery delay . . . . . _____ Minutes
Shutdown verify delay . . . . . _____ Minutes
Start monitoring delay. . . . . _____ Minutes
Start type (shutdown) . . . . . _____ AUTO COLD BUILDQ WARMSDBL
Start type (recovery) . . . . . _____ AUTO COLD BUILDQ WARMSDBL
DB control. . . . . _____ YES NO
XRF enabled . . . . . _____ YES NO

XRF details if XRF = YES

XRF Synchronization . . . . . _____ Y S N P T
Default XRF start type. . . . . _____ XRF ACTIVE BACKUP
XRF shut delay. . . . . _____ Seconds
XRF Watch wait. . . . . _____ Seconds
XRF unlock delay. . . . . _____ Minutes
Non automatic takeover. . . . . _____ YES NO
Partner subsystem ID. . . . . _____ IMS subsystem ID of partner IMS
Partner domainid. . . . . _____ Netview domain ID of partner IMS
Partner subsystem . . . . . _____ Subsystem name of backup control region
XRF Watch notify. . . . . _____ Seconds
XRF Watch alert . . . . . _____ Seconds

The following definitions are for SA13 only:

Major node1 . . . . . _____ Activate IMS VTAM major node
Major node2 . . . . . _____ Activate IMS VTAM major node
Other major1. . . . . _____ Activate other VTAM major node
Other major2. . . . . _____ Activate other VTAM major node
Auto-Operator . . . . . _____ NetView Auto-operator
Shutdown exit . . . . . _____ User exit name
XRF alternate start . . . . . _____ YES NO
XRF new alternate start _____ YES NO

```

Figure 152. IMS Control Region Specifications Panel for subtype CTL

The fields that you enter or update have the following meaning:

Subtype

This parameter describes the controller type. It can be entered on the APPLICATION INFO policy item of the application, or the application class on the *Subtype* field. The value shown is either the one specified on the application or the one specified on the application class to which the application is linked.

APPLid

identifies the receiver/sender name when the program-to-program interface is initiated and used. Use one of the following:

Applid

Use this keyword if this subsystem is defined as non-XRF.

(generic-applid,specific-applid)

If this subsystem is defined as XRF-capable, then use generic-applid as the name given to both the active and alternate subsystem and specific-applid as the specific name for this subsystem.

Appl1/Appl2 connect

If you want SA z/OS automation to check that the IMS APPLID is connectable prior to starting IMS, specify a value here for the IMS APPLID. APPLID1 or APPLID2 identifies the VTAM name. Use the specification APPLID1 for a non-XRF IMS subsystem. If the system is an XRF IMS, use both the APPLID1 and the APPLID2 specifications to define both APPLIDs that can be used by the IMS subsystem. APPLID1 will be checked when the HSBID is 1, APPLID2 will be checked when the HSBID is 2.

Default HSBID

For an XRF IMS control region, the DEFLTHSB specification describes the preferred HSBID to be used when restarting an IMS system in situations where it does not matter which HSBID is used (in terms of IMS recovery).

Startup parm1/2

If you have additional parameters that should be appended to the startup command to start IMS, then specify them here. For a non-XRF IMS subsystem, specify your local parameters using the PARMS1 parameter. For an XRF IMS subsystem, the parameters used will be based on the current HSBID. For example, if HSBID=1, then the parameters coded on the PARMS1 parameter will be used.

Shutgo

Specifying YES will allow shutdown of a control region to progress from a normal shutdown, then to an immediate shutdown, then to a forced shutdown (as needed) without any operator action.

IMS Subsystem ID

Specifies the subsystem ID (IMSID) specified in the IMS control region parameters or SYSGEN.

Default start type

This defines the default start type for the Start Functions panel, to be used for a control region startup. This start type will be used when SA z/OS determines that the subsystem should be running but is not. If the SA z/OS INGREQ command is issued to perform a start of a subsystem, the default start type will be used. If a default is not specified, the start will fail.

Default force

This parameter is used during an escalation of shutdown from type IMMED to type FORCE. It retrieves the default shut options for a type FORCE shutdown. This parameter specifies the dump option associated with a type FORCE shutdown.

Applid connect

During IMS startup, if this is specified as YES, then the IMS control region

Application Policy Object

will not be started unless the APPLID is connectable. In any case, an XRF alternate subsystem will not be started regardless of what is specified if the APPLID is not connectable.

Broadcast delay

If the BROADCAST or ABORT SHUTDOWN option is selected on one of the shutdown panels, this parameter defines the time in minutes between the execution of the /BRO command and the start of the shutdown (SHUTSYS) process.

Force transfer delay

This is used to specify the escalation interval in minutes between the transfer from the shutdown type of IMMED to the shutdown type of FORCE. The value specified in this timer overrides the value specified in the shutdown verify delay.

Immed transfer delay

This is used to specify the escalation interval in minutes between the transfer from the shutdown type of NORM to the shutdown type of IMMED. The value specified in this timer overrides the value specified in the shutdown verify delay.

Region recovery delay

After the first indication of an IMS control region abend (receipt of the DFS629 message), the number of minutes before the final abend recovery routine is invoked.

Shutdown verify delay

After the IMS shutdown checkpoint command is issued, the number of minutes before the shutdown verification process is invoked.

Start monitoring delay

This parameter is used for IMS initialization. This timer defines the interval for IMS Automation to wait before proceeding with IMS subsystem monitoring. IMS Automation will wait this interval before scheduling the function to report on the progress of the startup of an IMS complex.

Start type (shutdown)

This parameter defines the start type that will be used when a control region is restarted as part of a shutdown request.

Start type (recovery)

This parameter defines the start type that will be used when a control region is restarted after a recoverable abend has occurred.

DB control

This parameter indicates whether the control region is a DB control region. (If YES, then XRF=NO must also be specified.)

XRF This parameter is required for the control region only. It specifies whether the control region will be executing as an XRF complex.

XRF synchronization

This parameter is used for XRF systems only and controls the type and degree of region synchronization between the active and the alternate IMS subsystems. This parameter is effective when the parent IMS control region is the alternate. While the parent is the active IMS, the parameter is not used.

Region synchronization applies only to Batch Message Processing regions (SUBTYPE=BMP), Message Processing regions (SUBTYPE=TP) and Fast Path regions (SUBTYPE=FP).

- Y When coded on a control region subsystem entry, this parameter permits synchronization of the dependent regions. This parameter must be coded on a control region for any of the dependent regions to be synchronized. When coded on a dependent region, this parameter determines that when the partner region is stopped or started on the active IMS subsystem, this region is also stopped or started on the alternate IMS subsystem to mirror the active.
- S This parameter is not valid when SUBTYPE=CTL. When the partner region is started on the active IMS subsystem, this event is recorded. The region will be started on the alternate when a takeover occurs after takeover processing is complete.
- N When coded on a control region subsystem entry, this parameter disables all synchronization of the dependent regions. When coded on a dependent region, the region will not participate in any type of synchronization.
- P This parameter is not valid when SUBTYPE=CTL. This region will not participate in any type of synchronization; however, it will be started when the alternate IMS is started.
- T This parameter is not valid when SUBTYPE=CTL. This region will be started after the IMS Takeover.

Default XRF start type

This parameter is used for XRF systems only and determines whether the control region is to be started as the Active or Backup. Automation uses the status file to store the HSBID of the control region that is the Active system, for use when restarting the IMS system. When this information does not exist in the status file, this parameter determines which subsystem will be started as the Active system.

XRF shut delay

This parameter is used for XRF systems only. During shutdown of an XRF IMS complex with an alternate that is executing, IMS Automation will attempt the shutdown of the alternate prior to the active. For an "Immediate" type of shutdown, shut delay is the time in seconds to wait after initiating alternate shutdown before continuing with the active shutdown process.

XRF Watch wait

This parameter is used for XRF systems only. During XRF takeover processing, this time is the number of seconds between each invocation of takeover watch or monitor processing.

XRF unlock delay

This parameter is used for XRF systems only. During an XRF takeover, once the UNLOCK command has been issued by the IMS Automation Surveillance processing this parameter specifies the number of minutes to suspend the surveillance CLIST. After the suspension, the CLIST is invoked again to check XRF takeover processing.

Non automatic takeover

This parameter is used for XRF systems only. If the XRF complex is defined so that a takeover will not automatically occur (specified in the DFSHSBxx member of the IMS PROCLIB), a message will be issued to the MVS system console so the operator can respond to allow the takeover to occur or to stop the process. If the parameter specifies YES, then IMS Automation will respond with the affirmative reply to this message.

Application Policy Object

Partner subsystem ID

This parameter is used for XRF systems only and is required if XRF=YES. This is the subsystem ID for the partner IMS control region. This control region may be specified either in the local (same) or a remote domain.

Partner domainid

This parameter is used for XRF or FDR enabled systems only. For an XRF environment specify this parameter and XRF=YES. For an FDR enabled system specify this parameter and XRF=NO. This is the NetView domainID for the partner IMS control region in an XRF environment, or, the tracking FDR region in an FDR environment. This may be the local (same) or a remote domain.

Partner subsystem

This parameter is used for XRF or FDR enabled systems only. For a XRF environment specify this parameter and XRF=YES. For an FDR enabled system specify this parameter and XRF=NO. For the XRF CONTROL region this is the SA z/OS subsystem name of the alternate/backup control region. For the dependent regions this is the SA z/OS subsystem name of the corresponding XRF partner dependent regions. For an FDR enabled system, this is the SA z/OS subsystem name for the FDR region.

XRF Watch notify

This parameter is used for XRF systems only and is required if XRF=YES. This parameter can be used to tailor the XRF takeover surveillance processing. It is specified in seconds. If surveillance processing does not detect a change in the XRF status for the monitored IMS subsystem prior to the time specified in HERE, additional IMS Automation warning messages will be issued. These messages describe possible problems with the takeover. Once issued, the clock starts again and the messages are not issued until the time spent in surveillance once again exceeds the time specified in watch notify.

XRF Watch alert

This parameter is used for XRF systems only and is required if XRF=YES. This parameter can be used to tailor the XRF takeover surveillance processing. It is specified in seconds. Once surveillance processing exceeds the time specified in this parameter with no change in the XRF status, additional messages are issued indicating that operator intervention may be required to complete the takeover. Once issued, the messages will be issued again every XRF Watch wait time until an XRF status change is detected.

The following definitions apply only to SA OS/390 1.3:

Major node1/2

SA OS/390 1.3 users: If you want SA z/OS automation to check that the IMS VTAM Major Node is active (and make it active if it is not) prior to starting the IMS control region, then specify the correct major node here. The specification for an XRF IMS subsystem is similar to that for APPLIDs.

SA OS/390 Version 2 users: Specify the VTAM V NET,ACT,ID=xxx or V NET,INACT,ID=xxx commands for the required nodes in the *Prestart* and the *Postshutdown* command entries for each start type of the IMS control region policy. Alternatively, if you wish the startup/shutdown to wait until the node is active/inactive use the following commands:

- Active: PIPE CORRCMD V NET,ACT,ID=xxx | CONS
- Inactive: PIPE CORRCMD V NET,INACT,ID=xxx | CONS

Other major1/2

SA OS/390 1.3 users: If you want SA z/OS automation to check that any other VTAM Major Node is active (and make it active if it is not), then specify the correct node name here. The specification for an XRF IMS subsystem is similar to that for APPLIDs.

SA OS/390 Version 2 users: Specify the VTAM V NET,ACT,ID=xxx or V NET,INACT,ID=xxx commands for the required nodes in the *Prestart* and the *Postshutdown* command entries for each start type of the IMS control region policy. Alternatively, if you wish the startup/shutdown to wait until the node is active/inactive use the following commands:

- Active: PIPE CORRCMD V NET,ACT,ID=xxx | CONS
- Inactive: PIPE CORRCMD V NET,INACT,ID=xxx | CONS

Auto-Operator

This identifies the NetView Automated Operators that control this IMS system and its dependents. The value must be defined in an AUTOOP statement. Operators can be assigned to one or more IMS subsystems.

Shutdown exit

This parameter specifies that a user exit will be called. This user exit is invoked only at shutdown of the IMS control region. The user exit must be a CLIST and a member of the DSICLD concatenation of NetView.

XRF alternate start

This parameter is used for XRF systems only and is required if XRF=YES. When the control region is started and is the active in an XRF complex, this parameter specifies whether the alternate IMS control region should also be started immediately after the active becomes available.

When ALTSTART=YES is used, any service periods or triggers that are defined for the XRF backup or alternate subsystem will be ignored.

Note:

It is recommended that the same service periods are used for both XRF subsystems when ALTSTART=YES.

XRF new alternate start

This parameter is used for XRF systems only. After an XRF takeover, this parameter specifies whether a new alternate should be started to replace the old active IMS subsystem.

If the specified subtype is not CTL, the panel shown in Figure 153 on page 216 is displayed.

```

COMMANDS  HELP
-----
AOFGIDR          IMS Dependent Region specifications
Command ==> _____

Entry Type : Application          PolicyDB Name  : DATABASE_NAME
Entry Name  : IMS_TP             Enterprise Name : YOUR_ENTERPRISE

Subsystem   : IMS_TP
Subtype    : TP                  Subtype from application class IMS_CLASS_DR

Enter or update the following fields:
Owning Control region . _____
Default force . . . . . _____ DUMP NODUMP
Broadcast delay . . . . . _____ Minutes
XRF enabled . . . . . _____ YES NO
Partner subsystem . . . _____ Subsystem name of backup region

XRF details if XRF = YES

XRF Synchronization . . _          Y S N P T

```

Figure 153. IMS Dependent Region Specifications Panel

Control region name

Is the SA z/OS subsystem name of the owning control region. This parameter is necessary only when a dependent region is defined as a dependent of more than one IMS control region. This parameter enables IMS Automation to determine how to display, start, and stop the region. You may include system symbols and system automation symbols. See “Assigning System Automation Symbols (AOCCLONE)” on page 42 for details about using system automation symbols.

Default force

This parameter is used during an escalation of shutdown from type IMMED to type FORCE. It retrieves the default shut options for a type FORCE shutdown. This parameter specifies the dump option associated with a type FORCE shutdown.

Broadcast delay

If the BROADCAST or ABORT SHUTDOWN option is selected on one of the shutdown panels, this parameter defines the time in minutes between the execution of the /BRO command and the start of the shutdown (SHUTSYS) process.

XRF enabled

Specifies whether XRF synchronization should be enabled or not.

Partner subsystem

This parameter is used for XRF enabled systems only. For IMS dependent regions this is the SA z/OS subsystem name of the corresponding XRF partner dependent regions.

XRF synchronisation

This parameter is used for XRF systems only and controls the type and degree of region synchronization between the active and the alternate IMS subsystems. This parameter is effective when the parent IMS control region is the alternate. While the parent is the active IMS, the parameter is not used.

Y When the partner region is stopped or started on the active IMS subsystem this region is also stopped or started on the alternate IMS subsystem to mirror the active.

- N This region will not participate in any type of synchronization.
- P This region will not participate in any type of synchronization, however, it will be started when the alternate IMS is started.
- S When the partner region is started on the active IMS subsystem, this is recorded. The region will be started on the alternate when a takeover occurs after takeover processing is complete.
- T This region will be started after the IMS takeover.

Policy Items for OPC Subsystems

Figure 154 shows the *Policy Selection* panel for applications that have been created with application type OPC (see entry field *Application Type* in Figure 105 on page 145). This *Policy Selection* panel contains additional policy items for an OPC subsystem.

These policy items are only applicable to an OPC subsystem defined as an instance. If a subsystem CLASS of type OPC is selected, no additional policy items will be available.

```

ACTIONS  HELP
-----
AOFGEPOL          Policy Selection          Row 14 to 22 of 22
Command ==>>>          SCROLL==>> PAGE

Entry Type : Application      PolicyDB Name  : DATABASE_NAME
Entry Name  : OPC             Enterprise Name : YOUR_ENTERPRISE

Action      Policy Name      Policy Description
...
-----
OPC CONTROL  Define OPC Control entries
-----
...
***** Bottom of data *****

```

Figure 154. Policy Selection Panel for OPC Subsystems

The OPC specific policy item is:

OPC CONTROL

Use this policy item to specify OPC extensions to subsystem definitions. For more information, see “More about Policy Item OPC CONTROL.”

More about Policy Item OPC CONTROL

If you select policy item OPC CONTROL on the *Policy Selection* panel for OPC subsystems, SA z/OS displays the following panel where you can describe additional information for OPC subsystems.

Application Policy Object

```
COMMANDS  HELP
-----
AOFPOXL          OPC control specifications
Command ===>

Entry Type : Application          PolicyDB Name  : DATABASE_NAME
Entry Name : OPC                  Enterprise Name : YOUR_ENTERPRISE

Subsystem  : OPC
Subtype    : CONTROLLER          Subtype from APPLICATION INFO policy

Enter or update the following fields:
Subsystem ID . . . . . OPC
Controller ID. . . . .                (Tracker Only)
API LU Name. . . . .
```

Figure 155. OPC control specifications Panel

Fill in the following fields:

Subtype

This parameter describes the controller type. It can be entered on the APPLICATION INFO policy item of the application, or the application class on the *Subtype* field. The value shown is either the one specified on the application or the one specified on the application class to which the application is linked.

Subsystem ID

Enter the OPC subsystem ID.

Controller ID

Enter the OPC subsystem ID of the controller, controlling this tracker. This field is only used for tracker definitions. It allows for the specification of a remote controller. If the controller is not in the same sysplex as the tracker, then specify this field.

API LU Name

Enter the Logical Unit name of the controller, controlling this tracker. This field is only used for tracker definitions. It allows for the specification of a remote controller. If the controller is not in the same sysplex as the tracker, then specify this field.

For both the Controller ID and API LU Name fields, if the controller is in a remote sysplex or system that can be controlled by SA z/OS with the TARGET= parameter of the commands, then there is no need to specify these fields.

Policy Items for USS Subsystems

Figure 156 on page 219 shows the *Policy Selection* panel for applications that have been created with application type USS (see entry field *Application Type* in Figure 105 on page 145).

By using the USS CONTROL policy item you can define UNIX System Services specific data.

```

ACTIONS  HELP
-----
A0FGEPOL          Policy Selection          Row 14 to 22 of 22
Command ==>          SCROLL==> PAGE

Entry Type : Application          PolicyDB Name : DATABASE_NAME
Entry Name : USSTEST             Enterprise Name : YOUR_ENTERPRISE

Action    Policy Name    Policy Description
...
-----
USS CONTROL    Define USS specific data
-----
...
***** Bottom of data *****

```

Figure 156. Policy Selection Panel for USS Subsystems

More about Policy Item USS CONTROL

If you select policy item USS CONTROL on the *Policy Selection* panel for USS subsystems, SA z/OS displays the following panel where you can enter additional information for UNIX subsystems.

```

COMMANDS  HELP
-----
A0FGUSS          USS Control Specification
Command ==>          More: +

Entry Type : Application          PolicyDB Name : DATABASE_NAME
Entry Name : USSTEST             Enterprise Name : YOUR_ENTERPRISE

Subsystem name: USSTEST

User ID . . . . . _____

Monitoring Command. .
_____

Enter or update one of the following fields:

Command/Path. . . . .
_____

File Name . . . . .
_____

Monitored Port. . . . . _____

```

Figure 157. USS Control Specification Panel

Fill in the following fields:

User ID

Enter the UNIX user ID this resource belongs to.

Monitoring Command

Enter the UNIX System Services monitoring command that is used to get the status of the resource. This command must be a valid program in the

Application Policy Object

HFS. If the field is left blank, the SA z/OS supplied standard monitoring routine is used. The following return codes are possible:

- 0 The resource is available
- 4 The resource is starting
- 8 The resource is unavailable
- 12 An error occurred

If the first character is a '/', the specified command is considered to be an absolute path. Otherwise the monitoring routine must reside in the same directory as the SA z/OS routines.

Command/Path

Enter the name of the command that is running without its arguments as shown by the UNIX command "ps" with the format specification "comm".

File Name

Enter the path of a file in the HFS. If the file exists and the user ID specified above is the owner of the file the resource is available, otherwise the resource is not available.

Monitored Port

Enter the TCP port number this resource is supposed to listen on the local host.

Defining VTAM Application Subsystems

VTAM applications may require recovery commands to be issued should either VTAM be restarted, or the VTAM application node be reactivated. These commands differ from subsystem to subsystem and can be specified in the Messages/User Data policy items as described in the following section.

Registering VTAM Application Subsystems with SA z/OS Recovery

To enable VTAM application recovery to take place, the subsystems must be registered with the SA z/OS recovery code. This is achieved by using the INGVTAM command which is described in *System Automation for z/OS Programmer's Reference*. The following application policy items must be customized.

1. PRE-START policy

The PRE-START policy must have at least a NORMAL start item with the INGVTAM command to activate a list of major nodes. The following command can be used as an example:

```
INGVTAM &SUBSAPPL REQ=ACTIVATE MAJNODE=(majnode1,majnode2,...)
```

Where majnoden are VTAM application major nodes. Each major node will be varied active to VTAM when the subsystem prestart commands are issued. Note, it is expected that only one of the major nodes will contain the minor node that the VTAM application subsystem will use.

2. POST-SHUTDOWN policy

The POST-SHUTDOWN policy is used to deregister the subsystem with SA z/OS VTAM application recovery. Use the INGVTAM REQ=DEACTIVATE command in the policy. For example:

```
INGVTAM &SUBSAPPL REQ=DEACTIVATE
```

The DEACTIVATE request issues a vary net inactive for each major node registered by the REQ=ACTIVATE. The vary is not done if the major node is

shared by other subsystems that have also registered the major node. When the last subsystem registered issues an INGV TAM REQ=DEACTIVATE, the major node will be varied inactive. The only exception to this is when the major node contains model resources with wildcards in the node definition. In this case the major node is never inactivated.

3. ACORESTART Messages/User Data policy

The ACORESTART message policy must have the same definition as the PRE-START policy. This policy item is used to reregister the subsystem with SA z/OS VTAM application recovery.

4. NODEUP Messages/User Data policy

Enter commands that are issued when the minor node for the subsystem is reactivated or message IST093I is issued. Typically these commands reopen the VTAM ACB that the subsystem uses to communicate with VTAM.

5. VTAMUP Messages/User Data policy

Enter commands that are issued when the VTAM subsystem is restarted. Typically these commands reopen the VTAM ACB that the subsystem uses to communicate with VTAM.

6. Relationships policy

Optionally enter a relationship for the subsystem to ensure that the prestart commands are only issued when VTAM is up. The required relationship is:

```
PrepAvailable(WhenAvailable),Passive,Weak -> VTAM/APL/=
```

Where VTAM is the name of the VTAM subsystem and that is the supporting resource. *Passive* forces the relationship to wait until VTAM is UP. *Weak* specifies that only the supporting resource status is checked.

7. UP Messages/User Data policy

Enter a command in the UP message for the VTAM subsystem. With this command, use the following parameter:

```
INGVTAM REQ=ACTIVATE
```

Note, that no subsystem is specified on the INGV TAM command. This will force the INGV TAM command to issue the VTAMUP message against every subsystem that has registered with SA z/OS VTAM application recovery.

Events Policy Object

Events basically are used for external dependencies where they represent a process that the automation cannot handle. For example, an operator needs to manually edit a file before the application can be started. SA z/OS remembers which events are SET (have occurred) and can be told when to forget them (by defining an UNSET condition).

Creating a New Event

To define a new event, enter 44 or EVT for events in the panel shown in Figure 2 on page 7.

This displays a panel similar to the one shown in Figure 158 on page 222. This panel may show a list of already existing events. Enter the command **new** on the command line.

Events Policy Object

```

COMMANDS  ACTIONS  VIEW  HELP
-----
AOFGENAM          Entry Name Selection
Command ==> new                                     SCROLL==> PAGE

Entry Type : Event                                PolicyDB Name : DATABASE_NAME
                                                Enterprise Name : YOUR_ENTERPRISE

Action      Entry Name      C Short Description
-----
EVENT1     EVENT1A                    Startup event, backup completed
EVENT2     EVENT2A                    Startup event, AOR1 is ready
EVENT3     EVENT2B                    Startup event, AOR2 is ready

```

Figure 158. Entry Name Selection Panel for Events

A panel similar to the one shown in Figure 159 is displayed. Specify the event name, the UNSET condition, and a description.

```

COMMANDS  HELP
-----
AOFGDYN2          Define New Entry
Command ==> _____

Define new entry of type Event

Name . . . . . EVENT1
Unset Condition . . . . NONE (DOWN NONE START UP)

Short description . . . Backup successfully completed
Long description . . . _____
Long description . . . _____
Long description . . . _____
Long description . . . _____
Long description . . . _____

```

Figure 159. Define New Event Panel

The unset condition is preset to NONE. You can change this input field if desired. For more information on the unset condition, see “More about Policy Item CONDITION” on page 223.

Policy Items for Events

Figure 160 shows the policy items that are displayed when an event is selected from the *Entry Name Selection* panel for events.

```

ACTIONS  HELP
-----
AOFGEPOL          Policy Selection
Command ==> _____                                     SCROLL==> PAGE

Entry Type : Event                                PolicyDB Name : DATABASE_NAME
Entry Name : EVENT3                               Enterprise Name : YOUR_ENTERPRISE

Action      Policy Name      Policy Description
-----
S_____   DESCRIPTION    Enter description
           CONDITION      Define the unset condition
           _____
           COPY           Copy data from an existing entry

```

Figure 160. Policy Selection Panel for Events

The unique policy item for *Events* is:

CONDITION

With this policy item you can specify when SA z/OS should unset (forget) a previously set event.

More about Policy Item CONDITION

Selecting the CONDITION policy item will bring up a panel as shown in Figure 161 where you can define the *unset condition* of the current event.

```

COMMANDS  HELP
-----
A0FGAPEV          Unset Condition
Command ==> _____

Entry Type : Event          PolicyDB Name  : DATABASE_NAME
Entry Name  : EVENT3       Enterprise Name : YOUR_ENTERPRISE

Verify the following condition

Unset condition . . . NONE_ DOWN NONE START UP

```

Figure 161. Unset Condition Panel for Events

The unset condition determines when an event for an application is reset to *not occurred* (that is, unset). You can enter the following values:

NONE

Once set, the event will never be unset.

START

once set, the event will be unset if the application is already in the respective state or if the observed status of the application turns into STARTING.

UP

once set, the event will be unset if the application is already in the respective state or if the observed status of the application turns into one of the following:

AVAILABLE
DEGRADED

DOWN

once set, the event will be unset if the application is already in the respective state or if the observed status of the application turns into one of the following:

SOFTDOWN
HARDDOWN
SYSGONE
STANDBY

Service Periods Policy Object

Service periods define the availability of applications. A service period is a set of time intervals (service windows) during which an application should be active or inactive.

Figure 162 on page 224 shows the policy items that are displayed when an existing *Service Periods* entry is selected from the *Entry Name Selection* panel.

Service Periods Policy Object

```

ACTIONS  HELP
-----
AOFGEPOL                               Policy Selection                               Row 1 to 5 of 5
Command ==> _____                SCROLL==> PAGE

Entry Type : Service Period             PolicyDB Name   : DATABASE_NAME
Entry Name  : SERVP1                    Enterprise Name : YOUR_ENTERPRISE

Action     Policy Name      Policy Description
-----
          DESCRIPTION      Enter description
          SERVICE WINDOW    Define service windows
-----
          WHERE USED        List APLs, APGs and MTRs linked to this entry
          COPY              Copy from existing entry
***** Bottom of data *****
```

Figure 162. Policy Selection Panel for Service Periods

The unique policy item for *Service Periods* is:

SERVICE WINDOW

With this policy item you define the time frame (or frames) when an application or an application group should be available or unavailable. You need to link a service period with a defined service window to Applications, Application Groups, or Monitor Resources.

More about Policy Item SERVICE WINDOW

Selecting the SERVICE WINDOW policy item will bring up a panel as shown in Figure 163 on page 225 where you can define the time duration of the service period.

```

COMMANDS  HELP
-----
Service Windows
Command ==> _____

Entry Type : Service Period      PolicyDB Name : DATABASE_NAME
Entry Name : SERVPI             Enterprise Name : YOUR_ENTERPRISE

Note: Review help panel for complete description of data entry fields.
      Valid times are 00:00-24:00, valid priorities (P) are L and H.

      P  From To   From To   From To   From To   From To
Monday U  00:00 24:00  _____  _____  _____  _____
      D  _____  _____  _____  _____  _____  _____
Tuesday U  00:00 24:00  _____  _____  _____  _____
      D  _____  _____  _____  _____  _____  _____
Wednesday U  _____  _____  _____  _____  _____  _____
      D  _____  _____  _____  _____  _____  _____
Thursday U  _____  _____  _____  _____  _____  _____
      D  _____  _____  _____  _____  _____  _____
Friday U  _____  _____  _____  _____  _____  _____
      D  _____  _____  _____  _____  _____  _____
Saturday U  08:00 14:00  _____  _____  _____  _____
      D  _____  _____  _____  _____  _____  _____
Sunday U  _____  _____  _____  _____  _____  _____
      D  _____  _____  _____  _____  _____  _____
Weekday U  07:00 18:00  _____  _____  _____  _____
      D  _____  _____  _____  _____  _____  _____
Weekend U  _____  _____  _____  _____  _____  _____
      D  _____  _____  _____  _____  _____  _____
Daily U  _____  _____  _____  _____  _____  _____
      D  _____  _____  _____  _____  _____  _____
    
```

Figure 163. Service Windows Panel for Service Periods

A service period is a schedule of times (referred to as service windows) when a resource is expected to be active or inactive. Times that you enter into a line preceded by letter *U* will be used as From/To times for the periods when the resource should be available (UP). A line preceded by letter *D* will contain From/To times for DOWN periods. Start and Stop times are specified in 24 hour notation, 00:00-24:00, and in any order. For example, to keep an application continuously available from Monday through Tuesday around the clock, specify the times as shown:

```

      P  From To   From To   From To   From To   From To
Monday U  00:00 24:00  _____  _____  _____  _____
      D  _____  _____  _____  _____  _____  _____
Tuesday U  00:00 24:00  _____  _____  _____  _____
      D  _____  _____  _____  _____  _____  _____
    
```

The schedule is defined by specifying one or more (up to five) service windows for:

- **each day of the week:** Monday through Sunday
- **weekday days:** the weekday schedule (Monday through Friday)
- **weekend days:** the weekend schedule (Saturday and Sunday)
- **Daily:** all seven days; the daily schedule

Service Periods Policy Object

For the time between the specified intervals, the automation manager decides what to do with the resources.

For each UP and DOWN schedule, in the **P** column, you may specify a priority:

- L** for low priority; Orders resulting from a service period with low priority can be overruled by an operator's **INGREQ** command. This is the default.
- H** for high priority; H schedules override L schedules and low priority operator requests.

This priority is checked in case two goals get into conflict. The hierarchy of requests and priorities is implemented as follows:

Request from	wins over	request from
-----	-----	-----
Service period high	=====>	service period low, INGREQ low
INGREQ low	=====>	service period low
INGREQ high	=====>	service period high, service period low, INGREQ low

Note:

There are other methods of generating requests within SA z/OS. For a complete description of these methods and the implemented hierarchy of their priorities refer to the documentation of the SA z/OS concepts in *System Automation for z/OS User's Guide*.

When defining a service period keep in mind that the startup time is the time at which SA z/OS is to begin startup processing. It is not the time at which the resource will be available. The time until availability depends on how long the startup of an application or an application group takes.

According to the goal driven concept, a vote to start a resource is generated from a service period that you enter into an in a UP service window. A vote to stop a resource is generated from each service period that you enter into a DOWN service window. These votes have to compete with other votes that have been probably issued (for example, due to operator request). At the end of the service period, these votes are removed from SA z/OS. An end of an UP service window does not mean implicitly the start of a DOWN service window.

For more information about the hierarchy of service windows or the syntax of FROM and TO times, see the online help for the product.

If you later change a service period that is already active, and the service period is activated again, this may lead to conflicts and mismatches with overrides that have been made previously. So if you want to change a service period, check your existing NetView overrides that use this service period beforehand, so that no override is outside the new service period (see also the **INGSCHED** command, described in *System Automation for z/OS Operator's Commands*).

Triggers Policy Object

In combination with events, triggers are used to control the starting and stopping of applications on top of what is done with specified goals. You use events and triggers if external conditions must be fulfilled (such as a tape mount).

Figure 164 shows the policy items that are displayed when a trigger is selected from the *Entry Name Selection* panel.

ACTIONS		HELP

A0FGEPOL	Policy Selection	
Command ==>		SCROLL==> PAGE
Entry Type : Trigger	PolicyDB Name : DATABASE_NAME	
Entry Name : TRIGGER1	Enterprise Name : YOUR_ENTERPRISE	
Action	Policy Name	Policy Description
	DESCRIPTION	Enter description
S	CONDITION	Define the Trigger condition

	WHERE USED	List APLs and APGs using this entry
	COPY	Copy data from an existing entry

Figure 164. Policy Selection Panel for Triggers

The unique policy item for a trigger is:

CONDITION

Entering **S** in front of item **CONDITIONS** will bring up a panel as shown in Figure 165 on page 228 where you can define the startup and shutdown conditions for this trigger.

More about Policy Item CONDITION

With the **CONDITION** policy item you can:

1. Connect a service period to a trigger (**1**). Type **S** into the **ACTION** column in Figure 165 on page 228.

Note:

This feature is available only for compatibility with SA OS/390 1.3. Since SA OS/390 2.1, service periods are linked directly to application groups or applications.

2. Define up to ten startup conditions for the application that you want to connect to the trigger (**2**), see “Defining STARTUP and SHUTDOWN Conditions for a Trigger” on page 228.
3. Define up to ten shutdown conditions for the application that you want to connect to the trigger (**3**), see “Defining STARTUP and SHUTDOWN Conditions for a Trigger” on page 228.

Triggers Policy Object

```
COMMANDS  ACTIONS  VIEW  HELP
-----
A0FGAPT0          Trigger Conditions          SCROLL==> PAGE
Command ==>

Entry Type : Trigger          PolicyDB Name : DATABASE_NAME
Entry Name : TRIGGER1        Enterprise Name : YOUR_ENTERPRISE

Note: Service Period definitions are for SA OS/390 Version 1.3 only.
      In this case define them prior to the STARTUP/SHUTDOWN condition.

Action   Condition   Names
S_____ SERVICE PERIOD  SERVP1  1
_____  STARTUP 1      SERVICE EVENT1  2
_____  STARTUP 2
_____  STARTUP 3
_____  STARTUP 4
_____  STARTUP 5
_____  STARTUP 6
_____  STARTUP 7
_____  STARTUP 8
_____  STARTUP 9
_____  STARTUP 10
_____  SHUTDOWN 1    EVENT3  3
_____  SHUTDOWN 2
_____  SHUTDOWN 3
_____  SHUTDOWN 4
_____  SHUTDOWN 5
_____  SHUTDOWN 6
_____  SHUTDOWN 7
_____  SHUTDOWN 8
_____  SHUTDOWN 9
_____  SHUTDOWN 10
```

Figure 165. Trigger Conditions Panel

Note:

Of course, you get an empty *Trigger Conditions* panel when you define conditions for a new trigger. The entries that you can see here are only visible after you have finished the tasks described in the subsequent sections.

- A maximum number of 20 condition names (service period and events) can be selected for each condition.
- The overall number of different events in a trigger is limited to 28.
- An event can be specified either in STARTUP conditions or in SHUTDOWN conditions of a particular trigger, however, not in both types of conditions simultaneously.

Defining STARTUP and SHUTDOWN Conditions for a Trigger

If you type an S in front of a STARTUP condition on the panel shown in Figure 165 (2), SA z/OS displays another panel like the one shown in Figure 166 on page 229.

```

COMMANDS  ACTIONS  VIEW  HELP
-----
A0FGAPT1          STARTUP Condition for Trigger
Command ==>>>                                SCROLL==>> PAGE

Entry Type : Trigger                          PolicyDB Name  : DATABASE_NAME
Entry Name  : TRIGGER1                        Enterprise Name : YOUR_ENTERPRISE

Description. . . .

Service Period . . YES  YES NO

Action      Status   Event          Short Description
          SELECTED  EVENT1         Startup event, backup completed
          EVENT2A    Startup event, AOR1 is ready
          EVENT2B    Startup event, AOR2 is ready
          EVENT3     Shutdown event in case of emergency

```

Figure 166. STARTUP Condition for Trigger Panel

Figure 166 displays a list of events where you can select *one or more* events that should trigger the startup of an application. Typing an S will select an event and set its status to SELECTED. All selected events will be added to the currently selected startup condition.

- You can enter a description for the startup condition.
- Entering *YES* on the *Service Period* entry field connects the already selected service period to this condition. In this scenario, you can only connect service period *SERVPI* to any of the conditions for *TRIGGER1*. Therefore, enter *YES* on the *Service Period* entry field only for *STARTUP 1*.

Note:

This feature is available only for compatibility with SA OS/390 1.3. Since SA OS/390 2.1, service periods are linked directly to application groups or applications.

If you type an S in front of a SHUTDOWN condition on the panel shown in Figure 165 on page 228 (**3**), SA z/OS displays another panel similar to the one shown in Figure 166. The panel title in the panel displayed will now read *SHUTDOWN Condition for Trigger* and will contain a list of events which you can add to or remove from the currently selected shutdown condition.

The *Service Period* input field is inhibited when no service period has been selected for the trigger.

Processor Policy Object

Use the Processor Policy Object to define and control your processor hardware in the sysplex.

Creating a New Processor

How to create new policy objects in general is described in “How to Create New Policy Objects” on page 14. Figure 167 on page 230 shows the panel for defining a new *Processor* policy object.

Processor Policy Object

```

COMMANDS  HELP
-----
AOFGDYN2                                Define New Entry
Command ==> _____

Define new entry of type Processor

Name . . . . . _____

Processor Type . . . . eServer  (eServer PSM 9672 9674 2003 3000)
Mode . . . . . LPAR      (LPAR ESA)

Short description . . . _____
Long description . . . _____
Long description . . . _____
Long description . . . _____
Long description . . . _____
Long description . . . _____

```

Figure 167. Defining a New SA z/OS Processor Entry

Name The processor name must have 1 to 8 alphanumeric characters and must begin with an alphabetic character, #, \$, or @. The name must be different from the names of all groups, subgroups, systems (including the processor operations names), and processors defined in the current policy database.

Processor Type

Specifies the processor machine type of the target hardware. Select a name from the list shown to specify the processor type.

Use the generic type name eServer to specify any zSeries or 390-CMOS processor including those shown in the list. The actual processor type is determined at SA z/OS processor operations run time when a target system associated with the target hardware is initialized.

Use the type PSM to specify a ProcOps Service Machine on VM as 'virtual hardware' for VM guest systems. The default is eServer. For more details about the PSM, see *System Automation for z/OS Customizing and Programming*.

Mode Specifies the operating mode of the processor hardware as defined in the Reset Profile that is used for hardware activation. For zSeries, 390-CMOS in logical partition mode, and PSM processors specify LPAR.

Policy Items for Processors

The following figure shows the *Policy Selection* panel.

```

ACTIONS  HELP
-----
AOFGEPOL                                Policy Selection                                Entry created
Command ==> _____                                SCROLL==> PAGE

Entry Type : Processor                                PolicyDB Name : DATABASE_NAME
Entry Name : Procl                                  Enterprise Name : YOUR_ENTERPRISE

Action      Policy Name      Policy Description
-----
            DESCRIPTION    Enter description
            PROCESSOR INFO  Enter and display processor information
            LPARS AND SYSTEMS Define LPARs and select systems
            -----
            COPY            Copy data from an existing entry
            ***** Bottom of data *****

```

Figure 168. Policy Selection Panel for Processor

The unique policy items for the Processor policy object are:

PROCESSOR INFO

Using this policy, you can specify the processor type and mode, the connection protocol and network information.

LPARS AND SYSTEMS

This policy is displayed for processors with mode LPAR.

SYSTEMS

This policy is displayed for processors with mode ESA. Use this policy to select a system.

More about Policy Item PROCESSOR INFO

A panel similar to Figure 169 is displayed if you select the PROCESSOR INFO policy item from the *Policy Selection* panel for Processors.

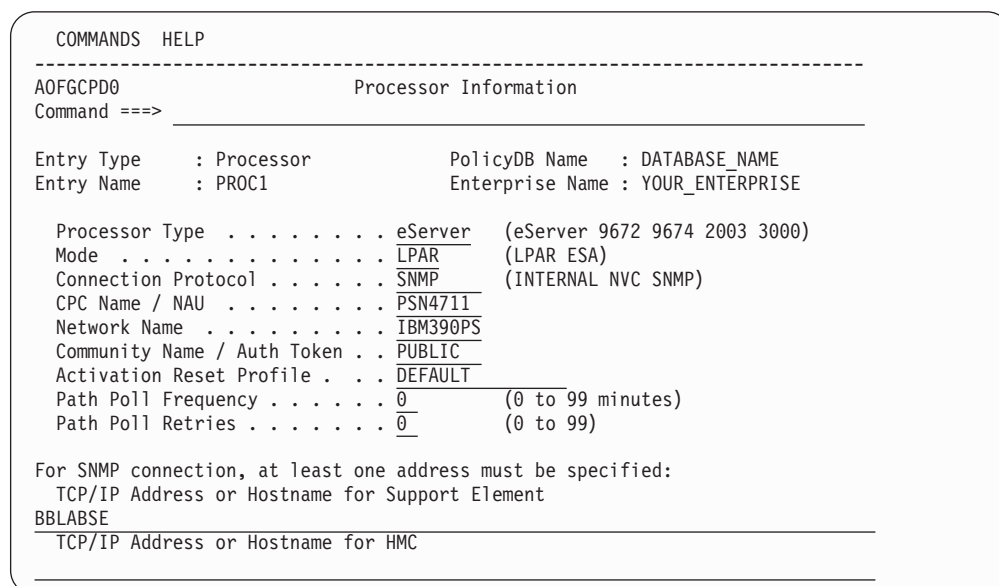

Figure 169. Processor Information Panel

On the Processor Information panel you can specify the following definitions so that the automation knows where the system is located to send the commands to the appropriate support element.

Processor Type

Specifies the processor machine type of the target hardware. Select a name from the list to specify the processor type. Use the generic type name eServer to specify any zSeries or 390-CMOS processor including those shown in the list. The actual processor type is determined at SA z/OS processor operations runtime when a target system associated with the target hardware is initialized. This field is required.

Mode Specifies the operating mode of the processor hardware as defined in the Reset Profile used for hardware activation. This field is required.

Connection Protocol

Indicates the protocol used for communication with the processor.

INTERNAL

Means connection via the operating system.

NVC Means connection via SNA network.

Processor Policy Object

SNMP

Means connection via TCP/IP.

A processor with connection INTERNAL is not built into the processor operations control file. It is used for Parallel Sysplex automation in combination with applications of type IMAGE. For more details, see *System Automation for z/OS Customizing and Programming*. With these definitions the automation knows where the system is located to send the commands to the appropriate support element.

CPC Name / NAU

For NVC and INTERNAL connections, this indicates the network addressable unit of the support element within the network. This field is required.

Network Name

For NVC and INTERNAL connections, this indicates the name of the SNA network in which the support element resides. This field is required. For SNMP connections, the central processor complex name of the support element is combined of Network Name and CPC Name.

Community Name / Auth Token

For SNMP and INTERNAL connections, this indicates the community name of the support element. For NVC connections, this indicates the authorization token. Both community name and authorization token are defined at the support element, and are used to validate command authorization. This field is required.

Activation Reset Profile

Indicates the Reset profile name to use when activating the target hardware. This profile name must match with the Reset profile name defined at the target hardware support element. This field is optional. The Reset profile name specified here will be used by ProcOps common command processing if the CNAME keyword is omitted from the ACTIVATE or LOAD command, and use of a Reset profile is appropriate.

If no Reset profile name is specified here, and the CNAME keyword is not used on the LOAD or ACTIVATE command, ProcOps omits the CNAME parameter from the command sent to the support element. In this case, the support element uses its default Reset profile.

Path Poll Frequency

Enter how often (in minutes) SA z/OS processor operations should poll the support element for status. Valid values are 0 to 99 minutes. Specify 0 to deactivate polling.

Path Poll Retries

Enter the number of attempts to retry that should occur before SA z/OS processor operations notifies the operator that the connection failed. Valid values are 0 to 99 retries.

TCP/IP Address or Hostname for Support Element

If SNMP connection is selected, then at least one address must be specified. If both are specified, the support element address has preference. HMC address alone may be considered if multiple processors should be controlled via one single connection.

More about Policy Item LPARS AND SYSTEMS

If you have created a Processor policy object with LPAR mode, the policy item LPARS AND SYSTEMS is available, and has the LPAR Definitions panel shown in Figure 170 associated with it.

COMMANDS	ACTIONS	HELP	

AOFGXC4P	LPAR Definitions		Row 1 to 13 of 20
Command ==>			SCROLL==> PAGE
Entry Type : Processor		PolicyDB Name : DATABASE_NAME	
Entry Name : PRLPR01		Enterprise Name : YOUR_ENTERPRISE	
Action	LPAR Name	Target Mode	Target System Name
_____	LP370	370	BBLAB01
_____	LPES01	ESA	_____
_____	LPLIN1	LINUX	LINUX1
_____	LPLIN2	LINUX	LINUX2
_____	_____	_____	_____
_____	_____	_____	_____
_____	_____	_____	_____
_____	_____	_____	_____
_____	_____	_____	_____
_____	_____	_____	_____
_____	_____	_____	_____
_____	_____	_____	_____
_____	_____	_____	_____
_____	_____	_____	_____

Figure 170. LPAR Definitions Panel

You can specify the following:

Action

Action allows you to remove LPAR definitions and to invoke the system selection panel:

- DELETE (D) deletes the current LPAR definition. Confirmation on a separate panel is not required.
- SYSTEM (S) displays a selection list of all defined systems allowing a system to link to the current .LPAR

LPAR Name

Specifies the name of the logical partition. Duplicate LPAR names without Target System Name are wiped out when the panel is left. However, it is possible to link different systems to one LPAR, so duplicate LPAR names are accepted when they have links to different systems. Linking one system to multiple LPARs is not accepted.

Target Mode

Specifies the mode of the system that is supposed to run in this LPAR. The Target Mode LINUX is used for hardware that supports LPARs for Linux only, where a reduced instruction set is provided and therefore cannot run MVS or VM. For a Linux system specify LINUX if the processor hardware is configured in 'LINUX Only' mode, otherwise specify ESA.

Target System Name

You can specify a system entry name, which establishes a "link" of this system to the partition. Any name is allowed here, it is not required that the system entry has already been defined. During build, such an undefined system is treated as not specified. If the system is already defined as SYS entry, it is checked that it is a valid selection according to the rules described in the following section for entry type SYS. Otherwise, an error message is displayed.

Policy Items for PSM Processors

Figure 171 shows the *Policy Selection* panel for PSM processors.

```

ACTIONS  HELP
-----
AOFGEPOL          Policy Selection          Entry created
Command ==> _____ SCROLL==> PAGE

Entry Type : Processor          PolicyDB Name : DATABASE_NAME
Entry Name : Proc1             Enterprise Name : YOUR_ENTERPRISE

Action      Policy Name          Policy Description
-----
            DESCRIPTION        Enter description
            PSM INFORMATION     Enter and display PSM processor information
            GUESTS AND SYSTEMS  Define VM guests and select systems
            -----
            COPY                Copy data from an existing entry
***** Bottom of data *****

```

Figure 171. Policy Selection Panel for PSM Processors

The unique policy items for the Processor policy object are:

PSM INFORMATION

Using this policy, you can specify the processor type and mode, the connection protocol and network information.

GUESTS AND SYSTEMS

This policy allows you to define VM guests and select systems. For more details, see “More about Policy Item GUESTS AND SYSTEMS” on page 236.

More about Policy Item PSM INFORMATION

A panel similar to Figure 172 is displayed if you select the PSM INFORMATION policy item from the *Policy Selection* panel for PSM Processors.

```

COMMANDS  HELP
-----
AOFGCPD1          ProcOps Service Machine Information
Command ==> _____

Entry Type      : Processor          PolicyDB Name : DATABASE_NAME
Entry Name      : PRLPR01           Enterprise Name : YOUR_ENTERPRISE

TCP/IP Address or Hostname . .
MULTISYS.PSM.PR2.US
-----
Message Server Port . . . . . 1234      (0 - 65535)
Command Server Port . . . . . 1234      (0 - 65535)
IP Stack . . . . .
Security Resource Name . . . . X1234
Security Network Name . . . . PRINEM
Community Name / Auth Token . . OKOK
Path Poll Frequency . . . . . 30        (0 to 99 minutes)
Path Poll Retries . . . . . 5         (0 to 99)
VM Host Target System Name . . PRL1
Service Machine Name . . . . . PRLPR01

```

Figure 172. ProcOps Service Machine Information Panel

On this panel you can update the following:

TCP/IP Address or Hostname

Indicates TCP/IP address or symbolic host name for communication with the ProcOps Service Machine. This address is required.

Message Server Port

Indicates the port the ProcOps Service Machine Message Server uses for communication with the ProcOps receiver task.

Command Server Port

Indicates the port the ProcOps Service Machine Command Server uses for communication with the ProcOps send program.

IP Stack

Indicates the to be used IP stack. If not defined, the default IP stack is used.

Security Resource Name

This field corresponds to the CPC Name / NAU name for NVC and INTERNAL connections and is used for SAF checking. This field is required.

Security Network Name

This field corresponds to the Network Name for NVC and INTERNAL connections and is used for SAF checking. This field is required.

Community Name / Auth Token For TCPIP connections

This indicates the authorization token (ProcOps Service Machines are connected only via TCPIP). This field is required.

Path Poll Frequency

Indicates how frequently the support element should be queried for status. Frequency must be specified in whole minutes in a range from 0 to 99. A frequency of 0 means that polling is deactivated. This field is required.

Path Poll Retries

Indicates the number of times query should be retried before notifying the operator. Valid values are 0 to 99 retries. This field is required.

VM Host Target System Name

Indicates the name of the VM host system if it is also defined in ProcOps This field is optional. The number of PSMs per hosting VM system is restricted to 12.

Note:

The host command ISQXPSM can only be used to operate the PSM via the VM host if this information is provided.

ProcOps Service Machine Name

Indicates the name of the PSM as it is known to the VM host system.

Note:

The host command ISQXPSM can only be used to operate the PSM via the VM host if this information is provided.

For ProcOps Service Machines, a Mode and Connection Protocol field is not available because the Mode is always LPAR and the Connection Protocol is always TCPIP and neither value can be changed.

name is allowed here; it is not required that the system entry has already been defined. During build, such an undefined system is treated as not specified.

If the system is already defined as a SYS entry, it is checked that it is a valid selection according to the rules described in the following section for entry type SYS. Otherwise, an error message is displayed.

The number of guest systems per PSM is restricted to 60. When a new guest system is defined, the number of guests that have already been defined for the associated PSM is checked. If there are already 60 defined, any further guest definition is rejected.

Monitor Resource Policy Object

The Monitor Resource (MTR) policy object allow you to obtain the health state of an object in two different ways:

- Actively, by polling—that is executing a monitoring command periodically
- Passively, by processing events

Monitor resources are connected to application resources (APLs) or application group resources (APGs). The health status of the monitored object is propagated to the APLs or APGs and results in a health status there.

Selecting *Monitor Resources* (MTR) from the *Entry Type Selection* panel will bring you to the *Entry Name Selection* panel that lists, if you have any, your current monitor resources. From this panel you can either create new monitor resources, or select an entry and action for one of the existing entries.

Figure 174 shows the policy items that are displayed when an existing Monitor Resources entry is selected from the *Entry Name Selection* panel.

```

ACTIONS  HELP
-----
AOFGEPOL          Policy Selection          Row 1 to 8 of 8
Command ==> _____ SCROLL==> PAGE

Entry Type : Monitor Resource      PolicyDB Name  : DATABASE_NAME
Entry Name  : MONITOR1             Enterprise Name: YOUR_ENTERPRISE

Action      Policy Name      Policy Description
-----
MONITOR INFO      Define monitor information
RELATIONSHIPS     Define relationships
HEALTHSTATE      Define commands for healthstate processing
SERVICE PERIOD   Select service period
-----
WHERE USED        List systems linked to this entry
COPY             Copy data from an existing entry
***** Bottom of data *****

```

Figure 174. Policy Selection for Monitor Resource

The unique policy items for the Monitor Resource policy object are:

MONITOR INFO

This option allows you to make definitions for the monitor resource. Refer to “More about Policy Item MONITOR INFO” on page 238 for more details.

Activate Command

This field is optional and is only needed to establish the monitoring environment.

Deactivate Command

This field is optional and is only needed to establish the monitoring environment.

Monitor Command

This can be any NetView command. If a command and an interval is specified, the command will be executed periodically while the monitor is active.

If a command is specified and no interval is specified, the command will be executed once during the startup phase.

If no command is specified the monitor is a passive monitor. In this case, the health status must be obtained via the INGMON command (see *System Automation for z/OS Programmer's Reference* for more details).

You may include system symbols and system automation symbols but they must be entered in uppercase letters (for example &AOCCLONE1). See "Assigning System Automation Symbols (AOCCLONE)" on page 42 for more details.

Monitoring Interval

Specifies an interval time for periodic execution of the monitor command. An Interval value of 0 will be forced to blank. If an Interval is specified a monitor command must also be specified.

Captured Messages Limit

Specifies the maximum number of captured messages that will be saved for the SA z/OS DISPMTR command. If the field is left blank the value can be inherited from the system default definition. If it is also not specified there, a default value of 0 will be used.

Owner

Specifies information for the operator about who to contact in case of error.

More about Policy Item HEALTHSTATE

If you select the HEALTHSTATE policy item from the Policy Selection panel for monitor resources, the *Healthstate Processing* panel is displayed, as shown in Figure 176 on page 240.

Monitor Resource Policy Object

```
COMMANDS  HELP
-----
Healthstate Processing          Row 1 to 2 of 20
Command ==> _____          SCROLL==> PAGE

Entry Name : MONITOR1

Enter commands to be executed when the monitor resource detects a change of
the healthstate of the monitored resource to one of the following values:
NORMAL, WARNING, MINOR, CRITICAL, FATAL or blank (which means for any change)

Healthstate   Automated Function/\'*\''
Command Text
-----
_____
_____

_____
_____
```

Figure 176. Healthstate Processing Panel

You can use this panel to enter commands to be executed when the monitor resource detects a change of the healthstate of the monitored resource: The following fields are available:

Healthstate

Defines the health state that the monitored resource must change to in order to initiate the specified commands. Valid values are :

- NORMAL
- WARNING
- MINOR
- CRITICAL
- FATAL
- blank

Leaving this field blank means that the specified commands will be executed in any health state change.

Automated Function

Enter the name of the automated function under which the command is to run. If the field is left blank, the function defaults to the one currently running the command list.

Note:

Entering a '*' enables return code checking for the specified command. This means that processing continues if the command returns a return code of 0; in all other cases the processing is stopped immediately.

Command Text

Enter the command or command list to be issued. Any system command must be prefaced with MVS.

Four substitution variables are available:

EHKVAR1

Contains the monitor name.

EHKVAR2

Contains the current health status.

EHKVAR3

Contains the old health status.

EHKVAR4

Contains the message.

A healthstate can be specified on the call to ACFCMD, which will issue the corresponding command or Command Group defined in the CMD entry.

A healthstate of blank can be specified to ensure that the corresponding command is issued regardless of the SEL= parameter included on the ACFCMD call. Thus, for any given healthstate processing, the blank entries will be issued in addition to the entries coded for that particular healthstate.

More about Policy Item SERVICE PERIOD

If you select the SERVICE PERIOD policy item from the Policy Selection panel for monitor resources, the Service Period for Monitor Resource panel is displayed, as shown in Figure 177.

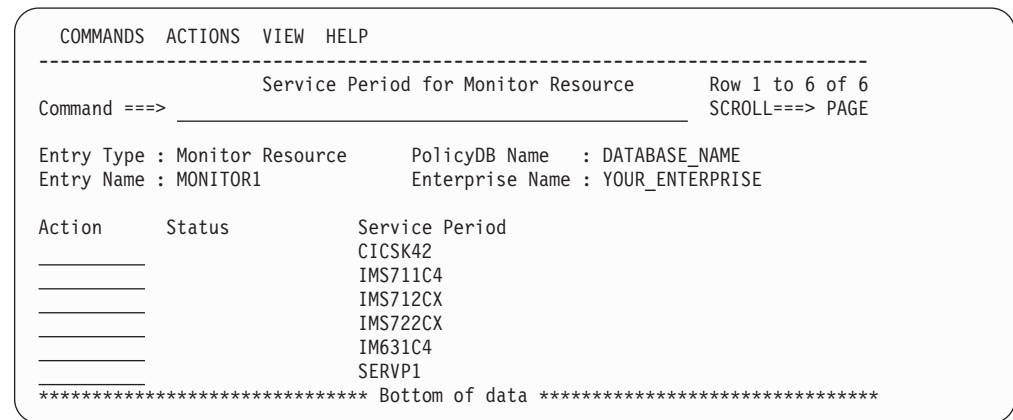

Figure 177. Service Period for Monitor Resource Panel

Here you can add service periods to or remove them from a monitor resource.

Product Automation Policy Object

Selecting *Product Automation* (PRD) from the *Entry Type Selection* panel will bring you to the *Entry type selections for Product Automation* panel shown in Figure 178 on page 242 where you can select the product for which you want to define automation policy. You can select from the following products:

- DB2, see "Defining Automation for DB2 Components" on page 242
- CICS, see "Defining Automation for CICS Components" on page 243
- IMS, see "Defining Automation for IMS Components" on page 247
- OPC, see "Defining Automation for OPC Components" on page 251

Product Automation Policy Object

```
MENU  OPTIONS  HELP
-----
Entry type selections for Product Automation
Option ==>>
-----
DB2 components                IMS components
10 DEN      DB2 System Defaults  20 ISA      IMS State/Action
                                     21 ISF      IMS Status file
                                     22 IRN      IMS resource name

OPC components                CICS components
30 OEN      OPC System details    40 CSA      CICS State/Action
31 OCS      Controller details     41 CCN      CICS Link
32 OSR      Special resources     42 CVP      Monitoring period
33 ODM      Workstation domainID
```

Figure 178. Entry Type Selections for Product Automation Panel

Defining Automation for DB2 Components

For DB2 components, the following entry type is available:

(DEN) DB2 System defaults

Use this option to define additional default information that is specifically required for DB2 automation within SA z/OS but not required for automation of other products or applications.

This entry type is described in more detail in the following section.

DB2 System Defaults

Figure 179 shows the policy items that are displayed when you select a DB2 System Default object from the related *Entry Name Selection* panel or when you are creating a new DB2 System Default object.

```
ACTIONS  HELP
-----
AOFGEPOL                Policy Selection
Command ==>>>                SCROLL==>> PAGE

Entry Type : DB2 System Defaults  PolicyDB Name : DATABASE_NAME
Entry Name : DB2_DEFAULT1        Enterprise Name : YOUR_ENTERPRISE

Action   Policy Name      Policy Description
        DESCRIPTION    Enter description
        DB2 SYSTEM DEFAULTS  Define DB2 System defaults
        RESOURCE THRESHOLDS  Define DB2 Resource thresholds
-----
        WHERE USED        List Systems linked to this entry
        COPY              Copy data from an existing entry
***** Bottom of data *****
```

Figure 179. Policy Selection Panel for DB2 System Defaults

The unique policy items for DB2 System Defaults are:

DB2 SYSTEM DEFAULTS

With this policy item you can specify whether for the system to which the current DB2 System Default is linked, data sharing should be active or not. You reach a panel similar to the one shown in Figure 149 on page 206 where you can specify DB2 defaults for the linked system.

RESOURCE THRESHOLDS

With this policy item you can define default threshold definitions for DB2 subsystems running on the systems to which the current DB2 system default will be linked. You will reach the panel *DB2 Resource thresholds selection* which is similar to the *CICS Resource thresholds selection* panel shown in Figure 147 on page 204 where you can define the equivalent information for DB2 subsystems running on the linked systems.

Defining Automation for CICS Components

For CICS components, the following entry types are available:

(CSA) State/Action tables

With this option, you can define a new or edit an existing state/action table for CICS. This is described in more detail in “CICS State/Action Tables.”

(CCN) Link definitions

Use this option to define the inter-region and inter-system communication (IRC and ISC) links so that they can be monitored by SA z/OS.

(CVP) Link Monitor periods

With this option, you can define service periods for the link monitoring definitions. Service periods can be related to a CICS link as defined with option (CCN) *Link definition*.

These options are described in more detail in the subsequent sections.

CICS State/Action Tables

Figure 180 shows the policy items that are displayed when you select a CICS state/action table entry from the related *Entry Name Selection* panel or when you are creating a new CICS state/action table entry. Starting from this panel, you can select state/action tables available to your CICS applications for specific problems.

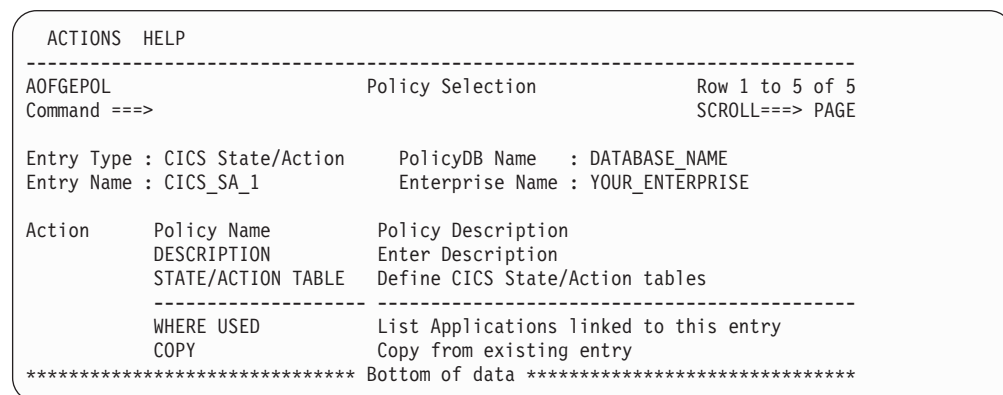

Figure 180. Policy Selection Panel for CICS State/Action Tables

The unique policy item for CICS state/action tables is:

STATE/ACTION TABLE

Use this policy item to define the state/action tables that are available to your CICS applications. For more information refer to “More about Policy Item STATE/ACTION TABLE.”

More about Policy Item STATE/ACTION TABLE: The *CICS State/Action tables* panel is displayed if you select policy item STATE/ACTION TABLE from the *Policy Selection* panel for CICS State/Action entries as shown in Figure 180. Use this

Product Automation Policy Object

panel to define the state/action tables that are available to your CICS applications. You can link these entries to CICS applications, using the STATE ACTION TABLE policy item for CICS applications as described “Policy Items for CICS Subsystems” on page 199.

```

COMMANDS  HELP
-----
AOFPCSA          CICS State/Action tables
Command ==>>>

Entry Type : CICS State/Action      PolicyDB Name  : DATABASE_NAME
Entry Name  : CICS_SA_1             Enterprise Name : YOUR_ENTERPRISE

State action name: CICS_SA_1

Enter or update the following fields:

Short on storage . . _____
Storage violation. . _____
Autoinstall problem. _____
VTAM ACB problem . . _____

```

Figure 181. CICS State/Action Tables Panel

Fill in the following fields:

Short on storage

The State/Action table used for short on storage recovery.

Storage violation

The State/Action table used for storage violation recovery.

Autoinstall problem

The State/Action table used for autoinstall problem recovery.

VTAM ACB problem

The State/Action table used for VTAM ACB problem recovery.

Link Definitions

Figure 182 shows the policy items that are displayed when you create or modify a link definition for CICS from the related *Entry Name Selection* panel.

```

ACTIONS  HELP
-----
AOFGEPOL          Policy Selection          CICS link created
Command ==>>>          SCROLL==>>> PAGE

Entry Type : CICS link      PolicyDB Name  : DATABASE_NAME
Entry Name  : LINK_DEF1    Enterprise Name : YOUR_ENTERPRISE

Action      Policy Name      Policy Description
-----
DESCRIPTION Enter description
CICS CONNECTION CICS Link monitoring definitions
MONITORING PERIOD Select Link monitoring period for connection
-----
WHERE USED      List APLs using this entry
COPY           Copy from existing entry
***** Bottom of data *****

```

Figure 182. Policy Selection Panel for CICS Link Definitions

The unique policy items for CICS link definitions are:

CICS CONNECTION

This policy item lets you describe the interregion and intersystem communication (IRC and ISC) links so that they can be monitored by

SA z/OS CICS Automation. For more information on how to do this, see "More about Policy Item CICS CONNECTION." Also refer to *System Automation for z/OS CICS Automation Programmer's Reference and Operator's Guide*, section CONNECTION.

MONITORING PERIOD

With this policy item you can select one monitoring period which has previously been defined with option (CVP) *Link Monitor periods* for the current CICS link definition (CICS connection).

For more information on link definitions, refer to *System Automation for z/OS CICS Automation Programmer's Reference and Operator's Guide*.

More about Policy Item CICS CONNECTION: If you select policy item CICS CONNECTION from the *Policy Selection* panel for CICS links, SA z/OS displays the following panel where you describe the inter-region and inter-system communication (IRC and ISC) links to be monitored by SA z/OS CICS Automation.

```

COMMANDS  HELP
-----
AOFPCCN          CICS connection links
Command ==>>>

Entry Type : CICS link          PolicyDB Name  : DATABASE_NAME
Entry Name  : LINK_DEF1        Enterprise Name : YOUR_ENTERPRISE

-----

Enter or update the following fields:

Connection id . . . . . ____          CICS sysid
Type . . . . . ____                  (IMS/CICS)
Echo . . . . . _____            (txn/pgm,seconds)
Time zone offset . . . . 0            (hh:mm,WEST/EAST)
Check interval . . . . 05:00         (mm:ss)
Max repair tries . . . . 3           (0-9)
Release delay . . . . . 05           (4-99)
Acquire delay . . . . . 05           (4-99)
Critical link (SDF) . . NO           YES      NO
-----

```

Figure 183. CICS Connection Links Panel

Fill in the following fields:

Connection id

The 4 character symbolic name by which this link is known to this CICS subsystem. This is defined on the CICS subsystem itself (SYSID).

Type Indicates the type of subsystem this link is attached to, valid values are "CICS" or "IMS", this is used only when you want echoplexing to occur.

Echo depends on the entry in the *Type* field:

CICS The transaction name used to call the echoplex program on the target subsystem.

IMS Any non-blank character.

The time parameter is used to define the time delay in seconds after which an echo response must have been received from the remote system before a message is issued. Valid values are from 1 to 99, default 3.

Product Automation Policy Object

Time zone offset

This parameter specifies the remote systems time offset relative to the UTC (Greenwich mean time). This is applied to the times specified in the DAY keyword to determine when monitoring is active for the remote system. Default value is 0.

Check interval

The time interval between 2 consecutive checks of a connection. Valid values are from 00:05 to 99:59, the default value is 05:00.

Max repair tries

Specifies the number of automatic actions that are to take place after the detection of a connection failure. Valid values are 0 to 9, default value is 3.

Release delay

Specifies the time delay in seconds needed by the system to release a connection. Valid values are 4 to 99, default value is 5.

Acquire delay

Specifies the time delay in seconds needed by the system to acquire a connection. Valid values are 4 to 99, default value is 5.

Critical link

Specifies whether or not a link failure for this link will change the severity shown on the SDF panels, default value is NO.

Link Monitor Periods

Figure 184 shows the policy items that are displayed when you select a monitoring period CICS from the related *Entry Name Selection* panel or if you are creating a new monitoring period.

```

ACTIONS  HELP
-----
AOFGEPOL          Policy Selection          Row 1 to 5 of 5
Command ==>>>          SCROLL==>> PAGE

Entry Type : Monitoring period      PolicyDB Name : DATABASE_NAME
Entry Name : MON_PERIOD_1          Enterprise Name : YOUR_ENTERPRISE

Action      Policy Name      Policy Description
           DESCRIPTION  Enter description
           MONITORING PERIOD  Define the monitoring period
-----
           WHERE USED      List APLs using this entry
           COPY            Copy from existing entry
***** Bottom of data *****
```

Figure 184. Policy Selection Panel for CICS Link Monitor Periods

The unique policy item for a CICS monitoring period is:

MONITORING PERIOD

With this policy item you can specify time periods when the current CICS connection should be monitored. You specify these time periods as described in “More about Policy Item MONITORING PERIOD.”

More about Policy Item MONITORING PERIOD: If you select policy item MONITORING PERIOD from the *Policy Selection* panel for CICS monitoring periods, SA z/OS brings up the following panel where you define the time frames for when the CICS connection link related to the (CCN) *Link definition* should be active.

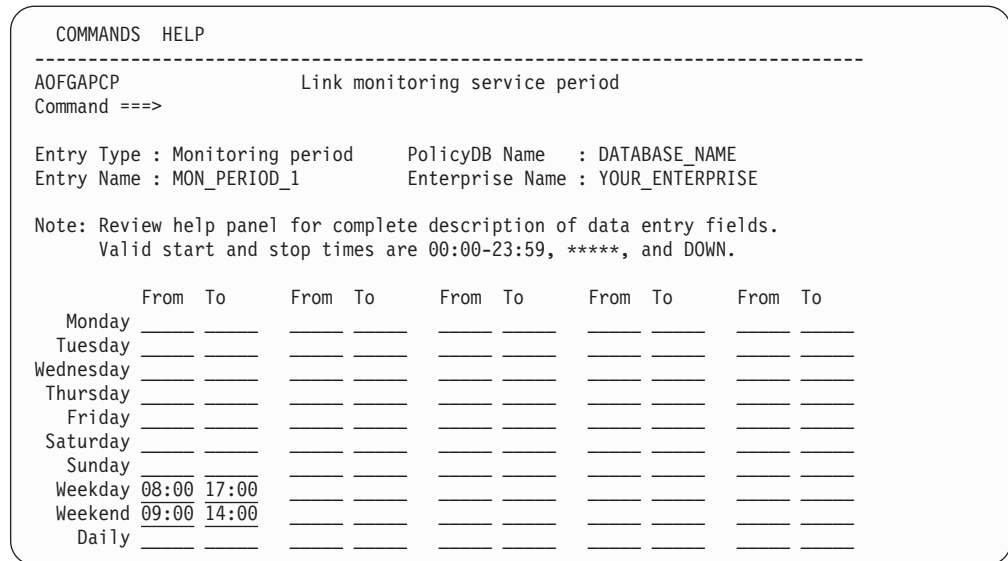

Figure 185. Link Monitoring Service Period Panel

For information about valid values and the syntax of the time frames, refer to the online help.

Defining Automation for IMS Components

For IMS components, the following entry types are available:

(ISA) State/Action tables

With this option, you can define or modify a state/action table for IMS. This is described in more detail in “IMS State/Action Tables.”

(ISF) IMS XRF status files

An IMS XRF status file policy object is used to define the partner domain and status file in an XRF environment. These objects are linked to *System* objects. (XRF stands for *extended recovery facilities*).

(IRN) IMS XRF Resources

With this option, you can match the XRF RSENAME to the IMS subsystems with which it is associated. This is described in more detail in “IMS XRF Resources” on page 250.

These are described in more detail in the subsequent sections.

IMS State/Action Tables

Figure 186 on page 248 shows the policy items that are displayed when you want to create a new state/action table for IMS or if you select an existing one from the related *Entry Name Selection* panel.

Product Automation Policy Object

```

ACTIONS  HELP
-----
AOFGEPOL                Policy Selection
Command ==>>>                SCROLL==>> PAGE

Entry Type : IMS State/Action      PolicyDB Name  : DATABASE_NAME
Entry Name  : IMS_SA_1             Enterprise Name : YOUR_ENTERPRISE

Action      Policy Name      Policy Description
            DESCRIPTION      Enter description
            IMS STATE/ACTION  Define IMS State/Action tables
-----
            WHERE USED       List Applications linked to this entry
            COPY              Copy data from existing entry
***** Bottom of data *****

```

Figure 186. Policy Selection Panel for IMS State/Action Table

The unique policy item for IMS state/action table is:

IMS STATE/ACTION

This policy item lets you define IMS state/action tables. How to do this is described in more detail in “More about Policy Item IMS STATE/ACTION.”

More about Policy Item IMS STATE/ACTION: The *IMS state action tables* panel is displayed if you select policy item IMS STATE/ACTION from the *Policy Selection* panel for IMS State/Action shown in Figure 186. Use this panel to define the state/action tables that are available to your applications. For detailed information on state/action tables please refer to *System Automation for z/OS IMS Automation Programmer’s Reference and Operator’s Guide*.

```

COMMANDS  HELP
-----
AOFPISA                IMS state action tables
Command ==>>>

Entry Type : IMS State/Action      PolicyDB Name  : DATABASE_NAME
Entry Name  : IMS_SA_1             Enterprise Name : YOUR_ENTERPRISE

State action name: IMS_SA_1

Enter or update the following table names:

MSC link recovery. . _____
OLDS error recovery. _____
MPP/BMP recovery . . _____

```

Figure 187. IMS State Action Tables Panel

To define a state/action table, fill in the following fields:

MSC link recovery

The state/action table used for automatic recovery from MSC link errors.

OLDS error recovery

The state/action table used to define procedures for automatic recovery from OLDS errors.

MPP/BMP recovery

The state/action table used to define automatic recovery procedures initiated when an MPP or BMP transaction/program has abended.

IMS XRF Status Files

Figure 188 shows the policy items that are displayed when you select an IMS XRF status file from the related *Entry Name Selection* panel or when you want to create a new IMS XRF status file.

```

ACTIONS  HELP
-----
AOFGEPOL          Policy Selection          Row 1 to 5 of 5
Command ==>>>          SCROLL==>>> PAGE

Entry Type : IMS Status file      PolicyDB Name  : DATABASE_NAME
Entry Name  : IMS_XRF_SF1        Enterprise Name : YOUR_ENTERPRISE

Action      Policy Name      Policy Description
-----
            DESCRIPTION    Enter description
            IMS STATUS FILE Define IMS status file names
-----
            WHERE USED     List Systems linked to this entry
            COPY           Copy data from an existing entry
***** Bottom of data *****

```

Figure 188. Policy Selection Panel for IMS XRF Status File

The unique policy item for IMS XRF status files is:

IMS STATUS FILE

This policy item lets you define IMS status file names. How to do this is described in more detail in “More about Policy Item IMS STATUS FILE.”

More about Policy Item IMS STATUS FILE: The *IMS Status file specification* panel is displayed if you select policy item IMS STATUS FILE from the *Policy Selection* panel for IMS XRF Status File shown in Figure 188.

```

COMMANDS  HELP
-----
AOFPISF          IMS Status file specification
Command ==>>>

Entry Type : IMS Status file      PolicyDB Name  : DATABASE_NAME
Entry Name  : IMS_XRF_SF1        Enterprise Name : YOUR_ENTERPRISE

IMS Status file entry name: IMS_XRF_SF1

Enter or update the following fields:

Partner domain name. _____
Partner status file.  _____

```

Figure 189. IMS Status File Specification Panel

The status file specification describes the partner IMS status file that will be used in an XRF IMS environment. To support an XRF IMS environment, IMS Automation must access the status file of the partner IMS subsystems. This is only required in an XRF environment.

Fill in the following fields:

Partner domain name

This parameter is the NetView domain ID that is controlling the partner IMS subsystem in an XRF environment.

Product Automation Policy Object

Partner status file

This parameter is the data set name of the status file used by the partner IMS in the partner's domain. This data set is dynamically allocated during SA z/OS initialization.

For more information about the status file specification refer to the description of the STSFILE keyword in *System Automation for z/OS IMS Automation Programmer's Reference and Operator's Guide*.

IMS XRF Resources

Figure 190 shows the policy items that are displayed when you select an IMS XRF resource from the related *Entry Name Selection* panel.

```

ACTIONS  HELP
-----
AOFGEPOL          Policy Selection          Row 1 to 5 of 5
Command ==>>>          SCROLL==>> PAGE

Entry Type : IMS resource name      PolicyDB Name  : DATABASE_NAME
Entry Name  : IMS_XRF_1             Enterprise Name : YOUR_ENTERPRISE

Action      Policy Name      Policy Description
DESCRIPTION
IMS RESOURCE NAMES  Define IMS resource names
-----
WHERE USED      List Systems linked to this entry
COPY            Copy data from an existing entry
***** Bottom of data *****
```

Figure 190. Policy Selection Panel for IMS XRF Resource

The unique policy item for IMS XRF resources is:

IMS RESOURCE NAMES

This policy item is used to match the XRF RSENAME to the IMS subsystems with which it is associated. These entries are linked to SYS entries. For more information, refer to "More about Policy Item IMS RESOURCE NAMES."

More about Policy Item IMS RESOURCE NAMES: The *IMS Resource names* panel is displayed if you select policy item IMS RESOURCE NAMES from the *Policy Selection* panel for IMS Resource names shown in Figure 190. Use this panel to define IMS resource names. Such an IMS resource name should be coded for each XRF IMS complex defined, to match the XRF RSENAME to the IMS subsystems with which it is associated. For more information on IMS resource names refer to *System Automation for z/OS IMS Automation Programmer's Reference and Operator's Guide* for the description of the IMSRESNM keyword.

```

COMMANDS  HELP
-----
AOFPIRN          IMS Resource names
Command ==>>>

Entry Type : IMS resource name      PolicyDB Name  : DATABASE_NAME
Entry Name  : IMS_XRF_1             Enterprise Name : YOUR_ENTERPRISE

IMS resource name: IMS_XRF_1

Enter or update the following table fields:

XRF Resource ID. . . . _____
XRF partner name1. . . _____
XRF partner name2. . . _____

```

Figure 191. IMS Resource Names Panel

To define IMS resource names, fill in the following fields:

XRF Resource ID

This is the value specified as the RSENAME for the XRF complex as defined in the DFSHSBxx member in the IMS PROCLIB.

XRF partner name1

This parameter is the SA z/OS subsystem name of one of the IMS control region subsystems that participate in an XRF complex.

XRF partner name2

This parameter is the partner IMS control region subsystem name that participates in this XRF complex.

The order in which the IMS subsystems are specified does not matter.

Defining Automation for OPC Components

For OPC components, the following entry types are available:

(OEN) OPC System details

With this option, you can define certain system wide defaults. Selecting this entry type will bring you to the *Entry Name Selection* panel for OPC system details where you can create or edit system defaults. You can link an OPC system detail to one or more *System* policy objects, however, you can link only one OPC system detail to a *System*.

(OCS) Controller details

With this option, you can link the OPC controller subsystem name with the NetView domain upon which it resides. Selecting this entry type will bring you to the *Entry Name Selection* panel for OPC controller details where you can create or edit controller details. You can link an OPC controller detail to one or more *System* policy objects, however, you can link only one OPC controller detail to a *System*.

(OSR) Special resources

Use this option to define special resources that are to be set for an OPC controller.

(ODM) Workstation domains

Use this option to relate an OPC automatic workstation to a NetView domain ID.

These are described in more detail in the subsequent sections.

OPC System Details

Figure 192 shows the policy items that are displayed when you select an OPC system detail from the related *Entry Name Selection* panel or if you want to create a new OPC system detail.

```

ACTIONS  HELP
-----
AOFGEPOL                Policy Selection                Row 1 to 5 of 5
Command ==>>>                SCROLL==>>> PAGE

Entry Type : OPC System details   PolicyDB Name : DATABASE_NAME
Entry Name : OPC_SYS_DET1         Enterprise Name : YOUR_ENTERPRISE

Action      Policy Name      Policy Description
-----
            DESCRIPTION   Enter description
            OPCA0 ENVIRON  Define OPCA0 environ entries
-----
            WHERE USED     List Systems linked to this entry
            COPY           Copy data from an existing entry
***** Bottom of data *****

```

Figure 192. Policy Selection Panel for OPC System Detail

The unique policy item for OPC system details is:

OPCA0 ENVIRON

This policy item checks the status on START and STOP requests, and specifies the retention of critical messages. If you select this policy item, SA z/OS displays the *OPC System details* panel which is described in more detail in “More about Policy Item OPCA0 ENVIRON.”

More about Policy Item OPCA0 ENVIRON: The OPCA0 ENVIRON policy item checks status on START and STOP requests, and specifies retention of critical messages. If you select this policy item from the *Policy Selection* panel for OPC system details, SA z/OS displays the panel shown in Figure 193.

```

COMMANDS  HELP
-----
AOFPOEN                OPC System details
Command ==>>>

Entry Type : OPC System details   PolicyDB Name : DATABASE_NAME
Entry Name : OPC_SYS_DET1         Enterprise Name : YOUR_ENTERPRISE

OPC system details entry name: OPC_SYS_DET1

Enter or update the following table names:

Status check on requests. . YES   (YES/NO)
Critical msg retention. . . PERM   (hh:mm/PERM)
Operation reset delay . . . NEVER  (hh:mm/NEVER)

```

Figure 193. OPC System Details Panel

The following fields can be filled in:

Status check

This entry controls checking of subsystem status on OPC Automation START, STOP, and RECYCLE requests. If not coded, OPC Automation will enforce the rule that START operations will be ended in error if the subsystem is already UP, and likewise for STOP operations if the subsystem is down. Code REQUEST=NO if you wish to have OPC Automation proceed as normal in this case. The default value is YES .

Critical msg retention

This entry specifies retention of OPC Automation critical messages automated with the DFCRIT command, and OPC error messages. The default is PERM, which means that messages will not be deleted on a timed basis.

Operation reset delay

OPRESET specifies how long the NetView interface to OPC may be unavailable before OPC Automation will not reset operations which ended in error while it was down. The NetView interface consists of both the NetView SA z/OS OPC Automation address space and its associated NetView SSI address space, over which requests flow from OPC to OPC Automation. When the interface is down, OPC Automation sets any operations destined for a NetView workstation to error status with an error code of UNTV. If no value is coded, or OPRESET=NEVER is coded, then no operations will be reset when the interface becomes available again. The default value is NEVER .

For more information refer to *System Automation for z/OS OPC Automation Programmer's Reference and Operator's Guide*.

Controller Details

Figure 194 shows the policy items that are displayed when you are creating a new OPC controller detail or when you select an existing OPC controller detail from the related *Entry Name Selection* panel.

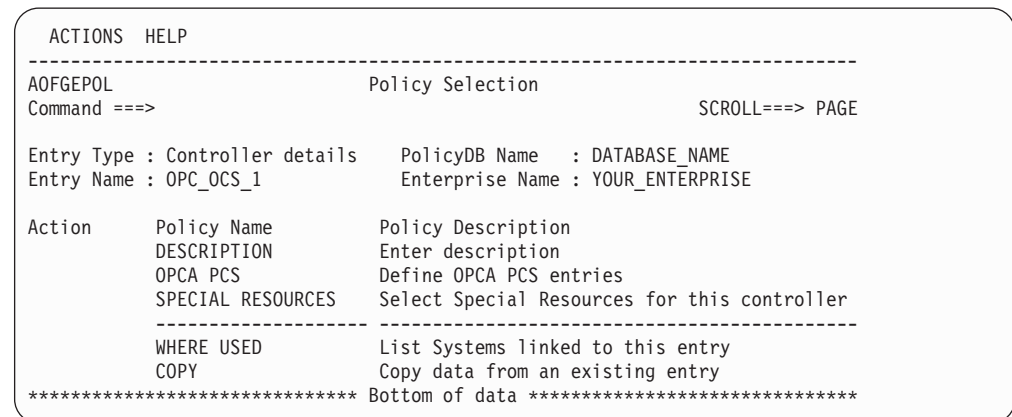

Figure 194. Policy Selection Panel for OPC Controller Details

The unique policy items for OPC controller details are:

OPCA PCS

With this policy item you specify either the NetView domain on which the OPC controller resides or that the local sysplex is to be searched for the active controller when required. It must also specify the subsystem name for the OPC controller. for more information, refer to “More about Policy Item OPCA PCS” on page 254.

SPECIAL RESOURCES

Use this policy item to select one or more special resources as defined with option (OSR) *Special resources* for the current controller. These selected special resources for OPC are used on the systems to which the current controller details entry is linked. (You can view the systems to which this entry is linked and link or unlink this entry to systems using the WHERE USED policy item).

Product Automation Policy Object

More about Policy Item OPCA PCS: The panel shown in Figure 195 appears if you select policy item OPCA PCS from the *Policy Selection* panel for OPC controller details. The OPCA PCS automation definition defines the NetView domain on which the OPC Controller resides and specifies the subsystem name for the OPC Controller system.

```
COMMANDS  HELP
-----
AOFPOCS          OPC Controller details
Command ==>>>

Entry Type : Controller details   PolicyDB Name : DATABASE_NAME
Entry Name : OPC_OCS_1           Enterprise Name : YOUR_ENTERPRISE

OPC PCS entry name: OPC_OCS_1

Enter or update the following table names:

Netview domain name. . . _____
OPC controller subsystem _____
OPC Special resources   NO__ (YES NO ALL)
```

Figure 195. OPC Controller Details Panel

Fill in the following fields:

NetView domain name

Specify the parameter as either a NetView domain ID (up to five characters) or the keyword SYSPLEX. If a domain ID is specified, it indicates that the OPC Controller always runs on the specified domain. The keyword SYSPLEX indicates that the OPC Controller may be run on any one of the systems in the local sysplex.

OPC controller subsystem

The MVS subsystem name of the OPC Controller as defined in the IEFSSNxx member.

Note:

When defining the OPC Controller to SA z/OS, this name must be used as the subsystem name and job name.

OPC Special resources

The following entries are valid:

YES The OPC special resources will be set for any SA z/OS monitored subsystem specified in the *OPC special resource definitions* panel (see Figure 197 on page 255). Ensure that the OPC Special Resources are defined if using this option.

Note:

If no OPC Special Resources were defined, and the OPC Special Resource SRSTAT=YES is defined in the *OPC Controller details* panel, then, when a BUILD is done for the ACF, the OPC Special resource definition will be reset to SRSTAT=NO as it would have detected that there were no OPC Special Resources defined in the ACF.

NO No Special Resources will be set. This is the default.

ALL Special Resources will be set for all SA z/OS Monitored subsystems. No Special Resource entries are required.

OPC Special Resources

Figure 196 shows the policy items that are displayed when you select an OPC special resource from the related *Entry Name Selection* panel.

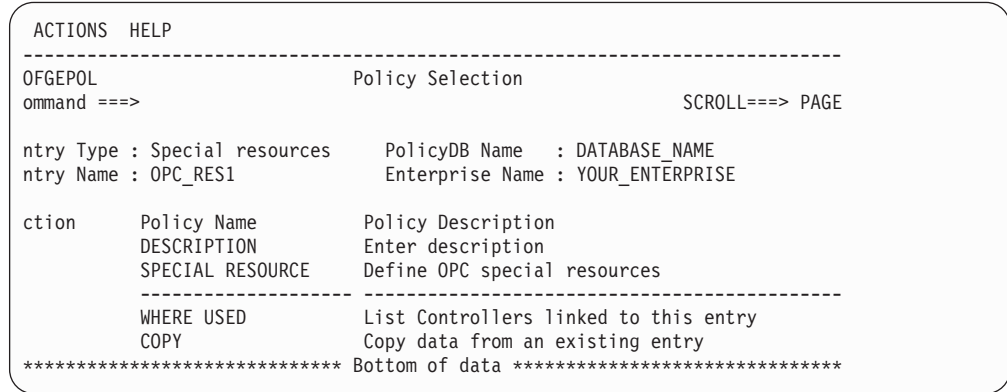

Figure 196. Policy Selection Panel for OPC Special Resources

The unique policy item for an OPC special resource is:

SPECIAL RESOURCE

With this policy item you can specify resources as special resources for OPC. SA z/OS will display the *OPC special resource definitions* panel. For a detailed description of this panel, refer to “More about Policy Item SPECIAL RESOURCE.”

More about Policy Item SPECIAL RESOURCE: With this policy item SA z/OS is able to globally control the creation and setting of OPC Special resources based on the status of SA z/OS monitored subsystems. This allows OPC to resolve job scheduling dependencies based on the status of SA z/OS automated resources. A group or groups of special resources can be linked to a controller definition defined with option 31 (see “Defining Automation for OPC Components” on page 251).

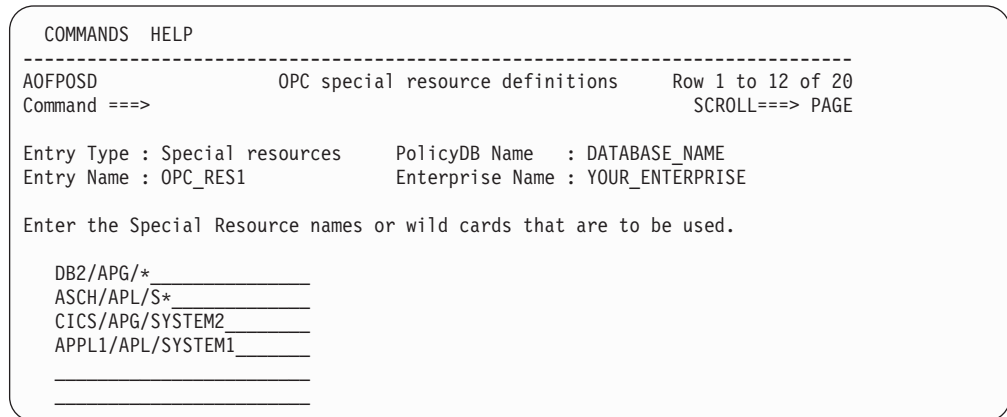

Figure 197. OPC Special Resource Definitions Panel

Fill in your special resource names with up to 24 characters. Wildcard characters and patterns may be entered.

Workstation Domains

Figure 198 shows the policy items that are displayed when you select an OPC workstation domain from the related *Entry Name Selection* panel.

```
ACTIONS  HELP
-----
AOFGEPOL          Policy Selection
Command ==>>>          SCROLL==>>> PAGE

Entry Type : Workstation domainID  PolicyDB Name  : DATABASE_NAME
Entry Name  : OPC_WST_DOM1         Enterprise Name : YOUR_ENTERPRISE

Action      Policy Name      Policy Description
           DESCRIPTION   Enter description
           OPCA DOMAINID Define the OPCA Domainid entries
-----
           WHERE USED    List Systems linked to this entry
           COPY          Copy data from an existing entry
***** Bottom of data *****
```

Figure 198. Policy Selection Panel for OPC Workstation Domain

The unique policy item for an OPC workstation domain is:

OPCA DOMAINID

If you select this policy item, the *Message Processing* panel will come up where you specify how SA z/OS should react if OPC issues the specified message. For a detailed description of this panel and how to define message processing policy on it, refer to Figure 113 on page 166. The *Message Processing* panel for OPC shows minor differences in the top of the panel compared to the one shown in Figure 113 on page 166. These are shown here:

```
Entry Type : Workstation domainID  PolicyDB Name  : DATABASE_NAME
Entry Name  : OPC_WST_DOM1         Enterprise Name : YOUR_ENTERPRISE

Message type: OPCA_DOMAINID
```

For more information refer to *System Automation for z/OS OPC Automation Programmer's Reference and Operator's Guide* under OPCA DOMAINID. Note that only a single entry of DOMAINID may be entered in the *Message ID* field; no other value will be accepted. The actual Workstation/Domain entries are made by entering CODE in the *Action* field.

Timers Policy Object

The *Timers* policy objects allow you to define sets of timers that run commands or automation procedures at scheduled times. Figure 199 on page 257 shows the policy items that are displayed when a new *Timers* entry is defined or when an existing *Timers* entry is selected from the *Entry Name Selection* panel.

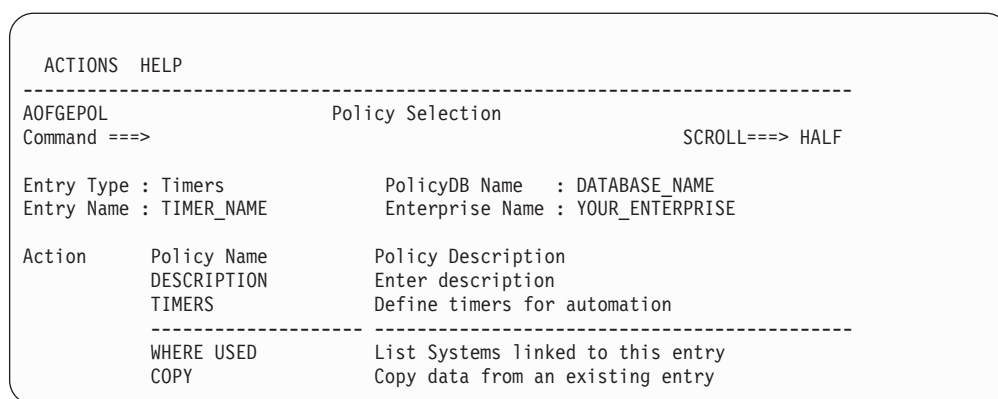

Figure 199. Policy Selection Panel for Timers

The unique policy item for Timers is:

TIMERS

You define a timer in the *Timer specification* panel shown in Figure 200.

SA z/OS displays the following panel if you select the TIMERS policy item from the *Policy Selection* panel for *Timers*.

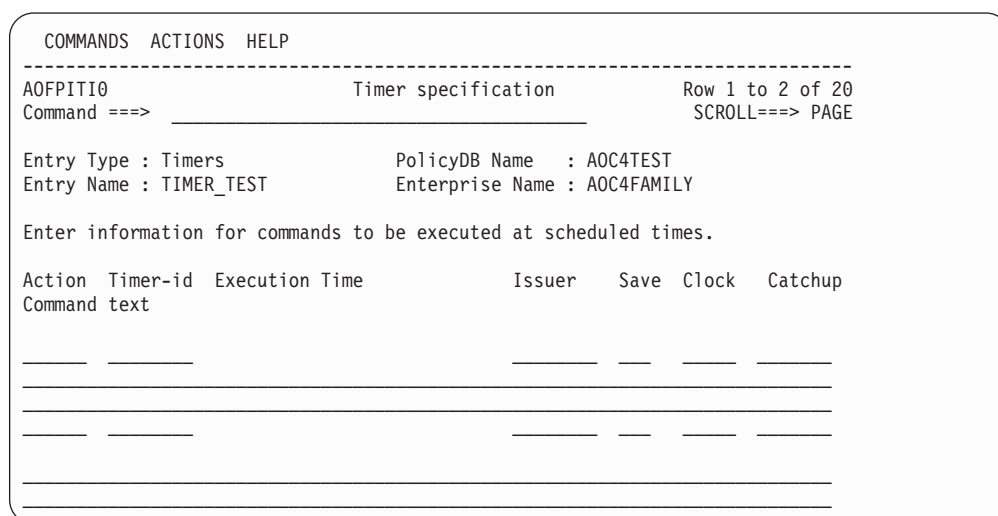

Figure 200. Timer Specification Panel

You should note that, at run time, the commands that you define here are converted to the NetView CHRON format.

A timer definition consists of:

Timer ID

When a user timer is defined with the SAVE-option outside the control of SA z/OS, it is recommended that a unique timer ID is specified to avoid duplicate timers being created at automation control file (ACF) reload.

Execution Time

When SA z/OS uses the timer. You can schedule a timer for a specific day and time, after a certain day of the year, or repetitively at intervals.

Issuer Where the timed command or application program should run. You can specify that the command or application program should run under:

Timers Policy Object

- A NetView operator ID, in which case SA z/OS issues the timer-driven command only if that operator is logged on.
 - The primary programmed operator interface task (PPT), in which case SA z/OS issues the timer-driven command even when an operator is not logged on.
 - An automation operator name.
- Save** Whether SA z/OS should save the timed event in the NetView SAVE/RESTORE database. You can enter one of the following values:
- YES
 - NO
- Clock** Specifies whether the command is to run if it were on a Greenwich Mean Time schedule or the local system time. You can enter one of the following values:
- GMT
 - LOCAL
- Catchup**
Whether a saved timer should be caught up after a system outage.
- Command text**
The actual timer-driven command or automation procedure SA z/OS issues or calls.

Timeout Settings Policy Object

This policy object enables you to create sets of timeout definitions. Each timeout definition can specify timeout values for:

- System, NetView, or SA z/OS commands
- Cross-domain logon requests
- Your own timeout variables

If the time limit is exceeded, then it is assumed that an error condition exists and an appropriate action is taken.

Although only two specific fields, Wait and XDOM, are given, you can add other timeout names that may be unique to your environment. Figure 201 shows the policy items that are displayed when a new Timeout Setting entry is defined or when an existing Timeout Setting entry is selected from the *Entry Name Selection* panel.

ACTIONS	HELP

AOFGEPOL	Policy Selection
Command ==>	SCROLL==> HALF
Entry Type : Timeout Settings	PolicyDB Name : DATABASE_NAME
Entry Name : TIMEOUT_NAME	Enterprise Name : YOUR_ENTERPRISE
Action	Policy Name
	DESCRIPTION
	TIMEOUT VALUES
	Policy Description
	Enter description
	Define timeout values

	WHERE USED
	COPY
	List Systems linked to this entry
	Copy data from an existing entry

Figure 201. Policy Selection Panel for Timeout Settings

The unique policy item for *Timeout Settings* is:

TIMEOUT VALUES

SA z/OS defines two timeout variables, XDOMTIME and WAITTIME. Values for these variables can be set in the Wait and XDOM Value fields of the *Environment Definition: TIMEOUT* panel. Figure 202 shows the definition panel for a Timeout Settings.

COMMANDS HELP

AOFPIET0 Environment Definition: TIMEOUT
Command ==>

Entry Type : Timeout Settings PolicyDB Name : DATABASE_NAME
Entry Name : TIMEOUT_NAME Enterprise Name : YOUR_ENTERPRISE

Enter SA z/OS defined timeout values.

Name	Value	Description
Wait	29	Wait commands in seconds
XDOM	120	Cross domain commands in seconds

Enter installation supplied timeout names and values.

Name	Value	Description
CEMT__	29__	_____
_____	_____	_____
_____	_____	_____
_____	_____	_____

Figure 202. Environment Definition: TIMEOUT Panel

The following timeout values can be entered:

Wait Defines how long automation processing waits for a response after issuing a system, NetView, or SA z/OS system operations command. The wait parameter is used in the automation code to determine when a response error condition has occurred. Depending on which part of the code was being used at the time of the error and how critical the command is, an action is taken. The default time is 29 seconds. The range of values is 1 to 32000 seconds.

It is recommended that you choose a value less than 30 seconds to avoid the NetView message DSI594A being displayed in SA z/OS full screen function. The field, wait, creates the global variable WAITTIME.

XDOM

Defines the maximum amount of time that message forwarding routines wait for a response from a cross-domain logon command. If this value is exceeded, the routines assume that the logon attempt failed. The default time is 120 seconds. The range of values is 1 to 32000 seconds. XDOM creates the global variable XDOMTIME.

Installation supplied timeout names and values

This section is used to define your own timeout values. Common global variables are created containing these values, and these variables can be used in your own automation procedures. The value of these variables must be in the range of 1 to 32000 seconds.

Timeout Settings Policy Object

Note:

You must ensure that the names of any global variables you create do not clash with SA z/OS external or internal global variable names. SA z/OS external global variables are documented in *System Automation for z/OS Customizing and Programming*. In addition, you should not use names beginning with EHK, AOF, SUBS, ING or ISQ.

For example, you can define the name TEST with a value of 30. This creates a global variable called TESTTIME containing the value 30. The variable TESTTIME can now be used in any automation procedure. You can enter an optional description of the timeout variable for reference.

Note:

The TESTTIME variable is initialized after SA z/OS has initialized its own environment from the automation control file. This means you should not use a variable such as TESTTIME in a routine which is invoked before SA z/OS is fully initialized.

Tape Attendance Policy Object

This policy object allows you to specify whether or not you want to monitor tape mounts on this system. If you do want to monitor tape mounts, you must enter warning and alert thresholds (in minutes and seconds) indicating how long a wait is allowed in mounting a tape before the response is considered unsatisfactory.

You can customize SA z/OS to respond to the IEF238D message while tape drives are attended by operators. This can be achieved by specifying a coded entry for the IEF238D message in the MESSAGES/USER DATA policy item of the *MVS Component* policy object. The coded entries should be entered as follows:

- CODE1 should contain a pattern match for the job name requiring the response to the IEF238D message. You can specify a trailing asterisk (*) to allow for generic job name matching.
- CODE2 should contain either D, W, C, DW, DC, WC or DWC where D is Device name, W is Wait and C is Cancel. The most likely combination to use would be DC (Device name or Cancel) and WC (Wait or Cancel).
- CODE3 is not required for this message and should be left blank.
- *Value Returned* should contain your reply to IEF238D dependent on the results of the CODE1 and CODE2 matching process. Typically this will be NOREPLY, CANCEL or WAIT.

SA z/OS uses the CDEMATCH common routine using the IEF238D CODE1 and CODE2 values to issue the returned value as the reply. This is achieved via an entry in the AT for the IEF238D as shipped with the samples. For further information, with regard to *Responding with Code Matching*, refer to chapter *Adding a Message to Automation in System Automation for z/OS Customizing and Programming*. For more details on the format of the IEF238D, refer to the system message documentation for your particular operating system level and release.

This policy object also allows you to set a schedule for unattended tape drives. If a job requests a tape mount at a time defined as unattended, then the job will be canceled. Figure 203 on page 261 shows the policy items that are displayed when a

new *Tape Attendance* entry is defined or when an existing *Tape Attendance* entry is selected from the *Entry Name Selection* panel.

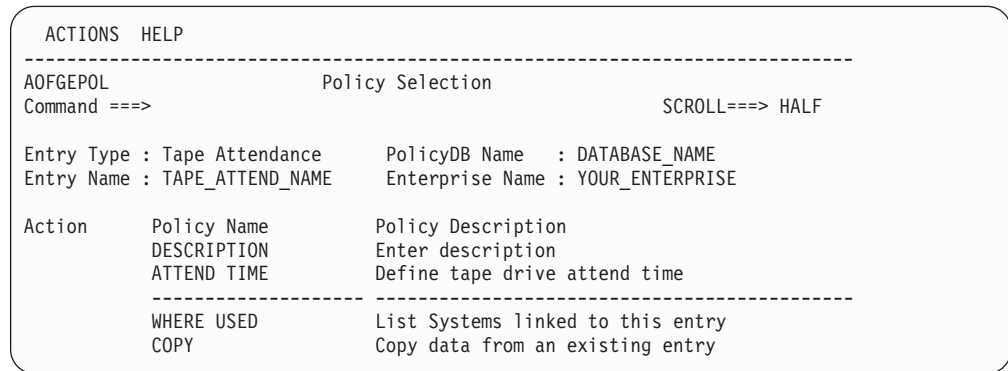

Figure 203. Policy Selection Panel for Tape Attendance

The unique policy item for *Tape Attendance* is:

ATTEND TIME

This policy item allows you to specify when tapes are attended and whether or not you want to monitor tape mounts on this system. If you do want to monitor tape mounts, you must enter warning and alert thresholds (in minutes and seconds) indicating the maximum tape mount delay that is allowed before the response is considered unsatisfactory. Refer to Figure 204 for more information on this policy item.

Figure 204 shows the *Environment Definition: TAPES* panel.

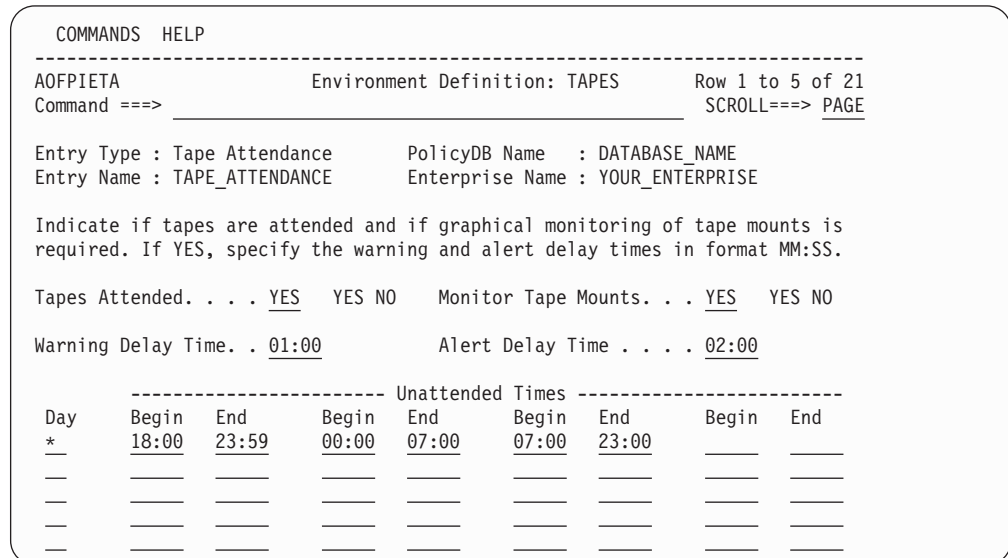

Figure 204. Environment Definition: TAPES Panel

The fields are:

Tapes Attended

Specify whether tape drives are attended or not. This is a global setting that indicates if there are any attended tapes attached to the system. If there are attended tapes then you can specify days and times at which they will not be attended.

Tape Attendance Policy Object

Monitor Tape Mounts

Specify whether tape mounts should be monitored on the SA z/OS workstation. If you enter YES in this field, SA z/OS will automatically create a Tape Mounts object for the NMC workstation. A Tape Mounts object is an icon that represents an unsatisfied tape mount request by a job. When SA z/OS detects a tape mount request, it creates an icon under the Tape_Mount group icon. The icon is green, initially, indicating a satisfactory condition. If the tape mount request is not satisfied before the Warning interval has expired, the icon changes color to white. If the tape mount request is still not satisfied after the Alert interval has expired, the icon changes color from white to red.

The icon is deleted automatically when the requested tape is mounted or the job requesting the tape mount is canceled.

Note:

The operator can specify whether the NMC workstation view that contains the tape mount icons is automatically refreshed. It is advisable to set this to refresh automatically so that tape mounts can be monitored without manual intervention.

The name of the tape mount object is of the form
SSSS.VVVVVV_DDD(D)

where:

SSSS

is the NetView domain name where the mount request was issued.
This may be a remote system.

VVVVVV

is the tape volume name

DDD(D)

is the device number that the tape should be mounted on. This device number is either 3 or 4 digits depending on the level of z/OS.

Warning Delay

The delay period, in minutes and seconds, after which the tape mount icon changes to the warning color of white if the tape mount has not been completed.

Alert Delay

The delay period, in minutes and seconds, between the time that the warning delay is reached and the time that the tape mount icon changes to the alert color of red, if the tape mount has not been completed.

If tapes are attended, enter days and times (24 hour clock) when unattended.

These fields are used to enter days and times when tape drives are unattended. A "*" character can be used in the Day field to specify all days of the week.

MVS Component Policy Object

This policy object allows you to apply automation to various z/OS data sets, resources and facilities. These z/OS data sets, resources, and facilities are referred to as MVS components.

You can set error thresholds and automation flags for the following MVS components:

- MVSDUMP (SYS1.DUMP00 - xx)
- SMFDUMP (SYS1.MANx)
- LOGREC (SYS1.LOGREC)
- SYSLOG (SYS1.SYSLOG.INDX)
- WTOBUF (z/OS Console Buffers)

In addition, you can customize the recovery procedure used for a WTOBUF overflow and automate responses to messages issued for MVS components. Figure 205 shows the policy items that are displayed when a new *MVS Component* entry is selected or when an existing *MVS Component* entry is selected from the *Entry Name Selection* panel.

ACTIONS		HELP
AOFGEPOL		Policy Selection
Command ==>		Row 1 to 11 of 11 SCROLL==> PAGE
Entry Type : MVS Component		PolicyDB Name : DATABASE_NAME
Entry Name : MVS_COMPONENTS		Enterprise Name : YOUR_ENTERPRISE
Action	Policy Name	Policy Description
-----	DESCRIPTION	Enter description
-----	MVSDUMP THRESHOLDS	Define MVS dump thresholds
-----	SMFDUMP THRESHOLDS	Define SMF dump thresholds
-----	LOGREC THRESHOLDS	Define LOGREC thresholds
-----	SYSLOG THRESHOLDS	Define SYSLOG thresholds
-----	MESSAGES/USER DATA	Define MVS messages and user data
-----	MINOR RESOURCE FLAGS	Define MVSESA sub-component flags
-----	WTOBUF RECOVERY	WTOBUF recovery (SA 2.1 and earlier)

-----	WHERE USED	List systems linked to this entry
-----	COPY	Copy data from an existing entry
***** Bottom of data *****		

Figure 205. Policy Selection Panel for MVS Components

The policy items for *MVS Component* policy objects are:

MVSDUMP THRESHOLDS

This option allows you to specify error thresholds for dump data sets. For more information see “More about the THRESHOLD Policy Items” on page 264.

SMFDUMP THRESHOLDS

This option allows you to specify error thresholds for System Management Facility (SMF) data sets. For more information see “More about the THRESHOLD Policy Items” on page 264.

LOGREC THRESHOLDS

This option allows you to specify error thresholds for LOGREC data sets. For more information see “More about the THRESHOLD Policy Items” on page 264.

SYSLOG THRESHOLDS

This option allows you to specify error thresholds for SYSLOG data sets. For more information see “More about the THRESHOLD Policy Items” on page 264.

MESSAGES/USER DATA

This policy item allows you to specify automated actions, such as the issuing of a command or reply, to be taken in response to a message issued

MVS Component Policy Object

by the application. You may specify commands if the application issues messages because something went wrong with the MVSDUMP, SMFDUMP, SYSLOG or LOGREC data sets. For more information see “More about Policy Item MESSAGES/USER DATA” on page 268.

MINOR RESOURCE FLAGS

This policy item allows you to define flags for minor resources for the system. Minor resources are any resources, such as messages or statuses, that are specified to be subsidiary to the major resource MVSESA.

Minor resources take, by default, the automation settings of their major resources. The main purposes in defining minor resources are to:

- Enable automation for minor resources
- Override the automation settings of major resources for a single minor resource, or a group of minor resources.

For information on this policy item see “More about Policy Item MINOR RESOURCE FLAGS” on page 269. For information on the relation of minor resources and automation flags refer to “Automation Flags and Minor Resource Flags” on page 39.

WTOBUF RECOVERY

This option allows you to customize recovery from write-to-operator (WTO) buffer shortage and full conditions at an operator console.

Note:

When SA z/OS receives a 100%-full WTOBUF message, it initiates the recovery process unless an operator has already performed the recovery. It is most likely that operators will handle 100%-full WTOBUF situations.

You can specify the number of backlogged console buffers allowed, and the time between WTOBUF recovery attempts. You can define a series of passes specifying commands to be issued in order to recover the WTOBUF. You can also specify parameters and additional commands to be issued after the buffer is cleared in order to reset the console to normal operation.

Refer to Figure 206 on page 265 for more information on this policy item.

More about the THRESHOLD Policy Items

For various threshold policy items, SA z/OS displays the appropriate panels as follows:

- for MVSDUMP THRESHOLDS: the *Component Definition: MVSDUMP* panel
- for SMFDUMP THRESHOLDS: the *Component Definition: SMF DUMP* panel
- for LOGREC THRESHOLDS: the *MVS Component Definition: LOGREC* panel
- for SYSLOG THRESHOLDS: the *Component Definition: SYSLOG* panel

The information provided in the THRESHOLDS dialogs is used to determine when an operator should be notified of an error situation. An attempt to recover an error (such as an abend of a subsystem) is handled by automation, but an operator may need to be informed if this error is occurring too often.

For more information about thresholds for *MVS Components*, refer to “Thresholds for MVS Components” on page 34.

More about the WTOBUF RECOVERY Policy Item

Note::

Use this policy only to define the WTO buffer shortage recovery process for SA OS/390 prior to version 2.1 (APAR level OW47903). For newer SA z/OS releases use the policy MESSAGES/USER DATA.

```

COMMANDS  HELP
-----
AOFPIEW0          Environment Definition: WTOBUF Overflow
Command ==>>> _____

Entry Type : MVS Component          PolicyDB Name  : DATABASE_NAME
Entry Name  : MVS_COMPONENTS        Enterprise Name : YOUR_ENTERPRISE

Important Note: Use this policy only to define the WTO buffer shortage
recovery process for SA z/OS prior to version 2.1 (APAR level OW47903).
For newer SA z/OS releases use the policy  MESSAGES/USER DATA.

Enter information and selection to restore console after WTOBUF overflow.

  NBUF ==> _____ Threshold to initiate recovery of console
  Retry ==> _____ Delay time between initiating recovery passes (hh:mm:ss)

----- Recovery Phase Selections -----
1 RECOVERY          Console recovery passes (R)
2 NORMCONS          Normal console mode after recovery (N)

```

Figure 206. Environment Definition: WTOBUF Overflow Panel

The following recovery parameters can be specified:

NBUF This is the number of backlogged console buffers allowed. When this number is reached, recovery is initiated. The valid range of values is 0 to 9999. The default is 100.

Retry This field represents the time between recovery attempts. The range is from 00:00:00 to 23:59:59. Each set of recovery actions is performed after waiting the time specified by the retry parameter until the WTOBUF relief message is received.

RECOVERY

This option specifies recovery operations. A panel similar to Figure 207 on page 266 is displayed if you select this option.

MVS Component Policy Object

```
COMMANDS  HELP
-----
AOFPIEW1          WTOBUF Recovery Passes          Row 1 to 2 of 29
Command ==> _____ SCROLL==> PAGE

Entry Type : MVS Component          PolicyDB Name : DATABASE_NAME
Entry Name  : MVS_COMPONENTS        Enterprise Name : YOUR_ENTERPRISE

Enter commands to be executed when a WTO buffer shortage is detected.
Commands may contain the variables &EHKVAR1 and &EHKVAR2.
&EHKVAR1 = the Console ID in trouble  &EHKVAR2 = CUU of console in trouble

Pass
Command Text
1
MVS K S,RTME=001,DEL=RD,L=&EHKVAR1
-----
1
MVS K E,D,L=&EHKVAR1
-----
```

Figure 207. WTOBUF Recovery Passes Panel for MVS Component

This panel defines the commands to be used for WTO buffer recovery and has the following options that can be filled in:

Pass/Command Text

This is a standard command specification and is used to define those commands to be issued when a WTO buffer shortage is detected. Recovering from the shortage may involve issuing several commands, so the PASS parameter can be used to define the command sequence.

A command to be issued on every pass should specify * as the pass number. The variables EHKVAR1 and EHKVAR2 are automatically filled with the console ID, or name if the ID is not specified, and the device number of the console in trouble. These variables can be used in any of the recovery commands, for example:

```
MVS K A,NONE,L=&EHKVAR1
```

If automation is on, the recovery process is as follows.

When the WTOBUF shortage or full message is received the MVS command 'D C,B' will be issued to determine which consoles have a buffer shortage. Recovery commands will be issued for those consoles with a buffer backlog greater than the number of buffers specified by the NBUF parameter. Automation decides which pass number to start the recovery process with based on the console roll mode as follows:

- If the roll mode = rd, the starting pass number = 2.
- If the roll mode = r and the roll time > 1, the starting pass number = 2.
- If the roll mode = r and the roll time <= 1, the starting pass number = 3.
- For all other combinations the starting pass number = 1.

After executing all the commands associated with a pass, the recovery process will be scheduled to issue the next pass after waiting the amount of time specified by the retry parameter. Automation will check to see if the WTOBUF relieved message has been received before each pass is issued.

NORMCONS

Choose this option to specify procedures for restoring normal console mode after a WTOBUF recovery.

A panel similar to Figure 208 is displayed.

When a WTOBUF shortage has been relieved by SA z/OS, consoles involved in the recovery will be restored to the normal operating mode. The normal console mode can be defined by completing the following options:

```

COMMANDS  HELP
-----
AOFPIEW2          Console Mode After WTOBUF Recovery      Row 1 to 1 of 20
Command ==> _____ SCROLL==> PAGE

Entry Type : MVS Component          PolicyDB Name   : DATABASE_NAME
Entry Name  : MVS_COMPONENTS        Enterprise Name : YOUR_ENTERPRISE

Enter parameters to reset console after WTO buffer shortage is relieved.

Roll time      ==> ____ Seconds between message rolls
Roll mode      ==> ____ Message deletion mode:
                                     Automatic (AUTO), Manual (MAN), Roll (ROLL),
                                     Roll all but action messages (ROLLD, roll-delete),
                                     Wrap (WRAP)
Console size   ==> ____ Minimum size of console used to run SA z/OS

Console Areas:  A   B   C   D   E   F   G   Total Area Allocated
Size           ==>  _   _   _   _   _   _   _   0

Additional Commands to Restore Normal Console Operation.
_____

```

Figure 208. Console Mode After WTOBUF Recovery Panel

The following fields can be specified:

Roll time

This is the time (in seconds) between messages rolling on the console. The value can be 0, 1/4, 1/2, or 1 to 999.

Roll mode

The message deletion mode. The following modes can be specified:

- **AUTO** - Enter this to specify automatic message deletion mode. When the screen is full, all flagged messages are removed.
- **MAN** - Enter this to specify manual message deletion mode. All messages must be removed from the screen manually.
- **ROLL** - Roll mode takes effect if this is entered. At each specified interval (defined in Roll Time field) a specific number of messages (defined in RNUM parameter of CONSOLxx member in PARMLIB) are rolled off the screen.
- **ROLLD** - Roll-deletable mode takes effect if this is entered. The messages roll off in the same way as roll mode except that action messages are held at the top of the screen.
- **WRAP** - Wrap mode takes effect. When the screen is full, the next message overlays the message at the top of the screen, and subsequent messages continue overlaying older messages down the screen.

MVS Component Policy Object

Console Size

The total number of lines on the console that may be used for display areas.

Console Areas

The seven letters (A-G) can represent seven different display areas on the console. The number of lines entered under the first letter defines a display area at the bottom of the screen. The next letters define areas moving towards the top of the screen. The total number of lines for the display areas should not exceed the number entered in Console Size.

Additional Commands to Restore Normal Console Operation.

Additional commands to restore the console to normal operating mode. The following commands will be issued if no values are specified:

```
'MVS K E,D,L=&EHKVAR1'  
'MVS K A,NONE,L=&EHKVAR1'
```

More about Policy Item MESSAGES/USER DATA

If you select policy item MESSAGES/USER DATA from the *Policy Selection* panel for MVS Components (Figure 205 on page 263), you come to the *Message Processing* panel shown in Figure 209.

```
ACTIONS  HELP  
-----  
AOFMSGX          Message Processing          Row 1 to 4 of 23  
Command ==>>>          SCROLL==>> PAGE  
  
Entry Type  : MVS Component          PolicyDB Name  : DATABASE_NAME  
Entry Name  : MVS_COMPONENTS        Enterprise Name : YOUR_ENTERPRISE  
  
Define message IDs and their automation actions.  
CMD = Command  REP = Reply  CODE = CODE  USER = User Data  
AUTO = AT Actions      OVR = AT Override  
  
Action  Message ID          Cmd Rep Code User Auto Ovr  
Description  
-----  
LOGREC          3  
Specifications for LOGREC  
SYSLOG          1  
Specifications for SYSLOG  
MVSDUMPTAKEN   1  
Dump is taken  
MVSDUMPRESET  
Dump reset
```

Figure 209. Message Processing Panel

The MESSAGES/USER DATA policy item allows you to specify message IDs, and special ones like MVSDUMPTAKEN, MVSDUMPRESET, MVSDUMP, SMFDUMP, SYSLOG, LOGREC, and WTOBUF.

On this panel, you can define how SA z/OS should react to an issued message. Message processing provided here is the same as provided for *Applications*. For more information refer to “More about Policy Item MESSAGES/USER DATA” on page 165 and *System Automation for z/OS Customizing and Programming*

More about Policy Item MINOR RESOURCE FLAGS

The *Minor Resource Selection* panel is displayed if you select policy item *MINOR RESOURCE FLAGS* on the *Policy Selection* panel for entry types *Application* or *MVS Component*.

```

COMMANDS  ACTIONS  HELP
-----
AOFPIMR4          Minor Resource Selection
Command ==>>>                                SCROLL==>> PAGE

Entry Type : MVS Component          PolicyDB Name : DATABASE_NAME
Entry Name  : MVS_COMPONENTS        Enterprise Name : YOUR_ENTERPRISE

Major Resource: MVSESA

Select minor resource to be altered.

Action Minor Resource
-      LOGREC _____
-      MVSDUMP _____
-      SCU0040 _____
-      SCU0050 _____
-      SCU0060 _____
-      SCU0070 _____
-      SCU0080 _____
-      SCU0090 _____
-      SMFDUMP _____
-      SYSLOG  _____
-      TAPES   _____
-      WTOBUF  _____

```

Figure 210. Minor Resource Selection Panel

The *Minor Resource Selection* panel allows you to manage your minor resource definitions. You can add, delete or rename minor resources. To add a minor resource, enter its name into the *Minor Resource* column. You can select a minor resource to edit the automation flags on the next panel *Flag Automation Specification*.

You can also define a hierarchy of minor resources. For example, for the minor resource TAPES in the example in Figure 210, you can define more detailed minor resources. The hierarchy of minor resources is denoted by dots. You can set automation flags for the complete hierarchy by setting them for the minor resource TAPES or you can set certain flags for selected lower level minor resources.

Example:

```

-      TAPES _____
-      TAPES.SYS1 _____
-      TAPES.SYS2 _____
-      TAPES.SYS3 _____
-      _____

```

MVSCOMP Defaults Policy Object

MVSCOMP Defaults allow you to set default values for MVS Component sets. Figure 211 on page 270 shows the policy items that are displayed when a new *MVSCOMP Defaults* entry is defined or when existing *MVSCOMP Defaults* entry is selected from the *Entry Name Selection* panel.

MVSCOMP Defaults Policy Object

```

ACTIONS  HELP
-----
AOFGEPOL          Policy Selection
Command ==>>>          SCROLL==>> PAGE

Entry Type : MVSCOMP Defaults      PolicyDB Name : DATABASE_NAME
Entry Name  : MVSCOMP_DFLTS_NAME   Enterprise Name : YOUR_ENTERPRISE

Action      Policy Name      Policy Description
-----
            DESCRIPTION   Enter description
            AUTOMATION FLAGS Define MVS component automation flags default
            THRESHOLDS    Define MVS component thresholds defaults
            -----
            WHERE USED     List Systems linked to this entry
            COPY           Copy data from an existing entry
            ***** Bottom of data *****

```

Figure 211. Policy Selection Panel for MVSCOMP Defaults

The unique policy items for *MVSCOMP Defaults* are:

AUTOMATION FLAGS

This option allows you to specify automation settings that will be used as defaults for MVS Components. The settings specified here will be used if you do not provide specific automation settings for MVS Components. See “Automation Flags” on page 34 for more information about setting automation flags.

THRESHOLDS

This policy item is used to set default error thresholds for *MVS Components*. The settings specified here will be used if you do not provide specific thresholds for MVS components. See “How SA z/OS Uses Error Thresholds” on page 31 for more information about error thresholds.

More than one *MVSCOMP Default* may be attached to a system, but it is recommended that you attach only one to avoid data being overwritten during ACF LOAD.

System Defaults Policy Object

This policy object allows you to set various defaults that are used throughout the system. The values set here may be overridden by other objects, such as Application class, Application Defaults, or MVSCOMP Defaults, or by setting appropriate values in individual application or MVS Component objects. Figure 212 on page 271 shows the policy items that are displayed when a new System Defaults entry is defined or when an existing System Defaults entry is selected from the *Entry Name Selection* panel.

ACTIONS		HELP
AOFGEPOL		Policy Selection
Command ==>		Row 1 to 8 of 8 SCROLL==> PAGE
Entry Type : System Defaults		PolicyDB Name : DATABASE_NAME
Entry Name : SYSTEM_DEFAULTS		Enterprise Name : YOUR_ENTERPRISE
Action	Policy Name	Policy Description
_____	DESCRIPTION	Enter description
_____	AUTOMATION FLAGS	Define system automation flag defaults
_____	THRESHOLDS	Define system thresholds defaults
_____	AUTOMATION OPTIONS	Define system automation options
_____	ENVIRONMENT	Define subsystem defaults

_____	WHERE USED	List systems linked to this entry
_____	COPY	Copy data from an existing entry
***** Bottom of data *****		

Figure 212. Policy Selection Panel for System Defaults

The unique policy items for System Defaults policy object are:

AUTOMATION FLAGS

This option allows you to specify automation settings that are used as defaults for the system. The settings specified here will be used if you do not provide specific automation settings for those policy objects which allow automation. See “Automation Flags” on page 34 for more information on setting automation flags.

THRESHOLDS

This policy item is used to set system-wide error thresholds. The settings specified here will be used if you do not provide object-specific threshold settings. See “How SA z/OS Uses Error Thresholds” on page 31 for more information on error thresholds.

AUTOMATION OPTIONS

This policy item is used to set the system-wide captured message limit. The value specified here will be used if you do not provide object-specific limits. See “More about Policy Item AUTOMATION OPTIONS” for more information.

ENVIRONMENT

This option allows you to set various defaults for applications you define to the system. The values entered in the *Subsystem Defaults* panel are used as default values for *Application* objects which are attached to this system and do not have this information specified.

More than one set of *System Defaults* may be attached to a system, but it is recommended that you attach only one to avoid data being overwritten during ACF LOAD.

More about Policy Item AUTOMATION OPTIONS

The *System Automation Options* panel, as shown in Figure 213 on page 272, is displayed if you select the AUTOMATION OPTIONS policy item on the *Policy Selection* panel for the System Defaults entry type.

System Defaults Policy Object

```
COMMANDS  HELP
-----
                                System Automation Options
Command ==> _____

Entry Type : System Defaults      PolicyDB Name : DATABASE_NAME
Entry Name : SYSTEM_DEFAULTS     Enterprise Name : YOUR_ENTERPRISE

Captured Messages Limit. . ____ (0 to 999, or blank)
```

Figure 213. System Automation Options Panel

The following parameter can be specified for system-wide defaults. If the corresponding entry is not specified for individual resources, this value will prevail.

Captured Messages Limit

This specifies the maximum number of messages that will be captured for each resource while SA z/OS is running. These messages will show up in the DISPINFO or DISPMTR command output or SA z/OS Graphic Interface.

More about Policy Item ENVIRONMENT

The *Subsystem Defaults* panel, as shown in Figure 214, is displayed if you select the ENVIRONMENT policy item on the *Policy Selection* panel for the System Defaults entry type.

```
COMMANDS  HELP
-----
                                Subsystem Defaults
AOFPIED0
Command ==> _____

Entry Type : System Defaults      PolicyDB Name : DATABASE_NAME
Entry Name : SYSTEM_DEFAULTS     Enterprise Name : YOUR_ENTERPRISE

Job Type . . . . . _____ (MVS NONMVS TRANSIENT)
Transient Rerun. . . . . _____ (YES NO)
Enter startup information:
Start on IPL . . . . . _____ (YES NO NONE blank)
Start on Recycle . . . . . _____ (YES NO NONE blank)
Start Timeout. . . . . _____ (time for "UP" status checks, hh:mm:ss)
Start Cycles . . . . . _____ (start timeout checks, 0 to 99)
Restart Option . . . . . _____ (ALWAYS ABENDONLY NEVER)
Enter shutdown information:
Shutdown Delay . . . . . _____ (hh:mm:ss)
Clean Up Delay . . . . . _____ (hh:mm:ss)
```

Figure 214. Subsystem Defaults Panel

The parameters can be specified for system wide subsystem defaults. If the corresponding entry is not specified for individual subsystems, these values will prevail. For more details about these parameters, refer to “Application Policy Object” on page 145.

Application Defaults Policy Object

The *Application Defaults* policy object specifies default values for automation flags and error threshold settings. These values will be used as the default for any Application object on the system to which the Application Defaults set is attached. If the application belongs to an application class with automation flags or error thresholds specified, the class policy takes precedence over the defaults. Figure 215 on page 273 shows the policy items that are displayed when a new Application

Defaults entry is defined or when an existing Application Defaults entry is selected from the *Entry Name Selection* panel.

ACTIONS		HELP

AOFGEPOL	Policy Selection	
Command ==>		SCROLL==> HALF
Entry Type : Application Defaults PolicyDB Name : DATABASE_NAME		
Entry Name : APPL_DEFAULTS_NAME Enterprise Name : YOUR_ENTERPRISE		
Action	Policy Name	Policy Description
	DESCRIPTION	Enter description
	AUTOMATION FLAGS	Define Application automation flag defaults
	THRESHOLDS	Define Application thresholds defaults

	WHERE USED	List Systems linked to this entry
	COPY	Copy data from an existing entry

Figure 215. Policy Selection Panel for Application Defaults

The unique policy items for Application Defaults policy are:

AUTOMATION FLAGS

This option allows you to specify automation flag settings that will be used as defaults for all applications on the system. The settings specified here will be used if you do not provide application-specific automation settings. See “Automation Flags” on page 34 for more information on setting automation flags.

THRESHOLDS

This option allows you to specify threshold settings that are used as defaults for all applications on the system. Settings specified here will override system default settings and will be used if you do not provide application-specific threshold settings. See “How SA z/OS Uses Error Thresholds” on page 31 for more information on setting thresholds.

More than one set of *Application Defaults* may be attached to a system, but it is recommended that you attach only one to avoid data being overwritten during ACF LOAD.

Auto Operators Policy Object

Automation operators are automated operator tasks, that can respond to messages from the operating system, applications, and network without requiring a human operator. Sets of automation operators can be linked to a system. Each automation operator task takes actions similar to those of a human operator, such as monitoring the system and handling and coordinating recovery and shutdown operations.

Automation operators are assigned specific messages on which to act. During automated operations, the messages are routed to the appropriate operator using the NetView ASSIGN command. Figure 216 on page 274 shows the policy items that are displayed when a new *Auto Operators* policy object is created or *Auto Operators* is selected from the *Entry Type Selection* panel.

Auto Operators Policy Object

```

ACTIONS  HELP
-----
AOFGEPOL          Policy Selection
Command ==>>>          SCROLL==>>> HALF

Entry Type : Auto Operators      PolicyDB Name : DATABASE_NAME
Entry Name : AUTO_OPERATORS_NAME Enterprise Name : YOUR_ENTERPRISE

Action   Policy Name      Policy Description
        DESCRIPTION
        OPERATORS        Enter description
                          Define automation operators
-----
        WHERE USED      List Systems linked to this entry
        COPY            Copy data from an existing entry

```

Figure 216. Policy Selection Panel for Auto Operators

The unique policy item for *Auto Operators* is:

OPERATORS

Automation operators are crucial to the operation of SA z/OS. The SA z/OS sample automation control file supplies definitions that are required in order to start SA z/OS. If you modify the sample definitions, or if you do not wish to use the sample definitions, you need to be aware of which automation operators are required, and what messages should be assigned to them. SA z/OS defines an *automated function name* for each automation operator it uses. Certain automated function names must be defined. These are listed in Table 8. The automated function names are included in the sample policy databases supplied with SA z/OS. If you are not using a sample policy database, you must include these automated function names in your policy database. The automation operators with which they are associated are defined in the sample NetView DSIOPF data set.

More about the OPERATORS Policy Item

Table 8 lists the automated function names that need to be defined.

Table 8. SA z/OS Mapping of NetView Automation Operator to SA z/OS Automated Function

Automated Function	Automation Operator	Description
AUTO1	AUTO1	Used for SA z/OS initialization
AUTO2	AUTO2	Used for SA z/OS initialization
BASEOPER	AUTBASE	Base automation: Backs up all other automation operators.
SYSOPER	AUTSYS	System automation: Acts as the primary system automation operator.
LOGOPER	AUTLOG	Used for message writing and for unassigned messages.
MSGOPER	AUTMSG	Message automation: Formats and routes messages.
AOFWRKxx	AUTWRKxx	Used for subsystem processing, for example startup, shutdown
NETOPER	AUTNET1, AUTNET2	VTAM and NetView automation: Acts as the network products automation operator.
JESOPER	AUTJES	JES automation: Acts as the JES2 or JES3 product automation operator.

Table 8. SA z/OS Mapping of NetView Automation Operator to SA z/OS Automated Function (continued)

Automated Function	Automation Operator	Description
MONOPER	AUTMON	Monitoring and startup automation: Performs active monitoring of resources.
RECOPER	AUTREC	Recovery automation: Acts as the primary recovery operator. It is not recommended that you use RECOPER for user automation that issues WTO/Rs. This situation can halt SA z/OS's WTO/R buffer recovery process, which may result in a buffer full situation.
RPCOPER	AUTRPC	Used for XCF requests
SHUTOPER	AUTSHUT	Shutdown automation: Acts as the base shutdown operator.
GSSOPER	AUTGSS	General automation. Acts as the operator for applications using SA z/OS generic automation routines, but does not execute these routines. Instead, it distributes them to the responsible AOFWRKxx automated functions. GSSOPER will also be used as backup in case there is no AOFWRKxx automated function defined.
GATOPER	GAT&DOMID	Gateway: Acts as the outbound gateway operator for automation notification message forwarding
MVSCONS <i>i</i>	AUTCON	Used for the MVS and NetView console interface. The MVS console with which it is associated can be changed in the customization dialog.
PPIOPER	AOFARCAT	ARM PPI receiver
HBOPER	AUTHB	Used by heartbeat function
XCFOPER	AUTXCF	Used for enhanced Parallel Sysplex automation functions.
XCFOPER2	AUTXCF2	Used for enhanced Parallel Sysplex automation functions.
XCFOPER3	AUTXCF3	Used for enhanced Parallel Sysplex automation functions.
HWOPER1-33	AUTHW1-33	Used for Hardware Validation messages.
PLEXOPER,1,2	AUTPLEX, 1, 2	Used for enhanced Parallel Sysplex automation functions.
POSTOPER	AUTPOST	Used for the serialization of INGPOST commands.

It is highly recommended that you assign these required automated functions the suggested automated operators as listed in the above table. If you attempt to share automated operators across more than 1 automated function you will experience a significant performance degradation during the ACF load process.

Sample DSIOPF definition statements are included in the AOFOPF sample that is shipped with SA z/OS. You may define additional automation operators, to suit your automation needs.

Auto Operators Policy Object

When defining SA z/OS automated functions, you must associate the SA z/OS automated function names with actual automation operator IDs defined in member DSIOFP in the NetView DSIPARM data set. For example, you can associate the SA z/OS name BASEOPER with the NetView automation operator ID AUTBASE, MSGOPER with AUTMSG, and JESOPER with AUTJES. You must also define synonyms for them in AOFMSGSY. See *System Automation for z/OS Customizing and Programming* for more information on synonyms. Figure 217 shows an example of an *Automation Operator Definition* panel.

```
COMMANDS  ACTIONS  HELP
-----
AOFPIA00          Automation Operator Definitions      Row 1 to 10 of 36
Command ==> _____ SCROLL==> PAGE

Entry Type : Auto Operators      PolicyDB Name : DATABASE_NAME
Entry Name : BASE_AUTOOPS       Enterprise Name : YOUR_ENTERPRISE

Actions: S = Select  M = Move  B = Before  A = After  I = Insert

Action      Automated
Function    Messages for this Operator (* notation ok)
-----
BASEOPER
GSSOPER
JESOPER
LOGOPER    *
MONOPER
MSGOPER    AOF*
MVSCONS
NETOPER
PPIOPER
RECOOPER   ERB*,IEA*,IEE*,IOS*
```

Figure 217. Automation Operator Definition Panel

Messages are entered in the *Messages for this Operator* field. You can specify:

- A single message, such as IEE115I
- A group of messages, by specifying a message prefix and an asterisk (*), such as AOF* or \$HASP*
- All messages, not otherwise assigned, by specifying an asterisk (*) only

How SA z/OS processes and assigns messages to automation operators depends on the order in which you specify automation operators on the *Automation Operator Definition* panel and the types of message you assign to each operator. The order in which operators are listed on the panel has meaning during operations. When a message occurs, SA z/OS searches this list of automation operators from the top to find which automation operator is associated with the message. To make sure SA z/OS assigns the right operator the right message, enter the more specific message ID assignments first in the automation operator list. Then, enter the more general message ID assignments later in the list. For example, if you want to make sure an automation operator receives all messages beginning with IEF4, you define that automation operator and message assignment in the list before an automation operator defined to receive all messages beginning with IE. The *Automation Operator Definition* panel has commands that help you change the order of automation operators in the list.

To continue specification of message IDs across multiple lines, insert a line where required and leave the automated function blank.

The following automated functions should not have messages assigned to them on the *Automation Operator Definition* panel:

- BASEOPER
- GATOPER
- MVSCONSi (where *i* is blank, A-Z, or 0-9)
- SHUTOPER
- HBOPER
- AOFWRKxx
- GSSOPER

For these automation operators, you should only specify the automated function name in the Automated Function field, and leave the Messages for this Operator field blank.

When you have entered the automated function and assigned messages a new panel will be displayed in which you can enter automation operators and NetView operators to receive messages. Figure 218 provides an example.

```

COMMANDS  HELP
-----
AOFPIA01          Automation Operator NetView Userids
Command ==>>>

Entry Type : Auto Operators          PolicyDB Name  : DATABASE_NAME
Entry Name  : BASE_AUTOOPS           Enterprise Name : YOUR_ENTERPRISE

Automated Function: BASEOPER
Messages assigned:

Enter automation operators and &net; operator(s) to receive messages.

Automation Operators          NetView Operators
Primary ==> A&DOMAIN.xyz ____ ==> _____
Backup  ==> X&SYSPROC. _____ ==> _____
                                         ==> _____
                                         ==> _____
                                         ==> _____

```

Figure 218. Automation Operator NetView Userids Panel

The fields are:

Automation Operators

Each automation operator relates to a specific NetView operator ID. Each message is assigned to a list of operators. This list includes the primary NetView ID, the secondary NetView ID (if specified), the primary NetView ID for SYSOPER, and the primary NetView ID for BASEOPER. The message is processed on the first operator in the list that is logged on when the message is received. If none of the operators are logged on, it will be processed on the task that started the system NetView Subsystem Interface Router task (SIR task), if it was started by a NetView task. In the NetView default initialization sequence, AUTO1 starts the SIR task. If the SIR task was not started by an autotask (that is, it has INIT=Y coded in DSIDMN) or the task that started it is no longer active, the message will not be automated. Similar lists of autotasks are defined in AOFMSGSY and are used to route commands to tasks from the NetView automation table.

If a group is specified (the ID starts with a "+"), then all the IDs that are assigned to the group are inserted into the list at that point.

You may also use SYSCONE variables and the &DOMAIN. variable for the automation operators and NetView operators specification.

Auto Operators Policy Object

NetView Operators

Defines NetView IDs to receive copies of the messages assigned to the automation operator. The ID must be logged on to receive the message and either the primary or backup operator must also be logged on. Operator "groups" can be defined by specifying a "+" as the first character.

SA z/OS displays a different panel if MVSCONSi is entered on the *Automation Operator Definition* panel. Figure 219 provides an example.

```
COMMANDS  HELP
-----
AOFPIA03          Automation Operator: MVSCONS
Command ==> _____

Entry Type : Auto Operators          PolicyDB Name  : DATABASE_NAME
Entry Name  : AUTO_OPERATORS         Enterprise Name: YOUR_ENTERPRISE

Automated Function: MVSCONS

MVS Console ID    ==>  _____  Console-id eligible to enter NetView cmds
Automation Operator ==>  _____  Operator-id

                                or

MVS Console Name  ==>  _____  Console-name eligible to enter NetView cmds
Automation Operator ==>  _____  Operator-id (optional)
```

Figure 219. *Automation Operator: MVSCONS Panel*

This panel allows you to specify an MVS console from which you can enter NetView commands. The MVS console, specified either by ID or by name, is associated with an automation operator.

The operator ID you enter here is used as the base for a series of sequentially numbered autotasks that are set up as servers for any real MVS consoles which SA z/OS detects attached to the machine. With the default ID of AUTCON and three consoles attached to the machine, autotasks AUTCON, AUTCON01 and AUTOCON02 is used. These should be defined in DSIOPF. The allocation of a server autotask to a real console allows it to issue NetView and SA z/OS commands by prefixing them with the NetView Subsystem Interface identification character. This character is set by the DSIG parameter in the JCL procedure for the NetView SSI. It defaults to %.

Additional MVS consoles may be specified by entering MVSCONSi in the Automated Function column on the *Automation Operator Definition* panel (AOFPIA00). The allowed values for the *i* suffix on MVSCONS are blank (MVSCONS), A-Z (MVSCONSA, MVSCONSB..., MVSCONSZ) and 0-9 (MVSCONS0, MVSCONS1..., MVSCONS9).

Structure of AOFWRKxx Operators

AOFWRKxx operators are used to distribute the work on different NetView tasks, so that they can run in parallel. AOFWRKxx operators are used as dedicated automated function responsible for all the work on a particular subsystem. However, since there might be too many subsystems defined, it may not be possible that each subsystem has a unique automated function for exclusive usage. Instead, several subsystems will share the same automated function. This

automated function is responsible for the subsystem's startup, shutdown, monitoring and message handling activities.

You must define at least three automated functions which are responsible for the subsystem automation. You have the possibility to define additional ones. So you can decide how much parallelism you want.

The naming of these automation operator entries is of type AOFWRKxx where xx is any number or character. The xx part of the automated function name does not have to be in sequence.

At ACF load time, each defined subsystem will be assigned an automated function from the pool of defined AOFWRKxx operators.

Behavior of SHUTDOWN, STARTUP and GSSOPER

There are changes in the behavior of the shutdown, the startup and in the usage of the GSSOPER automated function.

SHUTDOWN and STARTUP: A shutdown/startup can continue to process another subsystem on another automated function before a shutdown/startup command is completed. The shutdown/startup process can run in parallel.

GSSOPER Usage: The GSSOPER automated function is used for the generic routines ACTIVMSG, TERMMMSG and HALTMSG. These routines are routed from the message automation table to GSSOPER. The GSSOPER automated function will no longer execute these routines, it will only distribute them to the responsible AOFWRKxx automation operators. GSSOPER will also be used as backup when there is no AOFWRKxx automation operator defined.

Notify Operators Policy Object

The Notify Operators policy object allows you to define notification messages for certain operators. Select 38 Notify Operators on the Entry Selection panel to define these operators:

ACTIONS		HELP
AOFGEPOL		Policy Selection
Command ==>		Row 1 to 5 of 5 SCROLL==> PAGE
Entry Type :	Notify Operators	PolicyDB Name : DATABASE_NAME
Entry Name :	NOTIFY_OPERATORS	Enterprise Name : YOUR_ENTERPRISE
Action	Policy Name	Policy Description
_____	DESCRIPTION	Enter description
_____	NOTIFY_OPERATORS	Define forward messages to operators
_____	WHERE USED	List systems linked to this entry
_____	COPY	Copy data from an existing entry
***** Bottom of data *****		

Figure 220. Policy Selection Panel for Notify Operators

NOTIFY OPERATORS

Notification operators are human NetView operators who receive SA z/OS notification messages, which are messages about events SA z/OS detects or actions it takes. These notification messages are routed to one or more

Notify Operators Policy Object

logged-on human operators, using the message forwarding path you set up in the *Network* policy object. The messages can optionally be held until the operator clears them.

```

COMMANDS  ACTIONS  HELP
-----
AOFPIN00                                Operator Notification
Command ==> _____ SCROLL==> PAGE

Entry Type : Notify Operators      PolicyDB Name : DATABASE_NAME
Entry Name : SAMPLE_NFYOP_01      Enterprise Name : YOUR_ENTERPRISE

Enter operator information and select message type(s) to be held on screen.

Action : S = Select for message class assignment      Notify: Yes or No
Messages: S = Select messages to be held

A Operator      Operator      Notify  ----- Messages -----
  ID            Description          Information
                                     Eventual Action
                                     Immediate Decision
                                     System Wait
                                     Immediate Action
-  XXAOC05      SHIFT LEADER          YES    S  S  S  S
-  XXAOC06      SENIOR OPERATOR       NO    -   -   -   -
-  _____      _____              _____ -   -   -   -

```

Figure 221. Operator Notification Panel

On this panel you can select notification operators or define new notification operators that you want to be notified about selected message classes from applications on this system.

When you specify *Yes* for Assign User message classes, to have the operator notified about user-defined message classes, SA z/OS displays existing message classes that have been defined with policy item *Auto Msg Classes* of entry type ENT.

How to define messages for a message class and where to store them, is described in *System Automation for z/OS Customizing and Programming*.

```

COMMANDS  HELP
-----
AOF PINO1      Operator Notification Message Classes
Command ==>>

Entry Type : Notify Operators      PolicyDB Name : DATABASE_NAME
Entry Name : SAMPLE_NFYOP_01      Enterprise Name : YOUR_ENTERPRISE

Operator ID : XXAOC05
Description : SHIFT LEADER

Select S the message classes that are appropriate for this operator.
More:      +

A  Automation agent related message classes

    0 - Errors
    1 - Debug
    40 - ALL agent automation messages
    41 - reserved
    42 - reserved
    43 - Information
    44 - Action
    ...
    ...
    ...
    89 - Satisfactory, all resources
    90 - SA Infrastructure/environment

Assign User message classes ==> YES  Yes or No
    
```

Figure 222. Operator Notification Message Classes Panel

When defining notification operators, you can customize:

- Which operators receive notification messages
- The types of message held on notification operators’ console screens:
 - Immediate Action
 - Immediate Decision
 - Eventual Action
 - Information
 - System Wait
- The classes of messages sent to the operators. (See “More about Policy Item AUTO MSG CLASSES” on page 87 for information about defining your own message classes.) Each SA z/OS message can have one or more message classes associated with it. Similarly, each notification operator can have one or more message classes assigned. When messages are processed during automated or manual operations, the class of each message is compared to the classes defined for each notification operator. If a match occurs, the notification operator receives the message. All one and two digit numeric message classes are reserved for IBM use. You may use message classes made up of one alphabetic and one numeric character (or one numeric and one alphabetic).

Table 9 shows the message classes defined by SA z/OS. Message classes from 80 to 90 are relevant for monitoring the automation manager. These message classes are discussed in more detail in *System Automation for z/OS Messages and Codes*.

Table 9. SA z/OS Message Classes

Message Class Description	Message Class Number
<i>General Message Classes</i>	
Errors	0
Debug	1
<i>Automation Agent Related Message Classes</i>	

Notify Operators Policy Object

Table 9. SA z/OS Message Classes (continued)

Message Class Description	Message Class Number
All automation agent messages	40
Information	43
Action	44
Status	45
User intervention	46
Critical threshold setting exceeded	50
Frequent threshold setting exceeded	51
Infrequent threshold exceeded	52
Assist mode alert	55
IMS Automation Messages	60
<i>Automation Manager Related Message Classes</i>	
All automation manager messages	80
Intervention required	81
Automation denied	82
Automation Impacted	83
Awaiting Automation	84
In Automation	85
Degraded - Target resources	86
Degraded - All resources	87
Satisfactory - Target resources	88
Satisfactory - All resources	89
SA z/OS Infrastructure/Environment	90

For example, any operator defined with a notification operator class of all SA z/OS messages (class number 40 and 80) receives all SA z/OS messages. Operators responsible for system operations should receive all SA z/OS messages or a subset of those messages. As another example, you may want to have your lead operator receive all debug messages.

SA z/OS uses the general and console automation message classes only. The SA z/OS customization dialog supports the message classes used by SA z/OS only.

SA z/OS uses notification messages to update the status display facility (SDF).

Network Policy Object

When multiple z/OS systems are interconnected and require consolidated operations at one focal point system, you can use focal point services to monitor and control the systems. These services allow an operator to view the status of multiple systems from a single system acting as a focal point and to send messages, commands, and responses from a focal point system to other systems. The *Network* policy object allows you to:

- Define paths for sending messages, commands, or responses from one system to another.
- Define primary and backup focal point systems.

- Define gateway sessions connecting systems.
A gateway session uses autotasks both inbound to and outbound from a system to send data between systems.
Communication with the focal point system is now done using the NetView RMTCMD command or XCF. RMTCMD allows you to issue commands cross-domain, and see the responses on your operator task.
- Manage passwords for gateway autotasks (for downlevel systems only).
- Define user Terminal Access Facility (TAF) full-screen sessions and specify whether or not each of these should be initiated automatically when the operator logs on to the SA z/OS NetView Interface. If a TAF session is not defined to start automatically, you can initialize it using the OPER dialog.

Chapter 10, "Automating Networks," on page 347 provides more information on the definition of automation networks. Figure 223 shows the policy items that are displayed when a new *Network* policy object is defined or when an existing *Network* object is selected from the *Entry Name Selection* panel.

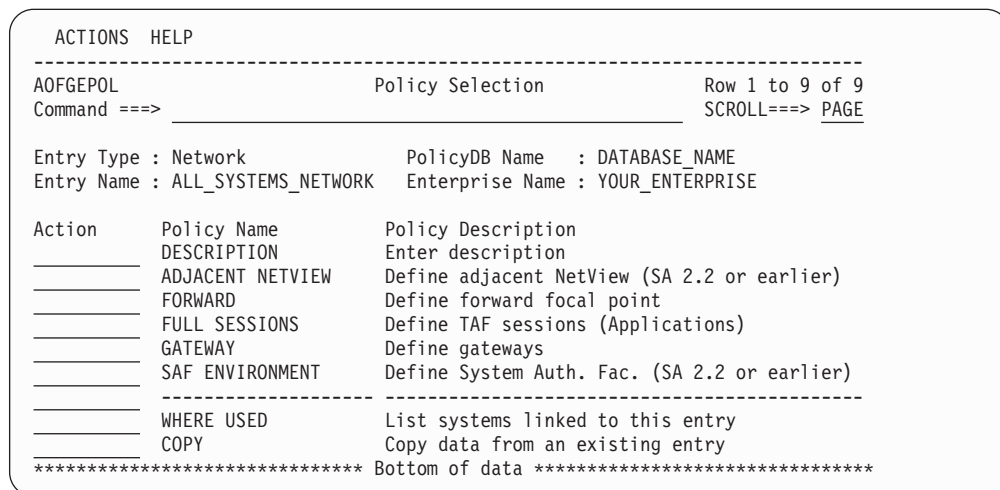

Figure 223. Policy Selection Panel for Network

The unique policy items for *Network* are:

ADJACENT NETVIEW

Note: Use this policy only to define the adjacent NetView domains for systems running SA OS/390 Version 2.2 or earlier. For newer SA z/OS releases the forwarding of status updates via an intermediate node to the focal point is no longer supported.

This option is used to define NetView domains that route commands, replies, and notification messages between NetView domains that do not have a direct connection between themselves. The adjacent domain should have a direct connection to the To domain, and the current domain should have a gateway to the Adjacent domain.

The fields are:

Network Policy Object

To Domain

The domain that is to receive the commands, replies, and notification messages from the current domain.

Adjacent Domain

The domain through which the commands, replies, and notification messages are forwarded to the To domain.

Alternate Adjacent

This domain is used if the adjacent domain is not active.

To-Domain Description

A one-line description of the To domain.

FORWARD

This option is used to define the domain which is to receive the notification messages to be forwarded from the current domain. Two domains can be specified in the following fields of the upcoming panel:

Primary Domain

In this field you enter the domain that is to receive the notification messages from the current domain. If this field is not filled in, the current domain will be the focal point (other domains forwarding messages to the current one without it forwarding any itself). The name must consist of up to 5 alphanumeric characters or can be &DOMAIN.

Backup Domain

If the primary domain is not active, the domain defined here acts as the backup and receives its messages. If this field is not filled in, the backup defaults to the current domain. The name must consist of up to 5 alphanumeric characters or can be &DOMAIN..

FULL SESSIONS

With this option you can define applications to which TAF full screen sessions can be established. The following fields can be specified:

Session Name

This field acts as a description of the application that is displayed on the interface panel.

Application ID

The application name as specified in VTAMLST.

System

The name of the system that the application runs on. This field also acts as a description field that is displayed on the interface panel.

GATEWAY

Note:

Because communication with the focal point is done by means of either the NetView RMTCMD command or XCF communication, the specification of password and logmode is no longer required.

Each domain that is to receive commands, replies, or notification messages must have a gateway defined for it. This includes the domain name and password for the outbound gateway autotask. The Gateway policy item consists of the following fields:

Domain

The names of the domains that should receive anything forwarded from the current domain.

Password

The password for the autotask to logon. The value RACFNNT can be entered if RACF is to be used to control passwords.

Logmode

The logmode that SA z/OS uses when logging on to the specified domain for the outbound gateway session.

Description

A description of the domain you are communicating with.

SAF ENVIRONMENT**Note:**

Use this policy only to define the System Authorization Facility (SAF) for systems running SA OS/390 version 2.2 or earlier. For newer SA z/OS releases the establishing of a gateway connection is only supported by means of the RMTCMD facility which does not require the specification of a password. Therefore SAF is not used to manage gateway access.

When the System Authorization Facility (SAF) is identified as being used to manage gateway access, SA z/OS maintains a VSAM database containing password and other information pertaining to the gateway autotasks. This option allows you to specify how this database is to be used and maintained. The following fields can be filled in:

Owner

If SAF is to be used to control the gateway autotasks, and a group of domains share the same SA z/OS password database, the owner of that database should be entered here. The owner is responsible for the maintenance of the passwords.

Group This field is only used in situations where multiple shared RACF databases are in use.

Share This field is used to list all the domains that share the SA z/OS password data set.

Mask The Mask field is used to describe the format to be used when generating passwords for gateway autotasks. This mask is used only for SAF-controlled NNT sessions and is applied when a new password is required. The password mask specified here may be overridden on an individual session basis by the INGPW command specification.

The password generation mask consists of 4 to 8 pairs of characters, each pair defining the attributes of a single password character. The first character of each pair determines how the second character is to be used.

- ! - A password character of the value indicated by the following mask character is required.
- % - A password character of the type indicated by the

Network Policy Object

- following mask character is required.
? - A password character of the type indicated by the following mask character is optional.

The password mask is processed left to right and will generate a string of characters having a length minimally equal to the number indicated as being required. SA z/OS requires passwords consisting of at least 4 characters. The password character type codes indicate the set of characters to be used when generating a new password. The valid type codes are as follows:

\$	- National only	(@,#,\$)
A	- Alphabetic only	(A-Z)
B	- Alphabetic/National	(A-Z,@,#,\$)
C	- Consonant (Alphabetic - No Vowels)	
E	- Even Numerics	(0,2,4,6,8)
N	- Numeric only	(0-9)
O	- Odd Numerics	(1,3,5,7,9)
V	- Vowels only	(A,E,I,O,U)
W	- Alphanumeric - No Vowels	
X	- Alphanumeric	(A-Z,0-9)
Y	- Alphanumeric/National	(A-Z,0-9,@,#,\$)
Z	- Alphanumeric/National - No Vowels	

The following mask specification would cause SA z/OS to generate SAF passwords beginning with 'NNT' followed by a national character, a consonant, and a two or three digit even number.

Password Mask ==> !N!N!T%\$%C?N%N%E

NNT Sessions Policy Object

Note:

Entry type NNT is no longer supported since SA z/OS Version 2.3. Use this function only to maintain systems with SA OS/390 releases up to 2.2 and for cleanup.

This policy object is used to define definitions for NetView to NetView sessions. Each *NNT Sessions* set can contain multiple defined NNT sessions. Figure 224 on page 287 shows the policy items that are displayed when a new *NNT Sessions* object is defined or when an existing *NNT Sessions* object is selected from the *Entry Name Selection* panel.

```

ACTIONS  HELP
-----
AOFGEPOL          Policy Selection
Command ==>>>                                SCROLL==>> HALF

Entry Type : NNT Sessions          PolicyDB Name : DATABASE_NAME
Entry Name : NNT_SESS_NAME        Enterprise Name : YOUR_ENTERPRISE

Action   Policy Name      Policy Description
        DESCRIPTION      Enter description
        SESSIONS         Define NNT sessions (NetView)
-----
        WHERE USED       List Systems linked to this entry
        COPY             Copy data from an existing entry

```

Figure 224. Policy Selection Panel for NNT Sessions

The unique policy item for NNT is:

SESSIONS

When you select this option, a panel similar to Figure 225 is displayed. You can list the user IDs you want to be used for NNT sessions. Each user ID must be valid on the domain to which the NNT session is being established. You can also enter a description for each ID.

```

COMMANDS  ACTIONS  HELP
-----
AOFGNNOF          NNT Sessions Definition
Command ==>>>                                Scroll ==>> PAGE

Entry Type : NNT Sessions          PolicyDB Name : DATABASE_NAME
Entry Name : NNT_SESS_NAME        Enterprise Name : YOUR_ENTERPRISE

Enter the Userid used to establish NNT sessions.

Action  Userid  Description
        XXAOC05  SHIFT LEADER
        XXAOC06  SENIOR OPERATOR
        XXAOC07  OTHER SENIOR OPERATOR
        XXAOC43  CONTRACT OPERATOR

```

Figure 225. NNT Sessions Definition Panel

To complete the definition for each user ID, enter an S (Select) in the Action column. A panel similar to Figure 226 is displayed.

```

COMMANDS  HELP
-----
AOFGNNDM          NNT Sessions Definition
Command ==>>>                                Scroll ==>> PAGE

Entry Type : NNT Sessions          PolicyDB Name : DATABASE_NAME
Entry Name : NNT_SESS_NAME        Enterprise Name : YOUR_ENTERPRISE

UserId : XXAOCXX

Enter the NetView domains used to establish NNT sessions.
Password: PROMPT or Password
Initialize: YES      =Initiated automatically
             NO      =Initiated thru operator interface

Domain  Password  Initialize  Description

```

Figure 226. NNT Sessions Definition Panel

The fields are:

NNT Sessions Policy Object

Domain

This field names the NetView domain to which a session is routed, that is, the NetView domain in which the NNT is activate.

Password

The password of the ID in the To-Userid field can be hardcoded here or the value PROMPT can be entered. If PROMPT is entered, the NetView to NetView session user is prompted for the password on an SA OS/390 logon panel.

Initialize

A YES in this field means that SA OS/390 attempts to establish the NetView to NetView session as soon as logging onto the current domain is complete. If NO is specified, the user has to initiate the NetView to NetView session from the operator interface.

Description

This description of the domain in the To-Domain field is displayed on the operator interface panel.

Resident CLISTs Policy Object

Note:

Since NetView 1.4, NetView automatically loads frequently used CLISTs into storage. You therefore no longer need to define your own resident CLISTs.

A resident CLIST is a CLIST that is loaded into and kept in NetView storage for the first and all subsequent calls.

Resident CLISTs can improve performance by removing the overhead required to access CLISTs stored on a direct access storage device (DASD) each time the CLIST is called. Resident CLISTs are automatically loaded into main storage, using the NetView LOADCL command, during initialization of the automation environment. Refer to *Tivoli NetView for z/OS Automated Operations Network User's Guide* for more information on using the LOADCL command for CLISTs.

If a new automation control file is loaded after SA z/OS is up and initialized, and that automation control file contains fewer automation procedures in the resident portion than the original automation control file loaded at initialization, then even if the procedures are not specified in the new file, they will not be dropped from storage. For example, if the original automation control file contained procedures A, B and C to be loaded resident, and the new automation control file contains procedures A, B, and D to be loaded resident, procedure D will be loaded but procedure C will not be dropped. Figure 227 on page 289 shows the policy items that are displayed when a new Resident CLIST entry is defined or when an existing Resident CLIST entry is selected from the *Entry Name Selection* panel.

ACTIONS		HELP

AOFGEPOL		Policy Selection
Command ==>		SCROLL==> PAGE
Entry Type :	Resident CLISTs	PolicyDB Name : DATABASE_NAME
Entry Name :	AOF_BASIC	Enterprise Name : YOUR_ENTERPRISE
Action	Policy Name	Policy Description
	DESCRIPTION	Enter description
	CLISTS	Define command lists to load to main storage

	WHERE USED	List Systems linked to this entry
	COPY	Copy data from an existing entry

Figure 227. Policy Selection Panel for Resident CLISTs

The unique policy item for Resident CLIST sets is:

CLISTS

This option allows you to enter the names of the CLISTs you want to be made resident during initialization of SA z/OS.

Status Details Policy Object

The status display facility (SDF) provides a display of automated systems and resources using assigned status colors. An operator monitors the status of automated systems and resources by viewing the SDF main panel. Typically, for example, an application shown in green on an SDF status panel indicates the application is up, while red indicates the application is stopped or in a problem state. Operators can use the SDF to monitor the system and decide which actions to take when problems occur. This section describes the entries used to define the SDF in the customization dialog. You only need to change these entries if you use values other than the SA z/OS-provided defaults. The entries specified here define statuses and the priorities assigned to those statuses. These entries are used by SA z/OS common routines to gather data for requests to add status descriptors to status components. Additional parameters manage existing status descriptors and eliminate redundancy.

Note:

Default SDF entries are provided in all sample policy databases and will default appropriately even if they are not included in an automation control file build.

Figure 228 on page 290 shows the policy items that are displayed when a new *Status Details* policy object is defined or when an existing *Status Details* object is selected from the *Entry Name Selection* panel.

Status Details Policy Object

```

ACTIONS  HELP
-----
AOFGEPOL                Policy Selection
Command ==>>>                SCROLL==>>> HALF

Entry Type : Status Details      PolicyDB Name : DATABASE_NAME
Entry Name : STATUS_DETAILS_NAME Enterprise Name : YOUR_ENTERPRISE

Action      Policy Name      Policy Description
           DESCRIPTION   Enter description
           SDF DETAILS   Enter status display facility details
-----
           WHERE USED    List Systems linked to this entry
           COPY          Copy data from an existing entry

```

Figure 228. Policy Selection Panel for Status Details

The unique policy item for *Status Details* is:

SDF DETAILS

You can use this policy item to define colors and highlights associated with each status.

Refer to “More about Policy Item SDF DETAILS” for more information about this policy item.

For more information on SDF customization, see *System Automation for z/OS User’s Guide*.

More about Policy Item SDF DETAILS

A panel like the following is displayed if you select the SDF DETAILS policy item from the *Policy Selection* panel for *Status Details*.

```

COMMANDS  HELP
-----
AOFGSCR                Status Display Facility Details      Row 1 to 13 of 64
Command ==>>>                SCROLL==>>> PAGE

Entry Type : Status Details      PolicyDB Name : DATABASE_NAME
Entry Name : STATUS_DEFINITIONS Enterprise Name : YOUR_ENTERPRISE

Status  Priority  Highlight  Color  Clear  Srv Req(noadd)
COMMLOST 110      REVERSE   RED    Y
RWTOR    110      REVERSE   RED    (Y,RV)  NOADD
BROKEN   120      REVERSE   RED    (Y,RV*)
BREAKING 130      BLINK     RED    (Y,RV*)
INACTIVE 140      UNDERSCORE RED    (Y,RV*)
EVENTP   150      NORMAL    PINK   (Y,RV*)
IWTOR    150      NORMAL    RED    Y
SPLFULL  150      NORMAL    RED    (Y,RV)
STOPPED  150      NORMAL    RED    (Y,RV*)
HALFDOWN 220     NORMAL    PINK   (Y,RV*)
STARTED2 230     BLINK     PINK   (Y,RV*)
STUCK    240     UNDERSCORE PINK   (Y,RV*)
EVENTY   250     NORMAL    YELLOW (Y,RV*)

```

Figure 229. Status Display Facility Details Panel

The fields are:

Status Any required name. The name must start with an alphabetic or numeric character or one of '@, #, or \$'. All other characters must be alphabetic, numeric, or one of '@, #, \$, ?, _ , !, or ¢. This value can be up to 8 characters long. It is recommended that you use the SA z/OS default statuses.

Priority

The priority number assigned to a particular status type. PRIORITY must be a valid number in the range specified in the AOFINIT member. Normally, priority determines the color displayed for a status. This is the recommended method. If the priority is not defined, the default is 99999999.

Highlight

The type of highlighting used for a particular status type. If this field is not specified, or HL=P is specified, highlighting is determined by the panel definition.

Color The color used for a particular status type. This is the color override entry. Use this parameter to override the priority and color relationship defined in the AOFINIT member. Although the color of the status descriptor is changed, the priority is still determined by the order in which the status descriptor is chained.

There is no default color associated with an SA z/OS status. Any color specifications defined using this parameter override the color defined for the range in which the priority falls.

Clear The CLEAR parameter helps manage redundant status descriptors. With SA z/OS, the reference value on a status descriptor is usually the status component name. This option is only available for statuses defined in the automation control file and accessed by SA z/OS common routines described in *System Automation for z/OS Programmer's Reference*. The following values are allowed:

- CLEAR=Y

Deletes any existing status descriptor for this status component with the same reference value as the status descriptor being added. This verifies that, for any given status component, there is only one status descriptor reflecting the true status.

- CLEAR=(Y,RV*)

Performs the same function as CLEAR=Y, and also deletes status descriptors with reference values prefixed with the same reference value (followed by anything else). For example, if the existing status descriptor for RMF has a reference value of RMF1, and the status descriptor being added has a reference value of RMF, the RMF1 status descriptor is deleted before the new RMF status descriptor is added.

- CLEAR=(Y,RV)

Performs the same function as CLEAR=(Y,RV*) but the reference value must be the same (not a wildcard).

- CLEAR=(Y,RV*,DA)

Performs the same function as CLEAR=(Y,RV*), and also deletes all status descriptors with similar data in the data field. (The data field is defined with the DATA keyword on the SDF request that adds the status descriptor to a chain of status descriptors.)

- CLEAR=(Y,RV2*,CO)

Performs the same function as CLEAR=(Y,RV*) with the following differences:

1. The color of the existing status descriptor must be the same as that specified in the color entry before it is deleted

Status Details Policy Object

2. Status descriptors having reference values prefixed with the new reference value followed by the number 2 are deleted, provided the color matches the status descriptor being added.
- CLEAR=N
Indicates that redundant status descriptors are not deleted.
- Srv** Determines the format of the reference value generated for this entry. If Y is specified for this entry, the generated reference value has the following format:
Status_component/Status
- Req (no add)**
Checks the SDF request. REQ=NOADD means the request is not added.

Notes:

1. Choosing reference values carefully simplifies how SDF handles adding and deleting status descriptors.
2. Always use the status component either as the reference value or as a prefix to a reference value.

Includes Policy Object

This policy object is available only for cleanup or for SA z/OS systems below version 2 and will no longer be supported. The BUILD function will still include this data set member in the automation control file, but SA z/OS ignores all user-defined members and issues an error message.

User E-T Pairs Policy Object

This policy object allows you to create your own entry-type pairs and associated keywords in the same format as those used by SA z/OS.

You can use *User E-T Pairs* to store data for your own automation procedures in the automation control file. *User E-T Pairs* are provided for situations in which there is no suitable, predefined SA z/OS policy object. Using the automation control file to store policy-specific information helps keep your automation procedures generic.

Figure 230 on page 293 shows the policy items that are displayed when a new *User E-T Pairs* policy object is defined or when an existing *User E-T Pairs* object is selected from the *Entry Name Selection* panel.

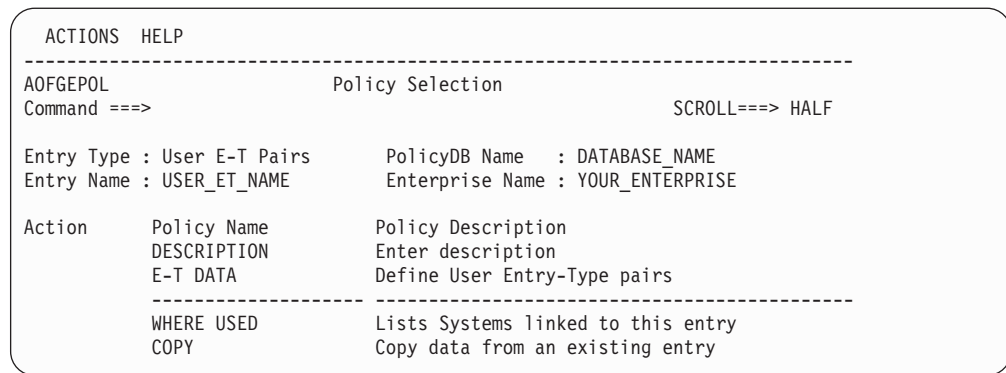

Figure 230. Policy Selection Panel for User E-T Pairs

The unique policy item for *User E-T Pairs* is:

E-T DATA

This policy item enables you to specify entry-type pairs for the set. You can also enter a description for each pair. Refer to “More about Policy Item E-T DATA” for more information on this policy item.

More about Policy Item E-T DATA

Figure 231 shows the *UET Entry-Type Selection* panel.

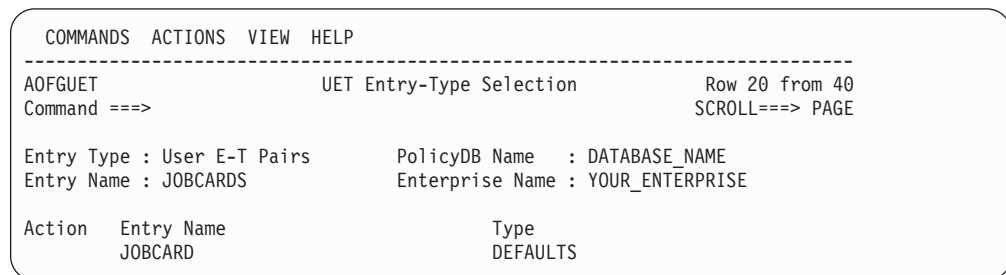

Figure 231. UET Entry-Type Selection Panel

The *Entry Name* and *Type* fields are used to define a unique set of key-data pairs. In general, the *Entry Name* field can contain any name except subsystem names existing in the policy database. The *Type* field can be used to identify groups of information for the entry name. You can define wild cards and types by appending the asterisk (*) character to the type value.

When you enter an E for Edit in the *Action* column, another panel, similar to Figure 232 on page 294, is displayed in which you can enter the keywords and user data for each Entry-Type pair.

A keyword is an identifier for the data that follows it. The set of keyword/data pairs may be null, and each keyword does not have to be unique; that is, each keyword may have multiple sets of data assigned to it.

The following rules apply for the user data:

- Data containing the special characters (') or imbedded spaces must be enclosed in delimiters. Valid delimiters are single quotation marks, double quotation marks, or parentheses.
- Any imbedded single quotation marks will be automatically doubled by the processing logic of the *UET Keyword-Data Specification* panel. For example, ABC'DEF'GHI will be changed to ABC"DEF"GHI

Chapter 6. Policy Database Maintenance

Option 4 (Policies) of the *Customization Dialog Primary Menu* panel allows you to maintain the list of your policy databases and to access various panels for selected policy databases.

Policy Database Selection List

If you have already created one or more policy databases, they are listed in the *Policy Data Base Selection* panel, as shown in Figure 233.

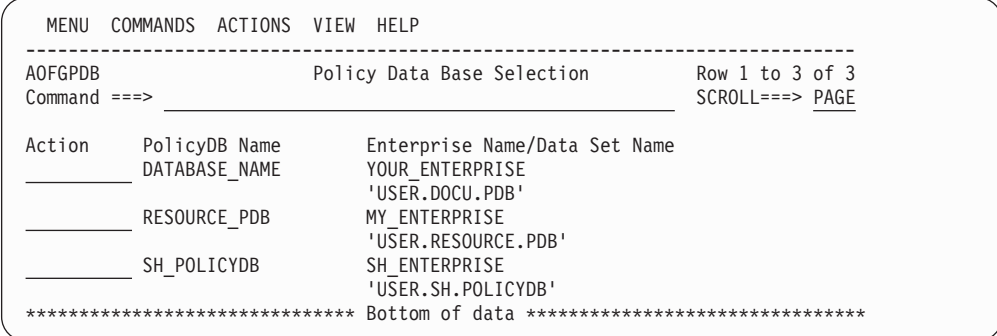

```
-----
MENU  COMMANDS  ACTIONS  VIEW  HELP
-----
A0FGPDB                                     Policy Data Base Selection          Row 1 to 3 of 3
Command ==>> _____                SCROLL==>> PAGE

Action   PolicyDB Name      Enterprise Name/Data Set Name
-----   DATABASE_NAME
_____  RESOURCE_PDB      MY_ENTERPRISE
_____  SH_POLICYDB        SH_ENTERPRISE
_____                                     'USER.SH.POLICYDB'
***** Bottom of data *****
```

Figure 233. Policy Data Base Selection Panel

Databases created with the NEW command automatically appear in your policy database list. In addition you can add other databases. To add a database, you need to know the name of its data set and have the appropriate authority to update it. You can work with one policy database from your list at a time.

To select a policy database:

1. Move the cursor to the line containing the database you want to use.
2. Type *s* in the *Action* column on that line.

The selected policy database is opened, and the *Entry Type Selection* panel for that database is displayed. At this point you are ready to start defining your enterprise.

The commands and actions available from the *Policy Data Base Selection* panel are:

(O) OPEN

This option lets you access the policy data for that database. The *Entry Type Selection* panel is displayed. With this option, you can edit the contents of policy database . See Figure 2 on page 7.

(N) NEW

This option lets you create a new policy database as described in “Creating a New Policy Database” on page 297. The *Create a New Policy Database* panel is displayed. See “Creating a New Policy Database” on page 297 for more details.

(E) EDIT

This option lets you change the Enterprise name and data set name of your policy database for the build, report, and log output. To change the data within the database, you must OPEN it. Using the EDIT option, you can

Policy Database Maintenance

also start and stop the logging of user activity. For more information, see “Specifying Settings for Policy Databases” on page 301.

(D) DELETE

This option lets you delete the policy database data set, and all references to the policy database. SA z/OS will display a panel asking you to confirm your request.

SA z/OS does not provide any extended security to prevent you from deleting policy database data sets. This must be provided by a System Authorization Facility (SAF) product such as RACF®.

Note:

SA z/OS does not allow you to delete more than one policy database at a time. If you enter multiple delete requests in the *Action* column, the first request is processed and the remainder are ignored.

(A) ADD

This option lets you add a policy database to the displayed list. You enter a policy database name, an enterprise name and the name of a policy database data set that already exists.

(M) REMOVE

This option lets you remove the policy database details from the displayed list. The data set itself is not affected.

Note:

If you remove a policy database from *all* display lists, the policy database still exists as an z/OS data set.

(B) BUILD

This option displays the *Build Functions Menu*. You can build various configuration files. This function is explained in Chapter 8, “Building and Distributing Control Files,” on page 313.

(G) MANAGE

This option will bring you to the *Data Management Select* panel shown in Figure 249 on page 327 which allows you to import policies or migrate an automation control file to a policy database of the current release of SA z/OS.

You can find more information about this option in Chapter 9, “Data Management,” on page 327.

(R) REPORT

This option displays the *Report Selection Menu* for the selected policy database. You can create a report of all automation data in the policy database. The report offers options to report either the full automation policy, or to select a specific entry type and name to be reported.

You can either create an unformatted file to be viewed in a TSO session, or an HTML file to be viewed by an Internet Browser.

The following reports can be created:

- A report for all objects in the policy database, that will not be used for building the system operations configuration files (unlinked entries and relationships).

- A report for all automatically generated resources, which are the resources of type APL, APG, and MTR.
- A report of all members in the system operations build output data set, that are not referenced by the actual configuration.
- A status message report.

For more information, see Chapter 7, “Creating Reports about Policy Databases,” on page 307.

(V) VIEW

This option toggles between two views. The summary view displays the policy database name and enterprise name for each policy database on one line. The extended view displays a second line for each policy database, giving the data set name.

(L) LOCATE

Entering LOCATE lets you position yourself within the displayed list. If the entry is identical, the selected entry is the first in the list. If the entry is not identical, then the next higher (alphabetically) entry is the second in the list. This is the same as the ISPF LOCATE function.

Creating a New Policy Database

A policy database is a partitioned data set (PDS) that contains policy data in its members. You create a new policy database from the *Policy Data Base Selection* panel by selecting 4 Policies from the *Customization Dialog Primary Menu* (this is the first panel you see when you start the SA z/OS customization dialog). Initially the *Policy Data Base Selection* panel shows no policy databases. Otherwise it shows all available policy databases. Figure 234 shows an example. You can see the name of the policy database together with its data set name on the *Policy Data Base Selection* panel if you select the “Name and data set name” option (option 2) from the VIEW pull-down. You can also choose to view just the policy database name by selecting option 1 from this pull-down.

```

MENU  COMMANDS  ACTIONS  VIEW  HELP
-----
AOFGPDB                Policy Data Base Selection          Row 1 to 3 of 3
Command ==>>          SCROLL==>> PAGE

Action  PolicyDB Name      Enterprise Name/Data Set Name
-----  DATABASE_NAME      -
        RESOURCE_PDB  MY_ENTERPRISE
        SH_POLICYDB   'USER.DOCU.PDB'
        'USER.RESOURCE.PDB'
        'USER.SH.POLICYDB'
***** Bottom of data *****

```

Figure 234. Policy Data Base Selection Panel

To create a new database, type N (New) on the command line. A panel similar to Figure 235 on page 298 is displayed.

Creating a New Policy Database

```

COMMANDS  HELP
-----
AOFGPDBN          Create a New Policy Database
Command ==> _____

To define a new policy database, specify the following information:
PolicyDB Name. . . . . _____
Enterprise Name. . . . . _____
Data Set Name. . . . . _____
More: +

Managed storage. . . . . NO          YES    NO
Management class . . . . . _____ Blank for default management class *
Storage class. . . . . _____ Blank for default storage class *
Volume serial. . . . . _____ Blank for authorized default volume
Data class . . . . . _____ Blank for default data class *
Space units. . . . . CYLINDERS     CYLS TRKS BLKS KB MB
Primary quantity . . . . . 1         1 to 999 - In above units
Secondary quantity . . . . . 1         0 to 999 - In above units
Directory blocks . . . . . 50        1 to 999 or blank - Required for PDS
Record format. . . . . FB
Record length. . . . . 80
Block size . . . . . 27920
Data Set Name type . . . . . PDS      LIBRARY PDS *
Device Type. . . . . SYSDA

* Used only if Managed storage = YES

Specify one of the existing policy databases to serve as the model
for the policy database that is being created:
Model PolicyDB name. . . *SYSPLEX _____ PolicyDB name or "?"
for list of names

```

Figure 235. Create a New Policy Database Panel

The fields for which you must enter data are listed below. For those fields that are not explicitly explained, refer to the appropriate z/OS literature.

PolicyDB Name

The name of this policy database, up to twenty characters in length.

Enterprise Name

The name of the enterprise for which this policy database is being defined, up to twenty characters in length.

Data Set Name

A valid z/OS data set name for the policy database. Standard rules for quoted and unquoted data set names apply. A quoted data set name is regarded as absolute. An unquoted data set name has your user ID prefixed automatically.

Managed Storage

This indicates whether the data set should be allocated on managed storage. If this field is set to YES, the fields marked with an * are used to allocate the data set. If NO is specified then these fields may be specified but are not used.

Management class

This specifies the management class that should be used to obtain the data management related information for the allocation of the data set.

Storage class

This specifies the storage class that should be used to obtain the storage related information for the allocation of the data set. The following data, related to storage class, can be specified if you are not using managed storage or you have not specified a storage class or if you wish to override the default storage class values.

Volume serial

The volume on which the database is to be stored. If this field is left blank, it defaults to your local system default.

Data class

This specifies the data class that should be used to obtain the data related information for the allocation of the data set. The following data, related to data class, can be specified if you are not using managed storage or you have not specified a data class or if you wish to override the default data class values:

Space Units

Valid allocation units for the data set are:

- CYLINDERS (this is the default)
- TRACKS
- BLOCKS
- MEGABYTES
- KILOBYTES

Primary quantity

This specifies the primary space allocation in space units. The default is 1.

Secondary quantity

This specifies the secondary space allocation in space units. The default is 1.

Directory blocks

Number of blocks to allocate for the directory. This field is only used when allocating a PDS. The default is 50.

Record format

This is FB and cannot be changed.

Record length

This is 80 and cannot be changed.

Block size

This defines the block size for the data set. It must be a multiple of 80.

Data Set Name type

This indicates whether the data set is to be allocated as a partitioned data set (PDS) or partitioned data set extended (LIBRARY).

Device Type

The type of storage device. This field defaults to SYSDA.

Note:

Many installations regularly delete data sets created on SYSDA volumes. If you want to create a permanent policy database you should not create it on a SYSDA volume. If the data set for a policy database is deleted, you will receive an error message when you attempt to open it. You can either recreate the data set if you have a backup, or enter M (REMOVE) against the policy database to remove it from your policy database list. Entering D (DELETE) will result in an error, since the data set has already been deleted.

Creating a New Policy Database

Model PolicyDB name

Enter the name of the policy database you want to use as a model for the new policy database. You can use one of the SA z/OS sample policy databases, or you can use a database you have already created. Enter “?” to see a list of the available databases. The *Select Model Policy Database* panel is displayed, from which you can select the database you want to use.

Note:

The DASD allocation figures shown in Figure 235 on page 298 are a suggested minimum only. Your storage requirements will depend on the size of your enterprise.

When you have finished entering the required data and have chosen a model database, enter the END command to create the new database. SA z/OS displays a *Command Progress Display* panel. When database creation is finished, the *Entry Type Selection* panel is displayed for the new database. See Figure 2 on page 7 for an example. If you want to leave the *Create a New Policy Database* panel without creating a new policy database, enter the CANCEL command.

Using Sample SA z/OS Policy Databases

SA z/OS provides sample enterprise organizations implemented as SA z/OS policy databases. Sample databases are installed when the SA z/OS customization dialog is installed. To use the samples, you must create a new policy database and select a sample database as a model.

The asterisk character (*) at the start of the database name indicates that this is a sample database.

The sample databases are:

*EMPTY

This sample is simply an empty database.

*MULTISYS - Multiple z/OS Images, Non Sysplex

This sample consists of several z/OS systems and standard applications containing basic definitions of the standard SA z/OS test configuration.

There is also a complete processor operations environment that includes a PSM processor and VM guest system, and a sample class definition of processor operations including IXC message automation.

In addition, it contains a sample class definition .

The following applications are included:

- APPC
- ASCH
- GMFHS
- JES2
- JES3
- LLA
- NetView
- RMF
- RODM

- TSO
- VLF
- VTAM

*SYSPLEX - Multiple z/OS Images, Sysplex

This sample consists of one sysplex with four systems and several standard applications with basic definitions.

In addition it contains the definitions of the following four products:

- CICS** Class/Instance definitions for several CICS versions/types.
- DB2** Class/Instance definitions for DB2 for all the different region types.
- IMS** Class/instance definitions for IMS version 6/7 for all the different region types.
- OPC** Class/Instance definitions for OPC 2.3 CONTROLLER/TRACKER/SERVER.

*SAP_HA

This sample consists of various definitions to enable SAP high availability. It has additional sample *Application* automation for:

- SAP Application Servers on several operating systems
- SAP Enqueue Replication Server
- SAP Enqueue Server
- SAP Gateway
- SAP Router
- HSM
- Internet Super Server (INETD, INETFILE, INETPORT)
- Network File System Server for TCP/IP (NFSS)
- USS applications
- VIPA

*WAS401_HA

This sample consists of various definitions to enable the SA z/OS high availability solution for WebSphere Application Server. It has additional sample *Application* automation for:

- RRS
- WebSphere 4.01 Application Server (Daemon, J2EE server, Interface repository, LDAP, MQ, Naming Server, SMS, Trace writer)
- TCP/IP
- IBM HTTP Server

Specifying Settings for Policy Databases

Specifying the Edit option from the *Policy Data Base Selection* panel for a policy database leads to the *Settings for Policy Data Base* panel, as shown in Figure 236 on page 302.

Specifying Settings for Policy Databases

```
COMMANDS  HELP
-----
AOFGPDBE          Settings for Policy Data Base DATABASE_NAME
Command ==> _____

Enterprise and data set names:
Enterprise Name . . . . MULTI-SYSTEMS
PolicyDB data set name. . 'MULTISYS.PDB'
Build output data set . . 'MULTISYS.SOCNTL'
Report output data set. . 'MULTISYS.PDB.REP'

PolicyDB activity log options:
Write log entries . . . . ON          (ON  OFF)
Log data set name 1 . . . 'MULTISYS.PDB.LOG1'
Log data set name 2 . . . 'MULTISYS.PDB.LOG2'

NetView Automation Table options:
AT scope. . . . . SYSTEM  (NONE ENTERPRISE SYSPLEX SYSTEM)
```

Figure 236. Settings for Policy Data Base Panel

The first set of fields on this panel allows you to specify enterprise and data set names, as follows:

Enterprise Name

This allows you to re-specify the enterprise name. If this policy database has also been added to the Policy Data Base Selection list of other users they need to REMOVE or ADD the policy database to get the new name.

PolicyDB data set name

This allows you to re-specify the enterprise data set name.

Build output data set

This allows you to specify where you want the configuration files that are created by the System Operations build to be stored.

Report output data set

This allows you to specify where you want the output, created by the REPORT function, to be stored. It is not recommended that you store the output as a member of the policy database itself due to record length problems.

If you leave the field empty, SA z/OS allocates a data set with a default name (the policy database data set name extended with .REP as the low level qualifier) and a default size.

If you do specify a data set name, SA z/OS allocates a data set with that name and a default size.

If you preallocate a data set and specify the name here, then SA z/OS uses that data set. It is recommended that you use format VB and a record length of 1000 to avoid truncations.

The second set of fields allows you to set logging options for this policy database. See “Logging Policy Database Modifications” on page 303 for more details.

The last field on this panel, *AT Scope*, allows you to define the scope of a NetView Automation Table. Valid definitions are:

NONE

No NetView automation table is built.

ENTERPRISE

One NetView automation table is built for the entire policy database.

SYSPLEX

One NetView automation table is built per Sysplex Group.

No NetView automation table is built for systems that are not linked to a sysplex group.

Note:

When the *AT Scope* is set to SYSPLEX, it is strongly recommended that you link all systems contained in the policy database to a group (GRP) of type 'SYSPLEX'.

If this is not done, no AT is built for systems that are not linked to groups at all, or that are linked to groups of type STANDARD. A corresponding warning is issued at configuration build time.

If an AT was not built for a system, the hard coded AT, named INGMMSG02, as it is delivered with SA z/OS 2.3, is loaded at automation run time.

SYSTEM

One NetView automation table is built per system (default). If the AT scope is changed to any value except NONE a build of type ALL will be performed.

Logging Policy Database Modifications

With SA z/OS you can write a log entry whenever a modification has been made for a specific Policy Database by using the policy database activity log option on the *Settings for Policy Data Base* panel (see Figure 236 on page 302). Fill in the following fields:

Write log entries

Turns logging ON or OFF for this Policy Database. The default value is OFF.

Log data set name

Allows the specification of two data sets for the activity log. Whenever a data set runs out of space, the dialog switches automatically to the other data set and continues writing the log records there.

If you leave this field blank, SA z/OS allocates data sets with a default name (the policy database data set name extended with .LOG1 or .LOG2 as low level qualifier) and a default size.

If you specify a data set name, SA z/OS allocates a data set with this name and a default size.

If you preallocate a data set and specify the name here, then SA z/OS uses this data set.

It is recommended that you use format VB and a record length of 250 to avoid truncations.

If the *Settings for Policy Data Base* panel is invoked and the specified policy database data set cannot be accessed, the log option fields are initially empty.

Whenever the policy database data set name is changed, the current log options are read from the policy database and displayed on the panel.

Specifying Settings for Policy Databases

The following information is logged:

- Editing a policy item (for example, changing an automation flag or a command)
- Changing a link, which includes
 - Entry type links, for example, a link between an application and an application group
 - Links of instances and classes
 - Resource links
- Adding events to a trigger
- Invoking the MIGRATE and MERGE commands (these commands change the policy database content)
- System operations BUILD, because it writes build statistics back into the policy database
- Creating and deleting objects
- Copying objects
- Errors (as long as a policy database is open)

The following information is *not* logged:

- Option changes (using selection *0 Settings*)
- Data set name changes (EDIT)
- REPORT function invocations
- VIEW functions (for example, view build report)
- Processor operations BUILD
- Initial conversion of policy database (when invoked the first time with SA z/OS)

A log entry includes the user ID, timestamp, and the policy item that was changed, or the command name and parameters if available. An example of an activity log is shown in Figure 237 on page 305.

```

2004/04/21 16:50:35 RTL : Log Data Set Created
2004/04/21 16:51:01 RTL : PDB activity logging turned on
2004/04/21 17:05:39 RTL : APL AUTOMATION_MANAGER EDIT
2004/04/21 17:05:50 RTL : modified policy LINK TO INSTANCES
2004/04/21 17:05:51 RTL : delinked from INSTANCE CICS_FOR_ENTRY
2004/04/22 08:40:45 RTL : APL AUTOMATION_MANAGER_1 EDIT
2004/04/22 08:41:17 RTL : modified policy DESCRIPTION
2004/04/22 08:41:36 RTL : modified policy AUTOMATION INFO
2004/04/22 08:41:45 RTL : modified policy LINK TO CLASS
2004/04/22 08:41:46 RTL : delinked from CLASS AUTOMATION_MANAGER
2004/04/22 08:41:52 RTL : modified policy LINK TO CLASS
2004/04/22 08:41:53 RTL : linked to CLASS AUTOMATION_MANAGER
2004/04/22 08:42:16 RTL : TMR ALL_TIMERS EDIT
2004/04/22 08:42:26 RTL : modified policy WHERE USED
2004/04/22 08:42:27 RTL : delinked from SYS AOCMIG1
2004/04/22 08:42:27 RTL : linked to SYS 99999
2004/04/22 08:42:51 RTL : modified policy TIMERS
2004/04/22 08:43:18 RTL : delinked from SYS AOCMIG1
2004/04/22 08:43:30 RTL : APG APG_AOCSYSM1 DELETE
2004/04/22 08:45:13 RTL : APG APG4ALLSYS NEW
2004/04/22 08:45:26 RTL : modified policy WHERE USED
2004/04/22 08:45:26 RTL : linked to GRP AOCPLEX
2004/04/22 08:45:48 RTL : modified policy APPLICATIONS
2004/04/22 08:45:48 RTL : linked to APL OPC_DATASERVER_ENTRY
2004/04/22 08:45:49 RTL : linked to APL OPCDUMY1
2004/04/22 08:45:50 RTL : linked to APL OPCDUMY2
2004/04/22 08:46:05 RTL : * * BUILD
2004/04/22 08:46:05 RTL : options: 1 REPORT.CFG ONLINE MODIFIED NORMAL
2004/04/22 08:47:18 RTL : terminated: return code 0

```

Figure 237. Example of an Activity Log

Chapter 7. Creating Reports about Policy Databases

If you select option 3 *Report* of the *Customization Dialog Primary Menu* shown in “How to Start the Customization Dialog” on page 12, the panel shown in Figure 238 is displayed, where you can create reports about various SA z/OS objects.

```

MENU  HELP
-----
A0FGREPK                               Report Selection Menu
Option ==>> _____

  1 Report                               Create Policy Data Base Report
  2 Unlinked                             Create List of entries not linked in Policy Data Base
  3 ViewUnlinked                         View List of unlinked entries

  4 Resources                             Create List of generated Resources
  5 ViewResources                       View List of generated Resources

  6 Unreferenced                         Create List of members not referenced by configuration
  7 ViewUnreferenced                   View List of unreferenced members

  8 StatusMsgs                           Create Status Messages Report
  9 ViewStatusMsgs                     View Status Messages Report
```

Figure 238. SA z/OS Report Selection Menu

You can select the following:

1 Report

With this option, you can create a report which includes all automation data of the selected policy database. SA z/OS displays the *Policy Data Base Report Parameters* panel, as shown in Figure 239 on page 308, where you can choose to create either the full automation policy report, or to create a report about a specific entry type and name.

Note:

Entry type ICL is not available in the *Entry Type* field and this entry type is not included in the policy database reports that are produced.

As the report generation can take a long time, you can also run this function in batch mode. The output may be extensive, therefore a separate data set is recommended.

You can also specify the format of the report. FLAT creates an unformatted file to be viewed in a TSO session. The name of this file is \$RPTFLAT. HTML creates an HTML file you can view with your internet browser. The name of this file is \$RPTHTML. The default value for the output format is FLAT.

Note:

Microsoft® Internet Explorer can only handle files with extension .HTML

Creating Reports about Policy Databases

The *Command Progress Display* panel informs you about the progress of the report generation.

```
OPTIONS  HELP
-----
AOFGRPTP          Policy Data Base Report Parameters
Option ==> _____ 0

  1 Create report for a complete enterprise
  2 Create report for entry type or entry name
    Entry Type. . . . . _____ (*, ?, or type)
    Entry Name. . . . . * _____ (*, ?, or name)

Report options:
  Output Data Set . . . . _____
  Mode . . . . . ONLINE (ONLINE BATCH)
  Format . . . . . FLAT (FLAT HTML)

Job statement information: (used for BATCH report)
//AOFRPT JOB _____
//* _____
//* _____
```

Figure 239. Policy Data Base Report Parameters Panel

The example in Figure 240 on page 309 shows a small part of the data listed in the report output format FLAT for the application JES2.

```

:
:
=====
JES2
=====
Short description      : JES2 policy definition
Long description      : Defines automation and monitoring characteristics
                       :                       for the JES2 job.
Application Type      : JES2
Subsystem Name        : JES2
MVS job name          : JES2
Scheduling subsystem  : MSTR
Command Prefix        : $
Start on IPL          : YES
Subsystem Startup Parameters : ,PARM=WARM,REL=710,SYS=&SYSNAME.

===== JES2 Drain Specifications =====
Drain lines           : YES
Drain VTAM interface  : YES
Drain printers        : YES
Force drain lines     : $E
Force drain VTAM interface : $E
Force drain printers  : $I

===== Application Messages and User Data =====
| Message id | Description |
-----|-----|
| $HASP095   |             | | |
|---|---|---|---|
| Code 1 | Code 2 | Code 3 | Value Returned |
-----|-----|
| *      | $PJ*   |        | STOPPING        |
| ERROR* | $K03   |        | STOPPING        |
| ABEND* | SA22   |        | STOPPING        |
| *      | *      |        | ABENDING        |
-----|-----|
| $HASP098   |             |
-----|-----|
| Pass/Selection | Reply Text |
-----|-----|
| 1              | DUMP       |
| 2              | END        |
-----|-----|
| POSTSTART     | Executed after startup has been initiated | |
|---|---|---|
| Pass | Automated Function | Command Text |
-----|-----|
|      | JESOPER           | MVS F BPXOINIT,RESTART=FORKS |
-----|-----|

===== Relationships =====
| Relationship Type | Supporting Resource | Automation | Chaining | Satisfy condition |
-----|-----|-----|-----|-----|
| PREPUNAVAILABLE | VTAM/APL/=         | PASSIVE   | WEAK     | WhenDown          |
:
:

```

Figure 240. Example of Report Output Format FLAT

2 Unlinked

This option lets you create a report of all entries within the current policy database that would be ignored during BUILD processing. This includes:

- all objects in the policy database that are not linked to a system or sysplex
- all non-MVS systems

Creating Reports about Policy Databases

- all relationships that are not used during a build

It does not include the entry type *Processor* (PRO).

3 ViewUnlinked

With this option, you can look at the report of all unreferenced objects created by option 2 *Unlinked*.

4 Resources

With this option, you can create a list of all generated resources. In the *Command Progress Display* you will see in which member of the current policy database data set the generated list has been stored.

5 ViewResources

With this option, you can view a list generated with option 4 *Resources* for each existing system.

```
File Edit Confirm Menu Utilities Compilers Test Help
ssssssssssssssssssssssssssssssssssssssssssssssssssssssssssssssssssssssssssssssssssssssssssss
VIEW      HART.SCENARIO($RPTRES) - 01.00          Columns 00001 00072
Command ==>                                     Scroll ==> PAGE
***** ***** Top of Data *****
000001
000002 Application resources for system: SYSTEM1
000003
000004 DB2IRLM/APL/SYSTEM1          DB2IRLM          APL
000005 DB2MAIN/APL/SYSTEM1         DB2MAIN          APL
000006 DWH/APL/SYSTEM1              DWH              APL
000007 TCP/IP/APL/SYSTEM1          TCP/IP           APL
000008 VTAM/APL/SYSTEM1            VTAM             APL
000009
000010 Application resources for system: SYSTEM2
000011
000012 CICS/AOR1/APL/SYSTEM2          CICS/AOR1        APL
000013 CICS/FOR/APL/SYSTEM2          CICS/FOR         APL
000014 CICS/MAIN/APL/SYSTEM2        CICS/MAIN        APL
000015 CICS/STOR/APL/SYSTEM2         CICS/STOR        APL
000016 DWH/APL/SYSTEM2              DWH              APL
000017
000018 ApplicationGroup resources for system: SYSTEM1
000019
000021 DB2/APG/SYSTEM1                DB2              APG
000022 NET/APG/SYSTEM1                NET              APG
000023 WBSRVAPG/APG/SYSTEM1          WBSRVAPG        APG
000024
000025 ApplicationGroup resources for system: SYSTEM2
000026
000027 NET/APG/SYSTEM2                NET              APG
000028
000029 Sysplex ApplicationGroup resources
000030
000031 CICS/APG                        CICS             SYSPLEX1
000032 CICS_APG/APG                    CICS_APG         SYSPLEX1
000033 CICS_APG2/APG                    CICS_APG2        SYSPLEX1
000034 CICS_APG3/APG                    CICS_APG3        SYSPLEX1
000035 CICS_APG4/APG                    CICS_APG4        SYSPLEX1
000036 DWHAPG/APG                      DWHAPG           SYSPLEX1
```

Figure 241. List of Generated Resources

6 Unreferenced

This option creates a report of all members in the system operations build output data set, that are not referenced by the actual configuration anchored in the ACF map member AOFACFMP. It helps to identify members that can be deleted when you perform a data set cleanup. The report is divided in two sections:

1. The first section lists all unreferenced members that have been identified as valid configuration files, together with some additional information such as entry name, or build time.
2. The second section lists all other unreferenced members, where either no build statistics could be found, or which have not been identified as valid configuration files.

Report members created by the Customization Dialog itself such as build report member \$BLDRPT are not included in the report. To run this report, a successful build is required. Otherwise the control file fragments may be damaged and incomplete, and the content of the report is unpredictable.

7 ViewUnreferenced

With this option you can read the report of all unreferenced members created by option 6.

```

***** Top of Data *****
Unreferenced Member Report for Sys-Ops Build Output Data Set

PolicyDB Name       : SA22_SYSTEMTEST
PolicyDB Data Set   : 'MULTISYS.PDB'
Build Output Data Set : 'MULTISYS.SOCNTL'
UserId              : OPER
Creation Date       : 04/04/11
Creation Time       : 14:26:41

Members with build statistics

Member   Entry Name      Build Date/Time  UserId
        YY/MM/DD  HH:MM
Z98YAAPL CLASS_CICS_TS      04/03/26  09:09  HUT
Z981AAPL FTPOE         04/03/28  10:58  HUT
Z986AAPL SYS_DB2DIST  04/03/26  09:09  HUT
Z987AAPL SYS_DB2SPAS  04/03/26  09:09  HUT
Z988AAPL ZFS         04/03/27  13:11  FREI
Z99AAAPL USS_PORT     04/03/26  09:09  HUT
Z99BAAPL USS_FILE     04/03/26  09:09  HUT
Z99CAAPL USS_APPLICATION 04/03/26  09:09  HUT
Z99DAAPL CLASS_SYS_DB2_CHILDS 04/03/26  09:09  HUT
Z99HAAPL SYS_MQ       04/03/26  09:09  HUT
Z99IAAPL SYS_DB2MSTR  04/03/26  09:09  HUT
Z99JAAPL SYS_DB2IRLM  04/03/26  09:09  HUT
Z99KAAPL SYS_DB2DBM1  04/03/26  09:09  HUT
Z99XAAPL OAM         04/03/27  13:10  FREI
Z99ZAAPG APG_KEY4    04/03/27  12:49  FREI
Z991AAPL NFS         04/03/27  13:10  FREI
    
```

Figure 242. Unreferenced Member Report

8 StatusMsgs

Select this option to create a *Status Messages Report*. This includes Status Messages that are predefined by SA z/OS as well as user-defined Status Messages. The report shows the message ID, message description, and resource status indicated by this message and, if it is defined in the policy database, the entry name and the entry type that the message has been defined for. An example of the start of the Status Messages Report is shown in Figure 244 on page 313.

Note:

The existing Policy Data Base Report remains unchanged.

Creating Reports about Policy Databases

Selecting option 8 produces the response as shown in Figure 243.

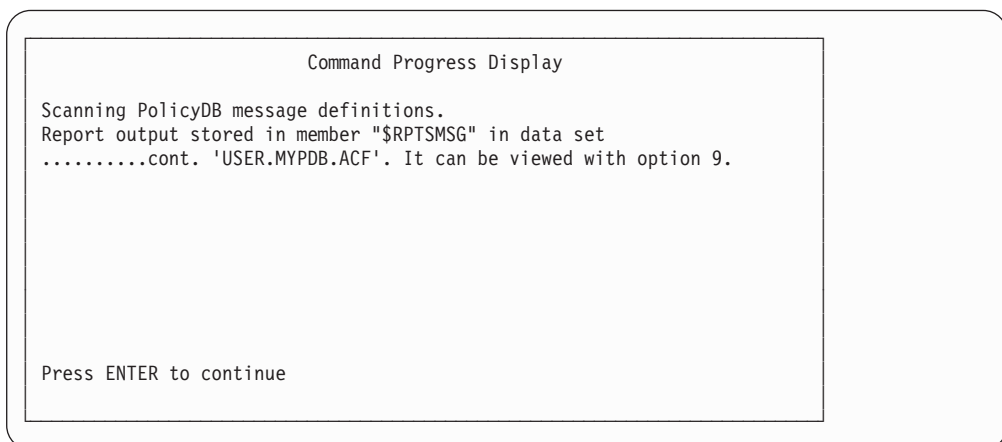

Figure 243. Command Progress Display for the Status Messages Report

Pressing Enter returns you to the *Report Selection* panel from where you can view the report by selecting option 9.

9 ViewStatusMsgs

Select this option to view the Status Message Report that was created by using option 8. If no report has been created, a message will inform you of this. An example of the start of the Status Messages Report is shown in Figure 244 on page 313.

In the report, user-defined messages are listed with their associated entry name and entry type, whereas those messages listed without these columns are predefined SA z/OS messages.

```

/*****/
/*                                          */
/* Function : Status Messages Report      */
/*                                          */
/* PolicyDB                               */
/* Name      : USER                      */
/* Data set: 'USER.MYPDB.PDB'           */
/* Output   : 'USER.MYPDB.ACF'         */
/*                                          */
/* User      : USER                      */
/* Date/Time : 2004/04/24 at 12:09     */
/*                                          */
/*****/

```

Message id/Description	Entry Name	Typ	Status
EMM2CLZ	EMMCLA	APL	UP
AAA006I	EMM1	APL	UP
XYZ444I	EMM1	APL	UP
ATB010I			TERMINATING
BBMZA001I			UP
BBMZA999I			TERMINATED
BBOU0001I			ACTIVE
BBOU0002I	J2EE Control Region active		TERMINATED
BBOU0003E	WAS Control Regions ended normally		BREAKING
BBOU0008I	WAS Control Regions ended abnormally		TERMINATING
BBOU0009E	WAS DAEMON ended normally		ABENDING
BBOU0016I	WAS DAEMON ended abnormally		UP
BBOU0020I	DAEMON up		UP
BBOU0021I	SMS, Naming, IR, J2EE Control Region up		UP
....			
....			

Figure 244. Example Status Messages Report (Excerpt)

Chapter 8. Building and Distributing Control Files

How to Define Data Sets for Build Processing	314	BUILD Error Messages	322
How to Build the Configuration Files	314	Distributing the System Operations	
Building the Processor Control File	315	Configuration Files	324
Usage Notes	316	Generating a Job for Batch Build	326
Building the System Operations Configuration Files	317		
System Operations Configuration Files Build			
Options	318		

Note:

Throughout this book the term *automation control file* is used to refer to the master include file and all the members that it includes.

Building and Distributing Control Files

After you have completed the SA z/OS customization process, the following data and control files can be built:

- Processor operations control file (needed for processor operations functions)
- System Operations configuration files (ACF, AMC, AT, and MPFLSTSA files), which are needed for automation
- NetView operator definitions

Note:

You must use the customization dialog to create the system operations configuration files. Do not edit any of the system operations configuration files manually.

How to Define Data Sets for Build Processing

To use the batch options of the build facility for automation control files, you must first specify the names of the data sets required for the batch processing. These names form the DD name concatenations to be included in the JCL of the batch processing job.

The data set names are saved in an ISPF table in the partitioned data set referenced by the AOFTABL DD name, for example, ING.CUSTOM.AOFTABL (allocated during installation of SA z/OS).

On the *Customization Dialog Primary Menu* panel of the customization dialog, select the *Settings* option. This brings up the *Customization Dialog Settings Menu* (see Figure 266 on page 370).

On this panel, choose option 11, *DSNAMES*. The *Data Set Customization Details* panel is displayed (see Figure 270 on page 375).

For more information, refer to “Defining Data Sets for Batch Processing” on page 375.

How to Build the Configuration Files

Exiting the customization dialog does not automatically build these files. You build them by selecting the BUILD (B) function either on the OPTIONS pull-down menu of the *Entry Type Selection* panel, or on the COMMANDS pull-down menu of the *Policy Data Base Selection* panel. The following panel is displayed:

```
      MENU  HELP
-----
AOFGBLDK          Build Functions Menu
Option ==> _____

  1 ALL           Build all files
  2 Proc-Ops     Build Processor Operations Control File
  3 Sys-Ops     Build System Operations Configuration Files
```

Figure 245. Build Functions Menu Panel

The *Build Functions Menu* offers the following functions to create control files:

1. Build all files

Causes all files required by SA z/OS system operations and processor operations to perform all automation to be built. These files are:

- the processor control file
- the system operations Automation Control Files (ACF)
- the system operations Automation Manager Configuration File
- the NetView automation table (AT)
- the MPFLSTSA member

Selecting option 1 is equivalent to selecting options 2 and 3 sequentially.

2. Build the Processor Operations Control File

Causes the information required by processor operations to be generated in a processor operations control file. Also provides an option to specify the name of the message log for the processor operations control file generation process. The processor operations control file should be rebuilt after any changes to the definitions of enterprise, groups, subgroups, systems, processors, communications paths, or communications tasks. The processor operations control file should be built prior to building the system operations configuration files because the name of the processor operations file to be used for automation is placed in the ACF.

3. Build the System Operations Configuration Files

Causes enterprise automation data for SA z/OS system operations to be built. This data consists of:

- the automation control file (ACF), which is built into a set of file fragments and a master include file
- the automation manager configuration file (AMC file)
- the NetView automation table (AT)
- the MPFLSTSA member

Building the Processor Control File

To create the processor control file, you can use option 2 on the *Build Functions Menu*.

When you request a build of the processor control file, it is built from information on the enterprise, groups, subgroups, systems, and processors, already entered in the policy database. This means that any time you change definitions of any of these, the processor control file needs to be rebuilt.

Use the panel shown in Figure 246 to identify the fully qualified names of both the SA z/OS processor control file and the control file message log.

```

COMMANDS  HELP
-----
ISQDPG01      Processor Operations Control File Build
Option ==>>> _____

1 Build Processor Control File

   Control file data set . . . . MULTISYS.POCNTL
   Control file log data set . . MULTISYS.POLOG

2 Build NetView Operator Definitions

   Data set name. . . . . MULTISYS.CNTL.NVOPS

3 Browse Control file log
    
```

Figure 246. Processor Operations Control File Build Panel

Building the Processor Control File

For SA z/OS processor operations, the processor control file, and control file log must reside in a sequential data set.

This panel has the following sections:

1 Build Processor Control File

Builds the ProcOps Control File and writes all build messages in a separate log file. The following needs to be specified:

Control file

Identifies the data set containing the ProcOps Control File

Control file log

Identifies the data set containing information about a successful build or errors in the configuration definition.

2 Build NetView Operator Definitions

Builds a sample NetView Operator Definitions file. The number of target control tasks and message monitor tasks is calculated as the number of current processors that are defined with a connection protocol other than INTERNAL.

The file can be used to update the AOFOPFPO sample that is included in the NetView DSIOPF member.

Data set name

Identifies the data set containing the NetView Operator Definitions sample file.

3 Browse Control file log

Allows you to view the ProcOps control file log containing all messages sent from the control file generation process. The log is accessed in browse mode.

Note:

For the resulting NetView operator definition file, each message monitor task and target control task is a NetView autotask. These autotasks must be defined to the NetView program to enable SA z/OS processor operations.

To retain any operator and autotask definitions that you already use, make sure you generate the SA z/OS definitions into a new data set or member. The generate function erases any statements in the chosen data set. Integrate the contents of the new NetView operator definition file into the DSIOPF member of the NetView DSIPARM data set. The statements can be anywhere in the NetView DSIOPF member.

The customization dialog generates automation operator definitions with an operator profile of ISQPROF. ISQPROF is provided in the SINGNPRF data set and should be added as a member of a data set in the DSIPRF path. If your data center has changed the ISQPROF profile name, you must change the profile name in each of the automation operator definition statements.

Usage Notes

The SA z/OS processor control file contains information specific to your SA z/OS configuration and is used to start SA z/OS processor operations. Before you generate the processor control file, you must allocate and catalog the data sets for it and its log. The INGEDLGA job does this for you early in the installation

process. If you decide to use more than one control file before you generate each processor control file, you must allocate and catalog the data sets for them and their logs.

If the control file you specified already contains data, a confirmation panel is displayed to allow you to confirm whether you want the existing control file to be overwritten.

If the data set name of either the control file or control file log has been changed (using PF3), the values are stored into the enterprise policy database. To avoid this, exit the panel with CANCEL.

The processor operations control file should be built prior to building the automation control file because the name of the processor control file to be used for automation is placed in the ACF.

The enterprise member of the automation control file should be rebuilt after any change to the name of the processor control file. This name is used in the automated startup of the processor operations application.

After you have used the generation function, check the *Control File Log* panel by selecting the *Browse Control file log* option on the *Processor Operations Control File Build* panel. This is option 3 in Figure 246 on page 315. To determine the correct response for any processor control file log messages, see *System Automation for z/OS Messages and Codes*.

Once you complete the actions recommended for all of the messages, generate the processor control file again.

The control file log receives messages from the control file generation process. These messages indicate why an attempt to generate a control file produced an incomplete control file or was unsuccessful. When a control file is generated successfully, a message to that effect is displayed, and no messages are written in the control file log.

To successfully generate an SA z/OS control file, you must have completed the required fields in all the configuration panels. If you try to generate a processor operations control file for incomplete definitions, a message is displayed that the control file is incomplete or was not generated. When this occurs, examine the control file log to determine what needs to be corrected.

Building the System Operations Configuration Files

To build a new enterprise automation configuration, that is, a set of new system operations configuration files (automation control file, automation manager configuration file, NetView automation table, and MPFLSTSA member), you have the following options to invoke the BUILD process:

- On the *Policy Data Base Selection* panel, type the command *B* into the *Action* column of the policy database for which you want to invoke the BUILD process. This will bring you to the *Build Functions Menu* (see Figure 245 on page 314).
- Use option 3 on the *Build Functions Menu* (Figure 245 on page 314). This will bring you to the *Build Parameters* panel shown in Figure 247 on page 319.
- From the *Entry Type Selection* panel, you can invoke the build functions either by choosing the BUILD (B) command from the command pull-down. This will bring you to the *Build Functions Menu*. Or, if you want to process a certain entry

Building the System Operations Configuration Files

type, you enter the BUILD (F) command on the command line and specify the identifier for the entry type that you want to build. For example, enter: BUILD SYS to build all defined system objects. You are presented with the *Build Parameters* panel (see Figure 247 on page 319 with the entry fields filled in according to your previous selection. The build function builds all systems irrespective of whether they have been modified or not.

- From the *Entry Name Selection* panel, you can enter the BUILD (or F) command in the action column against the object you want to build. For example, to build the JES2 Subsystem enter F against JES2 in the *Entry Name Selection* panel for *Application* policy objects.

Optionally, you can enter the command on the command line, for example:

```
F JES2
```

You get the *Build Parameters* panel (see Figure 247 on page 319) with entry fields filled in according to your previous selection.

A *Command Progress Display* panel shows the progress of the build. If errors are encountered during the build process, the Command Progress Display will display a message. The automation configuration files are placed in the data sets that you defined in the *Output Data Set* field.

Every new build generates the automation configuration map AOFACFMP which contains

- for each system one ACF $xnnn$ system include member which is used by the automation agents
- for each sysplex one HSA $xnnn$ sysplex include member, which describes the automation manager configuration

The ACF, AMC, AT, and MPF build will always be invoked together. This is due to the fact that the configuration data always needs to be synchronized so that the automation agents and the automation manager operate on the same data.

Each automation control file fragment contains information about a specific resource defined through the dialogs. Each z/OS system in the enterprise has its own master include file. The master include file references the automation members that are appropriate for that system. The name of the master include file for each system is created by SA z/OS. It starts with prefix ACF followed by four alphanumeric characters.

System Operations Configuration Files Build Options

The *Build Parameters* panel allows you to specify the information required to build the system operations configuration files that are required for automation. You can build these system operations configuration files for standalone systems, individual sysplexes or your complete enterprise, using the options shown in Figure 247 on page 319.

```

MENU  OPTIONS  HELP
-----
AOFGBLDP                               Build Parameters
Option ==>>> _____

  1 Build a complete enterprise
  2 Build sysplex group or stand alone system
     Sysplex / System name . . . . _____ (*, ?, or name)
  3 Build entry type or entry name
     Entry Type. . . . . _____ (*, ?, or type)
     Entry Name. . . . . _____ (*, ?, or name)
  4 View build report

Build options:
Output Data Set . . . . MULTISYS.SOCNTL _____
Mode . . . . . ONLINE (ONLINE BATCH)
Type . . . . . MODIFIED (MODIFIED ALL)
Configuration . . . . . NORMAL (NORMAL ALTERNATE)

Job statement information: (used for BATCH build)
//AOFRPT JOB _____
//* _____

```

Figure 247. Build Parameters Panel

These options are:

- 1 Builds all System Operations automation configuration files for a complete enterprise.

Note:

This option must be successfully completed at least once before you can use options 2 or 3.

- 2 Allows the selection of a single sysplex group or a standalone system.

This build option performs a complete build of all objects linked to the selected sysplex or standalone system. For a big policy database, this options helps to reduce build time for small changes, while creating a complete set of configuration files that are ready for automation.

- 3 Allows you to specify an entry type and name to be rebuild. Only the ACF fragments for that entry will be updated.

If for example, a timer object is modified and linked to another system, a build of this object with option 3 would only build that fragment and update the timestamp in the system include member, but not build the link changes for the system.

The same is true if an object is renamed. A build with option 3 of the new name would not add this new object to the system include member. Instead a build with option 2 is required.

For entry type *System*, this has the consequence that a selective build is rejected if there is also a link change pending.

However, if this option is used with entries of type *Events*, *Triggers*, *Service Periods*, *Application*, *ApplicationGroup*, *System*, or *Group*, a check is made as to whether data that affect the automation manager has been changed. In this case, building only the ACF fragment for the requested entry would mean that your previously generated AMC files would no longer be compatible with your current ACF files. To avoid this, a complete build (using build type MOD) will

Building the System Operations Configuration Files

automatically be invoked. Before the build actually starts a confirmation panel is displayed explaining this situation, and allowing you to defer the build.

You will see the same behavior with automation tables if this option is used with entries of type APL or MVC. A check is made as to whether data has been changed that affect the NetView automation table. If so, a confirmation panel is displayed allowing you to defer or to start a complete build (using build option MOD).

If you enter a '?' into this field, SA z/OS will display a list of either entry types and/or a list of available entry names for the selected entry type.

- 4 Allows you to view the build report available on the build output data set. It invokes the ISPF VIEW function. If there is no build report, an empty screen is displayed.

Notes:

1. If a policy database is new, or the build output data set is empty, a full build is required to produce a complete set of system operations configuration files. This means a build with option 1 and Type = ALL needs to be issued. For all subsequent builds, option 2 or 3 and Type = MODIFIED can be used.
2. While build option 2 only updates a single system or sysplex, deleted standalone systems and sysplexes still remain in the configuration files. For example, a deleted sysplex or standalone system is not removed from the ACF map AOFACFMP. So, you may consider issuing a build with option 1 whenever a large number of parts has been deleted, to clean up unnecessary entries from the configuration files.
3. No fragments are built for processors of type PSM.

You can enter values for the following fields:

Output Data Set

Use this field to specify where you want to store the build output. The data set must be an existing partitioned data set.

If the data set is not empty, but already contains a control file, the policy database name and the configuration name within the data set are compared with those of the requested build. If they do not match, a message is issued and the build is not started.

Mode Use this field to specify how to process the BUILD request:

ONLINE

Indicates that the BUILD should run in the foreground.

BATCH

Indicates that the BUILD should run in the background.

The default value is ONLINE (if this field is set to blank).

Type Use this field to specify which entries are to be processed.

MODIFIED

Indicates that only those entries that have been changed since the last BUILD request should be processed.

With this option, the build distinguishes between:

- data changes in the ACF

Building the System Operations Configuration Files

- link changes in the ACF
- data changes in the AMC file
- link changes in the AMC file

Depending on the type of change, the affected objects are identified, and only the necessary parts of the configuration file are rebuilt.

For example:

- If a new *timer* is linked to one system, only the system include member for that system is rebuilt. For all other system include members only the header timestamps are updated, and the build of the AMC file, AT, and MPFLSTSA member is skipped, because timer data does not go to the automation manager configuration file, AT, or MPFLSTSA member.
- If a new *application* is linked to a Sysplex Application Group, the build determines which systems are linked to that sysplex, and the include members for those systems are rebuilt automatically, together with the AMC, AT, and MPFLSTSA member for that sysplex.
- If the AT Scope is changed, only the AT and MPFLSTSA member are built.

ALL Indicates that all entries are to be processed unconditionally, even if there has been no change to those entries since the last BUILD request.

If a build type "ALL" is selected together with build option 2, only the configuration files belonging to the selected sysplex or standalone system are rebuilt.

The default value is MODIFIED (if this field is set to blank).

The very first build after installing a new release must be a build of type ALL in order to get a complete set of configuration files for the automation manager and automation agent structure.

Configuration

This field allows you to select between alternative configurations.

NORMAL

indicates that only those entries linked to the systems of the NORMAL configuration are processed by the current build.

ALTERNATE

indicates that only those entries linked to the systems of the ALTERNATE configuration are processed by the current build. These systems must have been marked with a "+" in their MVS system name.

NORMAL and ALTERNATE configurations must be build into different data sets. The default value is NORMAL (if this field is set to blanks).

If you specified that the BUILD request should run in BATCH mode, then you need to provide a valid JOB statement for the batch job.

The information that you specify here is saved in your ISPF profile data set and is used as the initial values the next time you issue the BUILD command.

BUILD Error Messages

The messages in the popup panel showing the command progress indicate error and warning situations. In most cases, it should not be necessary to check the build output member for unusual entries or error indications. Furthermore, the message log can be viewed from the panel where the build has been issued.

There are build errors that may stop the build, for example, resources in a loop, and other messages that are tolerated, for example, duplicate application subsystem names linked to the same system. Terminating build errors are shown with the label *ERROR* in the message prefix section, while tolerated errors are shown with the label *WARNING* in the message prefix section.

When an error is shown, no usable set of configuration files has been created. It is necessary to correct the cause of the problem and run the build again.

When a warning is shown, the configuration files can be used for automation. However it is recommended that you fix the problem and run the build again.

A possible cause for a warning during ACF fragment build may be that there are policy database objects with missing or conflicting definitions, that are not critical for automation, for example, an application default entry (type ADF) without any definitions. In this case, the build function continues, but issues a warning message. This message is displayed whenever a full enterprise build is issued, and does not require that the application be linked to a system.

There is a summary message at the end of the AT build report, and specific messages that show, for example, the object name somewhere within the build progress messages. The specific message reads:

```
.....WARNING. System MIGR_TEST includes the following entries with
.....cont. an unsatisfactory build status in main member ACFZ995:
..... -- SYSTEM_DEFAULTS (NUL)
```

The summary message at the bottom of the build message log reads:

```
.....WARNING. Missing or conflicting definitions found for entry
.....cont. types: SDF. The entry names are listed in the build
.....cont. report.
```

Possible causes for a warning during system main include member build are:

- Classes with duplicate subsystem names linked to the same system. In this situation, the first subsystem is used, and all following subsystems with the same name are skipped. So these subsystems are not known to the automation agent, and may remain as initialized objects in the automation manager.
- Applications with duplicate MVS jobnames linked to the same system. The processing is the same as for duplicate subsystems.
- If missing or conflicting definitions are detected, which are not critical for automation, a warning message is shown and the entry name is listed together with the status *NUL*. There are only a few situations where this can occur, for example, an application default entry (type ADF) without any definitions.
- If an object is linked and has been previously built, however it does not exist in the build output data set, then a warning message is shown and the entry name is listed together with the status *DEL*. The build function continues, but the object is not included in the system operations control files.

Note that such a warning message may cause a rebuild of the objects in error and the linked systems and sysplexes. So, a build of type MOD may rebuild more

systems and sysplexes than you would expect due to the actual changes. Possible causes for a warning during automation manager configuration file build are:

- The AMC logic member could not be found. The build function searches in the sample PDB data set for the current logic member. If this data set is not allocated, or contains no logic member, it could be added to the Configuration Files by the user.
- A trigger is linked to the current sysplex, but no conditions have been specified. The trigger will not be added to the automation manager configuration file.
- One or more application groups are linked to the current sysplex without an automation name being specified. The build function continues, but no resources will be created for this application group(s).
- One or more supporting application resources are not linked to the system. The relationships are not added to the automation manager configuration file.

Possible causes for a warning during AT and MPFLSTSA build are:

- Conflicting status message definitions for the same message ID but on separate policy database entries
- AT entry override definitions for the same message ID for one policy database entry but a status message definition for different policy database entries
- The AT scope being set to SYSPLEX but the changes that affect the AT being made for systems that are not linked to any sysplex

It is possible to tailor the level of detail of the messages for the trigger, application group, and AT warning. When invoking option *0 Settings*, there is a selection *3 MESSAGE* that allows the message level to be set. With level 1 (which is the default), in the above situation just one summary message is displayed per manager configuration, whilst level 2 will display all details of the definitions causing the problem.

Furthermore, that panel offers an option for message logging. By default, this value is *ON*, which means that all important dialog messages, including messages shown in a command progress popup window, are written into the ISPF LOG. The value *OFF* suppresses this, and it may be useful to switch this message logging off, if a build is run with message level 2.

Independent from the message logging switch, error messages are always written to the ISPF LOG. You cannot turn this off.

If the user profile *AOFPROF* for batch build is not allocated, the default message level is 3 to write all possible messages to the batch report and the ISPF LOG.

Batch Build: It is possible to start a batch build independent from the customization dialog. So you can for example, add further job steps or you can automatically start the batch build. However, this build also needs exclusive access to the policy database, because build progress and statistics are written to the policy database while the job is running. A sample JCL of such a job is provided in member *INGEBBLD* of the *SINGSAMP* library. Build return codes are:

- 0** successful
- 4** build complete, however, some warning messages are issued. Also issued if user exit *INGEX02* ended with a *RC > 0*.
- 8** user exit *INGEX01* ended with *RC > 0*. Build processing not started. No configuration files built.

20 severe error; build terminated without usable configuration

Distributing the System Operations Configuration Files

The SA z/OS automation configuration consists of four components:

- the automation manager's automation manager configuration file (AMC)
- the automation agent's automation control files (ACF)
- the NetView automation table (AT)
- the MPFLSTSA member

These files are also referred to as *system operations configuration files* in the customization dialog.

The partitioned data set generated by the BUILD contains these four components. SA z/OS runs on a sysplex basis, that is, the same ACF, AMC, and AT files must be available to all of the automation agents and automation managers in the sysplex.

The automation agent automatically finds the automation configuration data set and dynamically allocates it. It is highly recommended that you do not allocate the data set within DSIPARM. (For further information, refer to the section that describes using SA z/OS partitioned data sets in *System Automation for z/OS Planning and Installation*.) The automation configuration data set must either be shared or have exactly the same name on all systems within a sysplex. It can be shared within an enterprise.

You then have the choice to:

- Copy the members into the initial configuration data set that the automation manager was started with. Then issue an INGAMS REFRESH command with an * as the data set name.
- Issue an INGAMS REFRESH command with the name of the new partitioned data set. This will cause the automation manager and the automation agent to read from the new partitioned data set.

An automation agent needs to run on every system that is automated by SA z/OS and at least one automation manager needs to run per sysplex and one per standalone system. Automation managers can manage systems sysplex-wide. Figure 248 on page 325 shows a sample automation configuration and presents the build process.

The MPFLSTSA member must be copied to a z/OS parmlib data set.

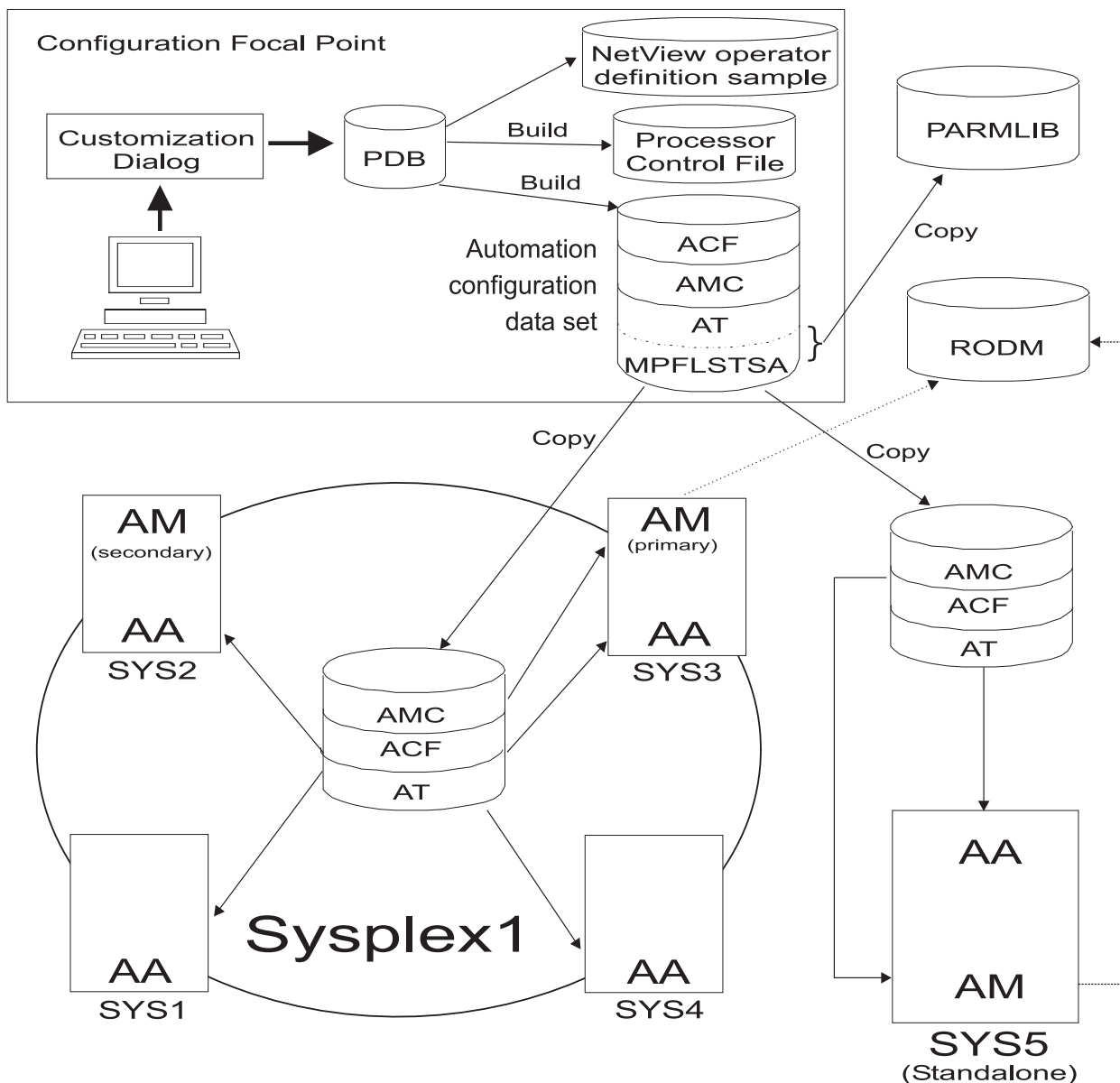

Figure 248. SA z/OS Automation Configuration

Figure 248 shows a sample enterprise consisting of one sysplex *Sysplex1* and one standalone system *SYS5*. The sysplex consists of four systems *SYS1*, *SYS2*, *SYS3*, *SYS4* and has a primary and a secondary automation manager (AM). The sysplex shares a copy of the system operations configuration files and the standalone system has its own copy of the same files.

The sysplex in our example has one primary and optionally one secondary automation manager and one automation agent on each system. The standalone system must have one automation manager (AM) and one automation agent (AA).

The enterprise wide policy database for your sysplex and the standalone system is created and maintained with the customization dialog on any suitable system. For the purpose of the diagram shown in Figure 248, it is called the *configuration focal point*.

Building the System Operations Configuration Files

The configuration build is also performed with the customization dialog and the configuration files are distributed from there to the locations where needed.

Using the customization dialog's BUILD function, you produce the following output:

- the Processor Operations Control File
- the System Operations Configuration Files

You could share one common automation configuration file in your enterprise, or you can copy the automation configuration file to where it is needed as shown in our scenario. Both automation managers feed the enterprise-wide RODM data base dynamically with information that is available from both AMCs and from information that becomes available during automation processing (like status changes). This feeding is done automatically by the SA z/OS topology manager after you have started it. The generated data is used by the NMC workstation to display predefined graphical views.

The automation manager's AMC file and the automation agent's ACF files must match. Therefore the automation manager and an automation agent exchange a token to verify that the automation configuration matches. You can share one common data set containing all automation manager configuration files and all automation control files within a sysplex.

Note:

It is mandatory to create and maintain policy databases with the customization dialog.

The automation configuration files must be distributed to each system in the SA z/OS enterprise where SA z/OS system operations functions are to run. In general, this is all of the z/OS systems in the SA z/OS enterprise. In a sysplex, the data set name of the automation configuration file must be equal on all systems in the sysplex.

However, it is highly recommended that you use a shared data set in a sysplex, and it is preferable that you use a shared data set for the whole enterprise.

Generating a Job for Batch Build

You can run a job for batch build that performs the same processing as the BUILD function of the customization dialog. The SINGSAMP sample library contains a sample job for this task in member INGEBBLD. Before submitting this job, you need to edit the jobcard appropriately as described in the sample itself.

The build can only run if the output data set exists and is allocated. If the data sets are not SMS-managed, allocating the data set within the same job step does not work because the cataloging is done by z/OS at end of the job (or job step). Therefore the allocation and cataloging of the build output data set must be done in a separate job (or job step) prior to the build job (or job step).

Chapter 9. Data Management

This chapter provides information about functions provided by SA z/OS to import selected entries from another policy database, or to migrate agent control file data into a policy database.

Panel Interaction

If you select option 5 *Data Management* from the *Customization Dialog Primary Menu*, you reach the *Data Management Select* panel, as shown in Figure 249.

```

MENU  HELP
-----
A0FGIMP0          Data Management Select Panel
Option ==>>> _____
 
  1 Import          Import policies into current Policy Data Base
  9 Migrate        Migrate ACF files (Agent Data) into Policy Data Base

```

Figure 249. *Data Management Select Panel*

This panel allows you to select how to manage the policy database data. Your options are:

1 Import

Allows you to select entry data from another policy database and to add them to the current policy database. See “Importing Policy Database Data” for more details.

Note:

Note: The entry data are imported with all their policies, except the link information and the resource definitions.

9 Migrate

Allows you to migrate an Automation Control File (Agent Data) or Automation Control File fragments (ACF fragments), that is automation agent data *only*, into an existing policy database. See “Migrating the Automation Control File” on page 329 for more details.

Note:

This function should mainly be used to migrate an ACF or ACF fragments from an SA OS/390 release 1.3 or earlier.

Importing Policy Database Data

Selecting the import option leads to the panel shown in Figure 250 on page 328.

```

MENU  HELP
-----
A0FGIMPP                               Policy Data Base Import
Option ==>> _____

Current PDB (target of import)          : DATABASE_NAME
Enterprise Name                          : YOUR_ENTERPRISE

1 Import Policy Data
   PDB name (source of import) . IMPORT_DATABASE      (? or name)
   Entry type . . . . . APL                          (? or type)
2 View import report

```

Figure 250. Policy Data Base Import Panel

This panel allows you to specify the information required to import entry data from another policy database. It has the following options:

1 Import Policy Data

This option allows you to select the following:

- A policy database from which entry data will be imported. This field is initially empty. Entering a question mark (?) in this field and pressing Enter displays the *Policy Data Base Selection* panel..
- An entry type for which selected entries will be imported. This field is initially empty. Entering a question mark (?) in this field and pressing Enter displays the *Entry Name Selection* panel.

Note:

The import of entry type ENT (enterprise policies) is not supported.

2 View import report

This allows you to view the import report that is available in the target policy database. It invokes the ISPF VIEW function. If there is no import report, an empty screen is displayed.

The information that you specify here is saved in your ISPF profile data set and used as the initial values the next time you issue the import function.

Requesting Option 1 on this panel will take you to a list of the existing entries for the specified type (see Figure 251 for an example).

Here you can select which entries are to be copied. After making your selections

```

COMMANDS  ACTIONS  HELP
-----
A0FGIMPS          Entry Name Selection          Row 1 to 9 of 9
Command ==> _____          SCROLL==> PAGE

Action  Status   Entry Name          Short Description
-----  -
_____  _____  ER0_ALERT          ICLI Alert Router
_____  SELECTED  ER0_APPSRV         SAP R/3 Application Server Instance
_____  _____  ER0_CO             SAP R/3 Syslog Collector
_____  _____  ER0_DB2DBM1        DB2 for SAP; DBM1
_____  _____  ER0_DB2DIST        DB2 for SAP ER0; DIST
s_____  _____  ER0_DB2IRLM        DB2 for SAP ER0; IRLM
_____  _____  ER0_DB2MSTR        DB2 for SAP ER0; MSTR
_____  _____  ER0_DB2SPAS        DB2 for SAP ER0; SPAS
_____  _____  ER0_ERS            SAP R/3 Enqueue Replication Server
***** Bottom of data *****

```

Figure 251. Entry Name Selection Panel for Import Policy Data

and pressing ENTER, a panel is displayed where you can confirm your selections, as shown in Figure 252.

```

COMMANDS  HELP
-----
A0FGIMP2          Confirm Selected Entry Names For Import          Row 1 to 2 of 2
Command ==> _____          SCROLL==> PAGE

Press ENTER to start Import Process.
Press CANCEL or PF3 to return.

Selected Names      Description
ER0_APPSRV          SAP R/3 Application Server Instance
ER0_DB2IRLM         DB2 for SAP ER0; IRLM
***** Bottom of data *****

```

Figure 252. Confirm Selected Entry Names For Import Panel

Pressing ENTER will start the import processing, while CANCEL or PF3 will take you back to the previous panel.

Migrating the Automation Control File

For the automation manager, it is necessary to create the automation manager configuration file, which can only be built using the customization dialog. Thus all data must be available in a policy database.

If the customization dialog has not yet been used, and all automation definitions are stored in an ACF that has been edited manually, the MIGRATE function of the customization dialog should be used. It recognizes all valid ACF keywords, and merges the corresponding values into an existing policy database. In detail, the following steps are required:

1. If the customization dialog has never been used before, no user specific policy database exists. To create one, specify option 4 on the *Customization Dialog Primary Menu* to go to the *Policy Data Base Selection* panel, and specify the command NEW. On the subsequent panel, a model policy database (PolicyDB) name is required. Entering a question mark in the corresponding field gives a list of samples, where one can be selected. A description of the samples can be found in "Using Sample SA z/OS Policy Databases" on page 300. This allows

Data Management

you to select a sample that best matches your installation requirements. If a new policy database has been created, it will be listed on the *Policy Data Base Selection* panel.

2. On the *Policy Data Base Selection* panel, use the Data Management command for the policy database into which you want to copy the automation control file data. Then the *Data Management Select* panel will be displayed. On this panel, the entry name for the system that will be used as the target and the MVS system name needs to be specified. It is not necessary that this system already exists. If it does not exist, the MIGRATE function will create the system automatically.

In the *Source Data Set* field, enter the data set name and the member name that contains the ACF definitions (or the main member containing the include statements for the fragments) for the system to be migrated.

If you have multiple systems defined, each with its own ACF, they have to be migrated one after the other. It is not possible to migrate multiple systems at the same time, because a specific target system must always be specified.

3. Before the migration is started, specific objects can be selected or excluded from migration. However, if a complete ACF is to be migrated into a new policy database, it is not necessary to go into these details. By default, all entry types are selected, and the migration can be started without any further specification. The MIGRATE function will copy all source definitions into the corresponding entry types automatically.

4. If it is necessary to select specific objects for migration, the corresponding option on the *Data Management Select* panel has to be selected. This gives a list of all entry types found in the source data set. There each entry type can be selected or excluded for migration. And if it is necessary to be even more specific, for each entry type a list of the entry names found for that type can be displayed. There it is possible to check for duplicates, and rename entries, if required.

If a complete ACF is migrated into a new policy database, this selection of specific entry types and names can be skipped.

5. If the preparations are done, the migration itself can be started. As it may take some time to complete, the progress is indicated on a special screen that is updated automatically and shows all migration steps as they are executed. Furthermore, a report of the migration will be written and stored as member in the target data set. The member name needs to be specified on the *Data Management Select* panel.

6. All data belonging to one entry in the ACF are copied into one entry within the target policy database. Depending on the specification in the ACF, it may be more or less difficult for the migration to find the name of such an entry.
7. Any lowercase characters encountered in the automation control files that are being migrated will be translated to uppercase unless they are enclosed in matching pairs of either " or '.

Note:

Migration of MTR resources is not supported.

You have the following alternative methods of invoking the migration function:

- From the *Customization Dialog Primary Menu* (Figure 5 on page 12) select option 5 *Data Management*.

- From the *Policy Data Base Selection* panel, you can select action *Migrate (G)* against the policy database to that you want to migrate your data to.

In both cases, you reach the *Data Management Select* panel shown in Figure 249 on page 327 that you can use to migrate an automation control file into a policy database of the current release of SA z/OS

For every enterprise (every policy database) you migrate on a *System* level, that is you migrate each single automation control file main include fragment for each system.

Note:

The more selectively you specify your migration process the better the performance will be. For example, specifying a certain automation control file fragment instead of specifying the main include member may be useful if you only want to migrate certain parts of an enterprise. The various selection methods that are available are described below.

Selecting the migrate option leads to the panel shown in Figure 253.

```

MENU  OPTIONS  HELP
-----
AOFGMSYN                System Migration Definitions
Option ==>>> _____ More:  +

  1 Select Migration Objects
  2 Start Online Migration
  3 Start Batch Migration
  4 View Migration Report

Source definitions:
Dataset & member. . 'USER.SH.POLICYDB(ACFZ998)'

Target definitions:
PolicyDB name      : DATABASE_NAME
Dataset name       : 'USER.TEST.USER.PDB'
Report member . . . $RPTMIG          Member name in target data set
Overwrite system. . YES              YES NO
System Entry Name . NEW_SYSTEM_01    Entry Name of new/changed system
MVS Sysname . . . . FOC1             MVS System Name
Short Description . _____

Job statement information: (used for BATCH migrate)
//AOFMIGR JOB
//*
//*

```

Figure 253. System Migration Definitions Panel

This panel allows you to specify the information required to migrate a system's data from an automation control file fragment into a target policy database. The system name you specify in the *System Entry Name* field, is either created in the target policy database or, if it already exists, it is overwritten. You have the following options:

- **1 Select Migration Objects**

This option allows you to specify the selective migration of objects from ACF fragments. It leads to the *System Object Migration* panel (Figure 254 on page 334) where you can select those entry types that you want to migrate to the current policy database whilst explicitly excluding the rest of the inputs.

Data Management

Within the selected entry types you can later select certain existing entry names that you want to migrate. To achieve this, enter the command *EDIT (E)* against a selected entry type. The *Entry Name Migration* panel (Figure 255 on page 335) is then displayed.

After you have selected all objects (entry types and entry names) for migration, return to the *Data Management Select* panel where you can now start the migration using one of the two following Start Migration options.

- **2 Start Online Migration**

This option immediately starts the migration of the specified ACF fragment to the current policy database in the foreground.

- **3 Start Batch Migration**

This option starts the migration process in the background. In this case, you need to provide a valid JOB statement IN *Job statement information* on the same panel.

For definitions of the data set allocations needed for batch migration, see “Defining Data Sets for Batch Processing” on page 375.

- **4 View Migration Report**

This option invokes the ISPF VIEW function to view the migration report that was created as specified in the *Report member* field for this target policy data set.

Notes:

1. If option 1, 2, or 3 is entered the first time, all ACF data is read and saved for further processing *until you exit this panel*.
2. If option 2 or 3 is used after option 1 has been used, and the selections have been saved, this data is used for migration.
3. If the selections have been canceled, processing starts again by reading the ACF data.
4. If option 1 is used again after the selections have been canceled, processing starts again by reading the ACF data.

In the fields below these options, specify the following source and target definitions:

Dataset & member

This specifies the name of a partitioned data set together with the member name containing the ACF of the system to be migrated, for example, 'ADMIN1.FOCAL.LIB(ACFZ998)' or 'KEY3.SH.POLICYDB(ACFZ998)'. The member name must be specified. The source data set cannot be the same as the target data set.

PolicyDB name

Already specified and cannot be changed.

Dataset name

Already specified and cannot be changed.

Report member

This specifies the member name where the migration report will be written. The member will be created in the TARGET data set.

Overwrite System

This specifies whether the system entry in the policy database will be overwritten during migration if the system entry already exists. For existing system entries you have to specify YES to continue.

Note:

In this field, you can prevent SA z/OS from unintentionally overwriting existing information in the policy database for this system. The default is NO. A message, *System entry name exists*, is displayed if this field is set to NO and you try to use the same system entry name as already exists in the policy database. To proceed, you must either change the system name or set this field to YES.

System Entry Name

This specifies the entry name of the system to be migrated into. Note especially that you also define the system name into which you want to migrate the old system's ACF fragment.

Note:

If the system already exists in the target policy database it will be updated with the migration data, otherwise the new system will be created. To verify that the system already exists just press ENTER

MVS Sysname

This specifies the MVS system identifier for the migrated system.

Note:

If the system already exists in the target policy database the MVS SYSNAME must be the one already defined in the policy database. The special notation with a trailing 'plus-sign' is allowed. The first three characters of the SYSNAME must not be AOF because these are reserved for internal processing of the SA z/OS System Operations functions.

Short Description

This specifies the short description of the migrated system.

If you specified that the MIGRATE request should be run in BATCH mode then you need to provide a valid JOB statement in the *Job statement information* field.

The information that you specify here is saved in your ISPF profile data set and used as the initial values for the next MIGRATE request.

Selecting option 1 *Select Migration Objects* on the *Data Management Select* panel leads to the panel shown in Figure 254 on page 334.

```

COMMANDS  ACTIONS  HELP
-----
AOFGMOBJ          System Object Migration
Command ==>>>                                SCROLL==>>> PAGE

Entry Name : SAMPLE_SYSTEM_01      PolicyDB Name : DATABASE_NAME
System Name : SYS1                  Enterprise Name : YOUR_ENTERPRISE

Target DSN   : 'KEY3.DOCU.PDB'
Source DSN   : 'KEY3.SH.POLICYDB(ACFZ998)''

Action      Migr-Status   Type      Description
-----
                                     ENT      Enterprise
                                     GRP      Groups
                                     SBG      Sub_groups
                                     SYS      Systems
                                     APG      Appl_groups
          SELECTED      APL      Applications
                                     EVT      Events
                                     SVP      Service_Periods
                                     TRG      Triggers
                                     PRO      Processors
                                     TMR      Timers
                                     TMO      Timeout_Settings
                                     TPA      Tape_Attendance
                                     MVC      MVS_components
                                     MDF      MVSCOMP_defaults
                                     SDF      System_defaults
                                     ADF      Appl_Defaults
                                     AOP      Auto_Operators
                                     NFY      Notify Operators
                                     NTW      Network
                                     NNT      NNT_Sessions
                                     RES      Resident_Clists
                                     SCR      SDF_Status_Details
                                     PRD      Product_Automation
                                     UET      User_ET_Pairs

```

Figure 254. System Object Migration Panel

On this panel, all entry types are initially selected. You can issue the following actions for the entry types:

- **ADD (A)** to add an entry type to the SELECTED list; if you type A * into the command line, all entry types will be selected.
- **REMOVE (M)** to remove an entry type from the SELECTED list; if you type M * into the command line, all selected entry types will be deselected.
- **EDIT (E)** to edit the selected entry type before migration; you will be presented with the *Entry Name Migration* panel with a list of entries of that type from which you can select the ones you want to migrate or blank out the names of those that you do not want to migrate (see Figure 255 on page 335).

If you enter the command CANCEL, all changes made on this panel and on the *Entry Name Migration* panel (which is displayed if action "EDIT" was selected) are deleted and the migration process starts as if it has been invoked for the first time.

Notes:

1. To migrate ACF fragments of AMC data from releases prior to SA OS/390 2.2, you must select ENT. .
2. To migrate an application with product automation data, you must select APL and PRD.
3. To migrate ACF fragments of type SYS from releases prior to SA OS/390 2.2, you must select SYS and NFY.
4. The migration of MTR resources is not supported.

Note: To migrate ACF fragments of AMC data from releases prior to SA OS/390 2.2, you must select ENT. To migrate an application with product automation data, you must select APL and PRD. To migrate ACF fragments of type SYS from releases prior to SA OS/390 2.2, you must select SYS and NFY.

```

COMMANDS  HELP
-----
AOFGMENM          Entry Name Migration
Command ===>                                SCROLL===> PAGE

Entry Name : SAMPLE_SYSTEM_01      PolicyDB Name : DATABASE_NAME
System Name : FOC1                 Enterprise Name : YOUR_ENTERPRISE

You may specify the name and description used to migrate the APL entries
into the Policy DB. To avoid migration blank out the name.

Migration Name      Dup  Description
APPC                *   APPC/MVS automation policy
ASCH                *   ASCH automation policy
JES2                *   JES2 policy definition
JES3                *   JES3 automation policy
TRANSIENT1          *   Transient job 1 policy details
TRANSIENT2          *   Transient job 2 policy details
TSO                 *   TSO automation policy
VLF                 *   VLF automation policy
VTAM                *   VTAM policy definition

```

Figure 255. Entry Name Migration Panel

An asterisk (*) in the *Dup* column indicates that the specified name already exists in the policy database. The existing entry will be replaced during migration.

Remember:

You can only start migration from the *Data Management Select* panel using either option 2 *Start Online Migration* or 3 *Start Batch Migration*.

When you have finished migrating your existing automation control file to the selected policy database, you need to use the BUILD command to build a new automation control file.

Notes:

1. Migrating an automation control file does not build an SA z/OS automation control file. The information from your old automation control file is migrated into an SA z/OS policy database. To build an SA z/OS automation control file, you must choose Option 3 from the *Build Functions Menu*.
2. If you have automation control files from multiple systems to migrate, migrate each automation control file into your policy database for each system.

Entry Name Creation

Table 10 describes how SA z/OS creates names and descriptions for the entry types to be migrated.

Table 10. Creation of Entry Names

Entry Type	Entry Name	Description
ENT	From table AOFTENT (ENTNAME)	From table AOFTENT (ENTDESCS)
SYS	From panel AOFGMSYN	From panel AOFGMSYN
GRP	From ACF line 'GROUP entryname'	From ACF line '* Desc : short_description' or '' if the '* Desc' line is not available
SBG	From ACF line 'SUBGROUP entryname'	From ACF line '* Desc : short_description' or '' if the '* Desc' line is not available
APG	From ACF line 'APPLGROUP entryname'	From ACF line '* Desc : short_description' or '' if the '* Desc' line is not available
APL	From ACF line '* Built : userId yy/mm/dd hh:mm:ss entryname' or from ACF line 'SUBSYSTEM_sysname subsysname' if the '* Built' line is not available. The name created will be: 'subsysname_sysname'.	From ACF line '* Desc : short_description' or '' if the '* Desc' line is not available
PRO	From ACF line 'PROCESSOR entryname'	From ACF line '* Desc : short_description' or '' if the '* Desc' line is not available
TMR	From ACF line '* Built : userId yy/mm/dd hh:mm:ss entryname' or 'TIMER_sysname' if the '* Built' line is not available	From ACF line '* Desc : short_description' or '' if the '* Desc' line is not available
TMO	From ACF line '* Built : userId yy/mm/dd hh:mm:ss entryname' or 'TMO_SET_sysname' if the '* Built' line is not available	From ACF line '* Desc : short_description' or '' if the '* Desc' line is not available
TPA	From ACF line '* Built : userId yy/mm/dd hh:mm:ss entryname' or 'TAPE_ATT_sysname' if the '* Built' line is not available	From ACF line '* Desc : short_description' or '' if the '* Desc' line is not available

Table 10. Creation of Entry Names (continued)

Entry Type	Entry Name	Description
MVC	From ACF line '* Built : userId yy/mm/dd hh:mm:ss entryname' or 'MVS_COMP_sysname' if the '* Built' line is not available	From ACF line '* Desc : short_description' or '' if the '* Desc' line is not available
MDF	From ACF line '* Built : userId yy/mm/dd hh:mm:ss entryname' or 'MVSCOMP_DFT_sysname' if the '* Built' line is not available	From ACF line '* Desc : short_description' or '' if the '* Desc' line is not available
SDF	From ACF line '* Built : userId yy/mm/dd hh:mm:ss entryname' or 'SYSTEM_DFT_sysname' if the '* Built' line is not available	From ACF line '* Desc : short_description' or '' if the '* Desc' line is not available
ADF	From ACF line '* Built : userId yy/mm/dd hh:mm:ss entryname' or 'APPL_DFT_sysname' if the '* Built' line is not available	From ACF line '* Desc : short_description' or '' if the '* Desc' line is not available
AOP	From ACF line '* Built : userId yy/mm/dd hh:mm:ss entryname' or 'AUTOOPS_sysname' if the '* Built' line is not available	From ACF line '* Desc : short_description' or '' if the '* Desc' line is not available
NFY	From ACF line '* Built : userId yy/mm/dd hh:mm:ss entryname' or 'NOTIFYOP_sysname' if the '* Built' line is not available	From ACF line '* Desc : short_description' or '' if the '* Desc' line is not available
NTW	From ACF line '* Built : userId yy/mm/dd hh:mm:ss entryname' or 'NETWORK_sysname' if the '* Built' line is not available	From ACF line '* Desc : short_description' or '' if the '* Desc' line is not available
NNT	From ACF line '* Built : userId yy/mm/dd hh:mm:ss entryname' or 'NNT_SESSION_sysname' if the '* Built' line is not available	From ACF line '* Desc : short_description' or '' if the '* Desc' line is not available
RES	From ACF line '* Built : userId yy/mm/dd hh:mm:ss entryname' or 'RES_CLISTS_sysname' if the '* Built' line is not available	From ACF line '* Desc : short_description' or '' if the '* Desc' line is not available
SCR	From ACF line '* Built : userId yy/mm/dd hh:mm:ss entryname' or 'STAT_DETAIL_sysname' if the '* Built' line is not available	From ACF line '* Desc : short_description' or '' if the '* Desc' line is not available
EVT	From ACF line '@EXTCOND entryname'	From ACF line '* Desc : short_description' or '' if the '* Desc' line is not available
SVP	From ACF line '@SERVICE entryname'	From ACF line '* Desc : short_description' or '' if the '* Desc' line is not available
TRG	From ACF line '@TRIGGER entryname'	From ACF line '* Desc : short_description' or '' if the '* Desc' line is not available
PRD	not applicable	not applicable

Table 10. Creation of Entry Names (continued)

Entry Type	Entry Name	Description
UET	From ACF line '* Built : userId yy/mm/dd hh:mm:ss entryname' or 'USER_ET_sysname' if the '* Built' line is not available	From ACF line '* Desc : short_description' or '' if the '* Desc' line is not available

The MIGRATE function checks for the comment line starting with * *Built*, and takes the entry name from there. Such a line is created automatically, if the ACF is built using the customization dialog.

If such a comment line is not available, a fixed entry name is created as described in Table 10 on page 336 and all definitions are stored into this entry. In a manually edited ACF, it may be helpful to insert comment lines with entry names as shown above to group the definitions accordingly, so that the migration is able to store the definitions into the policy database with their meaningful names.

Restrictions: If an application or an application group entry name is migrated into the policy database and the same entry name already exists, only the existing subsystem/automation name will be used during the migration process. The subsystem/automation name from the input will be ignored. The reason for this is that these names are used for creating resource names and when the subsystem name or automation name has changed, the resource name would be invalidated and the automation manager data would be incorrect afterwards.

Notes:

1. Definitions relevant for subsystems need to be migrated *together* with the subsystem's ACF data *in one step* in order to have them migrated to the correct application. If this is not observed, the definitions will be migrated to *User E-T Pairss*.
2. If migrating *Application* fragments, an application group is automatically created. This is required to guarantee that the application is linked to the appropriate system. All applications found in the migration ACF-source are linked to this application group. The entry name of this application group is *APG_sysname*.
3. PARENT definitions in application fragments are converted to either HASPARENT or HASPASSIVEPARENT relationships. The type of relationship created is determined by the value specified in the APL Relationship Type field in the policy database Converts Options panel (see "Initial Policy Database Conversion" on page 355. The default value is HASPARENT.
4. If no description has been given in the entry name migration panel (AOFGMENM), the description found in the ACF fragment (keyword SDESC or DESC) will be used.

Migration of Include Files and Product Automation Definitions

Note:

Product Automation stands for automation of the DB2, CICS, IMS and OPC products, formerly referred to as *Features*.

With the introduction of the automation manager, it is required to have all configuration data in one place. Any data added via a user include file that is maintained outside of the customization dialog will not be available for SA z/OS Version 2 releases. Therefore, it is mandatory to migrate these members.

If the includes contain definitions that are available as entry types within the customization dialog, they are migrated into the corresponding entry types of the current SA z/OS release. If the definitions are not known to the current SA z/OS release, they will be migrated to entries of *User E-T Pairs (UET)*.

As an example, the following definitions using non-ACF keywords are assumed to be part of the source ACF:

```
* Desc : User E-T Pairs HSM
* Built : OPER1 99/08/11 14:31:23 HSM
*
HSMMAIL BCDS,
  MAILLIMIT=80%,
  MAILOP=(I-SC.DATABASESYSTEM),
  MAILTXT=(BACKUP CONTROL DATASET OF HSM),
  MAILTXT=(IS 80% FULL),
  LIMIT=97%
```

The MIGRATE function checks for the comment line starting with * **Built**, and takes the entry name from there. Such a line is created automatically, if the ACF is built using the customization dialog. Each User E-T Pairs (UET) entry consists of one or more entry-type pairs each of which consists of one or more keyword-data pairs. In this case, *HSMMAIL BCDS* is treated as an entry-type pair, which includes all the following keyword-data pairs. After migration, the customization dialog shows the definitions in the following way:

```

SA z/OS UET Keyword-Data Specification      Row 83 from 194
Command ==>                               SCROLL==> PAGE

Entry Type : User E-T Pairs                PolicyDB Name : DATABASE_NAME
Entry Name : HSM                          Enterprise Name : YOUR_ENTERPRISE
Entry-Type : HSMMAIL                      BCDS

Action Keyword/Data
----- MAILLIMIT
      80%
----- MAILOP
      (I-SC.DATABASESYSTEM)
----- MAILTXT
      (BACKUP CONTROL DATASET OF HSM)
----- MAILTXT
      (IS 80% FULL)
----- LIMIT
      97%
```

Figure 256. UET Keyword-Data Specification for Entry Name HSMMAIL

Data Management

Until now, definitions for product automation for CICS, IMS, and OPC were contained in separate members, that were included in the ACF either via entry type **ICL (Includes)**, or via manually added include statements. As mentioned above, Includes via the Dialog will no longer be supported, and manually added include members will be rejected by the ACF load, so they also have to be migrated into the policy database.

With SA OS/390 2.1, the customization dialog has been extended to allow specification of all the ACF entries required for product automation. Also the migration will automatically move these definitions to their appropriate entry types. Refer to the relevant product-specific reference manuals for further details of these new entry types.

As a specific example of product automation definitions, the following CICS definitions are assumed to be part of the source ACF:

```
*                               SUBSYSTEM SPECIFICATION
SUBSYSTEM CICS4A,
  PARENT=(CICS4),
  SHUTDLY=00:03:00,
  STRTDLY=00:03:00,
  JOB=CICS4A,
  SDESC='TEST-CICS'
*                               DEFINES CICS
CICSCNTL CICS4A,
  APPLID=IPUAJCIA,
  MAJNODE=IPUJBC,
  AUTOOPS=CICSOP01,
  KEYPOINTREQ=YES,
  SMFID=215
*                               HEALTH CHECKING
HEALTHCHK CICS4A,
  FUNCTION=(0,EVECHLTH,00:10:00,30,AUTO,'SAMPLE COBOL HEALTH')
*                               LINK MONITORING
CONNECTION CICS4A.IM4A,
  DESC='IMS521 (IPUAHI51) on AOC2',
  DAY=(WEEKDAY,0830-1500),
  DAY=(WEEKEND,0900-1800),
  TYPE=IMS,
  ECHO=(x,60),
  ACQDELAY=15,
  RELDELAY=15,
  MAXREPAIR=5,
  CRITICAL=YES
*                               SERVICE PERIODS
SERVICE CICS4A,
  DAY=(DAILY,0815-1715),
  DAY=(WEEKEND,DOWN-DOWN)
*                               TRIGGER DEFINITION
TRIGGER CICS4A,
  STARTUP=(SERVICE)
*                               MINOR RESOURCE THRESHOLDS
THRESHOLDS CICS4A.TRAN,
  CRIT=(2,00:05),
  FREQ=(4,01:00),
  INFR=(5,24:00)
*
```

Figure 257. ACF Definitions for CICS

All entries (except SERVICE and TRIGGER) will be migrated into an application definition. If the target policy database does not yet contain an application with

that name, the migration can be run without problems. If however the target policy database has already an application with that name, there are three possibilities:

1. The conflict can be resolved by changing the name of the source application on the *Application Entryname Migration* panel before the migration is started. This panel shows that an entry with the same name already exists, and allows you to change that name.
2. If the migration is run with the duplicate name, then the entry in the target PolicyDB is overwritten with the definitions from the ACF keywords.
3. As mentioned before, you can specify an entry name by inserting a * **Built** line in the source before migrating the ACF.

Keywords SERVICE and TRIGGER will be migrated into service period and trigger definitions of the current SA z/OS release.

The following screens show how the ACF entries from Figure 257 on page 340 will be migrated into the customization dialog.

SUBSYSTEM SPECIFICATION

```
SUBSYSTEM CICS4A,
  PARENT=(CICS4),
  SHUTDLY=00:03:00,
  STRTDLY=00:03:00,
  JOB=CICS4A,
  SDESC='TEST-CICS'
```

After migration, you can find the subsystem specification from the automation control file under policy item APPLICATION INFO of entry type APL with entry name *CICS4A_sysname*. *sysname* is the MVS sysname chosen for the migration.

CICS DEFINITION

```
CICSCNTL CICS4A,
  APPLID=IPUAJCIA,
  MAJNODE=IPUJBC,
  AUTOOPS=CICSOP01,
  KEYPOINTREQ=YES,
  SMFID=215
```

The CICSCNTL entry will be migrated to entry type APL (application type CICS) with entry name *CICS4A_sysname*. Selecting policy item CICS CONTROL from this application will present the following panel:

Data Management

```
COMMANDS  HELP
-----
AOFPCLX          CICS control specifications
Command ==>

Entry Type : Application      PolicyDB Name : DATABASE_NAME
Entry Name : CICS             Enterprise Name : YOUR_ENTERPRISE  More:  +
Subsystem  : CICS
Subtype   : TOR              Subtype from APPLICATION INFO policy

Enter or update the following fields:
APPLid. . . . IPUAJCIA
Major node. . IPUJBC
Keypoint req. YES          YES NO
SMFid . . . . 215          SMF record number
CMASid. . . .             CICSplex/SM CMAS region identifier

The following definitions are for SA13 only:

Auto operator CICSOP01      Automation operator name
Start timer                 Startup time (mm:ss)
Cold timer                  Cold start time (mm:ss)
Warm timer                  Warm start time (mm:ss)
Emerg. timer                Emergency start time (mm:ss)
```

HEALTH CHECKING

```
HEALTHCHK CICS4A,
FUNCTION=(0,EVECHLTH,00:10:00,30,AUTO,'SAMPLE COBOL HEALTH')
```

The HEALTH CHECKING entry will be migrated to entry type APL (application type CICS) with entry name *CICS4A_sysname*. Selecting policy item MESSAGES/USER DATA from this application will present the following panel:

```
COMMANDS  ACTIONS  HELP
-----
Message Processing          Row 1 to 8
Command ==>                SCROLL==> PAGE

Entry Type : Application      PolicyDB Name : DATABASE_NAME
Entry Name : CICS4A_sysname   Enterprise Name : YOUR_ENTERPRISE

Subsystem  : CICS4A

Enter messages issued by this resource that will result in automated actions.
Actions: CMD = Command  REP = Reply  CODE = CODE  USER = User defined values

Action  Message ID          Cmd  Rep  Code  User
Description
ABCODESYSTEM          34
Specifications for ABCODESYSTEM
ABCODETRAN            4
Specifications for ABCODETRAN
user  HEALTHCHK              1
Specifications for HEALTHCHK
```

Selecting message HEALTHCHK with action USER will present the following panel:

```

COMMANDS  HELP
-----
Command ==>                                User Defined Data                Row 1 to 4 of 21
                                           SCROLL==> CSR

Entry Type : Application                    PolicyDB Name   : DATABASE_NAME
Entry Name  : CICS4A_sysname                Enterprise Name : YOUR_ENTERPRISE

Subsystem   : CICS4A Message ID : HEALTHCHK

To change keyword-data pair, specify the following:

Keyword
Data
FUNCTION
(0,EVECHLTH,00:10:00,30,AUTO,'SAMPLE COBOL HEALTH')

```

LINK MONITORING

```

CONNECTION CICS4A.IM4A,
DESC='IMS521 (IPUAHI51) on AOC2',
DAY=(WEEKDAY,0830-1500),
DAY=(WEEKEND,0900-1800),
TYPE=IMS,
ECHO=(x,60),
ACQDELAY=15,
RELDELAY=15,
MAXREPAIR=5,
CRITICAL=YES

```

The LINK MONITORING entry from the ACF will be migrated to entry type *CCN* (CICS link definition) under the name *CICS4AIM4A*. Note that the period (.) has been removed from the name found in the ACF. Selecting policy item *CICS CONNECTION* from this CICS link, you will be presented with a panel like the following one:

```

COMMANDS  HELP
-----
Command ==>                                CICS connection links

Entry Type : CICS link                      PolicyDB Name   : DATABASE_NAME
Entry Name  : CICS4AIM4A                    Enterprise Name : YOUR_ENTERPRISE

-----

Enter or update the following fields:

Connection id . . . . . IM4A                CICS sysid
Type . . . . . IMS                          (IMS/CICS)
Echo . . . . . (X,60)                       (txn/pgm,seconds)
Time zone offset . . . . . 0                 (hh:mm,WEST/EAST)
Check interval . . . . . 05:00              (mm:ss)
Max repair tries . . . . . 5                 (0-9)
Release delay . . . . . 15                  (4-99)
Acquire delay . . . . . 15                  (4-99)
Critical link (SDF) . . YES                  YES          NO

```

The monitoring period information from the ACF is migrated to entry type *CVP* under the name in our example, *CICS4AIM4A*.

Selecting its policy item *MONITORING PERIOD* will display the panel shown in Figure 258 on page 344.

```

COMMANDS  HELP
-----
                                Link monitoring service period
Command ==>

Entry Type : Monitoring period      PolicyDB Name : DATABASE_NAME
Entry Name : CICS4AIM4A             Enterprise Name : YOUR_ENTERPRISE

Note: Review help panel for complete description of data entry fields.
      Valid start and stop times are 00:00-23:59, *****, and DOWN.

          Start/Stop  Start/Stop  Start/Stop  Start/Stop  Start/Stop
Monday
Tuesday
Wednesday
Thursday
Friday
Saturday
Sunday
Weekday 08:30 15:00
Weekend 09:00 18:00
Daily
    
```

Figure 258. Monitoring Service Period

The migration also links the generated monitoring period (see Figure 258) to the migrated CICS connection CICS4AIM4A. You can view this link by selecting policy item MONITORING PERIOD from this CICS link CICS4AIM4A. You will be presented with a panel like the following one:

```

COMMANDS  ACTIONS  VIEW  HELP
-----
A0FGXC4E      Monitoring period for CICS link      Row 1 to 2 of 2
Command ==>                                     SCROLL==> PAGE

Entry Type : CICS link          PolicyDB Name : DATABASE_NAME
Entry Name : CICS4AIM4A        Enterprise Name : YOUR_ENTERPRISE

Action      Status      Monitoring period/Short Description
          SELECTED      CICS4AIM4A
                               Migrated from connection CICS4AIM4A
    
```

SA z/OS will also link the application (APL) CICS4A_sysname and the CICS connection (CCN) CICS4AIM4A. You can view the result by selecting policy item CICS CONNECTION from application CICS4A_sysname. This will present a panel similar to the following:

```

COMMANDS  ACTIONS  VIEW  HELP
-----
                                CICS link for Application      Row 1 to 3 of 3
Command ==>                                     SCROLL==> CSR

Entry Type : Application        PolicyDB Name : DATABASE_NAME
Entry Name : CICS4A_sysname     Enterprise Name : YOUR_ENTERPRISE

Action      Status      CICS link/Short Description
          Selected      CICS4AIM4A
                               IMS521 (IPUAHI51) on AOC2
***** Bottom of data *****
    
```

MINOR RESOURCE THRESHOLDS

```

THRESHOLDS CICS4A.TRAN,
              CRIT=(2,00:05),
              FREQ=(4,01:00),
              INFR=(5,24:00)
    
```

The THRESHOLDS entry will be migrated to entry type APL to the application with entry name CICS4A_sysname (application type CICS). Selecting policy item RESOURCE THRESHOLDS from this application and then selecting the CICS resource threshold TRAN that you want to see will present the following panel:

```

COMMANDS  HELP
-----
                                Thresholds Definition
Command ==>

Entry Type : Application          PolicyDB Name : DATABASE_NAME
Entry Name : CICS4A_sysname      Enterprise Name : YOUR_ENTERPRISE

Resource:   CICS4A.TRAN
Description:

Specify the number of times an event must occur to define a particular level.

----- Levels -----
Resource          Critical          Frequent          Infrequent
                  Number Interval    Number Interval    Number Interval
                  (hh:mm)          (hh:mm)          (hh:mm)
CICSK4D.TRAN      02    00:05           04    01:00           05    24:00

```

SERVICE PERIODS

```

SERVICE CICS4A,
    DAY=(DAILY,0815-1715),
    DAY=(WEEKEND,DOWN-DOWN)

```

You can find this extract from the ACF under policy item SERVICE WINDOW of the service period with the entry name CICS4A (entry type SVP). The link between the application (APL) and the SVP can be found under policy item SERVICE PERIOD of entry type APL with entry name CICS4A_sysname.

TRIGGER DEFINITION

```

TRIGGER CICS4A,
    STARTUP=(SERVICE)

```

You can find this extract from the ACF under policy item CONDITION of the trigger with the entry name CICS4A (entry type TRG). The link between the application (APL) and the TRG can be found under policy item TRIGGER of entry type APL with entry name CICS4A_sysname.

Generating a Job for Batch Migrate

You can run a job for batch migration that performs the same processing as the Migration function of the customization dialog. The SINGSAMP sample library contains a sample job for this task in member INGEBMIG. Before submitting this job, you need to edit the jobcard appropriately as described in the sample itself.

Chapter 10. Automating Networks

Automation Network Definition Process	347	Defining an Outbound Gateway Autotask	349
Defining an SDF Focal Point System.	348	Defining Automatically-Initiated TAF Full-Screen	
Defining Gateway Sessions	349	Sessions	350

Automation Network Definition Process

This section summarizes the steps for defining an automation network to SA z/OS. More detail for each step of the process is provided later in this chapter.

1. Define your message forwarding paths between different systems. To do this, you define:
 - A primary focal point, where all notifications are sent.
 - An optional backup focal point, used when the primary focal point is unavailable.
 - Target systems, which are monitored and controlled by the focal point system.
 - Gateway sessions between the systems.

“Defining Gateway Sessions” on page 349 describes how to define gateway sessions.
2. Modify the NetView definitions to reflect your automation network configuration. The chapter on how to install SA z/OS on host systems in *System Automation for z/OS Planning and Installation* provides details.

For an example of the automation network definition process, also refer to the chapter about installing SA z/OS on host systems in *System Automation for z/OS Planning and Installation*.

These definitions create a path allowing message forwarding from target systems to the focal point system.

A message forwarding path is best implemented by defining systems in the following top-down manner:

1. Primary focal point system
2. Backup focal point system
3. Target systems

Defining the primary focal point first ensures that it is ready to handle forwarded messages as soon as forwarding is turned on for the target systems.

If the message forwarding path is not yet implemented on all systems in an automation network, messages are displayed to notification operators on the target systems. Once the message forwarding path is implemented, notifications are forwarded to the focal point system.

If the target systems are implemented first, additional overhead occurs because the target systems unsuccessfully attempt to forward notifications, and the notifications are logged in the NetView log.

Defining an SDF Focal Point System

The focal point system and backup focal point systems are defined using the *Network* entry type in the customization dialog. Each system has a single entry in the automation policy defining the next system or domain in the message forwarding path. Figure 259 shows an example automation network. In this example, the primary focal point system is CHI01. The backup focal point is CHI02.

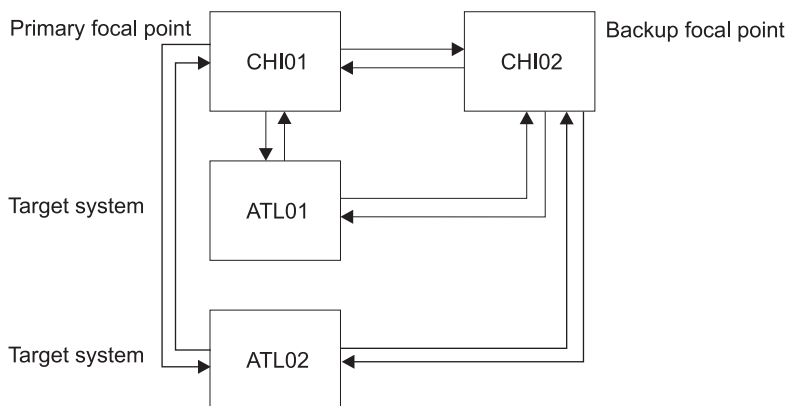

Figure 259. Focal Point Forwarding Definitions for Systems

The corresponding focal-point forwarding definitions in the automation policy for systems CHI02, ATL01 and ATL02 are as follows. You reach the required panel by selecting the FORWARD policy item of a *Network* entry type.

- CHI02 automation policy:

```

COMMANDS  HELP
-----
AOFpine2      Notification Forwarding
Command ==>>

Entry Type : Network          PolicyDB Name  : DATABASE_NAME
Entry Name  : FOCAL_NETWORK    Enterprise Name : YOUR_ENTERPRISE

Enter the NetView domains for automation notification forwarding.

Primary Domain ==> CHI01      Current Domain ID
Backup Domain  ==> &DOMAIN.   Backup Domain ID
  
```

Figure 260. Notification Forwarding Panel for CHI02

- ATL01 and ATL02 automation policy:

```

COMMANDS  HELP
-----
AOFpine2      Notification Forwarding
Command ==>>

Entry Type : Network          PolicyDB Name  : DATABASE_NAME
Entry Name  : FOCAL_NETWORK    Enterprise Name : YOUR_ENTERPRISE

Enter the NetView domains for automation notification forwarding.

Primary Domain ==> CHI01      Current Domain ID
Backup Domain  ==> CHI02     Backup Domain ID
  
```

Figure 261. Notification Forwarding Panel for ATL01 and ATL02

In Figure 259 on page 348, the automation policies for system CHI01 do not have any forward focal point definitions. This is because SA z/OS considers the current system as the primary focal point and displays messages *without* forwarding them if either or both of the following is true:

- The forward focal point is not defined in the automation policy for the system.
- The system specified in a forward focal point definition is the current system.

Defining Gateway Sessions

To define gateway sessions:

1. For each system, define the *outbound* gateway autotask (GATOPER) on the Auto Operators policy object of the customization dialog. See “Defining an Outbound Gateway Autotask” for details.
2. On the SA z/OS Network policy object, use the GATEWAY policy item to define the destination systems to which the originating system connects.
3. Define operator IDs used for all inbound and outbound gateway autotasks used on the system in the NetView DSIPARM data set member DSIOPF. See the chapter on how to install SA z/OS on host systems in *System Automation for z/OS Planning and Installation* for details.

Defining an Outbound Gateway Autotask

In any system, only the outbound gateway task is defined using the *Auto Operators* entry type.

If GATOPER has not previously been defined, type the automation operator name, *gatoper*, in the *Automated Function* field of the *Auto Operator Definition* policy item, as shown in Figure 262.

COMMANDS	ACTIONS	HELP

A0FP1A00	Automation Operator Definitions	Row 1 to 10 of 20
Command ==>		SCROLL==> PAGE
Entry Type : Auto Operators	PolicyDB Name : DATABASE_NAME	
Entry Name : CHI100PS	Enterprise Name : YOUR_ENTERPRISE	
Actions: S = Select M = Move B = Before A = After I = Insert		
Action	Automated Function	Messages for this Operator (* notation ok)
	<u>gatoper</u>	

Figure 262. Automation Operator Definitions Panel

You do not have to specify any messages for GATOPER. When you press Enter, the *Automation Operator NetView Userids* panel is displayed automatically, as shown in Figure 263 on page 350.

If GATOPER has previously been defined, then select it by entering an S in the *Action* column.

Automation Network Definition Process

Enter the NetView operator ID that is associated with the GATOPER function on the *Automation Operator NetView Userids* panel.

Note:

This NetView operator ID must be unique within the enterprise.

For example, to define the outbound gateway autotask for system CHI01 in the automation network shown in *System Automation for z/OS Planning and Installation*, the values shown in Figure 263 are specified.

```
COMMANDS  HELP
-----
AOFPIA01          Automation Operator NetView Userids
Command ==> _____

Entry Type : Auto Operators          PolicyDB Name : DATABASE_NAME
Entry Name : CHI100PS                Enterprise Name : YOUR_ENTERPRISE

Automated Function: GATOPER
Messages assigned:

Enter automation operators and NetView operator(s) to receive messages.

Automation Operators          NetView Operators
Primary ==> GAT&DOMAIN.        ==> _____
Backup  ==> _____          ==> _____
                                         ==> _____
                                         ==> _____
                                         ==> _____
```

Figure 263. Automation Operator NetView Userids Panel

Defining Automatically-Initiated TAF Full-Screen Sessions

You can automatically establish Terminal Access Facility (TAF) full-screen sessions for applications that SA z/OS monitors, so that the operators need not define the sessions on a daily basis.

These TAF full-screen sessions are defined in the FULL SESSIONS policy item for a *Network* policy object.

In addition to defining TAF full-screen sessions using the customization dialog, you follow the NetView process for customizing TAF full-screen sessions, as outlined in *Tivoli NetView for z/OS Customization Guide*

Once TAF full-screen sessions are set up, they can be managed using the TAF Fullscreen Menu in the SA z/OS Operator Interface. See *System Automation for z/OS User's Guide* for more information on managing TAF full-screen sessions.

To define an application on the *Fullscreen TAF Application Definition* panel that you reach by selecting the FULL SESSIONS policy item of a *Network* policy object, specify the following:

- The session name, or the name of the application for which a TAF full-screen session is to be established, for example, TSO. This name is displayed in the Description field on the TAF Fullscreen Menu operator panel. This value can be the same as that used for the application ID.

Defining Automatically-Initiated TAF Full-Screen Sessions

- The application ID. You can obtain this value from the library containing the network definitions (VTAMLST) or from your network system programmer.
- The system name on which the application runs, for example, CHI01. This is an information-only field and is displayed in the System field on the TAF Fullscreen Menu operator panel.

For example, the following panel defines a TAF full-screen session for TSO in system CHI01:

```
COMMANDS  HELP
-----
AOFpine3          Fullscreen TAF Application Definition  Row 1 to 10 of 20
Command ==>>    SCROLL==>> PAGE

Entry Type : Network          PolicyDB Name : DATABASE_NAME
Entry Name  : FOCAL_NETWORK    Enterprise Name : YOUR_ENTERPRISE

Enter the applications with which SA z/OS operators can establish TAF
sessions automatically using the operator interface.

Session Name  Application ID  System
  TSO         TAIN1         CHI01
  _____  _____  _____
  _____  _____  _____
  _____  _____  _____
  _____  _____  _____
  _____  _____  _____
  _____  _____  _____
  _____  _____  _____
  _____  _____  _____
```

Figure 264. Fullscreen TAF Application Definition Panel

Chapter 11. How System Operations Coordinates with Automatic Restart Manager

SA z/OS system operations provides coordination with the Automatic Restart Manager. The Automatic Restart Manager (ARM) is a base OS/390 component. It is a recovery function that automatically restarts designated applications when:

- The application abends.
- The system on which the application is running is part of a sysplex, and that system fails. In this case, ARM will attempt to restart the application on another system within the sysplex.

SA z/OS coordinates with ARM to:

- Determine which facility is responsible for restarting a specific application.
- Avoid possible duplications or conflicts in application recovery attempts.
- Allow you to take full advantage of SA z/OS fallback capabilities for applications running on sysplexes. SA z/OS continues to automate an application after it has been moved to a fallback system, provided SA z/OS is installed on that system. If it is not installed on the fallback system, SA z/OS is still aware that the application is active on a system other than its primary one and does not attempt to restart it.

You have to define the Automatic Restart Manager policy using the administrative data utility for ARM policy data (IXCMIAPU) described in *OS/390 MVS Setting Up a Sysplex*.

SA z/OS resolves Automatic Restart Manager statuses to SA z/OS statuses, incorporates Automatic Restart Manager-related conditions, and provides one status related to Automatic Restart Manager:

- EXTSTART - The application is being started or restarted externally.

Defining an ARM Element Name

Automatic Restart Manager uses element names to identify the applications with which it works. Each Automatic Restart Manager enabled application must have a unique element name for itself that it uses in all communication with Automatic Restart Manager. Automatic Restart Manager tracks the element name and has its policy defined in terms of element names. If an application moves between systems it **MUST** continue to use the same element name as it did on the original system. For more information on defining Automatic Restart Manager names to SA z/OS, see "Application Policy Object" on page 145.

All Automatic Restart Manager elements are unregistered initially. Transitions between statuses are caused by:

- IXCARM macro invocations
- Application failures
- System failures
- Timeouts

A minor resource definition *subsystem.OARM* can be used to tailor automation behaviour during ARM restart processing. As an example, a *subsystem.OARM* minor resource could be specified with a RESTART EXIT enabled to drive a user supplied

Defining an ARM Element Name

exit during ARM restart. The user exit would control additional actions to be taken during ARM restart of the subsystem. If the RESTART flag for this minor resource is resolved to 'N', SA z/OS will not allow ARM to attempt a restart of the application.

Rather than use the *subsystem.0ARM* minor resource definition, a RESTART EXIT could also be specified against the major resource definition for the application. In this case the exit would be driven for all application restarts, not just ARM.

Defining a MOVE Group for Automatic Restart Manager

All resources with the same ARM element name should be linked to one Sysplex Application Group of nature MOVE (MOVE group).

An application's ARM element name is defined either during creation on the *Define New Entry* panel for applications or after creation via policy item APPLICATION INFO, in both cases in the field *MVS Automatic Restart Management Element Name*.

In order to ensure an application in a MOVE group has completely deregistered from ARM before the automation manager attempts to restart it, a Prepareavailable/WhenObservedDown (passive) relationship must be defined for each ARMed application in the MOVE group with the MOVE group defined as the supporting resource.

For more information on how to define MOVE groups refer to "Creating a New ApplicationGroup" on page 125.

Chapter 12. Conversion Function

This chapter provides information on what you should be aware of before using the new release of SA z/OS. In detail, the following topics are discussed:

- “Moved and Restructured Data”
- “Initial Policy Database Conversion”

The conversion function creates a report named *\$RPTCNV* as a member in the data set of the policy database. All messages are logged.

Moved and Restructured Data

The following changes have been made:

- JES3 MONITOR for SA z/OS has been replaced by the new entry type MTR (MONITOR). Automatic conversion is *not* done during the initial conversion.
- For entry type APL, the *Jobtype* and *Transient Rerun* fields have been moved from policy item AUTOMATION INFO to APPLICATION INFO.
- For entry type SYS the Automation Symbol definitions have been moved from policy item SYSTEM INFO to AUTOMATION SYMBOLS.
- The selection value ALWAYS is no longer a special keyword for:
 - commands and replies in policy item MESSAGES/USER DATA
 - commands in policy item STARTUP

It is set to blank during initial conversion.

Initial Policy Database Conversion

During the very first opening of a policy database with the customization dialog, a conversion to the new layout is done automatically. There are special conversion options available by selecting *0 Settings* on the *Customization Dialog Primary Menu*, and then *4 CONVERT* on the *Customization Dialog Settings Menu*. This displays the *PDB Convert Option* panel, as shown in Figure 265 on page 356. This panel is used to specify the options for the PDB Conversion. These options will be saved in your ISPF profile pool and remain in effect until set again

On this panel, SA z/OS allows you to request the generation of an automation name for application groups during the very first conversion of a policy database. If an application group has an automation name, SA z/OS can generate resources from such entries.

Initial Policy Database Conversion

```
COMMANDS  HELP
-----
AOFGCOPT          PDB Convert Options
Command ==> _____

Specify how the following data should be set up during PDB converts. These
options will be saved in your ISPF profile pool and remain in effect until
set again.
The Set Message Type and APG Automation Name are used only for the initial
convert on all Policy Databases. The APL Relationship Type option will be
used for both the initial convert on all Policy Databases and any subsequent
convert triggered due to the usage of the Migrate function.

Set Message Type . . . . NO          YES NO
                                     Set to Ignore for AT build

APG Automation Name. . . NO         YES NO
(conversion from SA 1.3)           Set up name during convert

APL Relationship Type. . HASPARENT   HASPARENT HASPASSIVEPARENT
(conversion from SA 1.3            Define type for relationships
and migration)                    created during convert
```

Figure 265. PDB Convert Option Panel

This panel contains the following fields:

Set message type

Specify whether the message type should be set to *Ignore* for AT build during the *initial* policy database conversion, which is the very first conversion done during the first opening of the policy database:

YES

This indicates that the AUTO action that is used to define status message automation is set to IGNORE for those message IDs that are defined in the policy database and where no AT entry is forced by SA z/OS. No AT entry is then created for these messages during AT build. This allows for the gradual exploitation of the SA z/OS-generated AT for individually selected messages.

NO

This indicates that all message definitions remain unchanged. The messages will be used to build AT entries when running the Configuration Build process.

Note:

This option takes effect for the *initial* policy database conversion only. Subsequent conversions that might be triggered due to the usage of the Migrate function do not honor this option.

APG Automation Name

Specify whether an automation name should be set up during the initial policy database conversion. Select one of the following values:

YES Indicates that the automation name for each APG entry in the policy database will be set with the entry name of the APG entry, if it is less than or equal to 11 characters. If the entry name is more than 11 characters long, the automation name will be forced to blank.

NO Indicates that the automation name for each APG entry in the PDB will be filled with blank.

Notes:

1. This conversion option should be set to YES. Otherwise SA z/OS cannot generate resources for these entries. The default value is NO.
2. This option takes effect for the *initial* policy database conversion only. Subsequent conversions that might be triggered due to the usage of the Migrate function do not honor this option.
3. This applies only for conversion from SA OS/390 1.3.

APL Relationship Type

Specify the relationship type for relationships created during initial policy database conversion, which is the very first conversion done during the first opening of the policy database, and also for new relationships that are created by use of the MIGRATE function. Select one of the following:

HASPARENT

Indicates that relationships that are created will be set up as HASPARENT relationships. The PARENT/CHILD relationships from earlier releases of SA z/OS will be converted to HASPARENT relationships during the conversion process. A start request will be issued against the supporting resource (PARENT) if it is down, and a start request is issued against the supported resource (CHILD).

HASPASSIVEPARENT

Indicates that relationships that are created will be set up as HASPASSIVEPARENT relationships. The PARENT/CHILD relationships from earlier releases of SA z/OS will be converted to HASPASSIVEPARENT relationships during the conversion process. A start request will *not* be issued against the supporting resource (PARENT) if it is down, and a start request is issued against the supported resource (CHILD).

The default value is HASPARENT.

Notes:

1. The *APL Relationship Type* option takes effect for both the initial PDB conversion and any subsequent conversions that might be triggered by the use of the Migrate function.
2. This option applies only to conversion from SA OS/390 1.3.

Converted Data

During initial conversion the following data will be converted:

- The PARENTS of all applications will be converted to either HASPARENT or HASPASSIVEPARENT relationships.

Any instances that have inherited their startcmds or shutoptions parent relationships from a class will be assigned the new HASPARENT StartsMe/StopsMe relationships during the conversion process.

- The STARTUP definitions of all applications will be converted to EXTERNAL STARTUP definitions.

Initial Policy Database Conversion

- The SHUTOPTIONS definitions of all applications will be converted to EXTERNAL SHUTDOWN definitions.

Additionally, if a class/instance pair is converted from SA OS/390 1.3 where the instance originally inherited its SHUTOPTIONS from the class, the following translation will be performed during the ACF build process:

If a HASPARENT, or HASPASSIVEPARENT relationship of either StopsMe or StartsMeAndStopsMe exists for an instance and a similar relationship of either StopsMe or StartsMeAndStopsMe exists for a linked class, then the ACF build output will contain a SHUTOPTIONS value for the instance. The SHUTOPTIONS value for the instance will be taken from the HASPARENT or HASPASSIVEPARENT relationship of the instance and not the class.

This is depicted in the following example:

From SA OS/390 1.3:

```
SUBSYSTEM_CLASS SYS_CLASS,  
  PARENT=CLS_PARENT,  
  SHUTOPTIONS=(PARENT)
```

```
SUBSYSTEM SYS_INST  
  PARENT=INST_PARENT,  
  OBJECTCLASS=SYS_CLASS
```

To SA z/OS 2.3:

In the dialogs, the following relationships are generated during the conversion process:

For APL class SYS_CLASS

```
1  HASPARENT      CLS_PARENT/APL/=    (StopsMe)
```

For APL SYS_INST with Class SYS_CLASS

```
1  HASPARENT      INST_PARENT/APL/=  (Stopsme)
```

These entries will be built as:

```
SUBSYSTEM_CLASS SYS_CLASS,  
  PARENT=CLS_PARENT,  
  SHUTOPTIONS=(CLS_PARENT)
```

```
SUBSYSTEM SYS_INST,  
  PARENT=INST_PARENT,  
  OBJECTCLASS=SYS_CLASS,  
  SHUTOPTIONS=(INST_PARENT)
```

Example:

Imagine the following definitions for entry type *Application* from SA OS/390 1.3 on the *Application Automation Definition* panel:

```
Parents ... SUBSYS1, SUBSYS2, SUBSYS3  
Startup ... PARENT  
Shutoptions ... SUBSYS2, SUBSYS3
```

These will be converted to the following definitions:

- on the same *Application Automation Definition* panel:

```
External Startup ... ALWAYS  
External Shutdown ... ALWAYS
```

- the following relationships will be created and will be visible on the *Relationship Selection List* panel:

```

COMMANDS  ACTIONS  VIEW  HELP
-----
A0FGXREL                                Relationship Selection List
Command ==>>

Entry Type : Application                  PolicyDB Name : DATABASE_NAME
Entry Name : APPC                        Enterprise Name : YOUR_ENTERPRISE

Action #  Type                Supporting Resource                Auto  Chain
-----  -  -
_____  _1  HASPARENT                SUBSYS1/APL/=                      Auto  Chain
_____  _2  HASPARENT                SUBSYS2/APL/=                      Auto  Chain
_____  _3  HASPARENT                SUBSYS3/APL/=                      Auto  Chain

```

- For all applications which are linked to systems, resources will be created
- If the convert option is set to 'YES' then for all application groups which have an entryname of less than 11 characters, an automation name will be generated.
- For all application groups which are linked to systems or sysplex and an 'automation name' is given, resources are created
- For all application groups where a resource has been created, a resource-to-resource link will be created for each application which is linked to the application group.
- The commands specified under policy item RESTART for *Applications* will be converted to commands with message ID ACORESTART under policy item MESSAGES/USER DATA.
- Service period windows are converted to the new syntax in the following way:
 - As old service periods were the schedules where an application was expected to be active, they are converted to new UP service periods.
 - DOWN-DOWN service periods are converted to the new DOWN service periods from 00:00 - 24:00;
 - Service periods in **** notation are converted to 00:00 if they are coded as start time of the first service period;
 - Service periods in **** notation are converted to 24:00 if they are coded as stop time of the last service period;
- Service periods linked to triggers are converted to direct links to the application.
- User E-T pairs which refer to an existing subsystem name will be converted to the policy item MESSAGES/USER DATA. Depending on the keyword the data will be converted to the CMD, REPLY, CODE or USER part of the message.
- The policy items MVSDUMP AUTOMATION, SMFDUMP AUTOMATION, LOGREC AUTOMATION and SYSLOG AUTOMATION of entry type MVC do no longer exist. The data is converted to policy item MINOR RESOURCE FLAGS which is introduced for entry type MVC.
- The message which could be specified under policy 'THRESHOLD' for MVSDUMP, SMFDUMP, LOGREC and SYSLOG has been converted to policy 'MESSAGES/USER DATA'.
- The policy item 'MINOR RESOURCE FLAGS' of entry type SYS no longer exists. Minor resources of system (SYS) entries are converted to minor resources of MVS Components (MVC). To ensure this occurs, a new MVC entry is created with the following name structure *MVS_COMPn_sysid* where 'n' might be omitted or a number between 1 and 99 to ensure that a new entry is created and an existing one is not overwritten. Additionally a link is created between the newly created MVC entry and the SYS entry where the minor resources came from.

Initial Policy Database Conversion

- Resync of ACF prefix value for each entryname in the PDB with table AOFTETP (formally done during each ACF build).
- Since the introduction of SA OS/390 2.1 it is no longer possible to link different applications with the same subsystem name to the same system. Those links are deleted by the conversion by deleting the link between the application and the application group.
- All feature definitions are converted to product automation entries of the customization dialog.
- All PC-related processor data is deleted.
- All PC-related communication path data is deleted.
- All communication task data is deleted.
- Remaining processor and communication path data is converted to the new layout.
- Notify operators defined in entry type SYS are converted to the new separate entry type NFY.
- Auto message classes defined in the separate entry type AMC are converted to the entry type ENT.
- All systems of type TPF are deleted.
- Application data of IMS applications is converted to the new layout.
- User E-T pairs with the following entry type pairs are converted to the entry types PRO, APL and GRP:
 - PROCESSOR proname
 - IMAGECNTL subsysname
 - ENVIRON TEMP@SYSPLEX
- The SAVE definitions of timers are converted to the new layout.

Cross Reference of SA OS/390 1.3 Feature Keywords to SA z/OS 2.3 Customization Dialog Entries

In SA OS/390 1.3 you had two ways to define CICS, IMS or OPC keywords to SA OS/390 automation: you either edited the ACF directly or entered the keywords into the *User E-T Pairs* via the customization dialog and had SA OS/390 build the ACF.

These definitions are automatically converted to SA z/OS 2.3 Customization Dialog entries.

The feature keyword conversions either take place by using the Conversion function, when a policy database in SA OS/390 1.3 format is opened or by using the Migration functions, when an ACF is migrated (and type PRD is selected). Table 11 on page 361 contains details of all the entries that are migrated or converted for product automation.

The following terms are used in Table 11 on page 361:

Format change

This means the data entry format is slightly modified from the original ACF entries, refer to the Product Automation dialog documentation.

New This means that a new dialog function has been implemented for this definition.

Obsolete

This means that the original entry type no longer exists.

Table 11. Cross Reference of SA OS/390 1.3 Feature Keywords to SA z/OS 2.3 Dialog Entries

Keyword	SA z/OS 2.3 Migration/Conversion Target
CICS Keywords , where Application Messages is stated, this refers to the MESSAGES/USER DATA policy item of the appropriate CICS subsystem definition.	
ACORESTART	Application Messages
Automation Flags	Application Automation info
AUTOOPS	Auto Operators (not in CICSCNTL any more)
SDF	SDF
ENVIRON SETUP CICS	Obsolete
ENVIRON TIMEOUT	TIMEOUT
SHUTDOWN	Application
STARTUP	Application
SUBSYSTEM	Application (Application type = CICS)
THRESHOLDS	New <i>Application</i> policy item (CICS) RESOURCE THRESHOLDS
ABCODESYSTM	Application Messages
ABCODETRAN	Format change, Application Messages
AREA	Obsolete, new CICS State/Action, link to APL
CICSCNTL	New <i>Application</i> policy item CICS CONTROL
CICSGROUP	Obsolete, handled in base code
CONNECTION	New define connection, link to APL
EXTCOND	Migrated to entry type <i>Events</i>
HEALTHCHK	Format change, Application Messages
LISTSHUT	Format change, Application Messages
PRODUCT	Obsolete, new CICS State/Action, link to APL
RCVRSOS	Format change, Application Messages
RCVRTRAN	Format change, Application Messages
SERVICE	Migrated to entry type <i>Service Periods</i>
TRIGGER	Migrated to entry type <i>Triggers</i>
IMS Keywords , where Application Messages is stated, this refers to the MESSAGES/USER DATA policy item of the appropriate IMS subsystem definition.	
ABCODEPROG	Format change, Application Messages
ABCODES, ACTCODES, ALTCODES	Application Messages
ABCODETRAN	Format change, Application Messages
ACORESTART	Application Messages
AREA	Obsolete, new IMS State/Action, link to APL
AUTOOPS	Auto Operators (not in IMSCNTL any more)
BRO	Application Messages
CHE	Application Messages
CQS0031A	Application Messages
CQS0032A	Application Messages

Initial Policy Database Conversion

Table 11. Cross Reference of SA OS/390 1.3 Feature Keywords to SA z/OS 2.3 Dialog Entries (continued)

Keyword	SA z/OS 2.3 Migration/Conversion Target
CQS0033A	Application Messages
CQSET	Application Messages
DFS2142	Application Messages
DFS2161I	Application Messages
DFS2169I	Application Messages
DFS3258A	Application Messages
DFS3869A/DFS3869I	Application Messages
DFS554A	Application Messages
DFS810A	Application Messages
DFS989I	Application Messages
DFS994I	Application Messages
ENVIRON	New <i>Application</i> policy item IMS ENVIRON
ENVIRON SETUP	Obsolete
EXTCOND	Migrated to entry type <i>Events</i>
FORCE	Application Messages
HOLDQ	Application Messages
IMSCNTL	New <i>Application</i> policy item IMS CONTROL
IMS CRITMSG	Obsolete
IMSGROUP	no longer used
IMSRSENM	New, IMS RESOURCE NAME Policy
INITSTART	Application Messages
IPS	Application Messages
NTFYOP	Application Messages
OLDS	Application Messages
POSTCHKP	Application Messages
PRECHKP	Application Messages
PRODUCT	Obsolete, new IMS State/Action, link to APL
RECONS	Application Messages
RECOVERY	Application Messages
RELEASEQ	Application Messages
RESTART	Application Messages
RESTARTABORT	Application Messages
SDF	SDF policies
SERVICE	Migrated to entry type <i>Service Periods</i>
SHUTINIT	Application Messages
SHUTNORM	Application Messages
SHUTIMMED	Application Messages
SHUTFORCE	Application Messages
SHUTTYPES	Application Messages

Table 11. Cross Reference of SA OS/390 1.3 Feature Keywords to SA z/OS 2.3 Dialog Entries (continued)

Keyword	SA z/OS 2.3 Migration/Conversion Target
SNAPQ	Application Messages
START	Application Messages
STARTUP	Application Messages
STOPBMPREGION	Application Messages
STOPFPREGION	Application Messages
STOPREGION	Application Messages
STSFIL	New, ISF entry type, policy object IMS status file, policy item IMS STATUS FILE
SUBSYSTEM	Application Policy (TYPE=IMS)
TCO	Application Messages
TCOMEMBERS	Application Messages
THRESHOLDS	New IMS resource thresholds
TPABEND	Application Messages
TRIGGER	Migrated to entry type <i>Triggers</i>
UNLKAVM	Application Messages
UNLOCK	Application Messages
UP	Application Messages
USERSTART	Application Messages
VTAMTERMS	Application Messages
%INCLUDE	Obsolete (no longer permitted)
\$PI	Application Messages
\$SI	Application Messages
\$TI	Application Messages
OPC Keywords , where Application Messages is stated, this refers to the MESSAGES/USER DATA policy item of the appropriate OPC subsystem definition.	
OPCA (CODE)	Application Messages
OPCACMD	Application Messages
OPCA DOMAINID	New, WORKSTATION DOMAINS policy
ENVIRON OPCA0	New, OPC SYSTEM DETAILS policy
OPCAPARM	Application Messages
OPCA PCS	New, CONTROLLER DETAILS policy
OPCA OPCSRSTAT	New, SPECIAL RESOURCES policy linked to CONTROLLER DETAILS
OPCCNTL	New, Application OPC CONTROL policy

Selective Policy Database Conversion

After your entries have been migrated to the policy database, the conversion is done to convert the old data which might have been migrated to the policy database to the new format. The migration functions automatically start the conversion function.

Note:

The conversion function, after having migrated, will not start the product automation conversion as this has already been performed by the migration.

Generating a Job for Batch Conversion

You can run a job for batch conversion that performs the same processing as the conversion function of the customization dialog. The SINGSAMP sample library contains a sample job for this task in member INGEBCNV. Before submitting this job, you need to edit the jobcard appropriately as described in the sample itself.

Appendix A. Concurrent Customization by Multiple Users

Note:

Concurrent user access is supported for *Application*, *ApplicationGroup*, and *Monitor Resource*

Concurrent user access allows simultaneous update for applications and application groups, that means, several users can open the same policy database, select entry types *ApplicationGroup*, *Application*, and *Monitor Resource* and perform updates for different objects at the same time.

If such entry types have been updated, and several builds are issued for different output data sets, the changed object is rebuilt whenever there are changes since the last build for that output data set, thus guaranteeing consistent and complete automation control files.

The following subsections describe the consequences for users working simultaneously on these entry types within one policy database.

Concurrent User Access Capabilities

If a policy database is selected for processing (command *OPEN*), access to that policy database for other users is possible, that is, multiple opening of a policy database is supported.

Working on entry types other than *Application*, *ApplicationGroup*, or *Monitor Resource* with several users, or performing commands other than *OPEN* or *SELECT* against a policy database while an application, application group, or monitor resource is being edited, may not work.

This limitation depends on the data tables that are needed for the selected action or command, and it is indicated by specific messages. The most common situations are described in the following sections.

Policy Definitions Usage

If you want to change your Enterprise Policy Options by selecting option 10 on the *Customization Dialog Settings Menu* panel (see Figure 266 on page 370), while another user works with a policy database, the selection is not possible and an appropriate message is displayed.

On the other hand, if you are accessing the SA z/OS policy items for modification, this will prevent other users from accessing any policy item and an appropriate message is displayed.

Policy Database Selection

If you want to issue a *BUILD*, *DELETE*, *MIGRATE*, or *REPORT* command from the *Policy Data Base Selection* panel while another user has accessed the same policy database, the command is rejected and an appropriate message is displayed.

| You can only add or remove such links, if you exclusively access the entry types
| *Application*, *ApplicationGroup*, or *Monitor Resource*. If another user is currently
| editing them, then a message is displayed indicating that updates are not possible.

| The same is true for the trigger policy item where you can maintain the link of the
| current application, application group, or monitor resource to a trigger.

| **Automated NetView Automation Table Build**

| If you have the automated AT and MPFLSTSA build enabled (this is the default
| behavior), each policy change that affects the ATs or MPFLSTSA member is
| recorded for each system. This requires the exclusive access of entry type SYSTEM.
| If another user is currently using these files, then a message is displayed that
| updates are not possible.

Appendix B. More about Using the Customization Dialog

Getting Help	369	User-written Functions	377
Changing Your Customization Dialog Environment	369	Alternate Configuration Support	378
Extending Policy Definitions	371	How to Define Alternate Configurations for	
Defining Data Sets for Batch Processing	375	Systems	378
Define ISPF Temporary Data Sets for Batch		How to Build Alternate Configurations.	379
Build	376	Restrictions	379

Use this appendix to find out how to get help when using the customization dialog and how to change the customization dialog environment.

Getting Help

Online help is available for the customization dialog. You can display online help by entering the HELP command (or press the PF key associated with the HELP command) while on a particular dialog panel.

When selecting *HELP* from the action bar, the pull-down lists the following selections:

Automation Help

This help provides online information about important functions of the customization dialog. It combines the help panels of the functional panels within the customization dialog. This combination allows you to view the help panels sequentially, or you can choose selected topics from lists that are displayed on many of the help pages.

Changes for this Release

This panel provides a list of the changes and enhancements that have been added to the customization dialog for the different releases of version 2.

Changing Your Customization Dialog Environment

You can invoke the *Settings* function from the *Customization Dialog Primary Menu* or from the Menu pull-down of the *Policy Data Base Selection* panel.

The first three options on the *Customization Dialog Settings Menu* panel (see Figure 266 on page 370) allow you to change the customization dialog environment for your user ID. This is a usability function only and has no effect on the policy database contents.

Changing Your Customization Dialog Environment

```
MENU  HELP
-----
AOFGCUST          Customization Dialog Settings Menu
Option ==>>> _____

The following options apply only to your userid:

  1 ALIAS          Define alias for standard commands      ( AOFALIAS )
  2 DISPLAY       Define display characteristics      ( AOFDISPL )
  3 MESSAGE       Define message and logging options  ( AOFMSG   )
  4 CONVERT       Define PDB conversion options

The following options apply to all SA z/OS users:

 10 POLICY        Modify SA z/OS policy definitions    ( AOFPOLCY )
 11 DSNAMES      Define SA z/OS data set names        ( AOFDSNAM )
 12 WORKDSN      Define ISPF temporary data sets for batch build
```

Figure 266. SA z/OS Customization Dialog Settings Menu

ALIAS

This option allows you to change commands and command abbreviations that can be entered on the command line or action column in the customization dialog.

DISPLAY

This option allows you to change the line spacing for lists that appear in the customization dialog.

MESSAGE

This option allows you to specify the level of detail in the messages you receive when you run various customization dialog options or batch jobs, and whether or not the messages are written to the ISPF log.

These settings are stored in the ISPF application profile. To have them available to the batch processing (build or migrate), make sure that your ISPF profile data set is allocated to the table library, DDname: AOFTLIB, as described in “Defining Data Sets for Batch Processing” on page 375.

CONVERT

This option lets you specify whether SA z/OS should create an automation name for an *ApplicationGroup* resource during the very first conversion of a policy database. Refer to “Initial Policy Database Conversion” on page 355 for more information.

POLICY

See “Extending Policy Definitions” on page 371;

DSNAMES

See “Defining Data Sets for Batch Processing” on page 375;

WORKDSN

See “Define ISPF Temporary Data Sets for Batch Build” on page 376;

Extending Policy Definitions

With SA z/OS you can extend your policy definitions by creating new policy items or modifying existing ones. Any user-defined policy items that you create or modify are now kept separate from the SA z/OS policies. This means that with future releases of SA z/OS you will not have to redefine those policy items that you have created or modified.

To create new policy items or modify existing ones, you should perform the following steps:

1. Select option 10 *POLICY* from the *Customization Dialog Settings Menu* (see Figure 266 on page 370). The *Entry Type Selection* panel is then displayed, as shown in Figure 267 (this figure does not show all 36 available entry types).

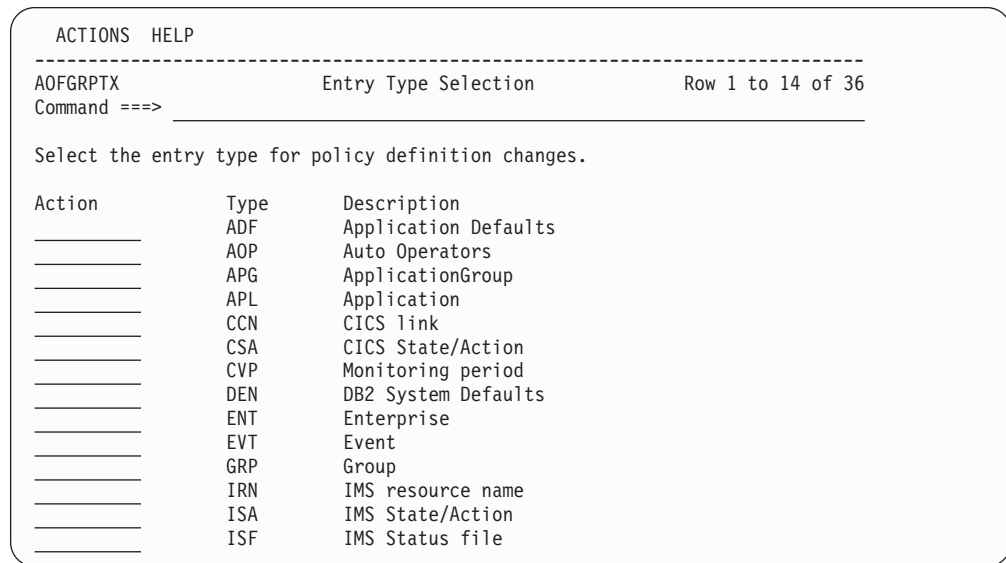

Figure 267. Entry Type Selection Panel

2. Select the entry type for which you want to create a new policy item or modify one. The *Edit Policy Selections* panel is displayed, listing all current policy items for this entry type, as shown in Figure 268 on page 372. Any user-defined policy items are indicated by *USR* in the *Status* column.

Changing Your Customization Dialog Environment

COMMANDS	ACTIONS	HELP	
AOFGCP01		Edit Policy Selections	
Command ==>		Row 1 to 14 of 46	
		SCROLL==> PAGE	
Entry Type : Group			
Act	Stat	Policy Name	Policy Description
---	SEL	DESCRIPTION	Enter description
---	SEL	LINK TO INSTANCES	Link class to instances
---	SEL	LINK TO CLASS	Link instance to class
---	USR	WAC INFO	Define WAC application information
---	SEL	AUTOMATION INFO	Define application automation information
---	SEL	AUTOMATION FLAGS	Define application automation flags
---	SEL	TRIGGER	Select trigger
---	SEL	SERVICE PERIOD	Select service period
---	SEL	RELATIONSHIPS	Define relationships
---	SEL	MESSAGES/USER DATA	Define application messages and user data
---	SEL	STARTUP	Define startup procedures
---	SEL	SHUTDOWN	Define shutdown procedures
---	SEL	THRESHOLDS	Define error thresholds
---	SEL	MINOR RESOURCE FLAGS	Define application sub-component flags

Figure 268. Edit Policy Selections Panel

3. On the *Edit Policy Selections* panel you can:
 - Create a new entry by entering NEW on the command line. The new entry is added to the top of the list.
 - Create a new entry by entering INSERT in the Action column. The new entry is added after the entry where INSERT was specified.
 - Edit an entry by entering EDIT in the Action column.

Note:

Any modifications to the existing SA z/OS policy definitions are solely your responsibility.

- Delete a user-defined entry by entering DELETE in the Action column.
 - Suppress an SA z/OS entry by entering REMOVE in the Action column.
 - Activate a deselected entry by entering SELECT in the Action column.
 - Leave this panel saving all changes by entering the END command.
 - Discard all changes by entering the CANCEL command.
4. If you choose to insert a new policy item for an entry type, or edit an existing policy item, the *Define Policy Selection* panel is displayed. The example in Figure 269 on page 373 shows how to define policy item APPLICATION INFO of entry type *Application*

```

COMMANDS  HELP
-----
A0FGCP02          Define Policy Selection
Command ==> _____

Entry Type : Application

Enter or update the following to define the Policy Definition:

Name . . . . . APPLICATION INFO
Description . . Define application information
Help Action . . PGM(ISPTUTOR) PARM(AOFHLP0)
Edit Action . . CMD(AOFF#POL AOFGLPA0,APL,EXIT(AOFFVAP1))
User Note . . .
. . .
. . .
. . .
. . .

Filter attributes . . _____
    
```

Figure 269. Define Policy Selection Panel

If you want to create policy items you must specify an ISPF action for the selection of the new policy item from the *Policy Selection* panel. You must then create your own ISPF input panel for the new policy item.

Each policy selection consists of information defining:

- How the policy appears on the *Policy Selection* panel.
- How the policy is processed when it is selected.
- Under what conditions the policy should be displayed.

This panel has the following fields:

Entry Type

Indicates the entry for which the policy is being defined. This field is set based on the entry type you had previously selected.

Policy Name

This is the name of the policy you are defining. It appears in the first column of the *Policy Selection* panel. This field is required.

Description

This is a short description of the policy. It appears in the second column of the *Policy Selection* panel. This field is required.

Help Action

Specifies the action to be taken when policy help is requested (by entering HELP in the Action column on the *Policy Selection* panel). The action must be a valid ISPF SELECT service. For example, to display an ISPF panel enter:

```
PGM(ISPTUTOR) PARM(panel-name)
```

The help text should describe the function provided by this policy rather than describing how to enter the data for the policy.

This field is optional; if no action is specified then *HELP* will not be available from the *Policy Selection* panel for this policy.

Edit Action

Specifies the action to be taken when the policy is selected from the *Policy Selection* panel. The action must be a valid ISPF SELECT Service. This field is required.

Changing Your Customization Dialog Environment

User Note

These fields are not shown on the *Policy Selection* panel. They can be used for documentation purposes. These fields are optional.

You can also specify filtering conditions, that is, attributes of the entry being processed from the *Policy Selection* panel that can be used to determine whether or not this policy should be displayed. The following filtering information can be specified:

Filter attributes

This specifies attributes that an entry must have in order for this policy to be displayed. This field contains multiple words, each word identifying one attribute. All the attributes specified must be satisfied in order for the policy to be displayed. If no attributes are specified then the policy is valid for all entries. The attributes that can be specified are defined by SA z/OS and differ based on the entry type, as shown in Table 12.

Table 12. Policy Selection Filter Attributes

Entry Type	Attribute	Value
Group	Group type	(blank) STANDARD SYSPLEX
System	Operating System type	(blank) CF LINUX MVS VM VSE
ApplicationGroup	ApplicationGroup type	(blank) SYSPLEX SYSTEM
Application	Object type	(blank) CLASS INSTANCE
	Application type	(blank) IMAGE JES2 JES3 CICS IMS DB2 OPC USS
Processor	Processor type/mode	(blank) LPAR ESA PSM
Others	none	

The following rules apply to the filtering attributes:

1. If no attributes are specified (indicated by *blank*) in Table 12), the policy is always displayed for all entries.
2. If multiple attributes are specified then all attributes must be satisfied in order for the policy to be displayed. For example:

Changing Your Customization Dialog Environment

JES2 CLASS This displays the policy for application entries that are classes and are of type JES2.

JES2 This displays the policy for application entries that are of type JES2 and either class or instances.

- For each ATTRIBUTE, the words listed in the VALUE column are mutually exclusive. If you specify both values the policy will never be displayed as both conditions cannot be true at the same time. For example:

JES2 JES3 This is never displayed because an application can be either JES2 or JES3 but not both.

- No validity checking is done on the attribute values. If an invalid value is specified the policy will never be displayed since the condition cannot be satisfied. For example:

JES4 This is never displayed because an application cannot be of type JES4.

Defining Data Sets for Batch Processing

Use Option 11 of the *Customization Dialog Settings Menu* panel to define the batch processing data sets. This needs to be done only once, when you install SA z/OS. For details, see *System Automation for z/OS Planning and Installation*.

To use the batch options of the build or migrate function you must first specify the names of the data sets required for the batch processing. These names form the DD name concatenations to be included in the JCL of the batch processing job.

COMMANDS		HELP	

AOFGCUSD		Data Set Customization Details	
Command ==>		SCROLL==> PAGE	
DDname	Seq Bas	Data set name	Volume Unit
AOFEXEC	98 YES	'ING.SINGIREX'	_____
AOFEXEC	99 YES	'SYS1.ISPF.ISPEXEC'	_____
AOFIPDB	99 YES	'ING.SINGIPDB'	_____
AOFLLIB	98 YES	'ING.SINGIMOD'	_____
AOFLLIB	99 YES	'SYS1.ISPF.ISPLOAD'	_____
AOFMLIB	98 YES	'ING.SINGIMSG'	_____
AOFMLIB	99 YES	'SYS1.ISPF.ISPMENU'	_____
AOFPLIB	98 YES	'ING.SINGIPNL'	_____
AOFPLIB	99 YES	'SYS1.ISPF.ISPPENU'	_____
AOFSLIB	98 YES	'ING.SINGISKL'	_____
AOFSLIB	99 YES	'SYS1.ISPF.ISPSLIB'	_____
AOFSTEP	99 YES	'ING.SINGIMOD'	_____
AOFTLIB	96 NO	'HART.ISPF.ISPPROF'	_____
AOFTLIB	97 NO	'HART.USER.SINGITBL'	_____
AOFTLIB	98 YES	'ING.SINGITBL'	_____
AOFTLIB	99 YES	'SYS1.ISPF.ISPTENU'	_____

Figure 270. SA z/OS Data Set Customization Details Panel

On the *Data Set Customization Details* panel, a table is displayed with groups of data definition (DD) names and data set names. You must modify the data set names in accordance with your local naming conventions.

Each column can be modified as follows:

DDname

No new DD names may be added, but another entry for an existing DD name may be added at the end of the table. It will be inserted at the

Changing Your Customization Dialog Environment

correct position within the table when saved. An entry may be deleted by blanking out the DD name, but if an entry is removed incorrectly then the batch functions become inoperative.

Seq This entry should contain a number from 1 to 99. This value will position the entry into the correct concatenation sequence when the JCL is built. The higher the number the further down the concatenation sequence it will appear. The values 98 and 99 are reserved.

Base The Base column indicates a reserved DD name entry and should not be removed. All entries that are not reserved (see the **Seq** column description) must have the value of "NO".

Data Set Name

This is the fully qualified data set name, including quotation marks, that are represented by this DD name.

Volume

May be left blank for catalogued data sets, otherwise enter the label ID of the volume on which this data set resides (as would be coded for an ALLOC JCL entry). SMS may be entered for any data set under space management.

Unit Must be left blank for catalogued and/or space managed data sets, otherwise you must enter the unit relevant to the volume on which this data set resides (as would be coded for an ALLOC JCL entry).

AOFIPDB is needed to get access to the automation manager logic file.

AOFTLIB needs two data sets to be allocated additionally to the ISPF and SA z/OS table libraries:

- The user's ISPF table output library is needed to get access to the tables with user modifications, for example, the data set specifications;
- The user's ISPF profile is needed to get access to the dialog settings, for example, messages and logging options.

In our example from Figure 270 on page 375, these are:

```
'HART.ISPF.ISPPROF'  
'HART.USER.SINGITBL'
```

Note:

The user's ISPF table output library should also be allocated to DDname AOFTABL.

Define ISPF Temporary Data Sets for Batch Build

Use Option 12 on the *Customization Dialog Settings Menu* panel to define the data sets for the batch build. SA z/OS displays the following panel:

```

MENU  OPTIONS  HELP
-----
AOFGWKDS      ISPF Temporary Data Sets Preallocation for Batch
Command ==>>>

                                                    More:  +
Specify ISPF work data sets, used by ISPF for processing file tailoring
services during batch build.

//ISPWRK1 DD DISP=NEW,UNIT=SYSALLDA,SPACE=(CYL,(5,10)),
//          DCB=(LRECL=256,RECFM=FB)
//ISPWRK2 DD DISP=NEW,UNIT=SYSALLDA,SPACE=(CYL,(5,10)),
//          DCB=(LRECL=256,RECFM=FB)
//ISPWRK3 DD DISP=NEW,UNIT=SYSALLDA,SPACE=(CYL,(5,10)),
//          DCB=(LRECL=256,RECFM=FB)
//ISPWRK4 DD DISP=NEW,UNIT=SYSALLDA,SPACE=(CYL,(5,10)),
//          DCB=(LRECL=256,RECFM=FB)
//ISPCTL1 DD DISP=NEW,UNIT=SYSALLDA,SPACE=(CYL,(5,10)),
//          DCB=(LRECL=80,RECFM=FB)

```

This panel allows to add or modify job control data to preallocate temporary ISPF data sets, which are used for the batch build. The build function creates the ACF and AMC output files in two steps. First, all members are created and stored into a temporary file using ISPF file tailoring. In a second step this file is written to disk creating all the individual members.

To hold the intermediate files, ISPF work and control data sets are used. If the default allocations of ISPF are not sufficient, they can be changed on this panel.

The DDnames ISPWRKx are used by ISPF for file tailoring services. The DDnames ISPCTLx are used by ISPF to hold the file tailoring output and to pass it to the subsequent functions that write the members to the output data set.

User-written Functions

Option *U User* on the *Customization Dialog Primary Menu* displays the *User-written Functions Selection Menu*. This menu allows for adding installation specific functions to the customization dialog.

As an example, one selection has already been provided:

```
1 - Transmit      Transmit build output to a remote node
```

If you select this option 1, SA z/OS displays the *Send Policy Data Base* panel (see Figure 271 on page 378), where you can distribute policy databases to remote nodes.

To add further selections, edit the panel (member AOFGUSR) and:

- add selection number and description to the panel)BODY section
- add a line to the TRANSLATE instruction in the panel)PROC section, containing the selection number and the command string which invokes the new function.

The *Send Policy Data Base* panel allows you to transmit a build output data set to a specified node and user ID.

User-written Functions

```
MENU  HELP
-----
AOFGCM DX                      Send Policy Data Base
Command ==>

To transmit the build output data set to a remote node,
specify or revise the following values:

Data set name . . . 'HART.DOCU.PDB'

Target:
User ID or nickname . . . SMITH   Node ID . . KEY1

Transmit command parameters:
Command parameters. . . .

To issue the transmit command, enter the SEND command ( PF6 ).
To exit from this panel without transmitting data, enter the CANCEL
or END command.
```

Figure 271. Send Policy Data Base Panel

With the parameter specified on this screen, a TSO TRANSMIT command is created. The transmission is started by issuing the SEND command (PF 6).

Data set name

This entry field is filled with the build output data set name of the current policy database, if that data set name is available. The name is always fully qualified and follows the TSO data set naming conventions.

User ID or nickname

allows to specify the target user ID or nickname. Input in this field is saved across sessions.

Node ID

allows to specify the target node. This field may remain empty, if a nickname has been specified. Input in this field is saved across sessions.

Command parameters

allows to specify parameters for the TRANSMIT command. Any values specified here are appended to the TRANSMIT command as they have been typed in. Input in this field is saved across sessions.

Alternate Configuration Support

There may be situations, for example, in disaster recovery or on weekends, when you want to have an alternative automation configuration for one or more systems out of your enterprise (policy database).

The customization dialog allows you to specify an alternate configuration by:

- marking a system as part of an alternate configuration
- allowing a specific build for normal or alternate configurations
- enforcing the build of normal or alternate configurations into different output data sets

All other definitions and links remain unchanged, for example, an application group can be linked to a normal systems, an alternate systems, or to both.

How to Define Alternate Configurations for Systems

For each system, either on the *Define New Entry* panel or in the policy item SYSTEM INFO, the existing MVS system name in field *MVS SYSNAME* allows you

to add a "+" sign to the system name. This will be used as an indication that this system belongs to the alternate configuration. The "+" sign can only be added to the end of the system name.

Furthermore, this "+" sign can be specified in the supporting resource definition of a relationship, and on the initial migration panel.

When a new system is defined and its processor operations name (in field *ProcOps name*) is defaulted with the MVS system name, any "+" is removed.

In the policy item AUTOMATION SETUP for *Systems* the fields *MVS SYSNAME* and *SDF Root Name* are defaulted with the MVS system name and any "+" is removed (see also Figure 88 on page 117).

When linking systems to a group or subgroup, the configuration type is not checked. If for example, a sysplex is intended for an alternate configuration, you have to ensure that only systems for this configuration are linked to that sysplex.

How to Build Alternate Configurations

The *Build Parameters* panel (see Figure 247 on page 319) has an option to select either a normal or alternate configuration build. The default is NORMAL. To avoid overwriting an existing configuration with wrong data, the build checks the configuration type in the build output data set. If there is already a configuration of a different type, the build is not started, and a warning message is displayed. If the policy database contains a normal and an alternate configuration, they have to be built into different output data sets.

Furthermore, the policy database name is checked to prevent an automation control file being destroyed by building a configuration into the wrong output data set.

When building an alternate configuration, all "+" signs are removed from the MVS system name. Thus the generated automation configuration files can be used for automation simply by switching the data sets.

If a policy database contains two configurations, the build picks out the systems that are linked to the selected configuration:

- The ACF map AOFACFMP contains only the systems marked for the selected configuration via the "+" sign added to the MVS system name.
- System include members (ACFZxxx) are generated only for the systems of the selected configuration.
- The AMC file, which is sysplex oriented, consists of members for each sysplex and standalone system. In each sysplex, it contains only the systems that are marked for the selected configuration, and standalone system members are created only for systems of the selected configuration.
- The ATs are generated only for the systems of the selected configuration.
- The MPFLSTSA member is built for the messages that belong to the selected configuration.

Restrictions

For performance reasons, the build with option 1, which is a build of the complete policy database, does not check each object as to which system it is linked to. So the build output data set will contain fragments of each object in the policy database, regardless of which configuration they are linked to. Of course,

Alternate Configuration Support

fragments of the wrong configuration cannot be accessed by automation, because they are not included via system main include members. However, the build output data sets need to be large enough to hold all fragments.

Furthermore, with build option 3, it is possible to update each fragment in a data set, independent of its link to a configuration.

The *Unlinked* report (see Chapter 7, “Creating Reports about Policy Databases,” on page 307) does not include relationships that have been defined across configurations. That means, if a relationship is defined between a resource in configuration NRM and another resource in configuration ALT, it is not included by the build function. However, the *Unlinked* report does not show it as not used.

It is not possible to define processor operations proxy resources for systems belonging to the alternate configuration, because the Processor Operations name must be different for all systems. For examples on how to use proxy definitions see *System Automation for z/OS Customizing and Programming*.

Appendix C. Message Definitions That Do Not Create AT Entries

The following are reserved keywords that must not be used as messages IDs otherwise no AT entry will be built for them:

ABENDED	ABENDING	ACORESTART	ACTIVE
AUTODOWN	BREAKING	BRO	BROKEN
CHE	CITIME	CQSET	CTLDOWN
DOMAINID	FORCE	HALTED	HOLDQ
INACTIVE	JESABEND	LOGREC	MDSCOUNTA- MDSCOUNTZ
MVSDUMP	MVSDUMPRESET	NOJSM	OPCACMD
POSTCHKP	PPIACTIVE	PRECHKP	RCVRTRAN
RCVRVIOL	RELEASEQ	RESTARTABORT	RUNNING
SHUTFORCEDDF	SHUTTYPES	SNAPQ	STADC
START	STARTED2	STOPBMPREGION	STOPFPREGION
STOPPED	STOPPING	STOPREGION	STUCK
TCO	UNLKAVM	UNLOCK	UP
VTAMTERMS			

Glossary

This glossary includes terms and definitions from:

- The *IBM Dictionary of Computing* New York: McGraw-Hill, 1994.
- The *American National Standard Dictionary for Information Systems*, ANSI X3.172-1990, copyright 1990 by the American National Standards Institute (ANSI). Copies can be purchased from the American National Standards Institute, 1430 Broadway, New York, New York 10018. Definitions are identified by the symbol (A) after the definition.
- The *Information Technology Vocabulary* developed by Subcommittee 1, Joint Technical Committee 1, of the International Organization for Standardization and the International Electrotechnical Commission (ISO/IEC JTC1/SC1). Definitions of published parts of this vocabulary are identified by the symbol (I) after the definition; definitions taken from draft international standards, committee drafts, and working papers being developed by ISO/IEC JTC1/SC1 are identified by the symbol (T) after the definition, indicating that final agreement has not yet been reached among the participating National Bodies of SC1.

The following cross-references are used in this glossary:

Contrast with. This refers to a term that has an opposed or substantively different meaning.

Deprecated term for. This indicates that the term should not be used. It refers to a preferred term, which is defined in its proper place in the glossary.

See. This refers the reader to multiple-word terms in which this term appears.

See also. This refers the reader to terms that have a related, but not synonymous, meaning.

Synonym for. This indicates that the term has the same meaning as a preferred term, which is defined in the glossary.

Synonymous with. This is a backward reference from a defined term to all other terms that have the same meaning.

A

ACF. Automation control file.

ACF/NCP. Advanced Communications Function for the Network Control Program. See *Advanced Communications Function* and *Network Control Program*.

ACF/VTAM. Advanced Communications Function for the Virtual Telecommunications Access Method. Synonym for *VTAM*. See *Advanced Communications Function* and *Virtual Telecommunications Access Method*.

active monitoring. In SA z/OS, the acquiring of resource status information by soliciting such information at regular, user-defined intervals. See also *passive monitoring*.

adapter. Hardware card that enables a device, such as a workstation, to communicate with another device, such as a monitor, a printer, or some other I/O device.

Address Space Workflow. In RMF, a measure of how a job uses system resources and the speed at which the job moves through the system. A low workflow indicates that a job has few of the resources it needs and is contending with other jobs for system resources. A high workflow indicates that a job has all the resources it needs to execute.

adjacent hosts. Systems connected in a peer relationship using adjacent NetView sessions for purposes of monitoring and control.

adjacent NetView. In SA z/OS, the system defined as the communication path between two SA z/OS systems that do not have a direct link. An adjacent NetView is used for message forwarding and as a communication link between two SA z/OS systems. For example, the adjacent NetView is used when sending responses from a focal point to a remote system.

Advanced Communications Function (ACF). A group of IBM licensed programs (principally VTAM, TCAM, NCP, and SSP) that use the concepts of Systems Network Architecture (SNA), including distribution of function and resource sharing.

advanced program-to-program communication (APPC). A set of inter-program communication services that support cooperative transaction processing in a Systems Network Architecture (SNA) network. APPC is the implementation, on a given system, of SNA's logical unit type 6.2.

alert. (1) In SNA, a record sent to a system problem management focal point or to a collection point to communicate the existence of an alert condition. (2) In NetView, a high-priority event that warrants immediate

attention. A database record is generated for certain event types that are defined by user-constructed filters.

alert condition. A problem or impending problem for which some or all of the process of problem determination, diagnosis, and resolution is expected to require action at a control point.

alert focal-point system. See entry for NPDA focal-point system under *focal—point system*.

alert threshold. An application or volume service value that determines the level at which SA z/OS changes the associated icon in the graphic interface to the alert color. SA z/OS may also issue an alert. See *warning threshold*.

AMC. (1) Automation Manager Configuration (2) The Auto Msg Classes entry type

APF. Authorized program facility.

API. Application programming interface.

APPC. Advanced program-to-program communications.

application. An z/OS subsystem or job monitored by SA z/OS.

Application entry. A construct, created with the customization dialogs, used to represent and contain policy for an application.

application group. A named set of applications. An application group is part of an SA z/OS enterprise definition and is used for monitoring purposes.

ApplicationGroup entry. A construct, created with the customization dialogs, used to represent and contain policy for an application group.

application program. (1) A program written for or by a user that applies to the user's work, such as a program that does inventory or payroll. (2) A program used to connect and communicate with stations in a network, enabling users to perform application-oriented activities.

ARM. Automatic restart management.

ASCB. Address space control block.

ASCB status. An application status derived by SA z/OS running a routine (the ASCB checker) that searches the z/OS address space control blocks (ASCBs) for address spaces with a particular job name. The job name used by the ASCB checker is the job name defined in the customization dialog for the application.

ASCII (American National Standard Code for Information Interchange). The standard code, using a coded character set consisting of 7-bit coded characters

(8-bit including parity check), for information interchange among data processing systems, data communication systems, and associated equipment. The ASCII set consists of control characters and graphic characters. (A)

ASF. Automation status file.

assist mode facility. An SA z/OS facility that uses SDF and enables interaction with automation before SA z/OS takes an automation action. SDF prompts the operator with a suggested action, then provides options for using that action, modifying and using the action, or canceling the action. Also called assist mode, it is enabled using the customization dialogs, or dynamically.

authorized program facility (APF). A facility that permits identification of programs that are authorized to use restricted functions.

automated function. SA z/OS automated functions are automation operators, NetView autotasks that are assigned to perform specific automation functions. However, SA z/OS defines its own synonyms, or *automated function names*, for the NetView autotasks, and these function names are referred to in the sample policy databases provided by SA z/OS. For example, the automation operator AUTBASE corresponds to the SA z/OS automated function BASEOPER.

automated console operations (ACO). The concept (versus a product) of using computers to perform a large subset of tasks ordinarily performed by operators, or assisting operators in performing these tasks.

automatic restart management. A z/OS recovery function that improves the availability of specified subsystems and applications by automatically restarting them under certain circumstances. Automatic restart management is a function of the Cross-System Coupling Facility (XCF) component of z/OS.

automatic restart management element name. In MVS 5.2 or later, z/OS automatic restart management requires the specification of a unique sixteen character name for each address space that registers with it. All automatic restart management policy is defined in terms of the element name, including SA z/OS's interface with it.

automation. The automatic initiation of actions in response to detected conditions or events. SA z/OS provides automation for z/OS applications, z/OS components, and remote systems that run z/OS. SA z/OS also provides tools that can be used to develop additional automation.

automation agent. In SA z/OS, the automation function is split up between the automation manager and the automation agents. The observing, reacting and doing parts are located within the NetView address

space, and are known as the *automation agents*. The automation agents are responsible for:

- recovery processing
- message processing
- active monitoring; they propagate status changes to the automation manager

| **automation configuration file.** The data set that
| consists of:

- | • the automation control file (ACF)
- | • the automation manager configuration file (AMC)
- | • the NetView automation table (AT)
- | • the MPFLSTSA member

automation control file (ACF). In SA z/OS, a file that contains system-level automation policy information. There is one master automation control file for each NetView system on which SA z/OS is installed. Additional policy information and all resource status information is contained in the policy database (PDB). The SA z/OS customization dialogs must be used to build the automation control files. They must not be edited manually.

automation flags. In SA z/OS, the automation policy settings that determine the operator functions that are automated for a resource and the times during which automation is active. When SA z/OS is running, automation is controlled by automation flag policy settings and override settings (if any) entered by the operator. Automation flags are set using the customization dialogs.

automation manager. In SA z/OS, the automation function is split up between the automation manager and the automation agents. The coordination, decision making and controlling functions are processed by each sysplex's *automation manager*.

The automation manager contains a model of all of the automated resources within the sysplex. The automation agents feed the automation manager with status information and perform the actions that the automation manager tells them to.

The automation manager provides *sysplex-wide* automation.

Automation Manager Configuration. The Automation Manager Configuration file (AMC) contains an image of the automated systems in a sysplex or of a standalone system.

Automation NetView. In SA z/OS the NetView that performs routine operator tasks with command procedures or uses other ways of automating system and network management, issuing automatic responses to messages and management services units.

automation operator. NetView automation operators are NetView autotasks that are assigned to perform specific automation functions. See also *automated*

function. NetView automation operators may receive messages and process automation procedures. There are no logged-on users associated with automation operators. Each automation operator is an operating system task and runs concurrently with other NetView tasks. An automation operator could be set up to handle JES2 messages that schedule automation procedures, and an automation statement could route such messages to the automation operator. Similar to *operator station task*. SA z/OS message monitor tasks and target control tasks are automation operators.

automation policy. The policy information governing automation for individual systems. This includes automation for applications, z/OS subsystems, z/OS data sets, and z/OS components.

automation policy settings. The automation policy information contained in the automation control file. This information is entered using the customization dialogs. You can display or modify these settings using the customization dialogs.

automation procedure. A sequence of commands, packaged as a NetView command list or a command processor written in a high-level language. An automation procedure performs automation functions and runs under NetView.

automation status file. In SA z/OS, a file containing status information for each automated subsystem, component or data set. This information is used by SA z/OS automation when taking action or when determining what action to take. In Release 2 and above of AOC/MVS, status information is also maintained in the operational information base.

automation table (AT). See *NetView automation table*.

autotask. A NetView automation task that receives messages and processes automation procedures. There are no logged-on users associated with autotasks. Each autotask is an operating system task and runs concurrently with other NetView tasks. An autotask could be set up to handle JES2 messages that schedule automation procedures, and an automation statement could route such messages to the autotasks. Similar to *operator station task*. SA z/OS message monitor tasks and target control tasks are autotasks. Also called *automation operator*.

available. In VTAM programs, pertaining to a logical unit that is active, connected, enabled, and not at its session limit.

B

basic mode. A central processor mode that does not use logical partitioning. Contrast with *logically partitioned (LPAR) mode*.

BCP Internal Interface. Processor function of CMOS-390, zSeries processor families. It allows the communication between basic control programs such as z/OS and the processor support element in order to exchange information or to perform processor control functions. Programs using this function can perform hardware operations such as ACTIVATE or SYSTEM RESET.

beaconing. The repeated transmission of a frame or messages (beacon) by a console or workstation upon detection of a line break or outage.

BookManager. An IBM product that lets users view softcopy documents on their workstations.

C

central processor (CP). The part of the computer that contains the sequencing and processing facilities for instruction execution, initial program load (IPL), and other machine operations.

central processor complex (CPC). A physical collection of hardware that consists of central storage, one or more central processors, timers, and channels.

central site. In a distributed data processing network, the central site is usually defined as the focal point for alerts, application design, and remote system management tasks such as problem management.

CFR/CFS and ISC/ISR. I/O operations can display and return data about integrated system channels (ISC) connected to a coupling facility and coupling facility receiver (CFR) channels and coupling facility sender (CFS) channels.

channel. A path along which signals can be sent; for example, data channel, output channel. See also *link*.

channel path identifier. A system-unique value assigned to each channel path.

CHPID. In SA z/OS, channel path ID; the address of a channel.

CHPID port. A label that describes the system name, logical partitions, and channel paths.

channel-attached. (1) Attached directly by I/O channels to a host processor (for example, a channel-attached device). (2) Attached to a controlling unit by cables, rather than by telecommunication lines. Contrast with *link-attached*. Synonymous with *local*.

CI. Console integration.

CICS/VS. Customer Information Control System for Virtual Storage.

CLIST. Command list.

clone. A set of definitions for application instances that are derived from a basic application definition by substituting a number of different system-specific values into the basic definition.

clone ID. A generic means of handling system-specific values such as the MVS SYSCLONE or the VTAM subarea number. Clone IDs can be substituted into application definitions and commands to customize a basic application definition for the system that it is to be instantiated on.

CNC. A channel path that transfers data between a host system image and an ESCON control unit. It can be point-to-point or switchable.

command. A request for the performance of an operation or the execution of a particular program.

command facility. The component of NetView that is a base for command processors that can monitor, control, automate, and improve the operation of a network. The successor to NCCF.

command list (CLIST). (1) A list of commands and statements, written in the NetView command list language or the REXX language, designed to perform a specific function for the user. In its simplest form, a command list is a list of commands. More complex command lists incorporate variable substitution and conditional logic, making the command list more like a conventional program. Command lists are typically interpreted rather than being compiled. (2) In SA z/OS, REXX command lists that can be used for automation procedures.

command procedure. In NetView, either a command list or a command processor.

command processor. A module designed to perform a specific function. Command processors, which can be written in assembler or a high-level language (HLL), are issued as commands.

Command Tree/2. An OS/2-based program that helps you build commands on an OS/2 window, then routes the commands to the destination you specify (such as a 3270 session, a file, a command line, or an application program). It provides the capability for operators to build commands and route them to a specified destination.

common commands. The SA z/OS subset of the CPC operations management commands.

common routine. One of several SA z/OS programs that perform frequently used automation functions. Common routines can be used to create new automation procedures.

Common User Access (CUA) architecture. Guidelines for the dialog between a human and a workstation or terminal.

communication controller. A type of communication control unit whose operations are controlled by one or more programs stored and executed in the unit or by a program executed in a processor to which the controller is connected. It manages the details of line control and the routing of data through a network.

communication line. Deprecated term for *telecommunication line*.

connectivity view. In SA z/OS, a display that uses graphic images for I/O devices and lines to show how they are connected.

console automation. The process of having NetView facilities provide the console input usually handled by the operator.

console connection. In SA z/OS, the 3270 or ASCII (serial) connection between a PS/2 computer and a target system. Through this connection, the workstation appears (to the target system) to be a console.

console integration (CI). A hardware facility that if supported by an operating system, allows operating system messages to be transferred through an internal hardware interface for display on a system console. Conversely, it allows operating system commands entered at a system console to be transferred through an internal hardware interface to the operating system for processing.

consoles. Workstations and 3270-type devices that manage your enterprise.

Control units. Hardware units that control I/O operations for one or more devices. You can view information about control units through I/O operations, and can start or stop data going to them by blocking and unblocking ports.

controller. A unit that controls I/O operations for one or more devices.

couple data set. A data set that is created through the XCF couple data set format utility and, depending on its designated type, is shared by some or all of the z/OS systems in a sysplex. See also *sysplex couple data set* and *XCF couple data set*.

coupling facility. The hardware element that provides high-speed caching, list processing, and locking functions in a sysplex.

CP. Central processor.

CPC. Central processor complex.

CPC operations management commands. A set of commands and responses for controlling the operation of System/390 CPCs.

CPC subset. All or part of a CPC. It contains the minimum *resource* to support a single control program.

CPCB. Command processor control block; an I/O operations internal control block that contains information about the command being processed.

CPU. Central processing unit. Deprecated term for *processor*.

cross-system coupling facility (XCF). XCF is a component of z/OS that provides functions to support cooperation between authorized programs running within a sysplex.

CTC. The channel-to-channel (CTC) channel can communicate with a CTC on another host for intersystem communication.

Customer Information Control System (CICS). A general-purpose transactional program that controls online communication between terminal users and a database for a large number of end users on a real-time basis.

customization dialogs. The customization dialogs are an ISPF application. They are used to customize the enterprise policy, like, for example, the enterprise resources and the relationships between resources, or the automation policy for systems in the enterprise. How to use these dialogs is described in *System Automation for z/OS Customizing and Programming*.

CVC. A channel operating in converted (CVC) mode transfers data in blocks and a CBY channel path transfers data in bytes. Converted CVC or CBY channel paths can communicate with a parallel control unit. This resembles a point-to-point parallel path and dedicated connection, regardless whether it passes through a switch.

D

DASD. Direct access storage device.

data services task (DST). The NetView subtask that gathers, records, and manages data in a VSAM file or a network device that contains network management information.

data set. The major unit of data storage and retrieval, consisting of a collection of data in one of several prescribed arrangements and described by control information to which the system has access.

data set members. Members of partitioned data sets that are individually named elements of a larger file that can be retrieved by name.

DBCS. Double-byte character set.

DCCF. Disabled console communication facility.

DCF. Document composition facility.

DELAY Report. An RMF report that shows the activity of each job in the system and the hardware and software resources that are delaying each job.

Devices. You can see information about all devices (such as printers, tape or disk drives, displays, or communications controllers) attached to a particular switch, and control paths and jobs to devices.

DEVR Report. An RMF report that presents information about the activity of I/O devices that are delaying jobs.

dialog. Interactive 3270 panels.

direct access storage device (DASD). A device in which the access time is effectively independent of the location of the data; for example, a disk.

disabled console communication facility (DCCF). A z/OS component that provides limited-function console communication during system recovery situations.

display. (1) To present information for viewing, usually on the screen of a workstation or on a hardcopy device. (2) Deprecated term for *panel*.

disk operating system (DOS). (1) An operating system for computer systems that use disks and diskettes for auxiliary storage of programs and data. (2) Software for a personal computer that controls the processing of programs. For the IBM Personal Computer, the full name is Personal Computer Disk Operating System (PCDOS).

distribution manager. The component of the NetView program that enables the host system to use, send, and delete files and programs in a network of computers.

domain. (1) An access method and its application programs, communication controllers, connecting lines, modems, and attached workstations. (2) In SNA, a system services control point (SSCP) and the physical units (PUs), logical units (LUs), links, link stations, and associated resources that the SSCP can control by means of activation requests and deactivation requests.

double-byte character set (DBCS). A character set, such as Kanji, in which each character is represented by a 2-byte code.

DP enterprise. Data processing enterprise.

| **DSIPARM.** This file is a collection of members of
| NetView's customization.

DST. Data Services Task.

E

EBCDIC. Extended binary-coded decimal interchange code. A coded character set consisting of 8-bit coded characters.

ECB. Event control block. A control block used to represent the status of an event.

EMCS. Extended multiple console support.

enterprise. An organization, such as a business or a school, that uses data processing.

| **enterprise monitoring.** Enterprise monitoring is used
| by SA z/OS to update the *NetView Management Console*
| (*NMC*) resource status information that is stored in the
| *Resource Object Data Manager (RODM)*. Resource status
| information is acquired by enterprise monitoring of the
| *Resource Measurement Facility (RMF) Monitor III* service
| information at user-defined intervals. SA z/OS stores
| this information in its operational information base,
| where it is used to update the information presented to
| the operator in graphic displays.

entries. Resources, such as processors, entered on panels.

entry type. Resources, such as processors or applications, used for automation and monitoring.

environment. Data processing enterprise.

error threshold. An automation policy setting that specifies when SA z/OS should stop trying to restart or recover an application, subsystem or component, or offload a data set.

ESA. Enterprise Systems Architecture.

eServer. Processor family group designator used by the SA z/OS customization dialogs to define a target hardware as member of the zSeries or 390-CMOS processor families.

event. (1) In NetView, a record indicating irregularities of operation in physical elements of a network. (2) An occurrence of significance to a task; for example, the completion of an asynchronous operation, such as an input/output operation. (3) Events are part of a trigger condition, in a way that if all events of a trigger condition have occurred, a *STARTUP* or *SHUTDOWN* of an application is performed.

exception condition. An occurrence on a system that is a deviation from normal operation. SA z/OS monitoring highlights exception conditions and allows an SA z/OS enterprise to be managed by exception.

extended recovery facility (XRF). A facility that minimizes the effect of failures in z/OS, VTAM, the host processor, or high availability applications during sessions between high availability applications and designated terminals. This facility provides an alternate subsystem to take over sessions from the failing subsystem.

F

fallback system. See *secondary system*.

field. A collection of bytes within a record that are logically related and are processed as a unit.

file manager commands. A set of SA z/OS commands that read data from or write data to the automation control file or the operational information base. These commands are useful in the development of automation that uses SA z/OS facilities.

focal point. In NetView, the focal-point domain is the central host domain. It is the central control point for any management services element containing control of the network management data.

focus host. A processor with the role in the context of a unified system image

focal point system. (1) A system that can administer, manage, or control one or more target systems. There are a number of different focal point systems associated with IBM automation products. (2) **NMC focal point system.** The NMC focal point system is a NetView system with an attached workstation server and LAN that gathers information about the state of the network. This focal point system uses RODM to store the data it collects in the data model. The information stored in RODM can be accessed from any LAN-connected workstation with NetView Management Console installed. (3) **NPDA focal point system.** This is a NetView system that collects all the NPDA alerts that are generated within your enterprise. It is supported by NetView. If you have SA z/OS installed the NPDA focal point system must be the same as your NMC focal point system. The NPDA focal point system is also known as the *alert focal point system*. (4) **SA z/OS Processor Operations focal point system.** This is a NetView system that has SA z/OS host code installed. The SA z/OS Processor Operations focal point system receives messages from the systems and operator consoles of the machines that it controls. It provides full systems and operations console function for its target systems. It can be used to IPL these systems. Note that some restrictions apply to the Hardware Management Console for an S/390 microprocessor cluster. (5) **SA z/OS SDF focal point system.** The SA z/OS SDF focal point system is an SA z/OS NetView system that collects status information from other SA z/OS NetViews within your enterprise. (6) **Status focal point system.** In NetView, the system to which STATMON, VTAM and NLDM send status information on network resources. If you have a NMC focal point, it must be on the same system as the Status focal point. (7) **Hardware Management Console.** Although not listed as a focal point, the Hardware Management Console acts as a focal point for the console functions of an S/390 microprocessor cluster. Unlike all the other focal points in this definition, the

Hardware Management Console runs on a LAN-connected workstation,

frame. For a System/390 microprocessor cluster, a frame contains one or two central processor complexes (CPCs), support elements, and AC power distribution.

full-screen mode. In NetView, a form of panel presentation that makes it possible to display the contents of an entire workstation screen at once. Full-screen mode can be used for fill-in-the-blanks prompting. Contrast with *line mode*.

G

gateway session. A NetView-NetView Task session with another system in which the SA z/OS outbound gateway operator logs onto the other NetView session without human operator intervention. Each end of a gateway session has both an inbound and outbound gateway operator.

generic alert. Encoded alert information that uses code points (defined by IBM and possibly customized by users or application programs) stored at an alert receiver, such as NetView.

generic routines. In SA z/OS, a set of self-contained automation routines that can be called from the NetView automation table, or from user-written automation procedures.

group. A collection of target systems defined through configuration dialogs. An installation might set up a group to refer to a physical site or an organizational or application entity.

group entry. A construct, created with the customization dialogs, used to represent and contain policy for a group.

group entry type. A collection of target systems defined through the customization dialog. An installation might set up a group to refer to a physical site or an organizational entity. Groups can, for example, be of type STANDARD or SYSPLEX.

H

Hardware Management Console. A console used by the operator to monitor and control a System/390 microprocessor cluster.

Hardware Management Console Application (HWMCA). A direct-manipulation object-oriented graphical user interface that provides single point of control and single system image for hardware elements. HWMCA provides customer grouping support, aggregated and real-time system status using colors, consolidated hardware messages support, consolidated operating system messages support, consolidated

service support, and hardware commands targeted at a single system, multiple systems, or a customer group of systems.

heartbeat. In SA z/OS, a function that monitors the validity of the status forwarding path between remote systems and the NMC focal point, and monitors the availability of remote z/OS systems, to ensure that status information displayed on the SA z/OS workstation is current.

help panel. An online panel that tells you how to use a command or another aspect of a product.

hierarchy. In the NetView program, the resource types, display types, and data types that make up the organization, or levels, in a network.

high-level language (HLL). A programming language that does not reflect the structure of any particular computer or operating system. For the NetView program, the high-level languages are PL/I and C.

HLL. High-level language.

host system. In a coupled system or distributed system environment, the system on which the facilities for centralized automation run. SA z/OS publications refer to target systems or focal-point systems instead of hosts.

host (primary processor). The processor at which you enter a command (also known as the *issuing processor*).

HWMCA. Hardware Management Console Application. Application for the graphic hardware management console that monitors and controls a central processor complex. It is attached to a target processor (a system 390 microprocessor cluster) as a dedicated system console. This microprocessor uses OCF to process commands.

I

images. A grouping of processors and I/O devices that you define. You can define a single-image mode that allows a multiprocessor system to function as one central processor image.

IMS/VS. Information Management System/Virtual Storage.

inbound. In SA z/OS, messages sent to the focal-point system from the PC or target system.

inbound gateway operator. The automation operator that receives incoming messages, commands, and responses from the outbound gateway operator at the sending system. The inbound gateway operator handles communications with other systems using a gateway session.

Information Management System/Virtual Storage (IMS/VS). A database/data communication (DB/DC) system that can manage complex databases and networks. Synonymous with IMS.

INGEIO PROC. The I/O operations default procedure name; part of the SYS1.PROCLIB.

initial program load (IPL). (1) The initialization procedure that causes an operating system to commence operation. (2) The process by which a configuration image is loaded into storage at the beginning of a workday or after a system malfunction. (3) The process of loading system programs and preparing a system to run jobs.

initialize automation. SA z/OS-provided automation that issues the correct z/OS start command for each subsystem when SA z/OS is initialized. The automation ensures that subsystems are started in the order specified in the automation control file and that prerequisite applications are functional.

input/output support processor (IOSP). The hardware unit that provides I/O support functions for the primary support processor and maintenance support functions for the processor controller.

Interactive System Productivity Facility (ISPF). An IBM licensed program that serves as a full-screen editor and dialog manager. Used for writing application programs, it provides a means of generating standard screen panels and interactive dialogs between the application programmer and the terminal user.

interested operator list. The list of operators who are to receive messages from a specific target system.

internal token. A *logical token* (LTOK); name by which the I/O resource or object is known; stored in IODF.

IOCDs. I/O configuration data set. The data set that describes the I/O configuration.

I/O Ops. I/O operations.

IOSP. Input/Output Support Processor.

I/O operations. The part of SA z/OS that provides you with a single point of logical control for managing connectivity in your active I/O configurations. I/O operations takes an active role in detecting unusual conditions and lets you view and change paths between a processor and an I/O device, using dynamic switching (the ESCON director). Also known as I/O Ops.

I/O resource number. Combination of channel path identifier (CHPID), device number, etc. See internal token.

IPL. Initial program load.

ISA. Industry Standard Architecture.

ISPF. Interactive System Productivity Facility.

ISPF console. From this 3270-type console you are logged onto ISPF to use the runtime panels for I/O operations and SA z/OS customization panels.

issuing host. See *primary host*; the base program at which you enter a command for processing.

J

JCL. Job control language.

JES. Job entry subsystem.

job. (1) A set of data that completely defines a unit of work for a computer. A job usually includes all necessary computer programs, linkages, files, and instructions to the operating system. (2) An address space.

job control language (JCL). A problem-oriented language designed to express statements in a job that are used to identify the job or describe its requirements to an operating system.

job entry subsystem (JES). A facility for spooling, job queuing, and managing I/O. In SA z/OS publications, JES refers to JES2 or JES3, unless distinguished as being either one or the other.

K

Kanji. An ideographic character set used in Japanese. See also *double-byte character set*.

L

LAN. Local area network.

line mode. A form of screen presentation in which the information is presented a line at a time in the message area of the terminal screen. Contrast with *full-screen mode*.

link. (1) In SNA, the combination of the link connection and the link stations joining network nodes; for example, a System/370 channel and its associated protocols, a serial-by-bit connection under the control of synchronous data link control (SDLC). (2) In SA z/OS, link connection is the physical medium of transmission.

link-attached. Describes devices that are physically connected by a telecommunication line. Contrast with *channel-attached*.

Linux for zSeries and S/390. UNIX-like open source operating system conceived by Linus Torvalds and developed across the internet.

local. Pertaining to a device accessed directly without use of a telecommunication line. Synonymous with *channel-attached*.

local area network (LAN). (1) A network in which a set of devices is connected for communication. They can be connected to a larger network. See also *token ring*. (2) A network in which communications are limited to a moderately-sized geographic area such as a single office building, warehouse, or campus, and that do not generally extend across public rights-of-way.

logical partition (LP). A subset of the processor hardware that is defined to support an operating system. See also *logically partitioned (LPAR) mode*.

logical switch number (LSN). Assigned with the switch parameter of the CHPID macro of the IOCP.

logical token (LTOK). Resource number of an object in the IODF.

logical unit (LU). In SNA, a port through which an end user accesses the SNA network and the functions provided by system services control points (SSCPs). An LU can support at least two sessions — one with an SSCP and one with another LU — and may be capable of supporting many sessions with other LUs. See also *physical unit (PU)* and *system services control point (SSCP)*.

logical unit (LU) 6.2. A type of logical unit that supports general communications between programs in a distributed processing environment. LU 6.2 is characterized by (a) a peer relationship between session partners, (b) efficient use of a session for multiple transactions, (c) comprehensive end-to-end error processing, and (d) a generic application program interface (API) consisting of structured verbs that are mapped into a product implementation. Synonym for advanced program-to-program communications (APPC).

logically partitioned (LPAR) mode. A central processor mode that enables an operator to allocate system processor hardware resources among several logical partitions. Contrast with *basic mode*.

LOGR. The sysplex logger.

LP. Logical partition.

LPAR. Logically partitioned (mode).

LU. Logical unit.

LU-LU session. In SNA, a session between two logical units (LUs) in an SNA network. It provides communication between two end users, or between an end user and an LU services component.

LU 6.2. Logical unit 6.2.

LU 6.2 session. A session initiated by VTAM on behalf of an LU 6.2 application program, or a session initiated by a remote LU in which the application program specifies that VTAM is to control the session by using the APPCCMD macro.

M

| **MAT.** Deprecated term for NetView Automation Table.

MCA. Micro Channel* architecture.

MCS. Multiple console support.

member. A specific function (one or more modules/routines) of a multisystem application that is defined to XCF and assigned to a group by the multisystem application. A member resides on one system in the sysplex and can use XCF services to communicate (send and receive data) with other members of the same group.

| **message automation table (MAT).** Deprecated term
| for NetView Automation Table.

message class. A number that SA z/OS associates with a message to control routing of the message. During automated operations, the classes associated with each message issued by SA z/OS are compared to the classes assigned to each notification operator. Any operator with a class matching one of the message's classes receives the message.

message forwarding. The SA z/OS process of sending messages generated at an SA z/OS target system to the SA z/OS focal-point system.

message group. Several messages that are displayed together as a unit.

message monitor task. A task that starts and is associated with a number of communications tasks. Message monitor tasks receive inbound messages from a communications task, determine the originating target system, and route the messages to the appropriate target control tasks.

message processing facility (MPF). A z/OS table that screens all messages sent to the z/OS console. The MPF compares these messages with a customer-defined list of messages on which to automate, suppress from the z/OS console display, or both, and marks messages to automate or suppress. Messages are then broadcast on the subsystem interface (SSI).

message suppression. The ability to restrict the amount of message traffic displayed on the z/OS console.

Micro Channel architecture. The rules that define how subsystems and adapters use the Micro Channel bus in a computer. The architecture defines the services that each subsystem can or must provide.

microprocessor. A processor implemented on one or a small number of chips.

migration. Installation of a new version or release of a program to replace an earlier version or release.

MP. Multiprocessor.

MPF. Message processing facility.

| **MPFLSTSA.** The MPFLST member that is built by
| SA z/OS.

Multiple Virtual Storage (MVS). An IBM licensed program. MVS, which is the predecessor of OS/390, is an operating system that controls the running of programs on a System/390 or System/370 processor. MVS includes an appropriate level of the Data Facility Product (DFP) and Multiple Virtual Storage/Enterprise Systems Architecture System Product Version 5 (MVS/ESA SP5).

multiprocessor (MP). A CPC that can be physically partitioned to form two operating processor complexes.

multisystem application. An application program that has various functions distributed across z/OS images in a multisystem environment.

multisystem environment. An environment in which two or more z/OS images reside in one or more processors, and programs on one image can communicate with programs on the other images.

MVS. Multiple Virtual Storage, predecessor of z/OS.

MVS image. A single occurrence of the MVS/ESA operating system that has the ability to process work.

MVS/JES2. Multiple Virtual Storage/Job Entry System 2. A z/OS subsystem that receives jobs into the system, converts them to internal format, selects them for execution, processes their output, and purges them from the system. In an installation with more than one processor, each JES2 processor independently controls its job input, scheduling, and output processing.

MVS/ESA. Multiple Virtual Storage/Enterprise Systems Architecture.

N

NAU. (1) Network accessible unit. (2) Network addressable unit.

NCCF. Network Communications Control Facility.

NCP. (1) Network Control Program (IBM licensed program). Its full name is Advanced Communications Function for the Network Control Program. Synonymous with *ACF/NCP*. (2) Network control program (general term).

NetView. An IBM licensed program used to monitor a network, manage it, and diagnose network problems. NetView consists of a command facility that includes a presentation service, command processors, automation based on command lists, and a transaction processing structure on which the session monitor, hardware monitor, and terminal access facility (TAF) network management applications are built.

network accessible unit (NAU). A logical unit (LU), physical unit (PU), control point (CP), or system services control point (SSCP). It is the origin or the destination of information transmitted by the path control network. Synonymous with *network addressable unit*.

network addressable unit (NAU). Synonym for *network accessible unit*.

NetView automation procedures. A sequence of commands, packaged as a NetView command list or a command processor written in a high-level language. An automation procedure performs automation functions and runs under the NetView program.

| **NetView automation table (AT).** A table against
| which the NetView program compares incoming
| messages. A match with an entry triggers the specified
| response. SA z/OS entries in the NetView automation
| table trigger an SA z/OS response to target system
| conditions. Formerly known as the message automation
| table (MAT).

NetView Command list language. An interpretive language unique to NetView that is used to write command lists.

NetView (NCCF) console. A 3270-type console for NetView commands and runtime panels for system operations and processor operations.

NetView Graphic Monitor Facility (NGMF).
Deprecated term for NetView Management Console.

NetView hardware monitor. The component of NetView that helps identify network problems, such as hardware, software, and microcode, from a central control point using interactive display techniques. Formerly called *network problem determination application*.

NetView log. The log in which NetView records events pertaining to NetView and SA z/OS activities.

NetView message table. See *NetView automation table*.

| **NetView Management Console (NMC).** A function of
| the NetView program that provides a graphic,
| topological presentation of a network that is controlled
| by the NetView program. It provides the operator
| different views of a network, multiple levels of
| graphical detail, and dynamic resource status of the
| network. This function consists of a series of graphic

| windows that allows you to manage the network
| interactively. Formerly known as the NetView Graphic
| Monitor Facility (NGMF).

NetView-NetView task (NNT). The task under which a cross-domain NetView operator session runs. Each NetView program must have a NetView-NetView task to establish one NNT session. See also *operator station task*.

NetView-NetView Task session. A session between two NetView programs that runs under a NetView-NetView Task. In SA z/OS, NetView-NetView Task sessions are used for communication between focal point and remote systems.

NetView paths via logical unit (LU 6.2). A type of network-accessible port (VTAM connection) that enables end users to gain access to SNA network resources and communicate with each other. LU 6.2 permits communication between processor operations and the workstation.

network. (1) An interconnected group of nodes. (2) In data processing, a user application network. See *SNA network*.

Network Communications Control Facility (NCCF). The operations control facility for the network. NCCF consists of a presentation service, command processors, automation based on command lists, and a transaction processing structure on which the network management applications NLDM and NPDA are built. NCCF is a precursor to the NetView command facility.

Network Control Program (NCP). An IBM licensed program that provides communication controller support for single-domain, multiple-domain, and interconnected network capability. Its full name is Advanced Communications Function for the Network Control Program.

Networking NetView. In SA z/OS the NetView that performs network management functions, such as managing the configuration of a network. In SA z/OS it is common to also route alerts to the Networking NetView.

Network Problem Determination Application (NPDA). An NCCF application that helps you identify network problems, such as hardware, software, and microcode, from a central control point using interactive display methods. The alert manager for the network. The precursor of the NetView hardware monitor.

NGMF. Deprecated term for NetView Management Console.

NGMF focal-point system. Deprecated term for NMC focal point system.

NIP. Nucleus initialization program.

NMC focal point system. See *focal point system*

NMC workstation. The NMC workstation is the primary way to dynamically monitor SA z/OS systems. From the windows, you see messages, monitor status, view trends, and react to changes before they cause problems for end users. You can use multiple windows to monitor multiple views of the system.

NNT. NetView-NetView task.

notification message. An SA z/OS message sent to a human notification operator to provide information about significant automation actions. Notification messages are defined using the customization dialogs.

notification operator. A NetView console operator who is authorized to receive SA z/OS notification messages. Authorization is made through the customization dialogs.

NPDA. Network Problem Determination Application.

NPDA focal-point system. See *focal-point system*.

NTRI. NCP/token-ring interconnection.

nucleus initialization program (NIP). The program that initializes the resident control program; it allows the operator to request last-minute changes to certain options specified during system generation.

O

objective value. An average Workflow or Using value that SA z/OS can calculate for applications from past service data. SA z/OS uses the objective value to calculate warning and alert thresholds when none are explicitly defined.

OCA. In SA z/OS, operator console A, the active operator console for a target system. Contrast with *OCB*.

OCB. In SA z/OS, operator console B, the backup operator console for a target system. Contrast with *OCA*.

OCF. Operations command facility.

OCF-based processor. A central processor complex that uses an operations command facility for interacting with human operators or external programs to perform operations management functions on the CPC.

OPC/A. Operations Planning and Control/Advanced.

OPC/ESA. Operations Planning and Control/Enterprise Systems Architecture.

operating system (OS). Software that controls the execution of programs and that may provide services such as resource allocation, scheduling, input/output

control, and data management. Although operating systems are predominantly software, partial hardware implementations are possible. (T)

operations. The real-time control of a hardware device or software function.

operations command facility (OCF). A facility of the central processor complex that accepts and processes operations management commands.

Operations Planning and Control/Advanced (OPC/A). A set of IBM licensed programs that automate, plan, and control batch workload. OPC/A analyzes system and workload status and submits jobs accordingly.

Operations Planning and Control/ESA (OPC/ESA). A set of IBM licensed programs that automate, plan, and control batch workload. OPC/ESA analyzes system and workload status and submits jobs accordingly. The successor to OPC/A.

operator. (1) A person who keeps a system running. (2) A person or program responsible for managing activities controlled by a given piece of software such as z/OS, the NetView program, or IMS. (3) A person who operates a device. (4) In a language statement, the lexical entity that indicates the action to be performed on operands.

operator console. (1) A functional unit containing devices that are used for communications between a computer operator and a computer. (T) (2) A display console used for communication between the operator and the system, used primarily to specify information concerning application programs and I/O operations and to monitor system operation. (3) In SA z/OS, a console that displays output from and sends input to the operating system (z/OS, LINUX, VM, VSE). Also called *operating system console*. In the SA z/OS operator commands and configuration dialogs, OC is used to designate a target system operator console.

operator station task (OST). The NetView task that establishes and maintains the online session with the network operator. There is one operator station task for each network operator who logs on to the NetView program.

operator view. A set of group, system, and resource definitions that are associated together for monitoring purposes. An operator view appears as a graphic display in the graphic interface showing the status of the defined groups, systems, and resources.

OperatorView entry. A construct, created with the customization dialogs, used to represent and contain policy for an operator view.

OS. Operating system.

z/OS component. A part of z/OS that performs a specific z/OS function. In SA z/OS, component refers to entities that are managed by SA z/OS automation.

z/OS subsystem. Software products that augment the z/OS operating system. JES and TSO/E are examples of z/OS subsystems. SA z/OS includes automation for some z/OS subsystems.

z/OS system. A z/OS image together with its associated hardware, which collectively are often referred to simply as a system, or z/OS system.

OSA. I/O operations can display the open system adapter (OSA) channel logical definition, physical attachment, and status. You can configure an OSA channel on or off.

OST. Operator station task.

outbound. In SA z/OS, messages or commands from the focal-point system to the target system.

outbound gateway operator. The automation operator that establishes connections to other systems. The outbound gateway operator handles communications with other systems through a gateway session. The automation operator sends messages, commands, and responses to the inbound gateway operator at the receiving system.

P

page. (1) The portion of a panel that is shown on a display surface at one time. (2) To transfer instructions, data, or both between real storage and external page or auxiliary storage.

panel. (1) A formatted display of information that appears on a terminal screen. Panels are full-screen 3270-type displays with a monospaced font, limited color and graphics. (2) By using SA z/OS panels you can see status, type commands on a command line using a keyboard, configure your system, and passthru to other consoles. See also *help panel*. (3) In computer graphics, a display image that defines the locations and characteristics of display fields on a display surface. Contrast with *screen*.

parallel channels. Parallel channels operate in either byte (BY) or block (BL) mode. You can change connectivity to a parallel channel operating in block mode.

parameter. (1) A variable that is given a constant value for a specified application and that may denote the application. (2) An item in a menu for which the user specifies a value or for which the system provides a value when the menu is interpreted. (3) Data passed to a program or procedure by a user or another program, namely as an operand in a language statement, as an item in a menu, or as a shared data structure.

partition. (1) A fixed-size division of storage. (2) In VSE, a division of the virtual address area that is available for program processing. (3) On an IBM Personal Computer fixed disk, one of four possible storage areas of variable size; one can be accessed by DOS, and each of the others may be assigned to another operating system.

partitionable CPC. A CPC that can be divided into 2 independent CPCs. See also *physical partition*, *single-image mode*, *MP*, *side*.

partitioned data set (PDS). A data set in direct access storage that is divided into partitions, called *members*, each of which can contain a program, part of a program, or data.

passive monitoring. In SA z/OS, the receiving of unsolicited messages from z/OS systems and their resources. These messages can prompt updates to resource status displays. See also *active monitoring*.

PCE. Processor controller. Also known as the “support processor” or “service processor” in some processor families.

| **PDB.** Policy Database

PDS. Partitioned data set.

physical partition. Part of a CPC that operates as a CPC in its own right, with its own copy of the operating system.

physical unit (PU). In SNA, the component that manages and monitors the resources (such as attached links and adjacent link stations) of a node, as requested by a system services control point (SSCP) through an SSCP-PU session. An SSCP activates a session with the physical unit to indirectly manage, through the PU, resources of the node such as attached links.

physically partitioned (PP) configuration. A mode of operation that allows a multiprocessor (MP) system to function as two or more independent CPCs having separate power, water, and maintenance boundaries. Contrast with *single-image (SI) configuration*.

POI. Program operator interface.

policy. The automation and monitoring specifications for an SA z/OS enterprise. See *System Automation for z/OS Defining Automation Policy*.

| **policy database.** The database where the automation policy is recorded. Also known as the PDB.

POR. Power-on reset.

port. (1) System hardware to which the I/O devices are attached. (2) On an ESCON switch, a port is an addressable connection. The switch routes data through the ports to the channel or control unit. Each port has a name that can be entered into a switch matrix, and you

can use commands to change the switch configuration. (3) An access point (for example, a logical unit) for data entry or exit. (4) A functional unit of a node through which data can enter or leave a data network. (5) In data communication, that part of a data processor that is dedicated to a single data channel for the purpose of receiving data from or transmitting data to one or more external, remote devices. (6) power-on reset (POR) (7) A function that re-initializes all the hardware in a CPC and loads the internal code that enables the CPC to load and run an operating system.

PP. Physically partitioned (configuration).

PPT. Primary POI task.

primary host. The base program at which you enter a command for processing.

primary POI task (PPT). The NetView subtask that processes all unsolicited messages received from the VTAM program operator interface (POI) and delivers them to the controlling operator or to the command processor. The PPT also processes the initial command specified to execute when NetView is initialized and timer request commands scheduled to execute under the PPT.

primary system. A system is a primary system for an application if the application is normally meant to be running there. SA z/OS starts the application on all the primary systems defined for it.

problem determination. The process of determining the source of a problem; for example, a program component, machine failure, telecommunication facilities, user or contractor-installed programs or equipment, environment failure such as a power loss, or user error.

processor controller. Hardware that provides support and diagnostic functions for the central processors.

processor operations. The part of SA z/OS that monitors and controls processor (hardware) operations. Processor operations provides a connection from a focal-point system to a target system. Through NetView on the focal-point system, processor operations automates operator and system consoles for monitoring and recovering target systems. Also known as ProcOps.

processor operations control file. Named by your system programmer, this file contains configuration and customization information. The programmer records the name of this control file in the processor operations file generation panel ISQDPG01.

| **Processor Operations Service Machine (PSM).** A
| processor that allows the control and monitoring of
| guest machines running under VM.

Processor Resource/Systems Manager (PR/SM). The feature that allows the processor to use several

operating system images simultaneously and provides logical partitioning capability. See also *LPAR*.

ProcOps. Processor operations.

product automation. Automation integrated into the base of SA z/OS for the products DB2, CICS, IMS, OPC (formerly called *features*).

program to program interface (PPI). A NetView function that allows user programs to send or receive data buffers from other user programs and to send alerts to the NetView hardware monitor from system and application programs.

protocol. In SNA, the meanings of, and the sequencing rules for, requests and responses used for managing the network, transferring data, and synchronizing the states of network components.

proxy resource. A resource defined like an entry type APL representing a processor operations target system.

PR/SM. Processor Resource/Systems Manager.

| **PSM.** Processor Operations Service Machine.

PU. Physical unit.

R

remote system. A system that receives resource status information from an SA z/OS focal-point system. An SA z/OS remote system is defined as part of the same SA z/OS enterprise as the SA z/OS focal-point system to which it is related.

requester. A requester is a workstation software, which enables users to log on to a domain, that is, to the server(s) belonging to this domain, and use the resources in this domain. After the log on to a domain, users can access the shared resources and use the processing capability of the server(s). Because the bigger part of shared resources is on the server(s), users can reduce hardware investment.

resource. (1) Any facility of the computing system or operating system required by a job or task, and including main storage, input/output devices, the processing unit, data sets, and control or processing programs. (2) In NetView, any hardware or software that provides function to the network. (3) In SA z/OS, any z/OS application, z/OS component, job, device, or target system capable of being monitored or automated through SA z/OS.

Resource Access Control Facility (RACF). A program that can provide data security for all your resources. RACF protects data from accidental or deliberate unauthorized disclosure, modification, or destruction.

resource group. A physically partitionable portion of a processor. Also known as a *side*.

Resource Monitoring Facility (RMF) Monitor III. A program that measures and reports on the availability and activity of system hardware and software resources, such as processors, devices, storage, and address spaces. RMF can issue online reports about system performance problems as they occur.

Resource Object Data Manager (RODM). A data cache manager designed to support process control and automation applications. RODM provides an in-memory data cache for maintaining real-time data in an address space that is accessible by multiple applications. RODM also allows an application to query an object and receive a rapid response and act on it.

resource token. A unique internal identifier of an ESCON resource or resource number of the object in the IODF.

restart automation. SA z/OS-provided automation that monitors subsystems to ensure that they are running. If a subsystem fails, SA z/OS attempts to restart it according to the policy in the automation control file.

Restructured Extended Executor (REXX). An interpretive language used to write command lists.

return code. A code returned from a program used to influence the issuing of subsequent instructions.

REXX. Restructured Extended Executor.

REXX procedure. A command list written with the Restructured Extended Executor (REXX), which is an interpretive language.

RMF. Resource Measurement Facility.

RODM. Resource Object Data Manager.

S

SAF. Security Authorization Facility.

SA z/OS. System Automation for z/OS

SA z/OS customization dialogs. An ISPF application through which the SA z/OS policy administrator defines policy for individual z/OS systems and builds automation control data and RODM load function files.

SA z/OS customization focal point system. See *focal point system*.

SA z/OS data model. The set of objects, classes and entity relationships necessary to support the function of SA z/OS and the NetView automation platform.

SA z/OS enterprise. The group of systems and resources defined in the customization dialogs under one enterprise name. An SA z/OS enterprise consists of connected z/OS systems running SA z/OS.

SA z/OS focal point system. See *focal point system*.

SA z/OS policy. The description of the systems and resources that make up an SA z/OS enterprise, together with their monitoring and automation definitions.

SA z/OS policy administrator. The member of the operations staff who is responsible for defining SA z/OS policy.

SA z/OS satellite. If you are running two NetViews on an z/OS system to split the automation and networking functions of NetView, it is common to route alerts to the Networking NetView. For SA z/OS to process alerts properly on the Networking NetView, you must install a subset of SA z/OS code, called an *SA z/OS satellite* on the Networking NetView.

| **SA z/OS SDF focal point system.** See *focal point system*.

SCA. In SA z/OS, system console A, the active system console for a target hardware. Contrast with SCB.

SCB. In SA z/OS, system console B, the backup system console for a target hardware. Contrast with SCA.

screen. Deprecated term for display panel.

screen handler. In SA z/OS, software that interprets all data to and from a full-screen image of a target system. The interpretation depends on the format of the data on the full-screen image. Every processor and operating system has its own format for the full-screen image. A screen handler controls one PS/2 connection to a target system.

SDF. Status Display Facility.

SDLC. Synchronous data link control.

SDSF. System Display and Search Facility.

secondary system. A system is a secondary system for an application if it is defined to automation on that system, but the application is not normally meant to be running there. Secondary systems are systems to which an application can be moved in the event that one or more of its primary systems are unavailable. SA z/OS does not start the application on its secondary systems.

server. A server is a workstation that shares resources, which include directories, printers, serial devices, and computing powers.

service language command (SLC). The line-oriented command language of processor controllers or service processors.

service processor (SVP). The name given to a processor controller on smaller System/370 processors.

service period. Service periods allow the users to schedule the availability of applications. A service period is a set of time intervals (service windows), during which an application should be active.

service threshold. An SA z/OS policy setting that determines when to notify the operator of deteriorating service for a resource. See also *alert threshold* and *warning threshold*.

session. In SNA, a logical connection between two network addressable units (NAUs) that can be activated, tailored to provide various protocols, and deactivated, as requested. Each session is uniquely identified in a transmission header by a pair of network addresses identifying the origin and destination NAUs of any transmissions exchanged during the session.

session monitor. The component of the NetView program that collects and correlates session-related data and provides online access to this information. The successor to NLDM.

shutdown automation. SA z/OS-provided automation that manages the shutdown process for subsystems by issuing shutdown commands and responding to prompts for additional information.

side. A part of a partitionable CPC that can run as a physical partition and is typically referred to as the A-side or the B-side.

Simple Network Management Protocol (SNMP). An IP based industry standard protocol to monitor and control resources in an IP network.

single image. A processor system capable of being physically partitioned that has not been physically partitioned. Single-image systems can be target hardware processors.

single-image (SI) mode. A mode of operation for a multiprocessor (MP) system that allows it to function as one CPC. By definition, a uniprocessor (UP) operates in single-image mode. Contrast with *physically partitioned (PP) configuration*.

SLC. Service language command.

SMP/E. System Modification Program Extended.

SNA. Systems Network Architecture.

SNA network. In SNA, the part of a user-application network that conforms to the formats and protocols of systems network architecture. It enables reliable transfer of data among end users and provides protocols for controlling the resources of various network configurations. The SNA network consists of network addressable units (NAUs), boundary function components, and the path control network.

SNMP. Simple Network Management Protocol (a TCP/IP protocol). A protocol that allows network management by elements, such as gateways, routers, and hosts. This protocol provides a means of communication between network elements regarding network resources.

solicited message. An SA z/OS message that directly responds to a command. Contrast with *unsolicited message*.

SSCP. System services control point.

SSI. Subsystem interface.

start automation. SA z/OS-provided automation that manages and completes the startup process for subsystems. During this process, SA z/OS replies to prompts for additional information, ensures that the startup process completes within specified time limits, notifies the operator of problems, if necessary, and brings subsystems to an UP (or ready) state.

startup. The point in time at which a subsystem or application is started.

status. The measure of the condition or availability of the resource.

status focal-point system. See *focal—point system*.

status display facility (SDF). The system operations part of SA z/OS that displays status of resources such as applications, gateways, and write-to-operator messages (WTORs) on dynamic color-coded panels. SDF shows spool usage problems and resource data from multiple systems.

steady state automation. The routine monitoring, both for presence and performance, of subsystems, applications, volumes and systems. Steady state automation may respond to messages, performance exceptions and discrepancies between its model of the system and reality.

structure. A construct used by z/OS to map and manage storage on a coupling facility. See cache structure, list structure, and lock structure.

subgroup. A named set of systems. A subgroup is part of an SA z/OS enterprise definition and is used for monitoring purposes.

SubGroup entry. A construct, created with the customization dialogs, used to represent and contain policy for a subgroup.

subsystem. (1) A secondary or subordinate system, usually capable of operating independent of, or asynchronously with, a controlling system. (2) In SA z/OS, an z/OS application or subsystem defined to SA z/OS.

subsystem interface. The z/OS interface over which all messages sent to the z/OS console are broadcast.

support element. A hardware unit that provides communications, monitoring, and diagnostic functions to a central processor complex (CPC).

support processor. Another name given to a processor controller on smaller System/370 processors; see *service processor*.

SVP. Service processor.

switches. ESCON directors are electronic units with ports that dynamically switch to route data to I/O devices. The switches are controlled by I/O operations commands that you enter on a workstation.

switch identifier. The switch device number (swchdevn), the logical switch number (LSN) and the switch name

symbolic destination name (SDN). Used locally at the workstation to relate to the VTAM application name.

synchronous data link control (SDLC). A discipline for managing synchronous, code-transparent, serial-by-bit information transfer over a link connection. Transmission exchanges may be duplex or half-duplex over switched or nonswitched links. The configuration of the link connection may be point-to-point, multipoint, or loop. SDLC conforms to subsets of the Advanced Data Communication Control Procedures (ADCCP) of the American National Standards Institute and High-Level Data Link Control (HDLC) of the International Standards Organization.

SYSINFO Report. An RMF report that presents an overview of the system, its workload, and the total number of jobs using resources or delayed for resources.

SysOps. System operations.

sysplex. A set of z/OS systems communicating and cooperating with each other through certain multisystem hardware components (coupling devices and timers) and software services (couple data sets).

In a sysplex, z/OS provides the coupling services that handle the messages, data, and status for the parts of a multisystem application that has its workload spread across two or more of the connected processors, sysplex timers, coupling facilities, and couple data sets (which contains policy and states for automation).

A parallel sysplex is a sysplex that includes a coupling facility.

sysplex application group. A sysplex application group is a grouping of applications that can run on any system in a sysplex.

sysplex couple data set. A couple data set that contains sysplex-wide data about systems, groups, and

members that use XCF services. All z/OS systems in a sysplex must have connectivity to the sysplex couple data set. See also *couple data set*.

Sysplex Timer. An IBM unit that synchronizes the time-of-day (TOD) clocks in multiple processors or processor sides. External Time Reference (ETR) is the z/OS generic name for the IBM Sysplex Timer (9037).

system. In SA z/OS, system means a focal point system (z/OS) or a target system (MVS, VM, VSE, LINUX, or CF).

| **System Automation for z/OS.** The full name for
| SA z/OS.

| **System Automation for OS/390.** The full name for
| SA OS/390, the predecessor to System Automation for
| z/OS.

system console. (1) A console, usually having a keyboard and a display screen, that is used by an operator to control and communicate with a system. (2) A logical device used for the operation and control of hardware functions (for example, IPL, alter/display, and reconfiguration). The system console can be assigned to any of the physical displays attached to a processor controller or support processor. (3) In SA z/OS, the hardware system console for processor controllers or service processors of processors connected using SA z/OS. In the SA z/OS operator commands and configuration dialogs, SC is used to designate the system console for a target hardware processor.

System Display and Search Facility (SDSF). An IBM licensed program that provides information about jobs, queues, and printers running under JES2 on a series of panels. Under SA z/OS you can select SDSF from a pull-down menu to see the resources' status, view the z/OS system log, see WTOR messages, and see active jobs on the system.

System entry. A construct, created with the customization dialogs, used to represent and contain policy for a system.

System Modification Program/Extended (SMP/E). An IBM licensed program that facilitates the process of installing and servicing an z/OS system.

system operations. The part of SA z/OS that monitors and controls system operations applications and subsystems such as NetView, SDSF, JES, RMF, TSO, RODM, ACF/VTAM, CICS, IMS, and OPC. Also known as SysOps.

system services control point (SSCP). In SNA, the focal point within an SNA network for managing the configuration, coordinating network operator and problem determination requests, and providing directory support and other session services for end users of the network. Multiple SSCPs, cooperating as

peers, can divide the network into domains of control, with each SSCP having a hierarchical control relationship to the physical units and logical units within its domain.

Systems Network Architecture (SNA). The description of the logical structure, formats, protocols, and operational sequences for transmitting information units through, and controlling the configuration and operation of, networks.

System/390 microprocessor cluster. A configuration that consists of central processor complexes (CPCs) and may have one or more integrated coupling facilities.

T

TAF. Terminal access facility.

target. A processor or system monitored and controlled by a focal-point system.

target control task. In SA z/OS, target control tasks process commands and send data to target systems and workstations through communications tasks. A target control task (a NetView autotask) is assigned to a target system when the target system is initialized.

target hardware. In SA z/OS, the physical hardware on which a target system runs. It can be a single-image or physically partitioned processor. Contrast with *target system*.

target system. (1) In a distributed system environment, a system that is monitored and controlled by the focal-point system. Multiple target systems can be controlled by a single focal-point system. (2) In SA z/OS, a computer system attached to the focal-point system for monitoring and control. The definition of a target system includes how remote sessions are established, what hardware is used, and what operating system is used.

task. (1) A basic unit of work to be accomplished by a computer. (2) In the NetView environment, an operator station task (logged-on operator), automation operator (autotask), application task, or user task. A NetView task performs work in the NetView environment. All SA z/OS tasks are NetView tasks. See also *communications task*, *message monitor task*, and *target control task*.

telecommunication line. Any physical medium, such as a wire or microwave beam, that is used to transmit data.

terminal access facility (TAF). (1) A NetView function that allows you to log onto multiple applications either on your system or other systems. You can define TAF sessions in the SA z/OS customization panels so you don't have to set them up each time you want to use them. (2) In NetView, a facility that allows a network

operator to control a number of subsystems. In a full-screen or operator control session, operators can control any combination of subsystems simultaneously.

terminal emulation. The capability of a microcomputer or personal computer to operate as if it were a particular type of terminal linked to a processing unit to access data.

threshold. A value that determines the point at which SA z/OS automation performs a predefined action. See *alert threshold*, *warning threshold*, and *error threshold*.

time of day (TOD). Typically refers to the time-of-day clock.

Time Sharing Option (TSO). An optional configuration of the operating system that provides conversational time sharing from remote stations. It is an interactive service on z/OS, MVS/ESA, and MVS/XA.

Time-Sharing Option/Extended (TSO/E). An option of z/OS that provides conversational timesharing from remote terminals. TSO/E allows a wide variety of users to perform many different kinds of tasks. It can handle short-running applications that use fewer sources as well as long-running applications that require large amounts of resources.

timers. A NetView command that issues a command or command processor (list of commands) at a specified time or time interval.

TOD. Time of day.

token ring. A network with a ring topology that passes tokens from one attaching device to another; for example, the IBM Token-Ring Network product.

TP. Transaction program.

transaction program. In the VTAM program, a program that performs services related to the processing of a transaction. One or more transaction programs may operate within a VTAM application program that is using the VTAM application program interface (API). In that situation, the transaction program would request services from the applications program using protocols defined by that application program. The application program, in turn, could request services from the VTAM program by issuing the APPCCMD macro instruction.

transitional automation. The actions involved in starting and stopping subsystems and applications that have been defined to SA z/OS. This can include issuing commands and responding to messages.

translating host. Role played by a host that turns a resource number into a token during a unification process.

trigger. Triggers, in combination with events and service periods, are used to control the starting and stopping of applications in a single system or a parallel sysplex.

TSO. Time Sharing Option.

TSO console. From this 3270-type console you are logged onto TSO or ISPF to use the runtime panels for I/O operations and SA z/OS customization panels.

TSO/E. TSO Extensions.

U

UCB. The unit control block; an MVS/ESA data area that represents a device and that is used for allocating devices and controlling I/O operations.

unsolicited message. An SA z/OS message that is not a direct response to a command. Contrast with *solicited message*.

user task. An application of the NetView program defined in a NetView TASK definition statement.

Using. An RMF Monitor III definition. Jobs getting service from hardware resources (processors or devices) are **using** these resources. The use of a resource by an address space can vary from 0% to 100% where 0% indicates no use during a Range period, and 100% indicates that the address space was found using the resource in every sample during that period. See also *Workflow*.

V

view. In the NetView Graphic Monitor Facility, a graphical picture of a network or part of a network. A view consists of nodes connected by links and may also include text and background lines. A view can be displayed, edited, and monitored for status information about network resources.

Virtual Storage Extended (VSE). An IBM licensed program whose full name is Virtual Storage Extended/Advanced Function. It is an operating system that controls the execution of programs.

Virtual Telecommunications Access Method (VTAM). An IBM licensed program that controls communication and the flow of data in an SNA network. It provides single-domain, multiple-domain, and interconnected network capability. Its full name is Advanced Communications Function for the Virtual Telecommunications Access Method. Synonymous with *ACF/VTAM*.

VM/ESA. Virtual Machine/Enterprise Systems Architecture.

volume. A direct access storage device (DASD) volume or a tape volume that serves a system in an SA z/OS enterprise.

volume entry. A construct, created with the customization dialogs, used to represent and contain policy for a volume.

volume group. A named set of volumes. A volume group is part of a system definition and is used for monitoring purposes.

volume group entry. An construct, created with the customization dialogs, used to represent and contain policy for a volume group.

Volume Workflow. The SA z/OS Volume Workflow variable is derived from the RMF Resource Workflow definition, and is used to measure the performance of volumes. SA z/OS calculates Volume Workflow using:

$$\text{Volume Workflow \%} = \frac{\text{accumulated Using}}{\text{accumulated Using} + \text{accumulated Delay}} * 100$$

The definition of **Using** is the percentage of time when a job has had a request accepted by a channel for the volume, but the request is not yet complete.

The definition of **Delay** is the delay that waiting jobs experience because of contention for the volume. See also *Address Space Workflow*.

VSE. Virtual Storage Extended.

VTAM. Virtual Telecommunications Access Method.

W

warning threshold. An application or volume service value that determines the level at which SA z/OS changes the associated icon in the graphic interface to the warning color. See *alert threshold*.

workflow. See *Address Space Workflow* and *Volume Workflow*.

workstation. In SA z/OS workstation means the *graphic workstation* that an operator uses for day-to-day operations.

write-to-operator (WTO). A request to send a message to an operator at the z/OS operator console. This request is made by an application and is handled by the WTO processor, which is part of the z/OS supervisor program.

write-to-operator-with-reply (WTOR). A request to send a message to an operator at the z/OS operator console that requires a response from the operator. This

request is made by an application and is handled by the WTO processor, which is part of the z/OS supervisor program.

WTO. Write-to-Operator.

WTOR. Write-to-Operator-with-Reply.

WWV. The US National Institute of Standards and Technology (NIST) radio station that provides standard time information. A second station, known as WWVB, provides standard time information at a different frequency.

X

XCF. Cross-system coupling facility.

XCF couple data set. The name for the sysplex couple data set prior to MVS/ESA System Product Version 5 Release 1. See also *sysplex couple data set*.

XCF group. A set of related members that a multisystem application defines to XCF. A member is a specific function, or instance, of the application. A member resides on one system and can communicate with other members of the same group across the sysplex.

XRF. Extended recovery facility.

Numerics

390-CMOS. Processor family group designator used in the SA z/OS processor operations documentation and in the online help to identify any of the following S/390 CMOS processor machine types: 9672, 9674, 2003, 3000, or 7060. SA z/OS processor operations uses the OCF facility of these processors to perform operations management functions. See *OCF-based processor*.

Index

Special characters

*EMPTY sample database 300
*MULTISYS sample database 300
*SAP_HA sample database 301
*SYSPLEX sample database 301
*WAS401_HA sample database 301

A

ABENDS (JES3) 194
ACF 10, 257
ACFFQRY 73
ACORESTART 167
Action Message Retention Facility 9
actions on policy databases 295
Adjacent Domain policy definition 284
ADJACENT NETVIEW policy item 283
alternate adjacent policy definition 284
alternate configuration support 378
alternate configurations 378
alternate data sets 97
AMC 10
AMC file 315, 324
AMRF 9
anchors
 heartbeat 98
 in RODM 98
 Lost&Found 98
 specifying 99
 sysplex 98
AOCCLONE IDs 42
AOCCLONE*See* system automation
 symbols 42
AOFADMON 118
AOFAJMON, *see* INGPJMON 119
AOFAPMON 118
AOFARCAT 275
AOFATMON 118
AOFPCSM 118
AOFMINORCHECK 39
AOFOPF sample 275
AOFOPFPO sample
 updating 316
AOFUXMON 118
AOFWRKxx 274
AOFWRKxx operators 278
APPC automation 9
APPLGROUP INFO policy item 128, 130
application (entry type) 4
application class 147
Application Defaults 6
Application Defaults policy item 111
APPLICATION DEFAULTS policy
 item 111
Application Defaults policy object 272
application group 4
 nature 126
 nature of 50
 Sysplex Application Group 49
 System Application Group 49
application group resource name 50
APPLICATION GROUPS policy item 93,
 110
APPLICATION INFO policy item 152,
 154
application instance 147
application monitor routine 118, 148,
 158
Application policy object 145
 creating a new 145
 policy items 151
application resource name 48
application resources
 automatically linking 54
 generating 52
application type 147
ApplicationGroup policy object 125
 creating a new 125
 policy items 128
APPLICATIONS policy item 128, 130
ARM
 MOVE group for 354
ARM element name 353
ASCB chaining 148
 with application automation 161
ASCH automation 9
assigning
 clone IDs 42
 system automation symbols 42
AT build, automated
 concurrent user access 367
ATTEND TIME policy item 261
AUTBASE 274
AUTCON 275
AUTGSS 275
AUTHB 275
AUTHW1 275
AUTJES 274
AUTLOG 274
AUTMON 275
AUTMSG 274
AUTNET1, AUTNET2 274
auto message classes 83
Auto Msg Classes 83
AUTO MSG CLASSES policy item 87
Auto Operators 6
Auto Operators policy item 111
AUTO OPERATORS policy item 111
Auto Operators policy object 273
AUTO1 274
AUTO2 274
automated AT build
 concurrent user access 367
automated function 169, 179, 182, 183
Automatic Restart Manager 353
 defining element names 156
 element name 353
 MOVE group for 354
 using clone values 156
automation
 goal driven 23
automation (*continued*)
 table policy definition 119
Automation automation flag 35
automation concepts 23
automation configuration 11, 324
 ACF 324
 AMC file 324
 automation control file 324
 automation manager configuration
 file 324
automation console policy item 110
AUTOMATION CONSOLE policy
 item 110, 116
automation control file 10, 324
 building 317
 distributing 324
 migrating 296, 329
automation flag
 Automation 35
 Initstart 36
 Recovery 36
 Restart 37
 Shutdown 36
 Start 36
 types 35
automation flags 34
 automation manager flags 38
 extended 154
 global automation flag 38
 hold flag 38
 minor resource flags 39
 resource status 38
 setting 37
 setting application defaults 273
automation flags policy definition 152
AUTOMATION FLAGS policy item 152,
 162, 270, 271, 273
automation info 152
AUTOMATION INFO policy item 152,
 157
automation manager configuration
 file 10, 315, 324
 building 317
 distributing 324
automation manager flags 38
automation manager global automation
 flag 38
automation name 50, 127
automation networks 347
 definition 282
automation operators 273
automation operators policy
 definition 274
AUTOMATION OPTIONS policy
 item 271
automation policy
 building 10
 distributing 10
automation procedure 9
automation resource name 127
automation setup policy definition 110

- AUTOMATION SETUP policy item 110, 117
- AUTOMATION SYMBOLS policy item 109, 114
- Automation Timeout policy item 110
- AUTOMATION TIMEOUT policy item 110
- Automation Timers policy item 110
- AUTOMATION TIMERS policy item 110
- autotask 6
- AUTPLEX 275
- AUTPOST 275
- AUTREC 275
- AUTRPC 275
- AUTSHUT 275
- AUTSYS 274
- AUTWRKxx 274
- AUTXCF 275
- AUTXCF2 275
- AUTXCF3 275
- availability target 139

B

- BASEOPER 274
- BASIC 50, 126
- batch build 323, 326
 - data sets 376
- batch build processing
 - defining data sets 375
- batch conversion 364
- batch migration 345
- behavior of application groups
 - ACTIVE 127
 - PASSIVE 127
- build
 - job for batch build 326
- BUILD 318
 - BUILD command 315
 - building processor control file 315
 - building system operations
 - configuration files 317
 - building the automation control file 317
 - building the automation manager
 - configuration file 317
 - building the MPFLSTSA member 317
 - building the NetView automation table 317
 - building the processor control file 315
 - description 313
 - on the *Policy Data Base Selection* panel 296
- BUILD automation policy 10
- BUILD error messages 322
- Build Functions Menu 314
- build processing
 - with BUILD command 318
- BUILDF command 318
- building
 - configuration files 314

C

- cancel input 14
- CDS 96
- chaining 136
- changing links
 - concurrent user access 366
- CICS automation 243
- CICS CONNECTION policy item 199, 202, 244, 245
- CICS CONTROL policy item 199, 200
- CICS link definitions 243, 244
 - policy items 244
- CICS link monitor periods 243, 246
- CICS monitoring periods 246
- CICS state/action table 243
- CICS state/action tables 243
- CICS subsystems
 - policy items 199
- cleanup delay policy definition 162
- CLISTS policy item 289
- clone ID
 - Automatic Restart Manager 353
- clone IDs
 - assigning 42
- clone values 156
- cloned element names 156
- CMD processing 168
- code processing 170
- command prefix 158
- command processing 168
- command routing mechanism 82, 85
- command shutdown processing
 - for INIT and FINAL 181
 - for NORM, IMMED and FORCE 182
- commands and requests 23
- common routine 9
- concurrent customization by multiple users 365
- concurrent user access 14, 365
 - automated AT build 367
 - changing links 366
 - entry name selection 366
 - entry type selection 366
 - policy database selection 365
 - policy definitions 365
- condition
 - relationship condition 137
 - shutdown 227
 - shutdown condition 40
 - startup 227
 - startup condition 40
 - unset condition 223
- condition (for relationships) 28
- CONDITION policy item
 - for a trigger 227
 - for an event 223
- configuration
 - of automation 11, 324
- configuration files
 - building 314
- configuration focal point system 11, 324
- configuration support, alternate 378
- considerations for automation 9
- console areas definition 268
- console definition 267
- console ID policy definition 116
- console name 116

- console size definition 268
- Control File
 - allocate 316
 - message log 317
 - name 87
- control file and control file log 315
- controller details
 - OPC 253
- CONTROLLER DETAILS policy item 112
- conversion
 - job for batch conversion 364
 - of initial policy database 355
 - selective policy database
 - conversion 363
- conversion function 355
- converted data 357
- COPY policy item 19
- copying policy 19
- couple data set 96
- CPCB (command processor control block) 387
- creating
 - policy database, new 297
 - policy object, new 14
- creating a policy database 297
- critical threshold 31, 32
- CRM 82, 85
- customization dialog 1
 - cancel input 14
 - changing 369
 - features 13
 - help 369
 - invocation 12
 - primary menu 2, 12
 - starting 12
 - using 11, 13

D

- data
 - moved and restructured 355
- DB2 automation 242
- DB2 CONTROL policy item 205
- DB2 subsystems
 - policy items 204
- DB2 System defaults 242
- DB2 System Defaults
 - policy items 242
- DB2 SYSTEM DEFAULTS policy item 111, 242
- defining
 - gateway sessions 349
 - outbound gateway autotask 349
 - SDF focal point system 348
 - TAF full-screen sessions 350
- dependency relationships 28
- dependent resource 28, 129, 132, 153, 238
- Description panel 19
- DESCRIPTION policy item 18
- DISPACF 73
- distribute automation policy 10
- distributing
 - system operations configuration files 324
 - the automation control file 324

documents, licensed xviii
drain, JES2 190
DSIOPF data set 274
DSIOPF member 316
DSIPARM
 description 388
dual NetView 115

E

E-T DATA policy item 293
element name 353
 Automatic Restart Manager 156
element names
 in Automatic Restart Manager 353
enterprise 3
enterprise definition 11, 82
Enterprise policy object 82, 221
 policy items 82
entry name creation 336
entry name selection
 concurrent user access 366
entry type
 introduction 3
 short description 3
entry type selection
 concurrent user access 366
environment definition, system
 defaults 271
ENVIRONMENT policy item 271, 272
error messages
 BUILD 322
error thresholds 31
event 39, 40
events 4
 scenario 70
events and conditions 40
Events policy object
 creating a new 221
 policy items 222
exit names policy definition 120
extended automation flags 154
extended recovery facilities 247
external shutdown 161
external startup 161
EXTERNALLY 134
EXTSTART status 353

F

FALLBACK 188
FALLBACK status
 support 188
 using 188
fast path 13
feature keywords
 cross reference with customization
 dialog 360
FINAL shutdown 180
focal point
 name 87
focal point NetView domains policy
 definition 284
focal point services 282
focal point system definition 348
FORCE shutdown 180

FORCEDOWN 134
FORWARD policy item 284
frequent threshold 32
FULL SESSIONS policy item 284
functional names for auto operators 274

G

GAT&DOMID 275
gateway
 inbound 349
 outbound 349
gateway monitor time policy
 definition 118
gateway policy definition 284
GATEWAY policy item 284
gateway sessions
 defining 349
GATOPER 275
GENERATED RESOURCES policy
 item 129, 143, 154, 188
generic routine 9
global automation flag 38
goal driven automation 23
graphic workstation description 394
graphical interface 8
GROUP INFO policy item 92, 94
Group policy object 90
 new, creating 90
grouping
 scenario 24
 support 23
grouping resources 8
groups 4
groups and resources 23
GSSOPER 275
 SHUTDOWN 279
 STARTUP 279
GUESTS AND SYSTEMS policy
 item 236

H

HASPARENT 134
HASPARENT relationship 29
HASPASSIVEPARENT 135
HASPASSIVEPARENT relationship 29
HBOPER 275
HEALTHSTATE policy item 238
heartbeat
 explanation 107
 heartbeat interval 106
 missing heartbeat delay 107
heartbeat anchor 98
heartbeat interval 106
help information 369
hold flag 38
HWMCA
 description 390
HWOPER 275

I

IMMED shutdown 180
importing
 policy database data 327

IMS automation 247
IMS CONTROL policy item 208, 209
IMS extended recovery facilities 247
IMS RESOURCE NAMES policy
 item 250
IMS STATE/ACTION policy item 248
IMS state/action table 247
IMS STATUS FILE policy item 249
IMS subsystems
 policy items 208
IMS XRF resources 247, 250
IMS XRF RESOURCES policy item 112
IMS XRF status files 247, 249
inbound gateway 349
includes 6
INCLUDES policy item 112
Includes policy object 292
infrequent threshold 32
ING.CUSTOM.AOFTABL 314, 375
INGAUTO 38
INGDLG 12
INGEIO 390
INGEVENT 39
INGMTSYS 119
INGPJMON 119
INGPOST command 98
INGREQ 23
INGSEND PARMS policy item 82, 85
INGSET 23
INGTHRES 32
INGXSG 98
initialized target system 121
INITSEL 12
Initstart automation flag 36
interested operator list 122
invoking the customization dialog 12
IPL
 MVS target system 123
 VM target system 124
IPL INFO 113
IPL INFO policy item 122
ISPF temporary data sets 376
ISQMTSYS, 119
IXCARM macro invocations 353
IXCMIAFU 353

J

JES2
 automation procedures 9
 recovery parameters 191
 spool recovery
 automation 9
 establishing 190
 from full condition 190
JES2 DRAIN 190, 193
JES2 SPOOLFULL 190
JES2 SPOOLSHORT 190, 192
JES2 subsystems
 policy items 190
JES3
 ABENDS 194
 automation procedures 9
 MONITOR 194
 recovery parameters 195

- JES3 (*continued*)
 - SPOOL
 - automated startup and shutdown 9
 - control 194
 - SPOOLFULL 194
 - SPOOLSHORT 194
 - JES3 ABENDS 198
 - JES3 MONITOR 196
 - JES3 SPOOLFULL 194
 - JES3 SPOOLSHORT 195
 - JES3 subsystems
 - policy items 194
 - JESOPER 274
 - job name
 - defined 149
 - job type
 - description 148
 - MVS 148
 - NONMVS 148
 - policy definition 148
 - TRANSIENT 148
- K**
- keywords for features 360
- L**
- licensed documents xviii
 - link definitions (CICS) 243, 244
 - link monitor periods (CICS) 243, 246
 - LINK TO CLASS policy item 151
 - LINK TO INSTANCES policy item 152
 - load profile name 121
 - LOCATE 297
 - logging policy database
 - modifications 303
 - LOGOPER 274
 - LOGREC
 - automation policy definition 9
 - thresholds policy 263
 - LookAt message retrieval tool xviii
 - Lost&Found anchor 98
 - LPARS AND SYSTEMS policy item 233
- M**
- MAKEAVAILABLE 133
 - MAKEUNAVAILABLE 133
 - MCSFLAGS policy definition 117
 - MEMBER OF policy item 154
 - , for application groups 144
 - for application groups 129
 - for applications 189
 - message
 - forwarding path, defining 347
 - message class 280
 - message classes 83, 281, 282
 - message IDs
 - reserved 167
 - message prefix 158
 - message processing 166
 - CMD processing 168
 - code processing 170
 - reply processing 169
 - message processing (*continued*)
 - scenario 74
 - user defined data 172
 - with user-defined data 74
 - message retrieval tool, LookAt xviii
 - messages
 - policy definition 153
 - response 123, 124
 - MESSAGES/USER DATA policy
 - item 153, 165, 263
 - MIGRATE command
 - Policy Data Base Selection 296
 - migrating
 - automation control file 296, 329
 - migration
 - entry name creation 336
 - include files 339
 - job for batch migration 345
 - product automation definition 339
 - selective migration 331
 - migration functions 327
 - minor resource flags 39
 - as subsidiary to major resource 264
 - for applications 153
 - MINOR RESOURCE FLAGS policy
 - item 153, 186, 264, 269
 - minor resources 269
 - AOFMINORCHECK 39
 - missing heartbeat 107
 - processing 107
 - missing heartbeat delay 107
 - missing heartbeat processing 107
 - MONITOR (JES3) 194
 - MONITOR INFO policy item 237, 238
 - monitor resource 5
 - Monitor Resource
 - policy object 237
 - monitoring
 - tape mounts 260
 - MONITORING PERIOD policy
 - item 245, 246
 - monitoring periods for CICS 246
 - Monitoring, Sysplex Timer 96
 - MONOPER 275
 - MOVE 50, 126
 - MOVE group 60
 - MOVE group for ARM 354
 - MOVED 188
 - moved and restructured data 355
 - MOVED status
 - Automatic Restart Manager 353
 - automation 353
 - using 188
 - MPF definitions 83, 89
 - MPFLSTSA file 315
 - MPFLSTSA member 10
 - building 317
 - distributing 324
 - MSGOPER 274
 - MVS Component 5
 - MVS Component policy item
 - to choose sets to be part of system object 111
 - MVS COMPONENT policy item 111
 - MVS Component policy object
 - dump data sets 9
 - using 262
 - MVS console policy definition 278
 - MVS job 148
 - MVS messages, responding to 263
 - MVS Target System IPL Information panel 123
 - MVSCOMP defaults 6
 - MVSCOMP Defaults policy item 111
 - MVSCOMP DEFAULTS policy item 111
 - MVSCOMP Defaults policy object 269
 - MVSCONSi 275
 - MVSDUMP
 - MVS Component policy object 262
 - thresholds policy 263
- N**
- naming restrictions 318
 - nature
 - BASIC 50
 - MOVE 50
 - SERVER 50
 - nature of an application group 50
 - nature of application groups
 - BASIC 126
 - MOVE 126
 - SERVER 126
 - NBUF policy definition 265
 - NETOPER 274
 - NetView
 - domain name 115
 - nomination before BUILD 10
 - operator definition file 316
 - operator profile 316
 - Operators 278
 - policy item 110
 - RMTCMD command 283
 - specifying domain name 115
 - NetView automation table 10, 315
 - building 317
 - distributing 324
 - updating 76
 - NETVIEW policy item 109, 115
 - Network 6
 - Network policy item 111
 - NETWORK policy item 111
 - Network policy object 282
 - networks automation
 - definition process 347
 - NMC DEFINITIONS panel 93
 - NMC DEFINITIONS policy item 93
 - NMC focal point system 389
 - NNT sessions 6
 - and minor resources 110
 - definition 287
 - NNT SESSIONS policy item 110
 - NNT Sessions policy object 286
 - NONMVS job 148
 - NORM shutdown 180
 - NORMCONS policy definition 267
 - notification forwarding 348
 - notification operator 280
 - notification operators 111, 280
 - Notify Operators 6
 - Notify Operators policy item 111
 - NOTIFY OPERATORS policy item 111
 - notify operators policy object 279

O

- OPC automation 251
- OPC CONTROL policy item 217
- OPC controller details 251, 253
 - policy items 253
- OPC special resources 251, 255
- OPC subsystems
 - policy items 217
- OPC system details 251, 252
- OPC SYSTEM DETAILS policy item 112
- OPC workstation domains 251, 256
- OPCA DOMAINID policy item 256
- OPCA PCS policy item 253, 254
- OPCAO ENVIRON policy item 252
- operator
 - definition file 316
 - profile 316
- operator console
 - interested operator 122
- OPERATORS policy item 274
- outbound gateway 349
 - autotask, defining 349
- output data set 320
- overview 1

P

- panelid 7
- password mask 285
- PLEXOPER 275
- Policy Data Base Selection panel 297
- policy database 11
 - adding to index 297
 - available actions 295
 - converting 331
 - creating 297
 - creating, new 297
 - data, importing 327
 - initial conversion of 355
 - logging modifications 303
 - reports 307
 - samples 300
 - sending to remote nodes 377
 - using existing 295
- policy database selection
 - concurrent user access 365
- policy definitions
 - concurrent user access 365
- policy item 3, 7
 - APPLICATION GROUPS 99
 - AUTOMATION OPTIONS 271
 - COPY 19
 - DESCRIPTION 18
 - ENVIRONMENT 272
 - WHERE USED 20
- Policy Item
 - IEADMCxx SYMBOLS 103
 - JOB DEFINITIONS 100
 - JOB/ASID DEFINITIONS 101
 - LOCAL PAGE DATA SET 99
 - NMC DEFINITIONS 98
 - RESOURCE DEFINITIONS 102
- policy items
 - create or modify 371
 - general policy items 18
- policy object (continued)
 - creating, new 14
- policy objects
 - Application 145
 - Application Defaults 272
 - ApplicationGroup 125
 - Auto Operators 273
 - copying 19
 - copying definitions 19
 - deleting 16
 - Enterprise 82, 221
 - Group 90
 - Includes 292
 - Monitor Resource 237
 - MVS Component 262
 - MVSCOMP Defaults 269
 - Network 282
 - NNT Sessions 286
 - Notify Operators 279
 - Processor 229
 - Product Automation 241
 - Resident CLISTS 288
 - Service Periods 223
 - Status Details 289
 - SubGroup 103
 - Sysplex Application Group 125, 128
 - System 105
 - System Application Group 128
 - System Defaults 270
 - Tape Attendance 260
 - Timeout Settings 258
 - Timers 256
 - Triggers 226
 - User E-T Pairs 292
- PolicyDB 298, 329
- POSTOPER 275
- POSTSTART 178
- PPIOPER 275
- preference value
 - default 127
 - scenarios 142, 143
- preference values 141
- preferences 65
- PREPAVAILABLE 134
- PREPUNAVAILABLE 134
- primary data sets 97
- primary JES policy definition 117
- primary menu
 - customization dialog 2, 12
- primary system association 187
- priority of requests 226
- processor control file 315
- PROCESSOR INFO policy item 231
- PROCESSOR OPERATIONS policy item 120
- PROCESSOR OPS INFO policy item 83, 86
- processor policy item 113
- PROCESSOR policy item 112
- Processor policy object 229
 - creating a new 229
 - policy items 230
 - policy items for PSM 234
- processors 5
- procname 42
- product automation 5, 396
 - CICS 243

- product automation (continued)
 - DB2 242
 - IMS 247
- Product Automation
 - policy object 241
- profile information before BUILD 10
- propagation of requests 29
- proxy resource 119
- PSM 230
- PSM INFORMATION policy item 234

R

- RECOPER 275
- recovering WTOBUF 265
- Recovery automation flag 36
- relationship condition 137
- relationship type 133
- relationships 132, 165
 - policy item for applications 152
- relationships concept 28
- RELATIONSHIPS policy item 129, 132, 152, 165, 238
- reply processing 169
- reply shutdown processing 183
- REPORT 296
- reports
 - about ApplicationGroups 307
 - about Applications 307
 - about generated resources 307
- request 23
 - calculation of schedules 28
 - INGREQ 23
 - priority 23
- request propagation 29
- reserved message IDs 167
- Resident CLISTS 6
- RESIDENT CLISTS policy item
 - with minor resources 111
- RESIDENT CLISTS policy item 110
- Resident CLISTS policy object 288
- resource
 - dependent 28, 129, 132, 153, 238
 - supporting 28, 129, 132, 153, 238
- resource name
 - WLM 157
- resource states
 - automation flags 38
 - description 38
 - list 38
 - SDF 39
- RESOURCE THRESHOLDS policy item 200, 205, 209, 243
 - CICS 203
 - DB2 207
- resources
 - explanation 46
 - grouping 8
 - scenario 25, 45
- resources and groups 23
- RESOURCES policy item 129, 139
- Restart automation flag 37
- restart option policy definition 160
- RMF 9
- RMTCMD command 283
- RODM
 - anchors 98

roll mode definition 267
roll time definition 267
route codes policy definition 116
RPCOPER 275

S

SA z/OS
 enterprise
 components 81
SA z/OS topology manager 326
SAF ENVIRONMENT policy item 285
sample policy databases 300
 *EMPTY 300
 *MULTISYS 300
 *SAP_HA 301
 *SYSPLEX 301
 *WAS401_HA 301
satisfactory target 140
schedule
 automatic calculation 28
 using 69
schedule override 69
Screens policy item 111
SCREENS policy item 111
SDF
 automation control file entry 290
 highlight 291
 priority policy definition 291
 root name policy definition 120
SDF DETAILS policy item 290
secondary system association 187
select migration objects 331
SEND COMMAND OPERS policy
 item 82, 83
sending policy databases 377
SERVER 50
SERVER group 67
service period 28, 129, 225, 238
 linking to application 152
 using 69
SERVICE PERIOD policy item 129, 131,
 152, 164, 238
service periods 4
Service Periods policy object 223
service window 28, 225
SERVICE WINDOW policy item 224
SESSIONS policy item 287
setting automation flags 37
settings menu 370
Settings option 369
SHUTDOWN
 GSSOPER 279
Shutdown automation flag 36
shutdown condition 39, 40, 41, 227, 229
SHUTDOWN condition for a trigger 228
shutdown delay policy definition 161
SHUTDOWN policy item 153, 179
shutdown processing
 command 181, 182
 reply 183
SHUTOPER 275
single NetView 115
SMF data sets 9
SMFDUMP
 MVS Component policy object 262
 thresholds policy 263

SPECIAL RESOURCE policy item
 OPC 255
SPECIAL RESOURCES policy item 253
SPOOLFULL 190
SPOOLFULL (JES3) 194
SPOOLSHORT 190
SPOOLSHORT(JES3) 194
standard Groups 92
 policy items 92
start
 start on IPL 159
 start on recycle 160
 start timeout policy definition 160
Start automation flag 36
starting the customization dialog 12
STARTUP 178
 GSSOPER 279
startup condition 39, 40, 41, 227
STARTUP condition for a trigger 228
startup condition list 229
startup phases
 POSTSTART 177
 PRESTART 177
 STARTUP 177
STARTUP policy item 153, 175
STATE ACTION TABLE policy item 200,
 203, 209
state/action table for CICS 243
STATE/ACTION TABLE policy
 item 243
state/action tables (CICS) 243
state/action tables (IMS) 247
state/action tables for CICS 243
Status Detail 6
Status Details
 display facility 289
 policy object 289
status forwarding path 107
SUBGROUP INFO policy item 104
SubGroup policy object 103
 creating a new 103
 policy items 104
subgroups 4
SUBGROUPS policy item 92, 94
subsystem
 shutdown 153
 startup 152, 153
 subsystem name 146
subtype 148
supporting resource 28, 129, 132, 153,
 238
symbol descriptions 83, 88
SYSLOG
 data sets 9
 MVS Component policy object 262
SYSLOG thresholds policy
 definition 263
SYSNAME naming restrictions 318
sysname policy item 119
SYSOPER 274
SysOps NetView 115
SysOps NetView Network Name 115
sysplex
 creating 46, 47
 sysplex anchor 98
Sysplex Application Group 49, 125, 126

Sysplex Application Group (*continued*)
 generating Sysplex Application Group
 resources 51
Sysplex Application Group policy
 object 125
 sysplex group 90
 sysplex Groups 92
 policy items 92
Sysplex Policy Definition panel 93
SYSPLEX policy item 93, 95
Sysplex Timer Monitoring 96
System Application Group 49, 126
 generating System Application Group
 resources 55
System Application Groups 128
system association policy definition 154
SYSTEM ASSOCIATION policy
 item 154, 187
system automation symbols 42
system categories 187
system console
 interested operator 122
System Defaults 6
System Defaults policy item
 and minor resources 111
SYSTEM DEFAULTS policy item 111
System Defaults policy object 270
SYSTEM INFO policy item 109, 113
system monitor time policy
 definition 118
system operations configuration
 files 315, 324
 building 317
 distributing 324
System policy object 105
 creating a new 105
 policy items 108
SYSTEMS policy item 95
 for Groups 92
 for SubGroups 105
systems, definitions 4

T

TAF 283
TAF full-screen sessions
 defining 350
TAF full-screen sessions policy
 definition 284
tape attendance 5
Tape Attendance policy item
 with minor resources 111
TAPE ATTENDANCE policy item 111
Tape Attendance policy object 260
tape mount, monitoring 260
tape policy 260
target
 focal point name 87
TARGET SYSTEM INFO 113
TARGET SYSTEM INFO policy item 121
target system information
 initialized target system 121
 load profile name 121
 time zones 121
target system time zones 121
task
 message monitor 87

- task (*continued*)
 - target control 87
- Terminal Access Facility 283, 350
- threshold
 - critical 31, 32
 - for applications 33
 - for MVS Components 34
 - for z/OS components 31
 - frequent 32
 - infrequent 32
 - MVSCOMP 32
- THRESHOLD policy items 264
- thresholds
 - setting up 31
- THRESHOLDS policy item 153, 185, 270, 271, 273
- TIMEAUTO 38
- timeout settings 5
- Timeout Settings policy object 258
- TIMEOUT VALUES policy item 259
- timeout variable 258
- timers 5
- TIMERS policy item 257
- Timers policy object 256
- To Domain policy definition 284
- TRANSIENT job 148
- trigger 39, 40
 - link to an application group 129
 - linking to application 152
 - restriction 42
- TRIGGER policy item 129, 131, 152, 164
- trigger policy object 4
- triggers
 - scenario 70
- triggers and conditions 40
- Triggers policy object 226
- TSO/E automation 9

U

- UCB (unit control block) 401
- unset condition 222, 223
- updating
 - AOFOPFPO sample 316
- updating the NetView automation table 76
- user defined data processing 172
- User E-T Pairs 6
 - description 110
 - policy object 292
 - scenario 72
- USER E-T PAIRS policy item 110
- user-written functions 377
- USS CONTROL policy item 219
- USS subsystems
 - policy items 218

V

- VIEW 297
- VM Target System IPL Information panel 124
- VTAM automation 9
- VTAMLST 284

W

- Where Used panel 17, 21
- WHERE USED policy item 20
- WLM resource name 157
- workstation domains
 - OPC 256
- WORKSTATION DOMAINS policy item 112
- WTOBUF
 - automation policy definition 9
 - recovery 262
 - routines 264
- WTOBUF RECOVERY policy item 264, 265

X

- XCF group name
 - INGXSG, default 98
 - INGXSG_{xy} 98
- XCFOPER 275
- XCFOPER2 275
- XCFOPER3 275
- XRF 247
- XRF STATUS FILES policy item 112

Z

- z/OS job name defined 149

Readers' Comments — We'd Like to Hear from You

System Automation for z/OS
Defining Automation Policy
Version 2 Release 3

Publication No. SC33-7039-05

Overall, how satisfied are you with the information in this book?

	Very Satisfied	Satisfied	Neutral	Dissatisfied	Very Dissatisfied
Overall satisfaction	<input type="checkbox"/>	<input type="checkbox"/>	<input type="checkbox"/>	<input type="checkbox"/>	<input type="checkbox"/>

How satisfied are you that the information in this book is:

	Very Satisfied	Satisfied	Neutral	Dissatisfied	Very Dissatisfied
Accurate	<input type="checkbox"/>	<input type="checkbox"/>	<input type="checkbox"/>	<input type="checkbox"/>	<input type="checkbox"/>
Complete	<input type="checkbox"/>	<input type="checkbox"/>	<input type="checkbox"/>	<input type="checkbox"/>	<input type="checkbox"/>
Easy to find	<input type="checkbox"/>	<input type="checkbox"/>	<input type="checkbox"/>	<input type="checkbox"/>	<input type="checkbox"/>
Easy to understand	<input type="checkbox"/>	<input type="checkbox"/>	<input type="checkbox"/>	<input type="checkbox"/>	<input type="checkbox"/>
Well organized	<input type="checkbox"/>	<input type="checkbox"/>	<input type="checkbox"/>	<input type="checkbox"/>	<input type="checkbox"/>
Applicable to your tasks	<input type="checkbox"/>	<input type="checkbox"/>	<input type="checkbox"/>	<input type="checkbox"/>	<input type="checkbox"/>

Please tell us how we can improve this book:

Thank you for your responses. May we contact you? Yes No

When you send comments to IBM, you grant IBM a nonexclusive right to use or distribute your comments in any way it believes appropriate without incurring any obligation to you.

Name

Address

Company or Organization

Phone No.



Fold and Tape

Please do not staple

Fold and Tape



NO POSTAGE
NECESSARY
IF MAILED IN THE
UNITED STATES

BUSINESS REPLY MAIL

FIRST-CLASS MAIL PERMIT NO. 40 ARMONK, NEW YORK

POSTAGE WILL BE PAID BY ADDRESSEE

IBM Deutschland Entwicklung GmbH
Department 3248
Schoenaicher Strasse 220
D-71032 Boeblingen
Federal Republic of Germany

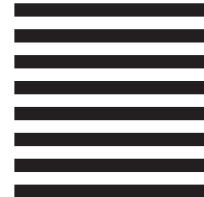

Fold and Tape

Please do not staple

Fold and Tape



Program Number: 5645-006

Printed in USA

SC33-7039-05



Spine information:



System Automation for z/OS

Defining Automation Policy

Version 2 Release 3

SC33-7039-05