

Tivoli System Automation for z/OS
Version 3 Release 3

Customizing and Programming



Tivoli System Automation for z/OS
Version 3 Release 3

Customizing and Programming



Note!

Before using this information and the product it supports, read the information in Appendix F, "Notices," on page 237.

This edition applies to IBM Tivoli System Automation for z/OS (Program Number 5698-SA3) Version 3, Release 3, an IBM licensed program, and to all subsequent releases and modifications until otherwise indicated in new editions.

| This edition replaces SC33-8260-06.

Order publications through your IBM representative or the IBM branch office serving your locality. Publications are not stocked at the address given below.

IBM welcomes your comments. A form for readers' comments appears at the back of this publication. If the form has been removed, address your comments to:

IBM Deutschland Research & Development GmbH
Department 3248
Schoenaicher Strasse 220
71032 Boeblingen
Germany

If you prefer to send comments electronically, use one of the following methods:

FAX (Germany): 07031 16-3456
FAX (Other Countries): +49 7031 16-3456
Internet: s390id@de.ibm.com

When you send information to IBM, you grant IBM a nonexclusive right to use or distribute the information in any way it believes appropriate without incurring any obligation to you.

© Copyright IBM Corporation 1996, 2010.

US Government Users Restricted Rights – Use, duplication or disclosure restricted by GSA ADP Schedule Contract with IBM Corp.

Contents

Figures	vii	Using Assist Mode to Test Automation Procedures	19
Tables	ix	Using AOCTRACE to Trace Automation Procedure Processing	19
Accessibility	xi	NetView Testing and Debugging Facilities	20
Using assistive technologies	xi	Where to Find More Testing Information	21
Keyboard navigation of the user interface	xi	Coding Your Own Information in the Automation Status File	21
z/OS information	xi	Programming Recommendations	21
About This Book	xiii	Global Variable Names	22
Who Should Use This Book.	xiii	Chapter 3. How to Add a Message to Automation.	23
Prerequisites	xiii	Conceptual Overview	23
Where to Find More Information	xiii	Defining Actions for Messages	23
The System Automation for z/OS Library	xiii	Defining CMD or REP Actions	24
Related Product Information	xiv	Defining AT Actions	24
Using LookAt to look up message explanations	xiv	Defining Message Overrides	26
Summary of Changes for SC34-2570-00	xiv	Extended Status Command Support	27
New Information	xv	Policy Definitions	27
Changed Information	xvi	Defining Entries for the Message Revision Table	28
Moved Information	xvi	Defining the AT/MRT Scope	29
Deleted Information	xvii	Build	29
Chapter 1. How to Add a New Application to Automation.	1	AT and MRT Build Concept	30
Preparation Before Automating an Application	1	Load	30
Address Space properties	1	Listings.	30
Step 1 - Application Start	1	A Guide to SA z/OS Automation Tables	30
Step 2 - Application Stop	2	NetView Automation Table Structure	30
Step 3 - Application Events	3	Integrating Automation Tables	32
Step 4 - Application Monitoring	4	Generic Automation Table Statements	33
Outstanding Reply Processing	5	System Operations Automation Flow	33
Topology	5	Inheritance Rules for Classes	35
Adding the Application to Automation	5	Define Application Information.	35
Define an Application Policy Object	5	Define Relationships	35
Build New Automation Configuration Files	6	Define Application Messages and User Data	35
Chapter 2. How to Create Automation Procedures	7	Define Startup Procedures	35
How Automation Procedures Are Called	7	Define Shutdown Procedures	36
How Automation Procedures Are Structured	8	Define Error Thresholds	36
Performing Initialization Processing	9	Define IMS Subsystem-Specific Data	36
Determining whether Automation Is Allowed	9	Chapter 4. How to Monitor Applications 37	
Performing Automation Processing	10	Observed Status Monitoring	37
How to Make Your Automation Procedures Generic	14	Health Monitoring	38
Processor Operations Commands	14	Overview	38
Developing Messages for Your Automation Procedures	15	Monitor Resource Commands	39
Example AOCMSG Call	15	Writing a Recovery Routine	40
Example Automation Procedure	16	Active Health Monitoring	41
Notes on the Automation Procedure Example	17	Passive, Event-Based Health Monitoring.	42
Installing Your Automation Procedures	18	Programming Techniques.	44
Testing and Debugging Automation Procedures	18	Health Monitoring using OMEGAMON	45
The Assist Mode Facility	18	Overview	46
		Assumptions	46
		OMEGAMON Interaction	47
		Health Monitoring Based on OMEGAMON Exceptions.	51

Health Monitoring Based on OMEGAMON XE Situations	53
Health Monitoring using CICSPlex SM	56
Component Overview	56
Creating an Application to Manage the VOST	56
Defining the Monitor Resources	56
Monitoring JES3 Components	57
AOFRJ3MN Routine	58
AOFRJ3RC Routine.	60
JES2 Spool Monitoring.	61
DB2 Connection Monitoring.	61
IMS Component Monitoring.	61

Chapter 5. Alert-Based Notification . . . 63

Overview	63
Communication Flow	63
Enabling Alerting	64
Setup in SA z/OS	64
INGALERT Command.	68

Chapter 6. Availability and Recovery Time Reporting 69

Overview	69
Resource Lifecycle	69
Layout of the SMF Record	70
Enabling SMF Records.	71
The INGPUSMF Utility	72
Output	72
The INGPUSMF Utility JCL	72
Return Codes.	73
Writing the SMF Report to DB2.	74
Customization	74
Output	75

Chapter 7. How to Automate Processor Operations-Controlled Resources . . . 77

Automating Processor Operations Resources of z/OS Target Systems Using Proxy Definitions	77
Concept	77
Customizing Automation for Proxy Resources.	78
Preparing Message Automation.	79
Automating Linux Console Messages.	80
The Linux Console Connection to NetView	80
Linux Console Automation with Mixed Case Character Data	80
Security Considerations	80
Restrictions and Limitations	81
How to Add a Processor Operations Message to Automation	81
Messages Issued by a Processor Operations Target System	81
Building the New Automation Definitions	85
Loading the Changed Automation Environment	85
Using Pipes and ISQCCMD for Synchronous HW Commands	86
Automating Asynchronous Hardware Commands with ISQCCMD and PIPES	87
VM Second Level Systems Support	88
Guest Target Systems	88
Customizing Target Systems.	89

Chapter 8. How to Automate USS Resources 93

Integration of z/OS UNIX System Services	93
Infrastructure Overview	94
Setting Up z/OS UNIX Automation	94
Customization of z/OS UNIX Resources.	94
Example: inetd	99
Hints and Tips	103
Trapping UNIX syslogd Messages	103
Debugging	103

Chapter 9. How to Enable Sysplex Automation 105

Sysplex Functions	105
Managing Couple Data Sets	105
Managing the System Logger	106
Managing Coupling Facilities	107
Recovery Actions	109
Hardware Validation	113
Enabling Hardware-Related Automation	115
Step 1: Defining the Processor	115
Step 2: Using the Policy Item PROCESSOR INFO	115
Step 3: Defining Logical Partitions	115
Step 4: Defining the System	115
Step 5: Connecting the System to the Processor	115
Step 6: Defining Logical Sysplexes	116
Step 7: Defining the Physical Sysplex	116
Enabling Continuous Availability of Couple Data Sets.	116
Enabling WTO(R) Buffer Shortage Recovery	117
Enabling System Removal	119
Step 1: Defining the Processor and System.	119
Step 2: Defining the Application with Application Type IMAGE	119
Step 3: Automating IXC102A and IXC402D Messages.	120
Enabling Long Running Enqueues (ENQs)	121
Step 1: Defining Resources	121
Step 2: Making Job/ASID Definitions	122
Step 3: Defining IEADMCxx Symbols	122
Step 4: Defining Commands	122
Step 5: Defining Snapshot Intervals	122
Enabling Auxiliary Storage Shortage Recovery	122
Step 1: Defining the Local Page Data Set	122
Step 2: Defining the Handling of Jobs	123
Defining Common Automation Items	123
Important Processor Operations Considerations	123
Customizing the System to Use the Functions	124
Additional Automation Operator IDs	124
Switching Sysplex Functions On and Off	124

Chapter 10. Automating Networks . . . 127

Automation Network Definition Process	127
Defining an SDF Focal Point System.	128
Defining Gateway Sessions.	129
Defining Automatically-Initiated TAF Fullscreen Sessions	130

Chapter 11. Defining a VTAM Application to SA z/OS 133

Registering VTAM Application Subsystems with SA z/OS Recovery 133

Chapter 12. Shutting Down z/OS systems in a GDPS Environment 135

Example Definition 135

Chapter 13. WTOR Processing 137

Process Flow of WTORS 137
Actions in Response to Incoming WTORS 138
Customizing how WTORS Are Stored by SA z/OS 138
Processing of Primary WTORS. 139
Usage Notes. 140

Chapter 14. SA z/OS User Exits 141

Initialization Exits 142
Environmental Setup Exits 142
AOFEXDEF 143
AOFEXI01 143
AOFEXI02 143
AOFEXI03 143
AOFEXI04 144
AOFEXI05 144
AOFEXI06 144
AOFEXINT 144
Static Exits 144
AOFEXSTA 145
AOFEXX02 146
AOFEXX03 146
AOFEXX04 146
AOFEXX15 146
AOFEXX16 147
Flag Exits. 147
Parameters 149
Task Global Variables. 149
Return Codes 149
Customization Dialog Exits. 150
User Exits for BUILD Processing 150
User Exits for COPY Processing 151
User Exits for DELETE Processing 152
User Exits for CONVERT Processing 152
User Exits for RENAME, and IMPORT Functions. 153
Invocation of Customization Dialog Exits . . . 153
Command Exits 154
AOFEXC00 154
AOFEXC01 154
AOFEXC02 154
AOFEXC03 154
AOFEXC04 154
AOFEXC05 155
AOFEXC06 155
AOFEXC07 155
AOFEXC08 155
AOFEXC09 155
AOFEXC10 155
AOFEXC11 156

AOFEXC12 156
AOFEXC13 156
AOFEXC14 156
AOFEXC15 156
AOFEXC16 156
AOFEXC17 157
AOFEXC18 157
AOFEXC19 157
AOFEXC20 157
AOFEXC21 158
AOFEXC22 158
AOFEXC23 158
Pseudo-Exits 158
Automation Control File Reload Permission Exit 158
Automation Control File Reload Action Exit . . 158
Subsystem Up at Initialization Commands . . 159
Testing Exits. 159

Chapter 15. Automation Solutions . . . 161

LOGREC Data Set Processing 162
SMF Data Set Processing 162
SYSLOG Processing 162
System Log Failure Recovery 162
SVC Dump Processing 163
Deletion of Processed WTORS from the Display 163
AMRF Buffer Shortage Processing 163
Drain Processing Prior to JES2 Shutdown . . . 164
TWS Automation Operation 164
IMS Transaction Recovery 164
AOFRSA01 165
AOFRSA02 166
AOFRSA03 168
AOFRSA08 170
AOFRSA0C 172
AOFRSA0E 175
AOFRSA0G 176
AOFRSD07 177
AOFRSD09 178
AOFRSD0F 180
AOFRSD0G 182
AOFRSD0H 183
EVEERTRN 185
EVIECT0X 186
EVIEET00 186
EVIEI006 187
EVIEI00Q. 187
EVISTRCT 188
EVISTRMN 188
EVJEAC04 188
EVJEOBSV 189
EVJRAC05 189
EVJRSACT 190
EVJRSJOB 190
HASP099 191
INGJRMJSP 191
INGRCJSP (AOFRSD01) 193
INGRX740 194

Appendix A. Global Variables 197

Read-Only Variables 197

Read/Write Variables	198
Parameter Defaults for Commands	205

Appendix B. Customizing the Status Display Facility 209

Overview of the Status Display Facility	209
How the Status Display Facility Works	209
Types of SDF Panels	209
Status Descriptors	210
SDF Tree Structures	211
How Status Descriptors Affect SDF	212
How SDF Helps Operations to Focus on Specific Problems	215
How SDF Panels Are Defined	215
Dynamically Loading Tree Structure and Panel Definition Members	216
Using SDF for Multiple Systems	216
SDF Components	217
How the SDF Task Is Started and Stopped	218
SDF Definition Process	218
Step 1: Defining SDF Hierarchy	219
Step 2: Defining SDF Panels	220
Step 3: (Optional) Customizing SDF Initialization Parameters	223
Step 4: (Optional) Defining SDF in the Customization Dialog	224

Appendix C. How System Operations Coordinates with Automatic Restart Manager 225

Defining an ARM Element Name	225
Defining a MOVE Group for Automatic Restart Manager	226

Appendix D. Message Automation . . . 227

Generic Synonyms: AOFMSGSY	227
SA z/OS Message Presentation: AOFMSGSY	228
Operator Cascades: AOFMSGSY	230
SA z/OS Topology Manager for NMC: AOFMSGST	233

Appendix E. TSO User Monitoring . . . 235

Appendix F. Notices 237

Programming Interface Information	238
Trademarks	238

Glossary 239

Index 261

Figures

1.	Application Lifecycle.	4	27.	MESSAGES/USER DATA Policy Item for Entry/Type-Pair MVSESA/LOGREC.	167
2.	Automation Procedures for System Operations	8	28.	Threshold Definitions for MVS Component SMFDUMP	169
3.	Automation Procedures for Processor Operations	8	29.	MESSAGES/USER DATA Policy Item for Entry/Type-Pair MVSESA/SMFDUMP	169
4.	Skeleton of an Automation Procedure.	14	30.	Threshold Definitions for MVS Component SYSLOG	171
5.	AT Structure	31	31.	MESSAGES/USER DATA Policy Item for Entry/Type-Pair MVSESA/SYSLOG	171
6.	Sample Monitor Command	42	32.	MVSDUMP Thresholds	174
7.	Take Action Dialog	55	33.	MVSESA AMRF Command Definitions	177
8.	Alert Communication Flow	64	34.	JES2 DRAIN Specifications Panel	181
9.	Events in the Lifecycle of an Application	69	35.	DISPACF Panel	181
10.	SMF Processing with z/OS Offloader	74	36.	DISPACF JES2 INITDRAIN Panel.	182
11.	Stop Definitions for a Process	99	37.	JES2 SPOOLSHORT Recovery Definition	184
12.	Delete a File	99	38.	DISPACF Command Response Panel	184
13.	Structure of inetd	100	39.	Threshold Definitions for MVS Component LOG	196
14.	Dependency Graphic for inetd	102	40.	MESSAGES/USER DATA Policy Item for Entry/Type-Pair MVSESA/LOG	196
15.	Example of a UNIX Message	103	41.	Example SDF Panels	210
16.	Sample Panel for Command Processing	121	42.	Example SDF Tree Structure.	211
17.	Sample Panel for Code Processing	121	43.	Status Descriptors Chained to Status Components	213
18.	Focal Point Forwarding Definitions for Systems	128	44.	Example Tree Structure Definition.	220
19.	Notification Forwarding Panel for CHI02	128	45.	Example SDF Panel	221
20.	Notification Forwarding Panel for ATL01 and ATL02	128	46.	Example Panel Definition Entry	222
21.	Automation Operator Definitions Panel	129			
22.	Automation Operator NetView Userids Panel	130			
23.	Fullscreen TAF Application Definition Panel	131			
24.	Example Processing of a Primary WTOR	140			
25.	SA z/OS Exit Sequence during SA z/OS Initialization	142			
26.	Threshold Definitions for MVS Component LOGREC	167			

Tables

1.	System Automation for z/OS Library	xiii	13.	Example Customization Dialog Definitions for inetd	101
2.	Application Start	1	14.	WTOBUF Recovery Process	118
3.	Application Stop (1)	2	15.	Example SYSTEM_SHUTDOWN Command Processing Entry	135
4.	Application Stop (2)	3	16.	Externalized Common Global Variables	197
5.	Observed Status Monitor Routines	37	17.	Global Variables to Enable Advanced Automation (CGLOBALS)	198
6.	Health Status Return Codes	41	18.	Global Variables That Define the Installation Defaults for Specific Commands	205
7.	Inform List Policy Items	65	19.	SDF Components	217
8.	Inform List Communication Methods	65	20.	Panel Definition Entry Description	222
9.	Code Processing Example for the INGALERT Message ID	68			
10.	Layout of the SMF Record	70			
11.	Format of INGPUSMF Utility Data Set Records	72			
12.	SINGSAMP SA z/OS Sample Library Routines	83			

Accessibility

Publications for this product are offered in Adobe Portable Document Format (PDF) and should be compliant with accessibility standards. If you experience difficulties when using PDF files, you may view the information through the z/OS Internet Library Web site or the z/OS Information Center. If you continue to experience problems, send an e-mail to mhvrcfs@us.ibm.com or write to:

IBM Corporation
Attention: MHVRCFS Reader Comments
Department H6MA, Mail Station P181
2455 South Road
Poughkeepsie, NY 12601-5400
U.S.A.

Accessibility features help a user who has a physical disability, such as restricted mobility or limited vision, to use software products successfully. The major accessibility features in z/OS® enable users to:

- Use assistive technologies such as screen readers and screen magnifier software
- Operate specific or equivalent features using only the keyboard
- Customize display attributes such as color, contrast, and font size

Using assistive technologies

Assistive technology products, such as screen readers, function with the user interfaces found in z/OS. Consult the assistive technology documentation for specific information when using such products to access z/OS interfaces.

Keyboard navigation of the user interface

Users can access z/OS user interfaces using TSO/E or ISPF. Refer to *z/OS TSO/E Primer*, *z/OS TSO/E User's Guide*, and *z/OS ISPF User's Guide Vol I* for information about accessing TSO/E and ISPF interfaces. These guides describe how to use TSO/E and ISPF, including the use of keyboard shortcuts or function keys (PF keys). Each guide includes the default settings for the PF keys and explains how to modify their functions.

z/OS information

z/OS information is accessible using screen readers with the BookServer/Library Server versions of z/OS books in the Internet library at:

<http://www.ibm.com/systems/z/os/zos/bkserv/>

About This Book

This book describes how to adapt your completed standard installation of IBM® Tivoli® System Automation for z/OS (SA z/OS) as described in *IBM Tivoli System Automation for z/OS Planning and Installation* to your environment. This book contains information on how to add new applications to automation and how to write your own automation procedures. It also contains information about how to add new messages for automated applications.

Who Should Use This Book

This book is primarily intended for automation programmers responsible for:

- Customizing system automation and the operations environment
- Developing automation procedures and other operations capabilities

Prerequisites

Throughout this book, it is expected that readers are familiar with System Automation for z/OS and the following documentation:

- *IBM Tivoli System Automation for z/OS Operator's Commands*
- *IBM Tivoli System Automation for z/OS Programmer's Reference*
- *IBM Tivoli System Automation for z/OS Defining Automation Policy*

Where to Find More Information

The System Automation for z/OS Library

Table 1 shows the information units in the System Automation for z/OS library:

Table 1. System Automation for z/OS Library

Title	Order Number
<i>IBM Tivoli System Automation for z/OS Planning and Installation</i>	SC34-2571
<i>IBM Tivoli System Automation for z/OS Customizing and Programming</i>	SC34-2570
<i>IBM Tivoli System Automation for z/OS Defining Automation Policy</i>	SC34-2572
<i>IBM Tivoli System Automation for z/OS User's Guide</i>	SC34-2573
<i>IBM Tivoli System Automation for z/OS Messages and Codes</i>	SC34-2574
<i>IBM Tivoli System Automation for z/OS Operator's Commands</i>	SC34-2575
<i>IBM Tivoli System Automation for z/OS Programmer's Reference</i>	SC34-2576
<i>IBM Tivoli System Automation for z/OS Product Automation Programmer's Reference and Operator's Guide</i>	SC34-2569
<i>IBM Tivoli System Automation for z/OS TWS Automation Programmer's Reference and Operator's Guide</i>	SC34-2579
<i>IBM Tivoli System Automation for z/OS End-to-End Automation Adapter</i>	SC34-2580
<i>System Automation for z/OS Monitoring Agent Configuration and User's Guide</i>	SC34-2581

The System Automation for z/OS books are also available on CD-ROM as part of the following collection kit:

IBM Online Library z/OS Software Products Collection (SK3T-4270)

SA z/OS Home Page

For the latest news on SA z/OS, visit the SA z/OS home page at http://www.ibm.com/systems/z/os/zos/features/system_automation

Related Product Information

You can find books in related product libraries that may be useful for support of the SA z/OS base program by visiting the z/OS Internet Library at <http://www.ibm.com/systems/z/os/zos/bkserv>

Using LookAt to look up message explanations

LookAt is an online facility that lets you look up explanations for most of the IBM messages you encounter, as well as for some system abends and codes. Using LookAt to find information is faster than a conventional search because in most cases LookAt goes directly to the message explanation.

You can use LookAt from these locations to find IBM message explanations for z/OS elements and features, z/VM[®], z/VSE[™], and Clusters for AIX[®] and Linux[®]:

- The Internet. You can access IBM message explanations directly from the LookAt Web site at www.ibm.com/systems/z/os/zos/bkserv/lookat/index.html
- Your z/OS TSO/E host system. You can install code on your z/OS or z/OS.e systems to access IBM message explanations using LookAt from a TSO/E command line (for example: TSO/E prompt, ISPF, or z/OS UNIX[®] System Services).
- Your Microsoft[®] Windows[®] workstation. You can install LookAt directly from the *z/OS Collection* (SK3T-4269) or the *z/OS and Software Products DVD Collection* (SK3T-4271) and use it from the resulting Windows graphical user interface (GUI). The command prompt (also known as the DOS > command line) version can still be used from the directory in which you install the Windows version of LookAt.
- Your wireless handheld device. You can use the LookAt Mobile Edition from www.ibm.com/systems/z/os/zos/bkserv/lookat/lookatm.html with a handheld device that has wireless access and an Internet browser (for example: Internet Explorer for Pocket PCs, Blazer or Eudora for Palm OS, or Opera for Linux handheld devices).

You can obtain code to install LookAt on your host system or Microsoft Windows workstation from:

- A CD-ROM in the *z/OS Collection* (SK3T-4269).
- The *z/OS and Software Products DVD Collection* (SK3T-4271).
- The LookAt Web site (click **Download** and then select the platform, release, collection, and location that suit your needs). More information is available in the LOOKAT.ME files available during the download process.

Summary of Changes for SC34-2570-00

This document contains information previously presented in System Automation for z/OS V3R2.0 Customizing and Programming, SC33-8260-07.

New Information

Shutting Down z/OS systems from GDPS

A new procedure to shutdown z/OS from GDPS is described in a new chapter, see Chapter 12, “Shutting Down z/OS systems in a GDPS Environment,” on page 135.

RESYNC SDFDEFS command

Reference to the use of the above command for generating SDF panels is included in “Dynamically Loading Tree Structure and Panel Definition Members” on page 216.

%INCLUDE Statement for SDF Panels

The %INCLUDE statement for SDF panels allows you to specify dynamic generation of the panel definitions, see “%INCLUDE Statement for SDF Panels” on page 223.

Command exits

The following command exits have been introduced:

- AOFEXC16 for INGTHRS
- AOFEXC18 for INGLKUP
- AOFEXC19 for INGAMS
- AOFEXC21 for INGOPC
- AOFEXC22 for trouble ticketing
- AOFEXC23 for authorization checking of requests that are passed using the TWS interface.

For more details, see “Command Exits” on page 154

DB2® connection monitoring

SA z/OS allows you to monitor DB2 connections for both CICS® and IMS™. See “DB2 Connection Monitoring” on page 61.

Enabling SMF records

Details are provided in Chapter 6, “Availability and Recovery Time Reporting,” on page 69, see “Enabling SMF Records” on page 71.

Extended alert-based notification

The alert-based notification service that SA z/OS provides has been extended to include the following notification targets:

- Tivoli Netcool/OMNIBus
- IBM Tivoli Service Request Manager®
- A user-defined alert handler

See Chapter 5, “Alert-Based Notification,” on page 63 for more details.

INGERRLS listing

If the testing or loading of an AT or MRT fails, a special INGERRLS listing is written to the DSILIST data set. See “Listings” on page 30.

INGJRMJSP automation routine

The INGJRMJSP automation routine has been introduced as part of an updated JES2 spool monitoring process, see “INGJRMJSP” on page 191.

NetView message revision table

SA z/OS now uses the NetView message revision table (MRT) as part of message processing. For more details, see Chapter 3, “How to Add a Message to Automation,” on page 23.

SDFCONF command

“Panel Definition Structure” on page 220 provides details about how to assign the PF4 key to the SDFCONF command to delete a record in SDF.

System operations processing

The dedicated *work operators* that SA z/OS uses for all subsystem-related processing are described in “System Operations Automation Flow” on page 33.

Task global variables set by INGMON

“Programming Techniques” on page 44 now provides details of the task global variables that are set by INGMON.

Changed Information

Adding a new application to automation

Revised procedures are provided for adding a new application to automation in Chapter 1, “How to Add a New Application to Automation,” on page 1.

DB2 License Files

Additional DB2 license file support for z/OS is described in “Writing the SMF Report to DB2” on page 74.

AOFEXC17 user exit

The details about this user exit for alerting have been updated. See “Command Exits” on page 154.

EVEERTRN automation routine

The parameters for the EVEERTRN have been retired. The routine no longer responds to message DFHAC2246, and message DFHAC2250 has been added.

Flag exits

The example and process information about flag exits has been updated, see “Flag Exits” on page 147.

JES2 spool monitoring

The JES2 spool recovery process has been extended to include an explicit monitoring routine, INGJRMJSP. For more details, see “JES2 Spool Monitoring” on page 61.

Message automation

Because of major changes to message processing, Chapter 3, “How to Add a Message to Automation,” on page 23 has been extensively rewritten. These changes also affect associated processing of various automation solutions that are supplied by SA z/OS, see Chapter 15, “Automation Solutions,” on page 161.

UNIX Automation

Details about customizing UNIX resources have been updated, see “Customization of z/OS UNIX Resources” on page 94.

WTO(R) buffer shortage recovery

The introduction to enabling WTO(R) buffer shortage recovery has been updated, see “Enabling WTO(R) Buffer Shortage Recovery” on page 117.

Moved Information

The information that was previously in “Step 7: Reload MPF List and Automation Configuration Files” has been moved to “Loading the Changed Automation Environment” on page 85.

The section “Generic Synonyms: AOFMSGSY” on page 227 has been moved from “A Guide to SA z/OS Automation Tables” on page 30 to Appendix D, “Message Automation,” on page 227.

The section “Inheritance Rules for Classes” on page 35 has been moved from Appendix D, “Message Automation,” on page 227 to Chapter 3, “How to Add a Message to Automation,” on page 23.

The following sections have been moved to this document from *IBM Tivoli System Automation for z/OS Defining Automation Policy*:

- “Extended Status Command Support” on page 27
- Chapter 10, “Automating Networks,” on page 127
- Appendix C, “How System Operations Coordinates with Automatic Restart Manager,” on page 225
- Chapter 11, “Defining a VTAM Application to SA z/OS,” on page 133

The chapter “DB2 Automation for System Automation for z/OS” has been moved to *Product Automation Programmer’s Reference and Operator’s Guide*.

Deleted Information

SYSIEFSD Resource Recovery

The SYSIEFSD resource recovery function is removed from “Handling Long-Running Enqueues (ENQs)” on page 109.

AOF_SET_AVM_RESTART_EXIT

This common global variable to set advanced automation options (AAOs) has been retired.

Automation routines

Because of the exploitation of the base functions of SA z/OS for the automation of CICS, the following automation routines have been retired:

- EVEEARMW
- EVEED004
- EVEEI004
- EVEEI006
- EVEEI009
- EVEEI010
- EVEEI115
- EVEERLSI
- EVEES100
- EVEET002
- EVEET003
- EVEETUOW
- EVERSPPI

Because of changes related to TWS Automation, the EVJEAC03 automation routine has been retired.

Message automation

Because of changes to message processing, the following sections have been deleted from Appendix D, “Message Automation,” on page 227:

- FORCED AT Entry Type
- RECOMMENDED AT Entry Type
- CONDITIONAL AT Entry Type
- Other Forced AT Entries
- Restricted Message IDs

| **TEC Notification: AOFMSGSY synonyms**

| The TEC Notification AOFMSGSY synonyms have been retired and deleted
| from “Generic Synonyms: AOFMSGSY” on page 227.

| **User exits**

| The INGEX12 and INGEX14 exits have been retired.

| You may notice changes in the style and structure of some content in this
| document—for example, headings that use uppercase for the first letter of initial
| words only, and procedures that have a different look and format. The changes are
| ongoing improvements to the consistency and retrievability of information in our
| documents.

| This document contains terminology, maintenance, and editorial changes. Technical
| changes or additions to the text and illustrations are indicated by a vertical line to
| the left of the change.

Chapter 1. How to Add a New Application to Automation

This chapter outlines the requirements to add and monitor a new application for SA z/OS.

Preparation Before Automating an Application

Before you can automate a product you need to extract its characteristics like its start and stop behaviour and parameters like its jobname.

The following steps should help you to obtain these characteristics. Once you have finished you need to add the application to your automation policy. Refer to *IBM Tivoli System Automation for z/OS Defining Automation Policy* for this activity. The main requirements for the automation of an application are:

- Address Space properties
- Application Start
- Application Shutdown
- Application Events
- Application Monitoring
- Outstanding Reply Processing
- Topology

Address Space properties

When adding an new application, you need to know the following most important characteristics of the application:

- Jobname
- JCL procedure name
- Is it scheduled by the Master Scheduler or a scheduling subsystem?
- Is it an MVS, OMVS application or another kind of application (for example a NetView task)
- Location for running the application: every sysplex's system, once in the sysplex or on a subset of systems within the sysplex?

The application's general properties are mostly defined in the APPLICATION INFO policy.

Step 1 - Application Start

Before you can introduce a new application you should consider how it is started and all the actions required to make it operational. Therefore it is important to know:

Table 2. Application Start

Actions Required	Available Functionality
Are there any actions to complete before the application itself could be started?	To include these actions in automation, use the application's PRESTART policy. Any command specified there is issued prior to the insertion of the start command.

How to Add a New Application to Automation

Table 2. Application Start (continued)

Actions Required	Available Functionality
What is the application's start command? And are there different start commands depending on the startup mode of an application (for example, the normal and the light start for a DB2 database)?	The start command should be located in the STARTUP policy. It also provides the full flexibility for different start commands by specifying different start types. Once a start type is set, the specified command will be chosen. The start type easily can be chosen/changed at System Automation's runtime.
Who starts the application when it is not started by System Automation? Is it started by another instance?	The APPLICATION INFO policy lets you specify an EXTERNAL STARTUP parameter.
Are there any actions to complete after the application initialization?	Use the POSTSTART policy to issue additional commands after the full initialization of the application.

Note: All startup policies support flexible start types.

Step 2 - Application Stop

Once the application is no longer required, you need to take all the necessary steps to bring it down in a planned way. Therefore it is important to know:

Table 3. Application Stop (1)

Actions Required	Available Functionality
Should you issue commands to prepare the application shutdown ?	Use the SHUTDOWN INIT policy to identify additional commands to be issued before the application termination can be initiated.
Which command initiates the termination process? And what happens when the stop command does not take effect?	System Automation has the concept of command escalation. It provides the capacity to specify an order of termination commands. System Automation will issue the first command and verify the effect before it inserts the next more effective command. There are three policies (SHUTDOWN NORM, IMMED, FORCE) where you can specify different shutdown command sequences for different shutdown types.
Who stops the application when it is not stopped by System Automation? Is there another instance controlling the application?	The APPLICATION INFO policy lets you specify an EXTERNAL SHUTDOWN parameter.
Are there any final termination actions to complete after an orderly application termination?	Use the SHUTDOWN FINAL policy to issue additional commands after the termination of the application.

Sometimes it can happen that an application terminates unexpectedly. In this case it might be necessary to complete some cleanup actions before the application can be restarted. Consequently it is necessary to know:

Table 4. Application Stop (2)

Actions Required	Available Functionality
Are there any necessary cleanup activities to be completed before the application can be restarted?	The concept of status commands addresses this issue. Once the application reaches a specific status, the defined command will be issued.
Is the application restartable in case of an unexpected termination?	System Automation recognizes several termination situations for applications. Depending on the situation System Automation is able to distinguish between a recoverable and an unrecoverable error. As a result, System Automation determines whether to restart the application or not. This concept is Code Match processing. Additionally the RESTART option in the APPLICATION INFO policy defines the circumstances when System Automation should restart the application.
Is the application restarted automatically by another application? Is the application ARM (Automatic Restart Manager) enabled and will it be restarted automatically?	System Automation provides the concept of Move groups to accomplish the same behavior as the ARM mechanism does. It is recommended to use Move groups for achieving high availability of applications.

Step 3 - Application Events

System Automation reacts to events. More specifically, it reacts to messages sent by applications or the system itself.

There are many kinds of applications. Each of them sends a varying degree of messages which can be used to determine its status. The messages represent different states during an application's life-cycle. Normally MVS resources provide proper messages to determine the status of an application. Resources within OMVS are mostly silent.

Step 3 points you to important messages in the life-cycle of the application. As you can see below a resource is started once. After an amount of initialization time it is fully operational. When the resource is no longer needed a stop command is invoked to terminate it. After the termination processing it does not exist any longer.

How to Add a New Application to Automation

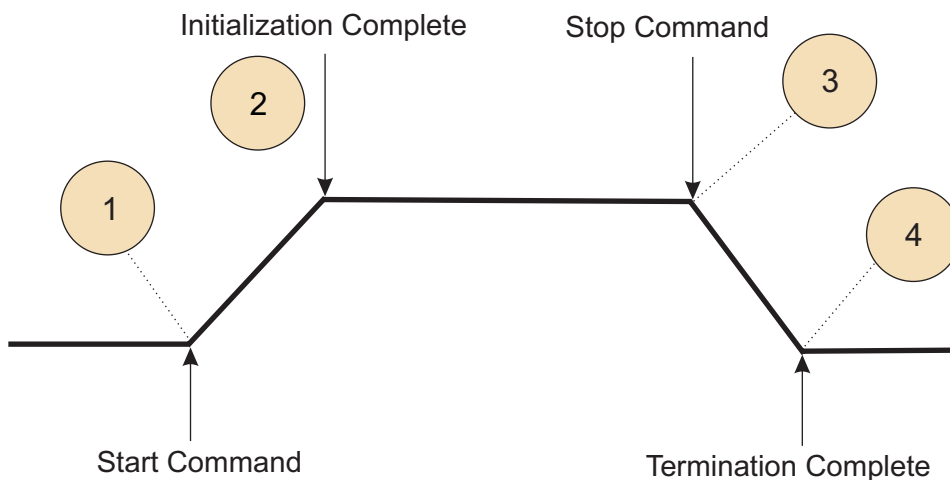

Figure 1. Application Lifecycle

What are the important messages at the points in the application's life-cycle as illustrated in Figure 1 above?

For example a message IEF403I is sent when the system observes that an application has been started. IEF404I is issued when the application terminated.

Are there are other kinds of usable events at the specific points?

Step 3 discusses also the situation of an unplanned application termination.

Are there important messages at point 3 and 4 of Figure 1 in case of an unplanned termination?

For example a message IEF450I points to an unplanned termination.

Step 4 - Application Monitoring

Automating resources does not only consist of starting and stopping the resources. It is also important to know methods that determine whether the component is working as expected or already terminated. System Automation provides proper monitoring routines to be able to determine its state.

What kind of an application is it and could the state of the application be determined by:

- The existence of an address space
- The existence of a USS process
- The status of a NetView task

The corresponding monitor could be specified in the field MONITOR ROUTINE.

Step 4 presents messages issued by applications and how communicative they are. So it is useful to decide whether an application must be actively monitored or its state could be reliably derived from messages. If this is the case the MONITOR INTERVAL could be set to NONE. It helps to reduce the messages in the NetView log and to reduce unnecessary system activity. The monitoring action itself takes place at the startup and shutdown cycle to verify the state of the application.

In contrast, there are less communicative applications. In this case a well balanced monitor interval (specific enough) ensures a periodic monitoring service to verify the applications status.

Sometimes it is not enough to know whether a resource is running or not. Many situations require more detailed information as well as its status. The concept of monitor resources provides the infrastructure to evaluate the status of resources in detail and to react properly to the specific situation.

Outstanding Reply Processing

SA z/OS keeps track of all outstanding Write-to-Operator Replies (WTORs) that it receives if it does not reply to them immediately. Because some applications may have more than one outstanding WTOR at the same time, and not all WTORs are equally important, they are classified accordingly. For more details refer to Chapter 13, "WTOR Processing," on page 137.

Topology

Normally the application to be automated depends on the underlying infrastructure, like JES2 or TCPIP. This means that this infrastructure must be available before you can start the application.

Vice versa the application can be a prerequisite for other applications, before they can be started.

Likewise you need to think about which other applications must be terminated prior to the termination of the application.

As described above, there are relationships between the applications.

At this point it might be helpful to draw a picture and to visualize the relationships between the application in case of a start and a stop situation.

SA z/OS provides Best Practice policies containing solutions for several products. The solutions are illustrated in PDF file format located in: /usr/lpp/ing/doc/policies.

Please refer to the appropriate file to find out more information about the solution you are trying to automate.

Adding the Application to Automation

Define an Application Policy Object

To add a new application to SA z/OS, you must create and define a new Application policy object using the SA z/OS customization dialog. With the customization dialog, you also define how the new application should be automated by SA z/OS, for example:

- Specifying startup or shutdown commands for the application,
- Specifying the appropriate monitoring routine,
- Specifying relationships to correlate it with other applications,
- Linking the application into an application group,
- Considering where the applications should be visible.

SA z/OS provides Best Practice policies containing solutions for several products.

How to Add a New Application to Automation

How to add a new application and how to access System Automation's Best Practice solutions is described in detail in *IBM Tivoli System Automation for z/OS Defining Automation Policy*.

Build New Automation Configuration Files

When you finish defining the application in the customization dialog, build the new automation configuration files from the updated policy database. See *IBM Tivoli System Automation for z/OS Defining Automation Policy* for more information.

After you have completed this step, the application is known to SA z/OS and can therefore be automated according to the policy that was defined in "Define an Application Policy Object" on page 5.

Chapter 2. How to Create Automation Procedures

You can write additional automation procedures to supplement the basic automation procedures that are supplied by SA z/OS. For example, you may want to develop procedures to automate an application that is used exclusively on your system or to perform specialized automated operations for a subsystem.

SA z/OS commands and routines perform basic functions such as logging messages and checking automation flags. You can use them in your own automation procedures.

SA z/OS generic routines and common routines are convenience routines that provide your automation procedures with a simple, standard way of interfacing with the automation control file, automation status file, and NetView log file. It is strongly recommended that you use these routines wherever possible in your own code.

“How Automation Procedures Are Structured” on page 8 describes how to structure your automation procedures. Refer to *IBM Tivoli System Automation for z/OS Programmer’s Reference* for detailed descriptions and examples of the generic routines, common routines and file manager commands you can use in your automation procedures.

How Automation Procedures Are Called

There are several ways to call an automation procedure including:

- Calling the automation procedure from the NetView automation table using SA z/OS generic routines
- Keying in the automation procedure name or its synonym into a NetView command line
- Calling the automation procedure from another program
- Starting the automation procedure with a timer
- Starting the automation procedure with the NetView EXCMD command
- Starting the automation procedure on an automation operator with the SA z/OS AOFEXCMD command routine
- In the customization dialog, entering your automation procedure name in the **Command text** or **Command** field of various policy items for the following entry types:
 - Application
 - MVS Component
 - Timers
 - Monitor Resources

Note: Not all routines can be called through all interfaces as some require extensive environmental setup before they are invoked.

How Automation Procedures Are Structured

It is recommended that the structure of automation procedures contain three main parts, as follows:

1. Perform initialization processing
2. Determine whether automation is allowed
3. Perform automation processing.

Figure 2 illustrates the structure of automation procedures for system operations and Figure 3 for processor operations.

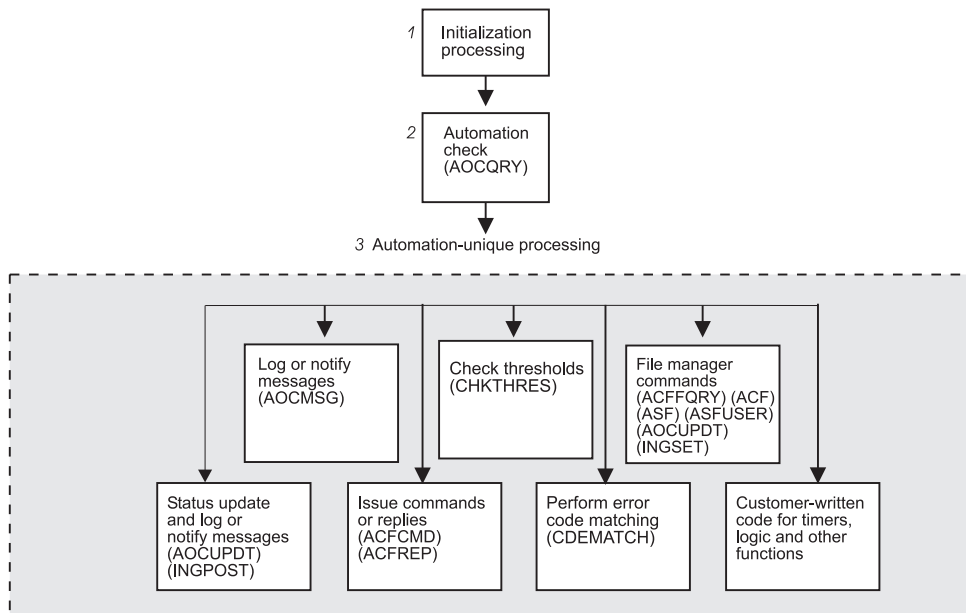

Figure 2. Automation Procedures for System Operations

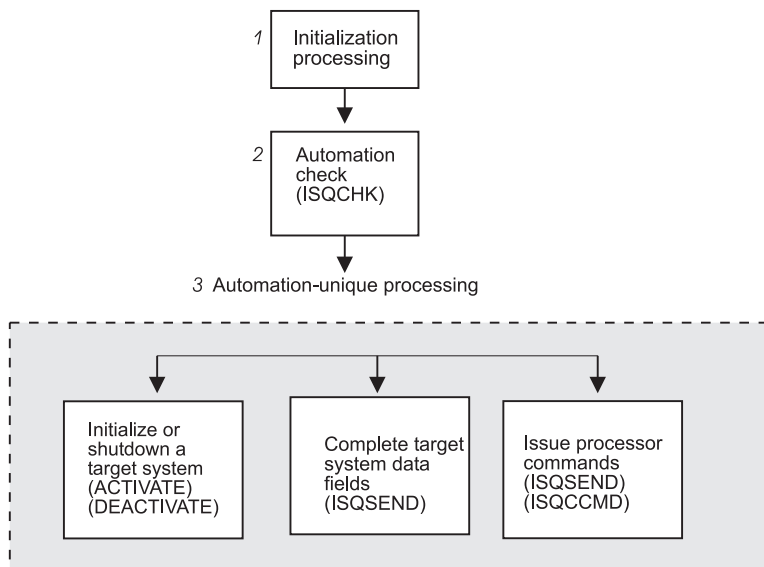

Figure 3. Automation Procedures for Processor Operations

The following sections provide more details about each part of an automation procedure.

Performing Initialization Processing

Initialization processing may not be required for simple automation procedures.

Initialization processing is responsible for:

- Setting up any error trap routines.
- Identifying the automation procedure by setting a local variable either explicitly or at execution time. This step makes it simpler to code routines that log messages and send notifications.
- Declaring the global variables, such as common and task global variables, that are used for subsystem definition values in the automation procedure.
See Appendix A, “Global Variables,” on page 197 for descriptions of global variables.
- Checking whether debugging is on.
- Issuing debugging messages, if debugging is turned on.
- Validating the automation procedure call.

This step can help prevent an operator from calling the automation procedure inappropriately. Automation procedures can also be validated using command authorization checking methods provided by NetView or an SAF product.

- Saving NetView message parameters. This step is necessary if your automation procedure uses the NetView WAIT statement and you need to access the original message text or control information.

For more information on coding automation procedure initialization sections, refer to “Example Automation Procedure” on page 16, to *Tivoli NetView for z/OS Customization Guide* and to *Tivoli NetView for z/OS Automation Guide*.

Determining whether Automation Is Allowed

System Operations

Automation procedures for applications and MVS components that are called from the NetView automation table should always perform an automation check by calling the AOCQRY common routine. AOCQRY checks that the automation flags allow automation. These checks eliminate the risk of automating messages for applications that should not be automated, or for which automation is turned off. AOCQRY also initializes most of the common and task global variables that are used in the automation procedure with values specific to the application.

Refer to *IBM Tivoli System Automation for z/OS Programmer's Reference* for more information on coding the automation check routine.

Processor Operations

Most of the processor operations commands run only when processor operations has been started. To determine whether processor operations is active, you can use the ISQCHK command in your automation routines. If processor operations is not running, ISQCHK returns return code 32 and issues the message:

```
ISQ0301 Cannot run cmd-name command until Processor Operations has started.
```

Your application can then issue the ISQSTART command to begin processor operations.

Performing Automation Processing

Automation processing is performed by any combination of SA z/OS routines and your own code. The following documentation gives more information on coding automation procedures:

- “Automation Processing in System Operations”
- “Automation Processing in Processor Operations” on page 11

Automation Processing in System Operations

This section contains information on how to customize automation processing for system operations.

Updating Status Information: You can update status information by calling the AOCUPDT common routine. This routine is used when a message indicates a status change. This would normally be done from the generic routines ACTIVMSG, HALTMSG, and TERMMSG. Making your own status updates may cause unpredictable results.

For more information, see *IBM Tivoli System Automation for z/OS Programmer's Reference*.

Logging Messages and Sending Notifications: You can log messages and send notifications by calling the AOCMSG common routine.

AOCMSG performs the following actions:

- Formats a message for display or logging
- Issues messages as SA z/OS notification messages to notification operators

For more information, see *IBM Tivoli System Automation for z/OS Programmer's Reference*.

Issuing Commands and Replies: You can issue commands and replies by calling the ACFCMD and ACFREP common routines. You can use these routines to:

- Issue one or more commands in response to a message.
- Issue a single reply in response to a message.
- Use the step-by-step (PASS) concept to react to or recover from an automation event.

ACFCMD issues one or more commands. It supports both a single reaction and the step-by-step (PASS) concept. For more information, see *IBM Tivoli System Automation for z/OS Programmer's Reference*.

ACFREP issues a single reply. It supports both a single reaction and the step-by-step (PASS) concept. For more information see *IBM Tivoli System Automation for z/OS Programmer's Reference*.

In many cases you may be able to use the ISSUEACT generic routine that also supports single and pass processing.

Checking Thresholds: You can check and update thresholds by calling the CHKTHRES common routine. Use CHKTHRES to track and maintain a threshold, and to change the recovery action based on the threshold level exceeded. For more information see *IBM Tivoli System Automation for z/OS Programmer's Reference*.

How Automation Procedures Are Structured

Checking Error Codes: You can check error codes by calling the CDEMATCH common routine. Use CDEMATCH to compare error codes in a message to a set of automation-unique error codes to determine the action to take. For more information, see *IBM Tivoli System Automation for z/OS Programmer's Reference*.

In some cases you may be able to use the code matching capabilities of the ISSUEACT and TERMMSG generic routines.

Using File Manager Commands: You can use file manager commands to access SA z/OS control files such as the automation control file and automation status file:

- Use the ACF command if you need to load or display the automation control file.
- Use the ACFFQRY command to query the automation control file quickly.
- Use the ASF command to display the automation status file.
- Use the ASFUSER command to modify the automation status file fields reserved for your own information.

For more information, see *IBM Tivoli System Automation for z/OS Programmer's Reference*.

Using External Code for Timers, Logic, and Other Functions: Your automation procedures may require code to set timers, to perform logic unique to your enterprise or to the automation procedure itself, and to perform other functions. Some examples include:

- Issuing commands and trapping responses.
You can issue commands and trap responses using the NetView WAIT or PIPE commands. You may need to use these commands in your code if it is necessary to check the value or status of a system component or application before continuing processing. For more information, see *Tivoli NetView for z/OS Customization Guide*.
- Setting Common Global and Task Global values to control processing.
You can set Common and Task Global values by using NetView commands. You may need to set these values if it is necessary to set a flag indicating progress, message counts, and other indicators that must be kept from one occurrence of a message to the next. See *IBM Tivoli System Automation for z/OS Defining Automation Policy* for a table of all externalized SA z/OS global variables. Also refer to the discussion of common and task global variables in *Tivoli NetView for z/OS Customization Guide*.
- Setting timer delays to resume processing.
You can set timer delays by using the NetView AT, AFTER, EVERY and CHRON commands. You can use these commands when an automation procedure must either resume processing or initiate another automation procedure after a given time to do additional processing. For example, you could use these commands to perform active monitoring of subsystems. For more information, see the discussion of AT, AFTER, EVERY and CHRON commands in *Tivoli NetView for z/OS Automated Operations Network User's Guide*.

Automation Processing in Processor Operations

This section contains information on how to customize automation processing for processor operations.

Initializing a Target System: If your routines need to start target systems (hardware and/or operating system), issue the ISQCCMD ACTIVATE command.

How Automation Procedures Are Structured

Shutting Down a Target System: If your routines need to shut down a target system, issue the ISQCCMD DEACTIVATE OCF command. Before issuing the command to close the target system, shut down all of your functioning subsystems. This avoids any unexpected situations at the target system.

Issuing Other OCF Commands: All OCF commands supported by processor operations can be issued from automation routines. See *IBM Tivoli System Automation for z/OS Operator's Commands* for details about these commands.

Reserved SA z/OS Commands: The SA z/OS commands ISQISUP, ISQISTAT, ISQCMMT, ISQSTRT, ISQXIPM, ISQGPOLL, and ISQGSMSG are not intended for your use. Do not use these in your automation routines. Unexpected results may occur.

The following commands can only be used from an operator console and should not be used in your automation routines or with ISQEXEC: ISQXDST, ISQXOPT, and ISQHELP.

The following commands are for automation and should not be used in your automation routines: ISQI101, ISQI212, ISQMCLR, ISQI320, ISQIUNX, ISQI347, ISQI470, ISQI886, ISQI888, ISQI889, ISQI128, ISQIVMT, ISQMVM11, ISQMVM12, ISQMWAIT, ISQMDCCF, ISQM020, and ISQIPLC.

Serializing Command Processing: Serializing command processing ensures that commands and automation routines are processed in the order in which they are sent to a target system console. It can also prevent the command sequence from being interrupted by other tasks.

Specific target control tasks are assigned to specific target systems during initialization of the target system. More than one target system can share a target control task, but a target system never has more than one target control task allocated to it to perform work.

When a command or an automation routine is sent to a target system, it can be processed partly in the issuing task (a logged-on operator or an autotask) and partially in a target control task. When the command or automation routine is to be processed by a target control task, it is either allocated to the target control task and processed, or queued to be processed by the target control task. This serializes the processing of commands and automation routines. Serializing ensures that they are processed in the order in which they were sent to the target system console.

The NetView program has priority defaults established during its initialization. Usually, everything running under NetView has a low priority. You can use the NetView DEFAULTS command to see what the settings are, but you should not change them. For SA z/OS command processing to be serialized as designed, all commands used in SA z/OS must have a priority setting of "low". If you change the priorities or have more than one priority for commands used in SA z/OS, the difference in the priorities may defeat the serialization that results from the architecture of the target control task.

Sending an Automation Routine to a Target Control Task: If you run the same series of SA z/OS commands regularly, you can program the commands into a NetView automation routine. Follow the guidelines you use for any NetView automation routine.

How Automation Procedures Are Structured

A NetView autotask or a logged-on operator can then run this routine or send it to a target control task. Use the following command to transfer an automation routine to a target control task:

```
ISQEXEC target-system-name SC routine-name
```

When you issue the ISQEXEC command to process an automation procedure, all of the commands are processed in the order in which they occur in the automation procedure. This is because the ISQEXEC command sends work to a target control task, which processes commands serially. Any other commands or automation routines issued to the same console by the ISQEXEC command are queued for processing by the target control task and do not start until the previous command or automation procedure completes.

The ISQEXEC command also frees the original task from any long-running command sequence. This lets you use the issuing task, such as an OST, for other work.

The ISQEXEC command does not lock consoles to ensure command serialization; the command serialization process is due to the target control task allocation scheme. Commands and automation routines are processed in the order in which they occur; however, it is possible for commands from other tasks to interrupt the command sequence.

For more information about the ISQEXEC command, see *IBM Tivoli System Automation for z/OS Operator's Commands*.

Locking a Console: Several routines and operators may attempt to address the same console at the same time. The ISQEXEC command does not prevent other tasks from interrupting the sequence of commands being processed by the target control task; it does not lock the console.

To prevent a sequence of commands from being interrupted, use the ISQXLOC and ISQXUNL commands. The ISQXLOC command locks access to the console. If a task attempts to issue a command to a locked console, the task is told that the console is locked, and the command fails. When you are finished with the sequence of commands that must be processed without interruption, issue the ISQXUNL command to unlock access to the console.

You can use the ISQXLOC and ISQXUNL commands within automation routines to ensure that they complete without interference from other tasks. For automation routines that issue a number of SA z/OS commands, put the following command after the ISQEXEC command and near the beginning of the routine:

```
ISQXLOC target-system-name SC
```

This locks access to the target system console to the current task until the lock is dropped by the command:

```
ISQXUNL target-system-name SC
```

Only the task that issued ISQXLOC can successfully issue ISQXUNL. If an ISQXLOC command is issued from a locked sequence of commands, it is rejected because the console is already locked.

When you lock a system console for a target system running on a logical partition, you lock that system console for all other target systems using that processor. A command sent to a system console for any other target system (logical partition) on that target hardware definition does not run until the console is unlocked.

How Automation Procedures Are Structured

If your automation routine cannot wait for a console to be released, use the ISQOVRD command to gain control of the console. Use the following command only in **critical** automation routines:

```
ISQOVRD target-system-name SC
```

When the routine issuing the override command completes, the lock is removed and the console is available.

How to Make Your Automation Procedures Generic

By using the SA z/OS common routines, you can make your own automation procedures generic. A generic automation procedure comprises three parts. For each part, there are special common routines that help you to fulfill your tasks:

Preparation

Check if automation is allowed and should be done. Use common routine AOCQRY.

Evaluation

What should be done? Use common routine CDEMATCH.

Execution

Do what should be done. Use common routines ACFCMD or ACFREP.

```
*****
*****      Preparation      *****
*****
*****
AOCQRY
- check if the resource is controlled by SA z/OS
- check if automation is allowed
- prepare/set task global variables for CDEMATCH, ACFCMD and ACFREP
...
CDEMATCH
- code matching (table search in ACF)
- find out required action
...
ACFCMD/ACFREP
- do required action:
  issue command / respond reply
```

Figure 4. Skeleton of an Automation Procedure

For more information on the mentioned common routines refer to *IBM Tivoli System Automation for z/OS Programmer's Reference*. For more information on command processing or reply processing refer to *IBM Tivoli System Automation for z/OS User's Guide*.

Processor Operations Commands

Whenever possible, your automation routines should make use of SA z/OS's processor operations OCF commands, also called common commands. These

commands are independent of the hardware type of the target system's processor. Therefore, the use of these commands minimizes the need for changes to your automation routines if you need to add new processors to your configuration. See *IBM Tivoli System Automation for z/OS Operator's Commands* for a detailed description of the processor operations commands.

Developing Messages for Your Automation Procedures

Depending on the scope of additional programming, creating new automation procedures may also require developing additional messages.

Some SA z/OS facilities and commands you can use to develop messages include:

- The AOCMSG common routine (see *IBM Tivoli System Automation for z/OS Programmer's Reference*).
- The AOCUPDT common routine (see *IBM Tivoli System Automation for z/OS Programmer's Reference*).

The following steps summarize the message development process.

1. Choose a message ID. Make sure it is unique.
2. Use NetView message services to define the message to NetView.
Put an entry for the message in a DSIMSG data set. This data set must be identified in a DSIMSG data definition (DD) name.
3. Use the AOCMSG common routine to issue the message (see *IBM Tivoli System Automation for z/OS Programmer's Reference*).
4. Add an entry for the message to your production copy of the NetView DSIMSG data set.

Example AOCMSG Call

This example shows how to code AOCMSG to issue message ABC123I.

Entries for messages in DSIMSG member DSIABC12 are as follows:

```
*****
120I ...
121I ...
122I ...
123I 10 40 THE EAGLE HAS &1
124I ...
*****
```

Your automation procedure contains the following AOCMSG call:

```
<other automation procedure code>
:
:
:   AOCMSG LANDED,ABC123
:
:
<other automation procedure code>
```

When AOCMSG is called as specified in the automation procedure, DSIMSG member DSIABC12 is searched for message ABC123I. Substitution for variable &1 occurs, and the following message is generated:

```
ABC123I THE EAGLE HAS LANDED
```

Note that the message is defined with a 10 and a 40 between the message ID and the first word of the message. These are the SA z/OS message classes to which the

Developing Messages for Your Automation Procedures

message belongs. When the message is issued a copy is sent to every notification operator who is assigned class 10 or class 40 messages.

Refer to *Tivoli NetView for z/OS Customization Guide* for further information on developing new messages.

Example Automation Procedure

This section provides an example of an application program that handles a z/OS message. The automation procedure uses a subset of the SA z/OS common routines or generic routines.

```
/* Example SA z/OS Automation Procedure */
```

```
1 Signal on Halt Name Aof_Error; Signal on Failure Name Aof_Error
Signal on Novalue Name Aof_Error; Signal on Syntax Name Aof_Error

2 Parse source .. ident .

3 "GLOBALV GETC AOFDEBUG AOF."||ident||".0DEBUG AOF."||ident||".0TRACE"
If AOFDEBUG = 'Y' Then
  "AOCMSG "||ident||",700,LOG,"||time()||","||opid()||","||Arg(1)
loc.0debug = AOF.ident.0DEBUG
loc.0trace = AOF.ident.0TRACE
loc.0me = ident
If loc.0trace <> '' Then Do
  loc.0debug = ''
  Trace Value loc.0trace
End

4 save_msg = msgid()
save_text = msgstr()
lrc = 0

5 /* This procedure can only be called for msg IEA099A */
If save_msg <> 'IEA099A' Then Do
  "AOCMSG "||loc.0me||",203,"||time()||","||opid()
Exit
End

6 "GLOBALV GETC AOFSYSTEM"
cmd = 'AOCQRY '||save_msg||' RECOVERY '||AOFSYSTEM
cmd
svretcode = rc
If loc.0debug = 'Y' Then
  "PIPE LIT /Called AOCQRY; Return Code was "||svretcode||"/" ,
  "| LOGTO NETLOG"

/* ----- **
** Check return code from AOCQRY **
** 0 = ok 1 = global flag off **
** 2 = specific flag off 3 = resource not in ACF **
** 4 = bad parms 5 = errors/timeout **
** ----- */
Select

7 When svretcode >= 3 Then Do
  "AOCMSG "loc.0me",206,,"time()",,,"cmd",RETCODE="svretcode
lrc = 1
End

8 When svretcode > 0 Then Do
  "GLOBALV GETT AUTOTYPE SUBSAPPL SUBSTYPE SUBSJOB"
  "AOCMSG "loc.0me",580,,"time()","SUBSAPPL","SUBSTYPE", ,
  SUBSJOB","AUTOTYPE","save_msg
lrc = 1
End
Otherwise Do
```

```

9      Parse Var save_text With . 'JOBNAME=' save_job 'ASID=' save_asid .

10     ehkvar1 = save_job
        ehkvar2 = save_asid
        "GLOBALV PUTT EHKVAR1 EHKVAR2"

11     cmd = 'ACFCMD ENTRY=' || AOFSYSTEM || ',MSGTYP=' || save_msg
        cmd
        svretcode = rc
        If loc.0debug = 'Y' Then
            "PIPE LIT /Called ACFCMD; Return Code was " || svretcode || "/" ,
            "| LOGTO NETLOG"

        /* ----- **
        ** Check return code from ACFCMD **
        ** 0 = ok 1 = no commands found in ACF **
        ** 4 = bad parms 5 = errors/timeout **
        ** ----- */
12     If svretcode > 1 Then Do
            "AOCMSG "loc.0me",206,, "time()",,, "cmd",RETCODE="svretcode
            lrc = 1
        End
        End
    End /* End of Select svretcode */

13 Exit lrc

14 Aof_Error:
    Signal Off Halt; Signal Off Failure
    Signal Off Novalue; Signal Off Syntax
    errtype = condition('C')
    errdesc = condition('D')
    Select
        When errtype = 'NOVALUE' Then rc = 'N/A'
        When errtype = 'SYNTAX' Then errdesc = errortext(rc)
        Otherwise Nop
    End
    "AOCMSG "errtype",760,, "loc.0me", "sigl", "rc", "errdesc
    Exit -5

```

Notes[®] on the Automation Procedure Example

- 1** This step sets error traps for negative return codes, operator halt commands, and REXX programming errors.
- 2** This step defines the identity of the automation procedure.
- 3** This step handles the debug and trace settings (refer to “Using AOCTRACE to Trace Automation Procedure Processing” on page 19).
- 4** Save the NetView message variables the automation procedure uses.
- 5** Perform authorization check. This procedure can only be called for a particular message.
- 6** This section performs the automation check:
 1. Fetch the AOFSYSTEM common global variable that contains the information under which entry name the system messages are stored in the automation control file (ACF).
 2. The automation procedure calls the AOCQRY command. This performs the automation flag check and presets some task global variables that are used by other common routines like ACFCMD.
- 7** Issue message AOF206I if call to AOCQRY fails.
- 8** Issue message AOF580I if automation flag is off.

Example Automation Procedure

- 9** Get the job name and asid reported in the message.
- 10** Set EHKVARn variables for ACFCMD.
- 11** Call ACFCMD to issue the command specified in the configuration files. The Automation Control File entry for the message IEA099A could look like this:

```
MVSESA IEA099A,  
CMD=(,,'MVS C &EHKVAR1,A=&EHKVAR2')
```
- 12** Issue message AOF206I if call to ACFCMD fails.
- 13** Exit with return code that indicates successful or unsuccessful processing.
- 14** This code logs a message if an error is trapped at step **1**.

Installing Your Automation Procedures

The installation process for a new automation procedure depends on the language in which the automation procedure is written.

- If the automation procedure uses a compiled language, such as PL/I, C, or Assembler:
 1. Compile or assemble your source into an object module.
 2. Link-edit the object module into a NetView load library.
 3. Include an entry for the automation procedure in the CNMCMDU member of the NetView DSIPARM data set.
- If the automation procedure uses an interpreted language such as NetView command list or REXX:
 1. Copy the automation procedure into a NetView command list library
 2. Optionally include an entry for this automation procedure in the DSICMD member of the NetView DSIPARM data set. Then it is more quickly found and invoked.

For more information on preparing your code for use and installing it, refer to *Tivoli NetView for z/OS Customization Guide*

Testing and Debugging Automation Procedures

This section describes SA z/OS and NetView facilities you can use for testing automation procedures, including:

- SA z/OS assist mode
- SA z/OS AOCTRACE operator facility
- NetView testing and debugging facilities

The Assist Mode Facility

SA z/OS provides an *assist mode* facility, so that you can verify actions of automation procedures and automation policy before letting them run in a completely automated environment.

When assist mode is on, actions that are normally taken by SA z/OS automation procedures, such as issuing a command or reply or calling a common routine, are not performed. Instead messages that describe what would have happened are written to the netlog.

The assist mode is associated with automation flags (Automation, Initstart, Start, Recovery, Terminate or Restart). Whether assist mode is used for any action is determined by the automation flag. This is checked to see whether that action is permitted.

Cases where you might want to use assist mode include:

- During early stages of developing and using your automation policy
- After changing your automation policy, such as after adding an application to automation
- After adding a new automation procedure to the SA z/OS code

Using Assist Mode to Test Automation Procedures

Assist mode can help you to detect problems with your automation procedures before they are added to your production code. Assist mode works by intercepting commands and replies before they are issued through NetView. The intercepted commands and replies, as coded in the automation policy, are reformatted into a message that is sent to the NetView log.

The reformatted command is issued in message AOF320I and the reformatted reply in message AOF323I. Each message contains detailed information about the action defined in the automation policy and the actual action to be issued.

During run time of SA z/OS, the assist mode can be enabled with the INGAUTO command to set the related automation flag to the value L. The DISPFLGS command can be used to view the current automation flag settings. Any other value for the automation flag deactivates assist mode.

When an event triggers an automated action and assist mode is enabled, SA z/OS logs the action in the NetView log. The log can be reviewed to ensure that automation has run as expected.

Assist mode works for all routines that call the SA z/OS common routine, after having checked the automation flag by calling AOCQRY.

Using AOCTRACE to Trace Automation Procedure Processing

The AOCTRACE command dialog maintains both global execution flow traces and automation procedure-specific debugging flags. Setting the global flag causes all routines that support tracing and all message IDs to record a statement in the NetView log whenever they are invoked. The AOFDEBUG global variable is used to pass the global flag information to the automation procedure. The global flag is set to null if the global trace is off, or Y if the global trace is on.

Setting the automation procedure-specific flags lets you obtain information about what the automation procedure is doing when it executes, or lets you activate a REXX trace. The debug flag is either null or Y, and is stored in the AOF.*clist*.0DEBUG common variable (where *clist* is the true automation procedure name).

The trace flag is set to null or a valid REXX trace type, as follows:

- A (All)
- R (Results)
- I (Intermediate)
- C (Commands)
- E (Errors)

Testing and Debugging Automation Procedures

- F (Failures)
- L (Labels)
- O (Off)
- N (Normal)

The S (Scan) trace type cannot be used.

The trace flag is stored in the common global variable AOF. *clist.OTRACE* (where *clist* is the true automation procedure name).

Message tracing can only be set from the command line, using the command AOCTRACE MSG/*id*,ON|OFF where *id* is the message to be traced.

AOCTRACE is documented in *IBM Tivoli System Automation for z/OS Operator's Commands*.

REXX Coding Example

For examples of code that can be placed at the beginning and end of your REXX automation procedures to handle trace and debug settings, see AOFEXC00 in the SINGSAMP library.

When writing code to support the debug feature, you should expose *loc.* on all your procedures and insert fragments of code to check the value of the *loc.0debug* flag and output relevant information. The *loc.0me* assignment makes the automation procedure name available everywhere, so you can prefix all debug messages with it. You can then tell where the messages are coming from. For example:

```
Myproc:
  Procedure expose loc.
  If loc.0debug = 'Y' Then
    'PIPE LIT /' loc.0debug ' has called procedure MYPROC/',
    '| LOGTO NETLOG'
  Return
```

NetView Testing and Debugging Facilities

NetView provides several facilities to assist in testing and debugging automation procedures.

To do detailed testing, you may want to trace every statement issued from automation procedures. This type of testing is enabled through the &CONTROL statement for NetView command lists and through the TRACE statement for REXX procedures.

You can also specify less detailed tracing on the TRACE and &CONTROL statements, so that only commands are traced. A comparable facility, the interactive debugging aid, is available for programs coded in PL/I and C.

Perform specific tracing by issuing NetView MSG LOG, PIPE LOGTO NETLOG commands at appropriate points throughout a NetView command list, REXX procedure, or PL/I routine.

To test for proper parsing and reaction to a message, write a short automation procedure to issue a NetView WTO command. This WTO is processed by the NetView automation table and triggers the appropriate automation procedure. If the automation procedure requires the job name, the job name must be temporarily hard-coded to the appropriate name. In this case, because the WTO was issued

from the NetView region, the job name associated with the message is the NetView region. A sample automation procedure follows:

```
WRITEWTO CLIST  
    WTO &PARMSTR  
    &EXIT
```

The sample automation procedure can issue any single-line message by calling the routine. For example, to issue message ABC123I, which indicates the start of a program, the command is:

```
WRITEWTO ABC123I My testprogram PRGTEST has started.
```

Where to Find More Testing Information

More information on testing can be found in the following books:

- *Tivoli NetView for z/OS Customization Guide*
This book lists requirements for your programs, including preparing your code for use, and detailed information on writing exit routines and command processors.
- *Tivoli NetView for z/OS Automation Guide*
This book has guidelines for creating new automation procedures, including a recommended development process.

Coding Your Own Information in the Automation Status File

You can code your own information in the automation status file with the ASFUSER command.

The automation status file has 40 user data fields that are associated with each resource that is defined within it. You may use these fields to store persistent information about resources that your code needs to access later. The information in the ASF is not lost when SA z/OS is shut down. It lasts until one of the following events occurs:

- The ASF VSAM data set is deleted and redefined,
- You bring SA z/OS up with an automation control file that does not include the application that the information has been defined for

Note that you should verify that the information you have stored in the automation status file is accurate whenever SA z/OS initializes, as circumstances may have changed while SA z/OS was down.

Each automation status file field reserved for your data can contain up to 20 characters. The ASFUSER command allows you to update and display data in these fields. See *IBM Tivoli System Automation for z/OS Programmer's Reference* for the ASFUSER command description.

Programming Recommendations

This section contains tips and techniques that may help to reduce the coding effort required when writing your own automation procedures, and to improve performance of your automation procedures.

- Use variables, such as &IDENT, &SUBSAPPL, &SUBSTYPE, and &SUBSJOB in place of parameter values.

Using &IDENT for automation procedure names allows for changes to automation procedure names (only the &IDENT variable value needs changing).

Programming Recommendations

The &SUBSxxx variables allow for subsystem and job name changes (changes to subsystem and job names need only be made in automation policy).

Using NetView command list language variable JOBNAME for the resource field on an AOCQRY call, an automation procedure can be written to support a known message for any job that can issue a message.

- Use defaults when possible to minimize coding.
- Use generic error codes (see CDEMATCH).
- Use available message parsing techniques:
 - Use the NetView command PARSEL2R or REXX PARSE command to parse a message without relying on a field position in a message.
 - Parse a message in the NetView automation table and send only necessary fields to an automation procedure.
- Consider not coding the ENTRY field in CDEMATCH calls (default is the SUBSAPPL returned from the last AOCQRY call).
- Use appropriate automation flags.
- Review the coding requirements in *Tivoli NetView for z/OS Customization Guide* including restrictions to consider when writing code, such as:
 - Restrictions when TVBINXIT is on
 - Variable names
 - Macro use
 - Register use
 - Re-entering programs
- Use SA z/OS generic routines where possible, because they:
 1. Reduce your maintenance overhead.
 2. Often use internal interfaces that are more efficient than the common routines. Similarly, it is better to use a common routine than to write your own code to process the response from an ACF command display request.
- Use SA z/OS's processor operations common commands where possible, because these:
 1. Are independent of the hardware type of the target system's processor
 2. Minimize the need for changes to your automation routines as you add new processors to your enterprise
- Consider using the NetView VIEW command to display online help text associated with new code, and to develop a fullscreen interface for new commands that are a part of the new code. Refer to *Tivoli NetView for z/OS Customization Guide* for information on the VIEW command.

Global Variable Names

When creating your own automation procedures, you must ensure that the names of any global variables you create do not clash with SA z/OS external or internal global variable names. In addition, you must not use names beginning with:

- CFG
- AOF
- ING
- ISQ
- EVI
- EVE
- EVJ

Chapter 3. How to Add a Message to Automation

SA z/OS exploits the NetView automation table (AT) and message revision table (MRT). The AT contains traps for messages that must be automated. If an action must be taken in response to a message, this action needs to be defined in the customization dialog. A related AT entry is required to call a routine to execute the action. The MRT allows you to modify message attributes such as color, route code, descriptor code, display and syslog settings, and text of original z/OS messages (rather than copies).

SA z/OS automatically generates the ATs and MRT.

Conceptual Overview

This section gives a brief overview of the main aspects of SA z/OS message automation:

- A list of messages that are involved in SA z/OS automation is generated by SA z/OS. This can then be used as a message processing facility (MPF) member.
- Message automation is a process that is based on the NetView AT and MRT.
- The AT and MRT are generated by SA z/OS.
- AT entries are created for messages that actions are defined for.
- Messages can be defined to indicate a status change.
- Messages can be marked to be ignored or suppressed, thus not generating an AT or MRT entry.
- Messages can be marked to be captured for further display.
- Most AT entries trap messages independent of the issuing product instance, component or module.
- Predefined AT entries can be changed.
- You can define the AT/MRT scope to determine precisely if and what kind of ATs or MRT are built.

Defining Actions for Messages

AT entries are generated by SA z/OS for messages that are defined for APL, MTR, or MVC policy entries and that have actions (for example, CMD or REP) defined for them.

Note: Throughout this chapter, whenever the term *policy entry* is used, it implies either an APL, MTR, or MVC policy entry, unless otherwise stated.

The first step in defining actions is to select a policy entry from the Policy Selection panel. From its policy selection list, select the MESSAGES/USER DATA policy item. This leads to the Message Processing panel, where you can then define actions for message IDs. If an AT entry is built according to the action, it only checks for the message ID by default, independent of the product instance, component or module issuing that message. If this is not intended, you can use the AT action (see “Defining Message Overrides” on page 26).

There are many messages that are already prepared by SA z/OS. For these messages specific AT entries are predefined by SA z/OS, see the

Defining Actions for Messages

+SA_PREDEFINED_MSGS MVS component entry. If you want to know what kind of AT entry is built for automating a particular message, you can view it on the Message Automation Overview panel.

Note: You must not use SA z/OS symbols (AOCCLONES) or system symbols for or in message IDs because a correct AT cannot be built.

Defining CMD or REP Actions

Suppose, for example, that you define a CMD or REP action for message XYZ222I on the Message panel, where XYZ222I is a completely new message that is not predefined by SA z/OS.

This definition leads to the creation of an AT entry for message XYZ222I using the ISSUEACT command after the next Configuration Build process.

Note: If you have code definitions that you expect to be passed to ISSUEACT, you have to manage the AT overrides to do this. This is *not* done by SA z/OS. See “Defining Message Overrides” on page 26.

Note that for MVC entries, messages have the parameter SYSTEMMSG=YES added to the SA z/OS command (ISSUEACT).

Defining AT Actions

You can define various AT actions for messages using the Message Automation Overview panel:

- The condition in the AT entry
- Status changes for messages
- Capturing messages to be displayed but not automated
- Preventing the building of AT entries

You can also edit the AT entries directly using the AO option from this panel. Note that if you use one of the other options after you have specified an override, SA z/OS requires you to confirm whether you want to delete the override that exists for the message because it cannot be combined with the other options.

Defining Conditions for AT Entries

You can improve the efficiency of AT processing by controlling where entries are placed within the AT and by specifying more precise conditions to trap the message. SA z/OS allows you to do this with the AT Entry Conditions panel, which you reach from the Message Automation Overview panel by entering the AC option.

Defining Status Messages

Many messages that indicate a state change of APL, MTR, and MVC resources are known to SA z/OS. The related AT entries are already predefined. For these messages there is no need to define them in the policy database.

If necessary, you can define additional application messages that indicate a state change. The AT action leads to the Message Automation Overview panel, where you can enter the AS option to display the AT Status Specification panel that lists resource states.

The Status Message Report shows all status messages. It lists all user-defined and predefined status messages and their associated statuses.

Status messages can be defined for MVC policy entries as well as for APL and MTR instances or classes. As an example, to define an UP state indicated by message XYZ444I, enter A in the Cmd field next to the message ID on the Message Processing panel. On the Message Automation Overview panel, enter the AS option to display the AT Status Specification panel and select the UP status. Here, XYZ444I is a message that is unknown to SA z/OS.

This definition leads to the creation of an AT entry for message XYZ444I using the ACTIVMSG command after the next configuration build process, as shown on the Message Automation Overview panel.

Notes:

1. There are certain messages that can be used as status messages, but for some messages, COD definitions are required (for example, IEF450I). TERMMSG sets the status depending on these definitions. For more details about TERMMSG, see *IBM Tivoli System Automation for z/OS Programmer's Reference*.
2. Automation table entries are generated based on the messages that are defined with MESSAGES/USER data. For size and performance reasons, these entries are message-oriented rather than job-oriented.

This means that an AT action (except IGNORE or SUPPRESS) for a particular message generates an AT entry. This entry traps that message independently of the issuing subsystem. It then sets the subsystem state as selected via the AT action.

If a state message should be processed for a particular subsystem only, you can define an AT override action.

Defining Captured Messages

If messages only need to be captured to be displayed but not automated, the AT Status Specification panel provides an additional Capture option for APL and MVC entries.

Messages that have a CMD or REP action defined for them or that are defined as status message are implicitly captured. There is no need to explicitly define these messages to be captured.

For example, to define message XYZ555I to be captured, enter option AS on the Message Automation Overview panel to display the AT Status Specification panel and select the Capture option. Here XYZ555I is a message that is unknown to SA z/OS.

This definition leads to the creation of an AT entry for message XYZ555I using the AOFCPMSG command after the next configuration build process, as shown on the Message Automation Overview panel.

Note: The status (AUTO) action is mutually exclusive with the OVR action.

Preventing the Building of AT, MRT and MPF Entries

Inhibiting AT, MRT, and MPFLSTSA Entries: Using the AUTO action you can select IGNORE or SUPPRESS for certain messages:

- Messages that are marked IGNORE do not cause an AT entry, MRT entry, or an MPFLSTSA entry to be generated.
- Messages that are marked SUPPRESS do not cause an AT entry or MRT entry to be generated. An MPFLSTSA entry is generated with the options SUP(YES),AUTO(NO).

Defining Actions for Messages

IGNORE and SUPPRESS overrule other actions that are defined for the same message.

The MPFLSTSA member is built for each policy database. Because IGNORE and SUPPRESS affect the build of the MPFLSTSA member, these definitions also have a policy database-wide scope. The MPFLSTSA member is built at an enterprise level, so whenever IGNORE is defined the MPF table is not built.

AT Entries That Are Never Built: There are many keywords that can be entered as message IDs in the customization dialog (for example, message MVSDUMPFULL). No AT entry is built for these keywords. A list of these keywords is given in the online help.

Defining Message Overrides

You can apply an override on the Message Processing panel for a message ID for an APL instance, APL class or an MVC entry.

The Message Automation Overview panel allows you to preview an AT entry and MRT entry as it would be built according to the actions that are defined for the message. If you have not made a specification that would produce an AT or MRT entry, you are informed of this in the preview section of the panel.

The AO option on the Message Automation Overview panel allows you to override an AT entry. You can change any part of the AT entry. Condition and action statements can be changed, added or deleted. Deleting the condition statement removes the AT override. Note that a syntax check is not performed, you have to ensure that the specification obeys NetView automation table syntax rules.

If you define a message with an AT action or condition, and then invoke the override panel, the preview of the AT entry is shown on the override editor screen. You can use this as a model for your own AT definition. Use the CANCEL command to exit the editor without saving your changes.

Note that if you use one of the other AT options after you have specified an override, SA z/OS checks whether you want to delete the override that exists for the message because it cannot be combined with the other options.

You can include SA z/OS symbols (AOCCLONES) and system symbols in an AT or MRT override definition. They are resolved at AT load time.

To define an override for message XYZ666I, for example, on the Message Processing panel, you can either change an existing AT entry that then becomes a user-defined AT entry, or, if no predefinitions are available, you can define a user-specific AT entry. For example, if message XYZ666I should be trapped, and routine MYREXX1 should be called as a result, enter:

```
IF MSGID = 'XYZ666I' THEN  
EXEC(CMD('MYREXX1') ROUTE(ONE %AOFOPWTORS%));
```

This definition leads to the creation of an AT entry for message XYZ666I using the routine MYREXX1 after the next configuration build process.

If you specify an override, nothing is added by SA z/OS during AT build because the override applies to all applications. Only the initial conversion of the policy database creates an override that contains all of the AT entries that would be built. After conversion, nothing else is added to the override. Thus if there is a message

with an override and then, for some application with that message, a command is added, you have to ensure that the command is honored.

Extended Status Command Support

The status command concept has been extended so that commands can be issued if another application reaches an “up” or “down” state. Thus, a command can be issued for one application (APL1) while another one (APL2[®]) enters a certain state. Application APL1 is a *consumer* that consumes services provided by application APL2, which is a *provider*. In certain cases it is valuable to trigger an action for the consumer if the provider enters an UP or DOWN state.

In addition to runtime variables such as &SUBSAPPL or &SUBSJOB, there are provider-specific runtime variables that can be used within a command or reply as specified for a Message ID in the MESSAGES/USER DATA policy. These variables start with &SU2 instead of &SUB. For a list of supported provider runtime variables, see ACFCMD and ACFREP in *IBM Tivoli System Automation for z/OS Programmer's Reference*.

Policy Definitions

Links must be defined in the APL policy for the consumer application. A link is a data pair that is represented by a consumer and a provider subsystem name:

- The consumer name is defined as the **Subsystem Name** of the consumer APL
- The provider name is defined in the MESSAGES/USER DATA policy item of the consumer APL as part of a Message ID

A link requires a definition for a message ID (UP_*provider-name* or DN_*provider-name*) in the MESSAGES/USER DATA policy and an action that must be taken for the consumer. If the link is to be dynamic, define a USR action with the Keyword/Data pair DYNAMIC=YES for the message ID. There are usually multiple message IDs defined for dynamic links (one per provider) that are determined at run time.

For example, if you want to start the MQ Listener for the MQCHIN application whenever the TCPIP application reaches an up state, you define a command for the message ID UP_TCPIP using the MESSAGES/USER DATA policy item of MQCHIN. On the Message Processing panel, enter the line command C for the UP_TCPIP message ID and on the subsequent Command Processing panel enter MVS START LISTENER in the **Command Text** field.

For dynamic links, you need to define message IDs for all the providers that might be used by a consumer. There are several alternatives for defining when a link is activated:

1. In the POSTSTART phase of the STARTUP policy item
2. Based on a user-selectable message before the consumer is in the UP state
3. Based on the “up” state (this can be UP or ENDED)
4. Based on a user-selectable message after the consumer is in the UP state

You can make these definitions in either the STARTUP or MESSAGES/USER DATA policy item. Corresponding policy definitions are required for link deactivation either in the SHUTDOWN or MESSAGES/USER DATA policy item.

You must supply a user-written REXX automation procedure that:

1. Identifies the provider

Defining Actions for Messages

2. Issues the INGLINK command to activate the link, if required

All the dynamic links of a consumer are automatically DEACTIVATED after the consumer is shut down. Thus you only need to define DEACTIVATE commands if you want this process to happen at an earlier point in time. Furthermore, you must not define a DEACTIVATE if the consumer is its own provider since this DEACTIVATE may take place before the DN_ message can be processed.

There is no difference in the DN_ and UP_ message processing between normal and transient applications, with one exception: when stopping a transient provider the corresponding DN_ message on the consumer is *not* processed.

Special Considerations

You can define a consumer as its own provider. This can be done to perform a predefined action for an application whenever it enters any “down” state. A “down” state in this context is an agent state of:

- DOWN
- RESTART
- AUTODOWN
- STOPPED
- CTLDOWN
- BROKEN

Thus you no longer need to define the same action for each of the agent states. To achieve this, define the same name in the DN_ message and subsystem name field of an application policy entry. You should note, however, that:

- The action defined for the DN_ message is executed even though the application is already in the “down” state. This is different to a configuration where the consumer and provider are distinct.
- Dynamic link definitions are not required. If you define a dynamic link, it is ignored.

Defining Entries for the Message Revision Table

The message revision table (MRT) enables user-defined modification of attributes such as color, route code, descriptor code, display and syslog settings, and text of original z/OS messages (rather than copies). You can make decisions about the message based on its message ID, job name, and many other properties. You can have only one MRT active per system.

Any MRT specifications that you make are independent of any AT entry data for the message. Thus if you make a definition for the MRT but not for the AT, any existing data for AT entry is still in effect.

The MS option on the Message Automation Overview panel allows you to define conditions and attributes that are used to generate NetView message revision table (MRT) entries for a message ID. Use the options on the Message Revision Table Conditions panel to specify the following:

- Delete the message completely (if you select this, no other selection is valid)
- Whether to automate the message
- Suppress the message from the console or system log
- Translate the message text to uppercase or append further text to it
- Change the color, highlighting, and intensity (if your terminal supports high intensity) attributes of the message. Only one selection for each of these attributes is allowed.

A syntax check is not made of the MRT entry because any system-specific definitions (for example, symbols) can only be verified on the system where the MRT is to run.

You should check that routines that are triggered by the AT entry for the message ID are compatible with any text that you append to the original message text.

You can also use the MO option on the Message Automation Overview panel to define the MRT entry directly using a fullscreen editor. Note that a syntax check is not performed on this panel. You must ensure that your specifications follow NetView message revision table syntax rules.

For more details, see the chapter “The Message Revision Table” in *IBM Tivoli NetView for z/OS Automation Guide*.

Defining the AT/MRT Scope

The **AT/MRT Scope** field on the Settings for Policy Database panel in the customization dialog allows you to define the scope of a NetView automation table (AT) and message revision table (MRT). Valid AT/MRT scope values are:

NONE

No AT, MRT, or MPFLSTSA member is built at configuration build time. Use this value if you want to maintain ATs yourself.

ENTERPRISE

One AT and one MRT is built to be shared within the whole enterprise.

SYSPLEX

One AT and one MRT is built to be shared within a sysplex.

SYSTEM

One AT and one MRT is built for each system of the selected policy database. (This is the default.)

If the AT/MRT scope changes from NONE to SYSTEM, a build of type ALL is required.

If the AT/MRT Scope is set to SYSPLEX, a standalone system must be linked to a sysplex group otherwise no AT or MRT is built for that system.

The scope for MPFLSTSA is either NONE or ENTERPRISE, if anything else is defined.

Build

Once you have made all the message definitions that you need, you can start the Configuration Build Process to build the configuration files containing the AT, MRT, and MPF table. For more information about the build function, see the chapter “Building and Distributing Configuration Files” in *IBM Tivoli System Automation for z/OS Defining Automation Policy*.

The AT fragments, MRT, and the MPFLSTSA member are built into the configuration data output data set.

This may require more space than you have allocated for the output data set. Thus enlarging the output data set may be required.

Build

This also applies to the DSILIST data set where the listings are stored.

It is recommended that you copy the build output to a Generation Data Group (GDG) to avoid token mismatch conditions and AT or MRT load errors.

AT and MRT Build Concept

The AT and MRT are built if necessary.

Note: If the MPF Header or Footer definitions have changed, an MPFLSTSA build is not performed. The changes are taken into account at the next build.

Load

After the NetView automation tables have been generated using the customization dialog, they are ready to be loaded. INGAMS REFRESH can be used to refresh the complete SA z/OS configuration, that is, the Automation Manager Configuration (AMC), the agent's Automation Control Files (ACFs) and the related NetView Automation Tables (ATs) as they are defined in the SA z/OS Policy Database. Alternatively, ATs can be loaded using ATLOAD.

Some AT entries are required for SA z/OS to operate properly. These entries reside in a separate AT that is loaded during SA z/OS initialization. This AT is called INGMSGSA. Do not edit it.

Listings

The DSILIST data set is used to store listings. For example, if you want to view the listing of the AT INGMSG01, issue the command:

```
br dsilist.ingmsg01
```

To view the listing of the MRT, issue:

```
br dsilist.ingmrt01
```

A listing is produced whenever SA z/OS loads an AT or MRT. You can use the advanced automation option (AAO) AOFMATLISTING to suppress listings by setting it to zero (see Appendix A, "Global Variables," on page 197).

The AT can be reloaded at configuration refresh (INGAMS, ACF ATLOAD). Because of this you should:

- Use a separate DSILIST data set for each NetView
- Allocate the DSILIST data set as a PDSE in order to prevent Sx37 errors

If the testing or loading of an AT or MRT fails, a special INGERRLS listing that contains the data of the failing AT or MRT is written to DSILIST. To view this listing issue the following command:

```
br dsilist.ingerrls
```

A Guide to SA z/OS Automation Tables

NetView Automation Table Structure

SA z/OS provides a ready-to-use AT, INGMSG01. To activate the AT, perform the following steps:

1. Define the AT member INGMSG01 in the SYSTEM INFO policy of the system in the customization dialogs
2. Build the automation configuration files
3. Refresh the configuration using INGAMS REFRESH
4. Restart NetView with the new configuration

The SA z/OS AT contains:

- All entries for the SA z/OS basic automation infrastructure, which reside in INGMSGSA
- AT entries for messages that are defined in the PDB
- User include fragments

You do not have to customize the AT INGMSG01. All unused entries are disabled automatically according to the configuration that you use. If you want to have additional entries that are valid only for your environment, you can use either a separate AT (specified in the customization dialog) or use one of the user includes.

Figure 5 shows the structure of the AT:

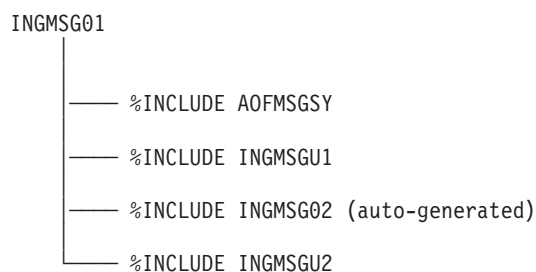

Figure 5. AT Structure

For information about how to use the INCLUDE fragments that SA z/OS provides, refer to “Using SA z/OS %INCLUDE Fragments” on page 32.

The following fragments are used by the AT:

Synonym Definitions

There is one fragment, AOFMSGSY, that is used to initialize the various synonyms used throughout the rest of the table. SA z/OS requires the synonyms to be suitably customized to reflect your environment. See “Generic Synonyms: AOFMSGSY” on page 227 for more details about the synonyms.

SA z/OS Functional Definitions

These definitions (located in the fragment that is loaded as INGMSG02) contain automation table statements for specific functions of SA z/OS. You should not change these statements. Any modifications can be made in INGMSGU1.

Master Automation Tables

This section discusses the three master automation tables that SA z/OS provides.

INGMSG00: The automation table INGMSG00 is used for SA z/OS initialization. INGMSG00 should not have be modified by the user.

This table makes use of the synonyms that are defined in AOFMSGSY.

NetView Automation Table Structure

INGMSG01: INGMSG01 is suitable for use as a primary automation table.

INGMSG01 should not be included into any other table but should be activated as a separate table.

AOFMSGST: This is a table suitable for a NetView with a SA z/OS Satellite installed.

Integrating Automation Tables

If you have any user-written automation table statements that you still want to use, you must now combine your primary table with SA z/OS's. There are several approaches to achieve this.

Refer to the NetView documentation for more information on how to use NetView automation tables.

Multiple Master Automation Tables

Besides INGMSG01, you can specify multiple additional NetView automation tables for a system in the customization dialog. The tables are concatenated as entered in this panel and processed in this concatenation order.

You need not modify the INGMSG01 automation table or any of the fragments, except AOFMSGSY. It is easy to maintain SA z/OS automation table fragments. However, you have to watch for new messages. It is easy to maintain your entries, because they are independent from SA z/OS entries.

Using SA z/OS %INCLUDE Fragments

INGMSG01 is the master include member. It provides some message suppression that is necessary to prevent mismatches and duplicate automation before the first %INCLUDE fragment.

The INGMSGU1 fragment can be used for user entries. These entries have precedence over the SA z/OS entries. The default INGMSGU1 fragment is an empty member.

The INGMSGU2 fragment can be used for all entries that SA z/OS does not provide any entries for. The default INGMSGU2 fragment is an empty member. During ACF COLD or WARM start the AT or ATs are loaded and they write a listing to the DSILIST data set. This enables the use of the NetView AUTOMAN command to monitor and manage the ATs. Make sure that the size of your DSILIST data set is sufficient to store these listings. Without these listings you can only monitor or manage the ATs using AUTOTBL. It is recommended that you define your DSILIST data set as a PDSE so that regular data set compression is not required. You should also make sure that the DSILIST DSN is unique to your NetView procedure.

Examples: An example output of AUTOTBL STATUS:

```
BNH361I THE AUTOMATION TABLE CONSISTS OF THE FOLLOWING LIST OF MEMBERS:  
AUTO2   COMPLETED INSERT FOR TABLE #1: INGMSG01 AT 04/16/02 19:34:59  
AUTO2   COMPLETED INSERT FOR TABLE #2: HAIMSG01 AT 04/16/02 19:35:00
```

```
IPSN0  
BNH363I THE AUTOMATION TABLE CONTAINS THE FOLLOWING DISABLED STATEMENTS:  
TABLE: INGMSG01 INCLUDE: __n/a__ GROUP   : INGCICS  
TABLE: INGMSG01 INCLUDE: __n/a__ GROUP   : INGIMAGE
```

```
TABLE: INGMMSG01 INCLUDE: ___n/a___ GROUP : INGIMS
TABLE: INGMMSG01 INCLUDE: ___n/a___ GROUP : INGJES3
TABLE: INGMMSG01 INCLUDE: ___n/a___ GROUP : INGOPC
```

An example of the AUTOMAN panel:

EZLKATGB AUTOMATION TABLE MANAGEMENT				
MEMBER	TYPE	LABEL/BLOCK/GROUP NAME(S)	STATUS	NUMBER OF STATEMENTS
INGMSG02	GROUP	INGCICS	DISABLED	222
INGMSG02	GROUP	INGDB2	ENABLED	120
INGMSG02	GROUP	INGIMAGE	DISABLED	1
INGMSG02	GROUP	INGIMS	DISABLED	107
INGMSG02	GROUP	INGJES2	ENABLED	1
INGMSG02	GROUP	INGJES3	DISABLED	1
INGMSG02	GROUP	INGOPC	DISABLED	10
INGMSG02	GROUP	INGUSS	ENABLED	1

In this example the configuration loaded does not use the IMS, CICS, OPC product automation and the IXC102A automation. It uses JES2, DB2 and USS automation.

Restriction: The NetView AUTOMAN cannot be used to RELOAD INGMMSG01.

Generic Automation Table Statements

The basic automation table contains a number of generic automation table entries that can reduce your automation table overhead considerably. These samples use some of the advanced features of SA z/OS to make automating your applications as simple and reliable as possible.

For some of these entries (IEF403I and IEF404I in particular) the message flow may be quite high. To handle this, you can insert additional entries in INGMMSGU1 to suppress a block of messages. For example, if all your batch jobs started with the characters BAT or JCL, then the following entry would suppress them:

```
IF MSGID = 'IEF40'. & DOMAINID = %AOFDOM% THEN BEGIN;
*
  IF (TOKEN(2) = 'BAT'. | TOKEN(2) = 'JCL'.)
    THEN DISPLAY(N) NETLOG(N);
*
END;
```

System Operations Automation Flow

SA z/OS uses dedicated *work operators* for all subsystem-related processing in order to:

- Keep the extra message-related workload off the NetView subsystem interface router task (CNMCSSIR) and primary POI task PPT
- Establish even load balancing
- Ensure that all messages for a subsystem are processed in the correct sequence

You define work operators in the customization dialog using the Automation Operators entry type (AOP). Here you define automated functions that allow you to specify automation operators, which are the NetView task name. This two-staged definition gives the flexibility to specify a second operator as a backup within the same Automated Function definition. The automation operator name that is specified here is the name of the task in NetView.

Generic Automation Table Statements

Note that the automation operators also need to be defined in the DSIOPF member in the NetView DSIPARM data set or in the SAF product.

By default SA z/OS provides 20 Automated Functions, AOFWRK01 through AOFWRK20, with the automation operator names AUTWRKxx. The number can be increased according to the installation needs.

During SA z/OS initialization or refresh the subsystems that are defined in the configuration file are evenly distributed among the automation operators in a round-robin manner. Thus each automation operator has a list of subsystems that it is responsible for. Each automation operator then subscribes for the messages of those subsystems via the NetView ASSIGN command. Finally the initial monitoring of SA z/OS is run on the appropriate automation operator, which is then locked until message AOF540I is issued.

When SA z/OS is fully initialized all messages for a subsystem are queued to the same automation operator. This ensures that all messages are processed in the order they have been received.

If the automation table action uses standard SA z/OS capabilities (that is, SA z/OS commands), the message is processed at the automation operator in the following three steps. However, if there is a complete user defined automation table entry (that is, an AT override), only the first step can be run:

1. The message is driven through the NetView automation tables.
2. If there is a match, the SA z/OS data model is applied, which includes automation flag checking, code matching, threshold comparison, pass evaluation, and message capturing.
3. Finally the command is executed or the outstanding reply is answered.

There are two places where this processing can be modified for single messages:

- The assignment of messages to AUTWRKxx automation operators can be overruled.

To do this, the AOF_ASSIGN_JOBNAME advanced automation option must be set to 0, which lets ASSIGN BY MESSAGE ID take precedence over the ASSIGN BY JOBNAME that is established by SA z/OS.

An ASSIGN command with the MSG parameter must be issued to redirect the message. That particular message is then assigned according to the user specification while all other messages still run on the automation operators that are assigned by SA z/OS. However this should be used with care because it suspends SA z/OS load balancing and breaks the serialized command processing for that subsystem.

- Execution of the command on the automation operator that has been assigned by SA z/OS can be overruled by specifying an Automated Function name together with the command in the MESSAGES/USER DATA policy in the customization dialog.

Execution of the command is then routed to the task that has been specified for the Automated Function. The automation table and data model processing is still run on the automation operator and thus proper sequencing is guaranteed.

SA z/OS internally uses the AOFEXCMD command (described in *IBM Tivoli System Automation for z/OS Programmer's Reference*) to queue the command to the specified automation operator. The routine checks whether the requested automation operator is available and, if this is not the case, it queues the command to a backup operator, so that in any case the command does not run on the current automation operator.

It is recommended that you use this only if there are special reasons, for example, for long running commands, because it may break the serialized command processing for that subsystem (if not all commands are executed on the same automation operator).

Inheritance Rules for Classes

Bear in mind the following inheritance rules for class data when building AT entries.

Define Application Information

Data is inherited in the APPLICATION INFO policy item per individual field, independent from each other (except for Transient Rerun). If a field is blank, the class value is inherited (if it is available). There are a few exceptions where the inheritance can be blocked without specifying an instance value with the special value NONE , for example, Restart after IPL.

Define Relationships

The External Startup and External Shutdown fields in the sub header area show inherited data individually in the same way as in the APPLICATION INFO policy item. However the relationships are only inherited as a whole if no relationships are defined for the child object.

Define Application Messages and User Data

Data is inherited per message ID. For example, assume a message ID has a command definition for the instance, and the same message ID is defined for a class with reply data. The command and reply data is not merged on the instance, and the class definitions are not inherited at all. Message overrides (OVR) are not inherited at all. All OVRs are used to generate AT entries at the level where they are specified.

Define Startup Procedures

The STARTUP policy offers two panels. The Subsystem Startup Processing panel with a subheader section with input fields that may show inherited values, and for each selected startup phase there is a Startup Command Processing panel with a command input area that also may show inherited data.

Subsystem Startup Processing

Data in the subheader section is inherited per individual field, similar to the APPLICATION INFO policy. Command definitions for the three phases PRESTART, STARTUP, and POSTSTART are inherited per start phase. So if PRESTART commands are defined for the instance and both PRESTART and STARTUP commands are defined for a class, the instance inherits the STARTUP commands from the class.

Startup Command Processing

Within each start phase the commands are inherited all together. So if a PRESTART command is defined for the instance and other PRESTART commands are defined for a class, none of the commands are merged on the instance. Instead the instance has only the one command defined there. No PRESTART commands are inherited from the class.

Define Shutdown Procedures

Shutdown specifications are inherited per phase. So if a SHUTINIT command is defined for the instance and both SHUTINIT and SHUTNORM commands are defined for a class, the instance inherits the SHUTNORM commands from the class. Furthermore, command and reply definitions for one phase are inherited together. So if for SHUTFORCE a command is defined for the instance, and the class has a reply defined for SHUTFORCE, nothing is inherited by that instance.

Changes within inherited data result in creating definitions for the current application. So if for a phase, commands and reply definitions are inherited, and then commands are modified, both the reply and the command definitions become data of the current application. If only commands are inherited for a phase, and then reply data is specified, the command definitions are also copied to the phase definition of the current application.

Define Error Thresholds

The data is inherited as a whole if no thresholds are defined for the child object – it is not possible to specify a level for Critical, Frequent, or Infrequent alone for an instance and inherit the other threshold levels from a class.

Define IMS Subsystem-Specific Data

| This policy combines fields that are built into the IMSCNTL and the
| ENVIRONMENT structures of the configuration files. The fields within a structure
| are inherited all together, but each structure is inherited independently from the
| other. Furthermore the IMSCNTL fields do not allow definitions for a class (though
| they are displayed on the class panel). And finally for a subtype other than CTL
| only a subset of the fields is available.

Thus there are three variations of this panel:

1. Instance of subtype CTL with all IMSCNTL and all ENVIRONMENT fields
2. Class of subtype CTL with all ENVIRONMENT fields
3. Instance or Class of subtype other than CTL with a subset of ENVIRONMENT fields (2 fields)

The first four fields (APPLid, Default HSBID, Startup parm1, Startup parm2) are never inherited. They cannot be specified for a class. The remaining fields are inherited all together in a blocks.

Automatic AT Generation

CMD (Command), REP (Reply), COD (Code), and USR (User Data) are inherited per message ID. For example, assume a message ID has a command definition on the instance, and the same message ID is defined for a class with reply data. The command and reply data are not merged on the instance, and the class definitions are not inherited at all.

Message Override and Status specifications provide instructions for the generation of the AT entry. This data is never inherited, but is used to create one AT entry for the object where they are specified. Remember that the AT is message oriented and the AT entry usually has the message ID as a condition, so for example, inheriting a Status would create duplicate entries.

Chapter 4. How to Monitor Applications

System Automation for z/OS provides different ways to monitor your applications:

- Using *observed status monitoring routines*, SA z/OS can determine whether your applications and several other automated resources are active, inactive, or in the process of being started. It is recommended to always enable observed status monitoring routines and to use the product-provided routines where possible. See “Observed Status Monitoring” for further details.
- With *monitor resources* you can optionally monitor the health of your applications and recover them on health status changes. SA z/OS distinguishes between active health monitoring and passive event-based health monitoring. See “Health Monitoring” on page 38 for further details.

Active and passive health monitoring is supported by SA z/OS in the following areas:

- Health monitoring of JES3, based on console messages
- Health monitoring of z/OS, DB2, CICS, IMS and other components, based on IBM Tivoli OMEGAMON II exceptions or IBM Tivoli OMEGAMON XE situations
- Health monitoring of CICS, based on CICSplex[®] SM
- Health monitoring of IMS, based on console messages

Observed Status Monitoring

SA z/OS determines the observed status of an application by running a routine identified by the policy administrator in the customization dialog. The routine can be specified for an individual application (refer to *IBM Tivoli System Automation for z/OS Defining Automation Policy*), and a default monitor routine can be specified for all applications on an entire system (see the AUTOMATION INFO policy item in the customization dialog).

Table 5 lists the routines that can be specified as application monitors.

Table 5. Observed Status Monitor Routines

AOFADMON	This routine has been deprecated and is provided only for compatibility with earlier releases. This routine determines the status of an application by issuing the MVS D A, <i>jobname</i> command. The job name used is the job name defined in the customization dialog for the application. Possible values for the application monitor status as determined by this routine are Active, Starting, Inactive. IBM recommends to use INGPJMON instead of AOFADMON.
AOFATMON	This routine is used to determine the status of a task operating within the NetView environment.
AOFAPMON	This routine determines the status of a program-to-program interface (PPI) receiver.
AOFCPSM	This routine is a dedicated routine used to monitor the status of the SA z/OS processor operations applications.
AOFNCOMON	This routine is used to determine the status of the NETCONV connection running between the NMC server and NetViewfor z/OS.

Table 5. Observed Status Monitor Routines (continued)

AOFUXMON	This routine determines the status of a resource with application type USS. This resource can either be a z/OS UNIX process, a file system in the UNIX file system (HFS), or a TCP port. Depending on the nature of the resource (process, file, or port) AOFUXMON decides which internal monitoring method to use.
INGPJMON	This routine determines the status of an application by searching z/OS for address spaces with a particular job name. The job name used is the job name defined in the customization dialog for the application.
INGMTSYS	With this routine, IMAGE applications for BCPII usage can be monitored.
INGPSMON	This routine monitors the subsystem's registration to the subsystem interface.
ISQMTSYS	With this routine, a processor operations target system resource represented by its proxy can be monitored. See "Automating Processor Operations Resources of z/OS Target Systems Using Proxy Definitions" on page 77 for examples of how to use a proxy definition. Active operator console connections are mandatory and are used for sending a z/OS command (for example, d t) and receiving the related response.

SA z/OS expects certain return codes from all monitor routines, either from SA z/OS provided ones or from your own routines. These can be one of the following:

RC	Meaning
0	Active
4	Starting
8	Inactive
12	Error

Health Monitoring

Overview

Health monitoring is accomplished using special resources called *monitor resources*. Monitor resources, which have a resource type MTR, are policy objects that are used to obtain the health status of other resources, typically applications or application groups, or more generally, any object that can be monitored. The health status is useful when you need to know how well a resource is performing and not simply that it is active.

The health status can be used to provide application-specific performance and health monitoring information, for example, an application may be active but it is failing to meet performance objectives defined by the system administrator. The health status can be used either for information only, or by the automation manager to make decisions and, if necessary, trigger automation for the application.

Monitor resources are defined in the customization dialog with entry type MTR. They are resources with similar characteristics as all other SA z/OS resources.

Monitor resources are connected to application resources (APLs) or application group resources (APGs). The health status of the monitored object is propagated to

the APLs and APGs and results in a combined health status there. You can define and connect MTRs in the customization dialog (see *IBM Tivoli System Automation for z/OS Defining Automation Policy*).

Monitor resources obtain the health status of an object in two different ways:

- Actively, by polling—that is executing a monitoring command periodically
- Passively, by processing events

Active monitors are scheduled periodically based on the interval defined in the MTR policy.

Passive monitors do not have a monitor interval but can have a monitor command defined for them for initial health status determination. They rely on other events to set the health status using the INGMON command.

Monitor resources can be explicitly bound to the object that they are monitoring and optionally to a job. This allows SA z/OS to handle a variety of monitoring events in a generic way. A monitored object can be, for example, an OMEGAMON XE situation, or an event posted by CICSplex System Manager (CICSplex SM). See “Passive, Event-Based Health Monitoring” on page 42. Note that the monitored object is derived from the monitor resource name, if none was specified.

There can be one or more recovery commands associated with each health status (NORMAL, WARNING, MINOR, CRITICAL and FATAL). These commands are invoked by SA z/OS when the monitor resource switches to the corresponding health status.

You can display and control monitor resources with the DISPMTR command. Monitor resources are also displayed on the Tivoli Enterprise Portal (TEP) as well as SDF and NMC, provided that the appropriate inform list specifications have been made.

Monitor Resource Commands

When defining a monitor resource you can specify activate, deactivate and monitor commands. Any command is suitable that can be executed in the NetView environment. These commands are divided into two groups:

- NetView activate and deactivate commands that expect a return code of zero
- Monitor commands that return a health status

The main difference between these two groups is that the activate and deactivate commands are executed only once, and SA z/OS expects a return code of zero.

If the activate command ended with a non-zero return code, the monitor resource remains in an INACTIVE status. The monitor resource ends in a BROKEN status if the deactivate command ended with a non-zero return code.

- The activate command is optional and can be used to establish the environment the monitoring routine can run in. The command is executed every time the monitor is started. The command must exit with return code 0.
- The deactivate command is optional and can be used to cleanup the environment. The command is executed every time the monitor is stopped. The command must exit with return code 0.
- The monitor command is executed after the activate command and then periodically if a monitoring interval is given. SA z/OS expects the monitor command to return a valid health status code. Additionally the monitor

command can issue a message that is then attached to the health status. The absence of a monitoring interval indicates that the given monitor resource is a passive or event-based health monitor. In this case, the monitor command is optional and, if specified, it is invoked for initial health monitoring only. Otherwise, if a monitoring interval is provided, the given monitor resource is an active health monitor. In this case, a monitor command must be provided to return a health status.

The activate, deactivate and monitor command can be a command procedure written in any language that is supported by NetView: REXX, Assembler, PL/I, C, or the NetView Command List Language (NCLL). Writing a monitor routine can be simple or it can be complex. The complexity depends upon the application that you are attempting to monitor.

Writing a Recovery Routine

The recovery routine is invoked every time the monitor resource switches to the health status that the recovery routine is defined for. The goal of the recovery routine is to bring the monitor resource, and thus the monitored object, back to a health status of NORMAL.

Recovery Techniques

User data in the MESSAGES/USER DATA policy item can be used to disable additional recovery processing while other recovery is already in progress. In combination with the predefined keyword DISABLETIME, the recovery disable time can be specified in the formats hh:mm:ss, mm:ss, :ss, or mm. While recovery is disabled, no commands are processed on behalf of this monitor resource for messages and exceptions that are specified in the MESSAGES/USER DATA policy item.

Recovery is automatically enabled after the recovery disable time has expired. Recovery can also be enabled prematurely by calling the INGMON command with the option CLEARING=YES, for example:

```
INGMON CI2XREP MSGTYPE=XREP CLEARING=YES
```

In some cases, it is necessary to force increasingly strong recovery actions over a period of time. This can be accomplished using a PASS count that starts at 1 and runs to 99. SA z/OS maintains the PASS count individually per message or exception, and increments the PASS count each time that message or exception is processed. Upon successful recovery, it is the installation's responsibility to reset the PASS count. When specified with option CLEARING=YES, INGMON enables command processing for messages and exceptions, and resets the PASS count.

Task Global Variables for Recovery Routines

The following task global variables can be accessed by the recovery routine:

Task Global Variable	Value
&EHKVAR1	Contains the monitor name
&EHKVAR2	Contains the current health status
&EHKVAR3	Contains the old health status
&EHKVAR4	Contains the message that is associated with the health status
&SUBSAPPL	Contains the monitor name
&SUBSTYPE	Contains the string MONITOR

Active Health Monitoring

In general, the monitor command needs to issue one or more commands to generate data, process the data, and set a return code. The return code is then used by SA z/OS to determine the health status for the resource. The possible return codes and the corresponding health status are given in Table 6.

Table 6. Health Status Return Codes

Return Code	Health Status	Description
1	BROKEN	The monitor detected an unrecoverable error. SA z/OS stops monitoring.
2	FAILED	The monitor is currently unable to obtain a health status. SA z/OS keeps the monitor active because the problem might disappear.
3	NORMAL	The monitor detected normal operation of the monitored object.
4	WARNING	The monitor detected a certain degree of degradation in the operation of the monitored object.
5	MINOR	The same as WARNING, but more severe.
6	CRITICAL	The same as MINOR, but more severe.
7	FATAL	The same as CRITICAL, but more severe.
8	DEFER	Used internally.

The health status values affect the compound status in the automation manager.

Most monitor commands use UNKNOWN, NORMAL, and WARNING statuses. The MINOR, CRITICAL, and FATAL statuses can be used as gradients to indicate that a problem is getting worse. BROKEN and FAILED are statuses that describe the status of the monitor itself and may be seen if an error is encountered with the monitor command.

Optionally, the monitor routine can issue a message describing the condition that is trapped by the SA z/OS process that invoked the monitor. The message can be viewed on the DISPMTR panel.

Every monitor command needs several basic steps:

1. Issue one or more commands to collect data and interrogate the results.
2. Based on the results from the command or commands, set the return code to a value from 1 through 8 and, optionally, perform processing based on that value.
3. Optionally, supply more descriptive information about the health status in a message that can be viewed with the DISPMTR command.
4. Exit with the return code so SA z/OS can set the health status appropriately.

Figure 6 on page 42 is an example using the NetView PING command within a PIPE to query the status of a TCP/IP stack on a remote system. The IP address is passed on input. The routine uses the average round trip time (RTT) for the request provided in message BNH770I to determine the health.

```

/*REXX MYMON */
Arg parm
monrcs='BROKEN FAILED NORMAL WARNING MINOR CRITICAL FATAL DEFER'
'PIPE (STAGESEP | NAME PING)',
'| NETV PING' parm,
'| LOCATE 1.8 /BNH770I /',
'| STEM out.'
if out.0 = 0 then
  lrc = wordpos('FATAL',monrcs)
else
  do
    parse var out.1 . 'averaging' ms 'ms' .
    say 'PING lasted' ms 'ms'
    select
      when ms < 10 then lrc = wordpos('NORMAL',monrcs)
      when ms < 20 then lrc = wordpos('WARNING',monrcs)
      when ms < 30 then lrc = wordpos('MINOR',monrcs)
      when ms < 40 then lrc = wordpos('CRITICAL',monrcs)
      otherwise lrc = wordpos('FATAL',monrcs)
    end
  end
Return lrc

```

Figure 6. Sample Monitor Command

Passive, Event-Based Health Monitoring

Overview

Passive, event-based monitoring allows you to react to events, for example a message, an OMEGAMON XE situation, or a CICSplex SM event, directly. In contrast to active health monitoring, SA z/OS does not have to query the monitored object status periodically but is informed only when such an event has occurred.

The definitions in the MONITOR INFO policy item for a monitor resource allow you to define an object that the monitor resource is bound to and optionally a job that the monitor resource accepts events from.

The **Monitored Object** specification for the monitor resource can follow any naming convention that might be required for the monitoring process. For example, for CICS monitoring it has the prefix CPSM, followed by the CICS name, the type (such as a connection), and the name. For a link called CT12, the monitored object is called as follows, for example:

```
CPSM.CICSTOR1.CONNECT.CT12.
```

Whereas for monitoring OMEGAMON XE situations, it has the prefix ITM, followed by the situation name, for example: ITM.MYAUXXSHORTAGE_WARN.

There can be only one monitored object per monitor resource but more than one monitor resource can be bound to a monitored object, for example, several IMS monitors might specify OLDS as an object.

You can also optionally specify the **Monitored Jobname** that a monitor resource accepts events from. Thus, for example in the case of IMS monitor resources, you might specify a job name of IMS1 for monitor resource MTR1 and IMS2 for MTR2. If an event arrives for OLDS and the issuer is IMS1 only MTR1 is affected.

Event Types

In the simplest case, an event is represented by a plain message issued by a job. All monitor resources that register for a particular message accept this message unless you also specified the monitored job name.

In other cases, for example for OMEGAMON XE situations or events reported by CICSplex SM, the event is represented by a triggering message provided by SA z/OS for the purpose of health monitoring only. This message, ING150I, that contains the monitored object name or the job can then be used by SA z/OS to locate the monitor resource and to set the health status or issue commands. This allows SA z/OS to handle a variety of monitoring events.

INGMON, the command that is responsible for health monitoring, is invoked from the NetView[®] automation table whenever ING150I or any other message a monitor resource has registered for is issued. It locates the monitor resource for a given monitored object or job and then looks up the code match table for the health status or commands, or both, that should be issued whenever the triggering event occurs.

Code Matching for Event-Triggering Messages

INGMON allows you to pass up to three codes that, when specified, are used to determine a specific set of commands to be issued in case of an event-triggering message. For message ING150I, SA z/OS creates an automation table entry where **Code 1** is used to select commands by event severity. For other messages, you can override the default automation table entry and pass the appropriate tokens in **Code 1**, **Code 2**, and **Code 3**, as you require.

In any case, the **Value Returned** field contains one or two tokens separated by a blank. The first token is a required command selector that can be one of the following:

selection

Execute commands with the given selection or commands for which no selection is specified.

Perform pass processing and execute all commands that match the current pass.

#selection

Interpret *selection* as another pseudo message ID. Perform pass processing for this message and execute all commands that match the current pass.

This is useful for pass processing on behalf of the event triggering message, for example, ING150I. Suppose you have one entry for WARNING and one for CRITICAL. When you do pass processing for ING150I your pass counter may be on 5, for example, when the first CRITICAL event comes in (because you already had 4 WARNING events).

However, with *#selection* you can specify, for example, a value returned of #MYWARN WARNING and #MYCRIT CRITICAL for the corresponding levels. INGMON performs pass processing for the pseudo-message MYWARN and set the health status WARNING for a WARNING event. For a CRITICAL event it performs independent pass processing for the pseudo-message MYCRIT and finally sets a health status of CRITICAL.

Remember to set the IGNORE action for the pseudo-messages to avoid AT entries being built.

The second token in the **Value Returned** column of the Code Processing panel indicates the optional health status to be set. If specified, it must be separated by a blank from the selection criterion.

Programming Techniques

Commands that are called by INGMON have access to the message that triggered the invocation using the NetView SAFE, AOFMSAFE, for example:

```
/* MYCLIST, called by INGMON */
'PIPE SAFE AOFMSAFE | STEM MSG.'
If msg.0 > 0 Then
  msgtext = msg.1      /* first message line */
```

In addition, INGMON fills the task global variables &EHKVAR0, &EHKVAR1-9, and &EHKVART with tokens that are derived from the message or exception that INGMON was invoked by. For messages, the assignment starts with the message ID, and for exceptions, it starts with the exception ID.

INGMON also sets the following task global variables:

&SUBSAPPL Contains the monitor name.

&SUBSTYPE Contains the string MONITOR.

&SUBDESC Contains the description of the monitor resource.

The following examples illustrate how message and exception tokens are assigned to these task global variables.

Example 1:

\$HASP9211 JES MAIN TASK NOT RUNNING. DURATION- hh:mm:ss.xx

Task Global Variable	Value
&EHKVAR0	\$HASP9211
&EHKVAR1	JES
&EHKVAR2	MAIN
&EHKVAR3	TASK
&EHKVAR4	NOT
&EHKVAR5	RUNNING.
&EHKVAR6	DURATION-
&EHKVAR7	hh:mm:ss.xx
&EHKVAR8 &EHKVAR9 &EHKVART	NULL

Example 2:

ING080I CI2XREP/MTR/KEYA OMSY4MVS OMIIMVS XREP Number of Outstanding Replies = 4

Task Global Variable	Value
&EHKVAR0	XREP
&EHKVAR1	Number
&EHKVAR2	of
&EHKVAR3	Outstanding

Task Global Variable	Value
&EHKVAR4	Replies
&EHKVAR5	=
&EHKVAR6	4
&EHKVAR7 &EHKVAR8 &EHKVAR9 &EHKVART	NULL

When defining commands to be issued by the INGMON command, the &EHKVAR x variables can be used to be replaced by the corresponding tokens of the message or exception.

When INGMON looks up the monitor resource for a given monitored object or job name, or both, it is possible to skip monitor resource processing dynamically through a user-specified REXX expression. In the absence of such a REXX expression, INGMON locates the monitor resource with the given monitored object name for the job that issued the message and proceeds with health status setting and commands as defined in the automation policy. By adding a REXX expression to the User Defined Data panel within the MESSAGES/USER DATA policy item for the automated message, further processing can be disabled depending on the result of this REXX expression.

To do this, the predefined keyword INGMON_FUNCTION is specified as a keyword and an arbitrary REXX expression is defined as the value in the User Data Processing panel. If the result of the REXX expression is false (that is, 0), processing is stopped, otherwise INGMON processing continues. The following example for the message ID MYMTR controls monitor resource processing, based on the day of week that is defined in the common global variable DAY_OF_WEEK. (processing continues only if the current day is not a Sunday):

Keyword	INGMON_FUNCTION
Data	cglobal('DAY_OF_WEEK') \= 'SUN'

When a monitor resource is defined with a monitor command but without an interval, the initial health status of such a passive monitor resource is obtained at monitor resource start time only. Any other health status update must be derived from events that the monitor resource has registered for.

It is however possible to issue the monitor command at any point in time by executing the command AOFRCMTR. This command expects the monitored object name and optionally a job name as parameters. It locates the corresponding monitor resource and, if specified, issues the monitor command.

See *IBM Tivoli System Automation for z/OS Programmer's Reference* for the syntax of AOFRCMTR.

Health Monitoring using OMEGAMON

SA z/OS allows you to interact with IBM Tivoli OMEGAMON II and IBM Tivoli OMEGAMON XE products to collect key performance indicators that represent the health status of address spaces, middleware, or even the system. The following sections show you how to interact with these products using monitor resources.

Overview

The SA z/OS OMEGAMON interface lets you gather a wide range of performance data on a system. You can gather data from the following performance monitoring products:

- IBM Tivoli OMEGAMON II for MVS
- IBM Tivoli OMEGAMON II for CICS
- IBM Tivoli OMEGAMON II for IMS
- IBM Tivoli OMEGAMON II for DB2
- IBM Tivoli OMEGAMON XE products
- Other IBM Tivoli Monitoring products running on z/OS

Exception analysis is an OMEGAMON feature that monitors predefined *thresholds* in a system. Each time exception analysis is invoked, an exception is displayed on the OMEGAMON console if a threshold is exceeded. Using SA z/OS, you can then act on these exception alerts by running execs or issuing commands, including issuing commands back to the host OMEGAMON.

Situations are much like exceptions but they are based on a combination of logical expressions and even on the status of other embedded situations. Each product based on the IBM Tivoli Monitoring infrastructure, such as IBM Tivoli OMEGAMON XE, provides a set of predefined situations that you can use as is, or modify as you wish. You can also create your own situations to tailor the monitoring to your specific needs. Situations are edited and displayed on the Tivoli Enterprise Portal (TEP). Using a TEP function called Reflex Automation, you can inform SA z/OS about a particular situation and then act upon it.

IBM Tivoli Monitoring services also allow you to interact with each and every product based on this infrastructure through a standardized SOAP services interface on the Tivoli Enterprise Monitoring Server (TEMS). SOAP services exist, for example, to obtain data from a particular object collected by Tivoli OMEGAMON XE for z/OS. Other services allow you to automatically manage situations and TEP workflow policies, or to send universal messages to the universal message console.

You can set up monitor resources to:

- Monitor sets of exceptions that may be of interest using an active monitor resource and set an application's health status based on the existence of such exceptions
- React to and resolve conditions that cause those exceptions
- Monitor sets of situations that may be of interest using a passive monitor resource, set an application's health status and react to and resolve conditions that cause those situations

Assumptions

Various topologies are possible for SA z/OS with IBM Tivoli OMEGAMON II monitors and IBM Tivoli Monitoring products such as OMEGAMON XE:

- There can be one or more monitoring product per system
- Connectivity is through VTAM® and the NetView Terminal Access Facility (TAF) for OMEGAMON II and through TCP/IP for OMEGAMON XE
- A TEMS SOAP Server is running locally, on a remote system or on a distributed system
- SA z/OS can act as a focal point either:

- Globally, monitoring data from monitoring products running on different systems
- Locally, monitoring data from monitoring products running on the local system

The following assumptions are made about the topologies that can be adopted for interaction with OMEGAMON II:

1. The OMEGAMON product is installed on each system where MVS and CICS, DB2, or IMS is installed.
2. OMEGAMON monitors are installed and configured already to support multiple VTAM-based connections to it. For interoperability with SA z/OS, logical units of type 3270 model 2 (24x80) are required.
3. OMEGAMON monitors are setup to interact with an external security product such as IBM SecureWay™ Security Server for z/OS (formerly RACF®).
4. OMEGAMON exceptions are reported when the threshold that is defined in OMEGAMON is exceeded. That threshold must be agreed within an installation because it must cater for the least severe condition that there might be an alert for.

The following assumption is made regarding the interaction with OMEGAMON XE:

1. Reflex automation is executed on the OMEGAMON XE agent that created the corresponding situation event

OMEGAMON Interaction

The following subsections assume that, for OMEGAMON II interaction, you have defined one or more OMEGAMON sessions and automated functions that are designated to handle network communication using the SA z/OS customization dialog. For details on defining OMEGAMON sessions, refer to the OMEGAMON SESSIONS and AUTHENTICATION policy items in the Network (NTW) entry type and to the OPERATORS policy in the Auto Operators (AOP) entry type described in *IBM Tivoli System Automation for z/OS Defining Automation Policy*.

For OMEGAMON XE interaction using SOAP services you have to specify each SOAP server in the automation policy that you want to connect to. For details on defining SOAP servers, refer to the SOAP SERVER policy item in the Network (NTW) entry type described in *IBM Tivoli System Automation for z/OS Defining Automation Policy*.

Using the INGOMX Programming Interface

INGOMX acts as the interface between operators (or auto-operators) and OMEGAMON. This includes not only any of the classic OMEGAMON monitors for CICS, DB2, IMS, and MVS, but also OMEGAMON XE monitors and other IBM Tivoli Monitoring products running on z/OS.

For the classic OMEGAMON monitors, INGOMX can be used to issue OMEGAMON major, minor, and immediate commands, and to filter one or more exceptions of interest from the list of exceptions reported by OMEGAMON exception analysis. Each request is written to the console (but not exposed to NetView) in the format as produced by the OMEGAMON monitor. When exception filtering is requested, multiple exception lines for one exception are combined into a single line and written to the console as a single message if the filter criterion (XTYPE) matches. INGOMX is best used within a NetView PIPE.

The INGOMX SOAP interface allows you to issue any of the SOAP services supported by the TEMS SOAP server, for example to

- Obtain attributes of interest from a particular OMEGAMON XE object, for example, Job_name and CPU_percent from the OMEGAMON XE for z/OS object Address_Space_CPU_Utilization
- Start and stop situations as well as TEP workflow policies
- Issue a universal message
- Send an event into the IBM Tivoli Monitoring platform

The full set of SOAP services and a description of the XML-syntax is described in *IBM Tivoli Monitoring Administrator's Guide*.

The following examples illustrate the use of INGOMX. They are based on an OMEGAMON for MVS session with the name OMSY4MVS. The same techniques also apply to other OMEGAMON monitors. For more details, refer to *IBM Tivoli System Automation for z/OS Programmer's Reference*.

Example 1. Returning Information on Common Storage Utilization Using the CSAA Command:

```

INGOMX EXECUTE,NAME=OMSY4MVS,CMD=CSAA
| IPXNG      CSAA  SUMMARY
| IPXNG      +
| IPXNG      +          System
| IPXNG      +          Maximum Pre-CSAA Orphan      Usage
| IPXNG      +          -----
| IPXNG      +          -----  -----  -----0  2  4  6  8  100
| IPXNG      +  CSA    3312K   1247K      0   1247K  37.6%|----->
| IPXNG      +  ECSA  307740K  78797K      0   78797K  25.6%|----->
| IPXNG      +  SQA   1620K    660K      0    660K  40.8%|----->
| IPXNG      +  ESQA  145696K  23930K      0   23930K  16.4%|-->

```

Example 2. Using OMEGAMON Command Modifiers:

```

INGOMX EXECUTE,NAME=OMSY4MVS,CMD=ALLJ,MOD=#
| IPXNG      #ALLJ      166
INGOMX EXECUTE,NAME=OMSY4MVS,CMD=ALLJ,MOD=<
| IPXNG      <ALLJ *MASTER* PCAUTH RASP TRACE DUMPSRV XCFAS GRS SMSPDSE+
| IPXNG      +      CONSOLE WLM ANTMAIN ANTAS000 OMVS IEFSCAS JESXCF ALLOCAS+
| IPXNG      ...

```

Example 3. Trapping Outstanding Operator Replies:

```
INGOMX TRAP,NAME=OMSY4MVS,XTYPE=(XREP)
| IPXNG    + XREP Number of Outstanding Replies = 5
```

Example 4. Issuing OMEGAMON Minor Commands:

```
/* REXX-Routine EXMINOR */
cmd.1 = "CMD=SYS" /* Major command, issued ahead of its minors */
cmd.2 = "CMD=FCSA" /* Minor: CSA frames below 16M */
cmd.3 = "CMD=FCOM" /* Minor: CSA, LPA, SQA, and nucleus below 16M */
cmd.0 = 3
'PIPE STEM cmd. COLLECT',
'| NETV INGOMX EXECUTE,NAME=OMSY4MVS,CMD=*',
'| CONSOLE ONLY'
* IPXNG EXMINOR
| IPXNG SYS >> WLM Goal mode OPT=00 SYSRES=(150526,8812) <<
| IPXNG fcsa 328 1312 K
| IPXNG fcom 849 3396 K
```

There is no need to explicitly establish a session between an operator and a particular OMEGAMON monitor before using INGOMX; such sessions are established automatically on their first use.

Selective protection of individual OMEGAMON sessions and commands, or both, is possible based on the NetView Command Authorization Table. Details can be found in the appendix, "Security and Authorization", in *IBM Tivoli System Automation for z/OS Planning and Installation*.

To use a SOAP service, for example to obtain certain attributes from an OMEGAMON XE object, you first have to describe the request's parameters in the form of an XML document. The XML document is validated and rejected by the SOAP server if it is found to be incorrect or incomplete. The spelling of the names enclosed in '<' and '>' is significant because XML is a case-sensitive document description language. Also, because the structure of every XML document is hierarchical, each element must be enclosed by an opening name (for example, '<CT_Get>') and a corresponding closing name denoted by a forward slash preceding the name (for example, '</CT_Get>').

The following is an example that describes the request parameters to retrieve the Job_Name, the address space ID (ASID), and the CPU_Percent attributes from the OMEGAMON XE for z/OS object, Address_Space_CPU_Utilization, for all jobs with a CPU percentage greater than 1.0. In this example, the object that has been queried is collected on the TEMS called KEYAS:CMS.

```
<CT_Get>
  <target>KEYAS:CMS</target>
  <object>Address_Space_CPU_Utilization</object>
  <attribute>Job_Name</attribute>
  <attribute>ASID</attribute>
  <attribute>CPU_Percent</attribute>
  <afilter>CPU_Percent;GT;10</afilter>
</CT_Get>
```

You can pass this XML document either by pointing INGOMX to a sequential or partitioned data set, or in the default SAFE, assuming INGOMX is invoked in a NetView PIPE.

When INGOMX is invoked, the SOAP server that is connected to must be specified. In the following example, it is assumed that you have defined a SOAP server called KEYAYA in the SOAP SERVER policy item of the Network (NTW) entry type using the SA z/OS customization dialog. This definition includes the host name or IP address, the SOAP server's port and the path name of the SOAP service. The request parameters as shown above are located in the member GETCPU in the partitioned data set SYS1.SOAP.DATA:

```
soapsds = 'SYS1.SOAP.DATA(GETCPU)'
soapsrv = 'KEYAYA'
Address NETVASIS 'PIPE (END % NAME GETCPU)',
'| NETV (MOE) INGOMX SOAPREQ SERVER='soapsrv' DATA='soapsds',
'| L: LOC 1.8 'd||'DWO369I '||d,
'| EDIT SKIPTO 'd||'RETURN CODE' ||d,
'| UPTO 'd||'.' ||d,
'| WORD 3 1',
'| VAR omx_rc',
'| %L:',
'| CON ONLY'
```

On the successful return of INGOMX, the output of the SOAP server is returned in the multiline ING160I message:

```
ING160I RESPONSE FROM SOAP SERVER: 9.xxx.xxx.xxx:1920///cms/soap
Job_Name:ASID:CPU_Percent
IXGLOGR:20:2.1
NET:59:2.1
RMFGAT:89:6.9
SDM1IRLM:108:1.7
BBOS001S:113:22.1
YANAMSJH:117:3.9
```

The first row of this message documents the IP address of the SOAP server that responded, that is, KEYAYA in the example (IP address anonymized).

The second row describes the names of the attributes returned by the SOAP server. The attribute names are separated from each other by the non-printable character X'FF' (represented by a :).

The third and all following rows contain the actual data that has been requested. The attribute values are presented in the same sequence as the corresponding attribute names in the second row. Also, like the attribute names, the attribute values are separated from each other by the non-printable character X'FF' (represented by a :).

The tabular structure of this message allows you to easily process it in a NetView PIPE.

Using the INGMTRAP Monitor Command

INGMTRAP is a customized interface to INGOMX that provides filtering capabilities for exceptions of interest as reported by OMEGAMON exception analysis and triggering of automation on behalf of such exceptions. For each exception that matches the XTYPE filter that is provided by the caller, INGMTRAP issues message ING080I, which is exposed to NetView. For example:

```
ING080I CI2XREP/MTR/KEYA OMSY4MVS OMIIMVS XREP Number of Outstanding Replies = 4
```

If no exception matches the XTYPE filter that is provided by the caller, INGMTRAP creates a ING081I message that is not exposed to NetView but written to the monitor resource's log to document that no exception has been found. For example:

```
ING081I CI2XREP/MTR/KEYA OMSY4MVS OMIIMVS NO EXCEPTION FOUND
```

INGMTRAP can only be used as a monitor command. This means that it has to be specified directly as a monitor command in the definition of a monitor resource, or it has to be called on behalf of such a monitor command. The following example illustrates what you need to specify on the MONITOR INFO policy in entry type monitor resource (MTR) in order to trap outstanding operator replies that are reported by OMEGAMON for MVS session OMSY4MVS:

```
INGMTRAP NAME=OMSY4MVS,XTYPE=(XREP)
```

Be careful when specifying a list of exceptions: each exception may cause an ING080I message to be issued. Because each occurrence of an ING080I message triggers health status processing of the monitor resource, make sure you understand the impact that this may have on the monitor resource's final health status.

For more details about INGMTRAP refer to *IBM Tivoli System Automation for z/OS Programmer's Reference*. For more details about defining monitor resources, refer to *IBM Tivoli System Automation for z/OS Defining Automation Policy*.

Health Monitoring Based on OMEGAMON Exceptions

This section describes how to set up the monitor resources for health-based monitoring based on OMEGAMON exceptions using the customization dialogs, provides a sample scenario, and gives recommendations when using OMEGAMON in combination with monitor resources.

Defining the Monitor Resources

By combining monitor resources and the OMEGAMON interaction methods described in "OMEGAMON Interaction" on page 47, automation can be triggered as a result of analyzing the output reported by OMEGAMON and by the setting of an appropriate health status.

OMEGAMON exceptions can be periodically monitored using a monitor resource and the monitor command INGMTRAP. There are a variety of ways to handle such exceptions:

1. In the customization dialog, the MESSAGES/USER DATA policy of a given monitor resource needs to state the health status of each exception that INGMTRAP has been set up to monitor. Unlike messages, OMEGAMON exceptions are denoted by a '+' sign, followed by a blank and then a 4-character OMEGAMON exception ID.
2. In addition to the health status, a series of one or more commands can be specified to handle that particular exception. Commands are processed in the same way as for any other resources that a MESSAGES/USER DATA policy is provided for, such as applications (APL). This includes escalation processing based on a PASS count, or processing based on a selection value that can be defined using CODEs that are derived from a message.
3. The HEALTHSTATE policy can be used to issue recovery commands on behalf of an OMEGAMON exception each time the health status changes.

No matter which method or combination of method are chosen, the process of handling an exception is triggered by the occurrence of an ING080I message for a particular monitor resource and exception. The automation table that is built from the definitions in the MESSAGES/USER DATA policy contains statements that invoke the INGMON command to set the monitor resource's health status and to issue commands in response to exceptions. In most cases, the necessary entries in

the NetView Automation Table are created automatically by SA z/OS. In some rare cases when, for example, command selection should be based on CODEs, it is necessary to override the automation table definition of the exception, and to specify up to 3 codes (CODE1, CODE2, and CODE3) on the invocation of INGMON.

Alternatively, an installation-written monitor command can be used to issue INGOMX for a series of exceptions to one or more OMEGAMON monitor. Such a monitor command then returns with an appropriate health status that is based on the analysis of the output produced by INGOMX. The recovery commands that are issued when the health status changes are specified in the HEALTHSTATE policy of that monitor resource.

Example Scenario

To illustrate how SA z/OS and OMEGAMON operate together, consider the following scenario.

Suppose there is a DB2 application that should be continuously monitored. Of particular interest is the availability of primary active logs. The LOGN exception indicates that fewer primary active logs exist than specified by the respective threshold value. This is considered a critical health indicator because it can cause a DB2 hang situation if the last primary active log becomes 100% full. Such a situation can only be resolved by making one or more additional primary active logs available again.

In order to monitor this situation and react accordingly, the automation policy has to be changed. First, define the session attributes for the OMEGAMON for DB2 monitor, if they do not yet exist, to be able to establish a VTAM connection. The OMEGAMON session is referred to by its *session name*. Then review the number of session operators (automation operators) that are started to handle the VTAM session traffic and add an additional one if a higher degree of parallelism is required. You need to ensure that the number of session operators and predefined NetView tasks are identical.

Next, add a new monitor resource (MTR) that periodically requests exception information from this OMEGAMON session. Add the MTR by means of a *HasParent* relationship to the DB2 subsystem to be monitored. This ensures that the MTR is activated when the DB2 subsystem is started, and deactivated when the DB2 subsystem is stopped. Also define the MTR via a *HasMonitor* relationship to the DB2 subsystem to ensure that the monitor's health status can be propagated to the application.

While the MTR is active, it uses the monitor command, INGMTRAP, to gather OMEGAMON exceptions that currently exist, based on the thresholds that are defined in the OMEGAMON for DB2 installation profile. INGMTRAP analyses all exceptions returned by OMEGAMON and filters out those exceptions that the MTR is interested in, in this example, LOGN. SA z/OS subsequently issues message ING080I to initiate exception processing.

Finally, also add a new rule to the NetView automation table (using the SA z/OS policy) that executes a REXX automation procedure to add a new log data set to the pool of primary active data sets whenever the LOGN exception is reported and the health status is CRITICAL (6). The MTR's health status is considered CRITICAL if the number of available primary active logs is equal to 1. If the LOGN exception is reported again in the next monitor interval, a second rule in the automation table sets the MTR's health status to FATAL (7), which triggers an application move

because normal recovery handling doesn't seem to work anymore. In addition, an alert is sent to the operator to inform him about this situation. If the LOGN exception is no longer reported, the MTR's health status is set to NORMAL (3).

The health status assigned to the MTR by means of the automation table is propagated to the DB2 application that owns this MTR. Thus, you can see at a glance whether the DB2 subsystem is okay or not.

Recommendations

You should consider the following recommendations when using OMEGAMON in combination with monitor resources:

- Avoid monitoring multiple exceptions using INGMTRAP. Note that there can be more than one exception that may trip and thus multiple ING080I messages may be generated. The monitor resource's health status, however, depends on the last ING080I message.
- Avoid setting different health statuses for the same exception that is monitored by different monitor resources using INGMTRAP. Note that only one automation table entry is generated by SA z/OS to process message ING080I for such an exception.

In these cases, the use of INGOMX, invoked from an installation-written monitor command, to determine a combined health status from multiple exceptions or to determine an individual health status for each monitor resource, is preferred to using INGMTRAP.

Health Monitoring Based on OMEGAMON XE Situations

This section gives an overview of passive, event-based monitoring of OMEGAMON XE situations and describes how to set up the monitor resources using the customization dialogs.

Overview

Unlike the exception-based monitoring that SA z/OS uses for classic OMEGAMON monitors, the IBM Tivoli Monitoring infrastructure provides the means to react to situations whenever they occur. On the Tivoli Enterprise Portal (TEP), a user can specify what kind of automated response (reflex automation) should be triggered for each individual situation.

SA z/OS makes use of this capability by providing a simple command called INGSIT. The ITM administrator enters this command on the TEP with the Situation Editor dialog for those situations where SA z/OS health monitoring or health-based automation should take place. For more details about INGSIT refer to *IBM Tivoli System Automation for z/OS Programmer's Reference*.

The Take Action command is carried out on the agent, for example, OMEGAMON XE for z/OS, and not the Tivoli Enterprise Monitoring Server (TEMS) unless the TEMS is running on the same system. This is because it is possible that the hub TEMS may not reside on z/OS and so the command may not be delivered.

INGSIT triggers message ING150I that allows you to set the health status of individual monitor resources. It is then possible to issue commands, such as recovery or notification commands, to automatically fix the situation. You can specify what the health status is and what associated commands are issued in the customization dialog.

Defining the Monitor Resources

To set up the monitor resources:

1. Define one MTR for each OMEGAMON XE situation that you want to respond to.
2. In the MONITOR INFO policy item fill in the following fields:

Monitored Object

Enter the name of the OMEGAMON XE situation in uppercase with a prefix of ITM, for example, ITM.MYSIT

Monitored Jobname

Enter an optional job name to match this situation to a particular monitor resource.

3. Define codes for the message ID ING150I in the MESSAGE/USER DATA policy of the MTR to yield the commands that are to be issued and to map the severity to a valid health status.

Example Scenario: Consider the following scenario:

The PAGEADD command is to be issued when an auxiliary storage shortage is detected, based on page data set utilization and page data sets that are not operational.

A situation called MyAuxShortage_Warn is defined by the installation that is true when both predefined situations OS390_Local_PageDS_PctFull_Warn and OS390_PageDSNotOperational_Warn are true.

As reflex automation, the following system command is issued on the managed system, that is, the system that produced the situations:

```
F NETV,INGSIT MyAuxShortage_Warn,warn
```

Where *NETV* is the job name of NetView address space.

This command is issued from the Take Action dialog, as shown in Figure 7 on page 55.

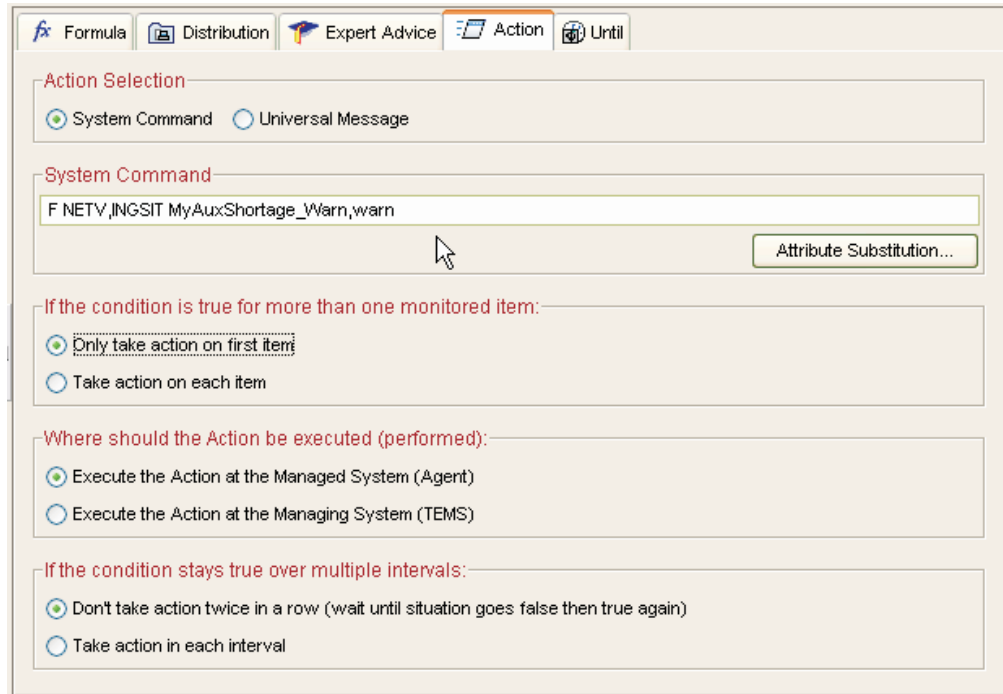

Figure 7. Take Action Dialog

INGSIT is called and produces an ING150I message, which contains the situation name that is mapped to the monitored object. Other optional information includes:

- The severity of the situation
- A job name that matches this situation to a particular monitor resource
- Other data that contains information related to the event

In this example, the situation, MyAuxShortage_Warn, and its severity, warn, are included.

Using the customization dialog, a monitor resource, for example, AUXSHORT, is created that specifies ITM.MYAUXSHORTAGE_WARN (in uppercase) as its monitored object.

ING150I is then specified in the MESSAGE/USER DATA policy item of the AUXSHORT monitor resource. In this example, the following code entry could be used to derive selection ADD and set the health status to MINOR:

Code 1	warn
Code 2	*
Code 3	*
Value Returned	ADD MINOR

In addition, one or more commands can be specified for ING150I for the selection that resulted from code match processing. In the example above, the PAGEADD command would be specified for selection ADD.

After executing all the commands that have been specified in the Command Processing panel for the selection, the health status that was mapped in the code processing is set (in this example, it was MINOR). Note that if no health status was specified in the code match table, it remains unchanged.

In a more sophisticated extension of this scenario, the situation, `MyAuxShortage_Warn`, as shown on the TEP is automatically acknowledged using SOAP services. To do this, a small request parameter XML-document must be created and sent to the TEMS SOAP server for processing. To acknowledge a situation, a `CT_Acknowledge` request must be issued as shown in the following example:

```
<CT_Acknowledge>
  <target>KEYAS:CMS</target>
  <name>MyAuxShortage_Warn</name>
  <source>KEYAPLEX:SYS1:MVSSYS</source>
  <data>System Automation is taking care of this</data>
</CT_Acknowledge>
```

The XML-document above references the TEMS that manages the situation (target), the situation itself (name), and the so-called monitoring agent (source) that is the source of this situation. With the data-element, you can pass any additional textual information to the person that is looking into this situation on the TEP.

As described in “OMEGAMON Interaction” on page 47, `INGOMX` is used to issue the SOAP request to the TEMS SOAP server. Once the situation has been acknowledged, it can be recognized as such on the TEP's situation event console or navigator flyover list.

Health Monitoring using CICSplex SM

This section introduces the components of event-based CICS monitoring and describes how to set up the monitor resources using the customization dialogs.

Component Overview

Event-based CICS link and health monitoring is implemented using CICSplex System Manager (CICSplex SM) objects. Whenever an event is received from CICSplex SM, message `ING150I` is issued.

`INGCPSM` is the event listener for CICSplex SM. Because it is a long-running automation procedure it needs to be run in a virtual operator station task (VOST). It scans the configuration on startup and listens for events. It then periodically checks whether the configuration has changed (that is, monitor resources have been added, deleted, or changed, etc.) or monitor resources are waiting for initial monitoring (that is, they have `STATUS=ACTIVE` and `HEALTH=UNKNOWN`).

Creating an Application to Manage the VOST

You can manage the VOST that executes `INGCPSM` using an application of type `NONMVS`:

- Start the VOST by using the `INGVSTRT` command as the start command of the APL, where its job name is used as the *attach_name* of the VOST.
- Stop the VOST using a sequence of `INGVSTOP` stop commands in the management APL.
- Monitor the status of the VOST using the `INGVMON` monitoring routine in the management APL.

For more details, see *IBM Tivoli System Automation for z/OS Programmer's Reference*.

Defining the Monitor Resources

To set up the monitor resources:

1. Define one MTR for each CPSM object (for example, each connection).

2. Fill in the **Monitored Object** field in the MONITOR INFO policy item according to the naming conventions, for example, CPSM.CICS1TOR.CONNECT.CON1
3. Leave the **Monitored Jobname** field empty.
4. Define codes for the message ID ING150I in the MESSAGE/USER DATA policy of the MTR to map the CPSM severities to valid health statuses, for example:

Code 1	Value Returned
VLS	* NORMAL
LS	* WARNING
LW	* WARNING
HW	* MINOR

Refer to the *CICS add-on policy for sample definitions to monitor the connection between two CICS resources.

Monitoring JES3 Components

The concept of a monitor resource is used to monitor the health of various JES3 components. SA z/OS provides two commands that support a strict separation of the monitoring part and the resulting recovery processing:

- AOFRJ3MN: used to monitor components in the JES3 environment, for example spool space.
- AOFRJ3RC: used to perform recovery actions against the monitored JES3 object.

The following example defines a spool space monitor:

1. Define a monitor resource with a “HasParent” relationship to the corresponding JES3 because it only makes sense to monitor the spool space when JES3 is active.
2. Activate and deactivate commands are not necessary for the spool monitor.
3. Use the AOFRJ3MN command as the monitor command and setup the monitoring interval as desired. In this example, spool usage of up to 60% is NORMAL, 61-70% WARNING, 71-80% MINOR, 81-90% CRITICAL and greater than 90% FATAL.

```
AOFRJ3MN JES3_subsys SPOOLSHORT 60,70,80,90
```

4. Define the recovery action in the HEALTHSTATE policy, for example:

```
NORMAL : AOFR3RC JES3_subsys SPOOLSHORT RESET
CRITICAL: AOFRJ3RC JES3_subsys SPOOLSHORT 05
FATAL : AOFRJ3RC JES3_subsys SPOOLSHORT 01
```

Issue one recovery command every minute. The commands are read from the SPOOLSHORT policy of the JES3 subsystem. When the spool usage goes down to 60% or less, the health status goes to NORMAL. This causes to invoke the AOFR3RC command but now with the RESET option - the RESET option stops recovery. It is recommended that you use JESOPER as the auto-operator for the recovery commands. Note, that the recovery commands for the SPOOLSHORT condition must be defined for the JES3 subsystem.

5. For the JES3 subsystem, define the necessary actions that should be performed for SPOOLSHORT in the Message/User data policy:

Pass	Automated Function	Command
1	JESOPER	MVS &SUBSCMDPFXF U,Q=HOLD,AGE=30D,N=ALL,C
2	JESOPER	MVS &SUBSCMDPFXF U,Q=HOLD,AGE=10D,N=ALL,C
3	JESOPER	MVS &SUBSCMDPFXF U,Q=HOLD,AGE=3D,N=ALL,C
10	JESOPER	MVS &SUBSCMDPFXF U,Q=HOLD,AGE=1D,N=ALL,C

This purges all jobs from the hold queue that are older than 30 days in the first pass. On pass 2, all jobs older than 10 days are purged. On pass 3 all jobs older than 3 days are purged. Finally, after 10 times the pass interval (in our example 5 minutes), all jobs older than 1 day are deleted if the recovery action is not reset in the meantime.

AOFRJ3MN Routine

Use this routine to monitor various objects in a JES3 environment. The following objects can be monitored:

- MDS queues (Fetch queue, Verify queue, Wait volume queue, Error queue, Allocation queue, Breakdown queue, Unavailable queue, Restart queue, System select queue, System verify queue)
- Current[®] setup depth
- Spool space

For each of the 10 JES3 MDS queues, thresholds may be set for each of the 4 health statuses (Warning, Minor, Critical and Fatal) indicating the number of jobs that particular queue may contain causing to set the corresponding health status. If, for example, the WARNING threshold for the Error queue is set to 5, if 5 or more jobs are pending on the MDS Error queue, the health status is set to Warning.

For the spool space the thresholds define the amount of used space that when exceeded causes to set the corresponding health status.

Whenever AOFRJ3MN is called, it issues the appropriate JES3 command (*I,Q,S for SPOOLSHORT and *I,S for the MDS queues) and parses the response. The value extracted from the message text is compared with the thresholds and then the return code is set to the corresponding health status. This simply sets the health status of the Monitor resource (MTR). No recovery action is taken by AOFRJ3MN routine. Use the HEALTHSTATE policy of the Monitor resource to define a recovery action for each health status, if necessary.

The syntax of the AOFRJ3MN routine is as follows:

▶▶ AOFRJ3MN—*jes3apl*—| object |—| threshold-list |—————▶▶

object:

MDCOUNTQ
MDCOUNTF
MDCOUNTV
MDCOUNTW
MDCOUNTE
MDCOUNTA
MDCOUNTB
MDCOUNTU
MDCOUNTR
MDCOUNTSS
MDCOUNTSV
SPOOLSHORT

threshold-list:

<i>warning,minor,critical,fatal</i>

jes3apl

Specifies the name of an APL of category JES3 for which this monitor works.

monitor

Specifies the JES3 object to be monitored:

MDCOUNTQ	Current setup depth
MDCOUNTF	Fetch queue
MDCOUNTV	Verify queue
MDCOUNTW	Wait volume queue
MDCOUNTE	Error queue
MDCOUNTA	Allocation queue
MDCOUNTB	Breakdown queue
MDCOUNTU	Unavailable queue
MDCOUNTR	restart queue
MDCOUNTSS	System select queue
MDCOUNTSV	System verify queue
SPOOLSHORT	Spool

threshold-list

Specifies a list of four threshold values separated by commas:

<i>warning</i>	Set health status to WARNING if this value is exceeded
<i>minor</i>	Set health status to MINOR if this value is exceeded
<i>critical</i>	Set health status to CRITICAL if this value is exceeded
<i>fatal</i>	Set health status to FATAL if this value is exceeded

If *warning* is not exceeded the health status is set to NORMAL.

Note that for SPOOLSHORT the values are in percent but for the MDS queues they are absolute numbers. No value checking is done by AOFRJ3MN except for whole numbers.

Note also that the thresholds are tested from FATAL to WARNING. So if you want to go directly from NORMAL to FATAL, you could specify 50,50,50,50

AOFRJ3RC Routine

This routine performs the recovery action against a monitored object in a JES3 environment.

When AOFRJ3RC is called, it checks whether the system that it is running that holds the JES3 global processor. If not AOFRJ3RC terminates without any further action.

The syntax of the AOFRJ3RC routine is as follows:

```
▶▶—AOFRJ3RC—jes3apl—msg-type—┌pass-interval—▶▶  
└RESET—
```

jes3apl Specifies the name of an APL of category JES3.

msg-type

Specifies the message type within the given JES3 APL that the recovery commands are to be read from:

pass-interval

Specifies the time interval that AOFRJ3RC should wait before executing the next pass. The format is in NetView notation (mm, hh:mm, hh:mm:ss or :ss).

RESET

If RESET is specified AOFRJ3RC stops the recovery.

AOFRJ3RC looks into the MESSAGE/USER DATA policy definition of the specified JES3 APL. It issues the command that is defined for PASS1 of the given message type. As long as there are commands in higher passes it sets up a NetView timer that re-calls AOFRJ3RC after the given pass interval. Whenever AOFRJ3RC is executed the command that is defined for the next pass is issued as long as one exists.

If RESET is specified instead of a pass interval any pending timer is killed and processing stops.

The return code is always zero.

Note: AOFRJ3RC issues the recovery commands in a *fire-and-forget* manner. It does not check whether the recovery action has the desired result. This is done by the monitor. After one or more monitor intervals the health status changes to a less severe one if the recovery shows an effect. If you want to stop recovery actions when the health status returns to NORMAL, for example, you have to code a HEALTHSTATE command that calls AOFRJ3RC with RESET.

JES2 Spool Monitoring

An SA z/OS monitor resource (MTR) is used to monitor JES2 spool file usage. This can be accomplished with an active monitor that queries the spool usage periodically or a passive monitor that listens for HSAP050 and HASP355 events.

The JES2 spool monitoring function that is provided includes the following items:

- Automation routines INGJRMJSP, INGRSJSP (AOFRSD01), AOFRSD09, and AOFRSD0H. See “INGJRMJSP” on page 191, “INGRSJSP (AOFRSD01)” on page 193, “AOFRSD09” on page 178, and “AOFRSD0H” on page 183.
- Automation table entries for system messages HASP050 and HASP355.
- Configuration parameters for the JES2 spool recovery process in the JES2 SPOOLSHORT and JES2 SPOOLFULL policy items of the JES2 application.

DB2 Connection Monitoring

SA z/OS allows you to monitor DB2 connections for both CICS and IMS:

CICS The CICS command CEMT INQUIRE DB2CONN is issued regularly after each monitor interval to query the status of the CICS DB2 connection.

For more details, see the sections “Monitoring of CICS DB2 Connections” and “INGRMCDB Routine for the Monitoring of CICS DB2 Connections” in *IBM Tivoli System Automation for z/OS Product Automation Programmer’s Reference and Operator’s Guide*

IMS The IMS command DISPLAY SUBSYS is issued regularly after each monitor interval and the response to this command is analyzed with respect to the status of the connection to a DB2 subsystem.

For more details, see the sections “Monitoring of IMS DB2 Connections” and “INGRMIDB Routine for the Monitoring of IMS DB2 Connections” in *IBM Tivoli System Automation for z/OS Product Automation Programmer’s Reference and Operator’s Guide*

IMS Component Monitoring

For IMS automation, SA z/OS enables the monitoring of online log data sets (OLDS) and recovery control data sets (RECON) of IMS control regions, and allows the status checking of the VTAM Application Control Blocks (ACB) and the enablement of logons.

The monitor routines that are provided for this and the necessary definitions to enable the monitoring functions are described in *IBM Tivoli System Automation for z/OS Product Automation Programmer’s Reference and Operator’s Guide*.

Chapter 5. Alert-Based Notification

SA z/OS provides an alert-based notification service that enables you to alert subject-matter experts. You can escalate automation problems that require manual intervention by sending alerts, events or trouble tickets to different kinds of notification targets. SA z/OS supports several communication methods that allow you to deliver alerts to notification targets such as:

- System Automation for Integrated Operations Management (SA IOM)
- Tivoli Enterprise Console (TEC)
- Tivoli NETCOOL/OMNIBus
- IBM Tivoli Service Request Manager
- A user-defined alert handler

Overview

The alert-based notification service of SA z/OS allows alerts to be sent to operators or system programmers for predefined situations. You can also customize when to issue alerts, if desired, using the customization dialog and the INGALERT utility. Alerts can only be issued for applications (APL), monitor resources (MTR), application groups (APG), and MVS components.

An alert is a set of information that is collected and sent by an SA z/OS automation agent to a target for notification processing. The information that is sent consists of the text that is to be forwarded to the alerted person or group. This information is supplemented by additional options that determine in detail the processing at the different kinds of notification targets.

In SA z/OS there are several predefined alert points that trigger alerts whenever a command encounters a problem situation, such as a resource becoming degraded or not being up within a given time interval.

Alerting can be enabled or disabled at various levels:

- Globally using the INGCNTL command
- Resource-specific using the resource's Inform List
- Alert-specific using code definitions for the message ID INGALERT

Communication Flow

Figure 8 on page 64 outlines the communication between the automation manager and the automation agents.

Alert-Based Notification

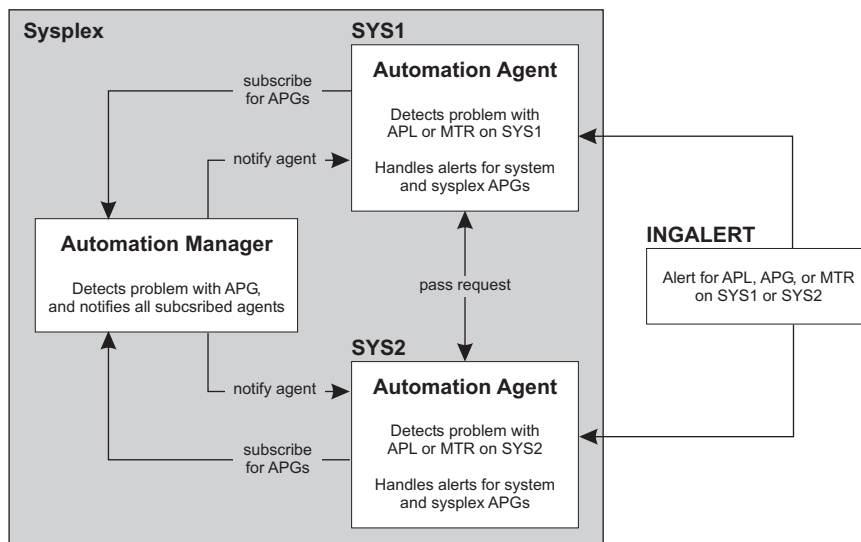

Figure 8. Alert Communication Flow

The automation agents on the systems in the sysplex subscribe to the automation manager to be alerted about problems with system or sysplex application groups (APGs). This is because the automation manager cannot itself send alerts to the notification targets. Whenever the automation manager detects a problem with an APG it sends an alert to the subscribed automation agents (one in case of a system APG, and all in case of a sysplex APG). Any alerts for sysplex APGs are handled by only one automation agent in the sysplex.

The automation agents can also receive alerts for applications, application groups, or monitor resources via the INGALERT command. If the affected resource is managed by a different automation agent, the request is passed on. The automation agent that manages the resource sends the alert to the notification target. If, for whatever reason, this automation agent cannot send the alert, it passes on the request to the next automation agent in the sysplex. This can happen several times until the alert is successfully sent or no more automation agents are available.

For each alert, the automation agent connects to a notification target, sends the alert and then disconnects. The automation agent does not maintain a permanent connection to the SA IOM server.

Enabling Alerting

By default alerting is not enabled. To activate it you must perform setup actions in both SA z/OS and notification target.

Setup in SA z/OS

You can turn alerting on or off at three different levels in SA z/OS:

- The system level, via the INGCNTL command. Turning off alerting means that no alerts are detected or accepted by the system. Alerting must be turned on explicitly either globally or selectively for at least one notification target.
- The resource level, via the Inform List policy field. Turning off alerting means that no alerts are detected or accepted for the resource. The notification target must be explicitly specified (or inherited from the defaults) to activate alerting for it.

- The alert ID level, via code definitions for the INGALERT message ID of the resource or MVS component entry.

INGCNTL Command

By default alerting is not enabled. You have to issue the INGCNTL command to enable it and set the connection properties for the notification target. This can be done as follows:

- In the NetView style sheet using auxiliary commands:

```
*****
* Auxiliary commands
*****
* Enable Alerting and set connection properties
auxInitCmd.A = INGCNTL SET ALERTMODE=IOM ALERTHOST=saiom:1040:SAALERT
```

- From the AOFEXDEF exit that is supplied with SA z/OS:

```
'INGCNTL SET ALERTMODE=IOM ALERTHOST=saiom:1040:SAALERT'
```

See *IBM Tivoli System Automation for z/OS Programmer's Reference* for more information about the INGCNTL command.

Inform List

You have to include the appropriate communication method for the notification target in the Inform List field of the appropriate policy item to explicitly enable alerting for specific resources or classes of resources, as shown in Table 7.

Table 7. Inform List Policy Items

Policy Object	Policy Item
Application Group (APG)	APPLGROUP INFO *
Application (APL)	APPLICATION INFO *
Monitor Resource (MTR)	MONITOR INFO *
MVSCOMP Defaults (MDF)	MVSESA INFO *
System Defaults (SDF)	AUTOMATION OPTIONS
Sysplex Defaults (XDF)	RESOURCE INFO
* Leaving the Inform List field blank allows the policy object to inherit the value specified in the system defaults or sysplex defaults definition.	

You must also specify the appropriate communication method for the desired notification target as shown in Table 8.

Table 8. Inform List Communication Methods

Value in Inform List	Communication Method	Supported Notification Target in SA z/OS
IOM	Peer-to-peer protocol of IBM Tivoli System Automation for Integrated Operations Management (SA IOM)	SA IOM
EIF	Tivoli Event Integration Facility (EIF)	TEC or OMNIBUS
TTT	XML	TSRM via TDI
USR	Command call	User-defined alert handler

You can specify a blank-separated list of values to enable alerting for several notification targets.

Alert-Based Notification

Code Processing

Code processing with the INGALERT message ID allows you to define additional characteristics for events to be passed to the notification target or to prevent event creation for certain alerts. Such definition can be made, dependent on the alert ID, issuing job and type of notification target.

Code definitions for message ID INGALERT can be used for resources of type APL, APG, MTR, and for MVS components. If no matching code definitions are found for the APL, APG or MTR resources, the INGALERT code definitions are checked for the corresponding MVS component entry on the system where the resource resides.

Enter the following in the Code Processing panel for the INGALERT message ID:

Code 1 The alert ID that identifies the type of alert. SA z/OS provides the following set of built-in alert points:

Alert ID	Description	For Resource Type
CMD_FAILED	Return code checking is on and the command ended with RC≠0	APL, MTR
COMM_FAILED	An error was detected during communication to another system	APL
CRITICAL_WTOR	Critical WTOR triggered OUTREP	APL
MSG/	Messages with a critical severity.	APL, APG, MTR
OS_DEGRADED	The observed status of the resource has become degraded	APL
OS_PROBLEM	The automation status is ZOMBIE or BROKEN, or a shutdown outside SA z/OS and restart is not allowed	APL
REC_FAILED	Automation was halted because the critical threshold for a minor resource was exceeded	APL
REP_FAILED	No further outstanding WTORs that are stored by SA z/OS need to be replied to	APL
START_FAILED	The start command failed	APL
START_PENDING	The up message was not received within the timeout interval	APL
STOP_PENDING	Ran out of stop commands	APL
CS_PROBLEM	The compound status PROBLEM has been set	APG

You can also use any user-defined alert ID. Simply specify it in the corresponding code entry and call INGALERT with this ID. Wildcards are supported.

Code 2 For APL this is the job name that alerting should be done for. For MVC it contains MVSESA. For APG and MTR Code 2 is ignored. Wildcards are supported. This allows you to set alerting for several APLs at once by using APL classes.

Code 3 The communication method that is used to send the alert to the notification target. Valid values are IOM, EIF, TTT or USR. Wildcards are supported.

Value Returned

This can be either IGNORE to prevent event creation, or parameters that are sent to the notification target together with the passed event. The meaning of these parameters depends on the type of communication method, as follows:

IOM The first two tokens of the Value Returned are considered to be:

- The priority of the alert (0–999).
- The escalation ID that is used in SA IOM to define the rules that determine how the alert should be processed. The length of this value is limited to 20 characters.

If the first two tokens have invalid values, the Value Returned is assumed to be IGNORE.

If you specify more than two tokens in the Value Returned field, the superfluous tokens are ignored.

EIF The Value Returned is considered to be the event severity. Valid values are HARMLESS, WARNING, MINOR, CRITICAL or FATAL, or a corresponding number between 1 and 5, where 1 corresponds to HARMLESS, etc. Both alternatives for specifying a severity can be used for events to TEC or NETCOOL/OMNIbus. When specifying the severity as a number, the code definition can also be used to send alerts to SA IOM.

If you do not specify a valid severity, the Value Returned is assumed to be IGNORE.

Superfluous tokens in the Value Returned field are ignored.

TTT If TSRM is the notification target, the values in Value Returned are used as:

- The priority of the trouble ticket as it is initially reported (1-5)
- The urgency, which is a indication of how quickly a trouble ticket should be resolved (1-5)
- The business impact or severity of the trouble ticket (1-5)

These values are not validated because other targets may expect other values.

If you specify more than three tokens in the Value Returned field, the superfluous tokens are ignored. If you specify less than three tokens, they are used according to their position and the missing tokens default to N/A.

USR The content of the Value Returned field is passed to the user-defined alert handler that is called.

Code Definitions Example: Consider the example in Table 9 on page 68.

Alert-Based Notification

Table 9. Code Processing Example for the *INGALERT* Message ID

Code 1	Code 2	Code 3	Value Returned
START_FAILED	IMS*	IOM	500 IMS_start
START_FAILED	DB2*	EIF	CRITICAL
*	*	*	IGNORE

The code definitions in this example result in the following behavior:

- Alerts with the alert ID `START_FAILED` for jobs with the name prefix `IMS` are sent to `IOM` with priority 500 and escalation ID `IMS_start`.
- Alerts with the alert ID `START_FAILED` for jobs with the name prefix `DB2` are sent as `EIF` events to `TEC` or `NETCOOL/OMNIBus` with event severity `CRITICAL`.
- All other alerts are ignored for all notification targets.

INGALERT Command

You can use the `INGALERT` command to inject alerts into a system. This can be from either the NetView automation table, an automation procedure, or the command line.

You can specify the following parameters:

- A resource name, the text `MVSESA`, or a job or subsystem name.
- The alert ID, for example, `CS_PROBLEM`, `CMD_FAILED`, etc.
- A message ID that identifies the message text or a text string that is passed to the notification target.

For example, the following can be used from the command line or an automation procedure:

```
INGALERT MYGRP/APG/SYS1 ID=MYALERT TEXT=(MYGRP HAS A PROBLEM)
```

In this example, `INGALERT` uses the alert ID, `MYALERT`, to obtain additional parameters via a matching code definition for the message ID `INGALERT`, and it uses the `TEXT` parameter value for the alert text.

The following can be used from the NetView automation table to send an alert whenever message `ABC123I` is issued:

```
IF MSGID='ABC123I'  
THEN  
EXEC(CMD('INGALERT'));
```

`INGALERT` uses `ABC123I` as the alert ID and the complete text of message `ABC123I` as the alert text. The resource parameter of `INGALERT` is defaulted to the job name of the subsystem that issued the message.

See *IBM Tivoli System Automation for z/OS Programmer's Reference* for more information about the `INGALERT` utility.

Chapter 6. Availability and Recovery Time Reporting

SA z/OS introduces support to assist you in billing users or reporting reliability of your critical applications or the software that those applications are dependent on. For example, you might want to charge accurately based on the amount of time required to run an application. This is of importance for non-MVS resources, such as USS applications, or monitoring resources that might run in the NetView address space.

Overview

SA z/OS collects and records job-related information, and writes System Management Facility (SMF) records at specific events in the lifetime of a resource. This resource can be:

- A subsystem (APL)
- An application group (APG) that is hosted by the local system as well as sysplex application groups
- A monitor resource (MTR)

The INGPUSMF batch utility produces a report file that you can import into a spreadsheet. You can also convert and write the report into DB2 tables that are provided and exploited by the IBM Tivoli System Automation Application Manager. For more details, see “Writing the SMF Report to DB2” on page 74.

You can control whether a record is written for a resource by entering the value SMF in the Inform List field in the resource's information policy item.

Resource Lifecycle

Figure 9 shows the events in the lifetime of an application when SA z/OS records information.

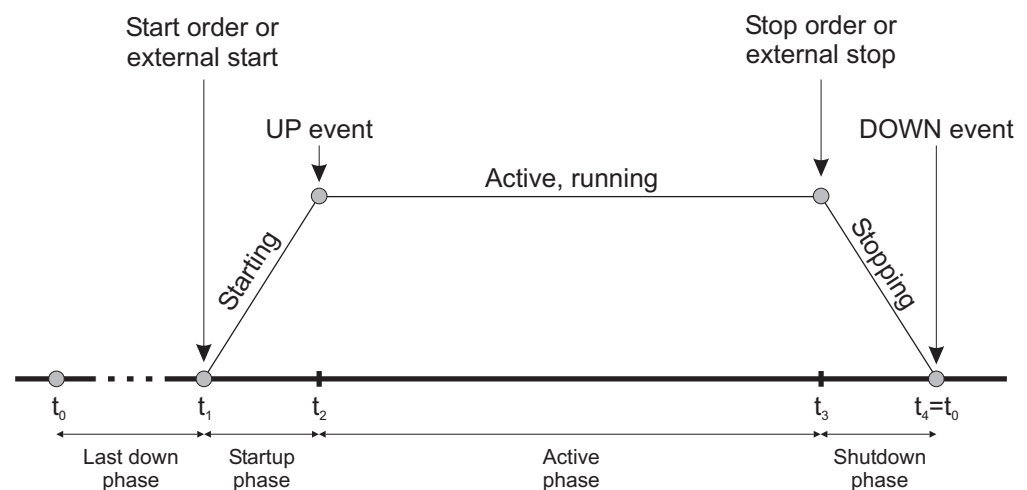

Figure 9. Events in the Lifecycle of an Application

These events are:

- Start order received from the automation manager (t_1)
- UP signal received (t_2)
- Stop order received from the automation manager (t_3)
- DOWN signal received ($t_4=t_0$)

By examining these records you can establish the following information for a given time period:

- Application up time and downtime
- Application startup and shutdown time
- The number of scheduled stoppages and the approximate amount of scheduled downtime
- The number of unscheduled stoppages and the approximate amount of unscheduled downtime

To make using SA z/OS SMF records easier, the following periods are automatically calculated and stored (in units of seconds) in the SMF record:

- The startup time (t_2-t_1)
- The shutdown time (t_4-t_3)
- The time the application was active (t_3-t_2)
- The last down time (t_1-t_4)

You therefore have a precise view of the lifecycle of the application.

Layout of the SMF Record

Table 10 provides details of the data that is stored in the SMF record.

Table 10. Layout of the SMF Record

Offset	Length	Format	Description
00	2	Binary	Record length. This field and the next (a total of 4 bytes) form the record descriptor word (RDW).
02	2	Binary	Segment descriptor. This is zero.
04	1	Binary	System Indicator Bit: 0 Reserved 1 Subtypes used
05	1	Binary	SMF Record Type. This is 114.
06	4	Binary	The time, since midnight, that the record was moved into the SMF buffer (in hundredths of a second).
10	4	Packed	The date when the record was moved into the SMF buffer, in the form <i>0cyydddF</i> .
14	4	EBCDIC	System Identification (from the SID parameter).
18	2	Binary	Record subtype: 1 Automation tracking record
20	2	Binary	Record version.
22	2	—	Reserved.
24	4	Binary	Offset to product section from start of record, including the record descriptor word (RDW).
28	2	Binary	Length of product section.
30	2	Binary	Number of product sections. This is always 1.

Table 10. Layout of the SMF Record (continued)

Offset	Length	Format	Description
32	4	Binary	Offset to resource section from start of record, including the record descriptor word (RDW).
36	2	Binary	Length of resource event section.
38	2	Binary	Number of resource event sections. This is always 1.
40	8	—	Reserved.
Product Section			
00	16	EBCDIC	Product name, for example SA z/OS V3R2M0.
16	8	EBCDIC	Name of the SYSPLEX.
24	8	EBCDIC	Domain identifier.
32	8	EBCDIC	MVS System name.
40	8	EBCDIC	XCF group name.
Automation Section			
00	24	EBCDIC	Resource name (in automation manager notation).
24	8	EBCDIC	Job name (optional).
32	2	Binary	Event type: X'0001' Starting X'0002' Active X'0003' Stopping X'0004' Inactive X'0005' Degraded
34	2	—	Reserved.
36	12	EBCDIC	Automation agent status (optional).
48	12	EBCDIC	Start type.
60	12	EBCDIC	Stop type.
72	5	EBCDIC	Termination type (abend code). Optional.
77	3	—	Reserved.
80	4	Binary	Total startup time in seconds.
84	4	Binary	Elapsed time in seconds that the resource was active.
88	4	Binary	Total shutdown time in seconds.
92	4	Binary	Last down time of resource in seconds.

Enabling SMF Records

To enable SMF records for a resource:

1. Ensure that the SMFPRMxx member in SYS1.PARMLIB is set up to collect type 114 SMF records by adding type 114 to the SYS(TYPE statement:
SYS(TYPE(30,...,114)
2. Specify SMF in the Inform List of the APPLICATION INFO policy item for the resource.

The INGPUSMF Utility

You can use the INGPUSMF utility to analyze SMF records and produce a data set that can be imported into a spreadsheet program. The data set contains the type 114 records that SA z/OS produces in a format that can easily be imported. By default, the fields are semicolon delimited.

Output

The first record in the data set is a title record that describes each column. The remaining records are the data records. One data record is written for each type 114 SMF record.

Table 11 describes the format of each record.

Table 11. Format of INGPUSMF Utility Data Set Records

Column	Description
1	SMF system ID
2	Date when SMF record was written, in YYYYMMDD format
3	Time when SMF record was written, in hhmmss format
4	SA z/OS product name, including release level
5	Name of sysplex
6	System name
7	NetView domain ID
8	XCF group name
9	Resource name in automation manager notation
10	Job name, if present
11	Event
12	Automation agent status
13	Startup time in seconds
14	Active time in seconds
15	Shutdown time in seconds
16	Down time in seconds
17	Start type
18	Stop type
19	Termination (abend) code

The INGPUSMF Utility JCL

The INGPUSMF utility runs as a batch job. See INGEUSMF for a sample. The meaning of the DD statements is as follows:

STEPLIB

The load library that contains the INGPUSMF utility. The utility resides in the SINGMOD1 library.

REPORT

The output data set that contains the spreadsheet import data set in a semicolon-delimited format. The record size is 255 bytes.

SYSPRINT

Contains information that is written by the utility.

HSATRACE

Is used for debugging purposes only. If present, the INGPUSMF utility writes trace entries to record the process flow.

SMFDATA

Contains the SMF records. The record format is: Variable, blocked, spanned.

USRPARMS

Contains user options, such as filter criteria or a specific separator character.

User Options

You can specify various options in the USRPARMS data set that control the processing of the utility. You must specify each option in a separate record. The option are defined as keyword=value pairs. If you specify an option several times, the last occurrence is used. The keyword must start in column 1 of the record. No blanks are allowed in front of or after the equal sign (=). A asterisk (*) is considered to be a comment.

The following options are supported:

SEPCHAR=*char*

Defines the separator character to be used to separate the columns. The default is a semicolon (;) if omitted

SYSID

Defines the SMF system ID used as a filter. Only SMF records that are generated by that system are taken. The value can be 1–4 characters.

FROM=*date*

The starting date used as a filter. The format is YYYYMMDD. All SMF records written on the specified date or later are taken.

TO=*date*

The ending date used as a filter. The format is YYYYMMDD All SMF records that are written no later than the specified date are taken.

RESOURCE=

Defines the resources in automation manager notation used as a filter. You can specify up to 10 resource names. The name can be a wildcard, such as *abc, abc* or *abc*.

Return Codes

The following return codes are set by the utility:

- 0 Normal completion.
- 8 Invalid option detected in the USRPARMS data set.
- 12 REPORT data set is not accessible.
- 16 A severe error occurred, for example, an open error for the SMFDATA data set, or writing a record to the REPORT file.

Writing the SMF Report to DB2

You can convert and write the SMF report that is produced by INGPUSMF into DB2 tables that are provided and exploited by the IBM Tivoli System Automation Application Manager.

The following reports are provided:

- **Startup and Shutdown Reports:**
 - Report the cumulative startup and shutdown times for a resource, including its dependencies.
 - Report resources with the longest startup and shutdown times in a selected domain.
- **Availability and Recovery Reports:**
 - Report a resource's uptimes and downtimes, unexpected outages and corresponding recovery times.
 - Report resources that had the highest number of unexpected outages in a selected domain.

A conversion utility, known as the z/OS offloader, delivers the z/OS domain data that is required to run these reports.

The z/OS offloader component runs as a batch job (see Figure 10) and uses existing and new programs that are installed into the end-to-end automation adapter HFS directory, which is normally /ust/lpp/ing/adapter.

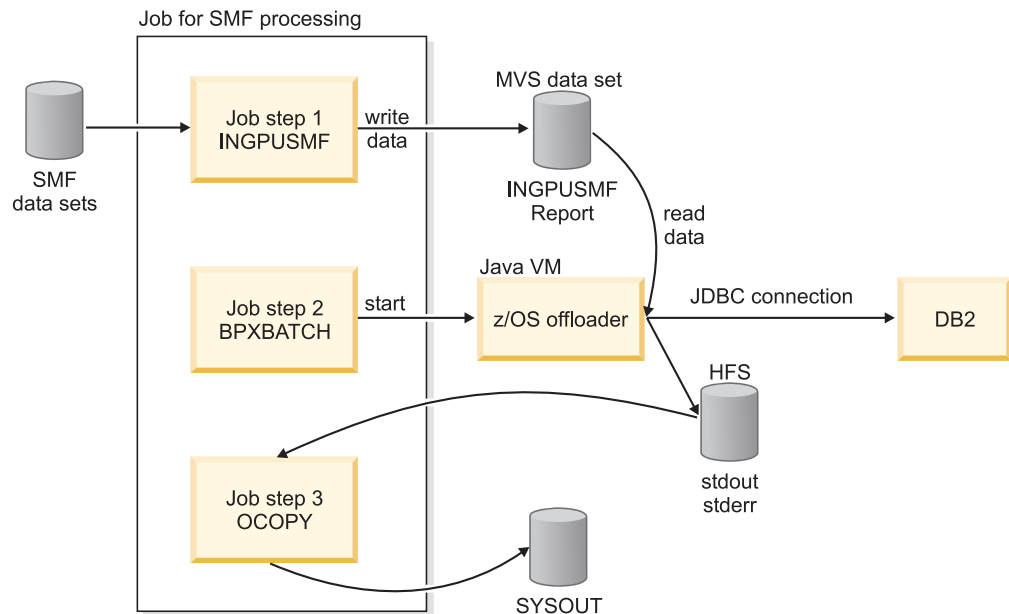

Figure 10. SMF Processing with z/OS Offloader

You can use the sample job INGXPRT to run the z/OS offloader.

Customization

After installing the z/OS offloader you must carry out the following customization steps:

Step 1. Customize the script /usr/lpp/ing/adapter/ingreport.sh.

Adapt the installation path:

INSTALL_DIR=/usr/lpp/ing/adapter

Step 2. Copy the sample job INGXRPT and follow the steps as described in it.

There are several input parameters that you need to set correctly otherwise the conversion utility cannot access the DB2 table:

Parameter	Details
INGDSN=HLQ.SMF.REPORT	The data set of the SMF report created by the INGPUSMF utility.
INGSEPCHAR=;	This must be the separator as used by the INGPUSMF utility.
INGDOMAIN= <i>MyDomain</i>	The name of the E2E domain as specified in the E2E adapter configuration file, <i>ing.adapter.plugin.properties</i> . If omitted the default is used, which consists of the sysplex name and XCF group name.
INGDB2_USER= <i>db2inst1</i>	The DB2 user name for remote logon.
INGDB2_PSW= <i>db2admin</i>	The DB2 password for remote logon.
INGDB2_PORT=50000	The TCP/IP port to connect to the remote DB2.
INGDB2_SERVER= <i>db2-host-name</i>	The TCP/IP host name to connect to the remote DB2.
INGDB2_NAME=EAUTODB	The DB2 name or the DB2 location if DB2 resides on z/OS.
INGDB2_SCHEMA=EAUTOUSR	The DB2 schema of the table.

Step 3. (Optional) If the database is located on a z/OS system, a DB2 license file is required. An appropriate license file for the z/OS platform, *db2jcc_license_*.jar*, must be installed in the application classpath. Connectivity to z/OS databases is enabled with the license file as defined by the following table.

Update DB2 database From==> To	License file required
Distributed system ==> z/OS DB2	<i>db2jcc_license_cisuz.jar</i>
z/OS system ==> z/OS DB2	<i>db2jcc_license_cisuz.jar</i>
z/OS system ==> distributed DB2	<i>db2jcc_license_cu.jar</i>

- a. Copy the appropriate license file, for example, from *DB2_INSTALL_PATH/db2/db2v8/jcc/classes/db2jcc_license_cisuz.jar* to the directory */usr/lpp/ing/adapter/lib*.
- b. Modify the classpath in the script */usr/lpp/ing/adapter/ingreport.sh* and add the license file for example:

```
DB2_LICENSE=$INSTALL_LIB/db2jcc_license_cu.jar
```

Step 4. Run the INGXRPT job that copies the SMF report to DB2.

Output

The output of the *ingreport.sh* shell script shows the progress of the z/OS offloader. Any errors that occur are reported in this output. See *IBM Tivoli System Automation for z/OS Messages and Codes* for details of these messages (INGX9850E, INGX9855E, and INGX9856E).

Chapter 7. How to Automate Processor Operations-Controlled Resources

This chapter contains information on how to customize your SA z/OS installation to enable the automation of messages coming from target systems that are controlled by processor operations. These target systems or resources are referred to as *processor operations resources* in the following.

Notes:

1. VM guest systems are treated the same as any other target systems that are controlled by ProcOps (see *IBM Tivoli System Automation for z/OS Operator's Commands* for details).
2. PSMs are "virtual" hardware and therefore not all target hardware commands apply (see *IBM Tivoli System Automation for z/OS Operator's Commands* for details).

With the method described in this chapter, you can use SA z/OS system operations to react on these messages. This information is contained in "Automating Processor Operations Resources of z/OS Target Systems Using Proxy Definitions," which introduces the general process how to achieve such message automation.

Automating Processor Operations Resources of z/OS Target Systems Using Proxy Definitions

SA z/OS processor operations can be used to automate messages that cannot be automated on the target systems themselves. Typically these messages include those appearing at IPL time.

In a sysplex environment there are additional messages (XCF WTORs) being displayed at IPL time when joining the sysplex and at shutdown time when a system is leaving a sysplex. These WTOR messages cannot be automated yet because SA z/OS system operations is not active at that time.

With the XCF message automation framework described in this chapter, you have a method of exploiting your own XCF message automation.

Note: There are XCF WTOR messages which are automatable by Sysplex Failure Management (SFM). In these cases, to avoid conflicting automation, it is not recommended that you automate these messages by SA z/OS.

Concept

You can use the SA z/OS standard interface and routines to handle system external messages in almost the same way as system internally generated messages. This applies to the way of defining message automation in the customization dialog as well as to the means available for controlling message automation at automation time.

To exploit the system operations mechanism for message automation, a *proxy resource* representing the processor operations resources must be generated in the customization dialog as entry type Application (APL).

How to Automate Processor Operations Controlled Resources

There is a one-to-one relation between a proxy and a processor operations resource (target system). How to implement this relation in the customization dialog is described in the following subsections.

Messages that are generated on external systems, where no SA z/OS is active or not yet active, can also be automated. The resources generating these messages are called *processor operations resources*. They are defined in the customization dialog as entry type System (SYS).

Customizing Automation for Proxy Resources

It is assumed that you have already used the customization dialog to define processor operations target systems and made these systems accessible to the processor operations focal point via the Processor Control file (see also *IBM Tivoli System Automation for z/OS Defining Automation Policy*). So for every processor operations target system that has been defined on the processor operations focal point, you should define a proxy resource. You do this by defining the proxy resource as entry type Application (APL) in the customization dialog.

Note: If you want to define many proxy resource applications, you can use the application class concept as described in *IBM Tivoli System Automation for z/OS Defining Automation Policy*.

Defining the proxy resource as an Application (APL) has another advantage: The system is then visible in the INGLIST panel and it can be managed and monitored like an application resource. SA z/OS users are able to not only use message automation for target system messages, they can also issue start and stop commands to IPL and shut down systems. These commands can be defined like any start and stop command for an application. Unlike application resources, target systems are managed by processor operations commands (for example, ISQCCMD *target_system_name* ACTIVATE FORCE(NO) or ISQSEND *target_system_name* OC vary xcf,*target_system_name*,off,retain=yes). Processor operations commands allow you to send MVS commands to target systems as well as hardware commands to the processor (support element).

The rules that you need to obey when defining the proxy resource are as follows:

1. You need to define (or have defined) the processor operations target systems that you want to automate. For those systems, the following rule applies:

MVS SYSNAME = ProcOps name

The **MVS SYSNAME** must be identical with the **ProcOps name**.

If this is not the case, you need to change it subsequently.

2. **Job Name = ProcOps name**

The **Job Name** of the application for the proxy resource must match the processor operations target system's name as defined when creating this system in the customization dialog.

3. **Job Type = NONMVS**

The **Job Type** for the proxy application must be NONMVS.

4. The **Monitor Routine** for the proxy application must be ISQMTSYS.

5. **Sysname = MVS SYSNAME**

The **Sysname** for the proxy application must match the **MVS SYSNAME** defined for the processor operations target system. This definition is used for resource monitoring.

How to Automate Processor Operations Controlled Resources

6. If you want to inhibit operators from performing a startup or shutdown for a target system resource using the INGREQ command, **External Startup** and **External Shutdown** must be set to 'ALWAYS'.
7. If you do not want the proxy resource to be automatically started, you should set the **Restart after IPL** option to NO.
8. Because you can only automate applications by linking them to systems via an application group, you need to define an application group for the proxy applications. Do not merge the proxy applications with other applications into this application group because destructive requests applied to a merged application group would also affect the proxy resources contained in that group.

You may choose PASSIVE behavior to not forward requests against the application group to each member. This prevents you from unintentionally sending requests to processor operations target systems represented by their proxies.

9. In the Message Processing panel for the proxy application define the messages to be automated in the **Message ID** column. Do not specify message ID ISQ900I, as this message is used as a carrier for the original target system message.

Enter cmd in the **Action** column to specify the command to be processed if the defined message occurs.

10. If the message to be automated is a WTOR, the variable &EHKVAR1 contains the reply ID. This variable may then be used as a parameter to the ISQSEND command:

```
ISQSEND &SUBSJOB OC R &EHKVAR1,COUPLE=00
```

Startup and Shutdown Considerations

Processor operations commands must be used to start or stop processor operations resources, for example:

- Start example:

```
ISQCMD &SUBSJOB LOAD FORCE(NO)
```

- Stop example:

```
Pass 1 ISQSEND &SUBSJOB OC Z EOD
```

```
Pass 2 ISQSEND &SUBSJOB OC VARY XCF,&SUBSAPPL,OFF,RETAIN=YES
```

Note:

If the delay time between sending the commands in pass 1 and pass 2 is not appropriate, you can define a resource-specific Shut Delay in the Application Automation Definition panel.

For more details about processor operations commands refer to *IBM Tivoli System Automation for z/OS Operator's Commands*.

Preparing Message Automation

The interaction with target systems is based on the SA z/OS processor operations component. Therefore the installation and customization of this component must be complete at this point.

Operating System messages from processor operations target systems receiving at the focal point are transferred to ISQ900I messages.

How to Automate Processor Operations Controlled Resources

ISQ901I is not relevant. It is used to inform interested operators about target system messages. It is not used for automation purposes.

MSCOPE() parameter in CONSOLxx member

MSCOPE allows you to specify those systems in the sysplex from which this console is to receive messages not explicitly routed to this console. An asterisk (*) indicates the system on which this CONSOLE statement is defined. Because the default is *ALL, indicating that unsolicited messages from all systems in the sysplex are to be received by this console, this parameter must be set to '*' for correct automation by SA z/OS processor operations.

Automating Linux Console Messages

The Linux Console Connection to NetView

When a Linux target system IPLs, its boot messages are displayed on the Console Integration facility (CI) of the System z[®] or 390-CMOS processor Support Element (SE). For SA z/OS processor operations, CI is the only supported interface to communicate with the Linux operating system. The communication between the processor operations focal point and CI is based on the NetView RUNCMD and the Support Element's Operator Command Facility (OCF), an SNA application. In SA z/OS processor operations, this connection path is referred to as a NetView Connection (NVC).

Linux Console Automation with Mixed Case Character Data

Unlike operating systems which translate console command input into uppercase characters, Linux is case sensitive. The NetView automation table syntax allows the use of mixed case characters in compare arguments of an IF statement. When an automation command is to be scheduled as a result of such a comparison, any message token arguments passed, are not translated into uppercase by NetView. Make sure that your automation routine does not do an uppercase translation of parameters passed. For example, in REXX use the statement PARSE ARG P1 P2 instead of ARG P1 P2, which implicitly performs a translation into uppercase. If a Linux message invokes your automation code and the message information is retrieved using NetView's GETMLINE function, no uppercase translation occurs. In order to send mixed case command data to the Linux console consider the following REXX statement:

```
Address Netvasis 'ISQsend MYlinux Oc whoami'
```

The addressed REXX command environment, Netvasis, passes the command string without doing an uppercase translation. The ISQSEND command internally translates its destination parameters into MYLINUX and OC but leaves command whoami as is.

Security Considerations

After Linux system initialization, usually a LOGIN prompt message is displayed allowing users defined to the system to login. The ISQSEND command interface does not suppress any password data from being displayed. You may use the NetView LOG suppression character to avoid the password information to be visible in the NetView log. In Support Element log files, such password data can be viewed in text form.

Restrictions and Limitations

The following Linux systems are supported:

- Linux systems running in an LPAR of a System z or 390-CMOS processor hardware
- Linux systems running on a System z or 390-CMOS processor hardware, configured in Basic mode
- Linux systems running as VM guest machines under z/VM Version 4.3 or higher

Linux systems running under a VM, which itself runs as a VM guest, are not supported.

In the command shell environments of a Linux console it is possible to pass control keys as character strings instead of pressing the keyboard control key combination to perform functions like Control-C. The current Linux support of SA z/OS processor operations has not been tested using this Linux capability. Any Linux program or command script that requires a user interaction with control keys should not be invoked using the SA z/OS processor operations ISQSEND interface.

How to Add a Processor Operations Message to Automation

Use the NetView automation table (AT) and the SA z/OS command set to implement console automation. You can automate the routine functions that an operator performs when a particular message is generated. For more information see *IBM Tivoli System Automation for z/OS Defining Automation Policy, SC33-7039*.

Messages Issued by a Processor Operations Target System

When a target system issues a message, the message is forwarded to the processor operations focal point system. The focal point system repackages the message within an SA z/OS ISQ900I message, an ISQ901I message, or both, and routes the message to the appropriate task:

- ISQ900I messages are routed to SA z/OS processor operations autotasks. If you want automation that you write to receive ISQ900I messages, use the ISQEXEC command to run the automation in a target control task. For information about using the ISQEXEC command, see section *Sending an Automation Routine to a Target Control Task* in “Issuing Other OCF Commands” on page 12. Your NetView automation table entries for SA z/OS should acknowledge the ISQ900I identifier for all target system messages forwarded to the processor operations focal point system. You can specify your ISQ900I automation table entries to be target system specific, however, this is not recommended.
- ISQ901I messages are routed to all logged-on operators identified as interested operators by the ISQXMON command or marked as such in the customization dialog.

For information about the ISQEXEC and ISQXMON commands, see *IBM Tivoli System Automation for z/OS Operator's Commands*.

A message forwarded from an SNMP connection consists of the following:

- ISQ900I or ISQ901I message identifier
- Name of target system where the message originated
- Console designator form describing where the message originated
- Message identifier and text of the original message from the target system

How to Automate Processor Operations Controlled Resources

For example, if a NetView connection forwards the message IEA101A SPECIFY SYSTEM PARAMETERS from the operating system to the focal point system, SA z/OS creates one or both of the following SA z/OS messages:

```
ISQ900I target-system-name OC IEA101A SPECIFY SYSTEM PARAMETERS
ISQ901I target-system-name OC IEA101A SPECIFY SYSTEM PARAMETERS
```

This message format applies to all processor operations target system messages. It is independent of the target system resource that generated the original message.

The processor operations target system message is sent in the same format as it would be displayed on the processor Support Element (SE) or Hardware Management Console (HMC).

Specifics of VM second level systems:

Messages from guest machine operating system appear in the following format:

```
ISQ900I psm-name.guest-name OC IEA101A SPECIFY SYSTEM PARAMETERS
```

Messages from CP on the virtual machine appear in the following format:

```
ISQ900I psm-name.guest.name OC HCPGSP2627I The virtual machine is
placed in CP mode due to a SIGP initial CPU reset from CPU 00.
```

Messages from the PSM itself appear in the following format:

```
ISQ700I psm-name SC ISQCS0314E Message Handler has failed.
```

Note:

Make sure your consoles issue messages in the format that you expect and write your NetView automation table entries accordingly.

Sample NetView Automation Table Statements

The following message response example presents a request for system parameters when the message ID string contains 'IEA101A':

```
IF      TEXT = . 'IEA101A SPECIFY SYSTEM PARAMETERS'
      & MSGID = 'ISQ900I' .
THEN    EXEC( CMD('ISQI101 ' ) ROUTE ( ONE * ))
        DISPLAY(N) NETLOG(Y);
```

This NetView automation table statement initiates the ISQI101 routine when the message condition is true.

Note: Text within messages may be in mixed case. Be sure your coding accounts for mixed case text.

Message ISQ211I

Some SA z/OS commands attempt to lock and unlock ports. Where an operator owns the lock for a port, the SA z/OS unlock command, ISQXUNL, returns RC=12 associated with message ISQ211I Unable to unlock *target name console*.

In such a case, you have the choice of either using the ISQOVRD command to force an unlock or you may end your automation with a message. Thereafter, you can view your NetView log to find out the reason for the lock of the port.

How to Automate Processor Operations Controlled Resources

Your automation may encounter this message ISQ211I frequently. Attempting to unlock a locked port is not an error condition; however, it may be a sign that the calling command did not succeed. Schedule your automation from messages that indicate positively that a command did not run, not from the ISQ211I message.

Processor Operations Command Messages

Some SA z/OS commands run on the target system. The message returned from these commands indicates only that the support element was told to schedule the operation. Consequently, the operation at the target system may not complete even though the SA z/OS message indicates a successful completion.

SA z/OS acknowledges only that the command was successfully forwarded to the support element. An unsuccessful operation at the target system generates an unsolicited message that the support element forwards to the focal point system in an ISQ900I message. Schedule your automation from the message that positively indicates that a target system operation did or did not complete.

The SINGSAMP SA z/OS sample library contains the PL/I source code for several automation routines that issue responses to selected messages. You can select the response that is most appropriate for your enterprise. You can also use them as models to create your own automation routines. The list in Table 12 summarizes these routines, the messages they respond to, and the responses they issue initially.

Table 12. SINGSAMP SA z/OS Sample Library Routines

SINGSAMP Member	Routine	Description
INGEI120	ISQI120	Responds to the following messages: IEA120A Device ddd volid read, reply cont or wait. IOS120A Device ddd shared (PR volid not read.) the recovery task, reply cont or wait. Issues the following response to the target: CONT
INGEI357	ISQI357	Responds to the following message: IEE357A Reply with SMF values or U. Issues the following response to the target: U
INGEI426	ISQI426	Responds to the following message: \$HASP426 Specify options - subsystem_id. Issues the following response to the target: WARM,NOREQ.
INGEI502	ISQI502	Responds to the following message: ICH502A Specify name for primary/backup RACF data set sequence nnn or none. Issues the following response to the target: NONE
INGEI877	ISQI877	Responds to the following message: IEA877A Specify full DASD SYS1.DUMP data sets to be emptied, tape units to be used as SYS1.DUMP data sets or GO. Issues the following response to the target: GO

How to Automate Processor Operations Controlled Resources

Table 12. SINGSAMP SA z/OS Sample Library Routines (continued)

SINGSAMP Member	Routine	Description
INGEI956	ISQI956	<p>Responds to the following message:</p> <p>IEE956A Reply - ftime = hh.mm.ss, name = operator,reason = (ipl,reason) or u.</p> <p>Issues the following response to the target: U</p>

The SA z/OS automation table entries in the ISQMSG0 member of the SINGNPRM data set include inactive entries that call these automation routines. To incorporate these routines into your automation, do the following:

1. Remove the comments from the corresponding automation table entries for the messages that initiate the automation routines you want to use. If you perform these steps as part of the initial SA z/OS installation, make these changes before you incorporate the SA z/OS entries. If you do this after the initial SA z/OS installation, change the NetView automation table.
2. Code the routines you are using to issue the responses you want.
3. Compile the PL/I source code for the routines you want to use, and link the resulting object code to your PL/I library.
4. Recycle the NetView program to activate the new entries.

For automation processing to occur, each message in the NetView automation table at the focal point system and at each target system must be made available to the system's NetView program. In z/OS, MPF controls message availability to the NetView program. Examine the MPF list member in the SYS1.PARMLIB data set to ensure that the necessary messages are marked for automation. For target systems using other operating systems, check the message suppression facilities used on those systems.

Testing Messages

SA z/OS provides a collection of NetView automation table entries for your SA z/OS configuration. NetView automation table entries are in the AOFCDM member of the SA z/OS SINGNPRM installation data set. When these entries are moved to your NetView automation table, they may need additional editing.

For example, you may already test for a particular message in your production NetView automation table. If you add an entry that tests for that same message, your automation table will not run as you expect. After a match with the test criteria is found, the search of the automation table is aborted. The second NetView automation table statement is not found. Consequently, the message does not drive all of your required actions.

To avoid this, combine entries into a single test condition. This ensures that all required actions are scheduled for all messages. For the following message:

```
IEA320A RESPECIFY PARAMETERS OR CANCEL
```

your NetView automation table may already have the following entry: (**1**)

```
IF      MSGID = 'IEA320A'
THEN   EXEC (CMD('USERJOB')) ROUTE( ONE * ) CONINUE(Y);
```

With SA z/OS installed, the following message appears when forwarded from System z or 390-CMOS processor hardware:

How to Automate Processor Operations Controlled Resources

```
ISQ900I SYS1 OC IEA320A RESPECIFY PARAMETERS OR CANCEL
```

After the SA z/OS entries are added, the NetView automation table includes the following entry:

```
IF      TEXT = . 'IEA320A RESPECIFY PARAMETERS' .
      & MSGID = 'ISQ900I' .
THEN
      EXEC (CMD('ISQI320 ' ) ROUTE( ONE * ) )
      DISPLAY(N) NETLOG(Y);
```

In this case, the first entry satisfies the IF test and the command USERJOB runs (1). The second command, ISQI320, is not scheduled to run because once the message matches a table entry, the autotask stops searching. Combine these two entries into a single entry, such as:

```
IF      TEXT = . 'IEA320A RESPECIFY PARAMETERS' .
      & MSGID = 'ISQ900I' .
THEN
      EXEC(CMD('ISQI320 ' ) ROUTE( ONE * ) )
      EXEC(CMD('USERJOB ' ) ROUTE( ONE * ) )
      DISPLAY(N) NETLOG(Y);
```

When you use the second example, both commands are scheduled.

If your NetView automation table tests the text of SA z/OS messages, the message format must match the character case for which you test. This can be done by requiring all sites to use the same format for their messages, or by duplicating AT entries in uppercase and in mixed formats.

Building the New Automation Definitions

When you are finished using the customization dialog to add message response and automation operator information to the automation policy, you need to build the system operations control files. The complete description of how to build and distribute these files is provided in *IBM Tivoli System Automation for z/OS Defining Automation Policy*.

The SA z/OS build function places the new automation definitions in the data set defined in the Build Parameters panel.

Copy the new automation definitions into the SA z/OS NetView DSIPARM concatenation in the NetView startup procedures, or concatenate it to the NetView DSIPARM data set.

Loading the Changed Automation Environment

To reload the AMC file, automation control file and the AT perform the following actions:

To reload the MPF list, enter the following command:

- From the z/OS console:
SET MPF=xx
- From a NetView console using the MVS prefix:
MVS SET MPF=xx

Where xx is the suffix of the MPF member in the SYS1.PARMLIB data set to load.

To reload the automation manager configuration file, all updated automation control files and the automation tables issue:

Loading the Changed Automation Environment

INGAMS REFRESH

Specify a data set name or an asterisk (*) which means reload the current data set.

Using Pipes and ISQCCMD for Synchronous HW Commands

The System Automation for z/OS Hardware interfaces command, ISQCCMD, available for Processor Operations SNMP connections and with imitations for BCP Internal Interface connections, allows the management and control of processors and logical partitions, as well as hardware activation profiles. When used in automation procedures, ISQCCMD provides an easy-to-use interface to automate processor operations management and configuration tasks.

The following HW commands return all their response information immediately to NetView on command completion and are therefore called *synchronous* commands:

- CCNTL
- CONDATA
- CPCDATA
- GETCLUSTER
- GETISTAT
- GETIINFO
- GETSDGA
- GETSINFO
- GETSSTAT
- ICNTL
- PROFILE
- STPDATA
- TCDATA

For SNMP and BCPii connections, ISQCCMD supports NetView PIPES. On completion of the ISQCCMD command, a PIPE KEEP with the name ISQ.SNMP contains the immediate command response of the HW command that was issued, for example:

```
* ISQCCMD G14 GETSINFO
| ISQ417I GETSINFO STATUS(SUCCESS)
| ISQ900I G14.KEY3 SC AOFA0017 GETSINFO G14 STATUS(OPERATING) PDATA(TYPE(2084)
| ,MODEL(B16),S/N(000020016F7A)) MODE(LPAR) APROF() CPCSNAME(IBM390PS.G14) NAME(G14)
| TSTIME(070825131936)
| ISQ419I ISQCCMD GETSINFO processing on G14 is complete.
* IPSFO PIPE KEEP ISQ.SNMP | CONS
| IPSFO AOFA0017 GETSINFO G14 STATUS(OPERATING)
| PDATA(TYPE(2084),MODEL(B16),S/N(000020016F7A)) MODE(LPAR) APROF()
| CPCSNAME(IBM390PS.G14) NAME(G14) TSTIME(070825131936)
```

In the example above, the HW common command GETSINFO was issued at a NetView console. Embedded in the 'ISQ' messages the response from the hardware is displayed on the console, starting at report ID AOFA0017.

The same information is available if you reference the PIPE KEEP with the name ISQ.SNMP, once the ISQCCMD command completed, as shown in the example, with the content of ISQ.SNMP displayed on the console.

In an automation procedure, this can be coded as shown in the following example:

```

/*ReXX*/
/* Display CPC information using the ISQ.SNMP KEEP */
Arg cpcname
'ISQCCMD 'cpcname' GETSINFO'
If RC = 0 Then Do
  'PIPE KEEP ISQ.SNMP ' ,
  ' | LOC /AOFA0017/ ' ,
  ' | LOC /'cpcname'/ ' ,
  ' | CONS ONLY'
End

```

As an alternative, you can get the immediate ISQCCMD HW responses directly into the PIPE input stream if you use the PIPE NETVIEW stage followed by an EXPOSE TOTRAP stage. In this case, all ISQ messages and the AOFA0017 report data is available for PIPE processing.

```

/*ReXX*/
/* Display CPC information in a PIPE */
Arg cpcname
'PIPE NETV ISQCCMD 'cpcname' GETSINFO' ,
' | EXPOSE TOTRAP ' ,
' | LOC /ISQ90/ , /* takes ISQ901I or ISQ900I */
' | LOC /AOFA0017/ ,
' | LOC /'cpcname'/ ' ,
' | CONS ONLY'

```

Automating Asynchronous Hardware Commands with ISQCCMD and PIPES

The following ISQCCMD hardware commands return two messages to NetView. First a message that the HW command has either been accepted for execution or rejected. Second, if an acceptance message was issued, a completion event message that contains the actual success or failure information of the command is sent asynchronously.

- ACTIVATE
- CBU
- CTRLCONS
- DEACTIVATE
- EXTINT
- LOAD
- OOCOD
- RESERVE
- RESTART
- START
- STOP
- STP
- SYSRESET
- TCM

Automation scripts using the ISQCCMD interface must distinguish between the accepted or rejected response of an asynchronous HW command and the actual command completion information, which may either indicate successful execution or a failure. The asynchronous command completion events from the hardware are made available for message automation and TRAP AND WAIT processing by ProcOps. Application scripts using the ISQCCMD interface can get the Accepted or

Loading the Changed Automation Environment

Rejected responses directly at ISQCCMD termination time. The Accepted response can then be used to wait for the command completion event message.

Member INGEI004 of the SINGSAMP library provides a REXX sample illustrating how asynchronous hardware commands can be automated using ISQCCMD and NetView PIPES, together with TRAP and WAIT.

VM Second Level Systems Support

This feature provides ProcOps support to control and monitor guest machines running under VM.

ProcOps allows an operating system to be IPLed into a processor, amongst other facilities. Such an operating system is VM. Within VM other operating systems can be IPLed as guest machines. Of particular interest are LINUX guest machines, but MVS, VSE and even VM guest machines may be possible. (Lower levels of guest machines are not considered). Previously there was no effective way to enter commands to and receive messages from such a guest target system in order to validate that it had IPLed correctly, or that it is behaving correctly.

With second level guest machine support you can:

- Capture messages issued by the guest machine itself and route these back to the ProcOps process for display or automated processing, or both
- Send commands to the guest machine from ProcOps, either as operator requests or automated actions

Guest Target Systems

The most likely guest machine that is used as a target system is a LINUX system. When a LINUX machine has a secondary user, the secondary user can use CP SEND commands to:

- Issue CP commands to the guest machine
- Log on as a user to LINUX
- Enter LINUX commands (after logging on)

(It is also possible to set up the LINUX system in such a way that LINUX commands can be entered on the VM console without logging on to LINUX.)

The secondary user receives:

- All "boot up messages"
- Responses to CP commands that are run on the guest machine
- Responses to logon and LINUX commands

MVS machines are more complex. When an MVS machine is running, the original VM user first becomes an NIP console and then an MCS console. In these console modes MVS takes over all I/O to and from the console, and MVS messages to it cannot be intercepted by any CP facilities. Hence the SCIF SEND command cannot be used to send commands to MVS, nor can MVS messages to this console be intercepted.

However a "virtual SCLP console" for the guest machine can be used. During the NIP phase of initialization, use of this console can be forced by configuring the guest virtual machine so that it has no usable 3270 consoles. NIP then directs its messages to the guest machine as line mode commands. This is analogous to the

Loading the Changed Automation Environment

stream of messages sent to the Operating System Messages (OSM) window on an HMC by an MVS system running in a logical partition.

Responses to any NIP messages are entered using the CP VINPUT command. Internally this is done when an ISQSEND command is issued to the operator console (OC) of the target system. To ensure that such VINPUT commands are processed correctly, the guest machine must be operating in RUN ON state at this time.

To ensure that RUN ON state is set, a CP SET RUN ON command is sent to all MVS guest machines at the time when the guest machine is started by the PSM.

Once MCS operation is established, important messages requiring operator action are directed to the guest machine. Again, these are analogous to the stream of messages directed to the OSM window of the HMC. Initially, commands cannot be entered to MVS. To do so, it is necessary to enter "Problem Determination Mode". To enter this mode, a VARY CONSOLE(*),ACTIVATE command must be entered. Once this is done:

- All MVS messages that are displayed are routed to the guest machine
- Commands may be entered using the CP VINPUT command.

Problem Determination is not generally recommended.

To enter LINUX commands it is normally necessary to log on to LINUX. This requires a user ID and a password. So, to provide for LINUX commands would require the specification of a user ID and a password to ProcOps, with all the attendant difficulties in the area of security. At present the LINUX system is considered IPL COMPLETE when specified messages have appeared. These do not require a user logon.

VM machines may also be guest machines. Third level guest machines are not supported.

VSE machines may also be guest machines.

Customizing Target Systems

LINUX

The LINUX target system should have in its VM Directory entry, a CONSOLE statement that sets its PSM as its default secondary user. For example, if the virtual machine LNXAO1 is controlled by a PSM running in virtual machine ISQPSM1, then its CONSOLE statement might be:

```
CONSOLE 009 3215 T ISQPSM1
```

When a LINUX target system is to be deactivated a FORCE command is used to shut it. The default guest signal timeout interval values (set by the SET SIGNAL command) and values defined for the guest machine determine the interval used when allowing the LINUX system to shut in an orderly fashion. If this function is required for a guest, you must ensure that this is set accordingly.

Such actions may include updating the etc/inittab entry on the LINUX system itself, and setting up a SHUTTRAP module on the VM host.

MVS

This too should have a CONSOLE statement in its VM directory entry that defines its PSM as its secondary user:

Loading the Changed Automation Environment

```
CONSOLE 01F 3270 T ISQPSM1
```

It should also IPL a CMS system as its initial action. Once this CMS system is IPLed it should run a PROFILE EXEC that includes the statements similar to the following:

```
SET RUN ON
DETACH 01F
IPL 7700
```

The SET RUN ON is needed so that when a response is to be sent to a NIP console the VINPUT command used is effective.

The DETACH is used so that when the MVS system IPLs it finds none of its defined 3270 consoles available to it. (You should also ensure that no user issues a VM DIAL to an address that is defined as a NIP or MCS console.)

The IPL command is used to IPL the MVS system.

The MVS system itself should have included in its active CONSOLxx definition a CONSOLE statement for the SYSCONS so that commands can be entered to MVS after it is IPLed, for example:

```
CONSOLE DEVNUM(SYSCONS)
        ROUTCODE(ALL)
        AUTH(MASTER)
        MSCOPE(*)
        CMDSYS(*)
        UD(Y)
```

VM

This too should have a CONSOLE statement in its VM directory entry that defines its PSM as its secondary user:

```
CONSOLE 01F 3270 T ISQPSM1
```

It should also IPL a CMS system as its initial action. Once this CMS system is IPLed it should run a PROFILE EXEC that includes the statements similar to the following:

```
SET RUN ON
DETACH 01F
IPL 7700
```

The SET RUN ON is needed so that when a response is to be sent to a console the VINPUT command used is effective.

The DETACH is used so that when the VM system IPLs it finds none of its defined 3270 consoles available to it. (You should also ensure that no user issues a VM DIAL to an address that is defined as a Operator Console)

The IPL command is used to IPL the VM system.

The VM system itself should include within its OPERATOR_CONSOLES statement in the SYSTEM CONFIG file (which resides on the "parm disk") a specification for the emulated system console, for example:

```
OPERATOR_CONSOLES 01F 020 System_Console
```

This ensures that when VM IPLs and finds no regular consoles available, it then uses the emulated system console. This in turn directs the messages to the secondary user as a stream of line-mode messages.

VSE

This too should have a CONSOLE statement in its VM directory entry that defines its PSM as its secondary user:

```
CONSOLE 01F 3270 T ISQPSM1
```

It should also IPL a CMS system as its initial action. Once this CMS system is IPLed it should run a PROFILE EXEC that includes the statements similar to the following:

```
TERM CONMODE 3215  
IPL 7700
```

The TERM CONMODE 3215 command sets the console into line mode.

Chapter 8. How to Automate USS Resources

This chapter describes how z/OS UNIX System Services are integrated into SA z/OS, how to set up z/OS UNIX automation, and provides tips about using z/OS UNIX automation.

Note

USS tasks behave differently when started as STCs rather than directly in the USS environment.

When a USS task is started as an STC, the starting user ID may differ so that, in most cases, the AOFUXMON monitor routine is not able to internally trigger ACTIVMSG UP=YES.

In this case it is much simpler for SA z/OS to start these applications with INGUSS. An AT entry is then not required for the UP message. SA z/OS is able to internally simulate this so that you do not have to worry about UP messages.

Job names (that is, the last character of the job name) are not predictable for USS resources. However, AOFUXMON is able to handle this by monitoring the path within USS and changing the defined job name in SA z/OS accordingly.

For the syslog daemon you would define the job name as SYSLOGD. When the application is started and changes the job name to, say, SYSLOGD7, AOFUXMON adjusts the SA z/OS data model to reflect this. However, this cannot be handled in the AT with a generic entry for SYSLOGD*. This is because the change in the job name is caused by the USS process that creates a new address space with a new name, so that the old address space with the old name terminates. This means that you get an ended message for the old address space and an UP message for the new address space. The sequence of these messages is also unpredictable.

Integration of z/OS UNIX System Services

The following functions are supported by SA z/OS for z/OS UNIX applications:

- Starting and stopping of applications
- Monitoring of:
 - Processes (represented by the command or path and user ID)
 - TCP Ports
 - Files and file systems
 - Generic User Monitoring (the user supplies a z/OS UNIX monitoring routine or script)
- Using an API to execute z/OS UNIX commands (INGUSS command)

Infrastructure Overview

The z/OS UNIX resources that should be automated must run in the z/OS UNIX of a z/OS system that is already automated by SA z/OS. From the automation manager's perspective the NetView agent of this system is responsible for the z/OS UNIX resources.

For command execution through INGUSS or user-defined monitoring, a z/OS UNIX program (provided by SA z/OS) is directly invoked by SA z/OS. This program (ingcmd) executes UNIX commands and runs when started by SA z/OS with the jobname INGCUNIX. The ingcmd program is the extension of the NetView-based agent into z/OS UNIX. To monitor the standard z/OS UNIX resources (processes, ports, or files) an internal SA z/OS routine is started.

When monitoring of the USS process indicates that it is down, its status is updated to AUTODOWN. However, because it may take some time before a USS process has ended (that is, to clean up the resources that it had acquired), monitoring is repeated after a cleanup delay. If you define your own USS processes, you should specify a suitable cleanup delay using the APPLICATION INFO policy item. Consider using an application class if you need to define several processes.

Setting Up z/OS UNIX Automation

Customization of z/OS UNIX Resources

z/OS UNIX resources are introduced to SA z/OS by defining them in the SA z/OS customization dialogs.

The customization dialogs support the application type USS. If USS is selected, you can enter z/OS UNIX-specific data such as a UNIX user ID, command or path, filename, or monitored port. Choose one of these fields to enter the data.

The start and stop definitions can be varied between MVS and z/OS UNIX commands. For example, to stop an application you can issue a UNIX kill command first and (if this was not successful) you can perform an MVS cancel later.

Definitions for Automation Setup

The HFS path where the program shipped with SA z/OS is located must be defined in the SA z/OS setup panel. When user-defined UNIX monitoring is used and no absolute path is specified for the monitoring routine, SA z/OS tries to start the user-defined monitoring routine in this directory.

Definitions for z/OS UNIX Resources

To define a new application entry (APL, class, or instance), specify the application type USS on the Define New Entry panel. When choosing the application type USS, the option USS Control is displayed on the Policy Selection panel.

Select USS Control on the Policy Selection panel to enter the data for the new z/OS UNIX resource. You can specify only the user ID and the z/OS UNIX monitoring routine for a class on this panel. All other definitions (for example, from/to, dependencies, etc.) can be entered as usual. For more details about this panel, see *IBM Tivoli System Automation for z/OS Defining Automation Policy*.

USS applications must be defined with a HASPARENT relationship to JES.

Use the USS Control Specification policy item for an object of type INSTANCE to define the resource as a:

Process

Enter the path of the command that is running (as shown by the UNIX command `ps -e`) in the **Process Command/Path** field.

TCP port

Enter the TCP port number that the resource is to listen to on the local host in the **Port Number** field.

File Enter the path of a file in the HFS in the **File Name** field.

Often the command/path specification, especially for Java™ processes, is not unique. The Filter field allows you to uniquely identify the USS process if this is not possible.

There are two methods of monitoring USS applications:

- The *standard* method is to specify the monitoring routine AOFUXMON in the APPLICATION INFO policy item, which is called by SA z/OS for UNIX System Services resources.
- If you choose to use your own script or program in the HFS, this is called by AOFUXMON. You must then specify the script or program in the **Monitoring Command** field of the USS CONTROL policy item, and you must also specify AOFUXMON in the APPLICATION INFO policy item.

If this program does not begin with a forward slash (/) it must reside in the same directory as the z/OS UNIX `ingcmd` routine that is supplied by SA z/OS. Otherwise the name specified is considered to be an absolute path identifier.

The UNIX monitoring routine must have an exit value. It can be one of the following:

- 0 Resource is available
- 4 Resource is starting
- 8 Resource is unavailable
- 12 Error occurred

If the user-specified monitoring routine loops, it receives a SIGKILL after the AOFUSSWAIT time (defined in the NetView stylesheet).

Hint:

It is possible to write a message from this UNIX monitoring routine to the MVS system log, in order to trigger an action or perform a status change through the NetView Automation Table (AT).

The monitoring routine AOFUXMON must be specified, otherwise the default monitoring routine (usually INGPJMON) is called, which is not sufficient for z/OS UNIX resources.

The **Job Type** field can be either MVS or NONMVS:

- MVS** Is only used for resources that represent a process with a unique jobname. For these resources SA z/OS accepts the following messages for status changes:
- IEF403I Job started

Setting Up z/OS UNIX Automation

- IEF404I Job ended
- IEF450I Job abended

If no start command is specified, the default MVS start method (s <JOBNAME>) is used.

NONMVS

SA z/OS ignores the messages listed above for status changes. This is necessary if the job name is not unique.

For z/OS UNIX resources the Start Delay interval that has been defined begins when SA z/OS issues a start command for an application. SA z/OS is informed by z/OS that the resource that is to be monitored has started. This results in the USS resource being set in the status ACTIVE. After the first start delay interval and successful monitoring, the ACTIVMSG command is triggered, which sets the agent status to UP. The default value for the Start Timeout is 2 minutes.

If you set the **Skip ACTIVE status** field in the APPLICATION INFO policy item to YES, the resource is immediately set to UP when SA z/OS is informed by z/OS that the process is running.

For application shutdown, SA z/OS is informed by z/OS as soon as the process has ended. At this point, SA z/OS immediately sets the resource into the AUTODOWN status.

As a result of this behavior you should carefully consider how you set the following parameters in the APPLICATION INFO policy item, either for the application or at the class level:

- Start Delay
- Start Cycles
- Skip ACTIVE status
- Shutdown Pass Interval
- Cleanup Delay

For more information, see the *USS best practices policy.

Automated Resources

Process Monitoring: No UNIX process identifiers (PIDs) can be monitored. The monitoring routine needs the start command and the user ID that the process belongs to. This information can be obtained with the UNIX command `ps`. In the following example all processes that belong to the user USER are displayed:

```
USER:/u/user/ingcmd>ps -e
      PID COMMAND
33554481 /bin/sh
50331698 /usr/sbin/rlogind2
33554486 /usr/lpp/netview/bin/cnmeunix
67108927 /bin/sh
83886176 /bin/ps
33554821 /usr/sbin/inetd
83886472 FTPD
67109276 /bin/sh
16777629 /usr/sbin/rlogind2
33554924 HSAPYTCP
```

This means that automation could not distinguish between the two processes started by `/usr/sbin/rlogind2`. Processes started by identical commands must have different user IDs.

Alternative 1: If it is necessary to automate processes running multiple instances, a user could use softlinks to distinguish between the different processes. For example, the process:

```
/u/user/usstest/testme
```

should be started more than once. In this case, create some softlinks:

```
USER:/u/user/usstest> ln -s testme test1
USER:/u/user/usstest> ln -s testme test2
```

This results in:

```
USER:/u/user/tt>ls -al
total 216
drwxrwxr-x  2 USER    DE#03243   8192 Jan 24 16:24 .
drwxr-xr-x 19 USER    DE#03243   8192 Jan 24 16:23 ..
lrwxrwxrwx  1 USER    DE#03243     6 Jan 24 16:24 test1 -> testme
lrwxrwxrwx  1 USER    DE#03243     6 Jan 24 16:24 test2 -> testme
-rwxrwxr-x  1 USER    DE#03243  94208 Jan 24 16:23 testme
```

These three programs (being the same "real" program) can be automated with the three different start commands `test1`, `test2`, and `testme`. These links may be created as a prestart command and deleted as a shutoff command.

Note: Only the command is used, not the parameters that were used to start the program. This is because a program may be started by SA z/OS with different startup parameters, depending on what the automation manager told the automation agent to do. In this case, the only constant value is the command, not the parameters.

Alternative 2: The same program can run in parallel several times by using different startup parameters (like Java programs). In this case it is inefficient to automate these processes as described above. Java programs run in a Java environment and are visible as Java processes, for example:

```
# ps -e
      PID TTY          TIME CMD
50331734 ?           5h24 .../V6R1/AP/AppServer/java/bin/java
83886173 ?           1:44 .../V6R1/AP/AppServer/java/bin/java
60341724 ?           2h36 .../V6R1/AP/AppServer/java/bin/java
73392173 ?           1:02 .../V6R1/AP/AppServer/java/bin/java
```

It is impossible in this case to distinguish and evaluate the process that should be monitored.

The command `ps -ef` shows the same processes (for example, programs running in a Java environment), without the fully-qualified Java path but with a parameter chain that is used for startup.

```
#ps -ef
      UID          PID PPID  C   STIME TTY   TIME CMD
EEZDMN  50331734    1   -   Jun 27 ?     5h25 java -Djava.util.logging.configureByServer=true
EEZDMN  83886173    1   -   Jun 27 ?     1:44 java -Dcom.ibm.eez.adapter.debug=true
EEZDMN  60341724    1   -   Jun 27 ?     2h36 java -Djava.util.logging.manager=connect
EEZDMN  73392173    1   -   Jun 27 ?     1:02 java -Djava.security.auth.login.config=/etc/security.conf
```

Mapping the output of both commands using the matching PID, a unique process can be evaluated and monitored. The process that is distinguished is then:

Setting Up z/OS UNIX Automation

```
/SYSTEM/local/WebSphere/V6R1/AP/AppServer/java/bin/java  
-Djava.util.logging.configureByServer=true
```

Where the data that is specified in the UNIX Control Specification panel in the **Process Command/Path** field is `/SYSTEM/local/WebSphere/V6R1/AP/AppServer/java/bin/java` and in the **with Filter** field is the filter `-Djava.util.logging.configureByServer=true`.

If the USS program has the sticky bit set, the MVS load is performed using the symbolic link name. For example, running two instances of `syslogd` requires the usage of a symbolic link, for example, `/tmp/syslogd`. A separate `/tmp` directory must be used so that the same name (`syslogd`) can be created.

TCP Port Monitoring: Exactly one TCP port number can be entered for one resource. SA z/OS monitors the local host as returned by the function `gethostid()`. When this port has a state of 'listening,' this resource is considered to be 'available' in terms of SA z/OS. All other states of the port map to 'unavailable.'

No user ID is required for definitions.

File or File-System Monitoring: The existence of a file (belonging to a certain user) is verified. Many applications create files at startup and delete these files when terminating normally. If more than one file should be monitored, this can be modeled as an application group (APG) in the automation manager.

This monitoring can be used to determine if a certain file system is mounted. The start command for this resource would be a UNIX 'mount' command, the stop command a UNIX 'umount'.

Start and Stop Definitions (INGUSS Command)

If the resource is to be controlled by traditional MVS commands, this could be done in the same way as for all other MVS applications. Issuing commands in the z/OS UNIX environment is done by specifying the INGUSS command in the start or stop definitions for the resource.

To issue commands in the USS environment use the INGUSS command (for more details see *IBM Tivoli System Automation for z/OS Programmer's Reference*).

Note: INGUSS can only be used if the primary JES is available. Therefore, z/OS UNIX resources using INGUSS need a HASPARENT dependency to JES. Most z/OS UNIX applications have this dependency. If you want to issue prestart commands, an additional PREPAVAILABLE dependency is necessary.

z/OS UNIX and MVS commands can be mixed in different shutdown passes.

Command Examples:

Start Command for a Process: To start a process with the command and job name specified in the customization dialogs, enter `INGUSS JOBNAME=&SUBSJOB &SUBSPATH &SUBSFILTER` in the **Command Text** field on the Startup Command Processing panel of the STARTUP policy item of the resource.

Only the command that was used to start an application or a process can be monitored. If the same program is to be started multiple times, a softlink as prestart command could be used to distinguish the processes.

Use a Softlink to Distinguish Processes That Run the Same Executable File as a Prestart Command: To create a softlink for &SUBSPATH (the path parameter of the resource issuing the command, for example, /u/user1/uss1) and link to the file /u/user1/usstest, enter the following command in the **Command Text** field on the PRESTART Command Processing panel:

```
INGUSS /bin/ln -s /u/user1/usstest &SUBSPATH
```

When looking at the HFS, this results in:

```
USER1:/u/user1>ls -l
total 408
lrwxrwxrwx  1 USER1  DE#03243      7 Feb 13 12:44 uss1 -> usstest
-rwxrwxr-x  1 USER1  DE#03243  163840 Jan 29 14:55 usstest
```

Stop Commands for a Process: A z/OS UNIX process may be stopped in different ways (using escalation passes). For example, you can first use the z/OS UNIX kill command, if that does not work use z/OS UNIX kill -9, and finally enter an MVS cancel command.

Enter the definitions for this example as shown in Figure 11 on the Command Processing panel for the normal shutdown phase of the resource (via its SHUTDOWN policy item).

Cmd	Ps	AutoFn/*	Command Text
1			INGUSS /bin/kill &SUBSPID
3			INGUSS /bin/kill -9 &SUBSPID
4			MVS C &SUBSUSSJOB,A=&SUBSASID

Figure 11. Stop Definitions for a Process

&SUBSPID is replaced at run time by the real PID of the process.

Stop Command for a File: A stop command for a file may be deleting the file. The file name entered in the customization dialogs can be found in &SUBSFILE, as shown in Figure 12.

Cmd	Ps	AutoFn/*	Command Text
1			INGUSS /bin/rm &SUBSFILE

Figure 12. Delete a File

Example: inetd

The inetd is the UNIX internet daemon. It allows you to invoke several others and it should be started at IPL time (normally through OMVSKERN with /etc/rc). It then listens for connections on certain internet sockets. Its configuration file is /etc/inetd.conf

The following is a sample inetd configuration file:

```
login    stream  tcp    nowait  OMVSKERN  /usr/sbin/rlogind rlogind -m
exec     stream  tcp    nowait  OMVSKERN  /usr/sbin/orexecd orexecd -d
otelnets stream  tcp    nowait  OMVSKERN  /usr/sbin/otelnets otelnets -k -t
daytime  stream  tcp    nowait  OMVSKERN  internal
time     stream  tcp    nowait  OMVSKERN  internal
netbios-ssn stream tcp    nowait  OMVSKERN  /local/samba/bin/smbd smbd
```

When a service request is detected at one of its sockets, it decides what service the socket corresponds to and invokes a program to service the request. Then it normally continues to listen on the socket the last request came in at (see Figure 13 on page 100)

Setting Up z/OS UNIX Automation

on page 100) .

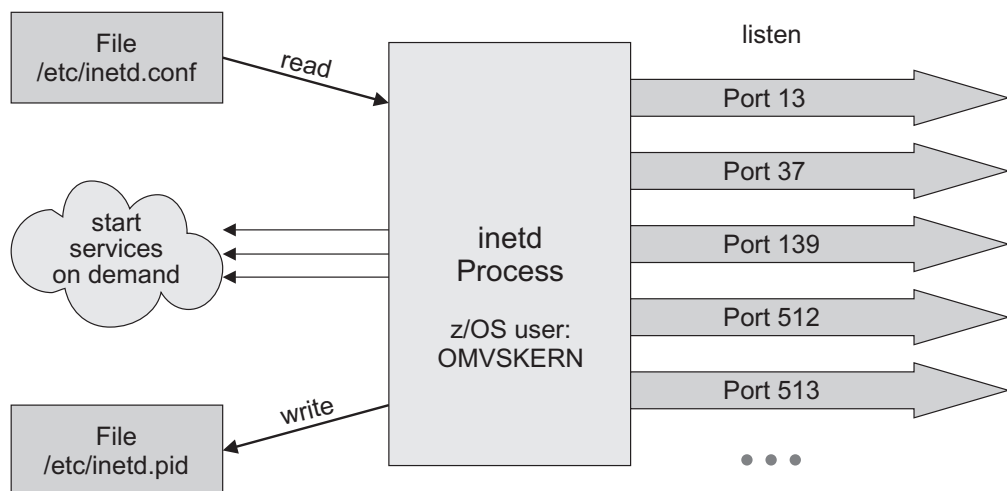

Figure 13. Structure of inetd

To check whether the internet daemon has been started, issue the `ps -e` command:

```
USER:/u/user/ingcmd>ps -e
      PID COMMAND
      33554481 /bin/sh
      50331698 /usr/sbin/rlogind2
      33554486 /usr/lpp/netview/bin/cnmeunix
      67108927 /bin/sh
      83886176 /bin/ps
      33554821 /usr/sbin/inetd
      83886472 FTPD
      67109276 /bin/sh
      16777629 /usr/sbin/rlogind2
      33554924 HSAPYTCP
```

This shows the process ID (PID) for the inetd process.

The `ps -ef` command supplies further parameters to identify the process referenced as **Filter**, for example:

```
# ps -ef | grep inetd
      UID      PID      PPID C  STIME  TTY  TIME CMD
      OMVSKERN 3554821 1    - Jun 30 ?   0:00 /usr/sbin/inetd /etc/inetd.conf
```

From this output, set the Filter as `/etc/inetd.conf`.

Next find out the z/OS user ID that the process is running on by issuing the following z/OS command and locating the user ID in the first column where the process ID (PID) is listed:

```
D OMVS,A=ALL
RESPONSE=SYS1
BPX0040I 17.11.01 DISPLAY OMVS 789
OMVS 000E ACTIVE OMVS=(00)
USER  JOBNAME ASID      PID      PPID STATE  START  CT_SECS
...
OMVSKERN INETD1 009F 33554821 1 1FI--- 19.23.26 .081
LATCHWAITPID= 0 CMD=/usr/sbin/inetd /etc/inetd.conf
```

The inetd that is started with the configuration file above listens on the following sockets:

```

USER:/etc>netstat -a | grep INET
INETD1  00006B80 0.0.0.0..13          0.0.0.0..0          Listen
INETD1  00006B7D 0.0.0.0..513         0.0.0.0..0          Listen
INETD1  00006B7E 0.0.0.0..512         0.0.0.0..0          Listen
INETD1  00006B7F 0.0.0.0..623         0.0.0.0..0          Listen
INETD1  00006B82 0.0.0.0..139         0.0.0.0..0          Listen
INETD1  00006B81 0.0.0.0..37          0.0.0.0..0          Listen
    
```

Whereas the services and the real port numbers correspond according to /etc/services:

```

daytime    13/tcp      #Daytime
time       37/tcp      timservr   #Time
netbios-ssn 139/tcp     #NETBIOS Session Service
exec       512/tcp     #remote process execution;
login      513/tcp     #remote login a la telnet;
otelnets   623/tcp     #OE telnet
    
```

You can define the UNIX internet daemon (inetd) using the fields of the USS Control policy item for applications (APLs) of type USS in the customization dialogs with, for example, the data in Table 13.

Table 13. Example Customization Dialog Definitions for inetd

	Process	File	Port
Application Name*	INETD/APL	INETFILE/APL	INETPORT/APL
User ID	OMVSKERN	OMVSKERN	OMVSKERN
Process Command/Path	usr/sbin/inetd		
Filter	/etc/inetd.conf		
File Name		/tmp/inetd.pid	
Port Number			513
* This is the name that was specified for the applications when they were created.			

Define a basic group containing all resources with relationships that indicate that:

- The file is created by the inetd process and can never be started or created directly by SA z/OS.
- The inetd process listening on the port can never be started or created directly by SA z/OS.

Setting Up z/OS UNIX Automation

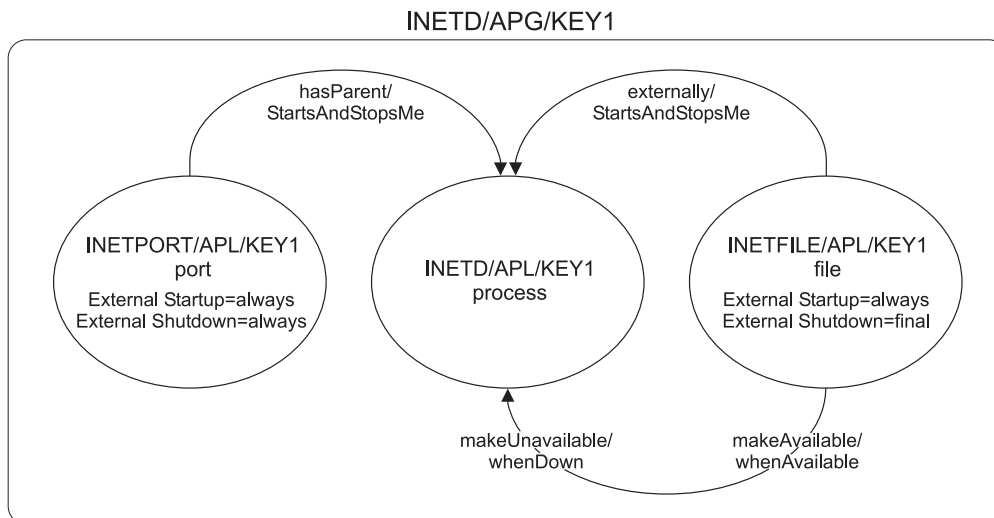

Figure 14. Dependency Graphic for inetd

The example in Figure 14 recognizes the inetd (modeled as a group) as up and running when the process /usr/sbin/inetd started by user OMVSKERN shows up, the file /tmp/inetd.pid exists, and port 513 is in the status 'listen' (inetd listens to this port for incoming login requests).

You can only choose a port that is defined in inetd/conf.

Start definition for INETFILE/APL

None.

Start definition for INETPORT/APL

None.

Start definition for INETD/APL

CMD: INGUSS JOBNAME=&SUBSJOB &SUBSPATH &SUBSFILTER

(&SUBSFILTER is substituted at run time by the parameter command/path.)

Stop definitions for INETFILE/APL

CMD: INGUSS /bin/rm &SUBSFILE

(This removes the file if it has not yet been removed by the inetd process.)

Stop definition for INETPORT/APL

None.

Stop definitions for INETD/APL

CMD: INGUSS /bin/kill &SUBSPID

CMD: INGUSS /bin/kill -9 &SUBSPID

CMD: MVS C &SUBSUSSJOB,A=&SUBSASID

&SUBSPID is replaced by the z/OS UNIX command routine with the real PID that matches the parameter's command/path and user ID. In the example in this section, this is 33554821:

```
USER:/u/user/ingcmd>ps -e
  PID COMMAND
 33554481 /bin/sh
 50331698 /usr/sbin/rlogind2
 33554486 /usr/lpp/netview/bin/cnmeunix
 67108927 /bin/sh
 83886176 /bin/ps
```

```

33554821 /usr/sbin/inetd
83886472 FTPD
67109276 /bin/sh
16777629 /usr/sbin/rlogind2
33554924 HSAPYTCP

```

SA z/OS provides the *USS best practices policy that provides definitions for several automated USS daemons, such as inetd.

Hints and Tips

Trapping UNIX syslogd Messages

To trap UNIX syslogd messages, an entry must be added to the syslogd configuration file `/etc/syslog.conf` in order to forward the messages to the MVS system log. Thus, messages can be processed by the NetView automation table (AT).

To forward all messages to the MVS log add the following entry:

```
*.* /dev/console
```

To send special messages to the MVS log only, follow the syslog message naming guidelines (for example, for warning messages use `*.warn`). You can use `/dev/console` as an ordinary file to write to.

To test this, issue the following UNIX command from a USS console:

```
echo 'This is a test message' >>/dev/console
```

The UNIX messages have the MVS message ID BPXF024I and are multiline messages.

Figure 15 shows an example of the output of the UNIX command in the system log.

```

M 13:45:21.34 STC03602 00000090 BPXF024I (USER) Feb 13 13:45:21 SYS1 syslogtest 67109100 : This is
S                               498
D                               498 00000090 a test message

```

Figure 15. Example of a UNIX Message

Debugging

Debugging can be activated for z/OS UNIX monitoring and command execution on the AOCTRACE panel. The automation procedure for monitoring is AOFUXMON and for command execution AOFRSUSS.

Turning on debugging for AOFRSUSS implicitly turns on debugging for `ingccmd` (the SA z/OS command server).

The debugging messages are written to the netlog and to the z/OS UNIX system log (syslogd).

Hints and Tips

Chapter 9. How to Enable Sysplex Automation

This chapter describes enhancements to Parallel Sysplex[®] automation, how to use the SA z/OS customization dialogs to enable them, and how to customize your system.

Note: If you use a host code page other than 037, the hexadecimal representation of the at sign (@) can be different. Use the letter represented by the hex code X'7C' for the at sign.

Sysplex Functions

The following functions are described:

- “Managing Couple Data Sets”
- “Managing the System Logger” on page 106
- “Managing Coupling Facilities” on page 107
- “Recovery Actions” on page 109
- “Hardware Validation” on page 113

Managing Couple Data Sets

Couple data sets (CDSs) contain control information about the sysplex and its resources, and are of crucial importance for the functioning of a Parallel Sysplex. Particularly important are the SYSPLEX couple data set, which contains information about the systems and the communication structure (XCF groups) of the sysplex, and the CFRM couple data set, which specifies its coupling facilities (CFs) and structures (see “Managing Coupling Facilities” on page 107). Every MVS system in a Parallel Sysplex must have access to these CDSs, and to those of all other implemented sysplex functions, such as SFM and Application Response Measurement (ARM).

If a member system cannot access a CDS, the corresponding sysplex function is impacted, and in some cases the sysplex goes down. It is therefore recommended that you define two CDSs to XCF for every CDS type required for the implementation of the sysplex. One of these, the *primary* CDS, is the one that is actually used. The other, which is called the *alternate* CDS, serves as a backup copy. The two CDSs contain the same data. Whenever the primary CDS changes, XCF updates the alternate CDS accordingly. If an alternate CDS is available for a certain type, XCF automatically switches to this alternate CDS whenever a member can no longer access the primary CDS.

All CDSs except the sysplex couple data set contain one or more user-defined configurations, called *policies*. For each CDS type, only one policy can be active. However, it is possible to switch the active policy at run time. Refer to *IBM Tivoli System Automation for z/OS Operator's Commands* for further information about the INGPLEX command.

SA z/OS offers two functions for easier CDS management:

- Automated creation and recovery of alternate couple data sets for continuous availability
- INGPLEX CDS, which simplifies management of couple data sets

Managing Couple Data Sets

Ensuring Continuous Availability of Couple Data Sets

When an alternate CDS exists for a given CDS type and the current primary CDS fails, XCF makes this alternate the primary CDS. After this switch, however, an alternate CDS no longer exists, and if the current primary CDS also fails, the problems that were to be avoided by the creation of an alternate occur again. To avoid this single-point-of-failure situation, SA z/OS provides a recovery mechanism that tries to ensure that an alternate CDS is always available for every CDS type used.

SA z/OS creates a new alternate CDS in the following two situations:

- During initialization, SA z/OS checks that an alternate CDS is specified for every primary CDS. If there is a primary CDS for which no alternate CDS exists, SA z/OS automatically creates it.
- At run time, SA z/OS ensures that a new alternate is created whenever the current alternate has been removed or switched to the primary one.

Customization

Recovery of alternate CDSs is initiated either by the CDS function of INGPlex or in the background (for example, at initialization time). Background recovery can be switched on and off by using the SA z/OS customization dialogs. Automatic re-creation with INGPlex CDS is always enabled.

You must specify the spare volumes that SA z/OS may use for creating missing alternate CDSs (using the policy item SYSPLEX from the Policy Selection panel for sysplex groups). This is also required for automatic creation with INGPlex CDS. Every CDS type has its own pool of spare volumes. Note that if you do not define spare volumes for a CDS type, no recovery is performed for this type. For details on the use of the customization dialogs, see “Enabling Continuous Availability of Couple Data Sets” on page 116.

You can control access to those functions of INGPlex CDS that modify the sysplex configuration. Refer to Appendix A of *IBM Tivoli System Automation for z/OS Planning and Installation* for details.

Managing the System Logger

Terms and Concepts

The *system logger* provides a sysplex-wide logging facility. Applications that use the system logger write their log data into *log streams*. Within a Parallel Sysplex, these log streams are usually associated with a coupling facility structure. For further information about coupling facility structures, refer to “Managing Coupling Facilities” on page 107. By using a coupling facility log stream, members of a multisystem application can merge their logs even when residing on different systems.

When an application writes data to a log stream this data is stored at first temporarily in the associated structure (coupling facility log stream) or a local buffer (DASD-only log stream). From there, it is off-loaded into a log stream data set which is automatically allocated by the system logger. When this log stream data set is full, the system logger allocates a second one, and so on.

The control information for the system logger, which includes a directory for the log stream data sets of every log stream, is contained in the LOGR couple data set. The total number of log stream data sets that can be allocated by the system logger is determined when the LOGR couple data set is formatted.

Two problems that can arise in connection with the log stream data sets are a shortage of directory space in the LOGR CDS and incorrect share options for the log stream data sets. SA z/OS provides the following recovery actions for these problems:

- The primary and alternate LOGR CDSs are automatically re-sized if there is a directory shortage
- The operator is notified if the share options for log stream data sets are not defined correctly

Resizing the LOGR Couple Data Sets in Case of Directory Shortage

The LOGR CDS contains information about the log stream data sets used by the system logger. This information is stored in *directory extents*. Every directory extent record can hold information about up to 168 log stream data sets. The number of directory extents available in a LOGR CDS is specified when the CDS is formatted (DSEXTENT parameter). When all available directory extents are used up the system logger can no longer allocate new log stream data sets. This can cause considerable problems for applications that use the system logger.

With SA z/OS, you can avoid this situation. If you switch on logger recovery, SA z/OS automatically reformats your primary and alternate LOGR CDS with an increased DSEXTENT parameter whenever the system reports a directory shortage.

Customization

Automation of system logger recovery is enabled through the SA z/OS customization dialogs. For more details, see “System Log Failure Recovery” on page 162.

Managing Coupling Facilities

A *coupling facility* (CF) is a logical partition that provides storage for data exchange between components of an application that is distributed across different systems in a Parallel Sysplex. A Parallel Sysplex can contain more than one CF. The storage of a coupling facility is divided into areas that are called *structures*. You can imagine a structure as a special kind of data set. It is these structures, which are identified by their name, that are accessed for reading and writing by the application components.

The association between CFs and structures is dynamic. A structure that is used by an application need not be allocated at all (for example, when the application is not running), and can be allocated on different CFs at different points in time. For every structure, there exists a *preference list* that defines the CFs on which it may be allocated. The order of the CFs in that list determines which CF is selected when more than one member of the list satisfies all allocation requirements (for example, provides enough space).

The preference list, the space requirements, and other properties of the structures are defined in the active CFRM policy. This policy is contained in the CFRM couple data set. Refer to “Managing Couple Data Sets” on page 105 for further information.

XES allocates a structure that does not yet reside on any CF when an application component needs to be connected to it. Note that the application component only specifies the name of the structure that it wants to access. It is XES that decides on which CF the structure is allocated. This decision is influenced by the structure definition in the active CFRM policy. After the structure has been allocated, the

Managing Coupling Facilities

requesting application component can access it, and further components of this application can require to connect to it. An application component that has access to an allocated structure is referred to as an *active connector* to this structure.

In the simplest case, XES deallocates a structure when all connected application components have disconnected from the structure. However, an application component can require that the structure or its own connection to the structure be *persistent*. When the *structure* is persistent it remains allocated even when the application component is no longer connected to it. When a *connection* is persistent the structure remains allocated after a failure of that connection. The application component in question remains a connector to the structure, although not an active one. It is now a *failed persistent* connector. In both cases, you can force the deallocation of the structure as soon as it no longer has active connectors.

Allocated structures can be *rebuilt*. Rebuilding is the process of reconstructing a structure on the same or another CF. A rebuild consists of three main steps. First, XES allocates the new structure instance. Then, the data of the old structure is reconstructed in the new structure. Finally, XES deallocates the old structure instance. Note that you cannot specify the target CF in your rebuild request. As with structure allocation, XES selects it from the preference list.

There are two methods for rebuild: user-managed and system-managed. With user-managed rebuild, the active connectors are responsible for reconstructing the data. With system-managed rebuild, XES transfers the data to the new structure instance. System-managed rebuild is thus also available for structures without active connectors. These structures can either themselves be persistent or have failed persistent connections.

When an application component connects to a structure, it specifies whether it allows the structure to be rebuilt through user-managed or system-managed rebuild. For structures with active connectors, both rebuild methods require that all active connectors allow the respective rebuild method.

You can also *duplex* structures. Duplexing means maintaining two instances of the same structure on different CFs at the same time. Duplexing serves to increase availability and usability of a structure.

Typical management tasks for CFs are removing a CF from the sysplex and reintegrating it again. These tasks have several steps that must be performed in a certain order and can be quite complex. To simplify these operations, SA z/OS offers the INGCF command. INGCF has several functions, which serve to manipulate structures and the CFs themselves. For more information, see *IBM Tivoli System Automation for z/OS Operator's Commands* and the online help.

Some functions deal with the sender paths of a coupling facility. They have the following limitations. First, at least one system in the sysplex that is running the automation must know the control unit ID (CUID) of the coupling facility. If this is not the case, no missing sender paths can be resolved.

A missing sender path occurs when a coupling facility is deactivated prior to a system IPL (or reIPL) and then activated afterwards. The system that has been IPLed (or reIPLed) does not recognize the coupling facility. To determine the missing sender paths, the automation calls the HOM interface of HCD. Resolving the missing path information is only possible when either the complete network address is defined in HCD along with the processor ID, or you provide the CPC

synonym used by the automation as the processor ID. However, it is recommended that you define both. If neither is defined, the system that misses the sender paths must run the automation.

Recovery Actions

Resolving WTO(R) Buffer Shortages

When all WTO(R) buffers are in use, it is possible that commands can no longer be processed. To resolve this, there are several options: you can extend the buffer, change the properties of the affected consoles, or cancel jobs that issue WTO(R)s.

SA z/OS provides recovery of buffer shortage in two stages. It first tries to extend the buffer and modify the console characteristics, if applicable. If this does not help, it then cancels jobs that issue WTO(R)s. You must specify which jobs can be canceled by SA z/OS if there is a buffer shortage.

Customization: Automation of buffer shortage recovery is enabled using the SA z/OS customization dialogs. For more information, see “Enabling WTO(R) Buffer Shortage Recovery” on page 117.

Handling Long-Running Enqueues (ENQs)

This type of recovery is divided into the following individual functions:

- Long-running enqueue recovery
- "Hung" command recovery
- Command flooding recovery

All these recoveries can be enabled and disabled individually or globally.

The long-running enqueue recovery function lets you:

- Check which resources are blocked
- Customize automation to cancel or keep the jobs that block the resource
- Customize automation to dump the jobs before they are canceled

You can determine which resources you want to monitor. You can define a value for the maximum time a job can lock a resource while other jobs are waiting for it. If this amount of time is exceeded, recovery takes place. Identification of and elimination of these potential bottlenecks helps to reduce the risk of a Parallel Sysplex outage.

While the time definition describes an inclusion list, you also have the possibility to define an *exclusion list* of resources that are not monitored at all.

For more information about enabling the ENQ function, see “Enabling Long Running Enqueues (ENQs)” on page 121.

This function has been extended by two supplementary functions:

- “"Hung" Command Recovery”
- “Command Flooding Recovery” on page 110

"Hung" Command Recovery: The purpose of this function is to detect hung commands that often result in multisystem outages. We distinguish three situations:

1. Commands that inhibit other commands from completing execution
2. Commands that inhibit jobs from completing execution

Recovery Actions

3. Jobs that inhibit commands from completing execution

Automation examines ENQ contention associated with command processing and builds a list of blockers and waiters. The SA z/OS policy is then examined to see how long waiting commands and waiting jobs are allowed to wait before automated action is taken. The policy is also examined to determine what action (DUMP, NODUMP, KEEP or exclude) is to be taken against the blocking command or job, as follows:

1. When a command inhibits other commands from completing and no policy definitions exist for any of the waiting commands, no automated action is taken.
2. When a command inhibits jobs from completing and no policy definitions exist for the blocking command, no automated action is taken.
3. When a job inhibits commands from completing and no policy definitions exist for any of the waiting commands, no automated action is taken.

If long-running ENQ and hung command recovery detect that the same resource requires automated action at the same time, the hung command recovery policy definitions take precedence and hung command recovery automates the resource.

The action taken (DUMP, NODUMP, KEEP or exclude) is identical to the long-running ENQ recovery action.

In either case only commands that are waiting on blocked resources are considered. "Hung" command recovery only considers those resources that are not being monitored by long-running ENQ recovery. If long-running ENQ recovery is disabled then all resources, even those defined as long-running ENQ resources, are considered for "hung" command recovery. It is also important to realize that if long-running ENQ recovery is enabled and a generic "catchall" resource definition applies, then "hung" command recovery cannot occur, because long-running ENQ recovery always take precedence.

Commands are executed by the master and console address spaces. Thus when a resource blocker is from either of these address spaces it is considered to be a blocking command rather than a blocking job.

As with resources, you can make similar definitions for commands that determine how long a command is permitted to lock a resource while other commands are waiting for the resource.

If the resource blocker is a job then recovery actions are only taken when the job has blocked the command for 3 consecutive iterations of "hung" command recovery processing. This results in a job blocking a command for no more than 90 to <120 seconds.

Recovery action for the blocking job or the job that issued the blocking command is the same as that specified for long-running ENQ recovery automation.

Command Flooding Recovery: The purpose of this function is to detect jobs that flood a command class. Command flooding can cause log buffer shortages and inhibits other commands from executing. Both can lead to a multisystem outage.

When all (50) TCBs that are reserved for command processing are in use, new commands are queued to the waiting queue. In this case the system issues message IEE806A which triggers this function to evaluate what jobs are causing the situation.

Jobs that just issue a set of commands, such as 200 (or more) "VARY dev,ONLINE" commands should *not* be considered during the evaluation. This is achieved by comparing the current and the previous snapshot of the affected command class.

Snapshot processing is scheduled when message IEE806A is trapped. The interval time between the snapshots is 3 seconds by default (see "Enabling Long Running Enqueues (ENQs)" on page 121 for details about adjusting this value if necessary). The interval should give these jobs enough time to finish issuing commands before the first snapshot is taken. Only jobs that issue commands on two consecutive snapshots become subject of the recovery action.

Before the recovery action takes place, the number of commands that are issued by the job must exceed a threshold (see below) and at least one of the commands must not be involved in a lock contention that is handled by the "hung" commands recovery.

The recovery action depends on the job definitions (see "Enabling Long Running Enqueues (ENQs)" on page 121). If the job can be canceled, the recovery also removes its waiting commands and terminates its executing commands. The recovery action is completed either with message ING922E or with message ING924E. The latter message is repeatedly issued approximately every minute until the waiting queue becomes empty.

The threshold is calculated by subtracting the number of jobs that are issuing commands in the command class from the total number of TCBs (50) that are reserved for command processing. This prevents jobs that repeatedly issue few commands from being evaluated.

The recovery ends when the message IEE061I is issued.

Note: The dump definitions are not in effect if a dump should be taken when the job is canceled. This is because the recovery routine of the job that is being canceled can suppress the dump.

Customization: Automation of handling long-running enqueues is enabled through the SA z/OS customization dialogs. For more details, see "Enabling Long Running Enqueues (ENQs)" on page 121.

System Removal

The purpose of this function is to isolate failed systems from a Parallel Sysplex by removing them as quickly as possible. It also ensures fast mean time to recovery (MTTR) for those system images that you wish to restart immediately if an unavoidable outage occurs.

Note: This function is unavailable when running on a z/OS image which runs under z/VM, even if the function is enabled.

In particular, the function automates the messages IXC102A and IXC402D.

The automation of the first message completes the Sysplex Failure Management (SFM). Under certain circumstances SFM cannot complete the isolation of a failed system. This is because SFM's HW isolation, resetting the channel subsystem (CSS) of the failed system, is driven through the CF. When connectivity between the system image and the coupling facility is lost, SFM cannot perform the hardware isolation (ISOLATE command) and defers resetting the system image until manual operator intervention occurs. Message IXC102A tells the operator to manually reset

Recovery Actions

the HW and then reply "DOWN" to the message, after which SFM safely partitions the system image out of the sysplex. The longer the delay lasts, the more the components and applications that rely on XCF messaging are impacted. The delay can eventually lead to a sysplex outage when the failed system has I/O operations pending. Automation of this message minimizes the delay.

The second message has the same impact as the first one. However, this message indicates a possible temporary inoperative status of the system due to a missing status update. For this reason the automation gives the system the chance to recover before the removal takes place by replying "INTERVAL=sss" to the first occurrence of message IXC402D. The interval time, sss, is the failure detection interval that is displayed by the command `D XCF,CPL`.

The automation does the removal of a system in two stages. The first stage clears any pending I/O operations by sending a hardware command to the Support Element. This requires information about the software running on the hardware. Because the system issuing message IXC102A or IXC402D does not necessarily have access to the hardware of the failed system, the automation needs predefined mapping between software and hardware. Depending on this mapping, it then routes the hardware command to the system that has access to the hardware of the failed system. For information about how to do the mapping refer to "Enabling System Removal" on page 119. For further information about the hardware requirements refer to *IBM Tivoli System Automation for z/OS Planning and Installation*.

The second stage replies to the outstanding WTOR with "DOWN" triggering the removal of the system from the sysplex.

Customization: Automation of message IXC102A is enabled through the SA z/OS customization dialogs. For more details, see "Step 3: Automating IXC102A and IXC402D Messages" on page 120.

Recovering Auxiliary Storage Shortage

With the automation of local page data sets, SA z/OS prevents auxiliary storage shortage outages by dynamically allocating spare local page data sets when needed. The function checks which jobs cause the shortage condition and whether additional page data sets can be added. If this is not possible, the job that is causing the shortage is canceled if this has been defined.

To enable local page data set automation customize the PAGTOTL parameter (defined in one of the IEASYSxx PARMLIB members used during IPL). Make sure to set the PAGTOTL parameter to a value greater than the number of local page data sets currently used.

Local page data sets must be defined in the master catalog and should not be SMS-managed. It is recommended to use preallocated local data sets instead of dynamically allocated ones. This makes the process faster because formatting newly allocated page data sets is time-consuming (10sec./35MB). Each predefined local page data set should be allocated with 10% space of local page space currently used by the system. If predefined page data sets can no longer be allocated, new local page data sets are created dynamically.

Customization: Automation of the recovery of auxiliary storage shortage is enabled through the SA z/OS customization dialogs. For more details, see "Enabling System Removal" on page 119.

Hardware Validation

This function performs cross-validation of the hardware configuration mapped out in the customization dialogs against the actual hardware configuration that is running. This information is critical to accurately control logical partitions (LPARs) on any supported CPC within the HMC/SE LAN over the BCP Internal Interface.

Hardware validation uses the CPC name, Partition name and Partition number to ensure that the LPARs defined in the customization dialogs are on the correct CPC and located on the correct partition number. However, this helps only for coupling facilities because their partition identifiers must be defined in the active CFRM policy.

For MVS images, information from the HMC/SE (such as system name and sysplex name that are stored during initialization) is used to verify the corresponding customization dialog definitions. During initialization of the automation's Hardware Command Interface and just before a disruptive request is sent to a partition, new checks are made to ensure that everything matches correctly.

Note: Only active images can be verified. For inactive images we must still rely on definitions made in the customization dialogs.

An active system in this context is a system belonging to the same sysplex as the system that runs the hardware validation, that is SA z/OS checks only systems and coupling facilities within its own sysplex.

Hardware validation runs on an SA z/OS system primarily during startup, and subsequently when changes to the definition in the customization dialogs are applied through the INGAMS REFRESH command. The validation checks the definitions of all registered systems, that is whenever an SA z/OS system performs the hardware validation, it validates all systems and coupling facilities that are active in the sysplex at this point in time. Registered systems are systems running msys for Operations or SA z/OS that have joined the same XCF group.

The validation of active systems and coupling facilities requires that the CPCs that host the active systems must all be defined in the customization dialogs.

The data for inactive systems cannot be verified. However, these definitions are checked for consistency across all registered systems. As soon as one of these inactive systems or coupling facilities joins the sysplex or is made available for use, the validation is run for the particular image only.

Retrieving actual hardware information can take up to 5 minutes per CPC depending on the model and its LPARs. During the time that the hardware validation takes place all other hardware-related automation is either delayed or cannot be performed, depending on the type of recovery. For this reason the validation carries out "delta" processing. That is validating only the data that has changed. This also includes the absence of data resulting in terminating CPC connections when CPC definitions are missing that have been applied by a prior validation. The actions resulting from the validation are performed on ALL registered systems. This has two advantages:

- you don't need to recycle NetView for changes in hardware definitions.
- you only need to make the changes available to one system.

Hardware Validation

The first part of the hardware validation triggered by the ACF command or the automation startup determines what CPC connections must be terminated and initiated, namely in this sequence. The resulting actions are performed on all registered systems. When this step has been completed successfully the image validation is performed.

The image validation collects actual hardware information, and verifies the current hardware definitions against the actual data and the definitions found on all other registered systems. It informs you if:

- A real system or coupling facility could not be validated because either actual hardware information or user definitions are not available
- The image definitions could not be evaluated because the actual hardware information is not available
- The real system or coupling facility is not active and the image definitions of some of the registered systems are different
- Any definition value has been corrected that was improperly defined or not defined at all

Changes in hardware definitions can be made available to all registered systems by simply invoking the command `INGAMS REFRESH` on only one of the these systems. There is one exception: the change of the authorization token value used for the communication with a particular CPC. A change of this value requires 3 steps:

1. In the first step you must remove the particular CPC definition and then invoke the ACF command as above.
2. When the command completes successfully the next step is to change the authorization token value of the CPC at the Support Element.
3. The final step is to define the CPC again with the new token value and invoke the ACF command again.

Note: This behavior of the `INGAMS` command applies to the hardware definitions *only*.

The second part of the validation is triggered by either the message `IXC517I` that is issued when a coupling facility is made available for use, or by the automation itself when notified that a system joined the sysplex. Both trigger the automation to perform only the validation of the new system or coupling facility. Multiple occurrences of messages for the same system or coupling facility are ignored while this system or coupling facility is validated. In case of a new system, the advantage here is that the real hardware is validated before the system starts NetView and the automation. If this automation then detects no difference between its current definitions and the definitions of the other registered systems—which is the normal case—only a consistency check takes place. This check does not require any real hardware information.

Prerequisites

Note: Hardware validation is not supported on MVS systems running under z/VM.

Enabling Hardware-Related Automation

To enable the sysplex automation that SA z/OS provides for recovery actions and coupling facility management, the following definitions must be made in the customization dialog.

Step 1: Defining the Processor

Use the customization dialog to define a new processor of Entry Type PRO. The name should be the real physical name of the processor defined in HCD. For more information, refer to the online help or the section "Creating a New Processor" in *IBM Tivoli System Automation for z/OS Defining Automation Policy*.

Step 2: Using the Policy Item PROCESSOR INFO

Use the Processor Information panel, to define a processor using entry type PRO.

Note: The connection type protocol must be INTERNAL
For more information, refer to the online help or the section "More about Policy Item PROCESSOR INFO" in *IBM Tivoli System Automation for z/OS Defining Automation Policy*.

Step 3: Defining Logical Partitions

If the processor that you have defined runs in LPAR mode, define its logical partitions using the LPAR Definitions panel. You should define all LPARs that are physically available on your processor, together with the systems that run on them.

For more information, refer to the online help or the section "More about Policy Item LPARS AND SYSTEMS" in *IBM Tivoli System Automation for z/OS Defining Automation Policy*.

Step 4: Defining the System

Define a system using entry type SYS, and the Define New Entry panel.

Note: To avoid receiving hardware validation messages during SA z/OS initialization, you should define all your systems (including your coupling facilities).

For more information, refer to the online help or the section "Creating a New System" in *IBM Tivoli System Automation for z/OS Defining Automation Policy*.

Step 5: Connecting the System to the Processor

Connect this system to the processor that you defined in "Step 2: Using the Policy Item PROCESSOR INFO" and to its logical partition (if you set the processor mode as LPAR).

Connect this system to the sysplex or standard group (see "Step 6: Defining Logical Sysplexes" on page 116 and "Step 7: Defining the Physical Sysplex" on page 116).

Note: MVS SYSNAME and the Image/ProcOps Name *must* be the same.

Restriction:

Enabling Hardware-Related Automation

Usually, the MVS SYSNAME may begin with a number. However, in this case, it must be the same as the Image/ProcOps Name, which *cannot* begin with a number. Therefore, this naming restriction also applies to the MVS SYSNAME.

Step 6: Defining Logical Sysplexes

Define EACH logical sysplex (systems within the same XCF group ID) using entry type GRP with group type SYSPLEX.

Use policy SYSPLEX to enter the real physical sysplex name. You can use the same name in several SYSPLEX GRPs.

Use policy SYSTEMS to connect all systems within the same XCF group ID to the SYSPLEX GRP. A system can only be connected to one SYSPLEX GRP.

Step 7: Defining the Physical Sysplex

Define your real physical sysplex using entry type GRP with group type STANDARD.

Use policy SYSTEMS to connect all systems of your physical sysplex to the STANDARD GRP.

Enabling Continuous Availability of Couple Data Sets

Couple data sets (CDSs) contain important information about how to manage certain aspects of your sysplex. For example, the SFM CDS (sysplex failure management couple data set) defines how the system manages system and signalling connectivity failures and PR/SM™ (Processor Resource/Systems Manager™) reconfiguration actions.

The following couple data sets are particularly important for the functioning of your Parallel Sysplex:

- The SYSPLEX couple data set, which defines the systems and the XCF groups of the sysplex
- The CFRM couple data set, which defines the coupling facilities and structures of the sysplex

It is recommended that you define alternate couple data sets for all couple data sets in your sysplex. These alternate couple data sets serve as backups when the primary CDS fails.

With the customization dialog you can specify a series of spare volumes for every CDS type, for example, SYSPLEX, ARM, CFRM. The first volume in the series is used to create an alternative CDS if one of the primary alternate CDSs fails.

In the customization dialog you define the potential alternate couple data sets using the Group entry type. Select a sysplex group, then select its policy item SYSPLEX (define sysplex policy) from the panel Policy Selection.

The Sysplex Policy Definition panel is displayed if you select policy item SYSPLEX from the Policy Selection panel for sysplex groups.

For a description of this panel refer to the online help or the section "More About Policy Item SYSPLEX" in *IBM Tivoli System Automation for z/OS Defining Automation Policy*.

Enabling WTO(R) Buffer Shortage Recovery

You can customize the WTO(R) buffer shortage recovery of SA z/OS with the MESSAGES/USER DATA policy item of the customization dialog for the MVS Component entry type (MVC). Code definitions for the message ID WTOBUF are used to specify jobs that are canceled or kept in case a WTO(R) buffer shortage is threatening. The jobs that you select for cancellation will then no longer issue WTO(R)s.

Specify code definitions for message ID WTOBUF with the following values:

CODE1

Specifies the name of the job which might or might not be canceled.

CODE2

This must be WTO, WTOR, or * to indicate which requests the job (or jobs) might or might not be canceled for. Use just * to specify WTO and WTOR requests.

CODE3

This must be blank.

Value Returned

This must be CANCEL to indicate that the job (or jobs) might be canceled or KEEP to indicate that they might not .

Example:

Code 1	Code 2	Code 3	Value Returned
JOB1	WTOR		KEEP
JOB2*	WTO		KEEP
JOB3*	*		CANCEL
JOB4*	*		KEEP
*	*		KEEP

To set up the default behavior for all jobs not explicitly defined, a specification of CODE1=* and CODE2=* is needed. To indicate that all other jobs might be canceled specify CANCEL in the **Value Returned** field, otherwise specify KEEP.

The job name *MASTER* cannot be entered in the **Code 1** field. Even if your default behavior is set up to cancel all jobs that have not been explicitly defined, a cancel command is not issued against *MASTER* if it is the job name being checked. This is because *MASTER* is non-cancelable.

WTO Recovery is performed when different messages are received by SA z/OS. The action taken when each of these messages is received is described in Table 14 on page 118.

Enabling WTO(R) Buffer Shortage Recovery

Table 14. WTOBUF Recovery Process

Recovery	Message	Actions in sequence	Command
WTO	IEA405E	Set console attributes.	
		If the deletion mode is not roll or wrap, set the mode to roll.	K S,DEL=R,L=x
		If any out-of-line display area exists, delete the status display.	K E,D,L=x
		If the interval between message rolls is greater than 1 second and not '*', set the interval to 0.25 seconds.	K S,RTME=1/4,L=x
		If the console receives messages not only from the local system and the WTO message buffer size has reached its maximum, remove the buffering systems from the list and add the local system to the list.	V CN(x),MSCOPE=(1)
	IEA404A	Suspend the console.	
		Requeue the messages to the hardcopy log.	K Q,L=x
		Vary the active console (COND=A) offline. For SMCS consoles, issue the appropriate VTAM command.	V {CN(x),OFFLINE NET,TERM,LU1=x, TYPE=FORCE }
		Cancel the job or TSO user that caused the shortage, but only when defined as a candidate during the customization.	C {jobnm,A=asid U=userid }
	IEA406I	Resume the console if it was suspended and if it is not a SMCS console.	
Restore console attributes.			
Set the deletion mode to the value before the buffer shortage occurred.			K S,DEL=old,L=x
Set the interval between message rolls to the value before the buffer shortage occurred.			K S,RTME=old,L=x
Set the list from which the console is to receive unsolicited messages to the list before the buffer shortage occurred.			V CN(x),MSCOPE=(1)
Increase the WTO message buffer size to minimize future shortages as follows: new = min(9999 ,max(1500 ,1.2 * current MLIM))			K M,MLIM=new
	Issue message AOF929 for permanent changes (MLIM).		

Table 14. WTOBUF Recovery Process (continued)

Recovery	Message	Actions in sequence	Command
WTO(R)	IEA230E	Increase the maximum number of reply IDs to the maximum allowable value if the maximum number of systems in the sysplex is greater than 8 or the system runs in local mode.	K M,RMAX=9999
		Increase the WTO(R) message buffer size if the current RMAX value is greater than the current RLIM value as follows: $\text{new} = \min(9999, \max(10 + 2 * \text{maxsys_in_sysplex}, 1.2 * \text{current RLIM}))$	K M,RLIM=new
	IEA231A	Cancel all jobs and TSO users that have outstanding WTO(R)s and that are defined as candidates during the customization.	C {jobnm,A=asid U=userid }
	IEA232I	Issue message AOF928 for irreversible changes (RMAX).	
		Issue message AOF929 for permanent changes (RLIM).	

Enabling System Removal

The SA z/OS Parallel Sysplex enhancements help you to resolve pending I/Os for systems being removed from the sysplex.

Because the automation must know where the system is located to send the command to the appropriate Support Element, you must use the customization dialog to define its hardware configuration.

Step 1: Defining the Processor and System

The processor and system must be defined as described in “Enabling Hardware-Related Automation” on page 115.

Step 2: Defining the Application with Application Type IMAGE

Use entry type APL to define a new application with Application Type IMAGE and subsystem name that is the same as the Image Name of the system that this application represents (as defined in “Step 4: Defining the System” on page 115).

Use entry type APL and select policy item APPLICATION INFO for your system. On the panel *Application Information* you can define a new application type IMAGE. For more information, refer to the online help or the section “Policy Items for Applications” in *IBM Tivoli System Automation for z/OS Defining Automation Policy*.

Because the application has been defined as type IMAGE, the job name is set by default to the subsystem name and cannot be changed.

The Subtype, Scheduling Subsystem, JCL Procedure Name, ARM Element Name, and WLM Resource Name are forced to be blank.

Some other definitions in the policy item AUTOMATION INFO are also defaulted:

- the Job Type is defaulted to NONMVS
- the Monitor Routine is defaulted to INGMTSYS if nothing is specified
- the External Startup is defaulted to ALWAYS if the Monitor Routine is INGMTSYS

Enabling System Removal

- the External Shutdown is defaulted to ALWAYS if the Monitor Routine is INGMTSYS

For more information, refer to the online help or the section "More About Policy Item AUTOMATION INFO" in *IBM Tivoli System Automation for z/OS Defining Automation Policy*.

Step 3: Automating IXC102A and IXC402D Messages

You can automate IXC102A and IXC402D messages to avoid sysplex outages.

Note: The following shows examples for defining commands and codes for message IXC102A.

You can specify one of the following four hardware commands for each system in the sysplex that is automated.

- SYSRESET [CLEAR]
- DEACTIVATE
- ACTIVATE [P(*image_profile_name*)]
- LOAD [P(*load_profile_name*)] [CLEAR]

Where:

CLEAR	Indicates that the storage is cleared
P	Specifies the profile to be used. The name can consist of up to 16 alphanumeric characters. If the parameter is omitted, the last profile is used.

Note:

The following restriction applies to the hardware commands ACTIVATE and LOAD:

Both commands invoke processor functions that can cause asynchronous events such as operator messages at BCP (Basic Control Program) Internal Interface initialization time or processor hardware wait states. Currently, the BCP Internal Interface does not allow the monitoring and control of these events.

Use policy item MESSAGES/USER DATA of the SA z/OS customization dialog to define commands and codes for message IXC102A and IXC402D. Enter CMD in the **Action** column and IXC102A in the **Message ID Description** column (or IXC402D for IXC402D message automation). For more information, refer to the online help or the section "More About Policy Item MESSAGES/USER DATA" in *IBM Tivoli System Automation for z/OS Defining Automation Policy*. The definitions here also apply to message IXC402D.

Pressing Enter displays the CMD Processing panel, as shown in Figure 16 on page 121. Use this panel to specify a valid command for the image and a "Pass/Selection" value that must match the "Value Returned" definition specified on the *Code Processing* panel.

ACTCODE
LOAD P(LOADPROF) CLEAR

Figure 16. Sample Panel for Command Processing

On the Code Processing panel, as shown in Figure 17, specify the following:

Code 1	Code 2	Code 3	Value Returned
IXC102A	BCPII		ACTCODE

Figure 17. Sample Panel for Code Processing

If you want to automate messages IXC102A and IXC402D using the Parallel Sysplex enhancements, you must enter IXC102A for Code 1 and BCPII for Code 2. Refer to “Important Processor Operations Considerations” on page 123 for more information.

Enabling Long Running Enqueues (ENQs)

If you automate long running ENQs, you must define the following:

- The resource or resources that are being checked
- The time frame when a long ENQ is detected

If you automate "hung" commands, you must define the following:

- The command (or commands) that are being monitored or excluded from monitoring
- The time frame for each command that a command is granted for completion or, if commands are to be excluded from monitoring, the exclusion keyword
- The action to be taken against this command if this command is determined to be a blocker of other commands or jobs

In addition, the following definitions can be made:

- The names of jobs that should be canceled or kept when detecting a long ENQ, a "hung" command, or command flooding
- The snapshot interval for a command class
- The title of the dump taken before the job is cancelled
- The default storage areas to be dumped
- Symbol definitions to be used when the dump specifications are provided by a PARMLIB member

Use the entry type GRP in the customization dialog to define the following policies:

- Resource definition
- JOB/ASID definitions
- IEADMCxx symbols
- Command definition
- Snapshot interval definition

Step 1: Defining Resources

Use the Long Running ENQ Resource Definition panel to define your resources. This panel is displayed if you select policy item RESOURCE DEFINITIONS from the Long Running Enqueue Policy section of the Policy Selection panel for sysplex

Enabling Long Running Enqueues (ENQs)

groups. For more information, refer to the online help or the section "More About Policy Item RESOURCE DEFINITIONS" in *IBM Tivoli System Automation for z/OS Defining Automation Policy*.

Step 2: Making Job/ASID Definitions

Use the Long Running ENQ Job/ASID Definitions panel that is displayed if you select policy item JOB/ASID DEFINITIONS from the Long Running Enqueue Policy section of the Policy Selection panel for sysplex groups. For more information, refer to the online help or the section "More About Policy Item JOB/ASID DEFINITIONS" in *IBM Tivoli System Automation for z/OS Defining Automation Policy*.

Step 3: Defining IEADMCxx Symbols

Use the *Long Running ENQ IEADMCxx Symbols* panel that is displayed if you select policy item IEADMCxx SYMBOLS from the Long Running Enqueue Policy section of the Policy Selection panel for sysplex groups. For more information, refer to the online help or the section "More About Policy Item IEADMCxx SYMBOLS" in *IBM Tivoli System Automation for z/OS Defining Automation Policy*.

Step 4: Defining Commands

Use the Long Running Command Definition panel to define your commands. This panel is displayed if you select policy item COMMAND DEFINITIONS from the Long Running Enqueue Policy section of the Policy Selection panel for sysplex groups. For more information, refer to the online help or the section "More About Policy Item COMMAND DEFINITIONS" in *IBM Tivoli System Automation for z/OS Defining Automation Policy*.

Step 5: Defining Snapshot Intervals

Use the Command Flooding Definition panel to define the individual snapshot times. This panel is displayed if you select policy item COMMAND FLOODING from the Long Running Enqueue Policy section of the Policy Selection panel for sysplex groups. For more information, refer to the online help or the section "More About Policy Item COMMAND FLOODING" in *IBM Tivoli System Automation for z/OS Defining Automation Policy*.

Enabling Auxiliary Storage Shortage Recovery

To prevent auxiliary storage shortage outages you can predefine local page data sets, using the SA z/OS customization dialog for entry type GRP to define the following:

- local page data set
- job definitions

Step 1: Defining the Local Page Data Set

Use the Local Page Data Set Recovery panel that is displayed if you select policy item LOCAL PAGE DATA SET from the Local Page Data Set Policy section of the Policy Selection panel for sysplex groups. For more information, refer to the online help or the section "More About Policy Item LOCAL PAGE DATA SET" in *IBM Tivoli System Automation for z/OS Defining Automation Policy*.

Step 2: Defining the Handling of Jobs

Use the Local Page Data Set Recovery Job Definition panel that is displayed if you select policy item JOB DEFINITIONS from the Local Page Data Set Policy section of the Policy Selection panel for sysplex groups. For more information, refer to the online help or the section "More About Policy Item JOB DEFINITIONS" in *IBM Tivoli System Automation for z/OS Defining Automation Policy*.

Defining Common Automation Items

There are definitions that relate to utilities running as a started task. The first one (Temporary Data Set HLQ/TEMPHLQ) replaces the usage of the first qualifier of the automation status file. The second definition (Started Task Job Name/STCJOBNM) allows the unique assignment of started task job names scheduled by the automation in case you have dedicated job name assignments that conflict with the procedure names provided by the automation.

It is recommended that you define the Temporary Data Set HLQ/TEMPHLQ. If it is not defined, the automation uses the first qualifier of the automation status file.

You can define both of these items using the Sysplex Policy Definition panel that is displayed if you select the policy item SYSPLEX from the Policy Selection panel for sysplexes. For more information, refer to the online help or the section "More About Policy Item SYSPLEX" in *IBM Tivoli System Automation for z/OS Defining Automation Policy*.

Important Processor Operations Considerations

Currently, the IXC102A automation and Coupling Facility activation or deactivation is the product automation that uses the BCP (Basic Control Program) Internal Interface to control the processor hardware.

If you use the automation capabilities of SA z/OS processor operations in your environment, make sure they do not conflict with the automation supplied by the Parallel Sysplex enhancements.

With the Parallel Sysplex enhancements, IXC102A and IXC402D automation uses the BCP Internal Interface, which is currently not fully compatible with processor operations.

If you want to use the IXC102A automation that is supplied as part of the Parallel Sysplex enhancements, make sure there is no processor operations related IXC102A automation defined in your automation policy.

Likewise, if you want to continue to use the processor operations based automation of messages IXC102A and IXC402D, the IXC102A automation flag provided by the Parallel Sysplex enhancements must be disabled.

Processor operations, which is a Focal Point™ type function, allows you to monitor and control processor hardware, including Coupling Facility images, from a single NetView, the processor operations Focal Point.

The BCP Internal Interface of the Parallel Sysplex enhancements allows you to perform hardware operations from each NetView in your sysplex member, as long as its processor hardware supports this. Refer to *IBM Tivoli System Automation for z/OS Planning and Installation* for more information.

Customizing the System to Use the Functions

Additional Automation Operator IDs

To support the Parallel Sysplex enhancements, you must define the following automation operators:

Automation Operator ID	Automated Function	Profile
AUTXCF	XCFOPER	AOFPRFAO
AUTXCF2	XCFOPER2	AOFPRFAO
AUTPLEX	PLEXOPER	AOFPRFAO
AUTPLEX2	PLEXOPR2	AOFPRFAO
AUTPLEX3	PLEXOPR3	AOFPRFAO
AUTHW001	HWOPER01	AOFPRFAO
AUTHW002–AUTHW033	HWOPER02–HWOPER33	AOFPRFHW

After you made the definitions, you have to build the new definition files via the customization dialog build function. Recycle your automation NetViews to activate the changes in the DSIPARM members.

Note: If you have different naming conventions in your setup and you change the NetView autotask IDs in the parmlib member AOFOPFA, you have to change the Primary Automation Operator fields of the AOP definitions accordingly.

Switching Sysplex Functions On and Off

Use the SA z/OS customization dialog to specify the following minor resource names:

- CDS** For the recovery of alternate CDSs.
- ENQ** Enables the handling of the next four individual recoveries.
- ENQ.CMDFLOOD** Enables the handling of commands that flood a particular command class.
- ENQ.HUNGCMD** Enables the handling of jobs and commands that inhibit other commands from completing execution.
- ENQ.LONGENQ** Enables the handling of long-running ENQs.
- LOG** For the recovery of the system log.
- LOGGER** For the recovery of the system logger.
- PAGE** For the recovery of auxiliary storage shortage.
- WTO** For the recovery of WTO(R) buffer shortages.
- XCF** For automating messages IXC102A and IXC402D.

By default, all recovery actions are enabled. If you want to disable them, use the customization dialog *Flag Automation Specification* and set the recovery flag to NO.

Customizing the System to Use the Functions

Note: You can change the automation recovery flag during run time by using the command INGAUTO.

Customizing the System to Use the Functions

Chapter 10. Automating Networks

Automation Network Definition Process	127	Defining an Outbound Gateway Autotask	129
Defining an SDF Focal Point System.	128	Defining Automatically-Initiated TAF Fullscreen Sessions	130
Defining Gateway Sessions	129		

Automation Network Definition Process

This section summarizes the steps for defining an automation network to SA z/OS. More detail for each step of the process is provided later in this chapter.

1. Define your message forwarding paths between different systems. To do this, you define:
 - A primary focal point, where all notifications are sent.
 - An optional backup focal point, used when the primary focal point is unavailable.
 - Target systems, which are monitored and controlled by the focal point system.
 - Gateway sessions between the systems.

“Defining Gateway Sessions” on page 129 describes how to define gateway sessions.
2. Modify the NetView definitions to reflect your automation network configuration. The chapter on how to install SA z/OS on host systems in *IBM Tivoli System Automation for z/OS Planning and Installation* provides details.

For an example of the automation network definition process, see also the chapter about installing SA z/OS on host systems in *IBM Tivoli System Automation for z/OS Planning and Installation*.

These definitions create a path allowing message forwarding from target systems to the focal point system.

A message forwarding path is best implemented by defining systems in the following top-down manner:

1. Primary focal point system
2. Backup focal point system
3. Target systems

Defining the primary focal point first ensures that it is ready to handle forwarded messages as soon as forwarding is turned on for the target systems.

If the message forwarding path is not yet implemented on all systems in an automation network, messages are displayed to notification operators on the target systems. Once the message forwarding path is implemented, notifications are forwarded to the focal point system.

If the target systems are implemented first, additional overhead occurs because the target systems unsuccessfully attempt to forward notifications, and the notifications are logged in the NetView log.

Defining an SDF Focal Point System

The focal point system and backup focal point systems are defined using the Network entry type in the customization dialog. Each system has a single entry in the automation policy defining the next system or domain in the message forwarding path. Figure 18 shows an example automation network. In this example, the primary focal point system is CHI01. The backup focal point is CHI02.

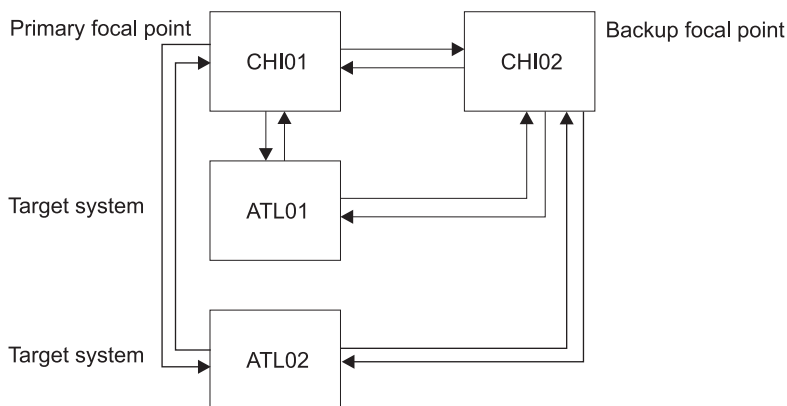

Figure 18. Focal Point Forwarding Definitions for Systems

The corresponding focal-point forwarding definitions in the automation policy for systems CHI02, ATL01 and ATL02 are as follows. You reach the required panel by selecting the FORWARD policy item of a Network entry type.

- CHI02 automation policy:

```

COMMANDS  HELP
-----
AOFpine2      Notification Forwarding
Command ==>>

Entry Type : Network      PolicyDB Name  : USER_PDB
Entry Name  : FOCAL_NETWORK Enterprise Name : USER_ENTERPRISE

Enter the NetView domains for automation notification forwarding.

Primary Domain ==> CHI01      Current Domain ID
Backup Domain  ==> &DOMAIN.  Backup Domain ID
  
```

Figure 19. Notification Forwarding Panel for CHI02

- ATL01 and ATL02 automation policy:

```

COMMANDS  HELP
-----
AOFpine2      Notification Forwarding
Command ==>>

Entry Type : Network      PolicyDB Name  : USER_PDB
Entry Name  : FOCAL_NETWORK Enterprise Name : USER_ENTERPRISE

Enter the NetView domains for automation notification forwarding.

Primary Domain ==> CHI01      Current Domain ID
Backup Domain  ==> CHI02     Backup Domain ID
  
```

Figure 20. Notification Forwarding Panel for ATL01 and ATL02

In Figure 18 on page 128, the automation policies for system CHI01 do not have any forward focal point definitions. This is because SA z/OS considers the current system as the primary focal point and displays messages *without* forwarding them if either or both of the following is true:

- The forward focal point is not defined in the automation policy for the system.
- The system specified in a forward focal point definition is the current system.

Defining Gateway Sessions

To define gateway sessions:

1. For each system, define the *outbound* gateway autotask (GATOPER) on the Automation Operators policy object of the customization dialog. See “Defining an Outbound Gateway Autotask” for details.
2. On the SA z/OS Network policy object, use the GATEWAY policy item to define the destination systems that the originating system connects to.
3. Define operator IDs used for all inbound and outbound gateway autotasks used on the system in the NetView DSIPARM data set member DSIOPF. See the chapter on how to install SA z/OS on host systems in *IBM Tivoli System Automation for z/OS Planning and Installation* for details.

Defining an Outbound Gateway Autotask

In any system, only the outbound gateway task is defined using the Automation Operators entry type.

If GATOPER has not previously been defined, type the automation operator name, *gatoper*, in the *Automated Function* field of the *Auto Operator Definition* policy item, as shown in Figure 21.

COMMANDS	ACTIONS	HELP

A0FP1A00	Automation Operator Definitions	Row 1 to 10 of 20
Command ==>		SCROLL==> PAGE
Entry Type : Automation Operators PolicyDB Name : USER_PDB		
Entry Name : CHI100PS Enterprise Name : USER_ENTERPRISE		
Actions: S = Select M = Move B = Before A = After I = Insert		
Action	Automated Function	Messages for this Operator (* notation ok)
	<u>gatoper</u>	

Figure 21. Automation Operator Definitions Panel

You do not have to specify any messages for GATOPER. When you press Enter, the Automation Operator NetView Userids panel is displayed automatically, as shown in Figure 22 on page 130.

If GATOPER has previously been defined, select it by entering an S in the *Action* column.

Automation Network Definition Process

Enter the NetView operator ID that is associated with the GATOPER function on the Automation Operator NetView Userids panel.

Note:

This NetView operator ID must be unique within the enterprise.

For example, to define the outbound gateway autotask for system CHI01 in the automation network shown in *IBM Tivoli System Automation for z/OS Planning and Installation*, the values shown in Figure 22 are specified.

```
COMMANDS  HELP
-----
AOFPIA01          Automation Operator Definitions
Command ==>>> _____

Entry Type : Automation Operators  PolicyDB Name   : USER_PDB
Entry Name  : CHI100PS             Enterprise Name : ENTERPRISE_NAME

Automated Function: GATOPER
Messages assigned:

MVS Console Name . . _____ Console for NetView cmds

Enter automation operators and NetView operator(s) to receive messages.

Automation Operators          NetView Operators
Primary . . GAT&DOMAIN.      Id 1 . . _____
Backup. . . _____       Id 2 . . _____
                               Id 3 . . _____
                               Id 4 . . _____
                               Id 5 . . _____
                               Id 6 . . _____
```

Figure 22. Automation Operator NetView Userids Panel

Defining Automatically-Initiated TAF Fullscreen Sessions

You can automatically establish Terminal Access Facility (TAF) fullscreen sessions for applications that SA z/OS monitors, so that the operators need not define the sessions on a daily basis.

These TAF fullscreen sessions are defined in the FULL SESSIONS policy item for a Network policy object.

In addition to defining TAF fullscreen sessions using the customization dialog, you follow the NetView process for customizing TAF fullscreen sessions, as outlined in *Tivoli NetView for z/OS Customization Guide*

Once TAF fullscreen sessions are set up, they can be managed using the TAF Fullscreen Menu in the SA z/OS Operator Interface. See *IBM Tivoli System Automation for z/OS User's Guide* for more information on managing TAF fullscreen sessions.

To define an application on the Fullscreen TAF Application Definition panel that you reach by selecting the FULL SESSIONS policy item of a Network policy object, specify the following:

- The session name, or the name of the application that a TAF fullscreen session is to be established for, for example, TSO. This name is displayed in the

Defining Automatically-Initiated TAF Fullscreen Sessions

Description field on the TAF Fullscreen Menu operator panel. This value can be the same as that used for the application ID.

- The application ID. You can obtain this value from the library containing the network definitions (VTAMLST) or from your network system programmer.
- The system name that the application runs on, for example, CHI01. This is an information-only field and is displayed in the System field on the TAF Fullscreen Menu operator panel.

For example, the following panel defines a TAF fullscreen session for TSO in system CHI01:

```
COMMANDS  HELP
-----
AOFPINE3          Fullscreen TAF Application Definition  Row 1 to 10 of 20
Command ==> _____ SCROLL==> PAGE

Entry Type : Network          PolicyDB Name  : USER_PDB
Entry Name  : FOCAL_NETWORK   Enterprise Name : USER_ENTERPRISE

Enter the applications with which SA z/OS operators can establish TAF
sessions automatically using the operator interface.

Session Name  Application ID  System
  TSO         TAIN1         CHI01
  _____  _____  _____
  _____  _____  _____
  _____  _____  _____
  _____  _____  _____
  _____  _____  _____
  _____  _____  _____
  _____  _____  _____
  _____  _____  _____
```

Figure 23. Fullscreen TAF Application Definition Panel

Chapter 11. Defining a VTAM Application to SA z/OS

VTAM applications need to have Application nodes activated for the application to operate correctly. This is normally not a problem if an application is to run on a single system. However, if the application is to be switched from one system to another (via a move group or server group), the application node definition must be deleted from the system that the application is moving from. If this is not done, users may not be able to log on to the application because there is a definition for the application node that is not active, that is, the application has not opened the node ACB.

To alleviate this problem, the application node must be deleted from the old system and created on the new system. Unfortunately, the only way to delete a node in VTAM is to deactivate its major node, that is, the member that it is defined in.

Newer releases of VTAM have introduced the concept of *Model node definitions*. In this case a major node is created with the type of node and a name that includes wildcards. Whenever a node of the type is accessed, VTAM will use the name requested to match the models. It will then dynamically create a node based on the model definitions with the name requested. When the node is no longer required it will delete it. What this means for application nodes is that a model definition can be defined once on each VTAM in the network that the application might be run on. Then when the application is started and opens its ACB, VTAM will dynamically create the node for it. Likewise when moving the application, upon closing the ACB, VTAM will delete the node and another VTAM on another system will dynamically create the node.

VTAM applications may require recovery commands to be issued if VTAM is restarted, or the VTAM application node is reactivated. These commands differ from subsystem to subsystem and can be specified in the Messages/User Data policy items as described in the following section.

The INGVTAM command provides a method of activating the Major Nodes for an application before the application is started, and deactivating the Major Nodes after it is down. To enable the function you must code the INGVTAM command in the prestart, ACORESTART, post-shut policies. In addition, if VTAM should ever be restarted whilst the applications are running, the major nodes must be reactivated. This can be accomplished by coding the INGVTAM command in the UP messages/user data policy for the VTAM subsystem.

Registering VTAM Application Subsystems with SA z/OS Recovery

To enable VTAM application recovery to take place, the subsystems must be registered with the SA z/OS recovery code. This is achieved by using the INGVTAM command that is described in *IBM Tivoli System Automation for z/OS Programmer's Reference*. The following application policy items must be customized:

1. PRE-START policy

The PRE-START policy must have at least a NORMAL start item with the INGVTAM command to activate a list of major nodes. The following command can be used as an example:

```
INGVTAM &SUBSAPPL REQ=ACTIVATE MAJNODE=(majnode1,majnode2,...)
```

Defining a VTAM Application to SA z/OS

Where *majnodes* are VTAM application major nodes. Each major node will be varied active to VTAM when the subsystem prestart commands are issued. Note, it is expected that only one of the major nodes will contain the minor node that the VTAM application subsystem will use.

2. POST-SHUTDOWN policy

The POST-SHUTDOWN policy is used to deregister the subsystem with SA z/OS VTAM application recovery. Use the `INGVTAM REQ=DEACTIVATE` command in the policy. For example:

```
INGVTAM &SUBSAPPL REQ=DEACTIVATE
```

The `DEACTIVATE` request issues a vary net inactive for each major node registered by the `REQ=ACTIVATE`. The vary is not done if the major node is shared by other subsystems that have also registered the major node. When the last subsystem registered issues an `INGVTAM REQ=DEACTIVATE`, the major node will be varied inactive. The only exception to this is when the major node contains model resources with wildcards in the node definition. In this case the major node is never inactivated.

3. ACORESTART Messages/User Data policy

The `ACORESTART` message policy must have the same definition as the `PRE-START` policy. This policy item is used to reregister the subsystem with SA z/OS VTAM application recovery.

4. VTAMUP Messages/User Data policy

Enter commands that are issued when the VTAM subsystem is restarted. Typically these commands reopen the VTAM ACB that the subsystem uses to communicate with VTAM.

5. Relationships policy

Optionally enter a relationship for the subsystem to ensure that the prestart commands are only issued when VTAM is up. The required relationship is:

```
PrepAvailable(WhenAvailable),Passive,Weak -> VTAM/APL/=
```

Where `VTAM` is the name of the VTAM subsystem and that is the supporting resource. `Passive` forces the relationship to wait until VTAM is UP. `Weak` specifies that only the supporting resource status is checked.

In addition the UP message for VTAM should have the following command:

```
INGVTAM REQ=ACTIVATE
```

When `INGVTAM` is executed with `REQ=ACTIVATE` and no positional subsystem, it finds all the subsystems that had previously registered via `INGVTAM` and issues `Vary NET ACT` commands for their major nodes. After this has been done, it will execute any policy command(s) that is/are specified to `USER MESSAGE VTAMUP` for the subsystems.

Chapter 12. Shutting Down z/OS systems in a GDPS Environment

SA z/OS allows you to shutdown z/OS systems either through the INGREQ ALL command in a GDPS® production environment or from a GDPS controlling system. There are two distinct phases in the final shutdown processing that are defined using the special message id SYSTEM_SHUTDOWN message/user data policy item for the MVS Component entry type:

Phase 1

This phase begins when the resource that is identified by the GDPS STOPAPPL parameter (the STOPAPPL resource) has been terminated. In this phase you can specify additional INGREQ stop commands or any other commands through NetView to terminate any subsystems that are still present.

Phase 2

This phase begins after the takeover of OMVS and any local automation manager (PAM and SAMs). Only NetView commands or z/OS commands issued through NetView can be specified. For example, the MVS Z EOD command.

Notes:

1. OMVS and all local automation managers are always shutdown by SA z/OS automatically. Do not specify termination commands for OMVS or automation managers in PHASE1 or PHASE2.
2. Be aware that the NetView address space is still present and must stay up in order to signal the nearly termination of the system to GDPS.

The scenario is based on the provided best practice policies *BASE and *GDPS. For more details refer to the MVC entry GDPS_SYSTEM_SHUTDOWN in the *GDPS best practice policy.

Example Definition

The actions you take to shutdown z/OS systems from within GDPS are defined using the SYSTEM_SHUTDOWN message/user data policy item for the MVS Component entry type. These actions can include instructing SA z/OS to shutdown resources out of the affected dependency path of GDPS STOPAPPL, shutdown file systems, and so on.

Table 15. Example SYSTEM_SHUTDOWN Command Processing Entry

Cmd	Ps/Select	AutoFn/*	Command Text
	PHASE1		INGREQ RACF/APL/&SYSNAME. REQ=STOP PRECHECK=NO REMOVE=SYSGONE VERIFY=NO OUTMODE=LINE
	PHASE1		INGREQ RRS/APL/&SYSNAME. REQ=STOP PRECHECK=NO REMOVE=SYSGONE VERIFY=NO OUTMODE=LINE
	PHASE1		INGREQ GDPS_ALL/APG/&SYSNAME. REQ=STOP PRECHECK=NO REMOVE=SYSGONE VERIFY=NO OUTMODE=LINE
	PHASE1		INGREQ LOOKASIDE/APG/&SYSNAME. REQ=STOP PRECHECK=NO REMOVE=SYSGONE VERIFY=NO OUTMODE=LINE
	PHASE1		INGRCHCK BASE_SYS/APG/&SYSNAME.OBSERVED=(SO HA)

Table 15. Example SYSTEM_SHUTDOWN Command Processing Entry (continued)

Cmd	Ps/Select	AutoFn/*	Command Text
	PHASE1		INGRCHCK LOOKASIDE/APG/&SYSNAME.OBSERVED=(SO HA)
	PHASE2		MVS Z EOD

Table 15 on page 135 shows example definitions for the SYSTEM_SHUTDOWN entry that place stop votes against the listed resources in PHASE1 in a sequential order. The desired completion of the resource shutdown is processed in parallel. The specified INGRCHCK command at the end of the PHASE1 sequences waits for the completion of the stop requests for the specified resources.

For example:

```
INGRCHCK LOOKASIDE/APG/&SYSNAME OBSERVED=(SOFTDOWN HARDDOWN)
INGRCHCK LOOKASIDE/APG/&SYSNAME OBSERVED=(SOFTDOWN HA)
```

For more information about the INGRCHCK command, see *IBM Tivoli System Automation for z/OS Operator's Commands*.

If synchronization is necessary, the FDBK option for the INGREQ command permits waiting until the appropriate subsystem has been shutdown. The FDBK=WAIT option causes an INGREQ stop command to be processed sequentially. In this way it slows down the shutdown process.

The primary and all secondary automation managers (PAM and SAMs) on the local system will be shutdown by SA z/OS automatically unless they are moved to another system. OMVS will be shutdown by SA z/OS automatically too. Only the MVS Z OED command is issued in PHASE2.

Chapter 13. WTOR Processing

When System Automation for z/OS receives WTORs (write-to-operator-with-reply requests), it either automatically replies to them, or stores them if they are to be used for recovery or to shut down the subsystem that issued them. WTORs that are stored for later use are known as outstanding WTORs.

Process Flow of WTORs

All WTORs that are issued at a system should be forwarded to NetView. Otherwise SA z/OS is not able to process them.

From NetView V5R2 the following definition in the message revision table ensures that all WTORs are provided to NetView for automation:

```
UPON (ALWAYS)
  SELECT
  * Ensure all WTORs are being automated
    WHEN (WQE SUBSTR 345 C2D ^= "+0")
      REVISE("Y" AUTOMATE)
    OTHERWISE
  END
```

For earlier releases of NetView:

- The known WTORs that are to be forwarded to NetView have to be defined for automation in the MPF table
- The unknown WTORs have to be forwarded by means of an assembler exit

Incoming WTORs are processed by the NetView automation table (AT) and this triggers commands according to the processing purpose:

Called Generic Routine	Processing Purpose
ISSUEACT	<ol style="list-style-type: none">1. Issue commands or replies (or both) that have been defined to a subsystem.2. Store the WTOR if it has not been replied to.
ACTIVMSG, HALTMSG, TERMMSG	<ol style="list-style-type: none">1. Update the status of the subsystem that issued the WTOR.2. Issue defined commands or replies (or both).3. Store the WTOR if it has not been replied to.
INGMON	<ol style="list-style-type: none">1. Issue commands or replies (or both) that have been defined to a monitor resource.2. Store the WTOR if it has not been replied to.
OUTREP	Store the WTOR.

The commands (other than OUTREP) are routed to the first active task that is defined in the AT synonym %AOFOPGSSOPER%. Thus they are usually routed to the work operator of the subsystem that issued the WTOR. This is done based on the job name that is associated with the WTOR.

Generic routines that process WTORs from subsystems that are not defined in SA z/OS or are from MVS components are routed to tasks that the WTORs have been assigned to based on their message ID.

The OUTREP command is routed to the first active task that is defined in the AT synonym %AOFOPSYSSOPER%.

Actions in Response to Incoming WTORs

You can use the MESSAGES/USER DATA automation policy item to define what response SA z/OS should make to incoming WTORs for applications, monitor resources and MVS components, as follows:

- Use the CMD action (possibly combined with the CODE action) to define commands that are to be issued in response to an incoming WTOR.
- Use the REP action (possibly combined with the CODE action) to define a reply that is to be made immediately in response to an incoming WTOR.
- Use the AUTO action to define the incoming WTOR as a status message that changes the status of the subsystem that issued the WTOR.

NetView automation table statements are created that call the relevant command, depending on the defined actions.

If you used CODE definitions to define actions, the automation table statements that are created have to be supplemented with an OVR action to tell SA z/OS what variable information is to be extracted from the WTOR and how to pass this data as code values to the related command.

WTORs that have no actions defined for them are stored by SA z/OS via OUTREP. Appropriate automation table statements are created for this purpose.

Customizing how WTORs Are Stored by SA z/OS

SA z/OS keeps track of all outstanding WTORs that have not yet been replied to and displays them via SDF or NMC.

These outstanding WTORs include:

- Permanent outstanding WTORs that are issued by applications at startup and thus provide an interface for critical operator communication and shutdown
- WTORs that no replies have been defined for in the SA z/OS automation policy
- WTORs that were issued before SA z/OS had initialized or during down time of SA z/OS

You can use the automation policy to define the severity for outstanding WTORs and a priority that allows you to distinguish between primary and secondary WTORs:

Severity

The severity of a WTOR determines the color of the WTOR in SDF and NMC. The following values can be specified for the severity:

- | | |
|------------------|---|
| NORMAL | Ordinary messages that do not indicate a problem. |
| UNUSUAL | Messages that might indicate a problem. |
| IMPORTANT | Messages that indicate serious problems. |
| IGNORE | Messages that are to be ignored by SA z/OS. |

Priority

A primary WTOR is stored and can later be used for operator communication and to shut down the subsystem that issued it. In contrast, secondary WTORs are replied to immediately, or may be stored to be displayed in SDF and NMC.

This customization is done with code definitions in the MESSAGES/USER DATA policy item for a message ID of WTORS. For details see the description of the OUTREP command in *IBM Tivoli System Automation for z/OS Programmer's Reference*.

Processing of Primary WTORs

To prevent SA z/OS from replying to primary WTORs as soon as they are received, the replies are *not* defined directly for the message ID of the primary WTOR. Instead, the issuing of replies to primary WTORs is invoked by other messages or executed commands. Thus the replies for primary WTORs that are to be deferred are defined for the ID of these invoking messages, or the replies to be issued are provided for a predetermined message ID. For example, the SHUTDOWN automation policy item is used to define the replies to be issued during shutdown.

The reply ID of any stored, primary WTOR to a subsystem can be used for operator communication or the shutdown of this subsystem.

If SA z/OS has to communicate with a subsystem by issuing a reply but an outstanding WTOR has not yet been stored for the subsystem, the RETRY option is used to wait for the required WTOR.

You can define multiple replies with the same pass or selection option for a message ID. These replies can be used in response to a sequence of incoming primary WTORs.

Example

Message ABC123D is issued by application ABCAPPL during startup as permanent, outstanding WTOR and SA z/OS stores it as primary WTOR for this application. During the lifetime of the application, whenever message ABC789I is issued in special situations, a reply should be issued to the permanent, outstanding WTOR ABC123D for this application. The MESSAGES/USER DATA automation policy item for message ID ABC789I of the application is used to define this reply.

When message ABC789I is issued by the application, SA z/OS retrieves the reply ID of the permanent, outstanding WTOR and issues command MVS R 117,ABC RESTORE, as shown in Figure 24 on page 140.

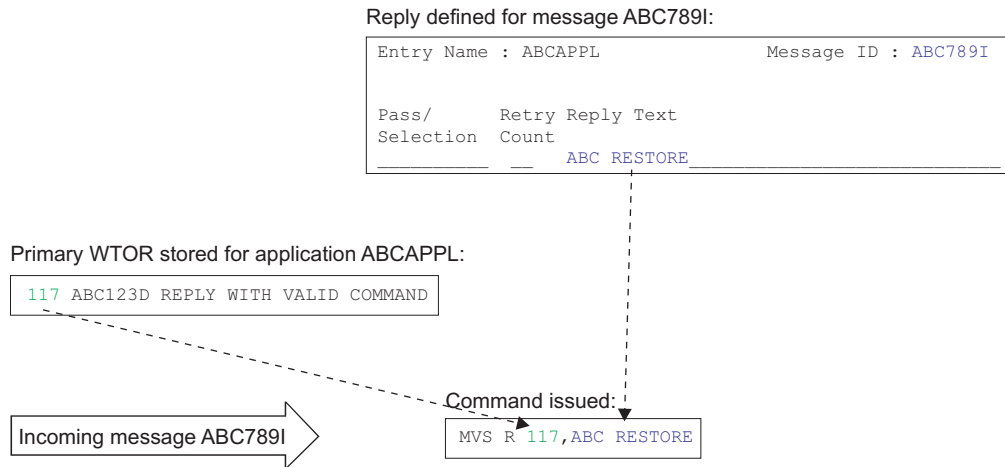

Figure 24. Example Processing of a Primary WTOR

Restrictions

The reply IDs of a subsystem's outstanding primary WTORS are stored by SA z/OS as a blank-separated list without leading zeros. The storage for this is restricted to 255 bytes. If this limit is reached, the reply IDs of further incoming primary WTORS are ignored.

Usage Notes

When storing incoming WTORS, a search for code definitions for the message ID, WTORS, is first made in the entry for the subsystem that issued the WTOR. If the subsystem itself cannot be found in the automation policy or the code definitions that are searched for are not found for the subsystem, they are searched for under the MVSESA entry. For subsystems such as IMS or NetView that have a permanent outstanding reply, you should specify the code definitions for the subsystem entries themselves instead of MVSESA. This improves performance by reducing searches within the automation policy.

Chapter 14. SA z/OS User Exits

To allow user-specific activities that are not covered by the customization dialogs, SA z/OS provides support for the following classes of user exits:

- Initialization exits that are called at the start of SA z/OS initialization, before message AOF603D is issued, see “Initialization Exits” on page 142
- Static exits that are called at fixed points during SA z/OS processing, see “Static Exits” on page 144
- Flag exits that are called when SA z/OS needs to evaluate an automation flag, see “Flag Exits” on page 147
- Customization Dialog exits that can be called during certain phases when working with the customization dialog, see “Customization Dialog Exits” on page 150
- Command exits that can be called during the processing of certain commands, see “Command Exits” on page 154

Additionally, SA z/OS has a number of facilities that behave in an exit-like manner, see “Pseudo-Exits” on page 158.

Figure 25 on page 142 shows the sequence that exits may be invoked in during SA z/OS initialization.

Initialization Exits

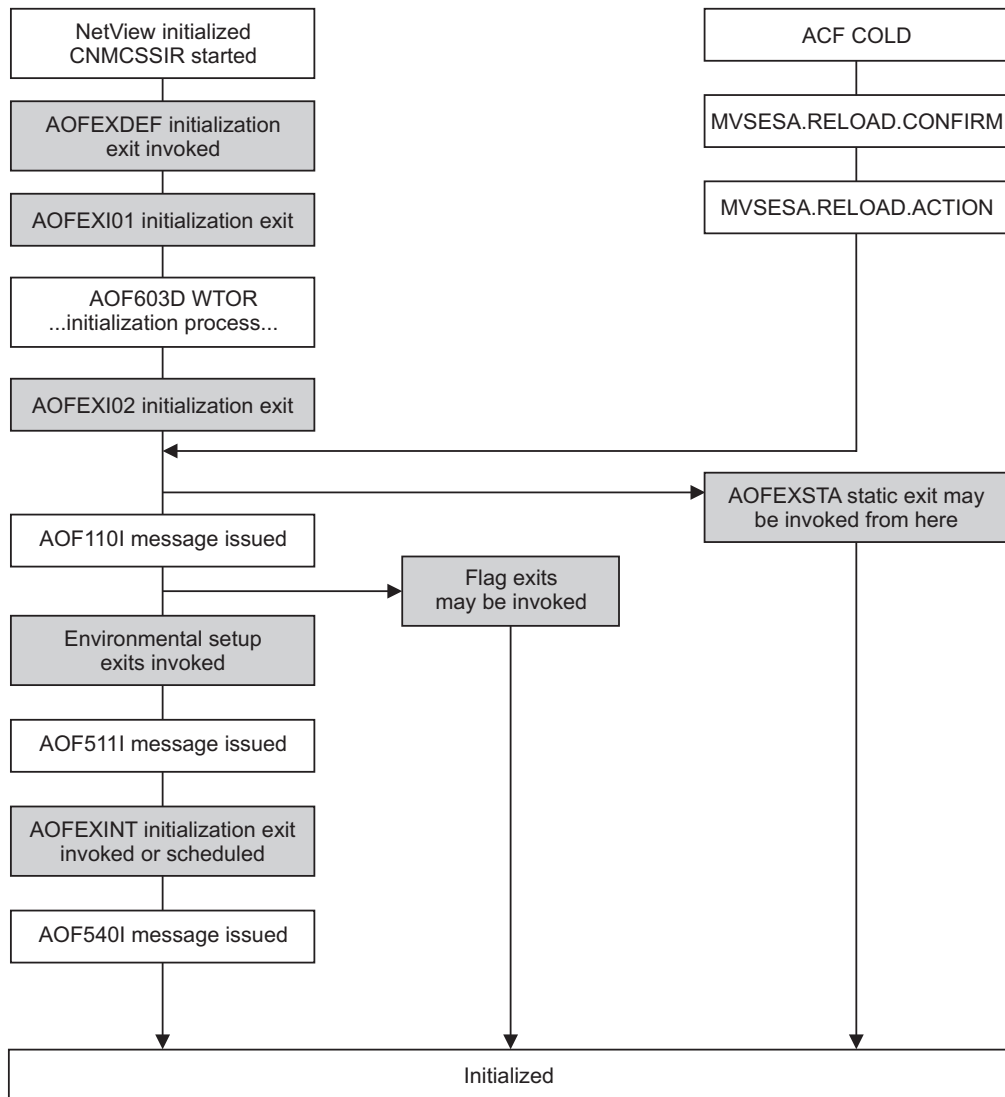

Figure 25. SA z/OS Exit Sequence during SA z/OS Initialization

Initialization Exits

These exits are invoked at the start of SA z/OS initialization, before message AOF603D is issued.

Environmental Setup Exits

The SA z/OS customization dialog allows you to define a string of exits that are invoked during SA z/OS initialization processing. These exits are defined using the SYSTEM INFO policy item of the System (SYS) entry type. See *IBM Tivoli System Automation for z/OS Defining Automation Policy* for more information.

Environmental setup exits are invoked after SA z/OS has started its various tasks, but before the primary automation table has been loaded. You can use these exits to initiate your own automation, but some SA z/OS services may be unavailable because SA z/OS has not yet finished initializing when these exits are called. In particular, status information may be inaccurate because SA z/OS may not have finished resynchronization. Environmental setup exits run on AUTO1.

Parameters

Parameters are passed in sequence, delimited by blanks.

INITIALIZATION

INITIALIZATION is a constant.

RELOAD | REFRESH | IPL | RECYCLE

RELOAD Indicates that the automation control file has been reloaded.
REFRESH Indicates that the automation control file has been refreshed.
IPL Indicates that SA z/OS has just been restarted after a system IPL.
RECYCLE Indicates that NetView has been restarted.

Return Codes

0 is expected. If you return a non-zero return code you may prevent other exits from being invoked or disrupt SA z/OS initialization.

Usage Notes

- These exits are not driven if you run RESYNC.
- Unlike the other static exits, you must specify the name of the routine or routines to invoke in the automation control file.

AOFEXDEF

This exit is called at the start of SA z/OS initialization, before message AOF603D is issued. For example, using AOFEXDEF you can load a different MPF table.

This exit is run on AUTO1.

Parameters: None.

Return Codes: 0 is expected.

AOFEXI01

This exit is invoked before the AOF603D ENTER AUTOMATION OPTIONS reply is issued. It is invoked in a NetView PIPE and gets the data that is displayed in the AOF767I message as input in the default SAFE. With this exit you can add or remove lines from the message and add additional options to the reply.

Parameters: None.

Return Codes: 0 is expected.

AOFEXI02

This exit is invoked after the operator has replied to the AOF603D reply. It gets the operator's response to the reply as input in the default safe and it can remove, add, or change the options that the operator has entered.

Parameters: None.

Return Codes: 0 is expected.

AOFEXI03

This exit is invoked before SA z/OS loads NetView automation table. It can be used to create statistics of the currently loaded ATs. Together with the AT listings that SA z/OS produces at load, these statistics can be used for any purpose.

Initialization Exits

Parameters: None.

Return Codes: 0 is expected.

AOFEXI04

This exit is invoked after SA z/OS loads NetView automation tables. It can be used to store the AT listings that SA z/OS produces at load.

Parameters: None.

Return Codes: 0 is expected.

AOFEXI05

This exit is called before either an ACF load or refresh takes place. The parameter indicates what action the automation agent is going to process: REFRESH or LOAD.

Parameters: Type of ACF action (REFRESH or LOAD).

Return Codes: 0 (**Note:** the return code is ignored by the caller).

AOFEXI06

This exit is called after an ACF process (LOAD or REFRESH) has completed (AOFCOMPL=YES) and before the AOF540I message is issued.

Parameters: Type of ACF action (REFRESH or LOAD).

Return Codes: 0 (**Note:** the return code is ignored by the caller).

AOFEXINT

This exit is called when SA z/OS initialization is complete, before message AOF540I is issued. You can use AOFEXINT to call your own initialization processing after SA z/OS has finished. Refer also to the description of the global variable AOFSERXINT in "AOFSERXINT global variable" on page 203.

Parameters: The input parameter is the *Starttype* which is one of the following: RESYNC, IPL, REFRESH, RELOAD, RECYCLE.

Return Codes: 0 is expected.

Static Exits

These exits are invoked at fixed points in SA z/OS processing. They are always invoked if they are found in the DSICLD concatenation. Positive return codes from these exits are generally ignored, though it is recommended that you always exit with a return code of 0.

The main purpose of static exits is to allow you to take your own actions at specific points during SA z/OS processing. The static exits available are described below.

AOFEXSTA

This exit is called from AOCUPDT every time the automation status of an application is updated.

Note: It is not necessary for AOCUPDT to *change* an application automation status for this exit to be called. The exit is still invoked if the update does not result in a change of status.

AOFEXSTA can be used to perform any special status transition processing that cannot be triggered by other methods.

Note: This exit is invoked frequently, and is invoked at times when SA z/OS is not fully initialized. Your exit code should be as robust and efficient as possible.

SA z/OS attempts to load AOFEXSTA into storage at initialization. If this attempt fails, AOFEXSTA is not invoked on any AOCUPDT calls. To activate the exit it must be present in the DSICLD concatenation when the automation control file is loaded or reloaded.

AOFEXSTA runs on the task that called AOCUPDT, after all other processing has finished.

Attention: AOFEXSTA is scheduled with EXCMD opid(). If your operators are issuing commands that change application statuses and you want to use AOFEXSTA, you may have to modify your command authorization definitions.

Parameters: Parameters are passed in sequence, delimited by commas.

Resource type

SA z/OS uses types of SUBSYSTEM, MVSESA, WTORS, and SPOOL. Other users may use other resource types.

Resource Name

For an application, this is the name of the subsystem it is defined as.

Automation Status

For an application, this is one of the automation statuses that is supported by SA z/OS.

SDF Root

This is the SDF Root, as specified in the customization dialog, for the system that originated the status update. Generally the exit is driven only for status changes on other systems on the automation focal point.

Return Codes: 0 is expected.

Restrictions:

- Because the exit is scheduled with EXCMD, the status update and subsequent processing in the caller will have completed before the exit is invoked.
- Check the resource type and the SDF root to ensure you are only trying to process the right things.
- Plan carefully before you take any action to change the status of an application from this exit. If you are not careful you may create a loop (AOCUPDT to AOFEXSTA to AOCUPDT to AOFEXSTA).

Note:

Consider using ISSUEACT or status change commands as alternatives to AOFEXSTA, because AOFEXSTA is invoked for **every** status update that seriously degrades performance.

If the advanced automation options are set up appropriately, the ACTIVMSG and TERMMMSG commands issues commands whenever an application changes to a particular status. It may be more appropriate to place commands here, rather than in the status change exit, which gets driven for every status update of every resource. It is recommended to use status change commands for better performance.

AOFEXX02

The exit allows the installation to decide whether or not an SDF update should be performed for the specified resource.

A non-zero return code from the exit causes the SDF update processing to be skipped, both locally as well as for the focal point.

This exit is called prior to posting entries to SDF to provide the facility to filter out specific events.

Refer to the sample exit for details of the parameters passed to the exit and the return codes.

AOFEXX03

The exit allows the installation to decide whether or not status change notification should be forwarded to the NMC focal point for the specified resource.

A non-zero return code from the exit causes status change forwarding to be skipped.

This exit is called prior to posting entries to NMC to provide the facility to filter out specific events.

Refer to the sample exit for details of the parameters passed to the exit and the return codes.

AOFEXX04

This exit is called from CHKTHRES every time that this routine is called to check the number of errors recorded in the automation status file for a given resource against error thresholds that are defined in the automation control file.

Refer to the sample exit for details of the parameters passed to the exit and the return codes.

AOFEXX15

This exit allows you to write a log entry for each status change notification that arrives at the NMC focal point.

Refer to the sample exit for details of the parameters passed to the exit.

AOFEXX16

This exit allows you to repair your own minor resources following a topology resynchronization or rebuild.

No parameters are passed to this exit.

Flag Exits

Using automation flag exits you can cause your automated operations code to exit normal SA z/OS processing to an external source, such as a scheduling function, to determine whether automation should be on or off for a given resource at that particular instant.

Flag exits can be defined for any flag (AUTOMATION, INITSTART, START, RECOVERY, TERMINATE, or RESTART) on any major or minor resource. See the description of the MINOR RESOURCES policy item in *IBM Tivoli System Automation for z/OS Defining Automation Policy* for more information on minor resources.

You can specify multiple exits for each flag.

A flag exit is invoked only if SA z/OS checks the value of the current flag setting during the flag evaluation process of AOCQRY, as described in *IBM Tivoli System Automation for z/OS Programmer's Reference*. If one of the global or specific flags, which have to be checked in one iteration step during the evaluation process over the inheritance hierarchy levels is set to NO, the other flag no longer has to be checked.

With the default BYPASS option of AOCQRY, exits that have been defined for the automation flag of a resource are executed when that automation flag is checked during flag evaluation and the flag value is EXITS.

With the FORCED option of AOCQRY, exits that have been defined for the automation flag of a resource are executed when that automation flag is checked during flag evaluation, independent of the flag value, as long as it is not empty.

If an automation flag is set to EXITS, the flag value is assumed to be YES during flag checking as long as none of the exits that have been defined for the checked resource switch the flag to NO. Exits that are forced to execute do not change the flag value.

Flag settings are determined by:

- The automation policy settings
- NOAUTO periods (the flag is OFF during a NOAUTO period)
- The user-entered INGAUTO command

For example, if you enter the following flag settings:

Resource	Flag	Setting
DEFAULTS	AUTOMATION	YES
SUBSYSTEM	RESTART	NO
JES2	AUTOMATION	Exit J2AUT
JES2	START	Exit J2STR

Flag Exits

Resource	Flag	Setting
JES2	RECOVERY	NO
JES2	TERMINATE	Exits J2SD1 and J2SD2

The effective flags for JES2 are:

Flag	Effective setting
AUTOMATION	YES, Exit J2AUT
INITSTART	YES
START	YES, Exit J2STR
RECOVERY	NO
TERMINATE	YES, Exits J2SD1 and J2SD2
RESTART	NO

When SA z/OS checks the current value of any flag for the JES2 application, the process is as follows:

Flag	Process
AUTOMATION	<ol style="list-style-type: none"> 1. Call exit J2AUT. 2. If the exit returns: <ul style="list-style-type: none"> • RC=0: AUTOMATION flag is YES • RC>0: AUTOMATION flag is NO
INITSTART	<ol style="list-style-type: none"> 1. Call exit J2AUT (because of AUTOMATION global flag). 2. If the exit returns: <ul style="list-style-type: none"> • RC=0: INITSTART flag is YES • RC>0: INITSTART flag is NO
START	<ol style="list-style-type: none"> 1. Call exit J2AUT (because of AUTOMATION global flag). 2. If exit returns RC=0, call exit J2STR. 3. If: <ul style="list-style-type: none"> • Both flags return RC=0: START flag is YES • Either flag returns RC>0: START flag is NO
RECOVERY	RECOVERY flag is NO
TERMINATE	<ol style="list-style-type: none"> 1. Call exit J2AUT (because of AUTOMATION global flag). 2. If exit returns RC=0, call exit J2SD1. 3. If exit J2SD1 returns RC=0, call exit J2SD2. 4. If: <ul style="list-style-type: none"> • Both flags return RC=0: TERMINATE flag is YES • Either flag returns RC>0: TERMINATE flag is NO
RESTART	<ol style="list-style-type: none"> 1. Call exit J2AUT (because of AUTOMATION global flag). 2. Regardless of the return code, the RESTART flag is NO.

Note: Normally the START and RECOVERY flags are checked by SA z/OS only for minor resources but not for the subsystem itself.

Parameters

Parameters are supplied in sequence, delimited by blanks.

Flag

This is the name of the flag that is being checked. Possible values are AUTOMATION, INITSTART, START, RECOVERY, TERMINATE or RESTART.

Time Setting

Time Setting is a constant. It can be either:

AUTO

Automation is currently turned on.

NOAUTO

Automation is currently turned off.

A value of NOAUTO is possible only if AOCQRY is called with the parameter EXITS=FORCED.

Note: This ensures that the exit is invoked, but it is not possible for an exit to override a NOAUTO period.

Resource Name

This is the name of the resource that the flag is being requested for. For minor resources it contains the fully qualified minor resource name. Given no flag definition for TSO.USER.MAG1 and an exit enabled for TSO.USER, the resource name passed to the exit would be TSO.USER.MAG1 if a check was made for TSO.USER.MAG1.

Resource Type

This is the type of the resource that the flag is being requested for. Possible values are DEFAULTS, SUBSYSTEM, or MVSESA (the value of the common global variable AOFSYSTEM).

Target Prefix

This is the TGPFX value with which AOCQRY was invoked. If TGPFX is not specified, the value SUB is passed.

Task Global Variables

The task global variables that are set by the AOCQRY command are available in flag exits.

Return Codes

- 0 Automation is allowed by the exit.
- > 0 Automation is not allowed.

Notes:

1. Flag exits are always called through the AOCQRY command. This means that the task global variables for the resource have been primed and are available for use. Normally the names of the task global variables are prefixed with SUB, but if AOCQRY is called with a different value for parameter TGPFX, they are found in variables that are prefixed with that value. You should use the TGPFX parameter that is passed to locate the task global variables.
2. The set of task global variables that are set by AOCQRY depends on the values for the resource and request parameter. Make sure that the task global variables that you rely on in your exit are being set up.

Flag Exits

3. If an exit is invoked for a minor resource, the task global variables are set for the major resource that is associated with that minor resource.
4. If you call AOCQRY from within your exit you must specify a TGPFEX value that is different from the TGPFEX parameter value you were passed. You are responsible for ensuring the uniqueness of all TGPFEXs if you nest AOCQRY exits. Because this can become quite complex, it is recommended you avoid nesting exits.
5. Do not code calls to ACFCMD, ACFREP, or CDEMATCH because these use task global variables that are prefixed with SUB that may not be set up for the application that you want to process.
6. Do not change any of the task global variables that have been set by AOCQRY.
7. Flag exits may be called frequently, so performance is important.
8. If AOCQRY is specified with FORCE and multiple exits are defined for a flag, the exits are called in order.

Customization Dialog Exits

SA z/OS provides a series of user exits that can be invoked during certain phases while working with the customization dialog. They are:

- “User Exits for BUILD Processing”
- “User Exits for COPY Processing” on page 151
- “User Exits for DELETE Processing” on page 152
- “User Exits for CONVERT Processing” on page 152
- “User Exits for RENAME, and IMPORT Functions” on page 153

“Invocation of Customization Dialog Exits” on page 153 provides information on how to activate the user exits.

User Exits for BUILD Processing

The following user exits are provided for the process of building the automation control file.

- **INGEX10::** This is called before the automation control file build function starts. This exit is only available when the build process is initiated from the customization dialogs.
- **INGEX01::** This is called before the automation control file build function starts. This exit is available when the build process is initiated from the customization dialogs, from a batch job submitted via the customization dialogs, or from a batch job submitted independently from the customization dialogs.
When a BUILD mode of BATCH is selected in the customization dialogs, the JCL for the batch job is submitted and INGEX01 is called when the job begins execution and before the automation control file build function starts in batch.
- **INGEX02::** This is called after the configuration file build has ended. This exit is available when the BUILD process is initiated from the customization dialogs, from a batch job submitted through the customization dialogs, or from a batch job submitted independently from the customization dialogs.

The following parameters are passed to both INGEX01 and INGEX02 exits, separated by commas:

- Parm1 = PolicyDB name
- Parm2 = Enterprise name
- Parm3 = BUILD output data set
- Parm4 = entry type (or blank)

- Parm5 = entry name (or blank)
- Parm6 = BUILD type (MOD/ALL)
- Parm7 = BUILD mode (ONLINE/BATCH)
- Parm8 = Configuration (0=NORMAL/1=ALTERNATE)
- Parm9 = Sysplex name (or blank)
- Parm10 = Build option (1,2, or 3)
- Parm11 = return code (for INGEX02 *only*)

If user exit INGEX10 produces return code RC = 0, build processing continues. If a return code RC > 0 is produced, an error message is returned and the build processing terminates.

If user exit INGEX10 ends with return code RC > 0, user exits INGEX01 and INGEX02 are not called. Processing terminates.

If user exit INGEX10 ends with return code RC > 0 and a BUILD mode of BATCH was selected in the customization dialogs, no JCL is submitted to run the build in batch. Processing terminates.

If user exit INGEX01 produces return code RC = 0, build processing continues. If a return code RC > 0 is produced, an error message is returned and build processing terminates. If the build is run in batch mode, and a return code RC > 0 is produced, the job finishes with a return code RC 08.

If user exit INGEX01 ended with return code RC > 0, user exit INGEX02 is not called because the build function was not started. Processing terminates.

User exit INGEX02 is always called when the BUILD process has started, irrespective of whether it has completed or not.

If user exit INGEX02 produces a return code RC > 0, an error message is displayed. If the build is run in batch mode, and a return code RC > 0 is produced, the job completes with a return code RC 04. If a severe build error occurred, the job completes with a return code RC 20.

The return codes and their meaning are as follows:

- 0 Successful
- 4 Build with minor errors
- 12 No build (data is inconsistent)
- 20 No build (severe errors)

User Exits for COPY Processing

Two user exits are implemented for the COPY processing.

1. **INGEX03:** This is called before the COPY function starts. The following parameters are passed:
 - Entry name of the entry to be copied to (target)
 - Entry name of the entry to be copied from (source)
 - Entry type (for example, APL)
2. **INGEX04:** This is called after the COPY function has ended. The following parameters are passed:
 - Entry name of the entry to be copied to (target)
 - Entry name of the entry to be copied from (source)

Customization Dialog Exits

- Entry type (for example, APL)
- Indicator whether the COPY process was successful or not (S=successful, U=unsuccessful)

If user exit INGEX03 produces return code RC = 0, COPY processing continues. If a return code RC > 0 is produced, an error message is displayed, the COPY function does not start, and processing terminates.

If user exit INGEX03 ended with return code RC > 0, the user exit INGEX04 is not called because the COPY processing will terminate.

User exit INGEX04 is always called once the COPY function has started. The information about the success or failure of the COPY function is passed as a parameter.

If user exit INGEX04 produces a return code RC > 0, an error message is displayed.

User Exits for DELETE Processing

Two user exits are implemented for the DELETE processing.

1. **INGEX05:** This is called before the DELETE process starts. The following parameters are passed:
 - Entry name of the entry to be deleted
 - Entry type (for example, APL)
2. **INGEX06:** This is called after the DELETE process has ended. The following parameters are passed:
 - Entry name of the entry to be deleted
 - Entry type (for example, APL)
 - Indicator whether the DELETE process was successful or not (S=successful, U=unsuccessful)

If user exit INGEX05 produces return code RC = 0, the DELETE processing continues. If a return code RC > 0 is produced, an error message is displayed, the DELETE function does not start and the processing terminates.

If user exit INGEX05 ended with a return code RC > 0, user exit INGEX06 is not called because the DELETE processing will terminate.

User exit INGEX06 is always called once the DELETE function has started. The information about the success or failure of the DELETE function is passed as a parameter.

If user exit INGEX06 produces a return code RC > 0, an error message is displayed.

User Exits for CONVERT Processing

Two user exits are implemented for the CONVERT processing.

1. **INGEX07:** This is called before the CONVERT process starts. No parameters are passed.
2. **INGEX08:** This is called after the CONVERT process has ended. No parameters are passed.

If user exit INGEX07 produces return code RC = 0, the CONVERT processing continues. If a return code RC > 0 is produced, an error message is displayed, the CONVERT function does not start and the processing terminates.

If user exit INGEX07 ended with a return code RC > 0, user exit INGEX08 is not called because the CONVERT processing will terminate.

User exit INGEX08 is always called once the CONVERT function has started.

If user exit INGEX08 produces a return code RC > 0, an error message is displayed.

User Exits for RENAME, and IMPORT Functions

The following user exits are provided for the renaming, and import functions.

1. **INGEX09:** This is called when the log data set is switched, usually because the current data set is full. One parameter is passed:
 - Name of current log data set, for example, the data set that went out of space
2. **INGEX15:** This is called before an entry is renamed. The following parameters are passed:
 - Entry Name
 - Entry Type
3. **INGEX16:** This is called after an entry has been renamed. The following parameters are passed:
 - Entry Type
 - Old Entry Name
 - New Entry Name
4. **INGEX17:** This is called during the IMPORT function, when reading data from the source policy database. One parameter is passed:
 - Name of copy data work table. This table contains the entry types and entry names of the data to be copied.
5. **INGEX18:** This is called after the IMPORT function has ended. INGEX18 is only called if INGEX17 was called at the beginning of the IMPORT function. If checks have been made that prevent INGEX17 being called, INGEX18 is not called either.

One parameter is passed:

 - Indicator whether the IMPORT process was successful (S=successful, U=unsuccessful)
6. **INGEX20:** This is called after the links have been changed. No parameters are passed.
7. **INGEX21:** This is called before the policy database report is invoked. No parameters are passed.

Invocation of Customization Dialog Exits

The user exits are part of the SA z/OS product. Therefore they are supplied in the same data set as all other ISPF REXX modules (part of SINGIREX). All of the supplied samples just perform a 'RETURN' with return code RC=0.

You have two possibilities to apply your user modifications:

Customization Dialog Exits

1. Edit the user exit (or exits) in the supplied library. Your changes do not have any consequences for the code of the SA z/OS product. These exits are not serviced (via PTF) by IBM because they do not include any code at the time of product delivery.
2. Supply the modified user exit in a private data set. Then you have to concatenate your private data set to your SYSEXEC library chain. As INGDLG supports multiple data set names specified for ddname SYSEXEC, this can be done in the following way:

```
INGDLG SELECT(ADMIN) ALLOCATE(YES) HLQ(SYS1)
        SYSEXEC(usr.private.dsn SYS1.SINGIREX)
```

This example assumes that the high level qualifier of the data sets where the IBM supplied parts exist is SYS1.

If you specify the SYSEXEC parameter in the INGDLG call, you need to specify the IBM supplied library explicitly with its **fully qualified** data set name.

Command Exits

These exits can be called during the processing of certain commands.

AOFEXC00

The AOFEXC00 exit routine is called if the selection L has been entered in the AOC command dialog. No parameters are passed to the routine. The purpose of this routine is to act as the starting point for installation-provided local functions.

AOFEXC01

If this exit is defined, it is invoked during INGREQ processing before Precheck and Verification processing.

The exit allows you to modify the parameters that are passed.

Refer to the sample exit for details of the parameters that are passed to the exit and the return codes.

AOFEXC02

If this exit routine is defined, it is invoked during INGSCHED processing before the schedule override file is updated. The parameters are positional and separated by a comma.

Refer to the sample exit for details of the parameters that are passed to the exit and the return codes.

AOFEXC03

If this exit routine is defined, it is invoked by the DISPINFO command slave to retrieve user-supplied information about the subsystem. The input for the routine is the subsystem name. The data returned by the exit is shown as part of the DISPINFO output.

Refer to the sample exit for details of the parameters that are passed to the exit and the return codes.

AOFEXC04

If this exit routine is defined, the command code U is supported for the DISPMTR, DISPSTAT, and INGLIST commands. The input for the AOFEXC04 exit is the

resource name (subsystem name for DISPSTAT) and the location of the resource. The location is either the system name if the resource resides on a system member of the local sysplex, or the domain ID if the resource resides on a system which is outside of the local sysplex. The parameters are separated by a comma.

Refer to the sample exit for details of the parameters that are passed to the exit and the return codes.

AOFEXC05

This exist is called on entry of the INGLIST command. The exit allows you to modify the input parameters. The modified input parameters are returned to the INGLIST command by sending a message (single or multiline) to the console, for example:

```
OBSERVED=* DESIRED=*
```

Refer to the sample exit for details of the parameters that are passed to the exit and the return codes.

AOFEXC06

| This exist is called on entry of the INGSET command with the SET action. The exit
| allows you to perform authorization checking of the resources for the INGSET
| command.

Refer to the sample exit for details of the parameters that are passed to the exit and the return codes.

AOFEXC07

This exit is called on entry of the INGIMS command. The exit allows you to perform authorization checking of the IMS subsystem that is the subject of the INGIMS command.

Refer to the sample exit for details of the parameters that are passed to the exit and the return codes.

AOFEXC08

| This exit is called on entry of the INGVOTE command. The exit allows you to
| perform authorization checking of the resources for the INGVOTE command.
| Because the INGSET CANCEL/KILL action uses the INGVOTE command, this exit
| is also called when performing this action.

Refer to the sample exit for details of the parameters that are passed to the exit and the return codes.

AOFEXC09

This exit is called on entry of the SETSTATE command. The exit allows you to perform authorization checking of the resources for the SETSTATE command.

Refer to the sample exit for details of the parameters that are passed to the exit and the return codes.

AOFEXC10

This exit is called on entry of the INGEVENT command. The exit allows you to perform authorization checking of the resources for the INGEVENT command.

Command Exits

Refer to the sample exit for details of the parameters that are passed to the exit and the return codes.

AOFEXC11

This exit is called on entry of the INGCICS command. The exit allows you to perform authorization checking of the resources for the INGCICS command.

Refer to the sample exit for details of the parameters that are passed to the exit and the return codes.

AOFEXC12

This exit is called on entry to the command slave (EVJRVCMD) for the TWS command server (EVJRVCMD0). The exit allows you to perform authorization checking of the commands scheduled via the TWS batch interface (EVJRYCMD) against the user ID of the batch job requesting the command.

Refer to the sample exit for details of the parameters passed to the exit and the return codes.

AOFEXC13

This exit is called on entry to the INGGROUP and INGMOVE commands. The exit allows you to perform authorization checking of the user ID that issues the command.

Refer to the sample exit for details of the parameters passed to the exit and the return codes.

AOFEXC14

This exit is called by the SA z/OS GDPS termination routine (INGRGDPS) after stopping the PAM or selecting a SAM to become the PAM.

Refer to the sample exit for details of the return codes.

AOFEXC15

If this exit routine is defined, it is invoked during INGREQ processing after the GO confirmation has been received.

The user exit is called in a PIPE. Refer to the sample exit for details of the parameters that are passed to the exit.

AOFEXC16

This exit is invoked by the INGTHRES command prior to updating or deleting the thresholds for a given resource. It allows you to perform authorization checking of the requested action. If the exit returns with a non-zero return code and additional data is written to the console, this data is shown in the message panel. If no additional data is passed back in the exit, message AOF227I is issued.

Refer to the sample exit for details of the parameters that are passed to the exit and the return codes.

AOFEXC17

This exit is invoked by the INGALERT command. It allows you to:

- Modify the event text
- Reduce the Inform List with event notification targets such as IOM, EIF, TTT, and USR
- Modify the value that is returned from the matching code definition with information such as the event severity or whether to ignore the event

Refer to the sample exit for details of the parameters that are passed to the exit and the return codes.

AOFEXC18

This exit is invoked by the INGLKUP command. It is driven prior to stopping or canceling the specified address space. It allows you to perform authorization checking of the requested action. If the exit returns with a non-zero return code and additional data is written to the console, this data is shown in the message panel. If no additional data is passed back in the exit, message AOF227I is issued.

Refer to the sample exit for details of the parameters that are passed to the exit and the return codes.

AOFEXC19

This exit is invoked by the INGAMS command. It is driven in the following cases:

- Enabling or disabling access to the takeover file
- Suspending or resuming systems
- Refreshing the configuration
- Performing a diagnostic action (starting or stopping recording, taking a snapshot)
- Switching the primary automation manager

The exit allows you to perform authorization checking of the INGAMS command. If the exit returns with a non-zero return code and additional data is written to the console, this data is shown in the message panel. If no additional data is passed back in the exit, message AOF227I is issued.

Refer to the sample exit for details of the parameters that are passed to the exit and the return codes.

AOFEXC20

This exit is called when a command is passed via the TWS request interface. The exit allows the installation to perform authorization checking. The exit allows the user to modify the command that is passed. The modified command must be returned by sending a message (single-line) to the console.

The installation exit is called in a PIPE. If the exit returns a bad return code and additional data is written to the console, this data is written in the netlog. If no additional data is passed in the exit, message AOF227I is issued.

Refer to the sample exit for details of the parameters that are passed to the exit and the return codes.

Command Exits

AOFEXC21

This exit is invoked by the INGOPC command with the option REQ=MOD. It allows you to perform authorization checking of the requested action. If the exit returns with a non-zero return code and additional data is written to the console, this data is shown in the message panel. If no additional data is passed back in the exit, message AOF227I is issued.

Refer to the sample exit for details of the parameters that are passed to the exit and the return codes.

AOFEXC22

This exit is called when a trouble ticket is created using the INGALERT command. It allows you to determine the trouble ticket detail data that is to be written to the detail data set.

Refer to the sample exit for details of the parameters that are passed to the exit and the return codes.

AOFEXC23

This exit is invoked when a request is passed via the TWS interface. It allows you to perform authorization checking of the requested action. If the exit returns a non-zero return code and additional data is written to the console, this data is taken as a message. If no additional data is passed back in the exit, message AOF227I is issued.

Refer to the sample exit for details of the parameters that are passed to the exit and the return codes.

Pseudo-Exits

This section discusses a number of places where SA z/OS either makes special use of a flag exit or has a function with certain, exit-like, qualities.

Automation Control File Reload Permission Exit

When an operator issues the ACF COLD command, SA z/OS checks the global AUTOMATION flag of minor resource MVSESA.RELOAD.CONFIRM. If the flag is set to NO, the automation control file reload is not allowed. If the flag is set to YES, the task global AOFCONFIRM is checked. If AOFCONFIRM has been set to a non-null value, the user is prompted to confirm that they want the automation control file to be reloaded.

Notes:

1. Note that an exit can be associated with the global AUTOMATION flag for this resource.
2. An automation control file cannot be loaded if the global AUTOMATION flag for the major resource MVSESA is set to N. If the global AUTOMATION flag for the minor resource MVSESA.RELOAD.CONFIRM is set to Y, reloading the ACF is permitted.

Automation Control File Reload Action Exit

After the automation control file reload permission exit is checked, when SA z/OS is committed to reloading the automation control file, it checks the global

AUTOMATION flag for minor resource MVSESA.RELOAD.ACTION. The actual setting of this flag (ON or OFF) is ignored, but any exits defined for it are invoked. All exits should return a return code of 0.

Subsystem Up at Initialization Commands

Using the customization dialog you can specify commands that are run if SA z/OS finishes resynchronizing statuses and an application is found to be up. These commands can be useful for synchronizing local automation that has been built on top of SA z/OS.

Testing Exits

Exits should be well tested with a variety of different input parameters before they are put into production. For exits that need AOCQRY task globals, you can call AOCQRY to set up the globals without evaluating the flag exits, and then invoke the exit on its own for testing purposes. This method saves the overhead of calling AOCQRY every time you run the exit.

Attention:

If you have a syntax error or a no-value-condition in your exit it can cause parts of SA z/OS to abend, resulting in severe disruption of your automation.

Testing Exits

Chapter 15. Automation Solutions

SA z/OS provides solutions that enable automatic processing of z/OS components, data sets and job scheduling systems as well as automation procedures that are useful tools in the automation processing context. By using these prefabricated automation procedures you can save the time to develop your own procedures to handle the processing in corresponding situations.

In particular these automation routines provide solutions for:

- “LOGREC Data Set Processing” on page 162
- “SMF Data Set Processing” on page 162
- “SYSLOG Processing” on page 162
- “System Log Failure Recovery” on page 162
- “SVC Dump Processing” on page 163
- “Deletion of Processed WTORs from the Display” on page 163
- “AMRF Buffer Shortage Processing” on page 163
- “JES2 Spool Monitoring” on page 61
- “Drain Processing Prior to JES2 Shutdown” on page 164
- “TWS Automation Operation” on page 164
- “IMS Transaction Recovery” on page 164

The solutions for automatic processing of these situations include definitions in the automation configuration files and automation procedures.

It is common to all the solutions that are provided that the automation procedures first determine whether automation is allowed by checking the corresponding automation flags with the AOCQRY command. See *IBM Tivoli System Automation for z/OS Defining Automation Policy* for further information concerning types and settings of automation flags. Use the DISPFLGS command to display or temporarily change the current settings of the automation flags.

Some of the automation routines respond to messages by issuing commands from the automation configuration files. Most of these automation routines keep track of the reception of these messages and compare the frequency of the incoming messages with predefined thresholds of infrequent, frequent, and critical levels. If such a defined threshold is exceeded, it is used as the option for selecting the appropriate commands according to the first field in the command entry of the MESSAGES/USER DATA policy item of the configuration file. If no threshold is exceeded the commands defined for the selection option ALWAYS are issued. See “How SA z/OS Uses Error Thresholds” in *IBM Tivoli System Automation for z/OS User’s Guide* for further information on setting up thresholds.

This chapter describes the details of the automation functions that are provided with SA z/OS.

LOGREC Data Set Processing

The logrec recovery function responds to system messages that indicate that the logrec data set is full or nearly full. The recovery function issues predefined commands to dump and clear the logrec data sets. While the recovery function is in progress, it prevents the automation processing being started a second time.

The logrec recovery function includes the following items:

- Automation routines AOFRSA01 and AOFRSA02, see “AOFRSA01” on page 165 and “AOFRSA02” on page 166
- Automation table entries for system messages IFB040I, IFB060E, IFB080E, IFB081I, and IFC001I
- Error threshold definitions for MVS component minor resource LOGREC
- Command specification in the MESSAGES/USER DATA automation policy item for the special message ID LOGREC

SMF Data Set Processing

The SMF recovery function that is provided responds to system messages that indicate that the SMF data set is full or has been switched. Predefined commands from the configuration files are selected to dump and clear the contents of the SMF data set. The commands to be selected can be defined depending on the occurrence of the incoming messages. The SMF recovery function includes the following items:

- Automation routine AOFRSA03, see “AOFRSA03” on page 168
- Automation table entries for system messages IEE362A, IEE362I, IEE391A and IEE392I
- Error threshold definitions for MVS component minor resource SMFDUMP
- Command specification in the MESSAGES/USER DATA automation policy item for the special message ID SMFDUMP

SYSLOG Processing

The syslog function that is provided responds to messages that are queued to the syslog. The function starts an external writer to save the syslog that was queued. The commands to be selected can be defined depending on the occurrence of the incoming messages.

The syslog function includes the following items:

- Automation routine AOFRSA08, see “AOFRSA08” on page 170
- Automation table entry for system message IEE043I
- Error threshold definitions for MVS component minor resource SYSLOG
- Command specification in the MESSAGES/USER DATA automation policy item for the special message ID SYSLOG

System Log Failure Recovery

The system log failure recovery function that is provided responds to a system log inactive message by restarting the system log. If the system log should be available to be used as the hardcopy medium, the recovery function assigns the system log as the hardcopy medium.

The recovery commands are only issued if the occurrence of the system log inactive message that is received does not exceed a defined critical threshold.

The system log failure recovery function that is provided includes the following items:

- Automation routine INGRX740, see “INGRX740” on page 194
- Automation table entries for system messages IEE037D, IEE041I, IEE533E, IEE769E, IEE043I
- Recovery automation flag for the MVS component minor resource LOG
- Error threshold definitions for the MVS component minor resource LOG
- Command specification in the MESSAGES/USERDATA automation policy item for the special message ID LOG

SVC Dump Processing

The SVC dump processing function that is provided responds to an SVC dump-taken message by issuing predefined commands from the configuration files to handle the dump. The commands to be selected can be defined depending on the occurrence of the incoming messages.

The provided SVC dump processing function includes the following items:

- Automation routine AOFRSA0C, see “AOFRSA0C” on page 172
- Automation table entries for system messages IEA611I and IEA911E
- Error threshold definitions for MVS component minor resource MVSDUMP
- Command specification in the MESSAGES/USER DATA automation policy item for the following special message IDs:
 - MVSDUMP
 - MVSDUMPTAKEN
 - MVSDUMPRESET

Deletion of Processed WTORs from the Display

The WTOR processing function that is provided deletes WTORs from SA z/OS display capabilities when they are replied to or canceled.

The WTOR processing function includes the following items:

- Automation routine AOFRSA0E, see “AOFRSA0E” on page 175
- Automation table entries for system messages IEE400I and IEE600I

AMRF Buffer Shortage Processing

The AMRF buffer shortage processing function that is provided responds to messages that report buffer shortage of the action message retention facility (AMRF). The function issues commands from the configuration files to process buffer shortage automation.

The AMRF buffer shortage processing function that is provided includes the following items:

- Automation routine AOFRSA0G, see “AOFRSA0G” on page 176
- Automation table entries for system messages IEA359E, IEA360A and IEA361I
- Command specification in the MESSAGES/USER DATA automation policy item for the following special message IDs:
 - AMRFSHORT
 - AMRFFULL

AMRF Buffer Shortage Processing

– AMRFCLEAR

Drain Processing Prior to JES2 Shutdown

SA z/OS provides functions for drain processing of JES2 resources prior to JES2 shutdown.

The JES2 drain processing function that is provided includes the following items:

- Automation routines AOFRSD07, AOFRSD0F, AOFRSD0G. See “AOFRSD07” on page 177, “AOFRSD0F” on page 180 and “AOFRSD0G” on page 182.
- Automation table entries for system message HASP607.
- Specifications in the JES2 DRAIN automation policy item for the JES2 applications that are to be drained and how they are to be drained prior to JES2 shutdown.

TWS Automation Operation

SA z/OS provides functions to respond to errors with TWS operations and jobs.

The functions that are provided include the following routines and AT entries for associated messages:

- EVJEAC04 and EVJ120I, see “EVJEAC04” on page 188
- EVJRAC05 and EQQE026I, see “EVJRAC05” on page 189
- EVJRSJOB and EQQE107I, EQQE107I, and EQQW079W, see “EVJRSJOB” on page 190

IMS Transaction Recovery

SA z/OS provides an IMS transaction recovery function. This responds to an IMS application program abend message by issuing predefined replies or commands from the configuration files for recovery purposes. A recovery action is not issued if the program is excluded from recovery processing, or the occurrence of the incoming message exceeds a predefined critical threshold.

The IMS transaction recovery function that is provided by SA z/OS includes the following:

- Automation routine EVIECT0X, see “EVIECT0X” on page 186
- A NetView automation table entry for the application program abend message, DFS554A
- The subsystem that issues the abend message has the following automation policy definitions:
 - Error threshold definitions in the MINOR RESOURCE policy item for the minor resource *PROG.progid* or *TRAN.tran*
 - Code definitions in the MESSAGES/USER DATA policy item for the message types *ABCODEPROG.progid*, *ABCODEPROG*, *ABCODETRAN.tran*, or *ABCODETRAN*
 - Reply or command specifications in the MESSAGES/USER DATA policy item for the message ID DFS554A

AOFRSA01

Purpose

You can use the AOFRSA01 automation routine to respond to logrec data set nearly full or full messages from your system by issuing commands from the configuration files to dump and clear the contents of the logrec data set.

AOFRSA01 keeps track of the incoming logrec data set messages and compares their occurrence with predefined thresholds of infrequent, frequent, and critical level. An exceeded threshold is used as the option to select the appropriate commands according to the first field in the command entry of the MVSESA/LOGREC entry/type-pair in the configuration file. If no threshold is exceeded the commands defined for the selection option ALWAYS are issued.

AOFRSA01 should be called from the NetView automation table.

Syntax

▶▶—AOFRSA01—◀◀

Restrictions

- Actions are only taken in AOFRSA01 if the recovery automation flag for LOGREC is on.
- Processing in AOFRSA01 is only done if it is called from NetView automation table by one of the expected messages IFB040I, IFB060E, IFB080E or IFB081I.
- The commands from automation policy to dump and clear the LOGREC data set are only issued if a LOGREC recovery function is not already in progress.

Usage

Automation routine AOFRSA01 is intended to respond to the following messages:

```
IFB040I SYS1.LOGREC AREA IS FULL, hh.mm.ss
IFB060E SYS1.LOGREC NEAR FULL
IFB080E LOGREC DATA SET NEAR FULL, DSN=dsname
IFB081I LOGREC DATA SET IS FULL,hh.mm.ss, DSN=dsn
```

The commands to issue are selected from the command entry of the MVSESA/LOGREC entry/type-pair in the configuration file.

If no threshold is reached when one of the expected messages arrive, all commands to entries with no selection option and to selection option ALWAYS are selected. If the threshold at level infrequent is exceeded, all commands to entries with no selection specification option and to selection option INFR are selected. In the same way a level of frequent corresponds to selection option FREQ and a level of critical corresponds to selection option CRIT.

Make sure that the automation routine AOFRSA02 is issued by message IFC001I from the NetView automation table, to indicate the completion of the LOGREC recovery function.

Global Variables

&EHKVAR1

When defining the commands in the configuration files to dump and clear the contents of the LOGREC data set, the variable &EHKVAR1 can be used for the name of the LOGREC data set. This variable is substituted with the complete data set name of the LOGREC data set name.

AOFRSA02

Purpose

You can use the AOFRSA02 automation routine to respond to the initialization message of the LOGREC data set to reset the flag, which indicates that the LOGREC recovery function is in progress

AOFRSA02 should be called from the NetView automation table.

Syntax

▶▶—AOFRSA02—▶▶

Restrictions

- Actions are only taken in AOFRSA02 if the recovery automation flag for LOGREC is on.
- Processing in AOFRSA02 is only done if it is called from NetView automation table.

Usage

Automation routine AOFRSA02 is intended to respond to the following message:
IFC001I D=devtyp N=x F=track1* L=track2* S=recd** DIP COMPLETE

This is produced during the initialization of the LOGREC data set and describes the limits of the data set.

The flag, indicating that the LOGREC recovery function is in progress, is used by automation routine AOFRSA01.

Examples

This example shows a sample scenario for LOGREC data set processing:

The following entries in the NetView automation table are created automatically to issue the appropriate automation routine when one of the expected messages arrives:

```
IF MSGID = 'IFB040I' | MSGID = 'IFB060E' |
   MSGID = 'IFB080I' | MSGID = 'IFB081I'
THEN
EXEC(CMD('AOFRSA01')ROUTE(ONE %AOFOPRECOPER%));

IF MSGID = 'IFC001I'
THEN
EXEC(CMD('AOFRSA02')ROUTE(ONE %AOFOPRECOPER%));
```

```

COMMANDS  HELP
-----
                                Thresholds Definition
Command ==> _____

Entry Type : MVS Component          PolicyDB Name  : DATABASE_NAME
Entry Name  : MVS_COMPONENTS        Enterprise Name: YOUR_ENTERPRISE

Resource   : MVSESA.LOGREC

Critical Number . . . . 3          (1 to 50)
Critical Interval . . . 00:05      (hh:mm or hhmm, 00:01 to 24:00)

Frequent Number . . . . 3          (1 to 50)
Frequent Interval . . . 00:30      (hh:mm or hhmm, 00:01 to 24:00)

Infrequent Number . . . 3          (1 to 50)
Infrequent Interval . . 24:00      (hh:mm or hhmm, 00:01 to 24:00)

```

Figure 26. Threshold Definitions for MVS Component LOGREC

```

Pass/Selection Automated Function/'*'
Command Text

MVS S CLRLOG,DSN=&EHKVAR1

```

Figure 27. MESSAGES/USER DATA Policy Item for Entry/Type-Pair MVSESA/LOGREC

Assume that the following message arrives the first time for one day:

IFB080E LOGREC DATA SET NEAR FULL, DSN=SYS1.AOC1.MAN3

Because none of the defined thresholds is exceeded, the automation routine AOFRSA01 searches for defined commands without selection option and to selection option ALWAYS to be issued. With the control file shown above the command MVS S CLRLOG,DSN=&EHKVAR1 is selected. Before issuing this command, the variable &EHKVAR1 is substituted by the data set name of the received message resulting in MVS S CLRLOG,DSN=SYS1.AOC1.MAN3.

If message IFB080E continues to arrive and the occurrence of the expected messages thus exceeds the infrequent, frequent or critical threshold, the automation routine AOFRSA01 searches for defined commands without selection option and to selection option INFR, FREQ or CRIT to be issued.

Because no command is defined with any selection option, only the defined command with no selection option is selected and issued, as in the previous case.

Message AOF589I, AOF588I or AOF587I is issued in cases, where an infrequent, frequent or critical threshold has been exceeded. These messages indicate that an infrequent, frequent or critical threshold action has been processed.

If the recovery processing for a LOGREC data set is still in progress when an expected error message arrives, the following message is issued:

AOF585I 15:45 : RECOVERY OF LOGREC IS ALREADY IN PROGRESS -

The recovery process is considered to be finished, when message IFC001I arrives telling that the LOGREC data set has been initialized.

AOFRSA03

Purpose

You can use the AOFRSA03 automation routine to respond to SMF data set full or switch messages from your system. AOFRSA03 issues commands from the configuration files to dump and clear the contents of the SMF data set.

AOFRSA03 keeps track of incoming SMF data set messages and compares their occurrence with predefined thresholds at infrequent, frequent, and critical levels. An exceeded threshold is used as the option for selecting the appropriate commands according to the first field in the command entry of the MVSESA/SMFDUMP entry/type pair in the configuration file. If no threshold is exceeded the commands that are defined for the selection option ALWAYS are issued.

AOFRSA03 should be called from the NetView automation table.

Syntax

▶▶—AOFRSA03—▶▶

Restrictions

- Actions in AOFRSA03 are only taken if the recovery automation flag for SMFDUMP is on.
- Processing in AOFRSA03 is only done if it is called from the NetView automation table by one of the expected messages: IEE362A, IEE262I, IEE391A or IEE392I.

Usage

Automation routine AOFRSA03 is intended to respond to the following messages:

```
IEE362A SMF ENTER DUMP FOR SYS1.MANn ON ser
IEE362I SMF ENTER DUMP FOR SYS1.MANn ON ser
IEE391A SMF ENTER DUMP FOR DATA SET ON VOLSER ser, DSN=dsname
IEE392I SMF ENTER DUMP FOR DATA SET ON VOLSER ser, DSN=dsname
```

that indicate that the SMF data set is ready to be dumped.

Global Variables

&EHKVAR1

When defining the commands in the configuration file to dump and clear the contents of the SMF data set, the variable &EHKVAR1 can be used for the name of the SMF data set. This variable is substituted with the complete data set name by AOFRSA03 when message IEE391A or IEE392I is received. In case of message IEE362A or IEE362I this variable is substituted with MANn, the second part of the SMF data set name.

&EHKVAR2

When defining the commands in the configuration file to dump and clear the contents of the SMF data set, the variable &EHKVAR2 can be used for the name of the SMF data set. This variable is substituted with the complete data set name by AOFRSA03 when message IEE391A, IEE392I, IEE362A, or IEE362I is received.

Examples

This example shows a sample scenario for SMF data set processing:

The following entries in the NetView automation table are created automatically to issue the appropriate automation routine when one of the expected messages arrives:

```
IF (MSGID = 'IEE362I' | MSGID = 'IEE362A' |
    MSGID = 'IEE391A' | MSGID = 'IEE392I')
THEN
EXEC(CMD('AOFRSA03')ROUTE(ONE %AOFOPRECOPER%));
```

COMMANDS HELP	

Thresholds Definition	
Command ==> _____	
Entry Type : MVS Component	PolicyDB Name : DATABASE_NAME
Entry Name : MVS_COMPONENTS	Enterprise Name : YOUR_ENTERPRISE
Resource : MVSESA.SMFDUMP	
Critical Number 3	(1 to 50)
Critical Interval . . . 00:05	(hh:mm or hhmm, 00:01 to 24:00)
Frequent Number 3	(1 to 50)
Frequent Interval . . . 00:30	(hh:mm or hhmm, 00:01 to 24:00)
Infrequent Number . . . 3	(1 to 50)
Infrequent Interval . . 24:00	(hh:mm or hhmm, 00:01 to 24:00)

Figure 28. Threshold Definitions for MVS Component SMFDUMP

Pass/Selection Automated Function/'*'
Command Text
MVS S SMFDUMP1,DA='&EHKVAR1''

Figure 29. MESSAGES/USER DATA Policy Item for Entry/Type-Pair MVSESA/SMFDUMP

Assume that the following message arrives the first time on one day:

```
IEE391A SMF ENTER DUMP FOR DATASET ON VOLSER 123, DSN=SYS1.AOC1.MAN3
```

Because none of the defined thresholds has been exceeded, the AOFRSA03 automation routine searches for commands to issue that have been defined without a selection option or with the selection option ALWAYS. With the control file shown above the command MVS S SMFDUMP1,DA='&EHKVAR1' is selected. Before issuing this command, the variable &EHKVAR1 is substituted with the data set name from the received message, resulting in MVS S SMFDUMP1,DA='SYS1.AOC1.MAN3'.

If message IEE391A continues to arrive and the occurrence of the expected messages thus exceeds the infrequent, frequent or critical thresholds, the AOFRSA03 automation routine searches for commands to issue that have been defined without a selection option or with selection option INFR, FREQ or CRIT.

Because no command has been defined with a selection option, only the command that has been defined without a selection option is selected and issued, as in the previous case.

AOFRSA03

Message AOF589I, AOF588I or AOF587I is issued in cases where an infrequent, frequent or critical threshold has been exceeded. These messages indicate that an infrequent, frequent or critical threshold action has been processed.

AOFRSA08

Purpose

You can use the AOFRSA08 automation routine to respond to syslog being queued messages by starting an external writer to save the syslog that was queued.

AOFRSA08 keeps track of the incoming syslog queued messages and compares their occurrence with predefined thresholds at infrequent, frequent, and critical levels. An exceeded threshold is used as the option for selecting the appropriate commands according to the first field in the command entry of the MVSESA/SYSLOG entry/type-pair in the configuration file. If no threshold is exceeded the commands that are defined for the selection option ALWAYS are issued.

AOFRSA08 should be called from the NetView automation table.

Syntax

▶▶—AOFRSA08—▶▶

Restrictions

- Processing in AOFRSA08 is only done if it is called from NetView automation table by the expected message IEE043I.
- Actions are only taken in AOFRSA08 if the recovery automation flag for SYSLOG is on and if the status of JES is UP or HALTED.

Usage

Automation routine AOFRSA08 is intended to respond to the message:
IEE043I A SYSTEM LOG DATA SET HAS BEEN QUEUED TO SYSOUT CLASS class

which indicates that the system closed the system log (SYSLOG) data set and queued the data set to a SYSOUT class.

The commands to issue are selected from the command entry of the MVSESA/SYSLOG entry/type-pair in the configuration file.

If no threshold is reached when one of the expected messages arrive, all commands that are defined for entries without a selection option and for the selection option ALWAYS are selected.

If the threshold at the infrequent level is exceeded, all commands that are defined for entries without a selection specification option and for entries with the selection option INFR are selected.

In the same way, a level of frequent corresponds to the selection option FREQ and a level of critical corresponds to the selection option CRIT.

Examples

This example shows a sample scenario for SYSLOG processing:

The following entry in the NetView automation table is created automatically to issue AOFRSA08 as response to the incoming IEE043I message:

```
IF MSGID = 'IEE043I'
THEN
EXEC(CMD('AOFRSA08')ROUTE(ONE %AOFOPRECOPER%));
```

COMMANDS HELP	

Thresholds Definition	
Command ==> _____	
Entry Type : MVS Component	PolicyDB Name : DATABASE_NAME
Entry Name : MVS_COMPONENTS	Enterprise Name : YOUR_ENTERPRISE
Resource : MVSESA.SYSLOG	
Critical Number 3	(1 to 50)
Critical Interval . . . 00:05	(hh:mm or hhmm, 00:01 to 24:00)
Frequent Number 3	(1 to 50)
Frequent Interval . . . 00:30	(hh:mm or hhmm, 00:01 to 24:00)
Infrequent Number . . . 3	(1 to 50)
Infrequent Interval . . 24:00	(hh:mm or hhmm, 00:01 to 24:00)

Figure 30. Threshold Definitions for MVS Component SYSLOG

Pass/Selection Automated Function/'*'	
Command Text	
MVS S SAVELOG _____	

Figure 31. MESSAGES/USER DATA Policy Item for Entry/Type-Pair MVSESA/SYSLOG

Assume that the following message arrives the first time for one day:

```
IEE043I A SYSTEM LOG DATA SET HAS BEEN QUEUED TO SYSOUT CLASS A
```

Because none of the defined thresholds is exceeded, the automation routine AOFRSA08 searches for defined commands without selection option and to selection option ALWAYS to be issued. With the control file shown above the command MVS S SAVELOG is selected.

If message IEE043I continues to arrive and the occurrence of the expected messages thus exceeds the infrequent, frequent or critical threshold, the automation routine AOFRSA08 searches for defined commands without selection option and to selection option INFR, FREQ or CRIT to be issued.

Because no command is defined with any selection option, only the defined command with no selection option is selected and issued, as in the previous case.

Message AOF589I, AOF588I or AOF587I is issued in cases, where an infrequent, frequent or critical threshold has been exceeded. These messages indicate that an infrequent, frequent or critical threshold action has been processed.

AOFRSA0C

Purpose

You can use the AOFRSA0C automation routine to respond to a SVC dump taken to a dump data set message by issuing commands from the configuration file to format the dump, to clear the dump data sets, or to prevent further dumping. The commands to issue are taken from the MVSESA/MVSDUMP and MVSESA/MVSDUMPTAKEN entry/type-pairs and selected according to the frequency of the incoming messages and the thresholds defined in the automation policies. The first field in the command entry gives detailed criteria to select the appropriate commands from the configuration file.

AOFRSA0C should be called from the NetView automation table.

Syntax

▶▶—AOFRSA0C—▶▶

Restrictions

- Actions in AOFRSA0C are only taken if the recovery automation flag for MVSDUMP is on.
- Processing in AOFRSA0C is only done if it is called from NetView automation table by one of the expected messages IEA611I or IEA911E.

Usage

Automation routine AOFRSA0C is intended to respond to the following messages:

```
IEA611I {COMPLETE|PARTIAL} DUMP ON dsname
DUMPID=dumpid REQUESTED BY JOB (jobname)
FOR ASIDS(id,id,...)
...
```

```
IEA911E {COMPLETE|PARTIAL} DUMP ON SYS1.DUMPnn
DUMPID=dumpid REQUESTED BY JOB (jobname)
FOR ASIDS(id,id,...)
...
```

These indicate that the system wrote a complete or partial SVC dump to an automatically allocated or pre-allocated dump data set on a direct access storage device or a tape volume.

AOFRSA0C keeps track on the reception of these messages and compares the frequency of the incoming messages with predefined thresholds of infrequent, frequent and critical level, where the thresholds to MVS component MVSDUMP are considered. The commands to issue are selected according to the frequency of the incoming messages.

If no threshold is reached, all commands to entries with no selection option and to selection option ALWAYS are selected. If the threshold at level infrequent is exceeded, all commands to entries with no selection option and to selection option INFR are selected. In the same way a level of frequent corresponds to selection option FREQ and a level of critical corresponds to selection option CRIT.

The commands to issue are taken from MVSESA/MVSDUMP entry/type-pair of the configuration file with respect to the frequency of the incoming of these messages.

If AOFRSA0C has been triggered by receipt of message IEA911E, all the commands from the MVSESA/MVSDUMPTAKEN entry/type-pair of the configuration file are also selected and issued, as long as the critical threshold has not been exceeded.

After dump processing has been done, AOFRSA0C further monitors the frequency of messages IEF611I and IEF911E in intervals of 15 minutes. As soon as the frequency falls below the infrequent threshold, all the commands of MVSESA/MVSDUMPRESET entry/type-pair are issued.

Global Variables

When defining the commands in the configuration file to handle the SVC dump data set, the variables &EHKVAR1 to &EHKVAR6 can be used to be substituted by variable contents of message IEA611I or IEA911E. The variables &EHKVAR1 to &EHKVAR6 are not available in command entries of type MVSDUMPRESET. These variables are substituted as follows:

&EHKVAR1

The dsname of IEA611I or suffix of SYS1.DUMPnn in IEA911E

&EHKVAR2

The data set name

&EHKVAR3

The dump ID

&EHKVAR4

The job name

&EHKVAR5

The ID of address space

&EHKVAR6

The dump type (PARTIAL or COMPLETE)

Examples

This example shows the use of automation routine AOFRSA0C in a sample context:

An entry in the NetView automation table is used to issue AOFRSA0C when one of the expected messages arrives:

```
IF MSGID = 'IEA611I' | MSGID = 'IEA911E'
THEN
EXEC(CMD('AOFRSA0C ')ROUTE(ONE %AOFOPRECOPER%));
```

Three threshold levels are defined in the automation policy for MVS component MVSDUMP:

```

AOFKAASR          SA z/OS - Command Dialogs
Domain ID = IPSNO ----- INGTHRES ----- Date = 08/28/03
Operator ID = SAUSER                               Time = 09:38:02

Specify thresholds and resource changes:

Resource  =>  MVSESA.MVSDUMP  Group or specific resource
System    =>  KEY3             System name, domain ID, sysplex name or *all

Critical  =>  6   errors in 00:30   Time (HH:MM)
Frequent  =>  4   errors in 00:20   Time (HH:MM)
Infrequent =>  2   errors in 00:20   Time (HH:MM)

Pressing ENTER will set the THRESHOLD values

Command ==>>
PF1=Help   PF2=End   PF3=Return
PF6=Roll   PF12=Retrieve
    
```

Figure 32. MVSDUMP Thresholds

The MESSAGES/USER DATA automation policy item of the MVSESA/MVSDUMP entry/type-pair contains the following command entries for the message ID MVSDUMP with selection options at different levels:

Ps/Select	Command Text
FREQ	'MVS DD ALLOC=INACTIVE'
INFR	'MVS DD ALLOC=ACTIVE'
CRIT	'MVS DD ALLOC=INACTIVE'

The MESSAGES/USER DATA automation policy item of the MVSESA/MVSDUMPTAKEN entry/type-pair contains the following entry without any selection options:

```
'MVS DD CLEAR,DSN=&EHKVAR1'
```

The MESSAGES/USER DATA automation policy item of the MVSESA/MVSDUMPRESET entry/type-pair contains the following entry without any selection options:

```
'MVS DD ALLOC=ACTIVE'
```

As long as no threshold is exceeded at receipt of one of the IEA611I and IEA911E messages, no action is taken.

If dumps have been taken more often than defined with the infrequent threshold, the command MVS DD ALLOC=ACTIVATE, specified in entry type MVSDUMP, is issued. This makes sure that automatic dump data set allocation is enabled. In cases when the dump has been written to a pre-allocated SYS1.DUMP data set, additionally the data set is cleared using the command MVS DD CLEAR,DSN=&EHKVAR1, specified in the entry type MVSDUMPTAKEN. Variable &EHKVAR1 is substituted by the numeric suffix of the SYS1.DUMP data set.

The same processing is done in cases when the incoming dump data set messages exceeds the frequent level.

As soon as the critical threshold is exceeded, the automation routine stops clearing pre-allocated SYS1.DUMP data sets.

After commands having been issued by the automatic processing of dump data sets, automation routine AOFRSA0C checks every 15 minutes whether the infrequent threshold is satisfied again. As soon as this situation is reached, automatic dump data set allocation is enabled again by command MVS DD ALLOC=ACTIVE, as defined in entry type MVSDUMPRESET.

AOFRSA0E

Purpose

Automation routine AOFRSA0E deletes WTORs from SA z/OS display capabilities when they are replied to or canceled.

Syntax



Parameters

id The reply identifiers for cancelled messages.

Restrictions

Processing in AOFRSA0E is only done if it is called from NetView automation table by message IEE400I or IEE600I or if one of these messages are passed by parameter.

Usage

Automation routine AOFRSA0E is intended to respond to the following messages:

```
IEE400I THESE MESSAGES CANCELED- id,id,id
IEE600I REPLY TO id IS; text
```

Message IEE400I says that the system cancelled messages because the issuing task ended or specifically requested that the messages be cancelled. Message IEE600I notifies all consoles that received a message that the system accepted a reply to the message.

As well AOFRSA0E can extract the identifiers of the messages to delete from passed parameters.

Example

The following example shows how to issue AOFRSA0E from the NetView automation table:

```
IF MSGID = 'IEE400I' | MSGID = 'IEE600I'
THEN
EXEC(CMD('AOFRSA0E ')ROUTE(ONE %AOFOPWTORS%));
```

AOFRSA0G

Purpose

You can use the AOFRSA0G automation routine to respond to messages reporting buffer shortage of the action message retention facility (AMRF) by issuing commands from the configuration file to process buffer shortage automation.

In the case of an incoming buffer shortage message, the commands to issue are taken from the MVSESA/AMRFSHORT entry/type-pair with the selection option PASS1 and reissued at 1 minute intervals with an incremented pass count.

In the case of a buffer full message, the commands to issue are taken from the MVSESA/AMRFFULL entry/type-pair. If buffer shortage relieved is reported, the commands that are defined for the MVSESA/AMRFCLEAR entry/type-pair are selected.

AOFRSA0G should be called from the NetView automation table.

Syntax

▶▶—AOFRSA0G—◀◀

Restrictions

- Actions are only taken in AOFRSA0G if the recovery automation flag for AMRF is on.
- Processing of system messages in AOFRSA0G is only done if it is called from NetView automation table by message IEA359I, IEA360A or IEA361I.

Usage

Automation routine AOFRSA0G is intended to respond to the messages:

```
IEA359E BUFFER SHORTAGE FOR RETAINED ACTION MESSAGES - 80% FULL
IEA360A SEVERE BUFFER SHORTAGE FOR RETAINED ACTION MESSAGES - 100% FULL
IEA361I BUFFER SHORTAGE RELIEVED FOR RETAINED ACTION MESSAGES
```

IEA359E and IEA360A reports buffer shortage of the buffer area for immediate action messages, non-critical and critical eventual action messages and WTOR messages. IEA361I indicates the reduction of the number of retained action messages so that the buffer is now less than 75% full.

If AOFRSA0G has been triggered on receipt of message IEA359I the commands to issue are taken from entry/type-pair MVSESA/AMRFSHORT, starting at selection option PASS1 and continuing with incremented selection options in 1 minute intervals until message IEA361 reports that buffer shortage has relieved. After arriving the maximal used selection option for a defined command processing restarts at selection option PASS1.

If AOFRSA0G has been triggered on receipt of message IEA360A all commands from entry/type-pair MVSESA/AMRFFULL are issued.

If AOFRSA0G has been triggered on receipt of message IEA361I all commands from entry/type-pair MVSESA/AMRFCLEAR are issued.

Examples

The following example shows a sample scenario for AMRF shortage processing:

Entries in the NetView automation table are used to issue AOFRSA0G when message IEA359E, IEA360E or IEA361I arrives:

```
IF MSGID = 'IEA359I'
THEN
EXEC(CMD('AOFRSA0G')ROUTE(ONE %AOFOPRECOPE%));
IF MSGID = 'IEA360A'
THEN
EXEC(CMD('AOFRSA0G')ROUTE(ONE %AOFOPRECOPE%));
IF MSGID = 'IEA361I'
THEN
EXEC(CMD('AOFRSA0G')ROUTE(ONE %AOFOPRECOPE%));
```

To specify how to respond to message IEA359E and IEA361I, the following command definitions are made in the automation policy under the entry/type-pair MVSESA/AMRFFULL and MVSESA/AMRFCLEAR:

```
Command = ACF ENTRY=MVSESA,TYPE=AMRF*,REQ=DISP
SYSTEM = AOC1      AUTOMATION CONFIGURATION DISPLAY - ENTRY= MVSESA
-----
AUTOMATION CONFIGURATION DISPLAY - ENTRY= MVSESA
TYPE IS AMRFCLEAR
CMD          = (,,'MVS CONTROL M,AMRF=Y')
TYPE IS AMRFFULL
CMD          = (,,'MVS CONTROL M,AMRF=N')
END OF MULTI-LINE MESSAGE GROUP
```

Figure 33. MVSESA AMRF Command Definitions

If for example message

```
IEA360A SEVERE BUFFER SHORTAGE FOR RETAINED ACTION MESSAGES - 100% FULL
```

arrives, AOFRSA0G is issued by the shown statement in the NetView automation table, which causes the command CONTROL M,AMRF=N to be issued to clear the AMRF buffers.

After AMRF buffer shortage is relieved, the incoming message

```
IEA361I BUFFER SHORTAGE RELIEVED FOR RETAINED ACTION MESSAGES
```

causes command CONTROL M,AMRF=Y to be issued to reactivate AMRF.

AOFRSD07

Purpose

You can use the AOFRSD07 automation routine to respond to a JES2 not dormant message during JES2 shutdown by issuing commands for resources that are not drained.

The commands to issue are taken from the automation policy item JES2 DRAIN of application JES2.

Additionally AOFRSD07 calls AOFRSD0F which outputs a list of all active jobs and started tasks and a list of all resources not yet drained.

AOFRSD07 should be called from the NetView automation table.

Syntax

▶▶—AOFRSD07—◀◀

Restrictions

Processing in AOFRSD07 is only done if:

- It is called from NetView automation table by JES2 message HASP607
- The terminate automation flag for JES2 is on
- JES2 is in shutdown progress

AOFRSA07 performs no processing under z/OS 1.7 and above because Console IDs are not valid in that environment.

Usage

Automation routine AOFRSD07 is intended to respond to message

```
HASP607 JES2 NOT DORMANT -- MEMBER DRAINING, RC=rc text
```

which indicates in case the P JES2 command was entered to withdraw JES2 from the system that not all of JES2's functions have completed.

To find out all resources not drained, the response to JES2 command DU,STA is processed. For each resource in status DRAINING the corresponding command from the automation policy item JES2 DRAIN for this resource type to force drain is issued. Resources in status ACTIVE are first stopped with JES2 command P resource, before the command from the automation policy item to force drain is issued. Resources in status INACTIVE are only stopped with JES2 command P resource.

In cases, where the automation is unable to issue actions on not yet drained resources, JES2 is set to status STUCK and a message is issued which tells that an operator action is required. Those situations occur if no command is specified in automation policy item JES2 DRAINED of JES2 to drain a resource or if a not yet drained resource is in an unknown status

AOFRSD09

Purpose

Automation routine AOFRSD09 is used for JES2 spool recovery. It is called by AOFRSD01 via a timer every retry interval to monitor spool utilization of JES2 and to successive issue the recovery commands of policy item JES2 SPOOLSHORT or JES2 SPOOLFULL.

For this purpose AOFRSD09 processes the following steps:

- AOFRSD09 issues the JES2 command D SPOOL to obtain the current spool usage.
- AOFRSD09 re-evaluates the target of recovery process based on the actual warning threshold for TG and the buffer value from the configuration file.
- If the recovery target has not yet been achieved and the current JES2 subsystem is responsible for the spool recovery, AOFRSD09 increments the pass count and issues the appropriate commands from the configuration file. In a shared JES2 environment, where all JES2 subsystems receive a copy of the spool shortage

message, AOFRD09 determine the appropriate JES2 subsystem for spool recovery. To do this, AOFRD09 compares the list of cpuids, as defined in configuration file, with the response to JES2 command D MEMBER,STATUS=ACTIVE. The first active cpuid on the list is considered to be the appropriate JES2 subsystem for spool recovery.

- In case the spool shortage problem has already been relieved, AOFRSD09 stops the recovery process and sets a timer to reset the pass count for the recovery commands after the reset interval.

You define recovery commands and configuration parameters for JES2 recovery processing, such as buffer value, reset interval and cpuid list, using automation policy item JES2 SPOOLSHORT for spool shortage recovery processing and JES2 SPOOLFULL for spool full recovery processing.

For further information about the JES2 SPOOLSHORT and JES2 SPOOLFULL automation policy items see *IBM Tivoli System Automation for z/OS Defining Automation Policy*.

Syntax

▶▶—AOFRSD09—*subsystem*—*recovery type*—◀◀

Parameters

subsystem

The subsystem name of JES2. This parameter is required.

recovery type

This parameter is used to distinguish between a JES2 spool shortage and a JES2 spool full condition. This parameter is required.

SHORT

The automatic recovery from a JES2 spool shortage condition is to be processed.

FULL The automatic recovery from a JES2 spool full condition is to be processed.

Restrictions

- Processing of recovery commands in AOFRSD09 is only done if the recovery automation flag for JES2 is on. Otherwise the recovery process is suspended and the pass count for selection recovery commands from the configuration file is not incremented.
- Automation routine AOFRSD09 should be processed by JESOPER. If it is called on another task it is routed back to JESOPER.
- Processing in AOFRSD09 is only done if the specified type of spool recovery process has been initiated by automation routine AOFRSD01.
- During a SPOOLFULL recovery condition, the processing for SPOOLSHORT recovery is suspended.

Usage

The recovery commands to issue are selected from the command entry of policy item JES2 SPOOLSHORT or JES2 SPOOLFULL. A pass count is used as selection

option and incremented at each successive processing of automation routine AOFRSD09. At initialization of the recovery process, the pass count is set to value PASS1 by automation routine AOFRSD01.

If pass processing runs out of defined recovery commands before the spool shortage condition is resolved, AOFRSD09 re-executes the recovery sequence from PASS1. You can change this behavior by setting the appropriate advanced automation option at start up of System Automation. You can use the AOFSPPOOLSHORTCMD variable (for SPOOLSHORT conditions) and the AOFSPPOOLFULLCMD variable (for SPOOLFULL conditions) to tell automation routine AOFRSD09 to stop recovery attempts when all commands have been executed and to issue message AOF294I to inform the operator that manual intervention is required in order to resolve the spool condition. For more information about advanced automation options refer to “Read/Write Variables” on page 198.

Global Variables

When defining the commands in the SPOOLFULL or SPOOLSHORT processing panel of the configuration file to handle the recovery, the variables &EHKVAR1 and &EHKVAR2 can be used to be substituted by variable contents. Variable &EHKVAR1 is substituted by the current spool utilization and &EHKVAR2 contains the recovery target.

AOFRSD0F

Purpose

Automation routine AOFRSD0F is used by AOFRSD07 for drain processing prior to JES2 shutdown. Every shutdown delay interval, AOFRSD0F displays all JES2 resources not yet drained. For this purpose it scans the response to JES2 command DA,S for executing tasks, the response to JES2 command DA,J for executing jobs and the response to JES2 command DU,STA for started devices or lines not yet drained and displays the result in a message.

Syntax

▶▶—AOFRSD0F—*subsystem*————▶▶

Parameters

subsystem
The subsystem name of JES2.

Restrictions

Processing in AOFRSD0F is only done if the following conditions are met:

- The subsystem is of type JES2
- JES2 is in shutdown progress
- The terminate automation flag is on

Usage

This automation routine is performed as part of the SHUTDOWN processing.

Examples

This example shows a sample scenario for JES2 drain processing prior to JES2 shutdown.

The following statement shows how AOFRSD07 is issued from the NetView automation table by JES2 message

```
$HASP607: IF MSGID(2) = 'HASP607'
THEN
EXEC(CMD('AOFRSD07')ROUTE(ONE %AOFOPJESOPER%));
```

Assume the following drain processing specifications in automation policy item JES2 DRAIN:

```

COMMANDS  HELP
-----
                                JES2 DRAIN Specifications
Command ==> _____

Entry Type : Application          PolicyDB Name  : DATABASE_NAME
Entry Name  : JES2                Enterprise Name : YOUR_ENTERPRISE

Subsystem: JES2
Enter information (Yes or No) for initial drain to bring down JES2 facilities.
LIN . . . . . YES      Drain lines
LOG . . . . . YES      Drain JES2-VTAM interface
OFF . . . . . NO       Drain spool offloaders
PRT . . . . . YES      Drain printers
RDR . . . . . YES      Drain readers
PUN . . . . . YES      Drain punches
Enter information (Command or No) for force drain if normal drain fails.
LIN . . . . . $E       Force drain lines
LOG . . . . . $E       Force drain JES2-VTAM interface
OFF . . . . . NO       Force drain spool offloaders
PRT . . . . . $I       Force drain printers
RDR . . . . . $C       Force drain readers
F1=HELP    F2=SPLIT    F3=END      F4=RETURN   F5=RFIND   F6=RCHANGE
F7=UP      F8=DOWN     F9=SWAP    F10=LEFT   F11=RIGHT  F12=RETRIEVE

```

Figure 34. JES2 DRAIN Specifications Panel

The list of commands to force drain of JES2 resources are passed to the JES2/FORCEDRAIN entry/type-pair in the configuration file and can be displayed with the DISPACF command:

```

Command = ACF ENTRY=JES2,TYPE=FORCEDRAIN,REQ=DISP
SYSTEM = KEY3      AUTOMATION CONFIGURATION DISPLAY - ENTRY= JES2
-----
AUTOMATION CONFIGURATION DISPLAY - ENTRY= JES2
TYPE IS FORCEDRAIN
LIN           = "$E"
LOG           = "$E"
OFF           = "NO"
PRT           = "$I"
RDR           = "$C"
PUN           = "$E"
END OF MULTI-LINE MESSAGE GROUP

```

Figure 35. DISPACF Panel

Assume that during a shutdown of JES2 message \$HASP607 arrives, indicating that not all of JES2's functions have completed and that JES2's response to command \$DU, STATUS is:

```
$HASP636 13.53.22 $DU,STA
LINE1     UNIT=0FF3,STATUS=ACTIVE/BOEVM9,DISCON=NO
```

AOFRSD0F

Automation routine AOFRSD07 first issues JES2 command \$PLINE1 to stop the line and then issues JES2 command \$E, according to the policy specifications FOR entry/type-pair JES2/FORCEDRAIN.

Then automation routine AOFRSD0F is executed every shutdown delay interval, to list all JES2 resources not drained.

AOFRSD0G

Purpose

You can use the AOFRSD0G automation routine to drain JES2 resources prior to JES2 shutdown. AOFRSD0G issues commands to drain the initiators, offloader tasks, lines, printers, punches and readers, depending on which resources are listed and enabled in the automation policy item JES2 DRAIN of application JES2.

AOFRSD0G is used by the DRAINJES command.

Syntax

▶▶—AOFRSD0G—*subsystem*—▶▶

Parameters

subsystem

The subsystem name of JES2.

Restrictions

- Processing in AOFRSD0G is only done if the subsystem is of type JES2.

Usage

For all resources enabled to initial drain in automation policy item JES2 DRAIN of application JES2 the JES2 command P is issued.

Example

Call AOFRSD0G JES2 to stop all resources enabled in JES2 DRAIN for init drain.

These resources can be listed with command DISPACF JES2 INITDRAIN.

```
Command = ACF ENTRY=JES2,TYPE=INITDRAIN,REQ=DISP
SYSTEM = AOC1      AUTOMATION CONFIGURATION DISPLAY - ENTRY= JES2
-----
AUTOMATION CONFIGURATION DISPLAY - ENTRY= JES2
TYPE IS INITDRAIN
LIN           = ""YES""
LOG           = ""YES""
OFF           = ""NO""
PRT           = ""YES""
RDR           = ""YES""
PUN           = ""YES""
END OF MULTI-LINE MESSAGE GROUP
```

Figure 36. DISPACF JES2 INITDRAIN Panel

AOFRSD0H

Purpose

The AOFRSD0H automation routine is used for JES2 spool recovery. It is called by AOFRSD09 with a timer command after the reset interval and cleans up the pass counter for the pass processing of the recovery commands of the configuration file.

Syntax

►►—AOFRSD0H—*subsystem*—*recovery type*—◄◄

Parameters

subsystem

The subsystem name of JES2. This parameter is required.

recovery type

This parameter is used to distinguish between a JES2 spool shortage and a JES2 spool full condition. This parameter is required.

SHORT

The pass counter for spool shortage recovery processing is to be reset.

FULL The pass counter for spool full recovery processing is to be reset.

Restrictions

- The AOFRSD0H automation routine should be processed by JESOPER. If it is called on another task it is routed back to JESOPER.
- Each recovery action during the reset interval
- AOFRSD0H is only scheduled after the reset interval if no new recovery action of the corresponding type SHORT or FULL has been taken during this time.
- The pass counter for spool full recovery processing is reset by AOFRSD0H after the reset interval, even if spool short recovery is still in progress.

Examples

The following example shows a sample scenario for JES2 spool recovery processing:

The following entries in the NetView automation table are used to issue the AOFRSD01 automation routine from the NetView automation table, when one of the expected messages arrives:

```
IF MSGID(2) = 'HASP050' & TEXT = '.'TGS'.
THEN
EXEC(CMD('AOFRSD01')ROUTE(ONE %AOFOPJESOPER%));
IF MSGID(2) = 'HASP355'
THEN
EXEC(CMD('AOFRSD01')ROUTE(ONE %AOFOPJESOPER%));
```

The SPOOLSHORT recovery is configured using the automation policy item JES2 SPOOLSHORT as shown in Figure 37 on page 184.

```

COMMANDS  HELP
-----
                                SPOOLSHORT Processing
Command ==> _____

Entry Type : Application          PolicyDB Name  : DATABASE_NAME
Entry Name  : JES2                Enterprise Name : YOUR_ENTERPRISE

Enter SPOOLSHORT settings.

Retry Time . . . . 00:05:00      Spool recovery attempt interval (hh:mm:ss)
Buffer . . . . . 5              Recovery target below TGWARN (0->50)
Reset Time . . . . 00:15:00      Recovery reset interval (hh:mm:ss)

Priority of systems for spool recovery:

CPUID  1  ___  2  ___  3  ___  4  ___  5  ___  6  ___  7  ___  8  ___
        9  ___ 10  ___ 11  ___ 12  ___ 13  ___ 14  ___ 15  ___ 16  ___
       17  ___ 18  ___ 19  ___ 20  ___ 21  ___ 22  ___ 23  ___ 24  ___
       25  ___ 26  ___ 27  ___ 28  ___ 29  ___ 30  ___ 31  ___ 32  ___

Edit Spoolshort Pass Commands . . YES  YES  NO

```

Figure 37. JES2 SPOOLSHORT Recovery Definition

Because no cpuids are defined, the own JES2 subsystem is responsible for JES2 spool recovery processing. Entering YES in **Edit Spoolshort Pass Commands** field allows you to edit the pass recovery commands that are defined as shown in the response panel to command DISPACF JES2, .

```

Command = ACF ENTRY=JES2,TYPE=*,REQ=DISP
SYSTEM = KEY3      AUTOMATION CONFIGURATION DISPLAY - ENTRY= JES2
-----
TYPE IS SPOOLSHORT
CMD      = (PASS1,, 'MVS $PQ,Q=N,A=3')
CMD      = (PASS1,, 'MVS $OQ,Q=N,A=3,CANCEL')
CMD      = (PASS1,, 'MVS $PQ,Q=V,A=3')
CMD      = (PASS1,, 'MVS $OQ,Q=V,A=3,CANCEL')
CMD      = (PASS2,, 'MVS $PQ,ALL,A=4')
CMD      = (PASS2,, 'MVS $OQ,ALL,A=4,CANCEL')
CMD      = (PASS3,, 'MVS $PQ,ALL,A=3')
CMD      = (PASS3,, 'MVS $OQ,ALL,A=3,CANCEL')
CMD      = (PASS4,, 'AORRSPLS RANGE=JOB1-5000,NAME=T*')
CMD      = (PASS4,, 'AORRSPLS RANGE=JOB5000-10000,NAME=T*')
CMD      = (PASS4,, 'AORRSPLS RANGE=JOB10000-15000,NAME=T*')
CMD      = (PASS4,, 'AORRSPLS RANGE=JOB15000-20000,NAME=T*')

```

Figure 38. DISPACF Command Response Panel

Assume that a JES2 spool shortage problem is reported by the following message:
\$HASP050 JES RESOURCE SHORTAGE OF TGS - 80% UTILIZATION REACHED

This issues the AOFRSD01 automation routine by the appropriate NetView automation table entry. AOFRSD01 initiates the JES2 SPOOLSHORT recovery process and sets an every timer to call the pass processing routine by issuing AOFRSD09 JES2 SHORT every 5 minutes, as defined in the customization dialog for SPOOLSHORT processing, see Figure 37.

AOFRSD09 redetermines the actual spool usage, compares it with the defined TGWARN of 80% and calculates the target of recovery as difference of TGWARN and the buffer value resulting in a value of 75. If this value is exceeded by the actual spool usage, all recovery commands with the PASS1 selection option in the configuration file for the SPOOLSHORT recovery type are issued. After the retry interval of 5 minutes, AOFRSD09 is reissued by the timer.

If AOFRSD09 now determines that the JES2 spool shortage problem has been relieved, it stops recovery processing and sets a timer to issue AOFRSD0H JES2 SHORT after the reset interval of 15 minutes.

If none of the expected JES2 messages arrives by the end of the reset interval, the AOFRSD0H automation routine resets the pass count to 1 so that the next SPOOLSHORT recovery process issues recovery commands beginning again at PASS1 selection option.

EVEERTRN

Purpose

The EVEERTRN routine handles transaction recovery.

It should be invoked from the NetView automation table.

Syntax

```
▶▶—EVEERTRN—◀◀
```

Usage

The EVEERTRN automation routine is intended to respond to the following messages by issuing the transaction recovery commands that are defined for the RCVRTRAN message ID:

```
DFHAC2231 date time applid Transaction tranid running program program name term
          termid has lost contact with its coordinator system during syncpoint and
          has abended with code ASP1. The unit of work is shunted until contact is
          restored{. EXCI job = }exci_id. condmsg
DFHAC2232 date time applid Transaction tranid running program program name term
          termid has lost contact with its coordinator system during syncpoint and
          has abended with code ASP0. All updates will be unilaterally
          committed{. EXCI job = }exci_id. condmsg
DFHAC2233 date time applid Transaction tranid running program program name term
          termid has lost contact with its coordinator system during syncpoint and
          has abended with code ASPP. All updates will be unilaterally backed
          out{. EXCI job = }exci_id. condmsg
DFHAC2236 date time applid Transaction tranid abend secondary abcode in program
          program name term termid. Updates to local recoverable resources will be
          backed out{. EXCI job = }exci_id. condmsg
DFHAC2245 date time applid A CICS-generated syncpoint request could not be completed
          normally because a connected system has requested that the unit of work be
          rolled back. Transaction tranid running program program name term termid
          has been abnormally terminated with code ASPF{. EXCI job = }exci_id. condmsg
DFHAC2247 date time applid Transaction tranid running program program name term
          termid has requested rollback, but was using a type of processing for which
          rollback is not supported. The transaction has been abnormally terminated
          with code ASP8 {. EXCI job = }exci_id. condmsg
DFHAC2248 date time applid Transaction tranid running program program name term
          termid has failed with abend ASP7 following the failure of a local
          resource owner in the prepare phase of syncpoint. Updates will be backed
          out{. EXCI job = }exci_id. condmsg
DFHAC2249 date time applid Transaction tranid running program program name term
          termid has failed with abend ASP7 following the failure of a remote system
          in the prepare phase of syncpoint. Updates will be backed
          out{. EXCI job = }exci_id. condmsg
DFHAC2250 date time applid the coordinator system has indicated that the current unit of work
          is to be backed out. Transaction tranid running program program name term
          termid has been abnormally terminated with abend ASP3{. EXCI job = }exci_id.
          condmsg
DFHAC2251 date time applid Transaction tranid running program program name term
          termid has failed with abend ASPQ. Syncpoint commit processing has failed
          while communicating with a remote system{. EXCI job = }exci_id. condmsg
DFHAC2252 date time applid Transaction tranid in program program name term termid
```

EVEERTRN

```
has lost contact with its coordinator system during syncpoint processing.  
No updates have been performed by this system; it has abended with code  
ASPR{. EXCI job = }exci_id. condmsg  
DFHAC2253 date time applid Transaction tranid running program program name term  
termid has failed with abend ASP2 due to the links to the remote systems  
being in an invalid state. Updates will be backed out{. EXCI job = }exci_id.  
condmsg
```

Note that these messages are not normally issued to the system console, so if transaction recovery is required the messages should be included in the MESSAGES/USER DATA policy so that the CICS message exit forces CICS to WTO them.

For more details, see the sections “How to Define Transaction Recovery” in the chapter “How to Set Up the Functions of CICS Automation” in *IBM Tivoli System Automation for z/OS Product Automation Programmer’s Reference and Operator’s Guide*.

EVIECT0X

Purpose

This routine can be used to perform recovery processing for transaction and program abends in response to the application program abend message DFS554A.

The routine performs the following actions:

- Parses all data from the DFS554A message
- Checks the appropriate automation flag
- Checks the code definitions for exclusions from recovery for the message types ABCODETRAN or ABCODEPROG
- Performs threshold checking for the triggering DFS554A message

The minor resource name that is used for automation flag checking and threshold checking is either TRAN.*tran* or PROG.*progid*.

If allowed, the recovery commands or replies for message DFS554A with the selection names PROG or TRAN are issued.

EVIECT0X should be called from the NetView automation table.

Syntax

▶▶—EVIECT0X—◀◀

EVIET00

Purpose

This routine is a command to process IMS TCO Automation.

This routine should be invoked from the NetView automation table.

Syntax

▶▶—EVIEET00—◀◀

Usage

The EVIEET00 automation routine is intended to respond to the following messages:

```
DFS3343E CANNOT PROCESS DFSTCF LOAD COMMAND, REASON=xx
DFS3350E TCO ABNORMALLY TERMINATED, SEE DUMP
DFS3351E TCO ABNORMALLY TERMINATED, SYSTEM ABEND, SEE DUMP
DFS3613I xxx TCB INITIALIZATION COMPLETE.
```

EVIEI006

Purpose

This routine handles the IMS control region restart errors.

This routine should be invoked from the NetView automation table.

Syntax

▶▶—EVIEI006—◀◀

Usage

The EVIEI006 automation routine is intended to respond to the following messages:

```
DFS166 CHECKPOINT ID NOT ON LOG RE-ENTER RESTART COMMAND
DFS033I DUPLICATE ENTRY ON SIGNON REQUEST, RESTART ABORTED
DFS0618A A RESTART OF A NON-ABNORMALLY TERMINATED SYSTEM MUST SPECIFY EMERGENCY
        BACKUP OR OVERRIDE.
DFS3131I A COLD START OR EMERGENCY RESTART REQUIRED
DFS3626I RESTART HAS BEEN ABORTED
```

EVIEI00Q

Purpose

This routine handles the IMS control region start up initializing. It resets IMS information held by System Automation and gathers the version number of the IMS control region.

This routine should be invoked from the NetView automation table.

Syntax

▶▶—EVIEI00Q—◀◀

Usage

The EVIEI00Q automation routine is intended to respond to the following messages:

EVIEI00Q

DFS3410I DATA SETS USED ARE DDNAME 'acblib-name' 'format-name' 'MODBLKS-name'
(time/date stamps if they exist)
INGI1010I Automated Operator Exit Initialized for IMS Level *vrn* .

EVISTRCT

Purpose

This routine Posts the IMS sysplex event to both SDF and NMC.

This routine should be invoked from the NetView automation table.

Syntax

▶▶—EVISTRCT—▶▶

Usage

The EVISTRCT automation routine is intended to respond to the following message:

CQS0205E STRUCTURE *structurename* IS FULL

EVISTRMN

Purpose

This routine resets the posted IMS sysplex event to both SDF and NMC.

This routine should be invoked from the NetView automation table.

Syntax

▶▶—EVISTRMN—▶▶

Usage

The automation routine EVISTRMN is intended to respond to the following message:

CQS0206I CQS *structurename percentage* BELOW THRESHOLD LEVEL

EVJEAC04

Purpose

This routine is called when message EVJ120I is trapped. The message is issued by SA z/OS when a TWS operation has been put into or reset from TWS error status.

The EVJEAC04 routine should be called from the NetView automation table.

Syntax

▶▶—EVJEAC04—▶▶

Usage

The automation routine EVJEAC04 is intended to respond to message:

```
EVJ120I applid iatime opnum job status wsname errcode
         abcode usrcode job#
```

This causes a Status Display Facility update and an NMC update to occur.

For an operation changing to error status, the update adds an entry to SDF and NMC, while an operation changing from error status removes an entry from SDF and NMC.

SDF entries are added to the OPC Automation Application in Error panel (OPCERR).

EVJEOBSV

Purpose

This routine is used to start and stop the TWS status observer.

The EVJEOBSV routine called from within the Policy definitions when starting or stopping the status observer. It is also called internally at SA z/OS initialization time and when an automation manager takeover has been completed as indicated by message HSAM1309I.

Syntax

```
▶▶—EVJEOBSV—┌—START—┐—————▶▶
               └—STOP—┘
```

Parameters

START

Establishes the subscription for the list of special resources defined in the policy.

STOP Removes the subscription.

EVJRAC05

Purpose

This routine is called when message EQQE026I is trapped. This message is issued by TWS when a TWS operation has detected a job error. This causes an entry to be added to SDF and the error situation to be posted to NMC.

The EVJRAC05 routine should be called from the NetView automation table.

Syntax

```
▶▶—EVJRAC05—▶▶—————▶▶
```

Usage

The automation routine EVJRAC05 is intended to respond to message:

```
EQQE026I APPLICATION APPL ENDED IN ERROR EC. OPER = OPERNUM,
        PRTY = PRI, IA = IA
```

This requests the operator to perform error recovery actions for the current job.

EVJRSACT

Purpose

This routine keeps track of whether or not the TWS controller is active or in standby. The information is stored in the automation manager.

The routine is called when trapping the following messages:

- EQQN013I
- EQQZ128I
- EQQZ201I

Syntax

```
▶▶—EVJRSACT—◀◀
```

EVJRSJOB

Purpose

This routine is called when trapping the following messages:

- EQQE107I
- EQQW079W
- EQQE037I

These messages are issued by TWS when the state of a batch job has changed. This causes an entry to be added to SDF and the error situation to be posted to NMC.

The EVJRSJOB routine should be called from the NetView automation table.

Syntax

```
▶▶—EVJRSJOB—◀◀
```

Usage

The automation routine EVJRSJOB is intended to respond to messages:

```
EQQE107I OPC-WLM SUCCESSFULLY PROMOTED JBNAM: JBNUM IN
        HI PERFORMANCE CLASS
```

```
EQQW079W JBNAM WILL NOT BE SUBMITTED TO WLM FOR
        PROMOTION. WLM REQUEST IS TOO OLD
```

```
EQQE037I JOB JOBNAME(JNUM), OPERATION (OPERNUM) IN
        APPLICATION APPL, IS LATE, WORK STATION = WSID,
        IA = ARRTIME
```

This requests the operator to investigate what is keeping the job from starting and take appropriate actions to enable it to start.

HASP099

Restrictions

Shutdown processing of the JES2 message HASP099 is only done if:

- Shutdown automation for JES2 is on
- JES2 is in the process of being shut down

Usage

The ISSUEACT command responds to message:

```
HASP099 ALL AVAILABLE FUNCTIONS COMPLETE
```

This indicates that all JES2 job processors have become dormant, and no JES2 RJE lines are active.

INGJRMJSP

Purpose

You use the INGJRMJSP automation routine to monitor JES2 spool file usage. It queries the spool usage to obtain the current spool usage and the warning level. If necessary it calls the INGRCJSP automation routine for JES2 spool recovery processing.

The INGRMJSP command also updates the SPOOL entry in the status display facility (SDF) every time it is called.

Syntax

```
▶▶—INGJRMJSP—◀◀
```

Restrictions

- Monitoring by INGJRMJSP is only done if it has been defined as the monitor command for an appropriate monitor resource in the customization dialog.

Usage

The INGJRMJSP monitoring routine queries the spool usage by issuing the D SPOOLDEF,TGSPACE command to obtain the current spool usage and the warning level as set up by the JES2 system programmer:

- If the spool file is full, INGJRMJSP sets the health status to CRITICAL and calls INGRCJSP.
- If the spool usage is above the warning level, INGJRMJSP sets the health status to WARNING and calls INGRCJSP.

Depending on the spool full percentage and the warning level, one of the following return codes is set:

Return code	Meaning
1	A severe error occurred: <ul style="list-style-type: none"> • The monitor does not have a job name • The monitored object is not SPOOL or associated with JES2 • The specified job name does not refer to a JES2 resource • No command prefix for JES2 was found
2	Monitoring command failed: <ul style="list-style-type: none"> • The D SPOOLDEF command failed
3	OK: Spool usage is below the warning level
4	WARNING: Spool usage is above the warning level
6	CRITICAL: The spool file is full

Example

To create a spool usage monitor in the customization dialog you must define the following items:

1. A monitor resource (MTR) with INGRMJSP as the monitoring command. For example, if you create a monitor resource called JES2SPOOL with the short description JES2 Spool Monitor, specify the following information in the MONITOR INFO policy item:

Monitored Object	SPOOL
Monitored Jobname	JES2
Activate Command	
Deactivate Command	
Monitor Command	INGRMJSP
Monitoring interval	00:15
Captured Messages Limit	20
Desired Available	
Inform List	SDF
Owner	
Info Link	

2. The following relationships to the JES2 application using the RELATIONSHIPS policy item:

Relationship type	Supporting Resource	Condition
HasParent	JES2/APL/=	
ForceDown	JES2/APL/=	WhenObservedDown

The monitor has a HasParent relationship to the corresponding JES2 resource because it only makes sense to monitor the spool usage when JES2 is active.

3. The following recovery actions in the HEALTHSTATE policy item:

State	Command
WARNING	INGRCJSP
CRITICAL	INGRCJSP

INGRCJSP (AOFRSD01)

Purpose

You can use the INGRJSP automation routine for JES2 spool recovery processing. It responds to JES2 spool shortage messages by initiating the recovery process for JES2 spool shortage. It responds to JES2 spool full messages by initiating the recovery process for JES2 spool full to downgrade the problem of excessive spool usage.

The INGRJSP routine does the following:

- Makes linear and first order predictions of spool usage, based on actual and historical values.
- Posts the spool status to the status display facility (SDF).
- Determines the target of recovery processing as the difference between the actual warning threshold for track groups and the buffer value from the configuration file. The spool shortage condition is considered as relieved if the recovery process achieves this target.
- Initiates pass processing to execute the recovery commands of the configuration file, as defined with the JES2 SPOOLSHORT or JES2 SPOOLFULL policy item. The pass processing itself is done by the AOFRSD09 automation routine, which is issued every retry interval. The retry interval is taken from the configuration file.

You define recovery commands and configuration parameters for JES2 recovery processing, such as buffer value and retry interval, using automation policy item JES2 SPOOLSHORT for spool shortage recovery processing and JES2 SPOOLFULL for spool full recovery processing.

For further information about the JES2 SPOOLSHORT and JES2 SPOOLFULL automation policy items see *IBM Tivoli System Automation for z/OS Defining Automation Policy*.

INGRCJSP should be called from the NetView automation table.

Syntax

▶▶—INGRCJSP—▶▶

Restrictions

- Processing in INGRJSP is only done if it is called from NetView automation table by JES2 messages HASP050 or HASP355.
- Message HASP355 is only processed if it reports a shortage of track groups (TG).

Usage

The INGRJSP automation routine is intended to respond to the following messages:

HASP050 JES2 RESOURCE SHORTAGE OF TGs - nnn% UTILIZATION REACHED

HASP355 SPOOL VOLUMES ARE FULL

INGRCJSP (AOFRSD01)

HASP050 indicates that JES2 has a shortage of track groups and the current spool utilization exceeds the current TGWARN value on this JES. TGNWARN is defined in the SPOOLDEF statement in the JES initialization member and can be changed dynamically.

HASP355 indicates that a request for JES2 direct access spool space cannot be processed because all available space has been allocated to JES2 functions or no spool volumes are available. Therefore the recovery targets in this case are based on a figure of 100% spool utilization.

You should code TGWARN in the SPOOLDEF statement in the JES initialization member so that SPOOLSHORT recovery is initiated before a SPOOLFULL condition is reached. If you do not do this the recovery process may become unpredictable.

When resetting after a SPOOLFULL condition, the problem is downgraded to a SPOOLSHORT condition. SA z/OS expects the SPOOLSHORT recovery that was previously running to activate and try to downgrade the problem to an OK. Without the prior SPOOLSHORT recovery, the spool status remains in SPOOLSHORT after a successful SPOOLFULL recovery.

The NetView automation table entries for JES2 messages must respect the one character prefix in front of the message identifier of JES2 messages that identifies the issuing JES.

The spool status is posted to SDF under the SPOOL generic, with the name of the subsystem as its specific name. To have these displayed on an SDF panel, you need status fields for *xxxx.SPOOL*, elements 1 through *n*, where *n* is the number of different subsystems that use the spool.

INGRX740

Purpose

You can use the INGRX740 automation routine to respond to some syslog related system messages by issuing defined recovery actions from the automation control file to restart the syslog or to assign the syslog as a hardcopy medium.

INGRX740 keeps track of the incoming IEE037D syslog inactive message and compares its occurrence with predefined thresholds for the MVS component minor resource, LOG. As long as the critical threshold level is not exceeded, a recovery action related to a previously received system message is issued.

If one of the messages IEE043I, IEE533E or IEE769E is received prior to the IEE037D message that is currently being processed, the commands that have been defined for IEE043I, IEE533E or IEE769E in the MVSESA/*msgid* entry/type-pair of the configuration file are issued. If none of these messages has been received prior to the IEE037D message that is currently being processed, the command MVS WRITELOG START is issued.

The recovery routine INGRX740 also responds to an incoming IEE041I message if this indicates that the SYSLOG data set is available for use as a hardcopy log. Commands are issued in response to message IEE041I that are defined in the MVSESA/IEE041I entry/type-pair of the configuration file. An appropriate command in this case would be MVS VARY SYSLOG,HARDCPY to have the SYSLOG receive the hardcopy log.

INGRX740 should be called from the NetView automation table.

Syntax

▶▶—INGRX740—▶▶

Restrictions and Limitations

Processing in routine INGRX740 is only done if the following conditions are met:

- The recovery automation flag for LOG is on.
- The routine is running on an automation task.
- The routine is called from NetView automation table by one of the expected messages
 - IEE037D
 - IEE041I
 - IEE533E
 - IEE769E
 - IEE043I

Actions in response to message IEE037D are only taken in INGRX740, if the Job Entry Subsystem is up and running.

Usage

Automation routine INGRX740 responds to the following messages:

```
IEE037D LOG NOT ACTIVE
IEE041I THE SYSTEM LOG IS NOW ACTIVE[-MAY BE VARIED AS HARDCOPY LOG]
IEE043I A SYSTEM LOG DATA SET HAS BEEN QUEUED TO SYSOUT CLASS class
IEE533E SYSTEM LOG INITIALIZATION HAS FAILED
IEE769E SYSTEM ERROR IN SYSTEM LOG
```

Example

This example shows a sample scenario for system log failure recovery.

The following entry in the NetView automation table is provided by SA z/OS to issue INGRX740 in response to incoming messages IEE043I and IEE037D:

```
IF MSGID = 'IEE037D' THEN
EXEC(CMD('INGRX740')ROUTE(ONE %AOFOPRECOPE%));
IF MSGID = 'IEE043I' THEN
EXEC(CMD('INGRX740')ROUTE(ONE %AOFOPRECOPE%));
```

Assume that the following threshold levels are defined in the automation policy for MVS component minor resource, LOG.

```

COMMANDS  HELP
-----
                                Thresholds Definition
Command ==> _____

Entry Type : MVS Component          PolicyDB Name  : DATABASE_NAME
Entry Name  : MVS_COMPONENTS        Enterprise Name : YOUR_ENTERPRISE

Resource   : MVSESA.LOG

Critical Number . . . . 3          (1 to 50)
Critical Interval . . . 00:05      (hh:mm or hhmm, 00:01 to 24:00)

Frequent Number . . . . 3          (1 to 50)
Frequent Interval . . . 00:30      (hh:mm or hhmm, 00:01 to 24:00)

Infrequent Number . . . 3          (1 to 50)
Infrequent Interval . . 24:00      (hh:mm or hhmm, 00:01 to 24:00)

```

Figure 39. Threshold Definitions for MVS Component LOG

Assume that a command is defined for message IEE043I in the automation policy item MESSAGES/USER DATA of MVS components, as shown in the following figure.

```

COMMANDS  HELP
-----
                                CMD Processing          Row 1 to 4 of 20
Command ==> _____          SCROLL==> PAGE

Entry Name : MVS_COMPONENTS      Message ID : IEE043I

Enter commands to be executed when resource issues the selected message.
or define this message as status message.

Status . . . _____ ('?' for selection list)

Pass/Selection Automated Function/'*'
Command Text

MVS WRITELOG START

```

Figure 40. MESSAGES/USER DATA Policy Item for Entry/Type-Pair MVSESA/LOG

Assume that the following messages arrive the first time for one day, while the Job Entry Subsystem is up and running and the recovery automation flag for the MVS component minor resource LOG has not been switched off:

```

IEE043I A SYSTEM LOG DATA SET HAS BEEN QUEUED TO SYSOUT CLASS 1
IEE037D LOG NOT ACTIVE

```

Because IEE043I has been received prior to message IEE037D and the critical threshold that has been defined for message IEE037D has not been exceeded, the command that has been defined for message IEE043I is issued in response to message IEE037D.

Appendix A. Global Variables

You must ensure that the names of any global variables you create do not clash with SA z/OS external or internal global variable names. You should check the following tables before creating any global variables of your own.

Read-Only Variables

There are two different classes of variables, based on the level of access available to the programmer:

Class 1:

Read-only variables. These variables are set by SA z/OS and require at minimum an automation control file reload to be changed.

Class 2:

Read-only variables. These variables are set by SA z/OS CLISTs. They should not be changed except by calling the appropriate CLISTs.

Table 16. Externalized Common Global Variables

Variable Name	Description	Class	Reference
AOF.clst.0DEBUG	Contains either a Y or blank. If it contains Y an intermediate level of debug that is supported by SA z/OS automation procedures is turned on.	2	
AOF.clst.0TRACE	Contains a REXX trace setting to be used by the automation procedure <i>clst</i> .	2	
AOFAOCCLOEx	Where <i>x</i> either does not exist (AOFAOCCLO) or is a value from 1 through 9 or A through Z. The AOFAOCCLOEx global variables contain the values specified for the &AOCCLOEx. variables for this system.	1	See the description of the System policy object in <i>IBM Tivoli System Automation for z/OS Defining Automation Policy</i> .
AOFCOMPL	Contains YES if initialization is complete.	2	
AOFDEBUG	Contains a REXX trace setting to be used globally.	2	See <i>IBM Tivoli System Automation for z/OS Planning and Installation</i> .
AOFINITIALSTARTTYP	Contains the value 'IPL' or 'RECYCLE' depending on whether SA z/OS has been started the first time after an IPL or after a NetView recycle.	1	
AOF_PRODLVL	Contains the release level of SA z/OS. The values are: SA z/OS 3.3 SA z/OS,V3R3M0 SA z/OS 3.2 SA z/OS,V3R2M0	1	
AOFJESPREFX	The command prefix for the primary scheduling subsystem.	1	
AOFSUBSYS	The subsystem name of the primary scheduling subsystem.	1	

Global Variables

Table 16. Externalized Common Global Variables (continued)

Variable Name	Description	Class	Reference
AOFSYSNAME	Contains the name of the system.	1	See AOCUPDT in <i>IBM Tivoli System Automation for z/OS Programmer's Reference</i> .
AOFSYSTEM	Contains the system type (MVSESA) as defined in the customization dialog.	1	The SYSTEM INFO panel of the customization dialog.

Read/Write Variables

Table 17 lists the common global variables that can be user-defined. You can set them in your startup exit to change the way that SA z/OS behaves. These variables should be set only once for an SA z/OS system. You can enable or disable advanced automation options (AAOs) by changing the settings of the global variables in your CNMSTGEN stylesheet. For example:

```
*****
* System Automation AAO CGlobals
*****
COMMON.AOFCNMASK = 290C0D0E0F101518
COMMON.INGREQ_ORIGINATOR = 1
COMMON.AOFRESTARTALWAYS = 0
COMMON.AOFUPDRODM = NO
COMMON.AOFUPDAM = NO
COMMON.AOFSMARTMAT = 0
```

After modifying the exit, an SA z/OS COLD START is required for these changes to take effect.

Table 17. Global Variables to Enable Advanced Automation (CGLOBALS)

Variable	Value	Effect
AOF_AAO_INJECT_NOFORCE_REQ	Any value	SA z/OS does not inject a STOP vote with Priority Force for source *RECYCLE when processing an INGREQ REQ=STOP RESTART=YES request. Instead the regular stop request is passed to the automation manager and removed automatically when the resource is down. This also removes any previous request for the resource that was made by the same source.
AOF_AAO_MSG_EHKVAR	YES	This indicates that when calling commands, the tokens of the triggering message are to be stored in variables EHKVAR0 through EHKVAR9 and EHKVART, if not specified in parameter EHKVAR. YES is the default.
	NO	This indicates that the tokens of the triggering message are not to be stored in EHKVAR variables, if not specified in parameter EHKVAR.
AOF_AAO_MVSTAPEMON	>0	Set this value to represent the number of iterations for INGRTAPE to continue monitoring using MVS commands after the LATE alert has been reached. A non-zero entry also indicates using MVS commands for all tape mount monitoring prior to the LATE alert.
	0	INGRTAPE relies on the receipt of the DOMMED message to satisfy any outstanding alerts.

Table 17. Global Variables to Enable Advanced Automation (CGLOBALS) (continued)

Variable	Value	Effect
AOF_AAO_RETENTIONPERIOD	0 to 1440	Defines how long (in minutes) SA z/OS should keep the CGLOBALS that are used to keep track of command requests that are received from TWS. The default is 60 minutes.
AOF_AAO_SDFROOT_LIST	User-defined	<p>Defines the value of the &SDFROOT variable that is used as the root name for the sample SDF panels that are provided with SA z/OS.</p> <p>The value can be the name of a single system or a list of system names separated by a blank character. A list can be used at the SDF focal point to have SA z/OS generate the necessary panel definitions for all systems in the list.</p>
AOF_AAO_TRANRERUN	YES	This indicates that a transient job can be rerun within the lifecycle of a particular z/OS, if not specified otherwise in the automation policy for this job.
	NO	This indicates that a transient job is only run once in the lifecycle of a particular z/OS, if not specified otherwise in the automation policy for this job. NO is the default value.
AOF_AAO_TWS_CMD_OUTPUT_NETLOG	YES NO	Set this AAO to YES to place the output of the command execution in the netlog.
AOF_AAO_TWS_ERRMSG		This AAO can be used to inhibit the ERRMSG parameter. If set to NON BLANK, it erases the contents of the ERRMSG parameter.
AOF_AAO_TWS_MAX_WAIT_TIME		Defines the installation default for the maximum wait time for the INGREQ and INGMOVE command. The default is taken when no wait time is specified in the completion information parameter.
AOF_AAO_TWS_RESYSPLEX	YES NO	<p>This AAO can be used to allow the TWS special resource name to use the SA z/OS Sysplex name instead of SYSPLEX to facilitate an enterprise wide naming convention.</p> <p>Default: NO for SYSPLEX</p>
AOF_AAO_VPCEINIT	0	SA z/OS does not invoke the GDPS initialization exit, VPCEINIT,
AOF_ASSIGN_JOBNAME	1	<p>This indicates that SA z/OS exploits the NetView "ASSIGN BY JOBNAME" feature with a higher priority than the "ASSIGN BY MESSAGE ID" feature (priority level 3).</p> <p>This is the default setting.</p>
	0	SA z/OS exploits the NetView "ASSIGN BY JOBNAME" feature with a lower priority than the "ASSIGN BY MESSAGE ID" feature (priority level 4).
AOF_E2E_EAS_PPI	User-defined	PPI receiver ID of the event/automation service to be used to forward events to the end-to-end automation adapter.

Global Variables

Table 17. Global Variables to Enable Advanced Automation (CGLOBALS) (continued)

Variable	Value	Effect
AOF_E2E_EVT_RETRY	1 to <i>n</i>	Specifies the number of retries, at intervals of one second, that are used to transfer events via PPI TECROUTE to the message adapter of the event/automation service. The events are then forwarded to the end-to-end automation adapter.
AOF_E2E_EXREQ_NETLOG	1	The output to requests received from the end-to-end automation adapter and issued by the primary automation agent, is logged to the NetView log.
	0	The output to those requests is not logged to the NetView log. 0 is the default setting.
AOF_E2E_TKOVN_TIMEOUT	hh:mm:ss	If a hot restart of the automation manager takes longer than the value specified in this variable, the end-to-end automation manager is informed about the outage and has to resynchronize with the first-level automation.
AOF_EMCS_AUTOTASK_ASSIGNMENT	1	SA z/OS assigns an autotask to extended MCS consoles with a console status of MASTER or ACTIVE
	0	SA z/OS does not assign an autotask to extended MCS consoles with a console status of MASTER or ACTIVE 0 is the default.
AOF_EMCS_CN_ASSIGNMENT	1	SA z/OS obtains an extended MCS console with a unique name for operator station tasks (OSTs). If an MVS console was obtained for the OST previously, it is released. 1 is the default setting.
	0	SA z/OS does not obtain an extended MCS console with a unique name for OSTs and the command AOCGETCN is disabled.
AOFACFINIT	1	This indicates that SA z/OS attempts to proceed with initialization despite error messages during the processing of the automation control file. 1 is the default setting.
	0	SA z/OS stops the initialization process upon such errors.
AOFARMQUERYRETRY	User-defined numeric value	The number of times AOFARMQ is called to query the ARM status of an element after a status of UNKNOWN is returned. If the ARM status does not change to another status before the number of retries is exhausted, SA z/OS continues processing and assume the element is not ARM-enabled. The default is 10.
AOFARMQUERYWAIT	User-defined numeric value	The number of seconds to wait between retries as specified in the AOFARMQUERYRETRY value above. The default is 15.

Table 17. Global Variables to Enable Advanced Automation (CGLOBALS) (continued)

Variable	Value	Effect
AOFCNMASK	User-defined	<p>The characters that are used in determining unique console names can be tailored by updating the common global variable AOFCNMASK. This global is used as a hex mask to extract characters from the following string when generating unique console names with command AOCGETCN:</p> <pre>left(opid(),8) right(opid(),8), left(aofsysname,4) right(aofsysname,4), left(applid(),8) right(applid(),8), 'ABCDEFGHIJKLMNOPQRSTUVWXYZ0123456789\$&#155;#@_!?'</pre> <p>Where</p> <ul style="list-style-type: none"> • opid() is a function that returns the OST task name • aofsysname is a common global that stores the system name • applid() is a function that returns VTAM LU name <p>The default for AOFCNMASK is 290C0D0E0F101718. X'29' selects character A in position 41, X'0C' through X'10' selects the last five characters of the opid in positions 12 to 16, X'17' and X'18' select the last two characters of the sysname in positions 23 and 24.</p> <p>If AOFCNMASK is null, AOCGETCN attempts to obtain a unique extended MCS console after a 1 minute interval, followed by a two minute interval and so forth for a maximum of 5 passes (15 minutes elapsed from the initial invocation of the command).</p> <p>For example, with AOFCNMASK: 2A01020304051718</p> <p>X'2A' selects character B in position 42, X'01' through X'05' selects the first five characters of the opid in positions 1 to 5, X'17' and X'18' select the last two characters of the sysname in positions 23 and 24.</p>
AOFDEFAULT_TARGET	User-defined	Sets a default for the TARGET parameter for all commands where this parameter is used.
AOFDESCA	0100001000001000	Descriptor code for action messages
AOFDESCD	0100001000001000	Descriptor code for decision messages
AOFDESCE	0010001000001000	Descriptor code for eventual action messages
AOFDESCI	0000011000001000	Descriptor code for informational messages
AOFDESCW	1000001000001000	Descriptor code for wait messages
AOFEXPLAIN_USER	User-defined	The EXPLAIN command accepts this variable to include help support for customer installation supplied terms. It can hold one or more pairs of <i>term/help panel</i> specifications separated by a blank. If the specified status in the EXPLAIN command is not a valid SA z/OS status, the command routine checks whether it is an installation defined term. If so, the associated help panel is displayed.

Global Variables

Table 17. Global Variables to Enable Advanced Automation (CGLOBALS) (continued)

Variable	Value	Effect
AOFINITREPLY	hh:mm:ss	The initial reply AOF603D is issued and automatically responded after hh:mm:ss. 00:02:00 (2 minutes) is the default setting.
	0	The initial reply AOF603D is not issued and automation continues with the default start without asking the operator.
AOF_INIT_MCSFLAG	User-defined valid value	This variable contains the MCSFLAG that is used for WTOs and WTORs that are issued by SA z/OS during initialization. The default is '00000000'.
AOF_INIT_ROUTCDE	User-defined valid value	This variable contains the ROUTCDE (routing code) that is used for WTOs and WTORs that are issued by SA z/OS during initialization. The default is '01000000'.
AOF_INIT_SYSCONID	User-defined valid value	This variable contains the SYSCONID that is used for WTOs and WTORs that are issued by SA z/OS during initialization. The default is blank.
AOFLOCALHOLD	0	INGNTFY and SA z/OS initialization executes the SETHOLD AUTO command on the notify operator. 0 is the default setting.
	1	SETHOLD must be manually invoked.
AOFMATLISTING	0	Setting this variable means that the NetView automation table listing is not placed in the DSILIST data set at NetView automation table load time.
AOFOPCCMDMSG	0	OPCAMOD only produces messages that are generated by INGOPC. 0 is the default setting.
	1	OPCAMOD produces EVJ011I, EVJ412I, EVJ420I, and EVJ423I messages.
AOFPAUSE	0 to 5	This is the number of seconds that SA z/OS allows for applications that have shut down to be cleared by MVS, in addition to their termination delay. As the AOFPAUSE value is applied to all applications it should be kept small. AOFPAUSE may be useful on a slow machine, where allowing an extra second or two before SA z/OS checks if the application has been cleared could avoid the need to use a termination delay timer. No matter how AOFPAUSE is set, the application status is not updated to AUTODOWN or CTLDOWN until SA z/OS is sure that the application has been cleared from the system by MVS. 0 is the default setting.

Table 17. Global Variables to Enable Advanced Automation (CGLOBALS) (continued)

Variable	Value	Effect
AOFRESTARTALWAYS	1	An application that has been shut down normally, outside the control of SA z/OS, with RESTARTOPT=ALWAYS, is restarted regardless of whether or not it has reached its critical error threshold.
	0	An application that has been shut down normally, outside the control of SA z/OS, with RESTARTOPT=ALWAYS, is <i>not</i> restarted if it has reached its critical error threshold. 0 is the default setting.
AOFRMTCMDWAIT	See NetView RMTCMD	Contains the installation wait time when RMTCMD is used for communication. 60 seconds is the default setting for RMTCMD.
AOFRPCWAIT	0 to <i>n</i>	This is the number of seconds that SA z/OS waits for command responses from other systems in the sysplex. 10 is the default setting.
AOFSENDALERT	Yes or No	This defines whether NetView alert forwarding (YES) or the command handler (NO) is used to forward data to the focal point. Yes is the default setting.
AOFSEXINT	1	The exit AOFEXINT is processed under the BASEOPER automation operator under the initialization process. This is the default.
	0	The exit AOFEXINT execution is serialized within the initialization process.
AOFSHUTDELAY	0 to 59	This is the number of minutes that SA z/OS waits for a termination message before continuing the shutdown process. Any values outside this range are treated as 0. With a setting of 0, message AOF745E is not issued. 0 is the default setting.

Global Variables

Table 17. Global Variables to Enable Advanced Automation (CGLOBALS) (continued)

Variable	Value	Effect
AOFSMARTMAT	0	The SA z/OS Agent is disabled from refreshing ATs. The AT fragment INGMMSG02 is included when SA z/OS initially loads INGMMSG01. Note that INGMMSG02 is no longer shipped. You therefore need to change the AT scope to ENTERPRISE and then run a SysOps build with MODIFIED in the TYPE build option field.
	1	The SA z/OS Agent is enabled to refresh ATs when an INGAMS REFRESH is issued. The AT fragment built by the customization dialog is <i>not</i> loaded; INGMMSG02 is used instead. Note that INGMMSG02 is no longer shipped. You therefore need to change the AT scope to ENTERPRISE and then run a SysOps build with MODIFIED in the TYPE build option field. The ATs are loaded after a successful test load. This allows the agent to inform the AM about a load problem of the AT. The agent may inform the AM of an AT load failure, thus stopping the configuration refresh.
	2	The SA z/OS Agent is enabled to load the AT that is generated by the customization dialog and to refresh ATs when an INGAMS REFRESH is issued. The AT that is built by the customization dialog is dynamically loaded into storage as the INGMMSG02 fragment. The ATs are loaded after a successful test load. This allows the agent to inform the AM about a load problem of the AT. The agent may inform the AM of an AT load failure, thus stopping the configuration refresh. This is the default value.
	3	The SA z/OS automation agent is enabled to load the MRT that is generated by the customization dialog and to refresh the MRT when an INGAMS REFRESH is issued.
AOFSPoolFULLCMD	1	SA z/OS does not execute the Spool recovery passes more than once. Message AOF2941I is issued if the SPOOLFULL condition persists.
	0	SA z/OS re-executes the Spool recovery commands. 0 is the default setting.
AOFSPoolSHORTCMD	1	SA z/OS does not execute the Spool recovery passes more than once. Message AOF2941I is issued if the SPOOLSHORT condition persists.
	0	SA z/OS re-executes the Spool recovery commands. 0 is the default setting.

Table 17. Global Variables to Enable Advanced Automation (CGLOBALS) (continued)

Variable	Value	Effect
AOFSTATUSCMDSEL	0	Issue all status commands or replies that are associated with the new status, without respect to any specified selection values. No thresholds are checked for the minor resource <i>subsystem.status</i> to derive selection criteria or prevent the issuing of commands or replies if critical thresholds are exceeded. If AOFSTATUSCMDSEL is not set, or it is set to a value other than 0, only commands or replies with a given selection criterion such as starttype or stoptype are issued.
AOFUPDAM	Yes or No	This controls whether updates are made in the automation manager. No is the default setting.
AOFUPDRODM	Yes or No	This controls whether updates are made in RODM and must be set to the same value for each system within a sysplex. No is the default setting.
AOFUSSWAIT	1 to <i>n</i>	This is the number of seconds SA z/OS waits for the completion of a user-defined z/OS UNIX monitoring routine (specified in the z/OS UNIX Control Specification panel) until it receives a timeout. When the timeout occurs, SA z/OS no longer waits for a response from the monitoring routine and sends a SIGKILL to the monitoring routine. 10 is the default setting.
INGIMS_CORRWAIT	User-defined numeric value	The number of seconds that INGIMS waits for output from an IMS command. If not specified, INGIMS uses the default CORRWAIT (CCDEF) value.
INGOPC_MULTIPLIER	1 to <i>n</i>	This is used in conjunction with AOFRMTCMDWAIT and AOFRPCWAIT to determine how long to wait before giving up.
INGREQ_ORIGINATOR	1	Indicates that SA z/OS assigns individual originator IDs for each operator issuing an INGREQ command.
	0	All operators are grouped under originator ID OPERATOR. 0 is the default setting.

Parameter Defaults for Commands

Table 18. Global Variables That Define the Installation Defaults for Specific Commands

Variable Name	Description	Reference ¹
AOFSETSTATEOVERRIDE	Sets the default OVERRIDE value for the SETSTATE command.	SETSTATE
AOFSETSTATESCOPE	Allows you to override the predefined default for the SCOPE parameter of the SETSTATE command.	SETSTATE
AOFSETSTATESTART	Allows you to override the predefined default for the START parameter of the SETSTATE command.	SETSTATE

Global Variables

Table 18. Global Variables That Define the Installation Defaults for Specific Commands (continued)

Variable Name	Description	Reference ¹
DISPEVT_WAIT	Sets the WAIT parameter of the DISPEVT command to the specified value.	DISPEVT
DISPEVTS_WAIT	Sets the WAIT parameter of the DISPEVTS command to the specified value.	DISPEVTS
DISPTRG_WAIT	Sets the WAIT parameter of the DISPTRG command to the specified value.	DISPTRG
INGAUTO_INTERVAL	Sets the default for the INTERVAL parameter of the INGAUTO command.	INGAUTO
INGEVENT_WAIT	Sets the WAIT parameter of the INGEVENT command to the specified value. The parameter specifies whether or not to wait until the request is complete.	INGEVENT
INGEXEC_RESP	Sets the RESP parameter of the INGEXEC command to the specified value.	INGEXEC
INGEXEC_SELECT	Sets the SELECT parameter of the INGEXEC command to the specified value.	INGEXEC
INGEXEC_WAIT	Sets the WAIT parameter of the INGEXEC command to the specified value.	INGEXEC
INGGROUP_WAIT	Sets the WAIT parameter of the INGGROUP command to the specified value. The parameter specifies whether or not to wait until the request is complete.	INGGROUP
INGHIST_MAX	Sets the MAX parameter of the INGHIST command to the specified value.	INGHIST
INGIMS_CMDWAIT	Sets the CMDWAIT parameter (the maximum wait time for a command to complete) of the INGIMS command to the specified value.	INGIMS
INGIMS_REQ	Sets the REQ parameter (the request to be issued to the IMS subsystem) of the INGIMS command to the specified value.	INGIMS
INGINFO_WAIT	Sets the WAIT parameter of the INGINFO command to the specified value.	INGINFO
INGLIST_WAIT	Sets the WAIT parameter of the INGLIST command to the specified value.	INGLIST
INGMON_WAIT	Sets the WAIT parameter of the INGMON command to the specified value.	INGMON
INGMOVE_WAIT	Sets the WAIT parameter of the INGMOVE command to the specified value.	INGMOVE
INGRELS_SHOW	Sets the SHOW parameter of the INGRELS command to the specified value.	INGRELS
INGRELS_WAIT	Sets the WAIT parameter of the INGRELS command to the specified value.	INGRELS
INGREQ_EXPIRE	Sets the default EXPIRE parameter of the INGREQ command to the specified value.	INGREQ
INGREQ_INTERRUPT	Sets the default INTERRUPT parameter of the INGREQ command to the specified value. The parameter specifies whether or not the automation manager should wait until the resource has reached its UP state, but the resource is still in the startup phase when the higher priority stop request is given.	INGREQ
INGREQ_OVERRIDE	Sets the default OVERRIDE parameter of the INGREQ command to the specified value.	INGREQ

Table 18. Global Variables That Define the Installation Defaults for Specific Commands (continued)

Variable Name	Description	Reference ¹
INGREQ_PRECHECK	Sets the default PRECHECK parameter of the INGREQ command to the specified value.	INGREQ
INGREQ_PRI	Sets the default priority (PRI parameter) of the INGREQ command to the specified value.	INGREQ
INGREQ_PRI.E2EMGR	Specifies the priority that incoming requests from the end-to-end automation manager are executed at. Default: LOW	INGREQ
INGREQ_REMOVE	Sets the default value for the REMOVE parameter of the INGREQ command to the specified value. If the resource reaches the specified status (condition), the request is automatically removed.	INGREQ
INGREQ_REMOVE.START	Sets the default value for the REMOVE parameter of the INGREQ START command. If not specified the value set by INGREQ_REMOVE is used.	INGREQ
INGREQ_REMOVE.STOP	Sets the default value for the REMOVE parameter of the INGREQ STOP command. If not specified the value set by INGREQ_REMOVE is used.	INGREQ
INGREQ_RESTART	Sets the default for the RESTART parameter of the INGREQ command when shutting down the resource.	INGREQ
INGREQ_SCOPE	Sets the SCOPE parameter of the INGREQ command to the specified value.	INGREQ
INGREQ_SOURCE	Sets the default SOURCE parameter of the INGREQ command to the specified value. The parameter specifies the originator of the request.	INGREQ
INGREQ_TIMEOUT	Sets the interval in minutes used to check for the INGREQ command used to check whether the request has been successfully completed, and whether to send a message or cancel the request if it has not been satisfied after that time.	INGREQ
INGREQ_TYPE	Sets the default startup/shutdown type (TYPE parameter) of the INGREQ command to the specified value.	INGREQ
INGREQ_VERIFY	Sets the default VERIFY parameter of the INGREQ command to the specified value.	INGREQ
INGREQ_WAIT	Sets the WAIT parameter of the INGREQ command to the specified value.	INGREQ
INGRPT_WAIT	Sets the WAIT parameter of the INGRPT command to the specified value.	INGRPT
INGSCHED_WAIT	Sets the WAIT parameter of the INGSCHED command to the specified value. The parameter specifies whether or not to wait until the request is complete.	INGSCHED
INGSET_VERIFY	Sets the default VERIFY parameter of the INGSET command to the specified value.	INGSET
INGSET_WAIT	Sets the WAIT parameter of the INGSET command to the specified value. The parameter specifies whether or not to wait until the request is complete.	INGSET
INGSTX_WAIT	Sets the WAIT parameter of the INGSTX command to the specified value.	INGSTX
INGTRIG_WAIT	Sets the WAIT parameter of the INGTRIG command to the specified value.	INGTRIG
INGVOTE_EXCLUDE	Sets the EXCLUDE parameter of the INGVOTE command to the specified value. The parameter specifies the resource types (for example SVP or GRP) to be excluded when showing all requests. Resources of that type are filtered out.	INGVOTE

Global Variables

Table 18. Global Variables That Define the Installation Defaults for Specific Commands (continued)

Variable Name	Description	Reference ¹
INGVOTE_STATUS	Sets the STATUS parameter of the INGVOTE command to the specified value. The parameter specifies which requests should be displayed: winning, losing or all.	INGVOTE
INGVOTE_VERIFY	Sets the default VERIFY parameter of the INGVOTE command to the specified value.	INGVOTE
INGVOTE_WAIT	Sets the WAIT parameter of the INGVOTE command to the specified value.	INGVOTE
1. See the specified command in <i>IBM Tivoli System Automation for z/OS Operator's Commands</i> .		

Appendix B. Customizing the Status Display Facility

Overview of the Status Display Facility

This appendix explains how to customize the Status Display Facility (SDF) panels, descriptors, and operations.

How the Status Display Facility Works

The SA z/OS Status Display Facility (SDF) uses colors and highlighting to represent subsystem resource states. Typically, a subsystem shown in green on the SDF status panel indicates it is up, while red indicates a subsystem in a stopped or problem state. SDF can be tailored to present the status of system components in a hierarchical manner.

Note: SDF works only with MVS systems and resources.

Types of SDF Panels

Figure 41 on page 210 shows several SDF screens for system CHI01. This figure shows the main types of panels used in SDF:

- The *root component*
- The *status component*
- The *detail status display*

In addition to these panel types, you can create other types of panels according to your system requirements and the applications you are monitoring.

Overview of the Status Display Facility

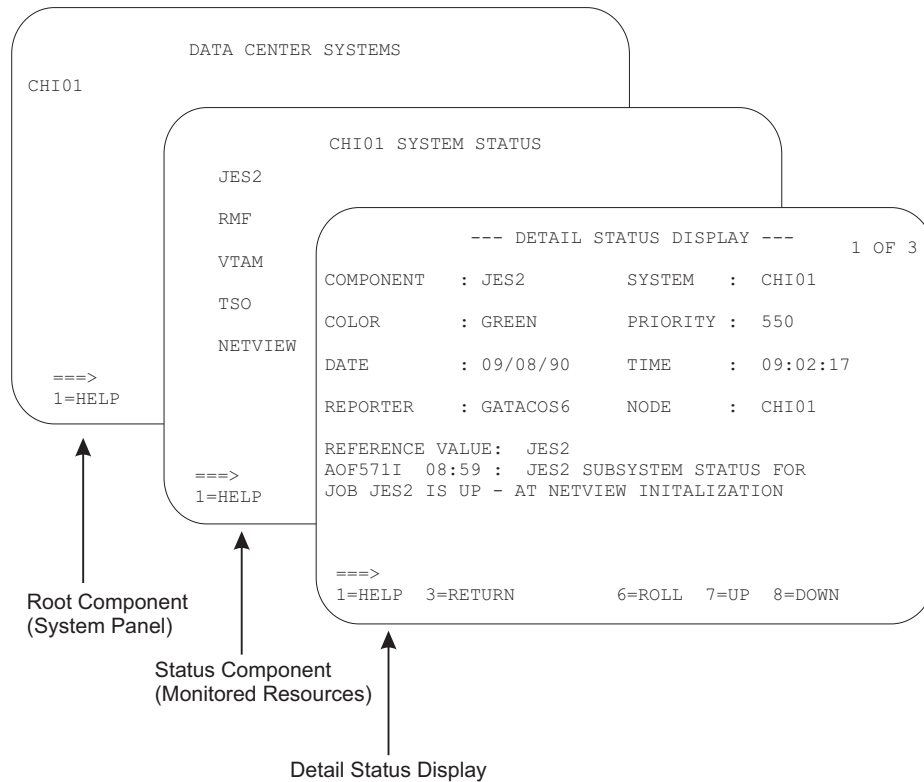

Figure 41. Example SDF Panels

Root Component

The root component is typically an element appearing on the first screen displayed when SDF is started. In Figure 41, the CHI01 system is the root component.

Status Component

Resources monitored by SDF are called *status components*. In Figure 41, system CHI01 has JES2, RMF, VTAM, TSO, and NetView status components, as shown on the CHI01 System Status panel. The status component panel displays all monitored resources in a system. Each monitored resource is shown in the color of its current status. For example, JES2 is shown in green if it is up.

Detail Status Display

A detail status display is built from information in a status descriptor (see “Status Descriptors”). This panel is displayed by tabbing to the appropriate resource on the status component panel and pressing the detail PF key. Each status component can have one or more status descriptors, or detail records, associated with it.

Figure 41 shows an example detail status display for a JES2 status descriptor. The 1 of 3 on the panel indicates that JES2 currently has three status descriptors, and therefore three detail status displays, associated with it.

Status Descriptors

A *status descriptor* is a detailed record of information about a resource status. In its raw form, a status descriptor is a multiline SA z/OS message containing information such as:

- Root component and status component to which the status descriptor applies

- Priority, color, and highlighting associated with the status descriptor (see “How Status Descriptors Affect SDF” on page 212 for more information)
- Date and time the status descriptor was generated
- Actual resource status information; for example, an SA z/OS message indicating the resource is up

SDF uses information in a status descriptor to generate a detail status display (see “Detail Status Display” on page 210). You do not usually look directly at a status descriptor; rather, you look at portions of it through a detail status display. For example, in Figure 41 on page 210, the detail status display presents information from a status descriptor for status component JES2. The 1 of 3 on the panel indicates that JES2 currently has three status descriptors associated with it.

SDF generates, displays, and deletes status descriptors.

SDF Tree Structures

SDF uses *tree structures* to set up the hierarchy of monitored resources displayed on SDF status panels. An SDF tree structure always starts with the system name as the root node and has a level number of one. Tree structure levels subordinate to the root node are the monitored resources. The level numbers of these resources reflect their dependency on each other.

You define SDF tree structures in NetView DSIPARM data set member AOFTREE.

Figure 42 shows an example SDF tree structure. Figure 41 on page 210 shows how these statements result in a tree structure.

```
1 SY1
  2 SYSTEM
    3 WTOR
    3 APPLIC
      4 AOFAPPL
        5 AOFSSI
      4 JES
      4 VTAM
    3 TSO
    3 RMF
  2 GATEWAY
  2 MONITOR
  2 APG
    3 GROUP
```

Figure 42. Example SDF Tree Structure

SA z/OS supplies a sample SDF tree structure in the SA z/OS sample library. This tree structure is referenced by a %INCLUDE statement in member AOFTREE in the NetView DSIPARM data set. You can customize this sample tree structure to meet your requirements. This order of dependency does *not* have to be the same as that used for system startup or shutdown using SA z/OS. System symbols are supported for the tree structure. This can help reduce both customization work and errors.

For example, using the tree structure in Figure 42, if there is a problem with TSO, it is not desirable to also change the VTAM status color, because VTAM is not having any problems. In contrast, in the SA z/OS startup and shutdown procedures, TSO is dependent on VTAM.

Overview of the Status Display Facility

More details on SDF tree structure definitions are in “Step 1: Defining SDF Hierarchy” on page 219.

How Status Descriptors Affect SDF

Status descriptors are the main units of information SDF uses. The information in status descriptors determines how your SDF status displays look at any point in time. This section explains how SDF uses status descriptors.

Priority and Color Assignments

Status descriptors are assigned both a priority number and a color. These color and priority assignments determine the colors in which status components are displayed. In SDF, a lower number indicates a higher priority. Status descriptors are connected to the status component in ascending order of priority.

Color and priority assignments for status descriptors are defined in two places:

- In the PRIORITY parameter in the AOFINIT member of the NetView DSIPARM data set. This parameter defines initial priority and color assignments used for status descriptors. The values defined in AOFINIT are used if no further customization is done to priority and color assignments. The default priority ranges and colors used in AOFINIT are:

Priority Range	Color
001 to 199	Red
200 to 299	Pink
300 to 399	Yellow
400 to 499	Turquoise
500 to 599	Green
600 to 699	Blue

White is used as the default status descriptor color (the DCOLOR parameter in member AOFINIT, described in *IBM Tivoli System Automation for z/OS Programmer's Reference*) and as the default color for a status component without a tree structure entry (the ERRCOLOR parameter in member AOFINIT, described in *IBM Tivoli System Automation for z/OS Programmer's Reference*). For more information on the PRIORITY parameter, see *IBM Tivoli System Automation for z/OS Programmer's Reference*.

- In the SDF definitions in the Status Details policy object. These entries define colors, highlighting, and priorities used for particular resource statuses. Color and priority assignments defined in the customization dialog can be used to override assignments in the AOFINIT member.

Note: Some of the resource statuses that appear in SDF displays do not directly correspond to resource statuses used in the automation status file. *IBM Tivoli System Automation for z/OS User's Guide* shows the default resource status types, colors, highlighting, and priorities provided with SA z/OS. These settings define to SA z/OS the parameters used when adding status descriptors to SDF.

For more information on the SDF Status Details definition, see “Step 4: (Optional) Defining SDF in the Customization Dialog” on page 224.

Chaining of Status Descriptors to Status Components

A resource status change causes a status descriptor to be generated. SDF adds this status descriptor to a chain of status descriptors. Chained status descriptors

Overview of the Status Display Facility

determine the status and color of status components. The highest-priority status descriptor in a chain determines the initial color in which the status component is displayed. The underlying chained priority numbers determine the color that successive detail status displays are shown in.

Status descriptors are chained off each level of status component in a tree structure. Status descriptors chained to lower-level status components are also chained to a higher-level status component, again in order of priority. Status descriptors are also chained off the root component. These status descriptors are all the status descriptors that currently exist at all levels of the tree structure.

For example, Figure 43 shows status descriptors currently generated for system SY1. The priority for each status descriptor is shown by a number.

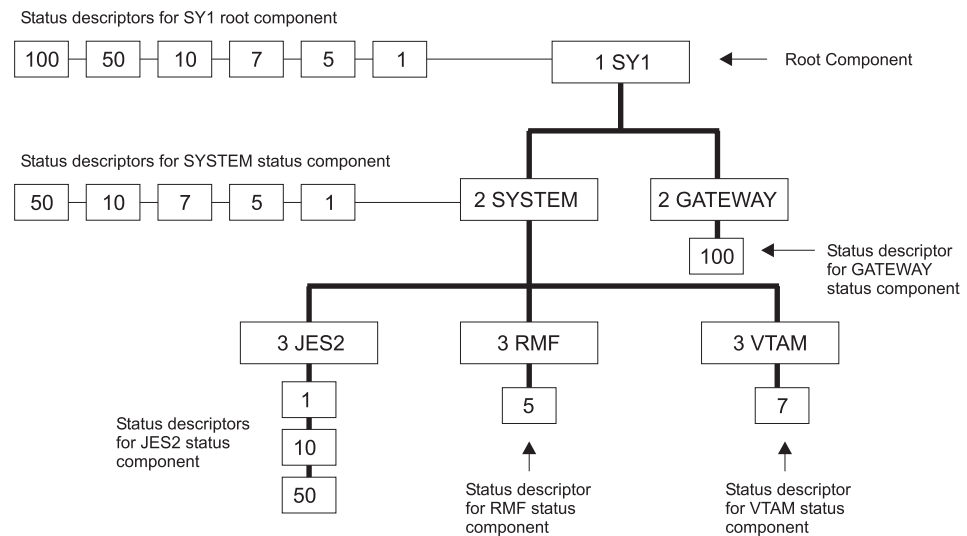

Figure 43. Status Descriptors Chained to Status Components

The status components at the lowest level in this tree structure, JES2, RMF, and VTAM, have status descriptors chained off them. Status component JES2 has three status descriptors chained, with priorities 1, 10, and 50. Because 1 is the highest priority, the status descriptor with priority 1 is organized first in the chain. This highest-priority status descriptor determines the color in which JES2 is displayed on the status panel. If an operator uses the detail PF key to view detail status displays for JES2, the information contained in the status descriptor with priority 1 is displayed first, then the detail status display for the status descriptor with priority 10, and so on.

At the SYSTEM status component level in the tree structure, all status descriptors from the lower-level status components are also chained. Because the status descriptors chained to RMF and VTAM have higher priorities than the priority 10 and 50 status descriptors for JES2, they are organized after the priority 1 status descriptor in the chain. An operator using the detail PF key at the SYSTEM level could view five detail status displays, ranging from priority 1 to priority 50.

Similarly, at the SY1 level in the tree structure, all status descriptors chained to all status components in the tree structure are chained in order of priority. An operator using the detail PF key at the SY1 level could view six detail status displays, ranging from priority 1 to priority 100.

Overview of the Status Display Facility

If a status component has multiple status descriptors with equal priorities, the status descriptors are chained off the status component in order of arrival time.

When a status descriptor no longer accurately reflects the actual status of a resource, SDF automatically deletes it from status descriptor chains. As an example of how priority determines order of status descriptors, suppose two status descriptors currently exist for status component JES2. If there are two status descriptors for JES2 with priorities of 120 and 140, the status descriptor with priority 120 is displayed first. In both cases, JES displays in red on the SDF status panel.

In SA z/OS, all statuses are defined in the automation control file. When an automation event occurs, the SA z/OS AOCUPDT command scans the automation control file for the SDF entry for that status. SA z/OS issues a request to add the status using the information from the automation control file.

For example, suppose subsystem RMF, shown on the example SDF panels in Figure 41 on page 210, is set to a STOPPING state. The SA z/OS AOCUPDT command scans the automation control file for the STOPPING state entry for SDF and generates a status descriptor, specifying a priority of 330. SDF adds the status descriptor to the RMF status component. RMF appears as yellow and blinking on the status panel. Once RMF is in a stopped state, the AOCUPDT command scans the automation control file for the STOPPED state SDF entry and generates a status descriptor with priority 130. SDF adds this new status descriptor to the RMF status component. Now, RMF appears in red on the SDF status panel.

Propagating Status Descriptors Upward and Downward in a Tree Structure

Based on the order of dependencies defined in a tree structure, status descriptors can be *propagated* upward or downward to status components in a tree structure. This propagation of status descriptors affects the color in which status components are displayed, as well as the detail status displays operators can view by using the detail PF key on a particular status component.

Propagation of status upward and downward in a tree structure is defined by the PROPUP and PROPDOWN parameter in the AOFINIT member (see *IBM Tivoli System Automation for z/OS Programmer's Reference* for descriptions).

The SA z/OS-provided defaults for status propagation in the AOFINIT member are to propagate status upward (PROPUP=YES) but not downward (PROPDOWN=NO).

When status is propagated upward in a tree structure, if a status descriptor is added or deleted at a lower level in the tree structure, it is also added or deleted from the cumulative chain of status descriptors at a higher-level node in the tree structure.

Propagation of status upward in a tree structure consolidates the status of all monitored resources in the system at the root node. In this way, the color of the root node reflects the most important or critical status in a computer operations center. For example, in Figure 42 on page 211, any color changes for AOFSSI are reflected in AOFAPPL, APPLIC, SYSTEM, and SY1, if SDF propagates status changes upward in the tree structure. In Figure 41 on page 210, if all monitored resources are green, the root node CHI01 on the Data Center Systems panel is also shown in green.

When status is propagated downward in a tree structure, if a status change occurs at a higher level in a tree structure, the changes are sent downward in the tree structure. This propagating downward could cause status descriptors at lower levels in the tree structure to be added or deleted.

Propagating status downward can be useful when an entire system is down. In such a case, you want SDF status panels to accurately reflect the system status. You do not want status components lower in the tree structure to retain previously generated status descriptors indicating that the components are up and running, because these status descriptors do not accurately reflect the status of the components. You can configure your SDF implementation to propagate status downward, and remove all status descriptors from all status components in a tree structure. If an operator tries displaying detailed status about any of the status components lower in the tree structure, they receive "NO DETAIL INFO AVAILABLE" messages. The empty chain color, defined by the EMPTYCOLOR parameter in member AOFINIT with a default color of blue, is also used to indicate that no detail information is available. See *IBM Tivoli System Automation for z/OS Programmer's Reference* for the EMPTYCOLOR description.

How SDF Helps Operations to Focus on Specific Problems

SDF structure and processing allows the program identifying a problem to be concerned only with the specific problem.

For example, suppose an application program detects a warning message for status component JES on CHI01. The following processing steps occur:

1. The application program issues a request to SDF to add a status descriptor for JES.
2. The status entry for JES on system CHI01 now indicates there is a problem with JES. If the SDF is configured to propagate status up the hierarchical tree structure, the status for system CHI01 also reflects the problem state. See *IBM Tivoli System Automation for z/OS Programmer's Reference* for details on the PROPUP SDF initialization parameter.
3. Now, suppose another more serious problem occurs. The application program which detects this new problem issues another request to SDF to add a status descriptor having a lower priority number than the status descriptor for the first problem.
4. Because status descriptors are chained in order of priority, the JES status now reflects the status descriptor color of the more serious problem.
5. When the more serious problem is resolved, the application program detecting the problem resolution issues a request to SDF to remove the status descriptor for this problem from the chain of JES status descriptors.
6. The status panel is updated to reflect the first problem.

How SDF Panels Are Defined

All SDF status panels, apart from detail status display panels, are defined in the AOFFNLS member of the NetView DSIPARM data set.

Member AOFFNLS can contain either one or both of the following:

- %INCLUDE statements referencing other NetView DSIPARM members containing definitions of panels. The %INCLUDE statement causes the named panel definition member to be loaded. This is the recommended method, and

Overview of the Status Display Facility

the method used in the SA z/OS-provided version of AOFPNLS. System symbols are supported for the %INCLUDE statements. This can help reduce both customization work and errors.

- Panel structure definitions for all SDF panels.

Panel members defined or referenced in AOFPNLS are loaded into system memory, and may be deleted, replaced, or temporarily made resident using the SDFPANEL command (see *IBM Tivoli System Automation for z/OS Programmer's Reference* for command description).

Panels that are to be dynamically loaded as needed (see “Dynamically Loading Tree Structure and Panel Definition Members”) must be defined in a NetView DSIPARM member having the same member name as the panel itself.

It is recommended that you include only frequently used panels in AOFPNLS, to conserve system memory. Other panels can be dynamically loaded when needed, either by pressing a SDF function key or by using the SCREEN command.

Note: Dynamic refresh only works with panels that are defined in AOFPNLS.

SDF internally formats and builds detail status display panels from the information in a status descriptor. You do not have to define and format detail status display panels. Status components defined in the panel definitions must also be defined in the corresponding tree structure. However, not all status components defined in the tree structure require a corresponding entry on the SDF status panel. For example, in Figure 42 on page 211, the APPLIC status component is only a pseudo-entry and may not actually be displayed on any SDF status display panel.

SDF status panels can be customized to reflect any environment. For example, you can define a panel to show the status of all JES subsystems on all processors in a computer operations center. The JES operator can view the panel to determine the status of any JES subsystem in the complex.

For detailed information on defining SDF panels, see “Step 2: Defining SDF Panels” on page 220.

Dynamically Loading Tree Structure and Panel Definition Members

Using %INCLUDE statements in the main SDF tree structure and panel definition members allows you to dynamically load tree structure and panel definition members without restarting SDF (see *IBM Tivoli System Automation for z/OS Programmer's Reference*). The SDFTREE command loads a tree structure definition member. The SDFPANEL command loads a panel definition member. You can dynamically reload members AOFTREE and AOFPNLS themselves.

The RESYNC SDFDEFS command generates the SDF panels using the advanced automation option (AAO) AOF_AAO_SDFROOT_LIST for the SDF root names that are to be applied. (See *IBM Tivoli System Automation for z/OS Operator's Commands*).

Using SDF for Multiple Systems

You can configure SDF so that multiple systems in an automation network can forward their resource status information to the SDF on the focal point system. In a multiple-system environment, the following must be defined:

- The tree structure for each system must be defined in the AOFTREE member of NetView DSIPARM on the focal point system SDF. The root name must be unique for each system tree structure.
- For target system SDF status update to occur on a focal point SDF, SA z/OS focal point services must already be implemented.

Because each root name must be unique in a multiple-system environment, any status component on any system defined to the focal point SDF can be uniquely addressed by prefixing the status component with the root component name:

```
ROOT_COMPONENT.STATUS_COMPONENT
```

For example:

```
SY1.JES2
```

Similarly, any SDF status descriptors forwarded from the target system to the focal point SDF are prefixed with the root name of the target system by SA z/OS routines.

SDF Components

SDF consists of the following components:

Table 19. SDF Components

Name	Type	Purpose
AOFTDDF	Task	Initializes SDF and maintains the status database. This initialization is an automated function.
SDF	Command	Starts an SDF operator session.
SDFTREE	Command	Dynamically loads or deletes an SDF tree structure definition member from the NetView DSIPARM data set.
SDFPANEL	Command	Dynamically loads or deletes an SDF panel definition member from the NetView DSIPARM data set.
AOFINIT	Input file	Contains SDF initialization parameters defined with the statements described in <i>IBM Tivoli System Automation for z/OS Programmer's Reference</i> . AOFINIT is in the NetView DSIPARM data set.
AOFTREE	Input file	Contains tree structures described in <i>IBM Tivoli System Automation for z/OS Programmer's Reference</i> . This member usually consists of a list of %INCLUDE statements referencing other members containing tree structures. AOFTREE is in the NetView DSIPARM data set.
AOFPNLS	Input file	Contains SDF panel parameters defined by the statements described in "Step 2: Defining SDF Panels" on page 220. This member usually consists of a list of %INCLUDE statements referencing other members containing panel definitions. AOFPNLS is in the NetView DSIPARM data set.
<i>panel_name</i>	Input file	A DSIPARM member containing the definition of one or more SDF panels or %INCLUDE statements identifying other DSIPARM panel definition members. It is highly recommended that panel definition members contain the definition of a single panel having the same name as the member.

Overview of the Status Display Facility

Table 19. SDF Components (continued)

Name	Type	Purpose
<i>tree_name</i>	Input file	A DSIPARM member containing the definition of one or more tree structures. It is highly recommended that tree definition members contain the definition of a single tree having the same root component name as the member name.

How the SDF Task Is Started and Stopped

During SA z/OS initialization, the AOFTDDF task loads members defining panel format, panel flow, and tree structures. Member AOFINIT defines parameters common to all SDF panels and basic initialization specifications, such as screen size, default PF keys, and the initial screen displayed when a SDF session is started. These AOFINIT parameters are described in *IBM Tivoli System Automation for z/OS Programmer's Reference*.

Starting the SDF Task

In SA z/OS code, the AOFTDDF task is started by the following command:

```
START TASK=AOFTDDF
```

Stopping the SDF Task

In SA z/OS code, the AOFTDDF task is stopped by the following command:

```
STOP TASK=AOFTDDF
```

Note: When SDF is restarted, all existing SDF status descriptors are lost, as they are kept only in memory.

SDF Definition Process

Use the following procedure to define the panels displayed in an SDF session. Details on each step are provided later in this chapter and in *IBM Tivoli System Automation for z/OS Programmer's Reference*.

1. Define the hierarchy of monitored resources used for your SDF panels, using tree structure statements in NetView DSIPARM data set members. These tree structure definition members should be referenced by %INCLUDE statements in the main SDF tree structure definition member, AOFTREE, in the NetView DSIPARM data set. See *IBM Tivoli System Automation for z/OS Programmer's Reference* for details.
2. Define SDF status panels using panel definition statements in NetView DSIPARM data set members. Panels can either be automatically loaded when SDF starts, or dynamically loaded using the SDFPANEL command. For panels to be automatically loaded, add a %INCLUDE statement specifying the panel definition member to the main panel definition member, AOFPNLS, in the NetView DSIPARM data set. See "Step 2: Defining SDF Panels" on page 220 for details.
Define and customize SDF status panels in the following general order:
 - a. Root panel
 - b. Status component panel for each entry on the root panel
 - c. Any other customized status panels.
3. Customize the SDF initialization parameters in NetView DSIPARM member AOFINIT, if necessary (optional), or use defaults. See *IBM Tivoli System Automation for z/OS Programmer's Reference* for detailed descriptions of SDF initialization parameters. Using defaults is recommended.

4. Define SDF resource status, color, highlight and priority values using the customization dialog to edit the SDF Status Display policy object, or use defaults. This step is optional. See *IBM Tivoli System Automation for z/OS Defining Automation Policy* for the description of the Status Display policy object. Using defaults is recommended.

Notes:

1. Resources that SA z/OS is not currently automating are not displayed on SDF panels.
2. To display the status of multiple systems and forward status from target systems to SDF on a focal point system, SA z/OS focal point services must already be implemented. See *IBM Tivoli System Automation for z/OS Defining Automation Policy* for details on configuring focal point services.

Step 1: Defining SDF Hierarchy

Member AOFTREE in the NetView DSIPARM data set contains a set of definitions that define the propagation hierarchy for status color changes. When the status changes for a component, the corresponding color change is propagated up or down the tree to the next higher or lower level component. The level is determined by the level number assigned to each component. The type of propagation is determined either by the entry in the AOFINIT member or by individual requests to add a status descriptor to a status component.

Note: SA z/OS does not use this SDF hierarchy for subsystem shutdown or startup procedures. Instead, SA z/OS uses subsystem entries defined in the automation policy to determine startup and shutdown relationships and hierarchies.

Tree Structure Definitions

AOFTREE contains tree structure definitions. To define tree structures, you can:

- Use %INCLUDE statements that reference other members containing definitions for specific tree structures. This is the recommended method, and the method used in the SA z/OS-provided version of AOFTREE.
On the %INCLUDE statement, the name of the referenced member must be enclosed in parentheses.
- Place all tree structure definitions in AOFTREE.
- Use a combination of both.

System symbols are supported wherever they are used in the AOFTREE, AOFINIT and AOFPNLS members. This can help reduce both customization work and errors.

Figure 44 on page 220 shows a typical tree structure definition:

SDF Definition Process

```
1 SY1
  2 SYSTEM
    3 WTOR
    3 APPLIC
      4 AOFAPPL
        5 AOFSSI
      4 JES
      4 VTAM
    3 TSO
    3 RMF
  2 GATEWAY
  2 MONITOR
  2 APG
  3 GROUP
```

Figure 44. Example Tree Structure Definition

In this tree structure, SY1 is the root component. This definition is in a separate member, named SY1. It is referenced by the following statement in the AOF TREE member:

```
%INCLUDE(SY1TREE)
```

Loading Tree Structures: All tree structures need not be loaded during initialization. Some can be loaded dynamically after SDF is started. To do this, use AOF TREE to define those tree structure entries that are loaded during initialization, then use the SDF TREE command to load additional tree structures as needed. For more information, see *IBM Tivoli System Automation for z/OS Programmer's Reference*.

Tree structures loaded after SDF is started must be contained in separate members. Each member must be named after the root component for which the tree structure is defined.

Step 2: Defining SDF Panels

SDF status panels are defined in NetView DSIPARM member AOF PNLS. SA z/OS loads the panel definitions in AOF PNLS when SDF is initialized.

Panel Definition Methods

To define panels in AOF PNLS, you can:

- Use %INCLUDE statements referencing separate NetView DSIPARM members containing panel definitions. This is the recommended method, and the method used in the SA z/OS-provided version of AOF PNLS. See “%INCLUDE Statement for SDF Panels” on page 223 for details on using the %INCLUDE statement for SDF panel definition members.
- Include actual definitions for all panels.
- Use a combination of both %INCLUDE statements and panel definitions.
- Include a subset of panel entries to load during initialization, so that additional panel definitions can be loaded only when needed (see *IBM Tivoli System Automation for z/OS Programmer's Reference*).

System symbols are supported wherever they are used in the AOF TREE, AOF INIT and AOF PNLS members. This can help reduce both customization work and errors.

Panel Definition Structure

The structure of each panel definition is as follows:

- Begin panel definition statement (PANEL)

- Status component definition statements, consisting of pairs of the following statements:
 - STATUSFIELD: defines location of a status component on a panel
 - STATUSTEXT: defines the text displayed in the STATUSFIELD
- Text fields and data definition statements, consisting of pairs of the following statements:
 - TEXTFIELD: defines locations and attributes for constant fields on panels
 - TEXTTEXT: defines text displayed in the TEXTFIELD
- Status panel PF key definitions (PFKnn)

You should assign the SDFCONF command to the PF4 key. Use the following definition:

```
PFK4=SDFCONF &ROOT,&COMPAPPL,&RV,&SID,&SNODE,&DATE,&TIME,&DA
```

Using SDFCONF to delete a record in SDF is useful because it prompts you for confirmation before performing the actual deletion.

You must call SDFCONF to delete exceptional messages, that is, captured messages with the severity Unusual, Important and Critical. The SDFCONF command removes a message entry from the SDF control structure and also from all other interfaces where the message is shown, for example, TEP and NMC.

- End panel statement (ENDPANEL)

Descriptions of these panel definition statements are in *IBM Tivoli System Automation for z/OS Programmer's Reference*.

Recommended Order for Defining Panels

When defining panels, it is recommended that you define them in the following order:

1. The root panel
2. The status components for each item listed on the root panel
3. Any other customized status panels

Note: This order of defining panels is a recommendation only. You can define your SDF panels in any order desired.

Example Panel Definition

Figure 45 shows how an example SDF panel looks when it is displayed.

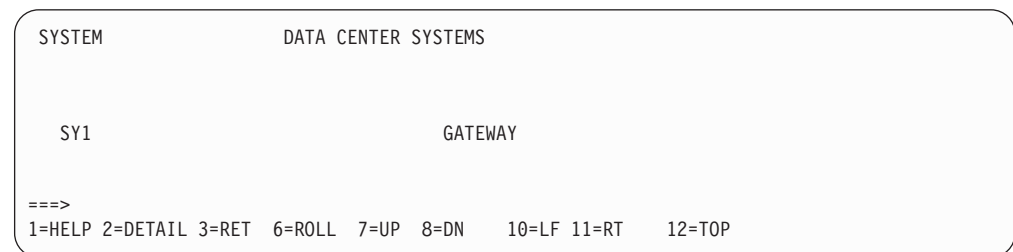

Figure 45. Example SDF Panel

Figure 46 on page 222 shows the panel definition statements required to define the panel in Figure 45.

```

PANEL(SYSTEM,24,80)
TEXTFIELD(01,02,10,WHITE,NORMAL)
TEXTTEXT(SYSTEM)
TF(01,25,57,WHITE,NORMAL)
TT(DATA CENTER SYSTEMS)
STATUSFIELD(SY1,04,04,11,N,,SY1SYS)
STATUSTEXT(SY1)
SF(SY1.GATEWAY,02,40,47,N,,GATEWAY)
ST(GATEWAY)
TF(24,01,79,T,NORMAL)
TT(1=HELP 2=DETAIL 3=RET 6=ROLL 7=UP 8=DN
10=LF 11=RT 12=TOP)
PFK1(AOCHELP SDF)
PFK2(DETAIL)
PFK3(RETURN)
PFK6(ROLL)
PFK7(UP)
PFK8(DOWN)
PFK10(LEFT)
PFK11(RIGHT)
PFK12(TOP)
ENDPANEL

```

Figure 46. Example Panel Definition Entry

In Figure 46, the panel name is SYSTEM. This panel definition can either be in a separate member referenced by a %INCLUDE statement in AOFPNLS or be directly coded in AOFPNLS. The recommended method is to use a separate member and a %INCLUDE statement. If it is in a separate member, the member name is SYSTEM. You do not have to explicitly define every PF key for the panel. PF key definitions not specified are picked up from definitions in NetView DSIPARM member AOFINIT.

Table 20 describes each statement in Figure 46:

Table 20. Panel Definition Entry Description

Statement	Description and Example Value
PANEL(SYSTEM,24,80)	The panel definition statement. The panel name is SYSTEM, the panel length is 24, and the panel width is 80.
TEXTFIELD(01,02,10,WHITE,NORMAL)	The text location statement defining constant panel fields. This field starts on line 01 in position 02 and ends in position 10. The color of the field is white and highlighting is normal.
TEXTTEXT(SYSTEM)	The text data statement specifying the actual data that goes in the text field just defined. This field contains the word SYSTEM. TEXTFIELD and TEXTTEXT are always grouped in pairs.
TF(01,25,57,WHITE,NORMAL)	Another TEXTFIELD statement for another constant field.
TT(DATA CENTER SYSTEMS)	Another TEXTTEXT statement for the text field just defined.
STATUSFIELD(SY1,04,04,11,N,,SY1SYS)	The location of the status component field. The status component is SY1. This field starts on line 04 in position 04 and ends in position 11. The highlighting level is normal. The next panel displayed when the Down PF key is pressed is SY1SYS.
STATUSTEXT(SY1)	The text data used for the name of the field just defined with the STATUSFIELD statement. In this case, the field name is SY1. STATUSFIELD and STATUSTEXT statements are grouped in pairs.
SF(SY1.GATEWAY,02,40,47,N,,GATEWAY)	Another STATUSFIELD definition.
ST(GATEWAY)	Another STATUSTEXT definition.

Table 20. Panel Definition Entry Description (continued)

Statement	Description and Example Value
TF(24,01,79,T,NORMAL) TT(1=HELP 2=DETAIL 3=RET 6=ROLL 7=UP, 8=DN 10=LF 11=RT 12=TOP)	Here, TEXTFIELD and TEXTTEXT are used to display PF key definitions. For this panel, these are the default definitions defined in AOFINIT. If you need values differing from the defaults, there is a statement for defining PF keys unique to this panel, DPFKnn. See <i>IBM Tivoli System Automation for z/OS Programmer's Reference</i> for a description of this statement.
PFK1(AOCHELP SDF) PFK2(DETAIL) PFK3(RETURN) PFK6(ROLL) PFK7(UP) PFK8(DOWN) PFK10(LEFT) PFK11(RIGHT) PFK12(TOP)	PF key definition statements.
ENDPANEL	The end panel statement, indicating that this is the end of definitions for this panel.

%INCLUDE Statement for SDF Panels

The %INCLUDE statement for SDF has the following features:

- The SDF %INCLUDE statement allows the specification of a list of members rather than a single member only. Each member name in the list represents a DSIPARM member that is to be loaded. Member names in the list are delimited by a comma.
- The SDF %INCLUDE statement requires parentheses around the specified member or members.
- You can specify the option STATIC or DYNAMIC for the SDF %INCLUDE statement. If you specify DYNAMIC, this generates the panel definitions for all of the system names that you specify in AOF_AAO_SDFROOT_LIST common global variable (see Table 17 on page 198). STATIC is the default.
- The target DSIPARM members may contain only complete panel definitions or additional %INCLUDE statements. Panel definitions must be contained within a single member, and therefore cannot be built using commonly defined segments.

System symbols are supported wherever they are used in the AOFTREE, AOFINIT and AOFPNLS members. This can help reduce both customization work and errors.

Step 3: (Optional) Customizing SDF Initialization Parameters

Member AOFINIT allows you to define parameters common to all SDF panels and SDF initialization specifications, such as:

- Initial screen shown when SDF is started
- Maximum operator logon limit
- Default PF key definitions
- Detail status display panel PF key definitions
- Detail status display panel PF key descriptions
- Default priorities and colors

These parameters define values for SDF when it is started.

System symbols are supported wherever they are used in the AOFTREE, AOFINIT and AOFPNLS members. This can help reduce both customization work and errors.

This step of SDF customization is optional. Using SA z/OS-provided default values for these parameters is recommended.

Note: User-defined statuses are not saved across a recycle or a monitor cycle. This means the status of a subsystem changes from the user-defined status to an appropriate SA z/OS status.

Step 4: (Optional) Defining SDF in the Customization Dialog

The SDF entries in the Status Display policy object allow you to define statuses and the priorities assigned to those statuses. These entries are used by SA z/OS commands to gather data for requests to add status descriptors to status components. The format and values used in SDF Status Detail definitions are described in *IBM Tivoli System Automation for z/OS Programmer's Reference*.

This step of SDF customization is optional. Using SA z/OS-provided definitions for SDF is recommended.

Appendix C. How System Operations Coordinates with Automatic Restart Manager

SA z/OS system operations provides coordination with the Automatic Restart Manager. The Automatic Restart Manager (ARM) is a base z/OS component. It is a recovery function that automatically restarts designated applications when:

- The application ends abnormally.
- The system that the application is running on is part of a sysplex, and that system fails. In this case, ARM will attempt to restart the application on another system within the sysplex.

SA z/OS coordinates with ARM to:

- Determine which facility is responsible for restarting a specific application.
- Avoid possible duplications or conflicts in application recovery attempts.
- Allow you to take full advantage of SA z/OS fallback capabilities for applications running on sysplexes. SA z/OS continues to automate an application after it has been moved to a fallback system, provided SA z/OS is installed on that system. If it is not installed on the fallback system, SA z/OS is still aware that the application is active on a system other than its primary one and does not attempt to restart it.

You have to define the Automatic Restart Manager policy using the administrative data utility for ARM policy data (IXCMIAPU) described in *z/OS MVS Setting Up a Sysplex*.

SA z/OS resolves Automatic Restart Manager statuses to SA z/OS statuses, incorporates Automatic Restart Manager-related conditions, and provides one status related to Automatic Restart Manager:

- EXTSTART - The application is being started or restarted externally.

Defining an ARM Element Name

Automatic Restart Manager uses element names to identify the applications with which it works. Each Automatic Restart Manager enabled application must have a unique element name for itself that it uses in all communication with Automatic Restart Manager. Automatic Restart Manager tracks the element name and has its policy defined in terms of element names. If an application moves between systems it **MUST** continue to use the same element name as it did on the original system. For more information on defining Automatic Restart Manager names to SA z/OS, see "Application Entry Type" in *IBM Tivoli System Automation for z/OS Defining Automation Policy*.

All Automatic Restart Manager elements are unregistered initially. Transitions between statuses are caused by:

- IXCARM macro invocations
- Application failures
- System failures
- Timeouts

Defining an ARM Element Name

A minor resource definition *subsystem.OARM* can be used to tailor automation behaviour during ARM restart processing. As an example, a *subsystem.OARM* minor resource could be specified with a RESTART EXIT enabled to drive a user supplied exit during ARM restart. The user exit would control additional actions to be taken during ARM restart of the subsystem. If the RESTART flag for this minor resource is resolved to 'N', SA z/OS will not allow ARM to attempt a restart of the application.

Rather than use the *subsystem.OARM* minor resource definition, a RESTART EXIT could also be specified against the major resource definition for the application. In this case the exit would be driven for all application restarts, not just ARM.

Other reasons for SA z/OS not to allow ARM to attempt a restart of the application are:

- The application's monitor indicates that the address space is already active.
- The application is involved in a shutdown.
- The application is in status BREAKING, BROKEN, or CTLDOWN.

Defining a MOVE Group for Automatic Restart Manager

All resources with the same ARM element name should be linked to one Sysplex Application Group of nature MOVE (MOVE group).

An application's ARM element name is defined either during creation on the Define New Entry panel for applications or after creation via policy item APPLICATION INFO, in both cases in the **MVS Automatic Restart Management Element Name** field.

In order to ensure an application in a MOVE group has completely deregistered from ARM before the automation manager attempts to restart it, a Prepareavailable/WhenObservedDown (passive) relationship must be defined for each ARMed application in the MOVE group with the MOVE group defined as the supporting resource.

To make sure that the automation manager will start the applications linked to a MOVE group, the applications should not be in a HardDown status. The Start On IPL option should not be set to NO.

For more information on how to define MOVE groups see “Creating a New ApplicationGroup” in *IBM Tivoli System Automation for z/OS Defining Automation Policy*.

Appendix D. Message Automation

Generic Synonyms: AOFMSGSY

This AOFMSGSY NetView automation table (AT) fragment contains a number of synonyms that must be appropriately set. It is used in most master automation tables to set up the environmental parameters for the other fragments. The AOFMSGSY member is supplied by SA z/OS (in the SINGNPRM data set). You must customize it for each of your systems. The customized copy should be placed in the domain-specific data set for that system.

Note that many values in this table fragment are enclosed in triple single quotation marks. This means that the value of the synonym is the value entered surrounded by a single set of single quotation marks. This is necessary so that the value is treated as a literal and not an automation table variable.

Synonym	Usage and Default
%AOFALWAYSACTION%	<p>This synonym contains the action statement used for all the messages within a Begin-End block that SA z/OS does not trigger any action for.</p> <p>Default: NULL</p> <p>The default is that <i>no</i> action is taken and the message does not continue to search for further matches within the same AT.</p>
%AOFDOM%	<p>This synonym should contain the domain ID of the SA z/OS NetView on the system that it is automating. The synonym is used to screen messages to prevent the SA z/OS on this machine from reacting to a message that originated on another machine. If not set correctly, your automation fails.</p> <p>Default: &DOMAIN.</p> <p>This is a default domain name used in a number of the samples.</p>
%AOFSYS%	<p>This synonym should contain the system name used in the last IPL of the system. It is used to screen messages to prevent the SA z/OS on this machine from reacting to events that have occurred on other machines. It is important if you are running on a JES3 global or in a sysplex with EMCS consoles. If not set correctly, your automation fails.</p> <p>Default: &SYSNAME.</p> <p>This is a default system name used in a number of the samples.</p>
%AOFSIRTASK%	<p>NetView has a CNMCSSIR task that handles communications between the main NetView task and its SSI address space. This synonym should be set to the name of the task. If the synonym is not set properly, SA z/OS fails to initialize.</p> <p>Default: &DOMAIN.SIR</p>

Generic Synonyms: AOFMSGSY

Synonym	Usage and Default
%AOFARMPPI%	<p>This synonym should contain the name of the NetView autotask that is running the PPI interface from SA z/OS to z/OS. It is used to route commands from the NetView automation table to the autotask.</p> <p>Default: AOFARCAT</p>
%AOFGMFHSWAIT%	<p>The time interval SA z/OS waits after GMFHS initialization is complete before issuing the command to update the RODM with the current application automation states. Following the issuing of message DUI4003I GMFHS NETWORK CONFIGURATION INITIALIZED SUCCESSFULLY, GMFHS resets the color of all SA z/OS icons to grey (unknown). To set the SA z/OS icons' color to the current automation states after the initialization of GMFHS, SA z/OS must wait and issue the update command AFTER GMFHS has reset the colors to grey.</p> <p>Default: 00:02:00</p>

SA z/OS Message Presentation: AOFMSGSY

The presentation of SA z/OS messages (prefixed with AOF, ING, HSA, EVJ, EVE and EVI) under NetView is controlled by the automation table. This uses a number of synonyms and task globals indicating your message display characteristics. The following synonyms determine the display characteristics for each type of message. There is one set for the normal presentation of the message (AOFNORMx) and a second set for the held presentation (AOFHOLDx).

Synonym	Usage and Default
%AOFHOLDI%	<p>This synonym defines the actions taken for SA z/OS information (type I) messages that are held on your NCCF console.</p> <p>Default: HOLD(Y) COLOR(GRE) XHILITE(REV)</p> <p>This:</p> <ul style="list-style-type: none"> • Ensures that the message is held • Causes the message to be displayed in reverse video green
%AOFHOLDA%	<p>This synonym defines the actions taken for SA z/OS immediate action (type A) messages that are held on your NCCF console. As a rule, you should specify HOLD(Y) in the action.</p> <p>Default: HOLD(Y) COLOR(RED) XHILITE(REV) BEEP(Y)</p> <p>This:</p> <ul style="list-style-type: none"> • Ensures that the message is held • Causes the message to be displayed in reverse video red • Sounds the terminal alarm when the message is displayed

SA z/OS Message Presentation: AOFMSGSY

Synonym	Usage and Default
%AOFHOLDD%	<p>This synonym defines the actions taken for SA z/OS decision (type D) messages that are held on your NCCF console. As a rule, you should specify HOLD(Y) in the action.</p> <p>Default: HOLD(Y) COLOR(WHI) XHILITE(REV) BEEP(Y)</p> <p>This:</p> <ul style="list-style-type: none"> • Ensures that the message is held • Causes the message to be displayed in reverse video white • Sounds the terminal alarm when the message is displayed
%AOFHOLDE%	<p>This synonym defines the actions taken for SA z/OS eventual action (type E) messages that are held on your NCCF console. As a rule, you should specify HOLD(Y) in the action.</p> <p>Default: HOLD(Y) COLOR(YEL) XHILITE(REV) BEEP(Y)</p> <p>This:</p> <ul style="list-style-type: none"> • Ensures that the message is held • Causes the message to be displayed in reverse video yellow • Sounds the terminal alarm when the message is displayed
%AOFHOLDW%	<p>This synonym defines the actions taken for SA z/OS wait state (type W) messages that are held on your NCCF console. As a rule, you should specify HOLD(Y) in the action.</p> <p>Default: HOLD(Y) COLOR(PIN) XHILITE(REV) BEEP(Y)</p> <p>This:</p> <ul style="list-style-type: none"> • Ensures that the message is held • Causes the message to be displayed in reverse video pink • Sounds the terminal alarm when the message is displayed
%AOFNORMI%	<p>This synonym defines the actions taken for SA z/OS information (type I) messages that are not held on your NCCF console. As a rule, you should not specify HOLD(Y) in the action.</p> <p>Default: COLOR(GRE)</p> <p>This:</p> <ul style="list-style-type: none"> • Ensures that the message is not held • Causes the message to be displayed in green
%AOFNORMA%	<p>This synonym defines the actions taken for SA z/OS Immediate Action (type A) messages that are held on your NCCF console. As a rule, you should not specify HOLD(Y) in the action.</p> <p>Default: COLOR(YEL) XHILITE(REV) BEEP(Y)</p> <p>This:</p> <ul style="list-style-type: none"> • Ensures that the message is held • Causes the message to be displayed in yellow • Sounds the terminal alarm when the message is displayed

SA z/OS Message Presentation: AOFMSGSY

Synonym	Usage and Default
%AOFNORMD%	<p>This synonym defines the actions taken for SA z/OS Decision (type D) messages that are held on your NCCF console. You may find it beneficial to force these messages to be held.</p> <p>Default: COLOR(WHI) XHILITE(BLI)</p> <p>This:</p> <ul style="list-style-type: none"> • Ensures that the message is held • Causes the message to be displayed in blinking white
%AOFNORME%	<p>This synonym defines the actions taken for SA z/OS Eventual Action (type E) messages that are not held on your NCCF console. As a rule, you should not specify HOLD(Y) in the action.</p> <p>Default: COLOR(YEL)</p> <p>This:</p> <ul style="list-style-type: none"> • Ensures that the message is not held • Causes the message to be displayed in yellow
%AOFNORMW%	<p>This synonym defines the actions taken for SA z/OS Wait State (type W) messages that are held on your NCCF console. You may find it beneficial to force these messages to be held.</p> <p>Default: HOLD(Y) COLOR(PIN) XHILITE(REV) BEEP(Y)</p> <p>This:</p> <ul style="list-style-type: none"> • Ensures that the message is held • Causes the message to be displayed in reverse video pink • Sounds the terminal alarm when the message is displayed

Operator Cascades: AOFMSGSY

The next set of synonyms defines a series of *operator cascades*. A cascade is basically a list of automation operators used in many of the fragments to route commands. If %CASCADE% is defined as a synonym for 'AUTMON AUTOBASE AUTO1' and you route a command to it with ROUTE (ONE %CASCADE%) on an EXEC statement, the command is run on the first autotask in the cascade that is logged on. This provides you with a flexible, controllable means of providing backup processing tasks in case one of your normal tasks is unavailable.

Synonym	Usage and Default
%AOFLOPAUTOx%	<p>This cascade defines the actions taken for SA z/OS information (type I) messages that are being held on your NCCF console. Given the number of informational messages that SA z/OS produces you may find it beneficial HOLD(N) to stop them from being held even if the user has asked for them to be held.</p> <p>Default: ' 'AUTOx' '</p>

Synonym	Usage and Default
%AOFOPAUTO1%	<p>This cascade is used to route commands to AUTO1. If you have renamed AUTO1 you must change the synonym.</p> <p>Default: AUTO1</p> <p>There is no backup for AUTO1. If it fails when it is needed, many other things will probably fail as well.</p>
%AOFOPAUTO2	<p>This cascade is used to route commands to AUTO2. If you have renamed AUTO2 you must change this synonym.</p> <p>Default: AUTO2 AUTO1</p> <p>If AUTO2 is not active, AUTO1 does its work.</p>
%AOFOPBASEOPER%	<p>This cascade is used to send commands to BASEOPER. If you are not using the standard names for SA z/OS autotasks you must change this synonym. BASEOPER is mainly defined as a fallback operator and has very little work directly routed to it.</p> <p>Default: AUTOBASE AUTO1</p> <p>AUTOBASE is the operator ID that SA z/OS uses for BASEOPER in its other samples. If AUTOBASE is not active, AUTO1 is tried.</p>
%AOFOPRPCOPER%	<p>This cascade is used for XCF communication management. If you are not using the standard names for SA z/OS autotasks you must change this synonym.</p> <p>Default: AUTRPC AUTSYS AUTOBASE AUTO1</p>
%AOFOPSYSOPER%	<p>This cascade is used to send commands to SYSOPER. If you are not using the standard names for SA z/OS autotasks you must change this synonym. SYSOPER is mainly defined as a fallback operator and has very little work directly routed to it.</p> <p>Default: AUTSYS AUTOBASE AUTO1</p> <p>AUTSYS is the operator ID that SA z/OS uses for SYSOPER in its other samples.</p>
%AOFOPMSGOPER%	<p>This cascade is used to send commands to MSGOPER. If you are not using the standard names for SA z/OS autotasks you must change this synonym. MSGOPER is mainly defined to respond to miscellaneous messages.</p> <p>Default: AUTMSG AUTSYS AUTOBASE AUTO1</p> <p>AUTMSG is the operator ID that SA z/OS uses for MSGOPER in its other samples.</p>

Operator Cascades: AOFMSGSY

Synonym	Usage and Default
%AOFOPNETOPER%	<p>This cascade is used to send commands to NETOPER. If you are not using the standard names for SA z/OS autotasks you must change this synonym. NETOPER is defined for VTAM automation.</p> <p>Default: AUTNET1 AUTNET2 AUTSYS AUTOBASE AUTO1</p> <p>AUTNET1 and AUTNET2 are the operator IDs that SA z/OS uses for NETOPER in its other samples. NETOPER is the only sample automation function to have a backup defined in the samples.</p>
%AOFOPJESOPER%	<p>This cascade is used to send commands to JESOPER. If you are not using the standard names for SA z/OS autotasks you must change this synonym. JESOPER is mainly defined for JES automation.</p> <p>Default: AUTJES AUTSYS AUTOBASE AUTO1</p> <p>AUTJES is the operator ID that SA z/OS uses for JESOPER in its other samples.</p>
%AOFOPMONOPER%	<p>This cascade is used to send commands to MONOPER. If you are not using the standard names for SA z/OS autotasks you must change this synonym. MONOPER is used for regular monitoring and subsystem startups.</p> <p>Default: AUTMON AUTSYS AUTOBASE AUTO1</p> <p>AUTMON is the operator ID that SA z/OS uses for MONOPER in its other samples.</p>
%AOFOPRECOPER%	<p>This cascade is used to send commands to RECOPER. If you are not using the standard names for SA z/OS autotasks you must change this synonym. RECOPER is used for recovery processing.</p> <p>Default: AUTREC AUTSYS AUTOBASE AUTO1</p> <p>AUTREC is the operator ID that SA z/OS uses for RECOPER in its other samples.</p>
%AOFOPSHUTOPER%	<p>This cascade is used to send commands to SHUTOPER. If you are not using the standard names for SA z/OS autotasks you must change this synonym. SHUTOPER coordinates automated shutdowns.</p> <p>Default: AUTSHUT AUTSYS AUTOBASE AUTO1</p> <p>AUTSHUT is the operator ID that SA z/OS uses for SHUTOPER in its other samples.</p>

Synonym	Usage and Default
%AOFOPGSSOPER%	<p>This cascade is used to send commands to GSSOPER. If you are not using the standard names for SA z/OS autotasks you must change this synonym. GSSOPER is used for generic subsystem automation.</p> <p>Default: * AUTGSS AUTSYS AUTOBASE AUTO1</p> <p>AUTGSS is the operator ID that SA z/OS uses for GSSOPER in its other samples.</p> <p>If you want to turn off the "ASSIGN BY JOBNAME" feature, that is, the advanced automation CGLOBAL variable <i>AOF_ASSIGN_JOBNAME</i> (see Appendix A, "Global Variables," on page 197) has been set to 0, you must remove the asterisk (*), because this may cause serialization problems.</p> <p>Note: NetView's ASSIGN-BY-JOBNAME command that occurs before automation table processing only affects messages that are associated with an MVS job name.</p>
%AOFOPWTORS%	<p>This cascade is used to route commands concerning WTORS. If you are not using the standard names for SA z/OS autotasks you must change this synonym. Its use ensures that all WTOR processing is done on the same task and this is serialized.</p> <p>Default: * AUTGSS AUTSYS AUTOBASE AUTO1</p> <p>This specifies that AUTSYS is to do all the WTOR processing.</p>
%AOFOPGATOPER%	<p>This cascade is used to route commands to this domain's gateway autotask. Because the autotask name contains the domain ID you must modify this synonym.</p> <p>Default: GATR<i>domain</i>.</p> <p>AOF01 is the default domain used in the other samples. There is no backup as the gateway CLISTs expect to be running on GATOPER.</p>

SA z/OS Topology Manager for NMC: AOFMSGST

These synonyms are used and defined in the AOFMSGST fragment.

Synonym	Usage and Default
%AOFOPTOPOMGR%	<p>This is the name of the autotask that the SA z/OS topology manager runs on this system.</p> <p>Default: &DOMAIN.TPO</p>
%AOFINITOPOCMD%	<p>This is the command issued to initialize the SA z/OS topology manager.</p> <p>Default: INGTPO INIT &DOMAIN.TPO</p>
%AOFOPHB%	<p>This is the name of the heart beat task needed on focal point.</p> <p>Default: AUTHB</p>

Appendix E. TSO User Monitoring

Active TSO users can be monitored in NMC and SDF using the SA z/OS command DFTSOU (EVJETSOU). To enable TSO user monitoring add the following entry to user AT include fragment INGMSGU1 (or to your own user message table):

```
IF (MSGID='IEF125I' | MSGID='IEF126I' | MSGID='IEF450I')
  THEN EXEC(CMD('DFTSOU UPDATE') ROUTE(ALL *))
  DISPLAY(N) NETLOG(N) CONTINUE(Y);
```

Also, put 'DFTSOU SCAN' in the ACORESTART message for the TSO subsystem.

When DFTSOU is called with the UPDATE parameter then:

- For IEF125I, an ADD request is sent to SDF and NMC for the TSO user that produces the message.
- For IEF126I, a DELETE request is sent to SDF and NMC for the TSO user that produces the message.
- For IEF450I, a DELETE request is sent to SDF and NMC for the failing TSO user. When IEF450I is specified, and the trap is coded in INGMSGU1, then CONTINUE(Y) must also be coded.

When DFTSOU is called with the SCAN parameter, an MVS D TS,L command is issued to identify all currently active TSO users. This data is then passed to SDF and NMC.

NMC updates are associated with NMC object TSO. SDF updates are associated with SDF tree entry TSOUSERS.

Appendix F. Notices

This information was developed for products and services offered in the U.S.A.

IBM may not offer the products, services, or features discussed in this document in other countries. Consult your local IBM representative for information on the products and services currently available in your area. Any reference to an IBM product, program, or service is not intended to state or imply that only that IBM product, program, or service may be used. Any functionally equivalent product, program, or service that does not infringe any IBM intellectual property right may be used instead. However, it is the user's responsibility to evaluate and verify the operation of any non-IBM product, program, or service.

IBM may have patents or pending patent applications covering subject matter in this document. The furnishing of this document does not give you any license to these patents. You can send license inquiries, in writing, to:

IBM Director of Licensing
IBM Corporation
North Castle Drive
Armonk, NY 10504-1785
USA

For license inquiries regarding double-byte (DBCS) information, contact the IBM Intellectual Property Department in your country or send inquiries, in writing, to:

Intellectual Property Licensing
Legal and Intellectual Property Law
IBM Japan, Ltd.
1623-14, Shimotsuruma, Yamato-shi
Kanagawa 242-8502 Japan

The following paragraph does not apply to the United Kingdom or any other country where such provisions are inconsistent with local law:

INTERNATIONAL BUSINESS MACHINES CORPORATION PROVIDES THIS PUBLICATION "AS IS" WITHOUT WARRANTY OF ANY KIND, EITHER EXPRESS OR IMPLIED, INCLUDING, BUT NOT LIMITED TO, THE IMPLIED WARRANTIES OF NON-INFRINGEMENT, MERCHANTABILITY OR FITNESS FOR A PARTICULAR PURPOSE. Some states do not allow disclaimer of express or implied warranties in certain transactions, therefore, this statement may not apply to you.

This information could include technical inaccuracies or typographical errors. Changes are periodically made to the information herein; these changes will be incorporated in new editions of the publication. IBM may make improvements and/or changes in the product(s) and/or the program(s) described in this publication at any time without notice.

Any references in this information to non-IBM Web sites are provided for convenience only and do not in any manner serve as an endorsement of those Web sites. The materials at those Web sites are not part of the materials for this IBM product and use of those Web sites is at your own risk.

IBM may use or distribute any of the information you supply in any way it believes appropriate without incurring any obligation to you.

Licensees of this program who wish to have information about it for the purpose of enabling: (i) the exchange of information between independently created programs and other programs (including this one) and (ii) the mutual use of the information which has been exchanged, should contact:

IBM Deutschland Research & Development GmbH
Department 3248
Schoenaicher Strasse 220
D-71032 Boeblingen
Federal Republic of Germany

Such information may be available, subject to appropriate terms and conditions, including in some cases, payment of a fee.

The licensed program described in this document and all licensed material available for it are provided by IBM under terms of the IBM Customer Agreement, IBM International Program License Agreement or any equivalent agreement between us.

This information contains examples of data and reports used in daily business operations. To illustrate them as completely as possible, the examples include the names of individuals, companies, brands, and products. All of these names are fictitious and any similarity to the names and addresses used by an actual business enterprise is entirely coincidental.

If you are viewing this information softcopy, the photographs and color illustrations may not appear.

Programming Interface Information

This publication documents information that is *not* intended to be used as a programming interface of IBM Tivoli System Automation for z/OS.

Trademarks

IBM, the IBM logo, and ibm.com are trademarks or registered trademarks of International Business Machines Corp., registered in many jurisdictions worldwide. Other product and service names might be trademarks of IBM or other companies. A current list of IBM trademarks is available on the Web at www.ibm.com/legal/copytrade.shtml.

Linux is a registered trademark of Linus Torvalds in the United States, other countries, or both.

Microsoft and Windows are trademarks of Microsoft Corporation in the United States, other countries, or both.

UNIX is a registered trademark of The Open Group in the United States and other countries.

Glossary

This glossary includes terms and definitions from:

- The *IBM Dictionary of Computing* New York: McGraw-Hill, 1994.
- The *American National Standard Dictionary for Information Systems*, ANSI X3.172-1990, copyright 1990 by the American National Standards Institute (ANSI). Copies can be purchased from the American National Standards Institute, 1430 Broadway, New York, New York 10018. Definitions are identified by the symbol (A) after the definition.
- The *Information Technology Vocabulary* developed by Subcommittee 1, Joint Technical Committee 1, of the International Organization for Standardization and the International Electrotechnical Commission (ISO/IEC JTC1/SC1). Definitions of published parts of this vocabulary are identified by the symbol (I) after the definition; definitions taken from draft international standards, committee drafts, and working papers being developed by ISO/IEC JTC1/SC1 are identified by the symbol (T) after the definition, indicating that final agreement has not yet been reached among the participating National Bodies of SC1.

The following cross-references are used in this glossary:

Contrast with. This refers to a term that has an opposed or substantively different meaning.

Deprecated term for. This indicates that the term should not be used. It refers to a preferred term, which is defined in its proper place in the glossary.

See. This refers the reader to multiple-word terms in which this term appears.

See also. This refers the reader to terms that have a related, but not synonymous, meaning.

Synonym for. This indicates that the term has the same meaning as a preferred term, which is defined in the glossary.

Synonymous with. This is a backward reference from a defined term to all other terms that have the same meaning.

A

ACF. See automation configuration file.

ACF/NCP. Advanced Communications Function for the Network Control Program. See Advanced Communications Function and Network Control Program.

ACF/VTAM. Advanced Communications Function for the Virtual Telecommunications Access Method. Synonym for VTAM. See Advanced Communications Function and Virtual Telecommunications Access Method.

active monitoring. In SA z/OS automation control file, the acquiring of resource status information by soliciting such information at regular, user-defined intervals. See also passive monitoring.

adapter. Hardware card that enables a device, such as a workstation, to communicate with another device, such as a monitor, a printer, or some other I/O device.

Address Space Workflow. In RMF, a measure of how a job uses system resources and the speed at which the job moves through the system. A low workflow indicates that a job has few of the resources it needs and is contending with other jobs for system resources. A high workflow indicates that a job has all the resources it needs to execute.

adjacent hosts. Systems connected in a peer relationship using adjacent NetView sessions for purposes of monitoring and control.

adjacent NetView. In SA z/OS, the system defined as the communication path between two SA z/OS systems that do not have a direct link. An adjacent NetView is used for message forwarding and as a communication link between two SA z/OS systems. For example, the adjacent NetView is used when sending responses from a focal point to a remote system.

Advanced Communications Function (ACF). A group of IBM licensed programs (principally VTAM, TCAM, NCP, and SSP) that use the concepts of Systems Network Architecture (SNA), including distribution of function and resource sharing.

advanced program-to-program communication (APPC). A set of inter-program communication services that support cooperative transaction processing in a Systems Network Architecture (SNA) network. APPC is the implementation, on a given system, of SNA's logical unit type 6.2.

alert. (1) In SNA, a record sent to a system problem management focal point or to a collection point to communicate the existence of an alert condition. (2) In

NetView, a high-priority event that warrants immediate attention. A database record is generated for certain event types that are defined by user-constructed filters.

alert condition. A problem or impending problem for which some or all of the process of problem determination, diagnosis, and resolution is expected to require action at a control point.

alert focal-point system. See NPDA focal point system.

alert threshold. An application or volume service value that determines the level at which SA z/OS changes the associated icon in the graphical interface to the alert color. SA z/OS may also issue an alert. See warning threshold.

AMC. (1) See Automation Manager Configuration. (2) The Auto Msg Classes entry type.

American Standard Code for Information Interchange (ASCII). A standard code used for information exchange among data processing systems, data communication systems, and associated equipment. ASCII uses a coded character set consisting of 7-bit coded characters (8-bit including parity check). The ASCII set consists of control characters and graphic characters. See also Extended Binary Coded Decimal Interchange Code.

APF. See authorized program facility.

API. See application programming interface.

APPC. See advanced program-to-program communication.

application. In SA z/OS, applications refer to z/OS subsystems, started tasks, or jobs that are automated and monitored by SA z/OS. On SNMP-capable processors, application can be used to refer to a subsystem or process.

Application entry. A construct, created with the customization dialogs, used to represent and contain policy for an application.

application group. A named set of applications. An application group is part of an SA z/OS enterprise definition and is used for monitoring purposes.

application program. (1) A program written for or by a user that applies to the user's work, such as a program that does inventory or payroll. (2) A program used to connect and communicate with stations in a network, enabling users to perform application-oriented activities.

application programming interface (API). An interface that allows an application program that is written in a high-level language to use specific data or functions of the operating system or another program.

ApplicationGroup entry. A construct, created with the customization dialogs, used to represent and contain policy for an application group.

ARM. See automatic restart management.

ASCB. Address space control block.

ASCB status. An application status derived by SA z/OS running a routine (the ASCB checker) that searches the z/OS address space control blocks (ASCBs) for address spaces with a particular job name. The job name used by the ASCB checker is the job name defined in the customization dialog for the application.

ASCII. See American Standard Code for Information Interchange.

ASF. See automation status file.

authorized program facility (APF). A facility that permits identification of programs that are authorized to use restricted functions.

automated console operations (ACO). The use of an automated procedure to replace or simplify the action that an operator takes from a console in response to system or network events.

automated function. SA z/OS automated functions are automation operators, NetView autotasks that are assigned to perform specific automation functions. However, SA z/OS defines its own synonyms, or *automated function names*, for the NetView autotasks, and these function names are referred to in the sample policy databases provided by SA z/OS. For example, the automation operator AUTBASE corresponds to the SA z/OS automated function BASEOPER.

automatic restart management (ARM). A z/OS recovery function that improves the availability of specified subsystems and applications by automatically restarting them under certain circumstances. Automatic restart management is a function of the Cross-System Coupling Facility (XCF) component of z/OS.

automatic restart management element name. In MVS 5.2 or later, z/OS automatic restart management requires the specification of a unique sixteen character name for each address space that registers with it. All automatic restart management policy is defined in terms of the element name, including SA z/OS's interface with it.

automation. The automatic initiation of actions in response to detected conditions or events. SA z/OS provides automation for z/OS applications, z/OS components, and remote systems that run z/OS. SA z/OS also provides tools that can be used to develop additional automation.

automation agent. In SA z/OS, the automation function is split up between the automation manager and the automation agents. The observing, reacting and doing parts are located within the NetView address space, and are known as the *automation agents*. The automation agents are responsible for:

- Recovery processing
- Message processing
- Active monitoring: they propagate status changes to the automation manager

automation configuration file. The SA z/OS customization dialogs must be used to build the automation configuration file. It consists of:

- | • The automation manager configuration file (AMC)
- | • The NetView automation table (AT)
- | • The NetView message revision table (MRT)
- | • The MPFLSTSA member

automation control file (ACF). In SA z/OS, a file that contains system-level automation policy information. There is one master automation control file for each NetView system that SA z/OS is installed on. Additional policy information and all resource status information is contained in the policy database (PDB). The SA z/OS customization dialogs must be used to build the automation control files. They must not be edited manually.

automation flags. In SA z/OS, the automation policy settings that determine the operator functions that are automated for a resource and the times during which automation is active. When SA z/OS is running, automation is controlled by automation flag policy settings and override settings (if any) entered by the operator. Automation flags are set using the customization dialogs.

automation manager. In SA z/OS, the automation function is split up between the automation manager and the automation agents. The coordination, decision making and controlling functions are processed by each sysplex's *automation manager*.

The automation manager contains a model of all of the automated resources within the sysplex. The automation agents feed the automation manager with status information and perform the actions that the automation manager tells them to.

The automation manager provides *sysplex-wide* automation.

Automation Manager Configuration. The Automation Manager Configuration file (AMC) contains an image of the automated systems in a sysplex or of a standalone system. See also “automation configuration file.”

Automation NetView. In SA z/OS the NetView that performs routine operator tasks with command procedures or uses other ways of automating system

and network management, issuing automatic responses to messages and management services units.

automation operator. NetView automation operators are NetView autotasks that are assigned to perform specific automation functions. See also automated function. NetView automation operators may receive messages and process automation procedures. There are no logged-on users associated with automation operators. Each automation operator is an operating system task and runs concurrently with other NetView tasks. An automation operator could be set up to handle JES2 messages that schedule automation procedures, and an automation statement could route such messages to the automation operator. Similar to *operator station task*. SA z/OS message monitor tasks and target control tasks are automation operators.

automation policy. The policy information governing automation for individual systems. This includes automation for applications, z/OS subsystems, z/OS data sets, and z/OS components.

automation policy settings. The automation policy information contained in the automation control file. This information is entered using the customization dialogs. You can display or modify these settings using the customization dialogs.

automation procedure. A sequence of commands, packaged as a NetView command list or a command processor written in a high-level language. An automation procedure performs automation functions and runs under NetView.

automation status file (ASF). In SA z/OS, a file containing status information for each automated subsystem, component or data set. This information is used by SA z/OS automation when taking action or when determining what action to take. In Release 2 and above of AOC/MVS, status information is also maintained in the operational information base.

automation table (AT). See NetView automation table.

autotask. A NetView automation task that receives messages and processes automation procedures. There are no logged-on users associated with autotasks. Each autotask is an operating system task and runs concurrently with other NetView tasks. An autotask could be set up to handle JES2 messages that schedule automation procedures, and an automation statement could route such messages to the autotasks. Similar to *operator station task*. SA z/OS message monitor tasks and target control tasks are autotasks. Also called *automation operator*.

available. In VTAM programs, pertaining to a logical unit that is active, connected, enabled, and not at its session limit.

B

Base Control Program (BCP). A program that provides essential services for the MVS and z/OS operating systems. The program includes functions that manage system resources. These functions include input/output, dispatch units of work, and the z/OS UNIX System Services kernel. See also Multiple Virtual Storage and z/OS.

basic mode. A central processor mode that does not use logical partitioning. Contrast with logically partitioned mode.

BCP. See Base Control Program.

BCP Internal Interface. Processor function of CMOS-390 and System z processor families. It allows for communication between basic control programs such as z/OS and the processor support element in order to exchange information or to perform processor control functions. Programs using this function can perform hardware operations such as ACTIVATE or SYSTEM RESET.

beaconing. The repeated transmission of a frame or messages (beacon) by a console or workstation upon detection of a line break or outage.

BookManager®. An IBM product that lets users view softcopy documents on their workstations.

C

central processor (CP). The part of the computer that contains the sequencing and processing facilities for instruction execution, initial program load (IPL), and other machine operations.

central processor complex (CPC). A physical collection of hardware that consists of central storage, one or more central processors, timers, and channels.

central site. In a distributed data processing network, the central site is usually defined as the focal point for alerts, application design, and remote system management tasks such as problem management.

CFR/CFS and ISC/ISR. I/O operations can display and return data about integrated system channels (ISC) connected to a coupling facility and coupling facility receiver (CFR) channels and coupling facility sender (CFS) channels.

channel. A path along which signals can be sent; for example, data channel, output channel. See also link.

channel path identifier. A system-unique value assigned to each channel path.

channel-attached. (1) Attached directly by I/O channels to a host processor (for example, a

channel-attached device). (2) Attached to a controlling unit by cables, rather than by telecommunication lines. Contrast with link-attached. Synonymous with local.

CHPID. In SA z/OS, channel path ID; the address of a channel.

CHPID port. A label that describes the system name, logical partitions, and channel paths.

CI. See console integration.

CICS/VS. Customer Information Control System for Virtual Storage. See Customer Information Control System.

CLIST. See command list.

clone. A set of definitions for application instances that are derived from a basic application definition by substituting a number of different system-specific values into the basic definition.

clone ID. A generic means of handling system-specific values such as the MVS SYSC clone or the VTAM subarea number. Clone IDs can be substituted into application definitions and commands to customize a basic application definition for the system that it is to be instantiated on.

CNC. A channel path that transfers data between a host system image and an ESCON® control unit. It can be point-to-point or switchable.

command. A request for the performance of an operation or the execution of a particular program.

command facility. The component of NetView that is a base for command processors that can monitor, control, automate, and improve the operation of a network. The successor to NCCF.

command list (CLIST). (1) A list of commands and statements, written in the NetView command list language or the REXX language, designed to perform a specific function for the user. In its simplest form, a command list is a list of commands. More complex command lists incorporate variable substitution and conditional logic, making the command list more like a conventional program. Command lists are typically interpreted rather than being compiled. (2) In SA z/OS, REXX command lists that can be used for automation procedures.

command procedure. In NetView, either a command list or a command processor.

command processor. A module designed to perform a specific function. Command processors, which can be written in assembler or a high-level language (HLL), are issued as commands.

command processor control block. An I/O operations internal control block that contains information about the command being processed.

Command Tree/2. An OS/2-based program that helps you build commands on an OS/2 window, then routes the commands to the destination you specify (such as a 3270 session, a file, a command line, or an application program). It provides the capability for operators to build commands and route them to a specified destination.

common commands. The SA z/OS subset of the CPC operations management commands.

common routine. One of several SA z/OS programs that perform frequently used automation functions. Common routines can be used to create new automation procedures.

Common User Access (CUA) architecture. Guidelines for the dialog between a human and a workstation or terminal.

communication controller. A type of communication control unit whose operations are controlled by one or more programs stored and executed in the unit or by a program executed in a processor to which the controller is connected. It manages the details of line control and the routing of data through a network.

communication line. Deprecated term for telecommunication line.

connectivity view. In SA z/OS, a display that uses graphic images for I/O devices and lines to show how they are connected.

console automation. The process of having NetView facilities provide the console input usually handled by the operator.

console connection. In SA z/OS, the 3270 or ASCII (serial) connection between a PS/2 computer and a target system. Through this connection, the workstation appears (to the target system) to be a console.

console integration (CI). A hardware facility that if supported by an operating system, allows operating system messages to be transferred through an internal hardware interface for display on a system console. Conversely, it allows operating system commands entered at a system console to be transferred through an internal hardware interface to the operating system for processing.

consoles. Workstations and 3270-type devices that manage your enterprise.

Control units. Hardware units that control I/O operations for one or more devices. You can view information about control units through I/O

operations, and can start or stop data going to them by blocking and unblocking ports.

controller. A unit that controls I/O operations for one or more devices.

converted mode (CVC). A channel operating in converted (CVC) mode transfers data in blocks and a CBY channel path transfers data in bytes. Converted CVC or CBY channel paths can communicate with a parallel control unit. This resembles a point-to-point parallel path and dedicated connection, regardless whether it passes through a switch.

couple data set. A data set that is created through the XCF couple data set format utility and, depending on its designated type, is shared by some or all of the z/OS systems in a sysplex. See also sysplex couple data set and XCF couple data set.

coupling facility. The hardware element that provides high-speed caching, list processing, and locking functions in a sysplex.

CP. See central processor.

CPC. See central processor complex.

CPC operations management commands. A set of commands and responses for controlling the operation of System/390[®] CPCs.

CPC subset. All or part of a CPC. It contains the minimum *resource* to support a single control program.

CPCB. See command processor control block.

CPU. Central processing unit. Deprecated term for processor.

cross-system coupling facility (XCF). A component of z/OS that provides functions to support cooperation between authorized programs running within a sysplex.

CTC. The channel-to-channel (CTC) channel can communicate with a CTC on another host for intersystem communication.

Customer Information Control System (CICS). A general-purpose transactional program that controls online communication between terminal users and a database for a large number of end users on a real-time basis.

customization dialogs. The customization dialogs are an ISPF application. They are used to customize the enterprise policy, like, for example, the enterprise resources and the relationships between resources, or the automation policy for systems in the enterprise. How to use these dialogs is described in *IBM Tivoli System Automation for z/OS Customizing and Programming*.

CVC. See converted mode.

D

DASD. See direct access storage device.

data services task (DST). The NetView subtask that gathers, records, and manages data in a VSAM file or a network device that contains network management information.

data set. The major unit of data storage and retrieval, consisting of a collection of data in one of several prescribed arrangements and described by control information to which the system has access.

data set members. Members of partitioned data sets that are individually named elements of a larger file that can be retrieved by name.

DBCS. See double-byte character set.

DCCF. See disabled console communication facility.

DCF. See Document Composition Facility.

DELAY Report. An RMF report that shows the activity of each job in the system and the hardware and software resources that are delaying each job.

device. A piece of equipment. Devices can be workstations, printers, disk drives, tape units, remote systems or communications controllers. You can see information about all devices attached to a particular switch, and control paths and jobs to devices.

DEVR Report. An RMF report that presents information about the activity of I/O devices that are delaying jobs.

dialog. Interactive 3270 panels.

direct access storage device (DASD). A device that allows storage to be directly accessed, such as a disk drive.

disabled console communication facility (DCCF). A z/OS component that provides limited-function console communication during system recovery situations.

disk operating system (DOS). (1) An operating system for computer systems that use disks and diskettes for auxiliary storage of programs and data. (2) Software for a personal computer that controls the processing of programs. For the IBM Personal Computer, the full name is Personal Computer Disk Operating System (PCDOS).

display. (1) To present information for viewing, usually on the screen of a workstation or on a hardcopy device. (2) Deprecated term for panel.

distribution manager. The component of the NetView program that enables the host system to use, send, and delete files and programs in a network of computers.

Document Composition Facility (DCF). An IBM licensed program used to format input to a printer.

domain. (1) An access method and its application programs, communication controllers, connecting lines, modems, and attached workstations. (2) In SNA, a system services control point (SSCP) and the physical units (PUs), logical units (LUs), links, link stations, and associated resources that the SSCP can control with activation requests and deactivation requests.

double-byte character set (DBCS). A character set, such as Kanji, in which each character is represented by a 2-byte code.

DP enterprise. Data processing enterprise.

DSIPARM. This file is a collection of members of NetView's customization.

DST. Data Services Task.

E

EBCDIC. See Extended Binary Coded Decimal Interchange Code.

ECB. See event control block.

EMCS. Extended multiple console support. See also multiple console support.

enterprise. The composite of all operational entities, functions, and resources that form the total business concern and that require an information system.

enterprise monitoring. Enterprise monitoring is used by SA z/OS to update the *NetView Management Console (NMC)* resource status information that is stored in the *Resource Object Data Manager (RODM)*. Resource status information is acquired by enterprise monitoring of the *Resource Measurement Facility (RMF) Monitor III* service information at user-defined intervals. SA z/OS stores this information in its operational information base, where it is used to update the information presented to the operator in graphic displays.

Enterprise Systems Architecture (ESA). A hardware architecture that reduces the effort required for managing data sets and extends addressability for system, subsystem, and application functions.

entries. Resources, such as processors, entered on panels.

entry type. Resources, such as processors or applications, used for automation and monitoring.

environment. Data processing enterprise.

error threshold. An automation policy setting that specifies when SA z/OS should stop trying to restart or recover an application, subsystem or component, or offload a data set.

ESA. See Enterprise Systems Architecture.

eServer™. Processor family group designator used by the SA z/OS customization dialogs to define a target hardware as member of the System z or 390-CMOS processor families.

event. (1) In NetView, a record indicating irregularities of operation in physical elements of a network. (2) An occurrence of significance to a task; for example, the completion of an asynchronous operation, such as an input/output operation. (3) Events are part of a trigger condition, such that if all events of a trigger condition have occurred, a startup or shutdown of an application is performed.

event control block (ECB). A control block used to represent the status of an event.

exception condition. An occurrence on a system that is a deviation from normal operation. SA z/OS monitoring highlights exception conditions and allows an SA z/OS enterprise to be managed by exception.

Extended Binary Coded Decimal Interchange Code (EBCDIC). A coded character set of 256 8-bit characters developed for the representation of textual data. See also American Standard Code for Information Interchange.

extended recovery facility (XRF). A facility that minimizes the effect of failures in z/OS, VTAM, the host processor, or high availability applications during sessions between high availability applications and designated terminals. This facility provides an alternate subsystem to take over sessions from the failing subsystem.

F

fallback system. See secondary system.

field. A collection of bytes within a record that are logically related and are processed as a unit.

file manager commands. A set of SA z/OS commands that read data from or write data to the automation control file or the operational information base. These commands are useful in the development of automation that uses SA z/OS facilities.

focal point. In NetView, the focal-point domain is the central host domain. It is the central control point for any management services element containing control of the network management data.

focal point system. (1) A system that can administer, manage, or control one or more target systems. There

are a number of different focal point system associated with IBM automation products. (2) **NMC focal point system.** The NMC focal point system is a NetView system with an attached workstation server and LAN that gathers information about the state of the network. This focal point system uses RODM to store the data it collects in the data model. The information stored in RODM can be accessed from any LAN-connected workstation with NetView Management Console installed. (3) **NPDA focal point system.** This is a NetView system that collects all the NPDA alerts that are generated within your enterprise. It is supported by NetView. If you have SA z/OS installed the NPDA focal point system must be the same as your NMC focal point system. The NPDA focal point system is also known as the *alert focal point system*. (4) **SA z/OS Processor Operations focal point system.** This is a NetView system that has SA z/OS host code installed. The SA z/OS Processor Operations focal point system receives messages from the systems and operator consoles of the machines that it controls. It provides full systems and operations console function for its target systems. It can be used to IPL these systems. Note that some restrictions apply to the Hardware Management Console for an S/390® microprocessor cluster. (5) **SA z/OS SDF focal point system.** The SA z/OS SDF focal point system is an SA z/OS NetView system that collects status information from other SA z/OS NetViews within your enterprise. (6) **Status focal point system.** In NetView, the system to which STATMON, VTAM and NLDM send status information on network resources. If you have a NMC focal point, it must be on the same system as the Status focal point. (7) **Hardware Management Console.** Although not listed as a focal point, the Hardware Management Console acts as a focal point for the console functions of an S/390 microprocessor cluster. Unlike all the other focal points in this definition, the Hardware Management Console runs on a LAN-connected workstation,

frame. For a System/390 microprocessor cluster, a frame contains one or two central processor complexes (CPCs), support elements, and AC power distribution.

full-screen mode. In NetView, a form of panel presentation that makes it possible to display the contents of an entire workstation screen at once. Full-screen mode can be used for fill-in-the-blanks prompting. Contrast with line mode.

G

gateway session. An NetView-NetView Task session with another system in which the SA z/OS outbound gateway operator logs onto the other NetView session without human operator intervention. Each end of a gateway session has both an inbound and outbound gateway operator.

generic alert. Encoded alert information that uses code points (defined by IBM and possibly customized by users or application programs) stored at an alert receiver, such as NetView.

generic routines. In SA z/OS, a set of self-contained automation routines that can be called from the NetView automation table, or from user-written automation procedures.

group. A collection of target systems defined through configuration dialogs. An installation might set up a group to refer to a physical site or an organizational or application entity.

group entry. A construct, created with the customization dialogs, used to represent and contain policy for a group.

group entry type. A collection of target systems defined through the customization dialog. An installation might set up a group to refer to a physical site or an organizational entity. Groups can, for example, be of type STANDARD or SYSPLEX.

H

Hardware Management Console (HMC). A system that controls managed systems, including the management of logical partitions and use of Capacity Upgrade on Demand. Using service applications, the HMC communicates with managed systems to detect, consolidate, and send information to IBM for analysis.

Hardware Management Console Application (HWMCA). A direct-manipulation object-oriented graphical user interface that provides a single point of control and single system image for hardware elements. The HWMCA provides grouping support, aggregated and real-time system status using colors, consolidated hardware messages support, consolidated operating system messages support, consolidated service support, and hardware commands targeted at a single system, multiple systems, or a group of systems.

heartbeat. In SA z/OS, a function that monitors the validity of the status forwarding path between remote systems and the NMC focal point, and monitors the availability of remote z/OS systems, to ensure that status information displayed on the SA z/OS workstation is current.

help panel. An online panel that tells you how to use a command or another aspect of a product.

hierarchy. In the NetView program, the resource types, display types, and data types that make up the organization, or levels, in a network.

high-level language (HLL). A programming language that provides some level of abstraction from assembler

language and independence from a particular type of machine. For the NetView program, the high-level languages are PL/I and C.

HLL. See high-level language.

host (primary processor). The processor that you enter a command at (also known as the *issuing processor*).

host system. In a coupled system or distributed system environment, the system on which the facilities for centralized automation run. SA z/OS publications refer to target systems or focal-point systems instead of hosts.

HWMCA. See Hardware Management Console Application.

I

I/O operations. The part of SA z/OS that provides you with a single point of logical control for managing connectivity in your active I/O configurations. I/O operations takes an active role in detecting unusual conditions and lets you view and change paths between a processor and an I/O device, using dynamic switching (the ESCON director). Also known as I/O Ops.

I/O Ops. See I/O operations.

I/O resource number. Combination of channel path identifier (CHPID), device number, etc. See internal token.

images. A grouping of processors and I/O devices that you define. You can define a single-image mode that allows a multiprocessor system to function as one central processor image.

IMS. See Information Management System.

IMS/VS. See Information Management System/Virtual Storage.

inbound. In SA z/OS, messages sent to the focal-point system from the PC or target system.

inbound gateway operator. The automation operator that receives incoming messages, commands, and responses from the outbound gateway operator at the sending system. The inbound gateway operator handles communications with other systems using a gateway session.

Information Management System (IMS). Any of several system environments available with a database manager and transaction processing that are capable of managing complex databases and terminal networks.

Information Management System/Virtual Storage (IMS/VS). A database/data communication (DB/DC) system that can manage complex databases and networks. Synonymous with Information Management System.

INGEIO PROC. The I/O operations default procedure name. It is part of the SYS1.PROCLIB.

initial microprogram load. The action of loading microprograms into computer storage.

initial program load (IPL). (1) The initialization procedure that causes an operating system to commence operation. (2) The process by which a configuration image is loaded into storage at the beginning of a workday or after a system malfunction. (3) The process of loading system programs and preparing a system to run jobs.

initialize automation. SA z/OS-provided automation that issues the correct z/OS start command for each subsystem when SA z/OS is initialized. The automation ensures that subsystems are started in the order specified in the automation control files and that prerequisite applications are functional.

input/output configuration data set (IOCDs). A configuration definition built by the I/O configuration program (IOCP) and stored on disk files associated with the processor controller.

input/output support processor (IOSP). The hardware unit that provides I/O support functions for the primary support processor and maintenance support functions for the processor controller.

Interactive System Productivity Facility (ISPF). An IBM licensed program that serves as a full-screen editor and dialog manager. Used for writing application programs, it provides a means of generating standard screen panels and interactive dialogs between the application programmer and the terminal user. See also Time Sharing Option.

interested operator list. The list of operators who are to receive messages from a specific target system.

internal token. A *logical token* (LTOK); name by which the I/O resource or object is known; stored in IODF.

IOCDs. See input/output configuration data set.

IOSP. See input/output support processor.

IPL. See initial program load.

ISPF. See Interactive System Productivity Facility.

ISPF console. You log on to ISPF from this 3270-type console to use the runtime panels for I/O operations and SA z/OS customization panels.

issuing host. The base program that you enter a command for processing with. See primary host.

J

JCL. See job control language.

JES. See job entry subsystem.

JES2. An MVS subsystem that receives jobs into the system, converts them to internal format, selects them for execution, processes their output, and purges them from the system. In an installation with more than one processor, each JES2 processor independently controls its job input, scheduling, and output processing. See also job entry subsystem and JES3

JES3. An MVS subsystem that receives jobs into the system, converts them to internal format, selects them for execution, processes their output, and purges them from the system. In complexes that have several loosely coupled processing units, the JES3 program manages processors so that the global processor exercises centralized control over the local processors and distributes jobs to them using a common job queue. See also job entry subsystem and JES2.

job. (1) A set of data that completely defines a unit of work for a computer. A job usually includes all necessary computer programs, linkages, files, and instructions to the operating system. (2) An address space.

job control language (JCL). A problem-oriented language designed to express statements in a job that are used to identify the job or describe its requirements to an operating system.

job entry subsystem (JES). An IBM licensed program that receives jobs into the system and processes all output data that is produced by jobs. In SA z/OS publications, JES refers to JES2 or JES3, unless otherwise stated. See also JES2 and JES3.

K

Kanji. An ideographic character set used in Japanese. See also double-byte character set.

L

LAN. See local area network.

line mode. A form of screen presentation in which the information is presented a line at a time in the message area of the terminal screen. Contrast with full-screen mode.

link. (1) In SNA, the combination of the link connection and the link stations joining network nodes; for example, a System/370 channel and its associated

protocols, a serial-by-bit connection under the control of synchronous data link control (SDLC). See synchronous data link control. (2) In SA z/OS, link connection is the physical medium of transmission.

link-attached. Describes devices that are physically connected by a telecommunication line. Contrast with channel-attached.

Linux on System z. UNIX-like open source operating system conceived by Linus Torvalds and developed across the internet.

local. Pertaining to a device accessed directly without use of a telecommunication line. Synonymous with channel-attached.

local area network (LAN). (1) A network in which a set of devices is connected for communication. They can be connected to a larger network. See also token ring. (2) A network that connects several devices in a limited area (such as a single building or campus) and that can be connected to a larger network.

logical partition (LP). A subset of the processor hardware that is defined to support an operating system. See also logically partitioned mode.

logical switch number (LSN). Assigned with the switch parameter of the CHPID macro of the IOCP.

logical token (LTOK). Resource number of an object in the IODF.

logical unit (LU). In SNA, a port through which an end user accesses the SNA network and the functions provided by system services control points (SSCPs). An LU can support at least two sessions, one with an SSCP and one with another LU, and may be capable of supporting many sessions with other LUs. See also physical unit and system services control point.

logical unit 6.2 (LU 6.2). A type of logical unit that supports general communications between programs in a distributed processing environment. LU 6.2 is characterized by:

- A peer relationship between session partners
- Efficient use of a session for multiple transactions
- A comprehensive end-to-end error processing
- A generic application program interface (API) consisting of structured verbs that are mapped to a product implementation

Synonym for advanced program-to-program communication.

logically partitioned (LPAR) mode. A central processor mode that enables an operator to allocate system processor hardware resources among several logical partitions. Contrast with basic mode.

LOGR. The sysplex logger.

LP. See logical partition.

LPAR. See logically partitioned mode.

LSN. See logical switch number.

LU. See logical unit.

LU 6.2. See logical unit 6.2.

LU 6.2 session. A session initiated by VTAM on behalf of an LU 6.2 application program, or a session initiated by a remote LU in which the application program specifies that VTAM is to control the session by using the APPCCMD macro. See logical unit 6.2.

LU-LU session. In SNA, a session between two logical units (LUs) in an SNA network. It provides communication between two end users, or between an end user and an LU services component.

M

MAT. Deprecated term for NetView automation table.

MCA. See Micro Channel architecture.

MCS. See multiple console support.

member. A specific function (one or more modules or routines) of a multisystem application that is defined to XCF and assigned to a group by the multisystem application. A member resides on one system in the sysplex and can use XCF services to communicate (send and receive data) with other members of the same group.

message automation table (MAT). Deprecated term for NetView automation table.

message class. A number that SA z/OS associates with a message to control routing of the message. During automated operations, the classes associated with each message issued by SA z/OS are compared to the classes assigned to each notification operator. Any operator with a class matching one of the message's classes receives the message.

message forwarding. The SA z/OS process of sending messages generated at an SA z/OS target system to the SA z/OS focal-point system.

message group. Several messages that are displayed together as a unit.

message monitor task. A task that starts and is associated with a number of communications tasks. Message monitor tasks receive inbound messages from a communications task, determine the originating target system, and route the messages to the appropriate target control tasks.

message processing facility (MPF). A z/OS table that screens all messages sent to the z/OS console. The MPF compares these messages with a customer-defined list

of messages on which to automate, suppress from the z/OS console display, or both, and marks messages to automate or suppress. Messages are then broadcast on the subsystem interface (SSI).

message suppression. The ability to restrict the amount of message traffic displayed on the z/OS console.

Micro Channel architecture. The rules that define how subsystems and adapters use the Micro Channel bus in a computer. The architecture defines the services that each subsystem can or must provide.

microprocessor. A processor implemented on one or a small number of chips.

migration. Installation of a new version or release of a program to replace an earlier version or release.

MP. Multiprocessor.

MPF. See message processing facility.

MPFLSTSA. The MPFLST member that is built by SA z/OS.

multi-MVS environment. physical processing system that is capable of operating more than one MVS image. See also MVS image.

multiple console support (MCS). A feature of MVS that permits selective message routing to multiple consoles.

Multiple Virtual Storage (MVS). An IBM operating system that accesses multiple address spaces in virtual storage. The predecessor of z/OS.

multiprocessor (MP). A CPC that can be physically partitioned to form two operating processor complexes.

multisystem application. An application program that has various functions distributed across z/OS images in a multisystem environment.

multisystem environment. An environment in which two or more systems reside on one or more processors, and one or more processors can communicate with programs on the other systems.

MVS. See Multiple Virtual Storage.

MVS image. A single occurrence of the MVS operating system that has the ability to process work. See also multi-MVS environment and single-MVS environment.

MVS/ESA. Multiple Virtual Storage/Enterprise Systems Architecture. See z/OS.

MVS/JES2. Multiple Virtual Storage/Job Entry System 2. A z/OS subsystem that receives jobs into the system, converts them to an internal format, selects them for

execution, processes their output, and purges them from the system. In an installation with more than one processor, each JES2 processor independently controls its job input, scheduling, and output processing.

N

NAU. (1) See network addressable unit. (2) See network accessible unit.

NCCF. See Network Communications Control Facility..

NCP. (1) See network control program (general term). (2) See Network Control Program (an IBM licensed program). Its full name is Advanced Communications Function for the Network Control Program. Synonymous with ACF/NCP.

NCP/token ring interconnection. A function used by ACF/NCP to support token ring-attached SNA devices. NTRI also provides translation from token ring-attached SNA devices (PUs) to switched (dial-up) devices.

NetView. An IBM licensed program used to monitor a network, manage it, and diagnose network problems. NetView consists of a command facility that includes a presentation service, command processors, automation based on command lists, and a transaction processing structure on which the session monitor, hardware monitor, and terminal access facility (TAF) network management applications are built.

NetView (NCCF) console. A 3270-type console for NetView commands and runtime panels for system operations and processor operations.

NetView automation procedures. A sequence of commands, packaged as a NetView command list or a command processor written in a high-level language. An automation procedure performs automation functions and runs under the NetView program.

NetView automation table (AT). A table against which the NetView program compares incoming messages. A match with an entry triggers the specified response. SA z/OS entries in the NetView automation table trigger an SA z/OS response to target system conditions. Formerly known as the message automation table (MAT).

NetView command list language. An interpretive language unique to NetView that is used to write command lists.

NetView Graphic Monitor Facility (NGMF). Deprecated term for NetView Management Console.

NetView hardware monitor. The component of NetView that helps identify network problems, such as hardware, software, and microcode, from a central

control point using interactive display techniques. Formerly called *network problem determination application*.

NetView log. The log that NetView records events relating to NetView and SA z/OS activities in.

NetView Management Console (NMC). A function of the NetView program that provides a graphic, topological presentation of a network that is controlled by the NetView program. It provides the operator different views of a network, multiple levels of graphical detail, and dynamic resource status of the network. This function consists of a series of graphic windows that allows you to manage the network interactively. Formerly known as the NetView Graphic Monitor Facility (NGMF).

NetView message table. See NetView automation table.

NetView paths via logical unit (LU 6.2). A type of network-accessible port (VTAM connection) that enables end users to gain access to SNA network resources and communicate with each other. LU 6.2 permits communication between processor operations and the workstation. See logical unit 6.2.

NetView-NetView task (NNT). The task that a cross-domain NetView operator session runs under. Each NetView program must have a NetView-NetView task to establish one NNT session. See also operator station task.

NetView-NetView task session. A session between two NetView programs that runs under a NetView-NetView task. In SA z/OS, NetView-NetView task sessions are used for communication between focal point and remote systems.

network. (1) An interconnected group of nodes. (2) In data processing, a user application network. See SNA network.

network accessible unit (NAU). In SNA networking, any device on the network that has a network address, including a logical unit (LU), physical unit (PU), control point (CP), or system services control point (SSCP). It is the origin or the destination of information transmitted by the path control network. Synonymous with network addressable unit.

network addressable unit (NAU). Synonym for network accessible unit.

Network Communications Control Facility (NCCF). The operations control facility for the network. NCCF consists of a presentation service, command processors, automation based on command lists, and a transaction processing structure on which the network management applications NLDM and NPDA are built. NCCF is a precursor to the NetView command facility.

Network Control Program (NCP). An IBM licensed program that provides communication controller support for single-domain, multiple-domain, and interconnected network capability. Its full name is Advanced Communications Function for the Network Control Program.

network control program (NCP). (1) A program that controls the operation of a communication controller. (2) A program used for requests and responses exchanged between physical units in a network for data flow control.

Network Problem Determination Application (NPDA). An NCCF application that helps you identify network problems, such as hardware, software, and microcode, from a central control point using interactive display methods. The alert manager for the network. The precursor of the NetView hardware monitor.

Networking NetView. In SA z/OS the NetView that performs network management functions, such as managing the configuration of a network. In SA z/OS it is common to also route alerts to the Networking NetView.

NGMF. Deprecated term for NetView Management Console.

NGMF focal-point system. Deprecated term for NMC focal point system.

NIP. See nucleus initialization program.

NMC focal point system. See focal point system

NMC workstation. The NMC workstation is the primary way to dynamically monitor SA z/OS systems. From the windows, you see messages, monitor status, view trends, and react to changes before they cause problems for end users. You can use multiple windows to monitor multiple views of the system.

NNT. See NetView-NetView task.

notification message. An SA z/OS message sent to a human notification operator to provide information about significant automation actions. Notification messages are defined using the customization dialogs.

notification operator. A NetView console operator who is authorized to receive SA z/OS notification messages. Authorization is made through the customization dialogs.

NPDA. See Network Problem Determination Application.

NPDA focal-point system. See focal point system.

NTRI. See NCP/token ring interconnection.

nucleus initialization program (NIP). The program that initializes the resident control program; it allows the operator to request last-minute changes to certain options specified during system generation.

O

objective value. An average Workflow or Using value that SA z/OS can calculate for applications from past service data. SA z/OS uses the objective value to calculate warning and alert thresholds when none are explicitly defined.

OCA. In SA z/OS, operator console A, the active operator console for a target system. Contrast with OCB.

OCB. In SA z/OS, operator console B, the backup operator console for a target system. Contrast with OCA.

OCF. See operations command facility.

OCF-based processor. A central processor complex that uses an operations command facility for interacting with human operators or external programs to perform operations management functions on the CPC.

OPC/A. See Operations Planning and Control/Advanced.

OPC/ESA. See Operations Planning and Control/Enterprise Systems Architecture.

Open Systems Adapter (OSA). I/O operations can display the Open System Adapter (OSA) channel logical definition, physical attachment, and status. You can configure an OSA channel on or off.

operating system (OS). Software that controls the execution of programs and that may provide services such as resource allocation, scheduling, input/output control, and data management. Although operating systems are predominantly software, partial hardware implementations are possible. (T)

operations. The real-time control of a hardware device or software function.

operations command facility (OCF). A facility of the central processor complex that accepts and processes operations management commands.

Operations Planning and Control/Advanced (OPC/A). A set of IBM licensed programs that automate, plan, and control batch workload. OPC/A analyzes system and workload status and submits jobs accordingly.

Operations Planning and Control/Enterprise Systems Architecture (OPC/ESA). A set of IBM licensed programs that automate, plan, and control batch

workload. OPC/ESA analyzes system and workload status and submits jobs accordingly. The successor to OPC/A.

operator. (1) A person who keeps a system running. (2) A person or program responsible for managing activities controlled by a given piece of software such as z/OS, the NetView program, or IMS. (3) A person who operates a device. (4) In a language statement, the lexical entity that indicates the action to be performed on operands.

operator console. (1) A functional unit containing devices that are used for communications between a computer operator and a computer. (T) (2) A display console used for communication between the operator and the system, used primarily to specify information concerning application programs and I/O operations and to monitor system operation. (3) In SA z/OS, a console that displays output from and sends input to the operating system (z/OS, LINUX, VM, VSE). Also called *operating system console*. In the SA z/OS operator commands and configuration dialogs, OC is used to designate a target system operator console.

operator station task (OST). The NetView task that establishes and maintains the online session with the network operator. There is one operator station task for each network operator who logs on to the NetView program.

operator view. A set of group, system, and resource definitions that are associated together for monitoring purposes. An operator view appears as a graphic display in the graphical interface showing the status of the defined groups, systems, and resources.

OperatorView entry. A construct, created with the customization dialogs, used to represent and contain policy for an operator view.

OS. See operating system.

OSA. See Open Systems Adapter.

OST. See operator station task.

outbound. In SA z/OS, messages or commands from the focal-point system to the target system.

outbound gateway operator. The automation operator that establishes connections to other systems. The outbound gateway operator handles communications with other systems through a gateway session. The automation operator sends messages, commands, and responses to the inbound gateway operator at the receiving system.

P

page. (1) The portion of a panel that is shown on a display surface at one time. (2) To transfer instructions, data, or both between real storage and external page or auxiliary storage.

panel. (1) A formatted display of information that appears on a terminal screen. Panels are full-screen 3270-type displays with a monospaced font, limited color and graphics. (2) By using SA z/OS panels you can see status, type commands on a command line using a keyboard, configure your system, and passthru to other consoles. See also help panel. (3) In computer graphics, a display image that defines the locations and characteristics of display fields on a display surface. Contrast with screen.

parallel channels. Parallel channels operate in either byte (BY) or block (BL) mode. You can change connectivity to a parallel channel operating in block mode.

parameter. (1) A variable that is given a constant value for a specified application and that may denote the application. (2) An item in a menu for which the user specifies a value or for which the system provides a value when the menu is interpreted. (3) Data passed to a program or procedure by a user or another program, specifically as an operand in a language statement, as an item in a menu, or as a shared data structure.

partition. (1) A fixed-size division of storage. (2) In VSE, a division of the virtual address area that is available for program processing. (3) On an IBM Personal Computer fixed disk, one of four possible storage areas of variable size; one can be accessed by DOS, and each of the others may be assigned to another operating system.

partitionable CPC. A CPC that can be divided into 2 independent CPCs. See also physical partition, single-image mode, MP, and side.

partitioned data set (PDS). A data set in direct access storage that is divided into partitions, called *members*, each of which can contain a program, part of a program, or data.

passive monitoring. In SA z/OS, the receiving of unsolicited messages from z/OS systems and their resources. These messages can prompt updates to resource status displays. See also active monitoring

PCE. A processor controller. Also known as the support processor or service processor in some processor families.

PDB. See policy database.

PDS. See partitioned data set.

physical partition. Part of a CPC that operates as a CPC in its own right, with its own copy of the operating system.

physical unit (PU). In SNA, the component that manages and monitors the resources (such as attached links and adjacent link stations) of a node, as requested by a system services control point (SSCP) through an SSCP-PU session. An SSCP activates a session with the physical unit to indirectly manage, through the PU, resources of the node such as attached links.

physically partitioned (PP) configuration. A mode of operation that allows a multiprocessor (MP) system to function as two or more independent CPCs having separate power, water, and maintenance boundaries. Contrast with single-image mode.

POI. See program operator interface.

policy. The automation and monitoring specifications for an SA z/OS enterprise. See *IBM Tivoli System Automation for z/OS Defining Automation Policy*.

policy database. The automation definitions (automation policy) that the automation programmer specifies using the customization dialog is stored in the policy database. Also known as the PDB. See also automation policy.

POR. See power-on reset.

port. (1) System hardware that the I/O devices are attached to. (2) In an ESCON switch, a port is an addressable connection. The switch routes data through the ports to the channel or control unit. Each port has a name that can be entered into a switch matrix, and you can use commands to change the switch configuration. (3) An access point (for example, a logical unit) for data entry or exit. (4) A functional unit of a node that data can enter or leave a data network through. (5) In data communication, that part of a data processor that is dedicated to a single data channel for the purpose of receiving data from or transmitting data to one or more external, remote devices.

power-on reset (POR). A function that re-initializes all the hardware in a CPC and loads the internal code that enables the CPC to load and run an operating system. See initial microprogram load.

PP. See physical partition.

PPI. See program to program interface.

PPT. See primary POI task.

PR/SM. See Processor Resource/Systems Manager.

primary host. The base program that you enter a command for processing at.

primary POI task (PPT). The NetView subtask that processes all unsolicited messages received from the

VTAM program operator interface (POI) and delivers them to the controlling operator or to the command processor. The PPT also processes the initial command specified to execute when NetView is initialized and timer request commands scheduled to execute under the PPT.

primary system. A system is a primary system for an application if the application is normally meant to be running there. SA z/OS starts the application on all the primary systems defined for it.

problem determination. The process of determining the source of a problem; for example, a program component, machine failure, telecommunication facilities, user or contractor-installed programs or equipment, environment failure such as a power loss, or user error.

processor. (1) A device for processing data from programmed instructions. It may be part of another unit. (2) In a computer, the part that interprets and executes instructions. Two typical components of a processor are a control unit and an arithmetic logic unit.

processor controller. Hardware that provides support and diagnostic functions for the central processors.

processor operations. The part of SA z/OS that monitors and controls processor (hardware) operations. Processor operations provides a connection from a focal-point system to a target system. Through NetView on the focal-point system, processor operations automates operator and system consoles for monitoring and recovering target systems. Also known as ProcOps.

Processor Resource/Systems Manager (PR/SM). The feature that allows the processor to use several operating system images simultaneously and provides logical partitioning capability. See also logically partitioned mode.

ProcOps. See processor operations.

ProcOps Service Machine (PSM). The PSM is a CMS user on a VM host system. It runs a CMS multitasking application that serves as "virtual hardware" for ProcOps. ProcOps communicates via the PSM with the VM guest systems that are defined as target systems within ProcOps.

product automation. Automation integrated into the base of SA z/OS for the products CICS, DB2, IMS, TWS (formerly called *features*).

program operator interface (POI). A NetView facility for receiving VTAM messages.

program to program interface (PPI). A NetView function that allows user programs to send or receive

data buffers from other user programs and to send alerts to the NetView hardware monitor from system and application programs.

protocol. In SNA, the meanings of, and the sequencing rules for, requests and responses used for managing the network, transferring data, and synchronizing the states of network components.

proxy resource. A resource defined like an entry type APL representing a processor operations target system.

PSM. See ProcOps Service Machine.

PU. See physical unit.

R

RACF. See Resource Access Control Facility.

remote system. A system that receives resource status information from an SA z/OS focal-point system. An SA z/OS remote system is defined as part of the same SA z/OS enterprise as the SA z/OS focal-point system to which it is related.

requester. A workstation from that user can log on to a domain from, that is, to the servers belonging to the domain, and use network resources. Users can access the shared resources and use the processing capability of the servers, thus reducing hardware investment.

resource. (1) Any facility of the computing system or operating system required by a job or task, and including main storage, input/output devices, the processing unit, data sets, and control or processing programs. (2) In NetView, any hardware or software that provides function to the network. (3) In SA z/OS, any z/OS application, z/OS component, job, device, or target system capable of being monitored or automated through SA z/OS.

Resource Access Control Facility (RACF). A program that can provide data security for all your resources. RACF protects data from accidental or deliberate unauthorized disclosure, modification, or destruction.

resource group. A physically partitionable portion of a processor. Also known as a *side*.

Resource Measurement Facility (RMF). A feature of z/OS that measures selected areas of system activity and presents the data collected in the format of printed reports, System Management Facility (SMF) records, or display reports.

Resource Object Data Manager (RODM). In NetView for z/OS, a component that provides an in-memory cache for maintaining real-time data in an address space that is accessible by multiple applications. RODM also allows an application to query an object and receive a rapid response and act on it.

resource token. A unique internal identifier of an ESCON resource or resource number of the object in the IODF.

restart automation. Automation provided by SA z/OS that monitors subsystems to ensure that they are running. If a subsystem fails, SA z/OS attempts to restart it according to the policy in the automation configuration file.

Restructured Extended Executor (REXX). A general-purpose, high-level, programming language, particularly suitable for EXEC procedures or programs for personal computing, used to write command lists.

return code. A code returned from a program used to influence the issuing of subsequent instructions.

REXX. See Restructured Extended Executor.

REXX procedure. A command list written with the Restructured Extended Executor (REXX), which is an interpretive language.

RMF. See Resource Measurement Facility.

RODM. See Resource Object Data Manager.

S

SAF. See Security Authorization Facility.

SA IOM. See System Automation for Integrated Operations Management.

SA z/OS. See System Automation for z/OS.

SA z/OS customization dialogs. An ISPF application through which the SA z/OS policy administrator defines policy for individual z/OS systems and builds automation control data and RODM load function files.

SA z/OS customization focal point system. See focal point system.

SA z/OS data model. The set of objects, classes and entity relationships necessary to support the function of SA z/OS and the NetView automation platform.

SA z/OS enterprise. The group of systems and resources defined in the customization dialogs under one enterprise name. An SA z/OS enterprise consists of connected z/OS systems running SA z/OS.

SA z/OS focal point system. See focal point system.

SA z/OS policy. The description of the systems and resources that make up an SA z/OS enterprise, together with their monitoring and automation definitions.

SA z/OS policy administrator. The member of the operations staff who is responsible for defining SA z/OS policy.

SA z/OS satellite. If you are running two NetViews on an z/OS system to split the automation and networking functions of NetView, it is common to route alerts to the Networking NetView. For SA z/OS to process alerts properly on the Networking NetView, you must install a subset of SA z/OS code, called an *SA z/OS satellite* on the Networking NetView.

SA z/OS SDF focal point system. See focal point system.

SCA. In SA z/OS, system console A, the active system console for a target hardware. Contrast with SCB.

SCB. In SA z/OS, system console B, the backup system console for a target hardware. Contrast with SCA.

screen. Deprecated term for panel.

screen handler. In SA z/OS, software that interprets all data to and from a full-screen image of a target system. The interpretation depends on the format of the data on the full-screen image. Every processor and operating system has its own format for the full-screen image. A screen handler controls one PS/2 connection to a target system.

SDF. See status display facility.

SDLCL. See synchronous data link control.

SDFS. See System Display and Search Facility.

secondary system. A system is a secondary system for an application if it is defined to automation on that system, but the application is not normally meant to be running there. Secondary systems are systems to which an application can be moved in the event that one or more of its primary systems are unavailable. SA z/OS does not start the application on its secondary systems.

Security Authorization Facility (SAF). An MVS interface with which programs can communicate with an external security manager, such as RACF.

server. A server is a workstation that shares resources, which include directories, printers, serial devices, and computing powers.

service language command (SLC). The line-oriented command language of processor controllers or service processors.

service period. Service periods allow the users to schedule the availability of applications. A service period is a set of time intervals (service windows), during which an application should be active.

service processor (SVP). The name given to a processor controller on smaller System/370 processors.

service threshold. An SA z/OS policy setting that determines when to notify the operator of deteriorating service for a resource. See also alert threshold and warning threshold.

session. In SNA, a logical connection between two network addressable units (NAUs) that can be activated, tailored to provide various protocols, and deactivated, as requested. Each session is uniquely identified in a transmission header by a pair of network addresses identifying the origin and destination NAUs of any transmissions exchanged during the session.

session monitor. The component of the NetView program that collects and correlates session-related data and provides online access to this information. The successor to NLDM.

shutdown automation. SA z/OS-provided automation that manages the shutdown process for subsystems by issuing shutdown commands and responding to prompts for additional information.

side. A part of a partitionable CPC that can run as a physical partition and is typically referred to as the A-side or the B-side.

Simple Network Management Protocol (SNMP). A set of protocols for monitoring systems and devices in complex networks. Information about managed devices is defined and stored in a Management Information Base (MIB).

single image. A processor system capable of being physically partitioned that has not been physically partitioned. Single-image systems can be target hardware processors.

single-MVS environment. An environment that supports one MVS image. See also MVS image.

single-image (SI) mode. A mode of operation for a multiprocessor (MP) system that allows it to function as one CPC. By definition, a uniprocessor (UP) operates in single-image mode. Contrast with physically partitioned (PP) configuration.

SLC. See service language command.

SMP/E. See System Modification Program/Extended.

SNA. See Systems Network Architecture.

SNA network. In SNA, the part of a user-application network that conforms to the formats and protocols of systems network architecture. It enables reliable transfer of data among end users and provides protocols for controlling the resources of various network configurations. The SNA network consists of

network addressable units (NAUs), boundary function components, and the path control network.

SNMP. See Simple Network Management Protocol.

solicited message. An SA z/OS message that directly responds to a command. Contrast with unsolicited message.

SSCP. See system services control point.

SSI. See subsystem interface.

start automation. SA z/OS-provided automation that manages and completes the startup process for subsystems. During this process, SA z/OS replies to prompts for additional information, ensures that the startup process completes within specified time limits, notifies the operator of problems, if necessary, and brings subsystems to an UP (or ready) state.

startup. The point in time that a subsystem or application is started.

status. The measure of the condition or availability of the resource.

status display facility (SDF). The system operations part of SA z/OS that displays status of resources such as applications, gateways, and write-to-operator messages (WTORs) on dynamic color-coded panels. SDF shows spool usage problems and resource data from multiple systems.

status focal-point system. See focal point system.

steady state automation. The routine monitoring, both for presence and performance, of subsystems, applications, volumes and systems. Steady state automation may respond to messages, performance exceptions and discrepancies between its model of the system and reality.

structure. A construct used by z/OS to map and manage storage on a coupling facility.

subgroup. A named set of systems. A subgroup is part of an SA z/OS enterprise definition and is used for monitoring purposes.

SubGroup entry. A construct, created with the customization dialogs, used to represent and contain policy for a subgroup.

subplex. Situations where the physical sysplex has been divided into subentities, for example, a test sysplex and a production sysplex. This may be done to isolate the test environment from the production environment.

subsystem. (1) A secondary or subordinate system, usually capable of operating independent of, or

asynchronously with, a controlling system. (2) In SA z/OS, an z/OS application or subsystem defined to SA z/OS.

subsystem interface (SSI). The z/OS interface over which all messages sent to the z/OS console are broadcast.

support element. A hardware unit that provides communications, monitoring, and diagnostic functions to a central processor complex (CPC).

support processor. Another name given to a processor controller on smaller System/370 processors. See service processor.

SVP. See service processor.

switch identifier. The switch device number (swchdevn), the logical switch number (LSN) and the switch name

switches. ESCON directors are electronic units with ports that dynamically switch to route data to I/O devices. The switches are controlled by I/O operations commands that you enter on a workstation.

symbolic destination name (SDN). Used locally at the workstation to relate to the VTAM application name.

synchronous data link control (SDLC). A discipline for managing synchronous, code-transparent, serial-by-bit information transfer over a link connection. Transmission exchanges may be duplex or half-duplex over switched or nonswitched links. The configuration of the link connection may be point-to-point, multipoint, or loop. SDLC conforms to subsets of the Advanced Data Communication Control Procedures (ADCCP) of the American National Standards Institute and High-Level Data Link Control (HDLC) of the International Standards Organization.

SYSINFO Report. An RMF report that presents an overview of the system, its workload, and the total number of jobs using resources or delayed for resources.

SysOps. See system operations.

sysplex. A set of z/OS systems communicating and cooperating with each other through certain multisystem hardware components (coupling devices and timers) and software services (couple data sets).

In a sysplex, z/OS provides the coupling services that handle the messages, data, and status for the parts of a multisystem application that has its workload spread across two or more of the connected processors, sysplex timers, coupling facilities, and couple data sets (which contains policy and states for automation).

A Parallel Sysplex is a sysplex that includes a coupling facility.

sysplex application group. A sysplex application group is a grouping of applications that can run on any system in a sysplex.

sysplex couple data set. A couple data set that contains sysplex-wide data about systems, groups, and members that use XCF services. All z/OS systems in a sysplex must have connectivity to the sysplex couple data set. See also couple data set.

Sysplex Timer®. An IBM unit that synchronizes the time-of-day (TOD) clocks in multiple processors or processor sides. External Time Reference (ETR) is the z/OS generic name for the IBM Sysplex Timer (9037).

system. In SA z/OS, system means a focal point system (z/OS) or a target system (MVS, VM, VSE, LINUX, or CF).

System Automation for Integrated Operations

Management. (1) An outboard automation solution for secure remote access to mainframe/distributed systems. Tivoli System Automation for Integrated Operations Management, previously Tivoli AF/REMOTE, allows users to manage mainframe and distributed systems from any location. (2) The full name for SA IOM.

System Automation for OS/390. The full name for SA OS/390, the predecessor to System Automation for z/OS.

System Automation for z/OS. The full name for SA z/OS.

system console. (1) A console, usually having a keyboard and a display screen, that is used by an operator to control and communicate with a system. (2) A logical device used for the operation and control of hardware functions (for example, IPL, alter/display, and reconfiguration). The system console can be assigned to any of the physical displays attached to a processor controller or support processor. (3) In SA z/OS, the hardware system console for processor controllers or service processors of processors connected using SA z/OS. In the SA z/OS operator commands and configuration dialogs, SC is used to designate the system console for a target hardware processor.

System Display and Search Facility (SDSF). An IBM licensed program that provides information about jobs, queues, and printers running under JES2 on a series of panels. Under SA z/OS you can select SDSF from a pull-down menu to see the resources' status, view the z/OS system log, see WTOR messages, and see active jobs on the system.

System entry. A construct, created with the customization dialogs, used to represent and contain policy for a system.

System Modification Program/Extended (SMP/E). An IBM licensed program that facilitates the process of installing and servicing an z/OS system.

system operations. The part of SA z/OS that monitors and controls system operations applications and subsystems such as NetView, SDSF, JES, RMF, TSO, RODM, ACF/VTAM, CICS, IMS, and OPC. Also known as SysOps.

system services control point (SSCP). In SNA, the focal point within an SNA network for managing the configuration, coordinating network operator and problem determination requests, and providing directory support and other session services for end users of the network. Multiple SSCPs, cooperating as peers, can divide the network into domains of control, with each SSCP having a hierarchical control relationship to the physical units and logical units within its domain.

System/390 microprocessor cluster. A configuration that consists of central processor complexes (CPCs) and may have one or more integrated coupling facilities.

Systems Network Architecture (SNA). The description of the logical structure, formats, protocols, and operational sequences for transmitting information units through, and controlling the configuration and operation of, networks.

T

TAF. See terminal access facility.

target. A processor or system monitored and controlled by a focal-point system.

target control task. In SA z/OS, target control tasks process commands and send data to target systems and workstations through communications tasks. A target control task (a NetView autotask) is assigned to a target system when the target system is initialized.

target hardware. In SA z/OS, the physical hardware on which a target system runs. It can be a single-image or physically partitioned processor. Contrast with target system.

target system. (1) In a distributed system environment, a system that is monitored and controlled by the focal-point system. Multiple target systems can be controlled by a single focal-point system. (2) In SA z/OS, a computer system attached to the focal-point system for monitoring and control. The definition of a target system includes how remote sessions are established, what hardware is used, and what operating system is used.

task. (1) A basic unit of work to be accomplished by a computer. (2) In the NetView environment, an operator station task (logged-on operator), automation operator

(autotask), application task, or user task. A NetView task performs work in the NetView environment. All SA z/OS tasks are NetView tasks. See also message monitor task, and target control task.

telecommunication line. Any physical medium, such as a wire or microwave beam, that is used to transmit data.

terminal access facility (TAF). (1) A NetView function that allows you to log onto multiple applications either on your system or other systems. You can define TAF sessions in the SA z/OS customization panels so you don't have to set them up each time you want to use them. (2) In NetView, a facility that allows a network operator to control a number of subsystems. In a full-screen or operator control session, operators can control any combination of subsystems simultaneously.

terminal emulation. The capability of a microcomputer or personal computer to operate as if it were a particular type of terminal linked to a processing unit to access data.

threshold. A value that determines the point at which SA z/OS automation performs a predefined action. See alert threshold, warning threshold, and error threshold.

time of day (TOD). Typically refers to the time-of-day clock.

Time Sharing Option (TSO). An optional configuration of the operating system that provides conversational time sharing from remote stations. It is an interactive service on z/OS, MVS/ESA, and MVS/XA.

Time-Sharing Option/Extended (TSO/E). An option of z/OS that provides conversational timesharing from remote terminals. TSO/E allows a wide variety of users to perform many different kinds of tasks. It can handle short-running applications that use fewer sources as well as long-running applications that require large amounts of resources.

timers. A NetView command that issues a command or command processor (list of commands) at a specified time or time interval.

Tivoli Workload Scheduler (TWS). A family of IBM licensed products that plan, execute and track jobs on several platforms and environments. The successor to OPC/A.

TOD. Time of day.

token ring. A network with a ring topology that passes tokens from one attaching device to another; for example, the IBM Token-Ring Network product.

TP. See transaction program.

transaction program. In the VTAM program, a program that performs services related to the processing of a transaction. One or more transaction programs may operate within a VTAM application program that is using the VTAM application program interface (API). In that situation, the transaction program would request services from the applications program using protocols defined by that application program. The application program, in turn, could request services from the VTAM program by issuing the APPCCMD macro instruction.

transitional automation. The actions involved in starting and stopping subsystems and applications that have been defined to SA z/OS. This can include issuing commands and responding to messages.

translating host. Role played by a host that turns a resource number into a token during a unification process.

trigger. Triggers, in combination with events and service periods, are used to control the starting and stopping of applications in a single system or a parallel sysplex.

TSO. See Time Sharing Option.

TSO console. From this 3270-type console you are logged onto TSO or ISPF to use the runtime panels for I/O operations and SA z/OS customization panels.

TSO/E. See Time-Sharing Option/Extended.

TWS. See Tivoli Workload Scheduler.

U

UCB. See unit control block.

unit control block (UCB). A control block in common storage that describes the characteristics of a particular I/O device on the operating system and that is used for allocating devices and controlling I/O operations.

unsolicited message. An SA z/OS message that is not a direct response to a command. Contrast with solicited message.

user task. An application of the NetView program defined in a NetView TASK definition statement.

Using. An RMF Monitor III definition. Jobs getting service from hardware resources (processors or devices) are **using** these resources. The use of a resource by an address space can vary from 0% to 100% where 0% indicates no use during a Range period, and 100% indicates that the address space was found using the resource in every sample during that period. See also Volume Workflow and Address Space Workflow.

V

view. In the NetView Graphic Monitor Facility, a graphical picture of a network or part of a network. A view consists of nodes connected by links and may also include text and background lines. A view can be displayed, edited, and monitored for status information about network resources.

Virtual Storage Extended (VSE). A system that consists of a basic operating system (VSE/Advanced Functions), and any IBM supplied and user-written programs required to meet the data processing needs of a user. VSE and the hardware that it controls form a complete computing system. Its current version is called VSE/ESA.

Virtual Telecommunications Access Method (VTAM). An IBM licensed program that controls communication and the flow of data in an SNA network. It provides single-domain, multiple-domain, and interconnected network capability. Its full name is Advanced Communications Function for the Virtual Telecommunications Access Method. Synonymous with ACF/VTAM.

VM Second Level Systems Support. With this function, Processor Operations is able to control VM second level systems (VM guest systems) in the same way that it controls systems running on real hardware.

VM/ESA®. Virtual Machine/Enterprise Systems Architecture. Its current version is called z/VM.

volume. A direct access storage device (DASD) volume or a tape volume that serves a system in an SA z/OS enterprise.

volume entry. A construct, created with the customization dialogs, used to represent and contain policy for a volume.

volume group. A named set of volumes. A volume group is part of a system definition and is used for monitoring purposes.

volume group entry. A construct, created with the customization dialogs, used to represent and contain policy for a volume group.

Volume Workflow. The SA z/OS Volume Workflow variable is derived from the RMF Resource Workflow definition, and is used to measure the performance of volumes. SA z/OS calculates Volume Workflow using:

$$\text{Volume Workflow \%} = \frac{\text{accumulated Using}}{\text{accumulated Using} + \text{accumulated Delay}} * 100$$

The definition of **Using** is the percentage of time when a job has had a request accepted by a channel for the volume, but the request is not yet complete.

The definition of **Delay** is the delay that waiting jobs experience because of contention for the volume.

See also Address Space Workflow.

VSE. See Virtual Storage Extended.

VTAM. See Virtual Telecommunications Access Method.

W

warning threshold. An application or volume service value that determines the level at which SA z/OS changes the associated icon in the graphical interface to the warning color. See alert threshold.

workflow. See Address Space Workflow and Volume Workflow.

workstation. In SA z/OS workstation means the *graphic workstation* that an operator uses for day-to-day operations.

write-to-operator (WTO). A request to send a message to an operator at the z/OS operator console. This request is made by an application and is handled by the WTO processor, which is part of the z/OS supervisor program.

write-to-operator-with-reply (WTOR). A request to send a message to an operator at the z/OS operator console that requires a response from the operator. This request is made by an application and is handled by the WTO processor, which is part of the z/OS supervisor program.

WTO. See write-to-operator.

WTOR. See write-to-operator-with-reply.

WWV. The US National Institute of Standards and Technology (NIST) radio station that provides standard time information. A second station, known as WWVB, provides standard time information at a different frequency.

X

XCF. See cross-system coupling facility.

XCF couple data set. The name for the sysplex couple data set prior to MVS/ESA System Product Version 5 Release 1. See also sysplex couple data set.

XCF group. A set of related members that a multisystem application defines to XCF. A member is a specific function, or instance, of the application. A

member resides on one system and can communicate with other members of the same group across the sysplex.

XRF. See extended recovery facility.

Z

z/OS. An IBM mainframe operating system that uses 64-bit real storage. See also Base Control Program.

z/OS component. A part of z/OS that performs a specific z/OS function. In SA z/OS, component refers to entities that are managed by SA z/OS automation.

z/OS subsystem. Software products that augment the z/OS operating system. JES and TSO/E are examples of z/OS subsystems. SA z/OS includes automation for some z/OS subsystems.

z/OS system. A z/OS image together with its associated hardware, which collectively are often referred to simply as a system, or z/OS system.

Numerics

390-CMOS. Processor family group designator used in the SA z/OS processor operations documentation and in the online help to identify any of the following S/390 CMOS processor machine types: 9672, 9674, 2003, 3000, or 7060. SA z/OS processor operations uses the OCF facility of these processors to perform operations management functions. See OCF-based processor.

Index

Special characters

"hung" command recovery 109

A

accessibility xi

active connector 108

active health monitoring 41

adding

 application to automation 1

 processor operations message to automation 81

additional automation operator IDs 124

additional SA z/OS automation

 procedures, programming 7

advanced automation options

 exits 143

 external global variables 197, 198

alerts

 communication flow 63

 enabling 64

 enabling at alert ID level 66

 enabling at system level 65

 enabling globally 65

 enabling with Inform List 65

 enabling with INGCNTL 65, 66

 notification 63

 overview 63

alternate CDS 105

 turning into primary CDS 106

alternate CDS recovery

 customizing 106

alternate couple data set

 specifying 116

AMRF buffer shortage processing 163

AOCMSG call 15

AOCMSG generic routine 10

AOCQRY common routine

 automation availability 9

 message automation 21

AOCTRACE

 use in testing 18

 use in traces 19

AOCUPDT command

 and AOFEXSTA exit 145

AOCUPDT common routine

 to update status information 10

AOF_AAO_MSG_EHKVAR 198

AOF_AAO_MVSTAPEMON 198

AOF_AAO_RETENTIONPERIOD 199

AOF_AAO_SDFROOT_LIST 199

AOF_AAO_TRANRERUN 199

AOF_AAO_TWS_CMD_OUTPUT_NETLOG 199

AOF_AAO_TWS_ERRMSG 199

AOF_AAO_TWS_MAX_WAIT_TIME 199

AOF_AAO_TWS_RESYSPLEX 199

AOF_ASSIGN_JOBNAME 199

AOF_E2E_EAS_PPI 199

AOF_E2E_EVT_RETRY 200

AOF_E2E_EXREQ_NETLOG 200

AOF_E2E_TKOVN_TIMEOUT 200

AOF_EMCS_AUTOTASK_

 ASSIGNMENT 200

AOF_EMCS_CN_ASSIGNMENT 200

AOF_INIT_MCSFLAG 202

AOF_INIT_ROUTCDE 202

AOF_INIT_SYSCONID 202

AOF_PRODLVL 197

AOF.0DEBUG 197

AOF.0TRACE 197

AOFACFINIT 200

AOFAOCCONE 197

AOFARMQUERYRETRY 200

AOFARMQUERYWAIT 200

AOFENMASK 201

AOFCOMPL 197

AOFCONFIRM global variable 158

AOFDEBUG 197

AOFDEBUG global variable 19

AOFDEFAULT_TARGET 201

AOFDOM 227, 228

AOFEXC00 exit 154

AOFEXC01 exit 154

AOFEXC02 exit 154

AOFEXC03 exit 154

AOFEXC04 exit 154

AOFEXC05 exit 155

AOFEXC06 exit 155

AOFEXC07 exit 155

AOFEXC08 exit 155

AOFEXC09 exit 155

AOFEXC11 exit 156

AOFEXC12 exit 156

AOFEXC13 exit 156

AOFEXC14 exit 156

AOFEXC15 exit 156

AOFEXC16 exit 156

AOFEXC17 exit 157

AOFEXC18 exit 157

AOFEXC19 exit 157

AOFEXC20 exit 157

AOFEXC21 exit 158

AOFEXC22 exit 158

AOFEXC23 exit 158

AOFEXDEF exit 143

AOFEXI01 exit 143

AOFEXI02 exit 143

AOFEXI03 exit 143

AOFEXI04 exit 144

AOFEXI05 exit 144

AOFEXI06 exit 144

AOFEXINT exit 144, 161, 203

AOFEXPLAIN_USER 201

AOFEXSTA exit 145

AOFEXX02 exit 146

AOFEXX03 exit 146

AOFEXX04 exit 146

AOFEXX15 exit 146

AOFEXX16 exit 147

AOFINITIALSTARTTYP 197

AOFINITREPLY 202

AOFJESPREFIX 197

AOFLOCALHOLD 202

AOFMATLISTING 202

AOFMSGST 32

AOFMSGSY 227

AOFOPCCMDMSG 202

AOFPAUSE 202

AOFRESTARTALWAYS 203

AOFRJ3MN monitoring routine 58

AOFRJ3RC monitoring routine 60

AOFRMTCMDWAIT 203

AOFRPCWAIT 203

AOFRSA01 automation routine 165

AOFRSA02 automation routine 166

AOFRSA03 automation routine 168

AOFRSA08 automation routine 170

AOFRSA0C automation routine 172

AOFRSA0E automation routine 175

AOFRSA0G automation routine 176

AOFRSD01 automation routine 193

AOFRSD07 automation routine 177

AOFRSD09 automation routine 178

AOFRSD0F automation routine 180

AOFRSD0G automation routine 182

AOFRSD0H automation routine 183

AOFSENDALERT 203

AOFSERXINT 203

AOFSETSTATEOVERRIDE 205

AOFSETSTATESCOPE 205

AOFSETSTATESTART 205

AOFSHUTDELAY 203

AOFSMARTMAT 204

AOFSPPOOLFULLCMD 204

AOFSPPOOLSHORTCMD 204

AOFSTATUSCMDSEL 205

AOFSSUBSYS 197

AOFSYS 227, 229

AOFSYSNAME 198

AOFSYSTEM 198

AOFUPDAM 205

AOFUPDROM 205

AOFUSSWAIT 205

application

 adding to automation 1

 health status 37

application monitor status 37

application monitoring 37

application type IMAGE, defining 119

application, VTAM, defining to

 SA z/OS 133

applications, z/OS UNIX 93

ARM

 See Automatic Restart Manager

ASCB chaining

 and global variables 200

ASFUSER command 21

assist mode

 for testing automation procedures 19

 overview 18

assumptions, health monitoring with

 OMEGAMON 46

- asynchronous hardware commands, using pipes and ISQCCMD for 87
 - AT actions, defining for message automation 24
 - AT build
 - concept for message automation 30
 - message automation 29
 - AT entries
 - preventing the building of 25
 - AT load, message automation 30
 - AT/MRT scope, defining for message automation 29
 - automated resources, z/OS UNIX
 - Automation 96
 - Automatic Restart Manager 225
 - defining element name 225
 - MOVE group for 226
 - automating
 - auxiliary storage shortage recovery 122
 - enqueues, long running 121
 - IXC102A message 111
 - IXC402D message 111
 - Linux console messages 80
 - Linux console messages, case sensitive 80
 - Linux console messages, restrictions and limitations 81
 - Linux console messages, security considerations 80
 - long running enqueues 121
 - message IXC102A 120
 - message IXC402D 120
 - USS resources 93
 - automating processor operations
 - controlled resources 77
 - automation
 - adding an application to 1
 - advanced functions 198
 - extending 7
 - messages 23
 - sysplex, enabling 105
 - automation control file
 - defining SDF 224
 - reload action exit 158
 - reload permission exit 158
 - automation flag exits
 - sample 149
 - automation networks 127
 - automation operator IDs
 - additional 124
 - automation procedures
 - calling 7
 - creating 7
 - debugging 18
 - description 7
 - developing messages 15
 - example 16
 - external code 11
 - global variable names 22
 - initializing 9
 - installing 18
 - making generic 14
 - programming recommendations 21
 - REXX coding example 20
 - structure of 8
 - testing 18
 - automation procedures (*continued*)
 - use of commands in 7
 - use of routines in 7
 - using AOCTRACE 19
 - writing your own 7
 - automation processing
 - performing 10
 - automation routine
 - AMRF buffer shortage processing 163
 - AOFRSA01 165
 - AOFRSA02 166
 - AOFRSA03 168
 - AOFRSA08 170
 - AOFRSA0C 172
 - AOFRSA0E 175
 - AOFRSA0G 176
 - AOFRSD07 177
 - AOFRSD09 178
 - AOFRSD0F 180
 - AOFRSD0G 182
 - AOFRSD0H 183
 - deletion of processed WTO(R)s from SDF 163
 - drain processing prior to JES2 shutdown 164
 - EVEERTRN 185
 - EVIET0X 186
 - EVIEET00 186
 - EVIEI006 187
 - EVIEI00Q 187
 - EVISTRCT 188
 - EVISTRMN 188
 - EVJEAC04 188
 - EVJEOSV 189
 - EVJRAC05 189
 - EVJRSACT 190
 - EVJRSJOB 190
 - HASP099 191
 - IMS transaction recovery 164
 - INGJRMJSP 191
 - INGRCJSP 193
 - INGRX740 194
 - introduction 161
 - LOGREC data set processing 162 processing 162
 - SMF data set processing 162
 - SVC dump processing 163
 - TWS Automation operation 164
 - automation setup, definitions for 94
 - automation status file
 - coding your own information 21
 - using commands 11
 - automation table
 - See* NetView automation table
 - auxiliary storage shortage recovery 112
 - automating 122
 - customizing 112
 - defining local page data set 122
 - defining the handling of jobs 123
 - availability, reporting 69
 - INGPUSMF utility 72
 - INGPUSMF utility JCL 72
 - INGPUSMF utility JCL, user options 73
 - INGPUSMF utility output 72
 - INGPUSMF utility return codes 73
 - availability, reporting (*continued*)
 - overview 69
 - resource lifecycle 69
 - SMF record layout 70
 - writing to DB2 74
- ## B
- BASEOPER 203
 - building
 - new automation definitions 85
- ## C
- calling
 - automation procedures 7
 - captured messages
 - defining for message automation 25
 - cascades 230
 - case sensitive, Linux console messages 80
 - CDEMATCH common routine 21
 - CDS
 - See* couple data set
 - CF
 - See* coupling facility
 - CFRM couple data set 107, 116
 - CFRM policy 107
 - CHKTHRES common routine 10
 - CICS health monitoring 53, 56
 - CICS link monitoring 56
 - CICS monitoring
 - component overview 56
 - defining monitor resources 56
 - VOST management 56
 - CICSplex monitoring 56
 - clone ID
 - Automatic Restart Manager 225
 - clone ID, Automatic Restart Manager 205
 - CMD actions, defining for message automation 24
 - CNMCMDU member 18
 - coding information in automation status file 21
 - command flooding recovery 110
 - command, SDFCONF 221
 - commands
 - processor operations 14
 - use in automation procedures 7
 - commands, defining for long running enqueues 122
 - commands, monitor resources 39
 - common automation items, defining 123
 - common global variables 11, 197
 - common routines 7
 - communication flow
 - alerts 63
 - connecting
 - system to processor 115
 - connector
 - active 108
 - failed persistent 108
 - continuous availability, couple data set
 - enabling 116
 - ensuring 106

- couple data set 105
 - alternate CDS 105
 - alternate CDS, recovery of 106
 - alternate, specifying 116
 - CFRM 116
 - enabling continuous availability of 116
 - ensuring continuous availability of 106
 - managing 105
 - policy 105
 - primary CDS 105
 - SYSPLEX 116
- coupling facility 107
- coupling facility, managing 107
- creating automation procedures 7
- customization dialog exits 150
- invocation 153
- customization of z/OS UNIX resources 94
- customize automation
 - for processor operations 11
 - for system operations 10
- customizing
 - alternate CDS recovery 106
 - auxiliary storage shortage 112
 - hung command recovery 111
 - IXC102A message automation 112
 - IXC402D message automation 112
 - LINUX target systems 89
 - MVS target systems 89
 - proxy resource automation 78
 - SDF 209
 - system logger recovery 107
 - system to use Parallel Sysplex enhancements 124
 - target systems 89
 - VM target systems 90
 - VSE target systems 91
 - WTO(R) buffer shortage recovery 109

D

- DB2, writing SMF report to 74
- debugging
 - automation procedures 18
 - NetView facilities 20
 - z/OS UNIX Automation 103

- defining
 - actions for message automation 23
 - application type IMAGE 119
 - AT actions for message automation 24
 - AT entry placement 24
 - AT/MRT scope for message automation 29
 - captured messages for message automation 25
 - CMD actions for message automation 24
 - commands for long running enqueues 122
 - common automation items 123
 - conditions for AT entries 24
 - gateway sessions 129

- defining (*continued*)
 - handling of jobs for auxiliary storage shortage recovery 123
 - IEADMCxx symbols for long running enqueues 122
 - IMAGE application type 119
 - local page data set for auxiliary storage shortage recovery 122
 - logical partitions 115
 - logical sysplex 116
 - message revision table entries 28
 - outbound gateway autotask 129
 - override for message automation 26
 - physical sysplex 116
 - processor 115, 119
 - REPLY actions for message automation 24
 - resources for long running enqueues 121
 - SDF focal point system 128
 - SDF in automation control file 224
 - snapshot intervals for long running enqueues 122
 - started task job name 123
 - status messages for message automation 24
 - SYSPLEX policy item 116
 - system 115
 - TAF fullscreen sessions 130
 - temporary data set HLQ 123
 - VTAM application to SA z/OS 133
- definitions for automation setup 94
- definitions for z/OS UNIX resources 94
- deletion of processed WTO(R)s from SDF 163
- developing messages for automation procedures 15
- directory extent 107
- disability xi
- DISPEVT_WAIT 206
- DISPEVTS_WAIT 206
- DISPTRG_WAIT 206
- drain processing prior to JES2 shutdown 164
- DSICMD member 18
- DSIPARM data set 18

E

- element name, Automatic Restart Manager
 - defining 225
- element names
 - in Automatic Restart Manager 225
- element names in Automatic Restart Manager 205
- enabling
 - alerting 64
 - alerting with INGCNTL 66
 - alerting, with Inform List 65
 - alerting, with INGCNTL 65
 - continuous availability of Couple Data Sets 116
 - sysplex automation 105
 - system removal 119
 - WTO(R) buffer shortage recovery 117

- ENQs
 - See enqueues
- enqueues 109
 - long running, automating 121
 - long running, customizing recovery of 111
 - long running, handling 109
- environmental setup exits 142
- error codes 11
- EVEERTRN automation routine 185
- events, resource lifecycle 69
- EVIECT0X automation routine 186
- EVIEET00 automation routine 186
- EVIEI006 automation routine 187
- EVIEI00Q automation routine 187
- EVISTRCT automation routine 188
- EVISTRMN automation routine 188
- EVJEAC04 automation routine 188
- EVJEOSV automation routine 189
- EVJRAC05 automation routine 189
- EVJRSACT automation routine 190
- EVJRSJOB automation routine 190
- example automation procedure 16
- examples of INGUSS command 98
- exits 158
 - AOFEXC00 154
 - AOFEXC01 154
 - AOFEXC02 154
 - AOFEXC03 154
 - AOFEXC04 154
 - AOFEXC05 155
 - AOFEXC06 155
 - AOFEXC07 155
 - AOFEXC08 155
 - AOFEXC09 155
 - AOFEXC11 156
 - AOFEXC12 156
 - AOFEXC13 156
 - AOFEXC14 156
 - AOFEXC15 156
 - AOFEXC16 156
 - AOFEXC17 157
 - AOFEXC18 157
 - AOFEXC19 157
 - AOFEXC20 157
 - AOFEXC21 158
 - AOFEXC22 158
 - AOFEXC23 158
 - AOFEXDEF 143
 - AOFEXI01 143
 - AOFEXI02 143
 - AOFEXI03 143
 - AOFEXI04 144
 - AOFEXI05 144
 - AOFEXI06 144
 - AOFEXINT 144, 161
 - AOFEXSTA 145
 - AOFEXX02 146
 - AOFEXX03 146
 - AOFEXX04 146
 - AOFEXX15 146
 - AOFEXX16 147
 - BUILD processing 150
 - CONVERT processing 152
 - COPY processing 151
 - customization dialog exits 150
 - DELETE processing 152

- exits (*continued*)
 - environmental setup exits 142
 - flag exits 147
 - IMPORT functions 153
 - INGEAXIT 147
 - INGEX01 150
 - INGEX02 150
 - INGEX03 151
 - INGEX04 151
 - INGEX05 152
 - INGEX06 152
 - INGEX07 152
 - INGEX08 152
 - INGEX09 153
 - INGEX12 153
 - INGEX14 153
 - INGEX16 153
 - INGEX17 153
 - INGEX18 153
 - pseudo-exits 158
 - RENAME functions 153
 - sample automation flag exits 149
 - static exits 144
 - status change commands 146
 - subsystem up at initialization
 - commands 159
 - testing 159
- EXPLAIN 201
- extended status command support
 - introduced 27
 - policy definitions 27
- extending automation 7
- external code, automation procedures 11
- external common global variables 197
- EXTSTART status 205, 225

F

- failed persistent connector 108
- failed system, isolation of 111
- file manager commands 11
- file monitoring, z/OS UNIX
 - Automation 98
- flag exits 147
- focal point system definition 128

G

- gateway
 - inbound 129
 - outbound 129
- gateway sessions
 - defining 129
- GDPS environment, shutting down z/OS
 - systems in 135
- generic
 - automation 33, 198
- generic automation procedures 14
- generic routines 7
- global variable names, for automation
 - procedures 22
- guest machines, processor operations
 - support 88
- guest target systems
 - LINUX 88
 - LINUX, user logon 89

- guest target systems (*continued*)
 - MVS 88, 89
 - MVS, NIP console 88
 - MVS, NIP messages 88, 89
 - MVS, problem determination
 - mode 89
 - ProcOps Service Machine 88
 - VSE 89

H

- hardware commands
 - asynchronous, using pipes and
 - ISQCCMD for 87
 - synchronous, using pipes and
 - ISQCCMD for 86
- HASP099 automation routine 191
- health monitoring
 - active 41
 - event-based 42
 - overview 38
 - passive 42
- health monitoring, OMEGAMON
 - exceptions
 - introduction 51
- health monitoring, OMEGAMON XE
 - situations
 - introduction 53
- health status return codes 41
- health-based automation using
 - OMEGAMON
 - programming techniques 44
 - recommendations 53
 - recovery techniques 40
- how to automate USS resources 93
- hung command recovery,
 - customizing 111

I

- IDENT 21
- IEADMCxx symbols, defining
 - for long running enqueues 122
- IMAGE application type, defining 119
- important considerations, processor
 - operations 123
- IMS automation, monitoring 61
- IMS transaction recovery 164
- inbound gateway 129
- INCLUDE statement 223
- INGAUTO_INTERVAL 206
- INGCF command 108
- INGDLG 154
- INGEAXIT exit 147
- INGEI004 member 88
- INGEVENT_WAIT 206
- INGEX01 150
- INGEX02 150
- INGEX03 151
- INGEX04 151
- INGEX05 152
- INGEX06 152
- INGEX07 152
- INGEX08 152
- INGEXEC_RESP 206
- INGEXEC_SELECT 206
- INGEXEC_WAIT 206
- INGGROUP_WAIT 206
- INGHIST_MAX 206
- INGIMS_CMDWAIT 206
- INGIMS_CORRWAIT 205
- INGIMS_REQ 206
- INGINFO_WAIT 206
- INGJRMJSP automation routine 191
- INGLIST_WAIT 206
- INGMON_WAIT 206
- INGMON, programming techniques 44
- INGMOVE_WAIT 206
- INGMSG00 31
- INGMSG01 32
- INGMTRAP monitor command 50
- INGOMX API 47
- INGOPC_MULTIPPLIER 205
- INGPUSMF utility
 - introduced 72
 - JCL 72
 - JCL, user options 73
 - output 72
 - return codes 73
- INGRCJSP automation routine 193
- INGRELS_SHOW 206
- INGRELS_WAIT 206
- INGREQ_EXPIRE 206
- INGREQ_INTERRUPT 206
- INGREQ_ORIGINATOR 205
- INGREQ_OVERRID 206
- INGREQ_PRECHECK 207
- INGREQ_PRI 207
- INGREQ_PRI.E2EMGR 207
- INGREQ_REMOVE 207
- INGREQ_REMOVE.START 207
- INGREQ_REMOVE.STOP 207
- INGREQ_RESTART 207
- INGREQ_SCOPE 207
- INGREQ_SOURCE 207
- INGREQ_TIMEOUT 207
- INGREQ_TYPE 207
- INGREQ_VERIFY 207
- INGREQ_WAIT 207
- INGRPT_WAIT 207
- INGRX740 automation routine 194
- INGSCHED_WAIT 207
- INGSET_VERIFY 207
- INGSET_WAIT 207
- INGSTX_WAIT 207
- INGTRIG_WAIT 207
- INGUSS command 98
 - examples 98
- INGVOTE_EXCLUDE 207
- INGVOTE_STATUS 208
- INGVOTE_VERIFY 208
- initialization processing,
 - AOFSEXINT 203
- initializing automation procedures 9
- installing
 - automation procedures 18
- integration of z/OS UNIX System
 - Services 93
- ISQCCMD
 - using for asynchronous hardware
 - commands 87
 - using for synchronous hardware
 - commands 86

- ISQEXEC command 12, 81
- ISQOVRD 82
- ISQOVRD command 13
- ISQXLOC command 13
- ISQXMOM command 81
- ISQXUNL command 13
- IXC102A message
 - automating 120
 - automation of 111
 - customizing automation of 112
- IXC402D message
 - automating 120
 - automation of 111
 - customizing automation of 112
- IXCARM macro invocations 225
- IXCMIAPU 225

J

- JES2 spool monitoring 61
- JES3 monitoring 57
- job handling, defining for auxiliary storage shortage recovery 123
- job/ASID definitions, making
 - for long running enqueues 122

K

- keyboard xi

L

- layout, SMF record 70
- Linux console connection to NetView 80
- Linux console messages
 - automating 80
 - case sensitive 80
 - restrictions and limitations 81
 - security considerations 80
- LINUX guest target systems, user logon 89
- LINUX target systems, customizing 89
- local page data set, defining
 - for auxiliary storage shortage recovery 122
- log stream 106
- log stream data set 106
- logical partition
 - defining 115
- logical sysplex, defining 116
- LOGR couple data set 106, 107
- LOGREC data set processing 162
- long running enqueues
 - automating 121
 - defining commands 122
 - defining IEADMCxx symbols 122
 - defining resources 121
 - defining snapshot intervals 122
 - handling 109
 - making job/ASID definitions 122
- LookAt message retrieval tool xiv

M

- making generic automation
 - procedures 14
- making job/ASID definitions
 - for long running enqueues 122
- managing
 - couple data set 105
 - coupling facilities 107
 - system logger 106
- master automation tables 31
 - multiple 32
- member, INGEI004 88
- message
 - forwarding 81
 - forwarding path, defining 127
 - ISQ900I 81
 - ISQ901I 81
 - IXC102A, automation of 111
 - IXC402D, automation of 111
 - testing 82, 84
- message automation 23
 - AT build 29
 - AT load 30
 - AT/MRT build concept 30
 - defining actions 23
 - defining AT actions 24
 - defining AT/MRT scope 29
 - defining captured messages 25
 - defining CMD actions 24
 - defining conditions for AT entries 24
 - defining message revision table
 - entries 28
 - defining overrides 26
 - defining REPLY actions 24
 - defining status messages 24
 - Linux console messages 80
 - Linux console messages, case sensitive 80
 - Linux console messages, restrictions and limitations 81
 - Linux console messages, security considerations 80
 - overview 23
 - preparing for processor operations
 - resources 79
 - preventing the building of AT, MRT and MPF entries 25
 - specifying entry placement 24
 - use of symbols 24
- message automation for processor operations resources 77
- message presentation 228
- message retrieval tool, LookAt xiv
- message revision table, defining
 - entries 28
- message testing 84
- messages
 - automation 23
 - classifications 30
 - developing for automation
 - procedures 15
 - trapping UNIX syslogd 103
- minor resources
 - resource name 149
- monitor command, INGMTRAP 50
- monitor resources 37
 - commands 39

- monitor resources (*continued*)
 - defining for CICS monitoring 56
 - defining for OMEGAMON XE situations 53
- monitor routine
 - writing your own 38
- monitoring
 - applications 37
 - CICS health 56
 - CICS link 56
 - CICSplex 56
 - health with OMEGAMON 45
 - health, active 41
 - health, event-based 42
 - health, overview 38
 - health, passive 42
 - IMS automation 61
 - JES3 components 57
 - observed status 37
 - using OMEGAMON XE situations 53
- monitoring routines
 - AOFRJ3MN 58
 - AOFRJ3RC 60
- monitoring routines for z/OS UNIX resources 95
- MOVE group for Automatic Restart Manager 226
- MOVED status
 - Automatic Restart Manager 225
 - automation 225
- MPF list 85
- MPFLSTSA entries
 - preventing the building of 25
- MRT build
 - concept for message automation 30
- MRT entries
 - preventing the building of 25
- MTR
 - See* monitor resources
- MVS Automatic Restart Manager
 - clone ID 205
 - element names 205
 - global variables 205
- MVS guest target systems
 - NIP console 88
 - NIP messages 88, 89
 - problem determination mode 89
- MVS target systems, customizing 89
- MVSESA.RELOAD.ACTION minor resource 159
- MVSESA.RELOAD.CONFIRM flag 158
- MVSESA.RELOAD.CONFIRM minor resource 158

N

- NetView
 - generic automation table entries 33
 - Linux console connection to 80
 - testing and debugging facilities 20
- NetView automation table
 - adding processor operations messages to 81
 - AOFMSGSY 227
 - defining conditions for AT entries 24
 - fragments 227
 - generic entries 33

NetView automation table *(continued)*

- integrating 32
- ISQEXEC 12, 81
- ISQOVRD 13
- ISQXLOC 13
- ISQXMON 81
- ISQXUNL 13
- master automation tables 31
- merging entries 85
- multiple master automation tables 32
- production 84
- reloading tables 85
- sample entry 82
- samples 30
- specifying entry placement 24
- structure 30
- user-written statements 32
- networks automation
 - definition process 127
- new automation definitions
 - building 85
- notification
 - alerts 63
- notification forwarding 128
- notifications 10

O

- observed status
 - monitoring 37
- OMEGAMON
 - assumptions 46
 - exception analysis 46
 - exceptions, health monitoring 51
 - health monitoring 53
 - health monitoring with 45
 - health-based automation,
 - programming techniques 44
 - health-based automation,
 - recommendations 53
 - health-based automation, recovery
 - techniques 40
 - interaction 47
 - monitoring, overview 46
 - session management, INGMTRAP 50
 - session management, INGOMX 47
 - usage scenario 52
- OMEGAMON XE situation monitoring
 - defining monitor resources 53
 - overview 53
- OMEGAMON XE situations,
 - monitoring 53
- operation, TWS Automation 164
- operator cascades 230
- outbound gateway 129
 - autotask, defining 129
- override
 - defining for message automation 26
- overview
 - alerts 63
 - message automation 23
 - monitoring with OMEGAMON 46

P

- panels
 - DISPACF 177, 181, 182
 - INGTHRES 174
 - JES2 181, 184
 - LOGREC 167
 - SMF 169
 - SYSLOG 171
- passive, event-based health monitoring 42
- persistent connection 108
- persistent structure 108
- physical sysplex, defining 116
- pipes
 - using for asynchronous hardware commands 87
 - using for synchronous hardware commands 86
- policy
 - CFRM 107
 - couple data set 105
- preference list 107
- preventing
 - the building of AT, MRT and MPF entries 25
- primary CDS 105
- problem determination mode
 - MVS guest target systems 89
- process monitoring, z/OS UNIX Automation 96
- processing, WTOR 137
- processor
 - defining 115, 119
- PROCESSOR INFO policy item
 - using 115
- processor operations
 - guest machines support 88
 - important considerations 123
- processor operations command messages 83
- processor operations commands 14
- processor operations controlled resources, automating 77
- processor operations resource 77
- processor operations resource message automation 77
- ProcOps Service Machine 88
 - guest target systems 88
- programming
 - additional SA z/OS automation procedures 7
 - recommendations for automation procedures 21
- programming recommendations automation procedures 21
- proxy resource 77
- proxy resources
 - customizing automation for 78
 - shutdown considerations 79
 - startup considerations 79
- pseudo-exits 158
- PSM
 - See* ProcOps Service Machine

R

- rebuild 108
 - system-managed 108
 - user-managed 108
 - recommendations
 - programming, for automation procedures 21
 - recovery
 - "hung" command 109
 - alternate CDS 106
 - alternate CDS, customizing 106
 - auxiliary storage shortage 112
 - auxiliary storage shortage,
 - automating 122
 - command flooding 110
 - handling long-running enqueues 109
 - long running enqueues,
 - customizing 111
 - system log failure 162
 - system logger, customizing 107
 - system logger, directory shortage 107
 - WTO(R) buffer shortage 109
 - WTO(R) buffer shortage,
 - customizing 109
 - WTOR(R) buffer shortage,
 - enabling 117
 - recovery time, reporting 69
 - INGPUSMF utility 72
 - INGPUSMF utility JCL 72
 - INGPUSMF utility JCL, user options 73
 - INGPUSMF utility output 72
 - INGPUSMF utility return codes 73
 - overview 69
 - resource lifecycle 69
 - SMF record layout 70
 - writing to DB2 74
- reload action exit 158
- reload permission exit 158
- RELOAD.ACTION flag 159
- RELOAD.CONFIRM flag 158
- reloading NetView automation table 85
- REPLY actions
 - defining for message automation 24
- reporting, availability and recovery time 69
- resolving
 - WTO(R) buffer shortages 109
- resource lifecycle, events 69
- resources, defining for long running enqueues 121
- restrictions and limitations, Linux console messages 81
- return codes, health status 41
- REXX coding example 20
- REXX PARSE 21
- REXX trace type 19
- routines
 - use in automation procedures 7

S

- SA IOM 63
- SA z/OS
 - commands ISQXIPM and ISQCMMT 12

- SA z/OS, defining VTAM application to 133
- sample
 - automation tables 30
- scenario
 - OMEGAMON 52
- SDF
 - and specific problems 215
 - components 217
 - customizing 209
 - customizing initialization parameters 223
 - defining hierarchy 219
 - defining in automation control file 224
 - defining in customization dialog 224
 - defining panels 220
 - definition process 218
 - for multiple systems 216
 - how it works 209
 - panels
 - definition 215, 220
 - types 209
 - starting and stopping 218
 - status descriptors 210
 - tree structures 211
- SDFCONF command 221
- second level systems, VM support 88
- security considerations, Linux console messages 80
- serialize command processing 12
- session management
 - OMEGAMON, INGMTRAP 50
 - OMEGAMON, INGOMX 47
- setting up z/OS UNIX automation 94
 - example 99
- SFM
 - See* Sysplex Failure Management
- shortcut keys xi
- shutdown considerations, proxy resource automation 79
- shutting down z/OS Systems from GDPS environment 135
- SMF data set processing 162
- SMF report, writing to DB2 74
- snapshot intervals, defining for long running enqueues 122
- spool monitoring, JES2 61
- start definitions for z/OS UNIX resources 98
- started task job name
 - defining 123
- startup considerations, proxy resource automation 79
- status change commands 146
- status command support, extended
 - introduced 27
 - policy definitions 27
- status descriptors 212
 - chaining to status components 212
 - propagating 214
- status information 10
- status messages
 - defining for message automation 24
- stop definitions for z/OS UNIX resources 98
- structure 107

- structure (*continued*)
 - allocation 107
 - automation procedures, of 8
 - deallocation 108
 - duplexing 108
 - persistent 108
 - preference list 107
 - rebuild 108
 - system-managed rebuild 108
 - user-managed rebuild 108
- SUBSAPPL 21
- SUBSJOB 21
- SUBSTYPE 21
- subsystem
 - adding to automation 1
 - up at initialization commands 159
- SVC dump processing 163
- symbols
 - use with message automation 24
- synchronous hardware commands, using pipes and ISQCCMD for 86
- SYSLOG processing 162
- syslogd messages, trapping 103
- sysplex automation
 - enabling 105
- SYSPLEX couple data set 116
- Sysplex Failure Management 111
- sysplex functions 105
 - switching on and off 124
- SYSPLEX policy item
 - defining 116
- system
 - connecting to processor 115
 - defining 115
- system log failure recovery 162
- system logger
 - directory extent 107
 - log stream 106
 - log stream data set 106
 - LOGR couple data set 107
 - managing 106
 - recovery, customizing 107
 - recovery, directory shortage 107
- system operations control files 85
- system removal 111
 - enabling 119
- system-managed rebuild 108

T

- TAF fullscreen sessions
 - defining 130
- target systems, customizing 89
- task global variables 11
- TCP port monitoring, z/OS UNIX Automation 98
- temporary data set HLQ
 - defining 123
- Terminal Access Facility 130
- testing
 - automation procedures 18
 - messages 84
 - more information 21
 - NetView facilities 20
- testing exits 159
- Topology Manager 233

- transaction recovery
 - IMS 164
- TRAP AND WAIT processing 87
- trapping UNIX syslogd messages 103
- TWS Automation
 - operation 164

U

- UNIX Automation
 - automated resources 96
 - debugging 103
 - file monitoring 98
 - hints and tips 103
 - process monitoring 96
 - setting up 94
 - setup example 99
 - TCP port monitoring 98
- UNIX resources
 - customization of 94
 - definitions for 94
 - monitoring routines for 95
 - start and stop definitions 98
- UNIX syslogd messages, trapping 103
- UNIX System Services, integration 93
- user exits 141
 - static exits 144
- user logon, LINUX guest target systems 89
- user-managed rebuild 108
- using
 - PROCESSOR INFO policy item 115
- USS resources
 - automating 93

V

- VM second level systems support 88
- VM target systems, customizing 90
- VOST management, CICS monitoring 56
- VSE guest target systems 89
- VSE target systems, customizing 91
- VTAM application, defining to SA z/OS 133

W

- WTO(R)
 - processed, deletion from SDF 163
- WTO(R) buffer 109
- WTO(R) buffer shortage recovery
 - customizing 109
- WTOR processing 137
- WTOR(R) buffer shortage
 - recovery, enabling 117

Z

- z/OS systems, shutting down in a GDPS Environment 135
- z/OS UNIX applications 93
 - infrastructure overview 94
- z/OS UNIX Automation
 - automated resources 96
 - debugging 103

- z/OS UNIX Automation (*continued*)
 - file monitoring 98
 - hints and tips 103
 - process monitoring 96
 - setting up 94
 - setup example 99
 - TCP port monitoring 98
- z/OS UNIX resources
 - customization of 94
 - definitions for 94
 - monitoring routines for 95
 - start and stop definitions 98
- z/OS UNIX System Services, integration of 93

Readers' Comments — We'd Like to Hear from You

System Automation for z/OS
Customizing and Programming
Version 3 Release 3

Publication No. SC34-2570-00

We appreciate your comments about this publication. Please comment on specific errors or omissions, accuracy, organization, subject matter, or completeness of this book. The comments you send should pertain to only the information in this manual or product and the way in which the information is presented.

For technical questions and information about products and prices, please contact your IBM branch office, your IBM business partner, or your authorized remarketer.

When you send comments to IBM, you grant IBM a nonexclusive right to use or distribute your comments in any way it believes appropriate without incurring any obligation to you. IBM or any other organizations will only use the personal information that you supply to contact you about the issues that you state on this form.

Comments:

Thank you for your support.

Submit your comments using one of these channels:

- Send your comments to the address on the reverse side of this form.
- Send a fax to the following number: FAX (Germany): 07031 16-3456
FAX (Other Countries): +49 7031 16-3456
- Send your comments via e-mail to: s390id@de.ibm.com

If you would like a response from IBM, please fill in the following information:

Name

Address

Company or Organization

Phone No.

E-mail address



Fold and Tape

Please do not staple

Fold and Tape



NO POSTAGE
NECESSARY
IF MAILED IN THE
UNITED STATES

BUSINESS REPLY MAIL

FIRST-CLASS MAIL PERMIT NO. 40 ARMONK, NEW YORK

POSTAGE WILL BE PAID BY ADDRESSEE

IBM Deutschland Research & Development GmbH
Department 3248
Schoenaicher Strasse 220
71032 Boeblingen
Germany

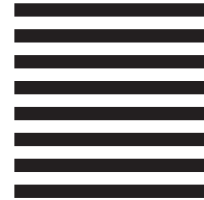

Fold and Tape

Please do not staple

Fold and Tape



Program Number: 5698-SA3

Printed in USA

SC34-2570-00

