

Tivoli System Automation for z/OS
Version 3 Release 3

Defining Automation Policy

IBM

Tivoli System Automation for z/OS
Version 3 Release 3

Defining Automation Policy

IBM

Note!

Before using this information and the product it supports, read the information in Appendix C, "Notices," on page 377.

This edition applies to IBM Tivoli System Automation for z/OS (Program Number 5698-SA3) Version 3 Release 3, an IBM licensed program, and to all subsequent releases and modifications until otherwise indicated in new editions.

| This edition replaces SC34-2572-00.

| IBM welcomes your comments. You may forward your comments electronically, or address your comments to:

| IBM Deutschland Research & Development GmbH

| Department 3248

| Schoenaicher Strasse 220

| 71032 Boeblingen

| Germany

If you prefer to send comments electronically, use one of the following methods:

FAX (Germany): 07031 16-3456

FAX (Other Countries): +49 7031 16-3456

Internet: s390id@de.ibm.com

When you send information to IBM, you grant IBM a nonexclusive right to use or distribute the information in any way it believes appropriate without incurring any obligation to you.

© Copyright IBM Corporation 1996, 2010.

US Government Users Restricted Rights – Use, duplication or disclosure restricted by GSA ADP Schedule Contract with IBM Corp.

Contents

Figures vii

Tables xi

Accessibility xiii

Using assistive technologies xiii
 Keyboard navigation of the user interface xiii
 z/OS information xiii

How to send your comments to IBM . . . xv

If you have a technical problem xv

About This Book xvii

Who Should Use This Book xvii
 Notes on Terminology xvii
 Where to Find More Information. xvii
 The System Automation for z/OS Library. xvii
 Related Product Information xviii
 Using LookAt to look up message explanations xviii
 Summary of Changes for SC34-2572-01 xix
 New Information xix
 Changed Information xx
 Moved Information xxii
 Deleted Information xxiii

Chapter 1. Introducing the Customization Dialog 1

How to Define Automation Policy: An Outline 2
 Entry Type Introduction 2
 Policy Objects and Policy Items 5
 Considerations for the SA z/OS Graphical Interface 7
 Grouping Resources Logically 7
 Considerations for Automation 8
 Assigning System Automation Symbols (AOCCLONE) 9
 Using System Symbols and System Automation Symbols 10
 Nested Classes 11
 Class Hierarchy 12
 Inheritance and Defaulting 13

Chapter 2. Using the Customization Dialog 15

How to Start the Customization Dialog 16
 Getting Help 17
 How to Navigate in the Customization Dialog. 17
 How to Use an Entry Type as a Fast Path 18
 How to Use a Policy Item as a Fast Path 19
 Concurrent User Access 19
 How to Cancel Input on a Panel 19
 How to Create New Policy Objects 19
 How to Rename a Policy Object 21
 How to Delete Policy Objects 22
 How to Delete a Single Policy Object. 22

How to Delete Several Policy Objects in One Go (Bulk Deletion) 22
 How to Find Data in a Policy Item 23
 Common Policy Items 25
 DESCRIPTION Policy Item 25
 COPY Policy Item 26
 WHERE USED Policy Item 27

Chapter 3. Scenarios on How to Use the Customization Dialog. 31

How to Work with Resources 31
 A Grouping Scenario 31
 Grouping the Resources 33
 How to Use Schedules (Service Periods). 57
 Schedule Override 57
 Early Start. 58
 How to Use Triggers and Events 58
 Scenario Environment and Behavior 58
 A Possible Solution. 59
 How to Use User E-T Pairs 65
 Step 1: Specifying User Data in the Customization Dialog 66
 Step 2: Access the User Data. 66
 How to Implement Message Processing with User-Defined Data 67
 Step 1: Specify the User-Defined Data 67
 Step 2: Specify the Commands 68
 Step 3: Update the NetView Automation Table 69
 Step 4: Write the REXX Script 71

Chapter 4. Entry Type Reference 73

Enterprise Entry Type 74
 Policy Items for an Enterprise 74
 SEND COMMAND OPERS Policy Item 75
 INGSEND PARMS Policy Item 76
 PROCOPS FOCAL POINTS Policy Item 77
 AUTO MSG CLASSES Policy Item. 78
 SYMBOL DESCRIPTION Policy Item. 79
 Group Entry Type 79
 Creating a New Group 80
 Policy Items for Standard Groups 81
 Policy Items for Sysplex Groups 82
 GROUP INFO Policy Item 84
 SUBGROUPS Policy Item. 85
 SYSTEMS Policy Item 85
 SYSPLEX Policy Item 86
 NMC DEFINITIONS Policy Item 88
 APPLICATION GROUPS Policy Item. 89
 LOCAL PAGE DATA SET Policy Item 90
 JOB DEFINITIONS Policy Item. 91
 JOB/ASID DEFINITIONS Policy Item 92
 COMMAND DEFINITIONS Policy Item. 93
 COMMAND FLOODING Policy Item 94
 RESOURCE DEFINITIONS Policy Item 95
 RECOVERY OPTIONS Policy Item 95

SubGroup Entry Type	97	Policy Items for Mainframe Processors	220
Creating a New SubGroup	97	Policy Items for PSM Processors	225
Policy Items for SubGroups	98	Monitor Resource Entry Type	229
System Entry Type	98	Policy Items for Monitor Resources	229
Creating a New System	99	MONITOR INFO Policy Item	230
Policy Items for Systems.	101	MESSAGES/USER DATA Policy Item	233
SYSTEM INFO Policy Item	105	HEALTHSTATE Policy Item	238
AUTOMATION SYMBOLS Policy Item	106	TRIGGER Policy Item	239
AUTOMATION CONSOLE Policy Item	108	Product Automation Entry Type	240
PROCESSOR Policy Item	109	Defining Automation for IMS Components	240
TARGET SYSTEM INFO Policy Item	109	Defining Automation for TWS Components	241
IPL INFO Policy Item.	111	Defining Automation for CICS Components	241
ApplicationGroup Entry Type	114	IMS State/Action Tables Entry Type	242
Creating a New ApplicationGroup	114	OPC System Detail Entry Type	243
Policy Items for ApplicationGroups	118	OPC Controller Details Entry Type	244
APPLGROUP INFO Policy Item	120	OPC Special Resources Entry Type	246
APPLICATIONS Policy Item	122	OPC Workstation Domains Entry Type	247
TRIGGER Policy Item	122	CICS Link Definitions Policy Object	249
SERVICE PERIOD Policy Item.	123	CICS Link Monitor Periods Policy Object	251
RELATIONSHIPS Policy Item	123	Messages Entry Type	252
RESOURCES Policy Item	129	MESSAGE AUTOMATION Policy Item.	252
GENERATED RESOURCES Policy Item	136	MPF DEFINITIONS Policy Item	255
MEMBER OF Policy Item	137	Timers Entry Type.	256
Application Entry Type	137	TIMERS Policy Item	256
Creating a New Application	138	Timeout Settings Entry Type	259
Policy Items for Applications	143	TIMEOUT VALUES Policy Item	260
UPWARD CLASS Policy Item	147	Tape Attendance Entry Type	261
DOWNWARD CLASS/INST Policy Item	147	ATTEND TIME Policy Item.	263
APPLICATION INFO Policy Item	149	MVS Component Entry Type	264
AUTOMATION FLAGS Policy Item	158	Policy Items for +SA_PREDEFINED_MSGS	265
APPLICATION SYMBOLS Policy Item	159	Policy Items for MVS Component	266
TRIGGER Policy Item	160	PREDEFINED MESSAGES Policy Item	267
SERVICE PERIOD Policy Item.	160	MESSAGES/USER DATA Policy Item	269
RELATIONSHIPS Policy Item	161	MINOR RESOURCES Policy Item	269
MESSAGES/USER DATA Policy Item	162	MVSCOMP Defaults Entry Type	271
STARTUP Policy Item	179	Policy Items for MVSCOMP Defaults	271
SHUTDOWN Policy Item	182	System Defaults Entry Type	272
THRESHOLDS Policy Item	190	Policy Items for System Defaults	272
MINOR RESOURCES Policy Item	191	AUTOMATION OPTIONS Policy Item	273
SYSTEM ASSOCIATION Policy Item	193	Application Defaults Entry Type	275
GENERATED RESOURCES Policy Item	193	Policy Items for Application Defaults	275
MEMBER OF Policy Item for Applications.	194	Automation Operators Entry Type	276
Policy Items for JES2 Subsystems.	195	Policy Items for Automation Operators.	276
Policy Items for JES3 Subsystems.	199	OPERATORS Policy Item	277
Policy Items for CICS Subsystems	201	Structure of AOFWRKxx Operators	281
Policy Items for DB2 Subsystems	202	Notify Operators Entry Type	281
Policy Items for IMS Subsystems	204	Policy Items for Notify Operators	281
Policy Items for TWS Subsystems	207	NOTIFY OPERATORS Policy Item	282
Policy Items for USS Subsystems	208	Network Entry Type	284
Events Entry Type	211	Policy Items for Network	285
Creating a New Event	211	SDF FOCALPOINT Policy Item	286
Policy Items for Events	212	FULL SESSIONS Policy Item	287
CONDITION Policy Item	213	GATEWAY Policy Item	288
Service Periods Entry Type	214	OMEGAMON Policy Item	288
Policy Items for Service Periods	214	AUTHENTICATION Policy Item	291
SERVICE WINDOW Policy Item	214	SOAP SERVER Policy Item	291
Triggers Entry Type	217	Sysplex Defaults Entry Type	293
Policy Items for Triggers.	217	Policy Items for Sysplex Defaults.	293
CONDITION Policy Item	217	RESOURCE INFO Policy Item.	294
Processor Entry Type	219	Resident CLISTs Entry Type	295
Creating a New Processor	219	Policy Items for Resident CLISTs	296

Status Display Entry Type	296	Making Updates with Text Files	350
Policy Items for Status Display	297	Supported Policies.	351
SDF DETAILS Policy Item	297	Updating Policy Objects Using Text Files	352
User E-T Pairs Entry Type	299	Creating New Policy Objects Using Text Files	356
Policy Items for User E-T Pairs	299	Deleting Policy Objects Using Text Files	359
E-T DATA Policy Item	300	Generating a Job for Batch Update	359
Chapter 5. Policy Database Maintenance	303	Chapter 10. Conversion Function	361
Policy Database Selection List	303	Moved and Restructured Data.	361
Creating a New Policy Database	305	Converting from SA z/OS 3.2.	361
Using SA z/OS Sample Policies	309	Initial Policy Database Conversion	362
Specifying Settings for Policy Databases	310	Selective Policy Database Conversion	362
Logging Policy Database Modifications.	312	Generating a Job for Batch Conversion	362
Chapter 6. Creating Reports about Policy Databases.	315	Appendix A. Concurrent Customization by Multiple Users	363
 		Concurrent User Access Capabilities.	363
Chapter 7. Building and Distributing Configuration Files	323	Policy Definitions Usage.	363
How to Define Data Sets for Build Processing	323	Policy Database Selection	363
Building the Configuration Files	323	Entry Type Selection	363
Configuration Files Build Options	324	Entry Name Selection	364
Distributing the Configuration Files	330	Changing Links	364
Generating a Job for Batch Build	332		
 		Appendix B. More about Using the Customization Dialog	365
Chapter 8. The NetView Automation Table and Message Revision Table	333	Changing Your Customization Dialog Environment 365	
The NetView Automation Table	333	Extending Policy Definitions	366
The NetView Message Revision Table	333	Defining Data Sets for Batch Processing	370
Enabling AT Updates.	334	Defining ISPF Temporary Data Sets for Batch Build	372
Setting AT/MRT Scope	334	User-written Functions	372
System and Application Specific Overrides	335	Alternate Configuration Support	373
Predefined SA z/OS Messages	336	How to Define Alternate Configurations for Systems	374
The INGMMSGSA Automation Table	336	How to Build Alternate Configurations.	374
The +SA_PREDEFINED_MSGS MVS Component Entry	336	Restrictions	375
Modifying Predefined Messages	337		
How to Apply Service Updates	338	Appendix C. Notices	377
 		Programming Interface Information	378
Chapter 9. Data Management.	343	Trademarks	378
Start Panel for Data Management.	343		
Importing Policy Database Data	343	Glossary	379
Batch Import with Data Modification	347		
Importing Sample Add-On Policies	347	Index	401

Figures

1. Entry Type Selection Panel	6	35. Scenario: Define New Entry Input Panel for	55
2. Entry Name Selection Panel for Groups	6	WBSRVAPG	55
3. Policy Selection Panel for Sysplex Groups	7	36. Scenario: Final Select Resources Panel for	57
4. Nested Class Links	13	WBSRVAPG	57
5. Inheritance from Classes and Defaulting	13	37. Policy Objects in the Solution	59
6. Customization Dialog Primary Menu	16	38. Generated Resources in the Solution	60
7. Define New Entry Panel for an Application	20	39. UET Entry-Type Selection Panel.	66
8. Sample Generic Define New Entry Panel	20	40. UET Keyword-Data Specification Panel	66
9. Entry Name Selection Panel: Rename Action	21	41. Scenario: Using the Message Processing Panel	68
10. Entry Name Rename Pop-up Panel	21	42. Scenario: User Data Processing Panel	68
11. Delete Confirmation Panel for a Single Policy	22	43. Scenario: Command Processing Panel	69
Object	22	44. Scenario: Message Processing Panel for AT	69
12. Confirmation Panel for Bulk Deletion with	23	Entry.	69
WHERE USED Links	23	45. Scenario: Message Automation Overview Panel	70
13. Sample Description Policy Item Panel.	26	Default Values	70
14. Hierarchy of Entry Types	29	46. Scenario: Editor with User Values for	70
15. Application Groups	32	Automation Table Entry	70
16. Grouping of Applications into Nested	33	47. Scenario: Message Automation Overview with	70
ApplicationGroups	33	User Values	70
17. Scenario: Current Configuration with Sysplex	40	48. Entry Type Selection Panel	73
Application Group CICS/AOR	40	49. Policy Selection Panel for Enterprises	74
18. Scenario: Current Configuration with	41	50. Operator Profile for Sending Commands Panel	75
Applications CICS/AOR, CPSMCMAS,	41	51. INGSND Command Params Panel.	77
CPSMWUI.	41	52. Processor Operations Focal Point Information	78
19. Scenario: Resources for the CICS/AOR Sysplex	42	Panel.	78
Application Group	42	53. AUTO MSG CLASSES Panel.	78
20. Scenario: Current Configuration with	44	54. System Automation Symbols (AOCCLONEx)	79
Application Group DB2	44	Description Panel	79
21. Scenario: Current Configuration with	44	55. Define New Entry Panel for a Sysplex Group	80
Applications Linked to DB2	44	56. Policy Selection Panel for Standard Groups	82
22. Scenario: Select System Panel for DB2	45	57. Policy Selection Panel for Sysplex Groups	83
Application group	45	58. Group Information Panel for Standard Groups	85
23. Scenario: Select Resources Panel for DB2	45	59. Subgroups Panel for Standard Groups	85
Application Group	45	60. Systems Panel for Standard Groups	86
24. Scenario: Grouping Resources	46	61. Sysplex Policy Definition Panel for Sysplex	86
25. Scenario: Resources for the CICS Sysplex	46	Groups	86
Application Group	46	62. NMC Definitions Panel for Sysplex Groups	88
26. Scenario: Current Configuration with	47	63. Group Information Panel for Standard Groups	90
Applications Linked to DB2	47	64. Local Page Data Set Recovery Panel	90
27. Scenario: Select Resources Panel for	47	65. Local Page Data Set Recovery Job Definition	91
Application Group NET	47	Panel.	91
28. Scenario: Select Resources Panel for DWHAPG	49	66. Long Running ENQ Job/ASID Definitions	92
with valid APG Resources	49	Panel.	92
29. Scenario: Select Resources Panel for	50	67. "Hung" Command Definitions Panel	93
DWHAPG2	50	68. Command Flooding Definition Panel	94
30. Scenario: Select Resources Panel for	51	69. Long Running ENQ Resource Definition Panel	95
DWHAPG2 after Selection	51	70. Recovery Options Panel	96
31. Scenario: Select Resources Panel for	51	71. Define New Entry Panel for a Subgroup	97
DWHAPG3	51	72. Policy Selection Panel for Subgroups	98
32. Scenario: Select Resources Panel for DWHAPG	52	73. Define New Entry Panel for a System.	99
with Valid APG Resources	52	74. Policy Selection Panel for Systems	102
33. Scenario: Setting Preferences with the Select	53	75. System Information Panel	105
Resources Panel for DWHAPG	53	76. Automation Symbols Panel	107
34. Scenario: Select Resources Panel for DWHAPG	53	77. Environment Definition: CONSOLE (Route	108
with Converted Preferences	53	Codes) Panel.	108
		78. Select Target Hardware for System Panel	109

79.	Target System Information Panel	110	132.	SPOOLSHORT Processing Panel	198
80.	MVS Target System IPL Information Panel	112	133.	JES2 DRAIN Processing Panel	198
81.	VM Target System IPL Information Panel	113	134.	Policy Selection Panel for JES3 Subsystems	199
82.	Define New Entry Panel for a Sysplex		135.	JES3 SPOOLFULL Processing Panel	200
	Application Group	115	136.	JES3 SPOOLSHORT Processing Panel	200
83.	Policy Selection Panel for System Application		137.	Policy Selection Panel for CICS Subsystems	201
	Groups.	118	138.	CICS Control Specifications Panel.	201
84.	Application Group Information Panel	120	139.	CICS Link for Application Panel	202
85.	Applications for ApplicationGroup Panel for		140.	Policy Selection Panel for DB2 Subsystems	202
	System Application Groups	122	141.	DB2 Control Entries Panel	203
86.	Trigger for ApplicationGroup Panel	123	142.	Policy Selection Panel for IMS Subsystems	205
87.	Service Period for ApplicationGroup Panel for		143.	IMS Control Region Specifications Panel for	
	System Application Groups	123		Subtype CTL.	206
88.	Relationship Selection List Panel	124	144.	Policy Selection Panel for TWS Subsystems	207
89.	Define Relationship Panel	124	145.	OPC control specifications Panel	208
90.	Example of Strong Chaining	128	146.	Policy Selection Panel for USS Subsystems	209
91.	Select Resources for ApplicationGroup Panel	129	147.	USS Control Specification Panel for	
92.	Generated Resources Panel	136		Application Classes	209
93.	Member of Panel for ApplicationGroups	137	148.	USS Control Specification Panel for	
94.	Define New Entry Panel for Applications	138		Application Instances	210
95.	Policy Selection Panel for Applications	143	149.	Entry Name Selection Panel for Events	212
96.	Upward Link to Class Panel	147	150.	Define New Event Panel.	212
97.	Downward Link to Classes or Instances Panel	148	151.	Policy Selection Panel for Events	213
98.	Application Information Panel	149	152.	Unset Condition Panel for Events.	213
99.	Flag Automation Specification Panel	158	153.	Policy Selection Panel for Service Periods	214
100.	Application Symbols Panel	159	154.	Service Windows Panel for Service Periods	215
101.	Trigger for Application Panel	160	155.	Policy Selection Panel for Triggers	217
102.	Service Period for Application Panel	160	156.	Trigger Conditions Panel.	218
103.	Relationship Selection List Panel	161	157.	STARTUP Condition for Trigger Panel	219
104.	Message Processing Panel	162	158.	Defining a New SA z/OS Processor Entry	219
105.	Command Processing Panel for Applications	164	159.	Policy Selection Panel for Processor	220
106.	Reply Processing Panel for Applications	166	160.	Processor Information Panel	221
107.	Code Processing Panel	167	161.	LPAR Definitions Panel	224
108.	User Data Processing Panel for Applications	171	162.	Policy Selection Panel for PSM Processors	225
109.	Message Automation Overview Panel	172	163.	ProcOps Service Machine Information Panel	226
110.	Automation Table entry Conditions Panel	173	164.	GUEST Definitions Panel	228
111.	AT Status Specification Panel	174	165.	Policy Selection for Monitor Resource	229
112.	Editor Panel to Specify an AT Override	175	166.	Monitor Resource Information Panel.	231
113.	AT/MRT Ignore Specification Panel	175	167.	Message Processing Panel with OMEGAMON	
114.	Message Revision Table Conditions Panel	176		Exception	234
115.	Editor Panel to Specify an MRT Override	177	168.	Message Automation Overview Panel	235
116.	Using the STARTUP Policy Item	179	169.	AT Status Specification Panel	235
117.	Subsystem Startup Processing Panel	180	170.	CMD Processing Panel for Monitor Resources	236
118.	Command Processing Panel for Startup		171.	Code Processing Panel	236
	Commands	181	172.	User Defined Data Panel.	237
119.	Subsystem Shutdown Processing Panel	183	173.	Monitor Resource CMD Processing Panel -	
120.	Command Processing Panel for SHUTINIT or			Pass Processing	237
	SHUTFINAL.	185	174.	User Defined Data Panel.	238
121.	Command Processing Panel for SHUTNORM,		175.	Command Processing Panel for the	
	SHUTIMMED, or SHUTFORCE	187		HEALTHSTATE Policy Item.	238
122.	Reply Processing Panel for SHUTINIT	188	176.	Trigger for Monitor Resource Panel	240
123.	Reply Processing Panel for SHUTNORM,		177.	Entry Type Selections for Product Automation	
	SHUTIMMED and SHUTFORCE	189		Panel	240
124.	Thresholds Definition Panel.	190	178.	Policy Selection Panel for IMS State/Action	
125.	Minor Resource Definitions Panel.	192		Table	242
126.	System Association Panel	193	179.	IMS State Action Tables Panel	243
127.	Generated Resources Panel	194	180.	Policy Selection Panel for OPC System Detail	243
128.	Member of Panel for Applications	194	181.	OPC System Details Panel	244
129.	Policy Selection Panel for JES2 Subsystems	195	182.	Policy Selection Panel for OPC Controller	
130.	SPOOLFULL Processing Panel	196		Details	245
131.	SPOOLFULL Processing Panel for JES2	197	183.	OPC Controller Details Panel	245

184. Policy Selection Panel for OPC Special Resources	246	223. GATEWAY Definitions Panel	288
185. OPC Special Resource Definitions Panel	247	224. OMEGAMON Sessions Definitions Panel	289
186. Policy Selection Panel for OPC Workstation Domain	247	225. OMEGAMON Session Attributes Panel	289
187. Code Processing Panel for TWS Workstation Domain IDs	248	226. Authentication Definitions Panel	291
188. Policy Selection Panel for CICS Link Definitions	249	227. SOAP Server Definitions Panel	292
189. CICS Connection Links Panel	250	228. SOAP-Server Attributes Panel	292
190. Policy Selection Panel for CICS Link Monitor Periods	251	229. Policy Selection Panel for Sysplex Defaults	294
191. Link Monitoring Service Period Panel	252	230. Sysplex Resource Information Defaults Panel	294
192. Message Definitions Panel	253	231. Policy Selection Panel for Resident CLISTS	296
193. Entries linked to Message Panel	254	232. Policy Selection Panel for Status Display	297
194. Message Automation Overview Panel	254	233. Status Display Facility Details Panel	297
195. MPF Header and Trailer Definition Panel	255	234. Policy Selection Panel for User E-T Pairs	300
196. Policy Selection Panel for Timers	256	235. UET Entry-Type Selection Panel	300
197. Timer Definitions Panel	257	236. UET Keyword-Data Specification Panel	301
198. Timer Definitions Panel 2	258	237. Policy Database Selection Panel	303
199. Policy Selection Panel for Timeout Settings	260	238. Policy Database Selection Panel	305
200. Environment Definition: TIMEOUT Panel	260	239. Create a New Policy Database Panel	306
201. Policy Selection Panel for Tape Attendance	262	240. New Policy Database Data Set Information Panel	307
202. Environment Definition: TAPES Panel	263	241. Settings for Policy Database Panel	311
203. Panel for MVS Component Selection	265	242. Example of an Activity Log	314
204. Panel for +SA_PREDEFINED_MSGS Policy Options	265	243. SA z/OS Report Selection Menu	315
205. Panel for SA_PREDEFINED_MSGS Processing	266	244. Policy Data Base Report Parameters Panel	316
206. Policy Selection Panel for MVS Components	267	245. Example of Report Output Format FLAT	318
207. Component Selection Panel for MVS Components	268	246. List of Generated Resources	319
208. Message Processing Panel for MVS Components	269	247. Unreferenced Member Report	320
209. Minor Resource Definitions Panel	270	248. Example Status Messages Report (Excerpt)	321
210. Policy Selection Panel for MVSCOMP Defaults	271	249. Example Symbols Report (Excerpt)	322
211. Policy Selection Panel for System Defaults	272	250. Build Parameters Panel	325
212. System Automation Options Panel	273	251. Message and Logging Functions Panel	329
213. Policy Selection Panel for Application Defaults	275	252. SA z/OS Automation Configuration	331
214. Policy Selection Panel for Automation Operators	276	253. APAR Apply Options panel	338
215. Automation Operator Definition Panel	279	254. Data Management Menu Panel	343
216. Automation Operator Definitions Panel	280	255. Policy Data Base Import Panel	344
217. Policy Selection Panel for Notify Operators	282	256. Entry Name Selection Panel for Import Policy Data	345
218. Operator Notification Panel	282	257. Selected Entry Names For Import Panel	345
219. Operator Notification Message Classes Panel	283	258. Modify Data Pop-Up Window	346
220. Policy Selection Panel for Network	285	259. Import Add-On Policies Panel	348
221. Notification Forwarding Panel	286	260. Entries of Selected Add-on Policies Panel	348
222. Fullscreen TAF Application Definition Panel	287	261. SA z/OS Customization Dialog Settings Menu	365
		262. Edit Policy Selections Panel	367
		263. Define Policy Selection Panel	368
		264. SA z/OS Data Set Customization Details Panel	370
		265. ISPF Temporary Data Sets Preallocation for Batch Panel	372
		266. Send Automation Configuration Data Sets Panel	373

Tables

1.	System Automation for z/OS Library	xvii	6.	Preference Value Scenarios	133
2.	System Symbols and System Automation Symbols	10	7.	SA z/OS Mapping of NetView Automation Operator to SA z/OS Automated Function	277
3.	System Symbols	11	8.	SA z/OS Message Classes	283
4.	System Automation Symbols	11	9.	Policy Selection Filter Attributes	369
5.	Entry Details for Applications in the Scenario	37			

Accessibility

Publications for this product are offered in Adobe Portable Document Format (PDF) and should be compliant with accessibility standards. If you experience difficulties when using PDF files, you may view the information through the z/OS Internet Library website or the z/OS Information Center. If you continue to experience problems, send an email to mhvrcfs@us.ibm.com or write to:

IBM Corporation
Attention: MHVRCFS Reader Comments
Department H6MA, Building 707
2455 South Road
Poughkeepsie, NY 12601-5400
U.S.A.

Accessibility features help a user who has a physical disability, such as restricted mobility or limited vision, to use software products successfully. The major accessibility features in z/OS® enable users to:

- Use assistive technologies such as screen readers and screen magnifier software
- Operate specific or equivalent features using only the keyboard
- Customize display attributes such as color, contrast, and font size

Using assistive technologies

Assistive technology products, such as screen readers, function with the user interfaces found in z/OS. Consult the assistive technology documentation for specific information when using such products to access z/OS interfaces.

Keyboard navigation of the user interface

Users can access z/OS user interfaces using TSO/E or ISPF. Refer to *z/OS TSO/E Primer*, *z/OS TSO/E User's Guide*, and *z/OS ISPF User's Guide Vol I* for information about accessing TSO/E and ISPF interfaces. These guides describe how to use TSO/E and ISPF, including the use of keyboard shortcuts or function keys (PF keys). Each guide includes the default settings for the PF keys and explains how to modify their functions.

z/OS information

z/OS information is accessible using screen readers with the BookServer or Library Server versions of z/OS books in the Internet library at:

<http://www.ibm.com/systems/z/os/zos/bkserv/>

How to send your comments to IBM

We appreciate your input on this publication. Feel free to comment on the clarity, accuracy, and completeness of the information or give us any other feedback that you might have.

Use one of the following methods to send us your comments:

1. Send an email to s390id@de.ibm.com
2. Visit the SA z/OS home page at http://www.ibm.com/systems/z/os/zos/features/system_automation/
3. Visit the Contact z/OS web page at <http://www.ibm.com/systems/z/os/zos/webqs.html>
4. Mail the comments to the following address:
IBM Deutschland Research & Development GmbH
Department 3248
Schoenaicher Str. 220
D-71032 Boeblingen
Federal Republic of Germany
5. Fax the comments to us as follows:
From Germany: 07031-16-3456
From all other countries: +(49)-7031-16-3456

Include the following information:

- Your name and address
- Your email address
- Your telephone or fax number
- The publication title and order number:
IBM Tivoli System Automation for z/OS V3R3.0 Defining Automation Policy
SC34-2572-01
- The topic and page number related to your comment
- The text of your comment.

When you send comments to IBM, you grant IBM a nonexclusive right to use or distribute your comments in any way it believes appropriate without incurring any obligation to you.

IBM or any other organizations will only use the personal information that you supply to contact you about the issues that you submit.

If you have a technical problem

Do not use the feedback methods listed above. Instead, do one of the following:

- Contact your IBM service representative
- Call IBM technical support
- Visit the IBM zSeries support web page at www.ibm.com/systems/z/support/.

About This Book

This book describes Tivoli® System Automation for z/OS (SA z/OS). This product plays a key role in supplying high-end automation solutions whereas Tivoli Systems (Tivoli Management Environment, Tivoli) delivers integrated cross-platform management functions. This book contains information about how to enable SA z/OS's automation.

Who Should Use This Book

This book is primarily intended for automation programmers responsible for defining and maintaining the automation policy.

Notes on Terminology

MVS™

References in this book to *MVS* refer either to the MVS/ESA product or to the MVS element of z/OS.

OPC

References in this book to *OPC* refer to Tivoli Workload Scheduler (TWS).

Resources, Applications, and Subsystems

These three terms are used in the SA z/OS library to designate automated entities. The correct term to be used depends on the context. See the chapter "Introduction" in *IBM Tivoli System Automation for z/OS Operator's Commands* for the definition of these terms.

Where to Find More Information

The System Automation for z/OS Library

Table 1 shows the information units in the System Automation for z/OS library:

Table 1. System Automation for z/OS Library

Title	Order Number
<i>IBM Tivoli System Automation for z/OS Planning and Installation</i>	SC34-2571
<i>IBM Tivoli System Automation for z/OS Customizing and Programming</i>	SC34-2570
<i>IBM Tivoli System Automation for z/OS Defining Automation Policy</i>	SC34-2572
<i>IBM Tivoli System Automation for z/OS User's Guide</i>	SC34-2573
<i>IBM Tivoli System Automation for z/OS Messages and Codes</i>	SC34-2574
<i>IBM Tivoli System Automation for z/OS Operator's Commands</i>	SC34-2575
<i>IBM Tivoli System Automation for z/OS Programmer's Reference</i>	SC34-2576

Table 1. System Automation for z/OS Library (continued)

Title	Order Number
<i>IBM Tivoli System Automation for z/OS Product Automation Programmer's Reference and Operator's Guide</i>	SC34-2569
<i>IBM Tivoli System Automation for z/OS TWS Automation Programmer's Reference and Operator's Guide</i>	SC34-2579
<i>IBM Tivoli System Automation for z/OS End-to-End Automation Adapter</i>	SC34-2580
<i>IBM Tivoli System Automation for z/OS Monitoring Agent Configuration and User's Guide</i>	SC34-2581

The System Automation for z/OS books are also available on CD-ROM as part of the following collection kit:

IBM® Online Library z/OS Software Products Collection (SK3T-4270)

SA z/OS Home Page

For the latest news on SA z/OS, visit the SA z/OS home page at http://www.ibm.com/systems/z/os/zos/features/system_automation

Related Product Information

You can find books in related product libraries that may be useful for support of the SA z/OS base program by visiting the z/OS Internet Library at <http://www.ibm.com/systems/z/os/zos/bkserv>

Using LookAt to look up message explanations

LookAt is an online facility that lets you look up explanations for most of the IBM messages you encounter, as well as for some system abends and codes. Using LookAt to find information is faster than a conventional search because in most cases LookAt goes directly to the message explanation.

You can use LookAt from these locations to find IBM message explanations for z/OS elements and features, z/VM®, z/VSE®, and Clusters for AIX® and Linux:

- The Internet. You can access IBM message explanations directly from the LookAt Website at www.ibm.com/systems/z/os/zos/bkserv/lookat/index.html
- Your z/OS TSO/E host system. You can install code on your z/OS or z/OS.e systems to access IBM message explanations using LookAt from a TSO/E command line (for example: TSO/E prompt, ISPF, or z/OS UNIX System Services).
- Your Microsoft Windows workstation. You can install LookAt directly from the *z/OS Collection* (SK3T-4269) or the *z/OS and Software Products DVD Collection* (SK3T-4271) and use it from the resulting Windows graphical user interface (GUI). The command prompt (also known as the DOS > command line) version can still be used from the directory in which you install the Windows version of LookAt.
- Your wireless handheld device. You can use the LookAt Mobile Edition from www.ibm.com/systems/z/os/zos/bkserv/lookat/lookatm.html with a handheld device that has wireless access and an Internet browser (for example: Internet Explorer for Pocket PCs, Blazer or Eudora for Palm OS, or Opera for Linux handheld devices).

You can obtain code to install LookAt on your host system or Microsoft Windows workstation from:

- A CD-ROM in the *z/OS Collection* (SK3T-4269).
- The *z/OS and Software Products DVD Collection* (SK3T-4271).
- The LookAt Website (click **Download** and then select the platform, release, collection, and location that suit your needs). More information is available in the LOOKAT.ME files available during the download process.

Summary of Changes for SC34-2572-01

This document contains information previously presented in System Automation for z/OS V3R3.0 Defining Automation Policy, SC34-2572-00.

The following sections provide details of significant or major changes in this edition. All changes are indicated by a vertical line to the left of the change.

New Information

The following information is new in this edition:

- The INGROMON monitoring routine is added for the Monitor Routine entry in “APPLICATION INFO Policy Item” on page 149.
- A policy item section for SA z/OS predefined messages (+SA_PREDEFINED_MSGS) is added in “MVS Component Entry Type” on page 264.
- The Connection Monitor Interval field is added in “PROCESSOR INFO Policy Item” on page 221 for Internal Processor data.
- IP Stack field information has been added to the screen illustration and descriptions in “USS CONTROL Policy Item” on page 209.
- You can use the FIND/RFIND command to find data in various policy items. See “How to Find Data in a Policy Item” on page 23 for more details.
- The following policy items:

Enterprise entry type

“MESSAGE AUTOMATION Policy Item” on page 252

MVS Component entry type

“PREDEFINED MESSAGES Policy Item” on page 267

- SA z/OS now builds a NetView message revision table and has introduced predefined messages in a NetView automation table called INGMSGSA and an MVS component (MVC) entry called +SA_PREDEFINED_MSGS. For more details, see Chapter 8, “The NetView Automation Table and Message Revision Table,” on page 333.
- You can apply service updates that affect the generation of NetView automation tables. See “How to Apply Service Updates” on page 338 for more details.
- The labels *BEGINAPL, *ENDAPL, *BEGINSYS and *ENDSYS have been introduced to mark an AT override section for selected application instances or classes, see “System and Application Specific Overrides” on page 335.
- You can modify data when you import it using character string replacement, see “Modifying Data” on page 346.
- SA z/OS provides a batch interface that can be invoked from a separate JCL, see “Batch Import with Data Modification” on page 347.
- You can delete policy objects using flat text file editing, see “Deleting Policy Objects Using Text Files” on page 359.

- Details of moved and restructured data in Chapter 10, “Conversion Function,” on page 361.

Changed Information

The following information has been changed in this edition:

&*JOBNAME. variable

A new variable &*JOBNAME. replaces the &SUBSJOB variable when “Converting from SA z/OS 3.2” on page 361.

- The “Readers' Comments - We'd like to hear from you” section at the back of this publication has been replaced with a new section “How to send your comments to IBM” on page xv. The hardcopy mail-in form has been replaced with a page that provides information appropriate for submitting comments to IBM.
- Figure 14 on page 29.
- The systems and their grouping in the scenario in “How to Work with Resources” on page 31.
- The panels that you use to create the following policy objects have changed:

Systems

The **MVS system name** field has been deleted and the **Image/ProcOps name** renamed **Image/System name**. See “Creating a New System” on page 99.

Application Groups

The **Prepare Move** field has been introduced, see “Prepare Move” on page 117.

Processors

The options for the **Processor Type** have changed, see “Creating a New Processor” on page 219.

- The following policy items and associated panels have changed:

Enterprise entry type

PROCOPS FOCAL POINTS replaces the PROCESSOR OPS INFO policy item, see “PROCOPS FOCAL POINTS Policy Item” on page 77.

System entry type

- **SYSTEM INFO**: The **MVS system name** field has been deleted and the **Image/ProcOps name** renamed **Image/System name**. The **Network ID** field has been deleted. See “SYSTEM INFO Policy Item” on page 105.
- **TARGET SYSTEM INFO**: You can enter BYPASS as a value for the **Initialized target system** field, see “TARGET SYSTEM INFO Policy Item” on page 109.

Application Groups

- **APPLGROUP INFO**: There are new options for the **Desired Available (ASIS)** and **Inform List (EIF, TTT, USR)** fields, see “APPLGROUP INFO Policy Item” on page 120.
- **MESSAGES/USER DATA**: Message processing has changed, see “MESSAGES/USER DATA Policy Item” on page 162.
- **RELATIONSHIPS**: You can specify a PEEROF relationship in the **Relationship Type** field, see “Defining Relationships” on page 124.

Applications

- **APPLICATION INFO**: The new **Skip ACTIVE status** field allows you to specify whether the application has a specific indication for the UP

status, new options for the **Desired Available** (ASIS) and **Inform List** (EIF, TTT, USR) fields, see “APPLICATION INFO Policy Item” on page 149.

- MESSAGES/USER DATA: Message processing has changed, see “MESSAGES/USER DATA Policy Item” on page 162.
- STARTUP and SHUTDOWN: The **Action** field on the Subsystem Startup Processing and Subsystem Shutdown Processing panels is now a **Cmd** field and the layout of the Command Processing panel has changed, see “STARTUP Policy Item” on page 179 and “SHUTDOWN Policy Item” on page 182.
- THRESHOLDS: You can now include seconds in thresholds definitions, see “THRESHOLDS Policy Item” on page 190.
- MINOR RESOURCES: The MINOR RESOURCE FLAGS and MINOR RESOURCE THRES policy items have been combined, see “MINOR RESOURCES Policy Item” on page 191.
- DB2[®] CONTROL: The TSO logoff delay field has been retired and other fields are only valid for earlier releases of SA z/OS, see “DB2 CONTROL Policy Item” on page 203.
- IMS[™] CONTROL: Because of changes to IMS processing, several fields have been retired, see “IMS CONTROL Policy Item” on page 205.
- USS CONTROL: The USS Control Specification panel now includes a **Filter** field and an **IP Stack** field, see “USS CONTROL Policy Item” on page 209.

Processors

- PROCESSOR INFO: The fields on this panel have been rearranged according to the connection protocol, see “PROCESSOR INFO Policy Item” on page 221.
- PSM INFORMATION: The **Site/Location Name** and **Enforce IPv4 for Hostname** fields have been added, see “PSM INFORMATION Policy Item” on page 225.

Monitor Resources

- MONITOR INFO: The **Desired Available** field includes the new option ASIS, and the **Inform List** field allows the new receivers, EIF, TTT, and USR. See “MONITOR INFO Policy Item” on page 230.
- MESSAGES/USER DATA: Message processing has changed, see “MESSAGES/USER DATA Policy Item” on page 233.
- HEALTHSTATE: The layout of the associated panel has changed, see “HEALTHSTATE Policy Item” on page 238.

Product Automation

- OPCA0 ENVIRON: The **Critical msg retention** field has been retired, see “OPCA0 ENVIRON Policy Item” on page 243.

MVS Components

- MESSAGES/USER DATA: Message processing has changed, see “MESSAGES/USER DATA Policy Item” on page 269.
- MINOR RESOURCES: The MINOR RESOURCE FLAGS and MINOR RESOURCE THRES policy items have been combined, see “MINOR RESOURCES Policy Item” on page 269.

System Defaults

- AUTOMATION OPTIONS: This policy item includes the new fields **Exceptional Messages Limit**, **Prepare Move**, and **Move Mode** and the **Desired Available** field includes the new option ASIS, and the **Inform List** field allows the new receivers, EIF, TTT, and USR. See “AUTOMATION OPTIONS Policy Item” on page 273.

Notify Operators

- NOTIFY OPERATORS: The Notify Operator Message Classes panel now allows you to assign user message classes, see “NOTIFY OPERATORS Policy Item” on page 282.

Networks

- SDF FOCALPOINT: The FORWARD policy item has been renamed, see “SDF FOCALPOINT Policy Item” on page 286.
- OMEGAMON®: The OMEGAMON Session Attributes panel now includes the **VTAM® Logmode** and **TAF SRCLU** fields, see “OMEGAMON Policy Item” on page 288.
- SOAP SERVER: The **Host Name** field on the SOAP-Server Attributes panel allows you to specify IPv6 and IPv4 addresses, and the panel now includes a **Protocol** field, see “SOAP SERVER Policy Item” on page 291.

Sysplex Defaults

- RESOURCE INFO: This policy item includes the new fields **Prepare Move** and **Move Mode**. The **Desired Available** field includes the new option ASIS, and the **Inform List** field allows the new receivers, EIF, TTT, and USR. See “RESOURCE INFO Policy Item” on page 294.
- The NetView® Automation option on the Settings for Policy Database panel also applies to the NetView message revision table (MRT), see “Specifying Settings for Policy Databases” on page 310.
- Because SA z/OS now builds a NetView message revision table and optionally builds a processor operations control file for systems that are running earlier releases, the information in Chapter 7, “Building and Distributing Configuration Files,” on page 323 has changed.
- The Entries of selected Add-on Policies panel now includes a list of options that are available along with their description in “Importing Sample Add-On Policies” on page 347.

Moved Information

The MESSAGE AUTOMATION and MPF DEFINITIONS policy items are removed from the Enterprise Entry Type section and placed in the Messages Entry Type section. See “Messages Entry Type” on page 252.

The information in “The Customization Dialog Primary Menu” has been moved to “How to Start the Customization Dialog” on page 16.

“Getting Help” on page 17 has been moved to Chapter 2, “Using the Customization Dialog,” on page 15.

- The following sections have been moved to *IBM Tivoli System Automation for z/OS User's Guide*:
 - “Goal Driven Automation”
 - “Automatic Calculation of Schedules (Service Periods)”
 - “Relationship Support”
 - “How SA z/OS Uses Error Thresholds”

- “Automation Flags”
- “Event and Trigger Support”
- The following sections have been moved to *IBM Tivoli System Automation for z/OS Customizing and Programming*:
 - “Automating Networks”
 - “How System Operations Coordinates with Automatic Restart Manager”
 - “WTO Buffer Shortage Recovery”
- “Assigning System Automation Symbols (AOCCLONE)” on page 9 and “Nested Classes” on page 11 have been moved to Chapter 1, “Introducing the Customization Dialog,” on page 1.
- “Building and Distributing SA z/OS Automation Policy” in Chapter 1, “Introducing the Customization Dialog,” on page 1 has been incorporated into Chapter 7, “Building and Distributing Configuration Files,” on page 323.
- The appendix “Example New Policy Objects via File Updates” has been moved to “Creating New Policy Objects Using Text Files” on page 356 and renamed, see “Examples” on page 357.

Deleted Information

The following information has been deleted:

- The list of special message IDs in the MESSAGES/USER DATA policy item for applications and MVS components.
- Product automation entry types: The following entry types have been retired:
 - IRN (IMS Resource Name)
 - ISF (IMS Status File)
- Policy items: The following policy items have been retired:

System entry type

IMS XRF RESOURCES, IMS XRF STATUS FILES

- The section about possible causes for a warning during AT and MPFLSTSA build in “BUILD Error Messages” on page 328.
- The section “Automated NetView Automation Table Build” has been deleted in Appendix A, “Concurrent Customization by Multiple Users,” on page 363.
- The section “Migrating the Automation Control File” in Chapter 9, “Data Management,” on page 343.

You may notice changes in the style and structure of some content in this document—for example, headings that use uppercase for the first letter of initial words only, and procedures that have a different look and format. The changes are ongoing improvements to the consistency and retrievability of information in our documents.

This document contains terminology, maintenance, and editorial changes. Technical changes or additions to the text and illustrations are indicated by a vertical line to the left of the change.

Chapter 1. Introducing the Customization Dialog

Before you can use SA z/OS to automate, monitor, and control the resources in your enterprise, you must define your enterprise's *automation policy*. You use the SA z/OS customization dialog to provide information for SA z/OS, such as:

- Which resources (such as systems or applications) you want to automate, monitor and control
- How resources are to be associated (that is, grouped) with each other for automation
- The dependencies between resources and groups of resources
- What sort of automation, such as automatic startup or shutdown, is to be applied to these resources and how
- The conditions that automated actions should occur under, and what actions should be performed
- When automation is to be active, and how it handles certain tasks and events during system operation

The customization dialog leads the SA z/OS policy administrator through the process of defining resources and automation for the enterprise. SA z/OS automatically extracts the required information from this to display resources graphically, for example, on the NMC workstation.

Before you begin to use the customization dialog to define your enterprise automation policy, you need to determine how you want SA z/OS to work within your enterprise. This is part of the process of planning to use SA z/OS. There are many considerations for planning to use SA z/OS that you should be aware of. For more information, see the planning instructions given in *IBM Tivoli System Automation for z/OS Planning and Installation*.

Note:

Do not use the customization dialogs on a Kanji terminal because they will not work. If you have your terminal defined as a 3278KN terminal, you can circumvent the Kanji restriction by going into ISPF option 0.1 (panel ID ISPOPT1) and redefining the TERMINAL TYPE to 3278.

The remainder of this chapter deals with the following topics:

- “How to Define Automation Policy: An Outline” on page 2 gives an outline of the process of creating enterprise automation policy.
- “Entry Type Introduction” on page 2 introduces the customization dialog entry types.
- “Considerations for the SA z/OS Graphical Interface” on page 7 provides information on how to customize the monitoring aspect of SA z/OS.
- “Considerations for Automation” on page 8 provides information on how to customize the automation aspect of SA z/OS.

How to Define Automation Policy: An Outline

Automation policy is needed if you want to use system operations or processor operations automation functions. The process of defining automation policy comprises the following steps:

1. At the configuration focal point where you have the customization dialog installed, create the information in the policy database using the ISPF input panels of the customization dialog.
2. Use the BUILD function of the customization dialog to produce the required output, that is, the configuration files: automation control file (ACF), automation manager configuration file (AMC), NetView automation table (AT), the message revision table (MRT), and the MPFLSTSA file.
3. Distribute the generated output to each system in the SA z/OS enterprise where SA z/OS system operations functions are to run. In general, this is all of the z/OS systems in the SA z/OS enterprise. In a sysplex, the data set name of the automation control file must be the same on all systems in the sysplex. However, it is highly recommended that you use a shared data set in a sysplex, and if possible, to use a shared data set for the whole enterprise.

See Chapter 7, “Building and Distributing Configuration Files,” on page 323 and Figure 252 on page 331 for more information on building and distributing the generated configuration files.

Entry Type Introduction

All resources in your enterprise, such as systems or applications, or other objects that you use to automate your enterprise data processing, such as components of your z/OS operating system, are called *entry types*. A complete list of SA z/OS entry types is given on the Entry Type Selection panel (see Figure 1 on page 6), which is the first panel you see after you have decided which enterprise or policy database you are going to work with.

For each entry type you can invoke a series of panels to create, modify, or delete entries of a certain entry type. A single instance of a particular entry type is called a *policy object*. These entries are referred to by their *entry name*.

When you select an object via its name, you get a list of *policy items* specific for the entry type that you are working with. For example, the *Timers* entry type may consist of several named sets of timer definitions, each containing a number of timers. These named sets are selected and linked to a particular system as required. Each set can be linked to an arbitrary number of systems and any number of sets can be linked to any particular system.

The letters and numbers in the following list indicate the entry type's index on the Entry Type Selection panel. You can use either numbers or letters to select the appropriate entry type. The alphanumeric index is used on other panels of the customization dialog to identify a certain entry type.

Detailed information and scenarios on how to automate the resources (applications and application groups) and make them available on certain systems is given in Chapter 3, “Scenarios on How to Use the Customization Dialog,” on page 31.

1/ENT Enterprise

An Enterprise is the top level of your SA z/OS structure. It comprises enterprise wide data for the complete policy database.

2/GRP Group

A group is the largest subdivision of an SA z/OS enterprise. An SA z/OS enterprise may have several groups, each consisting of systems or subgroups, or both.

A sysplex group can be used to represent a logical sysplex (systems within the same XCF group ID). A standard group can be used to represent a physical sysplex (systems in different XCF group IDs). The definition of groups is a prerequisite for sysplex-wide automation.

3/SBG Subgroup

Like groups, subgroups are collections of systems. You define a subgroup by selecting the member systems and assigning a name to the subgroup. Subgroups can be collected into groups. They offer a finer level of structuring groups.

4/SYS System

A system is an image of an operating system running on a host processor monitored by SA z/OS. The system may be MVS, VM, VSE, LINUX, or CF (coupling facility). A system definition includes for example:

- Links to other objects associated with the system, for example, links to application groups
- Application defaults
- System defaults
- System automation symbols

5/APG ApplicationGroup

An application group is a set of applications that you assign a name to. You can define two types of application groups: System Application Groups and Sysplex Application Groups. You assign System Application Groups to one or more systems and Sysplex Application Groups to one or more sysplexes.

6/APL Application

An application is a z/OS subsystem or job that runs on a system in the SA z/OS enterprise. SA z/OS monitors applications through the messages they issue to the system, MVS commands, and SA z/OS-provided services. An application can belong to more than one application group. An application definition includes:

- Subsystem name and the name of the procedure that runs the job
- Warning and alert thresholds
- Start and Stop specifications
- Individual automation flags

7/EVT Events

Events are used for external dependencies where they represent a process that the automation cannot handle. For example, an operator needs to manually edit a file before the application can continue. SA z/OS remembers which events are SET (have occurred) and can be told when to forget them (by defining an UNSET condition).

8/SVP Service Periods

Define the availability of applications. A service period is a set of time intervals (service windows) during which a resource (APL, APG, or MTR) should be active or inactive.

9/TRG Triggers

In combination with events, triggers are used to control the starting and stopping of resources (APL, APG, or MTR).

Entry Type Introduction

10/PRO Processor

A processor is the physical or physically-partitioned hardware that a system runs on. A "logical" processor, called the *ProcOps Service Machine* (PSM) monitors VM guest systems.

All processors of the IBM mainframe family are supported, which includes all IBM System z9[®], IBM System z10[™], IBM eServer[™] zSeries[®], and IBM S/390[®].

11/MTR Monitor Resource

The Monitor Resource entry type enables you to monitor the performance and health of an application. That is, a separate status informs you about the application's health. This health status can be used by the automation manager to make decisions and, if necessary, trigger automation for the subject application.

20/PRD Product Automation

With this entry type, you can define automation policy for IMS and TWS.

21/MSG Messages

This entry type displays a list of all the messages that are defined in the policy database together with the messages from the MVC entry, +SA_PREDEFINED_MSGS.

30/TMR Timers

Automation timer definitions. This object is used to schedule automation tasks which are periodic, or which must run at a particular time.

31/TMO Timeout Settings

The timeout values for responses to MVS commands and cross-domain commands. This entry type enables you to create sets of timeout definitions. Each timeout definition can specify timeout values for:

- System, NetView, or SA z/OS commands
- Cross-domain logon requests
- Your own timeout variables

If the time limit is exceeded, it is assumed that an error condition exists and an appropriate action is taken.

32/TPA Tape Attendance

Specifies the time during which tape drives are either attended or unattended. This entry type also allows you to specify whether you want to monitor tape mounts on this system. If you do want to monitor tape mounts, you must enter warning and alert thresholds (in minutes and seconds) indicating how long a wait is allowed in mounting a tape before the response is considered unsatisfactory.

33/MVC MVS Component

This entry type allows you to apply automation to various z/OS data sets, resources and facilities.

34/MDF MVSCOMP Defaults

Sets defaults for z/OS component (entry type MVS Component) automation.

35/SDF System Defaults

This entry type allows you to set various defaults that are used throughout the system. The values set here may be overridden by other entry types, such as Application, Application Defaults, or MVSCOMP Defaults, or by setting appropriate values in individual applications or MVS Component objects.

36/ADF Application Defaults

This entry type specifies default values for automation flags and error threshold settings. These values are used as the default for any Application object on the system that the Application Defaults set is attached to.

37/AOP Automation Operators

This entry type maps automation functions to automation operators. *Automation operators* are automated operator tasks, or *autotasks*, that can respond to operating system, application, and network messages without requiring a human operator. Sets of automation operators can be linked to a system. Each automation operator takes actions similar to those of a human operator, such as monitoring the system and handling and coordinating recovery and shutdown operations.

Automation operators are assigned specific messages to act on.

38/NFY Notify Operators

Defines NetView operators who receive notification messages.

39/NTW Network

Contains definitions for Gateway, SDF focal points, OMEGAMON sessions, TAF sessions, authentication, and SOAP servers.

40/XDF Sysplex Defaults

This entry type specifies default values for sysplex application groups.

41/RES Resident CLISTs

Automation CLISTs (that is, REXX scripts) that must be preloaded to improve performance.

42/SCR Status Display

Defines NetView Status Display facility (SDF) settings.

99/UET User E-T Pairs

User-defined entry/type data for the automation control file. Used for user-defined extensions to automation policy.

Policy Objects and Policy Items

A policy object is represented by an entry name for a particular entry type, for example, an application or timer.

Each policy object has a number of policy items associated with it. To define your policy, you enter data for the policy items of each policy object in the SA z/OS enterprise. For example, you choose option 2 on the Entry Type Selection panel (Figure 1 on page 6) to specify Group policy, Figure 2 on page 6 is displayed.

Entry Type Introduction

MENU OPTIONS HELP			

AOFGETYP	Entry Type Selection		
Option ==>>	_____		
1 ENT	Enterprise	30 TMR	Timers
2 GRP	Group	31 TMO	Timeout Settings
3 SBG	SubGroup	32 TPA	Tape Attendance
4 SYS	System (*)	33 MVC	MVS Component
5 APG	ApplicationGroup (*)	34 MDF	MVSCOMP Defaults
6 APL	Application (*)	35 SDF	System Defaults
7 EVT	Events	36 ADF	Application Defaults
8 SVP	Service Periods	37 AOP	Automation Operators
9 TRG	Triggers	38 NFY	Notify Operators
10 PRO	Processor	39 NTW	Network
11 MTR	Monitor Resource (*)	40 XDF	Sysplex Defaults
		41 RES	Resident CLISTS
20 PRD	Product Automation	42 SCR	Status Display
21 MSG	Messages (*)	99 UET	User E-T Pairs (*)
	(*) Multi-User-Capable		

Figure 1. Entry Type Selection Panel

A label for each panel (for example, AOFGETYP, AOFGENAM) is shown to the left of the panel title. This is the panel ID. You can toggle its display by entering the command PANELID at the command line.

Figure 2 shows the Group policy objects SYSPLEX1 and SYSPLEX2.

COMMANDS ACTIONS VIEW HELP			

AOFGENAM	Entry Name Selection		Row 1 of 2
Command ==>>	_____		SCROLL==>> PAGE
Entry Type :	Group	PolicyDB Name :	USER_PDB
		Enterprise Name :	USER_ENTERPRISE
Action	Entry Name	C	Short Description
S	SYSPLEX1		Sysplex with SYSTEM1, SYSTEM2, SYSTEM3
	SYSPLEX2		Sysplex with SYS1 and SYS2
***** Bottom of data *****			

Figure 2. Entry Name Selection Panel for Groups

If you select a group, the Policy Selection panel for this group is displayed, as shown in Figure 3 on page 7. This panel gives you a list of the policy items for a group. You can enter S (for SELECT) in the **Action** field next to any policy item to display the associated policy input panel. Figure 3 on page 7 shows the Policy Selection panel for groups, listing the policy items for the selected policy object SYSPLEX1.

```

ACTIONS  HELP
-----
AOFGEPOL                               Policy Selection                               Row 1 of 19
Command ==> _____                SCROLL==> PAGE

Entry Type : Group                      PolicyDB Name   : USER_PDB
Entry Name  : SYSPLEX1                   Enterprise Name : USER_ENTERPRISE

Action      Policy Name      Policy Description
-----
DESCRIPTION Enter description
GROUP INFO  Define group information
SUBGROUPS   Select subgroups for group
SYSTEMS     Select systems for group
-----
            -----SYSPLEX SPECIFIC POLICY-----
            SYSPLEX          Define sysplex policy
            NMC DEFINITIONS  Define NMC Data
            APPLICATION GROUPS Select application groups for sysplex
            SYSPLEX DEFAULTS  Select sysplex resource defaults for group
            -----
            LOCAL PAGE DATA SET Define local page data set recovery
            JOB DEFINITIONS     Define handling of jobs
            -----
            -----LONG RUNNING ENQUEUE POLICY-----
            JOB/ASID DEFINITIONS Define handling of long running jobs and ASID
            COMMAND DEFINITIONS Define "hung" commands
            COMMAND FLOODING    Define check intervals for command flooding
            RESOURCE DEFINITIONS Define long running enqueue resources
            RECOVERY OPTIONS     Define dump and miscellaneous options
            -----
            COPY              Copy data from an existing entry
            ***** Bottom of data *****

```

Figure 3. Policy Selection Panel for Sysplex Groups

Considerations for the SA z/OS Graphical Interface

The customization dialog leads the SA z/OS policy administrator through several panels to define the systems and other automated resources of the enterprise. The resulting *enterprise policy* provides the information that SA z/OS uses to provide objects for the displays on the NMC workstation.

The objects visible on the NMC workstation are based on the resources that are defined for NMC using the inform list specification in the customization dialog and therefore known to SA z/OS. For more details, see “APPLICATION INFO Policy Item” on page 149.

The automation manager component of SA z/OS monitors the resources and their status. SA z/OS permanently puts information about the resources and their status into the focal point RODM from where it is retrieved by the NMC workstation.

Grouping Resources Logically

To provide the hierarchy required for graphical representation on the NMC workstation, you need to define your enterprise in terms of the relationships between the resources. The reason for grouping your enterprise resources within SA z/OS is to simplify the representation of the status information that can be generated by your enterprise. The decisions you make on how to group your resources have a great impact on how powerful the graphic interface on the NMC workstation is for you. Each group (of systems or applications) can be represented by a single icon in the NMC workstation displays. SA z/OS monitoring acts as a filtering mechanism for the status data generated by the components of these groups. The status of the group is determined by the statuses of its members using an algorithm defined independently for each grouping of resources in your SA z/OS enterprise.

Considerations for the SA z/OS Graphical Interface

The grouping of resources allowed by SA z/OS is flexible. For example, systems may be grouped by geographical region or use or type. You may decide to place all high priority jobs in one application group and specify that the status of the group will be "degraded" if only one of its subsidiary applications has an unsatisfactory status.

For information on how to set up the graphical interface on the NMC workstation see *IBM Tivoli System Automation for z/OS Planning and Installation*. For information on how to use this graphical interface see *IBM Tivoli System Automation for z/OS User's Guide*.

Considerations for Automation

While information for monitoring of resources is defined at the enterprise level, automation of resources and applications is defined at the system level. Each system in an SA z/OS enterprise uses SA z/OS routines to automate operator functions for its own applications and z/OS components. The programs that automate these functions are called *SA z/OS automation procedures*. SA z/OS automation procedures invoke *common routines* and *generic routines* that are provided by SA z/OS. You can customize your automation by writing your own automation procedures that can also invoke the routines that are provided by SA z/OS.

SA z/OS provides automation procedures that are internally invoked according to the NetView automation table and that manage, for example, the following:

- WebSphere® Application Server
- SAP
- TCP/IP
- HTTP Server
- Job Entry Subsystem/2 (JES2)
- Job Entry Subsystem/3 (JES3)
- Time Sharing Option/Extensions (TSO/E)
- APPC
- ASCH
- Resource Measurement Facility™ (RMF™)
- Virtual Telecommunication Access Method (VTAM)
- NetView
- Transient jobs
- Non-z/OS resources
- Any other applications
- Special automation functions are also provided to manage CICS®, IMS, DB2, and to integrate with TWS

SA z/OS provides automation procedures that enable recovery of the following z/OS components and data sets:

- SYSLOG data sets
- LOGREC data sets
- System Management Facility (SMF) data sets
- Write-to-operator (WTO) buffers
- JES spools
- z/OS dump data sets
- Action Message Retention Facility (AMRF) buffers
- Sysplex resources, for example, coupling facility

With SA z/OS you can also define policies for the automated startup and shutdown of processors and for the automated IPL and shutdown of operating systems.

The above lists represent applications and z/OS components that SA z/OS provides automation for, but you are not limited to these. You can extend automation by adding new applications, and you can create your own automation procedures.

The SA z/OS policy administrator uses the customization dialog to set the way that enterprise resources are to be handled by SA z/OS when predefined conditions are met. In addition to invoking provided automation procedures, SA z/OS can be used to trigger user-written automation procedures.

Note:

In order to avoid problems with automation procedures and customization dialogs, do not use the following terms for entry names or application subsystem names: RC, RETURN, or SIGL.

Assigning System Automation Symbols (AOCCLONE)

You can assign up to 36 system automation symbols to each system (for example, &AOCCLONE., ~, &AOCCLONE1. through &AOCCLONE9., and &AOCCLONEA. through &AOCCLONEZ.). When you use a system automation symbol in a job name, each system can run with a unique job name while the application or subsystem shares a single automation policy across systems. The substitution can occur anywhere within the job name. Any of the 36 available system automation symbols can be used. You may specify more than one system automation symbol.

Note:

Be careful when cloning applications that are controlled by the Automatic Restart Manager. In most cases, the applications should be defined to Automatic Restart Manager as restart-in-place only. If you allow cross-system restarts for cloned applications, they may be restarted more than once on the same system.

The usage of system automation symbols is not limited to sysplexes. In addition to qualifying the job name, you can use system automation symbols for substitution anywhere within a defined literal, such as a shutdown command. The value of system automation symbols is also available for your automation through the NetView AOFAOCCCLONE common global variables (1 to 9, and A to Z). The AOFAOCCCLONE and each AOFAOCCCLONEn variable contains the value of the corresponding AOCCLONE variable.

Note:

The job name is the result of the substitution of any applicable &AOCCLONE. value and will be the name that is used for the whole automation of the application.

Assigning System Automation Symbols (AOCCLONE)

Using System Symbols and System Automation Symbols

You can specify system symbols as well as system automation symbols (AOCCLONE variables) in the fields in the customization dialog that are given in Table 2.

Table 2. System Symbols and System Automation Symbols

Entry Type	Policy Item	Field Name
APL	APPLICATION INFO	ARM element name Command prefix JCL procedure name Job name Startup parameter ¹ WLM resource name
	APPLICATION SYMBOLS	SYMBOL1–SYMBOL9 ¹
	DB2 CONTROL	DB2 Active Log Dataset Name DB2 Subsystem ID
	IMS CONTROL	IMS Control Region Name IMS Subsystem ID
	JES2/JES3 SPOOLFULL	Command text ¹
	JES2/JES3 SPOOLSHORT	Command text ¹
	MESSAGES/USER DATA	Message ID
	MESSAGES/USER DATA (type CMD)	Command text ¹
	MESSAGES/USER DATA (type CODE)	Code1/2/3 Value Returned ¹
	MESSAGES/USER DATA (type REPLY)	Reply text ¹
	MESSAGES/USER DATA (type USER)	Data ¹
	MINOR RESOURCES	Minor resource names ²
	OPC CONTROL	OPC Subsystem ID
	STARTUP	Command text ¹ Startup parameter ¹
	SHUTDOWN	Command text ¹ Reply text ¹
USS CONTROL	Command/Path ¹ File Name ¹ Filter ¹ Monitoring Command ¹ User ID	
GRP	SYSPLEX	Temporary Data Set HLQ
MVC	MESSAGES/USER DATA	Command text ¹ Message ID Reply text ¹
	MESSAGES/USER DATA (type CODE)	Code1/2/3 Value Returned ¹
	MESSAGES/USER DATA (type USER)	Data ¹
	MINOR RESOURCES	Minor resource names ²
MTR	MONITOR INFO	Activate command ¹ Deactivate command ¹ Monitor command ¹ Monitored Object ¹

Assigning System Automation Symbols (AOCCLONE)

Table 2. System Symbols and System Automation Symbols (continued)

Entry Type	Policy Item	Field Name
NTW	SOAP SERVER	Host Name ¹
SYS	AUTOMATION CONSOLE	Console Name
	SYSTEM INFO	UNIX Installation Path ¹
TMR	TIMERS	Command text ¹
UET	E-T DATA	Data ¹
<ol style="list-style-type: none">1. If you are using system automation symbols in fields that are not automatically translated to uppercase, these variables must be entered in uppercase.2. The ending period of a system automation symbol for minor resource names must be followed by at least one character, for example, DAT&AOCCLONE2.A		

Table 3 lists the fields in the customization dialog where you can only specify system symbols.

Table 3. System Symbols

Field Name	Policy Name
Automation Operators	Policy OPERATORS of entry type AOP
NetView Operators	Policy OPERATORS of entry type AOP
Console Name	Policy OPERATORS of entry type AOP

Table 4 lists the field in the customization dialog where you can only specify system automation symbols (AOCCLONE variables).

Table 4. System Automation Symbols

Field Name	Policy Name
Supporting Resource Name	Policy RELATIONSHIPS of entry type APL and APG

Nested Classes

Nested class support allows you to link one application class to another, thus enabling the specification of a class hierarchy. Links from a class can be made in two directions:

- *Downward* to multiple classes or instances, where the policy that is defined in the upper-level class is inherited by the classes or instances
- *Upward* to a single class, so that the lower-level application inherits the policy that is defined in the upper-level class

These classes can carry data on various levels, be nested, and an application can inherit data from a class chain. This can be particularly useful for policy databases with lots of applications of the same type, for example, large IMS installations with lots of IMS subsystems. You might define a top-level class with basic definitions for all IMS applications, and nested classes with more specific definitions for the various IMS subtypes, so that applications can inherit policy values from the top-level class and specific nested classes.

Class policies are inherited down to the instance level where any changes to the policy on that level override the inherited policy. Inherited policy data is displayed

Nested Classes

in a different color that you can change in the customization dialog Settings Menu (see “Changing Your Customization Dialog Environment” on page 365). Inherited data is displayed for linked instances for the following policies:

- “APPLICATION INFO Policy Item” on page 149
- “RELATIONSHIPS Policy Item” on page 161
- “MESSAGES/USER DATA Policy Item” on page 162
- “STARTUP Policy Item” on page 179
- “SHUTDOWN Policy Item” on page 182
- “THRESHOLDS Policy Item” on page 190
- “DB2 CONTROL Policy Item” on page 203
- “IMS CONTROL Policy Item” on page 205
- “OPC CONTROL Policy Item” on page 207
- “USS CONTROL Policy Item” on page 209

Note that you can overwrite inherited data for an instance with the *same* value for the following policy items:

- APPLICATION INFO
- THRESHOLDS
- DB2 CONTROL
- IMS CONTROL
- OPC CONTROL
- USS CONTROL

Example:

If an application instance is linked to a class with a job type of TRANSIENT and you change the Transient Rerun value, you also need to specify the Job Type TRANSIENT on the instance even though it has already been inherited from the class.

Class Hierarchy

Classes can be linked to each other and to instances according to the following rules:

- An application class can have one or more downward links to other classes or instances
- There can be only one upward link from an application class to any particular class
- There is no limit for the number of supported class levels

Figure 4 on page 13 shows example links that are allowed or forbidden between classes and instances.

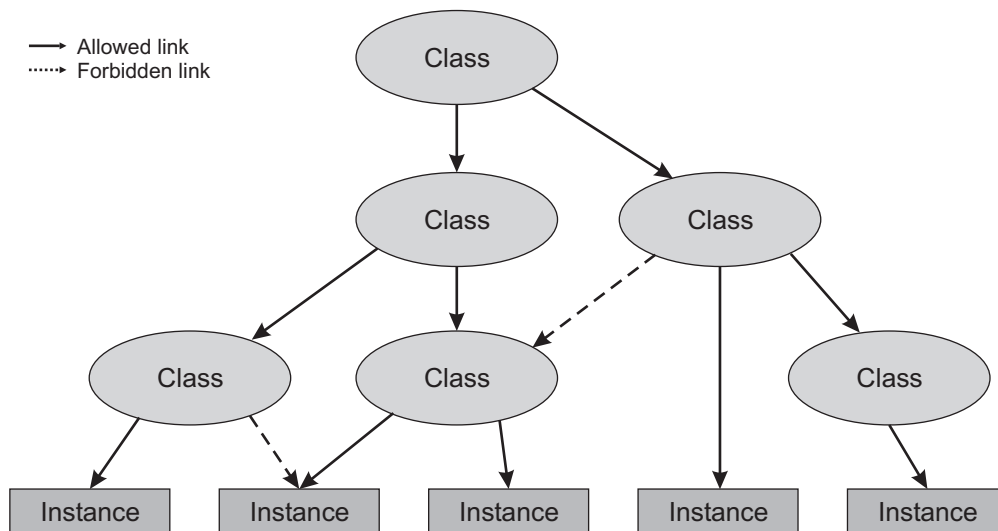

Figure 4. Nested Class Links

Inheritance and Defaulting

Figure 5 shows how inheritance from application classes relates to defaulting from the defaults policy items.

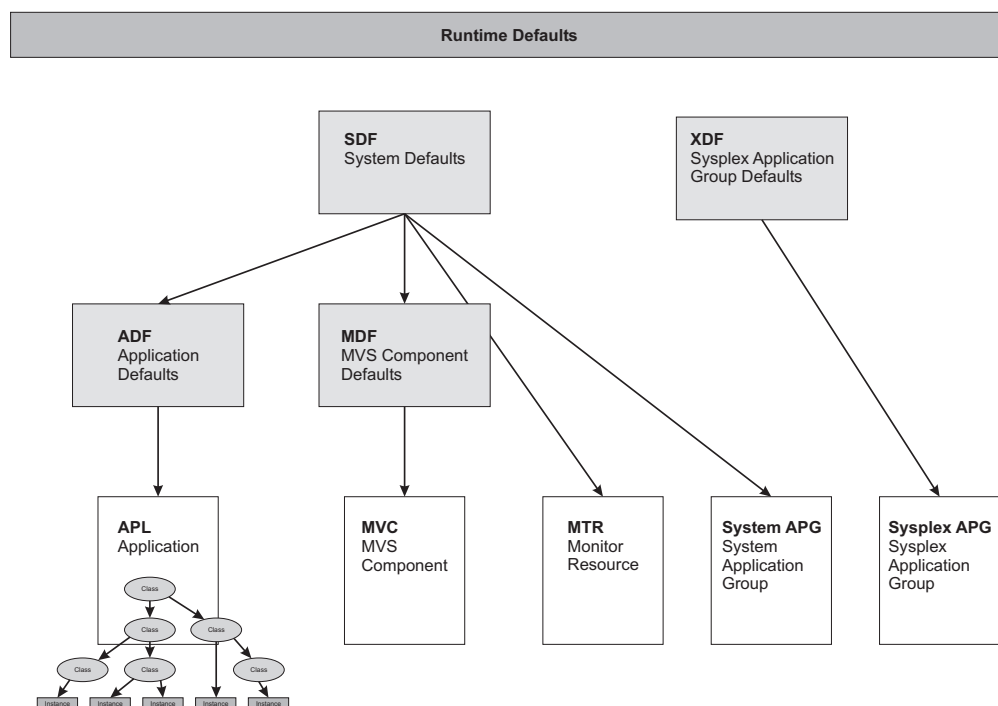

Figure 5. Inheritance from Classes and Defaulting

The data that is defined in Defaults policies and for application classes is handled differently. If class data is modified and built, a configuration refresh updates the applications that are linked to the modified classes. However, if defaults are modified and built, a configuration refresh updates only the global variables for the modified entries but not for the affected objects, for example, applications.

Nested Classes

Class/Instance Link Considerations

You should be aware of the following when making links between classes and instances:

- Only applications with either the same type or no type specification can be in a link chain
- Type-specific policies are *only* available if the type is specified explicitly rather than inherited

For example, the IMS CONTROL policy item is available for an application of type IMS. It is not available, however, for an application that does not have a type specification but is linked to a class of type IMS.

Thus, if an application without a type is linked to a class with a type specification, you should be aware that you can only specify type-specific data for the class, but it will be inherited by the instance.

Furthermore, if you need to specify type-specific data at the application level, you must specify the type for the application. For example, some of the fields for applications of type USS allow mixed case. An application without a type specification does not allow mixed-case data, but it could inherit such data from a class of type USS.

Chapter 2. Using the Customization Dialog

The SA z/OS customization dialog runs under Interactive System Productivity Facility (ISPF) Dialog Manager, which operates under Time Sharing Option/Extended (TSO/E). For information on installing the customization dialog and sample policy databases on the focal point system, see *IBM Tivoli System Automation for z/OS Planning and Installation*.

The customization dialog provides panels to create and work with SA z/OS automation policy definitions. The task of defining and building automation policy is performed on the SA z/OS configuration focal point system from where it is distributed to the systems and sysplexes that you want to automate (see also Figure 252 on page 331).

The combined definition of all the resources is called an *enterprise definition* or also an *automation configuration*. SA z/OS enterprise definition data entered in the customization dialog is stored in an z/OS data set called a *policy database*. You can define more than one enterprise, each with its own policy database, or you can store the automation policy of an enterprise in more than one policy database, however, the policy for all systems of a sysplex must be in the same policy database.

Your first step in defining automation policy will be to create a new policy database, using one of the sample databases as a model. SA z/OS provides sample policy databases containing sample enterprise definitions. These are described in “Using SA z/OS Sample Policies” on page 309.

To do this, you should create an empty policy database using the *EMPTY sample database, and then use the IMPORT function to import policy definitions from either the other sample databases that are supplied with SA z/OS, or from your own policy databases. For more details about importing policy databases, see “Importing Policy Database Data” on page 343. You should note that this is now the preferred method for creating new policy databases.

You can create many different SA z/OS enterprise definitions. However, SA z/OS uses only one enterprise definition at a time. Each SA z/OS enterprise definition is stored in a different policy database. The customization dialog enables you to edit, copy, delete, and build SA z/OS enterprise definitions after you create them.

You select entry types from the list shown on the Entry Type Selection panel (Figure 1 on page 6) and certain objects from these entry types to specify the way enterprise resources are to be handled by SA z/OS when predefined conditions are met. You can link automation policies to individual systems as required to meet your automation needs.

You can monitor systems and resources using the NMC workstation that are defined to SA z/OS even if you have not defined special automation policy for these resources. Conversely, you may automate your enterprise without monitoring it using the NMC workstation. If you want to use SA z/OS for automation only you must still use the customization dialog to create policy for the resources you want to automate.

How to Start the Customization Dialog

To start the customization dialog:

1. Log on to TSO/E using a logon procedure that makes the customization dialog available to you. See *IBM Tivoli System Automation for z/OS Planning and Installation* for instructions on how to create an appropriate logon procedure.
2. Select the customization dialog from the ISPF menu that it has been installed on. SA z/OS displays the Customization Dialog Primary Menu as shown in Figure 6.

```

MENU  OPTIONS  HELP
-----
AOF6PRM      SA z/OS 3.3 Customization Dialog Primary Menu
Option ==>> _____

  0 Settings          User parameters

  1 Open              Work with the Policy Database
  2 Build             Build functions for Policy Database
  3 Report            Generate reports from Policy Database
  4 Policies          Maintain Policy Database list
  5 Data Management  Import policies into a Policy Database
  U User              User-defined selections

  X Exit             Terminate Customization Dialog

To switch to another Policy Database, specify the Policy Database name
in the following field, or specify a ? to get a selection list.
Current Policy Database . . . USER_PDB _____

                          Licensed Materials - Property of IBM
                          5698-SA3 © Copyright IBM Corp. 1990, 2010 All Rights Reserved.
```

Figure 6. Customization Dialog Primary Menu

To start the customization dialog for a policy database of your choice, you can:

- Type the name of your desired policy database into the **Current® Policy Data Base** field (if not filled in from a previous invocation) and enter option 1 (you can also enter Open) at the Option line. This leads you directly to the Entry Type Selection panel shown in Figure 1 on page 6.
- Type ? in the **Current Policy Data Base** field and press Enter to get a list of available policy databases in the Policy Database Selection panel as shown in Figure 238 on page 305. Select the desired policy database from this panel. (You can also reach the Policy Database Selection panel by entering option 4, or Policies, at the Option line.)

If no policy databases are displayed on the Policy Database Selection panel when you start the customization dialog, you must either create a policy database (see “Creating a New Policy Database” on page 305) or add an existing policy database to the list.

If other users want to view the policy database that you have just created, they must add it to their policy database list on the Policy Database Selection panel using the ADD command.

You can also select the following options:

0 Settings

This option displays the Customization Dialog Settings Menu, see “Changing Your Customization Dialog Environment” on page 365.

2 Build

This option displays the Build Functions Menu, see Chapter 7, “Building and Distributing Configuration Files,” on page 323.

3 Report

This option displays the Report Selection Menu, see Chapter 6, “Creating Reports about Policy Databases,” on page 315.

4 Policies

This option displays the Policy Database Selection panel with the list of existing policy databases, see “Creating a New Policy Database” on page 305.

5 Data Management

This option displays the Data Management Menu panel, see “Start Panel for Data Management” on page 343.

U User

This option invokes the User-written Functions Selection Menu. This menu allows you to add installation-specific functions to the customization dialog. For more information see “User-written Functions” on page 372.

X Exit Use this option to exit the customization dialog

Getting Help

Online help is available for the customization dialog. You can display online help by entering the HELP command (or press the PF key associated with the HELP command) while on a particular dialog panel.

When selecting HELP from the action bar, the pull-down lists the following selections:

Automation Help

This help provides online information about important functions of the customization dialog. It combines the help panels of the functional panels within the customization dialog. This combination allows you to view the help panels sequentially, or you can choose selected topics from lists that are displayed on many of the help pages.

Changes for this Release

This panel provides a list of the changes and enhancements that have been added to the customization dialog for the different releases of version 2.

How to Navigate in the Customization Dialog

Many characteristics of the customization dialog are ISPF facilities. See *ISPF User's Guide* for details. You need to know the following characteristics of the customization dialog:

- For panels that display a list that you are required to select one or more entries from and specify an action against that entry, you can:
 - Enter “*action entry name*” on the command line, for example, *OPEN entry name*
 - Enter the action in the **Action** column next to the appropriate entry, for example, enter OPEN in the **Action** column next to entry name.
 - Select the entry by entering S or SELECT in the **Action** column next to the entry. Move the cursor to the ACTIONS menu bar entry, press Enter, and

How to Navigate in the Customization Dialog

enter the number corresponding to the action you want to take. For example, place an S in the **Action** column next to “entry name” and select 1 (OPEN) from the Action menu.

The action most likely to be used on a certain panel is always the first action listed in the ACTIONS pull-down menu. When you enter S or SELECT in the **Action** column and press Enter, this default action is used. For example, entering S under **Action** for “MY_ENTERPRISE” in the Policy Database Selection panel opens the MY_ENTERPRISE database.

Some panels display a list that you can select only one entry from. If you attempt to select more than one entry from such a list, only one selection is accepted. If one entry is already selected and you select another one, this new selection becomes active and the previous selection is removed.

From a list of policy items, you can select multiple items. Then they are processed sequentially. Pressing the END (PF3) key takes you to the next selected item to be processed without returning to the selection panel.

- The COMMANDS pull-down menu lists all commands that can be entered at the command line.
- The ACTIONS pull-down menu lists all actions that can be entered in the **Action** column for panels displaying entry lists.
- The VIEW pull-down menu lists the different levels of detail that can be displayed for the entries in an entry list. For example, in many entry lists you can display just the entry name and short description, or you can also display a detailed description for each entry.

Sample panels shown in this documentation may look different on your system depending on the selected view.

- On data entry panels, the END (PF3) key verifies input, saves the data, and exits the current panel.
- Pressing the Enter key verifies input and redisplay the current panel.
- In certain cases a long message is displayed in a pop-up window on the panel. If this pop-up window covers required input areas you can move it. For more information see the section “Movable Pop-Ups” in *z/OS ISPF Dialog Developer’s Guide and Reference*.

How to Use an Entry Type as a Fast Path

If the policy database that you want to work with is already displayed in the **Current Policy Data Base** field of the Customization Dialog Primary Menu, you can use the entry type abbreviation as a fast path at the **Option** line:

- You can directly type the code for the entry type that you want to work with. For example, to reach the Entry Name Selection panel for Applications, enter:
APL
- If you want to start with defining a new application group, for example, enter:
APG; NEW *application_group_name*
- If you want to reach a certain entry type and you already know the name of the object that you want to edit, you can enter a fast path from every panel within the customization dialog. For example, to reach the APPC application, enter:
=APL; S APPC

To reach the application group CICS_APG, enter:

```
=APG; S CICS_APG
```

To reach the Entry Name Selection panel for Applications, enter:

=APL

How to Use a Policy Item as a Fast Path

The Entry Name Selection panel has a special feature that allows you to jump directly to a particular policy item for an entry (skipping the Policy Selection panel for that entry). If you enter an abbreviation for a policy item in the Action column of an entry, SA z/OS immediately takes you to the policy item that best matches what you have typed. For example, if you are in entry type APL, entering I takes you to the Application Information policy item, and entering LC takes you to the Link Instance to Class policy item.

There are no predefined abbreviations for policy items; SA z/OS finds the best match for any input, for example, the beginning of policies or of words, and significant letters. This also ensures that abbreviations work for user-defined policy items.

Note the following special cases:

- Characters reserved for actions will not be matched with policy items. For example, S is reserved for action “select”. Thus it will not be matched with policy items (such as “SERVICE PERIOD”).
- If there is no best match, you will be taken to the Policy Selection panel, with an error message.

Concurrent User Access

Because you may have separate administrators for different areas (for example, JES or VTAM) who should be able to do their updates independently, the customization dialog allows concurrent update for several important entry types. These are marked with * on the Entry Type Selection Panel. For other entry types, only one user at a time can access a policy database. See also Appendix A, “Concurrent Customization by Multiple Users,” on page 363 for further information.

How to Cancel Input on a Panel

To cancel your input on the current panel, type CANCEL or C at the Command prompt. CANCEL can be used to discard data entered on the panel, whether you have pressed the Enter key. However, once the message

```
POLICY SAVED
```

is displayed when leaving a panel, the data entered has been saved and cannot be canceled. To delete input after this message is displayed, you must go back to that panel and type over existing values.

How to Create New Policy Objects

The process of creating a new policy object is the same for all types of policy objects, as follows:

1. From the Entry Type Selection panel, you select the desired policy object's entry type. For example, if you want to create a new Application object, enter option 6 or APL at the command line.
2. SA z/OS displays the Entry Name Selection panel for the selected entry type. You can either select action NEW from the COMMANDS pull-down or enter the command `new entry_type_name` at the panel's command line. The entry type name is optional for this command.

How to Create New Policy Objects

- SA z/OS displays the Define New Entry panel (an example for defining a new Application is shown in Figure 7) for the selected entry type, where you now specify the required information. See Chapter 4, “Entry Type Reference,” on page 73 for more information about how to create new policy objects.

```
COMMANDS  HELP
-----
AOFGDYN3                                Define New Entry
Command ==> _____

Define new entry of type Application

Entry Name . . . . . _____

Subsystem Name . . . . . _____
Object Type . . . . . INSTANCE      (CLASS INSTANCE)
Application Type . . . . . _____ (IMAGE JES2 JES3 CICS IMS DB2 OPC USS
or blank)
Subtype . . . . . _____         (For types CICS IMS DB2 OPC or blank)
Job Type . . . . . _____         (MVS NONMVS TRANSIENT)
Job Name . . . . . _____
Transient Rerun . . . . . _____ (YES NO)
Scheduling Subsystem . . . . . _____ (MSTR, JES Subsystem)
JCL Procedure Name . . . . . _____

Short description . . . . . _____
Long description 1 . . . . . _____
Long description 2 . . . . . _____
Long description 3 . . . . . _____
Long description 4 . . . . . _____
Long description 5 . . . . . _____
```

Figure 7. Define New Entry Panel for an Application

- If you specify an entry name and press Enter, the subsystem name and job name are defaulted to the entry name, if possible. This is also true for all other entry types where the entry name can be used as a default for further qualifications

Throughout Chapter 4, “Entry Type Reference,” on page 73, if there is no extra information given about creating a particular policy object, it is created using a generic panel, as shown in Figure 8.

```
COMMANDS  HELP
-----
AOFGDYN2                                Define New Entry
Command ==> _____

Define new entry of type Monitor Resource

Entry Name . . . . . _____

Short description . . . . . _____
Long description 1 . . . . . _____
Long description 2 . . . . . _____
Long description 3 . . . . . _____
Long description 4 . . . . . _____
Long description 5 . . . . . _____
```

Figure 8. Sample Generic Define New Entry Panel

For more details about the description fields, see “DESCRIPTION Policy Item” on page 25.

How to Rename a Policy Object

The process of renaming an existing policy object is the same for all types of policy object. From the Entry Name Selection panel, type r or rename in the **Action** field in front of the entry you want to rename, as shown in Figure 9.

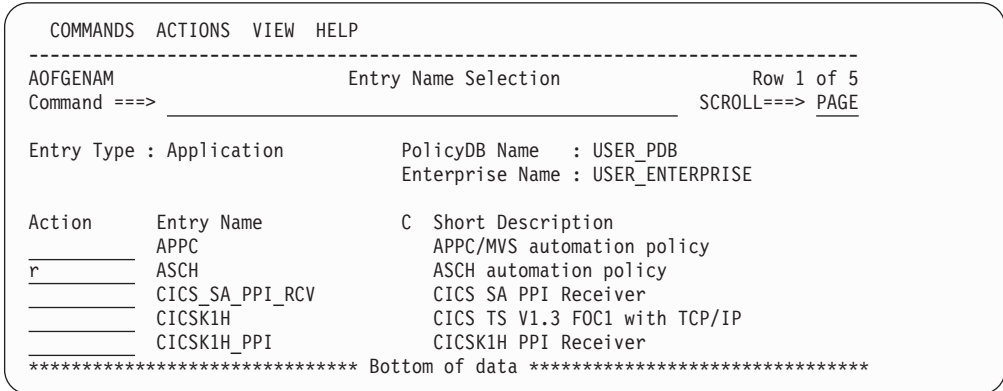

Figure 9. Entry Name Selection Panel: Rename Action

The sample screen shows a list of applications with command r in the action field of entry name ASCH. Pressing the Enter key will display a rename pop-up panel where you can enter the new entry name, as shown in Figure 10.

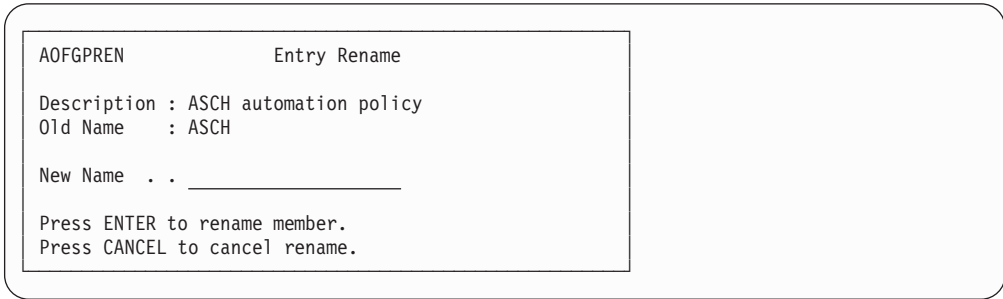

Figure 10. Entry Name Rename Pop-up Panel

Pressing Enter will start the renaming process; if the name you entered already exists or is invalid you will be required to enter a different name. After completion, the newly sorted Entry Name Selection panel will be displayed with the renamed entry as the top row. If there are multiple rename requests, the last renamed entry is shown as the top row.

You can leave the rename pop-up panel using END or CANCEL without renaming the policy object.

Note:
 To modify the Enterprise name, edit the policy database and then simply overwrite the name, see “Specifying Settings for Policy Databases” on page 310.

How to Delete Policy Objects

There are two ways to delete policy objects; you can:

- Delete a single policy object
- Delete any number of policy objects in one go (bulk deletion)

Note that if a *class* is selected for deletion and there are objects linked to it that inherit data, the confirmation panel is displayed. If a class is deleted that has only upward links, no confirmation panel is shown. These links are removed without further notification because there is no object left that loses data.

How to Delete a Single Policy Object

To delete a single policy object use action d against the policy object that you want to delete. This displays a confirmation panel; the example shown in Figure 11 lists any links that exist to the policy object.

```
COMMANDS  HELP
-----
A0FGMS05                                Confirm Delete                                Row 1 of 1
Command ==> _____

Name           : APL_OBJ
Short description :

Press ENTER to confirm delete of this entry.
Press CANCEL or END to cancel delete.

The following links exist in the WHERE USED policy:

Name           Type      Short Description
APL_OBJ        APL          ***** Bottom of data *****
```

Figure 11. Delete Confirmation Panel for a Single Policy Object

If the policy object to be deleted has any policy objects selected in its WHERE USED policy item (as reported in the confirmation panel), deleting it will automatically remove it from the corresponding policy items in those other policy objects (see Figure 14 on page 29 for the corresponding policy items).

Links between APL policy objects of object type CLASS and object type INSTANCE are treated analogously.

If a class is selected for deletion and there are objects linked to it that inherit data, a confirmation panel is displayed. However, if a class is deleted that has only upward links, a confirmation panel is not displayed. These upward links are removed without further notification because there are no objects left that lose the data.

How to Delete Several Policy Objects in One Go (Bulk Deletion)

To delete several policy objects in one go, type d in the action column against each of the policy objects that you want to delete and press Enter. This displays the confirmation panel shown in Figure 12 on page 23. Note that only policy objects of the same entry type can be deleted in one go.

```

COMMANDS  HELP
-----
A0FGMM05          Confirm Delete          Row 1 of 1
Command ==> _____

Name              : APL_OBJ
Short description :

Show confirmation for . . . . ALL   (ALL LINKED NONE)

Press ENTER to confirm delete of this entry.
Press CANCEL or END to cancel delete.

The following links exist in the WHERE USED policy:

Name              Type      Short Description
APL_OBJ           APL
***** Bottom of data *****

```

Figure 12. Confirmation Panel for Bulk Deletion with WHERE USED Links

You can use the **Show confirmation for** field to set how confirmation of the bulk deletion is handled:

ALL Only the policy object that is named on the confirmation panel will be deleted. The confirmation panel will then be redisplayed with the name and links of the next policy object that you marked with d.

This will continue until you change the value in the **Show confirmation for** field or all the policy objects that you marked with d have been deleted.

LINKED

The policy object that is named on the confirmation panel will be deleted. SA z/OS then processes the rest of the policy objects that you marked with d in the following way:

- Any policy object that is *not* involved in links will be deleted without further confirmation.
- As soon as a policy object with links is encountered the confirmation panel is redisplayed with that policy object's name and links on it.

NONE

All the policy objects that you marked with d will be deleted at once, without further confirmation.

Note that when a policy object with links is deleted, the links are treated exactly as in “How to Delete a Single Policy Object” on page 22.

How to Find Data in a Policy Item

You can use the FIND/RFIND command for the following policy items:

- MESSAGES/USER DATA of entry types APL, APG, MTR, and MVC
- STARTUP of entry types APL
- SHUTDOWN of entry types APL
- HEALTHSTATE of entry type MTR
- OPCA DOMAINID of entry type ODM
- E-T DATA of entry type UET

The FIND command is used to find and display the next occurrence of a character string in the data that is being edited. You can abbreviate it to F.

How to Find Data in a Policy Item

For every FIND command, you must specify the string of characters that is to be located. In most cases, you simply enter FIND, or its abbreviation F, followed by the character string. For example, to find the character string demo, enter the following:

```
find demo
```

The cursor is placed at the beginning of the string. Automatic scrolling is performed, if necessary, to bring the string into view. You can use left or right scrolling (by default, the PF10 and PF11 keys) to bring other fields into view.

Note:

Only the data that is *visible* is searched through for the following:

- The **Message ID** column on the Message Processing panel for entry types APL, APG and MTR
- The **Keyword** column on the UET Keyword-Data Specification panel

You should therefore consider expanding the column width so that all data is visible before performing a search.

You can limit the columns that are searched through by the FIND command by specifying a column name or a non-ambiguous abbreviation for it. The string is found if it is completely contained within the designated column. For example, to find the character string demo in the **Data** column on the UET Keyword-Data Specification panel, enter:

```
find demo data
```

To use the same string that was used in the previous FIND command, you can replace it with a * (asterisk). For example, to find the character string demo again in the **Data** column, enter:

```
find * data
```

If you want to find data strings that contain spaces or special characters, you can enclose the string in quotation marks. For example, to find the expression A = B, enter:

```
find 'a = b'
```

Normally the FIND command searches for the next occurrence of the specified character string, starting at the top of the displayed page or at the cursor position (if the cursor is within the data portion of the display). You can control the scope of the search by entering the optional parameter ALL. For example, to perform a search for all of the occurrences of the character string demo, starting at the beginning of the first line of data and continuing to the bottom, enter:

```
find demo all
```

If the string is found one or more times, the cursor is placed at the beginning of the first occurrence and the string is highlighted. You can use the RESET command to remove the highlighting.

A message is displayed indicating the number of times that the string was found. If you press the RFIND PF key (the default is PF5 or PF17), the second occurrence is found, then the third, etc. until the bottom of the data is reached.

If the string is not found within the data, a message is displayed indicating that the characters cannot be found.

The RFINd (repeat find) command can be used to repeat the last FIND command that was entered. Because this command is sensitive to the current position of the cursor, it is normally entered via a PF key. By pressing the RFINd PF key repeatedly, you can find successive occurrences of the specified character string. After the first occurrence of a character string has been found using the FIND command, the RFINd key will find the next occurrence. After the last occurrence of a character string has been found, you can use the RFINd key to continue the search, wrapping around from the bottom line to the top line of the data.

If you enter the optional ALL parameter or a column name as part of the FIND command, you can specify them in any order. Although normally not required, you can avoid ambiguity with the optional parameters by using quotation marks or apostrophes to enclose the character string that is to be found. For example, the following command is ambiguous:

```
find all k
```

It could mean either scan for the string all in the **Keyword** column, or scan for all occurrences of the string k. In such cases the message Put string in quotes is displayed. You should reenter the command with the search string in quotation marks.

If the FIND command cannot be interpreted, the message Parameter not recognized is displayed. Reenter the command with appropriate parameters.

If you exit a panel, the search string is not retained, so you need to enter a new FIND command if you return to the panel.

Common Policy Items

The following policy items are found on many policy definitions:

- DESCRIPTION
- COPY
- WHERE USED

DESCRIPTION Policy Item

Figure 13 on page 26 shows an example of a Description policy item panel (in this case for the SYSTEM entry type)

Common Policy Items

```
COMMANDS  HELP
-----
A0FGXDSC          Description
Command ==> _____

Entry Type : System          PolicyDB Name  : USER_PDB
Entry Name  : SAMPLE_SYSTEM_01 Enterprise Name : USER_ENTERPRISE

Enter or update the entry description:

Short Description. . . . Focal Point system
Long Description 1 . . . _____
Long Description 2 . . . _____
Long Description 3 . . . _____
Long Description 4 . . . _____
Long Description 5 . . . _____
```

Figure 13. Sample Description Policy Item Panel

Both types of description (short and long) can be displayed in the customization dialog, depending on the VIEW option that you choose.

Short Description

This is optional and can be up to forty characters in length. The short description is also used by the NMC workstation, DISPSTAT, and INGLIST.

Long Description

This is optional and can consist of up to five lines of up to fifty characters in length. The extended description is part of the DISPINFO display for applications.

COPY Policy Item

When creating a new policy object, you can use the COPY policy item to copy policy information from an existing object to the created object. This function displays a list of all the other entries of the same entry type in the SA z/OS enterprise that are eligible to be used as the source of the copy function.

Copy Process

The following outlines the process of using an object's COPY policy item when creating a new object.

1. Select an entry type from the Entry Type Selection panel. The Entry Name Selection panel is displayed.
2. Enter new (N) at the command line to create a new object. SA z/OS displays the Define New Entry panel for the policy object that you want create.
3. Enter information for the new object as prompted by its Define New Entry panel. Exit the panel (using the PF3 key or END command).
4. The Policy Selection panel for the new object is displayed. Select its COPY policy item.
5. A panel listing all the objects that are currently defined with the same entry type is displayed. Select the policy object that you want to copy policy information from. Take note of the following:
 - Groups of type SYSPLEX can only be copied from groups of type SYSPLEX, and groups of type STANDARD can only be copied from groups of type STANDARD (see "Creating a New Group" on page 80).
 - For entry type SYS, copying is only possible for those entries that have the same operating system.
 - For entry type APL, copying is only possible for those entries that have the same application type.

- Sysplex Application Groups can only be copied from Sysplex Application Groups, and System Application Groups can only be copied from System Application Groups (see “ApplicationGroup Entry Type” on page 114).
6. When the copy is complete, you return to the Policy Selection panel for the new object. A Copy complete message in the top right corner shows that the copy was successful.
If you copy groups or processors, you may receive the message Partial copy complete, which means that it has not been possible to copy all entries. The help function gives details about the data that was not copied.
 7. Complete the new application definition by performing any necessary modifications to the information that has been copied.

Information that Is Copied

The following indicates what information is or is not copied by the COPY policy item:

1. All source object data is copied to the target object for all entry types with two exceptions:
 - Any data that has to be entered during the creation process on the associated Define New Entry panel for the target object is not copied from the source object.
 - The short and extended description on the Define New Entry panel is copied from the source object whenever this is not already specified for the target object.
2. All the links to other objects that are lower down in the hierarchy of objects are copied from the source to the target. For example, if you copy an application group with linked applications, the links of the source application group are copied to the target application group.
3. None of the links to other objects that are higher up in the hierarchy of objects are copied from the source to the target. For example, if you copy an application that is linked to an application group, the copied target application is *not* linked to that application group.
4. If you copy a class or instance with “upward” links (that is, links to a class), these links are copied. However, if you copy a class that has “downward” links, they are *not* copied.
5. Links to members of sysplex groups (that is, links to subgroups, systems, or Sysplex Application Groups) are *not* copied. This is to avoid conflicts such as having the same system defined in more than one sysplex.
6. Links from systems to processors are not copied to avoid conflicts such as having the same system defined for more than one processor.
7. Resource links of application groups are not copied.

WHERE USED Policy Item

Almost every entry type has the WHERE USED policy item.

The WHERE USED policy item is effectively a container for *references* to existing policy objects. The container may be empty. To put a reference to a policy object in the container, *select* that policy object from within WHERE USED. SA z/OS automatically ensures that each reference in WHERE USED is matched by a reverse reference in an appropriate policy item of the other policy object (details further on in this section). Thus, WHERE USED actually contains one direction of *mutual* references. These mutual references are called “WHERE USED links” or “links”, for short.

Common Policy Items

What Policy Objects Can Be Linked?

Whether it is possible to have a link between two policy objects depends on their entry types. The entry types that SA z/OS supports are arranged in the hierarchy as shown in Figure 14 on page 29. The figure shows the various counterparts of WHERE USED. By following the arrows backwards, you can tell what information you will find in WHERE USED. That is, the entry type where a given policy object may be used.

Key to the figure:

Gray boxes in Figure 14 on page 29 represent entry types, and arrows represent policy items. When an arrow is attached to a white box inside a gray box (rather than to the gray box itself), the policy item that the arrow represents is only present on policy objects with the specific property named in the white box. An arrow named *z* from an entry type named *X* to an entry type named *Y* means:

- Every policy object in entry type *X* has a policy item named *z*. This policy item contains zero, one or more references to policy objects in entry type *Y*.
- Conversely, every policy object in entry type *Y* has the WHERE USED policy item. Any references in its WHERE USED policy item are to policy objects in entry type *X*.

With a few exceptions, the name of an arrow matches the name of the entry type that it points to (that is: the one that is *lower* in the hierarchy).

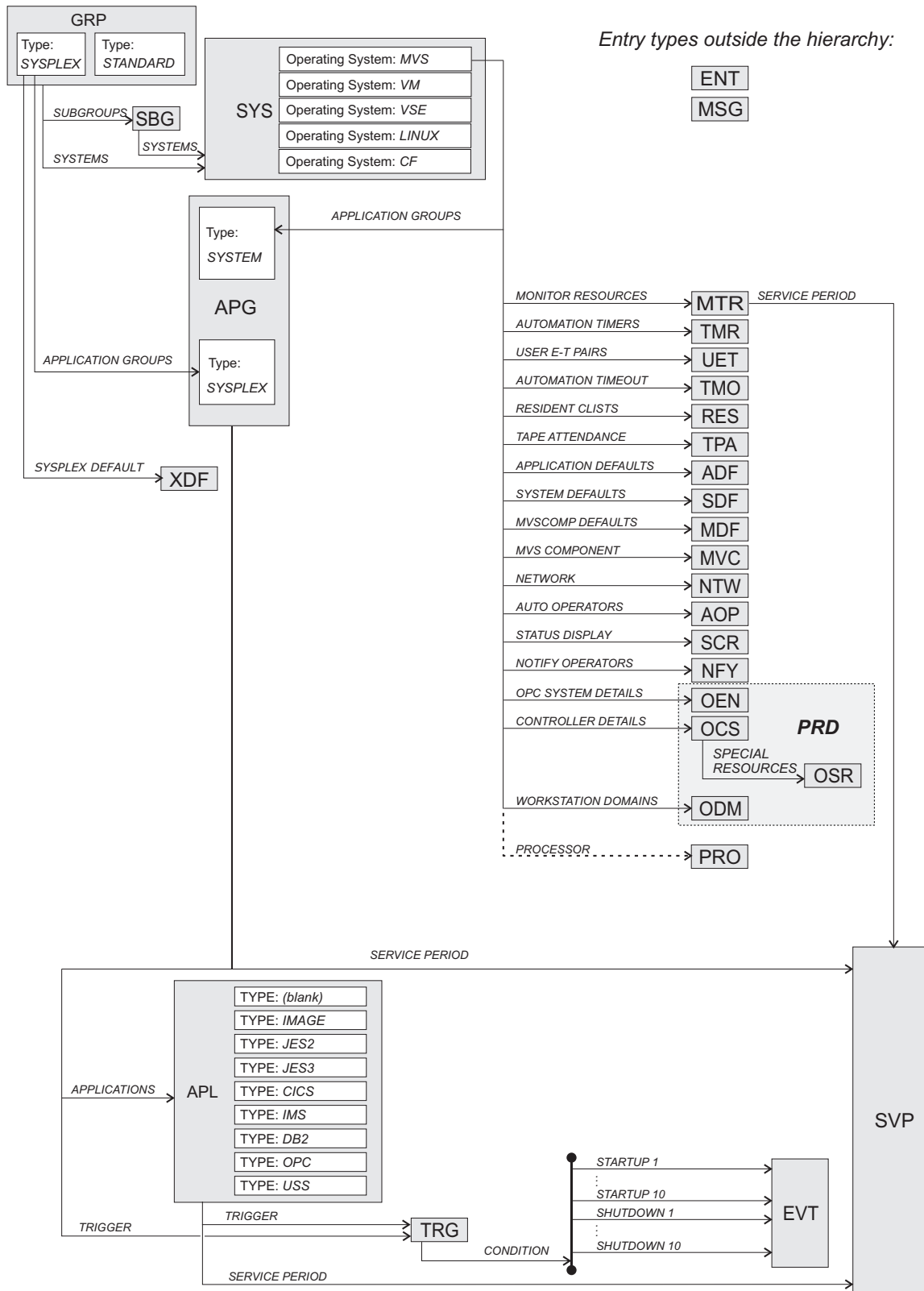

Figure 14. Hierarchy of Entry Types

Common Policy Items

How to Create, View or Remove Links

Because links are *mutual* references, there are two alternative approaches to create, view or remove them.

Bottom-Up Approach®:

Step 1. In the lower policy object (regarding the hierarchy in Figure 14 on page 29), open the WHERE USED policy item.

This displays a list of all the policy objects where the current one *may* be used. Those that have a status of SELECTED are the ones where the current one *is* actually used at present.

Step 2. To create a link, apply action “s” to the policy object in question.

Step 3. To remove a link, apply action “m” to the policy object in question.

Top-Down Approach:

Step 1. In the upper object (regarding the hierarchy in Figure 14 on page 29), open the policy item that takes you to the intended lower type, as shown in Figure 14 on page 29.

This displays a list of all the policy objects that the current one *may* use. Those that have a status of SELECTED are the ones that the current one *does* actually use at present.

Step 2. To create a link, apply action “s” to the policy object in question.

Step 3. To remove a link, apply action “m” to the policy object in question.

Chapter 3. Scenarios on How to Use the Customization Dialog

This chapter provides a series of scenarios on how to use the customization dialog to implement the appropriate automation policy:

This section discusses the following scenarios:

- “How to Work with Resources”
- “How to Use Schedules (Service Periods)” on page 57
- “How to Use Triggers and Events” on page 58
- “How to Use User E-T Pairs” on page 65
- “How to Implement Message Processing with User-Defined Data” on page 67

How to Work with Resources

This section contains a scenario on how to group resources for applications in a complex configuration.

A Grouping Scenario

The following scenario shows how grouping is performed on the conceptual level. For information on how to enter such a grouping policy into the customization dialog, see “Grouping the Resources” on page 33.

Grouping applications and nesting application groups is a process that can be logically divided into multiple steps:

- “Step 1: Identify Resources”
- “Step 2: Group the Resources” on page 32
- “Step 3: Nest the Groups” on page 32
- “Step 4: Match Resources to Systems” on page 33

Note:

Applications and application groups are also referred to with the general term *resources*.

Step 1: Identify Resources

Imagine a scenario with two application groups that represent a data warehouse and a Web server:

- The data warehouse requires the following resources:
 - VTAM
 - TCP/IP
 - DB2 (consisting of components DB2MSTR, DB2IRLM)
 - CICS (consisting of components CICSMAIN, CICS1AR1, CPSMCMAS, CPSMWUI, CICS1TOR, CICS1FOR)
 - DWH
- The Web server requires the following resources:
 - VTAM
 - TCP/IP
 - DB2 (consisting of components DB2MSTR, DB2IRLM, DB2DIST, DB2DBM1)
 - WBSRV

Step 2: Group the Resources

Some of the required resources that were identified in the previous step are candidates for aggregation:

- Resources that are made of multiple components. In our example, these are:
 - CICS1AR1, CPSMCMAS, and CPSMWUI, which could be aggregated into a group called CICSAOR, so that they can be automated as a unit.
 - The group CICS, which will contain resources CICSMAIN, CICS1TOR, CICS1FOR and the aggregated CICSAOR group.
 - The group DB2, which will contain resources DB2MSTR, DB21IRLM, DB2DIST, and DB2DBM1.
- Resources that are used by multiple exploiters. In our example, these are:
 - VTAM and TCP/IP, which are used by the data warehouse and the Web server. We will aggregate them into a group called NET.
 - DB2MSTR, DB21IRLM, DB2DIST, and DB2DBM1, which are used by the data warehouse and the Web server. We will aggregate them into a group called DB2.
- Finally we implement the data warehouse as the group DWHAPG and the Web server as the group WBSRVAPG to allow nesting the other groups into them as required later (see “Step 3: Nest the Groups”).

Figure 15 shows a possible aggregation of all components into groups.

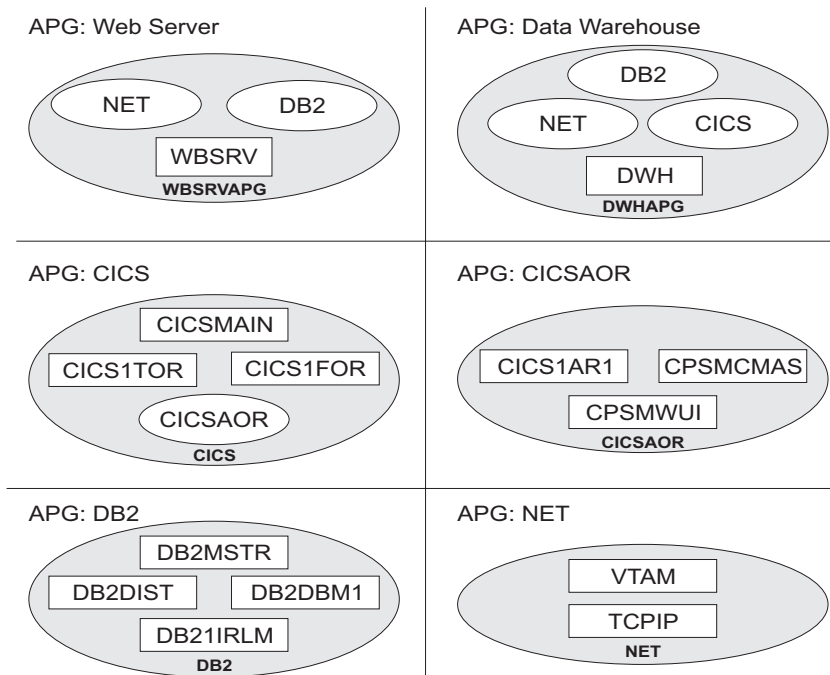

Figure 15. Application Groups

In Figure 15, oval labels represent application groups and rectangular labels represent applications. For example, application group CICS contains applications CICSMAIN, CICS1TOR, CICS1FOR and the nested application group CICSAOR.

Step 3: Nest the Groups

Figure 16 on page 33 shows how the application groups are nested in this environment. From an operator's point of view, a start request against WBSRVAPG

should start all imbedded components in a reasonable order. The same is true for requests against all other groups such as, for example, NET and DB2.

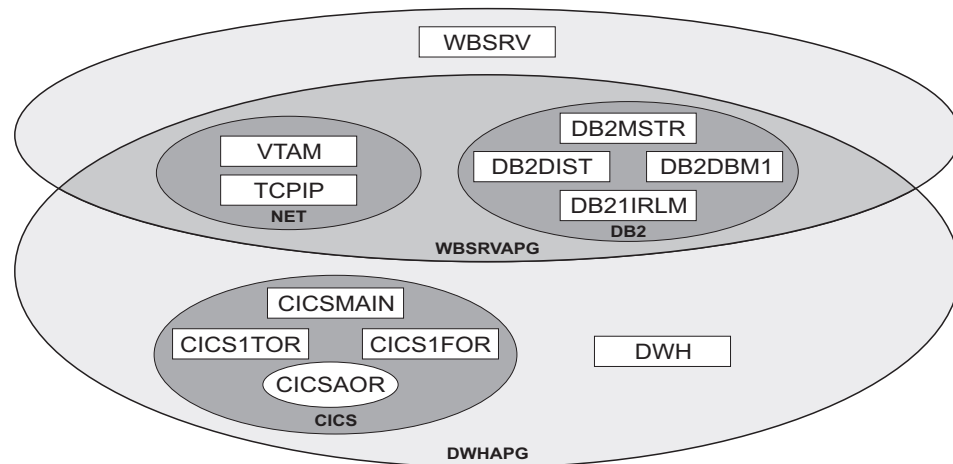

Figure 16. Grouping of Applications into Nested ApplicationGroups

Step 4: Match Resources to Systems

System administrators must next decide what systems and sysplexes these groups and applications should run on. Assume that in our scenario we have an environment of three z/OS systems SYSTEM1, SYSTEM2, SYSTEM3 that are members in sysplex SYSPLEX1.

In our example, a possible decision could be:

- The Web server group WBSRVAPG should run on SYSTEM1.
- The data warehouse group DWHAPG should run on SYSTEM2 and (if SYSTEM2 is not available) on SYSTEM3.
- The DB2 group, containing applications DB2MSTR, DB21IRLM, DB2DIST, and DB2DBM1, should run on SYSTEM2 and on SYSTEM3.
- The NET group, containing applications VTAM AND TCPIP, should run in the entire sysplex.
- The CICS group, containing applications CICSMAIN, CICS1FOR, CICS1TOR and the application group CICSAOR should run on SYSTEM2 and on SYSTEM3.

See “How to Work with Resources” on page 31 for detailed information on how to implement this scenario using the customization dialog.

Grouping the Resources

The complete process of grouping resources is divided into three steps:

- “Step 1: Creating the Policy Objects that Make Up the Sysplex”
- “Step 2: Creating the Applications” on page 36
- “Step 3: Creating the Application Groups” on page 37

Step 1: Creating the Policy Objects that Make Up the Sysplex

You start on the Entry Type Selection panel. It is assumed that the policy database is empty.

Creating a sysplex consists of:

Step 1: Creating the Policy Objects that Make Up the Sysplex

- Creating the systems
- Creating the sysplex group
- Linking the systems to the sysplex group

Step 1a: Creating the Systems: In this substep, you create the systems SYSTEM1, SYSTEM2 and SYSTEM3. You may want to read the information in “Creating a New System” on page 99 to see some sample customization dialog panels before you continue this scenario.

1. On the Entry Type Selection panel enter option 4 or SYS to get to the Entry Name Selection panel for systems, which currently displays an empty list.
2. Enter NEW SYSTEM1 at the command line.
The Define New Entry panel for systems is displayed. The **Entry name** field is already filled with SYSTEM1. The default operating system is MVS.
3. Press Enter to have the **Image/System name** field default to the same as the **Entry name** field. This also enters default values in the **Heartbeat Interval** and **Missing Heartbeat Delay** fields. Press PF3. The Policy Selection panel for systems is displayed, showing a message indicating that the system has been created.

Background: What Is a Resource?

The Image/System name will be part of the resource names that have a system scope.

This name usually consists of three parts:

- An 11-character identifier
- The entry type that it was derived from
- The System that it runs on (that is, the Image/System name that is specified for the system)

For sysplex-wide resources (for example, Sysplex Application Groups), the system identifier is omitted.

Resources of type APL, APG, or MTR are automatically generated when applications, application groups, or monitor resources are linked to systems. Resources of other types are generated dynamically when the system operations configuration files are built.

Within the customization dialog, resources of type APL, APG, or MTR can be viewed and they can be linked via special policy items.

4. Press PF3 or enter END to return to the Entry Name Selection panel showing SYSTEM1 in the list.
5. Repeat the previous steps to create SYSTEM2 and SYSTEM3. Now you have three systems in the list on the Entry Name Selection panel. Press PF3 to return to the Entry Type Selection panel.

Step 1b: Creating the Sysplex: You may want to read the information in “Creating a New Group” on page 80 to see some sample customization dialog panels before you continue with the scenario.

1. On the Entry Type Selection panel, enter option 2 or GRP to go to the Entry Name Selection panel for groups, which displays an empty list.
2. Enter NEW SYSPLEX1 at the command line.

Step 1: Creating the Policy Objects that Make Up the Sysplex

The Define New Entry panel for groups is displayed; the **Entry name** field is already filled with SYSPLEX1.

3. Change the **Group Type** field entry to SYSPLEX if necessary because you want to create a sysplex group.

Press PF3 to exit this panel. The Policy Selection panel for Groups is displayed, showing a message that the group has been created.

4. Consider specifying *default definitions* for all your sysplex resources (that is, sysplex application groups) using the Sysplex Defaults entry type (XDF) and linking it to your sysplex group, as follows:

- a. Return to the Entry Type Selection panel and select the Sysplex Defaults entry type by entering XDF or 40. This displays the Entry Name Selection panel for Sysplex Defaults.

- b. To create a new entry called, for example, XDF1, enter new xdf1 at the command line. This displays the Define New Entry panel with XDF1 in the **Entry name** field.

Press PF3 to exit this panel. The Policy Selection panel for Sysplex Defaults is displayed, showing a message that the entry has been created.

- c. Select the RESOURCE INFO policy item to display the Sysplex Resource Information Defaults panel. Type SDF NMC IOM in the **Inform List** field to have status changes propagated to SDF, NMC and SA IOM. Press PF3 to save the changes and return to the Policy Selection panel.

- d. Select the WHERE USED policy item to display the Where Used panel. Select the SYSPLEX1 sysplex by typing an S in the **Action** column and pressing Enter. Press PF3 to save the changes and return to the Policy Selection panel.

5. On the Policy Selection panel for the SYSPLEX Group entry type (which you can reach via the Entry Type Selection panel), select the SYSTEMS policy item. The Systems for Group panel is displayed showing the three systems defined in “Step 1a: Creating the Systems” on page 34.

6. Select all three systems with an S and press PF3 until you return to the Entry Type Selection panel.

Now your environment contains a sysplex with three z/OS systems.

Step 1: Creating the Policy Objects that Make Up the Sysplex

Background: Ways to Build a Sysplex

A sysplex for SA z/OS consists of z/OS systems within an XCF group with the same group ID. In the customization dialog such a sysplex *must* be built by creating a sysplex group and linking its systems.

This happens either *bottom-up* (from a system to a group, with the system's WHERE USED policy item) or *top-down* (from a group to a system, with the group's SYSTEM policy item).

For the bottom-up approach you must go into the SYS entry type, select all systems you want in the Sysplex, select each system's WHERE USED policy item where you get a list of sysplex groups and subgroups that you can link the system to.

You can also link groups with systems indirectly. This happens if you create SubGroup objects (SBG entry type) and link these subgroups bottom-up to groups *and* top-down to systems.

Sysplex groups usually consist of several systems, but systems can only be linked to one sysplex group (either directly or indirectly).

The following figure shows how you can create a sysplex:

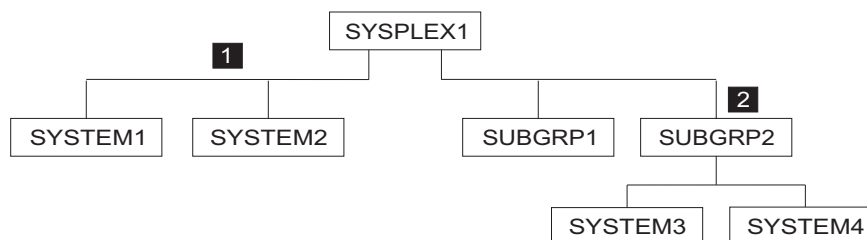

- 1** SYSTEM1 and SYSTEM2 are linked directly to sysplex SYSPLEX1.
- 2** SYSTEM3 and SYSTEM4 are linked to subgroup SUBGRP2 and this subgroup is linked to SYSPLEX1.

Step 2: Creating the Applications

In this step, you create all required application subsystems.

You may want to read the information in “Creating a New Application” on page 138 to see some sample panels of the customization dialog before you continue with the scenario.

1. On the Entry Type Selection panel enter option 6 or APL to get to the Entry Name Selection panel for applications, which is displayed with an empty list.
2. Enter NEW VTAM at the command line.

The Define New Entry panel for applications is displayed and the **Entry name** field is already filled with VTAM.

3. Press Enter to have the **Subsystem Name** and **Job Name** fields filled with their default value. These fields are mandatory. Both of them default to the application's **Entry name** (see “Subsystem Name” on page 138 and “Job Name” on page 141 for more information on this defaulting mechanism). So, in this case, they default to VTAM.

Step 2: Creating the Applications

Background: Application Resource Name

The Subsystem Name is used as the first part of the application's resource name. It is recommended to use the same name for the application entry name and subsystem name for better identification of applications and resources that will be derived from applications.

4. Press PF3 to leave this panel. The Policy Selection panel is displayed, showing a message that the application has been created.
5. On the Policy Selection panel for applications press PF3 again to return to the Entry Name Selection panel. It now shows VTAM in the list.
6. Repeat the previous steps for the rest of the applications using the values from Table 5.

Table 5. Entry Details for Applications in the Scenario

Entry Name	Application Type	Subtype
WBSRV (Web Server)	blank	–
DWH (Data Warehouse)	blank	–
CICSMAIN	CICS	TOR
CICS1TOR	CICS	TOR
CICS1FOR	CICS	FOR
CICS1AR1	CICS	AOR
CPSMCMAS	CICS	CPSM
CPSMWUI	CICS	WUI
DB2MSTR	DB2	MSTR
DB21IRLM	DB2	IRLM
DB2DIST	DB2	DIST
DB2DBM1	DB2	DBM1
TCPIP	blank	–

Now all subsystems (applications) are defined to your environment.

Step 3: Creating the Application Groups

In this step, you create all the required application groups and define the behavior of their members.

According to the example from “A Grouping Scenario” on page 31, the groups should run on the following systems:

- WBSRVAPG should run on SYSTEM1.
- DWHAPG should run on SYSTEM2 and alternatively on SYSTEM3.
- DB2 should run on SYSTEM2 and SYSTEM3.
- NET should run in the entire sysplex.
- CICS should run on SYSTEM2 and on SYSTEM3.

Step 3: Creating the Application Groups

Background: Sysplex Application Groups and System Application Groups

The application group type (SYSTEM or SYSPLEX) sets the boundaries for the automation of the application group and its members.

- Sysplex Application Groups can be located on multiple systems in one or more sysplexes.
- System Application Groups are located on single systems.

Use Sysplex Application Groups for DWHAPG, NET, and CICS. System Application Groups will be used for WBSRVAPG and DB2.

Step 3a: Create Sysplex Application Group CICSOR: You start with the creation of the sysplex application group CICSOR because CICSOR contains only applications that have already been defined (CICS1AR1, CPSMCMAS, CPSMWUI).

You may want to read the information in “Creating a New ApplicationGroup” on page 114 to see some sample customization dialog panels before you continue this scenario.

1. On the Entry Type Selection panel enter option 5 or APG . The Entry Name Selection panel is displayed with an empty list.
2. On the Entry Name Selection panel enter NEW CICSOR at the command line. The Define New Entry panel for application groups is displayed. The **Entry name** field has already been filled with CICSOR.
3. Check that the **Application Group Type** field contains SYSPLEX and the **Nature** field contains BASIC.

Background: Nature of an Application Group

In SA z/OS application groups can have one of three natures, depending on how many components must be available:

BASIC	In a BASIC application group <i>all</i> of its components must be available before the group is considered to be available.
MOVE	In a MOVE application group exactly <i>one</i> of its components must be available before the group is considered to be available. In MOVE groups you can specify alternative components to start if their primary component fail to start.
SERVER	In a SERVER application group <i>any</i> number of components can be specified that must be available before the group is considered to be available. In SERVER groups you can specify what should happen if their components fail to start.

The nature of an application group can be changed later on. However be careful with such a change, because the role of the application group will change too (and definitions made for a MOVE group, for example, may not be appropriate for a SERVER group).

In this scenario, the application group consists of three applications (CICS1AR1, CPSMCMAS, and CPSMWUI) that should all be available. You should therefore make it a BASIC Group.

4. Type CICSAOR in the **Automation Name** field.

Background: Application Group Resource Name

The Automation Name is used as the first part of this application group's resource name. It is recommended that you use the same name as the application group Entry name and Automation Name for better identification of application groups and resources that will be derived from them.

If you do not specify an Automation Name, no resource is generated for the application group. Nevertheless, the application resources for all applications that are linked to this application group are created and become available for automation.

5. Press PF3 to exit the panel. The Policy Selection panel for Groups is displayed showing a message that the application group has been created.
6. On the Policy Selection panel select the WHERE USED policy item. The Where Used panel is displayed with sysplex group SYSPLEX1.
7. Select the sysplex group and press PF3. You briefly see the Command Progress Display pop-up window, showing that the resource has been created, before it disappears automatically.

You can see the generated resources in the GENERATED RESOURCES policy item of the application group. Return to the Policy Selection panel for CICSAOR.

Step 3: Creating the Application Groups

Background: Generating Sysplex Application Group Resources

A Sysplex Application Group resource is created automatically if there is an Automation Name for the application group, and there is a link to a sysplex group.

Only one resource is created (rather than one resource per system) and the resource name does not have a system identifier.

CICSAOR has an Automation Name; therefore a resource for this application group is generated.

The current configuration with application group CICSAOR is shown in Figure 17.

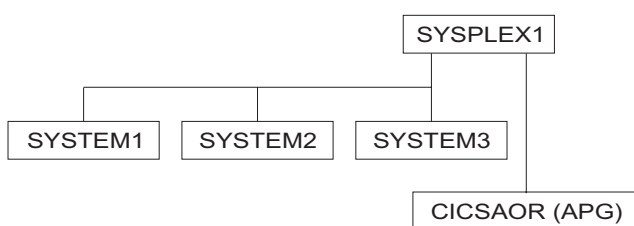

Figure 17. Scenario: Current Configuration with Sysplex Application Group CICSAOR

8. On the Policy Selection panel for CICSAOR select the APPLICATIONS policy item. This displays the Applications for ApplicationGroup panel with all of the applications.
9. Select CICS1AR1, CPSMCMAS, and CPSMWUI and press PF3 (END) to return to the Policy Selection panel for CICSAOR.

Step 3: Creating the Application Groups

Background: Generating Application Resources

Application resources are generated when applications are linked to systems. This is the case for CICS1AR1, CPSMCMAS, and CPSMWUI, which are now linked to CICS1AR1. There are also linked indirectly via sysplex SYSPLEX1 to SYSTEM1, SYSTEM2, and SYSTEM3.

One resource is generated for each linked system.

Again, you see the Command Progress Display pop-up window telling you that the resources are being created. For example, for CICS1AR1, the following resources are generated:

```
CICS1AR1/APL/SYSTEM1  
CICS1AR1/APL/SYSTEM2  
CICS1AR1/APL/SYSTEM3
```

For each application three resources are generated and linked to the application group resource.

Note: These application resources are deleted if one of the following happens:

- The application is deleted.
- The application group CICS1AR1 is deleted.
- Other parts of the link chain APL-APG-GRP-SYS are deleted or delinked (that is, if SYSPLEX1 or any of the systems SYSTEM1, SYSTEM2, or SYSTEM3, or the links between them are deleted).

The current links are shown in Figure 18.

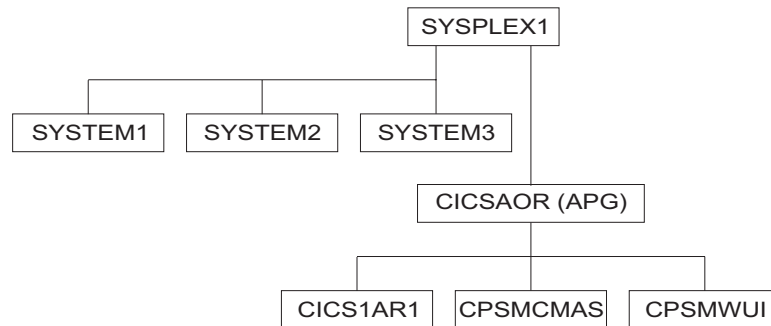

Figure 18. Scenario: Current Configuration with Applications CICS1AR1, CPSMCMAS, CPSMWUI

10. On the Policy Selection panel for CICS1AR1 select the RESOURCES policy item. This displays the Select Resources panel with 9 application resources selected, as shown in Figure 19 on page 42.

Step 3: Creating the Application Groups

```

COMMANDS  ACTIONS  HELP
-----
AOFGARS3          Select Resources          Row 1 to 9 of 9
Command ==> _____ SCROLL==> CSR

Entry Type : ApplicationGroup      Entry Name : CICSAOR
Sysplex   : SYSPLEX1

Number of selected Resources . . : 9
Show all Resources . . . . . NO    YES NO
Show only Resources with String. . _____

Action  Status      Resource Name      Entry Name
-----  -
_____ SELECTED   CICS1AR1/APL/SYSTEM1  CICS1AR1
_____ SELECTED   CICS1AR1/APL/SYSTEM2  CICS1AR1
_____ SELECTED   CICS1AR1/APL/SYSTEM3  CICS1AR1
_____ SELECTED   CPSMCMAS/APL/SYSTEM1  CPSMCMAS
_____ SELECTED   CPSMCMAS/APL/SYSTEM2  CPSMCMAS
_____ SELECTED   CPSMCMAS/APL/SYSTEM3  CPSMCMAS
_____ SELECTED   CPSMWUI/APL/SYSTEM1   CPSMWUI
_____ SELECTED   CPSMWUI/APL/SYSTEM2   CPSMWUI
_____ SELECTED   CPSMWUI/APL/SYSTEM3   CPSMWUI
***** Bottom of data *****

```

Figure 19. Scenario: Resources for the CICSAOR Sysplex Application Group

- On the Select Resources panel for CICSAOR, deselect the three resources on SYSTEM1, because CICS should not run on SYSTEM1. Type an M (the action code for REMOVE) in the **Action** column in front of each resource that you want to remove from the group.

When you press Enter, the **Number of selected Resources** field is now 6.

- Press PF3 (END) to return to the Policy Selection panel for CICSAOR.
- Select the APPLGROUP INFO policy item to display the Application Group Information panel for CICSAOR.
- Press PF8 to scroll to the bottom of the input field section and change the **Automatically link Application-Resources** field to NO.

You need to do this because the application group definitions are now complete. Further modifications within the sysplex should not affect the completed resource selections on the Select Resources panel.

Background: Automatically link Application-Resources Field

You should set this input field to NO if the definition of an application group resource (with its linked applications, its nature and its behavior and so on) is complete. This prevents any possible changes in the automation policy, such as changed system links or application links, from having an influence on this application group resource.

If this field is set to YES, the application group resource will be changed if system links or application links occur. That is, the number of generated application resources or linked application resources, and possibly the behavior of the application group resource will change. For example, if you link another system to SYSPLEX1, this produces three more resources in the CICSAOR application group, one for each linked application.

Later on, you will specify preference values for application resources, where automatically generated resources with their default preferences could adversely affect your completed application group definition.

Step 3: Creating the Application Groups

15. Press PF3 until you return to the Entry Name Selection panel.

The CICS AOR application group is now complete. If a start request is issued against CICS AOR, start requests for CICS1AR1, CPSPCMAS, and CPSPMWUI are also automatically issued on SYSTEM2 and SYSTEM3.

Step 3b: Create System Application Group DB2: The DB2 application group runs on two specific systems, so you define it as a *system* application group.

1. Enter NEW DB2 at the command line on the Entry Name Selection panel for application groups. This displays the Define New Entry panel for application groups and the **Entry name** field already filled with DB2.
2. Enter the required values on this panel:
 - a. In this scenario DB2 runs permanently on only two of the three systems of SYSPLEX1 (SYSTEM2 and SYSTEM3), so type SYSTEM in the **Application Group Type** field.
 - b. You want DB2 be started with all of its components but without specific backup considerations, so leave the **Nature** field as BASIC.
 - c. To generate resources you need an automation name, so type DB2 in the **Automation Name** field.

Press PF3. The Policy Selection panel is displayed indicating that the application group has been created.

Note:

A resource is not created for the APG at this point because the application group is not yet linked to any systems.

3. Select the WHERE USED policy item. This displays the Where Used panel with the three systems that you created in “Step 1a: Creating the Systems” on page 34.
4. DB2 should only run on SYSTEM2 and SYSTEM3. Select SYSTEM2 and SYSTEM3 and press PF3 (END). You will see the Command Progress Display pop-up window telling you that the following two resources have been created:

DB2/APG/SYSTEM2
DB2/APG/SYSTEM3

Background: Generating System Application Group Resources

A System Application Group resource is automatically generated if there is an Automation Name for the application group and a link to a system. One resource is generated for each linked system.

There are two ways to link a System Application Group to a system:

- For the application group use the WHERE USED policy item on the Policy Selection panel or the WHEREUSED (W) command on the Entry Name Selection panel to get to the list of systems, and then select at least one system.
- If you are on the Policy Selection panel for a system, select the APPLICATION GROUPS policy item and then select an application group.

The current configuration is shown in Figure 20 on page 44.

Step 3: Creating the Application Groups

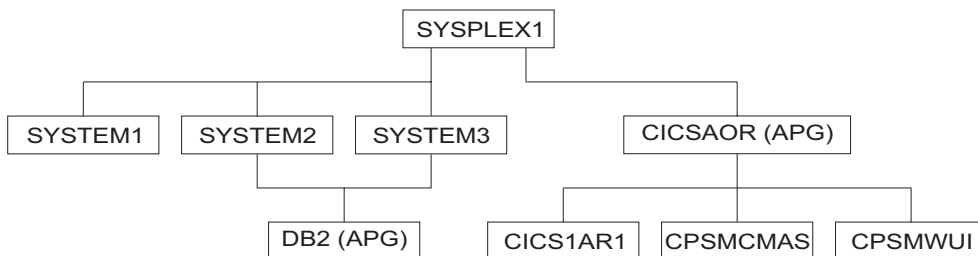

Figure 20. Scenario: Current Configuration with Application Group DB2

5. On the Policy Selection panel for DB2, select the APPLICATIONS policy item to link the required applications. This displays the Applications for ApplicationGroup panel with all 12 applications.
6. Select DB2MSTR, DB21IRLM, DB2DIST, and DB2DBM1, and press PF3 (END) to return to the Policy Selection panel.

Now DB2MSTR, DB21IRLM, DB2DIST, and DB2DBM1 are linked to two systems via the application group DB2. For the application group, the field **Automatically link Application-Resources into APG** is set to YES, which is the default.

One resource is generated for each system link of each application. The Command Progress Display pop-up window indicates that the following resources are generated:

```

DB21IRLM/APL/SYSTEM2
DB21IRLM/APL/SYSTEM3
DB2DBM1/APL/SYSTEM2
DB2DBM1/APL/SYSTEM3
DB2DIST/APL/SYSTEM2
DB2DIST/APL/SYSTEM3
DB2MSTR/APL/SYSTEM2
DB2MSTR/APL/SYSTEM3
  
```

The current configuration is shown in Figure 21.

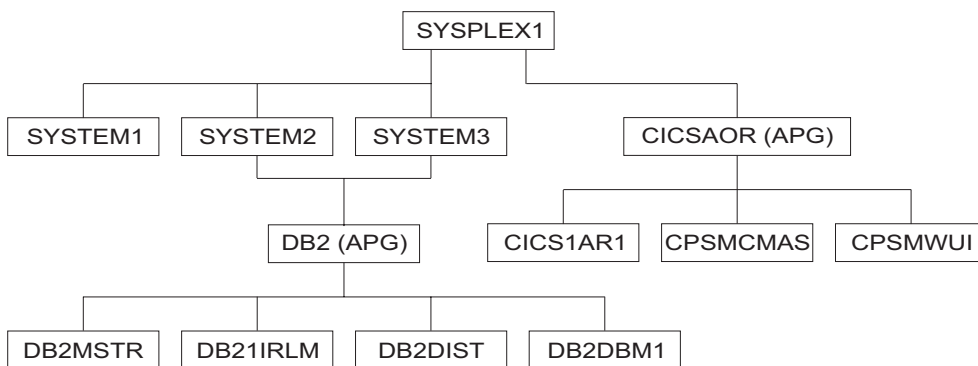

Figure 21. Scenario: Current Configuration with Applications Linked to DB2

7. On the Policy Selection panel for application group DB2, select the RESOURCES policy item.
This displays the Select System panel, showing the number of resources that have been selected for each of the two systems. You can compare the resulting panel on your system with Figure 22 on page 45.

Step 3: Creating the Application Groups

```

COMMANDS  ACTIONS  HELP
-----
A0FGARS1          Select System          Row 1 to 2 of 2
Command ==> _____ SCROLL==> PAGE

Entry Type : ApplicationGroup      PolicyDB Name  : USER_PDB
Entry Name : DB2                  Enterprise Name : USER_ENTERPRISE

Action      System          Selected Resources
-----
SYSTEM2    SYSTEM2          4
SYSTEM3    SYSTEM3          4
***** Bottom of data *****

```

Figure 22. Scenario: Select System Panel for DB2 Application group

8. A System Application Group can be linked to several systems. This generates application resources for those systems. So to work with the resource links, you first have to specify which system you want to get the resources for. This is done on the Select System panel by selecting one of the systems.
On the Select System panel, select either SYSTEM2 or SYSTEM3 and press Enter. This displays the Select Resources panel with, for example, the two APL Resources for SYSTEM2. You can compare the resulting panel on your system with Figure 23.

```

COMMANDS  ACTIONS  HELP
-----
A0FGARS3          Select Resources          Row 1 to 2 of 2
Command ==> _____ SCROLL==> PAGE

Entry Type : ApplicationGroup      Entry Name : DB2
System      : SYSTEM2

Number of selected Resources      : 4
Show all Resources . . . . . NO      YES NO
Show only Resources with String. . _____

Action  Status      Resource Name          Entry Name
-----
SELECTED DB2DBM1/APL/SYSTEM2   DB2DBM1
SELECTED DB2DIST/APL/SYSTEM2   DB2DIST
SELECTED DB21IRLM/APL/SYSTEM2   DB21IRLM
SELECTED DB2MSTR/APL/SYSTEM2   DB2MSTR
***** Bottom of data *****

```

Figure 23. Scenario: Select Resources Panel for DB2 Application Group

- Both applications should be started, so no change is required on this panel.
9. On the Select Resources panel, press PF3 (END) or CANCEL. This returns you to the Select System panel, where you can also view the Select Resources panel for the APL resources in SYSTEM3 to check the created links for SYSTEM3.
10. Press PF3 (END) twice to return to the Policy Selection panel for the DB2 application group.
11. Select the APPLGROUP INFO policy item to display the Application Group Information panel. Press PF8 to scroll down the input field section and change the **Automatically link Application-Resources into APG** field to NO.
The DB2 application group is now complete.
12. Press PF3 to return to the Entry Name Selection panel for application groups.
13. The application group DB2 is now complete. If a start request is issued against DB2 on SYSTEM2, start requests to the application resources DB2MSTR,

Step 3: Creating the Application Groups

DB21IRLM, DB2DIST, and DB2DBM1 are also automatically issued for SYSTEM2. A start request against application group DB2 on SYSTEM3 does the same for SYSTEM3.

Step 3c: Create System Application Group CICS: You create the CICS application group with a nature of BASIC and with links to three applications (CICSMAIN, CICS1TOR, CICS1FOR) that you defined in “Step 2: Creating the Applications” on page 36.

1. To create a System Application Group called CICS, repeat steps 2–8 of “Step 3b: Create System Application Group DB2” on page 43 accordingly. In the equivalent of step 8, select the applications CICSMAIN, CICS1TOR, and CICS1FOR on the Applications for ApplicationGroup panel.
2. On the Policy Selection panel for application group CICS, select the RESOURCES policy item. The Select System panel is displayed as shown in Figure 24.

```

COMMANDS  ACTIONS  HELP
-----
A0FGARS1          Select System          Row 1 to 2 of 2
Command ==> _____ SCROLL==> PAGE

Entry Type : ApplicationGroup      PolicyDB Name : USER_PDB
Entry Name : CICS                  Enterprise Name : USER_ENTERPRISE

Action      System              Selected Resources
-----
           SYSTEM2              3
           SYSTEM3              3
***** Bottom of data *****

```

Figure 24. Scenario: Grouping Resources

Select SYSTEM2. A panel is displayed similar to the one shown in Figure 25.

```

COMMANDS  ACTIONS  HELP
-----
A0FGARS3          Select Resources       Row 1 to 3 of 3
Command ==> _____ SCROLL==> PAGE

Entry Type : ApplicationGroup      Entry Name : CICS
System      : SYSTEM2

Number of selected Resources      : 3
Show all Resources . . . . . NO    YES NO
Show only Resources with String. . _____

Action  Status  Resource Name          Entry Name
-----
        SELECTED CICS1FOR/APL/SYSTEM2  CICS1FOR
        SELECTED CICSMAIN/APL/SYSTEM2  CICSMAIN
        SELECTED CICS1TOR/APL/SYSTEM2  CICS1TOR
***** Bottom of data *****

```

Figure 25. Scenario: Resources for the CICS Sysplex Application Group

Check the created links for SYSTEM3 too. The selected links should be the same.

3. Press PF3 to return to the Policy Selection panel and select the APPLGROUP INFO policy item. Once again, change the **Automatically link Application-Resources** field to NO.
4. Press PF3 to return to the Entry Name Selection panel for application groups.

Step 3: Creating the Application Groups

The CICS application group is now complete. If a start request is issued against CICS, start requests are also issued for the application resources CICS1FOR, CICSMAIN, and CICS1TOR (on SYSTEM2 and SYSTEM3).

The current configuration is shown in Figure 26.

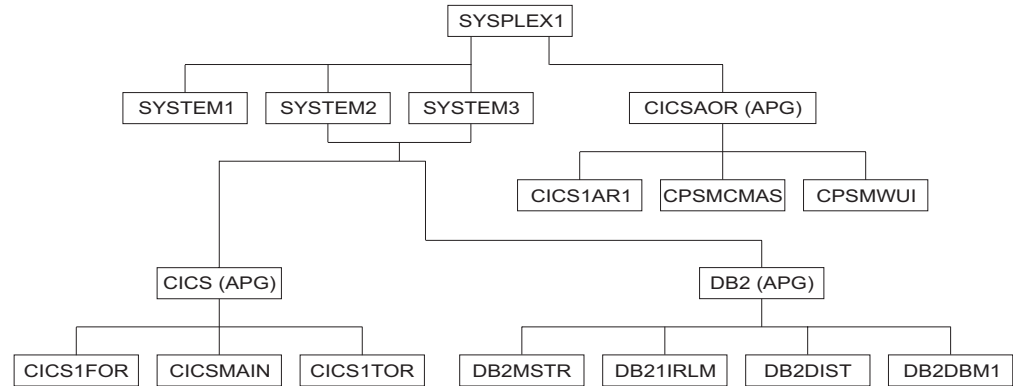

Figure 26. Scenario: Current Configuration with Applications Linked to DB2

Step 3d: Create Sysplex Application Group NET: The creation of Sysplex Application Group NET follows the previous examples, therefore, no detailed description of the required steps is contained here.

The Sysplex Application Group NET should run in the entire SYSPLEX1, and the applications VTAM and TCP/IP should be linked to it.

After your definitions are complete, the Select Resources panel for the NET application group should look like Figure 27.

```

COMMANDS  ACTIONS  HELP
-----
A0FGARS3          Select Resources          Row 1 to 6 of 6
Command ==>          SCROLL==> PAGE

Entry Type : ApplicationGroup      Entry Name : NET
Sysplex    : SYSPLEX1

Number of selected Resources      : 6
Show all Resources . . . . . NO    YES NO
Show only Resources with String. .

Action  Status  Resource Name      Entry Name
-----  -----  -----
SELECTED TCPIP/APL/SYSTEM1 TCPIP
SELECTED TCPIP/APL/SYSTEM2 TCPIP
SELECTED TCPIP/APL/SYSTEM3 TCPIP
SELECTED VTAM/APL/SYSTEM1 VTAM
SELECTED VTAM/APL/SYSTEM2 VTAM
SELECTED VTAM/APL/SYSTEM3 VTAM
***** Bottom of data *****

```

Figure 27. Scenario: Select Resources Panel for Application Group NET

Step 3e: Create MOVE Group DWHAPG: The Data Warehouse Group DWHAPG should run on one system (SYSTEM2) and, if something goes wrong on SYSTEM2, on SYSTEM3. This application group is created with the nature MOVE.

Step 3: Creating the Application Groups

Background: What Are Move Groups?

All previous application groups were of nature BASIC, which means that all of their components are equivalent and all of them need to be available before the application group is considered to be available.

A MOVE Group, in contrast, is designed for backup solutions. A MOVE Group can have many components, but exactly one is expected to be active. All other components are for backup only. Thus MOVE Groups usually contain members of one kind (where one application can replace the others).

The applications needed for the DWHAPG application group are available, but additional preparation is needed.

1. From the Entry Type Selection panel, enter option 5 or APG. The Entry Name Selection panel is displayed with four application groups: CICS, CICS/AOR, DB2, and NET.
2. Enter NEW DWHAPG at the command line. The Define New Entry panel is displayed with the **Name** field already filled with DWHAPG.
3. Enter the required values on this panel:
 - a. The application group DWHAPG should run alternatively on two of the three systems, so leave the **Application Group Type** field as SYSPLEX.
 - b. You want to start the components of DWHAPG exactly once, but with backups. Change **Nature** to MOVE.
 - c. To generate resources you need an automation name, so type DWHAPG in the **Automation Name** field.
4. Press PF3 to exit the panel. The Policy Selection panel for Groups is displayed showing a message that the application group has been created.
5. Select the WHERE USED policy item to display the Where Used panel with sysplex group SYSPLEX1.
6. Select the sysplex group and press PF3.
The Command Progress Display panel informs you that the DWHAPG/APG resource has been created.
7. Select the RESOURCES policy item. The Select Resources panel shows an empty list of resources. The reason is that you did not link any applications to the application group and so no application resources were generated.
Note that the **Availability Target** is 1 (exactly 1 resource is expected to be up in a MOVE Group). You cannot change this value.
8. Change the **Show all Resources** field to YES and press Enter.
The Select Resources panel is displayed, as shown in Figure 28 on page 49, with all valid application group resources:
 - Sysplex Application Group resources in the same sysplex: CICS/AOR/APG and NET/APG
 - System Application Group resources on one of the systems in the sysplex: CICS/APG/SYSTEM2, CICS/APG/SYSTEM3, DB2/APG/SYSTEM2, and DB2/APG/SYSTEM3

Step 3: Creating the Application Groups

```

COMMANDS  ACTIONS  HELP
-----
A0FGARS5          Select Resources          Row 1 of 6
Command ==>          SCROLL==> PAGE

Entry Type : ApplicationGroup      Entry Name : DWHAPG
Sysplex    : SYSPLEX1

Number of selected Resources : 0
Availability Target          : 1      (Move Application Group)
Show all Resources . . . . . YES    (YES NO)
Show only Resources with String.

Action  Preference  Resource Name      Entry Name
-----  -
         CICS/APG/SYSTEM2      CICS
         CICS/APG/SYSTEM3      CICS
         CICSAOR/APG           CICSAOR
         DB2/APG/SYSTEM2       DB2
         DB2/APG/SYSTEM3       DB2
         NET/APG               NET
***** Bottom of data *****

```

Figure 28. Scenario: Select Resources Panel for DWHAPG with valid APG Resources

However, this is not yet what you want. The purpose of your group is to start all of these components and the DWH application on either SYSTEM2 or SYSTEM3.

You need to define two additional application groups with the same contents, one for SYSTEM2 and one for SYSTEM3. Their names will be DWHAPG2 and DWHAPG3. DWHAPG will have these two APGs as members and start them alternatively.

You must define these groups as System Application Groups because they must contain the System Application Group CICS on SYSTEM2 and SYSTEM3.

9. Press PF3 until you return to the Entry Name Selection panel and enter NEW DWHAPG2 at the command line (you could also use the *fast path* =APG;NEW DWHAPG2).
The Define New Entry panel is displayed, with DWHAPG2 already in the **Name** field.
10. Enter the required values on this panel:
 - a. DWHAPG2 should run on a single system, so change the **Type** to SYSTEM.
 - b. Because you want to start all of the components of DWHAPG2, the **Nature** must be BASIC.
 - c. To generate resources you need an automation name, so type DWHAPG2 in the **Automation Name** field.
 - d. Press PF3 to exit the panel.
11. On the Policy Selection panel select the WHERE USED policy item, and then select SYSTEM2 sysplex group on the Where Used panel.
12. Press PF3 to exit the panel. The Command Progress Display panel is displayed, showing that the resource DWHAPG2/APG/SYSTEM2 has been generated.
13. Select the APPLICATIONS policy item. From the displayed list, select the application DWH. Press PF3 to exit the panel.
The application resource DWH/APL/SYSTEM2 is generated and linked to the application group resource DWHAPG2.
14. Select the RESOURCES policy item. The Select Resources panel with the APL Resource DWH/APL/SYSTEM2 is displayed. Select this APL Resource, if it is not already selected.

Step 3: Creating the Application Groups

- Change the **Show all Resources** field to YES and press Enter.
As a result, two application group resources are displayed together with the one application resource, as shown in Figure 29.

```

COMMANDS  ACTIONS  HELP
-----
A0FGARS3          Select Resources          Row 1 to 3 of 3
Command ==>> _____ SCROLL==>> PAGE

Entry Type : ApplicationGroup      Entry Name : DWHAPG2
System      : SYSTEM2

Number of selected Resources      : 1
Show all Resources . . . . . YES   YES NO
Show only Resources with String. . _____

Action   Status   Resource Name      Entry Name
-----
         _____ CICS/APG/SYSTEM2   CICS
         _____ DB2/APG/SYSTEM2   DB2
         _____ SELECTED DWH/APL/SYSTEM2   DWH

***** Bottom of data *****

```

Figure 29. Scenario: Select Resources Panel for DWHAPG2

- You want to use DWHAPG2 to start the application groups CICS and DB2 on SYSTEM2.
Select CICS on SYSTEM2 (the resource CICS/APG/SYSTEM2), DB2 on SYSTEM2 (the resource DB2/APG/SYSTEM2) and DWH on SYSTEM2 (the resource DWH/APL/SYSTEM2).

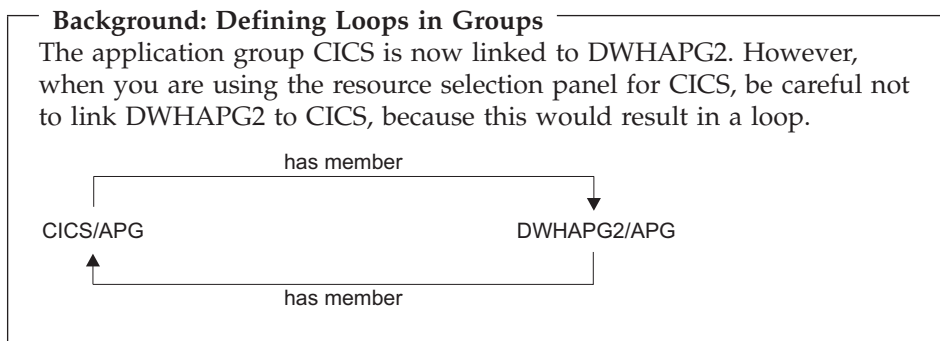

- The Select Resources panel with one application resource and two application group resources selected should now be as shown in Figure 30 on page 51.

Step 3: Creating the Application Groups

```

COMMANDS  ACTIONS  HELP
-----
A0FGARS3                               Select Resources                               Row 1 to 3 of 3
Command ==> _____                               SCROLL==> PAGE

Entry Type : ApplicationGroup           Entry Name : DWHAPG2
System      : SYSTEM2

Number of selected Resources           : 3
Show all Resources . . . . . YES      YES NO
Show only Resources with String. . . . _____

Action  Status  Resource Name      Entry Name
-----  -----  -
SELECTED CICS/APG/SYSTEM2  CICS
SELECTED DB2/APG/SYSTEM2  DB2
SELECTED DWH/APL/SYSTEM2  DWH
***** Bottom of data *****

```

Figure 30. Scenario: Select Resources Panel for DWHAPG2 after Selection

18. Press PF3 until you return to the Entry Name Selection panel.
19. Now create the DWHAPG3 system application group in the same way as for the DWHAPG2 application group, as described in steps 9 through 12, and link it to system SYSTEM3.
20. You want the same application members for the DWHAPG3 system application group as you already defined for DWHAPG2, but with their focus on SYSTEM3. You can do this by *copying* DWHAPG2. Select the COPY policy item and then select DWHAPG2 in the Select Entry for Copy panel.

Note:
 You should be aware that the COPY function only copies certain source object data and links. For more details, see “Information that Is Copied” on page 27.

The Command Progress Display pop-up window shows the resource being created.

After the copy process you are at the Policy Selection panel for DWHAPG3.

21. Select the RESOURCES policy item and link the resources that you need for SYSTEM3. The result should look like the panel shown in Figure 31.

```

COMMANDS  ACTIONS  HELP
-----
A0FGARS5                               Select Resources                               Row 1 to 3 of 3
Command ==> _____                               SCROLL==> PAGE

Entry Type : ApplicationGroup           Entry Name : DWHAPG3
System      : SYSTEM3

Number of selected Resources           : 3
Show all Resources . . . . . NO       YES NO
Show only Resources with String. . . . _____

Action  Status  Resource Name      Entry Name
-----  -----  -
SELECTED CICS/APG/SYSTEM3  CICS
SELECTED DB2/APG/SYSTEM3  DB2
SELECTED DWH/APL/SYSTEM3  DWH
***** Bottom of data *****

```

Figure 31. Scenario: Select Resources Panel for DWHAPG3

Press PF3 until you return to the Entry Name Selection panel.

Step 3: Creating the Application Groups

22. Now you have all the components for the DWHAPG move group. Select DWHAPG on the Entry Name Selection panel, and then select the RESOURCES policy item (alternatively, you can enter res in the **Action** field for DWHAPG).
23. The Select Resources panel for DWHAPG is displayed.
Change the **Show all Resources** field to YES and press Enter.
The Select Resources panel with eight APG resources is displayed, as shown in Figure 32.

```

COMMANDS  ACTIONS  HELP
-----
A0FGARS5          Select Resources          Row 1 to 8 of 8
Command ==>>>          SCROLL==>>> PAGE

Entry Type : ApplicationGroup      Entry Name : DWHAPG
Sysplex    : SYSPLEX1

Number of selected Resources : 0
Availability Target          : 1      (Move Application Group)
Show all Resources . . . . . YES      (YES NO)
Show only Resources with String. _____

Action  Preference  Resource Name          Entry Name
-----  -
          CICS/APG/SYSTEM2      CICS
          CICS/APG/SYSTEM3      CICS
          CICSAOR/APG            CICS
          DB2/APG/SYSTEM2        DB2
          DB2/APG/SYSTEM3        DB2
          DWHAPG2/APG/SYSTEM2    DWHAPG2
          DWHAPG3/APG/SYSTEM3    DWHAPG3
          NET/APG                NET
***** Bottom of data *****

```

Figure 32. Scenario: Select Resources Panel for DWHAPG with Valid APG Resources

24. To set the preferences, define:
 - a. The DWHAPG2 group on SYSTEM2 (DWHAPG2/APG/SYSTEM2) as primary by typing p in its **Action** field
 - b. The DWHAPG3 group on SYSTEM3 (DWHAPG3/APG/SYSTEM3) as secondary by typing 500 in its **Preference** field

This is shown in Figure 33 on page 53.

Step 3: Creating the Application Groups

```

COMMANDS  ACTIONS  HELP
-----
AOFGARS5          Select Resources          Row 1 to 8 of 8
Command ==>          SCROLL==> PAGE

Entry Type : ApplicationGroup      Entry Name : DWHAPG
Sysplex    : SYSPLEX1

Number of selected Resources : 0
Availability Target          : 1      (Move Application Group)
Show all Resources . . . . . YES    (YES NO)
Show only Resources with String.

Action  Preference  Resource Name      Entry Name
-----  -
          CICS/APG/SYSTEM2      CICS
          CICS/APG/SYSTEM3      CICS
          CICSAOR/APG          CICSAOR
          DB2/APG/SYSTEM2      DB2
          DB2/APG/SYSTEM3      DB2
          p          DWHAPG2/APG/SYSTEM2      DWHAPG2
          500         DWHAPG3/APG/SYSTEM3      DWHAPG3
          NET/APG          NET
***** Bottom of data *****

```

Figure 33. Scenario: Setting Preferences with the Select Resources Panel for DWHAPG

Press Enter. Figure 34 shows the Select Resources panel after pressing Enter, with the P action converted to the corresponding value of 700.

```

COMMANDS  ACTIONS  HELP
-----
AOFGARS5          Select Resources          Row 1 to 8 of 8
Command ==>          SCROLL==> PAGE

Entry Type : ApplicationGroup      Entry Name : DWHAPG
Sysplex    : SYSPLEX1

Number of selected Resources : 2
Availability Target          : 1      (Move Application Group)
Show all Resources . . . . . YES    (YES NO)
Show only Resources with String.

Action  Preference  Resource Name      Entry Name
-----  -
          CICS/APG/SYSTEM2      CICS
          CICS/APG/SYSTEM3      CICS
          CICSAOR/APG          CICSAOR
          DB2/APG/SYSTEM2      DB2
          DB2/APG/SYSTEM3      DB2
          700         DWHAPG2/APG/SYSTEM2      DWHAPG2
          500         DWHAPG3/APG/SYSTEM3      DWHAPG3
          NET/APG          NET
***** Bottom of data *****

```

Figure 34. Scenario: Select Resources Panel for DWHAPG with Converted Preferences

Note:

You can either set preferences directly in the **Preference** column or use the **Action** column:

- (P)RIMARY sets a primary preference of 700.
- SECON(D)ARY sets a secondary preference of 400.

Press PF3 to return to the Policy Selection panel for DWHAPG. A pop-up window indicated that the preference values have been saved.

Step 3: Creating the Application Groups

Background: Using Preferences to Define Specific Roles

The Resources panel for MOVE groups looks slightly different to the panel for BASIC groups. It has an additional field (**Availability Target**) that cannot be modified, and the second column in the scrollable part of the panel is called **Preferences**. Preferences are used to define specific roles for the resources that are linked to a group.

You want DWHAPG2 on SYSTEM2 be started and, if this fails, you want to start DWHAPG3 on SYSTEM3. To define this, start with preference values 700 for DWHAPG2 and 500 for DWHAPG3. They have the following meaning:

- 700** The resource is started when the group is started. The resource is not stopped unless a very high preference (greater than 950) alternative becomes available. (Use for the resource that normally runs).
- 500** The resource is started when the higher preference alternative becomes unavailable. It continues running when normal preference alternatives (that is, with a value of 700) become available again. It stops at the next (scheduled) outage. (Use for a backup resource).

For more details about preference values, see “RESOURCES Policy Item” on page 129.

The SECON(D)ARY command sets a preference of 400, which has the following meaning:

- 400** Resource is started when the higher preference alternative becomes unavailable. The difference to preference 500 is that the resource is stopped when the normal Preference (700) alternative becomes available again.

25. Select the APPLGROUP INFO policy item and change the **Automatically link Application-Resources** field to N0.
26. Press PF3 to return to the Entry Name Selection panel for application groups.

Application group DWHAPG is now complete. If a start request is issued against DWHAPG, its primary resource DWHAPG2 is started. If DWHAPG2 fails, a start vote is issued against DWHAPG3.

Step 3f: Create Sysplex Application Group WBSRVAPG: In this step you create the Sysplex Application Group WBSRVAPG as a SERVER group.

Background: What Is a SERVER Group?

SERVER groups are created when only a certain number of linked resources need to be available to consider the application group as being available.

A SERVER group with an **Availability Target** of 1 and appropriate preference values can behave like a MOVE group.

A SERVER group with an **Availability Target** of *ALL and all the preferences of its members set to 700 acts like a BASIC group.

The Web server group WBSRVAPG should run only on SYSTEM1. The WBSRV application and the NET application group are essential parts that must be up, but the DB2 application group is not necessarily needed.

1. Enter NEW WBSRVAPG at the command line.
The Define New Entry panel is displayed with the **Entry name** field already as WBSRVAPG.
2. Enter the required values on this panel:
 - a. The WBSRVAPG application group runs mainly on SYSTEM1. However, WBSRVAPG will have some members that run on other systems in the sysplex, so leave the **Application Group Type** field as SYSPLEX.
 - b. WBSRVAPG should start with all of its components, but it is acceptable if DB2 cannot be started. So change the **Nature** of the WBSRVAPG group to SERVER.
 - c. Change the default preference in the **Default Preference** field to 444. This is the initial value for all resources that will be linked automatically.
 - d. For resource generation you need an automation name; so enter WBSRVAPG in the **Automation Name** field.

The input in the Define New Entry panel should now look similar to Figure 35.

```

COMMANDS  HELP
-----
AOFGDYN3          Define New Entry
Command ==> _____ More: +
Define new entry of type ApplicationGroup

Entry Name . . . . . WBSRVAPG
Type . . . . . SYSPLEX (SYSTEM SYSPLEX)
Nature . . . . . SERVER (BASIC MOVE SERVER)
Default Preference . . . 444 (0 to 3200, *DEF)
Automation Name . . . . WBSRVAPG
Automatically link . . . YES (for Application-Resources)
Behaviour . . . . . ACTIVE (ACTIVE PASSIVE)
Prepare Move . . . . . (YES NO)
Move Mode . . . . . (PARALLEL SERIAL)

Short description . . . _____
Long description 1 . . . _____
Long description 2 . . . _____
Long description 3 . . . _____
Long description 4 . . . _____
Long description 5 . . . _____
    
```

Figure 35. Scenario: Define New Entry Input Panel for WBSRVAPG

Step 3: Creating the Application Groups

3. Press PF3 to create WBSRVAPG. The Policy Selection panel for WBSRVAPG is displayed with a message indicating that the application group has been created.
4. On the Policy Selection panel select the WHERE USED policy item. The Where Used panel is displayed with sysplex group SYSPLEX1.
5. Select the sysplex group and press PF3. The Command Progress Display pop-up window shows that the resource WBSRVAPG/APG has been created.
6. Select the APPLICATIONS policy item and select the application WBSRV. Press PF3 to return to the Policy Selection panel for WBSRVAPG. You will be notified that the following resources have been generated:

```
WBSRV/APL/SYSTEM1  
WBSRV/APL/SYSTEM2  
WBSRV/APL/SYSTEM3
```

7. Select the RESOURCES policy item of WBSRVAPG to get to the Select Resources panel for WBSRVAPG.

You can see that the preference for the linked resources is the value that you entered when you created the WBSRVAPG application group.

You can use the **Preference** field to fine-tune the automatic linking of application resources to an application group.

- a. Change the **Show all Resources** field to YES and press Enter to see the complete list of selectable resources.
- b. Now you need to change the preferences so that the WBSRVAPG application group is started on SYSTEM1 with WBSRV and NET as mandatory components and DB2 as optional. To achieve this:
 - 1) Set the **Availability Target** to 2.
 - 2) Enter 1000 in the **Preference** field for the mandatory components (WBSRV/APL/SYSTEM1 and NET/APG).
 - 3) Enter m in the **Action** field for WBSRV/APL/SYSTEM2 and WBSRV/APL/SYSTEM3 to deselect them.
 - 4) Enter a value between 501 and 999 in the **Preference** field for DB2/APG/SYSTEM2 and DB2/APG/SYSTEM3.

When the application group is started, all selected members with at least Preference 600 will also be started, but members with Preference 1000 are mandatory.

If you change the **Show all Resources** field to NO, your definitions should look like Figure 36 on page 57.

Step 3: Creating the Application Groups

```
COMMANDS  ACTIONS  HELP
-----
A0FGARS2          Select Resources          Row 1 to 4 of 4
Command ==> _____ SCROLL==> PAGE

Entry Type : ApplicationGroup      Entry Name : WBSRVAPG
Sysplex   : SYSPLEX1

Number of selected Resources : 4
Availability Target. . . . . 2      (-3 to 4 , *ALL)
Satisfactory Target. . . . . _____ (Level at which group is available)
Show all Resources . . . . . NO      (YES NO)
Show only Resources with String. _____

Action  Preference  Resource Name      Entry Name
-----  -
_____  700             DB2/APG/SYSTEM2   DB2
_____  700             DB2/APG/SYSTEM3   DB2
_____  1000            NET/APG            NET
_____  1000            WBSRV/APL/SYSTEM1 WBSRV
***** Bottom of data *****
```

Figure 36. Scenario: Final Select Resources Panel for WBSRVAPG

- Press PF3, select the APPLGROUP INFO policy item in the Policy Selection panel and change the **Automatically link Application-Resources into APG** field to NO on the Application Group Information panel.

The WBSRVAPG application group is complete. If a start request is issued against WBSRVAPG, both WBSRV and NET must be successfully started for WBSRVAPG to be available.

How to Use Schedules (Service Periods)

You can extend the scenario described in “A Grouping Scenario” on page 31 using service periods that automatically control the startup and shutdown of resources. Service periods can be linked to APLs, APGs, and MTRs.

You will extend the scenario so that:

- The data warehouse application is available from 9 a.m. to 10 p.m.
- The Web server is available from 4 a.m. through 11 p.m.

Three service periods are needed:

- SWBSRV linked to the WBSRVAPG (Web server) application group
- SDWH linked to the DWHAPG (data warehouse) application group
- SDB2DWN linked to the DB2 application group

The SDB2DWN service period should be for the resource to be down 24 hours a day, seven days a week. This will serve to shut down DB2 and CICS when they are not needed to support an application (WBSRV or DWH or anything else that is dependent upon them).

Schedule Override

The Web server needs to be available until midnight. So the operator just needs to override the SWBSRV service period (changing 11 p.m. to 12 a.m.). An appropriate action would be the only one required to reverse the override.

If you do not want to use service periods, you could just issue a high priority request for WBSRVAPG to be available sometime before 11 p.m.. To remove this request at midnight, you could either use INGREQ command with the expiration

How to Use Schedules (Service Periods)

time parameter, which will automatically remove the request. Or, at 12 a.m., you could use the INGVOTE command to remove this request.

Early Start

At 3 a.m. the Web server application needs to be started.

The operator simply creates an override for SWBSRV that says to start the Web server at 3 a.m. and keep it up until 11 p.m.. Everything will then happen automatically. This can be done several hours (or even days) in advance.

If the operator does not want to use service periods to achieve this, he or she just needs to issue a start command against the WBSRVAPG application group and all the required resources will be made available (and kept available) until the operator removes their request (if this is after 4 a.m., the resources will not be stopped because the desired status of the resource will not change. The requested AVAILABLE from the operator will be replaced with a requested AVAILABLE from the schedule).

How to Use Triggers and Events

This section describes a scenario on how to define automatic starts and stops that are based either on fixed time intervals (service periods) or on special conditions (events).

This scenario is based on the environment that you created in “How to Work with Resources” on page 31 and describes:

- What environment you need and when it should be available, see “Scenario Environment and Behavior”
- What policy objects and links you need and why you need them, see “A Possible Solution” on page 59
- How to enter these in the customization dialog (“Implementing the Solution” on page 61)

Note that, like service periods, triggers can be linked to APLs, APGs, and MTRs

Scenario Environment and Behavior

Assume that you are in the environment that you created in “How to Work with Resources” on page 31 and that you want to set up the following CICS applications:

- One terminal-owning region (TOR) on system SYSTEM3
- One application-owning region (AOR) on SYSPLEX1 to support this TOR

They should meet these requirements:

1. Between 7 a.m. and 6 p.m. on weekdays, and 8 a.m. and 2 p.m. on Saturdays:
 - a. The TOR should be available.
 - b. The AOR should be available on one of the systems in SYSPLEX1.
2. Before any of the CICS applications are started, certain related data sets need to be backed up.
3. A TOR does not make sense without an AOR, so you need relationships that ensure that:
 - a. The TOR should not be started until the AOR is available on one of the systems.

- b. If the AOR has to be shut down (for example, in an emergency) so that it is no longer available on *any* of the systems in the sysplex, the TOR must be shut down *first*.

Note:

It does not matter which system the AOR is available on and it need not be the same system throughout the specified periods. Thus it is enough to start the AOR on one of the systems and switch to another system when the AOR cannot or does not continue to run on its current system.

A Possible Solution

Figure 37 shows the policy objects and connections that you need to define in the customization dialog.

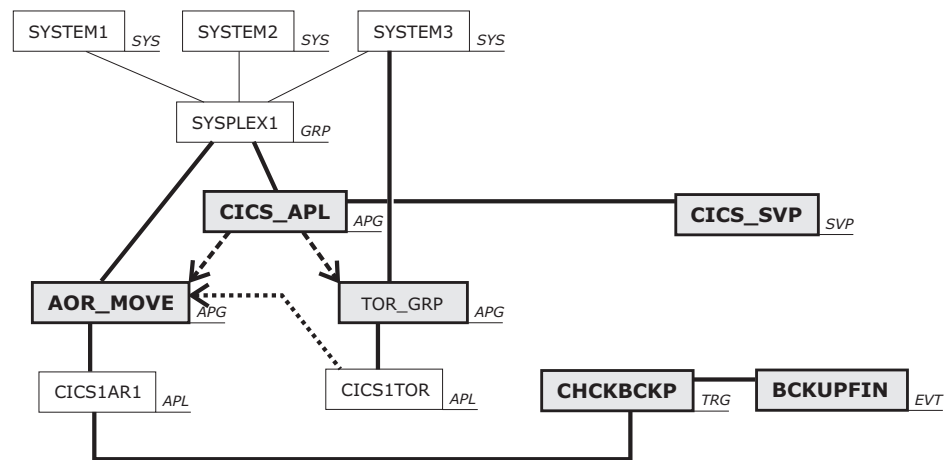

Legend:

A = Policy object defined in a previous scenario

A = Policy object to be defined in *this* scenario

SYS GRP APG APL SVP TRG EVT Entry type abbreviations found on the **Entry Type Selection** panel

For all lines and arrows: thin = defined in a previous scenario
thick = to be defined in *this* scenario

Values: A — B = Link between A and B

Resources: A - - - -> B = The resource generated from A has the resource generated from B as a member resource
= The resource generated from B is a member of the resource generated from A

Relationships: A> B = Every resource generated from A is dependent on one resource generated from B in a HASPARENT relationship

Figure 37. Policy Objects in the Solution

Note:

Some of the policy objects that you need here were already created in “How to Work with Resources” on page 31. So you can start from that existing policy database. If you do, you will have more entries and links in your policy database than are present in Figure 37, but the additional ones will not affect the solution of the current task.

How to Use Triggers and Events

Figure 38 shows the resources that will be generated from your policy objects.

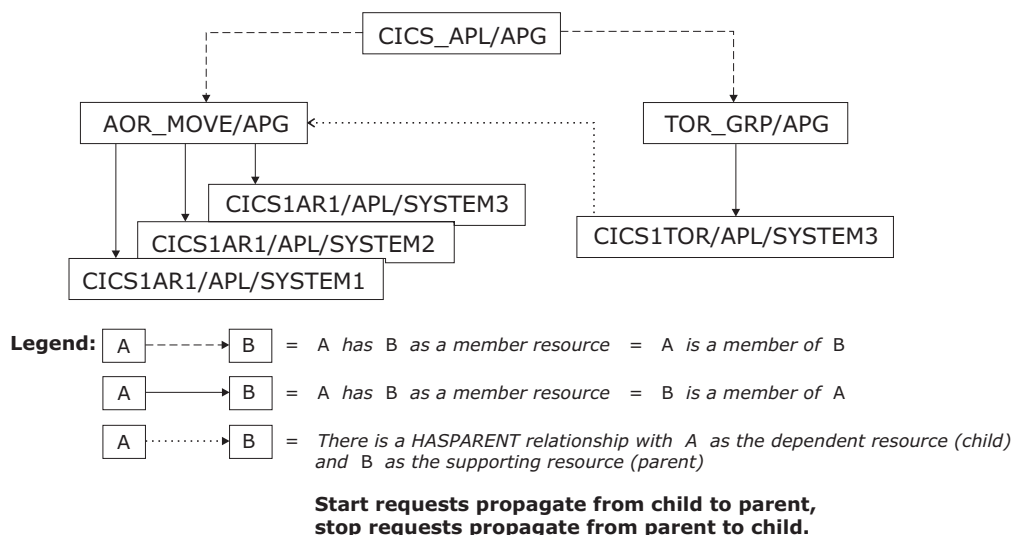

Figure 38. Generated Resources in the Solution

The AOR can run on different systems in the sysplex. This means you create *one* policy object of type APL to represent the AOR, but SA z/OS generates *three* resources from this policy object (one resource per system in the sysplex).

Background:

SA z/OS makes a distinction between applications (policy objects of type APL) and application *resources*.

You define applications in the customization dialog. SA z/OS *generates* application resources from the applications that you define.

You can use the application CICS1AR1 as the AOR, and CICS1TOR for the TOR. You defined both of these in “How to Work with Resources” on page 31.

Resources will only be generated from a policy object if it is linked to a system or sysplex. For entry type APL, the customization dialog does *not* allow you to create a *direct* link. What you need to do is link both the application and the system or sysplex to the same application *group*. In the plan shown in Figure 37 on page 59, this is done as follows:

- Application group AOR_MOVE provides indirect linking between application CICS1AR1 and sysplex SYSPLEX1
- Application group TOR_GRP provides indirect linking between application CICS1TOR and system SYSTEM3.

To have the CICS applications available when required, you need to define a service period (a policy object of type SVP). This is CICS_SVP in Figure 37 on page 59. There are two ways that you can use the service period:

1. Link the service period to both application groups AOR_MOVE and TOR_GRP.
2. Put AOR_MOVE and TOR_GRP together in another application group and link the service period to it.

The plan in Figure 37 on page 59 uses the second method. The application group that groups AOR_MOVE and TOR_GRP is CICS_APL.

To back up the data sets, you need to define an event (a policy object of type EVT) and combine it with a trigger (a policy object of type TRG). In Figure 37 the event is BCKUPFIN and the trigger is CHCKBCKP.

To start and stop the resources in the correct order, you need to define a HASPARENT relationship with a suitable supporting resource. This is an additional move group (policy object of type APG and nature MOVE), which is AOR_MOVE in Figure 37 on page 59.

Implementing the Solution

1. On the Customization Dialog Primary Menu panel, open the policy database that you created in the scenario described in “How to Work with Resources” on page 31.
2. Create a new application group called AOR_MOVE with these values:
 - **Application Group Type:** SYSPLEX
 - **Nature:** MOVE
 - **Automation Name:** AOR_MOVE
3. Use the WHERE USED policy item to link the application group AOR_MOVE to SYSPLEX1.
SA z/OS generates the APG resource: AOR_MOVE/APG
4. Link application CICS1AR1 to application group AOR_MOVE.
SA z/OS generates the following APL resources:
CICS1AR1/APL/SYSTEM1
CICS1AR1/APL/SYSTEM2
CICS1AR1/APL/SYSTEM3
5. In application group AOR_MOVE, select policy item RESOURCES and set the following preferences for the new APL resources:
 - 900 for CICS1AR1/APL/SYSTEM1, so that starting AOR_MOVE/APG starts CICS1AR1/APL/SYSTEM1
 - 600 for CICS1AR1/APL/SYSTEM2, so that it starts if CICS1AR1/APL/SYSTEM1 fails
 - 500 for CICS1AR1/APL/SYSTEM3, so that it starts if CICS1AR1/APL/SYSTEM2 also fails
6. Create a new application group called TOR_GRP with these values:
 - **Application Group Type:** SYSTEM
 - **Nature:** BASIC
 - **Automation Name:** TOR_GRP
7. Use the WHERE USED policy item to link the application group TOR_GRP to system SYSTEM3.
SA z/OS generates the APG resource: TOR_GRP/APG/SYSTEM3
8. Link application CICS1TOR to application group TOR_GRP.
SA z/OS generates the APL resource: CICS1TOR/APL/SYSTEM3
9. Define a HASPARENT relationship between CICS1TOR/APL/SYSTEM3 as the child (dependent resource) and AOR_MOVE/APG as the parent (supporting resource) as follows:
 - a. For application CICS1TOR, select policy item RELATIONSHIPS.

How to Use Triggers and Events

- b. On the Relationship Selection List panel, enter new hasparent at the command line.
 - c. On the Define Relationship panel, enter resource AOR_MOVE/APG in the **Supporting Resource** field.
10. Create a new application group called CICS_APL with these values:
 - **Application Group Type:** SYSPLEX
 - **Nature:** BASIC
 - **Automation Name:** CICS_APL
11. Use the WHERE USED policy item to link application group CICS_APL to group SYSPLEX1.

Result: SA z/OS generates the APG resource: CICS_APL/APG
12. Make TOR_GRP/APG/SYSTEM3 and AOR_MOVE/APG members of CICS_APL/APG as follows:
 - a. In application group CICS_APL, select policy item RESOURCES.
 - b. Overtyping N0 in the **Show all Resources** field with YES and pressing Enter. This displays the resources that have been generated so far.
 - c. Use action s to select the following resources:
 - AOR_MOVE/APG
 - TOR_GRP/APG/SYSTEM3
13. Create a new event called BCKUPFIN.

This event is set whenever the backup process that is required is completed.

Note:

SA z/OS can automatically set this event by trapping message IEF404I from the backup process. Use the INGEVENT command to set events.

14. Select policy item CONDITION and, on the Unset Condition panel that appears, enter the option that suits your needs in the **Unset Condition** field, for example UP.

Background:

The condition for unsetting an event will be checked on the *observed* status. There are eleven possible values for the observed status: six that indicate availability and five that indicate unavailability (see *IBM Tivoli System Automation for z/OS User's Guide* for details). Among those values that indicate availability, there is one named STARTING. The "UP" condition, for example, means: the observed status has a value that indicates availability, but is *not* the value STARTING.

The observed status belongs to generated resources, not to policy objects. In other words: a policy object does not have an observed status. Only the resources that are *generated from* the policy object have an observed status. So there is an observed status for each of the boxes in Figure 38 on page 60, but not for the boxes in Figure 37 on page 59.

As a result of all this, the condition for unsetting an event only has an effect when the event is related to a generated resource because only then is there an observed status that the condition can be checked on.

The only way that an event can be related to generated resources is via a *trigger*, as follows: when the event is linked to a trigger and the trigger is linked to an APL or APG policy object, the event will be *indirectly* related to every resource that is generated from that APL or APG policy object.

The key to understanding the effect of the unset condition is that SA z/OS maintains a *separate* event value for each generated resource that an event is indirectly related to. So an event may be set for one generated resource, but unset for another at the same time.

The effect of UP, for example, is that the event will be unset *for a particular generated resource* as soon as the observed status of *that* particular generated resource is given a value that indicates availability, but is different from the value STARTING.

15. Create a new trigger called CHCKBCKP, then enter trigger details as follows to make the trigger check backup completion before startups:
 - a. On the Policy Selection panel for the new trigger, select policy item CONDITION.
 - b. On the Trigger Conditions panel, select condition STARTUP 1.
 - c. On the STARTUP Condition for Trigger panel that follows, use action s to change the status of event BCKUPFIN to SELECTED.
16. Link trigger CHCKBCKP to application CICS1AR1 as follows:
 - a. Select policy item WHERE USED for trigger CHCKBCKP.
 - b. On the Where Used panel, select the application CICS1AR1.

As a result of linking trigger CHCKBCKP to both application CICS1AR1 and event BCKUPFIN, SA z/OS maintains a separate BCKUPFIN value for each of the three resources that were generated from application CICS1AR1 (that is, CICS1AR1/APL/SYSTEM1, CICS1AR1/APL/SYSTEM2, and CICS1AR1/APL/SYSTEM3). When you use INGEVENT to set the event, you can supply the name of one of these resources so that the event is only set for that particular resource, but remains unset for the others. If you do not supply

How to Use Triggers and Events

a resource parameter with INGEVENT, the event will be set for all three resources. They will, however, still be independent of each other, so they might be unset at different times.

17. Create a service period called CICS_SVP, then enter schedule details as follows:
 - a. On the Policy Selection panel for the new service period, select policy item SERVICE WINDOW.
 - b. On the Service Windows panel, scroll down to SATURDAY and WEEKDAY and fill in the following values:

Saturday	U	08:00	14:00																
	D																		

Weekday	U	07:00	18:00																
	D																		

18. Link service period CICS_SVP to application group CICS_APL as follows:
 - a. For service period CICS_SVP, select policy item WHERE USED.
 - b. On the Where Used panel, select the application group CICS_APL.

How the Solution Works

The key to understanding how this works is the distinction in SA z/OS between starting a resource and setting a resource's desired status to AVAILABLE (see *IBM Tivoli System Automation for z/OS User's Guide* for more information on the concept of desired status).

A desired status of AVAILABLE is a prerequisite for starting a resource, but it may not be enough. Further startup prerequisites may be attached to individual resources, for example, conditions that are implicit in a HASPARENT relationship.

You also need to be aware of what it means to start a resource. For an APL resource, this is obvious: it means that a start order is sent to the appropriate automation agent. For an APG resource, however, it means something different: the start request is propagated to some or all (depending on the APG resource's nature) of its member resources. Provided that the propagated start request wins over any other request that might be simultaneously sent to the same member resource, its desired status is set to AVAILABLE.

The resources in our scenario and the special prerequisites attached to them can be seen in Figure 38 on page 60. This is what happens:

1. Whenever the time of day enters the time window defined for availability in service period CICS_SVP, SA z/OS generates a start request to resource CICS_APL/APG.
2. If this start request wins over any concurrent requests to CICS_APL/APG from elsewhere, SA z/OS sets the desired status of CICS_APL/APG to AVAILABLE.
3. Resource CICS_APL/APG has no further start prerequisites attached to it, so it is started immediately.
4. CICS_APL/APG has a nature of BASIC, so starting CICS_APL/APG means that the start request is propagated to every resource that is a member of it. In this scenario, these are AOR_MOVE/APG and TOR_GRP/APG.
5. If the start request that is propagated to AOR_MOVE/APG and TOR_GRP/APG wins, SA z/OS sets the desired status of both application groups to AVAILABLE.

6. Neither AOR_MOVE/APG nor TOR_GRP/APG has any further start prerequisites attached to it, so they are started immediately.
7. Starting TOR_GRP/APG means that the start request is propagated to its only member, CICS1TOR/APL/SYSTEM3.
8. If the start request that is propagated to CICS1TOR/APL/SYSTEM3 wins, SA z/OS sets its desired status to AVAILABLE.
9. Because of the HASPARENT relationship that is attached to CICS1TOR/APL/SYSTEM3, a desired status of AVAILABLE is not yet enough to start CICS1TOR/APL/SYSTEM3. So nothing happens as long as its supporting resource, AOR_MOVE/APG, has not started up.
10. AOR_MOVE/APG is a *move* group, so starting AOR_MOVE/APG means that the start request is only propagated to *one* of its member resources. This is the one with the highest preference (referred to as its *primary member*). In this scenario, it is CICS1AR1/APL/SYSTEM1.
11. If the start request that is propagated to CICS1AR1/APL/SYSTEM1 wins, SA z/OS sets its desired status to AVAILABLE.
12. Because of the trigger, a desired status of AVAILABLE is not yet enough to start CICS1AR1/APL/SYSTEM1. So nothing happens before its backup event is set. As soon as the event is set for resource CICS1AR1/APL/SYSTEM1, it starts up.
13. Starting CICS1AR1/APL/SYSTEM1 means that the automation manager sends a start order for CICS1AR1/APL/SYSTEM1 to the automation agent on SYSTEM1.
14. When CICS1AR1/APL/SYSTEM1 is fully up and running, the automation agent on SYSTEM1 reports the fact to the automation manager, which sets the *observed* status of CICS1AR1/APL/SYSTEM1 to an observed status value that indicates availability, but is different from STARTING.
15. The new observed status passes up from CICS1AR1/APL/SYSTEM1 to AOR_MOVE/APG. So AOR_MOVE/APG, too, now has an observed status value that indicates availability, but is different from STARTING.
16. This supplies the second startup prerequisite for CICS1TOR/APL/SYSTEM3 that is implicit in its HASPARENT relationship, so CICS1TOR/APL/SYSTEM3 is now started, too.
17. Starting CICS1TOR/APL/SYSTEM3 means that the automation manager sends a start order for CICS1TOR/APL/SYSTEM3 to the automation agent on SYSTEM3.
18. When CICS1TOR/APL/SYSTEM3 is fully up and running, the automation agent on SYSTEM3 report the fact to the automation manager, which sets the *observed* status of CICS1TOR/APL/SYSTEM3 to an observed status value that indicates availability, but is different from STARTING.
19. For the reasons given in step 14 on page 62 and step 16 on page 63, the observed status of CICS1TOR/APL/SYSTEM3 is checked to determine when the BCKUPFIN event for CICS1TOR/APL/SYSTEM3 will be unset.

How to Use User E-T Pairs

This section describes how user-specified data that does not fit into one of the standard entry types (for example, APL, APG, or SYS) can be entered into a policy database and retrieved later on by the automation.

In this example, the data for a job card is modified.

Step 1: Specifying User Data in the Customization Dialog

Select entry type User E-T Pairs (99) from the Entry Type Selection panel. In this example, assume that an entry JOBCARDS for a set of jobcards has already been created. Select this entry.

If you select the E-T DATA policy item from the Policy Selection panel for the JOBCARDS User E-T Pairs, the UET Entry-Type Selection panel similar to Figure 39 is displayed.

```

COMMANDS  ACTIONS  VIEW  HELP
-----
A0FGUET          UET Entry-Type Selection          Row 8 of 13
Command ==>          SCROLL==> PAGE

Entry Type : User E-T Pairs          PolicyDB Name : USER_PDB
Entry Name : JOBCARDS                Enterprise Name : USER_ENTERPRISE

Action  Entry Name          Type
s      JOBCARD              DEFAULTS
      JOBCARD              ICKDSF
      JOBCARD              IDCAMS
      JOBCARD              IMSFUND
      JOBCARD              SENDMAIL
***** Bottom of data *****

```

Figure 39. UET Entry-Type Selection Panel

Enter S for Select in the **Action** column for the User E-T Pairs pair that you want to process. In this example, you want to process the JOBCARD of type DEFAULTS. SA z/OS displays the UET Keyword-Data Specification panel, where you can enter the keywords and user data for each Entry-Type pair data, as shown in Figure 40. For more details about this panel, see “E-T DATA Policy Item” on page 300.

A keyword is an identifier for the data that follows it. The set of keyword/data pairs may be null, and each keyword does not have to be unique; that is, each keyword may have multiple sets of data assigned to it.

```

COMMANDS  HELP
-----
A0FGDYNU  UET Keyword-Data Specification          Line 00000001 Col 001 075
Command ==>          Scroll ==> PAGE

Entry: JOBCARD          Type: DEFAULTS
Mixed case . . . NO_ (YES NO)          Keyword length. . . 20 (1-60)

Cmd Keyword          Data
---
JOBNAME              HAIAOC3*
CLASS                A
MSGCLASS             N
MSGLEVEL              (1,1)
REGION                4096K
***** Bottom of data *****

```

Figure 40. UET Keyword-Data Specification Panel

Step 2: Access the User Data

In a NetView session, you can use the command DISPACF to retrieve the data from the automation control file.

You can also retrieve the data using ACFFQRY from within a REXX script as shown in the following example:

```

Get_keyword: /* name of a subroutine in the REXX ecec */
  Arg keyword .
  len = Length(keyword)
  /* get the data within a pipe */
  'PIPE NetView ACFFQRY JOBCARD DEFAULTS | STEM ALL_DATA.',
  '| SEPARATE | LOCATE 1.' || len' /' || keyword || '/' ,
  '| STEM KEY.'
  If all_data.0 < 1 Then
    Call Terminal_Error 'PIPE 1 Failed'
  If all_data.1 <> 'ACFFQRY:0' Then
    Return
  If key.0 = 0 Then
    Say 'No Match for 'keyword
  Else Do i = 1 to key.0
    Say 'Match! 'key.i
  End

Return

```

This method returns the following data in the pipe:

```

| IPSNO
ACFFQRY:0
JOBCARD DEFAULTS
JOBNAME=HAIAOC3*
CLASS=A
MSGCLASS=N
MSGLEVEL=(1,1)
REGION=4096K

```

After this processing, the data is available in the key. stem variable and you can use it for further processing.

How to Implement Message Processing with User-Defined Data

This section describes how user-defined data is used to automatically execute commands if an application issues a certain message.

Consider the following scenario:

The HSM application issues the ARC0909E message that indicates the utilization percentage of the journal data set. You want to automate recovery of the HSM journal data set if it is more than 97% full. You therefore want SA z/OS to automatically issue two commands to HSM that will perform the recovery:

- **HOLD ALL:** To stop all further activities for HSM.
- **BACKVOL CDS:** To create a backup of the full journal data set and allocate a new one.

To implement this scenario, perform the steps described in the following sections.

Step 1: Specify the User-Defined Data

Select the application that you want to automate the recovery for and then select its MESSAGES/USER DATA policy item. This leads you to the Message Processing panel where you enter the message ID ARC0909E as shown in Figure 41 on page 68.

How to Implement Message Processing with User-Defined Data

specify your input as shown in Figure 43.

```
COMMANDS  HELP
-----
AOFGDYN9  Command Processing : ARC0909E          Line 00000001 Col 001 075
Command ==> _____ Scroll ==> PAGE

Cmd Ps/Select  AutoFn/*  Command Text
-----
_____      _____  MVS F &SUBSJOB, HOLD ALL
_____      _____  MVS F &SUBSJOB, BACKVOL CDS
_____
_____
_____
_____
_____
_____
_____
_____
***** Bottom of data *****
```

Figure 43. Scenario: Command Processing Panel

Step 3: Update the NetView Automation Table

You need to specify a NetView automation table (AT) entry to trigger a REXX script called YOUR_CLIST, which you will create in “Step 4: Write the REXX Script” on page 71.

You can specify the AT entry with the Automation Processing panel to override the predefined AT entry. To do this, enter A or AT in the **Action** column for message ARC0909E in the Message Processing panel, as shown in Figure 44.

```
COMMANDS  HELP
-----
AOFGDYNM          Message Processing          Line 00000001 Col 001 075
Command ==> _____ Scroll ==> PAGE

Entry Type : Application          PolicyDB Name  : USER_PDB
Entry Name  : HSM                 Enterprise Name : USER_ENTERPRISE

Line Commands: S (Cmd), C (Cmd), R (Rep), K (Cod), U (Usr), A (AT), M (MRT)
                I, D (insert or delete lines)
Message ID field length. . 14 (1 - 32)

Cmd Message id  Description          Cmd Rep Cod Usr A M
a  ARC0909E    HSM journal data set utilization    2      1
_____
_____
_____
_____
_____
_____
_____
_____
```

Figure 44. Scenario: Message Processing Panel for AT Entry

This leads to the Message Automation Overview panel, as shown in Figure 45 on page 70. This shows the default values for the message.

How to Implement Message Processing with User-Defined Data

```

COMMANDS  HELP
-----
AOFGMADV          Message Automation Overview          Scroll ==> PAGE
Command ==> _____

AC AT condition   MS MRT action selection   IG Ignore / Suppress via MPF
AS AT status     MO MRT override
AO AT override

Message ID : ARC0909E

Generated AT entry :
IF MSGID = 'ARC0909E' THEN
EXEC(CMD('ISSUEACT') ROUTE(ONE %AOFOPGSSOPER%));

No MRT entry will be generated because there are no specifications for this
message

```

Figure 45. Scenario: Message Automation Overview Panel Default Values

You need to change the action so enter AO at the command line to open the AT entry in an editor and update the entry, as shown in Figure 46.

```

File Edit Edit_Settings Menu Utilities Compilers Test Help
-----
ISREDDE2  USER.USER33.PDB(AOFTMP) - 01.00          Columns 00001 00072
Command ==> _____          Scroll ==> 11
***** ***** Top of Data *****
000001 IF MSGID = 'ARC0909E' THEN
000002 EXEC(CMD('YOUR_CLIST') ROUTE(ONE *));
***** ***** Bottom of Data *****

```

Figure 46. Scenario: Editor with User Values for Automation Table Entry

Saving the entry and pressing PF3 returns you to the Message Automation Overview panel, where you can see that the entry has been updated with your override, as shown in Figure 47

```

COMMANDS  HELP
-----
AOFGMADV          Message Automation Overview          Scroll ==> PAGE
Command ==> _____

AC AT condition   MS MRT action selection   IG Ignore / Suppress via MPF
AS AT status     MO MRT override
AO AT override

Message ID : ARC0909E

Generated AT entry :
IF MSGID = 'ARC0909E' THEN
EXEC(CMD('YOUR_CLIST') ROUTE(ONE *));

```

Figure 47. Scenario: Message Automation Overview with User Values

Alternatively, you can manually specify this automation table entry either in INGMMSGU1 (which is empty, but already included in INGMMSG01), or in your own automation table, which then needs to be specified in the SYSTEM INFO policy for entry type SYS. This entry should be as follows:

```

IF MSGID = 'ARC0909E'
THEN EXEC(CMD('YOUR_CLIST') ROUTE(ONE *));

```

Step 4: Write the REXX Script

The value specified on the User Data Processing panel (Figure 42 on page 68) is accessed in the PIPE statement using the ACFFQRY command and stored in the variable limit (**1**).

To issue the commands specified on the Command Processing panel (Figure 43 on page 69), the ACFCMD command is used (**2**).

```

/* REXX */

/* debugging ... */
.....

lrc = 0

/* Get the message from the safe */
"GETMLINE txt 1"

svmsgid = msgid()
svjobname = jobname()
Parse Var txt . type . ' IS ABOUT ' usage '% ' .

/* This sample recovers just type JRNL */
If type \= 'JRNL' Then Exit 0

/* Check the RECOVERY automation flag */
"AOCQRY "svjobname"."svmsgid" RECOVERY"
lrc = rc

Select
  /* Automation allowed */
  When lrc = 0 Then Do
    /* Get TGlobal variable from AOCQRY */
    "GLOBALV GETT SUBSAPPL"

    /* Get the user-data from the ACF */
    "PIPE (STAGESEP | NAME GETUDATA)" ,
      "NETV ACFFQRY "subsappl","svmsgid , 1
      "| SEPARATE" ,
      "| LOCATE 1.6 /LIMIT=" ,
      "| EDIT 7.2 1" ,
      "| VAR limit"

    /* If no limit was defined use default */
    If symbol('limit') = 'LIT' Then limit = '95'

    /* Check if limit is exceeded. If so, issue commands */
    If usage >= limit Then Do
      "ACFCMD MSGTYP="svmsgid 2
      lrc = rc

      /* Error occurred ? */
      If lrc \= 0 Then Do
        ...
      End
    End
  /* Automation not allowed */
  When lrc < 3 Then Do
    ...
  End
  /* Resource not known to SA */
  When lrc = 3 Then Nop
  /* Error occurred */
  Otherwise Do
    ...

```

How to Implement Message Processing with User-Defined Data

```
    End  
End  
Exit 1rc
```

Chapter 4. Entry Type Reference

This chapter describes how to define SA z/OS entry types. They are described in the following sections in the order they appear on the Entry Type Selection panel shown in Figure 48.

MENU OPTIONS HELP			

AOFGETYP		Entry Type Selection	
Option =====>			
1	ENT	Enterprise	30 TMR Timers
2	GRP	Group	31 TMO Timeout Settings
3	SBG	SubGroup	32 TPA Tape Attendance
4	SYS	System (*)	33 MVC MVS Component
5	APG	ApplicationGroup (*)	34 MDF MVSCOMP Defaults
6	APL	Application (*)	35 SDF System Defaults
7	EVT	Events	36 ADF Application Defaults
8	SVP	Service Periods	37 AOP Automation Operators
9	TRG	Triggers	38 NFY Notify Operators
10	PRO	Processor	39 NTW Network
11	MTR	Monitor Resource (*)	40 XDF Sysplex Defaults
			41 RES Resident CLISTs
20	PRD	Product Automation	42 SCR Status Display
21	MSG	Messages (*)	
			99 UET User E-T Pairs (*)
		(*) Multi-User-Capable	

Figure 48. Entry Type Selection Panel

This chapter discusses the following entry types:

- “Enterprise Entry Type” on page 74
- “Group Entry Type” on page 79
- “SubGroup Entry Type” on page 97
- “System Entry Type” on page 98
- “ApplicationGroup Entry Type” on page 114
- “Application Entry Type” on page 137
- “Events Entry Type” on page 211
- “Service Periods Entry Type” on page 214
- “Triggers Entry Type” on page 217
- “Processor Entry Type” on page 219
- “Monitor Resource Entry Type” on page 229
- “Product Automation Entry Type” on page 240
- “Messages Entry Type” on page 252
- “Timers Entry Type” on page 256
- “Timeout Settings Entry Type” on page 259
- “Tape Attendance Entry Type” on page 261
- “MVS Component Entry Type” on page 264
- “MVSCOMP Defaults Entry Type” on page 271
- “System Defaults Entry Type” on page 272
- “Application Defaults Entry Type” on page 275
- “Automation Operators Entry Type” on page 276
- “Notify Operators Entry Type” on page 281
- “Network Entry Type” on page 284
- “Sysplex Defaults Entry Type” on page 293
- “Resident CLISTs Entry Type” on page 295
- “Status Display Entry Type” on page 296
- “User E-T Pairs Entry Type” on page 299

Enterprise Entry Type

You can define one enterprise for each policy database. An enterprise definition includes:

- Enterprise description
- Operator profile and command parameters for INGSSEND
- Processor operations focal point information

Policy Items for an Enterprise

Figure 49 shows the policy items that are displayed when Enterprise is selected from the Entry Type Selection panel.

```

ACTIONS  HELP
-----
AOFGEPOL          Policy Selection          Row 1 to 9 of 9
Command ==>>>          SCROLL==>>> PAGE

Entry Type : Enterprise          PolicyDB Name : USER_PDB
Entry Name : MY_NEW_ENTERPRISE  Enterprise Name : USER_ENTERPRISE

Action      Policy Name      Policy Description
-----
DESCRIPTION      Enter description
SEND COMMAND OPERS  Define Operator Profile for sending commands
INGSSEND PARMS    Define INGSSEND Command Parms
PROCOPS FOCAL POINTS  Define processor operations focal point info
AUTO MSG CLASSES   Define Auto Msg Classes
SYMBOL DESCRIPTION  Enter system automation symbol description
DOCUMENTATION      Overall Policy Database documentation
***** Bottom of data *****

```

Figure 49. Policy Selection Panel for Enterprises

The policy items for Enterprises are:

SEND COMMAND OPERS

This policy item allows you to define default RMTCMD autotasks for operators sending commands to target domains, so that they do not have to remember which target operator ID to use for a particular domain. This gives you more flexibility than the RMTCMD default of taking the task ID of the issuing operator.

These definitions are also used for cross domain command routing to systems that are outside the local sysplex. This is valid for all operator commands supporting the TARGET parameter.

For more information, see “SEND COMMAND OPERS Policy Item” on page 75.

INGSSEND PARMS

This policy item allows you to define default parameters for the INGSSEND command.

For more information see “INGSSEND PARMS Policy Item” on page 76.

PROCOPS FOCAL POINTS

This policy item allows you to define focal point domain IDs. For more information, see “PROCOPS FOCAL POINTS Policy Item” on page 77.

AUTO MSG CLASSES

This policy item allows you to define your own message classes. Message classes that are defined here can be assigned to operators by using policy

NOTIFY OPERATORS of the entry type NFY. For more information, see "AUTO MSG CLASSES Policy Item" on page 78.

SYMBOL DESCRIPTION

This policy item allows you to enter system automation symbol descriptions. For more information, see "SYMBOL DESCRIPTION Policy Item" on page 79.

DOCUMENTATION

This policy item allows you to enter or update any text with the ISPF editor. You can use it to:

- Enter overall policy database descriptions
- View documentation that is shipped together with predefined SA z/OS sample add-on policies

Note:
The policy database is locked for updates by other users while you are editing data in this policy item.

SEND COMMAND OPERS Policy Item

Figure 50 shows the panel that is displayed when the SEND COMMAND OPERS policy item is selected.

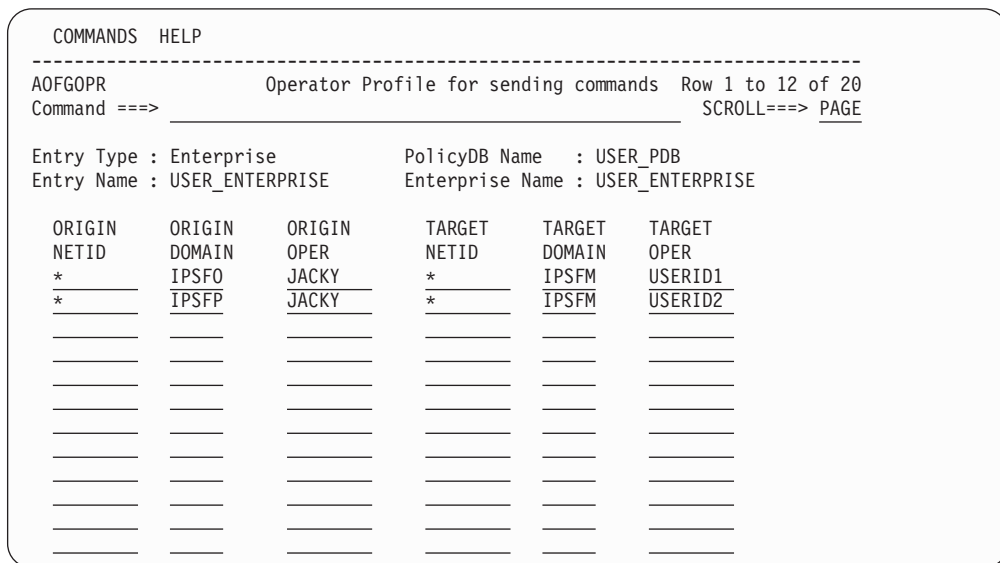

Figure 50. Operator Profile for Sending Commands Panel

This policy item allows you to define default RMTCMD autotasks for operators sending commands to target domains, so that they do not have to remember which target operator ID to use for a particular domain. This gives you more flexibility than the RMTCMD default of taking the task ID of the issuing operator.

These definitions are also used for cross domain command routing to systems that are outside the local sysplex. This is valid for all operator commands supporting the TARGET parameter.

This policy item is intended to help you migrate your cross domain command routing to RMTCMD by allowing you to use any naming scheme for RMTCMD autotasks. By default, RMTCMD uses the operator ID of the invoking task to

SEND COMMAND OPERS Policy Item for Enterprises

determine the RMTCMD autotask to issue a command to. Use the Operator Profile for Sending Commands panel to define an association between an origin operator and a target RMTCMD autotask. The INGSEND command uses predefined RMTCMD associations to resolve the OPER keyword (target operator ID to execute the routed command), if it has not been specified on an invocation. If INGSEND does not find an RMTCMD association for the invoking operator to the target domain in the automation control file, the RMTCMD default will be used to resolve the target operator ID. For more information on INGSEND, see *IBM Tivoli System Automation for z/OS User's Guide* and *IBM Tivoli System Automation for z/OS Operator's Commands*. For more information on RMTCMD, see *Tivoli NetView for z/OS Command Reference Volume 1*.

The definitions you enter here apply to all systems in the enterprise. They are included in the automation control file built for each system. At run time, INGSEND on each origin domain will use only the information intended for that particular origin Netid.Domain.

On the Operator Profile for Sending Commands panel (Figure 50 on page 75), the following fields are defined for both origin and target:

NETID

The Network ID is optional. The maximum length is eight characters. The first character must be alphanumeric. The rest must be either alphanumeric or national characters.

DOMAIN

The NetView Domain ID is optional. The maximum length is five characters. The first character must be alphanumeric. The rest must be either alphanumeric or national characters.

OPER The Origin Operator ID is required. The maximum length is eight characters.

The Target Operator ID is optional. If entered, it must be eight characters or less. If the field is left blank, it will resolve to the ORIGIN OPER value.

The operator ID you define here should have matching OPERATOR statements in the relevant DSIOPF for each origin and target domain.

Note:

For TARGET OPER, PPT or target domain concatenated with PPT is not allowed.

A wildcard character, *, can be used for NETID and DOMAIN. All fields are optional except for ORIGIN OPER. TARGET OPER will resolve to ORIGIN OPER if it is not entered. This is the NetView default.

INGSEND PARMS Policy Item

If you select policy item INGSEND PARMS from the Policy Selection panel for enterprises, a panel similar to Figure 51 on page 77 is shown.

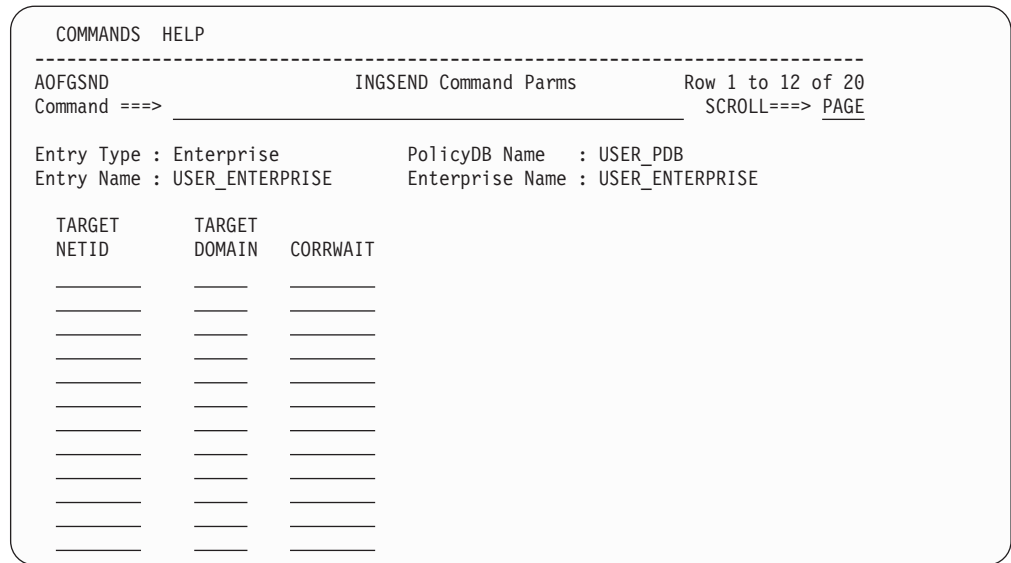

Figure 51. INGSND Command Params Panel

The System Operations INGSND command is used to route commands across domains. Only one command routing mechanism is supported: the NetView RMTCMD command.

RMTCMD-based INGSND invocations can involve usage of the NetView PIPE command. Because RMTCMD produces asynchronous command output, it is necessary to use the CORRWAIT Pipe stage to trap the asynchronous messages. You can customize the CORRWAIT time that INGSND uses per target domain.

Use wildcards for target netid and domain to specify the predominant CRM in your enterprise.

TARGET NETID

The Target Network ID is optional and, if entered, must be eight characters or less. The first character must be alphanumeric. The rest must be either alphanumeric or national characters. If left blank, it defaults to the wildcard value of '*'.

TARGET DOMAIN

The Target Domain is optional and, if entered, must be five characters or less. The first character must be alphanumeric. The rest must be either alphanumeric or national characters. If left blank, it defaults to the wildcard value of '*'.

Wildcard value of '*' is allowed.

CORRWAIT

The corrwait value is optional. This value is used by INGSND for the NetView PIPE CORRWAIT stage. If left blank, it defaults to 10 seconds.

PROCOPS FOCAL POINTS Policy Item

A panel, as shown in Figure 52 on page 78, is displayed if you select policy item PROCOPS FOCAL POINTS from the Policy Selection panel for enterprises.

PROCOPS FOCAL POINTS Policy Item for Enterprises

```
COMMANDS  HELP
-----
ISQDPD02      Processor Operations Focal Point Information
Command ==>

Entry Type : Enterprise      PolicyDB Name  : USER_PDB
Entry Name  : USER_ENTERPRISE Enterprise Name : USER_ENTERPRISE

Primary focal point name . . . _____
Backup focal point name . . . _____
```

Figure 52. Processor Operations Focal Point Information Panel

The panel contains the following fields:

Primary/Backup focal point name

Enter the domain name of the primary and backup NetView that is hosting processor operations. The customization dialog does not verify your entry.

This name is shown in the processor operations ISQXDST status display command.

AUTO MSG CLASSES Policy Item

A panel, as shown in Figure 53, is displayed if you select policy item AUTO MSG CLASSES on the Policy Selection panel for enterprises.

```
COMMANDS  HELP
-----
AOFPIEM0      User Auto Messages Classes      Row 1 to 10 of 20
Command ==> _____ SCROLL==> PAGE

Entry Type : Enterprise      PolicyDB Name  : USER_PDB
Entry Name  : USER_ENTERPRISE Enterprise Name : USER_ENTERPRISE

Define message classes by entering the class and its description.
Do not use any of the pre-defined SA z/OS message classes.
Message      Description
Class
-----
_____
_____
_____
_____
_____
_____
_____
_____
_____
_____
```

Figure 53. AUTO MSG CLASSES Panel

This panel defines the user message classes that are available to be assigned to notify operators by using policy NOTIFY OPERATORS of entry type NFY. The Auto Msg Classes entry type allows you to define your own message classes.

You can also enter a short description of each message class. Message classes must consist of an alpha and a numeric character. All double numeric message classes are reserved for use by IBM. See “Notify Operators Entry Type” on page 281 for more information on the message classes that SA z/OS defines.

Notes®:

1. No duplicate message classes are allowed.
2. Message classes used within any Notify Operators cannot be deleted.

For details about the definition restrictions of message classes, see the SA z/OS online help.

SYMBOL DESCRIPTION Policy Item

If you select policy item SYMBOL DESCRIPTION from the Policy Selection panel for enterprises, a panel similar to Figure 54 is shown.

```

COMMANDS  HELP
-----
AOFGSYMD      System Automation Symbols (AOCCLONEx) Description
Command ==> _____

Entry Type : Enterprise          PolicyDB Name : USER_PDB
Entry Name : USER_ENTERPRISE    Enterprise Name : USER_ENTERPRISE
                                           More:      +

General Use of
AOCCLONE . . . . Used for VTAM startlist suffix
AOCCLONE1 . . . . _____
AOCCLONE2 . . . . _____
AOCCLONE3 . . . . _____
AOCCLONE4 . . . . _____
AOCCLONE5 . . . . _____
AOCCLONE6 . . . . _____
AOCCLONE7 . . . . _____
AOCCLONE8 . . . . _____
AOCCLONE9 . . . . _____
AOCCLONEA . . . . _____
AOCCLONEB . . . . _____
AOCCLONEC . . . . _____
    
```

Figure 54. System Automation Symbols (AOCCLONEx) Description Panel

This panel allows you to enter the description of the general use of each system automation symbol.

AOCCLONEx

This allows you to describe the general use of each system automation symbol. This description is shown in the AUTOMATION SYMBOLS policy of all systems (entry type SYS) in the policy database.

Group Entry Type

A group is the largest subdivision of an SA z/OS enterprise. It is a set of systems or subgroups, or both, that you want to associate with one another for purposes of automation, monitoring on the NMC workstation or that you want to use with the SA z/OS processor operations functions. An SA z/OS enterprise may have many groups, each consisting of one or more systems and subgroups. You define a group by assigning a name to it and by selecting the member systems and subgroups.

The status of a group depends on the status of the systems or applications that it is comprised of. The status of a group is indicated by appropriate colors on the NMC workstation. You specify the number of systems or applications of a group that must be in an unsatisfactory state to cause SA z/OS to change the color of a group in the graphic display.

Creating a New Group

How to create new policy objects in general, is described in “How to Create New Policy Objects” on page 19.

Groups can be defined as either *standard groups* or *sysplex groups*. A standard group contains any combination of systems and subgroups. A sysplex group contains only systems or subgroups that belong to the same XCF group. For a sysplex group, there are additional policy items to describe certain sysplex-specific resources. A sysplex group may also have Sysplex Application Groups connected to it. Sysplex Application Groups are groups of applications that can be located on more than one system in the sysplex. A group must be defined as either a sysplex group or a standard group when it is created. Figure 55 is an example of the Define New Entry panel for groups.

A system may belong to many standard groups, but can belong to only one sysplex group.

If you want to monitor your newly created sysplex group on the NMC workstation, you need to specify an entry for this sysplex in the INGTOPOF file (see *IBM Tivoli System Automation for z/OS Planning and Installation*).

```
COMMANDS  HELP
-----
AOFGDYN2          Define New Entry
Command ==> _____

Define new entry of type Group

Entry name . . . . . SYSPLEX_1
Group Type . . . . . SYSPLEX (STANDARD SYSPLEX)
ProcOps Commands . . . . NO (YES NO)

Short description . . . _____
Long description 1 . . . _____
Long description 2 . . . _____
Long description 3 . . . _____
Long description 4 . . . _____
Long description 5 . . . _____
```

Figure 55. Define New Entry Panel for a Sysplex Group

The unique fields are:

Entry name

| This is the name of the entry as used by the SA z/OS dialogs. Each group
| must be assigned a unique, non-blank name. The name must be unique
| among the names of all groups, subgroups, systems (including both the
| entry names and the system/image names), and processors in the current
| policy database.

Note:

This name can be used in the TARGET parameter of SA z/OS commands. If the specified name is longer than 8 characters, truncation of the name may occur on certain SA z/OS fullscreen command panels.

When running in local mode (sysplex() function returns LOCAL) you must define a Group name if you want to use SA z/OS commands that target other systems via the TARGET parameter.

Group type

Use this field to specify the type of group you want to create. You can create either a Sysplex group if the group is to be associated with a sysplex, or a Standard group. Each type of group has specific policy items and restrictions associated with it. The value you enter here cannot be changed after the group is created.

The available values are:

SYSPLEX

If the Group is being used to represent a logical sysplex (a group of systems within the same XCF group ID).

STANDARD

For all other Groups, for example, to represent a physical sysplex (a group of systems within different XCF group IDs, such as a GDPS® site).

ProcOps Commands

Indicates whether processor operations commands issued against this group are to be accepted for processing. The default is NO. See *IBM Tivoli System Automation for z/OS Operator's Commands* for information about the processor operations commands.

Note:

If you specify YES, a processor operations command directed to that group will affect all systems in that group, even if those systems are associated with a subgroup of the group and that subgroup is **not** enabled for processor operations commands.

Policy Items for Standard Groups

Figure 56 on page 82 shows the policy items that are displayed for a standard group.

Policy Items for Standard Groups

```

ACTIONS  HELP
-----
AOFGEPOL                               Policy Selection                               Row 1 of 6
Command ==> _____                SCROLL==> PAGE

Entry Type : Group                      PolicyDB Name   : USER_PDB
Entry Name  : STANDARD_GROUP            Enterprise Name : USER_ENTERPRISE

Action      Policy Name      Policy Description
-----
            DESCRIPTION     Enter description
            GROUP INFO      Define group information
            SUBGROUPS       Select subgroups for group
            SYSTEMS         Select systems for group
            -----
            COPY             Copy data from an existing entry
            ***** Bottom of data *****

```

Figure 56. Policy Selection Panel for Standard Groups

The unique policy items for groups are:

GROUP INFO

This displays the type of group that was specified when the group was created. This can be either standard or sysplex. It also displays and allows you to update the current value of the processor operations commands indicator.

For more information, see “GROUP INFO Policy Item” on page 84.

SUBGROUPS

When you select this policy item, a list of all subgroups in the SA z/OS enterprise is displayed. Those subgroups that are related to the current group are marked with SELECT. You can add subgroups to the group, or remove subgroups from the group.

For more information, see “SUBGROUPS Policy Item” on page 85.

SYSTEMS

When you select this policy item, it displays a list of all systems in the SA z/OS enterprise. SELECTED in the **Status** column indicates the systems that have been linked to the group. You can add systems to or remove systems from the group.

For more information, see “SYSTEMS Policy Item” on page 85.

Policy Items for Sysplex Groups

You define a sysplex group when creating a new group object by specifying sysplex in the **Group Type** field of the Define New Entry panel. There are certain restrictions for sysplex groups:

- A system can be linked to only one sysplex group. The same system can be linked to other standard groups. This applies if the system is linked directly to the system group, or indirectly through a subgroup.
- A subgroup may be linked to only one sysplex group.

Figure 57 on page 83 is an example of the Policy Selection panel for Sysplex groups.

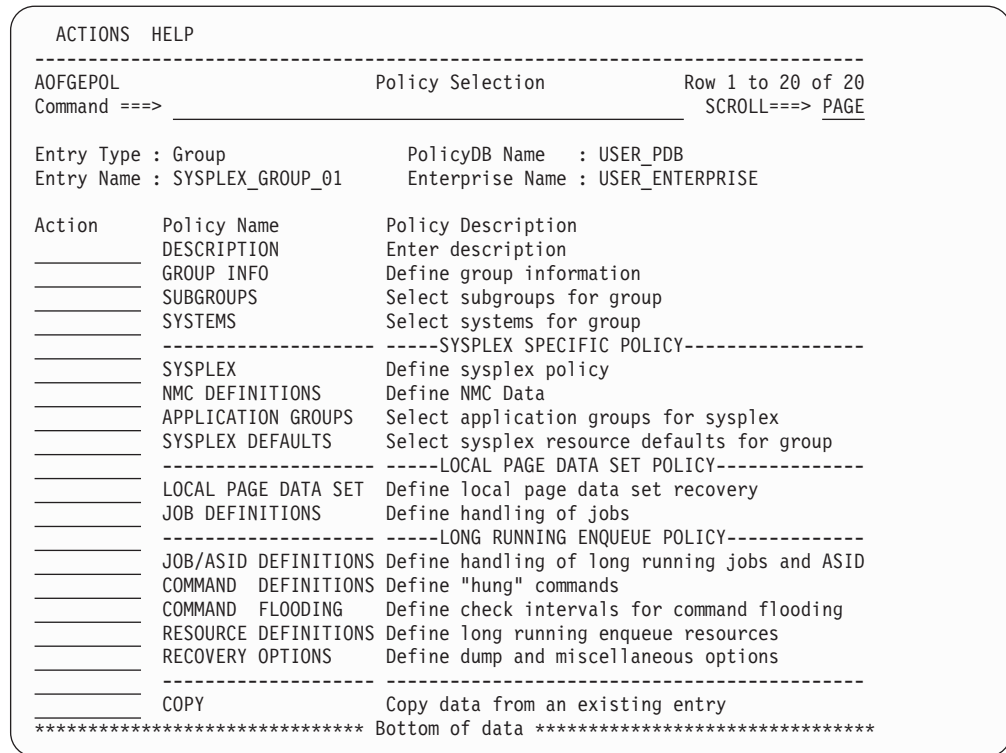

Figure 57. Policy Selection Panel for Sysplex Groups

The policy items for sysplex groups are the same as those for standard groups with the following additions:

SYSPLEX

This policy item allows you to describe certain resources associated with the sysplex. For more information, see “SYSPLEX Policy Item” on page 86.

NMC DEFINITIONS

This policy item allows you to make NMC definitions for the primary and secondary NMC Focal Point™ Domains. For more information, see “NMC DEFINITIONS Policy Item” on page 88.

APPLICATION GROUPS

This policy item displays a list of all Sysplex Application Groups, indicating which application groups are selected for this sysplex. For more information, see “APPLICATION GROUPS Policy Item” on page 89.

SYSPLEX DEFAULTS

When you select this policy item, it displays a list of all Sysplex Defaults entries in the enterprise. SELECTED in the **Status** column indicates the Sysplex Defaults entry that has been linked to the group. You can add a Sysplex Defaults set to or remove it from the group but only one set can be linked. For more information, see “Sysplex Defaults Entry Type” on page 293.

LOCAL PAGE DATA SET

With this policy item you can predefine local page data sets that are used in recovery situations to prevent auxiliary storage shortage outages. For more information, see “LOCAL PAGE DATA SET Policy Item” on page 90.

JOB DEFINITIONS

With this policy item you can define the jobs that can or cannot be

Policy Items for Sysplex Groups

canceled (KEEP/CANCEL), in case the job is responsible for the shortage condition. For more information, see “JOB DEFINITIONS Policy Item” on page 91.

JOB/ASID DEFINITIONS

With this policy item you can define the jobs and address space IDs that can or cannot be canceled. You can specify KEEP if the job must not be canceled, DUMP to dump the job after the wait time has expired, or NODUMP to suppress the dump before the job is canceled.

For more information, see “JOB/ASID DEFINITIONS Policy Item” on page 92.

COMMAND DEFINITIONS

With this policy item you can define which commands you want to monitor and define a maximum time that a command can be blocked by a job or another command before recovery action takes place.

You can also specify an action (KEEP, DUMP or NODUMP) to be taken against this command if it is found to be blocking other commands from executing.

For more information, see “COMMAND DEFINITIONS Policy Item” on page 93.

COMMAND FLOODING

With this policy item you can define individually the interval time for snapshot processing for each command class. When message IEE806A triggers the recovery, the first snapshot is taken after the interval has expired.

For more information, see “COMMAND FLOODING Policy Item” on page 94.

RESOURCE DEFINITIONS

With this policy item you can define DUMP and other miscellaneous recovery options, including the message delay time for message ING920I (issued when option KEEP is specified), and IEADMCxx symbols.

For more information, see “RESOURCE DEFINITIONS Policy Item” on page 95.

RECOVERY OPTIONS

With this policy item you can define DUMP and other miscellaneous recovery options including message delay time for message ING920I (issued when option KEEP is specified), and IEADMCxx symbols.

For more information, see “RECOVERY OPTIONS Policy Item” on page 95.

GROUP INFO Policy Item

A panel, as shown in Figure 58 on page 85, is displayed if you select policy item GROUP INFO on the Policy Selection panel for standard groups. (If the group type was defined as sysplex, this is reflected in the panel.)

```

COMMANDS  HELP
-----
A0FGGPA0          Group Information
Command ==> _____

Entry Type : Group          PolicyDB Name  : USER_PDB
Entry Name  : STANDARD_GROUP Enterprise Name : USER_ENTERPRISE

The following field was specified when the Group was defined
and cannot be modified:
Group Type : STANDARD

ProcOps Commands . . . . NO (YES NO)
    
```

Figure 58. Group Information Panel for Standard Groups

This panel displays the following information:

Group Type

This field cannot be changed; it was set when this group was created. For more details, see “Group Type” on page 81.

ProcOps Commands

For more details, see “ProcOps Commands ” on page 81.

SUBGROUPS Policy Item

A panel, as shown in Figure 59, is displayed if you select policy item SUBGROUPS on the Policy Selection panel for standard groups. (If the group type was defined as sysplex, this is reflected in the panel.)

```

COMMANDS  ACTIONS  VIEW  HELP
-----
A0FGXC4E          SubGroups for Group          Row 1 to 2 of 2
Command ==> _____          SCROLL==> PAGE

Entry Type : Group          PolicyDB Name  : USER_PDB
Entry Name  : STANDARD_GROUP Enterprise Name : USER_ENTERPRISE

Action      Status          SubGroup
-----
          FOCAL_POINT_SUBGROUP
          TARGET_SUBGROUP
***** Bottom of data *****
    
```

Figure 59. Subgroups Panel for Standard Groups

This panel allows you to manage the links between the current Group entry and the SubGroups entries. From this panel you can:

- Add a link between the entries with the ADD (A) command in the **Action** column.
- Remove a link between the entries with the REMOVE (M) command in the **Action** column.

SYSTEMS Policy Item

A panel, as shown in Figure 60 on page 86, is displayed if you select policy item SYSTEMS on the Policy Selection panel for standard groups. (If the group type was defined as sysplex, this is reflected in the panel.)

SYSTEMS Policy Item for Groups

```

COMMANDS  ACTIONS  VIEW  HELP
-----
A0FGXC4E          Systems for Group                      Row 1 of 4
Command ==> _____ SCROLL==> PAGE

Entry Type : Group          PolicyDB Name : USER_PDB
Entry Name : STANDARD_GROUP Enterprise Name : USER_ENTERPRISE

Action      Status          System
-----
_____    SELECTED        SAMPLE_SYSTEM_01
_____
_____
_____
***** Bottom of data *****

```

Figure 60. Systems Panel for Standard Groups

This panel allows you to manage the links between the current Group entry and Systems entries. From this panel you can:

- Add a link between the entries with the ADD (A) command in the **Action** column.
- Remove a link between the entries with the REMOVE (M) command in the **Action** column.

SYSPLEX Policy Item

A panel, as shown in Figure 61, is displayed if you select policy item SYSPLEX on the Policy Selection panel for sysplexes.

```

COMMANDS  HELP
-----
A0FGGPB0          Sysplex Policy Definition
Command ==> _____

Entry Type : Group          PolicyDB Name : USER_PDB
Entry Name : SYSPLEX_GROUP_01 Enterprise Name : USER_ENTERPRISE

Sysplex Name. . . . . _____
Sysplex Timer Monitoring. . . . . YES NO
Number Monitored Sysplex Timers . . . . . 1 2
Temporary Data Set HLQ. . . . . _____
                                          Data set HLQ (max. 17 chars)

Started Task Job Name . . . . . _____
Couple Data Set HLQ . . . . . _____

CDS type  Alternate volumes          Desired monitoring
Sysplex   _____               (PRIMARY ALTERNATE NONE)
ARM       _____               PRIMARY
CFRM     _____               NONE
LOGR     _____               NONE
SFM      _____               NONE
WLM      _____

```

Figure 61. Sysplex Policy Definition Panel for Sysplex Groups

The fields on the Sysplex Policy Definition panel are as follows:

Sysplex Name

Defines the name of the sysplex.

Sysplex Timer[®] Monitoring

If you have one or more sysplex timers in your sysplex and you want them monitored by the NMC workstation, enter YES and specify the number of monitored sysplex timers in the next field. Enter NO, if you do not want monitoring. This is the default.

Number Monitored Sysplex Timers

Enter 2 if you are using the sysplex timer with the Expanded Availability Option and you want to have two sysplex timers monitored by the NMC workstation. Enter 1 if you only want one sysplex timer monitored.

Temporary Data Set HLQ

Defines the high level qualifier to be used to assemble a data set name for allocating temporary data sets needed by programs running as started tasks. The qualifier can consist of up to 17 characters according to the z/OS data set naming rules (hlq1.hlq2.hlq3). Specify the name without quotes.

Started Task Job Name

Defines the job name to be used for programs running as started tasks. The name can consist of up to 8 characters according to the z/OS job naming rules.

Couple Data Set HLQ

Specify the high level qualifier to be used for the allocation of alternate couple data sets (CDS). The qualifier can consist of up to three parts according to the z/OS data set naming rules. When allocating an alternate CDS, this qualifier is appended with the type (for example, SYSPLEX) and CDS0*n*, where *n* is a sequence number.

CDS type Alternate volumes

Specify the types of couple data sets to be used, and the monitoring to be done.

The types of supported couple data sets are:

Sysplex

Contains the policy and status for basic sysplex functions and points to the other couple data sets.

ARM Contains the policy for automatic restart management.

CFRM Contains the policy for coupling facility resource management.

LOGR Contains an inventory for the sysplex logger function.

SFM Contains the policy for sysplex failure management.

WLM Contains the policy for the workload manager.

In the **Alternate volumes** column you can enter up to 8 volume names for allocating alternate couple data sets for types Sysplex, ARM, CFRM, LOGR and SFM (you cannot specify any alternate volumes for WLM). The names must be in accordance with the z/OS volume naming rules. When allocating alternate couple data sets, the allocation starts at the first specified volume and continues in the specified order.

Desired monitoring

The information you enter in this column determines when the SA z/OS NMC workstation displays the associated icon for a couple data set as satisfactory or unsatisfactory. For example, if you have a couple data set QUAL1.ARM.CDS0 that you want to be monitored as PRIMARY, but currently this data set is not available because the operator had to switch to an alternate ARM CDS, the icon for QUAL1.ARM.CDS0 is marked as being unsatisfactory (colored red).

SYSPLEX Policy Item for Groups

You specify the monitoring that is to be done for each type of couple data set as follows:

ALTERNATE

Indicates that you want to monitor both the primary and the alternate data set. In this case, when either the primary or the alternate fails, the related icon will turn red.

PRIMARY

Indicates that you want to monitor only the primary couple data set. In this case, there is only one icon (for the primary CDS) on the NMC workstation and the operator will only see when the primary itself is unavailable, no matter whether an alternate CDS is available to take over.

NONE

Indicates that none of the couple data sets are monitored. This is the default for all types of CDSs, except for the sysplex CDS. The default for the sysplex CDS is PRIMARY.

NMC DEFINITIONS Policy Item

A panel as shown in Figure 62 is displayed if you select policy item NMC DEFINITIONS on the Policy Selection panel for sysplexes.

```
COMMANDS  HELP
-----
AOFGNMC          NMC Definitions          Row 1 to 10 of 20
Command ==> _____ SCROLL==> PAGE

Entry Type : Group          PolicyDB Name : USER_PDB
Entry Name : SYSPLEX_GROUP_01 Enterprise Name : USER_ENTERPRISE

NMC Focal Points. . DOMS1,DOMS2
-----
Anchor   Description
-----
WTOR     NMC anchor for WTORs
TAPE     NMC anchor for tape mount requests
SYSPLEX  NMC anchor for sysplex related events
CRITMSG  NMC anchor for critical messages
-----
-----
-----
-----
-----
-----
-----
-----
-----
-----
```

Figure 62. NMC Definitions Panel for Sysplex Groups

The NMC Definitions panel displays the following information:

NMC Focal Points

Defines a list of NetView domain IDs that act as focal points. The domain IDs should be in the form 'netid.domain' or 'domain' and be separated by commas. You can include system symbols and system automation symbols.

Anchor

Allows you to specify anchors that are special objects in RODM and displayed on the topology client of the SA z/OS Graphic Interface. They are used to display and group minor resources that are derived from events such as WTORs and tape mount requests.

NMC DEFINITIONS Policy Item for Groups

Anchors are special objects that exist in RODM. They are displayed as icons on the NMC topology client. They are not automated by the automation manager. They play the role of major resources and serve these purposes:

- Anchors are used to display and group minor resources that are derived from events such as WTORS and tape mount requests.
- Lost&Found anchors are used to display minor resources that either the specified major resource or sysplex anchor does not exist for in RODM.
- Couple data sets (CDSs), coupling facilities (CFs) and external timer references (ETRs) are displayed as minor resources and are attached to the sysplex anchor.
- It is possible to attach a minor resource to a user-defined anchor with the INGPOST command. The major resource specified to INGPOST can be a regular resource (for example, APL, APG, SYS, etc.) or an anchor.
- Heartbeats (minor resources) are attached to a heartbeat anchor.

Specify the name of an anchor on this panel for these cases:

- To enable the display of WTORS and tape mount requests in the NMC topology client, the anchor names that must be specified are WTOR and TAPE respectively
- To define a sysplex anchor for 'homeless' minor resources, or to display CDSs, CFs, and ETRs, the name of the sysplex anchor is SYSPLEX
- To display minor resources that are created with INGPOST. The name used for the resource= parameter should be the name of the anchor that is specified here. For example, with resource=ANCHOR/MJR/CRITMSG the name of the anchor is CRITMSG

Do *not* specify an anchor on this panel for:

- Heartbeats. The anchor is automatically created by SA z/OS.
- Lost&Found anchors.

Description

Allows you to specify a description for the anchor. The value is only shown in the SA z/OS customization dialog panel. It is not displayed in the SA z/OS Graphic Interface.

APPLICATION GROUPS Policy Item

A panel, as shown in Figure 63 on page 90, is displayed if you select policy item APPLICATION GROUPS on the Policy Selection panel for sysplex groups.

APPLICATION GROUPS Policy Item for Groups

```

COMMANDS  ACTIONS  VIEW  HELP
-----
A0FGXC4E          Sysplex ApplGroups for Sysplex          Row 1 of 10
Command ==> _____          SCROLL==> PAGE

Entry Type : Group          PolicyDB Name : USER_PDB
Entry Name : SYSPLEX_GROUP_01      Enterprise Name : USER_ENTERPRISE

Action      Status          Sysplex ApplGroup
-----
_____    SELECTED        APPL_GROUP_MOVE
_____    SELECTED        APPL_GROUP_NAME
_____    SELECTED        APPLGR_DB531
_____    SELECTED        APPLGR_SGPLEX
_____    SELECTED        DB2_GROUP
_____    SELECTED        IMS7_XRF
_____    SELECTED        IMS711_GRP
_____    SELECTED        IMS721_GRP
_____    SELECTED        OPC_OBSERVER
_____    SELECTED        SYSPLEX_APPLGROUP
***** Bottom of data *****

```

Figure 63. Group Information Panel for Standard Groups

This panel allows you to manage the links between the current Sysplex entry and Sysplex ApplGroups entries.

LOCAL PAGE DATA SET Policy Item

With the automation of local page data sets, SA z/OS prevents auxiliary storage shortage outages, by dynamically allocating spare local page data sets when needed. When you select the LOCAL PAGE DATA SET policy item the Local Page Data Set Recovery panel is displayed, as shown in Figure 64.

```

COMMANDS  HELP
-----
A0FGLCLP          Local Page Data Set Recovery          Row 1 to 6 of 20
Command ==> _____          SCROLL==> PAGE

Entry Type : Group          PolicyDB Name : USER_PDB
Entry Name : SYSPLEX_GROUP_01      Enterprise Name : USER_ENTERPRISE

Page Data Set HLQ . . . . . _____
                                     Data set HLQ (max. 23 chars)
Number of Cylinders . . . . . 400    100-999

Page Data Set Volumes . . . . . _____
                                     _____

Data Set Names for Spare Page Data Sets
_____
_____
_____
_____
_____

```

Figure 64. Local Page Data Set Recovery Panel

Fill in the following fields:

Page Data Set HLQ

Defines a high level qualifier that is used to assemble a data set name for creating and allocating a page data. The qualifier can consist of up to 23 characters and must follow the naming conventions of MVS data sets (hlq.hlq2.hlq3). The high level qualifier must point to the master catalog and must not be SMS managed.

LOCAL PAGE DATA SET Policy Item for Groups

Number of Cylinders

Defines the maximum number of cylinders (100 to 999) used for the dynamic allocation of a local page data set. The default value is 400. Note that on a 3390 DASD, 100 cylinders is adequate to 70 MB and the formatting process takes approximately 20 seconds for this amount of space.

Page Data Set Volumes

Defines a list of volume IDs which are eligible when the automation is creating and allocating a new page data set. The volumes must be shared by all systems in the sysplex.

Data Set Names for Spare Page Data Sets

Defines the pre-formatted spare page data set to be used in the recovery situation. Specify the names without quotes. You can include system symbols and system automation symbols (see "Assigning System Automation Symbols (AOCCLONE)" on page 9). The data sets must be allocated on a volume shared by all systems in the sysplex and must be catalogued in the master catalog. In case the systems in the sysplex do not share the master catalog, the page data set must be re-catalogued on each system except the one which created the data set using the following IDCAMS statement:

```
DEF PAGESPACE(NAME(lpdsn) VOLUME(volume) RECATALOG)
```

JOB DEFINITIONS Policy Item

You can use the JOB DEFINITIONS policy item to customize the automation to cancel or keep jobs that are blocking a resource. When you select the JOB DEFINITIONS policy item the Local Page Data Set Recovery Job Definition panel is displayed, as shown in Figure 65.

```
COMMANDS  HELP
-----
AOFGCLCLJ      Local Page Data Set Recovery Job Definition Row 1 to 8 of 20
Command ==>> _____ SCROLL==>> PAGE

Entry Type : Group          PolicyDB Name  : USER_PDB
Entry Name  : SYSPLEX_GROUP_01 Enterprise Name : USER_ENTERPRISE

Define the jobs which can or cannot be cancelled (KEEP/CANCEL) in case the job
is one of those jobs responsible for the shortage condition.
A default specification with Job Name=* must exist.

Job Name/*  Handling
            (KEEP/CANCEL)
_____
_____
_____
_____
_____
_____
_____
_____
_____
_____
```

Figure 65. Local Page Data Set Recovery Job Definition Panel

Fill in the following fields:

Job Name/*

Defines the jobs that can or cannot be canceled if they are one of the jobs that are responsible for the shortage condition.

Handling

Specify KEEP if the job cannot be canceled. Otherwise specify CANCEL.

JOB DEFINITIONS Policy Item for Groups

You can also specify a wildcard character (*). You must define a default with Job Name=* and either KEEP if all jobs not explicitly defined cannot be canceled, or CANCEL if all jobs can be canceled.

JOB/ASID DEFINITIONS Policy Item

Entries specified in the JOB/ASID DEFINITIONS policy item apply to long-running ENQ, hung-command and command-flooding recovery. Specify the names of Jobs or ASIDs that require special treatment (KEEP, DUMP or NODUMP) when a TCB in the Job or ASID is found to be causing a long-running ENQ lockout, a hung-command situation or command flooding.

When you select the JOB/ASID DEFINITIONS policy item the Long Running ENQ Job/ASID Definitions panel is displayed, as shown in Figure 65 on page 91.

Job Name/ ASID/*	Action (KEEP/NODUMP/DUMP/dumpids)
*	KEEP
SCOT	NODUMP
SCOT1	NODUMP

Figure 66. Long Running ENQ Job/ASID Definitions Panel

Fill in the following fields:

Job Name/ASID/*

Defines the jobs and address space IDs that can or cannot be canceled if they are responsible for a long running ENQ or hung command.

Action

Specify:

- KEEP if the job or ASID cannot be canceled. Message ING920I is issued at user-defined intervals as long as the ENQ or hung command situation persists (see “Message Delay field” on page 96).
- NODUMP if the job or ASID can be canceled without a dump.
- DUMP if the job or ASID can be canceled with a dump. DUMP options are specified with the RECOVERY OPTIONS policy item (see “RECOVERY OPTIONS Policy Item” on page 95).

You can specify a trailing wildcard (*).

For long-running ENQ recovery you must define a default entry with Job name/ASID=* together with the action that will be appropriate for all jobs and ASIDs that are not explicitly defined. For hung-command recovery this default entry is ignored.

COMMAND DEFINITIONS Policy Item

With this policy item you can define which commands you want to monitor and define a maximum time that a command can be blocked by a job or another command before recovery action takes place.

You can also define an action (KEEP, DUMP or NODUMP) to be taken against this command if it is found to be blocking other commands from executing.

When you select the COMMAND DEFINITIONS policy item the "Hung" Command Definition panel is displayed, as shown in Figure 67.

```

COMMANDS  HELP
-----
AOFGENQC          "Hung" Command Definition          Row 1 to 6 of 20
Command ==>>>                                SCROLL==>>> PAGE
Entry Type : Group                               PolicyDB Name  : USER_PDB
Entry Name  : SYSPLEX_GROUP_01                 Enterprise Name : USER_ENTERPRISE

Define the commands and its parameter(s) together with the elapsed execution
time (30-999 sec) after that a command is treated as a "hung" command and the
action (KEEP/DUMP/NODUMP) to be taken on the blocker of the command.
If resources are excluded a default specification with Command=* and
Command Parameter(s)=* must exist.

Command/* Command Parameter(s)/*              Time/EXCL Action
                                           (30-999 s)
*          *                                  30         KEEP
D          M=CHP(02)                         30         NODUMP
D          TRACE                             60         NODUMP
D          M=CHP(01)                         EXCL
-----

```

Figure 67. "Hung" Command Definitions Panel

Fill in the following fields:

Command/*

Specify the name of a z/OS system command that you want to check whether it is a long-running command (for example, the z/OS command SET).

Note:

The MODIFY command (F) cannot be processed by hung-command recovery because it does not enqueue on any system resource. There is no need to automate the MODIFY command.

Command Parameter(s)/*

Specify the parameter (or parameters) of a z/OS command that is to be checked whether it is a long running command (for example, PROG as the parameter of the z/OS command SET).

Time/EXCL

Defines the execution time that elapses before a command is treated as a long-running command. Valid value is 30-999 seconds.

If the command should be excluded from long-running command checking, specify EXCL.

COMMAND DEFINITIONS Policy Item for Groups

Action

Defines the action to be taken (KEEP, DUMP or NODUMP) when the specified command blocks other commands from executing.

The action specified here will be overridden by the action that is specified in the JOB/ASID DEFINITIONS policy item for the job or ASID that issued the blocking command (often *MASTER* or CONSOLE).

For example, if a TSO user named FRED issued a D TRACE command that hung and blocked other commands from executing, and there is a Hung Command Definition of DISPLAY TRACE,30,NODUMP then, after 30 seconds the following would happen for different Job/ASID Definitions:

Job/ASID Definition	Result
FRED,KEEP	FRED's D TRACE command would not be canceled but message ING920I would be issued because <i>specific</i> Job/ASID definitions take precedence over COMMAND DEFINITIONS.
-	The D TRACE command would be canceled without a dump.
*,KEEP	The D TRACE command would be canceled without a dump because COMMAND DEFINITIONS take precedence over <i>default</i> Job/ASID definitions.

COMMAND FLOODING Policy Item

You can define individually the interval time for snapshot processing for each command class. When message IEE806A triggers the recovery, the first snapshot is taken after the interval has expired.

When you select the COMMAND FLOODING policy item the Command Flooding Definition panel is displayed, as shown in Figure 68.

```

COMMANDS  HELP
-----
AOFGENQF          Command Flooding Definition
Command ==>
Entry Type : Group          PolicyDB Name : USER_PDB
Entry Name : SYSPLEX_GROUP_01 Enterprise Name : USER_ENTERPRISE
SCROLL==> PAGE

Define the snapshot time (1-60 sec) after that the commands in this class are
evaluated for command flooding.

Command class M1 . . . _
               M2 . . . _
               M3 . . . _
               C1 . . . _
               C2 . . . _
               C3 . . . _
    
```

Figure 68. Command Flooding Definition Panel

Fill in the following field with the snapshot time for each command class:

Snapshot time

Defines the time the recovery routine should wait before it takes the next snapshot of the commands that are being executed or waiting in the command class. The time should be long enough to allow a task that issues a set of commands to finish before the first snapshot is taken. Valid value is 1-60 seconds. A default value of 3 seconds is used if nothing is specified.

RESOURCE DEFINITIONS Policy Item

You can specify which resources you want to monitor and define a value for the maximum time that a job can lock a resource while other jobs are waiting for the resource. If the amount of time is exceeded, the recovery takes place.

When you select the RESOURCE DEFINITIONS policy item the Long Running ENQ Resource Definition panel is displayed, as shown in Figure 69.

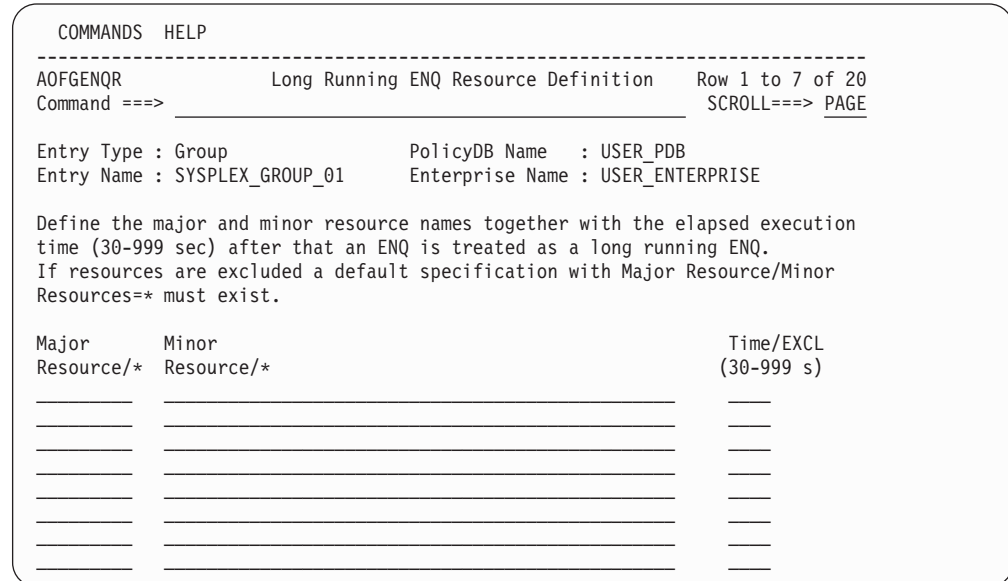

Figure 69. Long Running ENQ Resource Definition Panel

Fill in the following fields:

Major Resource/*

Defines the major resource name of the resource to be checked for long-running enqueues.

Minor Resource/*

Defines the minor resource name of the resource to be checked for long-running enqueues.

Time/EXCL

Defines the execution time that elapses before an enqueue is treated as a long-running ENQ. A valid value is 30-999 seconds. If the resource should be excluded from long-running enqueue checking, specify EXCL.

RECOVERY OPTIONS Policy Item

If you want to automate long-running ENQs, "hung" commands, or command flooding, you can specify dump options, a title for each dump being taken, and job names or address space IDs of the jobs that are kept or canceled.

Note that the dump options do not apply to command flooding because the recovery routine of the job being canceled can suppress the dump.

With this policy item you can define DUMP and other miscellaneous recovery options including message delay time for message ING920I (issued when option KEEP is specified), and IEADMCxx symbols.

RECOVERY OPTIONS Policy Item for Groups

When you select the RECOVERY OPTIONS policy item the Recovery Options panel is displayed, as shown in Figure 70.

```
COMMANDS  HELP
-----
AOFGENQS          Recovery Options          Row 1 to 3 of 20
Command ==> _____ SCROLL==> PAGE

Entry Type : Group          PolicyDB Name  : USER_PDB
Entry Name  : SYSPL1        Enterprise Name : USER_ENTERPRISE

Message Delay . . 1 Time between notification messages (1-60 minutes)

Dump Options . . . _____
Dump Title . . . . _____

Define the IEADMCxx symbols together with their substitution value for
selective jobs or address space IDs.

Job Name/* Symbol and Value
ASID/*      (&symbol.='value')
_____
_____
_____
```

Figure 70. Recovery Options Panel

Fill in the following fields:

Message Delay

Defines the number of minutes that automation waits before it reissues the message indicating that a job or a command is still blocking other jobs or commands but that the blocker must not be canceled.

Note:

Leaving the field blank results in a delay of 15 minutes.

Dump Options

Defines the DUMP option that is used for the SDATA parameter on the dump command. The following options are allowed:

ALLNUC	LPA	NOSUM	SERVERS	TRT
COUPLE	LSQA	NUC	SQA	WLM
CSA	NOPSA	PSA	SUM	XESDATA
GRSQ	NOSQA	RGN	SWA	

Note:

This value applies only to the jobs or address space IDs that are defined with DUMP in the following list.

Dump Title

Defines the title of each dump being taken with the default dump options.

Job Name/ASID/*

Defines the jobs and address space IDs together with their symbols and substitution value for use with the dump command parmlib members IEADMCxx.

Specification of a trailing wildcard (*) is allowed.

Symbol and Value

Defines the symbol names and their substitution value in the format &symbol='value'.

Valid characters for the symbol are A – Z, 0 – 9, @, # and \$. The value must be enclosed in single quotes and its length must not be longer than the symbol name.

SubGroup Entry Type

A subgroup is an intermediary grouping of the systems within a group. You define a subgroup by selecting the member systems and assigning a name to the subgroup. You do not have to define subgroups, but it may be useful to do so for a large enterprise. For example, a sysplex defined as a group may have subgroups consisting of systems running on one or more S/390 microprocessors within the sysplex so they can be managed separately from systems running on the other CPC types. Another option is to form subgroups based on system type, for example, all VM systems in one subgroup.

A system in a sysplex can belong to more than one subgroup within the sysplex group.

Creating a New SubGroup

How to create new policy objects in general, is described in “How to Create New Policy Objects” on page 19.

Figure 71 is an example of the Define New Entry panel for subgroups.

```

COMMANDS  HELP
-----
AOFGDYN2                                Define New Entry
Command ==> _____

Define new entry of type SubGroup

Entry Name . . . . . _____

ProcOps Commands . . . . NO  (YES NO)

Short description . . . _____
Long description 1 . . . _____
Long description 2 . . . _____
Long description 3 . . . _____
Long description 4 . . . _____
Long description 5 . . . _____
    
```

Figure 71. Define New Entry Panel for a Subgroup

The unique field on this panel is:

ProcOps Commands

Indicates whether processor operations commands issued against this subgroup are to be accepted for processing. The default is NO.

Creating a New SubGroup

Note:

If a group with which this subgroup is associated is enabled for processor operations commands, a processor operations command directed to that group will affect all systems in the group even if this subgroup is *not* enabled for processor operations commands.

Policy Items for SubGroups

Figure 72 shows the policy items that are displayed when a subgroup is selected from the Entry Name Selection panel.

ACTIONS		HELP
AOFGEPOL		Policy Selection
Command ==>		Row 1 of 6 SCROLL==> PAGE
Entry Type :	SubGroup	PolicyDB Name : USER_PDB
Entry Name :	TARGET_SUBGROUP	Enterprise Name : USER_ENTERPRISE
Action	Policy Name	Policy Description
_____	DESCRIPTION	Enter description
_____	SUBGROUP INFO	Display subgroup information
_____	SYSTEMS	Select systems for subgroup
_____	WHERE USED	List groups linked to this entry
_____	COPY	Copy data from an existing entry

Figure 72. Policy Selection Panel for Subgroups

The unique policy items for subgroups are:

SUBGROUP INFO

When you select this policy item, information about subgroups is displayed for verification and updating.

SYSTEMS

When you select this policy item, a list of all systems in the SA z/OS enterprise is displayed, indicating those systems that are related to this subgroup. You can add systems to the subgroup, or remove systems from the subgroup.

System Entry Type

A system is any host system in the SA z/OS enterprise. The operating systems can be either MVS or non-MVS. For system operations, the system must be MVS. For processor operations functions, the system can be MVS, VM, VSE, LINUX, or CF (coupling facility). A system definition includes:

- The operating system type
- Processor operations information
- Details about which IBM automation products are operating on the system
- Member application groups
- NetView and z/OS-related information
- Automation policy for the system (optional)

The information you supply here will determine what automation policy set objects are included in your system and how your system is automated.

The SA z/OS customization dialog allows concurrent user access capability for the System entry type. See Appendix A, “Concurrent Customization by Multiple Users,” on page 363 for further information.

Creating a New System

How to create new policy objects in general, is described in “How to Create New Policy Objects” on page 19.

Figure 73 shows the panel that is displayed when you create a new system from the Entry Name Selection panel for systems.

If you want to monitor your newly created system as a standalone system on the NMC workstation, you need to specify an entry for this sysplex in the INGTOPOF file (see *IBM Tivoli System Automation for z/OS Planning and Installation*).

```

COMMANDS  HELP
-----
AOFGDYN3          Define New Entry
Command ==> _____

Define new entry of type System

Entry name . . . . . SYS1_____

Operating system . . . . MVS_____ (MVS VM VSE LINUX CF)
Image/System name . . . . SYS1_____

Specify information for NMC Focal Point Communication (MVS systems only):
Heartbeat Interval . . . . . 5_____ (1 - 60 minutes)
Missing Heartbeat Delay . . . 30_____ (1 - 3600 seconds)

Short description . . . _____
Long description 1 . . . _____
Long description 2 . . . _____
Long description 3 . . . _____
Long description 4 . . . _____
Long description 5 . . . _____

```

Figure 73. Define New Entry Panel for a System

The fields that can be filled in are:

Entry name

This required name gives a unique name to the system that you are defining.

Valid characters are any alphanumeric character or any of the at sign (@), number sign (#), dollar sign (\$), question mark (?), or underscore (_), with the first character being alphanumeric, or @, #, or \$.

The entry name must be unique among the names of all groups, subgroups, systems, or processors and image/system names that are defined in the current policy database with the exception that the image/system name may match the system entry name.

Operating system

Defines the operating system to be run on the system. Valid values are MVS, VM, VSE, LINUX, or CF.

CF indicates the coupling facility control code for the coupling facility in a Parallel Sysplex.

LINUX identifies the Linux for zSeries operating system distributed for 390-CMOS and zSeries processors.

Creating a New System

This field is required and its default value is MVS.

Image/System name

Identifies the system. For MVS systems, this value *must match* the system name (SYSID) as specified in the IEASYSxx member of SYS1.PARMLIB.

Valid characters are any alphanumeric character or any of @, #, or \$. The name may start with a numeric character except for systems of type CF.

This name must be unique among the names of all groups, subgroups, systems, processors and image/system names that are defined in the current policy database.

Note:

To support an alternate configuration of a system, special notation with a trailing plus sign (+) is allowed. This trailing character is removed when the automation files are built. If you are going to enable automation for IXC102A/IXC402D the Image/System name must not start with a numeric character. For more information see *IBM Tivoli System Automation for z/OS Customizing and Programming*.

Heartbeat Interval

This specifies the time interval at which the SA z/OS system operations functions sends a generic alert from this system to the NMC focal point system. The SA z/OS system operations functions on the NMC focal point system use heartbeat alerts to verify the status forwarding path from each sysplex or single remote system. For more information see "The SA z/OS Heartbeat Function" on page 101.

The heartbeat interval is a required field in the range 1 to 60 minutes that defaults to 5 minutes. Heartbeat information is relevant for z/OS systems only.

The smaller the heartbeat interval, the faster SA z/OS can detect a status forwarding path failure. For example, if you define an interval of two minutes then, on average, SA z/OS will take one minute, plus the missing heartbeat delay time, to detect a failure in the status forwarding path.

Missing Heartbeat Delay

This specifies the time that the SA z/OS system operations functions on the NMC focal point system will wait after a heartbeat was expected. If this time expires without receiving the heartbeat, the system operations functions will begin missing heartbeat processing for the remote system. The field is provided as a way to buffer against temporary network delays. For more information see "The SA z/OS Heartbeat Function" on page 101.

The missing heartbeat delay is a required field in the range 1 to 3600 seconds that defaults to 30 seconds. Heartbeat information is relevant for z/OS systems only.

The smaller the missing heartbeat delay, the more sensitive SA z/OS is to temporary status forwarding path delays. The longer the delay, the slower SA z/OS will be to react to a missing heartbeat. Again, you will have to balance these two considerations.

Consideration must be given to the number of systems and subsystems being monitored in your enterprise. The larger the enterprise being monitored, the larger the delay should be. This is to ensure that at resync

time with high status forwarding to the focal point, any delays due to this do not cause unnecessary missing heartbeat processing.

The SA z/OS Heartbeat Function

The heartbeat function validates the path between remote systems and the focal point system. This path is known as the status forwarding path.

SA z/OS validates the status forwarding path by sending an alert, called the heartbeat alert, from each single remote system or from a designated system in the sysplex at a regular interval.

If the heartbeat is missing from the designated sysplex system, the SA z/OS topology manager tries to connect to another system in the sysplex. Only if all systems are not responding, SA z/OS invokes the missing heartbeat processing.

SA z/OS on the NMC focal point system expects heartbeats from each remote system at the interval defined for each system, but it expects a heartbeat only from one system in the sysplex. This interval is known as the heartbeat interval. Receiving a heartbeat on the NMC focal point system indicates that the status forwarding path from the remote system is up, and hence status for resources associated with that system can be considered to be current.

If SA z/OS on the NMC focal point system does not detect an expected heartbeat, it waits to allow for temporary network slowdowns, or any other temporary problems in the status forwarding path that may have delayed the heartbeat. The wait period is known as the missing heartbeat delay. When the missing heartbeat delay time expires, (or for a sysplex, when the missing heartbeat delay time expires for all systems in the sysplex) SA z/OS invokes its missing heartbeat processing for the remote system or the sysplex and changes the status of all associated resources to Unknown because SA z/OS is no longer able to receive status updates for those resources.

When setting the missing heartbeat delay period, consideration must be given to the number of sysplexes or single systems, and subsystems being monitored in your enterprise. The larger the enterprise being monitored, the larger the delay should be.

When SA z/OS detects that heartbeats from a remote system have resumed, it resynchronizes the NMC workstation status displayed for resources associated with the system by requesting that the remote system should resend all status information.

You can define both the heartbeat interval and the missing heartbeat delay for each MVS system in your enterprise.

Policy Items for Systems

Figure 74 on page 102 shows the z/OS policy items that are displayed when an MVS system is selected from the Entry Name Selection panel.

Notes:

1. Not all policies are displayed on one screen. Press PF8 to scroll down to see the second part of this panel.
2. Several of the policy items available from this panel allow you to select and manage the links between the system and a variety of entry types. The panels associated with these policy items are all very similar and straightforward to use and are not covered in this section.

```

ACTIONS  HELP
-----
AOFGEPOL          Policy Selection          Row 1 to 29 of 29
Command ==>>>          SCROLL==>> PAGE

Entry Type : System          PolicyDB Name : USER_PDB
Entry Name : SAMPLE_SYSTEM_01      Enterprise Name : USER_ENTERPRISE

Action      Policy Name      Policy Description
-----
DESCRIPTION      Enter description
SYSTEM INFO      Enter and display system information
AUTOMATION SYMBOLS      Define system automation symbols (AOCCLONEx)
AUTOMATION CONSOLE      Enter MVS route codes for notifications
APPLICATION GROUPS      Select applicationgroups for system
MONITOR RESOURCES      Select monitor resources for system
AUTOMATION TIMERS      Select timers for system
USER E-T PAIRS      Select user entry-type pairs for system
AUTOMATION TIMEOUT      Select timeout settings for system
RESIDENT CLISTS      Select resident clists for system
TAPE ATTENDANCE      Select tape attendance for system
APPLICATION DEFAULTS      Select application defaults for system
SYSTEM DEFAULTS      Select system defaults for system
MVSCOMP DEFAULTS      Select MVS Component Defaults for system
MVS COMPONENT      Select MVS Components for system
NETWORK      Select network for system
AUTOMATION OPERATORS      Select automation operators for system
STATUS DISPLAY      Select screen status definitions
NOTIFY OPERATORS      Select notify operators
OPC SYSTEM DETAILS      Select OPC system details for system
CONTROLLER DETAILS      Select OPC controller details for system
WORKSTATION DOMAINS      Select OPC Workstation domains for system
-----PROCESSOR OPERATIONS SPECIFIC POLICY-----
PROCESSOR      Select processor or partition
TARGET SYSTEM INFO      Basics, time zones, and interested operators
IPL INFO      Define IPL information
-----
WHERE USED      List groups/subgroups linked to this entry
COPY      Copy data from existing entry
***** Bottom of data *****

```

Figure 74. Policy Selection Panel for Systems

The policy items for systems are:

SYSTEM INFO

This displays and allows you to update the following:

- The operating system type for this system definition.
- The heartbeat interval and the missing heartbeat delay times.
- Details required for interacting with NetView. This information is required only if you are using enterprise monitoring.
- Details of your operating environment.

See “SYSTEM INFO Policy Item” on page 105 for more information.

AUTOMATION SYMBOLS

You can enter or update SA z/OS symbols that can be set to various system-specific values. These can then be substituted into several values, such as MVS automatic restart management element names, MVS workload manager resource names, job names, user specified commands and others. See "AUTOMATION SYMBOLS Policy Item" on page 106 for more information.

AUTOMATION CONSOLE

The automation console definitions are used when SA z/OS notification messages are to be sent as write-to-operator (WTO) messages to the MVS consoles. This policy item defines the route codes and MCSFLAGS necessary for this process. WTO messages are sent to the Automation Console when none of the notification operators defined in the NOTIFY OPERATORS policy item are logged on or when SYSOP is defined as a notification operator.

For more information on this policy item see "AUTOMATION CONSOLE Policy Item" on page 108.

APPLICATION GROUPS

When you select this policy item, a list of all System Application Groups that are linked to this system is displayed. You can add application groups to or remove them from the system.

MONITOR RESOURCES

This policy item allows you to manage links to Monitor Resource entries. See "Monitor Resource Entry Type" on page 229 for more information.

AUTOMATION TIMERS

This policy item displays a list of defined Automation Timer sets and allows you to choose which sets are to be associated with this system object. See "Timers Entry Type" on page 256 for more information.

USER E-T PAIRS

This policy item displays a list of defined User E-T Pairs sets and allows you to choose which sets are to be associated with this system object. See "User E-T Pairs Entry Type" on page 299 for more information.

AUTOMATION TIMEOUT

This policy item displays a list of defined Automation Timeout sets and allows you to choose which sets are to be associated with this system object. See "Timeout Settings Entry Type" on page 259 for more information.

RESIDENT CLISTS

This policy item displays a list of defined Resident CLIST sets and allows you to choose which sets are to be associated with this system object. See "Resident CLISTS Entry Type" on page 295 for more information.

TAPE ATTENDANCE

This policy item displays a list of defined Tape Attendance sets and allows you to choose which sets are to be associated with this system object. See "Tape Attendance Entry Type" on page 261 for more information.

APPLICATION DEFAULTS

This policy item displays a list of defined Application Defaults sets and allows you to choose a set to be associated with this system object. If an application belongs to an application class, the class inheritance takes precedence. See "Application Defaults Entry Type" on page 275 for more information.

Policy Items for Systems

SYSTEM DEFAULTS

This policy item displays a list of defined System Defaults sets and allows you to choose a set to be associated with this system object. If an application belongs to an application class, the class inheritance takes precedence. See “System Defaults Entry Type” on page 272 for more information.

MVSCOMP DEFAULTS

This policy item displays a list of defined MVSCOMP Defaults sets and allows you to choose a set to be associated with this system object. See “MVSCOMP Defaults Entry Type” on page 271 for more information.

MVS COMPONENT

This policy item displays a list of defined MVS Component sets and allows you to choose which sets are to be associated with this system object. See “MVS Component Entry Type” on page 264 for more information.

NETWORK

This policy item displays a list of defined Network sets and allows you to choose which sets are to be associated with this system object. See “Network Entry Type” on page 284 for more information.

AUTOMATION OPERATORS

This policy item displays a list of defined Automation Operator sets and allows you to choose which sets are to be associated with this system object. See “Automation Operators Entry Type” on page 276 for more information.

STATUS DISPLAY

This policy item displays a list Status Display Facility (SDF) Status Definition sets and allows you to choose which sets are to be associated with this system object. See “Status Display Entry Type” on page 296 for more information.

NOTIFY OPERATORS

This policy item displays a list of defined notification operator sets who receive SA z/OS notification messages. See “Notify Operators Entry Type” on page 281 for more information.

OPC SYSTEM DETAILS

This policy item allows you to manage links to OPC System Details. Only one entry should be linked to a system, otherwise multiple entries will be built with SA z/OS only loading the last one that is processed. See “OPC System Detail Entry Type” on page 243 for more information.

CONTROLLER DETAILS

This policy item allows you to manage links to OPC Controller Details. Only one entry should be linked to a system, otherwise multiple entries will be built with SA z/OS only loading the last one that is processed. See “OPC Controller Details Entry Type” on page 244 for more information.

WORKSTATION DOMAINS

This policy item allows you to manage links to workstation domain IDs. Only one entry should be linked to a system, otherwise multiple entries will be built with SA z/OS only loading the last one that is processed. See “OPC Workstation Domains Entry Type” on page 247 for more information.

PROCESSOR

Selection of this policy item displays a panel that lists all processors and

partitions defined in the enterprise. You can select one processor or partition that the system should run on. See "PROCESSOR Policy Item" on page 109 for more information.

TARGET SYSTEM INFO

This policy item displays basic information about the target system, for example, time zones, operators receiving messages from the system and operator consoles. See "TARGET SYSTEM INFO Policy Item" on page 109 for more information.

IPL INFO

With this policy item you can define IPL information for the MVS or VM target system. See "IPL INFO Policy Item" on page 111 for more information.

SYSTEM INFO Policy Item

The panel shown in Figure 75 is displayed when you select policy item SYSTEM INFO on the Policy Selection panel for Systems (Figure 74 on page 102).

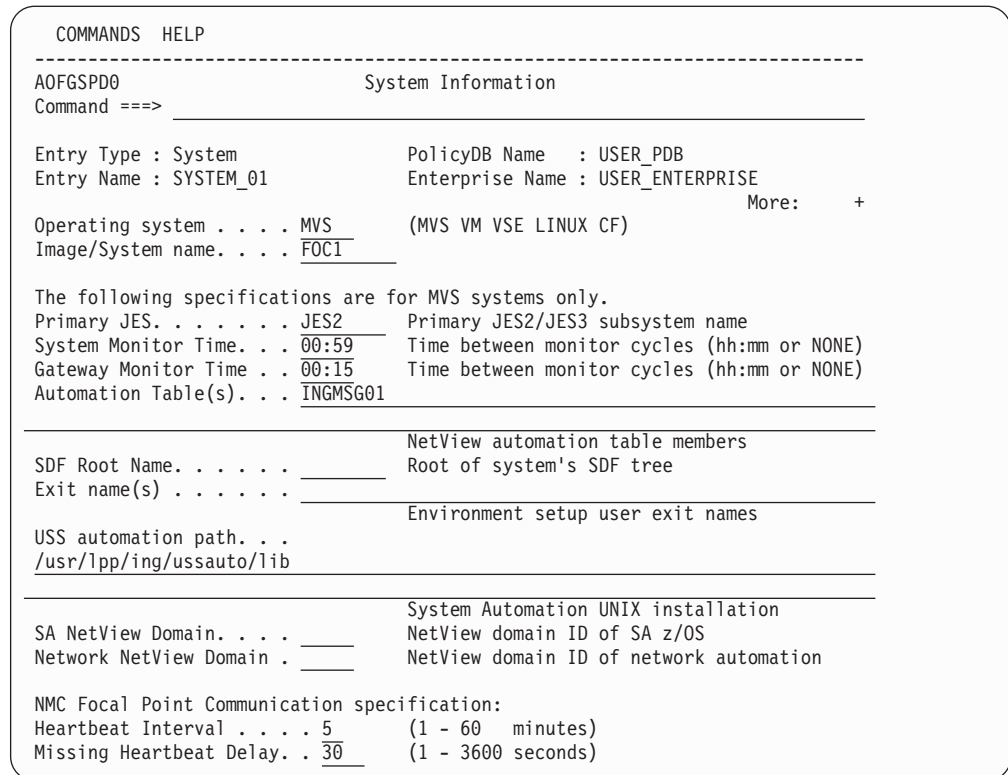

Figure 75. System Information Panel

You can enter the following information:

Operating system

Defines the operating system that runs on the system. See "Operating System" on page 99 for more details.

Image/System name

Identifies the system. See "Image/System Name" on page 100 for more details.

SYSTEM INFO Policy Item for Systems

Primary JES

The name of the primary Job Entry Subsystem as specified for a JES2 or JES3 subsystem. The named subsystem is the default scheduling subsystem.

System Monitor Time

The time between system monitoring cycles. The default is every 59 minutes. Monitoring may be suspended by specifying NONE.

Gateway Monitor Time

The time between gateway monitoring cycles. The default is 15 minutes. Monitoring may be suspended by specifying NONE.

Automation Table(s)

You may specify multiple NetView automation tables that are loaded and used for message automation. The automation tables are activated in the sequence as specified. The sequence of the automation tables is not changed during a configuration refresh (INGAMS REFRESH).

The first automation table of the list defined here replaces the SA z/OS initial automation table INGMMSG00 that was loaded during initialization. The default is INGMMSG01.

SDF Root Name

Defines the name used by SDF for the system name. This is the root component that is used during initialization. If nothing is entered the default is the **MVS System Name**

Exit name(s)

An installation exit or exits invoked to perform additional environment setup. This item is optional. See *IBM Tivoli System Automation for z/OS Customizing and Programming* for more information.

USS automation path

Defines the path where the SA z/OS USS automation programs (for example, INGCCMD) are installed. The SA z/OS installation default is /usr/lpp/ing/ussauto/lib.

SA NetView Domain

| This field is optional. It allows you to enter the domain ID of the NetView
| on the local system where SA z/OS runs. The field may be used for
| customer-specific and documentation purposes.

Network NetView Domain

| This field is optional. It allows you to enter the domain ID of the NetView
| on the local system where the network automation runs. The field may be
| used for customer-specific and documentation purposes.

Heartbeat Interval

See "Heartbeat Interval" on page 100 for more details.

Missing Heartbeat Delay

See "Missing Heartbeat Delay" on page 100 for more details.

AUTOMATION SYMBOLS Policy Item

The panel shown in Figure 76 on page 107 is displayed when you select policy item AUTOMATION SYMBOLS from the Policy Selection panel for Systems (Figure 74 on page 102).

```

COMMANDS  HELP
-----
AOFGSSYM          System Automation Symbols (AOCCLONEx)
Command ==> _____

Entry Type : System          PolicyDB Name   : USER_PDB
Entry Name  : SAMPLE_SYSTEM_01 Enterprise Name : USER_ENTERPRISE
                                           More:      +

AOCCLONE . . . . 01
General Use: Used for VTAM startlist suffix
Description . . . SAMPLE_SYSTEM_01 has VTAM startlist 01
-----
AOCCLONE1. . . .
General Use: _____
Description 1 . _____
AOCCLONE2. . . .
General Use: _____
Description 2 . _____
AOCCLONE3. . . .
General Use: _____
Description 3 . _____
AOCCLONE4. . . .
General Use: _____

```

Figure 76. Automation Symbols Panel

This panel allows you to enter or update system automation symbols that can be set to various system-specific values. These can then be substituted into several values, such as MVS automatic restart management element names, MVS workload manager resource names, job names, user-specified commands and others.

To specify that AOCCLONE value x is to be substituted, enter &AOCCLONEx. at the appropriate point in the field. You must specify both the leading ampersand (&) and the trailing period (.).

You may, additionally, specify the tilde (~) to get the 0th (unnumbered) AOCCLONE value substituted. For more details see “Using System Symbols and System Automation Symbols” on page 10.

This panel has the following fields:

General Use

This shows the description of the general use of the system automation symbol. It is defined in the SYMBOL DESCRIPTION policy item of the enterprise definitions (entry type ENT), see “SYMBOL DESCRIPTION Policy Item” on page 79.

AOCCLONEx

This allows you to specify the value of the system automation symbol (&AOCCLONEx variable).

Note:

Valid characters are A–Z, a–z, 0–9, @ (X'7C'), # (X'7B'), \$ (X'5B'), ? (X'6F'), _ (X'6D'), ! (X'5A'), and ¢ (X'4A'). The entered data is not automatically translated to upper case.

Description

This allows you to specify a specific description of the automation symbol for this system only.

AUTOMATION CONSOLE Policy Item

The panel shown in Figure 77 is displayed when you select policy item AUTOMATION CONSOLE from the Policy Selection panel for Systems (Figure 74 on page 102).

```

COMMANDS  HELP
-----
AOFPIEC0          Automation Console
Command ==> _____

Entry Type : System          PolicyDB Name  : USER_PDB
Entry Name  : SAMPLE_SYSTEM_01 Enterprise Name : USER_ENTERPRISE

Console Name. . . . . _____

Select the route codes:          Select the MCSFLAGS:

A Code   Definition              A Flag   Definition              More:   +
- All Display ALL messages
- 1 Master console action        - 1 Send msg conditionally to console
- 2 Master console information    - 2 Send msg unconditionally (QREG0)
- 3 Tape pool                    - 3 Immediate command response (RESP)
- 4 Direct access pool           - 4 Reply to WTOR (REPLY)
- 5 Tape library                 - 5 Broadcast to all active consoles
- 6 Disk library                 - 6 Queue for hard copy only (HDCPY)
- 7 Unit record pool             - 7 Do not append time to the message
- 8 Teleprocessing control        - 8 No hard copy if issued from
- 9 System error, maintenance    supervisor state (NOCPY)
- 10 Programmer information
- 11 Emulators
- 12 User
- 13 User
- 14 User
- 15 User
- 16 User
    
```

Figure 77. Environment Definition: CONSOLE (Route Codes) Panel

In order to define an automation console, you need to specify:

Console Name

This parameter defines the 1-8 alphanumeric console name specified in the CONSOL nn member of the z/OS PARMLIB.

Route Codes

The appropriate z/OS route codes can be selected from this panel. These route codes define which kind of messages the automation console is to receive. Each notification message has already been defined as one of these kinds of WTOs. The console can also be defined to receive all of the notification messages regardless of how they have been defined. The last four codes on the panel are reserved for user-defined codes.

The default routing code is 1 (only messages that appear as Master Console Action WTOs are displayed on the console). Further information on the route codes can be found in the MVS System Messages books.

MCSFLAGS

Select the appropriate MVS MCSFLAG from the list. These codes are used to provide additional information for the WTO messages (for example, if flag 7 is set, the time is not included with the WTO).

If flag 1 or 2 is set, the console name is required and the messages are queued to the specified console.

AUTOMATION CONSOLE Policy Item for Systems

Further information on the MCSFLAG codes can be found in *Tivoli NetView for z/OS Customization: Using REXX and the NetView Command List Language*

PROCESSOR Policy Item

The panel shown in Figure 78 is displayed when you select policy item PROCESSOR on the Policy Selection panel for Systems (Figure 74 on page 102).

```
COMMANDS  ACTIONS  HELP
-----
AOFGXWLU          Select Target Hardware for System   Row 1 to 11 of 11
Command ==> _____ SCROLL==> PAGE

Entry Type : System          PolicyDB Name  : USER_PDB
Entry Name  : SAMPLE_SYSTEM_01 Enterprise Name : USER_ENTERPRISE

Action      Status      Processor      CPC Name      LPAR Name
-----
_____          _____          PROSITE1      CPC1           SYK1
_____          _____          PROSITE1      CPC1           SYS3
_____          _____          PROSITE2      CPC2           SYK2
_____          SELECTED          PROSITE2      CPC2           SYS1
_____          _____          PROSITE2      CPC2           SYS2
_____          _____          VCPC          VCPC           MVSTEST1
_____          _____          Z9            CPC2           MVS2LPAR
_____          _____          Z9            CPC2           MVS3LPAR
_____          _____          Z900          CPC1           MVS1LPAR
_____          _____          Z900          CPC1           VMHOST1
_____          _____          Z990          CPC3
***** Bottom of data *****
```

Figure 78. Select Target Hardware for System Panel

This panel allows you to link a system to the target hardware. It displays a list of:

- All processors together with their LPARs
- All processors in basic mode

The panel displays the following information:

Processor

The processor entry name.

CPC Name

The CPC Name/NAU as specified on the Processor Information panel.

This field may be blank if data for the Processor Information policy has not yet been specified.

LPAR Name

The name of the logical partition as specified on the LPAR Definitions panel. This field is empty for basic processors.

TARGET SYSTEM INFO Policy Item

The panel shown in Figure 79 on page 110 is displayed when you select the TARGET SYSTEM INFO policy item on the Policy Selection panel for Systems (Figure 74 on page 102).

TARGET SYSTEM INFO Policy Item for Systems

```
COMMANDS  HELP
-----
A0FGPOTS          Target System Basic Characteristics
Command ==> _____

Entry Type : System          PolicyDB Name  : USER_PDB
Entry Name  : SAMPLE_SYSTEM_01 Enterprise Name : USER_ENTERPRISE

Enter basic information:
  Initialize target system. . . YES          (YES, NO, BYPASS)
  Load Profile Name . . . . . _____ (Activate Load Profile)

Enter target system time zones:
  Target time same as host . . YES          (YES or blank)
  Target time earlier . . . . . _____ (1 to 23, or blank)
  Target time later . . . . . _____ (1 to 23, or blank)

Enter operators who are to receive messages from console:
  System Console . . . . . SYSOP1  SYSOP2  SYSOP3  _____
  Operator Console . . . . . SYSOP4  _____
```

Figure 79. Target System Information Panel

Fill in the following fields:

Initialize target system

Enter YES to indicate that communication to the target system is automatically initialized when SA z/OS processor operations starts.

Enter NO if the target system communication should not be established when processor operations starts and the target status should be set to UNKNOWN. In this status the target system communication will be automatically initialized as soon as another target system that is running on the same LPAR mode hardware is initialized.

Enter BYPASS to set the target system status to CLOSED and to prevent automatic initialization communication to the target system when processor operations starts.

Note:

If you choose to initialize the target system automatically, be aware that when you start SA z/OS, the ISQSTART command may be completed before the target system is initialized.

Load Profile Name

Enter the load profile name defined at the support element. The name you choose must correspond with the load profile defined at the support element. Leave this field blank to take the default defined at the support element.

Note:

This profile name can contain only the characters A to Z and 0 to 9.

Target time same as host

If the target system is in the same time zone as the focal-point system, type YES or Y. If not, leave this field blank. For systems that run as guest systems under VM this field must be set to YES.

TARGET SYSTEM INFO Policy Item for Systems

Target time earlier

Enter the number of hours that the target system is earlier than the focal point system. (A target system in Los Angeles is three hours earlier than a focal-point system in New York.)

Target time later

Enter the number of hours that the target system is later than the focal point system. (A target system in New York is three hours later than a focal point system in Los Angeles.)

System Console

Enter the user IDs of the operators you want to receive system console messages. The operators listed receive messages only from the system console. You can enter any valid NetView user ID. This field is optional.

Operator Console

Enter the user IDs of the operators you want to receive operator console messages. You can enter any valid NetView user ID. This field is optional.

Notes:

1. For OCF-based systems using only console integration, the operating system messages are forwarded to the system console interested operator list.
2. Operators not on these lists do not see messages from these consoles unless their user IDs are added using the ISQXMON command when SA z/OS is running.

IPL INFO Policy Item

The panels that you can use to define your target system IPL information depend on the operating system that you are running.

MVS Target System IPL Information

The panel shown in Figure 80 on page 112 is displayed when you select the IPL INFO policy item on the Policy Selection panel for Systems (Figure 74 on page 102) for MVS.

IPL INFO Policy Item for Systems

```

COMMANDS  HELP
-----
A0FGP0MI          MVS Target System IPL Information
Command ==>>> _____ SCROLL==>> PAGE

Entry Type : System          PolicyDB Name  : USER_PDB
Entry Name  : SYS1          Enterprise Name : USER_ENTERPRISE

Enter responses to the following messages for the target system.

IEA101A specify system parameters
-----

IEA347A specify master catalog parameter
-----

IEA213A or IEA214A DUPLICATE VOLUME
-----
-----
-----
-----
-----
Provide default response when neither device is specified . . . YES

```

Figure 80. MVS Target System IPL Information Panel

Use this panel to define responses that are used during the MVS or z/OS target IPL process.

During the start process, the target system requests information from the operator. By providing the responses at this panel, the operator enables SA z/OS to respond to these messages. Target systems using VSE, LINUX, or CF do not request information from the operator during startup.

IEA101A specify system parameters

Enter the desired response to the IEA101A message. All IEA101A message responses begin with the characters R 0. You do not have to begin your response with these characters, they are provided by SA z/OS automation. Quotation marks are not necessary. The customization dialog does not verify your entry.

IEA347A specify master catalog parameter

Enter the desired response to the IEA347A message. The customization dialog does not verify your entry.

IEA212A or IEA213A/IEA214A DUPLICATE VOLUME

Specify the device addresses to be kept online if duplicate DASD volumes exist on a z/OS system at IPL time. You have 24 entries to specify real or generic DASD device addresses. Example for a generic device address: 012*. This indicates that all addresses from 0120 to 012F must remain online.

This entry works in conjunction with the automatic response selection.

Provide default response when neither device is specified. Specify YES or NO to indicate whether a default response is required if neither or both of the devices in the IEA213A/IEA214A message match those identified as required devices. For IEA214A messages, the current IPL (SYSRES) device is considered as being implicitly defined. If YES is selected, an automated response will always be provided. For a SYSRES device, the device shown in the message is dismounted. Otherwise the following applies:

- If neither device is in the reply list, the first device is demounted.

- If only one device is in the reply list, the remaining device is demounted.
- If both devices are in the reply list, the first device in the list as scanned from left to right remains mounted and the other device is demounted.
- If both devices are in the reply list due to the same generic device mask in the list as scanned from left to right, the second device is demounted.

A selection of NO will result in a response allowing the IPL to continue only if one and only one device is identified as being required. Otherwise, message ISQ1203 will be issued and the IPL process will be suspended. In such a case, the operator needs to react to system message ISQ1203.

A selection of NO and a generic device address of **** will always stop the IPL process if a duplicate volume is detected.

Notes:

1. For valid responses, see *z/OS MVS System Messages, Vol 3 (ASB-BPX)*.
2. Responses to IEA101A, IEA347A, IEA212A, and IEA213A can be changed without generating and loading new configuration files by the use of the host ISQXOPT command before IPLing the target system. However, these changes are not saved if SA z/OS processor is stopped or restarted.
3. You receive either message IEA212A or IEA213A depending on the level of your MVS system.
4. All message responses begin with the characters R 0. You do not have to begin your response with these characters; SA z/OS automation provides them. Quotation marks are also not necessary.

VM Target System IPL Information

To define the response to the VM IPL START message, use the panel shown in Figure 81. During the start process, the target system requests information from the operator. By providing the responses at this panel, the operator enables SA z/OS to respond to these messages.

```

COMMANDS  HELP
-----
A0FGPOVI          VM Target System IPL Information
Command ===> _____

Entry Type : System          PolicyDB Name  : USER_PDB
Entry Name  : VM1            Enterprise Name : USER_ENTERPRISE

Enter message for the target system.

VM IPL START message response
_____
    
```

Figure 81. VM Target System IPL Information Panel

VM IPL START message response

Enter the desired response to the VM IPL START message. The customization dialog does not verify your entry.

Note:

The VM IPL START message response field can be changed without generating and loading new configuration files. You can do this by issuing the host ISQXOPT command before you IPL the target system. However, these changes are not saved if processor operations or SA z/OS is stopped or restarted.

ApplicationGroup Entry Type

An application group is a set of applications that you assign a name to. There are two types of ApplicationGroups:

1. *System Application Groups*: application groups that are associated with particular systems.
2. *Sysplex Application Groups*: application groups that are associated with sysplexes.

A *Sysplex Application Group* is a special type of application group that is associated with one or more sysplexes. Sysplex Application Groups are used to monitor and automate applications and application groups that can run on multiple systems in a sysplex. Using Sysplex Application Groups means you do not need to connect the application group to each system of the sysplex. Instead, all applications of this Sysplex Application Group are known on all systems of the sysplex. You can then monitor the group at the sysplex level, rather than at system level.

The SA z/OS customization dialog allows concurrent user access capability for entry type ApplicationGroup. See also Appendix A, “Concurrent Customization by Multiple Users,” on page 363 for further information.

Creating a New ApplicationGroup

How to create new policy objects in general, is described in “How to Create New Policy Objects” on page 19.

Figure 82 on page 115 shows the panel that is displayed when you create a new application group with the New command from the Entry Name Selection panel for application groups.

```

COMMANDS  HELP
-----
AOFGDYN3          Define New Entry
Command ==> _____

Define new entry of type ApplicationGroup

Entry Name . . . . . _____

Type . . . . . SYSPLEX      (SYSTEM SYSPLEX)
Nature . . . . . BASIC      (BASIC MOVE SERVER)
Default Preference . . . *DEF (0 to 3200, *DEF)
Automation Name . . . . . _____
Automatically link . . . YES (for Application-Resources)
Behaviour . . . . . ACTIVE  (ACTIVE PASSIVE)
Prepare Move . . . . . _____ (YES NO)
Move Mode . . . . . _____ (PARALLEL SERIAL)

Short description . . . _____
Long description 1 . . . _____
Long description 2 . . . _____
Long description 3 . . . _____
Long description 4 . . . _____
Long description 5 . . . _____
    
```

Figure 82. Define New Entry Panel for a Sysplex Application Group

The unique fields are:

Entry Name

This is the name of the application group. It must be unique within the policy database. Valid names may contain up to twenty alphanumeric characters.

Application Group Type

This indicates whether the Application Group will be used for Systems or for a Sysplex. This attribute sets the boundaries for the selection of Resource members of the Application Group, and should be set as follows:

SYSPLEX

Use this type if the Application Group is being used to define sets of Applications and Resources that may be on multiple systems within a sysplex or sysplexes.

SYSTEM

Use this type if the Application Group is being used to define sets of Applications and Resources that be on single systems.

Application Group Types cannot be changed after this panel has been left.

Nature

In this field you can define the availability behavior of application groups and applications. You can specify one of the following attributes:

BASIC

The group is available when all of its resource members are available.

MOVE

The group is available when one of its resource members is available.

All members should be instances of the same application.

To avoid the following conflict, you should not define an application to be a member in two MOVE groups: Assume that

Creating a New ApplicationGroup

resource RES1 is a member in two MOVE groups. One of the MOVE groups starts a member that is not shared by the other MOVE group. This implies that RES1 should be down for this MOVE group, because only one member should be available. The second MOVE group now starts the shared member RES1. This causes the first MOVE group to run with two applications. The move group will ensure that only one member of the group will be active at any point in time.

SERVER

This is like a move group. Additionally, you need to define an *availability target* that determines how many of its members should be available to define the server group as being available, as well as a *satisfactory target* that specifies the number of members in the group that must be active before the automation manager treats the group as being in a satisfactory state.

All members should be instances of the same application.

If you do not make a specification, the default is BASIC.

Depending on your selection in the **Nature** field, the process of entering resources into a group is different, as described in “How to Work with Resources” on page 31. This section also provides examples of how to use the different natures appropriately.

Default Preference

This field specifies what preference should be used for application resources when automatically linking applications to ApplicationGroups (note that the **Automatically link** field below must be set to YES for automatic linking and that preference values are only used for SERVER and MOVE ApplicationGroups). The *DEF preference corresponds to default preference 700. This is the default for this field. For information about preference values and their meanings see “RESOURCES Policy Item” on page 129 and “Using Preferences to Define Specific Roles” on page 54. For more details about how an operator can override preference values, see *IBM Tivoli System Automation for z/OS User's Guide*.

Automation Name

If you want to automate and monitor the current application group, you need to specify an automation name in this field.

At the time an application group is created, it is not yet known which systems you want to link it to. So you need to use its *WHERE USED* policy item to connect it to the systems you want. Suppose you created a System Application Group called SYST_APG and linked it to systems SYSTEM1 (with the same MVS SYSNAME) and SYSTEM2 (with the same MVS SYSNAME). After pressing the END key, SA z/OS generates the following resources:

```
SYST_APG/APG/SYSTEM1
SYST_APG/APG/SYSTEM2
```

If you do not provide an automation name, an ACF fragment is not built for the APG and thus the APG is not included in the ACF main include member (ACFZxxx). If you change the automation name of an APG to or from blank (that is, no name is specified), you need to rebuild the main include member to reflect this change.

Automatically link

This entry field specifies whether applications that will later be linked to

the current ApplicationGroup should also be automatically linked as resources. This field should be changed to NO if no more resources should automatically be added if the group is linked to another system or sysplex. Otherwise the automation behavior might not be as expected for complex group definitions (that is, groups with manually adapted preference values or availability targets other than *ALL).

Note:

This field is only relevant for application groups that have a specified automation name. For others the default value YES is assumed.

Behaviour

With this field you can define whether requests to the application group should be propagated to the group members or not. With this option you can avoid having a resource unintentionally stopped if it is required for some other process outside the group.

ACTIVE

Propagates requests to all members of the application group according to the application group's nature, for example, a start request to a BASIC group is propagated to all members, as a BASIC group is considered to be available when all members are available. A start request to a MOVE group is forwarded to the member with the highest preference, as a MOVE group is considered to be available when exactly one member is available.

ACTIVE is the default.

PASSIVE

Does not propagate the requests to the group members. This enables monitoring and disables the automation of the application group.

Prepare Move

Specifies whether the downtime during the move or switch of a resource should be kept as short as possible.

For an application group of nature MOVE this means that the group member that is currently running will not be stopped until the replacement member is ready to be started, for example, all parents are available.

For an application group of nature SERVER this means that a group member will not be stopped until the replacement member that has just started is available.

To have the highest possible availability, it is recommended that you set this value to YES unless the application cannot support this.

If you leave this the field blank the value can be inherited from the system or sysplex defaults definition.

Note:

This field is only relevant for application groups with a nature of MOVE or SERVER. If nothing is specified or inherited the default value is YES.

Creating a New ApplicationGroup

Move Mode

Specifies how a move is made from an old member to a new one:

PARALLEL

The new member is started at the same time as the old member is being stopped. This is the default.

SERIAL

The new member is started after the old member has been stopped completely.

Note:

This field is only relevant for groups of type MOVE. The default value is PARALLEL. For groups of any other type it is forced to blank.

Policy Items for ApplicationGroups

As described in “Creating a New ApplicationGroup” on page 114, there are two types of application groups:

- System Application Groups
- Sysplex Application Groups

Figure 83 shows the policy items that are displayed when a System Application Group is selected from the Entry Name Selection panel.

```

ACTIONS  HELP
-----
AOFGEPOL          Policy Selection          Row 1 to 14 of 14
Command ==> _____ SCROLL==> PAGE

Entry Type : ApplicationGroup      PolicyDB Name : USER_PDB
Entry Name  : APPL_GROUP_NAME      Enterprise Name : USER_ENTERPRISE

Action      Policy Name      Policy Description
-----
            DESCRIPTION  Enter description
            APPLGROUP INFO Define applicationgroup information
            APPLICATIONS  Select applications for sysplex APG
            TRIGGER       Select trigger
            SERVICE PERIOD Select service period
            RELATIONSHIPS Define relationships
            MESSAGES/USER DATA Define messages and user data
            -----RESOURCES-----
            RESOURCES     Select resources and set preferences
            GENERATED RESOURCES List resources generated for this entry
            MEMBER OF     List resources where this entry is a member
            -----
            WHERE USED    List sysplex groups linked to this entry
            COPY          Copy data from existing entry
***** Bottom of data *****

```

Figure 83. Policy Selection Panel for System Application Groups

The unique policy items for application groups are:

APPLGROUP INFO

This policy item displays information about the Application Group, as specified when creating the application group. The panel is very similar to the one used for creating the application group. You may update indicated values in this panel. See “APPLGROUP INFO Policy Item” on page 120 for more information.

APPLICATIONS

When you select this policy item, a list of all applications in the SA z/OS enterprise is displayed, indicating which, if any, are associated with this application group. You can add applications to the application group or remove applications from the application group. If the current application group has a resource name, the appropriate APL resources are generated. According to the application group's settings, the application resources (APL resources) are linked as members into the application group resource (APG resource). See "APPLICATIONS Policy Item" on page 122 for more information on this policy item.

TRIGGER

Each application group may be linked to one trigger. With this policy item, you can use the Trigger for ApplicationGroup panel to link the application group to a trigger so that all of its applications will be started or stopped depending on the defined trigger conditions.

SERVICE PERIOD

With this policy item, you can use the Service Period for ApplicationGroup panel to link a service period to the application group. Its resources are then automatically started up or shut down in the time frame specified by the service period.

RELATIONSHIPS

This policy item has the same functionality for entry types Application, ApplicationGroup, and *Monitor Resource*. For each application, application group, or monitor resource you may specify several relationships. They will be used to automate the startup or stopping of those applications, application groups, and monitor resources. If you select this policy item, in the Relationship Selection List panel, you can view existing relationships or define new relationships for the current application, application group, or monitor resource.

You define relationships between dependent resources and supporting resources. In the customization dialog you define relationships always from the point of view of the dependent resource. So the resource that you have currently selected will become the dependent resource, when you define a new relationship.

See "RELATIONSHIPS Policy Item" on page 123 for more information on viewing existing or defining new dependency relationships.

MESSAGES/USER DATA

This policy item has the same functionality as for applications and MVS components. It allows you to specify automated actions, such as the issuing of a command or reply, to be taken in response to a message. However, because application groups do not produce 'real' messages, this policy behaves differently. Currently only the special message ID, INGALEERT, together with the command definitions assigned to it are honored by SA z/OS.

How to proceed in specifying this policy item is described in "MESSAGES/USER DATA Policy Item" on page 162, where the policy is described for applications.

RESOURCES

This policy item allows you to select resources for current ApplicationGroup and set their preferences or name.

Policy Items for ApplicationGroups

The panels displayed look different depending on the nature of the current application group. See Chapter 3, “Scenarios on How to Use the Customization Dialog,” on page 31 and “RESOURCES Policy Item” on page 129 for information on how to work with these different panels.

GENERATED RESOURCES

This policy item displays a list of all resources that have been generated for the current application group and for the applications that are linked to this application group. See “GENERATED RESOURCES Policy Item” on page 136 for a description of the Generated Resources panel.

MEMBER OF

As resources derived from application groups can be members of other APG resources, this policy item lets you see those resources that the current application group resource is a member of. See the Member of panel in “MEMBER OF Policy Item” on page 137 for more details.

APPLGROUP INFO Policy Item

A panel like Figure 84 is displayed if you select policy item APPLGROUP INFO from the Policy Selection Panel for Application Groups.

```
COMMANDS  HELP
-----
A0FGAPA0      Application Group Information
Command ==> _____

Entry Type : ApplicationGroup      PolicyDB Name  : USER_PDB
Entry Name  : APPL_GROUP_NAME     Enterprise Name: USER_ENTERPRISE

The following field was specified when the Application Group was
defined and cannot be modified:
  Application Group Type : SYSPLEX

Nature . . . . . BASIC              (BASIC MOVE SERVER)
Default Preference . . . . *DEF      (0 to 3200, *DEF)
Automation Name . . . . . _____
Behaviour. . . . . ACTIVE           (ACTIVE PASSIVE)
Desired Available. . . . . _____ (ALWAYS ONDEMAND ASIS)
Prepare Move . . . . . _____    (YES NO)
Move Mode. . . . . _____        (PARALLEL SERIAL)
Inform List. . . . . _____      (SDF NMC IOM SMF EIF TTT USR NONE)

Owner. . . . . _____
Info Link. . . . . _____

Automatically link Application-Resources
into APG . . . . . YES              (YES NO)
```

Figure 84. Application Group Information Panel

You can update the following values that are shown in the lower part of the panel:

Nature

See “Nature” on page 115 for more details.

Default Preference

See “Default Preference” on page 116 for more details.

Automation Name

See “Automation Name” on page 116 for more details.

Behaviour

See “Behaviour” on page 117 for more details.

Desired Available

Lets you specify the default desired status of the resource. The desired state of each resource is either Available or Unavailable, which is the goal that automation tries to achieve.

You can specify the following values:

ALWAYS

The desired state of the resource is set to Available, unless it is dependent on a resource that has a Desired Available setting of ONDEMAND. In this case the resource behaves as if it had a Desired Available setting of ONDEMAND itself.

This is the same behavior as in earlier releases of SA z/OS.

ONDEMAND

If there is *demand* for the resource to be available, its desired status is set to Available, otherwise its desired status is set to Unavailable.

Demand arises either from propagated MakeAvailable votes or implicitly through membership of a non-passive basic application group (APG) that has a desired status of Available. Demand does not arise from dependent resources with a Desired Available setting of ALWAYS.

A MakeAvailable vote that is propagated to the resource overrides any demand considerations.

An active ONDEMAND member of a move or server group is always sent a vote that sets its desired status, thus overriding any demand considerations.

ASIS The desired status is always set to the observed status. The resource remains in the status that it currently has and no action is taken by SA z/OS at any time, as long as there is no request placed for or propagated to the resource.

If you leave the field blank the value can be inherited from the system or sysplex defaults definition.

Note:

If nothing is specified or inherited the default value is ALWAYS.

Prepare Move

See "Prepare Move" on page 117 for more details.

Move Mode

See "Move Mode" on page 118 for more details.

Inform List

This field allows you to specify:

- Where the application is registered to
- Where all status changes are propagated to
- Whether SMF records are written

Valid receivers are SDF, NMC, IOM, SMF, EIF, TTT and USR. You can specify more than one receiver.

The list of values can be blank or comma separated. Neither system automation symbols (AOCCLONES) nor system symbols are allowed.

APPLGROUP INFO Policy Item for ApplicationGroups

If you leave the field blank, the value can be inherited from the system or sysplex defaults definition.

Specify NONE to prevent the default being used from the system defaults definition (for application groups of type SYSTEM, see “System Defaults Entry Type” on page 272) or the sysplex defaults definition (for application groups of type SYSPLEX, see “Sysplex Defaults Entry Type” on page 293).

Owner

Specifies who the operator should contact if there is an error.

Info Link

This field can be used to specify a location (for example, a URL) where additional information about the application can be found.

Automatically link Application-Resources

Specifies whether linked applications should also be automatically linked as resources. See also 116.

APPLICATIONS Policy Item

If you select an application group's policy item APPLICATIONS, you reach the Applications for ApplicationGroup panel. Figure 85 shows an example.

```
COMMANDS  ACTIONS  VIEW  HELP
-----
A0FGXC4E      Applications for ApplicationGroup      Row 1 to 13 of 106
Command ==> _____ SCROLL==> PAGE

Entry Type : ApplicationGroup      PolicyDB Name   : SCENARIO
Entry Name  : NET                  Enterprise Name  : USER_ENTERPRISE

Action      Status      Application
-----
_____    SELECTED    CICSARI
_____
_____    CPSMCMAS
_____    CPSMWUI
_____    CICS1FOR
_____    CICSMAIN
_____    CICS1TOR
_____    DB21IRLM
_____    DB2MSTR
_____    DWH
_____    SELECTED    TCPIP
_____    SELECTED    VTAM
_____    WBSRV
```

Figure 85. Applications for ApplicationGroup Panel for System Application Groups

Here you can add or remove applications from an application group. If you add an application to an application group that is already linked to a system, SA z/OS will generate a resource for this application. If you previously set the option **Automatically link Application-Resources** to YES when creating the application group, SA z/OS will also add the new resource into this application group. Otherwise, you simply have an independent application resource that you can start, stop, or automate as required.

TRIGGER Policy Item

If you select an application group's TRIGGER policy item, you reach the Trigger for ApplicationGroup panel if triggers have been defined for the application group. Figure 86 on page 123 shows an example. Use the panel to add triggers to or remove them from an application group. For more details about triggers, see the section “Event and Trigger Support” in *IBM Tivoli System Automation for z/OS*

User's Guide.

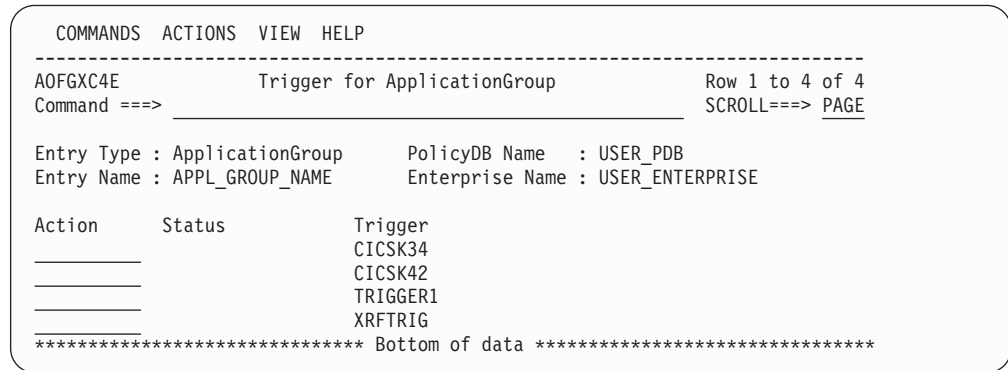

Figure 86. Trigger for ApplicationGroup Panel

SERVICE PERIOD Policy Item

If you select an application group's SERVICE PERIOD policy item, you reach the Service Period for ApplicationGroup panel if service periods have been defined for the application group. Figure 87 shows an example. Use the panel to add service periods to or remove them from an application group.

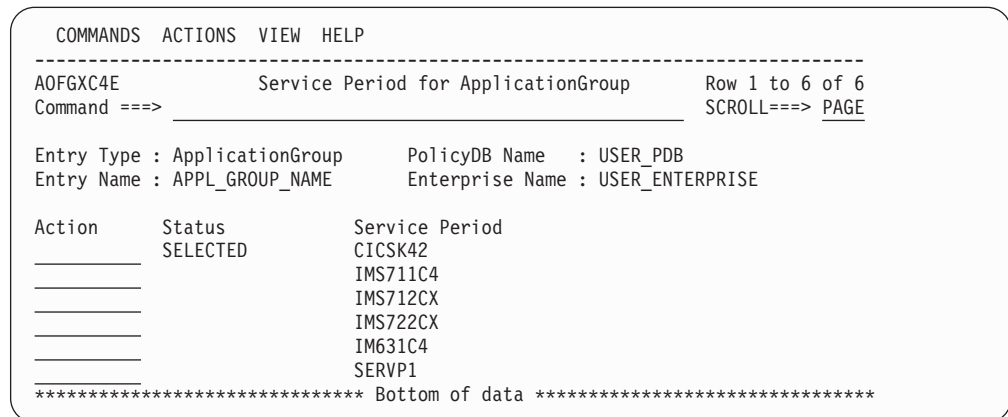

Figure 87. Service Period for ApplicationGroup Panel for System Application Groups

RELATIONSHIPS Policy Item

The Relationship Selection List panel (Figure 88 on page 124) is displayed if you select policy item RELATIONSHIPS from the Policy Selection panel for application groups. It shows information about existing relationships and allows you to define new relationships.

The ACTION pull-down choice offers actions to edit and delete selected relationships. The Delete command immediately deletes the relationship. The Edit command leads to the Define Relationship panel (as shown in Figure 88 on page 124).

RELATIONSHIPS Policy Item for ApplicationGroups

```

COMMANDS  ACTIONS  VIEW  HELP
-----
AOFGXREM          Relationship Selection List          Row 1 to 2 of 2
Command ==>>> _____

Entry Type : ApplicationGroup      PolicyDB Name  : USER_PDB
Entry Name  : APPL_GROUP_NAME      Enterprise Name : USER_ENTERPRISE

Action #   Type           Supporting Resource      Auto   Chain
-----
   1      HASPARENT       VTAM/APG/=
   1      MAKEAVAILABLE    S/APG/=                ACTIVE  WEAK
***** Bottom of data *****

```

Figure 88. Relationship Selection List Panel

This panel displays information about existing relationships. In all of the relationships for the current resource, this resource is the dependent resource. The columns have the same meaning as described in “Defining Relationships.”

Enter the NEW command on this panel to define new relationships as described in “Defining Relationships.”

Defining Relationships

You define relationships between dependent resources and supporting resources. In the customization dialog you always define relationships from the point of view of the dependent resource. So the resource that you are currently editing becomes the dependent resource for the relationship dependency that is being defined.

If you select this policy item, the Define Relationship panel is displayed, as shown in Figure 89. You specify the name of the supporting resource in the **Supporting Resource** field.

```

COMMANDS  HELP
-----
AOFGXRE0          Define Relationship
Command ==>>> _____

Entry Type : ApplicationGroup      PolicyDB Name  : USER_PDB
Entry Name  : APPL_GROUP_NAME      Enterprise Name : USER_ENTERPRISE

Autoname      :      APPL_GRP_01
Description. . . . .
Relationship Type. . HASPARENT
Supporting Resource. VTAM/APG/=
Sequence Number. . . 1
Automation . . . . .
Chaining . . . . .
Condition . . . . .

More:  +
MAKEAVAILABLE MAKEUNAVAILABLE
PREPAVAILABLE PREPUNAVAILABLE
HASPARENT HASPASSIVEPARENT
HASMONITOR PEEROF
FORCEDOWN EXTERNALLY

Resource Name
Sequence Number (1-99,blank)

ACTIVE PASSIVE
STRONG WEAK

Satisfy condition
(? for list of possible values)

```

Figure 89. Define Relationship Panel

This panel shows either the automation name (**Autoname**) for ApplicationGroups, or the subsystem name (**Subsystem**) for Applications.

This panel contains the following fields:

RELATIONSHIPS Policy Item for ApplicationGroups

Description

You can enter text up to 40 characters describe the relationship. It is stored only in the policy database and is not created in the automation configuration files.

Relationship Type

Define the relationship between the application group, referred to as the *dependent resource*, with any other resource, referred to as the *supporting resource*. The supporting resource can be an application, application group, or monitor resource.

Relationships and conditions are only observed by automation if the requested goal of the resources that are involved allow them. Dependencies are only checked if they are of importance to the existing desired goal.

Enter one of the following values:

MAKEAVAILABLE

The dependent resource cannot be started until the specified **Condition** has been fulfilled for the supporting resource. For example, if you specify WhenAvailable as the relationship condition, SA z/OS starts the dependent resource as soon as the supporting resource itself is available, if no request or goal contradicts this.

Note:

If a goal is not explicitly specified, the default goal is to make the resource available.

MAKEUNAVAILABLE

The dependent resource cannot be stopped until the specified **Condition** has been fulfilled for the supporting resource.

PREPAVAILABLE

If the desired goal of the resource is *MAKEAVAILABLE*, the PRESTART commands for the dependent resource are issued as soon as the specified **Condition** has been satisfied for the supporting resource.

PREPUNAVAILABLE

If the desired goal of the resource is *MAKEUNAVAILABLE*, the SHUTINIT commands for the dependent resource are issued as soon as the specified **Condition** has been satisfied for the supporting resource.

FORCEDOWN

This forces a shutdown of the dependent resource if the supporting resource has reached its specified satisfactory condition.

EXTERNALLY

At certain times the supporting resource performs various automated actions for the dependent resource. These actions are specified through the relationship condition (see "Condition" on page 128). For example, with this selection you specify that an external resource is responsible for starting or stopping the current (dependent) resource.

RELATIONSHIPS Policy Item for ApplicationGroups

HASMONITOR

Use this for relationships that define connections between application or application group resources and monitor resources.

HASPARENT

With this selection you specify that the current application or application group has a *parent*. The parent is the supporting resource that you specify in the **Supporting Resource** field (see “Supporting Resource”).

The dependent resource cannot be started until the supporting resource is available.

The supporting resource cannot be stopped before the dependent resource is unavailable.

At certain times the supporting resource performs various automated actions for the dependent resource. These actions are specified through the relationship condition (see “Condition” on page 128). For example, if you specify StartsMe as the relationship condition, the supporting resource starts the dependent resource whenever the supporting resource is started.

A request to start the dependent resource results in issuing a start request against the supporting resource if the supporting resource is down.

HASPASSIVEPARENT

The only difference between the HasPassiveParent and HasParent relationship is that a request to start the dependent resource does not result in the issuing of a start request against the supporting resource if the supporting resource is down. A start request must be issued against the supporting resource before the start request for the dependent resource is processed.

PEEROF

The PEEROF relationship means that any MakeAvailable votes that arrive at the supporting resource are propagated to the dependent resource.

Any MakeUnavailable votes that arrive at the supporting resource are *not* propagated to the dependent resource unless SCOPE=ALL has been specified.

Supporting Resource

Here you enter the name of the resource that the dependent resource has the previously defined relationship with. This name consists of two or three parts, separated by slashes, where the last part shows the system name. You can use the equal sign (=) which then stands for the local system of the dependent resource. The syntax for valid formats is similar to the syntax for generated resources:

APG-AutomationName/APG	(for sysplex APG)
APG-AutomationName/APG/MVSSysname	(for system APG)
APG-AutomationName/APG/=	(for system APG)
SubSystemName/APL/MVSSysname	(for APL)
SubSystemName/APL/=	(for APL)
MonitorName/MTR/MVSSysname	(for MTR)
MonitorName/MTR/=	(for MTR)

Note:

If the supporting resource is an APL resource, an MTR resource, or a system APG resource, one system automation symbol (&AOCCLONE., ~ or &AOCCLONEx. with $x=1$ through 9, A through Z) can be specified in the name. System symbols cannot be specified.

For *MVSSysname* the special notation with a trailing plus sign is allowed.

Sequence Number

This number is used when the ACF is built. Each relationship that has a number assigned to it is put in the ACF PARENT=(...) field. The first subsystem name in the list where the subsystem is defined in the current sysplex is used for AOCQRY. The position in the list is given by this number. Relationships with the same number are sorted within their sequence number. Valid values are 1 - 99 and blank.

Note:

Specifying this number is only valid for APL resources with a local system specification, that is, *subsysname/APL/=*. The number is forced to blank for relationships where the supporting resource is an APG , an MTR or an APL without a local system specification.

Automation

Defines the processing of SA z/OS to satisfy the specified relationship as follows:

ACTIVE

Specifies that SA z/OS attempts to bring the resource to the desired condition to satisfy the dependency. This is the default for MAKEAVAILABLE and MAKEUNAVAILABLE.

PASSIVE

Specifies that SA z/OS waits until the resource is in the desired condition to satisfy the dependency. That is, the request to bring the resource into the desired condition needs to come from outside, such as an operator command.

This field is forced to blank for the following relationships:

- HASMONITOR
- HASPARENT
- HASPASSIVEPARENT
- EXTERNALLY
- FORCEDOWN
- PEEROF

It is forced to PASSIVE for the following conditions:

- WhenGroupHasNotFailed
- WhenHardDown
- Any WhenObserved... condition

RELATIONSHIPS Policy Item for ApplicationGroups

Chaining

Defines whether the status of the supporting resource or attached subtree is to be considered:

STRONG

SA z/OS considers the status of the attached subtree.

WEAK

SA z/OS considers only the status of the supporting resource (this is the default for MAKEAVAILABLE and MAKEUNAVAILABLE).

This field is forced to blank for the following relationships:

- HASMONITOR
- HASPARENT
- HASPASSIVEPARENT
- EXTERNALLY
- FORCEDOWN
- PEEROF

It is forced to WEAK for PREPAVAILABLE and MAKEAVAILABLE relationships with a WhenGroupHasNotFailed condition.

Strong chaining causes SA z/OS to check all the relationships of the resources along the attached subtree. Weak chaining simply requires that the action is allowed on the dependent resource.

In the example shown in Figure 90 for strong chaining, SA z/OS also considers the dependencies between resources B and C, and B and D: A is only started if B, C, and D are up, or C is only stopped if A and B are down.

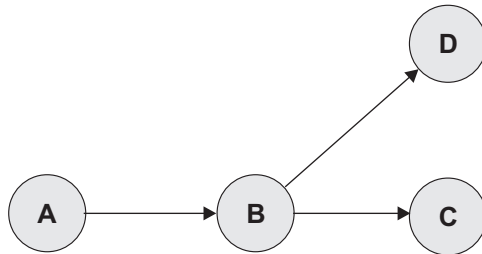

Figure 90. Example of Strong Chaining

Condition

Defines the condition that the supporting resource must have to satisfy the relationship. Enter ? to go to the Relationship Condition Selection panel from where you can select an appropriate value.

See “Relationship Conditions” on page 129 for more information on available condition values and the context that they may be used in. If no value is entered for this field the following default values are set:

Relationship	Default Condition
FORCEDDOWN	WhenObservedDown
HASMONOTOR	Forced to blank
MAKEAVAILABLE	WhenAvailable
MAKEUNAVAILABLE	WhenDown
PREPAVAILABLE	WhenAvailable

RELATIONSHIPS Policy Item for ApplicationGroups

Relationship	Default Condition
PREPUNAVAILABLE	WhenDown
HASPARENT	blank
HASPASSIVEPARENT	blank
PEEROF	Forced to blank
EXTERNALLY	StartsMe

Relationship Conditions: The relationship conditions that are available depend on the relationship.

See the online help for details of available relationship conditions.

RESOURCES Policy Item

When you select the RESOURCES policy item, you are first presented with a selection panel if the application group is linked to more than one system or sysplex. There are three different panels depending on whether the application group is of type Server, Move, or Basic. The panel shown in Figure 91 is for an application group of type Server.

If you want to add resource members to an application group of nature MOVE or SERVER, you can attach preference values to those resources (using the **Preference** column in Figure 91).

```

COMMANDS  ACTIONS  HELP
-----
A0FGARS2          Select Resources          Row 1 to 4 of 4
Command ==> _____ SCROLL==> PAGE

Entry Type : ApplicationGroup      Entry Name : SYSPLEX_APPLGROUP
Sysplex    : SYSPLEX_GROUP_01

Number of selected Resources : 4
Availability Target. . . . . *ALL (-3 to 4 , *ALL)
Satisfactory Target. . . . . *ALL (Level at which group is available)
Show all Resources . . . . . NO YES NO
Show only Resources with String. _____

Action  Preference  Resource Name      Entry Name
-----  -
700    SYSPLEX_JOB/APL/FOCB  SYSPLEX_JOB
700    SYSPLEX_JOB/APL/FOC1  SYSPLEX_JOB
700    SYSPLEX_JOB/APL/TGT1  SYSPLEX_JOB
700    SYSPLEX_JOB/APL/TGT2  SYSPLEX_JOB
***** Bottom of data *****

```

Figure 91. Select Resources for ApplicationGroup Panel

This panel has the following fields (unless stated, the fields apply to all application group types):

Number of selected Resources

This shows the current number of selected Resources.

Availability Target

This Availability Target is different depending on the type of application group:

Server Valid values for server application groups are:

RESOURCES Policy Item for ApplicationGroups

***ALL** This means that all selected resources must be *available* before the current application group-derived resource is considered as *available*.

number

This (positive) *number* is the number of selected resources that must be *available* before the current application group-derived resource is considered as *available*. This number must be less than or equal to the value in the **Number of selected Resources** field.

If you enter a value that is greater than the value in the **Number of selected Resources** field, it is changed to the maximum allowed when you leave the panel.

-number

This (negative) *number* is the number of selected resources *less than* the total that must be *available* before the current application group-derived Resource is considered as *available*. This number must be less than the value in the **Number of selected Resources** field.

If the value entered is less than or equal to the minimum value that is allowed, it will be changed to the minimum when you leave the panel.

Move The Availability Target is always 1. This field cannot be modified for move application groups.

Basic The Availability Target is not applicable and is not displayed for basic application groups.

Satisfactory Target

The Satisfactory Target is only applicable to server application groups. It specifies the number of members in the group that must be active before the automation manager treats the group as being in a satisfactory state.

Valid values for server application groups are the same as for the Availability Target.

The Satisfactory Target may be less than, or equal to the Availability Target, but cannot be higher.

If the Satisfactory Target is of type *-number* then it is treated relative to the adjusted Availability Target.

Show all Resources

This can be:

YES Shows all selectable resources.

NO Only shows *selected* resources.

Show only Resources with String

If you enter a string in this field, only matching resources are listed.

Wildcards are not supported.

Action

The following actions are valid from the ACTIONS menu and Action prompt:

(P)RIMARY Sets the preference value to 700.

SECON(D)ARY Sets the preference value to 400.

(A)DD Sets the preference value to 700.

RE(M)OVE Removes the preference value.

(S)ELECT Sets the preference value to 700.

Preference

A resource becomes SELECTED when a positive number is entered to this field. The preference value says what "role" the selected resource has. The maximum valid value is 3200. Any value greater than 3200 will be changed to that valid maximum.

The following roles are related to the preference values given:

- >2600** The resource always selected regardless of its state. Use this value if the APL or APG resource must run.
- ≥2000** The resource always selected unless the observed status of the resource is SYSGONE or HARDDOWN. It is only selected when no other viable member exists. A viable member is a resource that can be started and that is allowed to be started. In principle, the observed status is one of the following: SoftDown, Starting, Degraded, Available or WasAvailable.
- 1000** The resource always started, other resources stopped. (Use if you really want the APL or APG resource to run).
- 700** The resource is selected for startup after an IPL and after recovery situations. Members with preference 300 will be stopped in favour of this group. It is not stopped unless a very high preference alternative becomes available. This value is the default. Use it in a MOVE group for a resource that normally runs.
- 600** Used as a threshold. A resource with a preference of 600 and lower will not be selected at group startup.
- 500** This resource is not selected for startup after IPL but it is started as a backup after failure and continues running even though normal preference (700) alternatives become available. It is stopped at the next (scheduled) outage. Use this value in a MOVE group for the backup resource.
- 400** This resource is not selected for startup after IPL but it is started as a backup after failure. The difference to preference 500 is that the resource is stopped when normal preference (700) alternatives become available again.
- 300** Like 200, but a move to an alternate backup (Preference 500) would only occur at a (scheduled) outage.
- 200** Resource started as backup, stopped as soon as better alternative (Preference 450 and greater) becomes available. (Use where you can have a backup, but you don't really want one).
- 1** This means that the member will always be deselected and will always have a MakeUnavailable vote propagated to it. This can be useful if you want complete manual control of the move process.
- 0** This means that the member is a passive member and will never get a vote propagated to it by the group. If a member has its preference changed so it becomes passive, any votes that have been propagated to it from the group will be withdrawn.

RESOURCES Policy Item for ApplicationGroups

Note:

SA z/OS offers the possibility to consider the *workload* in its decision making via resource aware application move. This only takes place if the applications in a system or sysplex have the *same* effective preference values. It also does not affect any preference values that you have defined for your resources. For more details see "Resource Aware Application Move" in *IBM Tivoli System Automation for z/OS User's Guide*.

Preferences other than those listed are accepted. You can find more information on the meaning of preferences in "Preference field description" on page 131 and in "Controlling Application Move with Preference Values" in *IBM Tivoli System Automation for z/OS User's Guide*.

The effective preference of each group member is calculated to determine which group members get picked to be activated by the group. The primary inputs into this are the base preference (as specified through the customization dialogs) and the preference adjustment (specified indirectly through the INGGROUP interface). These are added together to produce the resource's adjusted preference (this is the same as the preference value you actually enter the INGGROUP panels).

The following modifiers are then applied to the resource's adjusted preference if it is >1.

Bonus	Reason
25	The member is currently selected and has an adjusted preference ≤1000.
175	The member is currently selected and has an adjusted preference >1000.
220	The member has observed status of Starting or Degraded and the system is not being stopped.
225	The member has observed status of Available or Stopping and the system is not being stopped.
-400	The member has an adjusted preference >1500 and either the system is being stopped or the system has already been stopped and the member thus has observed status of SysGone.

The working value for the preference may then be set to an absolute value if any of the following conditions are satisfied:

Value	Condition
3600	The member has an adjusted preference of 0 (indicating a passive member) and it has an observed status of Starting, Degraded, Available or WasAvailable.
100	The member has a working preference between 2–2599 and requires a resource on an Avoided system.

RESOURCES Policy Item for ApplicationGroups

Value	Condition
1	<p>The member has:</p> <ul style="list-style-type: none"> • An adjusted preference of 0 (indicating a passive member) and its observed status is none of Starting, Degraded, Available or WasAvailable. • A working preference of 2000–2599, there is a viable alternative resource and the member either has an observed status of HardDown or SysGone or the system that it is on is being stopped. • A working preference <2000 and has observed status of HardDown or SysGone. • A working preference <2600 and has observed status of StandBy, Unknown or Problem. • A working preference <2600, has observed status of Stopping or SoftDown and its automation flag is turned off. • A working preference <2600 and requires a member on an excluded system.

After all of these adjustments have been made, this produces the member's effective preference. Normally a Move or Server group will pick the members with the highest effective preferences to be available, however there are three special rules to take into consideration:

1. A member with an effective preference of 1 may never be picked. SA z/OS sends a MakeUnavailable vote.
2. A member with an effective preference <600 may only be picked if the group is in recovery mode (that is, it is recovering from a failure).
3. A member requiring a resource on an excluded system must be sent a MakeUnavailable vote, even if it has been picked. This can occur with resources that have adjusted preferences >2600.

Various scenarios are described in Table 6.

Table 6. Preference Value Scenarios

Scenario	Description
Absolute manual control	<p>Member to be activated gets preference 3200, all others get preference 1.</p> <p>The member with the 3200 preference will be selected. All others will always have a MakeUnavailable vote propagated to them.</p> <p>This does not change even if the system with the selected member leaves the sysplex.</p> <p>A shutdown of the primary system will not initiate a move of the application, as the 400 point penalty is not sufficient to drop its preference below 2600.</p>

RESOURCES Policy Item for ApplicationGroups

Table 6. Preference Value Scenarios (continued)

Scenario	Description
Move only after system failure	<p>Primary member defined preference 2800, backups preference 500.</p> <p>As long as the primary is not SYSGONE it will be selected. If the primary is SYSGONE, its preference drops to 2575 (2800 – 400 + 175), allowing an alternative viable member to be selected.</p> <p>The backups will only be viable if the resource was previously active because of the groups recovery mode.</p> <p>A shutdown of the primary system will not initiate a move of the application. Although the primary systems preference will be below 2600, there will be no viable alternatives as the backups may only be used if the group is in recovery mode.</p>
Move only if system down or stopping	<p>Primary member defined preference 2800, backups preference 700.</p> <p>As long as the primary member is not SYSGONE and its system is not being stopped it will be selected. If the primary member is SYSGONE or its system is being stopped, its preference drops to 2575 (2800 – 400 + 175), allowing an alternative viable resource to be selected.</p> <p>The backups are always viable.</p> <p>A shutdown of the primary system will initiate a move of the application during the shutdown.</p>
Sticky move only after system down or stopping	<p>Primary member defined preference 2801, backups preference 2800.</p> <p>As long as the primary member is not SYSGONE and its system is not being stopped, it will be selected. If the primary becomes SYSGONE or its system is being stopped, its preference drops to 2576 (2801 – 400 + 175), allowing one of the backups to be selected. The sticky bonus raises its preference to 2975 (2800 + 175), meaning that even when the primary returns the selected backup system will remain selected.</p> <p>It will only be deselected if it goes to SYSGONE or its system is being stopped, in which case the primary will be re-selected if it is available otherwise another backup would be picked.</p> <p>A shutdown of the primary system will initiate a move of the application during the shutdown.</p>

RESOURCES Policy Item for ApplicationGroups

Table 6. Preference Value Scenarios (continued)

Scenario	Description
Move only after system or application failure	<p>Primary member defined with preference 2400, backups preference 500.</p> <p>As long as the primary member does not fail to SYSGONE or HARDDOWN it remains selected. If it gets to HARDDOWN or SYSGONE without failing, there are no viable alternatives, so it will not be moved. If it does fail, its preference is between 2600 and 2000 and the backups are viable, so one of them can be picked.</p> <p>The backups are only viable if the group is in recovery mode (that is, the member was active when the failure occurred).</p>
Move only if system down, being stopped or application failure	<p>Primary member defined with preference 2400, backups preference 700.</p> <p>As long as the primary member is not SYSGONE or HARDDOWN and its system is not being stopped it remains selected. If it is HARDDOWN or SYSGONE or its system is being stopped its preference is between 2600 and 2000, so a viable alternative can be selected.</p> <p>A shutdown of the primary system will initiate a move of the application, as it will have lost its 225 point bonus for being available and have incurred a 400 point penalty, bringing its preference down to well below 2600, allowing the selection of an alternative resource if there is a viable one.</p>
Sticky move if system down or being stopped, move after application failure	<p>Primary member defined with preference 2401, backups preference 2400.</p> <p>As long as the primary is not SYSGONE or HARDDOWN and its system is not being stopped it remains selected. If it is SYSGONE or HARDDOWN or its system is being stopped its preference is between 2000–2600, so a viable alternative may be chosen.</p> <p>The sticky bonus raises the preference of the selected member to 2575 (2400 + 175), so it will remain selected until it gets to a state of SYSGONE or HARDDOWN or its system is being stopped, at which point another viable alternative will be selected, with the primary member having preference.</p> <p>The individual shutdown of the active member will not trigger a move.</p> <p>A shutdown of the primary system will result in a move of the application. It will have a 400 point penalty, dropping its preference to between 2600 and 2000, permitting the selection of a viable alternative.</p>

RESOURCES Policy Item for ApplicationGroups

Table 6. Preference Value Scenarios (continued)

Scenario	Description
Sticky move group, unless member stopped	<p>Primary member defined with preference 701, backups preference 700.</p> <p>As long as the primary member is startable, it remains selected. If it becomes non-startable, another member is selected and that remains selected as long as it is startable.</p> <p>Individually stopping the active member will trigger a move. If the members were defined with preferences >1500, the bonus would be 175 points rather than 25 points.</p>
Sticky move group, until told otherwise	<p>Primary member defined with preference 3200, backups with preference 1600.</p> <p>With base preferences of 3200, you get it picking a member when the sysplex is IPLd and retaining that one until an operator uses INGGROUP to make it pick another one.</p> <p>Beware of timing problems as the first system with a member to register will probably get it.</p>

GENERATED RESOURCES Policy Item

The Generated Resources panel appears if you select the GENERATED RESOURCES policy item from the Policy Selection panel for ApplicationGroups. This panel shows all resources that are generated by SA z/OS for the application group itself and all the resources for the applications that are members of this application group. This panel is for information only. No actions are allowed.

```

COMMANDS  HELP
-----
AOFGXRSR          Generated Resources          Row 1 to 8 of 8
Command ==>>> _____ SCROLL==>> PAGE

Entry Type : ApplicationGroup      PolicyDB Name : USER_PDB
Entry Name : NET                  Enterprise Name : USER_ENTERPRISE

Resource Name          Generated by link to
Resources for THIS entry:
NET/APG/SYSTEM1       SYSTEM1
NET/APG/SYSTEM2       SYSTEM2
Resources for APPLICATIONS (generated by links to this entry):
TCPIP/APL/SYSTEM1    NET
TCPIP/APL/SYSTEM2    NET
VTAM/APL/SYSTEM1     NET
VTAM/APL/SYSTEM2     NET
***** Bottom of data *****

```

Figure 92. Generated Resources Panel

This panel displays the following information:

Resources for THIS entry

Shows the resources generated for the application group. The display is different for application groups of type SYSPLEX or SYSTEM: No system information is shown for Sysplex Application Groups, as several systems can be part of the sysplex.

GENERATED RESOURCES Policy Item for ApplicationGroups

Resources for APPLICATIONS (generated by links to this entry)

Shows the resources generated for applications that are linked to the application group.

MEMBER OF Policy Item

The Member of panel appears if you select the MEMBER OF policy item from the Policy Selection panel for application groups.

```
COMMANDS  HELP
-----
AOFGXMOF          Member of
Command ==> _____ SCROLL==> PAGE

Entry Type : ApplicationGroup      PolicyDB Name : USER_PDB
Entry Name : APPL_GROUP_NAME      Enterprise Name : USER_ENTERPRISE

Own Resource...      ...is a member of      Preference Nature
NET/APG/SYSTEM1      WBSRVAPG/APG           700           MOVE/SERVER
NET/APG/SYSTEM2      WBSRVAPG/APG           700           MOVE/SERVER
***** Bottom of data *****
```

Figure 93. Member of Panel for ApplicationGroups

This panel lists all resources, where this ApplicationGroup is a member "resource-wise", that is, it lists all relations from resources that have been derived from the current ApplicationGroup to other resources. This panel is for information only. No data can be changed.

A Member of relation can be added or removed in the RESOURCES policy item of the entry that is given in the **...is a member of** column (that is, in the RESOURCES policy of the APG Entry Name that the "member of" resource was derived from).

If the owning APG resource (given **...is a member of**) is of nature SERVER or MOVE, the **Preference** column shows the preference value that was set for the current resource in the RESOURCES policy item of the owning resource. If the owning resource's nature is BASIC, the **Preference** column shows "SELECTED". For more details about available preference values see "Creating a New ApplicationGroup" on page 114.

In the example in Figure 93, the resource NET/APG/SYSTEM1 is a member of resource WBSRVAPG/APG.

Application Entry Type

An *application* is a z/OS subsystem, started task, application, batch job, or non-MVS resource that runs on a system in the SA z/OS enterprise. SA z/OS monitors applications through the messages they issue to the operator. The term application is also used to refer to a subsystem or process on an SNMP-capable machine. Note that SA z/OS does not provide automation for applications on non-MVS systems.

An application cannot be linked to a system directly. It must be defined as part of an application group, and it may belong to more than one application group. If a system is assigned multiple application groups containing the same application, SA z/OS ensures that the application is defined only once in the automation control file.

Application Entry Type

The SA z/OS customization dialog allows concurrent user access capability for the Application entry type. See Appendix A, "Concurrent Customization by Multiple Users," on page 363 for further information.

Creating a New Application

How to create new policy objects in general is described in "How to Create New Policy Objects" on page 19.

Figure 94 shows the panel that is displayed when you create a new application from the Entry Name Selection panel for applications.

```
COMMANDS  HELP
-----
AOFGDYN3          Define New Entry
Command ==> _____

Define new entry of type Application

Entry name . . . . . _____

Subsystem Name . . . . . _____
Object Type . . . . . INSTANCE (CLASS INSTANCE)
Application Type . . . . . _____ (IMAGE JES2 JES3 CICS IMS DB2 OPC USS
or blank)
Subtype . . . . . _____ (For types CICS IMS DB2 OPC or blank)
Job Type . . . . . _____ (MVS NONMVS TRANSIENT)
Job Name . . . . . _____
Transient Rerun . . . . . _____ (YES NO)
Scheduling Subsystem . . . . . _____ (MSTR, JES Subsystem)
JCL Procedure Name . . . . . _____

Short description . . . . . _____
Long description 1 . . . . . _____
Long description 2 . . . . . _____
Long description 3 . . . . . _____
Long description 4 . . . . . _____
Long description 5 . . . . . _____
```

Figure 94. Define New Entry Panel for Applications

When you define a new application, you provide the following information:

Entry Name

This field is required. It assigns a unique twenty-character name to the application you are defining. It is often convenient to use the same name for both the subsystem name and the application name. In some cases, however, it may be useful to have multiple applications with the same subsystem name. This enables you to have a standard "tree" of subsystems but to assign the right characteristics of an application to a specific system. The first character of the application name may not be numeric.

Subsystem Name

The subsystem name is required. It defaults to the application's entry name if the entry name complies with the restrictions for subsystem names (see below). Press Enter to have the default displayed in the field.

The subsystem name provides a unique, eleven-character name for the Application that you are defining. This name is used by SA z/OS automation. You can have multiple application instances with the same subsystem name, however, you should take care to ensure that only one of them is linked to any given system. The subsystem name of an application class must be unique across the whole policy database, that is, it cannot be the same as the subsystem name of any other application instance or class.

Note that the subsystem name of an existing application can be modified by overtyping the **Subsystem Name** field in the Application Information policy panel.

The restrictions on the subsystem name are:

- The length is limited to eleven characters.
- Valid characters are any alphanumeric character or any of @, #, \$, ? or _ (underscore), with the first character being alphanumeric or one of @, #, \$ or ?.
- See the online help for a list of values that are reserved for SA z/OS and cannot be used.

When defining applications on SNMP target systems, it is recommended that the subsystem name be the same as the name of the process or subsystem on the SNMP target system.

For applications of type IMAGE, the same value is required for the subsystem and the job name. Therefore the subsystem name must comply with the restrictions for job names (see “Job Name” on page 141).

Object Type

CLASS

If the entry represents common policy that is to be inherited by one or more other application entries that are defined as INSTANCES, select this object type. CLASSES are used only to define inherited policy; they do not represent actual applications that are managed by SA z/OS.

INSTANCE

If the entry represents an application that is to be managed by SA z/OS, select this object type. If you link an INSTANCE to a CLASS you can omit policy items from the INSTANCE, which allows that policy to be inherited from the specified CLASS.

Use of the CLASS object type allows you to define a common policy for multiple applications. This is advisable if these applications share common characteristics and functions. It decreases effort during:

- Initial definition
- Administrative changes (using the customization dialog)
- Run time changes (using the SA z/OS automation engine)

An application instance can be linked to a class using the UPWARD CLASS policy item. If a policy item is not specified for the instance, it is inherited from the class. Conversely, a policy item that is specified for an instance overrides any class specification.

Flag definitions for classes or defaults cannot be merged with specific resource definitions. For example, specifying a RESTART flag with an exit at class level and a RESTART flag with a NOAUTO period at resource level will not result in a resource definition with both. The presence of any definition at resource level takes precedence over those at class and default level. Likewise a class definition takes precedence over a default. The definitions for a specific flag type are not merged.

The inheritance of policy from an application class occurs during SA z/OS initialization. If an application policy item is not specified in either the application instance or the class, defaults are used from the application defaults, system defaults, and environment setup objects. Some policy

Creating a New Application

items are required to be specified for an application instance. Except for job name, these same items need to be specified for an application class, but note they will never be inherited.

SA z/OS supports run time changes to an application class. If the ACF command is used to change a policy item for a class, all those instances belonging to the class and inheriting that policy item are also updated.

Application Type

The application type is not required. You may specify one of the following values:

- JES2 if the application represents a JES2 application, see “Policy Items for JES2 Subsystems” on page 195.
- JES3 if the application represents a JES3 application, see “Policy Items for JES3 Subsystems” on page 199.
- DB2 if the application represents a DB2 application, see “Policy Items for DB2 Subsystems” on page 202.
- CICS if the application represents a CICS application, see “Policy Items for CICS Subsystems” on page 201.
- IMS if the application represents an IMS application, see “Policy Items for IMS Subsystems” on page 204.
- OPC if the application represents a TWS application, see “Policy Items for TWS Subsystems” on page 207.
- USS if the application represents an USS application, see “Policy Items for USS Subsystems” on page 208.
- IMAGE if the application represents a system image (to enable enhanced Parallel Sysplex functions). For details, see *IBM Tivoli System Automation for z/OS Customizing and Programming*.

If you specify one of these application types, except for CICS, additional policy options specific to their automation are displayed on the SA z/OS Policy Selection panel. Note that once you have specified the value and created the Application entry, the value cannot be changed. Only the blank value can be changed afterwards.

Subtype

Specifies the region subtype for CICS, DB2 and IMS or the type for OPC applications. The following values may be specified:

- **CICS:** AOR, TOR, FOR, DOR, QOR, CMAS, WUI
- **DB2:** MSTR, SPAS, IRLM, DBM1, DIST, WLMS
- **IMS:** CTL, TP, DBRC, DLS, FP, BMP, FDR
- **OPC:** CONTROLLER, TRACKER, SERVER, DATASERVER

For applications without a type specification, a subtype (including blank) can also be specified.

You must specify the subtype for application classes of type DB2 or IMS.

You cannot specify a value for applications of type USS, JES2, JES3, or IMAGE.

Job Type

This can be one of:

- **MVS** This is the standard MVS job type that SA z/OS normally handles. It is typically monitored using the ASCB checker. This job type can be specified explicitly with `JOBTYPE=MVS` for an application,

however, it is the assumed default if the Job Type entry is omitted from the definition of the application.

NONMVS

This is a type of resource that may be started by SA z/OS but which cannot be monitored using an ASCB check or the MVS D A method.

If the AOFATMON routine cannot be used to monitor this type of resource, either a user-provided application monitor routine is required or the message automation table must be correctly set up to maintain the job status accurately. This status is the only way of monitoring this class of job. NONMVS jobs must have STARTUP and SHUTDOWN commands defined.

TRANSIENT

This is a type of job that may be started by SA z/OS but terminates without the intervention of SA z/OS. It is a short running job that will generally, but not necessarily, terminate before SA z/OS does. It can be monitored using an ASCB check.

As far as monitoring is concerned, a TRANSIENT job is treated as a z/OS job, but it has special properties: transient jobs must START and END before their dependent applications are started.

You can specify shutdown passes for transient jobs if there is a possibility that they may need to be shut down by SA z/OS. These passes are optional.

Job Name

The job name is required. It defaults to the subsystem name if this complies with the restrictions on job names. Press Enter to have the default displayed in the field. For applications of type IMAGE, the job name is *forced* to the subsystem name. Thus, for applications of type IMAGE, the subsystem name *must* comply with the restrictions on job names.

The job name gives a unique name to the application to be run. There is a one-to-one mapping between the MVS job name and the subsystem name. SA z/OS automation interprets messages from MVS by taking the MVS job name and mapping it to the subsystem name.

You can have multiple applications with the same job name but you must ensure that only one of them is linked to a particular system. Duplicates are ignored by the BUILD function.

The restrictions on the job name are:

- It can be up to eight alphanumeric and national characters, including @, #, and \$, after clone resolution, provided the first character is not numeric.
- If the job type is NONMVS, you can also use _ and ?.
- You can include system symbols and system automation symbols.
- The special value *MASTER* is allowed for applications of type blank. If the object type is CLASS, a job name is not allowed.

For details about creating the start command, see “JCL Procedure Name” on page 142.

Creating a New Application

Transient Rerun

This field specifies whether a TRANSIENT application may be rerun within the lifetime of z/OS. The Transient Rerun option involves the concept of a *one-shot transient job*.

YES This indicates that the job will be rerun as appropriate. SETSTATE can be used to set it to RESTART status, and it can be part of a shutdown request with the RESTART option set to YES.

NO This indicates that the job will only be run once in the lifecycle of a particular z/OS. A value of NO affects the processing of the SETSTATE command. NO is the default value for transient jobs.

Note:

On an initial automation policy load, such as at IPL, a one-shot transient will run, terminate and go to ENDED status. If a SETSTATE or INGREQ with restart is attempted it will be rejected because a one-shot transient is only allowed to run once in the lifecycle of a particular z/OS.

A one-shot job remains in an ENDED state across a SA z/OS recycle.

There are some situations when even one-shot transient jobs will be rerun:

- If the automation status file is deleted and NetView is recycled, a one-shot transient job will be restarted.
- If a job is deleted from the automation policy, status information for that job is deleted during a refresh of the policy. If a later refresh is used to redefine the application to automation, the application status is set to DOWN. This may also result in the restart of a one-shot transient job being restarted.

Scheduling Subsystem

This is optional. It is the name of the subsystem that is to schedule this application, as follows:

MSTR The application is scheduled directly by the MVS/ESA master scheduler.

other The application is scheduled by another scheduling subsystem. The value entered is the name of that subsystem. The subsystem that is specified must be defined as type JES2 or JES3.

If you leave this field blank, it indicates that the application is scheduled by the primary JES.

For applications of type IMAGE the value is forced to blank.

JCL Procedure Name

The JCL Procedure Name is optional. It specifies the name of the JCL procedure that is used to create this instance of the application. If specified, the default start command for the application is:

```
MVS S procname,JOBNAME=jobname
```

Where *procname* is the JCL Procedure Name and *jobname* is the Job Name. If you do not specify a JCL procedure name, the default start command is:

```
MVS S jobname
```

You can include system symbols and system automation symbols (see “Assigning System Automation Symbols (AOCCLONE)” on page 9).

For applications of type IMAGE the value is forced to blank.

Policy Items for Applications

Figure 95 shows the policy items that are displayed when an Application is selected from the Entry Name Selection panel.

Some of the policy items may be set for all application automation on a certain system via the application or system defaults. For example, Thresholds can be set to a default value for all applications. If the definition of an application has no value specified for Thresholds, the value specified in the Application Defaults is used. If no value is specified in the Application Defaults any value specified in System Defaults is used. See also “Application Defaults Entry Type” on page 275 and “System Defaults Entry Type” on page 272.

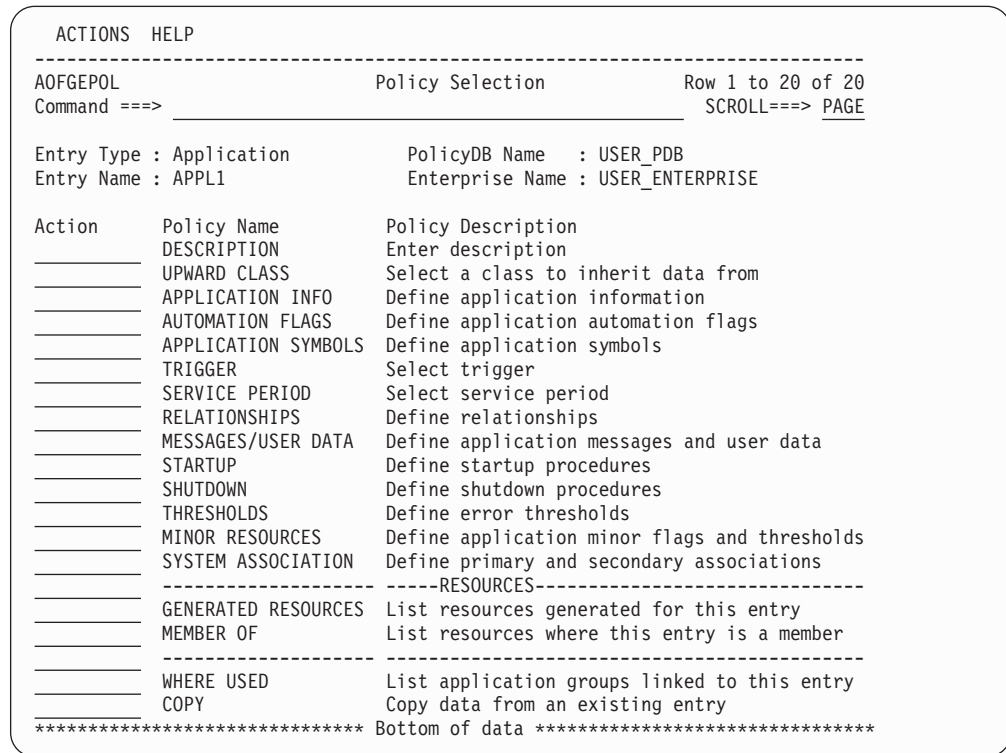

Figure 95. Policy Selection Panel for Applications

The unique policy items for Applications are:

UPWARD CLASS

This field is displayed if the application was defined as an INSTANCE or CLASS (see “Creating a New Application” on page 138). It lists all entries that have been defined as resource classes and allows you to select one class that this application should be linked to so that it inherits the policy values of that class or class chain.

See “UPWARD CLASS Policy Item” on page 147 for more information.

DOWNWARD CLASS/INST

This policy item is displayed if the application was defined as a CLASS

Policy Items for Applications

(see “Creating a New Application” on page 138) and it lists all class or instance entries. You can add or remove classes or instances linked to this class.

See “DOWNWARD CLASS/INST Policy Item” on page 147 for more information.

APPLICATION INFO

This policy item displays the Application Information panel that shows the policy for the current application as entered when it was created. It is also used to define the application to SA z/OS automation. You can edit part of the policy information on this panel. The fields that contain policy information that you must not modify are read-only. To change read-only information, you must delete and recreate the application.

See “APPLICATION INFO Policy Item” on page 149 for more information.

AUTOMATION FLAGS

Automation flags allow you to enable and disable automation. You can disable automation for specific time periods or turn it off entirely. You can also enable or disable automation for specific automation phases, such as Initstart, Start, Recovery, Shutdown, and Restart, and for responses to specific messages and status changes within these phases.

Determine whether the automation flags currently set for your system at the system wide defaults and application levels are appropriate for this application. If they are not, define one or more application automation flags in either the application instance or class policy object.

For more information, see “AUTOMATION FLAGS Policy Item” on page 158 and the section “Automation Flags” in *IBM Tivoli System Automation for z/OS User's Guide*.

APPLICATION SYMBOLS

Application symbols allow you to enter or update application symbols that can be set to various application-specific values. These can then be substituted using the runtime variables SUBSSYMBOL1 through SUBSSYMBOL9. Those variables can be used in a similar fashion to runtime variables like SUBSSPARM, SUBSSCHEDSS, SUBSJOB, etc.

For more information, see “APPLICATION SYMBOLS Policy Item” on page 159.

TRIGGER

Each application may be linked to one trigger. This policy item allows you to link the current application to a trigger. Only one trigger can be selected.

Triggers are used to control the starting and stopping of applications in a single system or a Parallel Sysplex. They determine the behavior of the requested action. For an application to be started, its desired status must be AVAILABLE and its startup trigger must be satisfied.

For an application to be stopped, its desired status must be UNAVAILABLE and its shutdown trigger must be satisfied.

For more information on how to use triggers, see “TRIGGER Policy Item” on page 160 and the section “Event and Trigger Support” in *IBM Tivoli System Automation for z/OS User's Guide*.

SERVICE PERIOD

Service periods allow users to schedule the availability of applications, application groups, or monitor resources. With this policy item you can

link a service period to the application so that it is automatically started up or shut down in the time frame specified with the service period.

For more information, see “SERVICE PERIOD Policy Item” on page 160.

RELATIONSHIPS

Relationships are used to define dependencies between resources that are used to perform in a controlled way startup or shutdown actions of dependent and supporting applications, application groups, and monitor resources.

This policy item has the same functionality for entry types Application, ApplicationGroup, and Monitor Resource. For each application, application group, or monitor resource you may specify several relationships. If you select this policy item, in the upcoming Relationship Selection List panel, you can view existing or define new relationships for the current application, application group, or monitor resource.

You define relationships between dependent resources and supporting resources. In the customization dialog you define relationships always from the point of view of the dependent resource. So the resource that you have currently selected will become the dependent resource, when you define a new relationship.

See “RELATIONSHIPS Policy Item” on page 123 for more information on viewing or defining dependency relationships.

MESSAGES/USER DATA

This policy item allows you to specify automated actions, such as the issuing of a command or reply, to be taken in response to a message issued by the application.

You can also specify some of the application statuses as messages to trigger the command of your choice.

How to proceed in specifying this policy item is described in “MESSAGES/USER DATA Policy Item” on page 162.

STARTUP

This policy item allows you to add, remove or modify startup procedures for the current application.

See “STARTUP Policy Item” on page 179 for more information how to specify the startup automation policy.

SHUTDOWN

You must specify NORMAL shutdown commands for any application that you want to automate with SA z/OS. You may also specify INIT, IMMED, FORCE, and FINAL shutdown commands.

Specifying shutdown commands or replies for the application allows the automation to perform application shutdowns. You can specify different shutdown commands or replies to be issued for the different types of shutdown situations.

How to achieve this is described in “SHUTDOWN Policy Item” on page 182.

THRESHOLDS

Error threshold definitions for an application define how manyabend errors can occur before a message is logged or restart processing is

Policy Items for Applications

stopped. If no error thresholds are set here, the application uses the thresholds that are defined in the Application Defaults entry type.

Determine whether existing default threshold values are appropriate for this application. If they are not appropriate, create a unique threshold entry for the application.

For more information on thresholds, see the section “How SA z/OS Uses Error Thresholds” in *IBM Tivoli System Automation for z/OS User’s Guide* and “THRESHOLDS Policy Item” on page 190.

MINOR RESOURCES

This policy item allows you to define flags and thresholds for minor resources for the application. Minor resources are any resources specified to be subsidiary to this application, for example, messages and statuses.

The main purposes in defining minor resources are to let you:

- Trigger automation for minor resources
- Override the automation settings of major resources for a single minor resource, or a select number of minor resources

See the description of the MINOR RESOURCES policy item in “MVS Component Entry Type” on page 264 for information on how to manage minor resources and “MINOR RESOURCES Policy Item” on page 191.

The automation flags that are associated with minor resources are sometimes called extended automation flags. See “Automation Flags and Minor Resource Flags” in *IBM Tivoli System Automation for z/OS User’s Guide* for information about them.

See also the section “Thresholds for Minor Resources” in *IBM Tivoli System Automation for z/OS User’s Guide*.

SYSTEM ASSOCIATION

This policy item allows you to define primary and secondary systems for the application. Primary and secondary categorizations help SA z/OS determine whether an application should be started by SA z/OS when SA z/OS is initialized on a system. These categories allow SA z/OS to perform automation, such as monitoring or shut down, on applications that can be moved by an external agent.

For a detailed description on how to define system categories with this option see “SYSTEM ASSOCIATION Policy Item” on page 193.

GENERATED RESOURCES

This policy item lists all resources that were generated for the current application. Application resources are generated when a link between an application and a system occurs. Applications can never be linked directly to systems. This link happens indirectly by linking an application to an application group (either in an application’s WHERE USED policy item or in an application group’s APPLICATIONS policy item.)

The GENERATED RESOURCES panel is displayed, which looks similar to the one shown in Figure 92 on page 136, except that the section, **Resources for THIS entry**, showing the application group resource is missing.

MEMBER OF

This policy item lets you see the APG Resources that the current application is a member of.

See “MEMBER OF Policy Item” on page 137 for more details.

UPWARD CLASS Policy Item

If you select the UPWARD CLASS policy item from the Policy Selection panel for Applications, the Upward Link to Class panel is displayed, as shown in Figure 96.

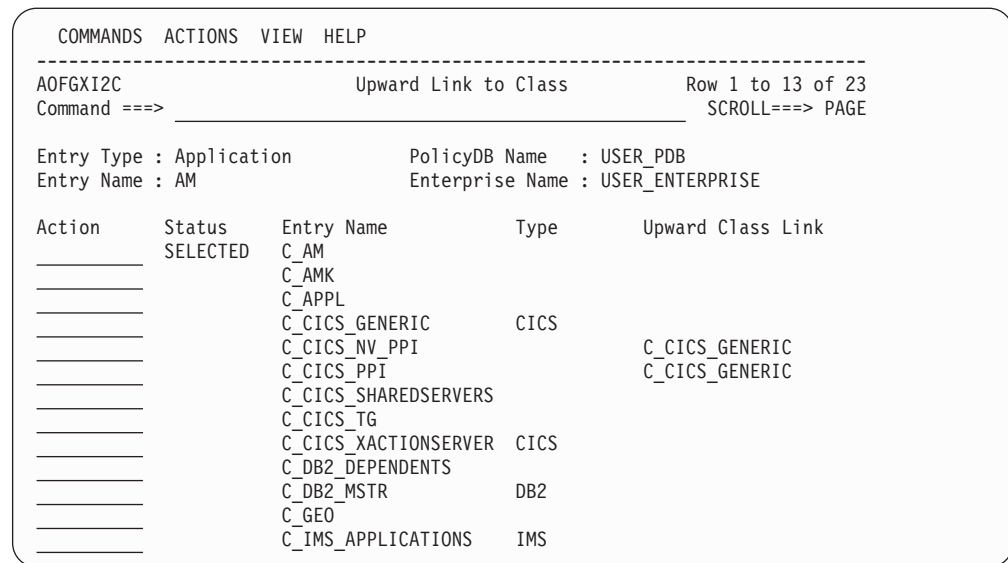

Figure 96. Upward Link to Class Panel

This panel allows you to manage the upward link from an application class or instance to a class of the same type. This link allows the instances or classes to inherit any policy data that has been defined in the selected class or other classes further up in the class chain.

- Use the **Action** field to manage the link by entering:
 - Add (A) or Select (S) to link the class or instance to this class
 - Remove (M) to unlink the class or instance from this class
- The **Status** column indicates whether this class or instance has been linked up to the class in the list.
- The **Type** column indicates what application type the class in the list was defined as.
- The **Upward Class Link** column indicates the class, if any, that the entry in the list is currently upwardly linked to.

To avoid circular links, a check is made to ensure that the class you select is not already linked in the downward tree of the current class.

See “Nested Classes” on page 11 for more details about nested class support.

DOWNWARD CLASS/INST Policy Item

If you select the DOWNWARD CLASS/INST policy item from the Policy Selection panel for Applications, the Downward Link to Classes or Instances panel is displayed, as shown in Figure 97 on page 148.

DOWNWARD CLASS/INST Policy Item for Applications

COMMANDS	ACTIONS	VIEW	HELP
A0FGXC2I		Downward Link to Classes or Instances	
Command ==>		Row 1 to 13 of 125	SCROLL==> PAGE
Entry Type : Application		PolicyDB Name : USER_PDB	
Entry Name : C_AM		Enterprise Name : USER_ENTERPRISE	
Action	Status	Entry Name	C Type Upward Class Link
_____	SELECTED	AM	C_AM
_____	SELECTED	AM2	C_AM
_____		APPC	
_____		ASCH	C_APPL
_____		BLSJPRMI	
_____		C_APPL	*
_____		C_CICS_NV_PPI	*
_____		C_CICS_PPI	*
_____		C_CICS_SHAREDSERVERS	*
_____		C_CICS_TG	*
_____		C_CICS_XACTIONSERVER	* CICS
_____		C_DB2_DEPENDENTS	*
_____		C_DB2_MSTR	* DB2

Figure 97. Downward Link to Classes or Instances Panel

This panel allows you to manage the downward links from an application class to classes or instances of the same type. These links allow the instances or classes to inherit any policy data that has been defined in this class or other classes further up in the class chain.

- Use the **Action** field to manage the links by entering:
 - Add (A) or Select (S) to link the class or instance to this class
 - Remove (M) to unlink the class or instance from this class
- The **Status** column indicates whether the entry in the list has been linked down to by this class.
- The **C** column indicates with an asterisk (*) that the entry is a class because this may not be obvious from the entry name.
- The **Type** column indicates what application type the entry was defined as. Note that an application class that you are working with can only be linked to entries of the same type as itself.
- The **Upward Class Link** column indicates the class, if any, that the entry in the list is currently upwardly linked to. If you select such an entry, you would change its class chain, so be careful not to break its data inheritance

To avoid circular links, a check is made to ensure that the class you select is not already linked in the upward tree of the current class.

Both link panels show the application type because class-instance links are only allowed if there is no type mismatch in the class hierarchy, that is, either the specified types must be the same or no type is specified.

To avoid type mismatches, the types of the link partner or the inherited types are checked. A link is invalid if the resulting class chain includes type specifications that do not match (for example, a class or instance of type IMS and another class or instance of type CICS). Thus, if both link partners (the current entry and the linked class or instance) have a type specified it is checked that they are identical. If either link partner has no type specified, the class hierarchy that leads to this entry is scanned to check whether an inherited type may cause a mismatch. If this is the case, a detailed link error message that includes the names of the conflicting entries is displayed.

See "Nested Classes" on page 11 for more details about nested class support.

APPLICATION INFO Policy Item

If you select the APPLICATION INFO policy item from the Policy Selection panel for Applications, the Application Information panel is displayed, as shown in Figure 98.

```

COMMANDS  HELP
-----
AOFGDYNA          Application Information
Command ==> _____

Entry Type : Application          PolicyDB Name : USER_PDB
Entry Name : APPL1              Enterprise Name : USER_ENTERPRISE
                                   More:      +
Application Type . . . . . _____ (IMAGE JES2 JES3 CICS IMS DB2 OPC USS
                                   or blank)
Subtype . . . . . _____ (For types CICS IMS DB2 OPC or blank)
Subsystem Name . . . . . APPL1
Job Type . . . . . _____ (MVS NONMVS TRANSIENT)
Job Name . . . . . APPL1
Transient Rerun . . . . . _____ (YES NO)
Scheduling Subsystem . . . . . _____ (MSTR, JES Subsystem)
JCL Procedure Name . . . . . _____
Captured Messages Limit. . . . . _____ (0 to 999)

Desired Available. . . . . _____ (ALWAYS ONDEMAND ASIS)
Restart after IPL. . . . . _____ (START NOSTART NONE)
Start Timeout . . . . . _____ (time for "UP" status checks, hh:mm:ss)
Start Cycles . . . . . _____ (start timeout checks, 0 to 99)
Restart Option . . . . . _____ (ALWAYS ABENDONLY NEVER)
External Startup . . . . . _____ (INITIAL ALWAYS NEVER)
Skip ACTIVE status . . . . . _____ (YES NO)
Startup Parameters . . . . . _____

External Shutdown. . . . . _____ (FINAL ALWAYS NEVER blank)
Shutdown Pass Interval . . . . . _____ (hh:mm:ss)
Cleanup Delay . . . . . _____ (hh:mm:ss)

Command Prefix . . . . . _____
Message Prefix . . . . . _____
Sysname . . . . . _____ (System name)
Monitor Routine. . . . . _____ (name NONE)
Monitor Interval . . . . . _____ (hh:mm NONE)
Inform List . . . . . _____ (SDF NMC IOM SMF EIF TTT USR NONE)

ARM Element Name . . . . . _____
WLM Resource Name 1 . . . . . _____
WLM Resource Name 2 . . . . . _____
WLM Resource Name 3 . . . . . _____
Owner . . . . . _____
Info Link. . . . . _____
    
```

Figure 98. Application Information Panel

Any policy values that have been inherited from linked classes are displayed in a different color. You can find out which class a value has been inherited from by typing the command `classname` (or its abbreviation `cn`) on the command line, moving the cursor to the field of interest and pressing Enter. You can override any inherited values by overtyping them. If you override any values for a class, they are individually applied to the current application and change color to turquoise to indicate this.

This panel displays the following information:

APPLICATION INFO Policy Item for Applications

Application Type

See "Application Type" on page 140 for more details.

Subtype

See "Subtype" on page 140 for more details.

Subsystem Name

This gives a unique, eleven-character name to the application that you are defining. This name is used by SA z/OS automation. You can have multiple application instances with the same subsystem name, however, only one of them can be linked to a system. The subsystem name of an application class must be unique across the whole policy database, that is, it cannot be the same as the subsystem name of any other application instance or class.

You can change the subsystem name by overwriting the existing name. If the application instance is linked, the name is checked to be unique across all subsystem names in the policy database. If you want to change the subsystem name to a name that already exists, you first need to unlink the application instance from all application groups.

If no subsystem name is specified, the default is the value of the Entry name (if this name is not longer than 8 characters for applications of type IMAGE, and not longer than 11 characters for all other application types).

For applications of type IMAGE the subsystem name can only be an 8-character name.

Note:

Certain values are reserved for SA z/OS and cannot be used. See the online help for a complete list.

Job Type

See "Job Type" on page 140 for more details.

Job Name

See "Job Name" on page 141 for more details.

Transient Rerun

See "Transient Rerun" on page 141 for more details.

Scheduling Subsystem

See "Scheduling Subsystem" on page 142 for more details.

JCL Procedure Name

See "JCL Procedure Name" on page 142 for more details.

Captured Messages Limit

Specifies the maximum number of *captured messages* that will be saved for the SA z/OS command DISPINFO.

If the field is left blank the value can be inherited from a class, the application defaults (ADF), or the system's default definition (SDF). If neither of these are specified a default value of 0 is used.

Desired Available

Lets you specify the default desired status of the resource. The desired state of each resource is either Available or Unavailable, which is the goal that automation tries to achieve.

You can specify the following values:

APPLICATION INFO Policy Item for Applications

ALWAYS

The resource's desired status is set to Available, unless it is dependent on a resource that has a Desired Available setting of ONDEMAND. In this case the resource behaves as if it had a Desired Available setting of ONDEMAND itself.

This is the same behavior as in earlier releases of SA z/OS.

ONDEMAND

If there is *demand* for the resource to be available, its desired status is set to Available, otherwise its desired status is set to Unavailable.

Demand arises either from propagated MakeAvailable votes or implicitly through membership of a non-passive basic application group (APG) that has a desired status of Available. Demand does not arise from dependent resources with a Desired Available setting of ALWAYS.

A MakeAvailable vote that is propagated to the resource overrides any demand considerations.

An active ONDEMAND member of a move or server group is always sent a vote that sets its desired status, thus overriding any demand considerations.

ASIS The desired status is always set to the observed status. The resource remains in the status that it currently has and no action is taken by SA z/OS at any time, as long as there is no request placed for or propagated to the resource.

If you leave the field blank the value can be inherited from a class or the system defaults definition.

Note:

If nothing is specified or inherited the default value is ALWAYS.

Restart after IPL

Specifies how SA z/OS determines the initial status of the application on the first occasion that SA z/OS is started after a z/OS IPL or an automation status file reallocation.

Reallocating the automation status file has the same effect as a z/OS IPL because SA z/OS stores the last IPL date and time in the automation status file. When the automation status file is deleted, SA z/OS assumes that the next startup is the first startup following a z/OS IPL.

You can specify four values for Restart after IPL:

START

The application is always startable when the start dependency is fulfilled. The application status is set to DOWN during initialization. It is recommended that you specify YES for critical applications such as JES, VTAM, and TSO. Replying NOSTART to message AOF603D (specify initialization options) overrides this setting.

NOSTART

This enforces a STOP request with priority FORCE to be injected during SA z/OS initialization. This results in a desired status of UNAVAILABLE and an observed status of SOFTDOWN, which

APPLICATION INFO Policy Item for Applications

produces a compound status of SATISFACTORY. If the observed status before IPL was HARDDOWN this status remains in HARDDOWN, which produces a compound status of PROBLEM.

NONE

This value is the same as leaving the field blank, except that if the application is an instance, it does not inherit the value from its related application class.

If you leave this field blank, it indicates that the application is startable, depending on its status. If the status is STOPPED, BROKEN or CTLDDOWN, it is not changed and the application is not started. Any transient status (for example, BREAKING) is changed to the corresponding final status (for example, BROKEN). Any other status is changed to DOWN during initialization and, if the INITSTART flag is set to YES, the application is started when all its relationships are fulfilled.

Start Timeout

Specifies an interval which begins when a start command for the application is issued by SA z/OS. After the expiration of this interval, a check occurs to determine whether the application recorded a status of STARTED and/or ACTIVE depending on the MVS active/inactive state at that time. Message AOF 571I is issued.

Note: If nothing is specified the default supplied by the automation agent is used, which is 2 minutes.

Start Cycles

Specifies the number of times to cycle the start timeout period before posting the subsystem as a problem which means the application is given a STARTED2 or INACTIVE status.

Note: If nothing is specified the default value is 1.

Restart Option

The circumstances that the application should be restarted under. The options are:

Always

The application is restarted if it was terminated without using the INGREQ command. Note that, if the advanced automation option AOFRESTARTALWAYS is set to 0, the application restart thresholds are checked. The application is restarted only if it has not exceeded the critical threshold. By default the application is restarted every time it is stopped outside the control of SA z/OS.

Abendonly

The application is eligible for restart only if it abnormally ends. The application is restarted only if its critical error threshold has not been exceeded.

Never The application is never eligible for restart by SA z/OS.

You can use this option to force a specific application state. For example, if an application is defined with the restart option set to Always and an operator tries to shut down the application without using the INGREQ command, the application will be restarted when it has completed its shutdown. The AOFRESTARTALWAYS advanced automation option can be used to modify this behavior.

External Startup

Specifies whether the application is started externally or via a specified startup procedure.

INITIAL

The application will only initially be started externally.

ALWAYS

The application will always be started externally.

NEVER

The application will never be started externally.

If you leave this field blank, the value can be inherited from a class definition. For applications of type IMAGE where the monitor routine is INGMTSYS the value is forced to ALWAYS.

Note: If nothing is specified or inherited the default supplied by the automation agent is used, which is NEVER.

Skip ACTIVE status

Specifies whether the application has a specific indication for the UP status.

YES

Sets the status to UP for standard applications if message IEF403I is trapped. For transient applications the status is changed from ACTIVE to RUNNING.

For USS applications with a job type of NONMVS it also sets the status to UP if the USS process exists.

NO or blank

It does not automatically set the status.

Startup Parameters

Specifies the desired subsystem startup parameters. These values are added to the MVS START command for the subsystem. For example, suppose the desired start command for VTAM is:

```
S VTAM, ,(LIST=00)
```

If this command is to be submitted from SA z/OS, the **Startup Parameters** field should contain:

```
, ,(LIST=00)
```

Whatever you enter in this field is appended directly to the MVS START command for the subsystem, therefore, the commas preceding (LIST=00) are necessary.

You can include system symbols and system automation symbols. See "Assigning System Automation Symbols (AOCCLONE)" on page 9 for details on using system automation symbols.

You may also include run time variables, such as SUBSAPPL, SUBSJOB, SUBSPROC, SUBSSHUTDLY and others. For a complete list of run time variables, see SA z/OS documentation.

External Shutdown

Specifies whether the application is stopped externally or via a specified shutdown procedure.

APPLICATION INFO Policy Item for Applications

FINAL

The application will be stopped externally if the external supporting resource (parent) is also being stopped.

ALWAYS

The application will always be stopped externally.

NEVER

The application will never be stopped externally.

If you this field is left blank, the value can be inherited from a class definition. For applications of type IMAGE where the monitor routine is INGMTSYS, the value is forced to ALWAYS.

Note: If nothing is specified or inherited, the default supplied by the automation agent is used, which is NEVER.

Shutdown Pass Interval

Used to tell SA z/OS how long to wait for attempts to shutdown the subsystem. These attempts are defined in the SHUTDOWN policy. If the field is left blank, the value can be inherited from a class or the application defaults definition.

Note: If nothing is specified or inherited, the default supplied by the automation agent is used, which is 2 minutes.

Cleanup Delay

Used to specify an interval which begins when the final termination message (TERMMSG FINAL=YES) for the subsystem is processed. The purpose of this delay is to allow for additional processing performed by or on behalf of the subsystem to the message being issued. If the field is left blank the value can be inherited from a class or the application defaults definition.

Note: If nothing is specified or inherited the default supplied by the automation agent is used, which is 12 seconds.

Command Prefix

This is the console prefix character for the application. Many applications, such as JES2, JES3, and NetView support the use of a command prefix character which identifies a command as belonging to that application. If such support is available for this application, enter the corresponding command character.

Any command that would normally be issued at a z/OS console should be prefixed with MVS. NetView commands to control NetView automation do not require the MVS prefix.

You can include system symbols and system automation symbols, see "Assigning System Automation Symbols (AOCCLONE)" on page 9.

Note:

The single quotation character (') is reserved for SA z/OS and should not be used.

Message Prefix

Specifies one or more message prefixes for this application. You only have

APPLICATION INFO Policy Item for Applications

to specify these message prefixes if the application issues messages that do not contain the MVS job name. These message prefixes must be unique for this application.

Sysname

The system name for the subsystem. This is only required for JES subsystems where the Sysname for the subsystem is not the same as the MVS Sysname. If Sysname is not specified, it will default to the name specified in the SYSTEM INFO policy item of the System entry type.

Monitor Routine

The name of the application monitor routine that is used to monitor the application's status.

The following specifications are valid:

AOFADMON

Monitors the status via MVS D A commands.

AOFAPMON

Routine used to monitor a PPI receiver.

AOFATMON

Monitors the status of a task in the NetView environment.

AOFCPSM

Dedicated routine used to monitor SA z/OS Processor Operations.

AOFNCOMON

Routine used to monitor the connection between the NMC focal point NetView and the NMC server application.

AOFUXMON

Routine used to monitor USS applications.

INGMTSYS

Dedicated routine used to monitor IMAGE applications for BCPII usage.

INGROMON

Dedicated routine used to monitor OMVS which should not be used for any other application.

ISQMTSYS

Dedicated routine used to monitor SA z/OS processor operations target system resources.

INGPJMON

Monitors the status via ASCB checking.

INGPSMON

Monitors the status via IEFSSI service.

INGVMON

Monitors the status of a VOST via LIST STATUS=VOST.

NONE

No monitoring routine is to be used.

username

A monitoring routine that has been defined and created by the user.

Note:

If a user-defined routine is not found by automation, the SA z/OS routine INGPJMON is used except for applications of type IMAGE, when INGMTSYS is the default.

For non-MVS applications, make sure that either a user-defined monitoring routine or NONE is specified.

If this application is linked to an application CLASS entry that has the Monitor Routine specified, the CLASS policy takes precedence over the Environment Setup policy.

Monitor Interval

This is the amount of time between application subsystem monitoring cycles. Monitoring may be suspended by specifying NONE.

Inform List

This field allows you to specify:

- Where the application is registered to
- Where all status changes are propagated to
- Whether SMF records are written

Valid receivers are SDF, NMC, IOM, SMF, EIF, TTT and USR. You can specify more than one receiver.

The list of values can be blank or comma separated. Neither system automation symbols (AOCCLONES) nor system symbols are allowed.

If the field is left blank the value is obtained from the systems default definition (see "System Defaults Entry Type" on page 272).

Specify NONE to prevent the default from the systems default definition. This prevents inheritance from the system's default definitions (SDF).

ARM Element Name

An application defined to MVS Automatic Restart Manager must have an element name that is unique within each sysplex where the application runs. Each element name consists of up to 16 alphanumeric and national characters including @, #, \$ and _ (underscore) after clone resolution, provided the first character is not numeric. Clone resolution occurs at automation control file load.

You can include system symbols and system automation symbols. For more details, see "Assigning System Automation Symbols (AOCCLONE)" on page 9.

The element name can be:

Constant

The element name is the same, regardless of which system the application is running on. This is required for applications that are restartable on multiple systems in the sysplex. An application with a constant Automatic Restart Manager element name may at the same time have a cloned job name.

Note:

An application with a cloned job name and a constant Automatic Restart Manager element name can be started on only one system within a sysplex.

For applications of type IMAGE the value is forced to blank.

Cloned

The application has a different element name on each system. The element name is derived from some attribute that is unique to the system that the application runs on. Applications with cloned element names must be defined to MVS Automatic Restart Manager in such a way that MVS will only attempt to restart them on the same system and not move them to other systems in the sysplex.

Applications with cloned element names may have constant job names. This can be useful if you want to have the same application running on multiple systems with Automatic Restart Manager recovery enabled.

For example, you have a USERPROC that runs on all your systems and you want Automatic Restart Manager recovery for it. Automatic restart management requires that USERPROC have a different element name on each system. Defining USERPROC to SA z/OS with a constant job name, but with a cloned element name (and perhaps some parameters to define the element name) allows you to define a single SA z/OS application with a different element name on each system.

WLM Resource Name 1–3

These are the names of the WLM Resources that are associated with the application.

The *same* WLM resource name can be used for *multiple* applications. If any of these applications are in the UP or ENDED automation status, the WLM resource status is set to ON. When all the applications that are associated with the same WLM resource name are in any other status, the resource is set to OFF.

You can include system symbols and system automation symbols, see “Assigning System Automation Symbols (AOCCLONE)” on page 9.

You can specify up to three different WLM resource names, but only one per field.

No WLM resource names are accepted for applications of type IMAGE.

All three WLM resource names are inherited together. Thus if you specify one for an instance and another for a class, this is not inherited.

Owner

This specifies information for the operator about who to contact in case of error.

Info Link

This field can be used to specify a location (for example, a URL) where additional information about the application can be found.

AUTOMATION FLAGS Policy Item

The Flag Automation Specification panel (Figure 99) is displayed if you select policy item AUTOMATION FLAGS from the Policy Selection panel for applications. For more details about automation flags, see the section “Automation Flags” in *IBM Tivoli System Automation for z/OS User’s Guide*.

```

COMMANDS  ACTIONS  HELP
-----
A0FGFAS1          Automation Flag Specification
Command ==> _____

Entry Type : Application          PolicyDB Name  : USER_PDB
Entry Name  : APPL1              Enterprise Name : USER_ENTERPRISE

Resource:  APPL1

Line Commands: S (Select for Exit processing)
Level of automation: Y = Yes  N = No  L = Log  E = Exits

Cmd  Flag          Auto      Exits
---  ---          ---      ---
Automation . . . _____  0
Recovery . . . _____  0
Start . . . . . _____  0
Terminate . . . _____  0
Initstart . . . _____  0
Restart . . . . . _____  0

Enter or Display times to disable automation . . NO _____ Yes  No
    
```

Figure 99. Flag Automation Specification Panel

This panel allows you to specify:

- The type of automation mode
- Whether automated operator functions will operate in log assist mode
- Whether user-provided exit routines are to be called to determine whether automation is to continue
- When automation occurs

There are six types of automation flags supported by SA z/OS:

Automation

Is the global automation flag that must be YES for the remaining flags to be used. If it is NO, there is no automation for the resource.

Recovery

Indicates whether recovery of the resource (actions on messages that are neither for the initialization nor the ending of the resource) is allowed.

Start Indicates whether the start command and actions or responses to initialization for the resource are allowed.

Terminate

Indicates whether the shutdown command and actions on or responses to ending messages are allowed.

InitStart

Indicates whether a resource can be started when its state is DOWN (that is, it controls initial starting of the resource).

Restart

Indicates whether the restarting of a resource that abnormally ended or was automatically shut down is allowed.

AUTOMATION FLAGS Policy Item for Applications

For each flag you may specify:

- Cmd** Enter S in the **Cmd** field to select the flag to define or delete user-defined exit routines.
- Auto** Use this field to control what particular automated responses are allowed:
- YES** Automation is active.
 - NO** Automation is not active.
 - LOG** LOG assist mode is active. Actions that should be taken under the chosen type of automation do not occur, but messages describing what would have happened are written to the NetView log.
 - EXITS** One or more user-provided exit routines have been defined.

The **Exits** field displays the number of exits that have been defined.

If you want to enable automation but specify times when it should be disabled, you can enter YES in the final input field. The Automation Disable panel is displayed where you can specify one or more time ranges when automation is disabled.

APPLICATION SYMBOLS Policy Item

If you select the APPLICATION SYMBOLS policy item from the Policy Selection panel for Applications, the Application Symbols panel is displayed, as shown in Figure 100.

```
COMMANDS  HELP
-----
AOFGDYNA          Application Symbols          Line 00000001
Command ==> _____ Scroll ==> PAGE

Entry Type : Application          PolicyDB Name  : USER_PDB
Entry Name  : APPL1              Enterprise Name: USER_ENTERPRISE

SYMBOL1 . . . . _____
Description 1 . _____
SYMBOL2 . . . . _____
Description 2 . _____
SYMBOL3 . . . . _____
Description 3 . _____
SYMBOL4 . . . . _____
Description 4 . _____
SYMBOL5 . . . . _____
Description 5 . _____
SYMBOL6 . . . . _____
Description 6 . _____
SYMBOL7 . . . . _____
Description 7 . _____
```

Figure 100. Application Symbols Panel

This panel allows you to enter or update application symbols that can be set to various application-specific values. These can then be substituted using the runtime variables SUBSSYMBOL1 through SUBSSYMBOL9. Those variables can be used in a similar fashion to runtime variables like SUBSSPARM, SUBSSCHEDSS, SUBSJOB, etc.

To specify that SUBSSYMBOL value x is to be substituted, enter &SUBSSYMBOLx at the appropriate point in the field. You must specify only the leading ampersand (&).

SYMBOLx

Allows you to specify the value of the application symbol. You can enter

APPLICATION SYMBOLS Policy Item for Applications

any character but you should avoid using any SA z/OS reserved runtime variables, such as &SUBSJOB or others.

Note:
The entered data is not automatically translated to upper case.

Description

Allows you to specify a description of the application symbol.

TRIGGER Policy Item

The Trigger for Application panel (Figure 101) is displayed if you select policy item TRIGGER from the Policy Selection panel for applications. For more details about triggers, see the section "Event and Trigger Support" in *IBM Tivoli System Automation for z/OS User's Guide*.

```
COMMANDS ACTIONS VIEW HELP
-----
A0FGXC4E          Trigger for Application          Row 1 of 4
Command ==>>> _____ SCROLL==>>> PAGE

Entry Type : Application          PolicyDB Name : USER_PDB
Entry Name  : APPL1              Enterprise Name : USER_ENTERPRISE

Action      Status      Trigger
-----
_____          CICSK34
_____          CICSK42
_____          TRIGGER1
_____          XRFTRIG
***** Bottom of data *****
```

Figure 101. Trigger for Application Panel

This panel allows you to add triggers to or remove them from an application.

SERVICE PERIOD Policy Item

If you select an application's SERVICE PERIOD policy item, you reach the Service Period for Application panel. Figure 102 shows an example.

```
COMMANDS ACTIONS VIEW HELP
-----
A0FGXC4E          Service Period for Application          Row 1 of 6
Command ==>>> _____ SCROLL==>>> PAGE

Entry Type : Application          PolicyDB Name : USER_PDB
Entry Name  : APPL1              Enterprise Name : USER_ENTERPRISE

Action      Status      Service Period
-----
_____     SELECTED    CICSK42
_____          IMS711C4
_____          IMS712CX
_____          IMS722CX
_____          IM631C4
_____          SERVP1
***** Bottom of data *****
```

Figure 102. Service Period for Application Panel

This panel allows you to add service periods to or remove them from an application.

RELATIONSHIPS Policy Item

The Relationship Selection List panel (Figure 88 on page 124) is displayed if you select policy item RELATIONSHIPS from the Policy Selection panel for applications. It shows information about existing relationships and allows you to define new relationships.

The ACTION pull-down choice offers actions to edit and delete selected relationships. The Delete command immediately deletes the relationship. The Edit command leads to the Define Relationship panel (as shown in Figure 103).

```

COMMANDS  ACTIONS  VIEW  HELP
-----
A0FGXREL          Relationship Selection List
Command ==> _____

Entry Type : Application          PolicyDB Name  : USER_PDB
Entry Name  : APPL1              Enterprise Name : USER_ENTERPRISE

External Startup . . . . . _____ (INITIAL ALWAYS NEVER blank)
External Shutdown. . . . . _____ (FINAL ALWAYS NEVER blank)

Action #   Type                Supporting Resource          Auto   Chain
-----
   1     HASPARENT              VTAM/APL/=
   _____ MAKEAVAILABLE          S/APG/=                      ACTIVE WEAK
***** Bottom of data *****

```

Figure 103. Relationship Selection List Panel

This panel displays information about existing relationships. In all of the relationships for the current resource, this resource is the dependent resource. The columns have the same meaning as described in “Defining Relationships” on page 124.

If the application is linked to a class, the **External Startup** and **External Shutdown** fields in the subheader area show inherited data individually, however the relationships are inherited only as a whole if no relationships are defined for the child object.

You can find out which class a value has been inherited from by typing the command `classname` (or its abbreviation `cn`) on the command line, moving the cursor to the field of interest and pressing Enter.

If the application has inherited relationships from a class, only these are displayed in a different color. If you change one of these relationships, all the inherited relationships become specific to that particular class or instance (and thus change color to reflect this).

Entering the NEW command from this panel to define new relationships takes you to the Define Relationship panel described in “Defining Relationships” on page 124.

The External Startup and External Shutdown fields are the ones from “APPLICATION INFO Policy Item” on page 149 (see “Startup Parameters” on page 153 and “External Shutdown” on page 153 for details).

MESSAGES/USER DATA Policy Item

If you select policy item MESSAGES/USER DATA from the Policy Selection panel for Applications (Figure 95 on page 143), the Message Processing panel shown in Figure 104 is displayed.

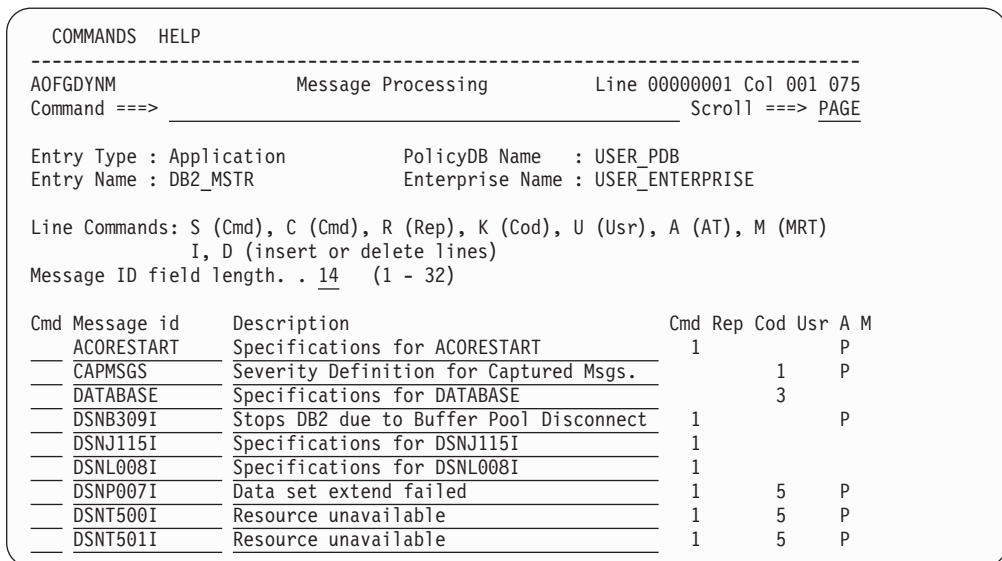

Figure 104. Message Processing Panel

On the Message Processing panel you specify how SA z/OS should react if the application issues the specified message. If the application is linked to a class, the panel shows both instance and class data sorted alphabetically, with the inherited data shown in a different color. For more details see “Nested Class Details” on page 177. You can find out which class a value has been inherited from by typing the command `classname` (or its abbreviation `cn`) on the command line, moving the cursor to the field of interest and pressing Enter.

Use the CANCEL command (abbreviated to C) to exit the panel without saving any changes to the data.

You can define message responses for each message ID. By default, the first 14 characters of the message ID is shown. The length of the description that is displayed depends on your screen width (for a 24x80 screen, it is 40 characters).

You can change the length of the message ID field with the **Message ID field length** field. Note that this value is not saved across sessions. If you increase the message ID field length, you can view any information on the right of the panel that is no longer displayed by scrolling right with the PF11 key.

You can enter different line commands in the **Cmd** column. Depending on what you type here, SA z/OS displays a follow-on panel where you further specify SA z/OS's automated reaction to the message. Note that the message ID must not end with an asterisk and cannot have any commas in it.

Generally, SA z/OS requires an entry in the NetView automation table that specifies which routine SA z/OS should use to process your specified action. SA z/OS is able automatically to build the NetView AT entries for all CMD, REP, and AT actions as well as for certain USR and COD actions.

MESSAGES/USER DATA Policy Item for Applications

Information about how to manage the NetView automation table is given in *IBM Tivoli System Automation for z/OS Customizing and Programming*.

The following line commands are available:

CMD To issue commands as a response to a message, see “Command Processing” on page 164.

REP To issue replies, see “Reply Processing” on page 166.

COD To check for certain codes within a message. For different sets of code values, you can define a corresponding value that is returned to the calling REXX script that checks for a matching code definition. See “Code Processing” on page 167.

USR You can specify your own data that is needed when SA z/OS runs user-specified actions if the current message requires more specific automation than provided by the generic routines (see “User Data Processing” on page 170).

Using the ACFFQRY common routine from within a REXX exec, you can retrieve the keywords entered into this panel and process them as needed. Syntax rules for specifying user data are available in the online help. For information on how to use ACFFQRY in a REXX exec see ACFFQRY in *IBM Tivoli System Automation for z/OS Programmer’s Reference*.

AT Use the associated panels to customize the AT entry that is built for the message ID. See “Message Automation Definitions” on page 171.

MRT Use the associated panels to customize the NetView message revision table (MRT) entry. See “Message Automation Definitions” on page 171.

The **A** and **M** columns indicate whether there are any specifications that are related to entries for the NetView automation table or message revision table as follows:

***** User data has been defined for the message ID. The * is always turquoise because the data cannot be associated with a class because there may be other instances with entries for the same message ID.

P There is a predefined entry for this message ID, shown in the color for inherited data.

You can enter FIND (abbreviated to F) at the command line on the Message Processing panel to search the displayed data for a specific string, for example, f abc. All occurrences of the string are highlighted and the cursor is positioned at the start of the first one. You can use the RESET command to remove the highlighting.

Note that only the data that is *visible* is searched through in the **Message ID** column. You should therefore consider expanding the column width so that the complete message ID is visible before performing a search.

You can use the RFINDD function key (PF5) to move to the next occurrence of the string. If you enter the RFINDD command at the command line it repeats the last find.

For more details, see “How to Find Data in a Policy Item” on page 23.

Working with Message IDs

If you add a new message ID that already exists elsewhere in the policy database and it has AT or MRT data specifications, pressing Enter causes the AT or MRT

MESSAGES/USER DATA Policy Item for Applications

data indicators to appear in the corresponding columns. Furthermore, if you do not specify a message description for a message that already exists in policy database, the description is filled in from either a user-specification or a predefined entry in +SA_PREDEFINED_MSGS.

If you change a message ID, not only are the commands, replies, etc. kept, but also any AT or MRT data. If you change the message ID to one that already exists, there may be a conflict. For example, if message ID ABC123 is changed to DEF456:

- If ABC123 has AT data, but DEF456 does not, the AT data from ABC123 is copied to DEF456.
- If ABC123 does not have any AT data, but DEF456 does, the AT data from DEF456 are kept.
- If ABC123 and DEF456 both have AT data that differs, the message ID change is not possible and the message Conflicting AT data is issued.

You should also bear in mind that if the message ABC123 has also been defined for another application, it keeps any AT or MRT data that has already been defined.

If you delete a message ID that has been specified in the MESSAGES/USER DATA policy item of just one application or MVS component, this deletes all related data. The message ID no longer exists in the policy database, and is no longer displayed in MESSAGE AUTOMATION policy item of entry type ENT, and any AT or MRT specifications are removed from the policy database.

If you delete a message ID that has been specified in the MESSAGES/USER DATA policy item for multiple objects, and AT or MRT data exists, this does not delete the AT or MRT data. Any AT or MRT data is deleted only if the message is deleted from the last remaining object in the policy database, or the object itself is deleted.

Command Processing

SA z/OS displays the Command Processing panel (Figure 105) if you enter the action code CMD in the **Cmd** column on the Message Processing panel.

```
COMMANDS  HELP
-----
AOFGDYN9      Message: HSAM1390E                Line 00000001 Col 001 075
Command ==>> _____ Scro11 ==>> PAGE

Cmd Ps/Select  AutoFn/*  Command Text
-----
LAST          _____  IMSCMD &SUBSAPPL /STA OLDS 99
SYSTEM       _____  IMSCMD &SUBSAPPL /LOG WAITING
_____
_____
_____
_____
_____
_____
_____
_____
_____
***** Bottom of data *****
```

Figure 105. Command Processing Panel for Applications

Use this panel to enter commands that are executed when the application issues the specified message. If you specify one of the automation commands that are provided by SA z/OS (see *IBM Tivoli System Automation for z/OS Operator's Commands*), they should be queued using the NetView CMD LOW command. This ensures that task global variables that are in use by the calling automation procedure are not changed by the calling command.

For a list of runtime variables that can be substituted into each command prior to execution, see ACFCMD in *IBM Tivoli System Automation for z/OS Programmer's Reference*.

You can use the following line commands in the **Cmd** field to manipulate the entries on this panel:

- Inn** Insert one or *nn*, if you specify a number, new lines after the selected line
- Rnn** Repeat the selected line one or *nn* times if you specify a number
- Dnn** Delete the selected line, and the following *nn* lines if you specify a number
- Mnn** Move the selected line and the following *nn* lines if you specify a number
- A** Move lines after the selected line
- B** Move lines before the selected line

You can use the FIND/RFIND command on this panel to locate data. See "How to Find Data in a Policy Item" on page 23 for more details.

You can use the PF10 and PF11 keys to scroll left and right to view more of the **Command Text** field.

The value that you enter in the **Ps/Select** field defines when the command or reply should be issued, as follows:

- Pass** Enter a number from 1 through 99 or an asterisk (*) in this field to specify a pass value. During the automation control file build, this value is prefixed with PASS to create the selection criterion for the CMD or REP entry.

Note:

For more information about pass processing see the description of the PASSES parameter for the ISSUEACT generic routine in *IBM Tivoli System Automation for z/OS Programmer's Reference*. Pay attention when specifying a number because this is treated as a selection.

- Select** An expression other than a pass value is considered a selection value and is not altered during the build process. A selection value can be a blank or any name that does not begin with a number or contain imbedded blanks, commas, quotes, or parentheses.

Note:

For commands issued by SA z/OS during startup or shutdown, an attempt is made to issue only the commands that are relevant to the particular start or stop type. SA z/OS looks for command definitions with a selection field that matches the start or stop type. Commands that are defined without a selection value are issued or selected for each start or stop type.

Where appropriate, the AAO AOFSTATUSCMDSEL is taken into consideration.

AutoFn/*

Enter the name of the automated function that the command is to run under. The AT entry that is generated does not reflect the automated function that you enter, however the execution of the command is routed internally to the automated function that you specify. If you leave the field

Command Processing for Applications

blank, the function defaults to the one currently running the command list. SA z/OS automated functions are mapped to NetView automation operators (see Table 7 on page 277 for more details).

Note:

Entering * enables return-code checking for the specified command. This means that processing continues if the command returns a return code of 0. In all other cases processing is stopped immediately. If you are running in LOG assist mode, return code checking has no effect because the commands are not executed.

Command Text

Enter the command or command list to be issued. You must preface a system command with MVS.

Pass or selection values can be repeated for several text entries. Each set of entries with the same pass or selection value forms a command group.

To process this message an entry in the NetView automation table is generated that uses the ISSUEACT generic routine. For more details, see ISSUEACT in *IBM Tivoli System Automation for z/OS Programmer's Reference*.

Reply Processing

SA z/OS displays the Reply Processing panel if you enter the action code REP in the **Cmd** column on the Message Processing panel.

```
COMMANDS HELP
-----
AOFGDYN9      Message: ARC0055A      Line 00000001 Col 001 075
Command ==>      Scroll ==> PAGE

Cmd Ps/Select Ct Reply Text
-----
-----
-----
-----
-----
-----
-----
-----
-----
-----
-----
***** Bottom of data *****
```

Figure 106. Reply Processing Panel for Applications

Use this panel to enter the replies that are to be issued when this resource issues the specified message. For a list of run time variables that can be substituted into each reply prior to execution, see ACFREP in *IBM Tivoli System Automation for z/OS Programmer's Reference*.

You can use line commands in the **Cmd** field to manipulate the entries on this panel as described in "Line Commands on Message Processing Panels" on page 165.

The use of the **Ps/Select** field is similar to that described in "The Ps/Select Field" on page 165. Pass or selection values can be repeated for several text entries. Each set of entries with the same pass or selection forms a reply group.

To process this message an entry in the NetView automation table is generated that uses the ISSUEACT generic routine. For more details, see ISSUEACT in *IBM Tivoli System Automation for z/OS Programmer's Reference*.

Additionally, there are the following fields:

Ct This is the **Retry Count** field. Enter a number in the range 1–99 in this field to define the number of retry attempts that are made before the common routine decides that a reply cannot be issued. A retry occurs when the outstanding reply number is not available. For the first retry there is a one second time delay and for all further retries there is a two second time delay. The default retry count is 0.

Reply Text

Code the actual reply to the message in this field. Enter it in the same format as you would do from an MVS console (without the R and the reply number). To specify a null reply, type NULL in this field.

Code Processing

SA z/OS displays the panel shown in Figure 107 if you enter the action code COD (K) in the **Cmd** column on the Message Processing panel.

```

AOFGDYN9      Message: WTORS      Line 00000001 Col 001 075
Command ==>> _____ Scroll ==>> PAGE

Cmd Code 1      Code 2      Code 3      Value Returned
-----
_____
_____
_____
_____
_____
_____
_____
_____
_____
_____
***** Bottom of data *****
    
```

Figure 107. Code Processing Panel

Use this panel to specify a series of code definitions. Each code definition consists of up to three code values and an associated Value Returned.

The code definitions can be used by automation procedures to check, if a set of up to three given values matches with one of the code definitions in the automation policy. The values to be checked may be extracted variable values from an automated message or any other retrieved values, for which a matching code definition is searched. The associated **Value Returned** of the matching code definition can be used to decide about the further processing in the automation procedure.

Code definitions are used by SA z/OS, for example, to determine the severity of received WTORS. Further on, when processing termination messages of resources, SA z/OS uses code definitions to decide what status to place the resource in. In your own automation routine, you can use the common routine CDEMATCH to compare a set of given values with a series of code definitions in the automation policy and to gather the Value Returned from the matching code definition. For more details about common routine CDEMATCH, see *IBM Tivoli System Automation for z/OS Programmer's Reference*.

Code Processing for Applications

You can use line commands in the **Cmd** field to manipulate the entries on this panel as described in “Line Commands on Message Processing Panels” on page 165.

The fields on this panel are used by the CDEMATCH routine.

Code 1, 2, 3

Patterns in these fields are compared with a set of up to three given values that are provided by an automation procedure. If one of the defined sets of code patterns matches, the content of the corresponding **Value Returned** field is returned to the automation procedure and no further comparison is made.

If no match is found at all a null string is returned.

If the pattern is a single token, string comparison is performed. Such a pattern can contain wildcard characters in any position and combination. An asterisk (*) matches a string of arbitrary length and a percent sign (%) matches a single character.

Preceding the asterisk or percent sign with a backslash (\) prevents these characters from being considered as wildcard characters.

A pattern can also consist of two tokens. In this case, the first token is a string or numeric comparison operator and the second is the value to be compared to (wildcard characters are not supported).

The following string comparison operators are supported:

\$EQ	equal to
\$NE	not equal to
\$GT	greater than
\$GE	greater than or equal to
\$LT	less than
\$LE	less than or equal to

String comparison is done by character and in binary format after all the values have been translated to uppercase. For strings with different lengths, the shorter string is padded with blank characters at the end of the string to make it the same length as the longer string. Strings that consist of whole numbers with or without leading zeros are not considered as equal.

The following numeric comparison operators are supported:

@EQ	equal to
@NE	not equal to
@GT	greater than
@GE	greater than or equal to
@LT	less than
@LE	less than or equal to

Whole numbers up to an absolute value of $2^{31}-1$ are accepted.

For numeric comparison, whole numbers with or without leading zeros considered as equal.

Note:

The usage of the code fields depends on the invocation of the CDEMATCH routine.

Value Returned

If all the specified values in the code fields match the passed values from the automation procedure, the value in this field is returned to the automation procedure to be used for decision making.

Note:

A special value of *IGNORE* is honored by the SA z/OS ISSUEACT command so that no operation is triggered.

Code match checking is used by SA z/OS in the following situations:

- Processing of messages with ISSUEACT to trigger appropriate commands or replies.
- Processing of messages or OMEGAMON exceptions with INGMON to update the status of a monitoring resource or to issue appropriate commands or replies.
- Processing of termination messages with TERMMSG to determine which status to place the resource in.
- Processing of WTORs with OUTREP to assign a severity.
- Capturing of messages with AOFCPMSG to assign a severity.
- Sending events with INGALERT to event notification targets such as IOM, EIF, TTT, or USR.

For details see the description of these commands in *IBM Tivoli System Automation for z/OS Programmer's Reference*.

- Processing of CICS abend messages using message ID ABCODESYSTEM to determine whether or not to restart the subsystem.
- Processing of CICS or IMS transaction abend recovery using message ID ABCODETRAN.
- Processing of IMS BMP region abends using message ID ABCODEPROG.

For details see the description of these message IDs in *IBM Tivoli System Automation for z/OS Product Automation Programmer's Reference and Operator's Guide*.

- Processing of WTO buffer shortage recovery. For details see *IBM Tivoli System Automation for z/OS Customizing and Programming*.

Example 1:

Code 1	Code 2	Code 3	Value Returned
*	IMSTCTL		WARNING
*	IMS%CTL		CRITICAL

When checking two values for a match with the code definitions of this example, the first code definition matches with the given values, if the second value is IMSTCTL. In this case, WARNING is returned as the value.

If the second given value consists of IMS and CTL with any single character other than T between, a match with the second code definition occurs and CRITICAL is returned as the value.

Consider the following examples:

Code Processing for Applications

Values checked	Value returned	Reason
DFS2013 and IMSTCTL	WARNING	These values match the first code definition
DFS2013 and IMS1CTL	CRITICAL	These values match the second code definition
DFS2013 and IMS10CTL	null string	These code values do not match any of the code definitions

Example 2:

Code 1	Code 2	Code 3	Value Returned
*	TEST*	*	WARNING
*	*	@GT 8	CRITICAL
*	*	*	WARNING

When checking three values for a match the code definitions of this example, the three values match the first code definition, if the second value begins with the string TEST.

Three given values match the second code definition, if the second value does not begin with string TEST and the third value is a whole number greater than 8.

For example, the three values IEF451I, TESTJOB1 and 4 match the first code definition and WARNING is returned as value.

When checking with the three values IEF451I, IMS1CTL and 12, value CRITICAL is returned from the matching second code definition.

When checking with the values IEF451I, IMS1CTL and 4, value WARNING is returned from the matching last code definition.

More information about this panel is given in the online help.

User Data Processing

SA z/OS displays the User Data Processing panel, as shown in Figure 108 on page 171, if you entered the action code USR in the **Cmd** column on the Message Processing panel.

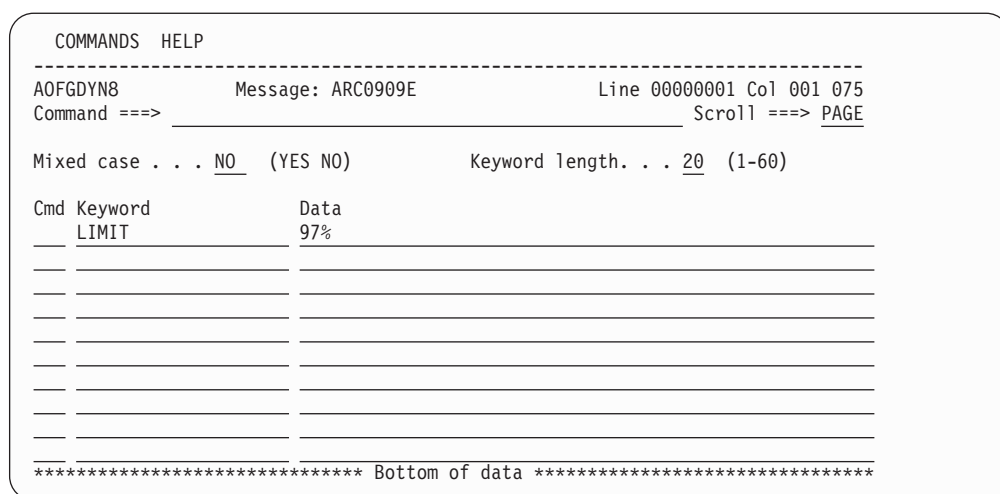

Figure 108. User Data Processing Panel for Applications

This panel allows you to manage the list of keyword-data pairs.

You can use this panel to let SA z/OS perform user specified actions in case the current message requires more specific automation than provided by the generic routines. Using the ACFFQRY common routine from within a REXX exec, you can retrieve the keywords entered into this panel and process them as needed. Syntax rules for how to specify user data is available in the online help. For information on how to use ACFFQRY in a REXX exec see ACFFQRY in *IBM Tivoli System Automation for z/OS Programmer's Reference*.

The following fields are available:

Mixed case

Specify whether the value entered in the **Data** field remains unchanged (YES) or is translated to upper case characters automatically (NO).

Keyword length

For better readability only the first 20 characters of the **Keyword** value and the first 55 characters of the **Data** value is shown. Enter a value in this field to change how much of each field is visible.

Keyword

A value is required and should represent the keyword that will be assigned to the user data.

Data

A value is required and can contain any characters. There are, however, rules regarding how the data value must be delimited if it contains any special characters. For more information about these rules, see the online help.

You can use line commands in the **Cmd** field to manipulate the entries on this panel as described in "Line Commands on Message Processing Panels" on page 165.

Message Automation Definitions

SA z/OS supports the automatic generation of NetView automation tables (ATs) and the message revision table (MRT). You enable the automatic generation of the ATs and MRT using the **AT/MRT scope** field when you edit the settings for policy databases (see Chapter 8, "The NetView Automation Table and Message Revision Table," on page 333).

Message Automation Definitions for Applications

If you do not enable the automatic generation of the ATs and MRT, you do not need to specify anything on the panels that are described in this section. If you do enable automatic generation, you can use the Message Automation Overview panel to view what SA z/OS will generate for a particular message in the AT and MRT. If the AT or MRT entry is not appropriate, you can use the options on the panel to modify it as described in this section.

If you enter AT in the **Cmd** field for a message ID, the Message Automation Overview panel is displayed, as shown in Figure 109.

```
COMMANDS  HELP
-----
AOFGMADV          Message Automation Overview
Command ==> _____ Scroll ==> PAGE

AC AT condition   MS MRT action selection   IG Ignore / Suppress via MPF
AS AT status      MO MRT override
AO AT override

Message ID : IEF451I

Generated AT entry :
* The variable SVJOB is set by the BEGIN statement for IEF4
IF MSGID = 'IEF451I' & ATF('ING$QRY APPL,,JOB='VALUE(SVJOB)) ^= ''
& TEXT = . '- ENDED BY CC' CCODE . THEN
EXEC(CMD('TERMMSG JOBNAME=' SVJOB ',CODE1=' SVJOB ',CODE2=' CCODE)
ROUTE(ONE %AOFOPGSSOPER%));

No MRT entry will be generated because there are no specifications for this
message
```

Figure 109. Message Automation Overview Panel

This panel allows you to:

- View the AT or MRT entry that SA z/OS will automatically generate for the message ID
- Define your own NetView Automation Table (AT) entries
- Override predefined AT entries for a given Entry Name and Message ID
- Modify the specifications that are used to generate NetView message revision table entries

You can use the options listed at the top of the panel to display further panels, as follows:

- AC** A panel to specify conditions for the AT entry, see “Specifying AT Entry Conditions” on page 173
- AS** A panel to select the SA z/OS status that is used to generate the AT action, see “Selecting a Status for the AT Entry” on page 174
- AO** A panel to specify the AT override, see “Specifying an AT Override” on page 174
- MS** A panel to specify what action is taken with the MRT entry that is generated, see “Specifying an Action for an MRT Entry” on page 176
- MO** A panel to specify an MRT override, see “Specifying an MRT Override” on page 177
- IG** A panel to specify whether an entry is ignored for the AT, MRT, or MPFLSTSA Message Processing Facility (MPF) member, see “Specifying that an Entry Is Not Built” on page 175

The scrollable AT/MRT preview area shows the AT and MRT entries that would be generated based on the current specifications. If, for example, you modify the AT conditions on a subsequent panel and return, the AT preview is updated to reflect the new specifications.

If a generated AT entry is based on an SA z/OS definition (that is, it is defined in the MVC entry +SA_PREDEFINED_MSGS), it is shown in the color that has been selected for class data.

Specifying AT Entry Conditions: Enter the line command AC on the Message Automation Overview panel to display the Automation Table entry Conditions panel, as shown in Figure 110.

```

COMMANDS  HELP
-----
AOFGMATC      Automation Table entry Conditions
Command ==> _____ Scroll ==> PAGE

Message ID : IEF451I

Message placement in AT . . . . _____ (TOP BOTTOM)
Check for message id . . . . _____ (YES NO)
Ignore message id character . . _____ (LEADING TRAILING BOTH)
Additional condition . . . . .

-----

Generated AT entry :
* The variable SVJOB is set by the BEGIN statement for IEF4
IF MSGID = 'IEF451I' & ATF('ING$QRY APPL,,JOB='VALUE(SVJOB)) ^= ' '
& TEXT = . '- ENDED BY CC' CCODE . THEN
EXEC(CMD('TERMMSG JOBNAME=' SVJOB ',CODE1=' SVJOB ',CODE2=' CCODE)
ROUTE(ONE %AOFOPGSSOPER%));
    
```

Figure 110. Automation Table entry Conditions Panel

The fields on this panel are:

Message placement in AT

Allows you to specify whether the generated AT entry should be placed at the beginning or end of the AT. In both cases the generated AT entry is not placed in a BEGIN-END block. If you set **Check for message id** to YES or blank, the default placement is in a BEGIN-END block, and if you set it to NO the default placement is BOTTOM.

Check for message id

Allows you to exclude the check IF MSGID = '...' from the AT condition. This may be necessary if for example you specify the complete condition in the **Additional condition** field. If checking for message is excluded, the AT entry is not placed in a BEGIN-END block.

Ignore message id character

Allows you to use only a portion of a message ID when checking for the message ID. Enter one the following to control which parts of the message ID are ignored:

- LEADING** The beginning of the message ID is ignored, that is, the suffix is used.
- TRAILING** The end of the message ID is ignored, that is, the prefix is used.
- BOTH** Both the beginning and the end of the message ID are ignored, that is, the string must appear somewhere within the message ID.

Message Automation Definitions for Applications

This behavior is achieved by adding a leading or trailing period to the AT condition, as shown in the preview in the lower half of the panel

Additional condition

Allows you to specify any text that is added to the AT condition. There is no syntax check for this field and it allows mixed case.

Pressing Enter updates the preview that is shown in the lower half of the panel.

If a preview is not generated, an explanation is displayed in the preview area, for example, No AT entry will be generated because there is no Command, Reply, or Status defined.

Press PF3 to save your changes or enter the CANCEL (C) command to discard them and then return to the Message Automation Overview panel.

Selecting a Status for the AT Entry: Enter the line command AS on the Message Automation Overview panel to display the AT Status Specification panel, as shown in Figure 111.

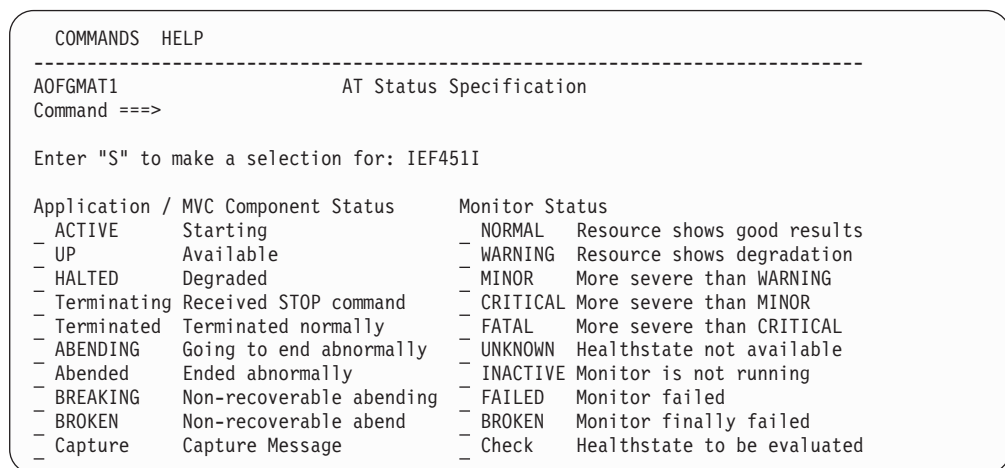

```
COMMANDS  HELP
-----
AOFGMAT1          AT Status Specification
Command ==>>>

Enter "S" to make a selection for: IEF451I

Application / MVC Component Status      Monitor Status
- ACTIVE      Starting                  - NORMAL     Resource shows good results
- UP          Available                    - WARNING    Resource shows degradation
- HALTED      Degraded                            - MINOR      More severe than WARNING
- Terminating Received STOP command      - CRITICAL   More severe than MINOR
- Terminated Terminated normally        - FATAL      More severe than CRITICAL
- ABENDING    Going to end abnormally              - UNKNOWN    Healthstate not available
- Abended     Ended abnormally                    - INACTIVE   Monitor is not running
- BREAKING    Non-recoverable abending            - FAILED     Monitor failed
- BROKEN      Non-recoverable abend               - BROKEN     Monitor finally failed
- Capture     Capture Message                     - Check      Healthstate to be evaluated
```

Figure 111. AT Status Specification Panel

You can select one status for an application or monitor resource, or both.

For messages that are defined for a monitor resource only but have an application status and a monitor status specification, the AT entry is generated both for the application status and the monitor status.

If you select a monitor status for a message but then remove the message from the MESSAGES/USER DATA policy item of the monitor resource, the monitor status is ignored for the AT build. The monitor status selection is however still shown on this panel until you remove it.

Press PF3 to save your changes or enter the CANCEL (C) command to discard them and then return to the Message Automation Overview panel.

Specifying an AT Override: Enter the line command AO on the Message Automation Overview panel to display the ISPF editor where you can specify an AT override, as shown in Figure 112 on page 175.

```

AT entry for message IEF451I      Columns 00001 00072
Command ==> _____ Scroll ==> CSR
***** ***** Top of Data *****
000001 IF
000002 MSGID = 'IEF451I' & ATF('ING$QRY APPL,,JOB='VALUE(SVJOB)') ^= ' '
000003 & TEXT = . '- ENDED BY CC' CCODE .
000004 THEN
000005 EXEC(CMD('TERMMMSG JOBNAME=' SVJOB ',CODE1=' SVJOB ',CODE2=' CCODE)
000006 ROUTE(ONE %AOFOPGSSOPER%));
000007 _____
000008 _____
000009 _____
000010 _____
000011 _____
000012 _____
000013 _____
000014 _____
000015 _____
    
```

Figure 112. Editor Panel to Specify an AT Override

If you have defined an AT action or condition, or both, and then invoke the override panel, the AT entry preview is shown on the override editor screen. You can use this as a model for your own AT definition. You can use system symbols and SA z/OS symbols in your specification.

Use the END command (PF3 key) to leave the editor panel and save any changes as an AT override.

Use the CANCEL command to leave the editor panel and discard any changes that you have made.

Notes:

1. You can only define one override per message ID and thus this override applies to all applications where the message has been specified. If you define a command against a message ID that already has an override you must ensure that the command is honored via the override.
2. Because any system-specific definitions cannot be resolved (for example, system symbols), a syntax check is not performed on this panel. However, after a build has been performed, you can check the syntax on the system where the AT is to be run using the command ACF CHECK.

Specifying that an Entry Is Not Built: Enter the line command IG on the Message Automation Overview panel to display the AT/MRT Ignore Specification panel, as shown in Figure 113.

```

COMMANDS  HELP
-----
AOFGMSGs          AT/MRT Ignore Specification
Command ==> _____

Enter "S" to make a selection for: IEF451I

Message Ignore or Suppress option
_ Ignore          No AT entry; no MRT entry; no MPFLSTSA entry
_ Suppress        No AT entry; no MRT entry; MPFLSTSA entry SUP(YES),AUTO(NO)
    
```

Figure 113. AT/MRT Ignore Specification Panel

Message Automation Definitions for Applications

This panel allows you to specify that an entry is not built for the AT, MRT, or Message Processing Facility (MPF) member MPFLSTSA. Enter S for one of the following options:

Ignore This option does not consider the data to be an automatable message. This specification is recommended for user data that is not a message and should not be automated.

No NetView automation table or message revision table entry is generated. No entry in the MPFLSTSA Message Processing Facility (MPF) member is provided.

Suppress

This option completely excludes the message from automation processing and suppresses its display on the MCS console.

No NetView automation table or message revision table entry is generated. The message is added to the MPFLSTSA MPF member with SUP(YES),AUTO(NO). Thus the message is stopped in the MPF member and effectively lost for any further processing.

Specifying an Action for an MRT Entry: Enter the line command MS on the Message Automation Overview panel to display the Message Revision Table Conditions panel, as shown in Figure 114.

```
COMMANDS  HELP
-----
AOFGMRT1          Message Revision Table Conditions
Command ==> _____

View or change specifications for message: IEF451I

_ Delete completely

_ Automate
_ Do not automate
_ Suppress from console
_ Suppress from system log
_ Translate to upper case

Append text . . . _____

Color           Highlighting           Intensity
_ Blue           _ Reverse video       _ Not intensified
_ Red            _ Underlined          _ Intensified
_ Pink          _ Blinking
_ Yellow
_ Green
_ White
_ Turquoise
```

Figure 114. Message Revision Table Conditions Panel

This panel allows you to view and modify specifications that are used to generate a NetView message revision table (MRT) entry for the current message ID.

The MRT enables you to intercept MVS messages before they are displayed, logged, automated, or routed through your sysplex. Use the options on this panel to make changes to the following aspects of the message:

- Automation.
- System log attributes.
- Message text.
- Color, highlighting, and intensity (if your terminal supports high intensity). Only one selection per column is allowed.

Message Automation Definitions for Applications

If you select **Delete completely** no other selection is valid.

The options **Automate** and **Do not automate** are mutually exclusive.

You can combine one of the automation specifications and all of the other conditions (except **Delete completely**).

Any MRT specifications that you make are independent of any AT entry data for the message. Thus if you make a definition for the MRT but not for the AT, any predefined data for AT entry is still in effect.

Specifying an MRT Override: Enter the line command MO on the Message Automation Overview panel to display the ISPF editor where you can specify a NetView message revision table entry override, as shown in Figure 115.

```

MRT entry for message IEF451I      Columns 00001 00072
Command ==> _____ Scroll ==> CSR
***** ***** Top of Data *****
000001 UPON ( MSGID = 'IEF451I' )
000002 REVISE('Y' AUTOMATE)
000003 REVISE('CR HR' COLOR)
000004 _____
000005 _____
000006 _____
000007 _____
000008 _____
000009 _____
000010 _____
000011 _____
000012 _____
000013 _____
000014 _____
000015 _____
```

Figure 115. Editor Panel to Specify an MRT Override

Use the END command (PF3 key) to leave the editor panel and save any changes as an MRT override. Use the CANCEL command to leave the editor panel and discard any changes that you have made.

Note:

Because any system-specific definitions cannot be resolved (for example, system symbols), a syntax check is not performed on this panel. However, after a build has been performed, you can check the syntax on the system where the AT is to be run using the command ACF CHECK.

Nested Class Details

CMD (Command), REP (Reply), COD (Code), and USR (User Data) policies are inherited per message ID. Thus if a message ID has a command definition for an instance and the same message ID is defined for a class with reply data, the command and reply data are not merged on the instance, and the class definitions are not inherited at all.

AT and MRT specifications provide instructions for the generation of the NetView automation table and message revision table entry. This data exists only once in the

Nested Classes for Applications

policy database and is not tied to a particular application, monitor resource or MVS Component. It is used to create one AT entry or one MRT entry. Thus the inheritance rules do not apply.

Examples: Consider the following examples that demonstrate how policy values are inherited and AT entries are built:

No overrides

A class has a command and a linked instance has a reply defined for the message ID, ABC123.

Result: The following AT entry is built:

```
IF MSGID = 'ABC123' THEN  
EXEC(CMD('ISSUEACT '))ROUTE(ONE %AOFOPGSSOPER%);
```

However, the command is *not* executed because it is not inherited by the instance and so is not loaded during automation agent initialization.

Two applications and an override

One application has a command defined for a message ID, another application has a reply defined for the same message ID, and an override is defined for the message ID.

Result: One AT entry is generated for the override. This override should deal with any commands or replies that should be executed

Panel Interaction: The Message Processing panel shows message IDs that are defined for the current application and any data that has been inherited from linked classes. Inherited message IDs are displayed in a different color. AT and MRT specifications are always indicated by an asterisk * for either an instance or a class. If the AT or MRT specifications are for predefined messages, these are indicated with a P in the color that is used for classes.

If a linked class and the current application have definitions for the same message ID, only the definition for the current application is displayed.

Consider the following examples that illustrate inheritance from class message IDs that are modified, and how the panel display reflects this:

Modifying commands for an inherited message ID

Consider an inherited message ID with command and reply definitions and a status definition. If you modify a command definition, this becomes a definition for the current application along with the reply data, however the status data is not affected.

Specifying AT data for an inherited message ID

Again, consider an inherited message ID with command and reply definitions and an AT definition. If you modify the AT data, the message ID does not become a definition for the current application. The display shows the message ID with the counts for Cmd and Rep in the color for inherited data and the * indicator for AT (the A column) in turquoise.

Command and reply for a class and instance

Consider a class definition that has a command defined for message ID, and a linked instance that has a reply defined for the same message ID, and there is also a Status definition, for example BROKEN.

One AT entry is generated using TERMMSG, the reply from the instance is executed, but the command from the class is not inherited (and thus not executed). The following line is displayed all in turquoise:

Cmd	Message id	Description	Cmd Rep	Cod	Usr	A	M
	ABC123	Descriptive text	1				*

STARTUP Policy Item

The STARTUP policy item is used to specify the scheduling subsystem, JCL procedure name (which are also available on the APPLICATION INFO policy item), the startup parameters and all the commands necessary to start a subsystem. These commands are issued when SA z/OS is going to start the subsystem.

You can use the STARTUP policy item to define several command sequences that are executed if an application requires certain start types that depend upon particular circumstances, such as a cold start, warm start or recovery start. You can use the INGREQ command to specify which command sequence should be taken.

You can also use this facility for performance improvements. Consider the example in Figure 116 if application A depends on application B, and B in turn depends on C, and A also has a PREPAVAILABLE relation to C, after C is started, you can have SA z/OS issue a sequence of prestart commands to A while the supporting resource B is starting.

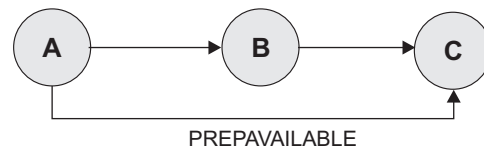

Figure 116. Using the STARTUP Policy Item

If you select the STARTUP policy item from the Policy Selection panel for Applications (Figure 95 on page 143), you come to the Subsystem Startup Processing panel shown in Figure 117 on page 180.

STARTUP Policy Item for Applications

```
COMMANDS  HELP
-----
A0FGASTT          Subsystem Startup Processing
Command ==> _____

Entry Type : Application          PolicyDB Name  : USER_PDB
Entry Name  : APPL1              Enterprise Name: USER_ENTERPRISE

Scheduling Subsystem. . _____ (MSTR, JES Subsystem)
JCL Procedure Name. . . _____
Startup Parameters. . . _____

Line Commands: S (Cmd), C (Cmd)

Cmd Phase      Description                                     Cmd
---
___ PRESTART   Executed before startup is initiated                    1
___ STARTUP    Executed to initiate the startup
___ POSTSTART  Executed after startup has completed                       2
```

Figure 117. Subsystem Startup Processing Panel

For each application, you can specify a list of commands (startup procedures) that are used:

- Before the application is started
- To start the application
- After the application has started

All specified commands are processed during the different startup phases of the application. The STARTUP policy item is used to specify all the necessary commands.

The advantage of this is that you can have SA z/OS perform certain actions for the preparation of an application. For example, before starting CICS, you can have the VTAM major node activated.

The fields in the subheader area can be inherited individually from a linked class and if they have been inherited, they are shown in a different color. Any commands that have been inherited for the prestart, start or poststart phases are also shown in this color in the **Cmd** column. You can find out which class a value has been inherited from by typing the command `classname` (or its abbreviation `cn`) on the command line, moving the cursor to the field of interest and pressing Enter.

Command definitions are inherited per start phase. For example, if a PRESTART command is defined for the instance and both PRESTART and STARTUP commands have been defined for the class, the instance inherits the STARTUP commands from the class.

You can fill in the following fields:

Scheduling Subsystem

This optional field specifies the name of the subsystem that is to schedule the current application. See “Scheduling Subsystem” on page 142 for more details.

JCL Procedure Name

Specifies the name of the JCL procedure that is used to create this instance of the application. See “JCL Procedure Name” on page 142 for more details.

Startup Parameters

Specifies the desired subsystem startup parameters. See “Startup Parameters” on page 153 for more details.

Specifying Startup Commands

You can specify commands by entering S or C in the **Cmd** field for the following startup phases:

PRESTART

Commands entered for this type are issued before the application is started. You can use these to perform preparation work, for example, having SA z/OS issue VTAM commands to activate additional connections.

If a PrepAvailable relationship is defined for the resource, the PRESTART commands are executed when the PrepAvailable condition is satisfied, or as soon as the start request becomes a winning one. Therefore, if the PRESTART commands rely on another resource running, you should define a PrepAvailable relationship.

STARTUP

You should enter only one command that is issued to start the application.

If you select this option, you need to specify the complete startup command, otherwise, no automatic startup command is generated from the policy specified in the APPLICATION INFO policy item (in the **Job Name** and **JCL Procedure Name** entry fields).

POSTSTART

Commands entered for this type are issued immediately after the UP message has been received.

The **Cmd** column displays the number of commands that have been entered for a particular startup entry.

For each of these phases (PRESTART, STARTUP, and POSTSTART) a Command Processing panel for that phase is displayed (as shown in Figure 118 for the POSTSTART), where you can enter the startup commands that are specific to the current application.

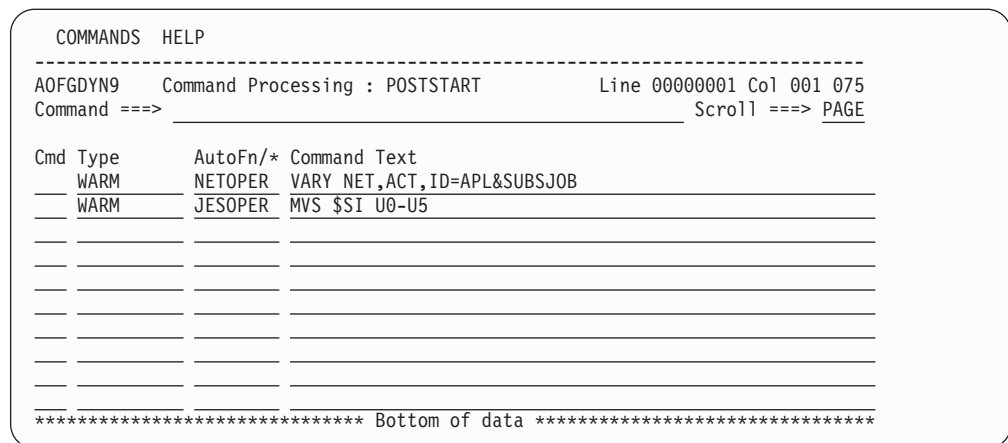

Figure 118. Command Processing Panel for Startup Commands

STARTUP Policy Item for Applications

The entries on this panel can be inherited from a class, in which case they are displayed in a different color. Because all of the commands are inherited together, if you edit one of them they all change color to indicate that they are now particular to that instance.

You can find out which class a value has been inherited from by typing the command `classname` (or its abbreviation `cn`) on the command line.

You can use line commands in the **Cmd** field to manipulate the entries on this panel as described in “Line Commands on Message Processing Panels” on page 165.

Use the following fields to enter the commands that are particular to this start phase:

Type Enter the condition (for example, COLD) that the command should be executed for. NORM is a predefined type of SA z/OS.

Leaving this field blank means that the command is executed for any condition.

AutoFn/*

Enter the name of the automated function that the command is to run under. The AT entry that is generated does not reflect the automated function that you enter, however the execution of the command is routed internally to the automated function that you specify. If you leave this field blank, the function defaults to the one that is currently running the command list. SA z/OS automated functions are mapped to NetView automation operators (see Table 7 on page 277 for more details).

Note:

Entering * enables return-code checking for the specified command. This means that processing continues if the command returns a return code of 0. In all other cases processing is stopped immediately. If you are running in LOG assist mode, return-code checking has no effect because the commands are not executed.

Command Text

Enter the command or command list that is to be issued. You must preface a system command with MVS.

SHUTDOWN Policy Item

If you select the SHUTDOWN policy item from the Policy Selection panel for Applications, the Subsystem Shutdown Processing panel is displayed, as shown in Figure 119 on page 183.

Cmd	Phase	Description	Cmd	Rep
---	INIT	Executed when shutdown is initiated	3	2
---	NORM	Executed when normal shutdown is invoked	4	4
---	IMMED	Executed when immediate shutdown is invoked	4	
---	FORCE	Executed when force shutdown is invoked	2	
---	FINAL	Executed after final termination message	4	

Figure 119. Subsystem Shutdown Processing Panel

Use the SHUTDOWN option to specify all the commands that are necessary to shut down a subsystem and follow-on activities.

Any commands or replies that have been inherited from linked classes for the different shutdown phases are shown in a different color in the **Cmd** and **Rep** columns.

You should bear in mind the following inheritance behavior for shutdown definitions:

- Shutdown specifications are inherited per phase. For example, if you define a SHUTINIT command for an instance that has been linked to a class that has both SHUTINIT and SHUTNORM commands defined for it, the instance inherits only the SHUTNORM commands from the class.
- Command and reply definitions for each phase are inherited together. For example, if you define a command for the SHUTFORCE phase for an instance that is linked to a class that has a reply defined for SHUTFORCE, nothing is inherited by that instance.
- If you modify any inherited data, that definition becomes one for the current application. For example, if command and reply definitions are inherited for a phase and you then modify the commands, both the reply and command definitions become data for the current application. This is also the case if an instance inherits only command definitions for a phase and you then define a reply for that phase.

You can find out which class a value has been inherited from by typing the command `classname` (or its abbreviation `cn`) on the command line, moving the cursor to the field of interest and pressing Enter.

Because shutdown procedures may involve replies to outstanding messages as well as commands, the **Cmd** field is used to indicate whether a command or reply is to be specified for a particular shutdown phase. If you enter either **CMD** or **REP**, you go to another panel where the actual commands and replies can be defined.

Similar to the startup processing of applications described in the previous section, the following commands or replies can be chosen from this panel:

INIT Commands and replies that you enter for this phase are issued when the shutdown process is initiated (that is, before the subsystem is brought down). Possible entries could be commands to send out warning messages to users or quiescing activities.

SHUTDOWN Policy Item for Applications

If you specified a PREPUNAVAILABLE relationship, the commands listed under INIT will be executed if the condition is satisfied.

Initial shutdown commands do any necessary processing for an application when shutdown begins, for example:

- You can use initial shutdown commands to issue a warning to any logged-on users that the application is shutting down.
- For the JES2 subsystem, you may wish to stop users on JES2 NJE lines from starting new transmissions or sessions.

Note:

You should not use the initial shutdown commands to actually shut down the application because unpredictable results may occur.

NORM

If the NORM option is selected for the INGREQ STOP command, all the commands and replies that are entered for this phase are issued. These entries should be the commands and replies that perform a normal shutdown of the subsystem.

IMMED

The commands and replies specified here are run if the IMMED option for INGREQ STOP is selected. These entries bring the subsystem down immediately.

FORCE

The entries specified here are run if the FORCE option for INGREQ STOP is selected. The commands and replies would be the typical ones a user would enter to force a subsystem off the system without any delay.

FINAL

The commands specified here are run after the final termination message has been received. Note that shutdown reply processing is not allowed for FINAL phases, that is, you can only specify commands for this shutdown phase.

The **Cmd** and **Rep** columns display the number of commands or replies that have been entered or inherited from a linked class for a particular shutdown entry.

You can use the *multiple pass* feature to issue one or more groups of shutdown commands or replies for all shutdown types except initial shutdown. Commands or replies with 1 in their corresponding pass fields are the entries that are issued during the first attempt at shutting down the subsystem. If, after a specified amount of time (entered in the **Shut Delay** field in the Application Automation Definition panel) the subsystem is still not down, another attempt (or pass) is made. The next pass runs all entries that have 2 in their pass field. This continues until the subsystem is down. Each pass may consist of zero or more commands and zero or one reply. Note that issuing multiple replies on a single pass is *not* advisable. Either code secondary replies on subsequent passes or chain them through the automation table and ISSUEREP.

All commands for a given pass are processed before any replies for that pass are processed. After each set of commands and replies is issued, SA z/OS waits for the amount of time defined in the **Shut Delay** field on the Application Automation Definition panel. After that time, if a call to the application monitor routine shows that the application has not shut down, the commands or reply, or both, defined

for the next pass are issued. If a call to the application monitor routine shows that the application has shut down, any subsequent shutdown passes are not processed. If the final termination message is not received within the time specified in AOFSHUTDELAY, SA z/OS assumes that the application is down.

If SA z/OS processes all the shutdown passes defined for an application and the application monitor routine still shows the application as active, a warning is sent to the operator and the application status is set to STUCK.

The next panel that is displayed depends on the type of shutdown processing that you specify in the **Cmd** field for the shutdown phases on the Subsystem Shutdown Processing panel:

- Specify command processing for all shutdown types by entering CMD, C or S.
- Specify reply processing for all shutdown types except FINAL by entering REP or R.

How to proceed is described in the following sections:

- “Shutdown Command Processing for INIT or FINAL”
- “Shutdown Command Processing for NORM, IMMED, or FORCE” on page 186
- “Shutdown Reply Processing for INIT” on page 188
- “Shutdown Reply Processing for NORM, IMMED, or FORCE” on page 189

Shutdown Command Processing for INIT or FINAL

To define shutdown commands for INIT or FINAL phases, you enter S or C in the **Cmd** field on the Subsystem Shutdown Processing panel for those phases. This displays a Command Processing panel, as shown in Figure 120.

```

COMMANDS  HELP
-----
AOFGDYN9  Command Processing : SHUTINIT          Line 00000001 Col 001 075
Command ==> _____ Scroll ==> PAGE

Cmd Type   AutoFn/* Command Text
-----
           MVS SEND 'VTAM COMING DOWN SHORTLY'
           _____
           _____
           _____
           _____
           _____
           _____
           _____
           _____
           _____
           _____
***** Bottom of data *****

```

Figure 120. Command Processing Panel for SHUTINIT or SHUTFINAL

You can use line commands in the **Cmd** field to manipulate the entries on this panel as described in “Specifying Startup Commands” on page 181.

Use the following fields to enter the commands that are particular to the specified shutdown phase:

Type Enter the condition that the command should be executed for. The following values (for the corresponding shutdown phases) are allowed:

Condition	Shutdown phase
NORM	SHUTNORM
IMMED	SHUTIMMED

SHUTDOWN Policy Item for Applications

Condition	Shutdown phase
FORCE	SHUTFORCE

AutoFn/*

Enter the name of the automated function that the command is to run under. The AT entry that is generated does not reflect the automated function that you enter, however the execution of the command is routed internally to the automated function that you specify. If you leave this field blank, the function defaults to the one that is currently running the command list. SA z/OS automated functions are mapped to NetView automation operators (see Table 7 on page 277 for more details).

Note:

Entering * enables return-code checking for the specified command. This means that processing continues if the command returns a return code of 0. In all other cases processing is stopped immediately. If you are running in LOG assist mode, return-code checking has no effect because the commands are not executed.

Command Text

Enter the command or command list that is to be issued. You must preface a system command with MVS.

Notes:

1. You cannot issue multiple passes of initial shutdown commands.
2. Do not invoke MDFYSHUT.

The entries on this panel can be inherited from a class, in which case they are displayed in a different color. Because all of the commands are inherited together, if you edit one of them they all change color to indicate that they are now particular to that instance.

You can find out which class a value has been inherited from by typing the command `classname` (or its abbreviation `cn`) on the command line.

Shutdown Command Processing for NORM, IMMED, or FORCE

To define shutdown commands for NORM, IMMED, or FORCE phases, you enter S or C in the **Cmd** field on the Subsystem Shutdown Processing panel for those phases. This displays a Command Processing panel, as shown in Figure 121 on page 187.

```

COMMANDS  HELP
-----
AOFGDYN9  Command Processing : SHUTNORM          Line 00000001 Col 001 075
Command ==> _____ Scroll ==> PAGE

Cmd Ps AutoFn/* Command Text
--- 1 _____ MVS Z NET,QUICK
--- 2 _____ MVS Z NET,CANCEL
-----
-----
-----
-----
-----
-----
-----
-----
-----
***** Bottom of data *****

```

Figure 121. Command Processing Panel for SHUTNORM, SHUTIMMED, or SHUTFORCE

You can use line commands in the **Cmd** field to manipulate the entries on this panel as described in “Specifying Startup Commands” on page 181.

Use the following fields to enter the commands that are particular for the specified shutdown phase:

Ps (Pass)

You can enter any number between 1 and 99 in this field. Commands or replies with 1 in their corresponding **Pass** field are the entries that are issued during the first attempt at shutting down the subsystem.

If after a specified amount of time (entered in the **Shut Delay** field on the Subsystem Definition panel) the subsystem is still not down, another attempt (or pass) is made. The next pass runs all entries that have 2 in their **Pass** field. This continues until the subsystem is down. If you do not specify a pass for a command, it is issued on every pass.

For example, Figure 121 defines the normal shutdown commands that are issued for the VTAM subsystem. This example defines two passes of shutdown commands. On the first pass, the command MVS Z NET,QUICK is issued. On the second pass, the command MVS Z NET,CANCEL is issued.

In another example, MVS P TSO could be a command for pass 1 and MVS C TSO could be the command for pass 2 (which means that if purging TSO fails, it is canceled).

AutoFn/*

Enter the name of the automated function that the command is to run under. The AT entry that is generated does not reflect the automated function that you enter, however the execution of the command is routed internally to the automated function that you specify. If you leave this field blank, the function defaults to the one that is currently running the command list. SA z/OS automated functions are mapped to NetView automation operators (see Table 7 on page 277 for more details).

SHUTDOWN Policy Item for Applications

Note:

Entering * enables return-code checking for the specified command. This means that processing continues if the command returns a return code of 0. In all other cases processing is stopped immediately. If you are running in LOG assist mode, return-code checking has no effect because the commands are not executed.

Command Text

Enter the command or command list to be issued. You must preface any system command with MVS.

If you want to use MDFYSHUT to change the shutdown pass processing, you should specify it as a command on one of the passes.

The entries on this panel can be inherited from a class, in which case they are displayed in a different color. Because all of the commands are inherited together, if you edit one of them they all change color to indicate that they are now particular to that instance.

You can find out which class a value has been inherited from by typing the command `classname` (or its abbreviation `cn`) on the command line.

Shutdown Reply Processing for INIT

You enter R in the **Cmd** field for the INIT phase on the Subsystem Shutdown Processing panel to define shutdown replies for that phase. This displays a Reply Processing panel, as shown in Figure 122.

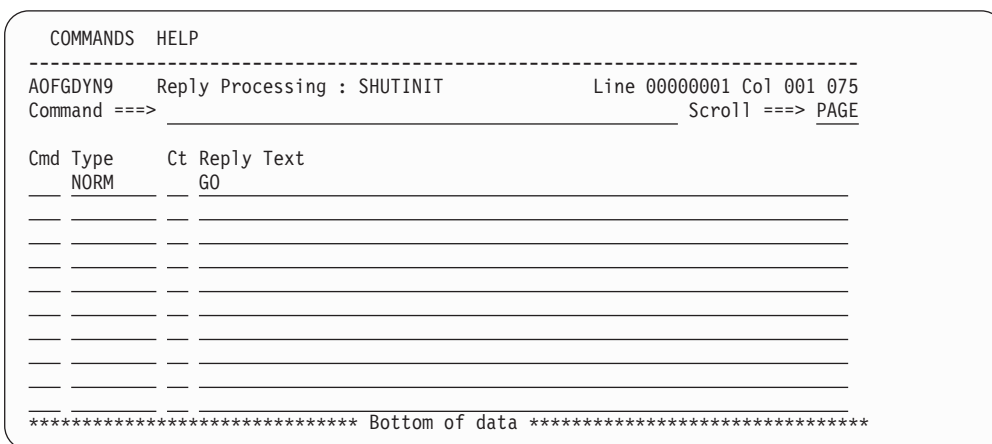

Figure 122. Reply Processing Panel for SHUTINIT

You can use line commands in the **Cmd** field to manipulate the entries on this panel as described in “Specifying Startup Commands” on page 181.

Use the following fields to enter the replies that are particular to the specified shutdown phase:

Type Enter the condition that the command should be executed for. The following values (for the corresponding shutdown phases) are allowed:

SHUTDOWN Policy Item for Applications

Condition	Shutdown Phase
NORM	SHUTNORM
IMMED	SHUTIMMED
FORCE	SHUTFORCE

Ct (Retry Count)

Enter a number in the range 1 to 99 in this field to define the number of retry attempts that are made before the common routine decides that a reply cannot be issued. A retry occurs when the outstanding reply number is not available. For the first retry there is a one-second delay, and for all further retries there is a two-second delay. The default retry count is 0.

Reply Text

Enter the reply that is to be issued when the selected shutdown phase is invoked for this subsystem. For a null reply enter NULL as the reply.

The entries on this panel can be inherited from a class, in which case they are displayed in a different color. Because all of the commands are inherited together, if you edit one of them they all change color to indicate that they are now particular to that instance.

You can find out which class a value has been inherited from by typing the command `classname` (or its abbreviation `cn`) on the command line.

Shutdown Reply Processing for NORM, IMMED, or FORCE

To define shutdown replies for NORM, IMMED, or FORCE phases, you enter R in the **Cmd** field on the Subsystem Shutdown Processing panel for those phases. This displays a Reply Processing panel, as shown in Figure 123.

```

COMMANDS  HELP
-----
A0FGDYN9  Reply Processing : SHUTNORM                               Line 00000001 Col 001 075
Command ==>                                     Scroll ==> PAGE

Cmd Ps Ct Reply Text
--- -- --
 1  9  SHUT
 3  9  I TA
 4  9  I TER ACQ
 5  9  END
-----
-----
-----
-----
-----
***** Bottom of data *****

```

Figure 123. Reply Processing Panel for SHUTNORM, SHUTIMMED and SHUTFORCE

You can use line commands in the **Cmd** field to manipulate the entries on this panel as described in “Specifying Startup Commands” on page 181.

Use the following fields to enter the replies that are particular to the specified shutdown phase:

Ps (Pass)

Enter a number between 1 and 99 in this field. Commands or replies with 1 in their corresponding **Pass** field are the entries that are issued during the first attempt at shutting down the subsystem.

SHUTDOWN Policy Item for Applications

If, after a specified amount of time (entered in the **Shut Delay** field on the Subsystem Definition panel) the subsystem is still not down, another attempt (or pass) is tried. The next pass runs all entries that have 2 in their **Pass** field. This continues until the subsystem is down. A pass number is required for each shutdown reply.

For example, MVS P TSO could be a command for pass 1 and MVS C TSO could be the command for pass 2 (which means that if purging TSO fails, it is canceled).

Ct (Retry Count)

Enter a number in the range 1 through 99 in this field to define the number of retry attempts that are made before the common routine decides that a reply cannot be issued. A retry occurs when the outstanding reply number is not available. For the first retry there is a one-second delay, and for all further retries there is a two-second delay. The default retry count is 0.

Reply Text

Enter the reply to be issued when the selected shutdown phase is invoked for this subsystem. For a null reply enter NULL as the reply.

The entries on this panel can be inherited from a class, in which case they are displayed in a different color. Because all of the commands are inherited together, if you edit one of them they all change color to indicate that they are now particular to that instance.

You can find out which class a value has been inherited from by typing the command `classname` (or its abbreviation `cn`) on the command line.

THRESHOLDS Policy Item

The Thresholds Definition panel is displayed if you select policy item THRESHOLDS on the Policy Selection panel for applications, as shown in Figure 124.

```
COMMANDS  HELP
-----
AOFGDYNA          Thresholds Definition          Line 00000001
Command ==> _____ Scroll ==> CSR

Entry Type : Application          PolicyDB Name  : USER_PDB
Entry Name  : APPL1              Enterprise Name: USER_ENTERPRISE

Resource   : APPL1

Critical Number . . . . 5          (1 to 50)
Critical Interval . . . 00:10:00   (hh:mm:ss or hhmss, 00:00:01 to 24:00:00)

Frequent Number . . . . 3          (1 to 50)
Frequent Interval . . . 01:00:00   (hh:mm:ss or hhmss, 00:00:01 to 24:00:00)

Infrequent Number . . . 3          (1 to 50)
Infrequent Interval . . 12:00:00   (hh:mm:ss or hhmss, 00:00:01 to 24:00:00)
```

Figure 124. Thresholds Definition Panel

The information provided in the THRESHOLDS dialogs is used to determine when an operator should be notified of an error situation. An attempt at recovering an error (such as an abend of a subsystem) is handled by automation, but an operator may want to know if this error is occurring often.

THRESHOLDS Policy Item for Applications

Thresholds can be set that let the operator know if certain errors are occurring infrequently, frequently or have reached a critical stage where the recovery process should be ended (to avoid endless loops). This is done by specifying how many times an error must happen in a certain time period for each error situation.

The entries on this panel can be inherited from a class, in which case they are displayed in a different color. Because all of the thresholds are inherited together, if you edit one of them, all of the thresholds change color to indicate that they are now particular to that instance because they are no longer inherited.

You can find out which class a value has been inherited from by typing the command `classname` (or its abbreviation `cn`) on the command line.

You can define three different threshold levels:

Infrequent

Issues a warning message and restart processing is done.

Frequent

Issues a warning message, but restart processing is still done.

Critical

Sets the resource to a status of BROKEN, stops the restart automation and issues a message.

You can enter data in the following fields:

Number

This field is used to define the number of occurrences of an error that creates the particular error level. The range of allowable numbers is 1 to 50.

Interval

The number of errors entered in the **Number** field must occur in a certain time period in order to create a specific error level. You specify this time period in the **Interval** field. You can specify it in the form HH:MM:SS or HHMMSS. Valid values are 00:00:01 to 24:00:00.

The values entered in the **Number** and **Interval** fields should be such that the threshold levels are reached in a logical manner (a critical threshold should not be reached before a frequent threshold).

Not all three threshold levels need be specified, for example, if an application needs only a specification for the critical number and interval, you can leave the frequent and infrequent fields empty.

For more information on setting thresholds see the section "How SA z/OS Uses Error Thresholds" in *IBM Tivoli System Automation for z/OS User's Guide*.

MINOR RESOURCES Policy Item

The Minor Resource Definitions panel, as shown in Figure 125 on page 192, is displayed if you select the MINOR RESOURCES policy item on the Policy Selection panel for applications.

MINOR RESOURCES Policy Item for Applications

```
COMMANDS  HELP
-----
AOFGMRES          Minor Resource Definitions          Row 1 to 9 of 20
Command ==>>> _____          SCROLL==>>> PAGE

Entry Type : Application          PolicyDB Name   : USER_PDB
Entry Name  : APPL1              Enterprise Name : USER_ENTERPRISE
Major Name  : APPL1

Line Commands: F (Flg), S (Thr), T (Thr)
               D (delete line)

Cmd  Minor Resource
---  _____
---  _____
---  _____
---  _____
---  _____
---  _____
---  _____
---  _____
```

Figure 125. Minor Resource Definitions Panel

This panel allows you to manage automation flags and thresholds for minor resources.

Major Name

This field shows the major resource name.

Cmd Use this field to enter a line command:

F or FLG

Enter automation flag definitions for the minor resource. See “AUTOMATION FLAGS Policy Item” on page 158 for more details.

S, T, or THR

Enter threshold definitions for the minor resource. See “THRESHOLDS Policy Item” on page 190 for more details.

D Deletes the minor resource definition.

Minor Resource

Use this field to specify the minor resource name. The following rules apply to the minor resource names:

- The name cannot contain any of the following characters: comma, single quotation mark, double quotation mark, left or right parenthesis, equal sign or a blank.
- The name cannot start or end with a period.
- The name cannot contain consecutive periods.

To add a minor resource enter a name in one of the empty entries at the bottom of the list.

To rename a minor resource overwrite the current name with a new name and press Enter.

SA z/OS provides automation routines for recovery actions that use the automation flags or thresholds that are defined for these minor resources together with commands that are defined for messages with the same name. For more information see the chapter “Automation Routines” in *IBM Tivoli System Automation for z/OS Customizing and Programming*.

See also the sections “Automation Flags and Minor Resource Flags” and “Thresholds for Minor Resources” in *IBM Tivoli System Automation for z/OS User’s Guide*.

SYSTEM ASSOCIATION Policy Item

The System Association panel, as shown in Figure 126, is displayed if you select the SYSTEM ASSOCIATION policy item on the Policy Selection panel for applications. Note that the specified definitions are not used for automation by SA z/OS. They are for customer-specific purposes only.

```

COMMANDS  ACTIONS  VIEW  HELP
-----
AOFGLPD0          System Association          Row 1 to 3 of 3
Command ==> _____ SCROLL==> PAGE

Entry Type : Application          PolicyDB Name : USER_PDB
Entry Name : APPL1                Enterprise Name : USER_ENTERPRISE

Action      Association      System
-----
           PRIMARY         SYSTEM1
           PRIMARY         SYSTEM2
           PRIMARY         SYSTEM3
***** Bottom of data *****

```

Figure 126. System Association Panel

Using MOVED and FALLBACK Status

SA z/OS provides two automation statuses, MOVED and FALLBACK, to handle applications that normally run on one system (the primary) but which can run on an alternative system (the secondary) if the primary is unavailable.

SA z/OS does not provide any logic to actually perform a fallback from a primary to a secondary system. If you want cross-system fallback, you must provide the coordinating logic yourself.

If you want the application moved automatically you will have to write your own code or define a MOVE-group.

GENERATED RESOURCES Policy Item

The Generated Resources panel appears if you select the GENERATED RESOURCES policy item from the Policy Selection panel for Applications, as shown in Figure 127 on page 194. This panel shows all resources that are generated by SA z/OS for the application. This panel is for information only. No actions are allowed.

Application resources are generated when a link between an application and a system occurs. Applications can never be linked directly to systems. This link happens indirectly by linking an application to an application group (either in an application's WHERE USED policy item or in an application group's APPLICATIONS policy item.)

GENERATED RESOURCES Policy Item for Applications

```

COMMANDS  HELP
-----
A0FGXRSG          Generated Resources          Row 1 of 2
Command ==>>>          SCROLL==>>> PAGE

Entry Type : Application      PolicyDB Name  : USER_PDB
Entry Name  : NET             Enterprise Name : USER_ENTERPRISE

Resource Name      Generated by link to
NET/APL/SYSTEM1   SYSTEM1
NET/APL/SYSTEM2   SYSTEM2
***** Bottom of data *****

```

Figure 127. Generated Resources Panel

This panel displays the following information:

Resource Name

Shows the resources that have generated for the application.

Generated by link to

This says who the owner of a resource is. In this case; owners are application groups because the current entry is an APL.

A link to the owner creates the resource, unlinking from the owner (or deletion of the owner) deletes the resource.

MEMBER OF Policy Item for Applications

The Member of panel is displayed if you select policy item *MEMBER OF* on the Policy Selection panel for applications.

```

COMMANDS  HELP
-----
A0FGXMOF          Member of          Row 1 of 2
Command ==>>>          SCROLL==>>> PAGE

Entry Type : Application      PolicyDB Name  : USER_PDB
Entry Name  : AOR1           Enterprise Name : USER_ENTERPRISE

Own Resource...      ...is a member of      Preference Nature
AOR1/APL/SYS1       AOR_G/APG              700           MOVE/SERVER
AOR1/APL/SYS2       AOR_G/APG              700           MOVE/SERVER

```

Figure 128. Member of Panel for Applications

This panel lists all Resources where this Application is a member "resource-wise", that is, it lists all relations from resources that have been derived from the current Application to other resources. This panel is for information only. No data can be changed.

Use the RESOURCES policy of an APG to add or remove it to the list in the **...is a member of** column (that is in the RESOURCES policy of the APG Entry Name that the member of Resource was derived from).

In this example, this panel is invoked for application AOR1, which is a member of a Sysplex Application Group. In such a case, you will see all the resources that are generated for the sysplex.

Policy Items for JES2 Subsystems

Figure 129 is an example of a Policy Selection panel for a JES2 subsystem.

```

ACTIONS  HELP
-----
AOFGEPOL                Policy Selection                Row 14 to 24 of 24
Command ==> _____ SCROLL==> PAGE

Entry Type : Application      PolicyDB Name  : USER_PDB
Entry Name  : JES2           Enterprise Name : USER_ENTERPRISE

Action      Policy Name      Policy Description
-----
.....
-----JES2 SPECIFIC POLICY-----
-----
JES2 SPOOLFULL      Define JES2 spool full procedures
JES2 SPOOLSHORT     Define JES2 spool short procedures
JES2 DRAIN          Define JES2 drain procedures
-----
.....
***** Bottom of data *****

```

Figure 129. Policy Selection Panel for JES2 Subsystems

See “Policy Items for Applications” on page 143 for descriptions of most policy items on this panel. The additional policy items are:

JES2 SPOOLFULL

Provides for recovery from a JES spool full condition. Figure 130 on page 196 shows the recovery parameters that can be specified for JES2 when this policy item is selected.

JES2 SPOOLSHORT

Provides for recovery from JES spool shortage condition. The recovery parameters available for JES2 spool shortage recovery are the same as for spool full recovery. See “JES2 SPOOLSHORT Policy Item” on page 197.

JES2 DRAIN

Allows you to specify which JES resources are to be drained and how they are to be drained in the event that a JES2 shutdown fails.

JES2 SPOOLFULL Policy Item

If you select policy item SPOOLFULL for a JES2 subsystem, SA z/OS displays the SPOOLFULL Processing panel.

JES2 SPOOLFULL Policy Item for JES2 Subsystems

```
COMMANDS  HELP
-----
AOFPIEJA          SPOOLFULL Processing
Command ==> _____

Entry Type : Application      PolicyDB Name  : USER_PDB
Entry Name  : JES2           Enterprise Name : USER_ENTERPRISE

Enter SPOOLFULL settings.
Retry Time . . . . _____ Spool recovery attempt interval (hh:mm:ss)
Buffer . . . . . _____   Recovery target below TGWARN (0->50)
Reset Time . . . . _____   Recovery reset interval (hh:mm:ss)

Priority of systems for spool recovery:

CPUID  1  ___  2  ___  3  ___  4  ___  5  ___  6  ___  7  ___  8  ___
       9  ___ 10  ___ 11  ___ 12  ___ 13  ___ 14  ___ 15  ___ 16  ___
      17  ___ 18  ___ 19  ___ 20  ___ 21  ___ 22  ___ 23  ___ 24  ___
      25  ___ 26  ___ 27  ___ 28  ___ 29  ___ 30  ___ 31  ___ 32  ___

Edit Spoolfull Pass Commands . . NO  YES  NO
```

Figure 130. SPOOLFULL Processing Panel

The following parameters can be entered:

Retry Time

The time entered in this field defines the time between attempts at spool recovery. If the first set of recovery commands has been issued and the spool is not recovered after this amount of time, the second set of defined commands is issued. Time range 00:00:00 to 23:59:59. The default is 5 minutes.

Buffer The percentage amount of spool that is to be recovered under the threshold (TGWARN for SPOOLSHORT, 100% for SPOOLFULL). The value must be positive and less than 75% of the threshold value. If invalid or not specified a default of 5 is used. For example, if TGWARN is set to 80 and Buffer is set to 10, SPOOLSHORT recovery will continue until spool utilization is less than 70%.

Reset time

This is the amount of time that must elapse after the spool has been driven below the recovery target before the spool incident is considered to be closed. If the spool exceeds the trigger threshold again before this interval is up, the recovery will begin again with the next pass, rather than restarting from pass 1.

The default is 15 minutes.

CPUID 1st - 32nd

An ordered list of system IDs belonging to the JES2 subsystems sharing the JES spool in a MAS definition. During the recovery the JES2 command D MEMBER,STATUS=ACTIVE,NAME is issued and the first machine in the list that is active on the display response is assumed to be responsible for handling the recovery.

Note:

You must keep the CPUID lists for JES subsystems sharing the spool space in synchronization.

JES2 SPOOLFULL Policy Item for JES2 Subsystems

If SA z/OS cannot find an active machine in the CPUID list, it will assume responsibility for the recovery itself. This can lead to multiple machines issuing recovery commands if your lists are incomplete.

Edit Spoolfull Pass Commands

Entering YES in this field allows you to edit the recovery commands. Figure 131 shows the SPOOLFULL Processing panel where you can enter commands to be issued during SPOOLFULL processing.

```
COMMANDS  HELP
-----
A0FPISPF          SPOOLFULL Processing
Command ==> _____ SCROLL==> PAGE

Entry Type : Application      PolicyDB Name  : USER_PDB
Entry Name  : JES2           Enterprise Name : USER_ENTERPRISE

Subsystem   : JES2
Description : JES2 policy definition

Enter the appropriate commands to issue when SPOOL is full.

Pass Automated Function/ '*'
Command Text
 1
MSG SYSOP '=====> SPOOL ALERT <====='
-----
 2
MSG SYSOP ' JES2 SPOOL SPACE IS FULL '
-----
 3
MSG SYSOP ' PERFORM INSTALLATION RECOVERY. '
-----
 4
MSG SYSOP '=====> SPOOL ALERT <====='
-----
```

Figure 131. SPOOLFULL Processing Panel for JES2

Commands are issued by passes, so a command to be issued on every pass should be specified without pass specification. Two substitution variables (EHKVAR1 and EHKVAR2) are available. EHKVAR1 contains the current spool utilization, and EHKVAR2 contains the recovery target.

JES2 SPOOLSHORT Policy Item

If you select policy item SPOOLSHORT for a JES2 subsystem, SA z/OS displays the SPOOLSHORT Processing panel, as shown in Figure 132 on page 198.

JES2 SPOOLSHORT Policy Item for JES2 Subsystems

```

COMMANDS  HELP
-----
AOFPIEJB          SPOOLSHORT Processing
Command ==> _____

Entry Type : Application      PolicyDB Name  : USER_PDB
Entry Name  : JES2           Enterprise Name : USER_ENTERPRISE

Enter SPOOLSHORT settings.
Retry Time . . . . _____  Spool recovery attempt interval (hh:mm:ss)
Buffer . . . . . _____    Recovery target below TGWARN (0->50)
Reset Time . . . . _____   Recovery reset interval (hh:mm:ss)

Priority of systems for spool recovery:

CPUID  1  ___  2  ___  3  ___  4  ___  5  ___  6  ___  7  ___  8  ___
       9  ___ 10  ___ 11  ___ 12  ___ 13  ___ 14  ___ 15  ___ 16  ___
      17  ___ 18  ___ 19  ___ 20  ___ 21  ___ 22  ___ 23  ___ 24  ___
      25  ___ 26  ___ 27  ___ 28  ___ 29  ___ 30  ___ 31  ___ 32  ___

Edit Spoolshort Pass Commands . . NO  YES  NO

```

Figure 132. SPOOLSHORT Processing Panel

The parameters that can be entered on this panel are similar to those described in “JES2 SPOOLFULL Policy Item” on page 195, and the Spoolshort Processing panel is similar to the Spoolfull Processing panel.

JES2 DRAIN Policy Item

If you select the DRAIN policy item for a JES2 subsystem, SA z/OS displays the JES2 DRAIN Processing panel, as shown in Figure 133.

```

COMMANDS  HELP
-----
AOFPISS7          JES2 DRAIN Specifications
Command ==> _____

Entry Type : Application      PolicyDB Name  : USER_PDB
Entry Name  : JES2           Enterprise Name : USER_ENTERPRISE

Subsystem: JES2
Enter information (Yes or No) for initial drain to bring down JES2 facilities.
LIN . . . . . _____  Drain lines
LOG . . . . . _____  Drain JES2-VTAM interface
OFF . . . . . _____  Drain spool offloaders
PRT . . . . . _____  Drain printers
RDR . . . . . _____  Drain readers
PUN . . . . . _____  Drain punches
Enter information (Command or No) for force drain if normal drain fails.
LIN . . . . . _____  Force drain lines
LOG . . . . . _____  Force drain JES2-VTAM interface
OFF . . . . . _____  Force drain spool offloaders
PRT . . . . . _____  Force drain printers
RDR . . . . . _____  Force drain readers

```

Figure 133. JES2 DRAIN Processing Panel

This panel is used to identify which JES resources are to be drained and how they are to be drained if a JES shutdown is unsuccessful:

Initial drain

Choose the resources that are to be stopped with a JES \$P command. An initial drain occurs either because of a JES shutdown or an operator issued DRAINJES. YES indicates that a stop command should be issued for the resource while a NO (the default) does not drain the resource type.

Force drain

Define the drain command to be entered for each resource if JES has not successfully shut down. Possible JES commands could be Restart (\$E), Cancel (\$C) or any other appropriate command. If NO is entered (the default), this resource type does not have any commands issued for it.

Policy Items for JES3 Subsystems

Figure 134 shows a Policy Selection panel for a JES3 subsystem.

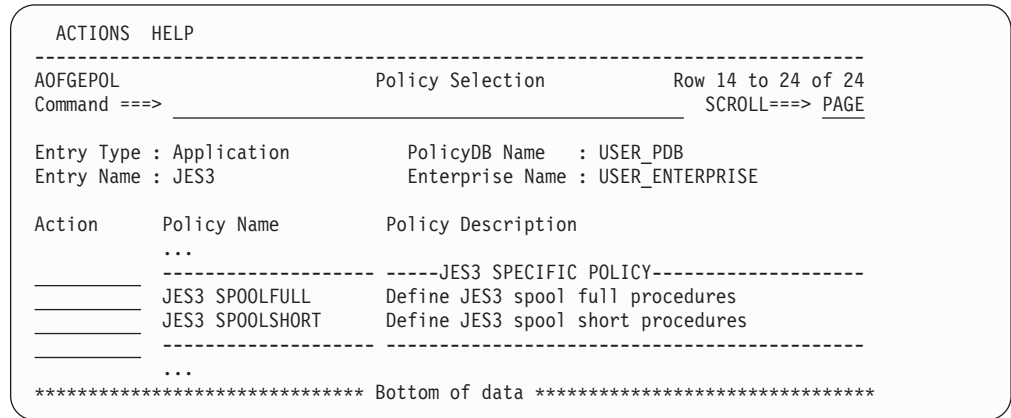

Figure 134. Policy Selection Panel for JES3 Subsystems

See “Policy Items for Applications” on page 143 for descriptions of most policy items on this panel. The additional policy items are:

JES3 SPOOLFULL

Allows you to specify recovery from JES spool full condition. For more information see “JES3 SPOOLFULL Policy Item.”

JES3 SPOOLSHORT

Allows you to specify recovery from JES spool short condition. For more information see “JES3 SPOOLSHORT Policy Item” on page 200.

JES3 SPOOLFULL Policy Item

If you select policy item SPOOLFULL for a JES3 subsystem, SA z/OS displays the SPOOLFULL Processing panel, as shown in Figure 135 on page 200.

JES3 SPOOLFULL Policy Item for JES3 Subsystems

```
COMMANDS  HELP
-----
A0FPISPF          SPOOLFULL Processing          Row 1 of 24
Command ==> _____ SCROLL==> PAGE

Entry Type : Application          PolicyDB Name  : USER_PDB
Entry Name  : JES3                Enterprise Name : USER_ENTERPRISE

Subsystem   : JES3
Description : JES3 automation policy

Enter the appropriate commands to issue when SPOOL is full.

Pass Automated Function/'*'
Command Text

MSG SYSOP '=====> SPOOL ALERT <====='

MSG SYSOP ' JES3 SPOOL SPACE IS FULL'
```

Figure 135. JES3 SPOOLFULL Processing Panel

Commands are issued by passes, so a command that is to be issued on every pass should be specified with an asterisk * in the **Pass** field. Two substitution variables are available: EHKVAR1 contains the current spool utilization and EHKVAR2 contains the recovery target.

JES3 SPOOLSHORT Policy Item

If you select policy item SPOOLSHORT for a JES3 subsystem, SA z/OS displays the SPOOLSHORT Processing panel, as shown in Figure 136.

```
COMMANDS  HELP
-----
A0FPISPS          SPOOLSHORT Processing          Row 1 of 37
Command ==> _____ SCROLL==> PAGE

Entry Type : Application          PolicyDB Name  : USER_PDB
Entry Name  : JES3                Enterprise Name : USER_ENTERPRISE

Subsystem   : JES3
Description : JES3 automation policy

Enter the appropriate commands to issue when SPOOL is short.

Pass Automated Function/'*'
Command Text

1
MSG SYSOP '=====> SPOOL ALERT <====='

1
MSG SYSOP ' SPOOL SPACE BELOW THRESHOLD'
```

Figure 136. JES3 SPOOLSHORT Processing Panel

Commands are issued by passes, so a command to be issued on every pass should be specified with an asterisk * in the **Pass** field. Two substitution variables are available: EHKVAR1 contains the current spool utilization and EHKVAR2 contains the recovery target.

Policy Items for CICS Subsystems

Figure 137 shows the Policy Selection panel for applications of type CICS (see the **Application Type** entry field in Figure 94 on page 138). This Policy Selection panel contains an additional policy item for a CICS subsystem.

Note:

The CICS Entry Type can only be used to maintain systems that are running an earlier version of SA z/OS (3.1 and 3.2).

```

ACTIONS  HELP
-----
AOFGEPOL          Policy Selection          Row 19 to 23 of 23
Command ==> _____ SCROLL==> PAGE

Entry Type : Application          PolicyDB Name  : USER_PDB
Entry Name  : CICS                Enterprise Name : USER_ENTERPRISE

Action      Policy Name          Policy Description
-----
          CICS CONTROL          Define CICS subsystem specific data
          ...
***** Bottom of data *****
    
```

Figure 137. Policy Selection Panel for CICS Subsystems

The CICS specific policy items are:

CICS CONTROL

With this policy item you can define the extended subsystem information required for CICS Automation. You will reach a panel described in “CICS CONTROL Policy Item” where you can fill in the required information.

CICS CONTROL Policy Item

With this policy item you can define the extended subsystem information required for CICS Automation, as shown in Figure 138.

```

COMMANDS  HELP
-----
AOFGDYNA          CICS control specifications          Line 00000001
Command ==> _____ Scroll ==> CSR

Entry Type : Application          PolicyDB Name  : USER_PDB
Entry Name  : CICS                Enterprise Name : USER_ENTERPRISE

Subsystem   : CICSTEST
Subtype    : TOR          defined in policy APPLICATION INFO

Reload transaction . . . . _____ (Message exit reload transaction)
***** Bottom of data *****
    
```

Figure 138. CICS Control Specifications Panel

Subtype

This parameter indicates the resource type. It can be entered in the **Subtype** field of the APPLICATION INFO policy item of the application instance or application class. The value shown is either for the application instance or the application class that the application is linked to.

JES3 SPOOLSHORT Policy Item for JES3 Subsystems

Fill in the following field:

Reload transaction

This specifies a reload transaction to reload the CICS message exit policy on configuration refresh (INGAMS REFRESH). The default value is SARL if nothing is specified. Enter NONE if no reload transaction is desired.

The extended CICS subsystem automation that you define here is also described in the CICSCNTL section in *IBM Tivoli System Automation for z/OS Product Automation Programmer's Reference and Operator's Guide*.

CICS CONNECTION Policy Item

With this policy item you can select CICS link monitoring definitions required for CICS Automation, as shown in Figure 139.

```
COMMANDS  ACTIONS  VIEW  HELP
-----
A0FGXC4E          CICS link for Application          Row 1 of 2
Command ==> _____ SCROLL==> PAGE

Entry Type : Application          PolicyDB Name : USER_PDB
Entry Name : CICS                 Enterprise Name : USER_ENTERPRISE

Action      Status          CICS link
-----
          _____      CICSK4CCK4C
          _____      EYUMAS1AMS2B
***** Bottom of data *****
```

Figure 139. CICS Link for Application Panel

This panel allows you to manage the links between the current Application entry and the CICS link entries.

Policy Items for DB2 Subsystems

Figure 140 shows the Policy Selection panel for applications that have been created with application type DB2 (see the **Application Type** field in Figure 94 on page 138).

```
ACTIONS  HELP
-----
A0FGEPOL          Policy Selection          Row 17 of 21
Command ==> _____ SCROLL==> PAGE

Entry Type : Application          PolicyDB Name : USER_PDB
Entry Name : DB2                 Enterprise Name : USER_ENTERPRISE

Action      Policy Name      Policy Description
-----
          -----
          DB2 CONTROL      Define DB2 subsystem specific data
          ...
***** Bottom of data *****
```

Figure 140. Policy Selection Panel for DB2 Subsystems

The DB2 specific policy items are:

DB2 CONTROL

With this policy item you can specify additional data for a DB2 subsystem of subtype MSTR. For more information see “DB2 CONTROL Policy Item” on page 203.

DB2 CONTROL Policy Item

Use this policy item to specify additional data for a DB2 subsystem of subtype MSTR, shown in Figure 141.

```

COMMANDS  HELP
-----
AOFGDYNA          DB2 Control Entries          Line 00000001
Command ==> _____ Scroll ==> PAGE

Entry Type : Application          PolicyDB Name  : USER_PDB
Entry Name  : DB2_MSTR           Enterprise Name: USER_ENTERPRISE

Subsystem   : DB2_MSTR
Subtype    : MSTR                defined in policy APPLICATION INFO

Subsystem ID . . . . . DB21
Active Log Dataset . . . . .
                        DSN1.DB21.LOGCOPY1
Log Full Threshold . . . . . _ (1 to 99 percent)

Process iteration delays:
STOP Tablespace Delay . . . . . (00:00:00 to 23:59:59)
Active Log Alert . . . . . (00:00:00 to 23:59:59)
Log Alert Threshold . . . . . (1 to 99)
Log Offload Interval . . . . . (00:00:00 to 23:59:59)

Definitions for pre SA V3.2/3.3 only:
Shutdown Indoubt . . . . . YES (YES, NO, blank)
Connection Monitor Delay . . . . . (00:00:00 to 23:59:59)
Terminate Thread Delay . . . . . (00:00:00 to 23:59:59)
Terminate Thread Cycles . . . . . (1 to 99)
***** Bottom of data *****

```

Figure 141. DB2 Control Entries Panel

On this panel, either all the fields are inherited from linked classes all together and displayed in a different color, or none of them are.

You can find out which class a value has been inherited from by typing the command `classname` (or its abbreviation `cn`) on the command line.

You can override any inherited values by overtyping them. If you override any values for a class, all the inherited values become specific to that particular class or instance (and thus change color to reflect this).

Subtype

This parameter shows the subtype. It can be entered in the **Subtype** field of the APPLICATION INFO policy item of the application instance or application class. The value shown is either for the application instance or the application class that the application is linked to.

Subsystem ID

This entry should correspond to the DB2 subsystem ID as defined in the system PARMLIB.

You can include system symbols and system automation symbols. See “Assigning System Automation Symbols (AOCCLONE)” on page 9.

Active Log Dataset

The name of the active log data set to check against before the command to message DSNJ002I is issued. This value is compared with the data set name in the message text. The specified value is implicitly appended with a wildcard character. You can include system symbols and system automation symbols.

DB2 CONTROL Policy Item for DB2 Subsystems

Log Full Threshold

How full that the active log data set is allowed to be before the command corresponding to the DSNJ110E message is issued. The default value is 90%.

STOP Tablespace Delay

This is the delay between STOP tablespace request cycles. Up to 3 cycles are performed to ensure that the tablespace is shut down. 2 minutes (00:02:00) is the default.

Active Log Alert

This is the amount of time after which the DSNJ111E alert is reset. The default value is 5 minutes (00:05:00).

Log Alert Threshold

This is the number of DSNJ111E alerts to allow for before issuing any associated commands. 5 alerts is the default.

Log Offload Interval

This is the amount of time to allow between DSNJ115I messages before issuing an alert plus any associated commands for the DSNJ115I message entry. 30 minutes is the default.

Shutdown Indoubt

This indicates whether indoubt threads should be checked for before shutting down DB2. Enter YES if the shutdown should proceed without checking for indoubt threads. If you specify NO, using precheck on the NetView shutdown panel still allows checking for indoubt threads.

Note that this field is only valid for releases earlier than SA z/OS 3.2 or 3.3.

Connection Monitor Delay

This is the delay between connection monitoring cycles. 30 minutes (00:30:00) is the default. This value is only used by SA z/OS 3.1 and 3.2 releases.

Terminate Thread Delay

This is the amount of time to delay between thread termination cycles. 2 minutes (00:02:00) is the default.

Note that this field is only valid for releases earlier than SA z/OS 3.2 or 3.3.

Terminate Thread Cycles

This is the number of cycles to attempt at terminating threads. 6 cycles is the default.

Note that this field is only valid for releases earlier than SA z/OS 3.2 or 3.3.

Policy Items for IMS Subsystems

Figure 142 on page 205 shows the Policy Selection panel for applications that have been created with application type IMS (see the **Application Type** entry field in Figure 94 on page 138). This Policy Selection panel contains additional policy items for an IMS subsystem.

Some of these policy items are only applicable to an IMS subsystem defined as an instance. If a subsystem CLASS of type IMS is selected, only the additional policy items IMS CONTROL and STATE ACTION TABLE are available.

```

ACTIONS  HELP
-----
AOFGEPOL                               Policy Selection                               Row 18 to 23 of 23
Command ==> _____                SCROLL==> PAGE

Entry Type : Application                 PolicyDB Name   : USER_PDB
Entry Name  : IMS                       Enterprise Name : USER_ENTERPRISE

Action      Policy Name                 Policy Description
-----
           IMS CONTROL                 Define IMS subsystem specific data
           STATE ACTION TABLE         Select IMS state action table
           ...
***** Bottom of data *****

```

Figure 142. Policy Selection Panel for IMS Subsystems

The IMS specific policy items are:

IMS CONTROL

Use this policy item to define additional IMS information for an IMS subsystem of subtype CTL. This policy item is only defined for an IMS control region. For more information see “IMS CONTROL Policy Item.”

STATE ACTION TABLE

If you select this policy item, SA z/OS displays a list of state/action tables that have previously been defined as described in “IMS State/Action Tables Entry Type” on page 242. From this list you can link one state/action table to the current IMS subsystem or change or remove an existing link.

Note that this policy item is only listed for systems that are running an earlier release of SA z/OS.

For more information see *IBM System Automation for z/OS Product Automation Programmer’s Reference and Operator’s Guide*.

IMS CONTROL Policy Item

If you select the IMS CONTROL policy item from the Policy Selection panel for IMS subsystems, and you have specified the subtype CTL, Figure 143 on page 206 is displayed where you describe the IMS/DC control region.

IMS CONTROL Policy Item for IMS Subsystems

```
COMMANDS  HELP
-----
AOFGDYNA          IMS Control Region specifications          Line 00000001
Command ==> _____ Scroll ==> PAGE

Entry Type : Application          PolicyDB Name   : USER_PDB
Entry Name  : IMSCTL              Enterprise Name : USER_ENTERPRISE

Subsystem   : IMSCTL
Subtype     : CTL                defined in policy APPLICATION INFO

Subsystem ID . . . . . _____
IMSplex name . . . . . _____

Definitions for pre SA V3.2/3.3 only:
DBCTL control region . . ____ (YES NO)
Applid . . . . . _____
Applid connect . . . . ____ (YES NO)
Broadcast delay . . . . ____ (0 to 99 minutes)
Shutgo . . . . . ____ (YES NO)
Default force . . . . ____ (DUMP NODUMP)
***** Bottom of data *****
```

Figure 143. IMS Control Region Specifications Panel for Subtype CTL

The fields that you enter or update have the following meaning:

Subtype

This parameter shows the subtype and is always CTL. It is the only required parameter and can be entered on the APPLICATION INFO policy item of the application, or the application class in the **Subtype** field. The value shown is either the one specified for the application or the application class that the application is linked to.

Subsystem ID

Specifies the subsystem ID (IMSID) specified in the IMS control region parameters or SYSGEN. You can include system symbols and system automation symbols, see “Assigning System Automation Symbols (AOCCLONE)” on page 9.

IMSplex name

Specifies the IMSplex name that is defined in the z/OS PROCLIB members. You must not specify an IMSplex name if you do not have the Common Service Layer (CSL) infrastructure in place.

The following field is for releases earlier than SA z/OS 3.3 only:

DBCTL control region

Specify YES to indicate that this is an IMS DBCTL control region, or NO to indicate that it is an IMS DB/DC control region.

The following definitions are for releases earlier than SA z/OS 3.2 only:

Applid

This identifies the receiver/sender name when the program-to-program interface is initiated and used in an IMS DB/DC control region. Use one of the following:

Applid

Use this keyword if this subsystem is defined as non-XRF.

(generic-applid,specific-applid)

If this subsystem is defined as XRF-capable, use *generic-applid* as the name given to both the active and alternate subsystem, and *specific-applid* as the specific name for this subsystem.

Note that this field is not available for application classes. You can include system symbols and system automation symbols, see “Assigning System Automation Symbols (AOCCLONE)” on page 9.

Applid connect

During IMS startup, if this is specified as YES, the IMS DB/DC control region will not be started unless the APPLID is connectable.

Broadcast delay

If the BROADCAST or ABORT SHUTDOWN option is selected on one of the shutdown panels, this parameter defines the time in minutes between the execution of the /BRO command and the start of the shutdown (SHUTSYS) process of the IMS DB/DC control region.

Shutgo

Specifying YES will allow shutdown of a control region to progress from a normal shutdown, then to an immediate shutdown, then to a forced shutdown (as needed) without any operator action.

Default force

This parameter is used during an escalation of the shutdown from type IMMED to type FORCE. It retrieves the default shut options for a type FORCE shutdown. This parameter specifies the dump option associated with a type FORCE shutdown.

Policy Items for TWS Subsystems

Figure 144 shows the Policy Selection panel for applications that have been created with application type OPC (see the **Application Type** entry field in Figure 94 on page 138). This Policy Selection panel contains additional policy items for an TWS subsystem.

These policy items are only applicable to an TWS subsystem defined as an instance. If a subsystem CLASS of type OPC is selected, no additional policy items are available.

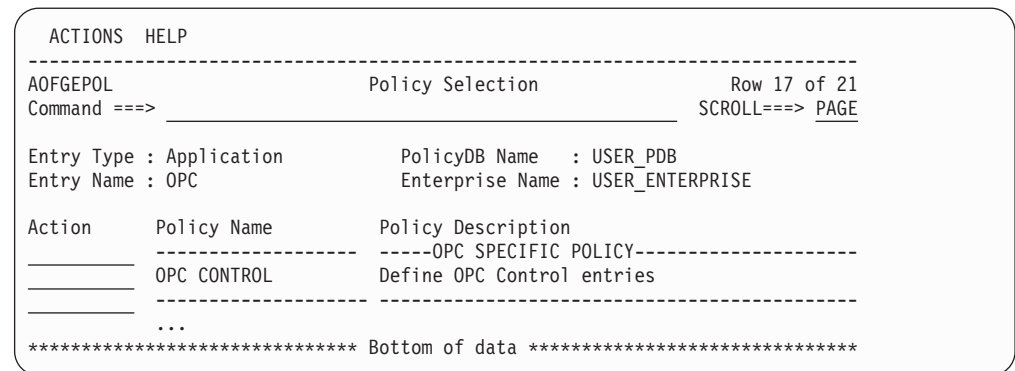

Figure 144. Policy Selection Panel for TWS Subsystems

The TWS specific policy item is:

OPC CONTROL

Use this policy item to specify TWS extensions to subsystem definitions. For more information, see “OPC CONTROL Policy Item.”

OPC CONTROL Policy Item

If you select the OPC CONTROL policy item on the Policy Selection panel for TWS subsystems, SA z/OS displays the panel in Figure 145 on page 208 where you can

OPC CONTROL Policy Item for TWS Subsystems

describe additional information for TWS subsystems.

```
COMMANDS  HELP
-----
AOFGDYNA          OPC control specifications          Line 00000001
Command ==>> _____ Scroll ==>> CSR

Entry Type : Application          PolicyDB Name  : USER_PDB
Entry Name  : TWSCTRL             Enterprise Name: USER_ENTERPRISE

Subsystem   : TWSCTRL
Subtype    : CONTROLLER           defined in policy APPLICATION INFO

Subsystem ID . . . . . _____
Controller ID . . . . . _____ (Tracker only)
Controller LU Name . . . _____ (Tracker only)
```

Figure 145. OPC control specifications Panel

Subtype

This parameter shows the subtype that was specified in the APPLICATION INFO policy item for the application itself or application class that this application is linked to.

Fill in the following fields:

Subsystem ID

Enter the TWS subsystem ID.

Controller ID

Enter the TWS subsystem ID of the controller that is controlling this tracker. This field is only used for tracker definitions. It allows for the specification of a remote controller. If the controller is not in the same sysplex as the tracker, specify this field.

Note:

Remote controllers with the hot standby function are not supported.

Controller LU Name

Enter the Logical Unit name of the controller that is controlling this tracker. This field is only used for tracker definitions. It allows for the specification of a remote controller. If the controller is not in the same sysplex as the tracker, specify this field.

You do not need to specify the **Controller ID** and **Controller LU Name** fields if the controller is in a remote sysplex or system that can be controlled by SA z/OS with the TARGET= parameter of the commands.

Policy Items for USS Subsystems

Figure 146 on page 209 shows the Policy Selection panel for applications that have been created with application type USS (see “Application Type” on page 140).

USS Applications must be defined with a HASPARENT relationship to JES.

By using the USS CONTROL policy item you can define UNIX System Services-specific data.

USS CONTROL Policy Item for USS Subsystems

```

ACTIONS  HELP
-----
AOFGEPOL                Policy Selection                Row 17 of 21
Command ==> _____ SCROLL==> PAGE

Entry Type : Application      PolicyDB Name   : USER_PDB
Entry Name  : USSTEST         Enterprise Name : USER_ENTERPRISE

Action      Policy Name      Policy Description
-----
           USS CONTROL      Define USS specific data
           ...
***** Bottom of data *****

```

Figure 146. Policy Selection Panel for USS Subsystems

USS CONTROL Policy Item

If you select the USS CONTROL policy item on the Policy Selection panel for USS subsystems, SA z/OS displays the panel shown in Figure 147 and Figure 148 on page 210 where you can enter additional information for UNIX subsystems.

```

COMMANDS  HELP
-----
AOFGDYNA                USS Control Specification        Line 00000001
Command ==> _____ Scroll ==> CSR

Entry Type : Application      PolicyDB Name   : USER_PDB
Entry Name  : C_USS_APPL     Enterprise Name : USER_ENTERPRISE

User ID . . . . . OMVSKERN

Monitoring Command . . .

Further definitions have to be done for the instance objects.
***** Bottom of data *****

```

Figure 147. USS Control Specification Panel for Application Classes

USS CONTROL Policy Item for USS Subsystems

```

COMMANDS  HELP
-----
AOFGDYNA          USS Control Specification          Line 00000001
Command ==>>> _____ Scroll ==>>> CSR

Entry Type : Application          PolicyDB Name  : USER_PDB
Entry Name  : SSHD                Enterprise Name : USER_ENTERPRISE

User ID . . . . . OMVSKERN _____

Monitoring Command . . .
_____

Specify either a USS Process, a USS File or a USS Port:
Process Command/Path . .
/usr/sbin/sshd
_____

with Filter . . . . .
USSFILT
_____

File Name . . . . .
_____

IP Stack . . . . . _____
Port Number . . . . . _____
***** Bottom of data *****

```

Figure 148. USS Control Specification Panel for Application Instances

If either of the values for the **User ID** or **Monitoring Command** has been inherited from linked classes, they are displayed in a different color. You can find out which class a value has been inherited from by typing the command `classname` (or its abbreviation `cn`) on the command line, moving the cursor to the field of interest and pressing Enter. You can override any inherited values by overtyping them. If you override either of the values that have been inherited, they are individually applied to the current application and change color to turquoise to indicate this.

For class objects, only User ID and Monitoring Command may be specified.

For instance objects, additionally either Process, File, or Port monitoring must be specified.

User ID

Enter the UNIX user ID that this resource belongs to.

Monitoring Command

Enter the UNIX System Services monitoring command that is used to get the status of the resource. This command must be a valid program in the HFS. If the field is left blank, the SA z/OS supplied standard monitoring routine is used. The return codes must be one of the following:

- 0 The resource is available.
- 4 The resource is starting.
- 8 The resource is unavailable.
- 12 An error occurred.

If the first character is a '/', the specified command is considered to be an absolute path. Otherwise the monitoring routine must be in the same directory as the SA z/OS routines.

For USS Process monitoring specify either one or both of the following fields:

Process Command/Path

Enter the path of the command that is running, as shown by the UNIX command `ps -e`.

Sample output of UNIX `ps -e` command:

```

PID ... CMD
  16 ... /usr/sbin/inetd
50331665 ... /bin/sh
50331666 ... /usr/sbin/sshd
83886161 ... /SYSTEM/local/WebSphere/V6R1/AP/AppServer/java/bin/java
50331736 ... /local/WebSphere/V6R1/AP/AppServer/java/bin/java
    
```

Filter Enter additional filter criteria to uniquely identify the USS process. This field is optional and can only be specified if a **Process Command/Path** specification is available.

As shown in the sample output for the **Process Command/Path** field, the command/path specification, especially for Java processes, is not unique. You can use the UNIX command `ps -ef` to obtain the complete definitions.

Sample output of UNIX `ps -ef` command:

```

PID ... CMD
83886161 ... java -Djava.util.logging.configureByServer=true
50331736 ... java -Dcom.ibm.eez.adapter.debug=true
    
```

Specify `-Djava.util.logging.configureByServer=true` as the filter to identify the first Java process listed above.

For USS File monitoring specify the following field:

File Name

Enter the path of a file in the HFS. If the file exists and the user ID that you specified is the owner of the file the resource is available, otherwise the resource is not available.

For USS Port monitoring specify either one or both of the following fields:

IP Stack

Enter the TCP/IP jobname to indicate the corresponding IP stack. Complete this field only if your system is configured for multiple IP stacks. If nothing is specified, the first active TCP/IP job is used. You may include system symbols and system automation symbols.

Port Number

Enter the TCP port number that this resource is supposed to listen to on the local host.

Events Entry Type

Events basically are used for external dependencies where they represent a process that the automation cannot handle. For example, an operator needs to manually edit a file before the application can be started. SA z/OS remembers which events are SET (have occurred) and can be told when to forget them (by defining an UNSET condition).

Creating a New Event

To begin defining a new event, access the Events entry type by entering 7 or EVT for events on the Entry Type Selection panel (Figure 1 on page 6).

Events Entry Type

This displays a panel similar to the one shown in Figure 149. This panel may show a list of existing events.

```
COMMANDS  ACTIONS  VIEW  HELP
-----
AOFGENAM          Entry Name Selection          Row 1 of 3
Command ==> new          SCROLL==> PAGE

Entry Type : Event          PolicyDB Name : USER_PDB
                             Enterprise Name : USER_ENTERPRISE

Action      Entry Name          C Short Description
-----
EVENT1      Startup event, backup completed
EVENT2A     Startup event, AOR1 is ready
EVENT2B     Startup event, AOR2 is ready
```

Figure 149. Entry Name Selection Panel for Events

Enter the command `new` at the command line. A panel similar to the one shown in Figure 150 is displayed. Specify the event name, the UNSET condition, and a description.

```
COMMANDS  HELP
-----
AOFGDYN2          Define New Entry
Command ==> _____

Define new entry of type Event

Entry Name . . . . . EVENT1
Unset Condition . . . . NONE (DOWN NONE START UP)

Short description . . . Backup successfully completed
Long description 1 . . . _____
Long description 2 . . . _____
Long description 3 . . . _____
Long description 4 . . . _____
Long description 5 . . . _____
```

Figure 150. Define New Event Panel

The unset condition is preset to NONE. You can change this input field if desired. For more information on the unset condition, see “CONDITION Policy Item” on page 213.

Policy Items for Events

Figure 151 on page 213 shows the policy items that are displayed when an event is selected from the Entry Name Selection panel for events.

```

ACTIONS  HELP
-----
AOFGEPOL          Policy Selection          Row 1 of 5
Command ==> new          SCROLL==> PAGE

Entry Type : Event          PolicyDB Name  : USER_PDB
Entry Name  : EVENT3       Enterprise Name : USER_ENTERPRISE

Action      Policy Name      Policy Description
-----
S           DESCRIPTION   Enter description
           CONDITION     Define the unset condition
           -----
           WHERE USED    List triggers linked to this entry
           COPY          Copy data from an existing entry
***** Bottom of data *****

```

Figure 151. Policy Selection Panel for Events

The unique policy item for Events is:

CONDITION

With this policy item you can specify when SA z/OS should unset (forget) a previously set event. See “CONDITION Policy Item.”

Note: On the WHERE USED panel for Events, only action “remove” is available.

CONDITION Policy Item

Selecting the CONDITION policy item will bring up a panel as shown in Figure 152 where you can define the *unset condition* of the current event.

```

COMMANDS  HELP
-----
AOFGAPEV          Unset Condition
Command ==> _____

Entry Type : Event          PolicyDB Name  : USER_PDB
Entry Name  : EVENT3       Enterprise Name : USER_ENTERPRISE

Verify the following condition

Unset condition . . . NONE DOWN NONE START UP

```

Figure 152. Unset Condition Panel for Events

The unset condition determines when an event for an application is reset to *not occurred* (that is, unset). You can enter the following values:

NONE

Once set, the event will never be unset.

START

Once set, the event will be unset if the application is already in the respective state or if the observed status of the application turns into STARTING.

UP

Once set, the event will be unset if the application is already in the respective state or if the observed status of the application turns into one of the following:

- AVAILABLE
- DEGRADED

CONDITION Policy Item for Events

DOWN

Once set, the event will be unset if the application is already in the respective state or if the observed status of the application turns into one of the following:

- SOFTDOWN
- HARDDOWN
- SYSGONE
- STANDBY

Service Periods Entry Type

Service periods define the availability of resources. A service period is a set of time intervals (service windows) during which a resource should be active or inactive.

Policy Items for Service Periods

Figure 153 shows the policy items that are displayed when an existing Service Periods entry is selected from the Entry Name Selection panel.

```

  ACTIONS  HELP
-----
AOFGEPOL          Policy Selection          Row 1 to 5 of 5
Command ==> _____ SCROLL==> PAGE

Entry Type : Service Period      PolicyDB Name  : USER_PDB
Entry Name  : SERVPI             Enterprise Name: USER_ENTERPRISE

Action      Policy Name      Policy Description
-----
            DESCRIPTION    Enter description
            SERVICE WINDOW  Define service windows
-----
            WHERE USED      List APLs, APGs and MTRs linked to this entry
            COPY            Copy from existing entry
***** Bottom of data *****
```

Figure 153. Policy Selection Panel for Service Periods

The unique policy item for Service Periods is:

SERVICE WINDOW

With this policy item you define the time frame (or frames) when an application, application group or monitor resource should be available or unavailable. You need to link a service period with a defined service window to Applications, Application Groups, or Monitor Resources.

SERVICE WINDOW Policy Item

Selecting the SERVICE WINDOW policy item displays a panel as shown in Figure 154 on page 215 where you can define the time duration of the service period.

SERVICE WINDOW Policy Item for Service Periods

```

COMMANDS  HELP
-----
A0FGAPSP                               Service Windows
Command ==> _____

Entry Type : Service Period             PolicyDB Name : USER_PDB
Entry Name : SERVPI                     Enterprise Name : USER_ENTERPRISE

Note: Review help panel for complete description of data entry fields.
      Valid times are 00:00-24:00, valid priorities (P) are L and H.

      P  From To   From To   From To   From To   From To
Monday U  00:00 24:00 _____ _____ _____ _____
      D  _____ _____ _____ _____ _____ _____
Tuesday U  00:00 24:00 _____ _____ _____ _____
      D  _____ _____ _____ _____ _____ _____
Wednesday U _____ _____ _____ _____ _____ _____
      D  _____ _____ _____ _____ _____ _____
Thursday U _____ _____ _____ _____ _____ _____
      D  _____ _____ _____ _____ _____ _____
Friday U _____ _____ _____ _____ _____ _____
      D  _____ _____ _____ _____ _____ _____
Saturday U  08:00 14:00 _____ _____ _____ _____
      D  _____ _____ _____ _____ _____ _____
Sunday U _____ _____ _____ _____ _____ _____
      D  _____ _____ _____ _____ _____ _____
Weekday U  07:00 18:00 _____ _____ _____ _____
      D  _____ _____ _____ _____ _____ _____
Weekend U _____ _____ _____ _____ _____ _____
      D  _____ _____ _____ _____ _____ _____
Daily U _____ _____ _____ _____ _____ _____
      D  _____ _____ _____ _____ _____ _____

```

Figure 154. Service Windows Panel for Service Periods

A service period is a schedule of times (referred to as service windows) when a resource is expected to be active or inactive. Times that you enter into a line preceded by the letter U will be used as From/To times for the periods when the resource should be available (UP). A line preceded by the letter D will contain From/To times for DOWN periods. Start and Stop times are specified in 24 hour notation, 00:00-24:00, and in any order. For example, to keep an application continuously available from Monday through Tuesday around the clock, specify the times as shown:

```

      P  From To   From To   From To   From To   From To
Monday U  00:00 24:00 _____ _____ _____ _____
      D  _____ _____ _____ _____ _____ _____
Tuesday U  00:00 24:00 _____ _____ _____ _____
      D  _____ _____ _____ _____ _____ _____

```

The schedule is defined by specifying one or more (up to five) service windows for:

- **Each day of the week:** Monday through Sunday
- **Weekday days:** the weekday schedule (Monday through Friday)
- **Weekend days:** the weekend schedule (Saturday and Sunday)

SERVICE WINDOW Policy Item for Service Periods

- **Daily:** all seven days; the daily schedule

For the time between the specified intervals, the automation manager decides what to do with the resources.

For each UP and DOWN schedule, you can specify a priority in the **P** column:

- L** For low priority. Orders resulting from a service period with low priority can be overruled by an operator's INGREQ command. This is the default.
- H** For high priority. H schedules override L schedules and low priority operator requests.

This priority is checked in case two goals conflict. The hierarchy of requests and priorities is implemented as follows:

Request from	Wins over request from
Service period high	Service period low, INGREQ low
INGREQ low	Service period low
INGREQ high	Service period high, service period low, INGREQ low

Note:

There are other methods of generating requests within SA z/OS. For a complete description of these methods and the implemented hierarchy of their priorities see the documentation of the SA z/OS concepts in *IBM Tivoli System Automation for z/OS User's Guide*.

When defining a service period keep in mind that the startup time is the time at which SA z/OS is to begin startup processing. It is not the time at which the resource will be available. The time until availability depends on how long the startup of an application or an application group takes.

According to the goal driven concept, a vote to start a resource is generated from a service period that you enter into an in a UP service window. A vote to stop a resource is generated from each service period that you enter into a DOWN service window. These votes have to compete with other votes that have been probably issued (for example, due to operator request). At the end of the service period, these votes are removed from SA z/OS. An end of an UP service window does not mean implicitly the start of a DOWN service window.

For more information about the hierarchy of service windows or the syntax of FROM and TO times, see the online help for the product.

If you later change a service period that is already active, and the service period is activated again, this may lead to conflicts and mismatches with overrides that have been made previously. So if you want to change a service period, check your existing NetView overrides that use this service period beforehand, so that no override is outside the new service period (see also the INGSCHED command, described in *IBM Tivoli System Automation for z/OS Operator's Commands*).

Triggers Entry Type

In combination with events, triggers are used to control the starting and stopping of resources beyond what is done with specified goals. You use events and triggers if external conditions must be fulfilled (such as a tape mount, for example).

Policy Items for Triggers

Figure 155 shows the policy items that are displayed when a trigger is selected from the Entry Name Selection panel.

ACTIONS		HELP
AOFGEPOL		Policy Selection
Command ==>		Row 1 to 5 of 5 SCROLL==> PAGE
Entry Type :	Trigger	PolicyDB Name : USER_PDB
Entry Name :	TRIGGER1	Enterprise Name : USER_ENTERPRISE
Action	Policy Name	Policy Description
_____	DESCRIPTION	Enter description
_____	CONDITION	Define the Trigger condition
_____	WHERE USED	List APLs, APGs and MTRs linked to this entry
_____	COPY	Copy data from an existing entry

Figure 155. Policy Selection Panel for Triggers

The unique policy item for a trigger is:

CONDITION

This policy item allows you to define the startup and shutdown conditions for this trigger. You need to link the trigger with its defined conditions to Applications, Application Groups, or Monitor Resources.

CONDITION Policy Item

With the CONDITION policy item you can:

1. Define up to ten startup conditions for the application that you want to connect to the trigger (**1**), see “Defining STARTUP and SHUTDOWN Conditions for a Trigger” on page 218.
2. Define up to ten shutdown conditions for the application that you want to connect to the trigger (**2**), see “Defining STARTUP and SHUTDOWN Conditions for a Trigger” on page 218.

CONDITION Policy Item for Triggers

```
COMMANDS  ACTIONS  VIEW  HELP
-----
A0FGAPT0          Trigger Conditions          Row 1 of 20
Command ==>          SCROLL==> PAGE

Entry Type : Trigger          PolicyDB Name : USER_PDB
Entry Name : TRIGGER1        Enterprise Name : USER_ENTERPRISE

Action   Condition   Names
-----
STARTUP 1   EVENT1 EVENT2 1
STARTUP 2
STARTUP 3
STARTUP 4
STARTUP 5
STARTUP 6
STARTUP 7
STARTUP 8
STARTUP 9
STARTUP 10
SHUTDOWN 1   EVENT3 2
SHUTDOWN 2
SHUTDOWN 3
SHUTDOWN 4
SHUTDOWN 5
SHUTDOWN 6
SHUTDOWN 7
SHUTDOWN 8
SHUTDOWN 9
SHUTDOWN 10
```

Figure 156. Trigger Conditions Panel

Note:

When you define conditions for a new trigger you get an empty Trigger Conditions panel. The entries in Figure 156 are only visible after you have finished the tasks described in the subsequent sections.

- A maximum number of 20 condition names (service period and events) can be selected for each condition.
- The overall number of different events in a trigger is limited to 28.
- An event can be specified either in STARTUP conditions or in SHUTDOWN conditions of a particular trigger, however, not in both types of conditions simultaneously.

Defining STARTUP and SHUTDOWN Conditions for a Trigger

If you enter S in front of a STARTUP condition on the panel shown in Figure 156 (1), SA z/OS displays another panel similar to Figure 157 on page 219.

```

COMMANDS  ACTIONS  VIEW  HELP
-----
AOFGAPT1          STARTUP Condition for Trigger          Row 1 of 2
Command ==> _____          SCROLL==> PAGE

Entry Type : Trigger          PolicyDB Name   : USER_PDB
Entry Name  : TRIGGER1        Enterprise Name : USER_ENTERPRISE

Description. . . . _____

Action      Status   Event          Short Description
-----
_____    SELECTED  EVENT1         Startup event, backup completed
_____    SELECTED  EVENT2         Startup event, AOR1 is ready
_____                    EVENT2B        Startup event, AOR2 is ready
_____                    EVENT3         Shutdown event in case of emergency
    
```

Figure 157. STARTUP Condition for Trigger Panel

Figure 157 displays a list of events where you can select *one or more* events that should trigger the startup of an application. Entering S in the **Action** field selects an event and sets its status to SELECTED. All selected events are added to the startup condition that is currently selected.

Additionally you can enter a description for the startup condition.

If you enter S in front of a SHUTDOWN condition on the panel shown in Figure 156 on page 218 (**2**), SA z/OS displays another panel similar to Figure 157. The title of the panel is SHUTDOWN Condition for Trigger and the panel contains a list of events that you can add to or remove from the currently selected shutdown condition.

Processor Entry Type

Use the Processor Entry Type to define and control your processor hardware in the sysplex.

Creating a New Processor

How to create new policy objects in general is described in “How to Create New Policy Objects” on page 19.

Figure 158 shows the panel for defining a new Processor policy object.

```

COMMANDS  HELP
-----
AOFGDYN2          Define New Entry
Command ==> _____

Define new entry of type Processor

Entry Name . . . . . _____

Processor Type . . . . Mainframe (Mainframe PSM)
Mode . . . . . LPAR (LPAR ESA)

Short description . . . _____
Long description 1 . . . _____
Long description 2 . . . _____
Long description 3 . . . _____
Long description 4 . . . _____
Long description 5 . . . _____
    
```

Figure 158. Defining a New SA z/OS Processor Entry

Processor Entry Type

Name The processor name must have 1 to 8 alphanumeric characters and must begin with an alphabetic character, #, \$, or @. The name must be different from the names of all groups, subgroups, systems (including the processor operations names), and processors defined in the current policy database.

Processor Type

Specifies the processor machine type of the target hardware. Select a name from the list shown to specify the processor type.

Use the generic type name Mainframe to specify the IBM Mainframe family that includes all IBM System z10, System z9, zSeries and S/390 types of processors. The actual processor type is determined at SA z/OS processor operations run time when a target system associated with the target hardware is initialized. The default is Mainframe.

Use the type PSM to specify a ProcOps Service Machine on VM as virtual hardware for VM guest systems. For more details about the PSM, see *IBM Tivoli System Automation for z/OS Customizing and Programming*.

Mode Specifies the operating mode of the processor hardware as defined in the Reset Profile that is used for hardware activation. For zSeries, 390-CMOS in logical partition mode, and PSM processors specify LPAR. Note that for processors of type PSM, the mode is forced to LPAR.

Policy Items for Mainframe Processors

Figure 159 shows the Policy Selection panel for processors.

```

ACTIONS  HELP
-----
AOFGEPOL          Policy Selection
Command ==> _____ SCROLL==> PAGE

Entry Type : Processor          PolicyDB Name  : USER_PDB
Entry Name  : PROC1            Enterprise Name: USER_ENTERPRISE

Action      Policy Name      Policy Description
-----
            DESCRIPTION    Enter description
            PROCESSOR INFO  Enter and display processor information
            LPARS AND SYSTEMS Define LPARs and select systems
            -----
            COPY            Copy data from an existing entry
            ***** Bottom of data *****
```

Figure 159. Policy Selection Panel for Processor

The unique policy items for the Processor entry type are:

PROCESSOR INFO

Using this policy, you can specify the processor type and mode, the connection protocol and network information. See “PROCESSOR INFO Policy Item” on page 221.

LPARS AND SYSTEMS

This policy is displayed for processors with mode LPAR. See “LPARS AND SYSTEMS Policy Item” on page 224.

SYSTEMS

This policy is displayed for processors with mode ESA. Use this policy to select a system.

PROCESSOR INFO Policy Item

A panel similar to Figure 160 is displayed if you select the PROCESSOR INFO policy item from the Policy Selection panel for Processors.

```

COMMANDS  HELP
-----
A0FGCPD0          Processor Information
Command ==> _____

Entry Type      : Processor          PolicyDB Name  : USER_PDB
Entry Name      : PROC1              Enterprise Name : USER_ENTERPRISE

Processor Type  : Mainframe          Processor Mode  : LPAR

Connection Protocol . . . . . INTERNAL SNMP (INTERNAL SNMP NVC)
CPC Name / NAU . . . . . CPC
Network Name . . . . . NET
Site/Location Name. . . . . SITE1

The following specifications are for INTERNAL processors only:
Auth Token. . . . . PUBLIC
Connection Monitoring Interval. 05:00 (mm:ss)

The following specifications are for SNMP or NVC processors only:
Community Name / Auth Token . . COMM
ProcOps Target HW Name. . . . THW1
IP Stack. . . . .
Activation Reset Profile . . . . DEFAULT
Path Poll Frequency . . . . . 0 (0 to 99 minutes)
Path Poll Retries . . . . . 0 (0 to 99)
Command Retries . . . . . 10 (0 to 99)
Command Retry Wait Time . . . . 1 (0 to 99 seconds)

For SNMP connection, at least one address must be specified:
TCP/IP Address or Hostname for Support Element first Adapter
SITE1SE
TCP/IP Address or Hostname for Support Element second Adapter or a HMC
    
```

Figure 160. Processor Information Panel

The fields at the top of this panel show the following information that was defined when the processor was created:

Processor Type

The processor machine type of the target hardware.

Processor Mode

The operating mode of the processor hardware as defined in the Reset Profile used for hardware activation.

Connection Protocol

Indicates the protocol used for communication with the processor:

INTERNAL

Connection via the operating system.

SNMP

Connection via TCP/IP.

NVC Connection via SNA network.

You can also specify INTERNAL SNMP or INTERNAL NVC but combining SNMP and NVC is not allowed

PROCESSOR INFO Policy Item for Mainframe Processors

Important Note:

Processors of type NVC are only supported for SA z/OS releases prior to SA z/OS V3R3.

On the Processor Information panel you can specify the following definitions so that the automation knows where the system is located to send the commands to the appropriate support element.

CPC Name / NAU

Indicates the network addressable unit of the support element within the network. This field is required for all connections that are supported (INTERNAL, NVC, and SNMP).

Network Name

Indicates the name of the SNA network that the support element is located in. This field is required for all connections that are supported (INTERNAL, NVC, and SNMP). For SNMP connections, the central processor complex name of the support element consists of the **Network Name** and **CPC Name**.

Site/Location Name

Specify a descriptive name for the processor's location.

The following specification is for INTERNAL processors:

Auth Token

The authorization token of the support element. It is defined at the support element, and is used to validate command authorization.

Connection Monitor Interval

Indicates how frequently the support element INTERNAL connection status should be monitored. Frequency must be specified using format mm:ss. The allowed minimum is 1 minute (01:00), the maximum is 99 minutes (99:00). If nothing is specified the default value is 5 minutes (05:00).

Note: At runtime this connection monitor will not monitor the INTERNAL connections of processors specified in the GDPS GEOPLEX DOMAIN definitions. These connections are exclusively monitored by the GDPS HMC monitor function.

The following specifications are for SNMP or NVC processors:

Community Name / Auth Token

For SNMP connections, this indicates the community name of the support element. For NVC connections, it indicates the authorization token. Both community name and authorization token are defined at the support element, and are used to validate command authorization. This field is required.

ProcOps Target HW Name

The name that Processor Operations knows the processor by. For processors with only SNMP or NVC specified as connection protocol this name is defaulted to the processor's entry name. If you specify multiple connection protocols this field is required and must be different from the processor's entry name.

IP Stack

The name of the IP stack to be used. If not defined, the default IP stack is used. Note that this field can only be specified for processors using the SNMP protocol.

Activation Reset Profile

Indicates the reset profile name to use when activating the target hardware. This profile name must match with the reset profile name defined at the target hardware support element. This field is optional. The reset profile name specified here will be used by Processor Operations common command processing if the CNAME keyword is omitted from the ACTIVATE or LOAD command, and use of a reset profile is appropriate.

If you do not specify a reset profile name, and the CNAME keyword is not used on the LOAD or ACTIVATE command, Processor Operations omits the CNAME parameter from the command that is sent to the support element. In this case, the support element uses its default reset profile.

Path Poll Frequency

Enter how often (in minutes) SA z/OS processor operations should poll the support element for status. Valid values are 0 to 99 minutes. Specify 0 to deactivate polling.

Path Poll Retries

Enter the number of attempts to retry path polling that should occur before SA z/OS processor operations notifies the operator that the connection failed. Valid values are 0 to 99 retries.

Command Retries

The number of retry steps for calling the hardware interface. If nothing is specified the default value is 10.

Note:

This field can only be specified for processors with the SNMP protocol.

Command Retry Wait Time

The wait time between the retry steps for calling the hardware interface. If nothing is specified the default value is 1 second.

Note:

This field can only be specified for processors with the SNMP protocol.

TCP/IP Address or Hostname for Support Element first Adapter/second Adapter or a HMC

TCP/IP Address or Hostname indicates the TCP/IP address or symbolic hostname for communication with the target hardware.

At least one address is required for SNMP connections. If you specify two addresses, the support element first adapter address has preference and the second adapter address can be used to recover from adapter failures. Use the Processor Operations ISQIPSWT focal point command to perform the switch from the first to the second adapter address. Depending on the Support Element version, a second adapter with an alternate address may not be supported.

LPARS AND SYSTEMS Policy Item for Mainframe Processors

cannot run MVS or VM. For a Linux system specify LINUX if the processor hardware is configured in 'LINUX Only' mode, otherwise specify ESA.

Valid LPAR Target Modes are 370, ESA, CF, and LINUX.

Valid VM GUEST Target Modes are 370, ESA, and LINUX.

Target System Name

You can specify a system entry name, which establishes a "link" of this system to the partition. Any name is allowed here, it is not required that the system entry has already been defined. During build, such an undefined system is treated as not specified. If the system is already defined as SYS entry, it is checked that it is a valid selection according to the rules described in the following section for entry type SYS. Otherwise, an error message is displayed.

Policy Items for PSM Processors

Figure 162 shows the Policy Selection panel for PSM processors.

```

  ACTIONS  HELP
-----
A0FGEPOL          Policy Selection          Entry created
Command ==> _____ SCROLL==> PAGE

Entry Type : Processor          PolicyDB Name : USER_PDB
Entry Name : PSMPROC1          Enterprise Name : USER_ENTERPRISE

Action   Policy Name   Policy Description
-----  -
        DESCRIPTION  Enter description
        PSM INFORMATION  Enter and display PSM processor information
        GUESTS AND SYSTEMS  Define VM guests and select systems
        -----
        COPY           Copy data from an existing entry
***** Bottom of data *****
```

Figure 162. Policy Selection Panel for PSM Processors

The unique policy items for the Processor entry type are:

PSM INFORMATION

Using this policy, you can specify the processor type and mode, and network information. See "PSM INFORMATION Policy Item."

GUESTS AND SYSTEMS

This policy allows you to define VM guests and select systems. For more details, see "GUESTS AND SYSTEMS Policy Item" on page 227.

PSM INFORMATION Policy Item

A panel similar to Figure 163 on page 226 is displayed if you select the PSM INFORMATION policy item from the Policy Selection panel for PSM Processors.

PSM INFORMATION Policy Item for PSM Processors

```

COMMANDS  HELP
-----
AOFGCPD1          ProcOps Service Machine Information
Command ==> _____

Entry Type       : Processor          PolicyDB Name   : USER_PDB
Entry Name       : PSMPROC1          Enterprise Name : USER_ENTERPRISE

Processor Type   : PSM                Processor Mode  : LPAR

Connection Protocol      : TCPIP
Security Resource Name . . . . . _____
Security Network Name . . . . . _____
Site/Location Name. . . . . _____
Community Name / Auth Token . . . . . _____
IP Stack . . . . . _____
VM Host Target System Name . . . . . _____
Service Machine Name . . . . . _____
Enforce IPv4 for Hostname . . . . . _____ (YES NO)
Message Server Port . . . . . _____ (0 - 65535)
Command Server Port . . . . . _____ (0 - 65535)
Path Poll Frequency . . . . . _____ (0 to 99 minutes)
Path Poll Retries . . . . . _____ (0 to 99)
TCP/IP Address or Hostname . . . . . _____

```

Figure 163. ProcOps Service Machine Information Panel

The ProcOps Service Machine Information panel shows the Processor Type, Processor Mode and Connection Protocol that were defined when the processor was created. For ProcOps Service Machines the Processor Mode is always LPAR and the Connection Protocol is always TCPIP, and neither value can be changed.

On this panel you can update the following:

Security Resource Name

This field corresponds to the **CPC Name / NAU** name of other processors and is used for SAF checking. This field is required.

Security Network Name

This field corresponds to the **Network Name** of other processors and is used for SAF checking. This field is required.

Site/Location Name

Specify a descriptive name for the processor's location.

Community Name / Auth Token

The authorization token for TCP/IP connections (ProcOps Service Machines are connected only via TCPIP). This field is required.

IP Stack

Indicates the name of the IP stack on the ProcOps Focal Point system that is to be used for this PSM connection.

If defined, the ProcOps FP TCP/IP must be configured for multiple IP stacks. If blank, the default IP stack is used, regardless of the TCP/IP stack configuration.

Leave the field blank if the ProcOps FP system is not configured for multiple TCP/IP stacks.

VM Host Target System Name

The name of the VM host system if it is also defined in ProcOps. This field is optional. The number of PSMs per hosting VM system is restricted to 12.

Note:

The host command ISQXPSM can only be used to operate the PSM via the VM host if this information is provided.

Service Machine Name

The name of the PSM as it is known to the VM host system.

Note:

The host command ISQXPSM can only be used to operate the PSM via the VM host if this information is provided.

Enforce IPv4 for Hostname

You should set this to YES to indicate that the connection to the PSM will use IPv4 in an IPv6-enabled environment. In IPv4-only environments the flag is ignored.

Note:

This flag will only be tested at Processor Operations run time if the Hostname address format is used. If nothing is specified the default value is NO.

Message Server Port

The port that the ProcOps Service Machine Message Server uses for communication with the ProcOps receiver task.

Command Server Port

The port that the ProcOps Service Machine Command Server uses for communication with the ProcOps send program.

Path Poll Frequency

How frequently the support element should be queried for status. The frequency must be specified in whole minutes in the range 0–99. A frequency of 0 means that polling is deactivated. This field is required.

Path Poll Retries

The number of times that the status query should be retried before notifying the operator. Valid values are 0–99 retries. This field is required.

TCP/IP Address or Hostname

The TCP/IP address or symbolic host name for communication with the ProcOps Service Machine. This address is required.

GUESTS AND SYSTEMS Policy Item

If you have created a Processor policy object of type PSM, the GUESTS AND SYSTEMS policy item is available, and has the GUEST Definitions panel shown in Figure 164 on page 228 associated with it.

GUESTS AND SYSTEMS Policy Item for PSM Processors

COMMANDS	ACTIONS	HELP	

A0FGXC4P	GUEST Definitions	Row 1 to 13 of 20	
Command ==>		SCROLL==> PAGE	
Entry Type : Processor	PolicyDB Name : USER_PDB		
Entry Name : PRLPR01	Enterprise Name : USER_ENTERPRISE		
Action	GUEST Name	Target Mode	Target System Name
	LINUX1	LINUX	LINUX1
	LINUX2	LINUX	LINUX2

Figure 164. GUEST Definitions Panel

This panel allows you to define VM GUESTs and to link systems to them. Within ProcOps, VM guest systems are treated like LPARs.

Action

Action allows you to remove VM GUEST definitions and to invoke the system selection panel:

- DELETE (D) deletes the current VM GUEST definition. Confirmation on a separate panel is not required.
- SYSTEM (S) displays a selection list of all defined systems allowing a system to link to the current VM GUEST

GUEST Name

Specifies the name of the VM GUEST. Duplicate VM GUEST names without Target System Name are wiped out when the panel is left. However, it is possible to link different systems to one VM GUEST, so duplicate VM GUEST names are accepted when they have links to different systems. Linking one system to multiple VM GUESTs is not accepted.

Target Mode

Specifies the mode of the system that is supposed to run on this VM GUEST. The Target Mode LINUX is used for hardware that supports VM GUESTs for Linux only, where a reduced instruction set is provided and therefore cannot run MVS or VM.

For a Linux system specify LINUX if the processor hardware is configured in 'LINUX Only' mode, otherwise specify ESA. Valid VM GUEST Target Modes are 370, ESA, and LINUX.

Target System Name

You can specify the name of the system that runs on this VM GUEST. Any name is allowed here; it is not required that the system entry has already been defined. During build, such an undefined system is treated as not specified.

If the system is already defined as a SYS entry, it is checked that it is a valid selection according to the rules described in the following section for entry type SYS. Otherwise, an error message is displayed.

The number of guest systems per PSM is restricted to 60. When a new guest system is defined, the number of guests that have already been defined for the associated PSM is checked. If there are already 60 defined, any further guest definition is rejected.

Monitor Resource Entry Type

The Monitor Resource (MTR) entry type allows you to obtain the health state of an object in two different ways:

- Actively, by polling, that is, executing a monitoring command periodically
- Passively, by processing events

Monitor resources are connected to application resources (APLs) or application group resources (APGs). The health status of the monitored object is propagated to the APLs or APGs and results in a health status there.

Selecting Monitor Resources (MTR) from the Entry Type Selection panel brings you to the Entry Name Selection panel that lists your current monitor resources, if you have any. From this panel you can either create new monitor resources, or select an entry and action for one of the existing entries.

Policy Items for Monitor Resources

Figure 165 shows the policy items that are displayed when an existing Monitor Resources entry is selected from the Entry Name Selection panel.

```

ACTIONS  HELP
-----
AOFGEPOL          Policy Selection          Row 1 of 9
Command ==> _____ SCROLL==> PAGE

Entry Type : Monitor Resource      PolicyDB Name  : USER_PDB
Entry Name  : MONITOR1             Enterprise Name: USER_ENTERPRISE

Action   Policy Name      Policy Description
-----
MONITOR INFO      Define monitor information
RELATIONSHIPS     Define relationships
MESSAGES/USER DATA Define monitor messages and user data
HEALTHSTATE      Define commands for healthstate processing
TRIGGER           Select trigger
SERVICE PERIOD   Select service period
-----
WHERE USED        List systems linked to this entry
COPY              Copy data from an existing entry
***** Bottom of data *****

```

Figure 165. Policy Selection for Monitor Resource

The unique policy items for the Monitor Resource entry type are:

MONITOR INFO

This policy item allows you to make definitions for the monitor resource. See “MONITOR INFO Policy Item” on page 230 for more details.

RELATIONSHIPS

This policy item has the same functionality for entry types Application, ApplicationGroup, and Monitor Resource. For each application, application group, or monitor resource you may specify several relationships. They will be used to automate the startup or stopping of those applications, application groups, and monitor resources. If you select this policy item, in

Monitor Resource Entry Type

the Relationship Selection List panel, you can view existing relationships or define new relationships for the current application, application group, or monitor resource.

You define relationships between dependent resources and supporting resources. In the customization dialog you define relationships always from the point of view of the dependent resource. So the resource that you have currently selected will become the dependent resource, when you define a new relationship.

See “RELATIONSHIPS Policy Item” on page 123 for more information on viewing existing or defining new dependency relationships.

MESSAGES/USER DATA

This policy item allows you to define actions to be taken in response to particular events. Normally, these events are message IDs, but they can also be OMEGAMON exceptions. See “MESSAGES/USER DATA Policy Item” on page 233 for details.

HEALTHSTATE

This policy item allows you to define the processing that takes place when the monitor resource detects a change of the health state of the monitored resource. See “HEALTHSTATE Policy Item” on page 238 and the section “Event and Trigger Support” in *IBM Tivoli System Automation for z/OS User's Guide* for more details.

TRIGGER

This policy item allows you to manage the link from the current Monitor Resource entry to the Trigger entry. Each Monitor Resource entry may be linked to one Trigger entry. See “TRIGGER Policy Item” on page 239 and the section “Event and Trigger Support” in *IBM Tivoli System Automation for z/OS User's Guide* for more details.

SERVICE PERIOD

This policy item allows you to link a service period to the monitor resource. Its resources are then automatically started up or shut down in the time frame specified by the service period.

MONITOR INFO Policy Item

If you select the MONITOR INFO policy item from the Policy Selection panel for monitor resources, the Monitor Resource Information panel is displayed, as shown in Figure 166 on page 231.

MONITOR INFO Policy Item for Monitor Resources

```
COMMANDS  HELP
-----
AOFGMTR          Monitor Resource Information
Command ==> _____

Entry Type : Monitor Resource      PolicyDB Name  : USER_PDB
Entry Name  : CI2XREP              Enterprise Name : USER_ENTERPRISE
More:      +

Monitored Object . . . . . JES2MON
Monitored Jobname. . . . . _____
Activate command. . . _____

Deactivate command. . _____

Monitor command . . . _____
INGMTRAP NAME=OMSY4MVS XTYPE=XREP

Monitoring Interval. . . . . 00:05          (hh:mm or blank)
Captured Messages Limit. . . 12          (0 to 999, or blank)
Desired Available. . . . . _____      (ALWAYS ONDEMAND ASIS)
Inform List . . . . . _____          (SDF NMC IOM SMF EIF TTT USR NONE)

Owner. . . . . Sysprog
Info Link. . . . . _____
```

Figure 166. Monitor Resource Information Panel

To create a new Monitor Resource entry, provide the following information:

Monitored Object

This is the name of the real object that is being monitored by this monitor resource. It is used to locate the monitor resource that is affected by a real monitor event.

For example, the following values can be used:

OLDS if the monitored object is the IMS Online Log Data Set

RECON if the monitored object is the IMS Recovery Control Data Set

For more details, see the section “Health Monitoring” in the chapter “How to Monitor Applications” in *IBM Tivoli System Automation for z/OS Customizing and Programming*.

You can include system symbols and system automation symbols. See “Assigning System Automation Symbols (AOCCLONE)” on page 9 for more details.

Note:

If you define the same message ID for different monitor resources, the name in the **Monitored Object** field must be identical. This is not required for messages ING150I and ING080I.

Monitored Jobname

This can be used to specify the name of the job that this monitor resource accepts events from. This ensures that only events that are issued from a specific job trigger automation actions for this monitor resource.

For example, if the monitor routine should only react for the IMS Online Log Data Set of a specific IMS, specify the job name here.

MONITOR INFO Policy Item for Monitor Resources

You can include system symbols and system automation symbols. See “Assigning System Automation Symbols (AOCCLONE)” on page 9 for more details.

Activate Command

This can be any NetView command. It is executed when the monitor resource is started.

You can include system symbols and system automation symbols but they must be entered in uppercase letters (for example, &AOCCLONE1.). See “Assigning System Automation Symbols (AOCCLONE)” on page 9 for details on using system automation symbols.

Deactivate Command

This can be any NetView command. It is executed when the monitor resource is stopped.

You can include system symbols and system automation symbols but they must be entered in uppercase letters (for example, &AOCCLONE1.). See “Assigning System Automation Symbols (AOCCLONE)” on page 9 for details on using system automation symbols.

Monitor Command

This can be any NetView command. If a command and an interval is specified, the command will be executed periodically while the monitor is active.

If a command is specified and no interval is specified, the command will be executed once during the startup phase.

If no command is specified the monitor is a passive monitor. In this case, the health status must be set via the INGMON command (see *IBM Tivoli System Automation for z/OS Programmer's Reference* for more details).

You can include system symbols and system automation symbols but they must be entered in uppercase letters (for example &AOCCLONE1). See “Assigning System Automation Symbols (AOCCLONE)” on page 9 for more details.

Monitoring Interval

Specifies an interval time for periodic execution of the monitor command. If you leave the field blank, no periodic monitoring is performed. If you specify an interval, you must also specify a monitor command.

Captured Messages Limit

Specifies the maximum number of history messages that will be saved for the SA z/OS DISPMTR command. If the field is left blank the value can be inherited from the system defaults definition. If it is also not specified there, a default value of 0 will be used.

Desired Available

Lets you specify the default desired status of the resource. The desired state of each resource is either Available or Unavailable, which is the goal that automation tries to achieve.

You can specify the following values:

ALWAYS

The desired state of the resource is set to Available, unless it is dependent on a resource that has a Desired Available setting of ONDEMAND. In this case the resource behaves as if it had a Desired Available setting of ONDEMAND itself.

MONITOR INFO Policy Item for Monitor Resources

This is the same behavior as in earlier releases of SA z/OS.

ONDEMAND

If there is *demand* for the resource to be available, its desired status is set to Available, otherwise its desired status is set to Unavailable.

Demand arises either from propagated MakeAvailable votes or implicitly through membership of a non-passive basic application group (APG) that has a desired status of Available. Demand does not arise from dependent resources with a Desired Available setting of ALWAYS.

A MakeAvailable vote that is propagated to the resource overrides any demand considerations.

An active ONDEMAND member of a move or server group is always sent a vote that sets its desired status, thus overriding any demand considerations.

ASIS The desired status is always set to the observed status. The resource remains in the status that it currently has and no action is taken by SA z/OS at any time, as long as there is no request placed for or propagated to the resource.

If you leave the field blank the value can be inherited from the system defaults definition.

Note:

If nothing is specified or inherited the default value is ALWAYS.

Inform List

This field allows you to specify:

- Where the application is registered to
- Where all status changes are propagated to

Valid receivers are SDF, NMC, IOM, SMF, EIF, TTT and USR. You can specify more than one receiver. The list of values can be blank or comma separated.

Neither system automation symbols (AOCCLONES) nor system symbols are allowed.

If the field is left blank the value is inherited from the systems default definition (see "System Defaults Entry Type" on page 272).

If the resource should not be registered at all, specify NONE. This will prevent inheritance from the systems default definitions.

Owner

Specifies information for the operator about who to contact in case of error.

Info Link

This field can be used to specify a location (for example, a URL) where additional information about the application can be found.

MESSAGES/USER DATA Policy Item

In entry type MTR, the MESSAGES/USER DATA policy item allows you to specify OMEGAMON exceptions and messages in the **Message ID** field, as shown in Figure 167 on page 234. Note that the '+' sign and the imbedded blank must be

MESSAGES/USER DATA Policy Item for Monitor Resources

specified to distinguish the exception from regular messages.

```
COMMANDS  HELP
-----
AOFGDYNM      Message Processing      Line 00000001 Col 001 075
Command ==>> _____ Scroll ==>> PAGE

Entry Type : Monitor Resource      PolicyDB Name : USER_PDB
Entry Name : OM_MON                Enterprise Name : USER_ENTERPRISE

Line Commands: S (Cmd), C (Cmd), R (Rep), K (Cod), U (Usr), A (AT), M (MRT)
I, D (insert or delete lines)
Message ID field length. . 14      (1 - 32)

Cmd Message id   Description          Cmd Rep Cod Usr A M
-----
A  + XCHN
-----
-----
-----
-----
-----
-----
-----
-----
```

Figure 167. Message Processing Panel with OMEGAMON Exception

With an OMEGAMON exception in the **Message id** field, you can use the line command Cmd to specify commands, Cod for codes, Usr for user data, and A for health states. This results in a default automation table entry that is processed whenever message ING080I is issued on behalf of the subject monitor and exception. If the defaults provided by the customization dialog do not meet your installation's needs, you can select an override action to modify the AT entry.

You can use the FIND command on the Message Processing panel to search the displayed data for a specific string. For more details, see "How to Find Data in a Policy Item" on page 23.

On the Command Processing panel (accessed via the Cmd line command), you can specify a set of one or more commands to react to the exception represented by ING080I

You can also define generic key/value pairs (USER DATA) that are available to the called command. SA z/OS provides a predefined key, DISABLETIME, which you can use to determine the time that processing for this particular exception will be disabled. The commands that are specified will be issued, but will only be re-issued if the exception still exists after the time specified with DISABLETIME. This is useful if the recovery for an exception takes a while and no subsequent parallel recovery actions should be taken while the initial recovery is still running.

The A line command allows you to select the health state of the monitor whenever this exception trips and message ING080I is issued. When A is specified, a panel similar to Figure 168 on page 235 is displayed.

MESSAGES/USER DATA Policy Item for Monitor Resources

```

COMMANDS  HELP
-----
AOFGMADV          Message Automation Overview
Command ==> _____ Scroll ==> PAGE

AC AT condition   MS MRT action selection   IG Ignore / Suppress via MPF
AS AT status      MO MRT override
AO AT override

Message ID : + XCHN

No AT entry will be generated because there is no Command, Reply, or Status
defined

No MRT entry will be generated because there are no specifications for this
message

```

Figure 168. Message Automation Overview Panel

Enter AS on this panel to display the AT Status Specification panel, as shown in Figure 169. Select the WARNING monitor status.

```

COMMANDS  HELP
-----
AOFGMAT1          AT Status Specification
Command ==> _____

Enter "S" to make a selection for: + XCHN

Application / MVC Component Status      Monitor Status
ACTIVE Starting                          NORMAL Resource shows good results
- UP Available                            S WARNING Resource shows degradation
- HALTED Degraded                          - MINOR More severe than WARNING
- Terminating Received STOP command      - CRITICAL More severe than MINOR
- Terminated Terminated normally        - FATAL More severe than CRITICAL
- ABENDING Going to end abnormally
- Abended Ended abnormally
- BREAKING Non-recoverable abending
- BROKEN Non-recoverable abend
- Capture Capture Message

```

Figure 169. AT Status Specification Panel

Pressing PF3 returns you to Message Automation Overview panel, where you can now see that the AT entry that will be generated for the + XCHN message is:

```

IF TOKEN(5) = 'XCHN' THEN
EXEC(CMD('INGMON 'MTRNM',STATUS=WARNING') ROUTE(ONE %AOFOPGSSOPER%));

```

Note:

The MTRNM variable is available for all exceptions that cause an ING080I message to be created.

The following series of panels shows a sample specification with different sets of commands based on attributes contained within the exception message.

As an example, the XCHN exception is used. A code entry is specified to return the value CONFIG whenever channel path 26 is found to be not available. The appropriate reaction is to issue the command MYCMD to fix it. In addition, and for all other channels that are not available, the administrator should be notified. Figure 170 on page 236 shows the input for the Cmd line command.

MESSAGES/USER DATA Policy Item for Monitor Resources

```

COMMANDS  HELP
-----
AOFGDYN9  Command Processing : + XCHN          Line 00000001 Col 001 075
Command ==> _____ Scroll ==> PAGE

Cmd Ps/Select  AutoFn/*  Command Text
--- CONFIG      _____ MYCMD
---              _____ MYALERT ADMIN
---              _____
---              _____
---              _____
---              _____
---              _____
---              _____
---              _____
***** Bottom of data *****

```

Figure 170. CMD Processing Panel for Monitor Resources

Figure 170 shows two commands, one with a selection CONFIG and another without a selection value. To execute the command in the CONFIG selection, a code entry must be defined that results in the value CONFIG. No special action is required to execute the commands in the other selection because they will always be issued.

With action COD on the Message Processing panel of Figure 167 on page 234, a table of codes can be specified that will be evaluated by INGMON to select the commands to issue based on the actual setting of one or more codes. Figure 171 shows an example where the value CONFIG is returned whenever *code1* has a value of 26. In this case, it is channel path 26 because the XCHN exception is being processed.

A row is matched whenever the conjunction of *code1*, *code2*, and *code3* evaluates to true. Otherwise, the next row is evaluated for a match. If no match is found, the value returned will be ALWAYS.

```

COMMANDS  HELP
-----
AOFGDYN9  Code Processing : + XCHN          Line 00000001 Col 001 075
Command ==> _____ Scroll ==> PAGE

Cmd Code 1      Code 2      Code 3      Value Returned
--- 26          *           _____  CONFIG
---              _____
---              _____
---              _____
---              _____
---              _____
---              _____
---              _____
---              _____
***** Bottom of data *****

```

Figure 171. Code Processing Panel

With action USR on the Message Processing panel of Figure 167 on page 234, a key/value pair can be specified that denotes the administrator to be notified, as shown in Figure 172 on page 237. (There must be a REXX exec that performs this function.)

MESSAGES/USER DATA Policy Item for Monitor Resources

```

COMMANDS  HELP
-----
AOFGDYN8  User Data Processing : + XCHN          Line 00000001 Col 001 075
Command ==> _____ Scroll ==> PAGE

Mixed case . . . NO (YES NO)          Keyword length. . . 20 (1-60)

Cmd Keyword          Data
---
  ADMIN              ADMIN@DOMAIN.NET
-----
-----
-----
-----
-----
-----
-----
-----
-----
***** Bottom of data *****

```

Figure 172. User Defined Data Panel

You can also use the Command Processing panel to set up Pass Processing to make multiple attempts to recover from or resolve the exception. PASS counts from 1 to 99 and is incremented for each instance of the message or exception, unless recovery is disabled. In the example in Figure 173, when the number of outstanding replies exceeds the OMEGAMON threshold:

- The first time, issue MYCMD and pass parameter 'ORANGE'
- The second time, do nothing
- The third time, issue MYCMD and pass parameter 'RED'

Note that a blank pass means that the command is always executed.

```

COMMANDS  HELP
-----
AOFGDYN9  Message: + XREP                          Line 00000001 Col 001 075
Command ==> _____ Scroll ==> PAGE

Cmd Ps/Select  AutoFn/*  Command Text
---
  1            _____  MYCMD 'ORANGE'
  3            _____  MYCMD 'RED'
-----
-----
-----
-----
-----
-----
-----
-----
-----
***** Bottom of data *****

```

Figure 173. Monitor Resource CMD Processing Panel - Pass Processing

The USR action can also be used to disable further processing within INGMON using the DISABLETIME keyword, as in Figure 174 on page 238. The data value is the time, which can be specified in the normal NetView format: hh:mm:ss, mm:ss, :ss, or mm..

A DISABLETIME of 0 means that the message processing for this particular combination of monitor and exception is disabled forever. If message processing should be enabled again or prematurely, an INGMON CLEARING request must be issued. It is best issued from within the command that handles the resolution.

MESSAGES/USER DATA Policy Item for Monitor Resources

```

COMMANDS  HELP
-----
AOFGDYN8      Message: + XCHN                      Line 00000001 Col 001 075
Command ==> _____ Scroll ==> PAGE

Mixed case . . . NO (YES NO)           Keyword length. . . 20 (1-60)

Cmd Keyword      Data
---
  DISABLETIME    15:00
-----
-----
-----
-----
-----
-----
-----
-----
-----
-----
***** Bottom of data *****

```

Figure 174. User Defined Data Panel

Action OVR on the Message Processing panel of Figure 167 on page 234 needs to be used to manually refine the NetView AT-entry in order to exploit the code entry. SA z/OS generates a default condition and action statement that can be modified by the installation. In the example, the condition statement would be modified to set a variable named MISSCHAN:

```

IF TOKEN(2)='MONITORS/MTR/SYS1' &
  TOKEN(5)='XCHN' &
  TOKEN(10)=MISSCHAN

```

The action statement would be modified to say:

```

EXEC(CMD 'INGMON MONITORS/MTR/SYS1 CODE1='MISSCHAN)

```

OVR can also be used to add the NetView THRESHOLD condition item to the condition statement suggested by SA z/OS. The THRESHOLD condition item counts the number of occurrences within a given time interval and returns a value of true (1) only if the count is equal to or higher than the specified threshold.

HEALTHSTATE Policy Item

If you select the HEALTHSTATE policy item from the Policy Selection panel for monitor resources, the Command Processing panel is displayed, as shown in Figure 175.

```

COMMANDS  HELP
-----
AOFGDYN9      Command Processing : HEALTH_RECOVERY    Line 00000001 Col 001 075
Command ==> _____ Scroll ==> PAGE

Cmd State      AutoFn/* Command Text
-----
-----
-----
-----
-----
-----
-----
-----
-----
-----
***** Bottom of data *****

```

Figure 175. Command Processing Panel for the HEALTHSTATE Policy Item

HEALTHSTATE Policy Item for Monitor Resources

You can use this panel to enter commands to be executed when the monitor resource detects a change in the healthstate of the monitored resource. The following fields are available:

State Defines the health state that the monitored resource must change to in order to initiate the specified commands. Valid values are :

- NORMAL
- WARNING
- MINOR
- CRITICAL
- FATAL
- blank

Leaving this field blank means that the specified commands will be executed in any health state change.

AutoFn/*

Enter the name of the automated function that the command is to run under. The AT entry that is generated does not reflect the automated function that you enter, however the execution of the command is routed internally to the automated function that you specify. If you leave this field blank, the function defaults to the one that is currently running the command list. SA z/OS automated functions are mapped to NetView automation operators (see Table 7 on page 277 for more details).

Note:

Entering * enables return-code checking for the specified command. This means that processing continues if the command returns a return code of 0. In all other cases processing is stopped immediately. If you are running in LOG assist mode, return code checking has no effect because the commands are not executed.

Command Text

Enter the command or command list to be issued. You must preface a system command with MVS.

You can use line commands in the **Cmd** field to manipulate the entries on this panel as described in “Line Commands on Message Processing Panels” on page 165.

You can use the FIND command on the Command Processing panel to search the displayed data for a specific string. For more details, see “How to Find Data in a Policy Item” on page 23.

A healthstate can be specified on the call to ACFCMD, which will issue the corresponding command or Command Group defined in the CMD entry.

A healthstate of blank can be specified to ensure that the corresponding command is issued regardless of the SEL= parameter included on the ACFCMD call. Thus, for any given healthstate processing, the blank entries will be issued in addition to the entries coded for that particular healthstate.

TRIGGER Policy Item

The Trigger for Monitor Resource panel Figure 176 on page 240 is displayed if you select policy item TRIGGER from the Policy Selection panel for monitor resources. For more details about triggers, see the section “Event and Trigger Support” in

TRIGGER Policy Item for Monitor Resources

IBM Tivoli System Automation for z/OS User's Guide.

```
COMMANDS  ACTIONS  VIEW  HELP
-----
A0FGXC4E      Trigger for Monitor Resource      Row 1 to 1 of 4
Command ==>> _____          SCROLL==>> PAGE

Entry Type : Monitor Resource      PolicyDB Name : USER_PDB
Entry Name : JES3MON              PolicyDB Name : USER_ENTERPRISE

Action      Status      Trigger
-----
_____          _____          CICSK34
_____          _____          CICSK42
_____          SELECTED      TRIGGER1
_____          _____          XRFTRIG
***** Bottom of data *****
```

Figure 176. Trigger for Monitor Resource Panel

This panel allows you to manage the link (only one is allowed) between the current Monitor Resource entry and a Trigger entry.

Product Automation Entry Type

Selecting Product Automation (PRD) from the Entry Type Selection panel will bring you to the Entry type selections for Product Automation panel shown in Figure 177 where you can select the product that you want to define automation policy for. You can select from the following products:

- CICS, see “Defining Automation for CICS Components” on page 241
- IMS, see “Defining Automation for IMS Components”
- TWS, see “Defining Automation for TWS Components” on page 241

```
MENU  HELP
-----
A0FGEPOM      Entry type selections for Product Automation
Option ==>> _____

IMS components
20 ISA      IMS State/Action (SA 3.1 or below only)

OPC components
30 OEN      OPC System Details
31 OCS      Controller Details
32 OSR      Special Resources
33 ODM      Workstation DomainID

CICS components
40 CCN      CICS Connection Link (SA 3.2 or below only)
41 CVP      CCN Monitor Period (SA 3.2 or below only)
```

Figure 177. Entry Type Selections for Product Automation Panel

Defining Automation for IMS Components

For IMS components, the following entry types are available:

(ISA) State/Action

With this option, you can define or modify a state/action table for IMS. This is described in more detail in “IMS State/Action Tables Entry Type” on page 242.

Note:

This policy item is only for systems that are running releases of SA z/OS 3.1 or earlier.

Defining Automation for TWS Components

For TWS components, the following entry types are available:

(OEN) OPC System details

With this option, you can define certain system wide defaults. Selecting this entry type brings you to the Entry Name Selection panel for OPC system details where you can create or edit system defaults. You can link an OPC system detail to one or more System policy objects, however, you can link only one OPC system detail to a System. This is described in more detail in “OPC System Detail Entry Type” on page 243.

(OCS) Controller details

With this option, you can link the TWS controller subsystem name with the NetView domain where it is located. Selecting this entry type will bring you to the Entry Name Selection panel for OPC controller details where you can create or edit controller details. You can link an OPC controller detail to one or more System policy objects, however, you can link only one OPC controller detail to a System. This is described in more detail in “OPC Controller Details Entry Type” on page 244.

(OSR) Special resources

Use this option to define special resources that are to be set for a TWS controller. This is described in more detail in “OPC Special Resources Entry Type” on page 246.

(ODM) Workstation domains

Use this option to relate a TWS automatic workstation to a NetView domain ID. This is described in more detail in “OPC Workstation Domains Entry Type” on page 247.

Defining Automation for CICS Components

It is recommended that you use *event-based monitoring* for your CICS link and health monitoring rather than the following policy items. Event-based CICS link and health monitoring is implemented using CICSplex[®] System Manager (CICSplex SM or CPSM) objects.

Whenever an event is received from CICSplex SM, message ING150I is issued. This acts as a trigger that allows you to set the health status of a Monitor Resource based on the monitored object name and job. You can define Monitor Resources for CPSM objects (for example, connections), and codes for message ID ING150I in the MESSAGE/USER DATA policy of the Monitor Resource to map the CPSM severities to valid health states. For more details see the section “Event-Based Monitoring Using Monitor Resources” in *IBM Tivoli System Automation for z/OS Customizing and Programming*.

Note:

The CICS Entry Type can only be used to maintain systems that are running an earlier version of SA z/OS (3.1 and 3.2).

Product Automation Entry Type

For CICS components, the following entry types are available:

(CCN) Link definitions

Use this option to define the interregion and intersystem communication (IRC and ISC) links so that they can be monitored by SA z/OS. This is described in more detail in “CICS Link Definitions Policy Object” on page 249.

(CVP) Link Monitor periods

With this option, you can define service periods for the link monitoring definitions. Service periods can be related to a CICS link as defined with the (CCN) Link definition option. This is described in more detail in “CICS Link Monitor Periods Policy Object” on page 251.

IMS State/Action Tables Entry Type

Figure 178 shows the policy items that are displayed when you want to create a new state/action table for IMS or if you select an existing one from the related Entry Name Selection panel.

Notes:

1. This entry type is only for systems that are running releases of SA z/OS 3.1 or earlier. The definitions are completely ignored in later releases.
2. For the State/Action function to work for the tables that are shipped with the product, the Entry Name must be IMS.

```

ACTIONS  HELP
-----
AOFGEPOL                               Policy Selection
Command ==> _____ SCROLL==> PAGE

Entry Type : IMS State/Action           PolicyDB Name  : USER_PDB
Entry Name  : IMS                       Enterprise Name : USER_ENTERPRISE

Action      Policy Name      Policy Description
-----
            DESCRIPTION      Enter description
            IMS STATE/ACTION  Define IMS State/Action tables
            -----
            WHERE USED        List Applications linked to this entry
            COPY               Copy data from existing entry
***** Bottom of data *****
```

Figure 178. Policy Selection Panel for IMS State/Action Table

The unique policy item for IMS state/action table is:

IMS STATE/ACTION

This policy item lets you define IMS state/action tables. How to do this is described in more detail in “IMS STATE/ACTION Policy Item.”

IMS STATE/ACTION Policy Item

The IMS state action tables panel is displayed if you select the IMS STATE/ACTION policy item from the Policy Selection panel for the IMS State/Action entry type shown in Figure 178. Use this panel to define the state/action tables that are available to your applications.

IMS STATE/ACTION Policy Item for IMS State/Action Tables

```

COMMANDS  HELP
-----
AOFPPISA          IMS State/Action Tables
Command ==>>> _____

Entry Type : IMS State/Action      PolicyDB Name  : USER_PDB
Entry Name  : IMS                  Enterprise Name : USER_ENTERPRISE

MSC link recovery. . . . EVISS002
OLDS error recovery. . . EVISS003
MPP/BMP recovery . . . . EVISS005

```

Figure 179. IMS State Action Tables Panel

To define a state/action table, fill in the following fields:

MSC link recovery

The state/action table used for automatic recovery from MSC link errors. The SA z/OS supplied state/action table is EVISS002.

OLDS error recovery

The state/action table used to define procedures for automatic recovery from OLDS errors. The SA z/OS supplied state/action table is EVISS003.

MPP/BMP recovery

The state/action table used to define automatic recovery procedures initiated when an MPP or BMP transaction/program has abended. The SA z/OS supplied state/action table is EVISS005.

OPC System Detail Entry Type

Figure 180 shows the policy items that are displayed when you select an OPC system detail from the related Entry Name Selection panel or if you want to create a new OPC system detail.

```

ACTIONS  HELP
-----
AOFGEPOL          Policy Selection          Row 1 to 5 of 5
Command ==>>> _____          SCROLL==>>> PAGE

Entry Type : OPC System details      PolicyDB Name  : USER_PDB
Entry Name  : OPC_SYS_DET1          Enterprise Name : USER_ENTERPRISE

Action      Policy Name      Policy Description
-----
            DESCRIPTION      Enter description
            OPCA0 ENVIRON      Define OPCA0 environ entries
            -----
            WHERE USED          List Systems linked to this entry
            COPY                Copy data from an existing entry
***** Bottom of data *****

```

Figure 180. Policy Selection Panel for OPC System Detail

The unique policy item for OPC system details is:

OPCA0 ENVIRON

| This policy item checks the status on START and STOP requests. If you
| select this policy item, SA z/OS displays the OPC System details panel,
| which is described in more detail in "OPCA0 ENVIRON Policy Item."

OPCA0 ENVIRON Policy Item

| The OPCA0 ENVIRON policy item checks the status on START and STOP
| requests. If you select this policy item from the Policy Selection panel for OPC

System Details, SA z/OS displays the panel shown in Figure 181.

```
COMMANDS  HELP
-----
AOFPOEN          OPC System details
Command ==>>> _____

Entry Type : OPC System details   PolicyDB Name  : USER_PDB
Entry Name  : OPC_SYS_DET1        Enterprise Name : USER_ENTERPRISE

Status check on requests. . YES    (YES/NO)
Operation reset delay . . . NEVER  (hh:mm/NEVER)
Batch Interface Server. . . EVJCMDRV (PPI Receiver Name)
```

Figure 181. OPC System Details Panel

The following fields can be filled in:

Status check

This entry controls the checking of subsystem status on TWS Automation START, STOP, and RECYCLE requests. If this is not coded, TWS Automation enforces the rule that START operations are ended in error if the subsystem is already UP, and likewise for STOP operations if the subsystem is down. Code REQUEST=NO if you want to have TWS Automation proceed as normal in this case. The default value is YES.

Operation reset delay

This specifies how long the NetView interface to TWS may be unavailable before TWS Automation will not reset operations that ended in error while it was down.

The NetView interface consists of both the NetView SA z/OS TWS Automation address space and its associated NetView SSI address space, over which requests flow from TWS to TWS Automation. When the interface is down, TWS Automation sets any operations destined for a NetView workstation to an error status with an error code of UNTV. If you do not code a value, no operations are reset when the interface becomes available again.

The default value is NEVER.

Batch Interface Server

This specifies the PPI name of the server that accepts commands from batch jobs and executes them on NetView. The default value is EVJCMDRV.

For more information see *IBM Tivoli System Automation for z/OS TWS Automation Programmer's Reference and Operator's Guide*.

OPC Controller Details Entry Type

Figure 182 on page 245 shows the policy items that are displayed when you create a new OPC controller detail or when you select an existing OPC controller detail from the related Entry Name Selection panel.

Note that if multiple controllers are running on the same system they must share the same Controller Details (OCS) definitions. If more than one OCS policy object is linked to the same system, the last is used.

```

ACTIONS  HELP
-----
AOFGEPOL                Policy Selection
Command ==> _____ SCROLL==> PAGE

Entry Type : Controller details   PolicyDB Name  : USER_PDB
Entry Name  : OPC_OCS_1           Enterprise Name : USER_ENTERPRISE

Action      Policy Name      Policy Description
-----
DESCRIPTION Enter description
OPCA PCS    Define OPCA PCS entries
SPECIAL RESOURCES Select Special Resources for this controller
-----
WHERE USED  List Systems linked to this entry
COPY       Copy data from an existing entry
***** Bottom of data *****

```

Figure 182. Policy Selection Panel for OPC Controller Details

The unique policy items for OPC controller details are:

OPCA PCS

With this policy item you either specify the NetView domain that the OPC controller resides on or specify that the local sysplex is to be searched for the active controller when required. You must also specify the subsystem name for the OPC controller. For more information, see “OPCA PCS Policy Item.”

SPECIAL RESOURCES

Use this policy item to select one or more special resources as defined with the (OSR) Special Resources entry type for the current controller. These selected special resources for TWS are used on the systems that the current controller details entry is linked to. (You can view the systems that this entry is linked to, and link or unlink this entry to systems using the WHERE USED policy item).

OPCA PCS Policy Item

The panel shown in Figure 183 appears if you select the OPCA PCS policy item from the Policy Selection panel for TWS controller details.

```

COMMANDS  HELP
-----
AOFPOCS                OPC Controller details
Command ==> _____

Entry Type : Controller details   PolicyDB Name  : USER_PDB
Entry Name  : OPC_OCS_1           Enterprise Name : USER_ENTERPRISE

OPC PCS entry name: OPC_OCS_1

Enter or update the following table names:

Netview domain name. . . SYSPLEX
OPC controller subsystem X
OPC Special resources  NO (YES NO ALL)

```

Figure 183. OPC Controller Details Panel

The OPCA PCS automation definition defines the NetView domain that the TWS Controller resides on and specifies the MVS subsystem name for the TWS Controller system.

Fill in the following fields:

OPCA PCS Policy Item for OPC Controller Details

NetView domain name

Specify the parameter as either a NetView domain ID (up to five characters) or the keyword SYSPLEX. If a domain ID is specified, it indicates that the TWS Controller always runs on the specified domain. The keyword SYSPLEX indicates that the TWS Controller may be run on any one of the systems in the local sysplex.

OPC controller subsystem

The MVS subsystem name of the TWS Controller as defined in the IEFSSN:xx member.

Note:

When defining the TWS Controller to SA z/OS, this name must be used as the subsystem name and job name.

OPC Special resources

The following entries are valid:

YES The OPC special resources will be set for any SA z/OS-monitored subsystem that is specified in the OPC special resource definitions panel (see Figure 185 on page 247). Ensure that OPC Special Resources are defined if using this option.

Note:

If no OPC Special Resources were defined, and the OPC Special Resource SRSTAT=YES is defined in the OPC Controller details panel, the value is automatically reset to NO during configuration build

NO No Special Resources will be set. This is the default.

ALL Special Resources will be set for all SA z/OS Monitored subsystems. No Special Resource entries are required.

OPC Special Resources Entry Type

Figure 184 shows the policy items that are displayed when you select an OPC special resource from the related Entry Name Selection panel.

```

ACTIONS  HELP
-----
AOFGEPOL                               Policy Selection
Command ===> _____ SCROLL===> PAGE

Entry Type : Special resources          PolicyDB Name  : USER_PDB
Entry Name  : OPC_RES1                  Enterprise Name : USER_ENTERPRISE

Action      Policy Name      Policy Description
-----
            DESCRIPTION    Enter description
            SPECIAL RESOURCE Define OPC special resources
-----
            WHERE USED      List Controllers linked to this entry
            COPY            Copy data from an existing entry
***** Bottom of data *****
```

Figure 184. Policy Selection Panel for OPC Special Resources

The unique policy item for an OPC special resource is:

SPECIAL RESOURCE

With this policy item you can specify resources as special resources for

OPC Special Resources Entry Type

TWS. SA z/OS will display the OPC special resource definitions panel. For a detailed description of this panel, see “SPECIAL RESOURCE Policy Item.”

SPECIAL RESOURCE Policy Item

With this policy item SA z/OS is able to globally control the creation and setting of OPC Special resources based on the status of SA z/OS monitored subsystems. This allows TWS to resolve job scheduling dependencies based on the status of SA z/OS automated resources. A group or groups of special resources can be linked to a controller definition defined with option 31 (see “Defining Automation for TWS Components” on page 241).

```
COMMANDS  HELP
-----
AOFPOSD          OPC special resource definitions      Row 1 to 12 of 20
Command ==> _____ SCROLL==> PAGE

Entry Type : Special resources      PolicyDB Name  : USER_PDB
Entry Name  : OPC_RES1              Enterprise Name : USER_ENTERPRISE

Enter the Special Resource names or wild cards that are to be used.

DB2/APG/*
ASCH/APL/S*
CICS/APG/SYSTEM2
APPL1/APL/SYSTEM1
_____
_____
_____
_____
_____
_____
_____
_____
_____
_____
```

Figure 185. OPC Special Resource Definitions Panel

Fill in your special resource names with up to 24 characters. You can enter wildcard characters and patterns.

OPC Workstation Domains Entry Type

Figure 186 shows the policy items that are displayed when you select an OPC workstation domain from the related Entry Name Selection panel.

```
ACTIONS  HELP
-----
AOFGEPOL          Policy Selection
Command ==> _____ SCROLL==> PAGE

Entry Type : Workstation domainID  PolicyDB Name  : USER_PDB
Entry Name  : OPC_WST_DOM1         Enterprise Name : USER_ENTERPRISE

Action      Policy Name      Policy Description
-----
DESCRIPTION DESCRIPTION    Enter description
-----
OPCA DOMAINID OPCA DOMAINID   Define the OPCA Domainid entries
-----
WHERE USED    WHERE USED      List Systems linked to this entry
-----
COPY          COPY            Copy data from an existing entry
***** Bottom of data *****
```

Figure 186. Policy Selection Panel for OPC Workstation Domain

The unique policy item for an OPC workstation domain is:

OPC Workstation Domains Entry Type

OPCA DOMAINID

If you select this policy item, it leads to the Code Processing panel where you specify how SA z/OS should react if TWS issues the specified message.

For a detailed description of this panel and how to define code processing policy with it, see “Code Processing for OPC Workstation Domains.”

For more information you should also see OPCA DOMAINID in *IBM Tivoli System Automation for z/OS TWS Automation Programmer’s Reference and Operator’s Guide*.

Code Processing for OPC Workstation Domains

You can use this policy item to define the system or sysplex that SA z/OS routes the request that is associated with the message to (see Figure 187).

Use the entry in the **Code 1** field, NVxx, to specify a NetView automatic general workstation with a NetView domain index of xx. This is resolved in the Controller NetView into the target NetView system through the definitions in the **Value Returned** field. These can be:

- The NetView domain ID
- The name of a remote sysplex. SA z/OS determines one of the systems in the remote sysplex that has a Gateway connection with the local system. This system is then used to route the command to.

Note:

A sysplex name should only be used for commands that operate sysplex-wide.

- SYSPLEX. All SA z/OS systems in the local sysplex are queried for the status of the application that is associated with the job name of the request.
- *LOCAL. The request is processed on the same system that the TWS controller runs on.

```

COMMANDS  HELP
-----
AOFGDYN9  Code Processing : DOMAINID                Line 00000001 Col 001 075
Command ===>                                     Scroll ===> PAGE

Cmd Code 1      Code 2      Code 3      Value Returned
---- NV01      -----      -----      -----
-----      -----      -----      -----
-----      -----      -----      -----
-----      -----      -----      -----
-----      -----      -----      -----
-----      -----      -----      -----
-----      -----      -----      -----
-----      -----      -----      -----
-----      -----      -----      -----
***** Bottom of data *****

```

Figure 187. Code Processing Panel for TWS Workstation Domain IDs

You can use the FIND command on the Code Processing panel to search the displayed data for a specific string. For more details, see “How to Find Data in a Policy Item” on page 23.

You can use line commands to manipulate the entries. You can also use operators in your code definitions to make comparisons with the values that are provided by the automation procedure. For more details see the online help.

CICS Link Definitions Policy Object

Figure 188 shows the policy items that are displayed when you create or modify a link definition for CICS from the related Entry Name Selection panel.

Note:

The CICS Entry Type can only be used to maintain systems that are running an earlier version of SA z/OS (3.1 and 3.2).

ACTIONS		HELP

AOFGEPOL	Policy Selection	CICS link created
Command ==> _____		
Entry Type : CICS link	PolicyDB Name : USER_PDB	
Entry Name : LINK_DEF1	Enterprise Name : USER_ENTERPRISE	
Action	Policy Name	Policy Description
_____	DESCRIPTION	Enter description
_____	CICS CONNECTION	CICS Link monitoring definitions
_____	MONITORING PERIOD	Select Link monitoring period for connection

_____	WHERE USED	List APLs using this entry
_____	COPY	Copy from existing entry
***** Bottom of data *****		

Figure 188. Policy Selection Panel for CICS Link Definitions

The unique policy items for CICS link definitions are:

CICS CONNECTION

This policy item lets you describe the interregion and intersystem communication (IRC and ISC) links so that they can be monitored by SA z/OS CICS Automation. For more information on how to do this, see “CICS CONNECTION Policy Item.” See also the section CONNECTION in *IBM Tivoli System Automation for z/OS Product Automation Programmer’s Reference and Operator’s Guide*.

MONITORING PERIOD

With this policy item you can select one monitoring period which has previously been defined with option (CVP) *Link Monitor periods* for the current CICS link definition (CICS connection).

For more information on link definitions, see *IBM Tivoli System Automation for z/OS Product Automation Programmer’s Reference and Operator’s Guide*.

CICS CONNECTION Policy Item

If you select policy item CICS CONNECTION from the Policy Selection panel for CICS links, SA z/OS displays the following panel where you describe the inter-region and inter-system communication (IRC and ISC) links to be monitored by SA z/OS CICS Automation.

Code Processing for OPC Workstation Domains

```

COMMANDS  HELP
-----
AOFPCCN          CICS connection links
Command ==> _____

Entry Type : CICS link          PolicyDB Name  : USER_PDB
Entry Name  : LINK_DEF1        Enterprise Name : USER_ENTERPRISE

-----

Enter or update the following fields:

Connection id . . . . . _____ CICS sysid
Type . . . . . _____ (IMS/CICS)
Echo . . . . . _____ (txn/pgm,seconds)
Time zone offset . . . . . 0 (hh:mm,WEST/EAST)
Check interval . . . . . 05:00 (mm:ss)
Max repair tries . . . . . 3 (0-9)
Release delay . . . . . 05 (4-99)
Acquire delay . . . . . 05 (4-99)
Critical link (SDF) . . . NO YES NO
-----

```

Figure 189. CICS Connection® Links Panel

Fill in the following fields:

Connection id

The 4 character symbolic name by which this link is known to this CICS subsystem. This is defined on the CICS subsystem itself (SYSID).

Type Indicates the type of subsystem this link is attached to, valid values are "CICS" or "IMS", this is used only when you want echoplexing to occur.

Echo depends on the entry in the *Type* field:

CICS The transaction name used to call the echoplex program on the target subsystem.

IMS Any non-blank character.

The time parameter is used to define the time delay in seconds after which an echo response must have been received from the remote system before a message is issued. Valid values are from 1 to 99, default 3.

Time zone offset

This parameter specifies the remote systems time offset relative to the UTC (Greenwich mean time). This is applied to the times specified in the DAY keyword to determine when monitoring is active for the remote system. Default value is 0.

Check interval

The time interval between 2 consecutive checks of a connection. Valid values are from 00:05 to 99:59, the default value is 05:00.

Max repair tries

Specifies the number of automatic actions that are to take place after the detection of a connection failure. Valid values are 0 to 9, default value is 3.

Release delay

Specifies the time delay in seconds needed by the system to release a connection. Valid values are 4 to 99, default value is 5.

Acquire delay

Specifies the time delay in seconds needed by the system to acquire a connection. Valid values are 4 to 99, default value is 5.

Critical link

Specifies whether a link failure for this link will change the severity shown on the SDF panels, default value is NO.

CICS Link Monitor Periods Policy Object

Figure 190 shows the policy items that are displayed when you select a monitoring period CICS from the related Entry Name Selection panel or if you are creating a new monitoring period.

Note:

The CICS Entry Type can only be used to maintain systems that are running an earlier version of SA z/OS (3.1 and 3.2).

```

ACTIONS  HELP
-----
AOFGEPOL          Policy Selection          Row 1 to 5 of 5
Command ==> _____ SCROLL==> PAGE

Entry Type : Monitoring period      PolicyDB Name : USER_PDB
Entry Name : MON_PERIOD_1          Enterprise Name : USER_ENTERPRISE

Action      Policy Name      Policy Description
-----
            DESCRIPTION   Enter description
            MONITORING PERIOD Define the monitoring period
            -----
            WHERE USED     List APLs using this entry
            COPY           Copy from existing entry
***** Bottom of data *****

```

Figure 190. Policy Selection Panel for CICS Link Monitor Periods

The unique policy item for a CICS monitoring period is:

MONITORING PERIOD

With this policy item you can specify time periods when the current CICS connection should be monitored. You specify these time periods as described in “MONITORING PERIOD Policy Item.”

MONITORING PERIOD Policy Item

If you select policy item MONITORING PERIOD from the Policy Selection panel for CICS monitoring periods, SA z/OS displays the following panel where you define the time frames for when the CICS connection link related to the (CCN) Link definition should be active.

Code Processing for OPC Workstation Domains

```
COMMANDS  HELP
-----
A0FGAPCP          Link monitoring service period
Command ==> _____

Entry Type : Monitoring period      PolicyDB Name  : USER_PDB
Entry Name  : MON_PERIOD_1          Enterprise Name: USER_ENTERPRISE

Note: Review help panel for complete description of data entry fields.
      Valid start and stop times are 00:00-23:59, *****, and DOWN.

      From To      From To      From To      From To      From To
Monday  _____  _____  _____  _____  _____
Tuesday _____  _____  _____  _____  _____
Wednesday _____  _____  _____  _____  _____
Thursday _____  _____  _____  _____  _____
Friday   _____  _____  _____  _____  _____
Saturday _____  _____  _____  _____  _____
Sunday   _____  _____  _____  _____  _____
Weekday  08:00 17:00  _____  _____  _____  _____
Weekend  09:00 14:00  _____  _____  _____  _____
Daily    _____  _____  _____  _____  _____
```

Figure 191. Link Monitoring Service Period Panel

For information about valid values and the syntax of the time frames, see the online help.

Messages Entry Type

The Messages entry type displays a list of all the messages that are defined in the policy database together with the messages from the special MVC entry, +SA_PREDEFINED_MSGS, which contains predefined messages that are used for the NetView automation table (AT) and message revision table (MRT) build. For more details about the Message Definitions panel, see "MESSAGE AUTOMATION Policy Item."

MESSAGE AUTOMATION Policy Item

If you select the MESSAGE AUTOMATION policy item from the Policy Selection panel for messages, a panel similar to Figure 192 on page 253 is shown.

MESSAGE AUTOMATION Policy Item for Messages

COMMANDS	ACTIONS	HELP		

AOFGMSLT	Message Definitions	Row 100 to 112 of 598		
Command ==>		SCROLL==> PAGE		

PolicyDB Name : USER_PDB	Enterprise Name : USER_ENTERPRISE			
Make a selection (S) or use shortcuts (WHU AC AS AO IG MS MO).				
Cmd	Message id	Description	AT	MRT
	BPXF024I	USS Automation status messages		O
---	BPXI004I	OMVS initialization complete		A
---	BPXI032E	FORK SERVICE has been shut down		A
---	BPXI055I	OMVS is stopping		A
---	BPXI056E	OMVS is down		A
---	BPXI058I	OMVS is restarted		A
---	BPXI059I	OMVS restart request rejected		A
---	BPXM041I	FORK SERVICE already started		A
---	BPXM042I	FORK SERVICE restarted		A
---	BREAKING	Subsystem status	I	I
---	BROKEN	Subsystem status	I	I
---	CAPMSGs	Message capturing - severity declaration	I	I

Figure 192. Message Definitions Panel

This policy shows a list of all the messages that are defined in the policy database together with the messages from the special MVC entry, +SA_PREDEFINED_MSGS, which contains predefined messages that are used for the NetView automation table (AT) and message revision table (MRT) build.

The messages are sorted alphabetically and shown together with their short description and status data. The AT and MRT status columns show whether there are specifications for the Netview automation table and message revision table build:

- I** Ignore or Suppress is specified for this message.
- C** An AT condition is specified for this message.
- A** A definition for this message causes a specific AT or MRT action. For the AT this is a status selection, for the MRT this is a selection resulting in a REVISE statement.
- O** An AT or MRT override is specified for this message.
- *** The message has user AT data and predefined AT data, and the specifications are not checked in detail to find out which AT data combination would be used for AT build.

This panel allows you to select one entry from the list displayed or manage its message definitions with the following command codes:

WHU Shows a list of the Applications, MVS Components, and Monitors where the current message is defined.

If you enter the WHU command for a message ID, this displays the Entries linked to Message panel. It shows you all the entries of type APL, MTR, and MVC where the message has been defined, as shown in Figure 193 on page 254, and helps you to ensure that message IDs are linked to the correct entries.

MESSAGE AUTOMATION Policy Item for Messages

```

COMMANDS  HELP
-----
AOFGMSL1          Entries linked to Message          Row 1 to 7 of 7
Command ==> _____ SCROLL==> PAGE

Message id : CAPMSG5

Entry name          Short Description          Type
+SA_PREDEFINED_MSGS  Messages predefined by SA for AT build  MVC
C_CICS              Class for CICS                  APL
C_DB2_MSTR          DB2 Class - DB2 Master          APL
C_IMS_CONTROL       Class for IMS Control regions    APL
C_IMS_SUBORDINATES  Class for IMS Subordinate Regions  APL
E2E_ADPT           E2E Automation Adapter          APL
IMSCQS             IMS Common Queue Server          APL
***** Bottom of data *****

```

Figure 193. Entries linked to Message Panel

- AC** Allows you to define the AT entry conditions for the message.
- AS** Allows you to define the status specifications for the message action.
- AO** Allows you to specify your own AT entry.
- IG** Allows you to manage the options to ignore or suppress the message.
- MS** Allows you to define the specifications that are used to generate the NetView message revision table.
- MO** Allows you to define your own MRT entry.

You can use the LOCATE (L) command to locate an entry in the list.

If you select an entry, this leads to the Message Automation Overview panel for that entry, as shown in Figure 194.

```

COMMANDS  HELP
-----
AOFGMADV          Message Automation Overview          Scroll ==> PAGE
Command ==> _____

AC AT condition    MS MRT action selection    IG Ignore / Suppress via MPF
AS AT status       MO MRT override
AO AT override

Message ID : HASP050

Generated AT entry :
IF MSGID = . 'HASP050' & TEXT = .'TGS'. THEN
EXEC(CMD('AOFRSD01')ROUTE(ONE %AOFOPJESOPER%));

No MRT entry will be generated because there are no specifications for this
message

```

Figure 194. Message Automation Overview Panel

The scrollable **AT/MRT preview** area shows the AT and MRT entries that would be generated based on the current specifications. If, for example, you modify the AT conditions on a subsequent panel and return, the AT preview is updated to reflect the new specifications.

If a generated AT entry is based on an SA z/OS definition (that is, it is defined in the MVC entry +SA_PREDEFINED_MSGS), it is shown in the color that has been selected for class data.

MESSAGE AUTOMATION Policy Item for Messages

Note that if a message is only predefined by SA z/OS (that is, it is only provided in MVC entry +SA_PREDEFINED_MSGS), but not specified for any application or MVS component in the policy database, you cannot modify it.

For more details about message automation definitions, see “Message Automation Definitions” on page 171.

For more details about the NetView automation table and message revision table see *IBM Tivoli NetView for z/OS Automation Guide*

MPF DEFINITIONS Policy Item

If you select policy item MPF DEFINITIONS from the Policy Selection panel for messages, a panel similar to Figure 195 is shown.

```
COMMANDS  HELP
-----
A0FGMPF      MPF Header and Trailer Definition
Command ==> _____

Entry Type : Enterprise      PolicyDB Name  : USER_PDB
Entry Name  : USER_ENTERPRISE Enterprise Name : USER_ENTERPRISE

MPF Header Lines
/* the default is suppress and automate
.DEFAULT,SUP(YES),RETAIN(I,CE),AUTO(YES)
____
____
____

MPF Trailer Lines
.NO_ENTRY,SUP(NO),RETAIN(I,CE),AUTO(YES)
____
____
____
```

Figure 195. MPF Header and Trailer Definition Panel

This panel allows you to enter or update definitions that will be included in the MPFLSTSA member during message processing facility (MPF) build.

The message processing facility (MPF) is a z/OS table that screens all messages that are sent to the z/OS console. The MPF compares these messages with a user-defined list of messages on which to automate, suppress from the z/OS console display, or both, and marks messages to automate or suppress.

MPF Header Lines

Specify up to 5 MPF statements that will be included at the top of the MPFLSTSA member, for example:

```
.NO_ENTRY,SUP(NO),RETAIN(I,CE),AUTO(YES)
```

or

```
.DEFAULT,SUP(YES),RETAIN(I,CE),AUTO(YES)
```

You can specify comment lines by including `/*` as the first 2 characters.

MPF Trailer Lines

Specify up to 3 MPF statements that will be included at the bottom of the MPFLSTSA member.

Note:

Changes in MPF header and trailer lines are taken into account during the *next* build of NetView automation tables when the MPF member is also rebuilt.

Timers Entry Type

The Timers entry type allows you to define sets of timers that run commands or automation procedures at scheduled times.

Figure 196 shows the policy items that are displayed when a new Timers entry is defined or when an existing Timers entry is selected from the Entry Name Selection panel.

```

ACTIONS  HELP
-----
A0FGEPOL          Policy Selection
Command ==> _____ SCROLL==> PAGE

Entry Type : Timers          PolicyDB Name  : USER_PDB
Entry Name  : TIMER_NAME     Enterprise Name : USER_ENTERPRISE

Action      Policy Name      Policy Description
-----
            DESCRIPTION     Enter description
            TIMERS          Define timers for automation
            -----
            WHERE USED      List Systems linked to this entry
            COPY            Copy data from an existing entry

```

Figure 196. Policy Selection Panel for Timers

The unique policy item for Timers is:

TIMERS

You define a timer in the Timer specification panel. For more details see "TIMERS Policy Item."

TIMERS Policy Item

SA z/OS displays the following panel if you select the TIMERS policy item from the Policy Selection panel for Timers.

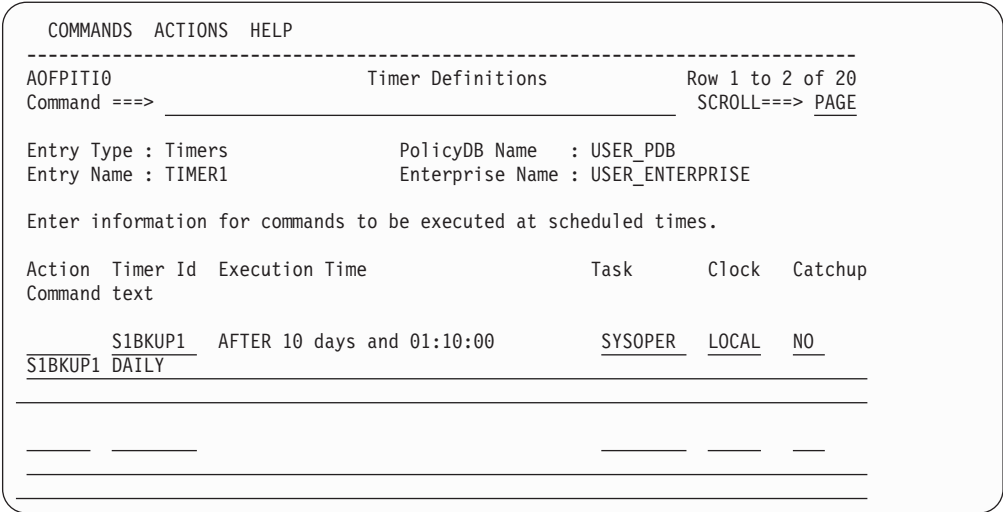

Figure 197. Timer Definitions Panel

You should note that, at run time, the commands that you define here are converted to the NetView CHRON format.

A timer definition consists of:

Timer ID

When a user timer is defined with the SAVE-option outside the control of SA z/OS, it is recommended that a unique timer ID is specified to avoid duplicate timers being created at automation control file (ACF) reload.

Note: The uniqueness of the timer ID applies to the system that uses this entry and all other timer entries that are used by the same system.

Task

Specify the automated function or NetView task name where the command should run. You may also specify a NetView operator group by using a plus sign (+) as the first character (for example, +OPERGRP). To run under the primary programmed task (PPT) specify PPT.

Note: Not all commands can run under the PPT.

Clock

Specifies whether the command is to run on a Greenwich Mean Time schedule or the local system time. You can enter either GMT or LOCAL.

Catchup

Specify whether a saved timer should be caught up (that is, it should still be run) after a system outage.

Note: This parameter will not work for every timer.

Command text

The actual timer-driven command or automation procedure that SA z/OS issues or calls.

TIMERS Policy Item for Timers

The **Execution Time** field cannot be filled in from this panel, but it shows the time at which the timer has been scheduled. This is the result of completing the Timer Definition panel (selected with an S in the **Action** column).

Use the S command code to define when the timer executes. This leads to the second Timer Definitions panel, as shown in Figure 198.

```
COMMANDS  HELP
-----
AOFPTI11                                Timer Definitions
Command ==> _____

Entry Type : Timers                      PolicyDB Name  : USER_PDB
Entry Name : TIMER1                      Enterprise Name : USER_ENTERPRISE
Timer Id   : S1BKUP1

Specify one timer definition and optional CHRON parameters.
Time, elapsed time and interval time may be hh:mm:ss, hh:mm or mm.

Number of Days . . After 10 days (1-365)   and 01:10:00 (elapsed time).
                  . . Every ___ days (1-365) and _____ (elapsed time).
Day of Week. . . . On ___ (Mon-Sun)       at _____ (time).
                  . . . Every ___ (Mon-Sun) at _____ (time).
                  . . . Every Weekday      at _____ (time).
                  . . . Every Weekend      at _____ (time).
                  . . . Every Day          at _____ (time).
Date . . . . . On _____ (mm/dd/yy) at _____ (time).
Time Only. . . . . At _____ (time).
                  . . . . . After _____ (elapsed time).
                  . . . . . Every _____ (elapsed time)
                  . . . . . from _____ to _____ (time).

CHRON parameter. . RECOVERY=AUTOLOGN
_____
_____
```

Figure 198. Timer Definitions Panel 2

You can use only *one* of the available options to define a timer, and additionally any valid NetView CHRON timer parameters. Note that entering the colons is optional for all the time fields (that is, you can enter, for example, 011000, which is then converted to 01:10:00).

The time and elapsed time can be entered as:

1. Hours, minutes and seconds
2. Hours and minutes
3. Minutes only (hours then defaults to 00)

Valid values are 00-23 (hours) and 00-59 (minutes and seconds). Specifying 24:00:00 is also valid for elapsed time.

Additionally, you can specify Xs for the time to indicate that the command should run at the next increment of time, for example, XX:00:00. This causes the command to run at the beginning of the next hour.

You can define timers in the various sections of the panel, based on the time interval, as follows:

Time interval	When the timer should expire
Number of Days , based on the elapsed time.	<p>After After a certain number of days and specified time interval.</p> <p>Every Periodically, after a specified number of days and specified time interval.</p>
Day of Week , based on the day of the week.	<p>On Only once at a certain time within the next seven days.</p> <p>Every Once a week at a certain time.</p> <p>Every Weekday At the same time every weekday (Monday through Friday).</p> <p>Every Weekend At the same time every weekend (Saturday or Sunday).</p> <p>Every Day At the same time every day.</p>
Date , if the timer is to expire on a particular day.	<p>On On a particular day. Note: Only future dates are allowed. If the year is 20 or less it is assumed to be 20xx.</p>
Time Only , based on a specified time.	<p>At At a certain time within the next 24 hours.</p> <p>After A certain period of time after the timer has been set.</p> <p>Every At regular intervals. Optionally you may specify a time frame (using the from and end fields) where the timer expires at the regular interval.</p>

The CHRON parameter can be any combination of NetView CHRON timer parameters, such as RECOVERY, NOTIFY, etc. However, the following parameters must *not* be specified because they are automatically created from the definitions that you make on this panel and the preceding panel:

AT	COMMAND	GMT/LOCAL	ROUTE
AFTER	EVERY	ID	SAVE/NOSAVE

For more details about the NetView CHRON commands that SA z/OS generates during initialization from see the online help.

Timeout Settings Entry Type

This entry type enables you to create sets of timeout definitions. Each timeout definition can specify timeout values for:

- System, NetView, or SA z/OS commands
- Cross-domain logon requests
- Your own timeout variables

If the time limit is exceeded, it is assumed that an error condition exists and an appropriate action is taken.

Timeout Settings Entry Type

Although only two specific fields, Wait and XDOM, are given, you can add other timeout names that may be unique to your environment. Figure 199 shows the policy items that are displayed when a new Timeout Setting entry is defined or when an existing Timeout Setting entry is selected from the Entry Name Selection panel.

```

ACTIONS  HELP
-----
AOFGEPOL                                Policy Selection
Command ==> _____ SCROLL==> PAGE

Entry Type : Timeout Settings           PolicyDB Name : USER_PDB
Entry Name : TIMEOUT_NAME              Enterprise Name : USER_ENTERPRISE

Action   Policy Name      Policy Description
-----   -
        DESCRIPTION    Enter description
        TIMEOUT VALUES Define timeout values
-----   -
        WHERE USED      List Systems linked to this entry
        COPY            Copy data from an existing entry
-----
```

Figure 199. Policy Selection Panel for Timeout Settings

The unique policy item for Timeout Settings is:

TIMEOUT VALUES

SA z/OS defines two timeout variables, XDOMTIME and WAITTIME. Values for these variables can be set in the Wait and XDOM Value fields of the Environment Definition: TIMEOUT panel. See “TIMEOUT VALUES Policy Item.”

TIMEOUT VALUES Policy Item

Figure 200 shows the definition panel for a Timeout Settings.

```

COMMANDS  HELP
-----
AOFPIET0                                TIMEOUT Definitions
Command ==> _____

Entry Type : Timeout Settings           PolicyDB Name : USER_PDB
Entry Name : TIMEOUT_NAME              Enterprise Name : USER_ENTERPRISE

Enter SA z/OS defined timeout values.

Name      Value      Description
Wait      29          Wait commands in seconds
XDOM      120         Cross domain commands in seconds

Enter installation supplied timeout names and values.

Name      Value      Description
CEMT      29          _____
_____  _____  _____
_____  _____  _____
_____  _____  _____
```

Figure 200. Environment Definition: TIMEOUT Panel

The following timeout values can be entered:

Wait Defines how long automation processing waits for a response after issuing a system, NetView, or SA z/OS system operations command. The wait parameter is used in the automation code to determine when a response error condition has occurred. Depending on which part of the code was

TIMEOUT VALUES Policy Item for Timeout Settings

being used at the time of the error and how critical the command is, an action is taken. The default time is 29 seconds. The range of values is 1 to 32000 seconds.

It is recommended that you choose a value less than 30 seconds to avoid the NetView message DSI594A being displayed in SA z/OS full screen function. The field, wait, creates the global variable WAITTIME.

XDOM

Defines the maximum amount of time that message forwarding routines wait for a response from a cross-domain logon command. If this value is exceeded, the routines assume that the logon attempt failed. The default time is 120 seconds. The range of values is 1 to 32000 seconds. XDOM creates the global variable XDOMTIME.

Installation supplied timeout names and values

This section is used to define your own timeout values. Common global variables are created containing these values, and these variables can be used in your own automation procedures. The value of these variables must be in the range of 1 to 32000 seconds.

Note:

You must ensure that the names of any global variables you create do not clash with SA z/OS external or internal global variable names. SA z/OS external global variables are documented in *IBM Tivoli System Automation for z/OS Customizing and Programming*. In addition, you should not use names beginning with AOF, EHK, EVE, EVI, EVJ, ING, ISQ, or SUBS.

For example, you can define the name TEST with a value of 30. This creates a global variable called TESTTIME containing the value 30. The variable TESTTIME can now be used in any automation procedure. You can enter an optional description of the timeout variable for reference.

Note:

The TESTTIME variable is initialized after SA z/OS has initialized its own environment from the automation control file. This means you must not use a variable such as TESTTIME in a routine that is invoked before SA z/OS is fully initialized.

Tape Attendance Entry Type

This entry type allows you to specify whether you want to monitor tape mounts on this system. If you do want to monitor tape mounts, you must enter warning and alert thresholds (in minutes and seconds) indicating how long a wait is allowed in mounting a tape before the response is considered unsatisfactory.

You can customize SA z/OS to respond to the IEF238D message while tape drives are attended by operators. This can be achieved by specifying an entry with code definitions for the IEF238D message in the MESSAGES/USER DATA policy item of the MVS Component entry type.

Tape Attendance Entry Type

The codes that are passed when checking for a code match with this entry are one of the following, depending on which of these terms is included in the IEF238D message:

- The job name as the first parameter, and either DEVICE or WAIT as the second parameter
- The job name as the first parameter, and DEVICE and WAIT as the second and third parameters

Therefore the coded entries should be entered as follows:

CODE1

This should contain a pattern match for the job name that needs the response to the IEF238D message.

CODE2

This should contain DEVICE or WAIT or an asterisk (*) to allow for both terms.

CODE3

This should contain WAIT (if CODE2=DEVICE), an asterisk (*), or can be left blank.

Value Returned

This should contain a selection name that has a reply defined for the IEF238D message, depending on the results of the code matching process.

SA z/OS provides a NetView automation table entry that extracts the values from the message that are to be checked for a code match and passes them as CODEX parameters to the ISSUEACT generic routine. ISSUEACT searches for a matching code definition and issues a reply, depending on the Value Returned of the matching code definition. For further information about message automation see the chapter "How to Add a Message to Automation" in *IBM Tivoli System Automation for z/OS Customizing and Programming*. For more details on the format of the IEF238D message, see the system message documentation for your particular operating system level and release.

This entry type also allows you to set a schedule for unattended tape drives. If a job requests a tape mount at a time defined as unattended, the job will be canceled. Figure 201 shows the policy items that are displayed when a new Tape Attendance entry is defined or when an existing Tape Attendance entry is selected from the Entry Name Selection panel.

ACTIONS		HELP

A0FGEPOL		Policy Selection
Command ==>		SCROLL==> PAGE
Entry Type :	Tape Attendance	PolicyDB Name : USER_PDB
Entry Name :	TAPE_ATTEND_NAME	Enterprise Name : USER_ENTERPRISE
Action	Policy Name	Policy Description
_____	DESCRIPTION	Enter description
_____	ATTEND TIME	Define tape drive attend time

_____	WHERE USED	List Systems linked to this entry
_____	COPY	Copy data from an existing entry

Figure 201. Policy Selection Panel for Tape Attendance

The unique policy item for Tape Attendance is:

ATTEND TIME Policy Item for Tape Attendance

Note:

The operator can specify whether the NMC workstation view that contains the tape mount icons is automatically refreshed. It is advisable to set this to refresh automatically so that tape mounts can be monitored without manual intervention.

The name of the tape mount object is of the form:

SSSS.VVVVVV_DDD(D)

Where:

SSSS Is the NetView domain name where the mount request was issued. This may be a remote system.

VVVVVV Is the tape volume name

DDD(D) Is the device number that the tape should be mounted on. This device number is either 3 or 4 digits depending on the level of z/OS.

Warning Delay

The delay period, in minutes and seconds, after which the tape mount icon changes to the warning color of white if the tape mount has not been completed.

Alert Delay

The delay period, in minutes and seconds, between the time that the warning delay is reached and the time that the tape mount icon changes to the alert color of red, if the tape mount has not been completed.

If tapes are attended, enter days and times (24 hour clock) when unattended.

These fields are used to enter days and times when tape drives are unattended. A "*" character can be used in the Day field to specify all days of the week.

MVS Component Entry Type

This entry type allows you to apply automation to various z/OS data sets, resources and facilities, which are referred to as MVS components.

You can set error thresholds and automation flags for the following MVS components:

- MVSDUMP (SYS1.DUMP00-xx)
- SMFDUMP (SYS1.MANx)
- LOGREC (SYS1.LOGREC)
- SYSLOG (SYS1.SYSLOG.INDX)

In addition, you can customize the recovery procedure that is used for a WTOBUF overflow and automate responses to messages that are issued for MVS components.

Figure 203 on page 265 is displayed when you select MVS Component from the Entry Type Selection menu.

```

COMMANDS  ACTIONS  VIEW  HELP
-----
AOFGENAM          Entry Name Selection          Row 1 to 2 of 2
Command ==>>>          SCROLL==>> PAGE

Entry Type : MVS Component          PolicyDB Name : USER_PDB
                                   Enterprise Name : USER_ENTERPRISE

Action      Entry Name          C Short Description
+SA_PREDEFINED_MSGS      Messages predefined by SA for AT build
MVS_COMPONENTS          MVS Components used in all systems
***** Bottom of data *****

F1=HELP      F2=SPLIT      F3=END      F4=RETURN      F5=RFIND      F6=RCHANGE
F7=UP        F8=DOWN       F9=SWAP     F10=LEFT      F11=RIGHT     F12=RETRIEVE

```

Figure 203. Panel for MVS Component Selection

The Policy Items for the MVS Component Entry Type are:

+SA_PREDEFINED_MSGS

View predefined messages by SA for AT build.

MVS_COMPONENTS

Define MVS components used in all systems.

Policy Items for +SA_PREDEFINED_MSGS

Figure 204 displays the policy items for +SA_PREDEFINED_MESSAGES, available from the MVS Component Entry Type screen.

```

ACTIONS  HELP
-----
AOFGEPOL          Policy Selection          Row 1 to 4 of 4
Command ==>>>          SCROLL==>> PAGE

Entry Type : MVS Component          PolicyDB Name : USER_PDB
Entry Name : +SA_PREDEFINED_MSGS    Enterprise Name : USER_ENTERPRISE

Action      Policy Name          Policy Description
DESCRIPTION      Enter description
MESSAGES/USER DATA      Define MVS messages and user data
-----
WHERE USED          List systems linked to this entry
***** Bottom of data *****

F1=HELP      F2=SPLIT      F3=END      F4=RETURN      F5=RFIND      F6=RCHANGE
F7=UP        F8=DOWN       F9=SWAP     F10=LEFT      F11=RIGHT     F12=RETRIEVE

```

Figure 204. Panel for +SA_PREDEFINED_MSGS Policy Options

The +SA_PREDEFINED_MSGS MVS Component entry has the following policy items:

SA_PREDEFINED_MSGS Policy Item for MVS Components

DESCRIPTION

The non-editable description that explains that the entry contains predefined messages for SA z/OS.

MESSAGES/USER DATA

This displays all the predefined SA z/OS messages. You cannot edit the entries in this policy item. See Figure 205.

WHERE USED

This allows you to link the entry to systems, as for other MVC entries.

Figure 205 displays the predefined system automation messages. The information may only be viewed. For full details on how to review or modify these message descriptions, refer to "The +SA_PREDEFINED_MSGS MVS Component Entry" on page 336.

```
COMMANDS  HELP
-----
AOFGDYNM          Message Processing          Line 00000001 Col 001 075
Command ==>>>                               Scroll ==>> PAGE

Entry Type : MVS Component          PolicyDB Name : USER_PDB
Entry Name : +SA_PREDEFINED_MSGS    Enterprise Name : USER_ENTERPRISE

Line Commands: S (Cmd), C (Cmd), R (Rep), K (Cod), U (Usr), A (AT), M (MRT)
               I, D (insert or delete lines)
Message ID field length. . 14      (1 - 32)

Cmd Message id   Description                               Cmd Rep Cod Usr A M
ABCODEPROG      IMS program abend codes                               P P
ABCODETRAN      IMS/CICS transaction abend codes           P P
ABENDING        Subsystem status                             P P
ACORESTART      Commands to be issued at SA z/OS restart   P P
ACTIVE          Subsystem status                             P P
AMRFCLEAR       AMRF recovery                                P
                                                         P
Warning: The data is predefined by SA and can only be viewed. To modify,
define the message for your own APL, MVC or MTR.
                                                         P
F7=UP           F8=DOWN          F9=SWAP          F10=LEFT        F11=RIGHT       F12=RETRIEVE
```

Figure 205. Panel for SA_PREDEFINED_MSGS Processing

Policy Items for MVS Component

Figure 206 on page 267 shows the policy items that are displayed when a new MVS Component entry is selected or when an existing MVS Component entry is selected from the Entry Name Selection panel.

SA_PREDEFINED_MSGS Policy Item for MVS Components

```

ACTIONS  HELP
-----
AOFGEPOL                                Policy Selection                                Entry created
Command ==> _____                    SCROLL==> PAGE

Entry Type : MVS Component                PolicyDB Name   : USER_PDB
Entry Name  : MVS_COMPONENTS              Enterprise Name : USER_ENTERPRISE

Action      Policy Name                    Policy Description
-----
PREDEFINED MESSAGES Select SA predefined messages for AT build
MESSAGES/USER DATA Define MVS messages and user data
MINOR RESOURCES   Define MVSESA minor flags and thresholds
-----
WHERE USED        List systems linked to this entry
COPY              Copy data from an existing entry
***** Bottom of data *****

```

Figure 206. Policy Selection Panel for MVS Components

The unique policy items for MVS Component entry types are:

PREDEFINED MESSAGES

This policy item allows you to specify a display level for the MESSAGES/USER DATA policy and offers a component selection for the messages in the MVS component +SA_PREDEFINED_MSGS. For more information see “PREDEFINED MESSAGES Policy Item.”

MESSAGES/USER DATA

This policy item allows you to specify automated actions, such as the issuing of a command or reply, to be taken in response to a message issued by the application. You may specify commands if the application issues messages because something went wrong with the MVSDUMP, SMFDUMP, SYSLOG or LOGREC data sets. For more information see “MESSAGES/USER DATA Policy Item” on page 269.

MINOR RESOURCES

This policy item allows you to define flags and thresholds for minor resources for the system. Minor resources are any resources, such as messages or statuses, that are specified to be subsidiary to the major resource MVSESA.

Minor resources take, by default, the automation settings of their major resources. The main purposes in defining minor resources are to:

- Enable automation for minor resources
- Override the automation settings of major resources for a single minor resource, or a group of minor resources

For information on this policy item see “MINOR RESOURCES Policy Item” on page 269. See also sections “Automation Flags and Minor Resource Flags” and “Thresholds for Minor Resources” in *IBM Tivoli System Automation for z/OS User’s Guide*.

PREDEFINED MESSAGES Policy Item

If you select the PREDEFINED MESSAGES policy item from the Policy Selection panel for MVS Components (Figure 206), the Component Selection panel is displayed, as shown in Figure 207 on page 268.

PREDEFINED MESSAGES Policy Item for MVS Components

```
COMMANDS  ACTIONS  HELP
-----
AOFGMCOS                                Component Selection          Row 1 to 11 of 31
Command ==> _____

Taylor amount of messages displayed on the MESSAGES/USER DATA policy:
Display level . . . 0 (0 - display only messages defined for this entry)
                   (1 - add SA predefined messages)

Deselect components for which SA predefined messages should not be used:
Cmd      Status      Component
-----
_____  SELECTED    zFS
_____  SELECTED    APPC
_____  SELECTED    CICS
_____  SELECTED    DB2
_____  SELECTED    DFHSM
_____  SELECTED    DFRMM
_____  SELECTED    GDPS
_____  SELECTED    GMFHS
_____  SELECTED    IMS
_____  SELECTED    JES2
_____  SELECTED    JES3
```

Figure 207. Component Selection Panel for MVS Components

This policy item allows you to specify how many messages are displayed in the MESSAGES/USER DATA policy item of this MVC entry, and to control the number of predefined messages that are used for the AT build.

Display level

Specifies whether the messages that have AT specifications predefined by SA z/OS are displayed in the MESSAGES/USER DATA policy of this MVC entry.

- 0** Displays only messages defined for this entry. This is the default.
- 1** Displays the messages that are defined for this entry together with the messages predefined by SA z/OS. For better readability, the predefined messages are displayed in the same color as the inherited data in application policies.

Note that this option only controls the messages that are displayed in the MESSAGES/USER DATA policy. It has no effect on the AT build.

Note

The predefined messages can only be shown if the special MVC entry, `+SA_PREDEFINED_MSGS`, is linked to the same systems that the current MVC entry is linked to.

Deselect components

Shows a list of those MVS components that predefined messages exist for.

You can select or deselect individual components. Initially all components are selected. If you deselect a component, it is not displayed in the MESSAGES/USER DATA policy item and it is not included in the AT build for the systems that this MVC entry is linked to.

Note that some of the predefined messages do not belong to any of the listed components. These messages that do not have a component relation are always displayed in the policy and used for the AT build. With a display level of 0, deselecting a component has no effect on the messages that are displayed in the MESSAGES/USER DATA policy item, but it does affect the AT build.

PREDEFINED MESSAGES Policy Item for MVS Components

You can select or remove single components with the line commands SELECT or REMOVE, or all components with the primary commands SELECT ALL or REMOVE ALL.

MESSAGES/USER DATA Policy Item

If you select policy item MESSAGES/USER DATA from the Policy Selection panel for MVS Components (Figure 206 on page 267), the Message Processing panel is displayed, as shown in Figure 208.

```
COMMANDS  HELP
-----
AOFGDYNM          Message Processing          Line 00000001 Col 001 075
Command ==> _____ Scroll ==> PAGE

Entry Type : MVS Component          PolicyDB Name  : USER_PDB
Entry Name  : MVS_COMPONENTS        Enterprise Name: USER_ENTERPRISE

Line Commands: S (Cmd), C (Cmd), R (Rep), K (Cod), U (Usr), A (AT), M (MRT)
                I, D (insert or delete lines)
Message ID field length. . 14 (1 - 32)

Cmd Message id  Description                               Cmd Rep Cod Usr A M
-----
IEA793A         No dump datasets available                               1
IEC613A         Unable to position a tape                               1
IEE767A         Buffer shortage on system log                           1
IEE768I         Buffer on system log relieved                           1
IEF238D         Cannot complete device allocation                       3      P
IEF450I         Job Abend                                              8      P
LOGREC          LOGREC commands                                       3      P
MVSDUMP         MVSDUMP Threshold Commands                             3      P
MVSDUMPRESET   MVSDUMP Reset Commands                                1      P
```

Figure 208. Message Processing Panel for MVS Components

The MESSAGES/USER DATA policy item allows you to specify message IDs. The message ID must not end with an asterisk and cannot have any commas in it.

On this panel, you can define how SA z/OS reacts to an issued message. Message processing provided here is the same as provided for Applications. For more information, see “MESSAGES/USER DATA Policy Item” on page 162 and *IBM Tivoli System Automation for z/OS Customizing and Programming*

MINOR RESOURCES Policy Item

The Minor Resource Definitions panel, as shown in Figure 209 on page 270, is displayed if you select the MINOR RESOURCES policy item in the Policy Selection panel for the MVS Component entry type.

MINOR RESOURCES Policy Item for MVS Components

```
COMMANDS  HELP
-----
AOFGMRES          Minor Resource Definitions          Row 1 to 9 of 20
Command ==>>> _____          SCROLL==>>> PAGE

Entry Type : MVS Component          PolicyDB Name   : USER_PDB
Entry Name  : MVS_COMPONENTS        Enterprise Name : USER_ENTERPRISE
Major Name  : MVSESA

Line Commands: F (Flg), S (Thr), T (Thr)
               D (delete line)

Cmd  Minor Resource
---  ENQ.CMDFLOOD
---  ENQ.HUNGCMD
---  ENQ.LONGENQ
---  ENQ.SYSIEFSD
---  _____
---  _____
---  _____
---  _____
---  _____
```

Figure 209. Minor Resource Definitions Panel

This panel allows you to manage automation flags and thresholds for minor resources.

Major Name

This field shows the major resource name.

Cmd Use this field to enter a line command:

F or FLG

Enter automation flag definitions for the minor resource. See “AUTOMATION FLAGS Policy Item” on page 158 for more details.

S, T, or THR

Enter threshold definitions for the minor resource. See “THRESHOLDS Policy Item” on page 190 for more details.

D Deletes the minor resource definition.

Minor Resource

Use this field to specify the minor resource name. The following rules apply to the minor resource names:

- The name cannot contain any of the following characters: comma, single quotation mark, double quotation mark, left or right parenthesis, equal sign or a blank.
- The name cannot start or end with a period.
- The name cannot contain consecutive periods.

To add a minor resource enter a name in one of the empty entries at the bottom of the list.

To rename a minor resource overwrite the current name with a new name and press Enter.

You can use special minor resource names for MVS Component processing, such as:

- MVSDUMP for system messages that report that an SVC dump has been made (IEA611E and IEA911E)
- SMFDUMP for system messages that report that the smfdump data set is full or has been switched (IEE362A, IEE362I, IEE391A, and IEE392I)

MINOR RESOURCES Policy Item for MVS Components

- LOGREC for system messages that report that the logrec data set is full or nearly full (IFB040I, IFB060E, IFB080E, IFB081I, and IFC001I)
- SYSLOG for system messages that report that the syslog has been queued (IEE043I)
- LOG for system messages that report that the syslog has become inactive (IEE037D—followed by IEE043I, IEE533E or IEE769E—and IEE041I)

SA z/OS provides automation routines for recovery actions that use the automation flags or thresholds that are defined for these minor resources together with commands that are defined for messages with the same name. For more information see the chapter “Automation Routines” in *IBM Tivoli System Automation for z/OS Customizing and Programming*.

MVSCOMP Defaults Entry Type

MVSCOMP Defaults allow you to set default values for MVS Component sets.

Policy Items for MVSCOMP Defaults

Figure 210 shows the policy items that are displayed when a new MVSCOMP Defaults entry is defined or when existing MVSCOMP Defaults entry is selected from the Entry Name Selection panel.

ACTIONS		HELP
AOFGEPOL		Policy Selection
Command ==>		Row 1 of 7 SCROLL==> PAGE
Entry Type : MVSCOMP Defaults		PolicyDB Name : USER_PDB
Entry Name : MVSCOMP_DFLT_NAME		Enterprise Name : USER_ENTERPRISE
Action	Policy Name	Policy Description
_____	DESCRIPTION	Enter description
_____	MVSESA INFO	Define MVS component information defaults
_____	AUTOMATION FLAGS	Define MVS component automation flags default
_____	THRESHOLDS	Define MVS component thresholds defaults

_____	WHERE USED	List systems linked to this entry
_____	COPY	Copy data from an existing entry
***** Bottom of data *****		

Figure 210. Policy Selection Panel for MVSCOMP Defaults

The unique policy items for MVSCOMP Defaults are:

MVSESA INFO

This option allows you to specify a captured messages limit as the maximum number of messages that will be captured for each MVSESA resource while SA z/OS is running. These messages will show up in the SA z/OS command DISPSYS. If the field is left blank the value can be inherited from the system defaults definition. If neither of them is specified, a default value of 0 is used.

You can use the **Inform List** field to specify where each MVSESA resource is registered to and who all status changes are propagated to. Valid receivers are SDF, NMC, IOM, EIF, TTT, and USR. You can specify one or more values. If the field is left blank the value can be inherited from the systems default definition. If the resource should not be registered at all, specify NONE. This will prevent inheritance from systems default definitions.

MVSCOMP Defaults Entry Type

AUTOMATION FLAGS

This option allows you to specify automation settings that will be used as defaults for MVS Components. The settings specified here will be used if you do not provide specific automation settings for MVS Components. See the section "Automation Flags" in *IBM Tivoli System Automation for z/OS User's Guide* for more information about setting automation flags.

THRESHOLDS

This policy item is used to set default error thresholds for MVS Components. The settings specified here will be used if you do not provide specific thresholds for MVS components. See the section "How SA z/OS Uses Error Thresholds" in *IBM Tivoli System Automation for z/OS User's Guide* for more information about error thresholds.

More than one MVSCOMP Default may be attached to a system, but it is recommended that you attach only one to avoid data being overwritten during SA z/OS initialization or an INGAMS REFRESH.

System Defaults Entry Type

THIS entry type ALLOWS YOU TO SET VARIOUS DEFAULTS THAT ARE USED THROUGHOUT THE SYSTEM. THE VALUES SET HERE MAY BE OVERRIDDEN BY OTHER OBJECTS, SUCH AS APPLICATION CLASS, APPLICATION DEFAULTS, OR MVSCOMP DEFAULTS, OR BY SETTING APPROPRIATE VALUES IN INDIVIDUAL APPLICATION OR MVS COMPONENT OBJECTS.

Policy Items for System Defaults

Figure 211 shows the policy items that are displayed when a new System Defaults entry is defined or when an existing System Defaults entry is selected from the Entry Name Selection panel.

```

ACTIONS  HELP
-----
AOFGEPOL                               Policy Selection                               Row 1 of 7
Command ==> _____                SCROLL==> PAGE

Entry Type : System Defaults             PolicyDB Name   : USER_PDB
Entry Name  : SYSTEM_DEFAULTS           Enterprise Name : USER_ENTERPRISE

Action      Policy Name      Policy Description
-----
AUTOMATION OPTIONS      Define system automation options
AUTOMATION FLAGS        Define system automation flag defaults
THRESHOLDS              Define system thresholds defaults
-----
WHERE USED               List systems linked to this entry
COPY                     Copy data from an existing entry
***** Bottom of data *****
```

Figure 211. Policy Selection Panel for System Defaults

The unique policy items for System Defaults entry type are:

AUTOMATION OPTIONS

This policy item is used to set system-wide options. See "AUTOMATION OPTIONS Policy Item" on page 273 for more information.

AUTOMATION FLAGS

This policy item allows you to specify automation settings that are used as defaults for the system. The settings specified here are used if you do not provide specific automation settings for those entry types that allow

automation. See the section “Automation Flags” in *IBM Tivoli System Automation for z/OS User’s Guide* for more information on setting automation flags.

THRESHOLDS

This policy item is used to set system-wide error thresholds. The settings specified here are used if you do not provide object-specific threshold settings. See the section “How SA z/OS Uses Error Thresholds” in *IBM Tivoli System Automation for z/OS User’s Guide* for more information on error thresholds.

More than one set of System Defaults may be attached to a system, but it is recommended that you attach only one to avoid data being overwritten during SA z/OS initialization or an INGAMS REFRESH.

AUTOMATION OPTIONS Policy Item

The System Automation Options panel, as shown in Figure 212, is displayed if you select the AUTOMATION OPTIONS policy item on the Policy Selection panel for the System Defaults entry type.

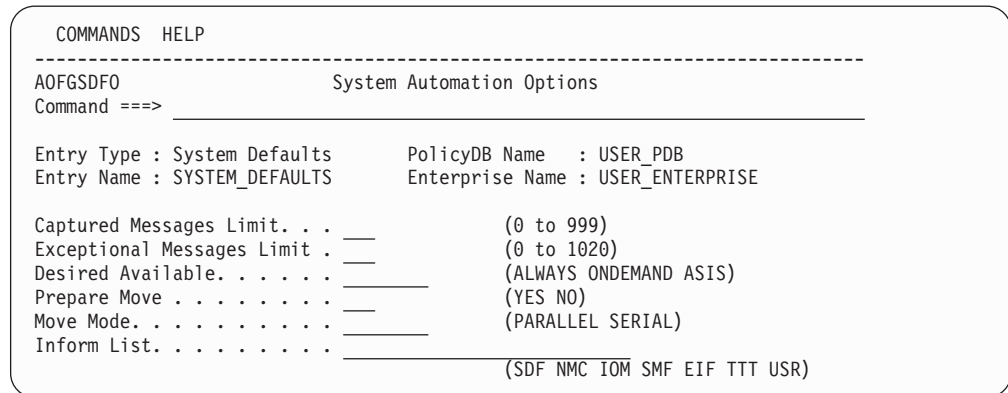

Figure 212. System Automation Options Panel

The following parameters can be specified for system-wide defaults. If the corresponding entry is not specified for individual resources, this value will prevail.

Captured Messages Limit

This specifies the maximum number of messages that will be captured for each resource while SA z/OS is running. These messages will show up in the DISPSYS, DISPINFO, or DISPMTR command output, or the SA z/OS Graphic Interface.

Exceptional Messages Limit

This defines the maximum number of exceptional messages (that is, those with a severity of UNUSUAL, IMPORTANT or CRITICAL) that are captured for the entire system while SA z/OS is running.

These messages are displayed with the SA z/OS INGMSGSGS command and in SDF, NMC, and TEP.

If you do not specify a value, the default is 300. The maximum is 1020.

Desired Available

Lets you specify the default desired status of the resource. The desired state of each resource is either Available or Unavailable, which is the goal that automation tries to achieve.

AUTOMATION OPTIONS Policy Item for System Defaults

You can specify the following values:

ALWAYS

The desired state of the resource is set to Available, unless it is dependent on a resource that has a Desired Available setting of ONDEMAND. In this case the resource behaves as if it had a Desired Available setting of ONDEMAND itself.

This is the same behavior as in earlier releases of SA z/OS.

ONDEMAND

If there is *demand* for the resource to be available, its desired status is set to Available, otherwise its desired status is set to Unavailable.

Demand arises either from propagated MakeAvailable votes or implicitly through membership of a non-passive basic application group (APG) that has a desired status of Available. Demand does not arise from dependent resources with a Desired Available setting of ALWAYS.

A MakeAvailable vote that is propagated to the resource overrides any demand considerations.

An active ONDEMAND member of a move or server group is always sent a vote that sets its desired status, thus overriding any demand considerations.

ASIS The desired status is always set to the observed status. The resource remains in the status that it currently has and no action is taken by SA z/OS at any time, as long as there is no request placed for or propagated to the resource.

Note:

If nothing is specified or inherited the default value is ALWAYS.

Prepare Move

Specifies whether the downtime during the move or switch of a resource should be kept as short as possible. For more details see "Prepare Move" on page 117.

Move Mode

Specifies how a move is made from an old member to a new one. For more details see "Move Mode" on page 118.

Inform List

This field allows you to specify:

- Where the application is registered to
- Where all status changes are propagated to
- Whether SMF records are written

Valid values are SDF, NMC, IOM, SMF, EIF, TTT, and USR. You can specify more than one value. The list of values can be blank or comma separated. If you do specify a value, no status changes are propagated.

System automation symbols (AOCCLONES) or system symbols are not allowed.

Application Defaults Entry Type

The Application Defaults entry type specifies default values for automation flags and error threshold settings. These values will be used as the default for any Application object on the system that the Application Defaults set is attached to. If the application belongs to an application class with automation flags or error thresholds specified, the class policy takes precedence over the defaults.

Policy Items for Application Defaults

Figure 213 shows the policy items that are displayed when a new Application Defaults entry is defined or when an existing Application Defaults entry is selected from the Entry Name Selection panel.

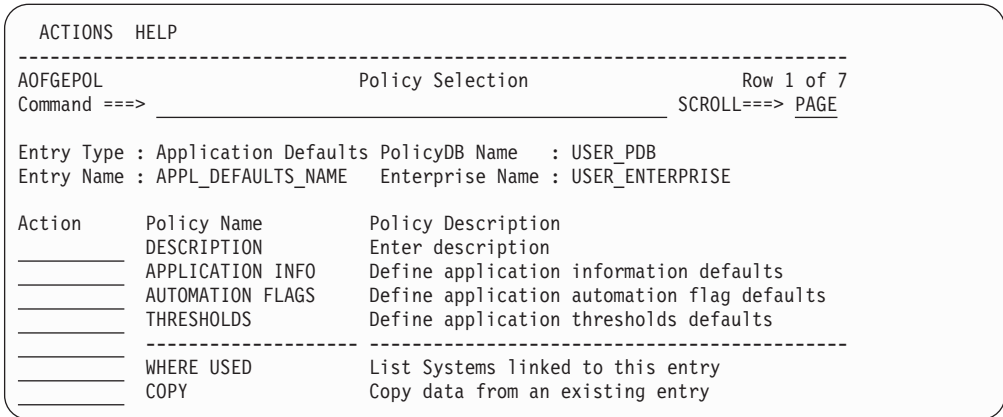

Figure 213. Policy Selection Panel for Application Defaults

The unique policy items for Application Defaults policy are:

APPLICATION INFO

This policy item allows you to set various defaults for applications that you define to the system. The values entered in the Application Information Defaults panel are used as default values for Application objects that are attached to this system and do not have this information specified. For more details about these parameters, see “Application Entry Type” on page 137.

AUTOMATION FLAGS

This policy item allows you to specify automation flag settings that are used as defaults for all applications on the system. The settings specified here are used if you do not provide application-specific automation settings. See the section “Automation Flags” in *IBM Tivoli System Automation for z/OS User’s Guide* for more information on setting automation flags.

THRESHOLDS

This policy item allows you to specify threshold settings that are used as defaults for all applications on the system. The settings specified here override system default settings and are used if you do not provide application-specific threshold settings. See the section “How SA z/OS Uses Error Thresholds” in *IBM Tivoli System Automation for z/OS User’s Guide* for more information on setting thresholds.

Application Defaults Entry Type

More than one set of Application Defaults may be attached to a system, but it is recommended that you attach only one to avoid data being overwritten during SA z/OS initialization or an INGAMS REFRESH.

Automation Operators Entry Type

Automation operators are automated operator tasks, that can respond to messages from the operating system, applications, and network without requiring a human operator. Sets of automation operators can be linked to a system. Each automation operator task takes actions similar to those of a human operator, such as monitoring the system and handling and coordinating recovery and shutdown operations.

Automation operators are assigned specific messages to act on. During automated operations, the messages are routed to the appropriate operator using the NetView ASSIGN command.

Policy Items for Automation Operators

Figure 214 shows the policy items that are displayed when a new Automation Operators policy object is created or Automation Operators is selected from the Entry Type Selection panel.

```

  ACTIONS  HELP
-----
AOFGEPOL          Policy Selection
Command ==> _____ SCROLL==> PAGE

Entry Type : Automation Operators PolicyDB Name : USER_PDB
Entry Name : AUTO_OPERATORS_NAME Enterprise Name : USER_ENTERPRISE

Action      Policy Name      Policy Description
-----
            DESCRIPTION    Enter description
            OPERATORS      Define automation operators
-----
            WHERE USED     List Systems linked to this entry
            COPY           Copy data from an existing entry
-----
```

Figure 214. Policy Selection Panel for Automation Operators

The unique policy item for Automation Operators is:

OPERATORS

Automation operators are crucial to the operation of SA z/OS. The SA z/OS sample automation control file supplies definitions that are required in order to start SA z/OS. If you modify the sample definitions, or you do not want to use them, you need to be aware of which automation operators are required, and what messages should be assigned to them.

SA z/OS defines an *automated function name* for each automation operator that it uses. Certain automated function names must be defined. These are listed in Table 7 on page 277. The automated function names are included in the sample policy databases that are supplied with SA z/OS. If you are not using a sample policy database, you must include these automated function names in your policy database. The automation operators that they are associated with must be defined in the NetView DSIOPF member.

OPERATORS Policy Item

Table 7 lists the automated function names that need to be defined.

Table 7. SA z/OS Mapping of NetView Automation Operator to SA z/OS Automated Function

Automated Function	Automation Operator	Description
AUTO1	AUTO1	Used for SA z/OS initialization
AUTO2	AUTO2	Used for SA z/OS initialization
BASEOPER	AUTBASE	Base automation: Backs up all other automation operators.
SYSOPER	AUTSYS	System automation: Acts as the primary system automation operator.
LOGOPER	AUTLOG	Used for message writing and for unassigned messages.
MSGOPER	AUTMSG	Message automation: Formats and routes messages.
AOFWRKxx	AUTWRKxx	Used for subsystem processing, for example startup, shutdown
NETOPER	AUTNET1, AUTNET2	VTAM and NetView automation: Acts as the network products automation operator.
JESOPER	AUTJES	JES automation: Acts as the JES2 or JES3 product automation operator.
MONOPER	AUTMON	Monitoring and startup automation: Performs active monitoring of resources.
RECOPER	AUTREC	Recovery automation: Acts as the primary recovery operator. It is not recommended that you use RECOPER for user automation that issues WTO/Rs. This situation can halt SA z/OS's WTO/R buffer recovery process, which may result in a buffer full situation.
RPCOPER	AUTRPC	Used for XCF requests
SHUTOPER	AUTSHUT	Shutdown automation: Acts as the base shutdown operator.
GSSOPER	AUTGSS	General automation. Acts as the operator for applications using SA z/OS generic automation routines, but does not execute these routines. Instead, it distributes them to the responsible AOFWRKxx automated functions. GSSOPER will also be used as backup in case there is no AOFWRKxx automated function defined.
GATOPER	GAT&DOMID	Gateway: Acts as the outbound gateway operator for automation notification message forwarding
MVSCONS <i>i</i>	AUTCON	Used for the MVS and NetView console interface.
PPIOPER	AOFARCAT	ARM PPI receiver
HBOPER	AUTHB	Used by heartbeat function
XCFOPER	AUTXCF	Used for enhanced Parallel Sysplex [®] automation functions.
XCFOPER2	AUTXCF2	Used for enhanced Parallel Sysplex automation functions.

OPERATORS Policy Item for Automation Operators

Table 7. SA z/OS Mapping of NetView Automation Operator to SA z/OS Automated Function (continued)

Automated Function	Automation Operator	Description
HWOPER1-33	AUTHW1-33	Used for Hardware Validation messages.
PLEXOPER	AUTPLEX	Used for enhanced Parallel Sysplex automation functions.
PLEXOPR2	AUTPLEX2	Used for enhanced Parallel Sysplex automation functions.
PLEXOPR3	AUTPLEX3	Used for enhanced Parallel Sysplex automation functions.
POSTOPER	AUTPOST	Used for the serialization of INGPOST commands on the target system.
POSTSLV	AUTPOSTS	Used for the serialization of INGPOST commands on the focal point.
AOFSESxx	AUTSESxx	Used for OMEGAMON sessions.
EVTOPER	AUTEVT1, AUTEVT2	Used for event subscription and the TWS command request interface.
ALRTOPER	AUTALERT	Used for alert-based notification.
	AUTTWS	

It is highly recommended that you assign the suggested automated operators to these required automated functions as listed in Table 7 on page 277. If you attempt to share automated operators across more than one automated function you will experience a significant performance degradation during SA z/OS initialization or an INGAMS REFRESH.

Sample DSIOPF definition statements are included in the AOFOPF* samples that are delivered with SA z/OS. You may define additional automation operators, to suit your automation needs.

When defining SA z/OS automated functions, you must associate the SA z/OS automated function names with actual automation operator IDs defined in member DSIOPF in the NetView DSIPARM data set. For example, you can associate the SA z/OS name BASEOPER with the NetView automation operator ID AUTBASE, MSGOPER with AUTMSG, and JESOPER with AUTJES. You must also define synonyms for them in AOFMSGSY. See *IBM Tivoli System Automation for z/OS Customizing and Programming* for more information on synonyms. Figure 215 on page 279 shows an example of an Automation Operator Definition panel.

You can find required definitions of automated functions can be found in the *BASE add-on policy. It is highly recommended that you assign the suggested automated operators to these required automated functions as given in *BASE. If you attempt to share automated operators across more than one automated function you will experience a significant performance degradation during SA z/OS initialization or an INGAMS REFRESH.

OPERATORS Policy Item for Automation Operators

COMMANDS	ACTIONS	HELP
AOFPIA00 Automation Operator Definitions Row 1 to 10 of 36 Command ==> _____ SCROLL==> PAGE		
Entry Type : Automation Operators PolicyDB Name : USER_PDB Entry Name : BASE_AUTOOPS Enterprise Name : USER_ENTERPRISE		
Actions: S = Select M = Move B = Before A = After I = Insert		
Action	Automated Function	Messages for this Operator (* notation ok)
_____	BASEOPER	_____
_____	GSSOPER	_____
_____	JESOPER	_____
_____	LOGOPER	*
_____	MONOPER	_____
_____	MSGOPER	AOF*
_____	MVSCONS	_____
_____	NETOPER	_____
_____	PPIOPER	_____
_____	RECOPER	ERB*,IEA*,IEE*,IOS*

Figure 215. Automation Operator Definition Panel

Messages are entered in the **Messages for this Operator** field. You can specify:

- A single message, such as IEE115I
- A group of messages, by specifying a message prefix and an asterisk (*), such as AOF* or \$HASP*
- All messages, not otherwise assigned, by specifying an asterisk (*) only

The order of the automation operators in the list is irrelevant for the execution. NetView ensures that the messages are assigned correctly with the most specific first, followed by the more general. You can use the following action codes to change the order of automation operators in the list:

(M) MOVE

Moves the automation operator to another position in the list that is marked with BEFORE and AFTER.

(B) BEFORE

Is used with MOVE. The automation operator is placed before the line marked with the BEFORE action.

(A) AFTER

Is used with MOVE. The automation operator is placed after the line marked with the AFTER action.

(I) INSERT

Inserts a new line directly underneath the current one. You can add another automation operator or message on this line.

To continue the specification of message IDs across several lines, insert a line where required and leave the automated function blank.

The following automated functions should not have messages assigned to them on the Automation Operator Definition panel:

- BASEOPER
- GATOPER
- MVSCONS_{*i*} (where *i* is blank, A-Z, or 0-9)
- SHUTOPER
- HBOPER

OPERATORS Policy Item for Automation Operators

- AOFWRKxx
- GSSOPER

For these automation operators, you should only specify the automated function name in the Automated Function field, and leave the Messages for this Operator field blank.

After you have entered the automated function and assigned messages, a new panel is displayed where you can enter the automation operators and NetView operators that are to receive messages. Figure 216 provides an example.

```
COMMANDS  HELP
-----
AOFPIA01          Automation Operator Definitions
Command ==>>> _____

Entry Type : Automation Operators  PolicyDB Name  : USER_PDB
Entry Name  : AOP_OBJ1             Enterprise Name : USER_ENTERPRISE

Automated Function: BASEOPER
Messages assigned:

MVS Console Name . . _____ Console for NetView cmds

Enter automation operators and NetView operator(s) to receive messages.

Automation Operators          NetView Operators
Primary . . AUTBASE           Id 1 . . _____
Backup. . . _____        Id 2 . . _____
                               Id 3 . . _____
                               Id 4 . . _____
                               Id 5 . . _____
                               Id 6 . . _____
```

Figure 216. Automation Operator Definitions Panel

The fields are:

MVS Console Name

This is a 1-8 alphanumeric field as defined in the `CONSOLnn` member of the MVS PARMLIB. The system console name `*MASTER*` or `*ANY*` can also be used. Otherwise, the first character of the name must be alphabetic. If console name is specified, the autotask is considered as an attended task. It will be applied to the Primary Automation Operator only.

The name may include any system symbol (for example, `&DOMAIN.`). System automation symbols (`&AOCCLONEx.`) are not allowed.

Automation Operators

Each automation operator relates to a specific NetView operator ID. Each message is assigned to a list of operators. This list includes the primary NetView ID, the secondary NetView ID (if specified), the primary NetView ID for SYSOPER, and the primary NetView ID for BASEOPER. The message is processed on the first operator in the list that is logged on when the message is received. If none of the operators are logged on, it will be processed on the task that started the system NetView Subsystem Interface Router task (SIR task), if it was started by a NetView task. In the NetView default initialization sequence, AUTO1 starts the SIR task. If the SIR task was not started by an autotask (that is, it has `INIT=Y` coded in `DSIDMN`) or the task that started it is no longer active, the message will not be automated. Similar lists of autotasks are defined in `AOFMSGSY` and are used to route commands to tasks from the NetView automation table.

OPERATORS Policy Item for Automation Operators

If a group is specified (the ID starts with a "+"), all the IDs that are assigned to the group are inserted into the list at that point.

You may also use SYSCLONE variables and the &DOMAIN. variable for the automation operators and NetView operators specification.

NetView Operators

Defines NetView IDs to receive copies of the messages assigned to the automation operator. The ID must be logged on to receive the message and either the primary or backup operator must also be logged on. Operator "groups" can be defined by specifying a "+" as the first character.

Structure of AOFWRKxx Operators

AOFWRKxx operators are used to distribute the work on different NetView tasks, so that they can run in parallel. AOFWRKxx operators are used as dedicated automated function responsible for all the work on a particular subsystem. However, because there might be too many subsystems defined, it may not be possible that each subsystem has a unique automated function for exclusive usage. Instead, several subsystems will share the same automated function. This automated function is responsible for the subsystem's startup, shutdown, monitoring and message handling activities.

You must define at least three automated functions which are responsible for the subsystem automation. You have the possibility to define additional ones. So you can decide how much parallelism you want.

The naming of these automation operator entries is of type AOFWRKxx where xx is any number or character. The xx part of the automated function name does not have to be in sequence.

At SA z/OS initialization or an INGAMS REFRESH, each defined subsystem will be assigned an automated function from the pool of defined AOFWRKxx operators.

Behavior of SHUTDOWN, STARTUP and GSSOPER

There are changes in the behavior of the shutdown, the startup and in the usage of the GSSOPER automated function.

SHUTDOWN and STARTUP: A shutdown/startup can continue to process another subsystem on another automated function before a shutdown/startup command is completed. The shutdown/startup process can run in parallel.

GSSOPER Usage: The GSSOPER automated function is used for the generic routines ACTIVMSG, TERMMSG and HALTMSG. These routines are routed from the message automation table to GSSOPER. The GSSOPER automated function will no longer execute these routines, it will only distribute them to the responsible AOFWRKxx automation operators. GSSOPER will also be used as backup when there is no AOFWRKxx automation operator defined.

Notify Operators Entry Type

The Notify Operators entry type allows you to define notification messages for certain operators.

Policy Items for Notify Operators

Figure 217 on page 282 shows the Entry Selection panel to define these operators.

Notify Operators Entry Type

```

ACTIONS  HELP
-----
AOFGEPOL                                Policy Selection                                Row 1 to 5 of 5
Command ==> _____                                SCROLL==> PAGE

Entry Type : Notify Operators              PolicyDB Name   : USER_PDB
Entry Name  : NOTIFY_OPERATORS            Enterprise Name : USER_ENTERPRISE

Action      Policy Name      Policy Description
-----
            DESCRIPTION      Enter description
            NOTIFY_OPERATORS  Define forward messages to operators
-----
            WHERE USED        List systems linked to this entry
            COPY              Copy data from an existing entry
***** Bottom of data *****

```

Figure 217. Policy Selection Panel for Notify Operators

NOTIFY OPERATORS

Notification operators are human NetView operators who receive SA z/OS notification messages, which are messages about events SA z/OS detects or actions it takes. These notification messages are routed to one or more logged-on human operators, using the message forwarding path you set up in the Network policy object. The messages can optionally be held until the operator clears them. See “NOTIFY OPERATORS Policy Item.”

NOTIFY OPERATORS Policy Item

Figure 218 shows the Operator Notification panel that you can use to select notification operators or define new notification operators that you want to be notified about selected message classes from applications on a system.

```

COMMANDS  ACTIONS  HELP
-----
AOFPIN00                                Operator Notification                                SCROLL==> PAGE
Command ==> _____

Entry Type : Notify Operators              PolicyDB Name   : USER_PDB
Entry Name  : SAMPLE_NFYOP_01            Enterprise Name : USER_ENTERPRISE

Enter operator information and select message type(s) to be held on screen.

Action : S = Select for message class assignment      Notify: Yes or No
Messages: S = Select messages to be held

A  Operator ID      Operator Description      Notify      ----- Messages -----
                                           Information
                                           Eventual Action
                                           Immediate Decision
                                           System Wait
                                           Immediate Action
-  XXAOC05          SHIFT LEADER              YES         S   S   S   S   S
-  XXAOC06          SENIOR OPERATOR          NO          -   -   -   -   -
-  _____          _____                _____  -   -   -   -   -

```

Figure 218. Operator Notification Panel

When you specify Yes in the **Assign User message classes** field on the Operator Notification Message Classes panel (Figure 219 on page 283), to have the operator notified about user-defined message classes, SA z/OS displays existing message classes that have been defined with the AUTO MSG CLASSES policy item of the Enterprise entry type (ENT).

NOTIFY OPERATORS Policy Item for Notify Operators

How to define messages for a message class and where to store them, is described in *IBM Tivoli System Automation for z/OS Customizing and Programming*.

```

COMMANDS  HELP
-----
AOFPIN01          Notify Operator Message Classes
Command ==> _____

Entry Type : Notify Operators      PolicyDB Name  : USER_PDB
Entry Name  : SAMPLE_NFYOP_01     Enterprise Name: USER_ENTERPRISE

OperatorID  : XXA0C05              Description   : SHIFT LEADER

Assign User message classes . . NO (YES NO)

Select (S) the message classes that are appropriate for this operator.
More:      +
A  Automation agent related message classes

S  0 - Errors
-  1 - Debug
-  40 - ALL agent automation messages
-  41 - reserved
-  42 - reserved
S  43 - Information
-

```

Figure 219. Operator Notification Message Classes Panel

When defining notification operators, you can customize:

- Which operators receive notification messages
- The types of message held on notification operators' console screens:
 - Immediate Action
 - Immediate Decision
 - Possible Action
 - Information
 - System Wait
- The classes of messages sent to the operators. (See “AUTO MSG CLASSES Policy Item” on page 78 for information about defining your own message classes.) Each SA z/OS message can have one or more message classes associated with it. Similarly, each notification operator can have one or more message classes assigned. When messages are processed during automated or manual operations, the class of each message is compared to the classes defined for each notification operator. If a match occurs, the notification operator receives the message. All one and two digit numeric message classes are reserved for IBM use. You may use message classes made up of one alphabetic and one numeric character (or one numeric and one alphabetic).

Table 8 shows the message classes defined by SA z/OS. Message classes from 80 to 90 are relevant for monitoring the automation manager. These message classes are discussed in more detail in *IBM Tivoli System Automation for z/OS Messages and Codes*.

Table 8. SA z/OS Message Classes

Message Class Description	Message Class Number
<i>General Message Classes</i>	
Errors	0
Debug	1
<i>Automation Agent-Related Message Classes</i>	
All automation agent messages	40

NOTIFY OPERATORS Policy Item for Notify Operators

Table 8. SA z/OS Message Classes (continued)

Message Class Description	Message Class Number
Information	43
Action	44
Status	45
User intervention	46
Critical threshold setting exceeded	50
Frequent threshold setting exceeded	51
Infrequent threshold exceeded	52
IMS Automation Messages	60
<i>Automation Manager-Related Message Classes</i>	
All automation manager messages	80
Intervention required	81
Automation denied	82
Automation Impacted	83
Awaiting Automation	84
In Automation	85
Degraded — Target resources	86
Degraded — All resources	87
Satisfactory — Target resources	88
Satisfactory — All resources	89
SA z/OS Infrastructure/Environment	90

For example, any operator defined with a notification operator class of all SA z/OS messages (class number 40 and 80) receives all SA z/OS messages. Operators responsible for system operations should receive all SA z/OS messages or a subset of those messages. As another example, you may want to have your lead operator receive all debug messages.

SA z/OS uses the general and console automation message classes only. The SA z/OS customization dialog supports the message classes used by SA z/OS only.

SA z/OS uses notification messages to update the status display facility (SDF).

Network Entry Type

When multiple z/OS systems are interconnected and require consolidated operations at one focal point system, you can use focal point services to monitor and control the systems. These services allow an operator to view the status of multiple systems from a single system acting as a focal point and to send messages, commands, and responses from a focal point system to other systems. The Network entry type allows you to:

- Define paths for sending messages, commands, or responses from one system to another.
- Define primary and backup focal point systems.
- Define user Terminal Access Facility (TAF) fullscreen sessions and specify whether each of these should be initiated automatically when the operator logs

on to the SA z/OS NetView Interface. If a TAF session is not defined to start automatically, you can initialize it using the OPER dialog.

- Define gateway sessions connecting systems.

A gateway session uses autotasks both inbound to and outbound from a system to send data between systems.

Communication with the focal point system is performed using the NetView RMTCMD command or XCF. XCF is used when commands are sent to systems within the same sysplex (that is, with the same XCF group ID). Otherwise, RMTCMD is used. In both cases, you can see the responses on your operator task.

- Define OMEGAMON sessions.

OMEGAMON sessions can be used to retrieve exception information or general performance and availability data for health monitoring and proactive automation.

- Manage access keys to the NetView password data set, where passwords can be stored that are needed when OMEGAMON sessions have to be established.
- Define Simple Object Access Protocol (SOAP) servers and their attributes to be able to communicate with IBM Tivoli Monitoring (ITM).

The chapter “Automating Networks” in *IBM Tivoli System Automation for z/OS Customizing and Programming* provides more information on the defining automation networks.

Policy Items for Network

Figure 220 shows the policy items that are displayed when a new Network policy object is defined or when an existing Network object is selected from the Entry Name Selection panel.

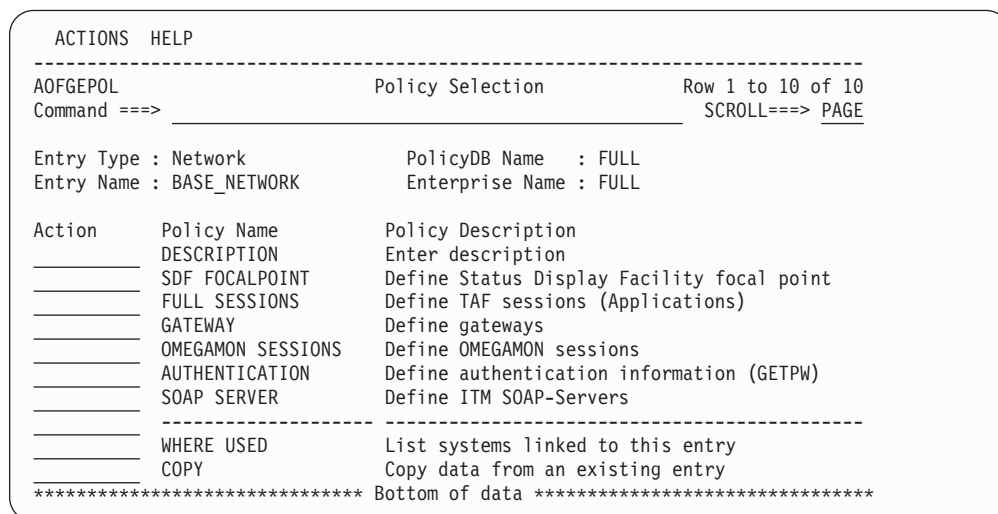

Figure 220. Policy Selection Panel for Network

The unique policy items for Network are:

SDF FOCALPOINT

This policy item is used to define the domain that is to receive the notification messages to be forwarded from the current domain. See “SDF FOCALPOINT Policy Item” on page 286 for more details.

Network Entry Type

FULL SESSIONS

With this policy item you can define applications that TAF fullscreen sessions can be established to. See “FULL SESSIONS Policy Item” on page 287 for more details.

GATEWAY

Each domain that is to receive commands, replies, or notification messages must have a gateway defined for it. Communication with the focal point system is performed via XCF (within the same sysplex) or the NetView RMTCMD command. See “GATEWAY Policy Item” on page 288 for more details.

OMEGAMON SESSIONS

This policy item is used to define the attributes used to establish and run a communication session with OMEGAMON based on the NetView Terminal Access Facility (TAF). See “OMEGAMON Policy Item” on page 288 for more details.

AUTHENTICATION

This policy item is used to define access keys for particular OMEGAMON application IDs in order to let SA z/OS retain passwords in the NetView password data set. See “AUTHENTICATION Policy Item” on page 291 for more details.

SOAP SERVER

This policy item is used to define SOAP servers and their attributes. See “SOAP SERVER Policy Item” on page 291 for more details.

SDF FOCALPOINT Policy Item

If you select the SDF FOCALPOINT policy item from the Network Policy Selection panel, the panel shown in Figure 221 is displayed.

```
COMMANDS  HELP
-----
A0FPINE2          Notification Forwarding
Command ==>>>

Entry Type : Network          PolicyDB Name : DATABASE_NAME
Entry Name : ALL_SYSTEMS_NETWORK Enterprise Name : YOUR_ENTERPRISE

Enter the Netview domains for automation notification forwarding.

Primary Domain . . . &DOMAIN.      Primary Domain ID
Backup Domain . . . &DOMAIN.      Backup Domain ID
```

Figure 221. Notification Forwarding Panel

This option is used to define the domain that is to receive the notification messages to be forwarded from the current domain. Two domains can be specified in the fields of the panel:

Primary Domain

This is the domain that serves as the primary focal point for the Status Display Facility (SDF) of SA z/OS.

The name must consist of up to 5 alphanumeric characters of can be &DOMAIN.

GATEWAY Policy Item

If you select the GATEWAY policy item from the Network Policy Selection panel, the panel shown in Figure 223 is displayed.

```
COMMANDS  HELP
-----
AOFpine4          GATEWAY Definitions          Row 1 to 11 of 24
Command ==> _____ SCROLL==> PAGE

Entry Type : Network          PolicyDB Name : DATABASE_NAME
Entry Name  : ALL_SYSTEMS_NETWORK Enterprise Name : YOUR_ENTERPRISE

Specify each NetView domain that commands or responses are forwarded to.

Domain  Description
DOMFB   Gateway to backup focal point
DOMF1   Gateway to main focal point
DOMT1   Gateway to target 1
DOMT2   Gateway to target 2
_____
_____
_____
_____
_____
_____
_____
_____
_____
_____
```

Figure 223. GATEWAY Definitions Panel

Each domain that is to receive commands, replies or notification messages must have a gateway defined for it. This includes the domain name for the outbound gateway autotask. To define the gateway, provide the following information:

Domain

The name of all the domains that should receive anything forwarded from the current domain.

Description

The description of the domain that is to be communicated with through the gateway.

For more details, see the section “Automating Networks” in *IBM Tivoli System Automation for z/OS Customizing and Programming*.

OMEGAMON Policy Item

If you select the OMEGAMON policy item from the Network Policy Selection panel, the panel shown in Figure 224 on page 289 is displayed.

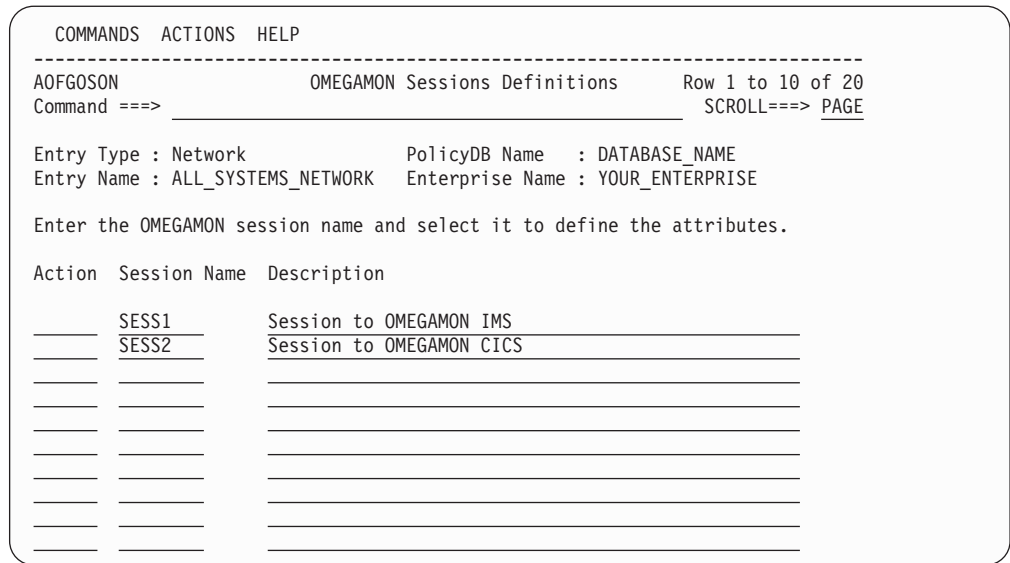

Figure 224. OMEGAMON Sessions Definitions Panel

This panel allows you to create, select or delete OMEGAMON sessions.

Action

Can be used to select (S) a session for further processing or delete (D) a session.

Session Name

A unique, eight character name for the session that you are defining. Any alphabetic, numeric, #, @ and \$ character can be used. The first character must be alphabetic.

Description

This is optional arbitrary text that describes the purpose of this session.

Selecting a session from the OMEGAMON Session Definitions panel leads to the OMEGAMON Session Attributes panel, as shown in Figure 225.

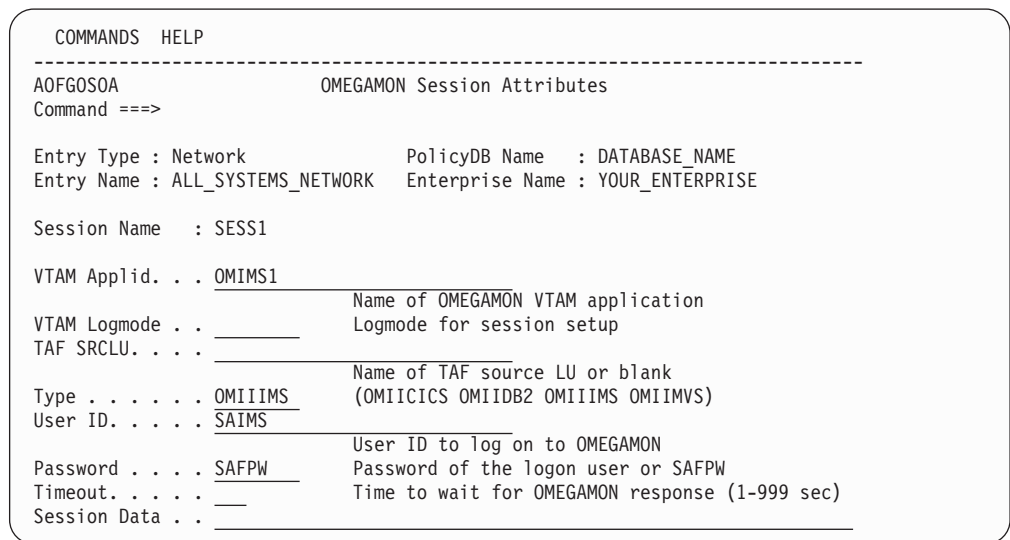

Figure 225. OMEGAMON Session Attributes Panel

OMEGAMON Policy Item for Networks

This panel allows you to define OMEGAMON sessions together with their attributes.

VTAM Applid

This is the name of the OMEGAMON VTAM application as defined by the installation during customization of the OMEGAMON product. The name is 1 to 8 characters long and may contain system and automation symbols.

VTAM Logmode

This is the logon mode name designating the device properties for the session setup to the OMEGAMON application. Because the NetView command BGNSESS is used with the ATTACH option, it must be compatible with a 24x80, non-queryable screen. If you do not specify the logmode, the default BIND image table as defined to VTAM is used.

TAF SRCLU

This is the name of the source LU that is assigned to this session by the installation. Specify this field if the default names that are created and assigned to a TAF session by NetView do not conform with your network naming conventions. If you leave the field blank, NetView assigns a name.

You can include system symbols and system automation symbols (see “Assigning System Automation Symbols (AOCCLONE)” on page 9).

Type This is the type of OMEGAMON monitor that a session is established with. Valid types are OMIICICS, OMIIDB2, OMIIMS, and OMIIMVS; they represent the OMEGAMON classic for CICS, DB2, IMS, and MVS, respectively.

User ID

This is the ID of the user that logs on to OMEGAMON when a session is established. To establish such a session, the user ID must be authorized to log on to OMEGAMON either within OMEGAMON itself or using an SAF-product.

To issue OMEGAMON commands, the user ID must also be authorized to issue commands that are protected by OMEGAMON internal command security or by the security profiles that are managed by an SAF product. For more details about user authorization, see the security chapter in *IBM Tivoli System Automation for z/OS Planning and Installation*.

The user ID has a maximum length of 8 characters and may contain system and automation symbols. It can be omitted if no OMEGAMON product level security is required.

Password

The password of the user who logs on to OMEGAMON. The password has a maximum length of 8 characters and must be specified if a user ID was specified.

The predefined keyword SAFPW may be used to allow SA z/OS to retain the password in the NetView password data set for the user ID. See also “AUTHENTICATION Policy Item” on page 291.

Timeout

This is the maximum time in seconds that SA z/OS waits for a response from OMEGAMON. If the specified timeout expires, the user is logged off and the session is terminated.

Any value between 1 and 999 seconds can be specified. The default value is derived from the setting of the WAITTIME variable (default: 29 seconds)

that can be set in CNMSTYLE or with the TIMEOUT VALUES policy item in the customization dialog (see “TIMEOUT VALUES Policy Item” on page 260).

Session Data

This is an optional 60-character field of data that is passed unchanged to OMEGAMON during logon. The data field must be used to specify the job name of a particular CICS region or the name of a particular DB2 subsystem that should be monitored by automation, for example:

CICS=PRDAOR1 where PRDAOR1 is the job name of the CICS region

DB2=SGG4 where SGG4 denotes the DB2 subsystem

AUTHENTICATION Policy Item

If you select the AUTHENTICATION policy item from the Network Policy Selection panel, the panel shown in Figure 226 is displayed.

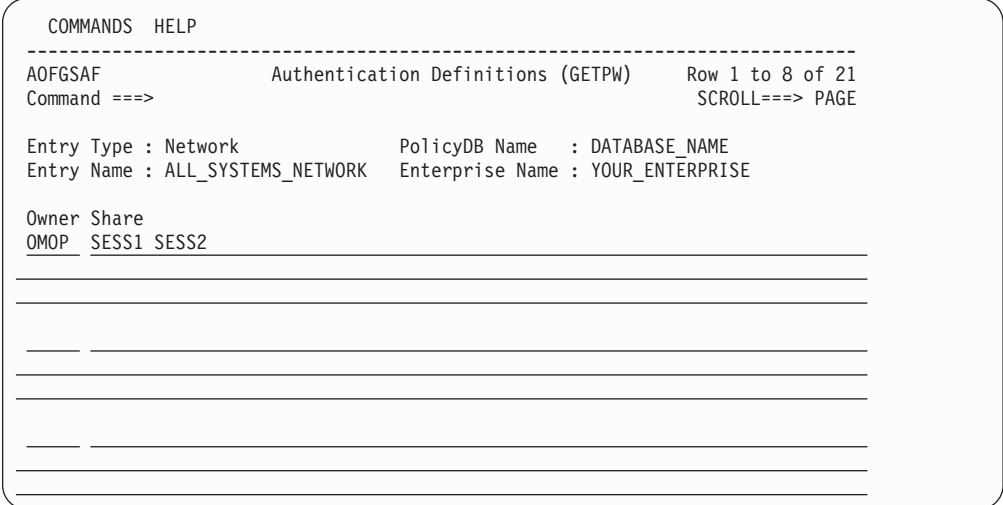

```
COMMANDS  HELP
-----
ADFGSAF      Authentication Definitions (GETPW)      Row 1 to 8 of 21
Command ==>>          SCROLL==>> PAGE

Entry Type : Network          PolicyDB Name : DATABASE_NAME
Entry Name : ALL_SYSTEMS_NETWORK  Enterprise Name : YOUR_ENTERPRISE

Owner Share
OMOP SESS1 SESS2
-----
-----
-----
-----
-----
-----
-----
-----
```

Figure 226. Authentication Definitions Panel

When SAFPW is specified as the password for a given OMEGAMON session, SA z/OS retrieves the actual password from the password data set using the user ID that is specified for this session and the owner that is specified in this policy item. For more details about the use of the NetView password data set, see the security chapter in *IBM Tivoli System Automation for z/OS Planning and Installation*.

Owner

Custom value of up to 5 characters that is used by SA z/OS to look up the password in the NetView password data set when an OMEGAMON session with any of the VTAM application IDs listed under **Share** is established.

Share This is the list of VTAM application IDs representing OMEGAMON monitors that passwords are kept for in the NetView password data set under the same owner. The application IDs may be delimited by blank or comma.

SOAP SERVER Policy Item

If you select the SOAP SERVER policy item from the Network Policy Selection panel, the panel shown in Figure 227 on page 292 is displayed.

SOAP SERVER Policy Item for Networks

```

COMMANDS  ACTIONS  HELP
-----
A0FGSOAS          SOAP-Server Definitions          Row 1 to 10 of 20
Command ==> _____          SCROLL==> PAGE

Entry Type : Network          PolicyDB Name : DATABASE_NAME
Entry Name : ALL_SYSTEMS_NETWORK Enterprise Name : YOUR_ENTERPRISE

Enter the SOAP-Server name and select it to define the attributes.

Action  Server Name  Description
-----  -
_____  _____  _____
_____  _____  _____
_____  _____  _____
_____  _____  _____
_____  _____  _____
_____  _____  _____
_____  _____  _____
_____  _____  _____
_____  _____  _____
_____  _____  _____

```

Figure 227. SOAP Server Definitions Panel

Use this panel to manage your IBM Tivoli Monitoring (ITM) SOAP server definitions.

Action

Use this field to select (S) a server for further processing or to delete (D) a server.

Server Name

Enter a unique 8-character name for the server. Any alphabetic, numeric, #, @ and \$ character can be used. The first character must be alphabetic.

Description

Enter descriptive text for the server.

Selecting a server leads to the SOAP-Server Attributes panel, as shown in Figure 228.

```

COMMANDS  HELP
-----
A0FGSOAA          SOAP-Server Attributes
Command ==> _____

Entry Type : Network          PolicyDB Name : DATABASE_NAME
Entry Name : ALL_SYSTEMS_NETWORK Enterprise Name : YOUR_ENTERPRISE

SOAP-Server Name : KEYATEMS

Host Name. . . . .
_____
Symbolic host name or IP-address of the SOAP-Server

Port Number. . . . 1920      Port number of the SOAP-Server (1-65535)
Protocol . . . . . HTTP      Protocol used for SOAP requests (HTTP or HTTPS)
Absolute Path. . . .
///cms/soap
_____
Absolute path of the SOAP-Server on that host

```

Figure 228. SOAP-Server Attributes Panel

Use this panel to define the SOAP server and its attributes. The following fields can be specified:

Host Name

This is the required address of the host where the SOAP server is running. It can be a symbolic host name (which consists of alphanumeric characters and dots) or an IP address. Both IPv4 and IPv6 address formats are allowed.

An IPv6 address consists of 8 hexadecimal qualifiers, each in the range 0–X'FFFF' separated by a colon. You can include system symbols and system automation symbols but they must be entered in uppercase.

An IPv4 address consists of 4 decimal qualifiers, each in the range 0–255, separated by a period. System symbols and system automation symbols are not supported in IPv4 format.

Port Number

This is the port number that the SOAP server is listening to. The default for the ITM SOAP server is 1920.

Protocol

This defines how data is exchanged between SA z/OS and the SOAP server. SOAP-requests can be issued using the HyperText Transfer Protocol (HTTP) or via HTTPS secured through Secure Socket Layer or Transaction Level Security protocols. The default protocol is HTTP.

Absolute Path

This is the absolute path of the SOAP service on the host that completes the address of a SOAP service. If there is no path, specify a forward slash (/) to denote the root directory as the SOAP server path. The default path that is used for ITM SOAP services is `///cms/soap`.

For more details about how SA z/OS uses SOAP messages and how to use them see *IBM Tivoli System Automation for z/OS Customizing and Programming*.

Sysplex Defaults Entry Type

The Sysplex Defaults entry type allows you to define sysplex resource information defaults.

Policy Items for Sysplex Defaults

Figure 229 on page 294 shows the Entry Selection panel to define sysplex resource information defaults.

Sysplex Defaults Entry Type

```

ACTIONS  HELP
-----
AOFGEPOL          Policy Selection          Row 1 to 5 of 5
Command ==> _____ SCROLL==> PAGE

Entry Type : Sysplex Defaults      PolicyDB Name : DATABA$E_NAME
Entry Name : SYSDEF1              Enterprise Name : NEW_ENTERPRISE

Action      Policy Name      Policy Description
-----
            DESCRIPTION  Enter description
            RESOURCE INFO Define sysplex resource information defaults
-----
            WHERE USED   List sysplex groups linked to this entry
            COPY         Copy data from an existing entry
***** Bottom of data *****

```

Figure 229. Policy Selection Panel for Sysplex Defaults

The unique policy item for the Sysplex Defaults entry type is:

RESOURCE INFO

Use this policy to specify where sysplex resources are registered to and how the desired status of the resource is determined in the absence of any propagated DesiredStatus votes on the resource. See "RESOURCE INFO Policy Item."

RESOURCE INFO Policy Item

Figure 230 shows the Sysplex Resource Information Defaults panel that you can use to define where sysplex resources are registered.

```

COMMANDS  HELP
-----
AOFGXDFI          Sysplex Resource Information Defaults
Command ==> _____

Entry Type : Sysplex Defaults      PolicyDB Name : DATABA$E_NAME
Entry Name : SYSDEF1              Enterprise Name : NEW_ENTERPRISE

Desired Available. . . . . _____ (ALWAYS ONDEMAND ASIS)
Prepare Move . . . . . _____ (YES NO)
Move Mode. . . . . _____ (PARALLEL SERIAL)
Inform List . . . . . _____ (SDF NMC IOM SMF EIF TTT USR)

```

Figure 230. Sysplex Resource Information Defaults Panel

Fill in the following fields:

Desired Available

Lets you specify the default desired status of the resource. The desired state of each resource is either Available or Unavailable, which is the goal that automation tries to achieve.

You can specify the following values:

ALWAYS

The desired state of the resource is set to Available, unless it is dependent on a resource that has a Desired Available setting of ONDEMAND. In this case the resource behaves as if it had a Desired Available setting of ONDEMAND itself.

This is the same behavior as in earlier releases of SA z/OS.

ONDEMAND

If there is *demand* for the resource to be available, its desired status is set to Available, otherwise its desired status is set to Unavailable.

Demand arises either from propagated MakeAvailable votes or implicitly through membership of a non-passive basic application group (APG) that has a desired status of Available. Demand does not arise from dependent resources with a Desired Available setting of ALWAYS.

A MakeAvailable vote that is propagated to the resource overrides any demand considerations.

An active ONDEMAND member of a move or server group is always sent a vote that sets its desired status, thus overriding any demand considerations.

ASIS The desired status is always set to the observed status. The resource remains in the status that it currently has and no action is taken by SA z/OS at any time, as long as there is no request placed for or propagated to the resource.

Note:

If nothing is specified or inherited the default value is ALWAYS.

Prepare Move

Specifies whether the downtime during the move or switch of a resource should be kept as short as possible. For more details see "Prepare Move" on page 117.

Move Mode

Specifies how a move is made from an old member to a new one. For more details see "Move Mode" on page 118.

Inform List

This field allows you to specify:

- Where the application is registered to
- Where all status changes are propagated to
- Whether SMF records are written

Valid receivers are SDF, NMC, IOM, SMF, EIF, TTT and USR. You can specify more than one receiver. The list of values can be blank or comma separated.

If nothing is specified, no status changes are propagated.

Resident CLISTs Entry Type

Because NetView automatically loads frequently used REXX scripts (CLISTs) into storage, you do not need to define your own resident REXX scripts. However, if you want to do this, you can define resident CLISTs that will then be automatically loaded during SA z/OS initialization.

A resident CLIST is a REXX script that is loaded into and kept in NetView storage for the first and all subsequent calls.

Resident CLISTs can improve performance by removing the overhead required to access REXX script that are stored on a direct access storage device (DASD) each

Resident CLISTs Entry Type

time the REXX script is called. Resident CLISTs are automatically loaded into main storage, using the NetView LOADCL command, during initialization of the automation environment. See *Tivoli NetView for z/OS Automated Operations Network User's Guide* for more information on using the LOADCL command for REXX scripts.

If a new automation control file is loaded after SA z/OS is up and initialized, and that automation control file contains fewer automation procedures in the resident portion than the original automation control file loaded at initialization, even if the procedures are not specified in the new file, they will not be dropped from storage. For example, if the original automation control file contained procedures A, B and C to be loaded resident, and the new automation control file contains procedures A, B, and D to be loaded resident, procedure D will be loaded but procedure C will not be dropped.

Policy Items for Resident CLISTs

Figure 231 shows the policy items that are displayed when a new Resident CLISTs entry is defined or when an existing Resident CLISTs entry is selected from the Entry Name Selection panel.

```

  ACTIONS  HELP
-----
AOFGEPOL          Policy Selection          Row 1 to 5 of 5
Command ==> _____ SCROLL==> PAGE

Entry Type : Resident CLISTs          PolicyDB Name : USER_PDB
Entry Name : AOF_BASIC                Enterprise Name : USER_ENTERPRISE

Action      Policy Name      Policy Description
-----
            DESCRIPTION    Enter description
            CLISTS         Define command lists to load to main storage
-----
            WHERE USED     List systems linked to this entry
            COPY           Copy data from an existing entry
***** Bottom of data *****
```

Figure 231. Policy Selection Panel for Resident CLISTs

The unique policy item for Resident CLISTs sets is:

CLISTs

This option allows you to enter the names of the REXX scripts (CLISTs) that you want to be made resident during initialization of SA z/OS.

Status Display Entry Type

The status display facility (SDF) provides a display of automated systems and resources using assigned status colors. An operator monitors the status of automated systems and resources by viewing the SDF main panel. Typically, for example, an application shown in green on an SDF status panel indicates the application is up, while red indicates the application is stopped or in a problem state. Operators can use the SDF to monitor the system and decide which actions to take when problems occur. This section describes the entries used to define the SDF in the customization dialog. You only need to change these entries if you use values other than the SA z/OS-provided defaults. The entries specified here define statuses and the priorities assigned to those statuses. These entries are used by SA z/OS common routines to gather data for requests to add status descriptors to status components. Additional parameters manage existing status descriptors and eliminate redundancy.

If no definitions exist the SA z/OS are in effect. For more details, see *IBM Tivoli System Automation for z/OS User's Guide*

Policy Items for Status Display

Figure 232 shows the policy items that are displayed when a new Status Display policy object is defined or when an existing Status Display object is selected from the Entry Name Selection panel.

```

ACTIONS  HELP
-----
AOFGEPOL          Policy Selection          Row 1 to 5 of 5
Command ==> _____ SCROLL==> PAGE

Entry Type : Status Display      PolicyDB Name  : USER_PDB
Entry Name  : STATUS_DETAILS_NAME Enterprise Name : USER_ENTERPRISE

Action      Policy Name      Policy Description
-----
            DESCRIPTION    Enter description
            SDF DETAILS     Enter status display facility details
            -----
            WHERE USED      List systems linked to this entry
            COPY             Copy data from an existing entry
            ***** Bottom of data *****

```

Figure 232. Policy Selection Panel for Status Display

The unique policy item for Status Display is:

SDF DETAILS

You can use this policy item to define colors and highlights associated with each status.

See "SDF DETAILS Policy Item" for more information about this policy item.

For more information on SDF customization, see *IBM Tivoli System Automation for z/OS User's Guide*.

SDF DETAILS Policy Item

A panel similar to Figure 233 is displayed if you select the SDF DETAILS policy item from the Policy Selection panel for Status Display.

These entries are show as an example but are not required in the definition. Please refer to the Table in the section "Subsystem Colors and Priorities" of *IBM Tivoli System Automation for z/OS User's Guide* for a list of SDF default settings.

```

COMMANDS  HELP
-----
AOFGSCR          Status Display Facility Details      Row 1 to 2 of 64
Command ==> _____ SCROLL==> PAGE

Entry Type : Status Display      PolicyDB Name  : USER_PDB
Entry Name  : STATUS_DEFINITIONS Enterprise Name : USER_ENTERPRISE

Status  Priority Highlight Color      Clear      Srv Req(noadd)
-----
STARTED2 230    BLINK     PINK      (Y,RV*)   -
STUCK    240    UNDERSCORE PINK      (Y,RV*)   -

```

Figure 233. Status Display Facility Details Panel

The fields are:

SDF DETAILS Policy Item for Status Display

Status Any required name. The name must start with an alphabetic or numeric character or one of '@, #, or \$'. All other characters must be alphabetic, numeric, or one of '@, #, \$, ?, _ , !, or ¢. This value can be up to 8 characters long. It is recommended that you use the SA z/OS default statuses.

Priority

The priority number assigned to a particular status type. PRIORITY must be a valid number in the range specified in the AOFINIT member. Normally, priority determines the color displayed for a status. This is the recommended method. If the priority is not defined, the default is 99999999.

Highlight

The type of highlighting used for a particular status type. If this field is not specified, or HL=P is specified, highlighting is determined by the panel definition.

Color The color used for a particular status type. This is the color override entry. Use this parameter to override the priority and color relationship that is defined in the AOFINIT member. Although the color of the status descriptor is changed, the priority is still determined by the order that the status descriptor is chained in.

There is no default color associated with an SA z/OS status. Any color specifications defined using this parameter override the color defined for the range that the priority is in.

Clear The CLEAR parameter helps manage redundant status descriptors. With SA z/OS, the reference value on a status descriptor is usually the status component name. This option is only available for statuses defined in the automation control file and accessed by SA z/OS common routines described in *IBM Tivoli System Automation for z/OS Programmer's Reference*. The following values are allowed:

Y Deletes any existing status descriptor for this status component with the same reference value as the status descriptor being added. This verifies that, for any given status component, there is only one status descriptor reflecting the true status.

(Y,RV*)

Performs the same function as CLEAR=Y, and also deletes status descriptors with reference values prefixed with the same reference value (followed by anything else). For example, if the existing status descriptor for RMF has a reference value of RMF1, and the status descriptor being added has a reference value of RMF, the RMF1 status descriptor is deleted before the new RMF status descriptor is added.

(Y,RV)

Performs the same function as CLEAR=(Y,RV*) but the reference value must be the same (not a wildcard).

(Y,RV*,DA)

Performs the same function as CLEAR=(Y,RV*), and also deletes all status descriptors with similar data in the data field. (The data field is defined with the DATA keyword on the SDF request that adds the status descriptor to a chain of status descriptors.)

(Y,RV2*,C0)

Performs the same function as CLEAR=(Y,RV*) with the following differences:

SDF DETAILS Policy Item for Status Display

- The color of the existing status descriptor must be the same as that specified in the color entry before it is deleted.
- Status descriptors that have reference values prefixed with the new reference value followed by the number 2 are deleted, provided that the color matches the status descriptor that is being added.

N Indicates that redundant status descriptors are not deleted.

Srv Determines the format of the reference value that is generated for this entry.

Y Generates Status_component/Status.

N or blank

Generates Status_component.

Req (noadd)

Specifies whether the component with this status is to be added to the SDF chain:

blank

The entry is to be added. This is the default value.

NOADD

The entry is not to be added.

Note:

Combining NOADD with Clear=Y causes a component to be removed from the SDF display when this status is reached.

User E-T Pairs Entry Type

This entry type allows you to create your own entry-type pairs and associated keywords in the same format as those used by SA z/OS.

You can use User E-T Pairs to store data for your own automation procedures in the automation control file. User E-T Pairs are provided for situations where there is no suitable, predefined SA z/OS entry type. Using the automation control file to store policy-specific information helps keep your automation procedures generic.

Policy Items for User E-T Pairs

Figure 234 on page 300 shows the policy items that are displayed when a new User E-T Pairs policy object is defined or when an existing User E-T Pairs object is selected from the Entry Name Selection panel.

User E-T Pairs Entry Type

```

ACTIONS  HELP
-----
AOFGEPOL          Policy Selection          Row 1 to 5 of 5
Command ==> _____ SCROLL==> PAGE

Entry Type : User E-T Pairs      PolicyDB Name  : USER_PDB
Entry Name  : USER_ET_NAME      Enterprise Name : USER_ENTERPRISE

Action      Policy Name      Policy Description
-----
            DESCRIPTION  Enter description
            E-T DATA    Define User Entry-Type pairs
-----
            WHERE USED   Lists Systems linked to this entry
            COPY         Copy data from an existing entry
  
```

Figure 234. Policy Selection Panel for User E-T Pairs

The unique policy item for User E-T Pairs is:

E-T DATA

This policy item enables you to specify entry-type pairs for the set. You can also enter a description for each pair. See “E-T DATA Policy Item” for more information on this policy item.

E-T DATA Policy Item

Figure 235 shows the UET Entry-Type Selection panel.

```

COMMANDS  ACTIONS  VIEW  HELP
-----
AOFGUET          UET Entry-Type Selection      Row 20 from 40
Command ==> _____ SCROLL==> PAGE

Entry Type : User E-T Pairs      PolicyDB Name  : USER_PDB
Entry Name  : JOBCARDS          Enterprise Name : USER_ENTERPRISE

Action  Entry Name      Type
-----
        JOBCARD        DEFAULTS
  
```

Figure 235. UET Entry-Type Selection Panel

The **Entry Name** and **Type** fields define a unique set of key-data pairs. In general, the **Entry Name** field can contain any name except subsystem names that already exist in the policy database. The **Type** field can be used to identify groups of information for the entry name. You can define wildcards and types by appending the asterisk (*) character to the type value.

The following actions are possible:

S(ELECT)

To select the entry-type pair for further processing. Another panel, similar to Figure 236 on page 301, is displayed where the keyword-data pairs can be entered.

E(DIT)

To select the entry-type pair to change the value of any of entry, type, short and long description.

D(ELETE)

To delete the complete entry-type pair with all associated keyword-data pairs.

The following VIEWS are possible:

- Entry-type pairs only
- Entry-type pairs with their short description
- Entry-type pairs with their long description

When you enter an E (for Edit) in the **Action** column, another panel, similar to Figure 236, is displayed where you can enter the keywords and user data for each Entry-Type pair.

A keyword is an identifier for the data that follows it. The set of keyword/data pairs may be null, and a keyword does not have to be unique; that is, each keyword may have multiple sets of data assigned to it.

The following rules apply to the user data:

- Data containing the special characters (),' or imbedded spaces must be enclosed in delimiters. Valid delimiters are single quotation marks, double quotation marks, or parentheses.
- Any imbedded single quotation marks will be automatically doubled by the processing logic of the UET Keyword-Data Specification panel. For example, ABC'DEF'GHI will be changed to ABC"DEF"GHI
- Imbedded single quotation marks must appear in pairs.

```

COMMANDS  HELP
-----
AOFGDYNU  UET Keyword-Data Specification
Command ==> _____ Scroll ==> PAGE

Entry: JOBCARD                      Type: DEFAULTS
Mixed case . . . NO_ (YES NO)       Keyword length. . . 20 (1-60)

Cmd Keyword                          Data
---
JOBNAME                               HAIAOC3*
CLASS                                 A
MSGCLASS                              N
MSGLEVEL                              (1,1)
REGION                               4096K
***** Bottom of data *****

```

Figure 236. UET Keyword-Data Specification Panel

The UET Keyword-Data Specification panel allows you to manage the list of keyword-data pairs for one entry-type pair of one User E-T pair entry.

You can define multiple keyword-data pairs for each entry-type pair. By default, the first 20 characters of the keyword value is shown. The length of the data value that is displayed depends on your screen width (for a 24x80 screen, it is 55 characters).

From this panel you can:

- Specify whether the value entered in the **Data** field remains unchanged (Mixed case=YES) or is automatically translated to uppercase characters (Mixed case=NO)
- Change the length of the field that the keyword value is displayed in using the **Keyword length** field
- Use the following line commands on the existing lines to enable you to easily add, remove and manage keyword-data pairs:
I*nn* Insert one or *nn* new lines after the selected line
R*nn* Repeat the selected line one or *nn* times

E-T DATA Policy Item for User E-T Pairs

Dnn Delete the selected line and the following *nn* lines
Mnn Move the selected line and the following *nn* lines
A Move lines after the selected line
B Move lines before the selected line

- Change data by overtyping the current values.

If necessary, use F11 to scroll to the right to view more of the data field.

| You can use the FIND command on the UET Keyword-Data Specification panel to
| search the displayed data for a specific string. For more details, see “How to Find
| Data in a Policy Item” on page 23.

| Note that only the data that is *visible* is searched through in the **Keyword** column.
| You should therefore consider expanding the column width so that the complete
| keyword is visible before performing a search.

From within a REXX exec, you can retrieve the data entered in the UET
Keyword-Data Specification panels using the ACFFQRY command. An example is
provided in “How to Use User E-T Pairs” on page 65

More than one set of User E-T Pairs may be attached to a system, but it is
recommended that you attach only one to avoid data being overwritten during
initialization of SA z/OS.

Chapter 5. Policy Database Maintenance

Option 4 (**Policies**) of the Customization Dialog Primary Menu panel allows you to maintain the list of your policy databases and to access various panels for selected policy databases.

Policy Database Selection List

If you have already created one or more policy databases, they are listed in the Policy Database Selection panel, as shown in Figure 237.

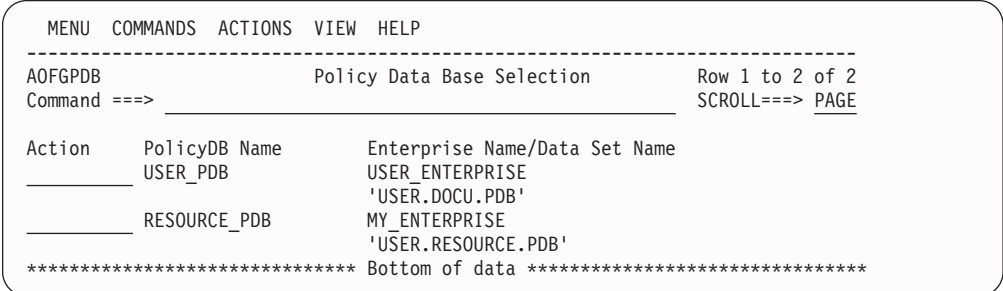

```

MENU  COMMANDS  ACTIONS  VIEW  HELP
-----
A0FGPDB          Policy Data Base Selection          Row 1 to 2 of 2
Command ==>>>          SCROLL==>>> PAGE

Action  PolicyDB Name      Enterprise Name/Data Set Name
-----  -
        USER_PDB          USER_ENTERPRISE
        'USER.DOCU.PDB'
        RESOURCE_PDB      MY_ENTERPRISE
        'USER.RESOURCE.PDB'
***** Bottom of data *****

```

Figure 237. Policy Database Selection Panel

Databases created with the NEW command automatically appear in your policy database list. You can add other databases if you know the name of their data set and have the appropriate authority to update them. You can only work with one policy database from your list at a time.

To select a policy database:

1. Move the cursor to the line containing the database you want to use.
2. Enter s in the **Action** column on that line.

The selected policy database is opened, and the Entry Type Selection panel for that database is displayed. At this point you are ready to start defining your enterprise.

The commands and actions available from the Policy Database Selection panel are:

(O) OPEN

This option lets you access the policy data for that database. The Entry Type Selection panel is displayed. With this option, you can edit the contents of policy database . See Figure 1 on page 6.

(N) NEW

This option lets you create a new policy database as described in “Creating a New Policy Database” on page 305. The Create a New Policy Database panel is displayed. See “Creating a New Policy Database” on page 305 for more details.

(E) EDIT

This option lets you change the Enterprise name and data set name of your policy database for the build, report, and log output. To change the data within the database, you must OPEN it. Using the EDIT option, you can also start and stop the logging of user activity. For more information, see “Specifying Settings for Policy Databases” on page 310.

Policy Database Maintenance

(D) DELETE

This option lets you delete the policy database data set, and all references to the policy database. SA z/OS will display a panel asking you to confirm your request.

SA z/OS does not provide any extended security to prevent you from deleting policy database data sets. This must be provided by a System Authorization Facility (SAF) product such as RACF®.

Note:

SA z/OS does not allow you to delete more than one policy database at a time. If you enter multiple delete requests in the **Action** column, the first request is processed and the remainder are ignored.

(A) ADD

This option lets you add a policy database to the displayed list. You enter a policy database name, an enterprise name and the name of a policy database data set that already exists.

(M) REMOVE

This option lets you remove the policy database details from the displayed list. The data set itself is not affected.

Note:

If you remove a policy database from *all* display lists, the policy database still exists as a z/OS data set.

(B) BUILD

This option displays the Build Functions Menu. You can build various configuration files. This function is explained in Chapter 7, “Building and Distributing Configuration Files,” on page 323.

(G) MANAGE

This option will take you to the Data Management Menu panel shown in Figure 254 on page 343, which allows you to import policies into a policy database of the current release of SA z/OS.

You can find more information about this option in Chapter 9, “Data Management,” on page 343.

(R) REPORT

This option displays the Report Selection Menu for the selected policy database. You can create a report of all automation data in the policy database. The report offers options to report either the full automation policy, or to select a specific entry type and name to be reported.

You can either create an unformatted file to be viewed in a TSO session, or an HTML file to be viewed by an Internet Browser.

The following reports can be created:

- A report for all objects in the policy database, that will not be used for building the system operations configuration files (unlinked entries and relationships).
- A report for all automatically generated resources, which are the resources of type APL, APG, and MTR.

- A report of all members in the system operations build output data set, that are not referenced by the actual configuration.
- A status message report.

For more information, see Chapter 6, “Creating Reports about Policy Databases,” on page 315.

(V) VIEW

This option toggles between two views. The summary view displays the policy database name and enterprise name for each policy database on one line. The extended view displays a second line for each policy database, giving the data set name.

(L) LOCATE

Entering LOCATE lets you position yourself within the displayed list. If the entry is identical, the selected entry is the first in the list. If the entry is not identical, the next higher (alphabetically) entry is the second in the list. This is the same as the ISPF LOCATE function.

Creating a New Policy Database

A policy database is a partitioned data set (PDS) that contains policy data in its members. To create a new policy database, follow these steps:

Step 1. Select option 4 (*Policies*) on the Customization Dialog Primary Menu.

This takes you to the Policy Database Selection panel, shown in Figure 238, which lists all policy databases that are currently available.

You can toggle the display of the data set and enterprise name in the VIEW pull-down menu.

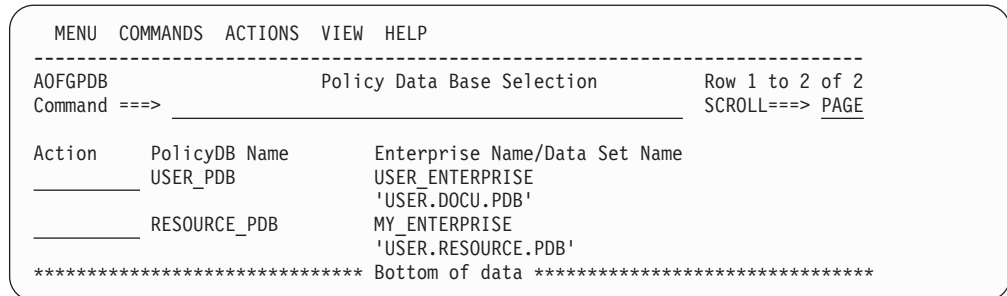

Figure 238. Policy Database Selection Panel

Step 2. Enter N or NEW on the command line.

This takes you to the Create a New Policy Database panel, shown in Figure 239 on page 306.

Creating a New Policy Database

COMMANDS	ACTIONS	HELP

AOFGPDBN	Create a New Policy Database	Row 1 to 8 of 15
Command ==> _____		
To define a new Policy Database, specify the following information:		
Policy Database Name . .	_____	
Enterprise Name.	_____	
Data Set Name.	_____	
Model Policy Database. .	*BASE	Policy Database name or "?" for list of names
Add-on policies to be added to a standard SA model policy database:		
Action	Status	Add-on Policy Customizable
_____		*CICS
_____		*DB2
_____		*E2E
_____		*GDPS
_____		*HYPERSWAP
_____		*IBMCOMP YES
_____		*IMS
_____		*ITM YES

Figure 239. Create a New Policy Database Panel

Step 3. Fill in the fields on this panel:

- The **PolicyDB Name** field is mandatory. Enter the name of the new policy database; this can be up to twenty characters in length.
- The **Enterprise Name** field is mandatory. This can be up to twenty characters in length. You can use the same value as in the **PolicyDB Name** field.
- The **Data Set Name** field is mandatory. This can be any valid z/OS data set name. Standard rules for quoted and unquoted data set names apply.

If you enter the name of an existing data set, a warning is issued. If you enter a name that has not been given to an existing data set, a new data set will be created. The policy database that you are creating will be stored in that new data set.

- The **Model PolicyDB name** field is mandatory. This must be an existing policy database name. The new policy database that you are creating will contain a *copy* of the model policy database.

You can use either of the SA z/OS sample policy databases *BASE or *EMPTY or a database that is currently in your list of policy databases.

If you do not want your new policy database to contain data that is copied from an existing policy database, use *EMPTY in this field.

If you want to see what model databases are available, type "?" in this field and press Enter. This will display the Select Model Policy Database panel that you can select a database from.

Note

If a user PDB is selected (that is, one without a '*' as the first character), no add-on PDBs can be selected.

- Selecting one or more of the sample add-on policies from the list on the panel is optional. If you do make a selection, the new policy database that you are creating will contain a copy of each add-on that you have selected. If an add-on policy is marked as customizable, this means that

it contains components that can be separately selected (for example, *ITM contains definitions for OMEGAMON II and OMEGAMON XE monitors).

Note:

Each of the sample add-on policies that are shipped with SA z/OS contain definitions that fully complement those in *BASE and *EMPTY.

Step 4. Press Enter to submit your input.

This takes you to the New Policy Database Data Set Information panel, shown in Figure 240.

```

COMMANDS  HELP
-----
AOFGPDBO          New Policy Database Dataset Information
Command ==>>>

New Policy Data Base : TEST
Attributes to be used for allocation of the new data set:

Managed storage. . . . . NO          YES    NO
Management class . . . . .          Blank for default management class  *
Storage class. . . . .          Blank for default storage class    *
Volume serial. . . . .          Blank for authorized default volume
Data class . . . . .          Blank for default data class      *
Space units. . . . . CYLINDERS      CYLS TRKS BLKS KB MB
Primary quantity . . . 1          1 to 999 - In above units
Secondary quantity . . 1          0 to 999 - In above units
Directory blocks . . . 50         1 to 999 or blank - Required for PDS
Record format. . . . : FB
Record length. . . . : 80
Block size . . . . . 32720
Data Set Name type . . PDS        LIBRARY  PDS          *
Device Type. . . . . SYSDA

* Used only if Managed storage = YES

Press ENTER to start creation of new PolicyDB.
    
```

Figure 240. New Policy Database Data Set Information Panel

Step 5. The fields that you must enter data in are listed below. For fields that are not explicitly explained, see the appropriate z/OS literature.

Managed Storage

This indicates whether the data set should be allocated on managed storage. If this field is set to YES, the fields marked with an * are used to allocate the data set. If NO is specified then these fields may be specified but are not used.

Management class

This specifies the management class that should be used to obtain the data management related information for the allocation of the data set.

Storage class

This specifies the storage class that should be used to obtain the storage related information for the allocation of the data set. The following data, related to storage class, can be specified if you are not using managed storage or you have not specified a storage class or if you wish to override the default storage class values.

Creating a New Policy Database

Volume serial

The volume that the database is to be stored on. If this field is left blank, it defaults to your local system default.

Data class

This specifies the data class that should be used to obtain the data related information for the allocation of the data set. The following data, related to data class, can be specified if you are not using managed storage or you have not specified a data class or if you wish to override the default data class values:

Space Units

Valid allocation units for the data set are:

- CYLINDERS (this is the default)
- TRACKS
- BLOCKS
- MEGABYTES
- KILOBYTES

Primary quantity

This specifies the primary space allocation in space units. The default is 1.

Secondary quantity

This specifies the secondary space allocation in space units. The default is 1.

Directory blocks

Number of blocks to allocate for the directory. This field is only used when allocating a PDS. The default is 50.

Record format

This is FB and cannot be changed.

Record length

This is 80 and cannot be changed.

Block size

This defines the block size for the data set. It must be a multiple of 80. The default is 32720.

Data Set Name type

This indicates whether the data set is to be allocated as a partitioned data set (PDS) or partitioned data set extended (LIBRARY).

Device Type

The type of storage device. This field defaults to SYSDA.

Note:

Many installations regularly delete data sets that are created on SYSDA volumes. If you want to create a permanent policy database you should not create it on a SYSDA volume. If the data set for a policy database is deleted, you will receive an error message when you attempt to open it. You can either recreate the data set if you have a backup, or enter M (REMOVE) against the policy database to remove it from your policy database list. Entering D (DELETE) will result in an error, because the data set has already been deleted.

Note:

The DASD allocation figures shown in Figure 240 on page 307 are a suggested minimum only. Your actual storage requirements depend on the size of your enterprise.

Step 6. Press Enter to submit your input.

This creates the new policy database. SA z/OS displays a Command Progress Display panel. When database creation is finished, the Entry Type Selection panel is displayed for the new database.

Using SA z/OS Sample Policies

SA z/OS provides sample enterprise organizations implemented as SA z/OS policies. The sample policies that are shipped with SA z/OS are installed when the SA z/OS customization dialog is installed.

To see what sample policies there are, navigate to the Create a New Policy Database panel as described in “Creating a New Policy Database” on page 305. The asterisk character (*) at the start of a policy name on that panel indicates that it is a sample.

Diagrams of the sample policies are also provided as PDF files that are located in the USS installation path. The default for this path is: /usr/lpp/ing/doc/policies/.

You can never modify the sample policies themselves. You can only modify *copies* of the samples. To create a copy of a sample policy, follow the steps in “Creating a New Policy Database” on page 305 and select the sample that you want to copy in step 3 on page 306.

For information on how to *import* a sample policy into an existing policy database, see “Importing Sample Add-On Policies” on page 347.

There are two kinds of sample policies: basic and add-on.

The basic policies are:

*EMPTY

This sample is simply an empty policy database.

Creating a New Policy Database

*BASE

This sample policy simplifies the exploitation of basic system automation using SA z/OS. This allows users to startup and shutdown a basic z/OS computing environment within a sysplex.

The *BASE policy contains the main z/OS, networking and security components that are required in most client shops:

1. z/OS Link List Look-Aside
2. z/OS Base components
3. z/OS Base applications
4. Networking components
5. Security components
6. SA z/OS components

The computing environment consists of three systems running within a sysplex. This environment is considered to be an appropriate base for high availability solutions, delivered as add-on model policies. Depending on your needs, these models can easily be tailored to less or more than three systems, just by unlinking or removing, or adding or linking systems.

A single system needs to be defined as a sysplex with only one system.

The add-on policies are:

- *CICS
- *DB2
- *E2E
- *GDPS
- *HYPERSWAP
- *IBMCOMP
- *IMS
- *ITM
- *NMC
- *PROCOPS
- *SAP
- *TBSM
- *TWS
- *USS
- *WEBSPPHERE

For information on what is in the sample add-on policies, use the view (v) action on the Create a New Policy Database panel (shown in Figure 239 on page 306).

Specifying Settings for Policy Databases

Specifying the Edit option from the Policy Database Selection panel for a policy database leads to the Settings for Policy Database panel, as shown in Figure 241 on page 311.

```

COMMANDS  HELP
-----
A0FGPDBE          Settings for Policy Data Base USER_PDB
Command ==> _____

Enterprise and data set names:
Enterprise Name . . . . . USER_ENTERPRISE _____
PolicyDB data set name. . . 'MULTISYS.PDB' _____
Build output data set . . . 'MULTISYS.SOCNTL' _____
Report output data set. . . 'MULTISYS.PDB.REP' _____
Report output file system . /u/oper/ _____
Data set names for update via file:
Output file name . . . . . _____
Input file name . . . . . _____

PolicyDB activity log options:
Write log entries . . . . . ON (ON OFF)
Log data set name 1 . . . . 'MULTISYS.PDB.LOG1' _____
Log data set name 2 . . . . 'MULTISYS.PDB.LOG2' _____

NetView Automation option:
AT/MRT scope . . . . . SYSTEM (NONE ENTERPRISE SYSPLEX SYSTEM)

```

Figure 241. Settings for Policy Database Panel

The first set of fields on this panel allows you to specify **Enterprise and data set names**, as follows:

Enterprise Name

This allows you to re-specify the enterprise name. If this policy database has also been added to the Policy Data Base Selection list of other users they need to REMOVE or ADD the policy database to get the new name.

PolicyDB data set name

This allows you to re-specify the enterprise data set name.

Build output data set

This allows you to specify where you want the configuration files that are created by the System Operations build to be stored.

Report output data set

This allows you to specify where you want the output, created by the REPORT function, to be stored. It is not recommended that you store the output as a member of the policy database itself due to record length problems.

If you leave the field empty, SA z/OS allocates a data set with a default name (the policy database data set name extended with .REP as the low-level qualifier) and a default size.

If you do specify a data set name, SA z/OS allocates a data set with that name and a default size.

If you preallocate a data set and specify the name here, SA z/OS uses that data set. For the complete policy database report, it is recommended that you use format VB and a record length of 1000 to avoid truncations.

For other reports, a record length of 132 is usually sufficient (see Figure 243 on page 315 for a list of other reports that are available).

Report output file system

This allows you to specify the UNIX system where the report output should be stored. No upper case translation is performed. If a directory is specified that does not exist, it is created.

Specifying Settings for Policy Databases

Output file name

This specifies where you want the output created by the file update function to be stored. It needs to be a sequential file. You can leave the output file name field empty. If you do, SA z/OS will allocate a data set with a default name (policy database data set name extended with a low level qualifier of .UPD) and a default size. If you specify a sequential file name that has not been preallocated, SA z/OS will allocate a data set with that name and a default size. If you preallocate a sequential file and specify the name here, SA z/OS will use that file. It is recommended to use format VB and a record length of 255 to avoid truncations.

Input file name

This specifies where you want the input created by the file update function to be stored, or the input for the policy database update to be read from. It needs to be a sequential file.

The second set of fields allows you to set **PolicyDB activity log options** for this policy database. See “Logging Policy Database Modifications” for more details.

The last section on this panel, **NetView Automation option AT/MRT Scope**, allows you to define the scope of the NetView Automation Table and Message Revision Table that are created by the configuration file build. See “Setting AT/MRT Scope” on page 334.

Logging Policy Database Modifications

With SA z/OS you can write a log entry whenever a modification has been made for a specific Policy Database by using the policy database activity log option on the Settings for Policy Data Base panel (see Figure 241 on page 311). Fill in the following fields:

Write log entries

Turns logging ON or OFF for this Policy Database. The default value is OFF.

Log data set name

This allows you to specify two data sets for the activity log. Whenever a data set runs out of space or cannot be accessed for some reason, the dialog switches automatically to the alternate data set and continues writing the log records there.

The alternate log data set is cleared and exit routine INGEX09 is called to allow user-specific actions, such as backing up the data set.

If you leave this field blank, SA z/OS allocates data sets with a default name (the policy database data set name extended with .LOG1 or .LOG2 as low level qualifier) and a default size.

If you specify a data set name, SA z/OS allocates a data set with this name and a default size.

If you preallocate a data set and specify the name here, SA z/OS uses this data set.

It is recommended that you use format VB and a record length of 250 to avoid truncations.

If the Settings for Policy Data Base panel is invoked and the specified policy database data set cannot be accessed, the log option fields are initially empty.

Specifying Settings for Policy Databases

Whenever the policy database data set name is changed, the current log options are read from the policy database and displayed on the panel.

The following information is logged:

- Editing a policy item (for example, changing an automation flag or a command)
- Changing a link, which includes:
 - Entry type links, for example, a link between an application and an application group
 - Links of instances and classes
 - Resource links
- Adding events to a trigger
- Invoking the DATA MANAGEMENT functions (these commands change the policy database content)
- Invoking control file build (it writes build statistics into the policy database)
- Creating and deleting objects
- Copying objects
- Errors (as long as a policy database is open)
- Renaming objects

The following information is *not* logged:

- Option changes (using selection *0 Settings*)
- Data set name changes (EDIT)
- REPORT function invocations
- VIEW functions (for example, view build report)
- Initial conversion of the policy database (when invoked the first time with SA z/OS)
- Invocation of batch functions, for example, batch build

A log entry includes the user ID, timestamp, and the policy item that was changed, or the command name and parameters if available. An example of an activity log is shown in Figure 242 on page 314.

```

2004/04/21 16:50:35 RTL : Log Data Set Created
2004/04/21 16:51:01 RTL : PDB activity logging turned on
2004/04/21 17:05:39 RTL : APL AUTOMATION_MANAGER EDIT
2004/04/21 17:05:50 RTL :
2004/04/21 17:05:51 RTL : modified policy LINK TO INSTANCES
2004/04/22 08:40:45 RTL : APL AUTOMATION_MANAGER_1 EDIT delinked from INSTANCE CICS_FOR_ENTRY
2004/04/22 08:41:17 RTL : modified policy DESCRIPTION
2004/04/22 08:41:36 RTL : modified policy AUTOMATION INFO
2004/04/22 08:41:45 RTL : modified policy LINK TO CLASS
2004/04/22 08:41:46 RTL : delinked from CLASS AUTOMATION_MANAGER
2004/04/22 08:41:52 RTL : modified policy LINK TO CLASS
2004/04/22 08:41:53 RTL : linked to CLASS AUTOMATION_MANAGER
2004/04/22 08:42:16 RTL : TMR ALL_TIMERS EDIT
2004/04/22 08:42:26 RTL : modified policy WHERE USED
2004/04/22 08:42:27 RTL : delinked from SYS AOCMIG1
2004/04/22 08:42:27 RTL : linked to SYS 99999
2004/04/22 08:42:51 RTL : modified policy TIMERS
2004/04/22 08:43:18 RTL : delinked from SYS AOCMIG1
2004/04/22 08:43:30 RTL : APG APG_AOCSYSM1 DELETE
2004/04/22 08:45:13 RTL : APG APG4ALLSYS NEW
2004/04/22 08:45:26 RTL : modified policy WHERE USED
2004/04/22 08:45:26 RTL : linked to GRP AOCPLEX
2004/04/22 08:45:48 RTL : modified policy APPLICATIONS
2004/04/22 08:45:48 RTL : linked to APL OPC_DATASERVER_ENTRY
2004/04/22 08:45:49 RTL : linked to APL OPCDUMY1
2004/04/22 08:45:50 RTL : linked to APL OPCDUMY2
2004/04/22 08:46:05 RTL : * * BUILD
2004/04/22 08:46:05 RTL : options: 1 REPORT.CFG ONLINE MODIFIED NORMAL
2004/04/22 08:47:18 RTL : terminated: return code 0

```

Figure 242. Example of an Activity Log

Chapter 6. Creating Reports about Policy Databases

If you select option *3 Report* of the Customization Dialog Primary Menu shown in “How to Start the Customization Dialog” on page 16, the panel shown in Figure 243 is displayed, where you can create reports about various SA z/OS objects.

```

MENU  HELP
-----
A0FGREPK                               Report Selection Menu
Option ====> _____

  1 Report          Create Policy Database Report
  2 Unlinked        Create List of entries not linked in Policy Database
  3 ViewUnlinked    View List of unlinked entries

  4 Resources       Create List of generated Resources
  5 ViewResources   View List of generated Resources

  6 MemberList      Create List of unused members in configuration data set
  7 ViewMemberList  View List of unused members

  8 StatusMsgs      Create Status Messages Report
  9 ViewStatusMsgs View Status Messages Report

  A Symbols         Create List of Symbols (AOCCLOEx) in Policy Database
  B ViewSymbols     View List of Symbols
```

Figure 243. SA z/OS Report Selection Menu

1 Report

Use this option to create a report that includes all the automation data of the selected policy database. SA z/OS displays the Policy Data Base Report Parameters panel, as shown in Figure 244 on page 316, where you can choose to create either the full automation policy report, or to create a report about a specific entry type and name. You can also run this function in batch mode.

Creating Reports about Policy Databases

```
OPTIONS  HELP
-----
AOFGRPTP          Policy Data Base Report Parameters
Option ==>>> _____

  1 Create report for a complete enterprise
  2 Create report for entry type or entry name
      Entry Type. . . . . _____ (*, ?, or type)
      Entry Name. . . . . _____ (*, ?, or name)

Report options:
Data set type . . . . . PDS          (PDS FS)
PDS name . . . . . USER.MYPDB.REP
File system directory . /u/oper/
Member / file name . . $RPTHTML
Mode . . . . . ONLINE          (ONLINE BATCH)
Format . . . . . FLAT          (FLAT HTML)
HTML file split . . . . 1          (1 to 99 or *)

Job statement information: (used for BATCH report)
//AOFRPT  JOB
//*
//*
```

Figure 244. Policy Data Base Report Parameters Panel

Use the **Report options** section of the panel to specify how the report is created and saved.

Data set type

Specify the output type for the report:

PDS The report is stored as a partitioned data set.

FS The report is written to a UNIX file system (HFS or ZFS).

The default is PDS.

PDS name

If the data set type is PDS, this field can remain empty. A default data set name is assumed and a default allocation is performed. Any user input is translated to upper case.

File system directory

If the data set type is FS, you need to enter the file system directory. There is no default. No uppercase translation is performed. If you specify a directory that does not exist, it is created.

Member / file name

Specify the member or file name for the report. The default is \$RPTHTML or \$RPTFLAT. Any name that you specify is saved across sessions.

For a PDS it must be a valid TSO member name. When it is downloaded to a PC, you must add the file extension .html. Note also that the file name for FS is *case-sensitive*.

If you choose to split an HTML file that is targeted to a PDS, the last 1 or 2 characters of the file name are replaced with a serial number. This is 1-*n* if you specify a single figure split value, or 01-*nn* for a 2-digit value. Thus, \$RPTHTML becomes either \$RPTHTM1-\$RPTHTM*n* or \$RPTHT01-\$RPTHT*nn*.

If split files are directed to an FS director, the running number is appended to the specified member name, and a .html suffix is added as the files are written.

If a member with the specified or generated split-file name already exists, you are asked to confirm the report generation before it is overwritten.

Mode

Specify whether the report should be created in the foreground (ONLINE) or background (BATCH). The default is ONLINE.

Format

Specify the format of the report:

- FLAT creates a plain text file to be viewed in a TSO session.
- HTML creates an HTML file that you can view with your Internet browser. This version of the report creates hyperlinks for all entry names and resource names that take you to the start of the data for the selected entry or resource. These links also work if the HTML report has been split into several files. Note however that a hyperlink is not created if the application or application group name is not unique (for example, there are identical subsystem names for different applications) or it does not exist in the policy database.

The default is FLAT.

HTML file split

If you have large policy databases that produce large reports you may find that your Internet browser has difficulties handling a single large file. You can use this field to have the HTML report split into several smaller files, as follows:

1 One file is generated. This is the default.

nn (>1)

The report is split into *nn* files that are all roughly the same size. The files are split between policy entries.

* The report output is split with a default size of 10.000 lines per file.

The Command Progress Display panel informs you about the progress of report generation.

You can run a job for batch report creation. The SINGSAMP sample library contains a sample job in member INGEBRPT. The output data set or file system must exist before you run this job.

The example in Figure 245 on page 318 shows a small part of the data listed in the report output format FLAT for the application JES2.

Creating Reports about Policy Databases

```

:
:
:
=====
JES2
=====
Short description      : JES2 policy definition
Long description      : Defines automation and monitoring characteristics
                        for the JES2 job.

Application Type      : JES2
Subsystem Name        : JES2
MVS job name          : JES2
Scheduling subsystem  : MSTR
Command Prefix        : $
Restart after IPL     : START
Subsystem Startup Parameters : ,PARM=WARM,REL=710,SYS=&SYSNAME.

===== JES2 Drain Specifications =====
Drain lines           : YES
Drain VTAM interface : YES
Drain printers        : YES
Force drain lines     : $E
Force drain VTAM interface : $E
Force drain printers  : $I

===== Application Messages and User Data =====
| Message id | Description |
-----|-----|
| $HASP095   |             |
-----|-----|

| Code 1 | Code 2 | Code 3 | Value Returned |
-----|-----|-----|-----|
| *      | $PJ*   |        | STOPPING        |
| ERROR* | $K03   |        | STOPPING        |
| ABEND* | SA22   |        | STOPPING        |
| *      | *      |        | ABENDING        |
-----|-----|-----|-----|

| $HASP098   |             |
-----|-----|

| Pass/Selection | Reply Text |
-----|-----|
| 1              | DUMP       |
| 2              | END        |
-----|-----|

| POSTSTART | Executed after startup has been initiated |
-----|-----|

| Pass | Automated Function | Command Text |
-----|-----|
|      | JESOPER           | MVS F BPXOINIT,RESTART=FORKS |
-----|-----|

===== Relationships =====
| Relationship Type | Supporting Resource | Automation | Chaining | Satisfy condition |
-----|-----|-----|-----|-----|
| PREPUNAVAILABLE | VTAM/APL/=         | PASSIVE   | WEAK     | WhenDown           |
:
:
:

```

Figure 245. Example of Report Output Format FLAT

2 Unlinked

Use this option to create a report of all entries within the current policy database that would be ignored during BUILD processing. This includes all:

- Objects in the policy database that are not linked to a system or sysplex
- Relationships that are not used during a build

3 ViewUnlinked

Use this option to view the report of all unreferenced objects created by option **2 Unlinked**.

4 Resources

Use this option to create a list of all generated resources. In the Command Progress Display you will see in which member of the current policy database data set the generated list has been stored.

5 ViewResources

Use this option to view a list that is generated with option **4 Resources** for each existing system.

```

File Edit Edit_Settings Menu Utilities Compilers Test Help
-----
ISREDDE2 COPYBASE.PDB.REP(RPTRES) - 01.00 Columns 00001 00072
Command ==>> _____ Scroll ==>> 14
***** ***** Top of Data *****
==MSG> -Warning- The UNDO command is not available until you change
==MSG> your edit profile using the command RECOVERY ON.
000001 *****
000002 *
000003 * Function RESOURCE REPORT
000004 * Policy Database name BASE
000005 * Policy Database data set name 'COPYBASE.PDB'
000006 * Version SA 3.1
000007 *
000008 * UserId OPER
000009 * Creation Date Monday, 25 Jul 2005
000010 * Creation Time 12:00
000011 *
000012 *****
000013
000014 Monitor resources (MTR) for system: SYS1
000015
000016 JES2MON/MTR/SYS1 JES2MON
000017
000018 Monitor resources (MTR) for system: SYS2
000019
000020 JES2MON/MTR/SYS2 JES2MON
000021
000022 Monitor resources (MTR) for system: SYS3
000023

```

Figure 246. List of Generated Resources

6 MemberList

Use this option to create a report of all members in the system operations build output data set that are not referenced by the actual configuration anchored in the ACF map member AOFACFMP. This helps to identify members that can be deleted when you perform a data set cleanup. The report is divided in two sections:

1. The first section lists all unreferenced members that have been identified as valid configuration files, together with some additional information such as entry name, or build time.

Creating Reports about Policy Databases

- The second section lists all other unreferenced members, where either no build statistics could be found, or which have not been identified as valid configuration files.

Report members created by the customization dialog itself such as build report member \$BLDRPT are not included in the report. To run this report, a successful build is required. Otherwise the control file fragments may be damaged and incomplete, and the content of the report is unpredictable.

7 ViewMemberList

Use this option to read the report of all unreferenced members that was created by option **6 MemberList**.

```
***** Top of Data *****
Unreferenced Member Report for Sys-Ops Build Output Data Set

PolicyDB Name       : USER_PDB
PolicyDB Data Set   : 'MULTISYS.PDB'
Build Output Data Set : 'MULTISYS.SOCNTL'
UserId              : OPER
Creation Date       : 05/03/03
Creation Time       : 14:26:41

Members with build statistics

Member  Entry Name          Build Date/Time  UserId
      YY/MM/DD  HH:MM
Z98YAAPL CLASS_CICS_TS        05/03/26  09:09  HUT
Z981AAPL FTPOE          05/03/28  10:58  HUT
Z986AAPL SYS_DB2DIST    05/03/26  09:09  HUT
Z987AAPL SYS_DB2SPAS    05/03/26  09:09  HUT
Z988AAPL ZFS            05/03/27  13:11  FREI
Z99AAAPL USS_PORT       05/03/26  09:09  HUT
Z99BAAPL USS_FILE       05/03/26  09:09  HUT
Z99CAAPL USS_APPLICATION 05/03/26  09:09  HUT
Z99DAAPL CLASS_SYS_DB2_CHILDS 05/03/26  09:09  HUT
Z99HAAPL SYS_MQ         05/03/26  09:09  HUT
Z99IAAPL SYS_DB2MSTR    05/03/26  09:09  HUT
Z99JAAPL SYS_DB2IRLM    05/03/26  09:09  HUT
Z99KAAPL SYS_DB2DBM1    05/03/26  09:09  HUT
Z99XAAPL OAM            05/03/27  13:10  FREI
Z99ZAAPG APG_KEY4      05/03/27  12:49  FREI
Z991AAPL NFS            05/03/27  13:10  FREI
```

Figure 247. Unreferenced Member Report

8 StatusMsgs

Select this option to create a *Status Messages Report*. This includes status messages that are predefined by SA z/OS as well as user-defined status messages. The report shows the message ID, message description, and resource status indicated by this message and, if it is defined in the policy database, the entry name and the entry type that the message has been defined for. An example of the start of the Status Messages Report is shown in Figure 248 on page 321.

Pressing Enter returns you to the Report Selection panel, where you can view the report by selecting option **9 ViewStatusMsgs**.

9 ViewStatusMsgs

Select this option to view the Status Message Report that was created by using option 8. An example of the start of the Status Messages Report is shown in Figure 248 on page 321.

In the report, user-defined messages are listed with their associated entry name and entry type, whereas those messages listed without these

columns are predefined SA z/OS messages.

```

/*****/
/*                                         */
/* Function : Status Messages Report      */
/*                                         */
/* PolicyDB                               */
/* Name      : USER                       */
/* Data set: 'USER.MYPDB.PDB'            */
/* Output   : 'USER.MYPDB.ACF'           */
/*                                         */
/* User     : USER                       */
/* Date/Time : 2005/04/24 at 12:09       */
/*                                         */
/*****/

Message id/Description | Entry Name | Typ | Status
-----+-----+----+-----
EMM2CLZ                | EMMCLA    | APL | UP
AAA006I                | EMM1      | APL | UP
XYZ444I                | EMM1      | APL | UP
ATB010I                |           |     | TERMINATING
BBMZA001I              |           |     | UP
BBMZA999I              |           |     | TERMINATED
BBOU0001I              |           |     | ACTIVE
        J2EE Control Region active
BBOU0002I              |           |     | TERMINATED
        WAS Control Regions ended normally
BBOU0003E              |           |     | BREAKING
        WAS Control Regions ended abnormally
BBOU0008I              |           |     | TERMINATING
        WAS DAEMON ended normally
BBOU0009E              |           |     | ABENDING
        WAS DAEMON ended abnormally
BBOU0016I              |           |     | UP
        DAEMON up
BBOU0020I              |           |     | UP
        SMS, Naming, IR, J2EE Control Region up
BBOU0021I              |           |     | UP
.....
.....

```

Figure 248. Example Status Messages Report (Excerpt)

A Symbols

This option allows you to create a report with information about all the system automation symbols (AOCCLONEx) in the policy database.

The report file is written to the report output data set (default name is the policy database data set name with .REP as the low level qualifier). The member name is RTPSYM.

The report includes:

- The Symbolname and Description, as defined in the Enterprise (ENT) SYMBOL DEFINITION policy
- For each Symbolname it shows the System name, Value and Specific Description as defined in the System (SYS) AUTOMATION SYMBOLS policy for each System entry where either the Value or Specific Description have been defined for that Symbolname

B ViewSymbols

Select this option to view the Symbols Report that was created by using option A. An example of the start of the Symbols Report is shown in Figure 249 on page 322.

Creating Reports about Policy Databases

```
*****
*
* Function                SYMBOLS REPORT
* Policy Database name    BASE
* Policy Database data set name COPYBASE.PDB
* Version                 SA 3.2
*
* UserId                  OPER
* Creation Date           Monday, 11 Sep 2006
* Creation Time           15:20
*
*****
*
----- Symbolname ----- |General Description
System                    |Value      |Specific Description
*
----- AOCCLONE ----- |MVS root suffix
DEMOMVS                   |A          |
DEMOMVS2                   |B          |
DEMOMVS3                   |C          |
TESTMVS                    |T          |
ZSERVERO                   |T          |
*
----- AOCCLONE1 ----- |VTAM subarea
DEMOMVS                   |16        |VTAM subarea
DEMOMVS2                   |17        |
DEMOMVS3                   |18        |
```

Figure 249. Example Symbols Report (Excerpt)

Chapter 7. Building and Distributing Configuration Files

How to Define Data Sets for Build Processing	323	BUILD Error Messages	328
Building the Configuration Files	323	Distributing the Configuration Files	330
Configuration Files Build Options	324	Generating a Job for Batch Build	332

After you have completed the SA z/OS customization process, you can build the configuration files that are needed for automation.

Note:

You must use the customization dialog to create the configuration files. Do not edit any of the configuration files manually.

How to Define Data Sets for Build Processing

To use the batch options of the build facility for automation control files, you must first specify the names of the data sets required for the batch processing. These names form the DD name concatenations to be included in the JCL of the batch processing job.

The data set names are saved in an ISPF table in the partitioned data set that is referenced by the AOFTABL DD name, for example, ING.CUSTOM.AOFTABL (allocated during installation of SA z/OS).

On the Customization Dialog Primary Menu panel, select the Settings option. This displays the Customization Dialog Settings Menu (see Figure 261 on page 365). On this panel, choose option 11, DSNAMES. The Data Set Customization Details panel is displayed (see Figure 264 on page 370).

For more information, see “Defining Data Sets for Batch Processing” on page 370.

Building the Configuration Files

Building the configuration files causes enterprise automation data for SA z/OS to be built. This data consists of:

- The automation control file (ACF), which is built into a set of file fragments and a master include file
- The automation manager configuration file (AMC file)
- The NetView automation table (AT)
- The message revision table (MRT)
- The MPFLSTSA member
- Optionally, a processor operations control file (only for systems that are running earlier releases of SA z/OS)

The enterprise-wide policy database for your sysplex and the standalone system is created and maintained with the customization dialog on any suitable system. This is called the *configuration focal point*.

The configuration build is performed with the customization dialog and the configuration files are distributed from there to the locations where needed.

Building the Configuration Files

To build a new enterprise automation configuration you invoke the BUILD process, as follows:

- From the Policy Database Selection panel, enter the action code B in the **Action** column of the policy database that you want to invoke the BUILD process for.
- From the Entry Type Selection panel, you can invoke the build function as follows:
 - Choose the BUILD (B) command from the **Command** menu.
 - If you want to process a certain entry type, enter the BUILDF (F) command at the command line and specify the identifier for the entry type that you want to build. For example, to build all system objects that you have defined, enter BUILDF SYS or F SYS. You go to the Build Parameters panel (see Figure 250 on page 325) with the entry fields filled in according to the parameters that you entered with the BUILDF command.

Note that the build function builds all systems irrespective of whether they have been modified or not.

- From the Entry Name Selection panel, you can invoke the build function as follows:
 - Enter the BUILDF (or F) command in the **Action** column against the object you want to build. For example, to build the JES2 subsystem enter F against JES2 in the Entry Name Selection panel for Application policy objects.
 - Enter the BUILDF (F) command at the command line for the object you want to build, for example, F JES2.

You then go to the Build Parameters panel (see Figure 250 on page 325) with the entry fields filled in according to parameters that you entered with the BUILDF command.

A Command Progress Display panel shows the progress of the build. If errors are encountered during the build process, the Command Progress Display displays a message. The automation configuration files are placed in the data sets that you defined in the **Output Data Set** field on the Build Parameters panel.

Every new build generates an automation configuration map AOFACFMP that contains:

- For each system, one ACF $xnnn$ system include member that is used by the automation agents
- For each sysplex, one HSA $xnnn$ sysplex include member that describes the automation manager configuration

The ACF, AMC, AT, and MPF build is always invoked together. This is because the configuration data always needs to be synchronized so that the automation agents and the automation manager operate on the same data.

Each automation control file fragment contains information about a specific resource that is defined through the customization dialogs. Each z/OS system in the enterprise has its own master include file. The master include file references the automation members that are appropriate for that system. The name of the master include file for each system is created by SA z/OS. It starts with prefix ACF followed by four alphanumeric characters.

Configuration Files Build Options

The Build Parameters panel allows you to specify the information required to build the configuration files that are required for automation. You can build these

configuration files for standalone systems, individual sysplexes or your complete enterprise, using the options shown in Figure 250.

```

MENU  HELP
-----
AOFGBLDP                      Build Parameters
Option ==>> _____

 1 Build a complete enterprise
 2 Build sysplex group or stand alone system
   Sysplex / System name. . _____ (*, ?, or name)
 3 Build entry type or entry name
   Entry Type. . . . . SYS          (*, ?, or type)
   Entry Name. . . . . *            (*, ?, or name)
 4 View build report
 9 Build Processor Operations (pre SA V3.3 and ONLINE only)
   ProcOps Control File. . . MULTISYS.POCNTL
-----

Build options:
Output Data Set . . . . MULTISYS.SOCNTL
Mode. . . . . ONLINE      (ONLINE BATCH)
Type. . . . . MODIFIED    (MODIFIED ALL)
Configuration . . . . . NORMAL (NORMAL ALTERNATE)

Job statement information: (used for BATCH build)
//AOFRPT JOB
//*
//*

```

Figure 250. Build Parameters Panel

You can enter one of the following build processes:

1 Build a complete enterprise

Builds all automation configuration files for a complete enterprise.

Note:

This option must be successfully completed at least once before you can use options 2, 3, or 9.

2 Build sysplex group or stand alone system

Allows the selection of a single sysplex group or a standalone system.

This build option performs a complete build of all objects linked to the selected sysplex or standalone system. For a large policy database, this options helps to reduce build time for small changes, while creating a complete set of configuration files that are ready for automation.

3 Build entry type or entry name

Allows you to specify an entry type and name to be rebuilt. Only the ACF fragments for that entry will be updated.

If for example, a timer object is modified and linked to another system, a build of this object with option 3 would only build that fragment and update the timestamp in the system include member, but not build the link changes for the system.

The same is true if an object is renamed. A build with option 3 of the new name would not add this new object to the system include member. Instead a build with option 2 is required.

For entry type System, this has the consequence that a selective build is rejected if there is also a link change pending.

Building the Configuration Files

However, if this option is used with entries of type Events, Triggers, Service Periods, Application, ApplicationGroup, System, or Group, a check is made as to whether data that affect the automation manager has been changed.

For certain entry types (for example, Service Periods, Events, Triggers) this option cannot be used because they do not have data included that needs to be built into an ACF fragment. In this case, building only the ACF fragment for the requested entry would mean that your previously generated AMC files would no longer be compatible with your current ACF files. To avoid this, a complete build (using build type MOD) will automatically be invoked. Before the build actually starts a confirmation panel is displayed explaining this situation, and allowing you to defer the build.

You will see the same behavior with automation tables if this option is used with entries of type APL or MVC. A check is made as to whether data has been changed that affect the NetView automation table. If so, a confirmation panel is displayed allowing you to defer or to start a complete build (using build option MOD).

If you enter a '?' in this field, SA z/OS displays a list of either entry types or a list of available entry names for the selected entry type, or both.

4 View build report

Allows you to view the build report available on the build output data set. It invokes the ISPF VIEW function. If there is no build report, an empty screen is displayed.

9 Build Processor Operations

Allows you to use SA z/OS 3.3 processor operations ACF entries to build a processor operations control file for a focal point system that is running a release of SA z/OS earlier than V3.3.

The data that is created during an automation configuration build in the Output Data Set is read, processor operations definitions are created and the generated output is placed in the ProcOps Control File. You must allocate the data set as a sequential file before the build can be started. You can use sample job INGEDLGA to allocate it (see *IBM Tivoli System Automation for z/OS Planning and Installation*).

Notes:

1. If a policy database is new, or the build output data set is empty, a full build is required to produce a complete set of configuration files. This means you need to issue a build with option 1 and Type = ALL. For all subsequent builds, option 2 or 3 and Type = MODIFIED can be used.
2. While build option 2 only updates a single system or sysplex, deleted standalone systems and sysplexes still remain in the configuration files. For example, a deleted sysplex or standalone system is not removed from the ACF map AOFACFMP. So, you may consider issuing a build with option 1 whenever a large number of parts has been deleted, to clean up unnecessary entries from the configuration files.
3. Fragments are not built for all entry types (for example, not for SVP or TRG).

In the **Build options** section, you can enter values for the following fields:

Output Data Set

Use this field to specify where you want to store the build output. The data set must be an existing partitioned data set.

If the data set is not empty, but already contains a control file, the policy database name and the configuration name within the data set are compared with those of the requested build. If they do not match, a message is issued and the build is not started.

Mode Use this field to specify how to process the BUILD request:

ONLINE Indicates that the BUILD should run in the foreground.

BATCH Indicates that the BUILD should run in the background.

The default value is ONLINE (if this field is set to blank).

Type Use this field to specify which entries are to be processed.

MODIFIED

Indicates that only those entries that have been changed since the last BUILD request should be processed.

With this option, the build distinguishes between:

- Data changes in the ACF
- Link changes in the ACF
- Data changes in the AMC file
- Link changes in the AMC file

Depending on the type of change, the affected objects are identified, and only the necessary parts of the configuration file are rebuilt.

For example:

- If a new *timer* is linked to one system, only the system include member for that system is rebuilt. For all other system include members only the header timestamps are updated, and the build of the AMC file, AT, MRT, and MPFLSTSA member is skipped, because timer data does not go to the automation manager configuration file, AT, MRT, or MPFLSTSA member.
- If a new *application* is linked to a Sysplex Application Group, the build determines which systems are linked to that sysplex, and the include members for those systems are rebuilt automatically, together with the AMC, AT, MRT, and MPFLSTSA member for that sysplex.
- If the AT/MRT Scope is changed, only the AT, MRT, and MPFLSTSA member are built.

ALL Indicates that all entries are to be processed unconditionally, even if there has been no change to those entries since the last BUILD request.

If a build type of ALL is selected together with build option 2, only the configuration files that belong to the selected sysplex or standalone system are rebuilt.

The default value is MODIFIED (if this field is set to blank).

The very first build after installing a new release must be a build of type ALL in order to get a complete set of configuration files for the automation manager and automation agent structure.

Configuration

This field allows you to select between alternative configurations:

Building the Configuration Files

NORMAL

indicates that only those entries linked to the systems of the NORMAL configuration are processed by the current build.

ALTERNATE

indicates that only those entries linked to the systems of the ALTERNATE configuration are processed by the current build. These systems must have been marked with a "+" in their MVS system name.

NORMAL and ALTERNATE configurations must be built into different data sets. The default value is NORMAL (if this field is set to blanks).

In the **Job statement information** section you must enter a valid JOB statement for the batch job, if you specified that the BUILD request should run in BATCH mode.

The information that you specify here is saved in your ISPF profile data set and is used as the initial values the next time you issue the BUILD command.

BUILD Error Messages

The messages in the pop-up panel showing the command progress indicate error and warning situations. In most cases, it should not be necessary to check the build output member for unusual entries or error indications. Furthermore, the message log can be viewed from the panel where the build has been issued.

There are build errors that may stop the build, for example, resources in a loop, and other messages that are tolerated, for example, duplicate MVS job names linked to the same system. Build errors that cause termination are shown with the label ERROR in the message prefix section, while tolerated errors are shown with the label WARNING in the message prefix section.

If an error is shown, no usable set of configuration files was created. It is necessary to correct the cause of the problem and run the build again.

If a warning is shown, the configuration files can be used for automation. However it is recommended that you fix the problem and run the build again.

A possible cause for a warning during ACF fragment build may be that there are policy database objects with missing or conflicting definitions, that are not critical for automation, for example, an application default entry (type ADF) without any definitions. In this case, the build function continues, but issues a warning message. This message is displayed whenever a full enterprise build is issued, and does not require that the application be linked to a system.

There is a summary message at the end of the AT build report, and specific messages that show, for example, the object name somewhere within the build progress messages. The specific message reads:

```
.....WARNING. System MIGR_TEST includes the following entries with
.....cont. an unsatisfactory build status in main member ACFZ995:
..... -- SYSTEM_DEFAULTS (NUL)
```

The summary message at the bottom of the build message log reads:

```
.....WARNING. Missing or conflicting definitions found for entry
.....cont. types: SDF. The entry names are listed in the build
.....cont. report.
```

Possible causes for a warning during system main include member build are:

- Conflicting type definitions for an application instance that is linked to an application class.
- Applications with duplicate MVS job names linked to the same system. The processing is the same as for duplicate subsystems.
- If missing or conflicting definitions are detected, which are not critical for automation, a warning message is shown and the entry name is listed together with the status NUL. There are only a few situations where this can occur, for example, an application default entry (type ADF) without any definitions.
- If an object is linked and has been previously built, however it does not exist in the build output data set, a warning message is shown and the entry name is listed together with the status DEL. The build function continues, but the object is not included in the control files.

Note that such a warning message may cause a rebuild of the objects in error and the linked systems and sysplexes. So, a build of type MOD may rebuild more systems and sysplexes than you would expect due to the actual changes. Possible causes for a warning during automation manager configuration file build are:

- The AMC logic member could not be found. The build function searches in the sample PDB data set for the current logic member. If this data set is not allocated, or contains no logic member, it could be added to the Configuration Files by the user.
- A trigger is linked to the current sysplex, but no conditions have been specified. The trigger will not be added to the automation manager configuration file.
- One or more application groups are linked to the current sysplex without an automation name being specified. The build function continues, but no resources will be created for these application groups.
- One or more supporting application resources are not linked to the system. The relationships are not added to the automation manager configuration file.

You can tailor the level of detail of the warning messages. When you invoke the **0 Settings** option, selecting **3 MESSAGE** allows the message level to be set, as shown in Figure 251.

```

COMMANDS  HELP
-----
AOFGCMSG          Message and Logging Functions
Command ==> _____

The message level is used to control the number of messages that are
produced on the "Command Progress Display" panel (AOFGZIPS):

    Message level . . . . . 0  0 - Minimum      One message per major
                                processing section
                                1 - Intermediate One message per primary
                                entry type being processed
                                2 - Maximum      Additional messages for
                                                other than primary entry

Enable checking for Processor Operations and write messages to build report:
ProcOps Message logging . . ON OFF
    
```

Figure 251. Message and Logging Functions Panel

With level 1 (the default), in the above situation just one summary message is displayed per manager configuration, whilst level 2 displays all details of the definitions causing the problem.

Building the Configuration Files

You can also specify whether SA z/OS should check for Processor Operations-related messages during configuration build and write them to the build report \$BLDRPT. The default value is OFF. If you use processor operations you should set this option to ON.

Independent of the message logging switch, error messages are always written to the ISPF LOG. You cannot turn this off.

If the AOFPROF user profile for batch build is not allocated, the default message level is 2 to write all possible messages to the batch report and the ISPF LOG.

Distributing the Configuration Files

The SA z/OS configuration files consists of the following components:

- The automation manager's automation manager configuration file (AMC)
- The automation agent's automation control files (ACF)
- The NetView automation table (AT)
- The NetView message revision table (MRT)
- The MPFLSTSA member

SA z/OS runs on a sysplex basis, that is, the same ACF, AMC, and AT files must be available to all of the automation agents and automation managers in the sysplex.

It is recommended that you perform the build into a fixed partitioned data set, which allows a build with a type of MOD. Do not use this data set for the automation agents and automation managers. Instead you should copy it into a configuration file GDG. This helps to avoid token mismatches due to changes in the configuration data set, for example, a new build into the data set that is used by the automation agent and automation manager. Additionally, there are always backup versions of the configuration file available so that the configuration can fall back to a previous generation if there is a problem.

An automation agent needs to run on every system that is automated by SA z/OS and at least one automation manager needs to run per sysplex and one per standalone system. Automation managers can manage systems sysplex-wide. Figure 252 on page 331 shows a sample automation configuration and presents the build process.

The MPFLSTSA member must be copied to a z/OS parmlib data set.

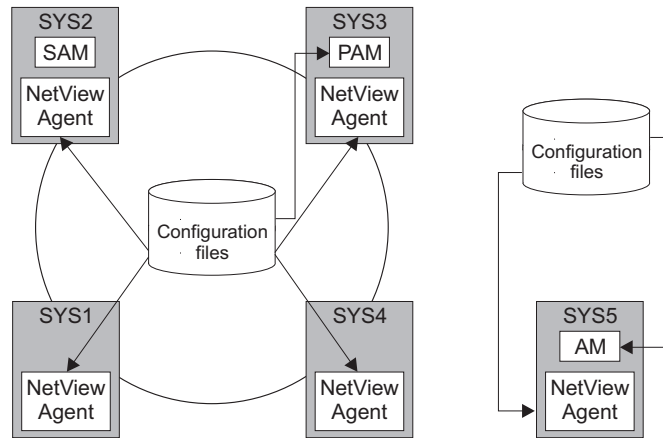

Figure 252. SA z/OS Automation Configuration

Figure 252 shows a sample enterprise consisting of one sysplex Sysplex1 and one standalone system SYS5. The sysplex consists of four systems SYS1, SYS2, SYS3, SYS4 and has a primary and a secondary automation manager (PAM and SAM). The sysplex shares a copy of the system operations configuration files and the standalone system has its own copy of the same files.

The sysplex in this example has one primary and optionally one secondary automation manager and one automation agent on each system. The standalone system must have one automation manager (AM) and one automation agent.

You could share one common automation configuration file in your enterprise, or you can copy the automation configuration file to where it is needed as shown in our scenario. Both automation managers feed the enterprise-wide RODM data base dynamically with information that is available from both AMCs and from information that becomes available during automation processing (like status changes). This feeding is done automatically by the SA z/OS topology manager after you have started it. The generated data is used by the NMC workstation to display predefined graphical views.

The automation manager's AMC file and the automation agent's ACF files must match. Therefore the automation manager and an automation agent exchange a token to verify that the automation configuration matches. You can share one common data set containing all automation manager configuration files and all automation control files within a sysplex.

Note:

It is mandatory to create and maintain policy databases with the customization dialog.

The automation configuration files must be distributed to each system in the SA z/OS enterprise where SA z/OS system operations functions are to run. In general, this is all of the z/OS systems in the SA z/OS enterprise. In a sysplex, the data set name of the automation configuration file must be equal on all systems in the sysplex.

However, it is highly recommended that you use a shared data set in a sysplex, and it is preferable that you use a shared data set for the whole enterprise.

Generating a Job for Batch Build

You can run a job for batch build that performs the same processing as the BUILD function of the customization dialog. The SINGSAMP sample library contains a sample job for this task in the member INGEBCON. Before submitting this job, you need to edit the jobcard appropriately as described in the sample itself.

The build can only run if the output data set exists and is allocated. If the data sets are not SMS-managed, allocating the data set within the same job step does not work because the cataloging is done by z/OS at end of the job (or job step). Therefore the allocation and cataloging of the build output data set must be done in a separate job (or job step) prior to the build job (or job step).

The batch build produces the following return codes:

- 0** Successful.
- 4** Build complete, however, some warning messages are issued. Also issued if user exit INGEX02 ended with a RC > 0.
- 8** User exit INGEX01 ended with RC > 0. Build processing not started. No configuration files built.
- 16** Build not started. The policy database is from a previous version of SA z/OS. The policy database must be converted first before a batch build will be successful.
- 20** Severe error: build terminated without usable configuration.

SA z/OS provides user exits at invocation and termination of the build function. For more details, see “User Exits for BUILD Processing” in *IBM Tivoli System Automation for z/OS Customizing and Programming*.

Chapter 8. The NetView Automation Table and Message Revision Table

This chapter introduces the NetView automation table (AT) and the message revision table (MRT), which SA z/OS uses when processing messages, and how you can use the customization dialog to maintain your AT and MRT entries.

The NetView Automation Table

The NetView automation table (AT) enables you to respond automatically to messages. It contains statements that define actions that NetView takes when it receives specific messages. For example, you can issue a response in the form of a command, command list, or command processor. You can also set attributes and processing options. For example, you can suppress, log, or route messages.

You can specify any number of actions for SA z/OS to take when an incoming message matches your conditions. Actions can be commands, command lists, and command processors. For simple responses, a single command might be sufficient, such as a NetView command, a VTAM command, or a system or subsystem command. For more complex responses, you can write command lists or command processors. The AT specifies the task that the action is performed under, enabling you to run automation procedures under an autotask.

Actions also include setting message-processing options. For any particular message, you can use message-processing options to specify such things as:

- Suppressing the message (and which operator it should be displayed for)
- Triggering the execution of a command
- Setting the status of a resource
- Setting the health state of a monitor resource
- Running user-specific processing, such as performing alerting by creating a trouble ticket
- Taking a recovery action in case of a failure

For an introduction to NetView and NetView automation tables, see *IBM Tivoli NetView for z/OS Automation Guide* and *IBM Tivoli NetView for z/OS User's Guide*.

The NetView Message Revision Table

The message revision table (MRT) enables user-defined modification of attributes such as color, route code, descriptor code, display and syslog settings, and text of original z/OS messages (rather than copies). You can make decisions about the message based on its message ID, job name, and many other properties. For example, you can take the following actions:

- Revise messages before they are presented to the system log, console or automation
- Treat a message differently depending on its source
- Suppress messages entirely
- Automate only

The message revision table can override actions taken by the z/OS message processing facility (MPF) and can generally replace the MPF. It can also remain active even while NetView is not, but the subsystem interface (SSI) address space is required. However, loading or querying the MRT, or gathering statistics, depends on the functional NetView address space being active.

Note that you can have only one MRT for your enterprise.

For more details, see *IBM Tivoli NetView for z/OS Automation Guide*.

Enabling AT Updates

You use the AOFSMARTMAT advanced automation option (AAO) in your CNMSTGEN stylesheet to configure how the SA z/OS automation agent performs refreshes of your ATs.

If AOFSMARTMAT is set to 0, the SA z/OS automation agent is disabled from refreshing ATs and any changes that you make to your AT entries with the customization dialog are not loaded by the automation agent. You therefore need to set AOFSMARTMAT to 1 or 2 to enable the changes that you make to your AT entries to be propagated to your SA z/OS systems. Note that the default setting for AOFSMARTMAT is 2.

For more details, see the description of AOFSMARTMAT in the table “Global Variables to Enable Advanced Automation (CGLOBALS)” in *IBM Tivoli System Automation for z/OS Customizing and Programming*.

Setting AT/MRT Scope

The last section on this panel, **NetView Automation option AT/MRT Scope**, allows you to define the scope of the NetView Automation Table and Message Revision Table that are created by the configuration file build. Valid definitions are:

NONE

No NetView automation table or message revision table is built.

ENTERPRISE

One NetView automation table and one message revision table are built for the entire policy database.

SYSPLEX

One NetView automation table and one message revision table are built per Sysplex Group.

One NetView automation table and one message revision table are built for each system that is not linked to a sysplex group.

SYSTEM

One NetView automation table and one message revision table are built per system (default).

If the AT/MRT scope is changed to any value except NONE, the tables are rebuilt at the next configuration file build.

System and Application Specific Overrides

Within an override, you can use the keywords `*BEGINSYS` and `*ENDSYS` to mark a section for selected systems only. Each marked system is contained only in the AT of the corresponding system. Furthermore you can use the keywords `*BEGINAPL` and `*ENDAPL` to mark a section for selected applications only. Usually this would be a class, but the specification of instances is also supported. Each marked sequence is contained only in the AT where an instance is linked.

The keywords are accepted in upper case and mixed case. The Begin keywords allow the specification of one or more entry names, separated by blanks or commas. A Begin keyword without a entry name is ignored and the current selection (if any) remains in effect. If you need to specify more entry names than fit onto one line, use a continuation line by adding another line with the Begin keyword. The name specifications in multiple consecutive lines with Begin keywords are evaluated together.

There is no syntax check for the specified names and it is not verified whether the names exist as application or system entries in the policy database. If a Begin keyword is specified with a name that does not exist in the policy database, then that portion of the override is excluded from all ATs being built.

The End keywords indicate the end of the current selection and have the following properties:

- The End keyword cannot be qualified with specific entry names. Any text that follows the End keyword on the same line is ignored.
- An End keyword that does not have a matching Begin keyword is ignored.
- If there is no matching end for a Begin keyword, the current selection remains in effect until either the override ends or another specification of the same Begin keyword is found.

You cannot nest `*BEGINAPL` or `*BEGINSYS` keywords. Whenever a `*BEGINSYS` is found, a full system evaluation is run replacing any selections from a previous `*BEGINSYS`. The same is true for `*BEGINAPL`. However a `*BEGINSYS` specification remains in effect if a `*BEGINAPL` specification is found, and vice versa.

During initial conversion the `*BEGINAPL` and `*ENDAPL` keywords are generated automatically if multiple overrides are found for different systems or applications. Here is an example for a portion of an override with the keywords added:

```
*BEGINAPL C_TWS_CTRL
IF (GROUP:IGNOPC) MSGID = 'EQW065I' & TOKEN(3) = 'WRITER'
THEN
EXEC(CMD('ACTIVMSG UP=YES')) ROUTE (ONE %AOFOPGSSOPER%);
*ENDAPL
```

If the variable "&*JOBNAME." is used in an override it is resolved for all jobnames across all classes for which the message is specified. This can be limited to a subset of classes or instances with the keyword `*BEGINAPL`. If no linked instances can be found then the variable "&JOBNAME." is resolved with a placeholder/period(.).

It is recommended to use these keywords as little as possible because the evaluation may increase the build time depending on the specified names (for example, with a lot of instances) and to avoid convoluted overrides. Especially it is recommended to avoid combinations of `*BEGINSYS` and `*BEGINAPL` within one override.

Rename, delete, import and copy in combination with *BEGINAPL and *BEGINSYS.

If an application or system is deleted, a scan for the corresponding *BEGINAPL or *BEGINSYS keyword is run across all message overrides. If the deleted entry name is found within a list of names then it is removed from the list. If there is a Begin keyword where only the deleted name is specified then the complete section of the override is deleted.

If an application or system is renamed, a scan of the corresponding *BEGINAPL or *BEGINSYS keyword is run across all message overrides. Wherever the name is found it is replaced with the new name.

If data are imported into a target policy database, and there is a message with an override among the imported data while the same message exists already in the target policy database with an override, then *BEGINAPL keywords are inserted with the corresponding application names.

If application data are copied, and a message with an override is contained in the copied data, then a check is done to confirm if the "copy-from" application is specified in a *BEGINAPL keyword within the copied override. If this is the case then the "copy-to" application name is added to that *BEGINAPL keyword.

Predefined SA z/OS Messages

Messages that are predefined by SA z/OS are provided in:

- A NetView automation table called INGMSGSA
- An MVS component (MVC) entry called +SA_PREDEFINED_MSGS

The INGMSGSA Automation Table

SA z/OS provides an automation table, called INGMSGSA, that contains all the statements that are required for SA z/OS to work properly.

You must not modify the INGMSGSA automation table. If you need your own automation for messages that are processed in INGMSGSA, you can achieve that by using a separate AT that runs parallel with INGMSGSA. SA z/OS does not stop any message in INGMSGSA and prevent its processing in other ATs.

INGMSGSA is loaded unconditionally as the first AT ahead of any other ATs that you declare in the customization dialog. Thus there is no need for you to specify it.

For more details about SA z/OS and ATs, see "A Guide to SA z/OS Automation Tables" in *IBM Tivoli System Automation for z/OS Customizing and Programming*.

The +SA_PREDEFINED_MSGS MVS Component Entry

The +SA_PREDEFINED_MSGS MVS component entry contains all the messages that are predefined by SA z/OS except the essential messages that are already provided in the INGMSGSA automation table.

The +SA_PREDEFINED_MSGS MVS component entry allows you view all that SA z/OS would automatically generate AT entries for. It thus also allows you to check a particular AT entry that is predefined by SA z/OS to verify that it is appropriate for your environment.

You cannot modify, delete or rename the +SA_PREDEFINED_MSGS MVS component entry. It is updated via an automatic APAR application process (see “How to Apply Service Updates” on page 338). You can, however, view the contents of the entry by selecting it from the list of MVS components.

Policy Items

The +SA_PREDEFINED_MSGS MVS component entry has the following policy items:

DESCRIPTION

The non-editable description that explains that the entry contains predefined messages for SA z/OS.

MESSAGES/USER DATA

This displays all the predefined SA z/OS messages. You cannot edit the entries in this policy item.

WHERE USED

This allows you to link the entry to systems, as for other MVC entries.

Modifying Predefined Messages

There are different ways that you can modify predefined messages:

- Unlinking systems from the +SA_PREDEFINED_MSGS MVS component entry with its WHERE USED policy item. The predefined messages are then not used for the AT of that system.
- Deselecting components in a user-defined MVC entry through the PREDEFINED MESSAGES policy item. The MVC entry must be linked to those systems where the deselection should take effect. Note that if multiple MVC entries are linked to a system, all components that are selected in at least one of the MVC members are added to the AT build. That is, only those components that are deselected in all linked MVC members are excluded from the AT build.
- Overwriting individual messages through the MESSAGES/USER DATA policy item of an MVC entry. How you do this depends on the display level that is set in the PREDEFINED MESSAGES policy item:
 - If it is set to 1, all predefined messages that have not been deselected are shown in the MESSAGES/USER DATA policy item. They have the same color as inherited messages for applications.

If you now add a command or just modify the description of a message, it becomes a message specification for the current MVC entry. You can now modify the AT or MRT specification, or both, according to your own needs. This new specification superimposes the predefined SA z/OS data.
 - If it is set to 0, you can enter a predefined message ID in an empty row in the list. The existence of predefined data for an AT or MRT specification is indicated with a P in the corresponding column. You can now modify this predefined data.
- Overwriting individual messages through the MESSAGES/USER DATA policy item of an APL entry. As with predefined messages of an MVC entry, if the display level in the PREDEFINED MESSAGES policy item is set to 0, you can simply add the message ID and modify the predefined AT or MRT data according to your needs.

AT/MRT specifications are processed by NetView per system. And the system specific AT contains the entries for the messages from all instances linked to that system. So if a message is issued by multiple applications, an AT specification is

not required once per application, but only once per AT. That is why an AT specification in SA z/OS applies to the message wherever it is defined across all applications.

If you specify an override for a message with a predefined AT entry then the user override completely replaces the predefined specification. This is indicated in the AT preview section of the corresponding panels where only the AT entry based on the user specifications is shown. The AT is generated as is shown in the preview section, only the user override is used within the AT.

If you want to run with a predefined AT entry on most of your systems, but need a specific override for one application only, then it is recommended you specify the message ID for that single application together with a unique suffix and add that specific override there. This results in different message IDs and so the specific user override will not replace the predefined AT entry.

Note that AT and MRT specifications are independent of each other, so, for example, you can define changes for the MRT entry without affecting a predefined AT entry for the message.

How to Apply Service Updates

Whenever maintenance updates that affect the generation of NetView automation tables via SA z/OS are available, the AT/MRT APAR Apply Options panel is displayed. An example is shown in Figure 253.

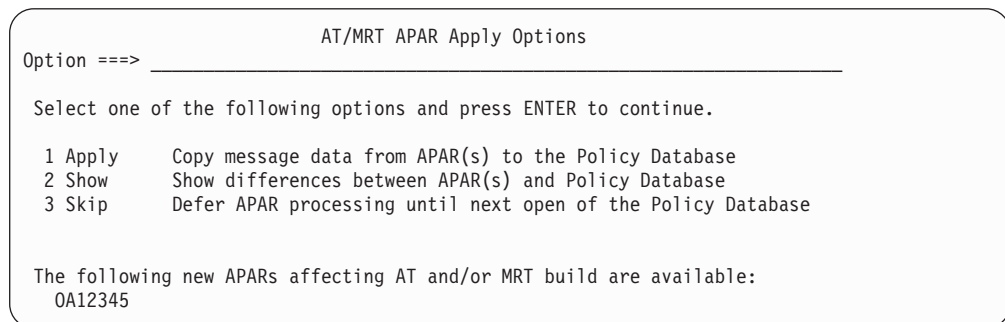

Figure 253. APAR Apply Options panel

Choose one of the following options by entering its number:

1 Apply

Copies the changes from the shipped tables in SINGITBL into the +SA_PREDEFINED_MSGS MVC entry. Processing continues with the option that you specified before this panel was displayed (for example, displaying the Entry Type Selection panel or Report Selection Menu). The message APAR applied successfully is shown on the next panel.

The changes that were made by applying the APAR are in effect for the next configuration file build and no further action is required. This option is recommended if you have not made any user modifications for the AT build.

This option also creates a detailed report about the differences and writes it to an output data set (see “Service Updates Report” on page 339). The report member name is SRVyyddd where yy is the year and ddd is the day, for example, SRV09327.

2 Show

Creates a detailed report as for option 1 (see "Service Updates Report").
No data is copied to the +SA_PREDEFINED_MSGS MVC entry.

3 Skip Does not copy any data and continues with the option that you specified before this panel was displayed. The message APAR apply deferred is shown on the next panel. The APAR Apply Options panel is displayed again when you next open a policy database. This option is recommended if you want to check the changes before they are applied to the policy database.

The END, RETURN, and CANCEL commands have the same effect as this option.

Note:

The APAR application process is sufficient only if you use a NetView automation table that is generated by SA z/OS. If you maintain your own AT manually you need to make the necessary changes yourself.

The panel shows the APAR that caused the panel to be displayed. It is possible that multiple APARs are shown if more than one APAR with AT-related changes has been installed, or a policy database has not been opened for a long time and several APARs with AT changes have been installed in the meantime.

Service Updates Report

The service updates report provides details of:

- New messages that have a generated AT entry. It includes the predefined AT entry that is generated.
- Deleted messages that have a generated AT entry, including the predefined AT entry.
- Messages that have a modified AT entry. It includes the old and new AT entry and, if it exists in the policy database, the user-defined AT entry for the message.

The following shows an example of the report.

```
*****
*
* Function                               Service Updates for AT build
* Policy Database name                   CUSTOM
* Policy Database data set name          CUSTOM.PDB
* Version                                SA 3.3
*
* UserId                                  BILLY
* Creation Date                           Wednesday, 30 Dec 2009
* Creation Time                            16:12
*
*****

*****
*
* This report includes the following APAR(s). For details see the
* APAR description(s):
*
*****
OA11111 OA22222 OA33333
*****
*
```

```

* New message(s)
*
*****

SLS0451I          - SLS No matching HOSTid

New predefined Automation Table entry :

    IF MSGID = . 'SLS0451I' THEN
    EXEC(CMD('TERMMSG FINAL=NO,BREAK=YES') ROUTE(ONE %AOFOPGSSOPER%));

SLS0452I          - SLS Attach failed for module

New predefined Automation Table entry :

    IF MSGID = . 'SLS0452I' THEN
    EXEC(CMD('TERMMSG FINAL=NO,BREAK=YES') ROUTE(ONE %AOFOPGSSOPER%));

*****
*
* Deleted message(s)
*
*****

OMV999I          - VPS Subsystem request failure

Old predefined Automation Table entry :

    IF MSGID = 'OMV999I' THEN EXEC(CMD('TERMMSG
    FINAL=YES')ROUTE(ONE * AUTGSS AUTSYS AUTO1));

OMV999I          - OMII component has ended

Old predefined Automation Table entry :

    IF MSGID = 'OMV999I' THEN EXEC(CMD('TERMMSG
    FINAL=YES')ROUTE(ONE * AUTGSS AUTSYS AUTO1));

*****
*
* Modified message(s)
*
*****

HSAL1108I        - Refresh of the takeover file completed

Old predefined Automation Table entry :

    IF MSGID = 'HSAL1108I' THEN
    EXEC(CMD('ACTIVMSG UP=YES') ROUTE(ONE %AOFOPGSSOPER%));

New predefined Automation Table entry :

    IF MSGID = 'HSAL1108I' & ATF('ING$QRY STAT') = 'HALTED' THEN
    EXEC(CMD('ACTIVMSG UP=YES') ROUTE(ONE %AOFOPGSSOPER%));

User defined Automation Table entry :

    IF MSGID = 'HSAL1108I' THEN
    EXEC(CMD('USEREXEC PARM1,PARM2') ROUTE(ONE %AOFOPGSSOPER%));

IEF238D          - Allocation error

Old predefined Automation Table entry :

```

```
|
|
|      IF MSGID = 'IEF238D' & JOBNAME = SVJOB
|      & ACQUIRE('PAD /''/ /CODE2=/ 1 W 6.1 STRIP N /,CODE3=/ N
|      SKIPTO /,/ SKIPTO /''/ 2.4 N') = CODES THEN
|      EXEC(CMD('ISSUEACT CODE1=' SVJOB ',' CODES ',SYSTEMMSG=YES')
|      ROUTE(ONE %AOFOPGSSOPER%));
```

New predefined Automation Table entry :

```
|
|      IF MSGID = 'IEF238D' & JOBNAME = SVJOB
|      & ACQUIRE('PAD /''/ /CODE2=/ 1 W 6.1 STRIP N /,CODE3=/ N
|      SKIPTO /,/ 3.6 STRIP N') = CODES THEN
|      EXEC(CMD('ISSUEACT CODE1=' SVJOB ',' CODES ',SYSTEMMSG=YES')
|      ROUTE(ONE %AOFOPGSSOPER%));
```

User predefined Automation Table entry :

```
|
|      NONE
|
```

Chapter 9. Data Management

This chapter provides information about SA z/OS functions for:

- Importing selected entries from another policy database
- Importing sample add-on policies
- Making bulk policy updates via flat files

Start Panel for Data Management

Option 5 (Data Management) on the Customization Dialog Primary Menu takes you to the Data Management Menu panel, shown in Figure 254.

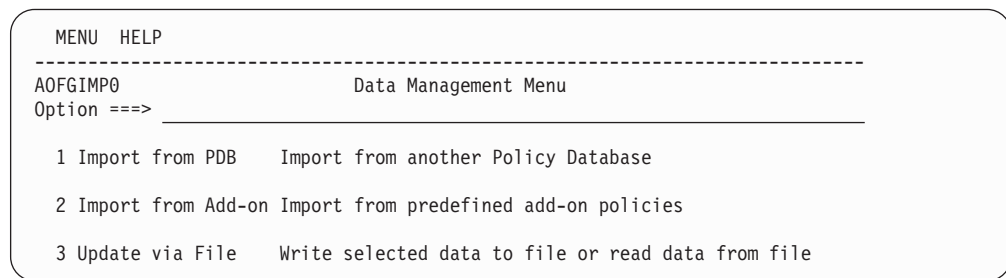

Figure 254. Data Management Menu Panel

Your options on this panel are:

1 Import from PDB

This option enables you to select entries in a policy database and add them to the current policy database. See “Importing Policy Database Data” for details.

2 Import from Add-on

This option enables you to select sample add-on policies and add all or part of their entries to the current policy database. See “Importing Sample Add-On Policies” on page 347 for details.

3 Update via File

This option enables you to export the policy database data of a selected entry type to a flat file. After you have modified this data or added new entries, the flat file can be read in again. All the modified or newly added entries will be updated in the policy database or added to it without any further panel interaction. See “Making Updates with Text Files” on page 350 for details.

Importing Policy Database Data

Selecting option 1 (Import from PDB) on the Data Management Menu panel leads to the panel shown in Figure 255 on page 344.

Importing Policy Database Data

```
MENU  HELP
-----
A0FGIMPP          Import entries from a Policy Database
Option ==>>> _____

Current Policy Database      : BASE
Enterprise Name              : BASE

1 Import Policy Data
  Source Policy Database. . . . . IMPORT_DATABASE      (? or name)
  Entry type . . . . . APL                            (? or type)
  Import linked entries . . . . . NO                  (YES or NO)
                                          (applies to GRP,SYS,APG,APL,TRG only)

2 View import report
```

Figure 255. Policy Data Base Import Panel

This panel enables you to select entries in a policy database and add them to your current one, and view the import report for the target policy database. It has the following options:

1 Import Policy Data

This option allows you to define the following:

- An existing policy database that data will be imported from.
Entering a question mark (?) in this field and pressing Enter displays the Policy Database Selection panel where you can select one of the existing policy databases.
You can import data from the current database. This allows you to clone existing definitions for SYS, APL, APG and MTR entry types.
- The particular entry type that selected entries will be imported for.
Entering a question mark (?) in this field and pressing Enter displays the Entry Type Selection panel where you can select one of the existing entry types.
- Whether you want to import entries that are linked to the entry type that you selected in the **Entry type** field.

The following rules determine which linked entries are also imported, depending on the entry type that is imported:

GRP Linked entry types SBG or SYS are also imported. For sysplex groups, any linked APG entry type of type SYSPLEX is imported.

The links between resources where the group is involved are imported.

SYS All entry types that are linked to the selected systems are imported along with the resources that belong to those systems and the links between the resources in the systems.

APG Linked entry types APL, SVP or TRG are also imported.

APL If the application has an object type of CLASS, its instances and their service periods and triggers are imported.

If the application has an object type of INSTANCE, the class application that it is linked to and its service periods and triggers are imported.

TRG The entries of entry type EVT that are selected in its startup or shutdown conditions are imported along with it.

Note:
Importing entry type ENT (enterprise policies) is not supported.

2 View import report

This allows you to view the import report that is available in the target policy database. It invokes the ISPF VIEW function. If there is no import report, an empty screen is displayed.

The information that you specify here is saved in your ISPF profile data set and used as the initial values the next time you issue the import function.

Selecting **1 Import Policy Data** on this panel takes you to a list of existing entries for the specified type (see Figure 256 for an example).

```

COMMANDS  ACTIONS  HELP
-----
A0FGIMPS          Entry Name Selection                      Row 1 of 9
Command ==>> _____ SCROLL==>> PAGE

Action  Status  Entry Name          Short Description
-----  -
_____ SELECTED ER0_APPSRV          SAP R/3 Application Server Instance
_____          ER0_CO              SAP R/3 Syslog Collector
_____          ER0_DB2DBM1         DB2 for SAP; DBM1
_____          ER0_DB2DIST         DB2 for SAP ER0; DIST
_____          ER0_DB2IRLM         DB2 for SAP ER0; IRLM
_____          ER0_DB2MSTR         DB2 for SAP ER0; MSTR
_____          ER0_DB2SPAS         DB2 for SAP ER0; SPAS
_____          ER0_ERS             SAP R/3 Enqueue Replication Server
***** Bottom of data *****

```

Figure 256. Entry Name Selection Panel for Import Policy Data

Here you can select entries that you want to:

- Copy to your current policy database
- Get a *modified* copy of for your current policy database

Making selections and pressing Enter takes you to the panel shown in Figure 257, which displays the entries that you selected.

```

COMMANDS  ACTIONS  HELP
-----
A0FGIMP3          Selected Entry Names for Import          Row 1 to 2 of 2
Command ==>> _____ SCROLL==>> PAGE

1 Modify data      2 Check data      3 Import start      4 View report

Action Entry Name          Type C D Short Description
-----  -
_____ ER0_APPSRV          APL      SAP R/3 Application Server Instance
_____ ER0_DB2IRLM         APL      DB2 for SAP ER0; IRLM
***** Bottom of data *****

```

Figure 257. Selected Entry Names For Import Panel

This panel allows you to modify the selected entries before you import them. You can:

- Rename entries in the list by:
 - Overtyping their names

Importing Policy Database Data

- Entering RENAME (R) in the **Action** field

If there is already an entry with the same name and type in the current policy database, it is marked as a duplicate (column **D** is set to Y).

- Overtyping an entry's **Short Description** field (this only affects non-duplicate entries).
- Remove entries from the list by:
 - Blanking their names
 - Entering REMOVE (M) in the **Action** field
- Locate an entry by entering LOCATE (L) at the command line.
- Modify data using character string replacement by entering 1 or MODIFY (M) at the command line. This opens a Modify data pop-up window, as shown in Figure 258.

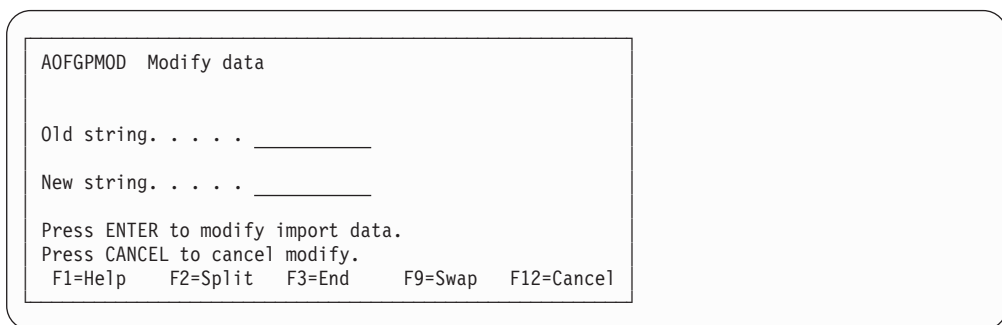

Figure 258. Modify Data Pop-Up Window

Type data in the **Old string** and **New string** fields.

Replacement happens in a predefined set of fields in the import data. This set of fields supports the cloning of complete systems, for example, IMS, CICS, or SAP solutions.

You can update all relevant fields at once with a single modify action. This only works if the naming of a solution was done systematically (for example, consistently using an IMS subsystem ID of IMS1).

The modification for certain fields is case-sensitive. For a complete list of modifiable fields (including whether data modification is case-sensitive) see the online help.

Note:

No checks are made to prevent &AOCCLONE variables that are used in fields being modified.

- Check the data that is to be imported by entering 2 or CHECK (K) at the command line.

This executes an integrity check of the data and links to be imported so that there are no conflicts with definitions in the current policy database. Error messages for any conflicting data properties that are detected are listed in the import report. An import is not carried out.
- Start the import process by entering 3 or IMPORT (I) at the command line.

This executes the same data integrity check as with option 2 and, if no conflicts are found, imports the data into the current policy database.
- View the import report by entering 4 or VIEW (V) at the command line.

This allows you to view the most recent import or data check report that is available in the current policy database. It invokes the ISPF VIEW function. If there is no import report, an empty screen is displayed.

- Return to the Entry Name Selection panel by pressing the END or PF3 key.
- Go to the Data Management panel by entering CANCEL (C) at the command line.

Note:

If the entry is a class, column C is set to *.

Batch Import with Data Modification

SA z/OS provides a batch interface that can be invoked from a separate JCL. The SINGSAMP sample library contains a sample job for this task in the member INGEIMP. Before submitting this job, you need to edit the jobcard appropriately as described in the sample itself.

The batch job needs the following input parameters:

- Target policy database name
- Target policy database data set name
- Source policy database name
- Source policy database data set name
- Entry name (to be imported)
- Entry type (to be imported)
- Whether entries linked to the selected entries as well as the links themselves should be imported
- List of strings to be modified, separated by blanks
- List of replacement strings, which must have as many words as the list of strings to be modified

The batch import produces the following return codes:

- 0 Successful.
- 8 Import did not run due to incomplete or conflicting specifications
- 20 Severe error: no data imported.

Importing Sample Add-On Policies

SA z/OS comes with a number of sample add-on policies that you can import into an existing policy database to speed up database development. Importing add-on policies into a policy database means adding a copy of the sample to that policy database. The add-on policies themselves are not modified.

To import sample add-on policies:

1. Specify the *target* policy database that you want to import the sample *into* in the **Current Policy Data Base** field of the Customization Dialog Primary Menu and select option **5 Data Management**.

2. On the Data Management Menu panel, select option **2 Import from Add-on**.

This takes you to the Import Add-On Policies panel, shown in Figure 259 on page 348, which displays a list of the add-on sample policies that SA z/OS provides.

Importing Sample Add-On Policies

```

ACTIONS  HELP
-----
AOFGPIMA          Import Add-on Policies          Row 1 of 15
Command ==> _____

1 Import selected add-on policies
2 View import report

Current Policy Database: BASE
Add-on policies to be added to the current policy database:
Action  Status  Add-on Policy  Customizable
-----  -
*_____  SELECTED  *CICS
*_____  *DB2
*_____  *E2E
*_____  *GDPS
*_____  *HYPERSWAP
*_____  *IBMCOMP      YES
*_____  *IMS
*_____  *ITM          YES
*_____  *NMC
*_____  *PROCOPS
*_____  *SAP          YES
*_____  *TBSM
*_____  *TWS
*_____  *USS
*_____  *WEBSPPHRE   YES
***** Bottom of data *****

```

Figure 259. Import Add-On Policies Panel

YES in the **Customizable** column indicates that a policy has several components. If you enter C in the **Action** field for a customizable add-on policy, this displays the Select Add-on Policy Components panel. From the list of the components you can select or deselect the components that you want to include in the import.

3. Select the add-on samples that you want to import and invoke option **1 Import selected add-on policies**.

This performs a check of the selected policies (a pop-up window shows the progress of the checks). A panel similar to Figure 260 is then displayed.

```

COMMANDS  ACTIONS  HELP
-----
AOFGIMP3          Entries of selected Add-on Policies  Row 1 to 14 of 28
Command ==> _____  SCROLL==> PAGE

1 Modify data      2 Check data      3 Import start    4 View report

Action Entry Name      Type C D Short Description
-----
SYSplex1          GRP  Y Placeholder. Original in *BASE
SYS1              SYS  Y Placeholder. Original defined in *BASE
SYS2              SYS  Y Placeholder. Original defined in *BASE
SYS3              SYS  Y Placeholder. Original defined in *BASE
CICS_NETVIEW_SSI APG  CICS NetView Subsystem Interface
CICS_SHARED       APG  CICS Shared Servers for CF Structures
CICS_1            APG  CICS Instance #1 (System group)
CICS_1 X          APG  CICS Instance #1 (SysPlex group)
C CICS_NV_PPI     APL  * Class for CICS Netview PPI receivers
C CICS_PPI        APL  * Class for PPI receivers running in CICS
C CICS_SHAREDSERVERS APL  * Class for CICS Shared Servers
C CICS_XACTIONSERVER APL  * Class for CICS Transaction Server
CICSDT            APL  CICS Shared Data Tables CF Support
CICSNC            APL  CICS Shared Named Counter CF Support
***** Bottom of data *****

```

Figure 260. Entries of Selected Add-on Policies Panel

4. This panel allows you to modify the selected entries before you import them.

If the entry is a class, column **C** is set to “*”.

If there is already an entry with the same name and type in the current policy database, it is marked as a duplicate (column **D** is set to **Y**).

You can:

- Rename entries in the list by:
 - Overtyping their names
 - Entering RENAME (R) in the **Action** field
- Overtyping an entry's **Short Description** field (this only effects non-duplicate entries).
- Remove entries from the list by:
 - Blanking their names
 - Entering REMOVE (M) in the **Action** field
- Locate an entry by entering LOCATE (L) on the command line.
- Modify data using character string replacement by entering 1 or MODIFY (M) at the command line. See the online help for details of which entry types and fields you can use character string replacement with.

Note that the modify action is supported only for a single selected add-on policy, rather than several simultaneously.

A Modify data pop-up window opens, similar to Figure 258 on page 346. For details about using this window, see “Modifying Data” on page 346.

- Check the data that is to be imported by entering 2 or CHECK (K) at the command line.

This executes an integrity check of the data and links to be imported so that there are no conflicts with definitions in the current policy database. Error messages for any conflicting data properties that are detected are listed in the import report. An import is not carried out.
- Start the import process by entering 3 or IMPORT (I) at the command line.

This executes the same data integrity check as with option 2 and, if no conflicts are found, imports the data into the current policy database.
- View the import report by entering 4 or VIEW (V) at the command line.

This allows you to view the most recent import or data check report that is available in the current policy database. It invokes the ISPF VIEW function. If there is no import report, an empty screen is displayed.
- Return to the Import Add-On Policies panel by pressing the END or PF3 key.
- Go to the Data Management panel by entering CANCEL (C) at the command line.

Warning: Consistent Naming

Importing an add-on policy includes importing all relationships and links between policy objects in that database. You therefore need to make sure that naming is consistent across your current policy database and the sample that you want to add if you start from one of the following:

- A copy of the *BASE sample policy database, but you modify it before importing an add-on policy
- A policy database that you have created yourself on the basis of the *EMPTY sample policy database

This is so that relationships and links can be resolved during the import operation. When there are relationships or links that cannot be resolved, an “unresolved link” message is displayed in the progress indication panel.

Making Updates with Text Files

You can carry out bulk updates of policy objects using a flat text file. You can select one or more policy objects and their associated policy items and have their data written to a text file. You can then edit the text file to update the policies and then import the updated file into your policy database.

This update method can be quicker than using the customization dialog if you want to update several entries, but you must take care that the syntax is correct.

Currently, only policy objects of type APG, APL, MTR, and UET are supported.

Note that the flat-file bulk update facility does not allow concurrent user access.

For example, to update APL policy objects via a text file, follow these steps:

Step 1. Edit the text file:

Use option 5 (Edit output file) on the Policy Data Base Update Selection panel to edit the data set where you put your text policy data.

Step 2. Check syntax (optional):

Although a syntax check is performed when you import a text file, you can use option 2 (Perform syntax check) to check that the syntax of the file data complies with the data in the policy database before you import the file. This can save you time because it allows you to check the syntax without invoking the complete import process.

Step 3. Import the updated text file:

On the Data Management Menu panel, make sure that the **Input File Name** field specifies the data set with your updated policy data. If you do not provide a name in this field, SA z/OS will put in the name of the data set previously used for output.

Type 3 on the option line and press Enter.

Further update processing is controlled by the **Mode** setting:

ONLINE

This is the default value. It indicates that the update should run in the foreground. It displays a command progress display.

Processing is as follows:

- a. A syntax check of the whole text file is performed. Only when the syntax check has finished successfully does the actual policy database update take place.
- b. If there is a timestamp in the text file and it is more recent than the last modification of entries in the policy database, the policy database is modified.
Otherwise a confirmation panel with the names of the most recently modified entries is displayed, where you can either confirm or cancel the update processing.

Messages from the update are written to a report data set that can be viewed with option 4 in the Policy Database Update Selection panel.

The data set with the text policy data is not affected by the import. In particular it is not deleted.

BATCH

This indicates that the update should run in the background. Processing is as follows:

- a. A batch job is started, executing the policy database update as soon as it obtains exclusive access to the database. This requires you to specify valid JOB statement information in the panel.
- b. A syntax check of the whole text file is performed. Only when the syntax check has finished successfully, does the actual policy database update take place.
- c. If there is a timestamp in the text file and it is more recent than the last modification of entries the policy database, the policy database is modified.
Otherwise the update process ends with messages in the report data set giving the reasons for ending without updating the policy database.

The settings in the **Mode** field and **Job statement information** are saved in your ISPF profile data set and are used as the initial values the next time you issue the UPDATE command.

Supported Policies

Apart from the policies that are available for applications, the following policies are supported for other entry types:

Application Groups

DESCRIPTION
APPLGROUP INFO
RELATIONSHIPS
MESSAGES/USER DATA

Monitor Resources

DESCRIPTION
MONITOR INFO
RELATIONSHIPS
MESSAGES/USER DATA
HEALTHSTATE

User E-T Pairs

DESCRIPTION

E-T DATA

Updating Policy Objects Using Text Files

Each policy object in the text file is represented by the following structure:

```
UPD <Entry Type>      - <Entry Name>
  <Policy Item>       ( field|block|policy replacement )
    <Field>            : <Value>
    <Field>            : <Value>
    ...
  <Policy Item>       ( field|block|policy replacement )
    <Field>            : <Value>
    <Field>            : <Value>
    ...
  ...
```

The actual values for the Entry Type, Entry Name, Policy Item and Field variables depend on the selections that you made when the file was created and what data is in your policy database, for example:

```
UPD APL                - AM
  RELATIONSHIPS        ( policy replacement )
    Relationship Type   : MAKEUNAVAILABLE
    Supporting Resource : AM2/APL/=
    Description         : Prevents takeover at system shutdown
    Sequence Number    :
    Automation         : PASSIVE
    Chaining           : WEAK
    Condition          : WhenDown
* MESSAGES/USER DATA  no data available
```

Do not modify the *<Policy Item>* or *<Field>* segments because the syntax of the file will be invalid and the file will fail syntax checking.

If the file does fail the syntax check, you can view the update report and fix any errors that are reported before trying the update again.

The text after each policy item indicates which type of data replacement is possible:

- Field replacement: the data that you specify in the text file replaces only the corresponding data in the policy database and nothing else.
- Block replacement: the row and all data that is nested underneath it is treated as one block of data, and each such block replaces the corresponding data in the policy database.
- Policy replacement: the policy definition in the text file replaces the whole policy definition in the policy database.

Note:

The *<Policy Item>* lines must begin in column 2 or 3 or the file will fail the syntax check.

Field Replacement

With *field replacement* the specified data in the file replaces only the corresponding data in the policy database. A blank value for a field in the file discards a value that may be in the policy database or resets it to a default in the same way as for the input field on the panel. The data in any other fields that belong to a policy but are not specified in the text file remains unchanged.

Block Replacement

With *block replacement* a data row marked with a dash indicates a data block that consists of that row and all data that is nested underneath it. Each such block replaces the corresponding data in the policy database. Other blocks for the same policy item remain unchanged. A data block where you have edited all the fields to blank would delete all the corresponding data from the policy database. For example, the following would delete the reply definitions from a message:

```
Action          - REPLY
  Pass/Selection :
  Retry Count   :
  Reply Text    :
```

You can also specify just the block header line to delete all the data in that block. Thus, the equivalent for previous example would be:

```
Action          - REPLY
```

Example 1: Create or Change Policy Messages for APL TSO in the *BASE Policy Database: All of these changes are made in one file.

1. The data in the text file is initially:

```
UPD APL          - TSO
  MESSAGES/USER DATA ( block replacement )
  Message id      : IKT001D
  Description     : Active users during TCAS start
  Action         - REPLY
    Pass/Selection :
    Retry Count   :
    Reply Text    : U
```

Change Message ID IKT001D to TEBULK and create a new message for this message ID:

```
UPD APL          - TSO
  MESSAGES/USER DATA ( block replacement )
  Message id      : TEBULK
  Description     : Active users during TCAS start
  Action         - REPLY
    Pass/Selection :
    Retry Count   :
    Reply Text    : U
    Pass/Selection : *
    Retry Count   : 1
    Reply Text    : dump
```

2. Create a new Message ID TEST for the application TSO:

```
UPD APL          - TSO
  MESSAGES/USER DATA ( block replacement )
  ...
  Message id      : TEST
  Description     : test bulk
  Action         - code
    Code 1       : 9999
    Code 2       :
    Code 3       :
    Value Returned : TERM
```

Example 2: Change or Insert SHUTDOWN for the APL C_TWS in Sample *TWS Policy Database:

1. Delete pass 4 for PHASE NORM, change the pass from 2 to 4 for PHASE IMMED, and insert a reply for PHASE INIT:

Making Updates with Text Files

```
UPD APL                - C_TWS
SHUTDOWN              ( bLock replacement )
Phase                 : NORM
Action                - CMD
Pass                  : 1
Automated Function/'*' :
Command Text          : MVS P &SUBSJOB
Pass                  : 4
Automated Function/'*' :
Command Text         : MVS C &SUBSJOB
Phase                 : IMMED
Action                - CMD
Pass                  : 1
Automated Function/'*' :
Command Text          : MVS P &SUBSJOB
Pass                  : 4
Automated Function/'*' :
Command Text          : MVS C &SUBSJOB
Phase                 : FORCE
Action                - CMD
Pass                  : 1
Automated Function/'*' :
Command Text          : MVS C &SUBSJOB
Phase                 : INIT
Action                : REPLY
Reply Text           : TEST BULKUPDATE
```

Policy Replacement

With *policy replacement* the data in the text file replaces the whole policy item definition in the policy database. For example:

- An application has two relationships defined for it in the policy database and one relationship in the text file. After the file update has been completed the application has only the one relationship from the text file.
- An application has some USS data defined in the policy database, while all USS fields in the text file for the application are blank. After the file update has been completed the application no longer has any USS data.

Empty lines are allowed anywhere in the file. They are ignored when the file update is performed. Comment lines are also allowed anywhere in the file. They have an asterisk in the first column and are skipped during file import.

If a field is specified several times, the last definition wins, even if it is an empty field. The following sequence in the APPLICATION INFO policy would remove any Owner data from the policy database for the corresponding application:

```
Owner                 : OPERATOR
Owner                 :
```

Example: Create or Change Policy Relationships for the APLs TCPIP, JES2 and JES3 in the *BASE Policy Database: All of these changes are made in one file.

1. The data in the text file is initially:

```
UPD APL                - JES2
RELATIONSHIPS          ( policy replacement )
Relationship Type       : HASMONITOR
Supporting Resource    : JES2MON/MTR/=
Description             : Relationship to JES2 Monitor
Sequence Number        :
Automation             :
Chaining               :
Condition              :
*
Relationship Type      : PREPUNAVAILABLE
```

```

Supporting Resource : VTAM/APL/=
Description         : Delay DRAINJES until VTAM is down
Sequence Number    :
Automation         : PASSIVE
Chaining           : WEAK
Condition          : WhenDown
  
```

Change the second relationship for JES2:

```

UPD APL - JES2
RELATIONSHIPS ( policy replacement )
  Relationship Type : HASMONITOR
  Supporting Resource : JES2MON/MTR/=
  Description       : Relationship to JES2 Monitor
  Sequence Number   :
  Automation       :
  Chaining         :
  Condition        :
*
  Relationship Type : PREPAVAILABLE
  Supporting Resource : VTAM/APL/=
  Description       : Edit the description for test
  Sequence Number   : 1
  Automation       : PASSIVE
  Chaining         : WEAK
  Condition        : WhenDown
  
```

2. Add a new relationship to JES3. The data in the text file is initially:

```

UPD APL - JES3
* RELATIONSHIPS no data available
  
```

Edit the file as follows:

```

...
UPD APL - JES3
RELATIONSHIPS ( policy replacement )
  Relationship Type : HASMONITOR
  Supporting Resource : JES3MON/MTR/=
  Description       : Relationship to JES3 Monitor
  Sequence Number   :
  Automation       :
  Chaining         :
  Condition        :
  
```

3. Delete the second relationship from TCPIP (blank all fields or delete all lines for the second relationship). The data in the text file is initially:

```

UPD APL - TCPIP
RELATIONSHIPS ( policy replacement )
  Relationship Type : HASPARENT
  Supporting Resource : RESOLVER/APL/=
  Description       : TCPIP requires RESOLVER for addr xlation
  Sequence Number   :
  Automation       :
  Chaining         :
  Condition        :
*
  Relationship Type : HASPARENT
  Supporting Resource : VTAM/APL/=
  Description       : TCPIP is dependent on VTAM
  Sequence Number   :
  Automation       :
  Chaining         :
  Condition        :
  
```

Edit the file, for example, as follows:

Making Updates with Text Files

```
...
UPD APL                - TCPIP
  RELATIONSHIPS        ( policy replacement )
    Relationship Type   : HASPARENT
    Supporting Resource : RESOLVER/APL/=
    Description         : TCPIP requires RESOLVER for addr xlation
    Sequence Number    :
    Automation         :
    Chaining           :
    Condition          :
*
  Relationship Type    :
  Supporting Resource  :
  Description         :
  Sequence Number     :
  Automation         :
  Chaining           :
  Condition          :
```

Creating New Policy Objects Using Text Files

To create new policy objects, insert sections that have the following structure:

```
NEW <Entry Type>      : <new entry name>
COPY                  : <name of existing entry to copy data from>
WHERE_USED <parent entry type> : <name of existing entry to link to>
LINK_TO_CLASS        : <name of existing APL class entry to link to>
```

You can create new policy objects for any entry type *except* for type ENT (enterprise).

These sections can be inserted anywhere in the text file, with the following conditions:

- Policy object sections are not broken apart by other ones.
- The keywords (NEW, COPY, WHERE_USED, and LINK_TO_CLASS) *must* begin in column 1. Any <Policy Item> lines must begin in column 2 or 3. All other data must be indented.

The keywords LINK_TO_CLASS (for entry type APL only), COPY, and WHERE_USED are optional. If they are specified, they can appear in any order.

The NEW keyword allows additional specifications, for example, subsystem name, in the same notation as for the update function. All the fields that are available on the NEW panel for the entry type that you are creating are also valid here. For detailed examples, see “Examples” on page 357.

The COPY keyword works in the same way as the COPY policy in the customization dialog panels. This means that the same limitations apply with respect to type, subtype, or class/instance compatibilities.

For each keyword, the specification of only one value is allowed. To link an application to several application groups, the WHERE_USED keyword may appear as many times as you require.

The WHERE_USED keyword may need an optional parameter, <parent entry type>, for entries that might be linked to several parent types, for example, Service Periods to Applications, Application Groups or Monitor Resources.

If the parent entry type is omitted, the following defaults are assumed:

- For SYS the default is GRP

- For SVP the default is APL
- For TRG the default is APL.

The parent entry type for Application Groups defaults according to the Application Group's type. If the type is SYSPLEX the default link parent entry type is Group, otherwise it is System.

If either of the COPY or LINK_TO_CLASS keywords is specified several times, the last one is used (the last specification overwrites any previous one) even if it is blank.

The following example shows a more elaborate definition:

```
NEW APL          : $IMS711_MSG_REGION5
  Subsystem Name : IMS711M5
  Application Type : IMS
  Job Name       : IMS711M5
  Short description : IMS V7 - IMS711 Message region on SYS1
LINK_TO_CLASS   : CLASS_IMS_TP
WHERE_USED APG  : IMS711_CONTROL
WHERE_USED APG  : APPLGR_MAINT
COPY            : IMS713M0
```

Note:

You should take care with the order of your definitions. It is possible that a class link that you set with a LINK_TO_CLASS definition is overwritten by a class link that is inherited by a COPY command that is executed after the LINK_TO_CLASS definition.

The instructions to create new entries and the data to modify existing fields are both run from a flat file. As a consequence they can be combined so that the following would be possible:

```
NEW APL      : IMS721RC
COPY        : IMS713RC
WHERE_USED   : IMS721_CONTROL
LINK_TO_CLASS: CLASS_IMS_DBRC

UPD APL          : IMS721RC
  DESCRIPTION
  Short description : IMS V7 - IMS721 DBRC region on SYS2
  RELATIONSHIPS
  Relationship Type : HASPARENT
  Supporting Resource : IMS721C4/APL/=
  Description       :
  Sequence Number   : 1
  Automation        :
  Chaining          :
  Condition         :
```

If the keyword NEW or UPD is specified more than once with the same application name, only the last specification is processed. All previous are ignored. If a specification is ignored, all data rows are skipped up to the next occurrence of NEW or UPD keyword. If a NEW or UPD keyword is skipped, an informational message is issued.

Examples

To create new policy objects, insert sections that have the following structure:

Making Updates with Text Files

```
NEW <Entry Type>           : <new entry name>
COPY                       : <name of existing entry to copy data from>
WHERE_USED <parent entry type> : <name of existing entry to link to>
LINK_TO_CLASS              : <name of existing APL class entry to link to>
```

You can create new policy objects for any entry type *except* for type ENT (enterprise). All the fields that are available on the NEW panel for the entry type that you are creating are also valid here.

This appendix provides examples for the following entry types:

- APL
- APG
- MTR
- UET

These are the most common entry types that you are likely to want to create new policy objects for via file updates.

Application: The following is an example for a new IMS Application Class entry, APLNEW, with data copied from an existing application, OTHERAPL, and linked to another class, IMSCLASS1:

```
NEW APL                   : APLNEW
  Subsystem Name          : APLNEW
  Object Type             : CLASS
  Application Type        : IMS
  Subtype                 : CTL
  Job Type                :
  Job Name                :
  Transient Rerun         :
  Scheduling Subsystem    :
  JCL Procedure Name      :
  Short Description       : New IMS application
  Long Description 1      :
  Long Description 2      :
  Long Description 3      :
  Long Description 4      :
  Long Description 5      :
COPY                      : OTHERAPL
LINK_TO_CLASS             : IMSCLASS1
```

Application Group: The following is an example for a new system Application Group entry, APGNEW, with data copied from an existing application group, OTHERAPG, and linked to an existing system, SYSTEM1:

```
NEW APG                   : APGNEW
  Type                   : SYSTEM
  Nature                 : BASIC
  Default Preference     : *DEF
  Automation Name        : APGAUTO
  Automatically link     : YES
  Behaviour              : ACTIVE
  Move Mode              :
  Short Description      : New Application Group of type System
  Long Description 1     :
  Long Description 2     :
  Long Description 3     :
  Long Description 4     :
  Long Description 5     :
COPY                     : OTHERAPG
WHERE_USED SYS           : SYSTEM1
```

Monitor Resource: The following is an example for a new Monitor Resource entry, MTRNEW:

```

NEW MTR          : MTRNEW
  Monitored object : OBJECT1
  Monitored jobname : JOB1
  Short Description : New Monitor Resource
  Long Description 1 :
  Long Description 2 :
  Long Description 3 :
  Long Description 4 :
  Long Description 5 :
  
```

User Entry-Type Pair: The following is an example for a new User E-T Pair entry, UETNEW:

```

NEW UET          : UETNEW
  Short Description : New User E-T Pair.
  Long Description 1 : For this entry type only
  Long Description 2 : the description lines can be specified
  Long Description 3 : in combination with the file update
  Long Description 4 : keyword 'NEW'.
  Long Description 5 :
  
```

Deleting Policy Objects Using Text Files

You can delete policy objects for any entry type except for type ENT (Enterprise).

The DEL keyword has the following syntax:

```
DEL <Entry Type> : <existing entry name>
```

The keyword can appear anywhere in the file with the following restrictions:

- the keyword DEL must begin in column 1,
- the keyword does not break other sequences, for example, a new entry consisting of NEW and related COPY, WHERE_USED keywords,
- no detail specifications are needed in subsequent lines (unlike, for example, NEW or UPD).

For each specification of DEL, only one entry name is allowed. To delete multiple entries, a single DEL specification is required for each entry.

If there are multiple DEL specifications for the same entry type/name this is not handled as an error. The entry is deleted and WARNING messages are issued additionally for each duplicate specification to indicate there may be an error.

An entry can only be deleted via the DEL keyword if it is not referenced anywhere else in the file. For example, an application can only be deleted via file if it is not modified via UPD or created via NEW in the same file. If there is a need to delete an entry and recreate it, then the corresponding specifications have to be split into two files that need to be run one after the other.

Generating a Job for Batch Update

You can run a job for batch update that performs the same processing as the UPDATE function of the customization dialog. The SINGSAMP sample library contains a sample job for this task in member INGEBFLT. Before submitting this job, you need to edit the jobcard appropriately as described in the sample itself.

The batch update produces the following return codes:

0 Successful

Making Updates with Text Files

- 4 Syntax errors or timestamp conflicts were detected; the update was terminated. See the job log or report file for details.
- 8 The update text file could not be read or the report data set could not be reallocated. The update was terminated.
- >8 Severe error; update terminated. See the job log for details.

Chapter 10. Conversion Function

This chapter provides information on what you should be aware of before using the new release of SA z/OS. In detail, the following topics are discussed:

- “Moved and Restructured Data”
- “Initial Policy Database Conversion” on page 362

The conversion function creates a report called \$RPTCNV as a member in the data set of the policy database. All messages are logged.

Moved and Restructured Data

Converting from SA z/OS 3.2

The following changes apply when converting from SA z/OS 3.2:

- The values eServer, 9672, 9674 and 3000 are converted to Mainframe.
- The **Connection Protocol** is defaulted to TCPIP for PSM processors.
- The **ProcOps Target HW Name** is defaulted to the processors entry name for SNMP and NVC processors.
- The **Auth Token** value for SNMP and NVC processors must be blank.
- The **Command Retry** value for SNMP processors is defaulted to 10.
- The **Command Retry Wait Time** for SNMP processors is defaulted to 1.
- For non-MVS systems the data from the old **Image/ProcOps name** is taken to set the new **System/Image name**.
- For MVS systems the data from the old **MVS system name** is taken to set the **System/Image name**. If the old **MVS system name** and the **Image/ProcOps name** are not identical, conversion stops with a message telling you that this must first be changed.
- All links to CCN, CVP, IRN and ISF entry types are deleted.
- Data from minor resource flags and thresholds are merged into the MINOR RESOURCES policy item.
- Forces the CODE3 definitions for the message ID INGALERT to the value IOM.
- The character % in CODE1, 2, and 3 definitions are escaped, that is, prefixed with a \ character, to indicate that the % character is not a wildcard character.

The conversion process issues a warning message if:

- There are thresholds in UET entries
- There are processor definitions that are missing mandatory data

The conversion process transforms AT specifications in the following cases:

- If you have specified message IEF403I with a status of UP in the MESSAGES/USER DATA policy item for applications, the new field **Skip ACTIVE status** in the APPLICATION INFO policy is set to YES and this message entry is deleted.
- If multiple overrides for one message are combined into a single new override the keywords *BEGINAPL and *ENDAPL are inserted.

Moved and Restructured Data

- The variable &SUBSJOB is replaced with &*JOBNAME. to have a clear distinction from &SUBSJOB which is a runtime variable, while &*JOBNAME. is resolved during AT build. Whenever the variable is replaced, an informational message is issued.
- For any conversion of AT data an informational message is issued.

Initial Policy Database Conversion

The first time that a policy database is opened with the customization dialog, conversion to the current layout is done automatically. There are special conversion options available by selecting **0 Settings** in the Customization Dialog Primary Menu, and then **4 Convert** in the Customization Dialog Settings Menu. This displays the PDB Convert Option panel. This panel is used to specify the options for the PDB Conversion. These options are saved in your ISPF profile pool and remain in effect until set again

On this panel, SA z/OS allows you to request the generation of an automation name for application groups during the very first conversion of a policy database. If an application group has an automation name, SA z/OS can generate resources from such entries.

Selective Policy Database Conversion

After your entries have been migrated to the policy database, the conversion is done to convert the old data which might have been migrated to the policy database to the new format. The migration functions automatically start the conversion function.

Generating a Job for Batch Conversion

You can run a job for batch conversion that performs the same processing as the conversion function of the customization dialog. The SINGSAMP sample library contains a sample job for this task in member INGEBCNV. Before submitting this job, you need to edit the jobcard appropriately as described in the sample itself.

Appendix A. Concurrent Customization by Multiple Users

Concurrent user access is supported for entry types SYS, APG, APL, MSG, MTR, MVC, and UET. These are referred to as “multi-user capable entry types”.

The following subsections describe the consequences for users that want to work simultaneously on entry types within one policy database.

Concurrent User Access Capabilities

If a policy database is selected for processing (using the OPEN command), access to that policy database for other users is possible, that is, multiple opening of a policy database is supported.

Working on entry types other than the multi-user capable ones with several users, or performing commands other than OPEN or SELECT against a policy database while an entry in a multi-user capable entry type is being edited, may not work.

This limitation depends on the data tables that are needed for the selected action or command, and it is indicated by specific messages. The most common situations are described in the following sections.

Policy Definitions Usage

If you want to change your Enterprise Policy Options by selecting option 10 on the Customization Dialog Settings Menu panel (see Figure 261 on page 365), while another user works with a policy database, the selection is not possible and an appropriate message is displayed.

On the other hand, if you are accessing the SA z/OS policy items for modification, this will prevent other users from accessing any policy item and an appropriate message is displayed.

Policy Database Selection

If you want to issue a BUILD, DELETE, or REPORT command from the Policy Database Selection panel or use a DATA MANAGEMENT function while another user has accessed the same policy database, the command is rejected and an appropriate message is displayed.

Conversely, if you request access to a policy database via *S (Select)* or *O (Open)*, while a BUILD, DELETE, DATA MANAGEMENT function, or REPORT is in progress for this policy database, the access is rejected and an appropriate message is displayed.

For other commands there are also limitations, if a user has already opened the specific policy database. These limitations depend upon the selected entry types and actions, and are indicated by an appropriate message.

Entry Type Selection

If a policy database is opened successfully (with *S (Select)* or *O (Open)*), the Entry Type Selection panel is displayed. Here a specific Entry Type can be selected, or a BUILD can be requested.

Concurrent User Access Capabilities

If a BUILD command is issued from this screen, but another user has also opened this policy database to work with applications or any other entry type, the command is rejected and an appropriate message is displayed.

If an entry type other than the multi-user capable ones is selected, and another user has also selected an entry type of the same policy database, the selection may be rejected depending on the data tables needed for the selected entry type, and an appropriate message is displayed. In this case, editing is not possible, because concurrent user access is provided only for the multi-user capable entry types.

Entry Name Selection

On the Entry Name Selection panel a specific application can be selected, and a BUILD can be requested.

If you try a BUILD action, and the policy database has been simultaneously opened by another user, the command is rejected and an appropriate message is displayed.

If another user is currently editing the same application in the same policy database, access is allowed only to view the data, that is, changing the displayed data is not allowed. In this case, however, it is possible to select that application and view the data. A warning message is displayed on the Policy Selection panel, indicating that no updates will be accepted.

If, nevertheless, the displayed values are changed on the data entry panel for that policy option, these changes are not accepted when leaving that panel. If you try to leave the panel with the END command, a message will remind you that you must leave this panel with CANCEL.

Changing Links

The WHERE USED policy item for Systems allows you to change the links of one system to one or more groups or subgroups.

The WHERE USED policy item for Applications allows you to change the links of one application to one or more application groups.

The WHERE USED policy item for ApplicationGroups allows you to change the links of one application group to one or more systems or sysplexes.

The WHERE USED policy item for Monitor Resources allows you to change the links of one monitor resource to one or more monitor resources.

You can only add or remove such links, if you exclusively access the entry types System, Application, ApplicationGroup, or Monitor Resource. If another user is currently editing them, a message is displayed indicating that updates are not possible.

The same is true for the trigger policy item where you can maintain the link of the current application, application group, or monitor resource to a trigger.

Appendix B. More about Using the Customization Dialog

Changing Your Customization Dialog Environment	365	Alternate Configuration Support	373
Extending Policy Definitions	366	How to Define Alternate Configurations for	
Defining Data Sets for Batch Processing	370	Systems	374
Defining ISPF Temporary Data Sets for Batch		How to Build Alternate Configurations.	374
Build	372	Restrictions	375
User-written Functions	372		

Use this appendix to find out how to get help when using the customization dialog and how to change the customization dialog environment.

Changing Your Customization Dialog Environment

You can invoke the Settings function from the Customization Dialog Primary Menu or from the Menu pull-down of the Policy Database Selection panel.

The first three options in the Customization Dialog Settings Menu panel (see Figure 261) allow you to change the customization dialog environment for your user ID. This is a usability function only and has no effect on the policy database contents.

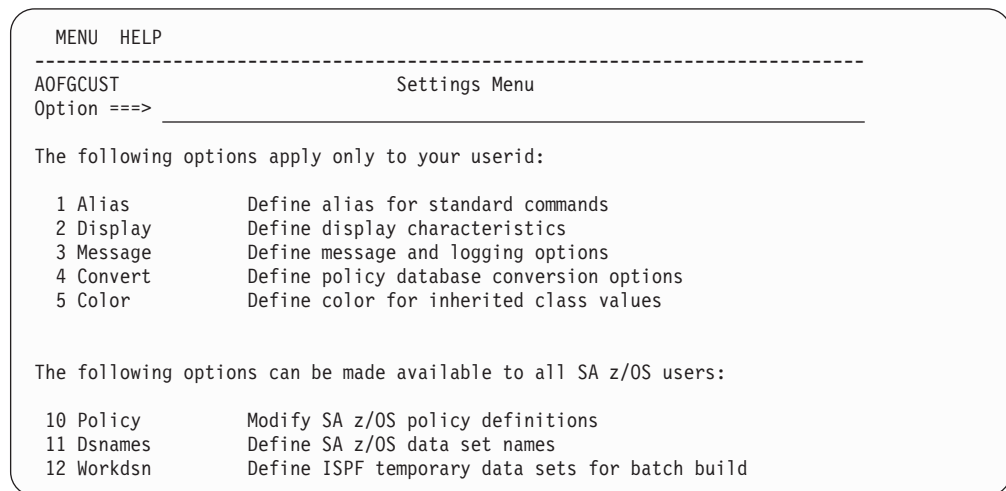

Figure 261. SA z/OS Customization Dialog Settings Menu

Alias This option allows you to change commands and command abbreviations that can be entered on the command line or action column in the customization dialog.

Display This option allows you to change the line spacing for lists that appear in the customization dialog.

Message This option allows you to specify the level of detail in the messages you receive when you run various customization dialog options or batch jobs, and whether the messages are written to the ISPF log.

Note

If you want to use SA z/OS 3.3 processor operations ACF entries to build a processor operations control file for a focal point system that is running an earlier release of SA z/OS, use this option to specify whether SA z/OS should invoke additional checking for processor operations-related warning messages during configuration build. SA z/OS writes these messages to the build report \$BLDRPT. The default value is OFF.

These settings are stored in the ISPF application profile. To have them available for batch processing (build or migration), make sure that your ISPF profile data set is allocated to the table library, DDname: AOFTLIB, as described in “Defining Data Sets for Batch Processing” on page 370.

Convert

This option lets you specify whether SA z/OS should create an automation name for an ApplicationGroup resource during the very first conversion of a policy database. See “Initial Policy Database Conversion” on page 362 for more information.

Color This option allows you to specify the color and reverse video option that is used to display inherited class values.

Policy See “Extending Policy Definitions”;

Dsnames

See “Defining Data Sets for Batch Processing” on page 370;

Workdsn

See “Defining ISPF Temporary Data Sets for Batch Build” on page 372;

Extending Policy Definitions

With SA z/OS you can extend your policy definitions by creating new policy items or modifying existing ones. Any user-defined policy items that you create or modify are now kept separate from the SA z/OS policies. This means that with future releases of SA z/OS you will not have to redefine those policy items that you have created or modified.

To create new policy items or modify existing ones, you should perform the following steps:

1. Select option **10 Policy** from the Customization Dialog Settings Menu (see Figure 261 on page 365). An Entry Type Selection panel is displayed.
2. Select the entry type that you want to create a new policy item or modify one for. The Edit Policy Selections panel is displayed, listing all current policy items for that entry type, as shown in Figure 262 on page 367. Any user-defined policy items are indicated by **USR** in the **Status** column.

Changing Your Customization Dialog Environment

COMMANDS		ACTIONS		HELP
AOFGCP01		Edit Policy Selections		Row 1 to 14 of 44
Command ==>				SCROLL==> PAGE
Entry Type : Group				
Act	Stat	Policy Name	Policy Description	
---	SEL	DESCRIPTION	Enter description	
---	SEL	UPWARD CLASS	Select a class to inherit data from	
---	SEL	DOWNWARD CLASS/INST	Select classes or instances that inherit data	
---	USR	WAC INFO	Define WAC application information	
---	SEL	APPLICATION INFO	Define application information	
---	SEL	AUTOMATION FLAGS	Define application automation flags	
---	SEL	TRIGGER	Select trigger	
---	SEL	SERVICE PERIOD	Select service period	
---	SEL	RELATIONSHIPS	Define relationships	
---	SEL	MESSAGES/USER DATA	Define messages and user data	
---	SEL	STARTUP	Define startup procedures	
---	SEL	SHUTDOWN	Define shutdown procedures	
---	SEL	THRESHOLDS	Define error thresholds	
---	SEL	MINOR RESOURCE FLAGS	Define application sub-component flags	

Figure 262. Edit Policy Selections Panel

3. In the Edit Policy Selections panel you can:

- Create a new entry by entering NEW at the command line. The new entry is added to the top of the list.
- Create a new entry by entering INSERT in the **Act** column. The new entry is added after the entry where INSERT was specified.
- Edit an entry by entering EDIT in the **Act** column.

Note:

Any modifications to the existing SA z/OS policy definitions are solely your responsibility.

- Delete a user-defined entry by entering DELETE in the **Act** column.
 - Suppress an SA z/OS entry by entering REMOVE in the **Act** column.
 - Activate a deselected entry by entering SELECT in the **Act** column.
 - Leave the panel and save all changes by entering the END command.
 - Discard all changes by entering the CANCEL command.
4. If you choose to insert a new policy item for an entry type, or edit an existing policy item, the Define Policy Selection panel is displayed. The example in Figure 263 on page 368 shows how to define policy item APPLICATION INFO of entry type Application

Changing Your Customization Dialog Environment

```
COMMANDS  HELP
-----
A0FGCP02          Define Policy Selection
Command ==> _____

Entry Type : Application

Enter or update the following to define the Policy Definition:

Name . . . . . APPLICATION INFO
Description . . Define application information
Help Action . . PGM(ISPTUTOR) PARM(AOFHLP0)
Edit Action . . CMD(AOFF#POL AOFGLPA0,APL,EXIT(AOFFVAP1))
User Note. . . _____
               . . . _____
               . . . _____
               . . . _____
               . . . _____

Filter attributes . . _____
```

Figure 263. Define Policy Selection Panel

If you want to create policy items you must specify an ISPF action for the selection of the new policy item from the Policy Selection panel. You must then create your own ISPF input panel for the new policy item.

Each policy selection consists of information defining:

- How the policy appears on the *Policy Selection* panel.
- How the policy is processed when it is selected.
- Under what conditions the policy should be displayed.

This panel has the following fields:

Entry Type

Indicates the entry that the policy is being defined for. This field is set based on the entry type you had previously selected.

Policy Name

This is the name of the policy you are defining. It appears in the first column of the Policy Selection panel. This field is required.

Description

This is a short description of the policy. It appears in the second column of the Policy Selection panel. This field is required.

Help Action

Specifies the action to be taken when policy help is requested (by entering HELP in the Action column on the Policy Selection panel). The action must be a valid ISPF SELECT service. For example, to display an ISPF panel enter:

```
PGM(ISPTUTOR) PARM(panel-name)
```

The help text should describe the function provided by this policy rather than describing how to enter the data for the policy.

This field is optional; if no action is specified HELP will not be available from the Policy Selection panel for this policy.

Edit Action

Specifies the action to be taken when the policy is selected from the Policy Selection panel. The action must be a valid ISPF SELECT Service. This field is required.

Changing Your Customization Dialog Environment

User Note

These fields are not shown on the Policy Selection panel. They can be used for documentation purposes. These fields are optional.

You can also specify filtering conditions, that is, attributes of the entry being processed from the Policy Selection panel that can be used to determine whether this policy should be displayed. The following filtering information can be specified:

Filter attributes

This specifies attributes that an entry must have in order for this policy to be displayed. This field contains multiple words, each word identifying one attribute. All the attributes specified must be satisfied in order for the policy to be displayed. If no attributes are specified then the policy is valid for all entries. The attributes that can be specified are defined by SA z/OS and differ based on the entry type, as shown in Table 9.

Table 9. Policy Selection Filter Attributes

Entry Type	Attribute	Value
Group	Group type	(blank) STANDARD SYSPLEX
System	Operating System type	(blank) CF LINUX MVS VM VSE
ApplicationGroup	ApplicationGroup type	(blank) SYSPLEX SYSTEM
Application	Object type	(blank) CLASS INSTANCE
	Application type	(blank) IMAGE JES2 JES3 CICS IMS DB2 OPC USS
Processor	Processor type/mode	(blank) LPAR ESA PSM
Others	–	

The following rules apply to the filtering attributes:

1. If no attributes are specified (indicated by *blank* in Table 9), the policy is always displayed for all entries.
2. If multiple attributes are specified then all attributes must be satisfied in order for the policy to be displayed. For example:

Changing Your Customization Dialog Environment

- JES2 CLASS This displays the policy for application entries that are classes and are of type JES2.
- JES2 This displays the policy for application entries that are of type JES2 and either class or instances.
3. For each ATTRIBUTE, the words listed in the VALUE column are mutually exclusive. If you specify both values the policy will never be displayed as both conditions cannot be true at the same time. For example:
- JES2 JES3 This is never displayed because an application can be either JES2 or JES3 but not both.
4. No validity checking is done on the attribute values. If an invalid value is specified the policy will never be displayed since the condition cannot be satisfied. For example:
- JES4 This is never displayed because an application cannot be of type JES4.

Defining Data Sets for Batch Processing

Use Option 11 of the Customization Dialog Settings Menu panel to define the batch processing data sets. This needs to be done only once when you install SA z/OS. For details, see *IBM Tivoli System Automation for z/OS Planning and Installation*.

To use the batch options of the build or migrate function you must first specify the names of the data sets required for the batch processing. These names form the DD name concatenations to be included in the JCL of the batch processing job.

COMMANDS		HELP				
DDname	Seq	Bas	Data set name	Volume	Unit	
AOFEXEC	98	YES	'ING.SINGIREX'			
AOFEXEC	99	YES	'SYS1.ISPF.ISPEXEC'			
AOFIPDB	99	YES	'ING.SINGIPDB'			
AOFLLIB	98	YES	'ING.SINGMOD1'			
AOFLLIB	99	YES	'SYS1.ISPF.ISPLOAD'			
AOFMLIB	98	YES	'ING.SINGIMSG'			
AOFMLIB	99	YES	'SYS1.ISPF.ISPMENU'			
AOFPLIB	98	YES	'ING.SINGIPNL'			
AOFPLIB	99	YES	'SYS1.ISPF.ISPPENU'			
AOFSLIB	98	YES	'ING.SINGISKL'			
AOFSLIB	99	YES	'SYS1.ISPF.ISPSLIB'			
AOFSTEP	99	YES	'ING.SINGMOD1'			
AOFTABL	97	NO	'OPER.USER.SINGITBL'			
AOFTLIB	96	NO	'OPER.ISPF.ISPPROF'			
AOFTLIB	97	NO	'OPER.USER.SINGITBL'			
AOFTLIB	98	YES	'ING.SINGITBL'			
AOFTLIB	99	YES	'SYS1.ISPF.ISPTLIB'			

Figure 264. SA z/OS Data Set Customization Details Panel

On the Data Set Customization Details panel, a table is displayed with groups of data definition (DD) names and data set names. You must modify the data set names in accordance with your local naming conventions.

Each column can be modified as follows:

Changing Your Customization Dialog Environment

DDname

No new DD names can be added, but a new entry for an existing DD name can be added at the end of the table. It is inserted at the correct position within the table when it is saved. An entry can be deleted by blanking out the DD name, but if an entry is removed incorrectly the batch functions become inoperative.

Seq This entry should be a number from 1 through 99. This value positions the entry in the correct concatenation sequence when the JCL is built. The higher the number, the further down the concatenation sequence it appears. The values 98 and 99 are reserved.

Base The Base column indicates a reserved DD name entry and should not be removed. All entries that are not reserved (see the **Seq** column description) must have the value of NO.

Data set name

This is the fully-qualified data set name, including quotation marks, that is represented by this DD name.

Volume

May be left blank for catalogued data sets, otherwise enter the label ID of the volume where the data set is located (as would be coded for an ALLOC JCL entry). SMS may be entered for any data set under space management.

Unit Must be left blank for catalogued and space managed data sets, otherwise you must enter the unit relevant to the volume where the data set is located (as would be coded for an ALLOC JCL entry).

AOFIPDB is needed to get access to the automation manager logic file.

For AOFTLIB the following data sets may be additionally allocated to the ISPF and SA z/OS table libraries:

- The user's ISPF table output library is needed to get access to the tables with user modifications, for example, the data set specifications
- The user's ISPF profile may be added to obtain access to the dialog, messages and logging options. If you omit this, the options that provide the most information are always used. This relates only to the settings in option 3 Message of the Customization Dialog Settings Menu panel.

In the example in Figure 264 on page 370, these are:

```
'OPER.ISPF.ISPPROF'  
'OPER.USER.SINGITBL'
```

To avoid ISPF enqueues with TSO users a temporary data set is always added as the first data set of the ISPTLIB data set allocations.

Note:

The user's ISPF table output library should also be allocated to DDname AOFTABL for functions such as the PDB report or updating the PDB using text files.

The ISPF load libraries should be allocated to DDname AOFSTEP if they have not been defined in LPA.

Changing Your Customization Dialog Environment

To avoid ISPF enqueues with the ISPF input table library name, a temporary data set is always added as the first data set of the ISPTLIB data set allocation.

Defining ISPF Temporary Data Sets for Batch Build

Use Option 12 in the Customization Dialog Settings Menu panel to define the data sets for the batch build. SA z/OS displays the ISPF Temporary Data Sets Preallocation for Batch panel (see Figure 265).

```
OPTIONS  HELP
-----
A0FGWKDS      ISPF Temporary Data Sets Preallocation for Batch
Command ==> _____ More: +
Specify ISPF work data sets, used by ISPF for processing file tailoring
services during batch build.

//ISPWRK1 DD DISP=NEW,UNIT=SYSALLDA,SPACE=(CYL,(5,10)),
//          DCB=(LRECL=256,RECFM=FB)
//ISPWRK2 DD DISP=NEW,UNIT=SYSALLDA,SPACE=(CYL,(5,10)),
//          DCB=(LRECL=256,RECFM=FB)
//ISPWRK3 DD DISP=NEW,UNIT=SYSALLDA,SPACE=(CYL,(5,10)),
//          DCB=(LRECL=256,RECFM=FB)
//ISPWRK4 DD DISP=NEW,UNIT=SYSALLDA,SPACE=(CYL,(5,10)),
//          DCB=(LRECL=256,RECFM=FB)
//ISPCTL1 DD DISP=NEW,UNIT=SYSALLDA,SPACE=(CYL,(5,10)),
//          DCB=(LRECL=80,RECFM=FB)
_____
_____
_____
_____
```

Figure 265. ISPF Temporary Data Sets Preallocation for Batch Panel

This panel allows you to add or modify job control data to preallocate temporary ISPF data sets that are used for the batch build. The build function creates the ACF and AMC output files in two steps:

1. All members are created and stored in a temporary file using ISPF file tailoring.
2. This file is written to disk creating all the individual members.

To hold the intermediate files, ISPF work and control data sets are used. If the default allocations of ISPF are not sufficient, they can be changed on this panel.

The ISPWRKx ddnames are used by ISPF for file tailoring services. The ISPCTLx ddnames are used by ISPF to hold the file tailoring output and to pass it to the subsequent functions that write the members to the output data set.

User-written Functions

Option **U User** on the Customization Dialog Primary Menu displays the User-written Functions Selection Menu. This menu allows you to add installation-specific functions to the customization dialog.

As an example, one selection has already been provided:

- 1 - Transmit Transmit build output to a remote node

If you select this option 1, SA z/OS displays the Send Policy Data Base panel (see Figure 266 on page 373), where you can distribute policy databases to remote nodes.

To add further selections, edit the panel (member AOFGUSR) and do the following:

- Add selection number and description to the panel)BODY section
- Add a line to the TRANSLATE instruction in the panel)PROC section, containing the selection number and the command string which invokes the new function.

The Send Policy Data Base panel allows you to transmit a build output data set to a specified node and user ID.

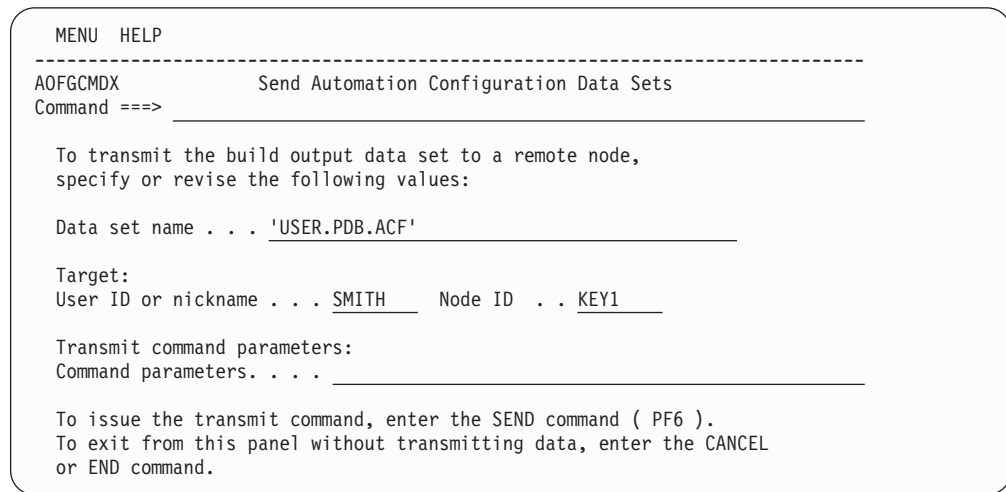

Figure 266. Send Automation Configuration Data Sets Panel

With the parameter specified on this screen, a TSO TRANSMIT command is created. The transmission is started by issuing the SEND command (PF 6).

Data set name

This entry field is filled with the build output data set name of the current policy database, if that data set name is available. The name is always fully qualified and follows the TSO data set naming conventions.

User ID or nickname

allows to specify the target user ID or nickname. Input in this field is saved across sessions.

Node ID

allows to specify the target node. This field may remain empty, if a nickname has been specified. Input in this field is saved across sessions.

Command parameters

allows to specify parameters for the TRANSMIT command. Any values specified here are appended to the TRANSMIT command as they have been typed in. Input in this field is saved across sessions.

Alternate Configuration Support

There may be situations, for example, in disaster recovery or on weekends, when you want to have an alternative automation configuration for one or more systems out of your enterprise (policy database).

The customization dialog allows you to specify an alternate configuration by:

- marking a system as part of an alternate configuration

Alternate Configuration Support

- allowing a specific build for normal or alternate configurations
- enforcing the build of normal or alternate configurations into different output data sets

All other definitions and links remain unchanged, for example, an application group can be linked to a normal systems, an alternate systems, or to both.

How to Define Alternate Configurations for Systems

For each system, either on the Define New Entry panel or in the policy item SYSTEM INFO, the existing MVS system name in the **MVS SYSNAME** field allows you to add a "+" sign to the system name. This is used as an indication that this system belongs to the alternate configuration. The "+" sign can only be added to the end of the system name.

Furthermore, this "+" sign can be specified in the supporting resource definition of a relationship, and on the initial migration panel.

When a new system is defined and its processor operations name (in the **ProcOps name** field) is defaulted with the MVS system name, any "+" is removed.

When linking systems to a group or subgroup, the configuration type is not checked. If, for example, a sysplex is intended for an alternate configuration, you have to ensure that only systems for this configuration are linked to that sysplex.

How to Build Alternate Configurations

The Build Parameters panel (see Figure 250 on page 325) has an option to select either a normal or alternate configuration build. The default is NORMAL. To avoid overwriting an existing configuration with wrong data, the build checks the configuration type in the build output data set. If there is already a configuration of a different type, the build is not started, and a warning message is displayed. If the policy database contains a normal and an alternate configuration, they have to be built into different output data sets.

Furthermore, the policy database name is checked to prevent an automation control file being destroyed by building a configuration into the wrong output data set.

When building an alternate configuration, all "+" signs are removed from the MVS system name. Thus the generated automation configuration files can be used for automation simply by switching the data sets.

If a policy database contains two configurations, the build picks out the systems that are linked to the selected configuration:

- The ACF map AOFACFMP contains only the systems marked for the selected configuration via the "+" sign added to the MVS system name.
- System include members (ACFZxxx) are generated only for the systems of the selected configuration.
- The AMC file, which is sysplex oriented, consists of members for each sysplex and standalone system. In each sysplex, it contains only the systems that are marked for the selected configuration, and standalone system members are created only for systems of the selected configuration.
- The ATs are generated only for the systems of the selected configuration.

- The MPFLSTSA member is built for the messages that belong to the selected configuration.

Restrictions

For performance reasons, building the complete policy database (option 1), does not check which system each object is linked to. Thus the build output data set will contain fragments of each object in the policy database, regardless of which configuration they are linked to. Of course, fragments of the wrong configuration cannot be accessed by automation because they are not included via system main include members. However, the build output data sets need to be large enough to hold all fragments.

Furthermore, with build option 3 (to build an entry type or entry name), it is possible to update each fragment in a data set, independent of its link to a configuration.

The *Unlinked* report (see Chapter 6, “Creating Reports about Policy Databases,” on page 315) does not include relationships that have been defined across configurations. That means, if a relationship is defined between a resource in configuration NRM and another resource in configuration ALT, it is not included by the build function. However, the *Unlinked* report does not show it as not used.

It is not possible to define processor operations proxy resources for systems belonging to the alternate configuration, because the Processor Operations name must be different for all systems. For examples on how to use proxy definitions see *IBM Tivoli System Automation for z/OS Customizing and Programming*.

Appendix C. Notices

This information was developed for products and services offered in the U.S.A.

IBM may not offer the products, services, or features discussed in this document in other countries. Consult your local IBM representative for information on the products and services currently available in your area. Any reference to an IBM product, program, or service is not intended to state or imply that only that IBM product, program, or service may be used. Any functionally equivalent product, program, or service that does not infringe any IBM intellectual property right may be used instead. However, it is the user's responsibility to evaluate and verify the operation of any non-IBM product, program, or service.

IBM may have patents or pending patent applications covering subject matter in this document. The furnishing of this document does not give you any license to these patents. You can send license inquiries, in writing, to:

IBM Director of Licensing
IBM Corporation
North Castle Drive
Armonk, NY 10504-1785
USA

For license inquiries regarding double-byte (DBCS) information, contact the IBM Intellectual Property Department in your country or send inquiries, in writing, to:

Intellectual Property Licensing
Legal and Intellectual Property Law
IBM Japan, Ltd.
1623-14, Shimotsuruma, Yamato-shi
Kanagawa 242-8502 Japan

The following paragraph does not apply to the United Kingdom or any other country where such provisions are inconsistent with local law:

INTERNATIONAL BUSINESS MACHINES CORPORATION PROVIDES THIS PUBLICATION "AS IS" WITHOUT WARRANTY OF ANY KIND, EITHER EXPRESS OR IMPLIED, INCLUDING, BUT NOT LIMITED TO, THE IMPLIED WARRANTIES OF NON-INFRINGEMENT, MERCHANTABILITY OR FITNESS FOR A PARTICULAR PURPOSE. Some states do not allow disclaimer of express or implied warranties in certain transactions, therefore, this statement may not apply to you.

This information could include technical inaccuracies or typographical errors. Changes are periodically made to the information herein; these changes will be incorporated in new editions of the publication. IBM may make improvements and/or changes in the product(s) and/or the program(s) described in this publication at any time without notice.

Any references in this information to non-IBM Websites are provided for convenience only and do not in any manner serve as an endorsement of those Websites. The materials at those Websites are not part of the materials for this IBM product and use of those Websites is at your own risk.

IBM may use or distribute any of the information you supply in any way it believes appropriate without incurring any obligation to you.

Licensees of this program who wish to have information about it for the purpose of enabling: (i) the exchange of information between independently created programs and other programs (including this one) and (ii) the mutual use of the information which has been exchanged, should contact:

IBM Deutschland Research & Development GmbH
Department 3248
Schoenaicher Strasse 220
D-71032 Boeblingen
Federal Republic of Germany

Such information may be available, subject to appropriate terms and conditions, including in some cases, payment of a fee.

The licensed program described in this document and all licensed material available for it are provided by IBM under terms of the IBM Customer Agreement, IBM International Program License Agreement or any equivalent agreement between us.

This information contains examples of data and reports used in daily business operations. To illustrate them as completely as possible, the examples include the names of individuals, companies, brands, and products. All of these names are fictitious and any similarity to the names and addresses used by an actual business enterprise is entirely coincidental.

If you are viewing this information softcopy, the photographs and color illustrations may not appear.

Programming Interface Information

This publication documents information that is *not* intended to be used as a programming interface of IBM Tivoli System Automation for z/OS.

Trademarks

IBM, the IBM logo, and ibm.com[®] are trademarks or registered trademarks of International Business Machines Corp., registered in many jurisdictions worldwide. Other product and service names might be trademarks of IBM or other companies. A current list of IBM trademarks is available on the Web at www.ibm.com/legal/copytrade.shtml.

Java and all Java-based trademarks and logos are trademarks of Sun Microsystems, Inc. in the United States, other countries, or both.

Linux is a registered trademark of Linus Torvalds in the United States, other countries, or both.

Microsoft and Windows are trademarks of Microsoft Corporation in the United States, other countries, or both.

UNIX is a registered trademark of The Open Group in the United States and other countries.

Glossary

This glossary includes terms and definitions from:

- The *IBM Dictionary of Computing* New York: McGraw-Hill, 1994.
- The *American National Standard Dictionary for Information Systems*, ANSI X3.172-1990, copyright 1990 by the American National Standards Institute (ANSI). Copies can be purchased from the American National Standards Institute, 1430 Broadway, New York, New York 10018. Definitions are identified by the symbol (A) after the definition.
- The *Information Technology Vocabulary* developed by Subcommittee 1, Joint Technical Committee 1, of the International Organization for Standardization and the International Electrotechnical Commission (ISO/IEC JTC1/SC1). Definitions of published parts of this vocabulary are identified by the symbol (I) after the definition; definitions taken from draft international standards, committee drafts, and working papers being developed by ISO/IEC JTC1/SC1 are identified by the symbol (T) after the definition, indicating that final agreement has not yet been reached among the participating National Bodies of SC1.

The following cross-references are used in this glossary:

Contrast with. This refers to a term that has an opposed or substantively different meaning.

Deprecated term for. This indicates that the term should not be used. It refers to a preferred term, which is defined in its proper place in the glossary.

See. This refers the reader to multiple-word terms in which this term appears.

See also. This refers the reader to terms that have a related, but not synonymous, meaning.

Synonym for. This indicates that the term has the same meaning as a preferred term, which is defined in the glossary.

Synonymous with. This is a backward reference from a defined term to all other terms that have the same meaning.

A

ACF. See automation configuration file.

ACF/NCP. Advanced Communications Function for the Network Control Program. See Advanced Communications Function and Network Control Program.

ACF/VTAM. Advanced Communications Function for the Virtual Telecommunications Access Method. Synonym for VTAM. See Advanced Communications Function and Virtual Telecommunications Access Method.

active monitoring. In SA z/OS automation control file, the acquiring of resource status information by soliciting such information at regular, user-defined intervals. See also passive monitoring.

adapter. Hardware card that enables a device, such as a workstation, to communicate with another device, such as a monitor, a printer, or some other I/O device.

Address Space Workflow. In RMF, a measure of how a job uses system resources and the speed at which the job moves through the system. A low workflow indicates that a job has few of the resources it needs and is contending with other jobs for system resources. A high workflow indicates that a job has all the resources it needs to execute.

adjacent hosts. Systems connected in a peer relationship using adjacent NetView sessions for purposes of monitoring and control.

adjacent NetView. In SA z/OS, the system defined as the communication path between two SA z/OS systems that do not have a direct link. An adjacent NetView is used for message forwarding and as a communication link between two SA z/OS systems. For example, the adjacent NetView is used when sending responses from a focal point to a remote system.

Advanced Communications Function (ACF). A group of IBM licensed programs (principally VTAM, TCAM, NCP, and SSP) that use the concepts of Systems Network Architecture (SNA), including distribution of function and resource sharing.

advanced program-to-program communication (APPC). A set of inter-program communication services that support cooperative transaction processing in a Systems Network Architecture (SNA) network. APPC is the implementation, on a given system, of SNA's logical unit type 6.2.

alert. (1) In SNA, a record sent to a system problem management focal point or to a collection point to communicate the existence of an alert condition. (2) In

NetView, a high-priority event that warrants immediate attention. A database record is generated for certain event types that are defined by user-constructed filters.

alert condition. A problem or impending problem for which some or all of the process of problem determination, diagnosis, and resolution is expected to require action at a control point.

alert focal-point system. See NPDA focal point system.

alert threshold. An application or volume service value that determines the level at which SA z/OS changes the associated icon in the graphical interface to the alert color. SA z/OS may also issue an alert. See warning threshold.

AMC. (1) See Automation Manager Configuration. (2) The Auto Msg Classes entry type.

American Standard Code for Information Interchange (ASCII). A standard code used for information exchange among data processing systems, data communication systems, and associated equipment. ASCII uses a coded character set consisting of 7-bit coded characters (8-bit including parity check). The ASCII set consists of control characters and graphic characters. See also Extended Binary Coded Decimal Interchange Code.

APF. See authorized program facility.

API. See application programming interface.

APPC. See advanced program-to-program communication.

application. In SA z/OS, applications refer to z/OS subsystems, started tasks, or jobs that are automated and monitored by SA z/OS. On SNMP-capable processors, application can be used to refer to a subsystem or process.

Application entry. A construct, created with the customization dialogs, used to represent and contain policy for an application.

application group. A named set of applications. An application group is part of an SA z/OS enterprise definition and is used for monitoring purposes.

application program. (1) A program written for or by a user that applies to the user's work, such as a program that does inventory or payroll. (2) A program used to connect and communicate with stations in a network, enabling users to perform application-oriented activities.

application programming interface (API). An interface that allows an application program that is written in a high-level language to use specific data or functions of the operating system or another program.

ApplicationGroup entry. A construct, created with the customization dialogs, used to represent and contain policy for an application group.

ARM. See automatic restart management.

ASCB. Address space control block.

ASCB status. An application status derived by SA z/OS running a routine (the ASCB checker) that searches the z/OS address space control blocks (ASCBs) for address spaces with a particular job name. The job name used by the ASCB checker is the job name defined in the customization dialog for the application.

ASCII. See American Standard Code for Information Interchange.

ASF. See automation status file.

authorized program facility (APF). A facility that permits identification of programs that are authorized to use restricted functions.

automated console operations (ACO). The use of an automated procedure to replace or simplify the action that an operator takes from a console in response to system or network events.

automated function. SA z/OS automated functions are automation operators, NetView autotasks that are assigned to perform specific automation functions. However, SA z/OS defines its own synonyms, or *automated function names*, for the NetView autotasks, and these function names are referred to in the sample policy databases provided by SA z/OS. For example, the automation operator AUTBASE corresponds to the SA z/OS automated function BASEOPER.

automatic restart management (ARM). A z/OS recovery function that improves the availability of specified subsystems and applications by automatically restarting them under certain circumstances. Automatic restart management is a function of the Cross-System Coupling Facility (XCF) component of z/OS.

automatic restart management element name. In MVS 5.2 or later, z/OS automatic restart management requires the specification of a unique sixteen character name for each address space that registers with it. All automatic restart management policy is defined in terms of the element name, including SA z/OS's interface with it.

automation. The automatic initiation of actions in response to detected conditions or events. SA z/OS provides automation for z/OS applications, z/OS components, and remote systems that run z/OS. SA z/OS also provides tools that can be used to develop additional automation.

automation agent. In SA z/OS, the automation function is split up between the automation manager and the automation agents. The observing, reacting and doing parts are located within the NetView address space, and are known as the *automation agents*. The automation agents are responsible for:

- Recovery processing
- Message processing
- Active monitoring: they propagate status changes to the automation manager

automation configuration file. The SA z/OS customization dialogs must be used to build the automation configuration file. It consists of:

- The automation manager configuration file (AMC)
- The NetView automation table (AT)
- The NetView message revision table (MRT)
- The MPFLSTSA member

automation control file (ACF). In SA z/OS, a file that contains system-level automation policy information. There is one master automation control file for each NetView system that SA z/OS is installed on. Additional policy information and all resource status information is contained in the policy database (PDB). The SA z/OS customization dialogs must be used to build the automation control files. They must not be edited manually.

automation flags. In SA z/OS, the automation policy settings that determine the operator functions that are automated for a resource and the times during which automation is active. When SA z/OS is running, automation is controlled by automation flag policy settings and override settings (if any) entered by the operator. Automation flags are set using the customization dialogs.

automation manager. In SA z/OS, the automation function is split up between the automation manager and the automation agents. The coordination, decision making and controlling functions are processed by each sysplex's *automation manager*.

The automation manager contains a model of all of the automated resources within the sysplex. The automation agents feed the automation manager with status information and perform the actions that the automation manager tells them to.

The automation manager provides *sysplex-wide* automation.

Automation Manager Configuration. The Automation Manager Configuration file (AMC) contains an image of the automated systems in a sysplex or of a standalone system. See also “automation configuration file.”

Automation NetView. In SA z/OS the NetView that performs routine operator tasks with command procedures or uses other ways of automating system

and network management, issuing automatic responses to messages and management services units.

automation operator. NetView automation operators are NetView autotasks that are assigned to perform specific automation functions. See also automated function. NetView automation operators may receive messages and process automation procedures. There are no logged-on users associated with automation operators. Each automation operator is an operating system task and runs concurrently with other NetView tasks. An automation operator could be set up to handle JES2 messages that schedule automation procedures, and an automation statement could route such messages to the automation operator. Similar to *operator station task*. SA z/OS message monitor tasks and target control tasks are automation operators.

automation policy. The policy information governing automation for individual systems. This includes automation for applications, z/OS subsystems, z/OS data sets, and z/OS components.

automation policy settings. The automation policy information contained in the automation control file. This information is entered using the customization dialogs. You can display or modify these settings using the customization dialogs.

automation procedure. A sequence of commands, packaged as a NetView command list or a command processor written in a high-level language. An automation procedure performs automation functions and runs under NetView.

automation status file (ASF). In SA z/OS, a file containing status information for each automated subsystem, component or data set. This information is used by SA z/OS automation when taking action or when determining what action to take. In Release 2 and above of AOC/MVS, status information is also maintained in the operational information base.

automation table (AT). See NetView automation table.

autotask. A NetView automation task that receives messages and processes automation procedures. There are no logged-on users associated with autotasks. Each autotask is an operating system task and runs concurrently with other NetView tasks. An autotask could be set up to handle JES2 messages that schedule automation procedures, and an automation statement could route such messages to the autotasks. Similar to *operator station task*. SA z/OS message monitor tasks and target control tasks are autotasks. Also called *automation operator*.

available. In VTAM programs, pertaining to a logical unit that is active, connected, enabled, and not at its session limit.

B

Base Control Program (BCP). A program that provides essential services for the MVS and z/OS operating systems. The program includes functions that manage system resources. These functions include input/output, dispatch units of work, and the z/OS UNIX System Services kernel. See also Multiple Virtual Storage and z/OS.

basic mode. A central processor mode that does not use logical partitioning. Contrast with logically partitioned mode.

BCP. See Base Control Program.

BCP Internal Interface. Processor function of CMOS-390 and System z[®] processor families. It allows for communication between basic control programs such as z/OS and the processor support element in order to exchange information or to perform processor control functions. Programs using this function can perform hardware operations such as ACTIVATE or SYSTEM RESET.

beaconing. The repeated transmission of a frame or messages (beacon) by a console or workstation upon detection of a line break or outage.

BookManager[®]. An IBM product that lets users view softcopy documents on their workstations.

C

central processor (CP). The part of the computer that contains the sequencing and processing facilities for instruction execution, initial program load (IPL), and other machine operations.

central processor complex (CPC). A physical collection of hardware that consists of central storage, one or more central processors, timers, and channels.

central site. In a distributed data processing network, the central site is usually defined as the focal point for alerts, application design, and remote system management tasks such as problem management.

CFR/CFS and ISC/ISR. I/O operations can display and return data about integrated system channels (ISC) connected to a coupling facility and coupling facility receiver (CFR) channels and coupling facility sender (CFS) channels.

channel. A path along which signals can be sent; for example, data channel, output channel. See also link.

channel path identifier. A system-unique value assigned to each channel path.

channel-attached. (1) Attached directly by I/O channels to a host processor (for example, a

channel-attached device). (2) Attached to a controlling unit by cables, rather than by telecommunication lines. Contrast with link-attached. Synonymous with local.

CHPID. In SA z/OS, channel path ID; the address of a channel.

CHPID port. A label that describes the system name, logical partitions, and channel paths.

CI. See console integration.

CICS/VS. Customer Information Control System for Virtual Storage. See Customer Information Control System.

CLIST. See command list.

clone. A set of definitions for application instances that are derived from a basic application definition by substituting a number of different system-specific values into the basic definition.

clone ID. A generic means of handling system-specific values such as the MVS SYSC clone or the VTAM subarea number. Clone IDs can be substituted into application definitions and commands to customize a basic application definition for the system that it is to be instantiated on.

CNC. A channel path that transfers data between a host system image and an ESCON[®] control unit. It can be point-to-point or switchable.

command. A request for the performance of an operation or the execution of a particular program.

command facility. The component of NetView that is a base for command processors that can monitor, control, automate, and improve the operation of a network. The successor to NCCF.

command list (CLIST). (1) A list of commands and statements, written in the NetView command list language or the REXX language, designed to perform a specific function for the user. In its simplest form, a command list is a list of commands. More complex command lists incorporate variable substitution and conditional logic, making the command list more like a conventional program. Command lists are typically interpreted rather than being compiled. (2) In SA z/OS, REXX command lists that can be used for automation procedures.

command procedure. In NetView, either a command list or a command processor.

command processor. A module designed to perform a specific function. Command processors, which can be written in assembler or a high-level language (HLL), are issued as commands.

command processor control block. An I/O operations internal control block that contains information about the command being processed.

Command Tree/2. An OS/2-based program that helps you build commands on an OS/2 window, then routes the commands to the destination you specify (such as a 3270 session, a file, a command line, or an application program). It provides the capability for operators to build commands and route them to a specified destination.

common commands. The SA z/OS subset of the CPC operations management commands.

common routine. One of several SA z/OS programs that perform frequently used automation functions. Common routines can be used to create new automation procedures.

Common User Access (CUA) architecture. Guidelines for the dialog between a human and a workstation or terminal.

communication controller. A type of communication control unit whose operations are controlled by one or more programs stored and executed in the unit or by a program executed in a processor to which the controller is connected. It manages the details of line control and the routing of data through a network.

communication line. Deprecated term for telecommunication line.

connectivity view. In SA z/OS, a display that uses graphic images for I/O devices and lines to show how they are connected.

console automation. The process of having NetView facilities provide the console input usually handled by the operator.

console connection. In SA z/OS, the 3270 or ASCII (serial) connection between a PS/2 computer and a target system. Through this connection, the workstation appears (to the target system) to be a console.

console integration (CI). A hardware facility that if supported by an operating system, allows operating system messages to be transferred through an internal hardware interface for display on a system console. Conversely, it allows operating system commands entered at a system console to be transferred through an internal hardware interface to the operating system for processing.

consoles. Workstations and 3270-type devices that manage your enterprise.

Control units. Hardware units that control I/O operations for one or more devices. You can view information about control units through I/O

operations, and can start or stop data going to them by blocking and unblocking ports.

controller. A unit that controls I/O operations for one or more devices.

converted mode (CVC). A channel operating in converted (CVC) mode transfers data in blocks and a CBY channel path transfers data in bytes. Converted CVC or CBY channel paths can communicate with a parallel control unit. This resembles a point-to-point parallel path and dedicated connection, regardless whether it passes through a switch.

couple data set. A data set that is created through the XCF couple data set format utility and, depending on its designated type, is shared by some or all of the z/OS systems in a sysplex. See also sysplex couple data set and XCF couple data set.

coupling facility. The hardware element that provides high-speed caching, list processing, and locking functions in a sysplex.

CP. See central processor.

CPC. See central processor complex.

CPC operations management commands. A set of commands and responses for controlling the operation of System/390[®] CPCs.

CPC subset. All or part of a CPC. It contains the minimum *resource* to support a single control program.

CPCB. See command processor control block.

CPU. Central processing unit. Deprecated term for processor.

cross-system coupling facility (XCF). A component of z/OS that provides functions to support cooperation between authorized programs running within a sysplex.

CTC. The channel-to-channel (CTC) channel can communicate with a CTC on another host for intersystem communication.

Customer Information Control System (CICS). A general-purpose transactional program that controls online communication between terminal users and a database for a large number of end users on a real-time basis.

customization dialogs. The customization dialogs are an ISPF application. They are used to customize the enterprise policy, like, for example, the enterprise resources and the relationships between resources, or the automation policy for systems in the enterprise. How to use these dialogs is described in *IBM Tivoli System Automation for z/OS Customizing and Programming*.

CVC. See converted mode.

D

DASD. See direct access storage device.

data services task (DST). The NetView subtask that gathers, records, and manages data in a VSAM file or a network device that contains network management information.

data set. The major unit of data storage and retrieval, consisting of a collection of data in one of several prescribed arrangements and described by control information to which the system has access.

data set members. Members of partitioned data sets that are individually named elements of a larger file that can be retrieved by name.

DBCS. See double-byte character set.

DCCF. See disabled console communication facility.

DCF. See Document Composition Facility.

DELAY Report. An RMF report that shows the activity of each job in the system and the hardware and software resources that are delaying each job.

device. A piece of equipment. Devices can be workstations, printers, disk drives, tape units, remote systems or communications controllers. You can see information about all devices attached to a particular switch, and control paths and jobs to devices.

DEVR Report. An RMF report that presents information about the activity of I/O devices that are delaying jobs.

dialog. Interactive 3270 panels.

direct access storage device (DASD). A device that allows storage to be directly accessed, such as a disk drive.

disabled console communication facility (DCCF). A z/OS component that provides limited-function console communication during system recovery situations.

disk operating system (DOS). (1) An operating system for computer systems that use disks and diskettes for auxiliary storage of programs and data. (2) Software for a personal computer that controls the processing of programs. For the IBM Personal Computer, the full name is Personal Computer Disk Operating System (PCDOS).

display. (1) To present information for viewing, usually on the screen of a workstation or on a hardcopy device. (2) Deprecated term for panel.

distribution manager. The component of the NetView program that enables the host system to use, send, and delete files and programs in a network of computers.

Document Composition Facility (DCF). An IBM licensed program used to format input to a printer.

domain. (1) An access method and its application programs, communication controllers, connecting lines, modems, and attached workstations. (2) In SNA, a system services control point (SSCP) and the physical units (PUs), logical units (LUs), links, link stations, and associated resources that the SSCP can control with activation requests and deactivation requests.

double-byte character set (DBCS). A character set, such as Kanji, in which each character is represented by a 2-byte code.

DP enterprise. Data processing enterprise.

DSIPARM. This file is a collection of members of NetView's customization.

DST. Data Services Task.

E

EBCDIC. See Extended Binary Coded Decimal Interchange Code.

ECB. See event control block.

EMCS. Extended multiple console support. See also multiple console support.

enterprise. The composite of all operational entities, functions, and resources that form the total business concern and that require an information system.

enterprise monitoring. Enterprise monitoring is used by SA z/OS to update the *NetView Management Console (NMC)* resource status information that is stored in the *Resource Object Data Manager (RODM)*. Resource status information is acquired by enterprise monitoring of the *Resource Measurement Facility (RMF) Monitor III* service information at user-defined intervals. SA z/OS stores this information in its operational information base, where it is used to update the information presented to the operator in graphic displays.

Enterprise Systems Architecture (ESA). A hardware architecture that reduces the effort required for managing data sets and extends addressability for system, subsystem, and application functions.

entries. Resources, such as processors, entered on panels.

entry type. Resources, such as processors or applications, used for automation and monitoring.

environment. Data processing enterprise.

error threshold. An automation policy setting that specifies when SA z/OS should stop trying to restart or recover an application, subsystem or component, or offload a data set.

ESA. See Enterprise Systems Architecture.

eServer. Processor family group designator used by the SA z/OS customization dialogs to define a target hardware as member of the System z or 390-CMOS processor families.

event. (1) In NetView, a record indicating irregularities of operation in physical elements of a network. (2) An occurrence of significance to a task; for example, the completion of an asynchronous operation, such as an input/output operation. (3) Events are part of a trigger condition, such that if all events of a trigger condition have occurred, a startup or shutdown of an application is performed.

event control block (ECB). A control block used to represent the status of an event.

exception condition. An occurrence on a system that is a deviation from normal operation. SA z/OS monitoring highlights exception conditions and allows an SA z/OS enterprise to be managed by exception.

Extended Binary Coded Decimal Interchange Code (EBCDIC). A coded character set of 256 8-bit characters developed for the representation of textual data. See also American Standard Code for Information Interchange.

extended recovery facility (XRF). A facility that minimizes the effect of failures in z/OS, VTAM, the host processor, or high availability applications during sessions between high availability applications and designated terminals. This facility provides an alternate subsystem to take over sessions from the failing subsystem.

F

fallback system. See secondary system.

field. A collection of bytes within a record that are logically related and are processed as a unit.

file manager commands. A set of SA z/OS commands that read data from or write data to the automation control file or the operational information base. These commands are useful in the development of automation that uses SA z/OS facilities.

focal point. In NetView, the focal-point domain is the central host domain. It is the central control point for any management services element containing control of the network management data.

focal point system. (1) A system that can administer, manage, or control one or more target systems. There

are a number of different focal point system associated with IBM automation products. (2) **NMC focal point system.** The NMC focal point system is a NetView system with an attached workstation server and LAN that gathers information about the state of the network. This focal point system uses RODM to store the data it collects in the data model. The information stored in RODM can be accessed from any LAN-connected workstation with NetView Management Console installed. (3) **NPDA focal point system.** This is a NetView system that collects all the NPDA alerts that are generated within your enterprise. It is supported by NetView. If you have SA z/OS installed the NPDA focal point system must be the same as your NMC focal point system. The NPDA focal point system is also known as the *alert focal point system*. (4) **SA z/OS Processor Operations focal point system.** This is a NetView system that has SA z/OS host code installed. The SA z/OS Processor Operations focal point system receives messages from the systems and operator consoles of the machines that it controls. It provides full systems and operations console function for its target systems. It can be used to IPL these systems. Note that some restrictions apply to the Hardware Management Console for an S/390 microprocessor cluster. (5) **SA z/OS SDF focal point system.** The SA z/OS SDF focal point system is an SA z/OS NetView system that collects status information from other SA z/OS NetViews within your enterprise. (6) **Status focal point system.** In NetView, the system to which STATMON, VTAM and NLDM send status information on network resources. If you have a NMC focal point, it must be on the same system as the Status focal point. (7) **Hardware Management Console.** Although not listed as a focal point, the Hardware Management Console acts as a focal point for the console functions of an S/390 microprocessor cluster. Unlike all the other focal points in this definition, the Hardware Management Console runs on a LAN-connected workstation,

frame. For a System/390 microprocessor cluster, a frame contains one or two central processor complexes (CPCs), support elements, and AC power distribution.

full-screen mode. In NetView, a form of panel presentation that makes it possible to display the contents of an entire workstation screen at once. Full-screen mode can be used for fill-in-the-blanks prompting. Contrast with line mode.

G

gateway session. An NetView-NetView Task session with another system in which the SA z/OS outbound gateway operator logs onto the other NetView session without human operator intervention. Each end of a gateway session has both an inbound and outbound gateway operator.

generic alert. Encoded alert information that uses code points (defined by IBM and possibly customized by users or application programs) stored at an alert receiver, such as NetView.

generic routines. In SA z/OS, a set of self-contained automation routines that can be called from the NetView automation table, or from user-written automation procedures.

group. A collection of target systems defined through configuration dialogs. An installation might set up a group to refer to a physical site or an organizational or application entity.

group entry. A construct, created with the customization dialogs, used to represent and contain policy for a group.

group entry type. A collection of target systems defined through the customization dialog. An installation might set up a group to refer to a physical site or an organizational entity. Groups can, for example, be of type STANDARD or SYSPLEX.

H

Hardware Management Console (HMC). A system that controls managed systems, including the management of logical partitions and use of Capacity Upgrade on Demand. Using service applications, the HMC communicates with managed systems to detect, consolidate, and send information to IBM for analysis.

Hardware Management Console Application (HWMCA). A direct-manipulation object-oriented graphical user interface that provides a single point of control and single system image for hardware elements. The HWMCA provides grouping support, aggregated and real-time system status using colors, consolidated hardware messages support, consolidated operating system messages support, consolidated service support, and hardware commands targeted at a single system, multiple systems, or a group of systems.

heartbeat. In SA z/OS, a function that monitors the validity of the status forwarding path between remote systems and the NMC focal point, and monitors the availability of remote z/OS systems, to ensure that status information displayed on the SA z/OS workstation is current.

help panel. An online panel that tells you how to use a command or another aspect of a product.

hierarchy. In the NetView program, the resource types, display types, and data types that make up the organization, or levels, in a network.

high-level language (HLL). A programming language that provides some level of abstraction from assembler

language and independence from a particular type of machine. For the NetView program, the high-level languages are PL/I and C.

HLL. See high-level language.

host (primary processor). The processor that you enter a command at (also known as the *issuing processor*).

host system. In a coupled system or distributed system environment, the system on which the facilities for centralized automation run. SA z/OS publications refer to target systems or focal-point systems instead of hosts.

HWMCA. See Hardware Management Console Application.

I

I/O operations. The part of SA z/OS that provides you with a single point of logical control for managing connectivity in your active I/O configurations. I/O operations takes an active role in detecting unusual conditions and lets you view and change paths between a processor and an I/O device, using dynamic switching (the ESCON director). Also known as I/O Ops.

I/O Ops. See I/O operations.

I/O resource number. Combination of channel path identifier (CHPID), device number, etc. See internal token.

images. A grouping of processors and I/O devices that you define. You can define a single-image mode that allows a multiprocessor system to function as one central processor image.

IMS. See Information Management System.

IMS/VS. See Information Management System/Virtual Storage.

inbound. In SA z/OS, messages sent to the focal-point system from the PC or target system.

inbound gateway operator. The automation operator that receives incoming messages, commands, and responses from the outbound gateway operator at the sending system. The inbound gateway operator handles communications with other systems using a gateway session.

Information Management System (IMS). Any of several system environments available with a database manager and transaction processing that are capable of managing complex databases and terminal networks.

Information Management System/Virtual Storage (IMS/VS). A database/data communication (DB/DC) system that can manage complex databases and networks. Synonymous with Information Management System.

INGEIO PROC. The I/O operations default procedure name. It is part of the SYS1.PROCLIB.

initial microprogram load. The action of loading microprograms into computer storage.

initial program load (IPL). (1) The initialization procedure that causes an operating system to commence operation. (2) The process by which a configuration image is loaded into storage at the beginning of a workday or after a system malfunction. (3) The process of loading system programs and preparing a system to run jobs.

initialize automation. SA z/OS-provided automation that issues the correct z/OS start command for each subsystem when SA z/OS is initialized. The automation ensures that subsystems are started in the order specified in the automation control files and that prerequisite applications are functional.

input/output configuration data set (IOCDs). A configuration definition built by the I/O configuration program (IOCP) and stored on disk files associated with the processor controller.

input/output support processor (IOSP). The hardware unit that provides I/O support functions for the primary support processor and maintenance support functions for the processor controller.

Interactive System Productivity Facility (ISPF). An IBM licensed program that serves as a full-screen editor and dialog manager. Used for writing application programs, it provides a means of generating standard screen panels and interactive dialogs between the application programmer and the terminal user. See also Time Sharing Option.

interested operator list. The list of operators who are to receive messages from a specific target system.

internal token. A *logical token* (LTOK); name by which the I/O resource or object is known; stored in IODF.

IOCDs. See input/output configuration data set.

IOSP. See input/output support processor.

IPL. See initial program load.

ISPF. See Interactive System Productivity Facility.

ISPF console. You log on to ISPF from this 3270-type console to use the runtime panels for I/O operations and SA z/OS customization panels.

issuing host. The base program that you enter a command for processing with. See primary host.

J

JCL. See job control language.

JES. See job entry subsystem.

JES2. An MVS subsystem that receives jobs into the system, converts them to internal format, selects them for execution, processes their output, and purges them from the system. In an installation with more than one processor, each JES2 processor independently controls its job input, scheduling, and output processing. See also job entry subsystem and JES3

JES3. An MVS subsystem that receives jobs into the system, converts them to internal format, selects them for execution, processes their output, and purges them from the system. In complexes that have several loosely coupled processing units, the JES3 program manages processors so that the global processor exercises centralized control over the local processors and distributes jobs to them using a common job queue. See also job entry subsystem and JES2.

job. (1) A set of data that completely defines a unit of work for a computer. A job usually includes all necessary computer programs, linkages, files, and instructions to the operating system. (2) An address space.

job control language (JCL). A problem-oriented language designed to express statements in a job that are used to identify the job or describe its requirements to an operating system.

job entry subsystem (JES). An IBM licensed program that receives jobs into the system and processes all output data that is produced by jobs. In SA z/OS publications, JES refers to JES2 or JES3, unless otherwise stated. See also JES2 and JES3.

K

Kanji. An ideographic character set used in Japanese. See also double-byte character set.

L

LAN. See local area network.

line mode. A form of screen presentation in which the information is presented a line at a time in the message area of the terminal screen. Contrast with full-screen mode.

link. (1) In SNA, the combination of the link connection and the link stations joining network nodes; for example, a System/370 channel and its associated

protocols, a serial-by-bit connection under the control of synchronous data link control (SDLC). See synchronous data link control. (2) In SA z/OS, link connection is the physical medium of transmission.

link-attached. Describes devices that are physically connected by a telecommunication line. Contrast with channel-attached.

Linux on System z. UNIX-like open source operating system conceived by Linus Torvalds and developed across the internet.

local. Pertaining to a device accessed directly without use of a telecommunication line. Synonymous with channel-attached.

local area network (LAN). (1) A network in which a set of devices is connected for communication. They can be connected to a larger network. See also token ring. (2) A network that connects several devices in a limited area (such as a single building or campus) and that can be connected to a larger network.

logical partition (LP). A subset of the processor hardware that is defined to support an operating system. See also logically partitioned mode.

logical switch number (LSN). Assigned with the switch parameter of the CHPID macro of the IOCP.

logical token (LTOK). Resource number of an object in the IODF.

logical unit (LU). In SNA, a port through which an end user accesses the SNA network and the functions provided by system services control points (SSCPs). An LU can support at least two sessions, one with an SSCP and one with another LU, and may be capable of supporting many sessions with other LUs. See also physical unit and system services control point.

logical unit 6.2 (LU 6.2). A type of logical unit that supports general communications between programs in a distributed processing environment. LU 6.2 is characterized by:

- A peer relationship between session partners
- Efficient use of a session for multiple transactions
- A comprehensive end-to-end error processing
- A generic application program interface (API) consisting of structured verbs that are mapped to a product implementation

Synonym for advanced program-to-program communication.

logically partitioned (LPAR) mode. A central processor mode that enables an operator to allocate system processor hardware resources among several logical partitions. Contrast with basic mode.

LOGR. The sysplex logger.

LP. See logical partition.

LPAR. See logically partitioned mode.

LSN. See logical switch number.

LU. See logical unit.

LU 6.2. See logical unit 6.2.

LU 6.2 session. A session initiated by VTAM on behalf of an LU 6.2 application program, or a session initiated by a remote LU in which the application program specifies that VTAM is to control the session by using the APPCCMD macro. See logical unit 6.2.

LU-LU session. In SNA, a session between two logical units (LUs) in an SNA network. It provides communication between two end users, or between an end user and an LU services component.

M

MAT. Deprecated term for NetView automation table.

MCA. See Micro Channel architecture.

MCS. See multiple console support.

member. A specific function (one or more modules or routines) of a multisystem application that is defined to XCF and assigned to a group by the multisystem application. A member resides on one system in the sysplex and can use XCF services to communicate (send and receive data) with other members of the same group.

message automation table (MAT). Deprecated term for NetView automation table.

message class. A number that SA z/OS associates with a message to control routing of the message. During automated operations, the classes associated with each message issued by SA z/OS are compared to the classes assigned to each notification operator. Any operator with a class matching one of the message's classes receives the message.

message forwarding. The SA z/OS process of sending messages generated at an SA z/OS target system to the SA z/OS focal-point system.

message group. Several messages that are displayed together as a unit.

message monitor task. A task that starts and is associated with a number of communications tasks. Message monitor tasks receive inbound messages from a communications task, determine the originating target system, and route the messages to the appropriate target control tasks.

message processing facility (MPF). A z/OS table that screens all messages sent to the z/OS console. The MPF compares these messages with a customer-defined list

of messages on which to automate, suppress from the z/OS console display, or both, and marks messages to automate or suppress. Messages are then broadcast on the subsystem interface (SSI).

message suppression. The ability to restrict the amount of message traffic displayed on the z/OS console.

Micro Channel architecture. The rules that define how subsystems and adapters use the Micro Channel bus in a computer. The architecture defines the services that each subsystem can or must provide.

microprocessor. A processor implemented on one or a small number of chips.

migration. Installation of a new version or release of a program to replace an earlier version or release.

MP. Multiprocessor.

MPF. See message processing facility.

MPFLSTSA. The MPFLST member that is built by SA z/OS.

multi-MVS environment. physical processing system that is capable of operating more than one MVS image. See also MVS image.

multiple console support (MCS). A feature of MVS that permits selective message routing to multiple consoles.

Multiple Virtual Storage (MVS). An IBM operating system that accesses multiple address spaces in virtual storage. The predecessor of z/OS.

multiprocessor (MP). A CPC that can be physically partitioned to form two operating processor complexes.

multisystem application. An application program that has various functions distributed across z/OS images in a multisystem environment.

multisystem environment. An environment in which two or more systems reside on one or more processors. Or one or more processors can communicate with programs on the other systems.

MVS. See Multiple Virtual Storage.

MVS image. A single occurrence of the MVS operating system that has the ability to process work. See also multi-MVS environment and single-MVS environment.

MVS/ESA. Multiple Virtual Storage/Enterprise Systems Architecture. See z/OS.

MVS/JES2. Multiple Virtual Storage/Job Entry System 2. A z/OS subsystem that receives jobs into the system, converts them to an internal format, selects them for

execution, processes their output, and purges them from the system. In an installation with more than one processor, each JES2 processor independently controls its job input, scheduling, and output processing.

N

NAU. (1) See network addressable unit. (2) See network accessible unit.

NCCF. See Network Communications Control Facility..

NCP. (1) See network control program (general term). (2) See Network Control Program (an IBM licensed program). Its full name is Advanced Communications Function for the Network Control Program. Synonymous with ACF/NCP.

NCP/token ring interconnection. A function used by ACF/NCP to support token ring-attached SNA devices. NTRI also provides translation from token ring-attached SNA devices (PUs) to switched (dial-up) devices.

NetView. An IBM licensed program used to monitor a network, manage it, and diagnose network problems. NetView consists of a command facility that includes a presentation service, command processors, automation based on command lists, and a transaction processing structure on which the session monitor, hardware monitor, and terminal access facility (TAF) network management applications are built.

NetView (NCCF) console. A 3270-type console for NetView commands and runtime panels for system operations and processor operations.

NetView automation procedures. A sequence of commands, packaged as a NetView command list or a command processor written in a high-level language. An automation procedure performs automation functions and runs under the NetView program.

NetView automation table (AT). A table against which the NetView program compares incoming messages. A match with an entry triggers the specified response. SA z/OS entries in the NetView automation table trigger an SA z/OS response to target system conditions. Formerly known as the message automation table (MAT).

NetView command list language. An interpretive language unique to NetView that is used to write command lists.

NetView Graphic Monitor Facility (NGMF). Deprecated term for NetView Management Console.

NetView hardware monitor. The component of NetView that helps identify network problems, such as hardware, software, and microcode, from a central

control point using interactive display techniques. Formerly called *network problem determination application*.

NetView log. The log that NetView records events relating to NetView and SA z/OS activities in.

NetView Management Console (NMC). A function of the NetView program that provides a graphic, topological presentation of a network that is controlled by the NetView program. It provides the operator different views of a network, multiple levels of graphical detail, and dynamic resource status of the network. This function consists of a series of graphic windows that allows you to manage the network interactively. Formerly known as the NetView Graphic Monitor Facility (NGMF).

NetView message table. See NetView automation table.

NetView paths via logical unit (LU 6.2). A type of network-accessible port (VTAM connection) that enables end users to gain access to SNA network resources and communicate with each other. LU 6.2 permits communication between processor operations and the workstation. See logical unit 6.2.

NetView-NetView task (NNT). The task that a cross-domain NetView operator session runs under. Each NetView program must have a NetView-NetView task to establish one NNT session. See also operator station task.

NetView-NetView task session. A session between two NetView programs that runs under a NetView-NetView task. In SA z/OS, NetView-NetView task sessions are used for communication between focal point and remote systems.

network. (1) An interconnected group of nodes. (2) In data processing, a user application network. See SNA network.

network accessible unit (NAU). In SNA networking, any device on the network that has a network address, including a logical unit (LU), physical unit (PU), control point (CP), or system services control point (SSCP). It is the origin or the destination of information transmitted by the path control network. Synonymous with network addressable unit.

network addressable unit (NAU). Synonym for network accessible unit.

Network Communications Control Facility (NCCF). The operations control facility for the network. NCCF consists of a presentation service, command processors, automation based on command lists, and a transaction processing structure on which the network management applications NLDM and NPDA are built. NCCF is a precursor to the NetView command facility.

Network Control Program (NCP). An IBM licensed program that provides communication controller support for single-domain, multiple-domain, and interconnected network capability. Its full name is Advanced Communications Function for the Network Control Program.

network control program (NCP). (1) A program that controls the operation of a communication controller. (2) A program used for requests and responses exchanged between physical units in a network for data flow control.

Network Problem Determination Application (NPDA). An NCCF application that helps you identify network problems, such as hardware, software, and microcode, from a central control point using interactive display methods. The alert manager for the network. The precursor of the NetView hardware monitor.

Networking NetView. In SA z/OS the NetView that performs network management functions, such as managing the configuration of a network. In SA z/OS it is common to also route alerts to the Networking NetView.

NGMF. Deprecated term for NetView Management Console.

NGMF focal-point system. Deprecated term for NMC focal point system.

NIP. See nucleus initialization program.

NMC focal point system. See focal point system

NMC workstation. The NMC workstation is the primary way to dynamically monitor SA z/OS systems. From the windows, you see messages, monitor status, view trends, and react to changes before they cause problems for end users. You can use multiple windows to monitor multiple views of the system.

NNT. See NetView-NetView task.

notification message. An SA z/OS message sent to a human notification operator to provide information about significant automation actions. Notification messages are defined using the customization dialogs.

notification operator. A NetView console operator who is authorized to receive SA z/OS notification messages. Authorization is made through the customization dialogs.

NPDA. See Network Problem Determination Application.

NPDA focal-point system. See focal point system.

NTRI. See NCP/token ring interconnection.

nucleus initialization program (NIP). The program that initializes the resident control program; it allows the operator to request last-minute changes to certain options specified during system generation.

O

objective value. An average Workflow or Using value that SA z/OS can calculate for applications from past service data. SA z/OS uses the objective value to calculate warning and alert thresholds when none are explicitly defined.

OCA. In SA z/OS, operator console A, the active operator console for a target system. Contrast with OCB.

OCB. In SA z/OS, operator console B, the backup operator console for a target system. Contrast with OCA.

OCF. See operations command facility.

OCF-based processor. A central processor complex that uses an operations command facility for interacting with human operators or external programs to perform operations management functions on the CPC.

OPC/A. See Operations Planning and Control/Advanced.

OPC/ESA. See Operations Planning and Control/Enterprise Systems Architecture.

Open Systems Adapter (OSA). I/O operations can display the Open System Adapter (OSA) channel logical definition, physical attachment, and status. You can configure an OSA channel on or off.

operating system (OS). Software that controls the execution of programs and that may provide services such as resource allocation, scheduling, input/output control, and data management. Although operating systems are predominantly software, partial hardware implementations are possible. (T)

operations. The real-time control of a hardware device or software function.

operations command facility (OCF). A facility of the central processor complex that accepts and processes operations management commands.

Operations Planning and Control/Advanced (OPC/A). A set of IBM licensed programs that automate, plan, and control batch workload. OPC/A analyzes system and workload status and submits jobs accordingly.

Operations Planning and Control/Enterprise Systems Architecture (OPC/ESA). A set of IBM licensed programs that automate, plan, and control batch

workload. OPC/ESA analyzes system and workload status and submits jobs accordingly. The successor to OPC/A.

operator. (1) A person who keeps a system running. (2) A person or program responsible for managing activities controlled by a given piece of software such as z/OS, the NetView program, or IMS. (3) A person who operates a device. (4) In a language statement, the lexical entity that indicates the action to be performed on operands.

operator console. (1) A functional unit containing devices that are used for communications between a computer operator and a computer. (T) (2) A display console used for communication between the operator and the system, used primarily to specify information concerning application programs and I/O operations and to monitor system operation. (3) In SA z/OS, a console that displays output from and sends input to the operating system (z/OS, LINUX, VM, VSE). Also called *operating system console*. In the SA z/OS operator commands and configuration dialogs, OC is used to designate a target system operator console.

operator station task (OST). The NetView task that establishes and maintains the online session with the network operator. There is one operator station task for each network operator who logs on to the NetView program.

operator view. A set of group, system, and resource definitions that are associated together for monitoring purposes. An operator view appears as a graphic display in the graphical interface showing the status of the defined groups, systems, and resources.

OperatorView entry. A construct, created with the customization dialogs, used to represent and contain policy for an operator view.

OS. See operating system.

OSA. See Open Systems Adapter.

OST. See operator station task.

outbound. In SA z/OS, messages or commands from the focal-point system to the target system.

outbound gateway operator. The automation operator that establishes connections to other systems. The outbound gateway operator handles communications with other systems through a gateway session. The automation operator sends messages, commands, and responses to the inbound gateway operator at the receiving system.

P

page. (1) The portion of a panel that is shown on a display surface at one time. (2) To transfer instructions, data, or both between real storage and external page or auxiliary storage.

panel. (1) A formatted display of information that appears on a terminal screen. Panels are full-screen 3270-type displays with a monospaced font, limited color and graphics. (2) By using SA z/OS panels you can see status, type commands on a command line using a keyboard, configure your system, and passthru to other consoles. See also help panel. (3) In computer graphics, a display image that defines the locations and characteristics of display fields on a display surface. Contrast with screen.

parallel channels. Parallel channels operate in either byte (BY) or block (BL) mode. You can change connectivity to a parallel channel operating in block mode.

parameter. (1) A variable that is given a constant value for a specified application and that may denote the application. (2) An item in a menu for which the user specifies a value or for which the system provides a value when the menu is interpreted. (3) Data passed to a program or procedure by a user or another program, specifically as an operand in a language statement, as an item in a menu, or as a shared data structure.

partition. (1) A fixed-size division of storage. (2) In VSE, a division of the virtual address area that is available for program processing. (3) On an IBM Personal Computer fixed disk, one of four possible storage areas of variable size; one can be accessed by DOS, and each of the others may be assigned to another operating system.

partitionable CPC. A CPC that can be divided into 2 independent CPCs. See also physical partition, single-image mode, MP, and side.

partitioned data set (PDS). A data set in direct access storage that is divided into partitions, called *members*, each of which can contain a program, part of a program, or data.

passive monitoring. In SA z/OS, the receiving of unsolicited messages from z/OS systems and their resources. These messages can prompt updates to resource status displays. See also active monitoring

PCE. A processor controller. Also known as the support processor or service processor in some processor families.

PDB. See policy database.

PDS. See partitioned data set.

physical partition. Part of a CPC that operates as a CPC in its own right, with its own copy of the operating system.

physical unit (PU). In SNA, the component that manages and monitors the resources (such as attached links and adjacent link stations) of a node, as requested by a system services control point (SSCP) through an SSCP-PU session. An SSCP activates a session with the physical unit to indirectly manage, through the PU, resources of the node such as attached links.

physically partitioned (PP) configuration. A mode of operation that allows a multiprocessor (MP) system to function as two or more independent CPCs having separate power, water, and maintenance boundaries. Contrast with single-image mode.

POI. See program operator interface.

policy. The automation and monitoring specifications for an SA z/OS enterprise. See *IBM Tivoli System Automation for z/OS Defining Automation Policy*.

policy database. The automation definitions (automation policy) that the automation programmer specifies using the customization dialog is stored in the policy database. Also known as the PDB. See also automation policy.

POR. See power-on reset.

port. (1) System hardware that the I/O devices are attached to. (2) In an ESCON switch, a port is an addressable connection. The switch routes data through the ports to the channel or control unit. Each port has a name that can be entered into a switch matrix, and you can use commands to change the switch configuration. (3) An access point (for example, a logical unit) for data entry or exit. (4) A functional unit of a node that data can enter or leave a data network through. (5) In data communication, that part of a data processor that is dedicated to a single data channel for the purpose of receiving data from or transmitting data to one or more external, remote devices.

power-on reset (POR). A function that re-initializes all the hardware in a CPC and loads the internal code that enables the CPC to load and run an operating system. See initial microprogram load.

PP. See physical partition.

PPI. See program to program interface.

PPT. See primary POI task.

PR/SM™. See Processor Resource/Systems Manager.

primary host. The base program that you enter a command for processing at.

primary POI task (PPT). The NetView subtask that processes all unsolicited messages received from the

VTAM program operator interface (POI) and delivers them to the controlling operator or to the command processor. The PPT also processes the initial command specified to execute when NetView is initialized and timer request commands scheduled to execute under the PPT.

primary system. A system is a primary system for an application if the application is normally meant to be running there. SA z/OS starts the application on all the primary systems defined for it.

problem determination. The process of determining the source of a problem; for example, a program component, machine failure, telecommunication facilities, user or contractor-installed programs or equipment, environment failure such as a power loss, or user error.

processor. (1) A device for processing data from programmed instructions. It may be part of another unit. (2) In a computer, the part that interprets and executes instructions. Two typical components of a processor are a control unit and an arithmetic logic unit.

processor controller. Hardware that provides support and diagnostic functions for the central processors.

processor operations. The part of SA z/OS that monitors and controls processor (hardware) operations. Processor operations provides a connection from a focal-point system to a target system. Through NetView on the focal-point system, processor operations automates operator and system consoles for monitoring and recovering target systems. Also known as ProcOps.

Processor Resource/Systems Manager™ (PR/SM). The feature that allows the processor to use several operating system images simultaneously and provides logical partitioning capability. See also logically partitioned mode.

ProcOps. See processor operations.

ProcOps Service Machine (PSM). The PSM is a CMS user on a VM host system. It runs a CMS multitasking application that serves as "virtual hardware" for ProcOps. ProcOps communicates via the PSM with the VM guest systems that are defined as target systems within ProcOps.

product automation. Automation integrated into the base of SA z/OS for the products CICS, DB2, IMS, TWS (formerly called *features*).

program operator interface (POI). A NetView facility for receiving VTAM messages.

program to program interface (PPI). A NetView function that allows user programs to send or receive

data buffers from other user programs and to send alerts to the NetView hardware monitor from system and application programs.

protocol. In SNA, the meanings of, and the sequencing rules for, requests and responses used for managing the network, transferring data, and synchronizing the states of network components.

proxy resource. A resource defined like an entry type APL representing a processor operations target system.

PSM. See ProcOps Service Machine.

PU. See physical unit.

R

RACF. See Resource Access Control Facility.

remote system. A system that receives resource status information from an SA z/OS focal-point system. An SA z/OS remote system is defined as part of the same SA z/OS enterprise as the SA z/OS focal-point system to which it is related.

requester. A workstation from that user can log on to a domain from, that is, to the servers belonging to the domain, and use network resources. Users can access the shared resources and use the processing capability of the servers, thus reducing hardware investment.

resource. (1) Any facility of the computing system or operating system required by a job or task, and including main storage, input/output devices, the processing unit, data sets, and control or processing programs. (2) In NetView, any hardware or software that provides function to the network. (3) In SA z/OS, any z/OS application, z/OS component, job, device, or target system capable of being monitored or automated through SA z/OS.

Resource Access Control Facility (RACF). A program that can provide data security for all your resources. RACF protects data from accidental or deliberate unauthorized disclosure, modification, or destruction.

resource group. A physically partitionable portion of a processor. Also known as a *side*.

Resource Measurement Facility (RMF). A feature of z/OS that measures selected areas of system activity and presents the data collected in the format of printed reports, System Management Facility (SMF) records, or display reports.

Resource Object Data Manager (RODM). In NetView for z/OS, a component that provides an in-memory cache for maintaining real-time data in an address space that is accessible by multiple applications. RODM also allows an application to query an object and receive a rapid response and act on it.

resource token. A unique internal identifier of an ESCON resource or resource number of the object in the IODF.

restart automation. Automation provided by SA z/OS that monitors subsystems to ensure that they are running. If a subsystem fails, SA z/OS attempts to restart it according to the policy in the automation configuration file.

Restructured Extended Executor (REXX). A general-purpose, high-level, programming language, particularly suitable for EXEC procedures or programs for personal computing, used to write command lists.

return code. A code returned from a program used to influence the issuing of subsequent instructions.

REXX. See Restructured Extended Executor.

REXX procedure. A command list written with the Restructured Extended Executor (REXX), which is an interpretive language.

RMF. See Resource Measurement Facility.

RODM. See Resource Object Data Manager.

S

SAF. See Security Authorization Facility.

SA IOM. See System Automation for Integrated Operations Management.

SA z/OS. See System Automation for z/OS.

SA z/OS customization dialogs. An ISPF application through which the SA z/OS policy administrator defines policy for individual z/OS systems and builds automation control data and RODM load function files.

SA z/OS customization focal point system. See focal point system.

SA z/OS data model. The set of objects, classes and entity relationships necessary to support the function of SA z/OS and the NetView automation platform.

SA z/OS enterprise. The group of systems and resources defined in the customization dialogs under one enterprise name. An SA z/OS enterprise consists of connected z/OS systems running SA z/OS.

SA z/OS focal point system. See focal point system.

SA z/OS policy. The description of the systems and resources that make up an SA z/OS enterprise, together with their monitoring and automation definitions.

SA z/OS policy administrator. The member of the operations staff who is responsible for defining SA z/OS policy.

SA z/OS satellite. If you are running two NetViews on an z/OS system to split the automation and networking functions of NetView, it is common to route alerts to the Networking NetView. For SA z/OS to process alerts properly on the Networking NetView, you must install a subset of SA z/OS code, called an *SA z/OS satellite* on the Networking NetView.

SA z/OS SDF focal point system. See focal point system.

SCA. In SA z/OS, system console A, the active system console for a target hardware. Contrast with SCB.

SCB. In SA z/OS, system console B, the backup system console for a target hardware. Contrast with SCA.

screen. Deprecated term for panel.

screen handler. In SA z/OS, software that interprets all data to and from a full-screen image of a target system. The interpretation depends on the format of the data on the full-screen image. Every processor and operating system has its own format for the full-screen image. A screen handler controls one PS/2 connection to a target system.

SDF. See status display facility.

SDLCL. See synchronous data link control.

SDFS. See System Display and Search Facility.

secondary system. A system is a secondary system for an application if it is defined to automation on that system, but the application is not normally meant to be running there. Secondary systems are systems to which an application can be moved in the event that one or more of its primary systems are unavailable. SA z/OS does not start the application on its secondary systems.

Security Authorization Facility (SAF). An MVS interface with which programs can communicate with an external security manager, such as RACF.

server. A server is a workstation that shares resources, which include directories, printers, serial devices, and computing powers.

service language command (SLC). The line-oriented command language of processor controllers or service processors.

service period. Service periods allow the users to schedule the availability of applications. A service period is a set of time intervals (service windows), during which an application should be active.

service processor (SVP). The name given to a processor controller on smaller System/370 processors.

service threshold. An SA z/OS policy setting that determines when to notify the operator of deteriorating service for a resource. See also alert threshold and warning threshold.

session. In SNA, a logical connection between two network addressable units (NAUs) that can be activated, tailored to provide various protocols, and deactivated, as requested. Each session is uniquely identified in a transmission header by a pair of network addresses identifying the origin and destination NAUs of any transmissions exchanged during the session.

session monitor. The component of the NetView program that collects and correlates session-related data and provides online access to this information. The successor to NLDM.

shutdown automation. SA z/OS-provided automation that manages the shutdown process for subsystems by issuing shutdown commands and responding to prompts for additional information.

side. A part of a partitionable CPC that can run as a physical partition and is typically referred to as the A-side or the B-side.

Simple Network Management Protocol (SNMP). A set of protocols for monitoring systems and devices in complex networks. Information about managed devices is defined and stored in a Management Information Base (MIB).

single image. A processor system capable of being physically partitioned that has not been physically partitioned. Single-image systems can be target hardware processors.

single-MVS environment. An environment that supports one MVS image. See also MVS image.

single-image (SI) mode. A mode of operation for a multiprocessor (MP) system that allows it to function as one CPC. By definition, a uniprocessor (UP) operates in single-image mode. Contrast with physically partitioned (PP) configuration.

SLC. See service language command.

SMP/E. See System Modification Program/Extended.

SNA. See Systems Network Architecture.

SNA network. In SNA, the part of a user-application network that conforms to the formats and protocols of systems network architecture. It enables reliable transfer of data among end users and provides protocols for controlling the resources of various network configurations. The SNA network consists of

network addressable units (NAUs), boundary function components, and the path control network.

SNMP. See Simple Network Management Protocol.

solicited message. An SA z/OS message that directly responds to a command. Contrast with unsolicited message.

SSCP. See system services control point.

SSI. See subsystem interface.

start automation. SA z/OS-provided automation that manages and completes the startup process for subsystems. During this process, SA z/OS replies to prompts for additional information, ensures that the startup process completes within specified time limits, notifies the operator of problems, if necessary, and brings subsystems to an UP (or ready) state.

startup. The point in time that a subsystem or application is started.

status. The measure of the condition or availability of the resource.

status display facility (SDF). The system operations part of SA z/OS that displays status of resources such as applications, gateways, and write-to-operator messages (WTORs) on dynamic color-coded panels. SDF shows spool usage problems and resource data from multiple systems.

status focal-point system. See focal point system.

steady state automation. The routine monitoring, both for presence and performance, of subsystems, applications, volumes and systems. Steady state automation may respond to messages, performance exceptions and discrepancies between its model of the system and reality.

structure. A construct used by z/OS to map and manage storage on a coupling facility.

subgroup. A named set of systems. A subgroup is part of an SA z/OS enterprise definition and is used for monitoring purposes.

SubGroup entry. A construct, created with the customization dialogs, used to represent and contain policy for a subgroup.

subplex. Situations where the physical sysplex has been divided into subentities, for example, a test sysplex and a production sysplex. This may be done to isolate the test environment from the production environment.

subsystem. (1) A secondary or subordinate system, usually capable of operating independent of, or

asynchronously with, a controlling system. (2) In SA z/OS, an z/OS application or subsystem defined to SA z/OS.

subsystem interface (SSI). The z/OS interface over which all messages sent to the z/OS console are broadcast.

support element. A hardware unit that provides communications, monitoring, and diagnostic functions to a central processor complex (CPC).

support processor. Another name given to a processor controller on smaller System/370 processors. See service processor.

SVP. See service processor.

switch identifier. The switch device number (swchdevn), the logical switch number (LSN) and the switch name

switches. ESCON directors are electronic units with ports that dynamically switch to route data to I/O devices. The switches are controlled by I/O operations commands that you enter on a workstation.

symbolic destination name (SDN). Used locally at the workstation to relate to the VTAM application name.

synchronous data link control (SDLC). A discipline for managing synchronous, code-transparent, serial-by-bit information transfer over a link connection. Transmission exchanges may be duplex or half-duplex over switched or nonswitched links. The configuration of the link connection may be point-to-point, multipoint, or loop. SDLC conforms to subsets of the Advanced Data Communication Control Procedures (ADCCP) of the American National Standards Institute and High-Level Data Link Control (HDLC) of the International Standards Organization.

SYSINFO Report. An RMF report that presents an overview of the system, its workload, and the total number of jobs using resources or delayed for resources.

SysOps. See system operations.

sysplex. A set of z/OS systems communicating and cooperating with each other through certain multisystem hardware components (coupling devices and timers) and software services (couple data sets).

In a sysplex, z/OS provides the coupling services that handle the messages, data, and status for the parts of a multisystem application that has its workload spread across two or more of the connected processors, sysplex timers, coupling facilities, and couple data sets (which contains policy and states for automation).

A Parallel Sysplex is a sysplex that includes a coupling facility.

sysplex application group. A sysplex application group is a grouping of applications that can run on any system in a sysplex.

sysplex couple data set. A couple data set that contains sysplex-wide data about systems, groups, and members that use XCF services. All z/OS systems in a sysplex must have connectivity to the sysplex couple data set. See also couple data set.

Sysplex Timer. An IBM unit that synchronizes the time-of-day (TOD) clocks in multiple processors or processor sides. External Time Reference (ETR) is the z/OS generic name for the IBM Sysplex Timer (9037).

system. In SA z/OS, system means a focal point system (z/OS) or a target system (MVS, VM, VSE, LINUX, or CF).

System Automation for Integrated Operations

Management. (1) An outboard automation solution for secure remote access to mainframe/distributed systems. Tivoli System Automation for Integrated Operations Management, previously Tivoli AF/REMOTE, allows users to manage mainframe and distributed systems from any location. (2) The full name for SA IOM.

System Automation for OS/390. The full name for SA OS/390, the predecessor to System Automation for z/OS.

System Automation for z/OS. The full name for SA z/OS.

system console. (1) A console, usually having a keyboard and a display screen, that is used by an operator to control and communicate with a system. (2) A logical device used for the operation and control of hardware functions (for example, IPL, alter/display, and reconfiguration). The system console can be assigned to any of the physical displays attached to a processor controller or support processor. (3) In SA z/OS, the hardware system console for processor controllers or service processors of processors connected using SA z/OS. In the SA z/OS operator commands and configuration dialogs, SC is used to designate the system console for a target hardware processor.

System Display and Search Facility (SDSF). An IBM licensed program that provides information about jobs, queues, and printers running under JES2 on a series of panels. Under SA z/OS you can select SDSF from a pull-down menu to see the resources' status, view the z/OS system log, see WTOR messages, and see active jobs on the system.

System entry. A construct, created with the customization dialogs, used to represent and contain policy for a system.

System Modification Program/Extended (SMP/E). An IBM licensed program that facilitates the process of installing and servicing an z/OS system.

system operations. The part of SA z/OS that monitors and controls system operations applications and subsystems such as NetView, SDSF, JES, RMF, TSO, RODM, ACF/VTAM, CICS, IMS, and OPC. Also known as SysOps.

system services control point (SSCP). In SNA, the focal point within an SNA network for managing the configuration, coordinating network operator and problem determination requests, and providing directory support and other session services for end users of the network. Multiple SSCPs, cooperating as peers, can divide the network into domains of control, with each SSCP having a hierarchical control relationship to the physical units and logical units within its domain.

System/390 microprocessor cluster. A configuration that consists of central processor complexes (CPCs) and may have one or more integrated coupling facilities.

Systems Network Architecture (SNA). The description of the logical structure, formats, protocols, and operational sequences for transmitting information units through, and controlling the configuration and operation of, networks.

T

TAF. See terminal access facility.

target. A processor or system monitored and controlled by a focal-point system.

target control task. In SA z/OS, target control tasks process commands and send data to target systems and workstations through communications tasks. A target control task (a NetView autotask) is assigned to a target system when the target system is initialized.

target hardware. In SA z/OS, the physical hardware on which a target system runs. It can be a single-image or physically partitioned processor. Contrast with target system.

target system. (1) In a distributed system environment, a system that is monitored and controlled by the focal-point system. Multiple target systems can be controlled by a single focal-point system. (2) In SA z/OS, a computer system attached to the focal-point system for monitoring and control. The definition of a target system includes how remote sessions are established, what hardware is used, and what operating system is used.

task. (1) A basic unit of work to be accomplished by a computer. (2) In the NetView environment, an operator station task (logged-on operator), automation operator

(autotask), application task, or user task. A NetView task performs work in the NetView environment. All SA z/OS tasks are NetView tasks. See also message monitor task, and target control task.

telecommunication line. Any physical medium, such as a wire or microwave beam, that is used to transmit data.

terminal access facility (TAF). (1) A NetView function that allows you to log onto multiple applications either on your system or other systems. You can define TAF sessions in the SA z/OS customization panels so you don't have to set them up each time you want to use them. (2) In NetView, a facility that allows a network operator to control a number of subsystems. In a full-screen or operator control session, operators can control any combination of subsystems simultaneously.

terminal emulation. The capability of a microcomputer or personal computer to operate as if it were a particular type of terminal linked to a processing unit to access data.

threshold. A value that determines the point at which SA z/OS automation performs a predefined action. See alert threshold, warning threshold, and error threshold.

time of day (TOD). Typically refers to the time-of-day clock.

Time Sharing Option (TSO). An optional configuration of the operating system that provides conversational time sharing from remote stations. It is an interactive service on z/OS, MVS/ESA, and MVS/XA.

Time-Sharing Option/Extended (TSO/E). An option of z/OS that provides conversational timesharing from remote terminals. TSO/E allows a wide variety of users to perform many different kinds of tasks. It can handle short-running applications that use fewer sources as well as long-running applications that require large amounts of resources.

timers. A NetView command that issues a command or command processor (list of commands) at a specified time or time interval.

Tivoli Workload Scheduler (TWS). A family of IBM licensed products that plan, execute and track jobs on several platforms and environments. The successor to OPC/A.

TOD. Time of day.

token ring. A network with a ring topology that passes tokens from one attaching device to another; for example, the IBM Token-Ring Network product.

TP. See transaction program.

transaction program. In the VTAM program, a program that performs services related to the processing of a transaction. One or more transaction programs may operate within a VTAM application program that is using the VTAM application program interface (API). In that situation, the transaction program would request services from the applications program using protocols defined by that application program. The application program, in turn, could request services from the VTAM program by issuing the APPCCMD macro instruction.

transitional automation. The actions involved in starting and stopping subsystems and applications that have been defined to SA z/OS. This can include issuing commands and responding to messages.

translating host. Role played by a host that turns a resource number into a token during a unification process.

trigger. Triggers, in combination with events and service periods, are used to control the starting and stopping of applications in a single system or a parallel sysplex.

TSO. See Time Sharing Option.

TSO console. From this 3270-type console you are logged onto TSO or ISPF to use the runtime panels for I/O operations and SA z/OS customization panels.

TSO/E. See Time-Sharing Option/Extended.

TWS. See Tivoli Workload Scheduler.

U

UCB. See unit control block.

unit control block (UCB). A control block in common storage that describes the characteristics of a particular I/O device on the operating system and that is used for allocating devices and controlling I/O operations.

unsolicited message. An SA z/OS message that is not a direct response to a command. Contrast with solicited message.

user task. An application of the NetView program defined in a NetView TASK definition statement.

Using. An RMF Monitor III definition. Jobs getting service from hardware resources (processors or devices) are **using** these resources. The use of a resource by an address space can vary from 0% to 100% where 0% indicates no use during a Range period, and 100% indicates that the address space was found using the resource in every sample during that period. See also Volume Workflow and Address Space Workflow.

V

view. In the NetView Graphic Monitor Facility, a graphical picture of a network or part of a network. A view consists of nodes connected by links and may also include text and background lines. A view can be displayed, edited, and monitored for status information about network resources.

Virtual Storage Extended (VSE). A system that consists of a basic operating system (VSE/Advanced Functions), and any IBM supplied and user-written programs required to meet the data processing needs of a user. VSE and the hardware that it controls form a complete computing system. Its current version is called VSE/ESA.

Virtual Telecommunications Access Method (VTAM). An IBM licensed program that controls communication and the flow of data in an SNA network. It provides single-domain, multiple-domain, and interconnected network capability. Its full name is Advanced Communications Function for the Virtual Telecommunications Access Method. Synonymous with ACF/VTAM.

VM Second Level Systems Support. With this function, Processor Operations is able to control VM second level systems (VM guest systems) in the same way that it controls systems running on real hardware.

VM/ESA®. Virtual Machine/Enterprise Systems Architecture. Its current version is called z/VM.

volume. A direct access storage device (DASD) volume or a tape volume that serves a system in an SA z/OS enterprise.

volume entry. A construct, created with the customization dialogs, used to represent and contain policy for a volume.

volume group. A named set of volumes. A volume group is part of a system definition and is used for monitoring purposes.

volume group entry. An construct, created with the customization dialogs, used to represent and contain policy for a volume group.

Volume Workflow. The SA z/OS Volume Workflow variable is derived from the RMF Resource Workflow definition, and is used to measure the performance of volumes. SA z/OS calculates Volume Workflow using:

$$\text{Volume Workflow \%} = \frac{\text{accumulated Using}}{\text{accumulated Using} + \text{accumulated Delay}} * 100$$

The definition of **Using** is the percentage of time when a job has had a request accepted by a channel for the volume, but the request is not yet complete.

The definition of **Delay** is the delay that waiting jobs experience because of contention for the volume.

See also Address Space Workflow.

VSE. See Virtual Storage Extended.

VTAM. See Virtual Telecommunications Access Method.

W

warning threshold. An application or volume service value that determines the level at which SA z/OS changes the associated icon in the graphical interface to the warning color. See alert threshold.

workflow. See Address Space Workflow and Volume Workflow.

workstation. In SA z/OS workstation means the *graphic workstation* that an operator uses for day-to-day operations.

write-to-operator (WTO). A request to send a message to an operator at the z/OS operator console. This request is made by an application and is handled by the WTO processor, which is part of the z/OS supervisor program.

write-to-operator-with-reply (WTOR). A request to send a message to an operator at the z/OS operator console that requires a response from the operator. This request is made by an application and is handled by the WTO processor, which is part of the z/OS supervisor program.

WTO. See write-to-operator.

WTOR. See write-to-operator-with-reply.

WWV. The US National Institute of Standards and Technology (NIST) radio station that provides standard time information. A second station, known as WWVB, provides standard time information at a different frequency.

X

XCF. See cross-system coupling facility.

XCF couple data set. The name for the sysplex couple data set prior to MVS/ESA System Product Version 5 Release 1. See also sysplex couple data set.

XCF group. A set of related members that a multisystem application defines to XCF. A member is a specific function, or instance, of the application. A

member resides on one system and can communicate with other members of the same group across the sysplex.

XRF. See extended recovery facility.

Z

z/OS. An IBM mainframe operating system that uses 64-bit real storage. See also Base Control Program.

z/OS component. A part of z/OS that performs a specific z/OS function. In SA z/OS, component refers to entities that are managed by SA z/OS automation.

z/OS subsystem. Software products that augment the z/OS operating system. JES and TSO/E are examples of z/OS subsystems. SA z/OS includes automation for some z/OS subsystems.

z/OS system. A z/OS image together with its associated hardware, which collectively are often referred to simply as a system, or z/OS system.

Numerics

390-CMOS. Processor family group designator used in the SA z/OS processor operations documentation and in the online help to identify any of the following S/390 CMOS processor machine types: 9672, 9674, 2003, 3000, or 7060. SA z/OS processor operations uses the OCF facility of these processors to perform operations management functions. See OCF-based processor.

Index

Special characters

*BASE sample policy 310
+SA_PREDEFINED_MSGS MVS
Component entry 265, 336

A

accessibility xiii
ACF 257
ACFFQRY 66
actions on policy databases 303
add-on sample policies
importing 347
listed 310
alternate configuration support 373
alternate configurations
building 374
defining 374
restrictions 375
alternate data sets, monitoring 88
AMC file 323
distributing 330
anchors
heartbeat 89
in RODM 89
Lost&Found 89
specifying 89
sysplex 89
AOCCLONE
See system automation symbols
AOCCLONE IDs 9
AOFARCAT 277
AOFOPF* samples 278
AOFSESxx 278
AOFSMARTMAT advanced automation
option, to enable AT updates 334
AOFWRKxx 277
AOFWRKxx operators 281
APPLGROUP INFO policy item 120
application
scenario, creating 36
application class 139
Application Defaults entry type 275
Application Defaults entry type, short
description 5
Application entry type
creating 138
introduction 137
policy items 143
application entry type, short
description 3
application group
nature 115
nature of 39
scenario, creating 37
Sysplex Application Group 38
System Application Group 38
application group entry type, short
description 3
application group resource name 39

APPLICATION GROUPS policy item
for sysplexes 89
for systems 103
APPLICATION INFO policy item
for application defaults 275
for applications 149
application instance 139
application monitor routine 141, 155
application move, resource aware 132
application resource name 37
application resources
automatically linking 42
generating 41
APPLICATION SYMBOLS policy
item 159
application type 140
ApplicationGroup entry type
creating 114
introducing 114
policy items 118
APPLICATIONS policy item 122
applying service updates 338
ASCB chaining
MVS job type 140
with application automation 154
assigning
clone IDs 9
system automation symbols 9
AT
See NetView automation table
ATTEND TIME policy item 263
AUTBASE 277
AUTCON 277
AUTEVT1 278
AUTEVT2 278
AUTGSS 277
AUTHB 277
AUTHENTICATION policy item 291
AUTHW1 278
AUTJES 277
AUTLOG 277
AUTMON 277
AUTMSG 277
AUTNET1, AUTNET2 277
AUTO MSG CLASSES policy item 78
AUTO1 277
AUTO2 277
automated function 166, 182, 186, 187
automated function name 277
Automatic Restart Manager
defining element names 156
using clone values for element
names 156
automation
considerations 8
table policy definition 106
automation configuration
ACF 330
AMC file 330
automation control file 330

automation configuration (*continued*)
automation manager configuration
file 330
introducing 15
AUTOMATION CONSOLE policy
item 108
automation control file
building 323
distributing 330
automation flags
setting application defaults 275
AUTOMATION FLAGS policy item
for Application Defaults 275
for applications 158
for MVSCOMP Defaults 272
for System Defaults 272
automation manager configuration
file 323
building 323
distributing 330
automation name 39, 116
automation networks
definition 284
automation operators 276
Automation Operators entry type 276
Automation Operators entry type, short
description 5
automation operators policy
definition 277
AUTOMATION OPTIONS policy
item 273
automation policy
defining, outlined 2
overview of defining 1
automation procedure
functions managed by 8
introducing 8
recovery of components and data
sets 8
automation resource name 116
AUTOMATION SYMBOLS policy
item 106
autotask 5
AUTPLEX 278
AUTPLEX2 278
AUTPLEX3 278
AUTPOST 278
AUTPOSTS 278
AUTREC 277
AUTRPC 277
AUTSESxx 278
AUTSHUT 277
AUTSYS 277
AUTWRKxx 277
AUTXCF 277
AUTXCF2 277
availability target 129

B

- BASEOPER 277
- BASIC 115
- BASIC application group 39
- batch build
 - INGEBCON 332
 - job 332
 - return codes 332
- batch build processing
 - defining data sets 370
 - defining ISPF temporary data sets 372
- batch conversion 362
- batch update
 - INGEBFLT 359
 - job 359
 - return codes 359
- behavior of application groups
 - ACTIVE 117
 - PASSIVE 117
- build
 - job for batch build 332, 359
- BUILD 324
 - automation control file 323
 - automation manager configuration file 323
 - description 323
 - MPFLSTSA member 323
 - NetView automation table 323
 - Policy Database Selection panel 304
 - system operations configuration files 323
- BUILD error messages 328
- build processing
 - with BUILD command 324
- BUILDF command 324
- bulk deletion
 - policy objects 22
- bulk update
 - See* updating

C

- canceling input 19
- CDS 87
- chaining 128
- changing links
 - concurrent user access 364
- CICS automation 242
- CICS CONNECTION policy item 202, 249
- CICS CONTROL policy item 201
- CICS link definitions 242, 249
 - policy items 249
- CICS link monitor periods 242, 251
- CICS subsystems
 - policy items 201
- classes, nested
 - See* nested classes
- cleanup delay policy definition 154
- CLISTS policy item 296
- clone IDs
 - assigning 9
- clone values 156
- CMD processing 164
- code processing 167

- COMMAND DEFINITIONS policy item 93
- COMMAND FLOODING policy item 94
- command prefix 154
- command processing 164
- command routing mechanism 76
- common routine, introduced 8
- components
 - recovery of with automation procedures 8
- components, SA z/OS enterprise 73
- concurrent customization by multiple users 363
- concurrent user access
 - changing links 364
 - entry name selection 364
 - entry type selection 363
 - introducing 19
 - policy database selection 363
 - policy definitions 363
- condition
 - relationship 129
 - shutdown 217
 - startup 217
 - unset condition 213
- CONDITION policy item
 - for a trigger 217
 - for an event 213
- configuration
 - of automation 15
- configuration files
 - distributing 330
- configuration focal point system 15
- configuration support, alternate 373
- considerations
 - automation 8
 - graphical interface 7
- console name 108
- controller details
 - OPC 244
- conversion
 - job for batch conversion 362
 - of initial policy database 362
 - selective policy database conversion 362
- conversion function 361
- COPY policy item 26
- copying policy
 - information that is copied 27
 - process 26
- couple data set 87
- creating
 - application groups 114
 - application groups, scenario 37
 - applications 138
 - applications, scenario 36
 - events 211
 - groups 80
 - MOVE sysplex application group, scenario 47
 - policy databases 305
 - policy objects 19
 - policy objects using text file updates 356
 - policy objects using text file updates, examples 357
 - policy objects, scenario 33

- creating (*continued*)
 - processors 219
 - SERVER sysplex application groups, scenario 54
 - subgroups 97
 - sysplex application groups, scenario 38, 47
 - sysplexes, scenario 34
 - system application groups, scenario 43, 46
 - systems 99
 - systems, scenario 34
- critical threshold 191
- CRM 76
- customization dialog 1
 - canceling input 19
 - changing environment 365
 - features 17
 - help 17
 - invocation 16
 - primary menu 16
 - primary menu, introducing 16
 - starting 16
 - using 15, 17

D

- data
 - finding in a panel 23
 - management 343
 - moved and restructured 361
- data sets
 - defining for batch processing 370
 - ISPF temporary, defining for batch processing 372
 - monitoring 88
 - recovery of with automation procedures 8
- DB2 CONTROL policy item 203
- DB2 subsystems
 - policy items 202
- Define Relationship panel 123
- defining
 - alternate configurations for systems 374
 - automation policy, outlined 2
 - automation policy, overview 1
 - data sets for batch processing 370
 - ISPF temporary data sets for batch processing 372
 - relationships 124
- deleting
 - policy object 22
 - policy objects using text file updates 359
 - several policy objects 22
 - single policy object 22
- dependent resource 124
- Description panel 26
- DESCRIPTION policy item 25
- desired status, setting 121, 150, 232, 273, 294
- DesiredStatus vote 121, 150, 232, 273, 294
- disability xiii
- DISPACF 66
- displaying panel ID 6

- distributing
 - automation control file 330
 - configuration files 330
- DOCUMENTATION policy item 75
- DOWNWARD CLASS/INST policy item 147
- drain, JES2 195
- DSIOPF member 276

E

- E-T DATA policy item 300
- element name, Automatic Restart Manager
 - cloned 156
 - constant 156
 - defining 156
- enterprise definition 15, 74
- Enterprise entry type 74, 211
 - policy items 74
- enterprise entry type, short description 2
- entry name selection
 - concurrent user access 364
- entry type
 - Application 137
 - Application Defaults 275
 - ApplicationGroup 114
 - Automation Operators 276
 - defined 2
 - Enterprise 74, 211
 - fast path 18
 - Group 79
 - introduction 2
 - Monitor Resource 229
 - MVS Component 264
 - MVSCOMP Defaults 271
 - Network 284
 - Notify Operators 281
 - Processor 219
 - Product Automation 240
 - Resident CLISTS 295
 - Service Periods 214
 - short description
 - application 3
 - Application Defaults 5
 - application group 3
 - Automation Operators 5
 - enterprise 2
 - events 3
 - group 3
 - messages 4
 - monitor resource 4
 - MVS Component 4
 - MVSCOMP Ddefaults 4
 - Network 5
 - Notify Operators 5
 - processor 4
 - product automation 4
 - Resident CLISTS 5
 - service periods 3
 - Status Display 5
 - subgroup 3
 - Sysplex Defaults 5
 - system 3
 - System Defaults 4
 - tape attendance 4

- entry type (*continued*)
 - short description (*continued*)
 - timeout settings 4
 - timers 4
 - triggers 3
 - User E-T Pairs 5
 - Status Display 296
 - SubGroup 97
 - Sysplex Application Group 114, 118
 - Sysplex Defaults 293
 - System 98
 - System Application Group 118
 - System Defaults 272
 - Tape Attendance 261
 - Timeout Settings 259
 - Timers 252, 256
 - Triggers 217
 - User E-T Pairs 299
- entry type selection
 - concurrent user access 363
- error messages
 - BUILD 328
- events
 - scenario 58
- Events entry type
 - creating 211
 - policy items 212
- events entry type, short description 3
- EVTOPER 278
- exit names policy definition 106
- extending policy definitions 366
- external shutdown 153
- external startup 153
- EXTERNALLY relationship 125

F

- FALLBACK status
 - support 193
 - using 193
- fast path
 - entry type 18
 - policy item 19
- FINAL shutdown 184
- FIND command 23
- finding data in a panel 23
- focal point
 - name 78
- focal point NetView domains policy
 - definition 286
- focal point services 284
- FORCE shutdown 184
- FORCEDOWN relationship 125
- frequent threshold 191
- FULL SESSIONS policy item 287
- functional names for automation operators 277
- functions
 - user-written 372
- functions managed by automation procedures 8

G

- GAT&DOMID 277
- gateway monitor time policy
 - definition 106
- gateway policy definition 288
- GATEWAY policy item 288
- GATOPER 277
- GENERATED RESOURCES policy
 - item 136, 193
- generic routine, introduced 8
- graphical interface, considerations for 7
- Group entry type 79
 - creating 80
- group entry type, short description 3
- GROUP INFO policy item 84
- grouping
 - resources 7
 - scenario 31
- groups
 - creating 80
 - standard 80
 - sysplex 80
- GSSOPER 277
- SHUTDOWN 281
- STARTUP 281
- GUESTS AND SYSTEMS policy item 227

H

- HASMONITOR relationship 126
- HASPARENT relationship 126
- HASPASSIVEPARENT relationship 126
- HBOPER 277
- heartbeat
 - explained 101
 - interval 100
 - missing heartbeat delay 100
- heartbeat anchor 89
- heartbeat interval 100
- help information 17
- HWOPER 278

I

- IEADMCxx SYMBOLS policy item
 - See* RECOVERY OPTIONS policy item
- IMMED shutdown 184
- importing
 - add-on sample policies 347
 - policy database data 343
 - policy database data, batch 347
- IMS automation 240
- IMS CONTROL policy item 205
- IMS STATE/ACTION policy item 242
- IMS state/action table 242
- IMS subsystems
 - policy items 204
- infrequent threshold 191
- ING.CUSTOM.AOFTABL 323, 370
- INGEBCON member for batch
 - build 332
- INGEBFLT member for batch
 - update 359
- INGEBRPT member, for batch report
 - creation 317

INGMSGSA automation table 336
 INGPOST command 89
 INGSSEND PARMS policy item 76
 initialize target system 110
 input, canceling 19
 interested operator list 111
 invoking the customization dialog 16
 IPL
 MVS target system 112
 VM target system 113
 IPL INFO policy item for systems 111
 ISPF temporary data sets, defining for
 batch build 372

J

JES2
 recovery parameters 196
 spool recovery
 establishing 195
 from full condition 195
 JES2 DRAIN 195, 198
 JES2 SPOOLFULL 195
 JES2 SPOOLSHORT 195, 197
 JES2 subsystems
 policy items 195
 JES3
 recovery parameters 200
 SPOOL
 control 199
 SPOOLFULL 199
 SPOOLSHORT 199
 JES3 SPOOLFULL 199
 JES3 SPOOLSHORT 200
 JES3 subsystems
 policy items 199
 JESOPER 277
 JOB DEFINITIONS policy item 91
 job name
 defined 141
 job type
 description 140
 MVS 140
 NONMVS 140
 policy definition 140
 TRANSIENT 141
 JOB/ASID DEFINITIONS policy item 92

K

keyboard xiii

L

labels, system, in overrides 335
 link definitions (CICS) 242, 249
 link monitor periods (CICS) 242, 251
 linking application resources
 automatically 42
 linking policy objects 28
 load profile name 110
 LOCAL PAGE DATA SET policy item 90
 LOCATE 305
 logging policy database
 modifications 312
 LOGOPER 277

LookAt message retrieval tool xviii
 Lost&Found anchor 89
 LPARS AND SYSTEMS policy item 224

M

maintenance, policy database 303
 MAKEAVAILABLE relationship 125
 MAKEUNAVAILABLE relationship 125
 MANAGE 304
 MCSFLAGS policy definition 108
 MEMBER OF policy item
 for application groups 137
 for applications 194
 MESSAGE AUTOMATION policy item
 for enterprises 252
 message class 282
 message classes 283
 message prefix 154
 message processing 162, 164
 code processing 167
 reply processing 166
 scenario 67
 user defined data 170
 with user-defined data 67
 message retrieval tool, LookAt xviii
 message revision table
 introducing 333
 messages
 predefined 336
 predefined, modifying 337
 response 112, 113
 messages entry type, short description 4
 MESSAGES/USER DATA policy item
 for applications 162
 for monitor resources 233
 for MVS componetns 269
 minor resources 269
 MINOR RESOURCES policy item, for
 applications 191
 MINOR RESOURCES policy item, for
 MVS components 269
 missing heartbeat 100
 processing 101
 missing heartbeat delay 100
 missing heartbeat processing 101
 modifications to policy database,
 logging 312
 MONITOR INFO policy item 230
 Monitor Resource
 entry type 229
 monitor resource entry type, short
 description 4
 monitoring
 alternate data sets 88
 primary data sets 88
 tape mounts 261
 MONITORING PERIOD policy item 251
 for CICS link definitions 249
 Monitoring, Sysplex Timer 87
 MONOPER 277
 MOVE 115
 MOVE application group 39
 MOVE group
 introduced 48
 moved and restructured data 361

MOVED status
 using 193
 MPF DEFINITIONS policy item 255
 MPFLSTSA member
 building 323
 distributing 330
 MSGOPER 277
 MVS Component
 +SA_PREDEFINED_MSGS 265, 336
 MVS Component entry type
 using 264
 MVS Component entry type, short
 description 4
 MVS job 140
 MVS Target System IPL Information
 panel 112
 MVSCOMP Defaults entry type 271
 MVSCOMP Defaults entry type, short
 description 4
 MVSCONSi 277
 MVS DUMP
 MVS Component entry type 264
 MVSESA INFO policy item
 for MVSCOMP Defaults 271

N

naming restrictions 324
 nature of application groups
 BASIC 39, 115
 introduced 39
 MOVE 39, 115
 SERVER 39, 115
 nested classes
 defaulting 13
 hierarchy 12
 inheritance 13
 introduced 11
 link considerations 14
 NETOPER 277
 NetView
 nomination before BUILD 2
 Operators 281
 RMTCMD command 285
 NetView automation table
 AOFSMARTMAT advanced
 automation option 334
 building 323
 distributing 330
 enabling updates 334
 INGMSGSA 336
 introduction 333
 scenario 69
 Network entry type 284
 Network entry type, short description 5
 NMC DEFINITIONS policy item 88
 NONMVS job 141
 NORM shutdown 184
 notification operators 282
 notify operators entry type 281
 Notify Operators entry type, short
 description 5
 NOTIFY OPERATORS policy item 282

O

- OMEGAMON sessions policy
 - definition 288
- OMEGAMON SESSIONS policy item 288
- OPC CONTROL policy item 207
- OPC controller details 241, 244
 - policy items 245
- OPC special resources 241, 246
- OPC subsystems
 - policy items 207
- OPC system details 241, 243
- OPC workstation domains 241, 247
- OPCA DOMAINID policy item 248
- OPCA PCS policy item 245
- OPCAO ENVIRON policy item 243
- operator console
 - interested operator 111
- OPERATORS policy item 277
- output data set 327
- overrides, application labels 335
- overrides, system labels 335
- overview of defining automation policy 1

P

- panel ID, displaying 6
- PEEROF relationship 278
- PLEXOPER 278
- PLEXOPR2 278
- PLEXOPR3 278
- policy
 - add-on sample 310
 - basic sample 309
 - samples 309
- policy database 15
 - adding to index 305
 - available actions 303
 - batch import 347
 - creating 305
 - creating policy objects using text file updates 356
 - data, importing 343
 - data, updating policy text files 352
 - data, updating via file 350
 - examples, creating policy objects using text file updates 357
 - initial conversion of 362
 - logging modifications 312
 - maintenance 303
 - reports 315
 - reports, batch creation 317
 - reports, job for batch creation 317
 - sending to remote nodes 373
 - specifying settings 310
 - updating data, block replacement 353
 - updating data, block replacement examples 353
 - updating data, field replacement 352
 - updating data, policy replacement 354
 - updating data, policy replacement examples 354
 - using existing 303

- policy database selection
 - concurrent user access 363
- policy definitions
 - concurrent user access 363
- policy definitions, extending 366
- policy item
 - APPLICATION GROUPS 89
 - APPLICATION GROUPS, for systems 103
 - AUTO MSG CLASSES 78
 - AUTOMATION CONSOLE 108
 - AUTOMATION OPTIONS 273
 - AUTOMATION SYMBOLS 106
 - COMMAND DEFINITIONS 93
 - COMMAND FLOODING 94
 - common policy items 25
 - COPY 26
 - create or modify 366
 - defined 2
 - DESCRIPTION 25
 - fast path 19
 - for standard groups 81
 - for sysplex groups 82
 - GROUP INFO 84
 - INGSEND PARMS 76
 - introducing 5
 - IPL INFO, for systems 111
 - JOB DEFINITIONS 91
 - JOB/ASID DEFINITIONS 92
 - LOCAL PAGE DATA SET 90
 - MESSAGE AUTOMATION for enterprises 252
 - MPF DEFINITIONS 255
 - NMC DEFINITIONS 88
 - PROCESSOR 109
 - PROCESSOR OPS INFO 77
 - RECOVERY OPTIONS 95
 - RELATIONSHIPS 123
 - RESOURCE DEFINITIONS 95
 - SEND COMMAND OPERS 75
 - SUBGROUP INFO 98
 - SUBGROUPS 85
 - SYMBOL DESCRIPTION 79
 - SYSPLEX 86
 - SYSTEM INFO 105
 - SYSTEMS 85
 - SYSTEMS, for SubGroups 98
 - TARGET SYSTEM INFO, for systems 109
 - WHERE USED 27
- policy object
 - bulk deletion 22
 - copying 26
 - copying definitions 26
 - creating 19
 - defined 2
 - deleting 22
 - deleting policy objects using text file updates 359
 - deleting several 22
 - introducing 5
 - renaming 21
 - scenario, creating 33
 - single, deleting 22
- policy objects
 - linking 28
- POSTOPER 278

- POSTSLV 278
- POSTSTART 181
- PPIOPER 277
- predefined SA z/OS messages
 - introduced 336
 - modifying 337
 - viewing generated AT entry 265, 336
- preference values
 - default 116
 - effective 132
 - overview 131
 - scenarios 133
- preferences 54
- PREPAVAILABLE relationship 125
- PREPUNAVAILABLE relationship 125
- primary data sets, monitoring 88
- primary JES policy definition 106
- primary menu
 - customization dialog 16
 - customization dialog, introducing 16
- priority of requests 216
- Processor entry type 219
 - creating 219
 - policy items for mainframe preprocessors 220
 - policy items for PSM 225
- processor entry type, short description 4
- PROCESSOR INFO policy item 221
- PROCESSOR OPS INFO policy item 77
- PROCESSOR policy item 109
- product automation
 - CICS 242
 - IMS 240
- Product Automation
 - entry type 240
- product automation entry type, short description 4
- profile information before BUILD 2
- PSM 220
- PSM INFORMATION policy item 225

R

- RECOPER 277
- RECOVERY OPTIONS policy item 95
- relationship
 - condition 129
 - EXTERNALLY 125
 - FORCEDOWN 125
 - HASMONITOR 126
 - HASPARENT 126
 - HASPASSIVEPARENT 126
 - MAKEAVAILABLE 125
 - MAKEUNAVAILABLE 125
 - PEEROF 126
 - PREPAVAILABLE 125
 - PREPUNAVAILABLE 125
- relationships
 - Define Relationship panel 123
 - defining 124
 - types 125
- RELATIONSHIPS policy item 123, 161
- renaming
 - policy object 21
- reply processing 166
- report
 - service updates 339

REPORT 304
 reports
 about ApplicationGroups 315
 about Applications 315
 about generated resources 315
 Resident CLISTS entry type 295
 Resident CLISTS entry type, short description 5
 resource
 background information 34
 dependent 124
 scenario 31
 supporting 124
 resource aware application move 132
 RESOURCE DEFINITIONS policy item 95
 RESOURCE INFO policy item 294
 resource name
 WLM 157
 resource states
 desired, setting 121, 150, 232, 273, 294
 resources
 grouping 7
 scenario 31
 scenario, grouping 32
 scenario, matching to systems 33
 scenario, nesting 32
 RESOURCES policy item 129
 restart option policy definition 152
 restrictions, building alternate configurations 375
 return codes
 batch build 332
 batch update 359
 REXX script, message scenario 71
 RFIND command 23
 RMTCMD command 285
 RODM anchors 89
 route codes policy definition 108
 RPCOPER 277

S

SA z/OS enterprise components 73
 SA z/OS topology manager 331
 sample policies
 *BASE 310
 add-on 310
 add-on, importing 347
 basic 309
 introduction 309
 satisfactory target 130
 scenario
 creating application groups 37
 creating applications 36
 creating MOVE sysplex application group 47
 creating policy objects 33
 creating SERVER sysplex application groups 54
 creating sysplex application groups 38, 47
 creating sysplexes 34
 creating system application groups 43, 46
 creating systems 34

scenario (*continued*)
 grouping 31
 grouping resources 32
 identifying resources 31
 matching resources to systems 33
 message processing 67
 nesting resources 32
 NetView automation table 69
 REXX script 71
 schedule override 57
 schedules 57
 service periods 57
 User E-T Pairs 65
 using customization dialog 31
 using triggers and events 58
 working with resources 31
 schedule
 scenario 57
 schedule override scenario 57
 SDF
 automation control file entry 297
 highlight 298
 priority policy definition 298
 root name policy definition 106
 SDF DETAILS policy item 297
 SDF FOCALPOINT policy item 286
 SEND COMMAND OPERS policy item 75
 sending policy databases to remote nodes 373
 SERVER application group 39
 SERVER group 55
 service period 119, 215
 scenario 57
 SERVICE PERIOD policy item 123, 160
 for application groups 119
 Service Periods entry type 214
 service periods entry type, short description 3
 service updates
 applying 338
 report 339
 service window 215
 SERVICE WINDOW policy item 214
 settings
 policy databases 310
 settings menu 365
 Settings option 365
 shortcut keys xiii
 SHUTDOWN
 GSSOPER 281
 shutdown command processing 181
 INIT or FINAL 185
 NORM, IMMED or FORCE 186
 shutdown condition 217, 219
 SHUTDOWN condition for a trigger 218
 shutdown delay policy definition 154
 SHUTDOWN policy item 182
 shutdown processing
 command 185
 for applications 182
 reply 188
 shutdown reply processing
 INIT 188
 NORM, IMMED or FORCE 189
 SHUTOPER 277

SMFDUMP
 MVS Component entry type 264
 SOAP SERVER policy item 291
 SPECIAL RESOURCE policy item
 OPC 247
 SPECIAL RESOURCES policy item
 for OPC controller details 245
 SPOOLFULL 195
 SPOOLFULL (JES3) 199
 SPOOLSHORT 195
 SPOOLSHORT (JES3) 199
 standard group 80
 standard groups, policy items 81
 start
 restart after IPL 151
 start timeout policy definition 152
 starting the customization dialog 16
 STARTUP 181
 GSSOPER 281
 startup condition 217
 STARTUP condition for a trigger 218
 startup condition list 219
 startup parameters 153
 startup phases
 POSTSTART 181
 PRESTART 181
 STARTUP 181
 STARTUP policy item 179
 STATE/ACTION TABLE policy item 205
 state/action tables
 IMS 240
 Status Display
 display facility 296
 entry type 296
 Status Display entry type, short description 5
 status forwarding path 101
 SubGroup entry type 97
 creating 97
 policy items 98
 subgroup entry type, short description 3
 SUBGROUP INFO policy item 98
 subgroups
 creating 97
 SUBGROUPS policy item 85
 subsystem
 name, defining 138
 subtype 140
 supporting resource 124
 symbol descriptions 79
 SYSLOG
 MVS Component entry type 264
 SYSNAME naming restrictions 324
 SYSOPER 277
 sysplex
 scenario, creating 34
 ways to create 36
 sysplex anchor 89
 sysplex application group
 scenario, creating 38, 47
 scenario, creating MOVE group 47
 scenario, creating SERVER group 54
 Sysplex Application Group 38, 114, 115
 generating Sysplex Application Group resources 40

- Sysplex Application Group entry type 114
- Sysplex Defaults entry type 293
- Sysplex Defaults entry type, short description 5
- sysplex group 80
- sysplex groups, policy items 82
- SYSPLEX policy item 86
- Sysplex Timer Monitoring 87
- system application group
 - scenario, creating 43, 46
- System Application Group 38, 115
 - resources, generating 43
- System Application Groups 118
- SYSTEM ASSOCIATION policy item 193
- system automation symbols 9
 - assigning 9
 - using 10
- system console
 - interested operator 111
- System Defaults entry type 272
- System Defaults entry type, short description 4
- System entry type 98
 - creating 99
 - policy items 101
- system entry type, short description 3
- SYSTEM INFO policy item 105
- system labels in overrides 335
- system monitor time policy
 - definition 106
- system operations configuration files
 - building 323
- system symbols
 - using 10
- systems
 - scenario, creating 34
- SYSTEMS policy item 85
 - for processors 220
 - for SubGroups 98

T

- TAF 284
- TAF fullscreen sessions policy
 - definition 287
- Tape Attendance entry type 261
- tape attendance entry type, short description 4
- tape mount, monitoring 261
- tape policy 261
- target
 - focal point name 78
- TARGET SYSTEM INFO
 - for systems 109
- target system information
 - initialize target system 110
 - load profile name 110
 - time zones 111
- target system time zones 111
- task
 - message monitor 78
 - target control 78
- Terminal Access Facility 284
- threshold
 - critical 191
 - frequent 191

- threshold (*continued*)
 - infrequent 191
- THRESHOLDS policy item 190
 - for application defaults 275
 - for MVSCOMP Defaults 272
 - for System Defaults 273
- Timeout Settings entry type 259
- timeout settings entry type, short description 4
- TIMEOUT VALUES policy item 260
- timeout variable 259
- Timers entry type 252, 256
- timers entry type, short description 4
- TIMERS policy item 256
- TRANSIENT job 141
- trigger
 - link to an application group 119
- TRIGGER policy item
 - for application groups 119, 122
 - for applications 160
 - for monitor resources 239
- triggers
 - scenario 58
- Triggers entry type 217
- triggers entry type, short description 3
- TWS automation 241

U

- unset condition 212, 213
- update
 - job for batch update 359
- updating
 - policy database data policy text files 352
 - policy database data via file 350
 - policy database data, block replacement 353
 - policy database data, block replacement examples 353
 - policy database data, field replacement 352
 - policy database data, policy replacement 354
 - policy database data, policy replacement examples 354
- UPWARD CLASS policy item 147
- user defined data processing 170
- User E-T Pairs
 - entry type 299
 - scenario 65
- User E-T Pairs entry type, short description 5
- user-written functions 372
- USS CONTROL policy item 209
- USS subsystems
 - policy items 208

V

- VIEW 305
- VM Target System IPL Information
 - panel 113
- vote, DesiredStatus 121, 150, 232, 273, 294
- VTAMLST 287

W

- WHERE USED policy item 27
- WLM resource name 157
- workstation domains
 - OPC 247

X

- XCFOPER 277
- XCFOPER2 277

Z

- z/OS job name defined 141



Program Number: 5645-006

Printed in USA

SC34-2572-01

