

Lotus technology solutions co- existing with your current infrastructure

Brendan Jansen
Senior IT Specialist
IBM Software Group

This session has three parts ...

- **Part 1** - Introduction
 - What is collaboration ?
 - Why is it important ?
- **Part 2** - How Lotus Products integrate today
 - QuickPlace, Discovery Server, Domino.Doc
 - LearningSpace, Extended Search
- **Part 3** - The Future
 - Lotus Strategy
 - Web Services
 - NextGEN

Part 1 - What is Collaboration?

- People working together for a common purpose

- Some common collaborative application characteristics
 - ▶ Workspaces and Discussion to solve problems together
 - ▶ Awareness of people on the network
 - ▶ Real-time conversation between people
 - ▶ Virtual meetings for remote teams
 - ▶ Structured workflow to route information to experts
 - ▶ Document repository for up to date information
 - ▶ e-Learning to enable the value chain

Collaboration In The Enterprise

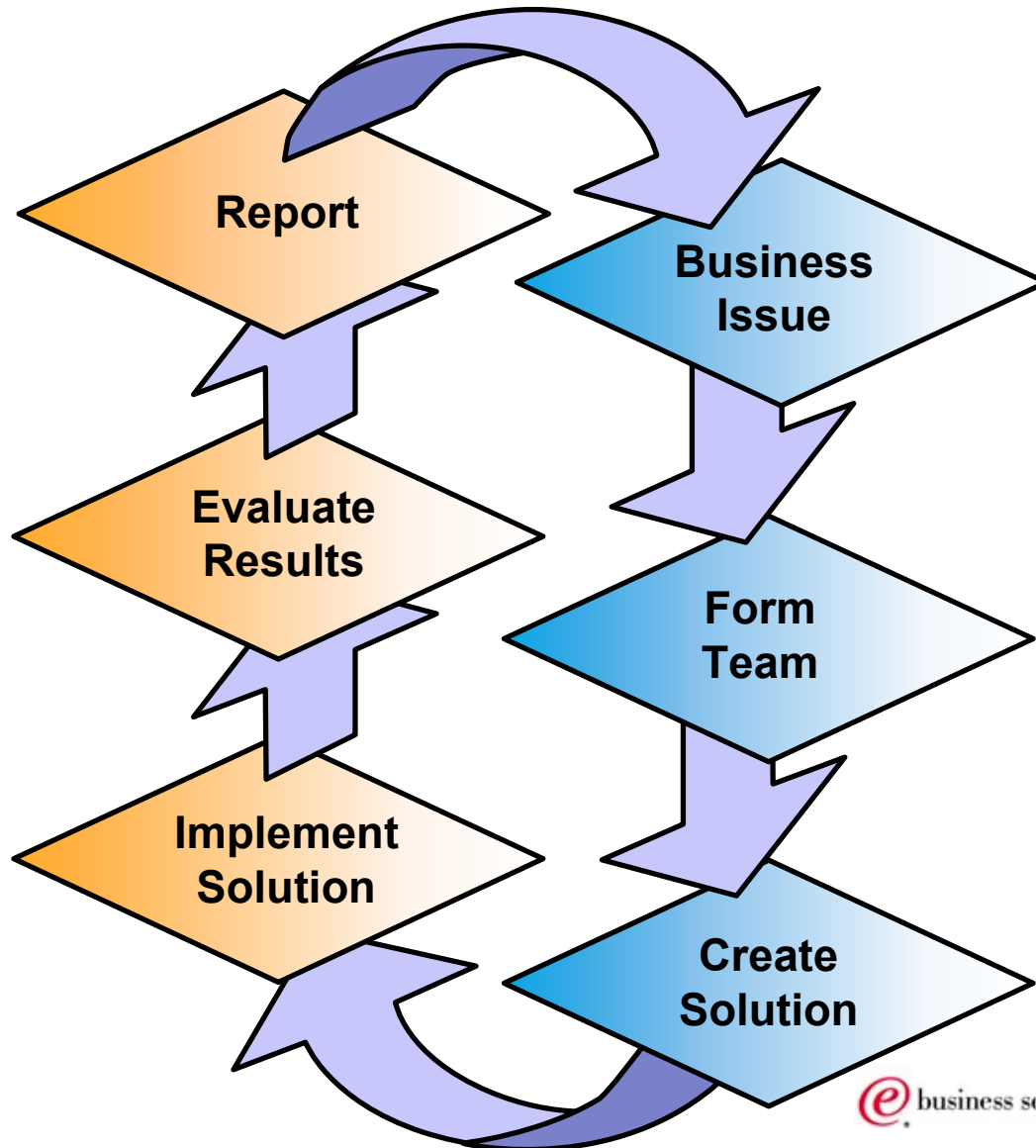

Collaboration In The Enterprise

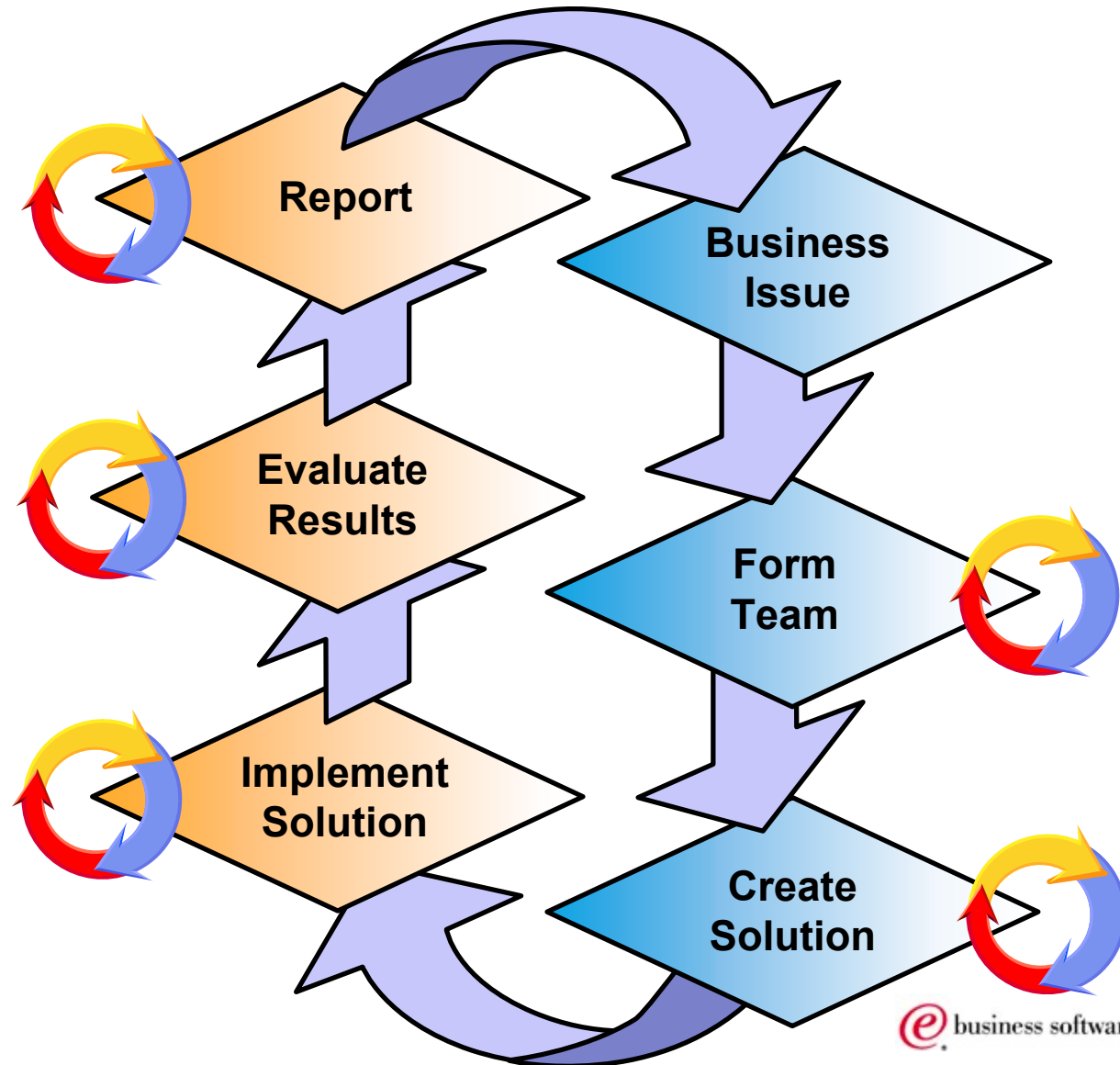

- Build
- Capture
- Create
- Design
- Share
- Organise
- Task

Collaboration In The Enterprise

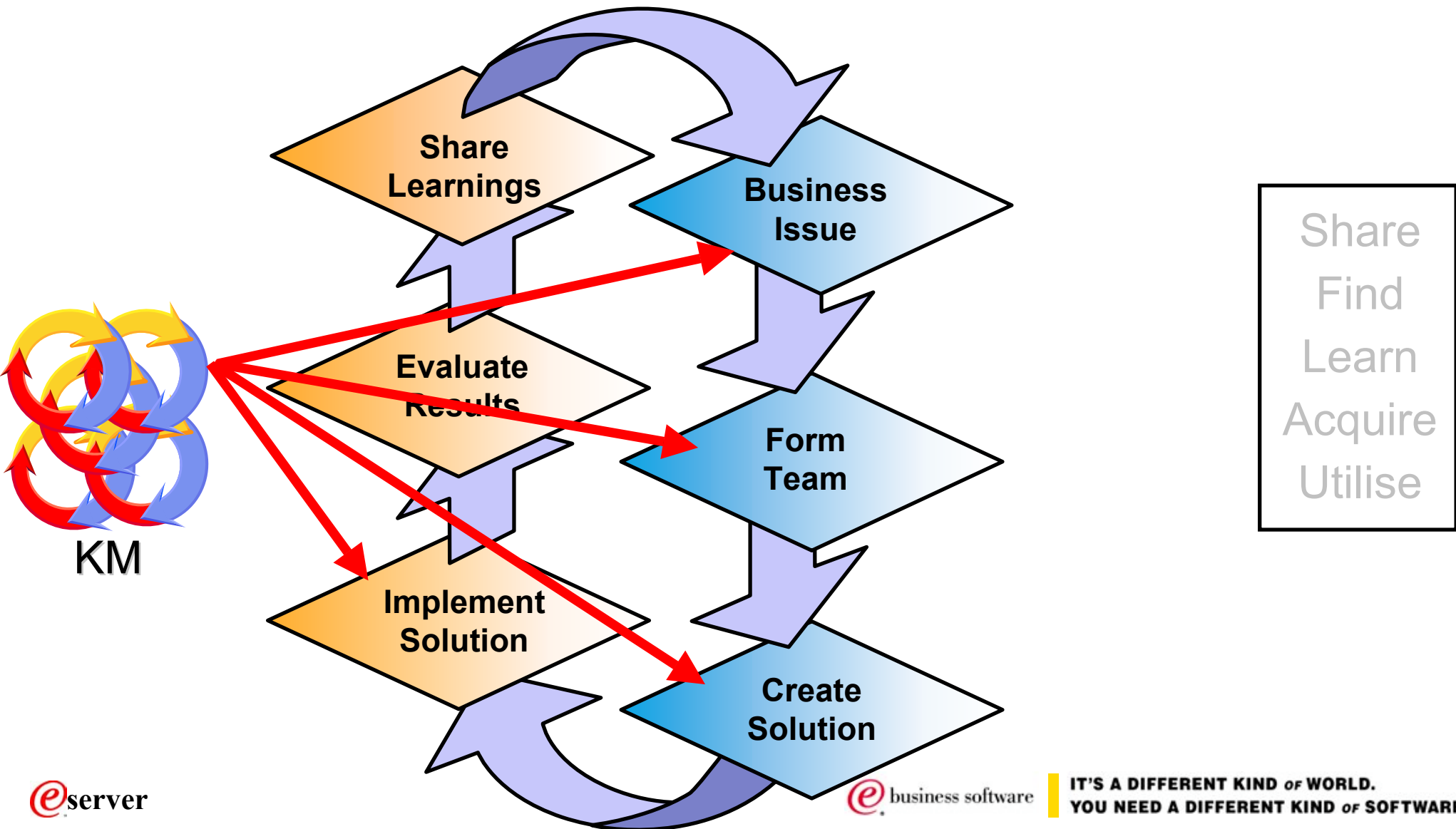

Collaborative applications

- Mail
- Real-time Interaction
- Teamware
- Workflow
- Document Management
- Knowledge Management

Potential Integration Points

- Directory
- Database
- Operating System
- Hardware Platform
- Protocols

Part 2 - Lotus Product Integration Examples

- QuickPlace
- Domino.Doc
- LearningSpace
- Extended Search
- Discovery Server

1. QuickPlace

- Directory Integration
 - Domino
 - LDAP
 - NT
- Platform Choices
 - iSeries
 - Solaris
 - Windows NT/2000
- Option to run on IIS
 - Existing Server
 - Windows HTTP Performance

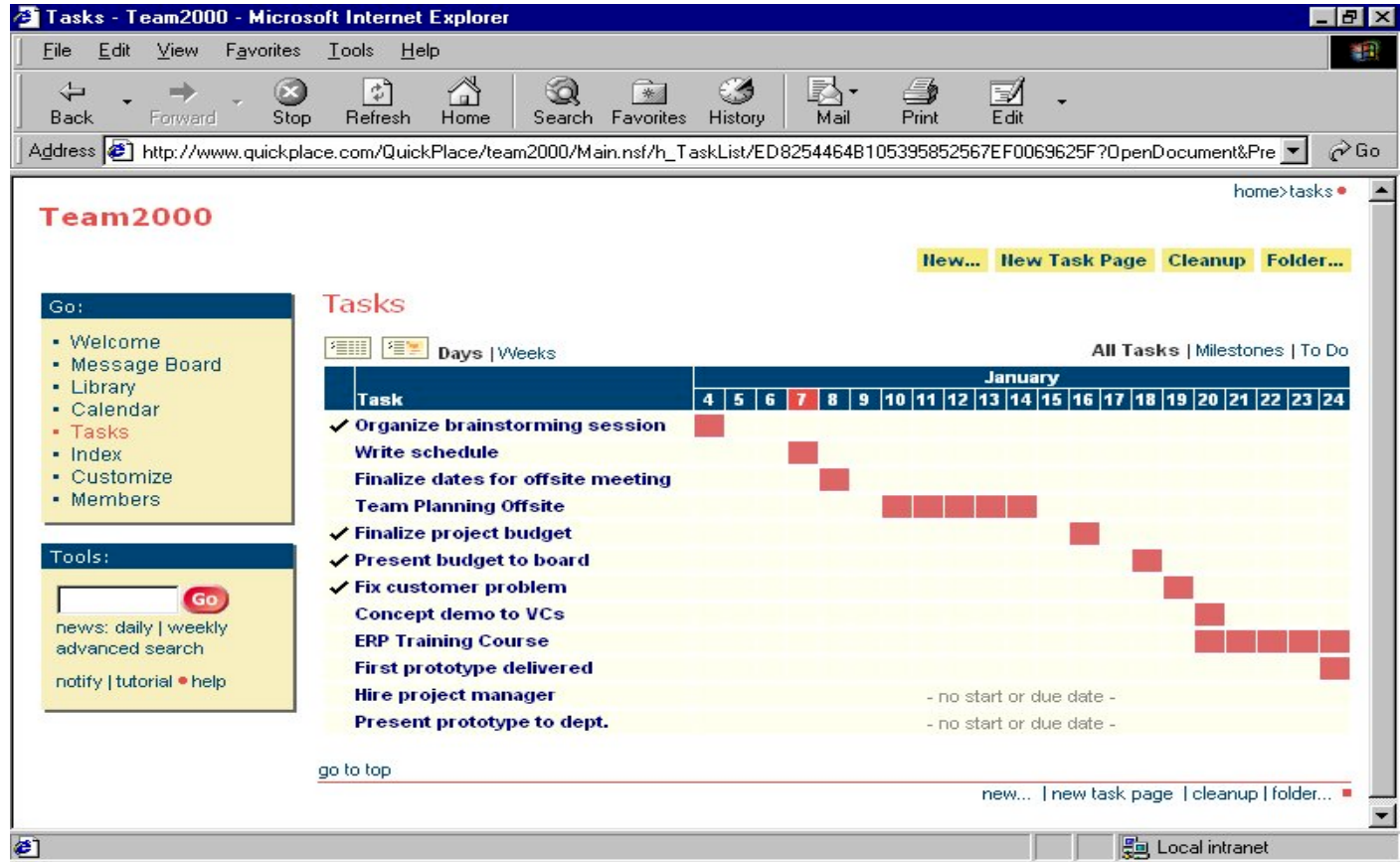

QuickPlace User Directory

Change User Directory



User Directory. You can make it easier for QuickPlace managers and users by specifying a user directory from which QuickPlace members can be selected.

Directory. You can specify a directory from which QuickPlace managers can select members. (You can read more about directory types at the bottom of this page.) To specify a directory, select its type and enter its name below:

Type:

Name:

Advanced Settings. You can enter specific settings for your directory or leave them blank to make use of the default settings.

Port number:

Search base:

Narrow searches to the QuickPlace name.

Note: Specify the search base using the Distinguished Name format.

Check to use credentials specified below when searching the directory.

Username:

Password:

Note: If your LDAP directory allows anonymous access, leave these fields blank. Otherwise, if your LDAP directory requires credentials to access information, please enter the username and password for the QuickPlace server to use when making requests.

Example Customer Deployment

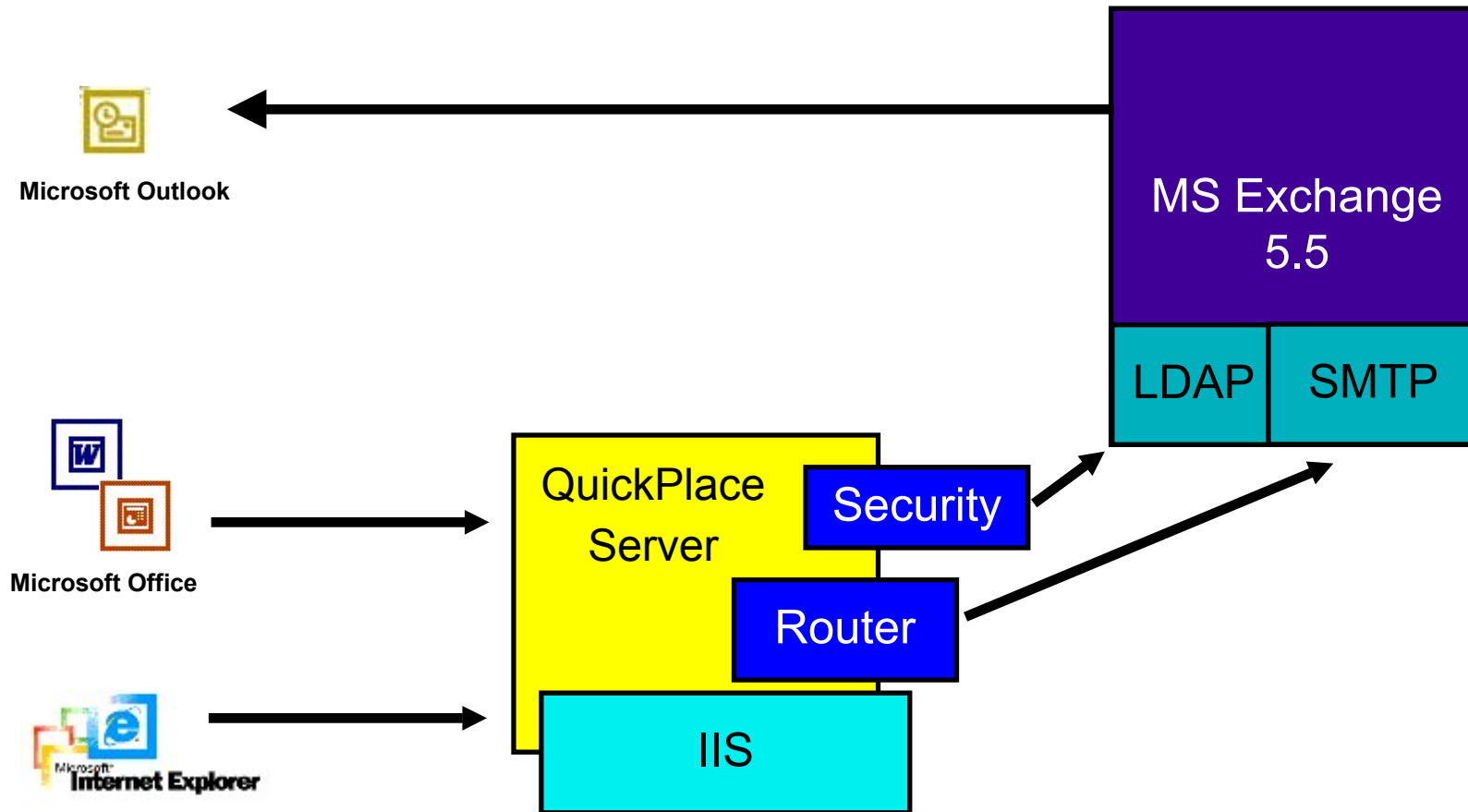

3. Domino.Doc

- Broad based Collaborative Document Management System
- Runs on Domino
 - Windows, Sun Solaris, AIX, OS/400, S/390
- Leverages
 - object store
 - replication (distribution)
 - scalability and flexibility
 - security services
 - development tools

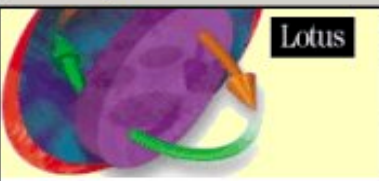

Lotus Domino.Doc

Search for [Advanced Search](#)

Getting Started | |

- My HomePage
- My Documents
 - Life Cycle
 - Checked Out Items
 - Favorites
 - Recently Edited
 - Saved Searches

- Site Map
 - Manufacturing
 - Corporate
 - Legal
 - Operations

Checked Out Items

Title	Date
Agreement # 345	12/07/2001
BrendanV Test	14/02/2002
Cameron's Repo	14/09/2001
Car Parking	30/01/2002
Claim against V	12/07/2001
EEO Policy	08/11/2001
FSM 1.1 Identify Segmentation Variables	07/05/2001
FSM 1.2 Complete Ex aternal Quantitve Research	17/04/2001

more ...

Description:
Document Type: Agreement
Date: 12/07/2001 6:58:44 AM
Author: Brendan Jansen/Lotus
File Cabinet: Legal Matters

Recently Edited

Title	Date
No Documents Found	

Life Cycle

Title	Status
ERG Report	Approved
Test Report	Approved
ABB Report	Pending Approval
Annual Leave	Pending Approval
Executive Summary	Pending Review
FSM 1 Develop & Manage Customer Segments	Pending Review
Market Analysis	Pending Review
Review Test 1	Pending Review

more ...

Favorites

Title	Type
Capital Items	Binder
Default Binder	Binder
Orica vs BHP	Binder
Purchasing Policy	Binder

3. Domino.Doc Integration

Requirement

- Integrate with other applications
- Integrate with data from other Applications
- Migration
- Numbering and Indexing

Capability

- Virtually anything you can do with Domino
- Open Document Management API (ODMA)
- Domino.Doc API
 - ▶ C++
 - ▶ VB
 - ▶ LotusScript

Example Customer Deployment

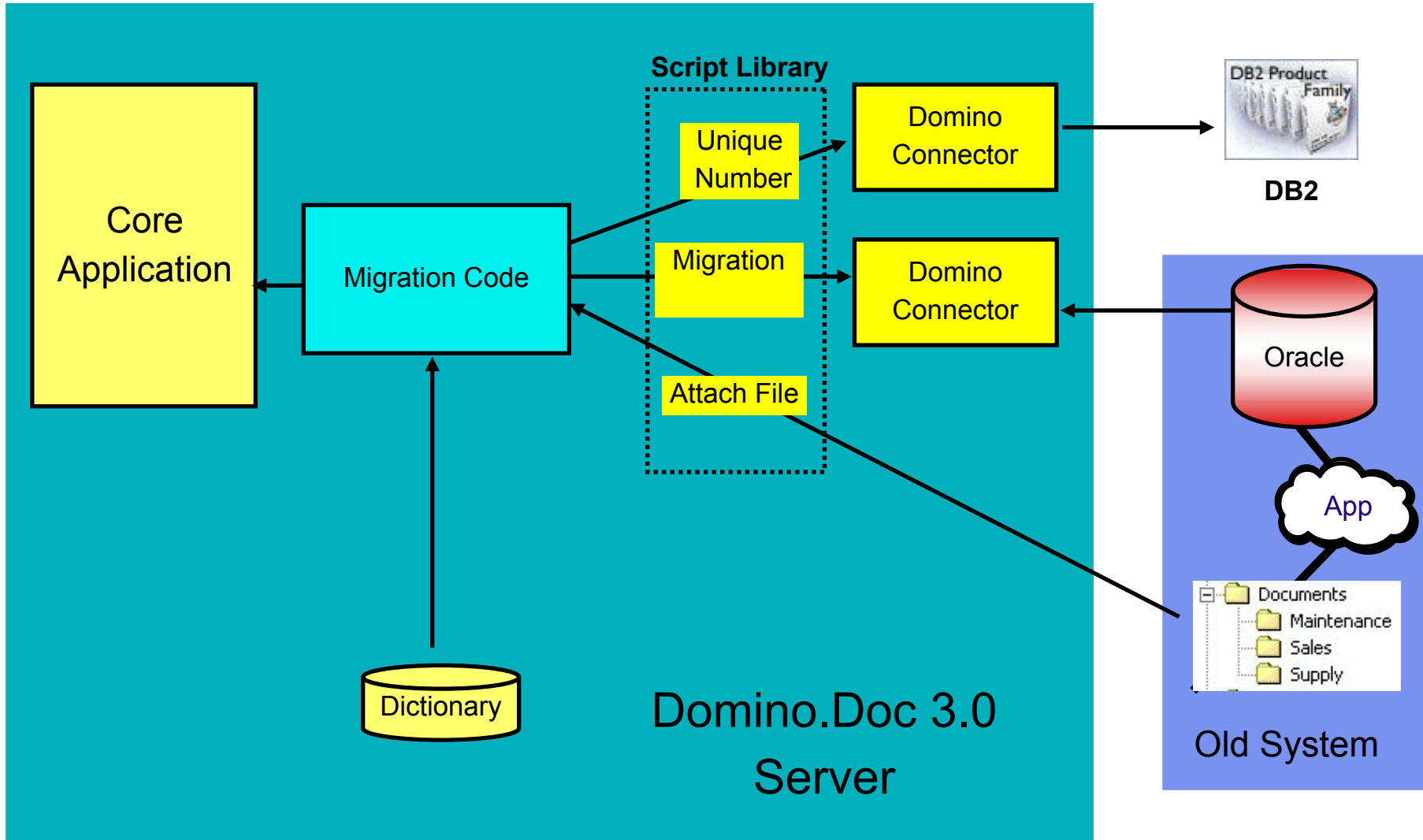

4. Lotus LearningSpace

- Web based architecture
 - J2EE architecture running with Websphere
 - Web services/SOAP support
- Windows and Unix server support
- Relational database support
 - DB2
 - Oracle
 - SQL Server
- LDAP directory support
- iCal calendaring support
- SMTP mail support

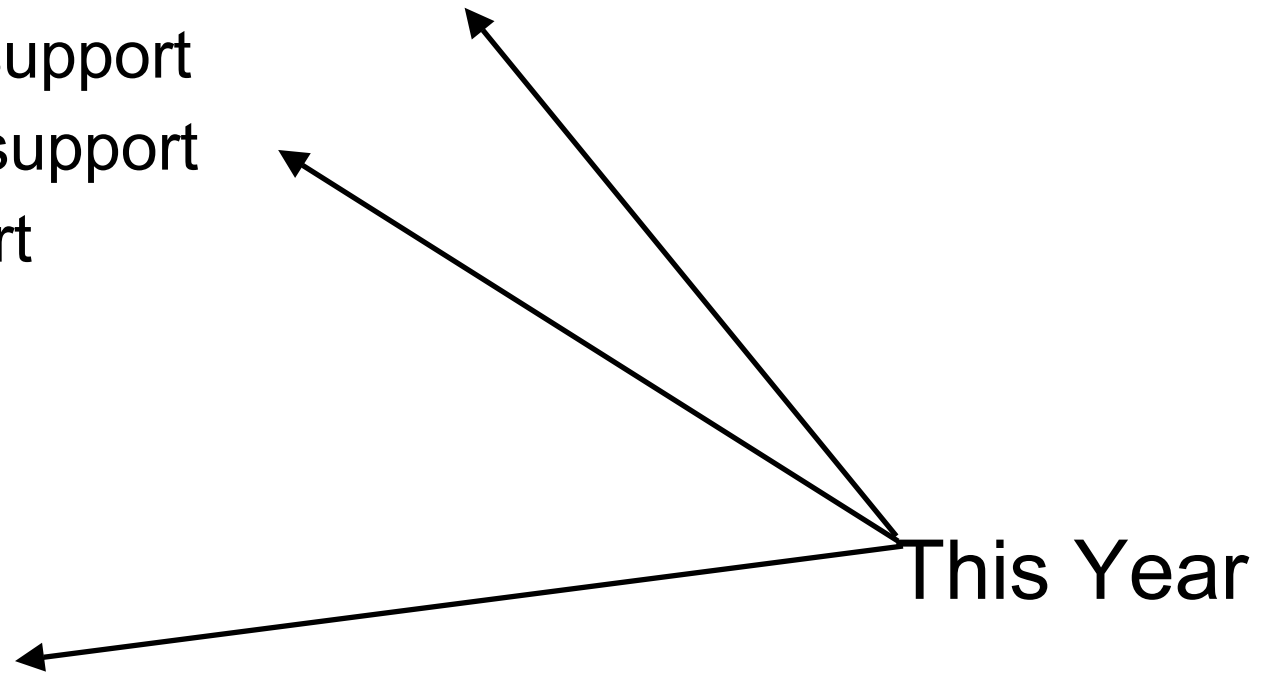

Example Customer Deployment

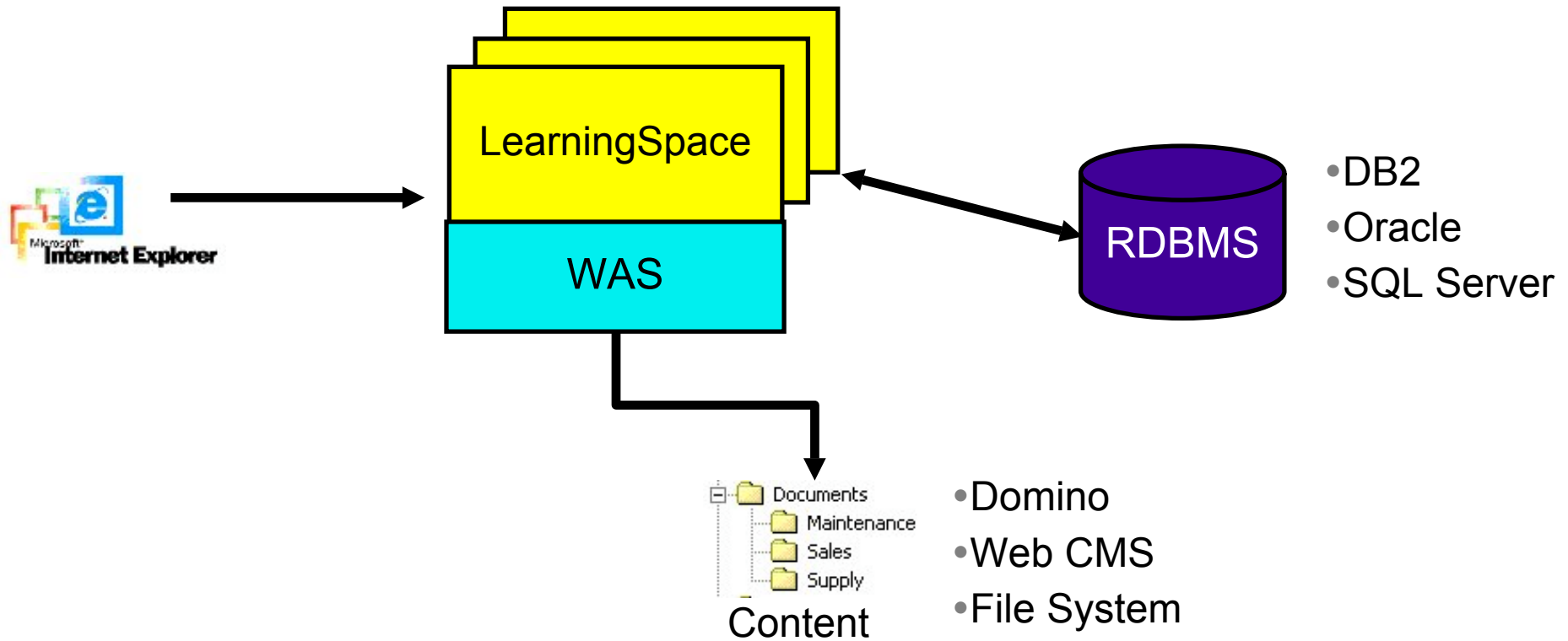

5. IBM Extended Search

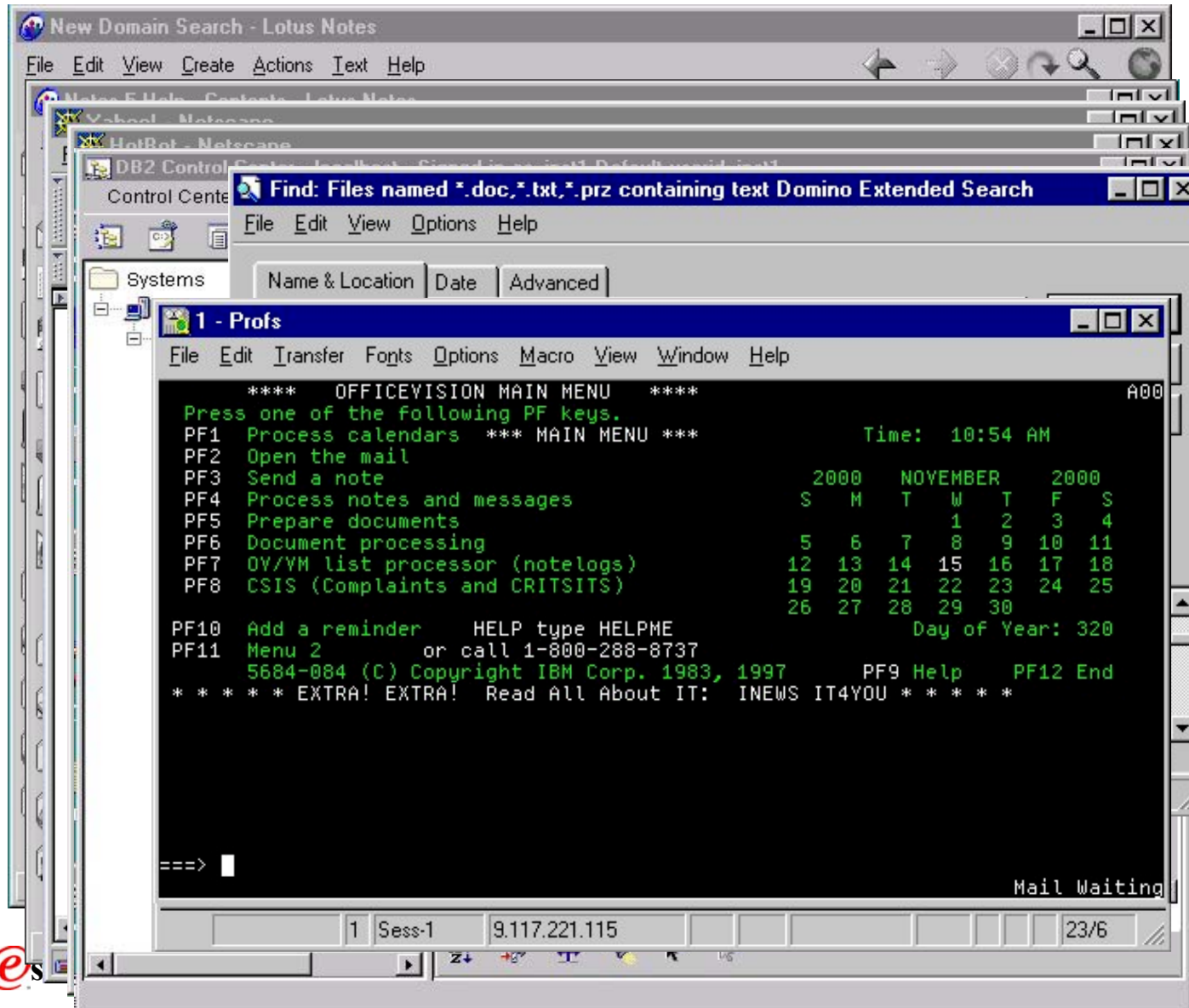

"This is hard because there are too many..."

- ✗ Interfaces to use
- ✗ Grammars to learn
- ✗ Results to interpret
- ✗ Sign-ON's

IT'S A DIFFERENT KIND OF WORLD.
YOU NEED A DIFFERENT KIND OF SOFTWARE.

Extended Search for Knowledge



"This is much easier"

- ✓ Single Interface
- ✓ One Grammar
- ✓ Consolidated Hitlist
- ✓ One Sign-on

Extended Search - Overview

Parallel, Distributed Search

Single Client Interface

- Web browser
- Notes client



ES Server

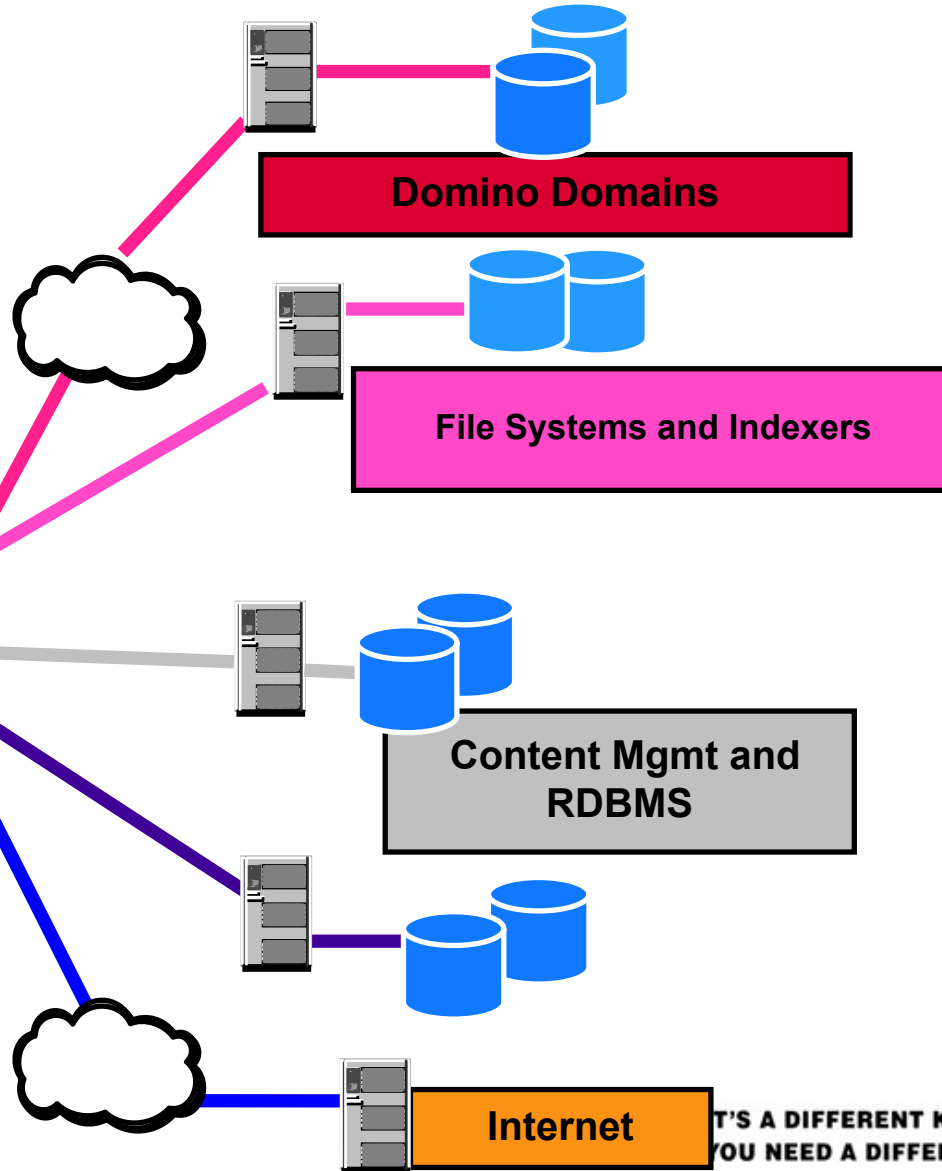

Breadth of Extended Searching

- Lotus Databases/Products
- Document Mgmt Systems
- Microsoft Indexes
- Mail Systems
- Directories
- Relational Data
- File System Content
- World Wide Web
- Information Access Toolkit



Breadth of Extended Searching

■ Lotus Databases/Products

- Document Mgmt Systems
- Microsoft Indexes
- Mail Systems
- Directories
- Relational Data
- File System Content
- World Wide Web
- Information Access Toolkit

■ **Lotus.** software

- Domino 4.5 onwards
- R5 Domain Index
- Multiple Domino Domains
- Domino.Doc
- LEI, DEC's enabled apps
- Lotus Discovery Server *
- QuickPlace *
- Sametime *

Breadth of Extended Searching

- Lotus Databases/Products
- Document Mgmt Systems
- Microsoft Indexes
- Mail Systems
- Directories
- Relational Data
- File System Content
- World Wide Web
- Information Access Toolkit



- Lotus Domino.Doc
 - ▶ Multiple libraries/file cabinets
- IBM EIP
 - ▶ VisualInfo
 - ▶ Digital Library
 - ▶ On Demand

Breadth of Extended Searching

- Lotus Databases/Products
- Document Mgmt Systems
- Microsoft Indexes
- Mail Systems
- Directories
- Relational Data
- File System Content
- World Wide Web
- Information Access Toolkit

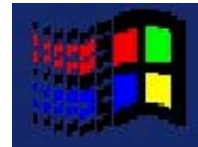

- Index Server
 - ▶ HTML, text, MS Office documents.
- Site Server
 - ▶ Multiple catalogs
 - ▶ Access to Exchange

Breadth of Extended Searching

- Lotus Databases/Products
- Document Mgmt Systems
- Microsoft Indexes
- Mail Systems
- Directories
- Relational Data
- File System Content
- World Wide Web
- Information Access Toolkit



- Domino (Lotus)
- MS Exchange 5.5
 - ▶ (thru SiteServer)
- MS Exchange 2000

Breadth of Extended Searching

- Lotus Databases/Products
- Document Mgmt Systems
- Microsoft Indexes
- Mail Systems
- Directories
- Relational Data
- File System Content
- World Wide Web
- Information Access Toolkit



- LDAP
 - ▶ IBM SecureWay
 - ▶ Domino LDAP Server
 - ▶ Netscape Directory Server
 - ▶ Exchange LDAP Server

Breadth of Extended Searching

- Lotus Databases/Products
- Document Mgmt Systems
- Microsoft Indexes
- Mail Systems
- Directories
- Relational Data
- File System Content
- World Wide Web
- Information Access Toolkit

1	2	3
2		
3		
4		

- ODBC
 - ▶ IBM's DB2
 - ▶ Oracle 8i
 - ▶ Sybase
 - ▶ MS SQL Server
 - ▶ Microsoft Access
- Native SQL Access
 - ▶ MS SQL Server *
 - ▶ Microsoft Access *

* Future release

Breadth of Extended Searching

- Lotus Databases/Products
- Document Mgmt Systems
- Microsoft Indexes
- Mail Systems
- Directories
- Relational Data
- File System Content
- World Wide Web
- Information Access Toolkit



- Network accessible drives
- Optional sub-directory search
- Searches any file that is not compressed (not indexed)

Breadth of Extended Searching

- Lotus Databases/Products
- Document Mgmt Systems
- Microsoft Indexes
- Mail Systems
- Directories
- Relational Data
- File System Content
- World Wide Web
- Information Access Toolkit

- 18 preconfigured web sites:

ABCNews.com, AOL.com
 Search, Alta Vista (Web),
 Business Wire (Last 7
 Days), CNN,
 Canada.com, EuroSeek
 Excite!, FAST Search,
 GoTo.com,
 Google!, HotBot - Web,
 Lycos, NBCi, PR
 Newswire (Last 72 Hours),
 Web
 Crawler, Yahoo News
 Headline Search, Yahoo!



Breadth of Extended Searching

- Lotus Databases/Products
- Document Mgmt Systems
- Microsoft Indexes
- Mail Systems
- Directories
- Relational Data
- File System Content
- World Wide Web
- **Extended Search Link Toolkit**



- Used to build your own Search link to...
 - ▶ Proprietary Databases
 - ▶ Commercial Content
- Atlantic Decisions
 - ▶ Verity Link

5. IBM Extended Search

- QuickPlace Search Link
 - ▶ Across application and server searches

- Web Services Extended Search support
 - ▶ Define and register ES search services to UDDI
 - ▶ Invoke XML defined services methods via SOAP

6. Discovery Server

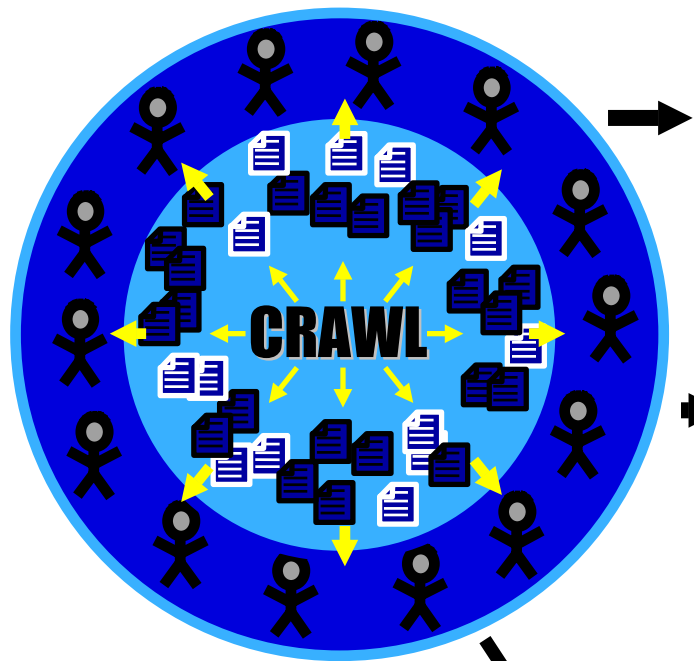

Keywords to Doc



Docs to Topics
Topics to Topics
Place to Topics
People to Topics



Value of Doc to Topic
Strength of Person to Topic

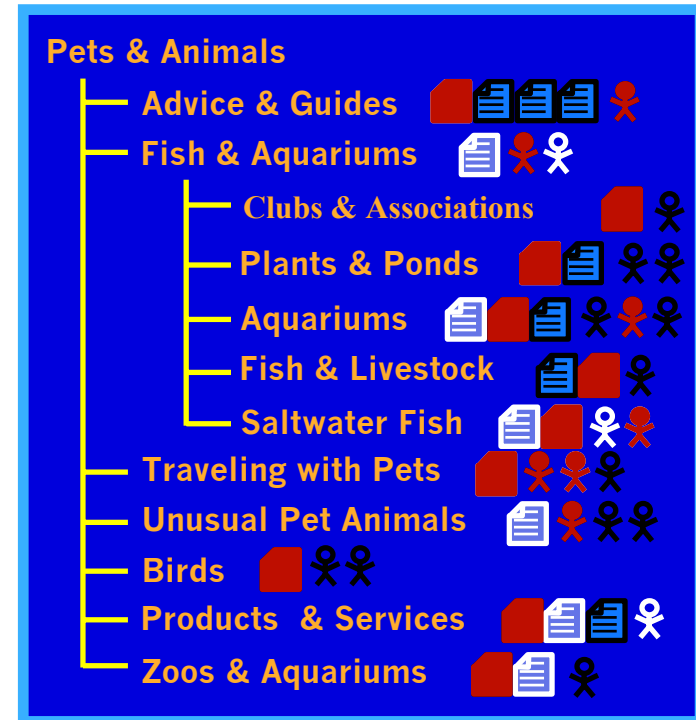
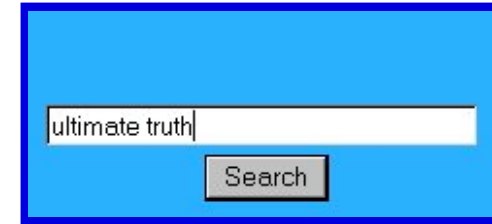

Discovery server produces the K-map

Lotus Discovery Server

Browse & Search Search Results Actions ?

Search: Everything About within this category GO

Category: Home > Technology > Internet

Browse:

- Research
- Development
- Support
- Maintenance
- Marketing
- Human Resources
- Manufacturing
- Site Operations

Documents (105)		Value	Author
Unable to establish phone connection	9	Jan Smith/IRIS	
Rocket Science: What's in a Word: A Critique of	9	Bob Wilcox/Lotus	
Displaying Notes Versions String	8	Steve Whitman/IRIS	
Dataware Technologies Acquires Sovereign Hill	3	Jan Smith/IRIS	
Unable to establish phone connection	3	Bob Wilcox/Lotus	
Rocket Science: What's in a Word: A Critique of	3	Steve Whitman/IRIS	
Displaying Notes Versions String	2	Jan Smith/IRIS	
Rocket Science: What's in a Word: A Critique of	2	Bob Wilcox/Lotus	
Dataware Technologies Acquires Sovereign Hill	1	Steve Whitman/IRIS	

People (3)		Affinity	Job Title
Dave Newitalic/Iris	9	Marketing Director	
Jeff Mitchell/Iris	9	Senior Developer	
Robert Norell/CAM/Lotu	8	Support Manager	

Places (0)		Contact
Corporate Info Place		Dave Newitalic/Iris
My Place		Jeff Mitchell/Iris
ReadyResponse Place		Robert Norell/CAM/Lotu

Discovery Server Spiders

Content Spiders

Domino
QuickPlace
Domino.Doc

File
Directory
(NT)

HTML/ Web

Directory Spiders

Domino
NAB

LDAP
v2 v3

E-mail Spiders

Domino
Mail

MS Exchange
(Beta)

Other Content

LDS Domino
Spider

DECS Connectors

DS XML
Spider
(SDK)

RDBMS / ERP

How to spider other content

XML Created Externally

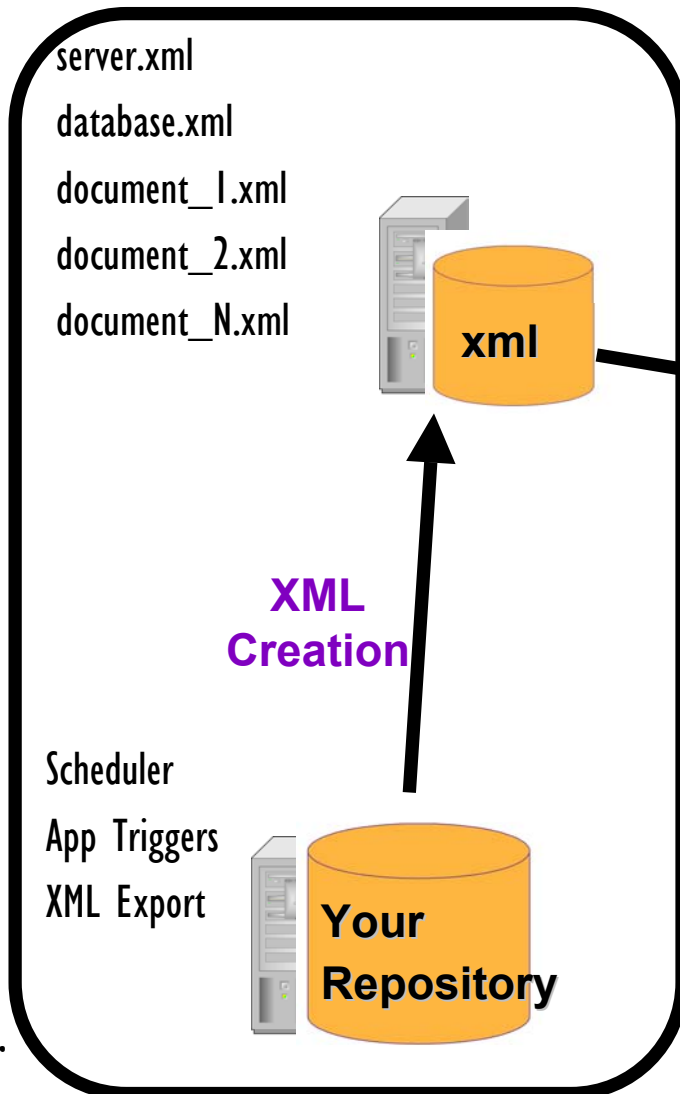

LDS Processes XML

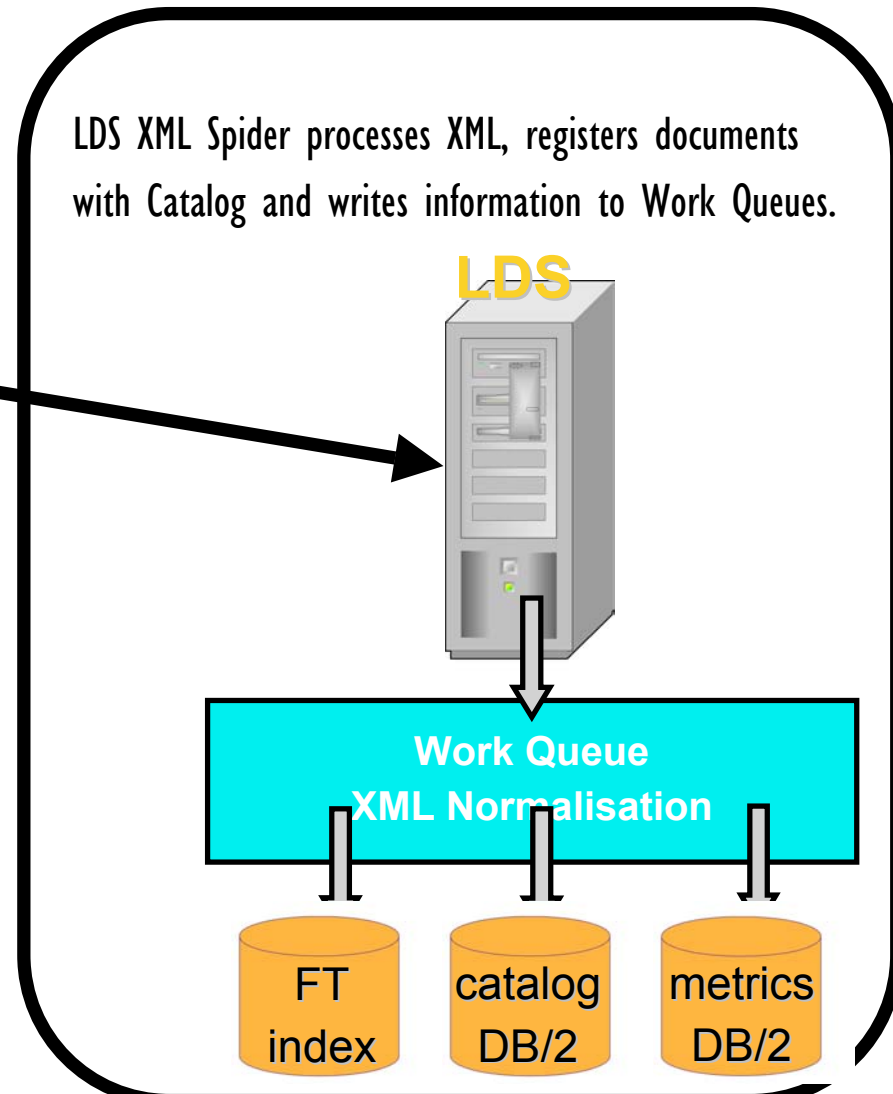

An XML Spider Example

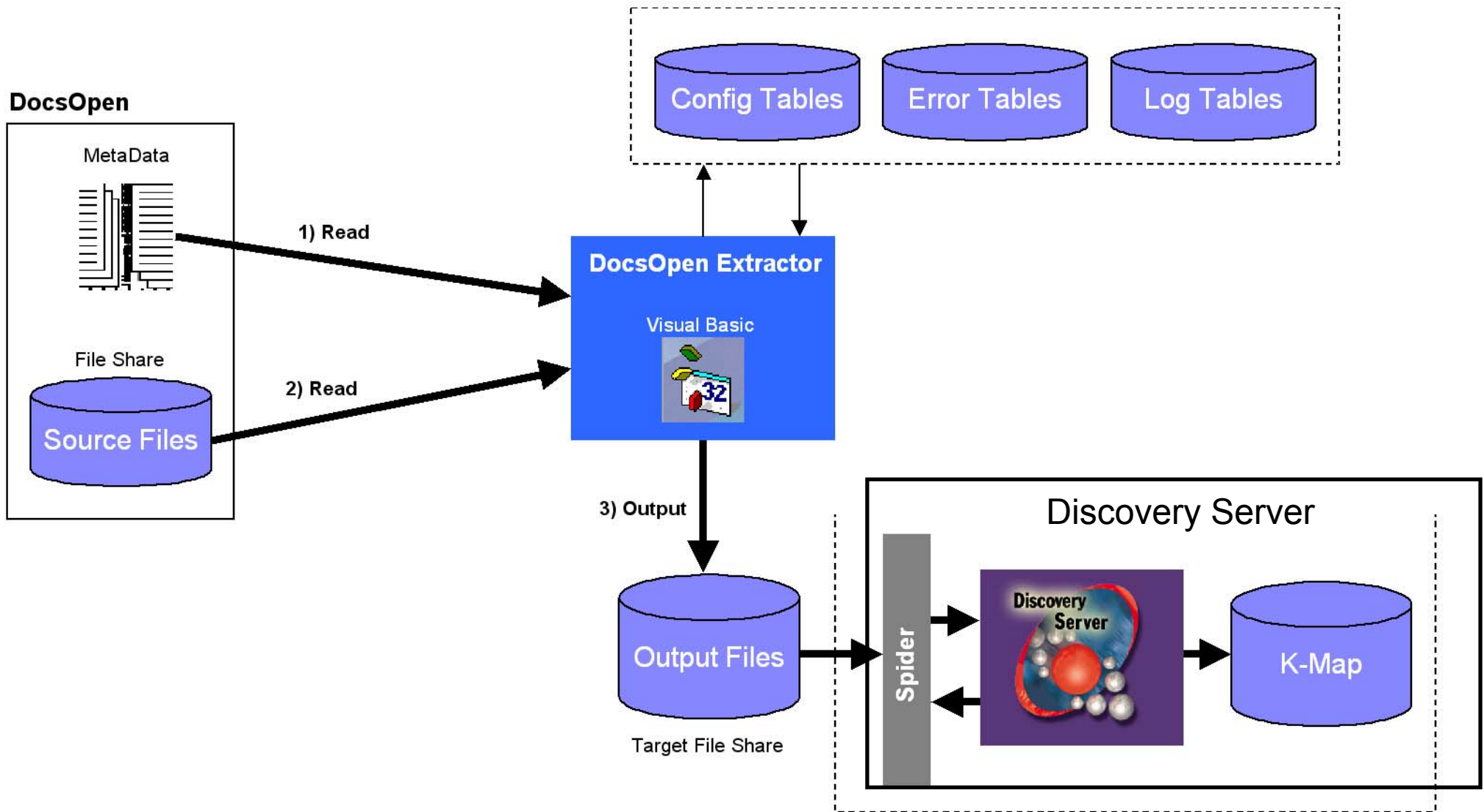

Lotus. software



Shaun ! Your slide here !

Part 3 - Technology Strategy

IBM Lotus is engaged in a managed evolution of existing products, from freestanding infrastructure applications to mix and match capabilities that add collaborative power to J2EE/multi-tier applications

Modularize products to
sustain leadership in the emerging
'contextual collaboration' era

Support current customer
investments while
providing a path
to new application models

Exploit **J2EE** and **Web services**
as technologies for
collaboration components

Standards Based Technologies

- J2EE

- ▶ Provides a complete set of services to components, handling many details of application behavior automatically
- ▶ Runs high-scale applications on multi-tier architectures
- ▶ Uses standardized, modular and reusable components (JSPs, servlets, EJBs)

- Web services

What are Web Services?

- A big step toward eliminating software islands
- Standards for connecting business processes...
 - ▶ XML
 - ▶ SOAP
 - ▶ WSDL
 - ▶ UDDI
- ...Used to create self-describing, modular functions
 - ▶ consumable by any entity with sufficient rights
 - ▶ process-to-process connection
 - ▶ across platforms and networks

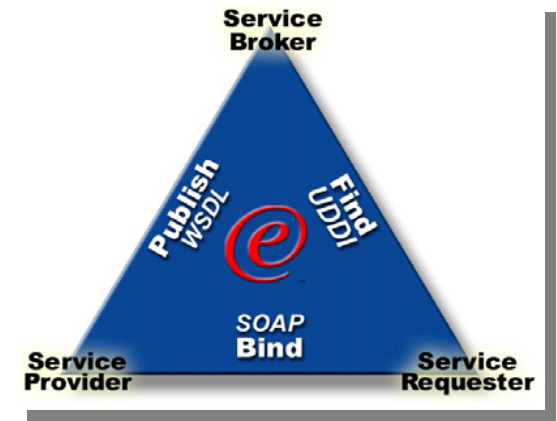

State of e-business Integration

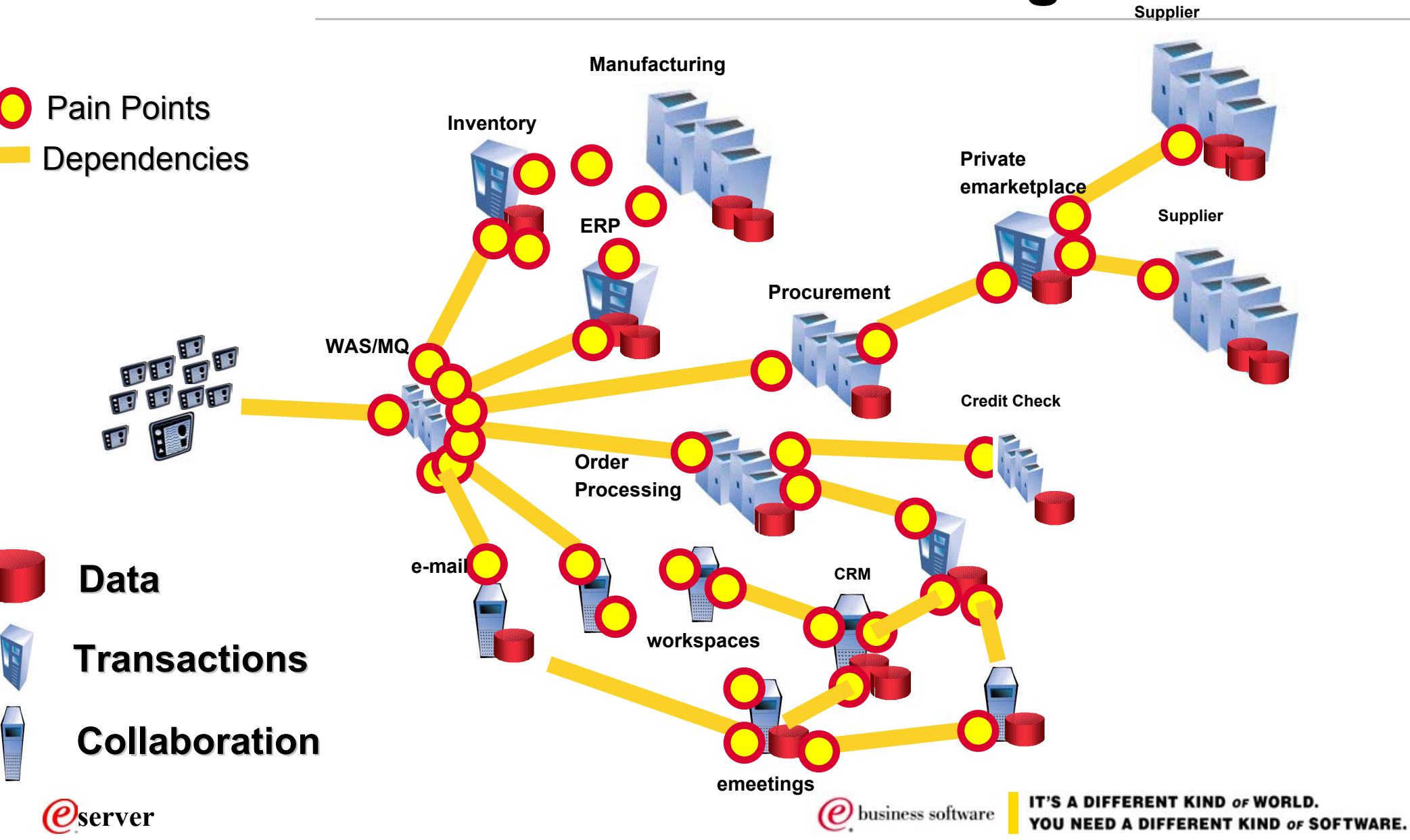

Web Services Model

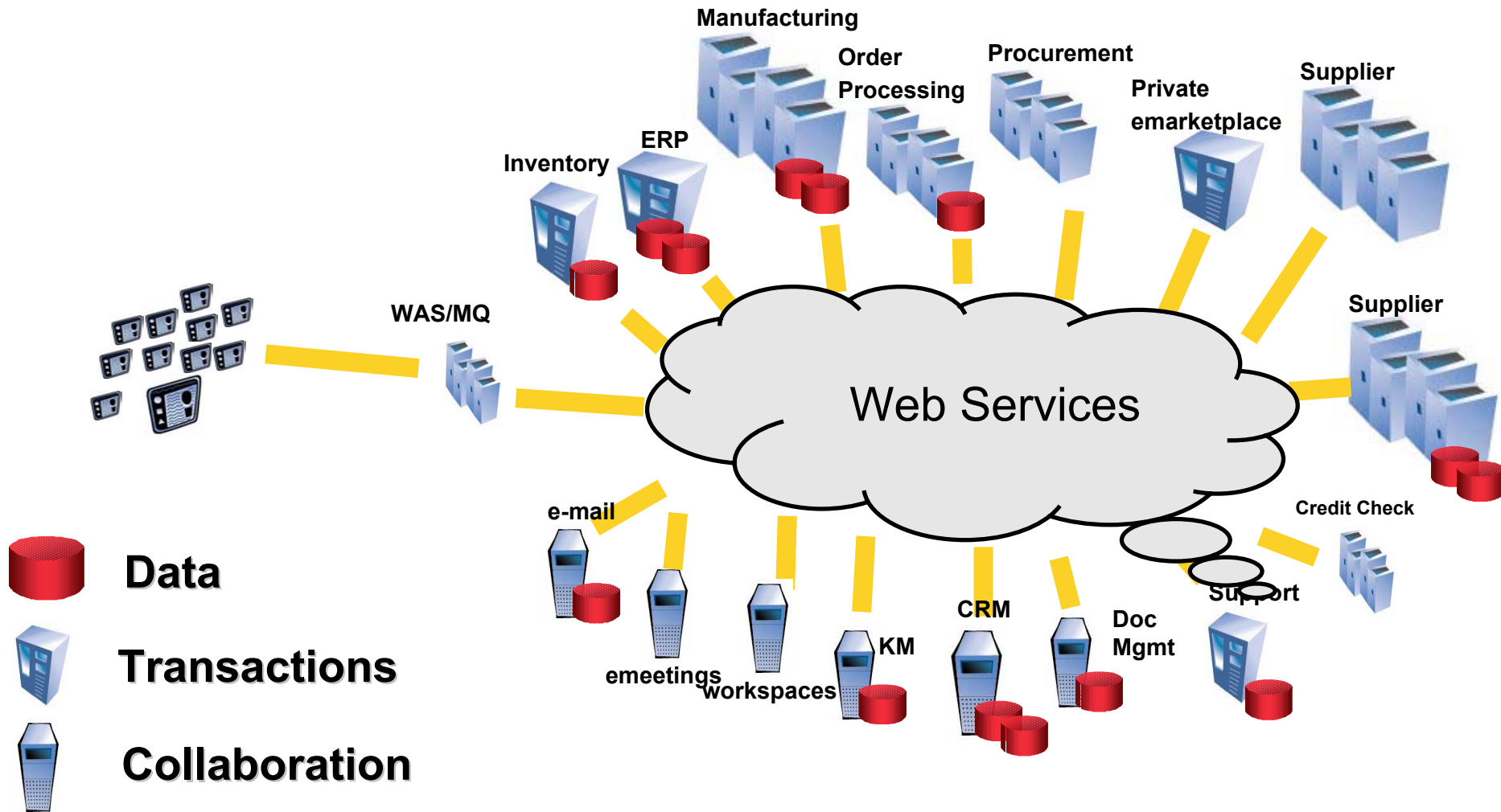

Evolve to Modular Drop-in Components for Collaboration

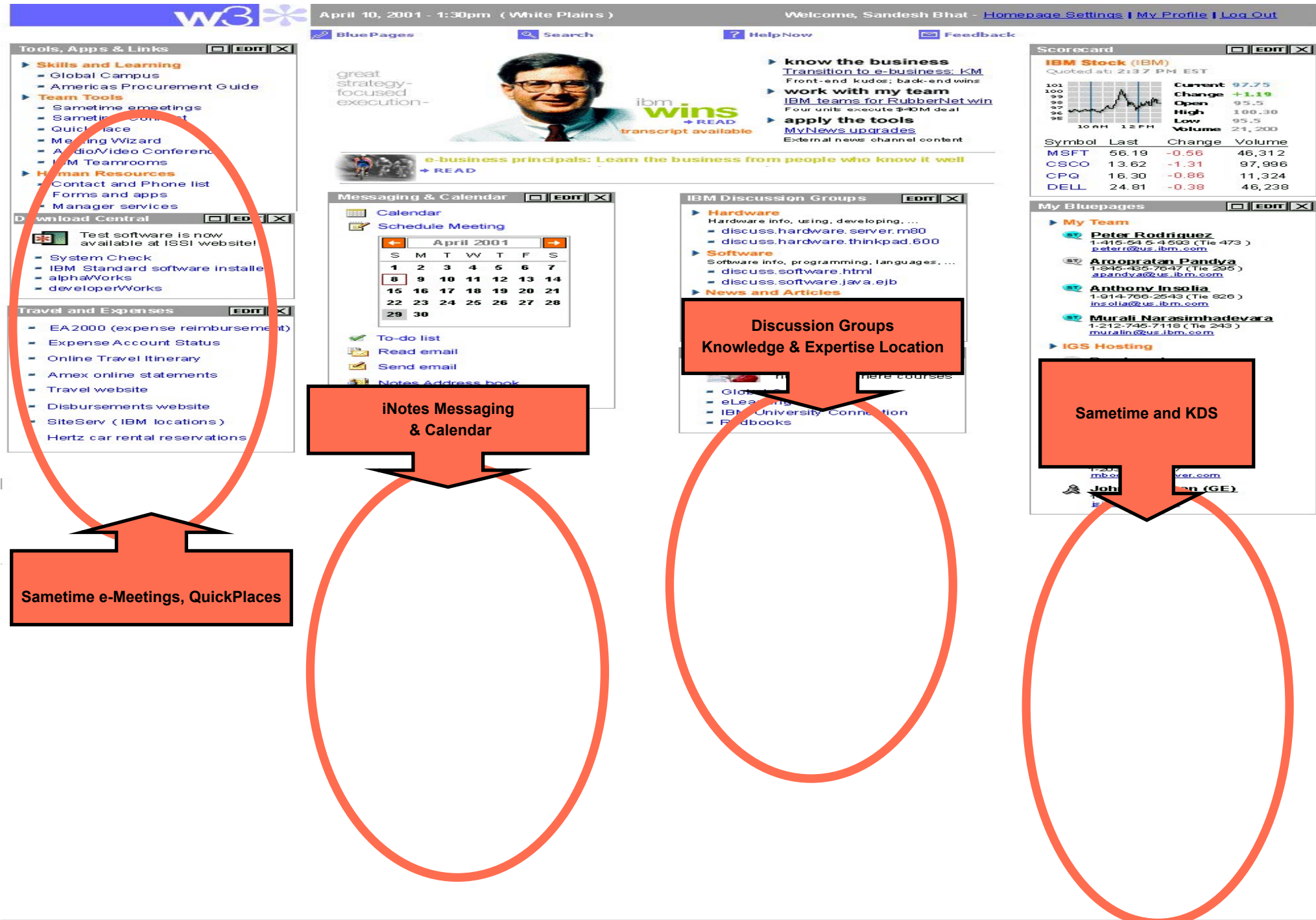

great strategy-focused execution-



ibm wins
transcript available

- ▶ **know the business**
[Transition to e-business: KM](#)
Front-end kudos; back-end wins
- ▶ **work with my team**
[IBM teams for RubberNet win](#)
Four units execute \$40M deal
- ▶ **apply the tools**
[MyNews upgrades](#)
External news channel content

e-business principals: Learn the business from people who know it well
▶ [READ](#)

Messaging & Calendar

Calendar

Schedule Meeting

April 2001						
S	M	T	W	T	F	S
1	2	3	4	5	6	7
8	9	10	11	12	13	14
15	16	17	18	19	20	21
22	23	24	25	26	27	28
29	30					

To-do list
Read email
Send email
Notes Address book

IBM Discussion Groups

- ▶ **Hardware**
Hardware info, using, developing, ...
- [discuss.hardware.server.m80](#)
- [discuss.hardware.thinkpad.600](#)
 - ▶ **Software**
Software info, programming, languages, ...
- [discuss.software.html](#)
- [discuss.software.java.ejb](#)
 - ▶ **News and Articles**
- here courses
- [Glossary](#)
 - [eLearning](#)
 - [IBM University Connection](#)
 - [Feedback](#)

Scorecard

IBM Stock (IBM)
Quoted at: 2:37 PM EST

101				
100				
99				
98				
97				
96				
95				
	10 AM	12 PM		

Current **97.75**
Change **+1.19**
Open **95.5**
High **100.30**
Low **95.5**
Volume **21,200**

Symbol	Last	Change	Volume
MSFT	56.19	-0.56	46,312
CSCO	13.62	-1.31	97,996
CPQ	16.30	-0.86	11,324
DELL	24.81	-0.38	46,238

My Bluepages

- ▶ **My Team**
 - [Peter Rodriguez](#)
1-415-545-4533 (Tie 473)
[peter@us.ibm.com](#)
 - [Aroopratan Pandya](#)
1-846-435-7647 (Tie 295)
[apandya@us.ibm.com](#)
 - [Anthony Insolia](#)
1-914-788-2543 (Tie 826)
[insolia@us.ibm.com](#)
 - [Murali Narasimhadevara](#)
1-212-746-7118 (Tie 243)
[muralin@us.ibm.com](#)
 - ▶ **IGS Hosting**
- [Joh](#)
[n \(GE\)](#)

Sametime e-Meetings, QuickPlaces

iNotes Messaging & Calendar

Discussion Groups
Knowledge & Expertise Location

Sametime and KDS

Opportunity:

Opportunity
 [] [New] [Save] 1 of 7+

*Name: Incentive Compensation - 2500 See	Sales Method: Standard Sales Process	Committed: <input checked="" type="checkbox"/>	*Close Date: 11/30/2001
Sales Team: CCHENG	Sales Stage: 06 - Short List	Revenue: \$2,625,000.00	Organization: Siebel Americas
Territories:	Account: Marriott International	Probability %: 20%	Lead Quality: 2-Very High
Description: Marriott is an existing customer with a critical need for a compensation solution.	Site: HQ	Expected Value: \$525,000.00	Source: Inbound - eMail Response

[] [New] [Save] 1 - 7 of 7+

Last Name	First Name	Mr/Ms	Work Phone #	Job Title	Email	Account	Site
Carlson	Mike	Mr.	(301) 380-5001	VP of Sales	mcarlson@marriott.	Marriott Internationa	HQ
Ellis	John	Mr.	(301) 555-3459	Director, IT	jellis@marriott.com		
Legters	John	Mr.	(301) 555-3459	Manager, Lodging S	jlegters@marriott.co	Marriott Internationa	HQ
Manning	James	Mr.	(408) 477-2006	VP, Information Sys	jmanning@marriott.c	Marriott Internationa	HQ
Metz	Curtis	Mr.	(301) 555-5387	Program Manager	cmetz@marriott.com	Marriott Internationa	HQ

Lotus Evolution to Standards

Incremental Capabilities

Discussions	Custom Apps	Web	e-meetings	Discovery	Portals
e-mail	Content	Scheduling	Workspaces	e-learning	Mobile

Solutions for Collaboration:
 Custom e-Learning Solutions
 e-Workplace portals
 e-Meetings
 Knowledge Discovery
 Grow with Lotus
 Move to Lotus

NAB	NetBios	HTTP	NNTP	IMAP	vCard	WSDL
NRPC	TCP/IP	SSL	POP3	SMTP	iCAL	UDDI
NSF	x.500	LDAP	XML	WML		
	LotusScript	Java	COM			SOAP
		RDB	CORBA		SIMPLE	

J2EE and Web Services
 Standards based infrastructure supporting collaboration capabilities

Technologies Added and Supported

Evolution of Development Focus

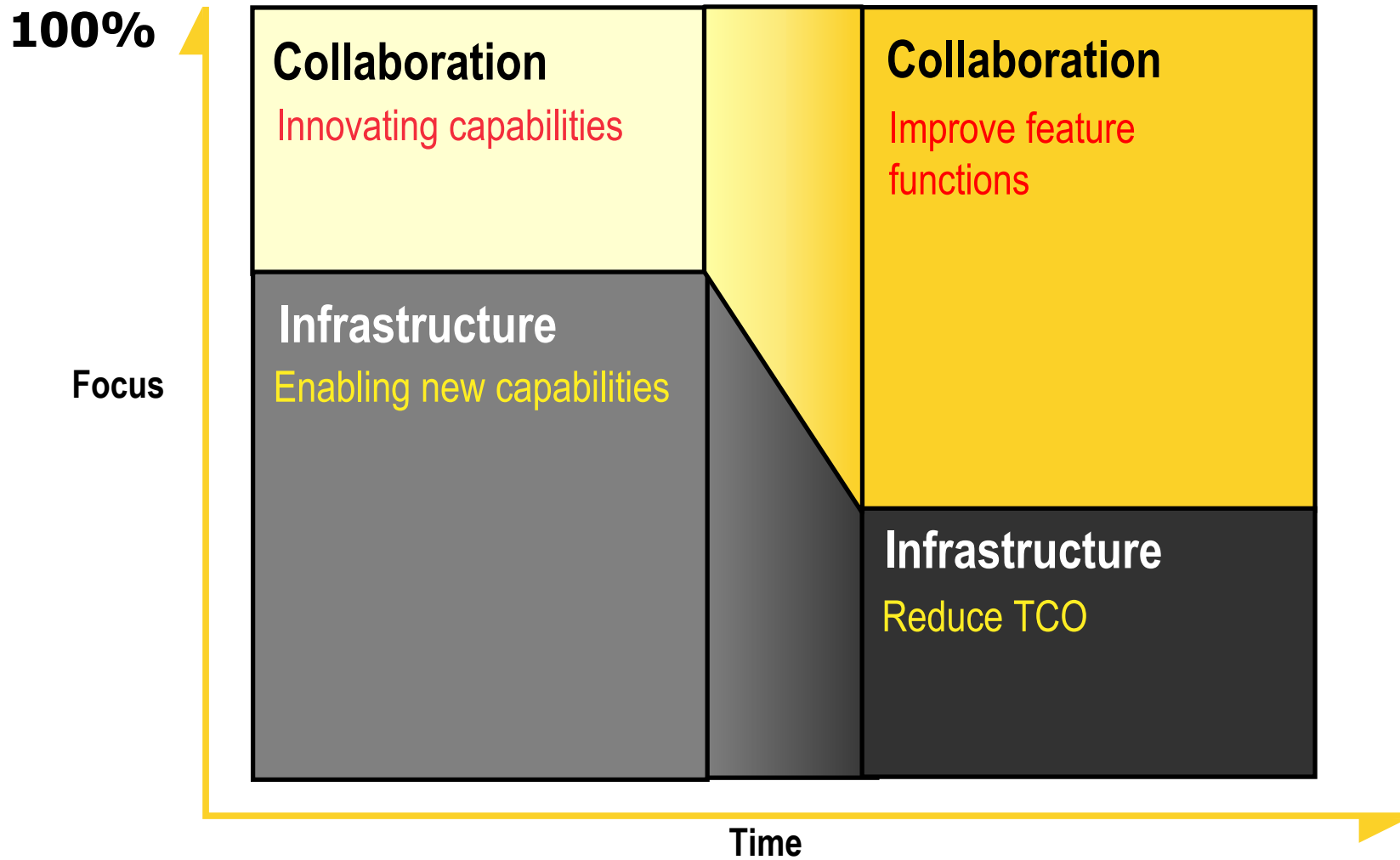

Lotus Will Continue Lead in NextGen Collaboration Era

Driven by concrete business unit demands, the market for next-generation collaboration tools... is poised for rapid acceleration... We expect the business-to-employee (B2E) market to be largely dominated by Lotus and Microsoft by 2004.

...we believe Domino shops would be foolish to look elsewhere for their B2E and B2B mainstream next-generation collaboration requirements...

META Group-- Collaboration: The Next Generation

November 2001

Getting you to the NextGen

- Skills development
 - ▶ J2EE, JSP, Web services, XML
- Organizational alignment
 - ▶ Align Domino developers with J2EE teams
- Solutions architecture
 - ▶ Design e-business solutions with contextual collaboration
 - ▶ Lotus software + J2EE = collaborative services for enterprise solutions

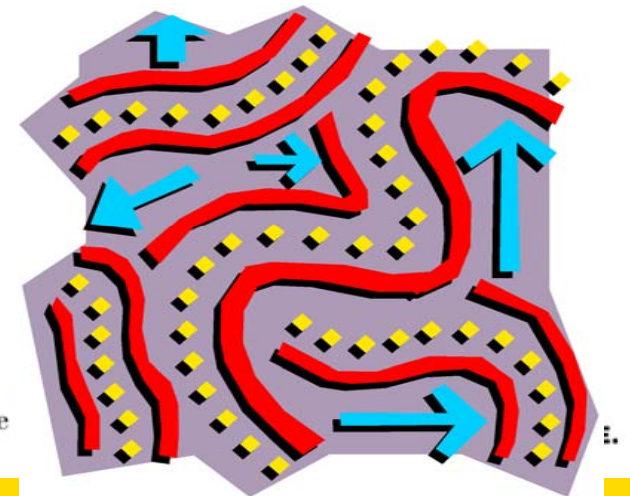

Summary

- Current business, technology, and market trends indicate it is time for the "NextGen"
- Lotus strategy:
 - ▶ Modular collaborative services
 - ▶ Self-contained evolves to flexible, scalable, standardised
- What you have deployed today will continue to work and remains relevant to your infrastructure

Thankyou



@business software

**IT'S A DIFFERENT KIND OF WORLD.
YOU NEED A DIFFERENT KIND OF SOFTWARE.**

Notes & Domino R6

- Notes client
 - Windows XP, Windows 2000, Windows NT, Windows 95, Windows 98
 - Macintosh
 - Citrix Metaframe for Windows
- Domino server
 - Windows 2000 Intel, Windows NT4 Intel
 - Unix: IBM AIX, Sun Solaris/SPARC, Linux Intel, HP-UX
 - iSeries (formerly AS/400)
 - zSeries (formerly S390)

Notes & Domino R6 DECS NEXT

- Enterprise Data in Domino Applications
 - ▶ Virtual Views
 - ▶ Virtual Documents
 - ▶ Virtual Agents

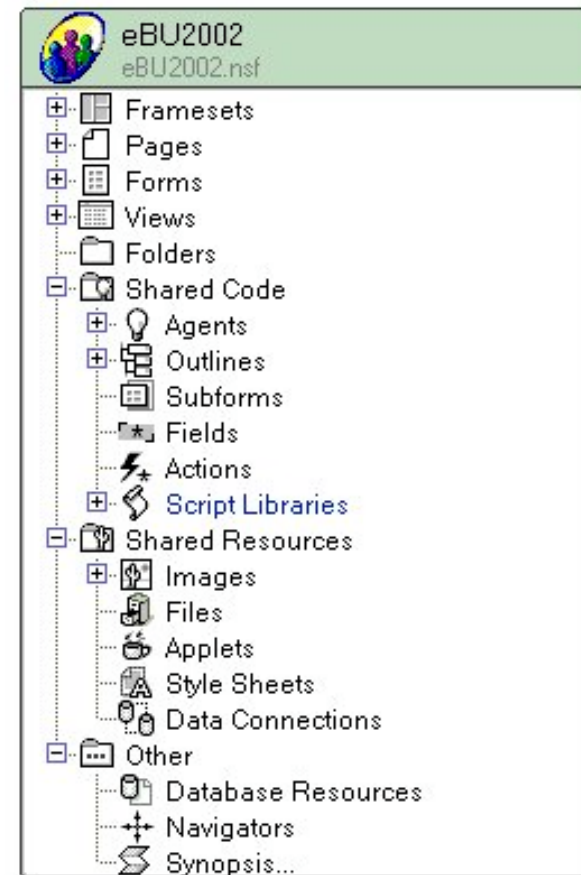

Advanced Realtime on its Way

- Technology code-named "Universal Server"
- Part of LEI.Next
- Virtualized documents, data, agents, and attachments
- Commonly requested features
 - ▶ dynamic keywords, integrated credentials, ...
- Full Domino service support
 - ▶ replication, views, full text search, etc...