

CICS® Transaction Server for OS/390®



CICS Customization Guide

Release 3

CICS® Transaction Server for OS/390®



CICS Customization Guide

Release 3

Note!

Before using this information and the product it supports, be sure to read the general information under "Notices" on page xvii.

Third edition (March 1999)

This edition applies to Release 3 of CICS Transaction Server for OS/390, program number 5655-147, and to all subsequent versions, releases, and modifications until otherwise indicated in new editions. Make sure you are using the correct edition for the level of the product.

This edition replaces and makes obsolete the previous edition, SC33-1683-01. The technical changes for this edition are summarized under "Summary of changes" and are indicated by a vertical bar to the left of a change.

Order publications through your IBM representative or the IBM branch office serving your locality. Publications are not stocked at the address given below.

At the back of this publication is a page entitled "Sending your comments to IBM". If you want to make comments, but the methods described are not available to you, please address them to:

IBM United Kingdom Laboratories, Information Development,
Mail Point 095, Hursley Park, Winchester, Hampshire, England, SO21 2JN.

When you send information to IBM, you grant IBM a nonexclusive right to use or distribute the information in any way it believes appropriate without incurring any obligation to you.

© **Copyright International Business Machines Corporation 1977, 1999. All rights reserved.**

US Government Users Restricted Rights – Use duplication or disclosure restricted by GSA ADP Schedule Contract with IBM Corp.

Contents

Notices	xvii
Programming interface information	xviii
Trademarks	xix
Preface	xxi
What this book is about	xxi
Who this book is for.	xxi
What you need to know to understand this book	xxi
How to use this book	xxi
Notes on terminology	xxi
Syntax notation and conventions used in this book	xxii
Bibliography	xxiii
CICS Transaction Server for OS/390	xxiii
CICS books for CICS Transaction Server for OS/390	xxiii
CICSplex SM books for CICS Transaction Server for OS/390	xxiv
Other CICS books	xxiv
Books from related libraries	xxiv
ACF/TCAM books	xxiv
MVS books	xxv
VTAM books	xxv
Other related books.	xxv
Determining if a publication is current	xxvi
Summary of changes.	xxvii
Changes for this edition	xxvii
Changes for CICS Transaction Server for OS/390 Release 2	xxvii
Changes for CICS Transaction Server for OS/390 Release 1	xxviii

Part 1. Customizing with user exit programs 1

Chapter 1. Global user exit programs	3
Overview — what is a global user exit?	3
Global user exit programs	4
Register conventions	4
31-bit addressing implications	5
Using CICS services	5
Using EDF with global user exits	6
The global work area	6
Making trace entries	7
Parameters passed to the global user exit program	7
Returning values to CICS	10
Restrictions on the use of fields as programming interfaces	11
Exit programs and the CICS storage protection facility	11
Errors in user exit programs.	12
Defining, enabling, and disabling an exit program	13
Invoking more than one exit program at a single exit	13
Invoking a single exit program at more than one exit	14
Sample global user exit programs	14
List of global user exit points	19
Activity keypoint program exit XAKUSER	25
Exit XAKUSER	25
Basic Mapping Support exits XBMIN and XBMOU	27

Exit XBMIN	28
Exit XBMOU	28
The field element table structure	29
Programming the XBMIN exit	30
Programming the XBMOU exit	30
Bridge facility exit	32
Exit XFAINTU	32
Data tables management exits XDTRD, XDTAD, and XDTLC	33
Exit XDTRD	33
Exit XDTAD	36
Exit XDTLC	37
DBCTL interface control program exit XXDFA	39
DBCTL tracking program exits XXDFB and XXDTO	40
Exit XXDFB	40
Exit XXDTO	41
Dispatcher domain exits XDSBWT and XDSAWT	42
Exit XDSBWT	42
Exit XDSAWT	42
DL/I interface program exits XDLIPRE and XDLIPOST	44
Exit XDLIPRE	45
Exit XDLIPOST	47
Dump domain exits XDUREQ, XDUREQC, XDUCLSE, and XDUOUT	49
Exit XDUREQ	49
The sample program for the XDUREQ exit, DFH\$XDRQ	52
Exit XDUREQC	52
Exit XDUCLSE	55
Exit XDUOUT	55
Enqueue EXEC interface program exits XNQEREQ and XNQEREQC	57
Exit XNQEREQ	57
Exit XNQEREQC	58
The command-level parameter structure	59
Sample exit program, DFH\$XNQE	63
EXEC interface program exits XEIIIN, XEIOU, XEISPIN, and XEISPOU	65
The command parameter list	65
Bypassing commands	66
Exit XEIIIN	66
Exit XEISPIN	67
Exit XEIOU	68
Exit XEISPOU	68
File control EXEC interface API exits XFCREQ and XFCREQC	70
The command-level parameter structure	71
Modifying fields in the command-level parameter structure	74
Modifying the EID	76
Use of the task token UEPTSTOK	77
Use of the parameter UEPFSHIP	77
The EIB	78
Example of how XFCREQ and XFCREQC can be used	78
Exit XFCREQ	79
Exit XFCREQC	80
File control EXEC interface SPI exits XFCAREQ and XFCAREQC	83
Exit XFCAREQ	84
Exit XFCAREQC	85
The command-level parameter structure	86
Modifying fields in the command-level parameter structure	91
Modifying the EID	94
Use of the task token UEPTSTOK	95

Modifying user arguments	95
File control file state program exits XFCSREQ and XFCSREQC	96
Exit XFCSREQ	97
Exit XFCSREQC	100
File control open/close program exit XFCNREC	105
Exit XFCNREC	106
File control quiesce receive exit, XFCVSDS	107
Exit XFCVSDS	108
File control quiesce send exit XFCQUIS	110
File control recovery program exits XFCBFAIL, XFCBOUT, XFCBOVER, and XFCLDEL	112
Order of invocation	112
Exit XFCBFAIL, file control backout failure exit	112
Exit XFCBOUT, file control backout exit	117
Exit XFCBOVER, file control backout override exit	119
Exit XFCLDEL, file control logical delete exit	122
Front End Programming Interface exits XSZARQ and XSZBRQ	125
“Good morning” message program exit XGMTTEXT	126
Intersystem communication program exits XISCONA and XISLCLQ	127
The XISCONA exit	127
The XISLCLQ exit	130
Interval control program exits XICREQ, XICEXP, and XICTENF	132
Exit XICREQ	132
Exit XICEXP	133
Exit XICTENF	133
Interval control EXEC interface program exits XICERREQ and XICEREQC	134
Exit XICERREQ	134
Exit XICEREQC	135
The command-level parameter structure	137
Loader domain exits XLDLOAD and XLDELETE	147
Exit XLDLOAD	147
Exit XLDELETE	148
Log manager domain exit XLGSTRM	149
Exit XLGSTRM	150
An example of how XLGSTRM can be used.	151
Message domain exit XMEOUT	152
Exit XMEOUT	153
The sample XMEOUT global user exit programs	155
Monitoring domain exit XMNOUT	156
Exit XMNOUT	156
Program control program exits XPCREQ, XPCREQC, XPCFTCH, XPCHAIR, XPCTA, and XPCABND	158
XPCREQ and XPCREQC	158
Exit XPCFTCH	165
Exit XPCHAIR	166
Exit XPCTA	168
Exit XPCABND	169
Resource manager interface program exits XRMIIN and XRMIOU	171
Exit XRMIIN	171
Exit XRMIOU	172
Resource management install and discard exit XRSINDI	173
Exit XRSINDI	173
Signon and signoff exits XSNON and XSNOFF	177
Exit XSNON	177
Exit XSNOFF	178
Statistics domain exit XSTOUT	180

Exit XSTOUT	180
System recovery program exit XSRAB	182
Exit XSRAB.	182
System termination program exit XSTERM	186
Exit XSTERM	186
Temporary storage domain exits XTSQRIN, XTSQROUT, XTSPTIN, and XTSPTOUT	187
Exit XTSQRIN.	187
Exit XTSQROUT	188
Exit XTSPTIN	190
Exit XTSPTOUT	191
Temporary storage EXEC interface program exits XTSERREQ and XTSEREQC	193
Exit XTSERREQ	194
Exit XTSEREQC	195
The command-level parameter structure	196
Terminal allocation program exit XALCAID	203
Exit XALCAID	203
Terminal control program exits XTCIN, XTCOUT, XTCATT, XTCTIN, and XTCTOUT	205
Exit XTCIN	205
Exit XTCOUT	205
Exit XTCATT	206
Exit XTCTIN	206
Exit XTCTOUT	207
'Terminal not known' condition exits XALTENF and XICTENF	208
The exits.	208
Exit XALTENF.	209
Exit XICTENF	212
The sample program for the XALTENF and XICTENF exits, DFHXTENF	214
Transaction manager domain exit XXMATT	216
Exit XXMATT	216
Transient data program exits XTDREQ, XTDIN, and XTDOUT	218
Exit XTDREQ	218
Exit XTDIN	219
Exit XTDOUT	220
Transient data EXEC interface program exits XTDEREQ and XTDEREQC	221
Exit XTDEREQ	221
Exit XTDEREQC	223
The command-level parameter structure	224
User log record recovery program exits XRCINIT and XRCINPT	230
Coding the exit programs.	230
Enabling the exit programs	231
Exit XRCINIT	232
Exit XRCINPT	232
VTAM terminal management program exit XZCATT	234
Exit XZCATT	234
VTAM working-set module exits XZCIN, XZCOUT, XZCOUT1, and XZIQUE	235
Exit XZCIN	235
Exit XZCOUT	235
Exit XZCOUT1	236
XZIQUE exit for managing intersystem queues.	237
Designing an XZIQUE global user exit program	243
XRF request-processing program exit XXRSTAT	246
Exit XXRSTAT.	246
Chapter 2. Task-related user exit programs	249

Introduction to the task-related user exit mechanism (the adapter)	249
The stub program	250
Returning control to the application program	251
Task-related user exits and EDF	252
The task-related user exit program	252
User exit parameter lists	253
The schedule flag word	265
Register handling in the task-related user exit program	266
Addressing-mode implications	267
Exit programs and the CICS storage protection facility	267
Recursion within a task-related user exit program	268
Using CICS services in your task-related user exit program	268
Work areas	269
Coding a program to be invoked by the CICS SPI	270
Coding a program to be invoked by the CICS syncpoint manager	270
Coding a program to be invoked by the CICS task manager	274
Coding a program to be invoked at CICS termination	275
Using EDF with your task-related user exit program	278
Adapter administration	280
What you must do before using the adapter	280
Tracing a task-related user exit program	282
Chapter 3. The user exit programming interface (XPI)	283
Overview	283
General form of an XPI call	286
Setting up the XPI environment	290
XPI register usage	291
The XPI copy books	291
Reentrancy considerations resulting from XPI calls	291
Global user exit XPI examples, showing the use of storage	292
An example showing how to build a parameter list incrementally	297
The XPI functions	298
Dispatcher functions	300
Synchronization protocols for SUSPEND and RESUME processing	300
The ADD_SUSPEND call	302
The SUSPEND call	304
The RESUME call	307
The DELETE_SUSPEND call	308
The WAIT_MVS call	309
The CHANGE_PRIORITY call	313
Dump control functions	314
The SYSTEM_DUMP call	314
The TRANSACTION_DUMP call	316
Enqueue domain functions	318
The ENQUEUE function	318
The DEQUEUE function	319
Kernel domain functions	320
The START_PURGE_PROTECTION function	320
The STOP_PURGE_PROTECTION function	320
Nesting purge protection calls	321
Loader functions	321
The DEFINE_PROGRAM call	321
The ACQUIRE_PROGRAM call	325
The RELEASE_PROGRAM call	327
The DELETE_PROGRAM call	328
Log manager functions	329

The INQUIRE_PARAMETERS call	329
The SET_PARAMETERS call	329
Monitoring functions.	330
The MONITOR call	330
The INQUIRE_MONITORING_DATA call	333
Program management functions	334
The INQUIRE_PROGRAM call.	335
The INQUIRE_CURRENT_PROGRAM call	341
The SET_PROGRAM call	343
The START_BROWSE_PROGRAM call	346
The GET_NEXT_PROGRAM call	347
The END_BROWSE_PROGRAM call	349
The INQUIRE_AUTOINSTALL call	350
The SET_AUTOINSTALL call	350
State data access functions	352
The INQ_APPLICATION_DATA call	352
The INQUIRE_SYSTEM call	355
The SET_SYSTEM call	359
Storage control functions	361
The GETMAIN call	361
The FREEMAIN call	364
The INQUIRE_ACCESS call	364
The INQUIRE_ELEMENT_LENGTH call	365
The INQUIRE_SHORT_ON_STORAGE call	366
The INQUIRE_TASK_STORAGE call	367
The SWITCH_SUBSPACE call.	368
Trace control function	369
The TRACE_PUT call	369
Transaction management functions	370
The INQUIRE_CONTEXT call	370
The INQUIRE_DTRTRAN call	371
The INQUIRE_MXT call	372
The INQUIRE_TCLASS call.	374
The INQUIRE_TRANDEF call	375
The INQUIRE_TRANSACTION call	383
The SET_TRANSACTION call	387
User journaling function	388
The WRITE_JOURNAL_DATA call	388

Part 2. Customizing with initialization and shutdown programs. 391

Chapter 4. Writing initialization and shutdown programs.	393
Initialization programs	393
First phase PLT programs	393
Second phase PLT programs	394
Shutdown programs.	394
First phase PLT programs	395
PLT programs for the second quiesce stage	395
The shutdown assist utility program, DFHCESD	395
General considerations	396
Storage keys for PLT programs	396

Part 3. Customizing with user-replaceable programs. 399

Chapter 5. General notes about user-replaceable programs.	401
--	------------

Rewriting user-replaceable programs	401
Assembling and link-editing user-replaceable programs.	402
User-replaceable programs and the storage protection facility	405
Execution key for user-replaceable programs	405
Data storage key for user-replaceable programs	406
Chapter 6. Writing a program error program.	407
The sample programs and copy books.	410
Chapter 7. Writing a transaction restart program	411
The DFHREST communications area	412
The CICS-supplied transaction restart program.	414
Chapter 8. Writing a terminal error program	415
Background to error handling for TCAM and sequential devices	415
When an abnormal condition occurs.	416
Terminal control program	416
Terminal abnormal condition program	416
Terminal error program	416
The communication area	417
Terminal abnormal condition line entry (TACLE)	417
The sample terminal error program	417
Components of the sample terminal error program	418
Structure of the sample terminal error program.	419
Sample terminal error program messages	423
Generating the sample terminal error program	425
User-written terminal error programs	437
Why write your own terminal error program?	438
Restrictions on the use of EXEC CICS commands	438
Addressing the contents of the communication area	438
Addressing the contents of the TACLE	441
Example of a user-written terminal error program	445
Chapter 9. Writing a node error program	449
Background to CICS-VTAM error handling	450
Why use a NEP to supplement CICS default actions?	450
An overview of writing a NEP	451
The default NEP	452
The sample NEP.	452
Multiple NEPs	455
When an abnormal condition occurs.	457
The communication area	458
The sample node error program	465
Compatibility with the sample terminal error program	466
Components of the sample node error program	466
Generating the sample node error program	469
User-written node error programs.	475
Restrictions on the use of EXEC CICS commands	475
Entry and addressability	476
Coding for the 3270 'unavailable printer' condition	476
Coding for session failures	477
Coding for specific VTAM sense codes.	478
Writing multiple NEPs	478
DFHZNEPI macros	478
Handling shutdown hung terminals in the node error program	480
Using the node error program with XRF or persistent sessions	480

The node error program in an XRF environment	480
The node error program with persistent session support	481
Changing the recovery notification	481
Changing the recovery message	482
Changing the recovery transaction	482
Using the node error program with VTAM generic resources	482
Chapter 10. Writing a program to control autoinstall of terminals	485
Preliminary considerations	485
Coding entries in the VTAM LOGON mode table	486
Using model terminal support (MTS)	487
The autoinstall control program for terminals, DFHZATDX.	487
The autoinstall control program at INSTALL	487
The communication area at INSTALL for terminals	488
How CICS builds the list of autoinstall models	490
Returning information to CICS	491
CICS action on return from the control program	494
The autoinstall control program at DELETE	495
The communication area at DELETE for terminals	495
Naming, testing, and debugging your autoinstall control program	496
Naming	496
Testing and debugging.	496
The sample programs and copy books.	497
Customizing the sample program.	499
Chapter 11. Writing a program to control autoinstall of consoles	505
Preliminary considerations	505
Leaving it all to CICS	505
Using an autoinstall control program.	506
The autoinstall control program at INSTALL	506
The communication area at INSTALL for consoles	507
How CICS builds the list of autoinstall models	508
Returning information to CICS	508
CICS action on return from the control program	510
The autoinstall control program at DELETE	510
The sample programs and copy books.	511
Chapter 12. Writing a program to control autoinstall of APPC connections	513
Preliminary considerations	513
Local APPC single-session connections initiated by CINIT	513
Local APPC parallel-session and single-session connections initiated by BIND	514
Autoinstall templates for APPC connections	514
Benefits of autoinstall	514
Requirements for autoinstall.	514
The autoinstall control program for APPC connections	515
Recovery and restart	515
The autoinstall control program at INSTALL	515
The communication area at INSTALL for APPC connections	516
The autoinstall control program at DELETE	519
When autoinstalled APPC connections are deleted	520
The sample autoinstall control program for APPC connections	520
Default actions of the sample program	520
Resource definitions	521
Chapter 13. Writing a program to control autoinstall of shipped terminals	523

Installing shipped terminals and connections	523
CICS-generated aliases	524
Resetting the terminal identifier	524
The autoinstall control program at INSTALL	525
The communications area at INSTALL for shipped terminals	526
The autoinstall control program at DELETE	528
Default actions of the sample programs	529
Chapter 14. Writing a program to control autoinstall of Client virtual terminals	531
How Client virtual terminals are autoinstalled	531
Autoinstall models	531
Terminal identifiers	532
Why override TERMIDs?	533
The autoinstall control program at INSTALL	534
The communications area at INSTALL for Client virtual terminals	534
The autoinstall control program at DELETE	536
Default actions of the sample programs	537
Chapter 15. Writing a program to control autoinstall of programs	539
Preliminary considerations	539
Autoinstall model definitions.	540
Autoinstalling programs invoked by EXEC CICS LINK commands	540
Autoinstall processing of mapsets	541
System autoinstall	541
Benefits of autoinstall	541
Reduced system administration costs	541
Saving in virtual storage	541
Faster startup times.	542
Requirements for autoinstall.	542
The autoinstall control program at INSTALL	543
The sample autoinstall control program for programs, DFHPGADX	546
Customizing the sample program	546
Resource definition	547
Testing and debugging your program	548
Chapter 16. Writing a dynamic routing program	549
Dynamic transaction routing.	550
Dynamic transactions	550
When the dynamic routing program is invoked	550
Information passed to the dynamic routing program	551
Changing the target CICS region	552
Changing the program name	553
Telling CICS whether to route or terminate a transaction	553
If the system is unavailable or unknown	554
Invoking the dynamic routing program at end of routed transactions	554
Invoking the dynamic routing program on abend	555
Modifying the initial terminal data	555
Modifying the application's communications area	555
Receiving information from a routed transaction	556
Some processing considerations	556
Unit of work considerations	557
Dynamic routing of DPL requests.	557
When the dynamic routing program is invoked	558
Changing the target CICS region	559
Changing the program name	559

Changing the transaction ID.	560
Telling CICS whether to route or terminate a DPL request.	560
If an error occurs in route selection	561
Invoking the dynamic routing program at end of routed requests	561
Modifying the application's input communications area	561
Monitoring the application's output communications area	562
Some processing considerations	562
Unit of work considerations	562
Parameters passed to the dynamic routing program	562
Naming your dynamic routing program	573
Testing your dynamic routing program	573
Dynamic transaction routing sample programs	574
Chapter 17. Writing a distributed routing program	575
Differences from the dynamic routing interface	576
Distributed routing of BTS activities	577
Which BTS activities can be dynamically routed?	577
When the distributed routing program is invoked	578
Changing the target CICS region	579
Telling CICS whether to route the activity	579
If an error occurs in route selection	579
Invoking the distributed routing program on the target region.	580
Some processing considerations	580
Routing of non-terminal-related START requests	581
Which requests can be dynamically routed?	581
When the distributed routing program is invoked	582
Changing the target CICS region	583
Telling CICS whether to route the request.	583
If an error occurs in route selection	584
Invoking the distributed routing program on the target region.	584
Some processing considerations	584
Parameters passed to the distributed routing program	585
Naming your distributed routing program	593
Distributed transaction routing sample programs	593
Chapter 18. Writing a CICS–DBCTL interface status program	595
The sample program and copy book	596
Chapter 19. Writing a 3270 bridge exit program	599
Chapter 20. Writing a security exit program for IIOP	601
Chapter 21. Writing a program to tailor JVM execution environment variables.	603
Environment variables	603

Part 4. Customizing the XRF overseer program 607

Chapter 22. The extended recovery facility overseer program	609
The sample overseer program	609
The functions of the sample program	609
How the sample overseer program interfaces with CICS	613
How to tell the overseer which actives and alternates to monitor	613
The DFHWOSM macros	614
The DFHWOSM tokens	615
DFHWOSM FUNC=BUILD macro	615

DFHWOSM FUNC=CLOSE macro	616
DFHWOSM FUNC=DSECT macro	616
DFHWOSM FUNC=JJC macro.	616
DFHWOSM FUNC={JJS QJJS} macro	617
DFHWOSM FUNC=OPEN macro.	618
DFHWOSM FUNC=OSCMD macro	618
DFHWOSM FUNC=READ macro	619
DFHWOSM FUNC=TERM macro.	622
Customizing the sample overseer program	623
Loop or wait detection	624
Assembling and link-editing the overseer program	625

Part 5. CICS journaling, monitoring, and statistics 627

Chapter 23. CICS logging and journaling	629
Log stream storage	629
Enabling, disabling, and reading journals	631
Enabling and disabling a journal	631
Reading journal records offline.	632
Structure and content of CICS Transaction Server for OS/390 format journal records	632
Format of general log block header	634
Format of general log journal record.	635
Start-of-run record	636
Format of caller data	636
Structure and content of COMPAT41-format journal records	645
Format of COMPAT41 journal control label header	646
Format of journal record	648
Identifying records for the start of tasks and UOWs	653
Format of journal records written to SMF	653
The SMF block header	654
The CICS product section	654
The CICS data section.	655
Chapter 24. CICS monitoring	657
Introduction to CICS monitoring	657
The classes of monitoring data	657
Performance class monitoring data	658
Exception class data	661
How performance and exception class data is passed to SMF	662
Controlling CICS monitoring.	662
CICS monitoring record formats	663
SMF header and SMF product section	663
CICS data section	666
Chapter 25. CICS statistics	677
Introduction to CICS statistics	677
Types of statistics data	677
Resetting statistics counters.	681
The EXEC CICS COLLECT STATISTICS command	682
CICS statistics record format	682
SMF header and SMF product section	683
CICS statistics data section	685
Global user exit in the CICS statistics domain	687
Processing the output from CICS statistics	688

Part 6. Customizing CICS compatibility interfaces 689

Chapter 26. Using TCAM with CICS	691
CICS with TCAM SNA	692
Protocol management	692
Function management header processing.	693
Batch processing.	694
Error processing for batch logical units.	694
Error processing	694
The TCAM application program interface	694
The CICS-TCAM interface	695
Data format.	696
Logic flow	697
Terminal error program	699
Message routing	700
Segment processing	700
Line pool specifications	701
Line locking.	702
TCAM queues.	703
TCAM devices.	704
Generalized TCAM message format.	705
TCAM with 3270 devices	706
TCAM user exits	707
Starting and terminating TCAM	707
CICS-TCAM startup.	707
CICS-TCAM abend and restart	707
CICS-TCAM termination	708
CICS and TCAM: program interrelationship	709
TCAM message control program (non-SNA).	710
Chapter 27. The dynamic allocation sample program	713
Overview of the dynamic allocation program.	713
Installing the program and transaction definitions	714
Terminal operation	714
Help feature	715
Values.	715
Abbreviation rules for keywords	716
System programming considerations	716
The flow of control when a DYNALLOC request is issued.	717

Part 7. Customizing CICS security processing. 719

Chapter 28. Invoking a user-written external security manager	721
An overview of the CICS-ESM interface	721
The MVS router	721
The MVS router exit	722
How ESM exit programs access CICS-related information.	724
For non-RACF users — the ESM parameter list	724
For RACF users — the RACF user exit parameter list	724
The installation data parameter list	725
CICS security control points.	727
Early verification processing.	729
Writing an early verification routine	730
Using CICS API commands in an early verification routine	730
Return and reason codes from the early verification routine	731

Chapter 29. Writing a “good night” program	733
The sample “good night” program, DFH0GNIT	735
What the sample program does	736
Customizing the sample program	736
<hr/>	
Part 8. Examining and modifying resource attributes	739
<hr/>	
Chapter 30. User programs for the system definition utility program (DFHCSDUP)	741
An overview of DFHCSDUP.	741
DFHCSDUP as a batch program	742
Writing a program to be invoked during EXTRACT processing	742
The EXTRACT command	742
When the user program is invoked	743
Parameters passed from DFHCSDUP to the user program	743
The sample EXTRACT programs	744
Assembling and link-editing EXTRACT programs	747
Invoking DFHCSDUP from a user program	751
Entry parameters for DFHCSDUP	752
Responsibilities of the user program.	754
The user exit points in DFHCSDUP	755
The sample program, DFH\$CUS1	760
Chapter 31. The programmable interface to the RDO transaction, CEDA.	761
Use of the programmable interface	762
Using DFHEDAP in a DTP environment	762
<hr/>	
Part 9. Appendixes	765
<hr/>	
Appendix A. Coding entries in the VTAM LOGON mode table	767
Overview.	767
TYPETERM device types and pointers to related LOGON mode data	768
VTAM MODEENT macro operands	770
PSERVIC screen size values for LUTYPEx devices	775
Matching models and LOGON mode entries.	776
LOGON mode definitions for CICS-supplied autoinstall models	786
Appendix B. Default actions of the node abnormal condition program	789
Default actions for terminal error codes	789
CICS messages associated with VTAM errors	795
Default actions for system sense codes	800
Action flag settings and meanings	802
Appendix C. Transient data write-to-terminal program (DFH\$TDWT)	803
Resource definitions required	803
Appendix D. Uppercase translation	805
Uppercase translation of national characters.	805
Using the XZCIN exit	805
Using DFHTCTDY	805
TS data sharing messages	806
Appendix E. The example program for the XTSEREQ global user exit, DFH\$XTSE	807

Index	823
Sending your comments to IBM	841

Notices

This information was developed for products and services offered in the U.S.A. IBM may not offer the products, services, or features discussed in this document in other countries. Consult your local IBM representative for information on the products and services currently available in your area. Any reference to an IBM product, program, or service is not intended to state or imply that only that IBM product, program, or service may be used. Any functionally equivalent product, program, or service that does not infringe any IBM intellectual property right may be used instead. However, it is the user's responsibility to evaluate and verify the operation of any non-IBM product, program, or service.

IBM may have patents or pending patent applications covering subject matter described in this document. The furnishing of this document does not give you any license to these patents. You can send license inquiries, in writing, to:

IBM Director of Licensing
IBM Corporation
North Castle Drive
Armonk, NY 10504-1785
U.S.A.

For license inquiries regarding double-byte (DBCS) information, contact the IBM Intellectual Property Department in your country or send inquiries, in writing, to:

IBM World Trade Asia Corporation
Licensing
2-31 Roppongi 3-chome, Minato-ku
Tokyo 106, Japan

The following paragraph does not apply in the United Kingdom or any other country where such provisions are inconsistent with local law:

INTERNATIONAL BUSINESS MACHINES CORPORATION PROVIDES THIS PUBLICATION "AS IS" WITHOUT WARRANTY OF ANY KIND, EITHER EXPRESS OR IMPLIED, INCLUDING, BUT NOT LIMITED TO, THE IMPLIED WARRANTIES OF NON-INFRINGEMENT, MERCHANTABILITY, OR FITNESS FOR A PARTICULAR PURPOSE. Some states do not allow disclaimer of express or implied warranties in certain transactions, therefore this statement may not apply to you.

This publication could include technical inaccuracies or typographical errors. Changes are periodically made to the information herein; these changes will be incorporated in new editions of the publication. IBM may make improvements and/or changes in the product(s) and/or the program(s) described in this publication at any time without notice.

Licensees of this program who wish to have information about it for the purpose of enabling: (i) the exchange of information between independently created programs and other programs (including this one) and (ii) the mutual use of the information which has been exchanged, should contact IBM United Kingdom Laboratories, MP151, Hursley Park, Winchester, Hampshire, England, SO21 2JN. Such information may be available, subject to appropriate terms and conditions, including in some cases, payment of a fee.

The licensed program described in this document and all licensed material available for it are provided by IBM under terms of the IBM Customer Agreement, IBM International Programming License Agreement, or any equivalent agreement between us.

This book contains sample programs. Permission is hereby granted to copy and store the sample programs into a data processing machine and to use the stored copies for study and instruction only. No permission is granted to use the sample programs for any other purpose.

Programming interface information

This book is intended to help you to customize your CICS Transaction Server for OS/390 Release 3 system. This book primarily documents Product-sensitive Programming Interface and Associated Guidance Information provided by CICS.

Product-sensitive programming interfaces allow the customer installation to perform tasks such as diagnosing, modifying, monitoring, repairing, tailoring, or tuning of CICS. Use of such interfaces creates dependencies on the detailed design or implementation of the IBM software product. Product-sensitive programming interfaces should be used only for these specialized purposes. Because of their dependencies on detailed design and implementation, it is to be expected that programs written to such interfaces may need to be changed in order to run with new product releases or versions, or as a result of service.

However, this book also documents General-use Programming Interface and Associated Guidance Information.

General-use programming interfaces allow the customer to write programs that request or receive the services of CICS.

General-use Programming Interface and Associated Guidance Information is identified where it occurs, either by an introductory statement to a chapter or section or by the following marking:

┌ **General-use programming interface** _____
General-use Programming Interface and Associated Guidance Information...
└ **End of General-use programming interface** _____

Trademarks

The following terms are trademarks of International Business Machines Corporation in the United States, or other countries, or both:

ACF/VTAM	IMS
BookManager	IMS/ESA
C/370	Language Environment
CICS	MVS/ESA
CICS/ESA	MQSeries
CICSplex	OS/390
DB2	RACF
DFSMS	System/370
IBM	VTAM

Java and all Java-based trademarks and logos are trademarks or registered trademarks of Sun Microsystems Inc, in the United States, or other countries, or both.

Other company, product, and service names may be trademarks or service marks of others.

Preface

What this book is about

This book provides the information needed to extend and modify an IBM® CICS® Transaction Server for OS/390® system to match your requirements. It describes how you can tailor your system by coding exit programs, by replacing specific CICS-supplied default programs with versions that you write yourself, and by adapting sample programs.

Who this book is for

This book is for those responsible for extending and enhancing a CICS system to meet the special processing needs of an installation.

What you need to know to understand this book

To use the information in this book, you need to be familiar with some of the architecture of CICS and the programming interface to CICS. General-use programming interface information is given in the *CICS Application Programming Reference* manual and the *CICS System Programming Reference* manual.

Resource definition information is in the *CICS Resource Definition Guide*.

To use the following chapters you need to be familiar with the telecommunications access methods (IBM ACF/VTAM® and IBM TCAM):

- “Chapter 8. Writing a terminal error program”
- “Chapter 9. Writing a node error program”
- “Chapter 10. Writing a program to control autoinstall of terminals”
- “Chapter 12. Writing a program to control autoinstall of APPC connections”
- “Chapter 26. Using TCAM with CICS”.

If your task involves error processing, you may need to consult the *CICS Messages and Codes* manual, the *CICS Problem Determination Guide*, or the *CICS Diagnosis Reference* manual.

How to use this book

The parts and chapters of the book are self-contained. Use an individual part or chapter as a guide when performing the task described in it.

Notes on terminology

In this book, the term “CICS”, used without any qualification, refers to the CICS element of IBM CICS Transaction Server for OS/390. The term “VTAM®” refers to ACF/VTAM. The term “TCAM” refers to the DCB interface of ACF/TCAM. The term “APPC” (advanced program-to-program communication) refers to the LUTYPE6.2 intersystem connection (ISC) protocol.

CICS Transaction Server for OS/390 Release 3 supports CICS applications written in:

- Assembler language
- C
- COBOL
- PL/I.

In this book, the phrase “the languages supported by CICS” refers to the above languages.

Syntax notation and conventions used in this book

The symbols { }, [], and | are used in the syntax descriptions of the EXEC CICS commands and macros referred to in this book. They are not part of the command and you should not include them in your code. Their meanings are as follows:

- Braces { } enclose two or more alternatives, one of which you **must** code.
- Square brackets [] tell you that the enclosed is optional.
- The “or” symbol | separates alternatives.

In addition to these symbols, the following conventions apply:

- Punctuation symbols and uppercase characters should be coded exactly as shown.
- Lowercase characters indicate that user text should be coded as required.
- Default values are shown like this: DEFAULT.
- Options that are enclosed neither in braces { } nor in square brackets [] are mandatory.
- The ellipsis ... means that the immediately preceding option can be coded one or more times.
- All EXEC CICS commands require a delimiter appropriate to the language of the application. For a COBOL program this is ‘END-EXEC’, for example. Delimiters are not included in the syntax descriptions of the commands.

Bibliography

CICS Transaction Server for OS/390

<i>CICS Transaction Server for OS/390: Planning for Installation</i>	GC33-1789
<i>CICS Transaction Server for OS/390: Release Guide</i>	GC34-5352
<i>CICS Transaction Server for OS/390: Migration Guide</i>	GC34-5353
<i>CICS Transaction Server for OS/390: Installation Guide</i>	GC33-1681
<i>CICS Transaction Server for OS/390: Program Directory</i>	GC33-1706
<i>CICS Transaction Server for OS/390: Licensed Program Specification</i>	GC33-1707

CICS books for CICS Transaction Server for OS/390

General	
<i>CICS Master Index</i>	SC33-1704
<i>CICS User's Handbook</i>	SX33-6104
<i>CICS Glossary</i> (softcopy only)	GC33-1705
Administration	
<i>CICS System Definition Guide</i>	SC33-1682
<i>CICS Customization Guide</i>	SC33-1683
<i>CICS Resource Definition Guide</i>	SC33-1684
<i>CICS Operations and Utilities Guide</i>	SC33-1685
<i>CICS Supplied Transactions</i>	SC33-1686
Programming	
<i>CICS Application Programming Guide</i>	SC33-1687
<i>CICS Application Programming Reference</i>	SC33-1688
<i>CICS System Programming Reference</i>	SC33-1689
<i>CICS Front End Programming Interface User's Guide</i>	SC33-1692
<i>CICS C++ OO Class Libraries</i>	SC34-5455
<i>CICS Distributed Transaction Programming Guide</i>	SC33-1691
<i>CICS Business Transaction Services</i>	SC34-5268
Diagnosis	
<i>CICS Problem Determination Guide</i>	GC33-1693
<i>CICS Messages and Codes</i>	GC33-1694
<i>CICS Diagnosis Reference</i>	LY33-6088
<i>CICS Data Areas</i>	LY33-6089
<i>CICS Trace Entries</i>	SC34-5446
<i>CICS Supplementary Data Areas</i>	LY33-6090
Communication	
<i>CICS Intercommunication Guide</i>	SC33-1695
<i>CICS Family: Interproduct Communication</i>	SC33-0824
<i>CICS Family: Communicating from CICS on System/390</i>	SC33-1697
<i>CICS External Interfaces Guide</i>	SC33-1944
<i>CICS Internet Guide</i>	SC34-5445
Special topics	
<i>CICS Recovery and Restart Guide</i>	SC33-1698
<i>CICS Performance Guide</i>	SC33-1699
<i>CICS IMS Database Control Guide</i>	SC33-1700
<i>CICS RACF Security Guide</i>	SC33-1701
<i>CICS Shared Data Tables Guide</i>	SC33-1702
<i>CICS Transaction Affinities Utility Guide</i>	SC33-1777
<i>CICS DB2 Guide</i>	SC33-1939

CICSplex SM books for CICS Transaction Server for OS/390

General

<i>CICSplex SM Master Index</i>	SC33-1812
<i>CICSplex SM Concepts and Planning</i>	GC33-0786
<i>CICSplex SM User Interface Guide</i>	SC33-0788
<i>CICSplex SM View Commands Reference Summary</i>	SX33-6099

Administration and Management

<i>CICSplex SM Administration</i>	SC34-5401
<i>CICSplex SM Operations Views Reference</i>	SC33-0789
<i>CICSplex SM Monitor Views Reference</i>	SC34-5402
<i>CICSplex SM Managing Workloads</i>	SC33-1807
<i>CICSplex SM Managing Resource Usage</i>	SC33-1808
<i>CICSplex SM Managing Business Applications</i>	SC33-1809

Programming

<i>CICSplex SM Application Programming Guide</i>	SC34-5457
<i>CICSplex SM Application Programming Reference</i>	SC34-5458

Diagnosis

<i>CICSplex SM Resource Tables Reference</i>	SC33-1220
<i>CICSplex SM Messages and Codes</i>	GC33-0790
<i>CICSplex SM Problem Determination</i>	GC33-0791

Other CICS books

<i>CICS Application Programming Primer (VS COBOL II)</i>	SC33-0674
<i>CICS Application Migration Aid Guide</i>	SC33-0768
<i>CICS Family: API Structure</i>	SC33-1007
<i>CICS Family: Client/Server Programming</i>	SC33-1435
<i>CICS Family: General Information</i>	GC33-0155
<i>CICS 4.1 Sample Applications Guide</i>	SC33-1173
<i>CICS/ESA 3.3 XRF Guide</i>	SC33-0661

If you have any questions about the CICS Transaction Server for OS/390 library, see *CICS Transaction Server for OS/390: Planning for Installation* which discusses both hardcopy and softcopy books and the ways that the books can be ordered.

Books from related libraries

This section lists the non-CICS books that are referred to in this manual.

ACF/TCAM books

- ACF/TCAM Installation and Migration Guide*, SC30-3121
- ACF/TCAM System Programmer's Guide*, SC30-3117
- ACF/TCAM Version 3 Application Programming*, SC30-3233.

MVS books

Short Title	Full Title
<i>Assembler Programming Guide</i>	<i>OS/390 MVS Assembler Services Guide</i> , GC28-1762
<i>Authorized Assembler Programming Guide</i>	<i>OS/390 MVS Authorized Assembler Services Guide</i> , GC28-1763
<i>Authorized Assembler Programming Reference Volume 1</i>	<i>OS/390 MVS Authorized Assembler Services Reference ALE-DYN</i> , GC28-1764
<i>Authorized Assembler Programming Reference Volume 2</i>	<i>OS/390 MVS Authorized Assembler Services Reference ENF-IXG</i> , GC28-1765
<i>Authorized Assembler Programming Reference Volume 3</i>	<i>OS/390 MVS Authorized Assembler Services Reference LLA-SDU</i> , GC28-1766
<i>Authorized Assembler Programming Reference Volume 4</i>	<i>OS/390 MVS Authorized Assembler Services Reference SET-WTO</i> , GC28-1767
<i>Data Areas Volume 1</i>	<i>OS/390 MVS Data Areas, Vol 1 (ABEP-DALT)</i> , SY28-1164
<i>Data Areas Volume 2</i>	<i>OS/390 MVS Data Areas, Vol 2 (DCCB-ITTCTE)</i> , SY28-1165
<i>Data Areas Volume 3</i>	<i>OS/390 MVS Data Areas, Vol 3 (IVT-RCWK)</i> , SY28-1166
<i>Data Areas Volume 4</i>	<i>OS/390 MVS Data Areas, Vol 4 (RD-SRRA)</i> , SY28-1167
<i>Data Areas Volume 5</i>	<i>OS/390 MVS Data Areas, Vol 5 (SSAG-XTLST)</i> , SY28-1168
—	<i>MVS/ESA Resource Measurement Facility (RMF), Version 5—Monitor I & II Reference and User's Guide</i> , LY28-1007
<i>System Management Facilities</i>	<i>OS/390 MVS System Management Facilities (SMF)</i> , GC28-1783

VTAM books

OS/390 eNetwork Communications Server: SNA Network Implementation, SC31-8563

OS/390 eNetwork Communications Server: SNA Programming, SC31-8573

Other related books

IBM ESA/370 Principles of Operation, SA22-7200

IMS/ESA Application Programming: DL/I Calls, SC26-3062

OS/390 Security Server External Security Interface (RACROUTE) Macro Reference, GC28-1922

OS/390 Security Server (RACF) Security Administrator's Guide, SC28-1915

Service Level Reporter Version 3 General Information, GH19-6529

SNA Formats, GA27-3136

SNA Sessions Between Logical Units, GC20-1868

Determining if a publication is current

IBM regularly updates its publications with new and changed information. When first published, both hardcopy and BookManager softcopy versions of a publication are usually in step. However, due to the time required to print and distribute hardcopy books, the BookManager version is more likely to have had last-minute changes made to it before publication.

Subsequent updates will probably be available in softcopy before they are available in hardcopy. This means that at any time from the availability of a release, softcopy versions should be regarded as the most up-to-date.

For CICS Transaction Server books, these softcopy updates appear regularly on the *Transaction Processing and Data Collection Kit* CD-ROM, SK2T-0730-xx. Each reissue of the collection kit is indicated by an updated order number suffix (the -xx part). For example, collection kit SK2T-0730-06 is more up-to-date than SK2T-0730-05. The collection kit is also clearly dated on the cover.

Updates to the softcopy are clearly marked by revision codes (usually a “#” character) to the left of the changes.

Summary of changes

This book is based on the *Customization Guide* for CICS Transaction Server for OS/390 Release 2, SC33-1683-01. Changes from that edition are indicated by vertical bars in the left margin.

Changes for this edition

These are the most significant changes for this edition:

- The following new global user exits are described in “Chapter 1. Global user exit programs” on page 3:
 - XBMIN and XBMOU, in CICS Basic Mapping Support
 - XLDDLOAD and XLDELETE, in the CICS loader domain
- The following global user exits have been modified:
 - XDTAD, XDTLC, and XDTRD
 - XISCONA
 - XNQEREQ and XNQEREQC
 - XFAINTU
 - XRSINDI
 - XTSPTIN, XTSQRIN, and XTSQRROUT
 - XTSEREQ and XTSEREQC
- Information about using the dynamic routing program to route DPL requests and transactions started by EXEC CICS START commands has been added to “Chapter 16. Writing a dynamic routing program” on page 549.
- A new user-replaceable program, DFHDSRP, is described in “Chapter 17. Writing a distributed routing program” on page 575.
- A new user-replaceable program, DFHJVMAT, is described in “Chapter 21. Writing a program to tailor JVM execution environment variables” on page 603. DFHJVMAT can be used to customize the execution attributes of the CICS Java virtual machine.
- A new user-replaceable program, DFHXOPUS, is described in “Chapter 20. Writing a security exit program for IIOP” on page 601. DFHXOPUS provides a USERID for inbound IIOP requests.

Changes for CICS Transaction Server for OS/390 Release 2

These were the most significant changes:

- The following new global user exits were described in “Chapter 1. Global user exit programs” on page 3:
 - In the dump domain:
 - XDUREQC
 - In the enqueue EXEC interface program:
 - XNQEREQ
 - XNQEREQC
 - In the EXEC interface program:
 - XEISPIN

- XEISPOUT
- In the file control recovery program:
 - XFCAREQ
 - XFCAREQC
- In the 3270 bridge facility management program:
 - XFAINTU
- The following new exit programming interface (XPI) function calls were introduced:
 - INQUIRE_CONTEXT
- A new user-replaceable program was described in “Chapter 19. Writing a 3270 bridge exit program” on page 599.

Changes for CICS Transaction Server for OS/390 Release 1

These were the most significant changes for this edition:

- **Changes to global user exits:**

The following new global user exits were described in “Chapter 1. Global user exit programs” on page 3:

- In the file control recovery program:
 - XFCBFAIL
 - XFCBOUT
 - XFCBOVER
 - XFCLDEL
- In the file control quiesce program:
 - XFCQUIS
 - XFCVSDS
- In the Log Manager domain:
 - XLGSTRM
- In the Temporary Storage domain:
 - XTSPTIN
 - XTSPTOUT
 - XTSQRIN
 - XTSQROUT

Changes were made to the following global user exits:

- XALTENF
- XFCNREC
- XFCREQ
- XFCREQC
- XFCSREQ
- XFCSREQC
- XICTENF
- XRCINIT
- XRCINPT
- XRSINDI

The following global user exits became obsolete:

- XDBDERR
- XDBFERR
- XDBIN
- XDBINIT
- XJCWB
- XJCWR
- XKCREQ
- XRCFCER
- XRCOPER
- XTSIN
- XTSOUT
- XTSREQ

- **Changes to task-related user exits:**

“Chapter 2. Task-related user exit programs” on page 249 describes how task-related user exits can be invoked for SPI calls; and, if CICS is in-doubt about the outcome of a unit of work, can be told to wait rather than to take a forced decision.

- **Changes to the exit programming interface (XPI):**

The following new XPI function calls were introduced:

- INQUIRE_PARAMETERS
- SET_PARAMETERS

The following existing XPI calls were modified—that is, new options were added, or obsolete options removed:

- INQUIRE_SYSTEM
- INQUIRE_TRANDEF
- INQUIRE_TRANSACTION
- SET_SYSTEM
- WRITE_JOURNAL_DATA

- **Extensions to the interface to the autoinstall user program:**

Two new chapters were added:

- “Chapter 13. Writing a program to control autoinstall of shipped terminals” on page 523
- “Chapter 14. Writing a program to control autoinstall of Client virtual terminals” on page 531.

Also, “Chapter 12. Writing a program to control autoinstall of APPC connections” on page 513 was extended, to describe extensions for generic resource support.

- **The CICS log manager:**

“Chapter 23. CICS logging and journaling” on page 629 was rewritten and extended to describe the functions of the new CICS log manager.

- **Miscellaneous changes:**

- “The shutdown assist utility program, DFHCESD” on page 395 describes the utility program that replaces the DFH\$SDAP program of CICS/ESA® 4.1.

- The descriptions of fields in CICS-produced monitoring records, previously in “Chapter 24. CICS monitoring” on page 657, were moved to the *CICS Performance Guide*.

Part 1. Customizing with user exit programs

Chapter 1. Global user exit programs

This chapter describes the CICS **global user exit points**, and how you can use them, in conjunction with programs of a special type that you write yourself (**global user exit programs**), to customize your CICS system. The chapter is divided into the following sections:

1. “**Overview — what is a global user exit?**” is an introduction to global user exits, describing their main features and what they can be used for.
2. “**Global user exit programs**” on page 4 covers topics that you need to consider when writing a global user exit program. It deals with the following:
 - “Register conventions” on page 4
 - “31-bit addressing implications” on page 5
 - “Using CICS services” on page 5
 - “Using EDF with global user exits” on page 6
 - “The global work area” on page 6
 - “Making trace entries” on page 7
 - “Parameters passed to the global user exit program” on page 7
 - “Returning values to CICS” on page 10
 - “Restrictions on the use of fields as programming interfaces” on page 11
 - “Exit programs and the CICS storage protection facility” on page 11
 - “Errors in user exit programs” on page 12
 - “Defining, enabling, and disabling an exit program” on page 13
 - “Invoking more than one exit program at a single exit” on page 13
 - “Invoking a single exit program at more than one exit” on page 14
 - “Sample global user exit programs” on page 14.
3. “**List of global user exit points**” on page 19 lists the global user exit points in alphabetical order. The sections that follow contain detailed information about each global user exit point, including the place in the CICS code at which it occurs, and the specific (as distinct from the standard) parameters that are passed to an exit program.

Overview — what is a global user exit?

A global user exit *point* (sometimes referred to simply as a “global user exit”) is a place in a CICS module or domain ¹ at which CICS can transfer control to a program that you have written (a global user exit *program*), and at which CICS can resume control when your exit program has finished its work. You do not have to use any of the global user exits, but you can use them to extend and customize the function of your CICS system according to your own requirements. For a complete list of the global user exit points, see Table 2 on page 19.

1. A domain is an isolated functional unit of CICS Transaction Server for OS/390 Release 3 that communicates with the rest of CICS and with other programs using a set of strictly defined and controlled interfaces.

global user exit programs

Each global user exit point has a unique identifier, and is located at a point in the module or domain at which it could be useful to do some extra processing. For example, at exit point XSTOUT in the statistics domain, an exit program can be given control before each statistics record is written to the SMF data set, and can access the relevant statistics record. You might want to use an exit program at this exit point to examine the statistics record and suppress the writing of unwanted records.

Global user exit support is provided automatically by CICS. However, there are several conventions that govern how you write your exit program, which are described in “Global user exit programs”. Also in that section is a list of the standard parameters that the calling modules and domains pass to an exit program, and some information about returning values to the caller.

Because global user exit programs work as if they were part of the CICS module or domain, there are limits on the use you can make of CICS services. Most global user exit programs cannot use EXEC CICS commands. By contrast, most global user exit programs can invoke some CICS services using the exit programming interface (XPI). For more information, see “Using CICS services” on page 5.

Note: Neither source nor object compatibility of CICS management modules is guaranteed from release to release. Any changes that affect exit programs are documented in the appropriate manual.

Global user exit programs

A global user exit program must be written in assembler language and must be quasireentrant. However, if your user exit program calls the XPI, it must be fully reentrant.² (For details about coding programs using XPI calls, refer to “Chapter 3. The user exit programming interface (XPI)” on page 283.)

Register conventions

The following register values are provided on entry to an exit program:

- Register 1 contains the address of the user exit parameter list DFHUEPAR. Write-to-operator (WTO) commands use register 1. If your exit program uses WTO commands, you should save the address of DFHUEPAR first.
- Register 13 contains the address of the standard register save area where your exit program should store its own registers immediately after being invoked. This address is also in the field UEPEPSA in the parameter list pointed to by register 1.
If you want to issue operating system requests that use register 13 to point to a save area, you must switch register 13 to point to another save area. You must restore register 13 to its original contents before returning from your user exit program to the caller.
- Register 14 contains the return address to which the exit program should branch on completion of its work. You do this using the BR 14 instruction after restoring the calling module’s registers, or using the RETURN macro.

2. A “reentrant” program is coded to allow one copy of itself to be used concurrently by several tasks; it does not modify itself while running. A “quasireentrant” program is serially reusable by different tasks. When it receives control it must be in the same state as when it relinquished control. Such a program can modify itself while running, and is therefore not fully reentrant.

- Register 15 contains the entry address of the exit program.

No other register values are guaranteed, and they should not be relied on. The exit program should save and restore any registers that it modifies, using the save area addressed by register 13.

31-bit addressing implications

- The global user exit is invoked in 31-bit AMODE.
- The global user exit may be either RMODE 24 or RMODE ANY.
- If you find it necessary to switch to 24-bit AMODE in the exit program, be sure to return correctly in 31-bit AMODE.
- Ensure the exit program is in 31-bit AMODE for XPI calls.
- Some of parameters passed in DFHUEPAR are addresses of storage above the 16MB line.

Access register implications

- The global user exit is invoked in primary-space translation mode. For information about translation modes, see the *IBM ESA/370 Principles of Operation* manual.
- The contents of the access registers are unpredictable. For information about access registers, see the *IBM ESA/370 Principles of Operation* manual.
- If the global user exit modifies any access registers, it must restore them before returning control. CICS does **not** provide a save area for this purpose.
- The global user exit must return control in primary addressing mode.

Using CICS services

The rules governing the use of CICS services in exit programs vary, depending on the exit point from which the exit program is being invoked. The following general rules apply:

- No CICS services can be invoked from any exit point in the dispatcher domain.
- CICS services can be invoked using the exit programming interface (XPI) from most exits. If you use the XPI, note the rules and restrictions that are listed for each exit and each of the XPI macros. The XPI is described in “Chapter 3. The user exit programming interface (XPI)” on page 283.
- Some CICS services can be requested using EXEC CICS commands from some exits. The valid commands are listed in the detailed descriptions of the exits. If no commands are listed, it means that no EXEC CICS API or SPI commands are supported.

An exit program invoked at an exit that does not support the use of EXEC CICS commands should not call a task-related user exit program (TRUE). (Calling a TRUE is equivalent to issuing an EXEC CICS command.) TRUEs are described in “Chapter 2. Task-related user exit programs” on page 249.

- All exit programs that issue EXEC CICS commands must first address the EIB. This is **not** done automatically via the DFHEIENT macro, as is the case with normal EXEC assembler-language programs. Therefore, the first EXEC command to be issued from an exit program must be EXEC CICS ADDRESS EIB (eib-register), where “eib-register” is the default register (R11) or the register given as a parameter to the DFHEIENT macro.

global user exit programs

All exit programs that issue EXEC CICS commands, and that use the DFHEIENT macro, should use the DFHEIRET macro to set a return code and return to CICS. See “Returning values to CICS” on page 10.

Important

- If your global user exit program does *not* contain EXEC CICS commands, **do not** use the CICS command-level translator when assembling the program.
- Do not make non-CICS (for example, RACF® or MVS) system service calls from global user exit programs.
- If an operating system request causes a wait, your whole CICS system will stop until the operating system request has been serviced.

Using EXEC CICS and XPI calls in the same exit program

There are a number of exits where you can use both EXEC CICS commands and XPI calls, but you should ensure that there is no conflict in the usage of register 13. To avoid such conflict, use the DATAREG option on the DFHEIENT macro (see “XPI register usage” on page 291 for information).

For an example of how to use EXEC CICS commands and XPI calls in the same global user exit program, see “Appendix E. The example program for the XTSERREQ global user exit, DFH\$XTSE” on page 807

Using EDF with global user exits

If you use the Execution Diagnostic Facility (EDF) to debug your applications, you must take care when compiling exit programs that issue EXEC CICS commands.

Normally, if an exit program issues EXEC CICS commands, these are displayed by EDF, if the latter is active. They appear between the “Start of Command” and “End of Command” screens for the command that caused the exit to be driven. If you want to suppress the display of EXEC CICS commands issued by your exit program, you must specify the NOEDF option when you translate the program. You should always specify NOEDF for programs in a production environment.

If an exit program that may be invoked during recovery processing issues EXEC CICS commands, you must translate it with the NOEDF option. Failure to do so may cause EDF to abend.

The global work area

When you enable an exit program, you can ask CICS to provide a global work area for the exit program. An exit program can have its own global work area, or it can share a work area that is owned by another exit program. Note that the work area is associated with the exit **program** rather than with the exit **point**. For ease of problem determination, the global work area should be shared only by exit programs that are invoked from the same management module or domain. The address and length of the global work area are addressed by parameters UEPGAA and UEPGAL of the DFHUEPAR parameter list, which is described in “DFHUEPAR standard parameters” on page 8. If a user exit program does not own a global work area, UEPGAA is set to zero.

global user exit programs

Application programs can communicate with user exit programs that use or share the same global work area. The application program uses the EXEC CICS EXTRACT EXIT command to obtain the address and length of the global work area.

A work area is freed only when all of the exit programs that use it are disabled. For examples of how to use a global work area, see the sample global user exit programs. They are listed in “Sample global user exit programs” on page 14.

Making trace entries

If tracing is active, an entry in the CICS trace table can be made immediately before and immediately after the execution of an exit program. To specify that these entries are to be made, use the UE option of either:

- The CETR transaction
- The EXEC CICS SET TRACETYPE command.

For global user exits in domains, extra trace calls giving more information are also available if you have set the AP option of EXEC CICS SET TRACETYPE to level 1 or 2. For information about trace entries, refer to the *CICS Problem Determination Guide*.

In some cases, when tracing is active, you can also make trace entries from within a user exit program, using the XPI DFHTRPTX TRACE_PUT macro described in “Chapter 3. The user exit programming interface (XPI)” on page 283. The individual descriptions of the global user exit points show whether the XPI DFHTRPTX macro can be used at each point.

Parameters passed to the global user exit program

The address of a parameter list is passed to the user exit program in register 1. The list contains some standard parameters that are passed to all global user exit programs, and may also contain some exit-specific parameters that are unique to the exit point from which the exit program is being invoked. Not all of the exit points have these extra parameters.

The exit-specific parameters are described with the individual exits in the section “List of global user exit points” on page 19. The standard parameter list is described in the following section.

You can map the parameter list using the DSECT DFHUEPAR, which is generated by the macro instruction

```
DFHUEXIT TYPE=EP, ID=exit_point_identifier
```

The ID parameter provides the extra data definitions that you need to map any exit-specific parameters. For example, the macro instruction

```
DFHUEXIT TYPE=EP, ID=XTDIN
```

generates the DSECT to map the standard parameters followed by the parameters that are specific to exit point XTDIN in the transient data program. If your exit program is to be invoked at more than one exit point, you can code up to 256 characters of relevant exit identifiers on a single DFHUEXIT macro instruction. For example:

```
DFHUEXIT TYPE=EP, ID=(XMNOUT, XSTOUT, XTDIN)
```

global user exit programs

If your exit program is to be invoked at every global user exit point, you can code:

```
DFHUEXIT TYPE=EP,ID=ALL
```

If your user exit program is to be used both as a global user exit program and as a task-related user exit program, you must code both:

```
DFHUEXIT TYPE=EP,ID=exit_point_identifier
```

and:

```
DFHUEXIT TYPE=RM
```

(in this order) to generate the DSECTs appropriate to both types of user exit.

If a global user exit program needs to use the DFHRMCAL macro to invoke an external RMI, the DFHRMCAL macro instruction must follow the DFHUEXIT macro.

DFHUEPAR standard parameters

```
DFHUEPAR DSECT
* STANDARD PARAMETERS
UEPEXN DS A ADDRESS OF EXIT NUMBER
UEPGAA DS A ADDRESS OF GLOBAL WORK AREA
* (ZERO = NO WORK AREA)
UEPGAL DS A ADDRESS OF GLOBAL WORK AREA LENGTH
UEPCRCR DS A ADDRESS OF CURRENT RETURN-CODE
UEPTCA DS A RESERVED
UEPCSA DS A RESERVED
UEPEPSA DS A ADDRESS OF REGISTER SAVE AREA
* FOR USE BY EXIT PROGRAM
UEPHMSA DS A ADDRESS OF SAVE AREA USED FOR
* HOST MODULE'S REGISTERS
UEPGIND DS A ADDRESS OF CALLER'S TASK INDICATORS
UEPSTACK DS A ADDRESS OF KERNEL STACK ENTRY
UEPXSTOR DS A ADDRESS OF STORAGE FOR XPI PARAMETERS
UEPTRACE DS A ADDRESS OF TRACE FLAG
```

UEPEXN

points to a 1-byte binary field whose contents identify the global user exit point from which the exit program is being invoked. You need this information if your exit program can be invoked from more than one exit point.

DFHUEXIT TYPE=EP generates a list of equated values that relate the exit names (exitids) to the exit numbers used internally by CICS to identify the exits. You should always use the exitids, because the exit numbers may change in any future releases of CICS.

UEPGAA

points to the global work area that was provided for the exit program when it was enabled. This is set to zero if no global work area is provided.

UEPGAL

points to a halfword that contains the length of the global work area.

UEPCRCR

points to a halfword that is to contain the return code value from the exit program. When more than one program is called at a user exit, this field contains (on entry to the second and subsequent programs) the return code that was set by the previously invoked program.

UEPTCA

points to fetch-protect storage. Use of this field results in an abend ASRD at execution time.

UEPCSA

points to fetch-protect storage. Use of this field results in an abend ASRD at execution time.

UEPEPSA

points to a save area in which the exit program should store its own registers on entry. When the exit program is entered, register 13 is also pointing to this area. The convention is to save registers 14, 15, 0–12 at offset 12 (decimal) onward.

UEPHMSA

points to the save area containing the registers of the calling module. Values for registers 14, 15, 0–13 are stored in this order from offset 12 (decimal) in this area.

Apart from register 15, which contains the return code value from the exit program, the values in this save area are used by CICS to reload the registers when returning to the calling CICS module. They should not be corrupted.

This address is **not** passed to global user exit programs invoked from exit points in CICS domains.

UEPGIND

points to a 3-byte field containing indicators for use in AP domain user exits. For non-AP domain user exits, the indicators are always zero.

The first indicator byte can take one of two symbolic values, UEPGANY and UEPGCICS, which you can test to determine whether data locations can be above or below 16MB, and whether the application's storage is in CICS-key or user-key storage:

UEPGANY

The application can accept addresses above 16MB. If the symbolic value is not UEPGANY, the application must be returned an address below 16MB.

UEPGCICS

The application's working storage and the task's life-time storage are in CICS-key storage (TASKDATAKEY=CICS). If the symbolic value is not UEPGCICS, the application's working storage and the task's life-time storage are in user-key storage (TASKDATAKEY=USER).

The second and third bytes contain a value indicating the TCB mode of the global user exit program's caller. This is represented in DFHUEPAR as both a two-character code and a symbolic value, as follows:

Table 1. TCB indicators in DFHUEPAR. Description

Symbolic value	2-byte code	Description
UEPTQR	QR	The quasi-reentrant mode TCB
UEPTCO	CO	The concurrent mode TCB
UEPTFO	FO	The file-owning mode TCB
UEPTRO	RO	The resource-owning mode TCB

global user exit programs

Table 1. TCB indicators in DFHUEPAR (continued). Description

Symbolic value	2-byte code	Description
UEPTRP	RP	The ONC/RPC mode TCB
UEPTSZ	SZ	The FEPI mode TCB
UEPTJ8	J8	The JVM mode TCB
UEPTL8	L8	An open mode TCB
UEPTSL	SL	The sockets listener mode TCB
UEPTSO	SO	The sockets mode TCB
UEPTS8	S8	The secure sockets layer mode TCB

UEPSTACK

points to the kernel stack entry. This value must be moved to the exit program's register 13 before invoking the XPI. For more information, refer to "Chapter 3. The user exit programming interface (XPI)" on page 283. The storage addressed by this field **must not be altered**. If it is corrupted, your exit program will have unpredictable effects on your CICS system.

UEPXSTOR

points to a 320-byte area of DFHUEH-owned LIFO storage that the exit program should use when invoking the XPI. For more information, refer to "Chapter 3. The user exit programming interface (XPI)" on page 283.

UEPTRACE

points to the trace flag, which indicates whether tracing is on in the calling management module or domain. This enables you to control your use of the XPI TRACE_PUT macro in line with the tracing in the CICS module or domain. The XPI TRACE_PUT function should be used only when tracing is on. The trace flag is a single byte, whose top bit is set on when tracing is switched on. You test this setting using the symbolic value UEPTRON. The rest of the byte addressed by UEPTRACE is reserved, and its contents should not be corrupted.

Returning values to CICS

At some exit points, you can influence what CICS does on return from an exit program by supplying a return code value. The return code value must be set in register 15 before leaving the exit program. Character strings equating to valid return code values are provided with the parameter list appropriate for each exit point. Always use the equated values rather than using hard-coded values. For example, at exit XMNOUT in the monitor domain, you are presented with the address of a monitoring record. If you decide in your exit program that this record should not be written to SMF, you can set the return code value UERCBYP (meaning "bypass this record") before returning to CICS, and CICS suppresses the record.

You cannot influence CICS actions in this way at all exit points. If you supply a return code value that is not expected at a particular exit point, the default return code indicating a normal response (usually UERCNORM) is assumed, unless the return code UERCPURG is set (see note below about UERCPURG). You are strongly advised not to let the return code default to the normal response as the result can be unpredictable. The normal response tells CICS to continue processing

global user exit programs

as if the exit program had not been invoked, and it is a valid option at most global user exit points. The exceptions are shown in the list of return codes provided with each exit description.

The return code currently established for an exit is addressed by parameter UEPCRCA of DFHUEPAR, and it is needed when two or more exit programs are used at one exit. For more information, see “Invoking more than one exit program at a single exit” on page 13.

The return codes that are valid at each of the global user exit points are described in “List of global user exit points” on page 19.

Important

- At some exit points, the return code UERCPURG is valid. These exits are identified in the following tables. To prevent unpredictable results, you must **not** set the return code UERCPURG except as described on page 289.
- Exit programs that issue EXEC CICS commands, and that use the DFHEIENT macro, should use the DFHEIRET macro to set a return code and return to CICS. The DFHEIRET macro:
 - Restores registers
 - Places a return code in register 15 after the registers are restored
 - Returns control to the address in register 14.

For example:

```
DFHEIRET RCREG=nn
```

where “nn” is the number of any register (other than 13) that contains the return code to be placed in register 15 after the registers are restored.

Restrictions on the use of fields as programming interfaces

The *CICS Data Areas* manual contains definitions of the control block fields that form part of the Product-sensitive and General-use programming interfaces of CICS. Fields that are **not** defined in the *CICS Data Areas* manual as either Product-sensitive programming interface or General-use programming interface fields are **not** intended for your use as part of a CICS programming interface.

Exit programs and the CICS storage protection facility

When you are running CICS with the storage protection facility, there are two points you need to consider for global user exits:

1. The execution key in which your user exit programs run
2. The storage key of data storage obtained for your exit programs.

Execution key for global user exit programs

When you are running with storage protection active, CICS always invokes global user exit programs in CICS key. Even if you specify EXECKEY(USER) on the program resource definition, CICS forces CICS key when it passes control to the exit program. However, if a global user exit program itself passes control to another

global user exit programs

program (via a link or transfer-control command), the program thus invoked is executed according to the execution key (EXECKEY) defined in its program resource definition.

Important

You are strongly recommended to specify EXECKEY(CICS) when defining both global user exit programs and programs to which an exit program passes control.

Data storage key for global user exit programs

The storage key of storage used by global user exit programs depends on how the storage is obtained:

- The CICS-supplied storage addressed by the UEPXSTOR parameter of DFHUEPAR, and any global work area specified when an exit program is enabled, are always in CICS key.
- Global user exit programs that can issue EXEC CICS commands can obtain storage by:
 - Explicit EXEC CICS GETMAIN commands
 - Implicit storage requests as a result of EXEC CICS commands that use the SET option.

The default storage key for storage obtained by EXEC CICS commands is set by the TASKDATAKEY of the transaction under which the exit program is invoked.

As an example, consider a transaction defined with TASKDATAKEY(USER) that issues a file control request, which causes an XFCREQ global user exit program to be invoked. In this case, any implicit or explicit storage acquired by the exit program by means of an EXEC CICS command is, by default, in user-key storage. However, on an EXEC CICS GETMAIN command, the exit program can override the TASKDATAKEY option by specifying either CICSDATAKEY or USERDATAKEY.

- When an exit program obtains storage by means of an XPI GETMAIN call, the storage key depends on the value specified on the STORAGE_CLASS option, which is mandatory, and which overrides the value of TASKDATAKEY.

Errors in user exit programs

Because global user exit programs are an extension to CICS code, they are subject to the environment that CICS is running in when they are called. If an error is detected at an exit point, CICS issues messages indicating which exit program was in error, the place in the program at which the error occurred, and the name of the associated exit point. The detection of an error is not guaranteed, because it depends on the CICS environment at the time of error, and on the nature of the error. For example, CICS might not recognize a looping user exit program, since the detection mechanism may have been turned off. Also, an abend in one of the exits XPCABND, XPCTA, or XSRAB may cause CICS to terminate abnormally, because an abend during abend processing causes CICS to terminate.

Exit programs invoked at some exit points (for example, XTSEREQ, XTSEREQC, XICEREQ, XICEREQC, XTDEREQ, or XTDEREQC) can enter a loop by issuing a

recursive command (such as a TS command at exit point XTSEREQ). The exits most likely to be affected provide a recursion count parameter, UEPRECUR, that you can use to prevent such loops.

Important

When coding user exit programs, you should bear in mind that the code is executed as an extension of CICS code, rather than as a transaction, and any errors could have disastrous results.

Defining, enabling, and disabling an exit program

When you have written an exit program, you must define it to CICS using the CEDA DEFINE PROGRAM command. (Note that you must specify RELOAD(NO).)

Having defined the exit program, you must also enable it. You do this using the EXEC CICS ENABLE command.³ When you have finished using the exit program, you should disable it, using the EXEC CICS DISABLE command.

Note: If a global user exit program is enabled before it has been installed and LPA=YES is specified as a system initialization parameter, CICS scans the LPA for the program. If message DFHLD0107I is issued, it means that CICS was unable to find the program in the LPA and is using the DFHRPL version.

For programming information about the EXEC CICS ENABLE and DISABLE commands, see the *CICS System Programming Reference* manual. For examples of how to enable and disable global user exit programs, see the sample programs listed on page 14.

Invoking more than one exit program at a single exit

There may be times when you want to invoke more than one exit program from a single global user exit point. For example, you might have two or more application packages that supply programs for the same CICS exit. Although such programs may work independently, you should note the following points:

- An exit program is only called at an exit if it has been made available for execution with the START option of the EXEC CICS ENABLE command. The order of invocation, when more than one exit program has been started at an exit point, is the order in which the programs were activated (that is, the order in which the EXEC CICS ENABLE commands associated them with the exit point). When programs work on the same data area, you should consider the order in which they are invoked. For example, in a terminal control output exit, an exit program might manipulate the same message in different ways, depending on the way an earlier exit program acted.
- Return code management is more complicated than it is for single programs. Each exit program sets a return code in register 15 as usual. The second and subsequent programs invoked from a single exit point can access the return code value set by the preceding program (the “current return code”) using the parameter UEPCRCA of DFHUEPAR.

3. Exit programs for exits in the user log record recovery program and the file control recovery control program can also be enabled using the TBEXITS system initialization parameter.

global user exit programs

The following rules apply to return codes if a second user exit program sets a different return code value from that selected by the previous program:

- If the new program supplies the same return code value as the current return code (addressed by UEPCRCA), then CICS acts on that value.
- If the new program supplies a different return code value from the current value addressed by UEPCRCA, CICS ignores both values and resets the “current return code” to the default value, usually UERCNORM, before calling any further exit programs for that exit point.
- If the new program sets an eligible value in register 15 **and** changes the “current value” field to match (as addressed by UEPCRCA), the new value is adopted and passed on to the next program (if any), or back to the calling CICS module or domain.

Invoking a single exit program at more than one exit

To invoke a single exit program from more than one exit point, you must issue an ENABLE command for each of the exit points. For programming information about how to issue an ENABLE command, see the *CICS System Programming Reference* manual. Be careful to specify GALENGTH or GAENTRYNAME on only the first ENABLE command, otherwise ‘INVEXITREQ’ may be returned.

Take into account the restrictions that apply to the use of CICS services, because these are dictated by the exit point itself rather than by the exit program. A command that can be issued from one exit point may cause problems when issued from a different exit point.

The global work area is associated with the exit **program**, rather than with the exit **point**: this means that the same global work area is used at each of the exit points at which the exit program is invoked.

Sample global user exit programs

CICS provides sample global user exit programs for the following global user exit points:

- XALTENF and XICTENF
- XBMIN and XBMOUT
- XDTAD, XD TLC, and XDTRD
- XDUREQ
- XFCBFAIL, XFCBOVER, and XFCLDEL
- XICEREQ
- XISCONA
- XMEOUT
- XNQERREQ and XNQEREQC
- XPCFTCH
- XPCTA
- XZCATT
- XZIQUE

The source of all the sample programs, and any associated copy books, is supplied in the CICSTS13.CICS.SDFHSAMP library. You can use the supplied programs as models on which to base your own versions.

Global work area (GWA) sample exit programs

This set of sample programs shows you how to:

- Enable a global user exit program and allocate a global work area (GWA).
- Obtain the address of an exit program's GWA.
- Access CICS system information, and make that information available to other global user exit programs.
- Share a GWA between global user exit programs, thereby making the information it contains available to more than one program, and overcoming limitations on the size of GWAs.
- Access information held in a global user exit program's GWA.

The GWA sample programs and copy books are:

DFH\$PCEX

A sample global user exit program, designed to be invoked at the XPCFTCH exit.

CICS also provides copy book DFH\$PCGA for use in this sample program.

DFH\$ZCAT

A sample global user exit program, designed to be invoked at the XZCATT exit.

CICS also provides copy book DFH\$ZCGA for use in this sample program.

DFH\$PCPI and DFH\$PCPL

DFH\$PCPI is designed to be invoked during program list table post initialization (PLTPI) processing, and is described in "The DFH\$PCPI program".

DFH\$PCPL is a dummy program, invoked by DFH\$PCPI, that causes the XPCFTCH user exit to be driven.

The DFH\$PCPI program: DFH\$PCPI consists of three main sections:

1. Section 1 obtains and processes any parameters passed to DFH\$PCPI on the INITPARMS system initialization parameter.
2. Section 2 shows how to use standard CICS facilities to obtain system information, and make that information available to a global user exit program. It performs the following processing:
 - Uses the EXEC CICS ENABLE command to enable the XPCFTCH sample user exit program, DFH\$PCEX, and allocate it a global work area.
 - Uses the EXEC CICS EXTRACT EXIT command to obtain the address of DFH\$PCEX's global work area.
 - Obtains CICS system information, and places it in DFH\$PCEX's global work area. The information obtained includes:
 - Job name
 - Applid
 - Sysid
 - CICS release
 - Date in various formats, including DATFORM
 - The address of the common work area (CWA)
 - CICS startup type (COLD, WARM).

global user exit programs

Most of the above information is obtained using EXEC CICS API commands such as:

- INQUIRE SYSTEM
 - ASSIGN
 - ADDRESS
 - ASKTIME
 - FORMATTIME.
- Uses the START option of the EXEC CICS ENABLE command to make DFH\$PCEX available for execution. This causes DFH\$PCEX to be driven for all LINKs and XCTLs.
 - Links to the dummy program, DFH\$PCPL, in order to drive DFH\$PCEX.
 - Uses the STOP option of the EXEC CICS DISABLE command to make DFH\$PCEX unavailable for execution. Note that this leaves DFH\$PCEX's global work area still allocated and accessible through the EXEC CICS EXTRACT EXIT command.
3. Section 3 of DFH\$PCPI shows how to share the system information in an exit program's global work area with other exit programs. (In doing so it demonstrates how application programs can access the same information by means of the EXEC CICS EXTRACT EXIT command.) It also shows how to use CICS shared storage to overcome the limitation of 32KB on the size of a GWA. The program obtains an area of 64KB below 16MB and an area of 128KB above 16MB (using GETMAIN). The use of shared storage enables the second user exit program (DFH\$ZCAT) to use a work area of only 12 bytes below 16MB.

The section performs the following processing:

- Uses EXEC CICS ENABLE to enable the DFH\$ZCAT user exit program, and allocate it a global work area
- Uses EXEC CICS EXTRACT EXIT to obtain the address of DFH\$ZCAT's global work area
- Stores the address of DFH\$PCEX's global work area in DFH\$ZCAT's global work area
- Uses GETMAIN to obtain the shared storage above and below the 16MB line, and stores the addresses in DFH\$ZCAT's global work area.

Sample program definitions: The following are examples of the RDO definitions required to define the sample programs to the CSD:

```
DEFINE PROGRAM(DFH$PCEX) GROUP(EXITGRP)
    LANGUAGE(ASSEMBLER) RELOAD(NO) RESIDENT(NO) USAGE(NORMAL)
    USELPACOPY(NO) STATUS(ENABLED) CEDF(YES) DATALOCATION(ANY)
    EXECKEY(CICS)
```

```
DEFINE PROGRAM(DFH$PCPI) GROUP(EXITGRP)
    LANGUAGE(ASSEMBLER) RELOAD(NO) RESIDENT(NO) USAGE(NORMAL)
    USELPACOPY(NO) STATUS(ENABLED) CEDF(YES) DATALOCATION(ANY)
    EXECKEY(CICS)
```

```
DEFINE PROGRAM(DFH$PCPL) GROUP(EXITGRP)
    LANGUAGE(ASSEMBLER) RELOAD(NO) RESIDENT(NO) USAGE(NORMAL)
    USELPACOPY(NO) STATUS(ENABLED) CEDF(YES) DATALOCATION(ANY)
    EXECKEY(CICS)
```

```
DEFINE PROGRAM(DFH$ZCAT) GROUP(EXITGRP)
    LANGUAGE(ASSEMBLER) RELOAD(NO) RESIDENT(NO) USAGE(NORMAL)
    USELPACOPY(NO) STATUS(ENABLED) CEDF(YES) DATALOCATION(ANY)
    EXECKEY(CICS)
```

DFH\$PCPI is designed to be run as a PLT program. If you write a similar program, you should define it in the **second** part of the PLTPI list (after the PROGRAM=DFHDELIM entry). Information about how to do this is in the *CICS Resource Definition Guide*.

The Basic Mapping Support sample exit program

CICS supplies a sample global user exit program for the Basic Mapping support exits:

DFH\$BMXT

A sample global user exit program, designed to be invoked at the XBMIN and XBMOU exits. The program shows how you can use the exits to modify mapped input and output data.

The data tables sample exit programs

CICS supplies one sample global user exit program for each of the data tables exit points. These are:

DFH\$DTAD

A sample global user exit program, designed to be invoked at the XDTAD exit.

DFH\$DTLC

A sample global user exit program, designed to be invoked at the XDTLC exit.

DFH\$DTRD

A sample global user exit program, designed to be invoked at the XDTRD exit.

DFH\$DTAD, DFH\$DTLC, and DFH\$DTRD are listed in the *CICS Shared Data Tables Guide*.

The dump domain sample exit program

There is one dump domain sample global user exit program:

DFH\$XDRQ

A sample global user exit program, designed to be invoked at the XDUREQ exit.

The enqueue EXEC interface sample exit program

There is one sample global user exit program for the enqueue EXEC interface.

DFH\$XNQE

A sample global user exit program, designed to be invoked at the XNQEREQ and XNQEREQC exits. The program demonstrates three ways of adding a SCOPE value to EXEC CICS ENQ and DEQ requests, to make the requests apply to multiple regions within the sysplex.

The file control recovery program sample exit programs

CICS provides three sample file control global user exit programs:

DFH\$FCBF

A sample exit program designed to be invoked at the XFCBAIL exit for handling backout failures. See “DFH\$FCBF sample global user exit program” on page 116.

global user exit programs

DFH\$FCBV

A sample exit program designed to be invoked at the XFCBOVER exit; it allows you to decide whether to allow an update to be backed out, following a batch update run that has overridden retained locks. See “DFH\$FCBV sample global user exit program” on page 121.

DFH\$FCLD

A sample exit program designed to be invoked at the XFCLDEL exit, which allows you to perform logical deletion of records from a VSAM ESDS data set or a BDAM data set, during backout. See “DFH\$FCLD sample global user exit program” on page 123.

You can define these programs by including the supplied resource group, DFH\$FCB, in your startup grouplist, or by using CEDA to install DFH\$FCB.

The function-shipping and DPL queue control sample exit program

You can use the XISCONA sample global user exit program to control the queuing of function-shipping and DPL requests:

DFHXIS

A sample global user exit program, designed to be invoked at the XISCONA exit.

The interval control EXEC interface sample exit program

DFH\$ICCN

A sample global user exit program, designed to be invoked at the XICERREQ exit. DFH\$ICCN is for use in a distributed routing environment, where you want to cancel a previously-issued interval control request but have no way of knowing to which region to direct the CANCEL. For examples of situations which DFH\$ICCN is designed to cope with, see the *CICS Intercommunication Guide*.

The ISC session queue management sample exit program

This sample program implements the same basic function provided by the QUEUELIMIT and MAXQTIME parameters on a connection resource definition. These parameters are passed to the XZIQUE global user program, which can change the way in which these parameters are used:

DFH\$XZIQ

A sample global user exit program, designed to be invoked at the XZIQUE exit, which is described on page “XZIQUE exit for managing intersystem queues” on page 237.

See “Sample exit program design” on page 244 for more details.

The message domain sample exit programs

These sample programs show you how to write a program to be invoked at a specific exit, to do a specific task. For example, the DFH\$SXP4 sample program shows you how to use the XMEOUT exit to reroute a console message to a transient data queue.

DFH\$SXPn

A set of sample global user exit programs designed to be invoked at the XMEOUT exit (where ‘n’ is 1 through 6).

The terminal-not-known sample exit program

You can use this sample global user exit program to handle terminal-not-known conditions arising from START and ATI requests:

DFHXTENF

A sample global user exit program, designed to be invoked at the XALTENF or XICTENF exit. The sample source code is shown on page “The sample program for the XALTENF and XICTENF exits, DFHXTENF” on page 214.

The transaction-abend sample exit program

There is one sample global user exit program for the XPCTA exit point:

DFH\$PCTA

This sample global user exit program is designed to be invoked at the XPCTA exit, to test whether the abend was caused by a storage protection exception condition. It is described on page “The sample XPCTA global user exit program, DFH\$PCTA” on page 169.

Example program

As well as the sample programs supplied in source code, there is an example listing, DFH\$XTSE, that shows you how to:

- Use EXEC CICS commands in a global user exit program
- Use EXEC CICS commands and XPI calls in the same exit program
- Modify the command parameter list in EXEC interface exits such as XTSEREQ and XICEREQ.

DFH\$XTSE is listed on page 807.

List of global user exit points

Table 2 lists the global user exit points in alphabetical order, giving a brief description and a page reference at which more information about each exit can be found.

Table 2. Alphabetical list of global user exit points

Exit name	Module or domain	Where or when invoked	Page
XAKUSER	Activity keypoint program	Immediately before the ‘end of keypoint’ record is written.	25
XALCAID	Terminal allocation program	Whenever an AID with data is canceled.	203
XALTENF		When an ATI request from transient data or interval control requires a terminal that is unknown in this system.	209
XBMIN	Basic Mapping Support	When an input mapping operation completes successfully.	28
XBMOUT		When a page of output has been built successfully.	28
XDLIPOST	DL/I interface program	On exit from the DL/I interface program.	47
XDLIPRE		On entry to the DL/I interface program.	45

global user exit points

Table 2. Alphabetical list of global user exit points (continued)

Exit name	Module or domain	Where or when invoked	Page
XDSAWT	Dispatcher domain	After an operating system wait.	42
XDSBWT		Before an operating system wait.	42
XDTAD	Data tables management	When a write request is issued to a data table.	36
XDTLC		At the completion of loading of a data table.	37
XDTRD		During the loading of a data table, whenever a record is retrieved from the source data set.	34
XDUCLSE	Dump domain	After the domain closes a transaction dump data set.	55
XDUOUT		Before the domain writes a record to the transaction dump data set.	55
XDUREQ		Before the domain takes a system or transaction dump.	49
XDUREQC		After a system or transaction dump has been taken (or failed or been suppressed).	52
XEIIN	EXEC interface program	Before the execution of any EXEC CICS API or SPI command.	66
XEIOUT		After the execution of any EXEC CICS API or SPI command.	68
XEISPIN		Before the execution of any EXEC CICS SPI command <i>except</i> EXEC CICS ENABLE, EXEC CICS DISABLE, or EXEC CICS EXTRACT EXIT.	67
XEISPOUT		After the execution of any EXEC CICS SPI command <i>except</i> EXEC CICS ENABLE, EXEC CICS DISABLE, or EXEC CICS EXTRACT EXIT.	68
XFAINTU	3270 bridge facility management program	When a bridge facility is created or deleted.	32
XFCAREQ	File control EXEC interface program	Before CICS processes a file control SPI request.	83
XFCAREQC		After a file control SPI request has completed.	83

Table 2. Alphabetical list of global user exit points (continued)

Exit name	Module or domain	Where or when invoked	Page
XFCBFAIL	File control recovery control program	When an error occurs during the backout of a UOW.	112
XFCBOUT		When CICS is about to back out a file update.	117
XFCBOVER		When CICS is about to skip backout of a UOW because a batch program has overridden RLS retained lock protection and opened a data set for batch processing.	119
XFCLDEL		When backing out writes to a VSAM ESDS or a BDAM data set.	122
XFCNREC	File control open/close program	When a mismatch is detected between the backout recovery setting for a file and its associated data set during file open processing.	106
XFCQUIS	File control quiesce send program	On completion, successful or failed, of a SET DSNAME QUIESCESTATE command.	110
XFCREQ	File control EXEC interface program	Before CICS processes a file control API request.	79
XFCREQC		After a file control API request has completed.	80
XFCSREQ	File control file state program	Before a file OPEN, CLOSE, ENABLE, or DISABLE command is attempted.	96
XFCSREQC		After a file OPEN, CLOSE, CANCEL CLOSE, ENABLE, or DISABLE command has been completed.	96
XFCVSDS	File control quiesce receive program	After RLS has informed CICS that processing is required as a result of a data set-related action occurring in the sysplex.	107
XGMTEXT	"Good morning" message program	Before the "good morning" message is sent.	126
XICERREQ	Interval control EXEC interface program	Before CICS processes an interval control API request.	134
XICEREQC		After an interval control API request has completed.	135
XICEXP	Interval control program	After expiry of an interval control time interval.	133
XICREQ		At the start of the interval control program, before request analysis.	132
XICTENF		When an EXEC CICS START command requires a terminal that is unknown in this system.	212

global user exit points

Table 2. Alphabetical list of global user exit points (continued)

Exit name	Module or domain	Where or when invoked	Page
XISCONA	Intersystem communication program	When a function shipping or DPL request is about to be queued because no sessions to the remote region are immediately available.	127
XISLCLQ		After an attempt to allocate a session for a function shipped START NOCHECK request fails because the remote system is not in service, a connection to the remote system cannot be established, or no sessions are immediately available and your XISCONA exit program has specified that the request is not to be queued in the issuing region.	130
XLDLOAD	Loader domain	After an instance of a program is brought into storage, and before the program is made available for use.	147
XLDELETE		After an instance of a program is released by CICS and just before the program is freed from storage.	148
XLGSTRM	Log manager domain	After the CICS log manager detects that a log stream does not exist, and before calling the MVS system logger to define the log stream.	149
XMEOUT	Message domain	Before a message is sent from the message domain to its destination.	153
XMNOUT	Monitoring domain	Before a record is either written to SMF or buffered before a write to SMF.	156
XNQEREQ	Enqueue EXEC interface program	Before CICS processes an enqueue API request.	57
XNQEREQC		After an enqueue API request has completed.	58
XPCABND	Program control program	Before a dump call is made.	169
XPCFTCH		Before an application program is given control.	165
XPCHAIR		Before a HANDLE ABEND routine is given control.	166
XPCREQ		Before a LINK request is processed.	158
XPCREQC		After a LINK request has been completed.	159
XPCTA		After an abend occurs, and before the environment is modified.	168
XRCINIT		User log record recovery program	During warm and emergency restart, if user recovery log records are detected in the CICS system log.
XRCINPT	During warm and emergency restart, for each user recovery log record found in the CICS system log.		232

global user exit points

Table 2. Alphabetical list of global user exit points (continued)

Exit name	Module or domain	Where or when invoked	Page
XRMIIN	Resource manager interface program	Before execution of an EXEC DLI, EXEC SQL, or RMI command.	171
XRMIOUT		After execution of an EXEC DLI, EXEC SQL, or RMI command.	171
XRSINDI	Resource management modules	Immediately after a successful install or discard of a resource.	173
XSNOFF	Security manager domain	After a terminal user signs off.	178
XSNON		After a terminal user signs on.	177
XSRAB	System recovery program	When the system recovery program finds a match for an MVS abend code in the SRT.	182
XSTERM	System termination program	During a normal system shutdown, immediately before TD buffers are cleared.	186
XSTOUT	Statistics domain	Before a statistics record is written to SMF.	180
XSZARQ	Front End Programming Interface	After a FEPI request has completed.	125
XSZBRQ		Before a FEPI request is actioned.	125
XCATT	Terminal control program	Before task attach.	206
XCIN		After an input event.	205
XCOUT		Before an output event.	205
XTCTIN		After a TCAM input event.	206
XTCTOUT		Before a TCAM output event.	207
XTDEREQ		Transient data EXEC interface program	Before CICS processes a transient data API request.
XTDEREQC	After a transient data API request has completed.		223
XTDIN	Transient data program	After receiving data from QSAM (extrapartition) or VSAM (intrapartition).	219
XTDOUT		Before passing data to a QSAM (extrapartition) or VSAM (intrapartition) user-defined transient data queue.	220
XTDREQ		Before request analysis.	218
XTSEREQ	Temporary storage EXEC interface program	Before CICS processes a temporary storage API request.	194
XTSEREQC		After a temporary storage API request has completed.	195
XTSPTIN	Temporary storage domain	Before invocation of a TSPT function.	190
XTSPTOUT		After invocation of a TSPT function.	191
XTSQRIN		Before invocation of a TSQR function.	187
XTSQROUT		After invocation of a TSQR function.	188
XXDFA	DBCTL interface control program	In the active CICS when CICS-DBCTL connection fails.	39

global user exit points

Table 2. Alphabetical list of global user exit points (continued)

Exit name	Module or domain	Where or when invoked	Page
XXDFB	DBCTL tracking program	In the alternate CICS when DBCTL fails.	40
XXDTO		In the alternate CICS when active DBCTL fails.	41
XXMATT	Transaction manager domain	When a user transaction is attached.	216
XXRSTAT	XRF request processing program	After a VTAM failure or a predatory takeover.	246
XZCATT	VTAM terminal management program	Before task attach.	234
XZCIN	VTAM working set module	After an input event.	235
XZCOUT		Before an output event.	235
XZCOUT1		Before a message is broken into RUs.	236
XZIQUE		<ol style="list-style-type: none"> 1. When an allocate request for a session is about to be queued. 2. When an allocate request succeeds following previous suppression of queuing. 	237

The following sections give detailed information about each of the global user exit points, including:

- The exit identifier
- The location of the exit
- The DFHUEPAR parameters, if any, that are unique to the exit
- The return codes that are valid for this exit point
- XPI calls that can be invoked.

In the following sections, the exit points are grouped according to their functional relationships. This usually means according to the CICS module or domain in which they occur. However, where exit points in different modules serve a similar function (XALTENF in the terminal allocation program and XICTENF in the interval control program, for example), the exits are grouped under a generic name (for example, “Terminal not known” condition exits). The groups of exits are presented in alphabetical order of module or generic name.

Accessing fields in CICS control blocks

When writing a program to be invoked from any of the global user exit points, note the warning contained in “Restrictions on the use of fields as programming interfaces” on page 11 about the use of control block fields as programming interfaces.

Activity keypoint program exit XAKUSER

The XAKUSER exit is invoked during the activity keypointing process. You can use this exit to record, on the system log, user data that must be restored following an emergency restart. For further information about the use of the exit, see the *CICS Recovery and Restart Guide*.

For best performance, journal control requests should not specify WAIT. CICS will force the records by writing a synchronous end of keypoint record upon return from the exit program.

Your exit program should be translated with the NOEDF option. Any program it links to should also be translated with this option. It is not possible to link to programs written in PL/I.

To ensure that it is called during every keypoint, your exit program should be enabled by means of a first phase PLTPI program—see “Initialization programs” on page 393. However, if it enabled at this stage, your program should not attempt to link to any program coded in VS COBOL II or C, as it may be invoked before these are initialized.

Important

Your exit program forms part of a critical CICS system activity. If it fails, CICS terminates.

Exit XAKUSER

When invoked

During the activity keypointing process.

Exit-specific parameters

UEPAKTYP

Address of a 1-byte field indicating the type of keypoint for which the exit is invoked. The possible values are:

UEPAKPER

Activity keypoint

UEPAKWSD

Warm shutdown keypoint.

Return codes

UERCNORM

Continue processing.

XPI calls

XPI must not be used.

API and SPI calls

The following commands are supported:

ADDRESS CWA

ADDRESS EIB

LINK (but only to local programs; distributed program links may not be used).

RETURN

activity keypoint program exit

WRITE JOURNALNAME.

Important

Only the listed EXEC CICS commands are allowed in the XAKUSER exit. The exit should link only to other programs with the same restrictions.

Basic Mapping Support exits XBMIN and XBMOU

The XBMIN exit allows you to intercept a RECEIVE MAP request after BMS has successfully processed the request. The XBMOU exit allows you to intercept a SEND MAP request after BMS has successfully processed the request; or, if cumulative mapping is in progress, on completion of each page of output.

The XBMIN exit is called, if enabled, when all the following are true:

- A RECEIVE MAP command has been successfully processed.
- The map referenced in the command contains at least one field specified as VALIDN=USEREXIT.
- At least one USEREXIT field has been returned in the inbound datastream and has been mapped into the application data structure.

Using XBMIN, you can:

- Analyze each field defined as VALIDN=USEREXIT mapped to the application on this request
- Use the mapset name, map name, and field length defined in the map, and the actual length of field data returned in the inbound datastream
- Modify the data in each field.

The XBMOU exit is called, if enabled, when all the following are true:

- A SEND MAP command has been successfully processed.
- The map referenced in the command contains at least one field specified as VALIDN=USEREXIT.
- At least one USEREXIT field has been generated in the outbound datastream.

Using XBMOU, you can:

- Analyze each field defined as VALIDN=USEREXIT which has been generated in the outbound datastream
- Use the mapset name, map name, and field length defined in the map, and the actual length of field data placed in the outbound datastream
- Modify the data in each field
- Modify the attributes sent with each field.

Both exits are passed four exit-specific parameters:

1. The address of the TCTTE associated with the mapping request
2. The address of the system EIB associated with the task issuing the mapping request
3. The address of a halfword binary count of the number of elements in the *field element table*
4. The address of the field element table.

Basic Mapping Support exits

Sample program, DFH\$BMXT

CICS supplies a sample program, DFH\$BMXT, that shows how mapped input and output data can be modified with reference to the information provided in the “field element” table. A copybook, DFHXBMS, is also supplied. This copybook is a DSECT which defines the structure of the field element.

Exit XBMIN

When invoked

After BMS has successfully processed an input mapping operation.

Exit-specific parameters

UEPBMTCT

Address of the TCTTE associated with the mapping request.

UEPEXECB

Address of the system EIB associated with the task.

UEPBMCNT

Address of the halfword binary number of “field elements” in the field element table.

UEPBMTAB

Address of the field element table.

Return codes

UERCNORM

Continue processing.

UERCPURG

Task purged during XPI call.

XPI calls

All can be used.

Exit XBMOU

When invoked

After BMS has successfully completed a page of output during an output mapping operation.

Exit-specific parameters

UEPBMTCT

Address of the TCTTE associated with the mapping request.

UEPEXECB

Address of the system EIB associated with the task.

UEPBMCNT

Address of the halfword binary number of “field elements” in the field element table.

UEPBMTAB

Address of the field element table.

Return codes

UERCNORM

Continue processing.

UERC PURG

Task purged during XPI call.

XPI calls

All can be used.

The field element table structure

The *field element table* contains one or more elements which provide information about each “field of interest” passed to the exit. A “field of interest” is a field which has been defined as VALIDN=USEREXIT in the map source file used to create the mapset referenced in the mapping operation.

Each field element has the following structure:

BMXMAPST

is an 8-byte area which contains the name of the mapset associated with this field. If terminal or alternate suffixes are used with mapset names in your CICS installation, the mapset name may have a suffix appended to the name specified in the mapping request.

BMXMAP

is a 7-byte area which contains the name of the map associated with this field.

BMXFDFB

is a one-byte field copied from the field specification in the map load module. It contains indicators as follows:

- X'80'** CASE=MIXED
- X'40'** Group field entry
- X'20'** Group field descriptor
- X'10'** ATTRB=DET
- X'08'** JUSTIFY=ZERO
- X'04'** JUSTIFY=RIGHT
- X'02'** INITIAL, XINIT, or GINIT specified
- X'01'** Named field (DSECT entry exists)

BMXMAPLN

is a halfword binary value which contains the field length defined in the LENGTH option of the DFHMDF macro.

BMXACTLN

is a halfword binary value which contains the actual length of the data received or transmitted in this field.

BMXDATA

is the address of the field data.

In the XBMIN exit, BMXDATA points into a work area which BMS has obtained for input mapping purposes. When the exit returns control, this work area is copied to the application data structure associated with this map.

In the XBMOU exit, BMXDATA points into a terminal input/output area (TIOA) in which BMS has generated an output datastream. When the exit returns

Basic Mapping Support exits

control, the TIOA is disposed of in accordance with the disposition of the TERMINAL (the default), SET, or PAGING option specified on the SEND MAP request.

BMXATTR

is only relevant in the XBMOU exit. It is the address of the attributes (if any) which BMS has placed in the output datastream preceding this field.

BMXMAPOF

is the offset of the field in the map. For example, if a map is defined as

```
MYMAP DFHM DI SIZE=(12,40)
```

and a field in this map is defined as

```
FLDA DFHM DF POS=(5,1)
```

the offset of this field (relative to zero) is 160 in decimal notation. In this example, BMXMAPOF would contain the value X'00A0'.

BMXBUF

is the offset of the field in the device buffer. Usually—that is, when the map dimensions are the same as the current screensize in use by the device—this value will be the same as that of BMXMAPOF. However, using the example given in the BMXMAPOF description above, if MYMAP is sent to a device currently using a 24 by 80 screensize, the offset of the field in the device buffer (again relative to zero) is 320 in decimal notation. In this example, BMXBUF would contain the value X'0140'.

Programming the XBMIN exit

This section contains some considerations specific to the XBMIN exit.

The actual data length (in BMXACTLN) may be less than the length defined in the map (in BMXMAPLN). This could happen, for example, if a terminal operator does not completely fill a data entry field. In this case, BMS will have right- or left-justified the data in the field and padded the field with blank or zero characters. This justification and padding occurs before the exit is invoked. Your exit program can, by checking the bit settings in the BMXFDFB field, determine how BMS performed justification and padding for the field.

The actual data length (in BMXACTLN) may be greater than the length defined in the map (in BMXMAPLN). This could happen, for example, if a map contains an unprotected field which is not immediately followed by another field. This allows the terminal operator to enter data past the end of the field. When this occurs, the data field is truncated by BMS according to the length defined for the field in the map. However, BMXACTLN contains the length of data found in the inbound datastream.

When modifying data in the XBMIN exit, the safest method is to use the length provided in BMXMAPLN, but to ensure that any pad characters added by BMS are preserved.

BMXATTR must be ignored in the XBMIN exit; it always contains binary zeroes.

Programming the XBMOU exit

This section contains some considerations specific to the XBMOU exit.

Basic Mapping Support exits

The actual data length (in BMXACTLN) may be less than the length defined in the map (in BMXMAPLN). This occurs due to the compression of trailing nulls performed by BMS for each output field.

The actual length of data cannot be changed in the exit program. The exit is invoked after the output datastream has been generated; consequently, an attempt to alter the data length could result in an invalid datastream. Therefore, if an XBMOU exit program modifies data, it must do so with reference to the length value in BMXACTLN.

BMXDATA may contain a null value. This can be caused by a SEND MAP request with the MAPONLY option when the map has fields without default data; this causes BMS to send an attribute sequence for the field but no data.

BMXATTR may contain a null value. This can be caused by a SEND MAP request with the DATAONLY option, when the application is updating the data in a field and not the attributes.

Cumulative mapping operations

When an application is performing cumulative mapping—that is, issuing a sequence of SEND MAP commands with the ACCUM option—BMS builds composite display in which a single page of output might be constructed from multiple SEND MAP requests. When cumulative mapping occurs, the XBMOU exit is called when a page has been built, not as each SEND MAP request is processed.

Message routing

When an application builds a routing message—for example, it issues a ROUTE command followed by one or more SEND MAP commands with the SET or PAGING option specified—the XBMOU exit is invoked in the same way as for a non-routed mapping request.

However, the UEPBMTCT parameter is passed as a null value for a routed message. This is because a routed message may be destined for multiple devices, and BMS has optimized the features supported by the devices targeted by the routed message. When processing a routed message in the XBMOU exit, referencing the TCTTE for any of these devices would probably not be relevant.

Bridge facility exit

When enabled, XFAINTU (Facility Initialization and Tidy Up) is called:

- Just after a new bridge facility has been built.
- Just before a bridge facility is deleted. This may be at the end of a task (when zero keep time is specified), or when a keep time expires before the facility is re-used.

Exit XFAINTU

When invoked

Just after a bridge facility is created and just before it is freed.

Exit-specific parameters

UEPFAREQ

Address of a 1-byte field that indicates why the exit has been called. Possible values are:

UEPFAIN

Initialization.

UEPFATU

Tidy-up.

UEPFATUT

Address of a 1-byte field that indicates the type of tidy-up required. Possible values are:

UEPFANTU

Normal tidy-up.

UEPFAETU

Expired tidy-up.

UEPFANAM

Address of the bridge facility name.

UEPFATYP

Address of a 1-byte field that indicates the facility type. The value is always:

UEPFABR

3270 bridge facility.

UEPFAUAA

Address of the bridge facility user area (TCTUA).

UEPFAUAL

Address of a one-byte field containing the length of the bridge facility user area.

Return codes

UERCNORM

Continue processing.

XPI calls

All can be used, except those that use Recovery Manager services.

API calls

All can be used except those that invoke task-related user exits, or use Recovery Manager services.

Data tables management exits XDTRD, XDTAD, and XDTLC

These exits apply to both:

- CICS shared data tables
- CICS coupling facility data tables.

XDTRD and XDTAD allow you to control the selection of records for inclusion in a data table, XDTRD being used to make such selections during loading, and XDTAD being invoked when records are subsequently added to a loaded data table (or to a CFDT that did not require loading). XDTRD also allows the contents of records that are included in a user-maintained table, or a coupling facility data table, to be modified before they are added.

For CICS shared data tables, XDTLC enables you to take action based on the fact that a data table has completed loading, which might be to end some restrictions that you have decided to place on access to the data table during loading, or to cater for an unsuccessful completion of the loading.

For a coupling facility data table, XDTLC allows your global user exit program to decide whether to accept an unsuccessfully loaded coupling facility data table. If the user exit program decides to accept the table, it remains open and available for access, but CICS does not mark it as loading completed. This is also the default action if no XDTLC exit is enabled. This means that application programs continue to receive the LOADING condition for any records that are beyond the key range of records successfully loaded into the table. This ensures that application programs are aware that not all the expected data is available. It also allows you to retry the load, when the cause of the failure has been corrected, by closing the file that initiated the load and reopening it. Alternatively, you could open another load-capable file that refers to the same data table. If your exit program decides to reject the table, it is closed and the records already loaded remain in the table. If the cause of the failure is corrected, a subsequent open for the data table allows the load to complete. XDTLC is not invoked for a coupling facility data table that is not loaded from a source data set.

Note that a program invoked from any of these exit points must declare a DSECT defining the data tables user exit parameter list pointed to by field UEPDTPL. (Although UEPDTPL is defined by a DFHUEXIT call, the parameter list that it addresses is not.) To do this, your program can include the copybook DFHXDTDS, which defines the DT_UE_PLIST DSECT.

If any tables specify OPENTIME=STARTUP or are opened implicitly, you should provide a program list table post-initialization (PLTPI) program to activate the user exits. Otherwise, the data table may start loading before the exits can be enabled. For more details about PLTPI programs, see “Chapter 4. Writing initialization and shutdown programs” on page 393.

Note: For additional information about using these exits with CICS shared data table support, see the *CICS Shared Data Tables Guide*.

Exit XDTRD

The XDTRD user exit is invoked just before CICS attempts to add to the data table a record that has been retrieved from the source data set.

data tables program exits

This normally occurs when the loading process retrieves a record during the sequential copying of the source data set. However, it can also occur when an application retrieves a record that is not in the data table and:

- For a user-maintained data table, loading is still in progress, or
- For a CICS-maintained data table, loading terminated before the end of the source data set was reached (because, for example, the data table was full).

Note: For a coupling facility data table the XDTRD exit is invoked only for a table that is loaded from a source data set.

The record retrieved from the source data set is passed as a parameter to the user exit program—see fields UEPDTRA and UEPDTRL. Your exit program can choose (depending, for example, on the key value—see fields UEPDTKA and UEPDTKL) whether to include the record in the data table or not.

Alternatively, the exit program can request that all subsequent records up to a specified key are skipped—see field UEPDTSKA; these records are not passed to the exit program. This facility is available only during loading. You can specify the key as a complete key, or you can specify just the leading characters by padding the skip-key area with binary zeros.

For a user-maintained data table, the program can also modify the data in the record to reduce the storage needed for the data table. Application programs that use the data table must be aware of any changes made to the record format by the exit program. If the record length is changed, the exit program must set the new length in the parameter list—see field UEPDTRL. The new length must not exceed the data buffer length—see field UEPDTRBL.

When invoked

Just before CICS tries to add to the data table a record that has been retrieved from the source data set.

Exit-specific parameters

UEPDTPPL

Address of the data table user exit parameter list, which is mapped by DSECT DT_UE_PLIST in copybook DFHXDTDS. The data table user exit parameter list contains:

UEPDTNAM

The 8-character data table name.

UEPDFTLG

A 1-byte flag field. The possible bit settings are:

UEPDTSDT (X'80')

The exit has been invoked by CICS shared data table support.

UEPDTCMT (X'40')

This is a CICS-maintained table. Only meaningful if UEPDTSDT is on.

UEPDTOPT (X'20')

The exit has been invoked for table loading. This means that optimization by skipping can be requested.

data tables program exits

UEPDCFT(X'10')

The exit has been invoked by coupling facility data table support.

UEPDTUMT (X'08')

This is a user-maintained table. Only meaningful if UEPDTSDT is on.

UEPDTRA

The address of the data record.

UEPDTRBL

The fullword length of the data table buffer.

UEPDTRL

The fullword length of the data record.

For user-maintained tables, the exit program can set a new length in this field, if it amends the record.

UEPDTKA

The address of the data table key.

UEPDTKL

The fullword length of the data table key.

UEPDTSLS

The fullword length of the name of the source data set. Only meaningful if either UEPDTSDT or UEPDCFT is on.

UEPDTSN

A 44-character field containing the name of the source data set. Only meaningful if either UEPDTSDT or UEPDCFT is on.

UEPDTSKA

The address of a skip-key area. When invoked for table loading, your exit program can return a key of length UEPDTKL in this area, and request load optimization by setting a return code of UERCSTOP. Only meaningful if either UEPDTSDT or UEPDCFT is on.

Return codes

UERCSTOP

Add the record to the data table.

UERCSTRJ

Reject the record: that is, do not add it to the table.

UERCSTOP

Skip this and the following records until a key is found that is equal to or greater than the key specified in the skip-key area. Only meaningful if either UEPDTSDT or UEPDCFT is on.

XPI calls

All can be used.

data tables program exits

Exit XDTAD

The XDTAD user exit is invoked when a write request is issued to a data table.

- For a user-maintained data table and coupling facility data table, the user exit is invoked once—before the record is added to the data table.
- For a CICS-maintained data table, the user exit is invoked twice—before the record is added to the source data set and then again before the record is added to the data table.

The record written by the application is passed as a parameter to the user exit program—see fields UEPDTRA and UEPDTRL. Your exit program can choose (depending on the key value, for example—see fields UEPDTKA and UEPDTKL) whether to include the record in the data table or not. This decision is indicated by setting the return code.

The XDTAD exit must not modify the data in the record. If you used XDTRD to truncate the data records when the data table was loaded, you must code your application so that it only tries to write records of the correct format for the data table.

A sample XDTAD exit program is listed in the *CICS Shared Data Tables Guide*.

When invoked

One or more times during the processing of a write request to a data table.

Exit-specific parameters

UEPDTPPL

Address of the data table user exit parameter list, which is mapped by DSECT DT_UE_PLIST in copybook DFHXDTDS. The data table user exit parameter list contains:

UEPDTPNAM

The 8-character data table name.

UEPDTPFLG

A 1-byte flag field. The possible bit settings are:

UEPDTPSDT (X'80')

The exit has been invoked by CICS shared data table support.

UEPDTPCMT (X'40')

This is a CICS-maintained table. Only meaningful if UEPDTPSDT is on.

UEPDTPCFT(X'10')

The exit has been invoked by coupling facility data table support.

UEPDTPUMT (X'08')

This is a user-maintained table. Only meaningful if UEPDTPSDT is on.

UEPDTPTRA

The address of the data record.

UEPDTPRBL

The fullword length of the data table buffer.

UEPDTLRL

The fullword length of the data record.

UEPDTKA

The address of the data table key.

UEPDTKL

The fullword length of the data table key.

UEPDTDSL

The fullword length of the name of the source data set.
Only meaningful if either UEPDTSDT or UEPDTCFT is on.

UEPDTDSN

A 44-character field containing the name of the source data set. Only meaningful if either UEPDTSDT or UEPDTCFT is on.

Return codes

UERC DTAC

Add the record to the data table.

UERC DTRJ

Reject the record: that is, do not add it to the table.

XPI calls

All can be used.

Exit XDTLC

The XDTLC user exit is invoked at the completion of data table loading—whether successful or not. **The user exit is not invoked if the data table is closed for any reason before loading is complete.** The XDTLC exit is invoked for a coupling facility data table only if the table is loaded from a source data set.

The exit program is informed if the loading did not complete successfully—see field UEPDTORC. This could occur, for example, if the maximum number of records was reached or there was insufficient virtual storage. In this case, the exit program can request that the file is closed immediately, by setting the return code.

When invoked

At the completion of table loading. It is not invoked if the loading process was terminated because the data table had been closed.

Exit-specific parameters

UEPDTPL

Address of the data table user exit parameter list, which is mapped by DSECT DT_UE_PLIST in copybook DFHXDTDS. The data table user exit parameter list contains:

UEPDTNAM

The 8-character data table name.

UEPDTFLG

A 1-byte flag field. The possible bit settings are:

UEPDTSDT (X'80')

The exit has been invoked by CICS shared data table support.

data tables program exits

UEPDCMT (X'40')

This is a CICS-maintained table. Only meaningful if UEPDTSDT is on.

UEPDCFT(X'10')

The exit has been invoked by coupling facility data table support.

UEPDTUMT (X'08')

This is a user-maintained table. Only meaningful if UEPDTSDT is on.

UEPDTORC

Data table open result code. The possible values are:

UEPDTLCS

Load successful

UEPDTLFL

Load unsuccessful.

UEPDTDSL

The fullword length of the name of the source data set. Only meaningful if either UEPDTSDT or UEPDCFT is on.

UEPDTDSN

A 44-character field containing the name of the source data set. Only meaningful if either UEPDTSDT or UEPDCFT is on.

Return codes

UERCDTOK

Accept the data table in its present state

UERCDTCL

Close the data table.

XPI calls

All can be used.

DBCTL interface control program exit XXDFA

When invoked

By an active CICS when its connection to DBCTL fails. Your exit program is invoked after the active CICS has informed the alternate CICS of the failure.

Exit-specific parameters

UEPDBXR

Address of CICS XRF information for use with DBCTL. The CICS XRF information can be mapped using the DSECT DFHDXUEP.

Return codes

UERCNOAC

Take no action.

UERC SWCH

Switch to the alternate DBCTL.

UERCABNO

Abend CICS without a dump.

UERCABDU

Abend CICS with a dump.

XPI calls

TRANSACTION_DUMP must not be used.

DBCTL tracking program exits XXDFB and XXDTO

Exit XXDFB

When invoked

By the alternate CICS when it receives a message from the active CICS indicating that connection to DBCTL has failed. The alternate and active CICS systems are running in different MVS images, perhaps in different central processing complexes (CPCs). More information about these exits is provided in the *CICS IMS Database Control Guide*.

Exit-specific parameters

UEPDBXR

Address of CICS XRF information for use with DBCTL. The CICS XRF information can be mapped using the DSECT DFHDXUEP.

Return codes

UERCNOAC

Take no action.

UERC SWCH

Switch to the alternate DBCTL.

UERCABNO

Abend CICS without a dump.

UERCABDU

Abend CICS with a dump.

The return code 'UERCNORM' is not available for use at this exit point.

XPI calls

The following must not be used:

INQUIRE_MONITORING_DATA

MONITOR

TRANSACTION_DUMP

WRITE_JOURNAL_DATA.

Exit XXDTO

When invoked

By an alternate CICS when it performs takeover under the following conditions:

- The active and alternate CICS systems are in different MVS images, perhaps in different processors.
- The active CICS was connected to, or trying to connect to, a DBCTL subsystem. (This does not include disconnecting from one DBCTL and reconnecting to another.)
- The takeover was not initiated by the XXDFB exit, or the takeover was initiated by XXDFB but the active system reestablished a DBCTL connection before takeover occurred and XXDTO was driven for a new DBCTL takeover decision.

Exit-specific parameters

UEPDBXR

Address of CICS XRF information for use with DBCTL. The CICS XRF information can be mapped using the DSECT DFHDXUEP.

Return codes

UERCNOAC

Take no action.

UERC SWCH

Switch to the alternate DBCTL.

UERCABNO

Abend CICS without a dump.

UERCABDU

Abend CICS with a dump.

The return code UERCNORM is not available for use at this exit point.

XPI calls

The following must not be used:

INQUIRE_MONITORING_DATA

MONITOR

TRANSACTION_DUMP

WRITE_JOURNAL_DATA.

Dispatcher domain exits XDSBWT and XDSAWT

The XDSBWT and XDSAWT exit points are located before and after the operating system wait. CICS services **cannot** be used in any exit program invoked from these exit points.

The XDSBWT and XDSAWT exits can be used to control the swapping state of the CICS address-space. It should be noted, however, that if the default state of the address-space is non-swappable then these exits cannot be used to override this state.

CICS uses a counter which is incremented for every SYSEVENT DONTSWAP request and decremented for every SYSEVENT OKSWAP request down to a minimum of 0. A SYSEVENT DONTSWAP request is issued when this counter goes up from 0 to 1. A SYSEVENT OKSWAP request is issued when this counter goes down from 1 to 0. In all other circumstances, the SYSEVENT is not issued.

Exit XDSBWT

When invoked

Before an operating system wait issued by the quasireentrant CICS TCB.

Exit-specific parameters

None.

Return codes

UERCNORM

Continue processing.

UERC_SWAP

Issue SYSEVENT to allow address-space swapping.

XPI calls

Must not be used.

Exit XDSAWT

When invoked

After an operating system wait issued by the quasireentrant CICS TCB.

Exit-specific parameters

UEPSYSRC

Address of the 4-byte return code from the SYSEVENT request made before the operating system wait. This return code will be in one of two different forms:

1. The SYSEVENT OKSWAP return code, or
2. If the SYSEVENT request was rejected by CICS, a special CICS return code which will take one of the following fullword decimal values:

- | | |
|-----------|---|
| 17 | The SYSEVENT OKSWAP was not issued. The outstanding count of SYSEVENT OKSWAP requests exceeds the count of SYSEVENT DONTSWAP requests. Before a SYSEVENT OKSWAP can be issued, a SYSEVENT DONTSWAP must be requested. |
| 19 | The SYSEVENT OKSWAP was not issued. The outstanding count of SYSEVENT DONTSWAP requests |

dispatcher domain exits

still exceeds the count of SYSEVENT OKSWAPs.
Further SYSEVENT OKSWAPs must be requested
before a SYSEVENT OKSWAP is issued by CICS.

Return codes

UERCNORM

Continue processing.

UERCNOSW

Issue SYSEVENT to suppress address-space swapping.

XPI calls

Must not be used.

DL/I interface program exits XDLIPRE and XDLIPOST

The XDLIPRE and XDLIPOST exit points are invoked following the issue of an EXEC DLI command or DL/I call. Exit XDLIPRE is invoked before the request is processed and XDLIPOST is invoked after the request is processed.

When the request is function shipped, the exits are invoked from both the application-owning region and the database-owning region. However, there are restrictions when they are invoked in a database-owning region, as described below.

The *CICS IMS Database Control Guide* contains a sample program for the XDLIPRE exit.

Notes:

1. The descriptions of the exits that follow show the general format of the application's parameter list. For detailed information about the format of the CALL-level DL/I parameter list, refer to the *IMS/ESA Application Programming: DL/I Calls* manual.
2. For all EXEC DLI calls, the application's parameter list is in assembler-language format (that is, the value of the program language byte pointed to by UEPLANG is always UEPASM, and the parameter list pointed to by UEPAPLIST is always in assembler-language format). This is because all EXEC DLI calls are converted into assembler-language CALL-level requests.
3. In an XDLIPRE exit program you can change the PSB name and the SYSID name. This helps availability if the originally specified SYSID fails.

You can change the SYSID from:

- A remote value to another remote value
- The local value to a remote value
- A remote value to the local value.

Changing the SYSID has an effect only if the associated PSB has a PDIR entry. The SYSID may be the local CICS (that is, the SYSIDNT specified on the CICS region) or a remote connection name. For the new SYSID to be used, the PSB name must have a PDIR entry; if it does not have a PDIR entry, the assumption is made that the local CICS is connected to DBCTL, and an attempt is made to run the IMS™ request there. An IMS schedule failure is handled in the same way as a failure to route to a connection that does not exist. If the SYSID is changed to either the same value as the SYSIDNT of the local CICS or blanks (hex '40404040'), CICS attempts to run the IMS request on the local system.

Exit XDLIPRE

When invoked

On entry to the DL/I interface program.

Exit-specific parameters

UEPCTYPE

Address of type-of-request byte. Values are:

UEPCEXEC

The original request was an EXEC DLI request.

UEPCCALL

The original request was a CALL-level request.

UEPCSHIP

The request has been function shipped from another region. When this value is set, restrictions apply to the setting and use of the rest of the exit parameters, as described below.

UEPAPLIST

Address of application's parameter list. The general format for COBOL and assembler language is:

```
plist address --> parm1 address --> parm1
                parm2 address --> parm2
                parm3 address --> parm3
                .....
                up to a maximum of 18 parameters
                excluding the optional parmcount.
```

The general format for PL/I is:

```
plist address --> parm1 address --> parm1 (parmcount)
                parm2 address --> locator descriptor --> parm2
                parm3 address --> locator descriptor --> parm3
                .....
                up to a maximum of 18 parameters
```

When UEPCTYPE is not UEPCSHIP, your exit program can change any of the parameters in the application parameter list. For UEPCSHIP requests, your exit program **cannot** change any of the parameters. Furthermore, for UEPCSHIP requests, UEPAPLIST points to a copy of the parameter list in the above format, but which contains only the first two parameters, parm1 and parm2.

Note: For PL/I applications, parm1 may or may not contain a parameter-count. Your exit program should check this field before using it.

UEPLANG

Address of program language byte. Values are:

UEPPLI

PL/I

UEPCBL

COBOL

UEPASM

Assembler language.

For UEPCSHIP requests, the language is always assembler.

DL/I interface program exits

UEPIOAX

Address of I/O area existence flag byte:

UEPIOA1

I/O area exists.

For UEPCSHIP requests, the I/O area existence flag is always off.

UEPIOA

Address of I/O area. This is the application's IOAREA, or DFHEDP's IOAREA in the case of EXEC DLI. The contents of the IOAREA can be overwritten in the exit: the new contents are used when the DL/I request is processed. However, it should be noted that IOAREAs can be in a program's static storage and, in this case, should not be overwritten.

For UEPCSHIP requests, UEPIOA is always zero.

UEPPSBNX

Address of PSB existence flag byte:

UEPPSB1

A PSB exists.

UEPPSBNM

Address of an area containing the 8-character PSB name. The contents of the area can be overwritten by the exit, for all types of request including UEPCSHIP; the new contents are used when the DL/I request is processed.

UEPSYSDX

Address of the SYSID existence flag byte:

UEPSYS1

A SYSID exists.

UEPSYSID

Address of an area containing the 4-character SYSID name. The contents of the area can be overwritten by the exit, for all types of request including UEPCSHIP; the new contents are used when the DL/I request is processed.

Return codes

UERCNORM

Continue processing

UERCBYP

Bypass DL/I request and return

UERCPURG

Task purged during XPI call.

XPI calls

All can be used.

Exit XDLIPOST

When invoked

On exit from the DL/I interface program.

Exit-specific parameters

UEPCTYPE

Address of type-of-request byte. Values are:

UEPCEXEC

An EXEC DLI request.

UEPCCALL

A CALL-level request.

UEPCSHIP

The request has been function shipped from another region. When this value is set, restrictions apply to the setting and use of the rest of the exit parameters, as described below.

UEPAPLIST

Address of application's parameter list. The general format for COBOL and assembler language is:

```
plist address --> parm1 address --> parm1
                parm2 address --> parm2
                parm3 address --> parm3
                .....
                up to a maximum of 18 parameters
                excluding the optional parmcount.
```

The general format for PL/I is:

```
plist address --> parm1 address --> parm1 (parmcount)
                parm2 address --> locator descriptor --> parm2
                parm3 address --> locator descriptor --> parm3
                .....
                up to a maximum of 18 parameters.
```

When UEPCTYPE is not UEPCSHIP, your exit program can change any of the parameters in the application parameter list. For UEPCSHIP requests, your exit program **cannot** change any of the parameters. Furthermore, for UEPCSHIP requests, UEPAPLIST points to a copy of the parameter list in the above format, but which contains only the first two parameters parm1 and parm2. See also the notes on page 44.

Note: For PL/I applications, parm1 may or may not contain a parameter-count. Your exit program should check this field before using it.

UEPLANG

Address of program language byte. Its values are:

UEPPLI

PL/I

UEPCBL

COBOL

UEPASM

Assembler language.

For UEPCSHIP requests, the language is always assembler.

DL/I interface program exits

UEPIOAX

Address of I/O area existence flag byte:

UEPIOA1

I/O area exists.

For UEPCSHIP requests, the I/O area existence flag is always off.

UEPIOA

Address of I/O area. This is the application's IOAREA, or DFHEDP's IOAREA in the case of EXEC DLI. The contents of the IOAREA can be overwritten in the exit and are returned to the application program in the new form. However, it should be noted that the application's IOAREA could be in the program's static storage and, in this case, should not be overwritten.

For UEPCSHIP requests, UEPIOA is always zero.

UEPUIBX

Address of UIB existence flag byte:

UEPUIB1

a UIB exists.

UEPUIB

Address of the UIB, which is mapped by DFHUIB in module DFHDBCOP. The contents of the UIB can be overwritten in the exit for all types of request, including UEPCSHIP. The new contents are returned to the application or to the region that function shipped the request.

Return codes

UERCNORM

Continue processing.

UERCPURG

Task purged during XPI call.

XPI calls

All can be used.

Dump domain exits XDUREQ, XDUREQC, XDUCLSE, and XDUOUT

There are four exits in the dump domain.

Exit XDUREQ

When invoked

Immediately before a system or transaction dump is taken.

Exit-specific parameters**UEPTRANID**

Address of the 4-byte transaction ID.

UEPUSER

Address of the 8-byte user ID.

UEPTERM

Address of the 4-byte terminal ID.

UEPPROG

Address of the 8-byte application program name, or nulls if there is no current application.

UEPDUMPC

Address of copy of the 8-byte dump code.

UEPABCDE

Address of a copy of the 8-byte Kernel error code in the format xxx/yyyy. xxx denotes the 3-digit hexadecimal MVS completion code (for example 0C1 or D37). If an MVS completion code is not applicable, xxx is three hyphens. The 4-digit code yyyy is a user abend code produced either by CICS or by another product on your system. UEPABCDE is completed only for abend codes corresponding to the following dump codes:

AP0001

SR0001

ASRA

ASRB

ASRD

Otherwise this field contains null characters.

UEPDUMPT

Address of the 1-byte dump-type identifier, which contains one of the following values:

UEPDTRAN

A transaction dump was requested.

UEPDSYST

A system dump was requested.

Note: The dump-type identifier indicates the type of dump request that was passed to the dump domain. It does not reflect any modification that may have been made to the original request by a user entry in the dump table.

dump domain exits

UEPXDSCP

Address of a 1-byte field indicating the current dump table DUMPSCOPE setting. It contains one of the following values:

UEPXDLOC

A system dump will be taken on the local MVS image only.

UEPXDREL

System dumps will be taken on both the local MVS image, and on related MVS images within the sysplex.

This field may be modified by the exit to update the dump table DUMPSCOPE setting.

UEPXDTXN

Address of a 1-byte field indicating the current dump table TRANDUMP setting. It contains one of the following values:

UEPXDYES

A transaction dump will be taken.

UEPXDNO

A transaction dump will not be taken.

This field may be modified by the exit to update the dump table TRANDUMP setting.

Note: This field is only valid if UEPDUMPT contains the value UEPDTRAN.

UEPXD SYS

Address of a 1-byte field indicating the current dump table SYSDUMP setting. It contains one of the following values:

UEPXDYES

A system dump will be taken.

UEPXDNO

A system dump will not be taken.

This field may be modified by the exit to update the dump table SYSDUMP setting.

UEPXDTRM

Address of a 1-byte field indicating the current dump table SHUTDOWN setting. It contains one of the following values:

UEPXDYES

The CICS system is to shutdown.

UEPXDNO

The CICS system is not to shutdown.

This field may be modified by the exit to update the dump table SHUTDOWN setting.

UEPXD MAX

Address of a 4-byte field which contains the current dump table MAXIMUM setting. This field may be modified by the exit to change the current dump table MAXIMUM setting. A change to the

dump domain exits

MAXIMUM setting will not suppress this dump request. A return code of UERCBYP may be used to suppress the current dump request.

UEPDXCNT

Address of a 4-byte field which contains the current dump table CURRENT setting.

UEPXDST

Address of a 16-byte field which contains the current dump table statistics for this dump code. The addressed field consists of four 4-byte fields containing binary integers:

- Number of transaction dumps taken
- Number of transaction dumps suppressed
- Number of system dumps taken
- Number of system dumps suppressed

Note: Statistics for transaction dumps are valid only if UEPDUMPT contains the value UEPDTRAN.

UEPXDDAE

Address of a 1-byte field which represents the current dump table DAEOPTION setting. It contains one of the following values:

UEPXDYES

The dump is eligible for DAE suppression.

UEPXDNO

The dump will not be suppressed by DAE.

This field may be modified by the exit to update the dump table DAEOPTION setting.

UEPDMPID

Address of a 9-character field in the format xxxx/xxxx, containing the dump identifier. The dump ID is the same as that output by the corresponding dump message.

UEPFMOD

Address of an 8-byte area containing, if the dump code is AP0001, the name of the failing module; otherwise null characters.

Note that field UEPPROG always addresses the name of the *current* application, regardless of where the failure occurred. UEPFMOD addresses the name of the module where the failure occurred, if known.

If the dump code is AP0001, there are three possibilities:

1. The field addressed by UEPFMOD contains the same name as the field addressed by UEPPROG—the failure occurred in application code.
2. The field addressed by UEPFMOD contains a different name from the field addressed by UEPPROG—the failure occurred in non-application code.
3. The field addressed by UEPFMOD contains '????????'—the failure was not in application code, but CICS was unable to determine the name of the failing module.

dump domain exits

Return codes

UERCNORM

Continue processing.

UERCBYP

Suppress dump.

UERCPURG

Task purged during XPI call.

XPI calls

WAIT_MVS can be used **only** when a UEPDUMPT indicates that a transaction dump is being taken. **Do not use any other calls.**

The sample program for the XDUREQ exit, DFH\$XDRQ

CICS supplies a sample program for the XDUREQ exit. The sample shows you how to manipulate the dump table entry, and how to permit or suppress the dump.

Exit XDUREQC

When invoked

Immediately after a system or transaction dump has been taken (or has failed or been suppressed).

Exit-specific parameters

UEPTRANID

Address of the 4-byte transaction ID.

UEPUSER

Address of the 8-byte user ID.

UEPTERM

Address of the 4-byte terminal ID.

UEPPROG

Address of the 8-byte application program name.

UEPDUMPC

Address of copy of the 8-byte dump code.

UEPABCDE

Address of a copy of the 8-byte Kernel error code in the format xxx/yyyy. xxx denotes the 3-digit hexadecimal MVS completion code (for example X'0C1' or X'D37'). If an MVS completion code is not applicable, xxx is three hyphens. The 4-digit code yyyy is a user abend code produced either by CICS or by another product on your system. UEPABCDE is completed only for abend codes corresponding to the following dump codes:

AP0001

SR0001

ASRA

ASRB

ASRD

Otherwise this field contains null characters.

UEPDUMPT

Address of the 1-byte dump-type identifier, which contains one of the following values:

UEPDTRAN

A transaction dump was requested.

UEPDSYST

A system dump was requested.

Note: The dump-type identifier indicates the type of dump request that was passed to the dump domain. It does not reflect any modification that may have been made to the original request by a user entry in the dump table.

UEPXDSCP

Address of a 1-byte field indicating the current dump table DUMPSCOPE setting. It contains one of the following values:

UEPXDLOC

A system dump will be taken on the local MVS image only.

UEPXDREL

System dumps will be taken on both the local MVS image, and on related MVS images within the sysplex.

This field may be modified by the exit to update the dump table DUMPSCOPE setting.

UEPXDTXN

Address of a 1-byte field indicating the current dump table TRANDUMP setting. It contains one of the following values:

UEPXDYES

A transaction dump will be taken.

UEPXDNO

A transaction dump will not be taken.

This field may be modified by the exit to update the dump table TRANDUMP setting.

Note: This field is only valid if UEPDUMPT contains the value UEPDTRAN.

UEPXDSYS

Address of a 1-byte field indicating the current dump table SYSDUMP setting. It contains one of the following values:

UEPXDYES

A system dump will be taken.

UEPXDNO

A system dump will not be taken.

This field may be modified by the exit to update the dump table SYSDUMP setting.

UEPXDTRM

Address of a 1-byte field indicating the current dump table SHUTDOWN setting. It contains one of the following values:

dump domain exits

UEPXDYES

The CICS system is to shutdown.

UEPXDNO

The CICS system is not to shutdown.

This field may be modified by the exit to update the dump table SHUTDOWN setting.

UEPXDMAX

Address of a 4-byte field which contains the current dump table MAXIMUM setting. This field may be modified by the exit to change the current dump table MAXIMUM setting.

UEPXD CNT

Address of a 4-byte field which contains the current dump table CURRENT setting.

UEPXD TST

Address of a 16-byte field which contains the current dump table statistics for this dumpcode. The addressed field consists of four 4-byte fields containing binary integers:

Number of transaction dumps taken

Number of transaction dumps suppressed

Number of system dumps taken

Number of system dumps suppressed.

Note: Statistics for transactions dumps are valid only if UEPDUMPT contains the value UEPDTRAN.

UEPXDDAE

Address of a 1-byte field which represents the current dump table DAEOPTION setting. It contains one of the following values:

UEPXDYES

The dump was suppressed by DAE.

UEPXDNO

The dump was not suppressed by DAE.

This field may be modified by the exit to update the dump table DAEOPTION setting.

UEPDMPID

Address of a 9-character field in the format xxxx/xxxx, containing the dump identifier. The dump ID is the same as that output by the corresponding dump message.

UEPDRESP

Address of the 2-byte dump response code.

UEPDREAS

Address of the 2-byte dump reason code.

Return codes

UERCNORM

Continue processing.

XPI calls

WAIT_MVS can be used only when a UEPDUMPT indicates that a transaction dump is being taken. Do not use any other calls.

Exit XDUCLSE

When invoked

Immediately after a transaction dump data set has been closed.

Exit-specific parameters

UEPTRANID

Address of the 4-byte transaction ID.

UEPUSER

Address of the 8-byte user ID.

UEPTERM

Address of the 4-byte terminal ID.

UEPPROG

Address of the 8-byte application program name.

UEPDMPDD

Address of the 8-byte dump data set ddname.

UEPDMPDSN

Address of the 44-byte dump data set dsname.

Return codes

UERCNORM

Continue processing.

UERCSWCH

The autoswitch flag is set on.

XPI calls

WAIT_MVS can be used. **Do not use any other calls.**

Exit XDUOUT

When invoked

Before a record is written to the transaction dump data set.

Exit-specific parameters

UEPTRANID

Address of the 4-byte transaction ID.

UEPUSER

Address of the 8-byte user ID.

UEPTERM

Address of the 4-byte terminal ID.

UEPPROG

Address of the 8-byte application program name.

UEPDMPFC

Address of the 1-byte function code. The equated values are:

UEPDMPWR

Buffer is about to be written.

dump domain exits

UEPDMPRE

Dump is about to restart after autoswitch.

UEPDMPAB

Abnormal termination of dump.

UEPDMPDY

Buffer is about to be written, and the CICS dump data set is a dummy file or is closed.

UEPDMPBF

Address of the dump buffer, whose length is addressed by the parameter UEPDMLEN.

UEPDMPLEN

Address of the 2-byte dump-buffer length.

Return codes

UERCNORM

Continue processing.

UERCBYP

Suppress dump record output.

XPI calls

WAIT_MVS can be used. **Do not use any other calls.**

Enqueue EXEC interface program exits XNQEREQ and XNQEREQC

The XNQEREQ exit allows you to intercept enqueue API requests before any action has been taken on the request. The XNQEREQC exit allows you to intercept the response after an enqueue API request has completed.

The API requests affected are:

- EXEC CICS ENQ
- EXEC CICS DEQ.

Using **XNQEREQ**, you can:

- Analyze the API parameter list (function, keywords, argument values, and responses).
- Modify any input parameter value prior to execution of a request.
- Prevent execution of a request. This enables you to replace the CICS function with your own processing.

Using **XNQEREQC**, you can analyze the API parameter list.

You can also:

- Pass data between your XNQEREQ and XNQEREQC exit programs when they are invoked for the same request
- Pass data between your enqueue exit programs when they are invoked within the same task.

Exit XNQEREQ

When invoked

Before CICS processes an EXEC CICS ENQ or DEQ request, or attempts to match it to an installed ENQMODEL resource definition.

Exit-specific parameters

UEPCLPS

Address of a copy of the command parameter list. See “The command-level parameter structure” on page 59.

UEPNQTOK

Address of a 4-byte area which can be used to pass information between XNQEREQ and XNQEREQC for a single enqueue request.

UEPRCODE

Address of a 6-byte hexadecimal copy of the EIB return code EIBRCODE. For details of EIB return codes, see the *CICS Application Programming Reference* manual.

UEPRES

Address of a 4-byte binary copy of the EIB response code EIBRESP.

UEPRES2

Address of a 4-byte binary copy of the EIB response code EIBRESP2.

UEPTSTOK

Address of a 4-byte token which can be used to pass information

enqueue EXEC interface program exits

between successive enqueue requests within the same task (for example, between successive invocations of the XNQEREQ exit).

UEPRECUR

Address of a halfword recursion counter. The counter is set to 0 when the exit is first invoked, and is incremented for each recursive call.

UEPSCOPE

Address of the 4-byte ENQSCOPE name to be used.

Return codes

UERCBYP

Bypass this request.

UERCNORM

Continue processing.

UERPURG

Task purged during XPI call.

XPI calls

All can be used.

API and SPI commands

All can be used.

Note: Take care when issuing recursive commands. For example, you must avoid entering a loop when issuing an enqueue request from the XNQEREQ exit. Use of the recursion counter UEPRECUR is recommended.

Exit XNQEREQC

When invoked

After an enqueue API request has completed, before return from the enqueue EXEC interface program.

Exit-specific parameters

UEPCLPS

Address of a copy of the command parameter list. See "The command-level parameter structure" on page 59.

UEPNQTOK

Address of a 4-byte area which can be used to pass information between XNQEREQ and XNQEREQC for a single enqueue request.

UEPRCODE

Address of a 6-byte hexadecimal copy of the EIB return code EIBRCODE. For details of EIB return codes, see the *CICS Application Programming Reference* manual.

UEPRES

Address of a 4-byte binary copy of the EIB response code EIBRESP.

UEPRES2

Address of a 4-byte binary copy of the EIB response code EIBRESP2.

enqueue EXEC interface program exits

UEPTSTOK

Address of a 4-byte token which can be used to pass information between successive enqueue requests within the same task (for example, between successive invocations of the XNQEREQC exit).

UEPRECUR

Address of a halfword recursion counter. The counter is set to 0 when the exit is first invoked, and is incremented for each recursive call.

UEPSCOPE

Address of the 4-byte ENQSCOPE name used.

Return codes

UERCNORM

Continue processing.

UERCPURG

Task purged during XPI call.

XPI calls

All can be used.

API and SPI commands

All can be used.

You can update the copies of EIBRCODE, EIBRESP, and EIBRESP2 that you are given in the parameter list. If you update the values, CICS copies the new values into the application program's EIB after the completion of XNQEREQC or if you specify a return code of UERCBYP in XNQEREQC.

You must set valid enqueue responses. You must set all three of EIBRCODE, EIBRESP, and EIBRESP2 to a consistent set of values, such as would be set by the enqueue domain to describe a valid completion. CICS does not check the consistency of EIBRCODE, EIBRESP, and EIBRESP2. If EIBRCODE is set to a non-zero value and EIBRESP is set to zero, CICS will override EIBRESP with a non-zero value. To help you set values for EIBRCODE, EIBRESP, and EIBRESP2, the values used by the enqueue domain are specified in DSECT DFHNQUED.

Note: Take care when issuing recursive commands not to cause a loop. For example, it is your responsibility to avoid entering a loop when issuing an enqueue request from the XNQEREQC exit. Use of the recursion counter UEPRECUR is recommended.

The command-level parameter structure

The command-level parameter structure consists of a series of addresses. The first address points to the EXEC interface descriptor (EID), which consists of a bit string that describes the type of request and identifies each keyword specified with the request. The remaining addresses point to pieces of data associated with the request.

You can examine the EID to determine the type of request and the keywords specified. You can examine the other parameters in the list to determine the values of the keywords. You can also modify values of keywords specified on the request.

enqueue EXEC interface program exits

End of parameter list indicator

The high-order bit is set on in the last address set in the parameter list to indicate that it is the last one in the list. On return from your user exit program, CICS scans the parameter list for the high-order bit to find the last parameter. Therefore, if you modify the length of the parameter list, you must also reset the high-order bit to indicate which is the new last address.

The UEPLPS exit-specific parameter

The UEPLPS exit-specific parameter is included in both exit XNQEREQ and exit XNQEREQC. It is the address of the command-level parameter structure. The command-level parameter structure contains four addresses, NQ_ADDR0 through NQ_ADDR3. It is defined in the DSECT NQ_ADDR_LIST, which you should copy into your exit program by including the statement COPY DFHNQUED.

The command-level parameter list is made up as follows.

Note: The relationship between arguments, keywords, data types, and input/output types is summarized for the enqueue commands in Table 3 on page 62.

NQ_ADDR0

is the address of a 9-byte area called the EID, which is made up as follows:

NQ_GROUP
NQ_FUNCT
NQ_BITS1
NQ_BITS2
NQ_EIDOPT5
NQ_EIDOPT6
NQ_EIDOPT7
NQ_EIDOPT8

NQ_GROUP

Always X'12', indicating that this is a task control request.

NQ_FUNCT

One byte that defines the type of request:

X'04' ENQ
X'06' DEQ

NQ_BITS1

Existence bits that define which arguments were specified. To obtain the argument associated with a keyword, you need to use the appropriate address from the command-level parameter structure. Before using this address, you must check the associated existence bit. If the existence bit is set off, the argument was not specified in the request and the address should not be used.

X'80' Set if the request contains an argument for the RESOURCE keyword. If set, **NQ_ADDR1** is meaningful.

X'40' Set if the request contains an argument for the LENGTH keyword. If set, **NQ_ADDR2** is meaningful.

enqueue EXEC interface program exits

X'20' Set if the request contains an argument for the MAXLIFETIME keyword. If set, **NQ_ADDR3** is meaningful.

NQ_BITS2

Two bytes not used by the enqueue domain.

NQ_EIDOPT5

One byte not used by the enqueue domain.

NQ_EIDOPT6

One byte not used by the enqueue domain.

NQ_EIDOPT7

One byte not used by the enqueue domain.

NQ_EIDOPT8

Indicates whether certain keywords were specified on the request.

X'04' NOSUSPEND was specified.

X'02' DEQ was specified.

X'01' ENQ was specified.

NQ_ADDR1

is the address of an area containing the value from RESOURCE.

NQ_ADDR2

is the address of the halfword value of LENGTH.

NQ_ADDR3

is the address of the fullword value of MAXLIFETIME.

Modifying fields in the command-level parameter structure

The fields that are passed to the enqueue domain are used as input to the request. The correct method of modifying an input field is to create a new copy of it, and to change the address in the command-level parameter list to point to your new data.

Notes:

1. You must never modify an input field by altering the data that is pointed to by the command-level parameter list. To do so would corrupt storage belonging to the application program and would cause a failure when the program attempted to reuse the field.
2. There are no output fields on EXEC CICS ENQ and DEQ requests.

Modifying the EID

It is not possible to modify the EID to make major changes to requests. It is not possible, for example, to change an ENQ request to a DEQ request. However, you can make minor changes to requests, such as to turn on the existence bit for LENGTH. The list that follows shows the bits in the EID that can be modified. Any attempt to modify any other part of the EID is ignored.

NQ_BITS1

X'40' The existence bit for LENGTH

X'20' The existence bit for MAXLIFETIME.

NQ_EIDOPT7

A user exit program at XNQREQ can set the following on or off for ENQ commands:

enqueue EXEC interface program exits

X'04' The existence bit for NOSUSPEND.

The EID is reset to its original value before return to the application program. That is, changes made to the EID are retained for the duration of the enqueue request only.

Note: Your user exit program is prevented from making major changes to the EID. However, you must take great care when making the minor modifications that **are** permitted.

Use of the task token UEPTSTOK

UEPTSTOK provides the address of a 4-byte area that you can use to pass information between successive enqueue requests in the same task. (By contrast, UEPNQTOK is usable only for the duration of a single enqueue request, because its contents may be destroyed at the end of the request.) For example, if you need to pass information between successive invocations of the XNQEREQ exit, UEPTSTOK provides a means of doing this.

Table 3. User arguments and associated keywords, data types, and input/output types

Argument	Keyword	Data type	Input/output type
Arg1	RESOURCE	DATA-AREA	input
Arg2	LENGTH	BIN(15)	input
Arg3	MAXLIFETIME	CVDA	input

Modifying user arguments

User exit programs can modify user input arguments by:

1. Obtaining sufficient storage to hold the modified argument
2. Setting the storage to the required value
3. Setting the associated pointer in the parameter list to the address of the newly-acquired area.

Notes:

1. CICS does not check changes to argument values, so any changes must be verified by the user exit program making the changes.
2. It is not advisable for XNQEREQC to modify input arguments.

Adding user arguments

Global user exit programs can add arguments associated with the LENGTH and MAXLIFETIME keywords. You must ensure that the arguments you specify or modify in your exit programs are valid. The valid values for MAXLIFETIME are DFHVALUE(TASK) and DFHVALUE(UOW), which are 233 and 246 respectively.

Assuming that the argument to be added does not already exist, the user exit program must:

1. Obtain storage for the argument to be added
2. Initialize the storage to the required value
3. Select and set up the appropriate pointer from the parameter list
4. Select and set up the appropriate argument existence bit in the EID
5. Modify the parameter list to reflect the new end of list indicator.

Removing user arguments

User exit programs can remove arguments (for which the program is totally responsible) associated with the LENGTH and MAXLIFETIME keywords:

Assuming that the argument to be removed exists, the user exit program must:

1. Switch the corresponding argument existence bit to '0'b in the EID
2. Modify the parameter list to reflect the new end of list indicator.

Sample exit program, DFH\$XNQE

CICS supplies a sample exit program, DFH\$XNQE, for the XNQEREQ exit.

The program gives examples of:

- Coding Exec Interface Global User Exits
- Issuing a mixture of XPI and EXEC CICS API calls within Global User Exits
- Three methods of adding a SCOPE value to exec ENQ and DEQ requests, so that they apply to multiple regions within the Sysplex. Methods A and B force a match to an installed ENQMODEL resource definition. Method C bypasses the use of ENQMODEL resource definitions even if there would have been a match.

The methods are:

Method A

Prefix the Resource name with a 1- to 255-character value (this sample uses a 4-character value) for the ENQNAME on the ENQMODEL resource definition to which you wish to force a match. The exit terminates and processing continues as though the chosen ENQMODEL had been matched normally. The scope is then supplied by the matched ENQMODEL definition.

This method applies only to resource names shorter than 255-n (where n is the length of your chosen prefix).

Method B

Similar to method A, but you replace the first 1- to 8-characters of the resource name with your chosen string instead of prefixing it. This method:

- applies only to resource names of length equal to or greater than that of your replacement string.
- is an alternative to method A when a resource name too long to allow the use of that method.

Method C

Place a 4-character Scope value in UEPSCOPE, and return UERCSCPE in R15. This will bypass any installed ENQMODEL resource definition, forcing a Sysplex Scope ENQ/DEQ request.

This method is not recommended if you have an ENQMODEL table, because the latter is designed to preserve data integrity by preventing the possibility of a region scope enqueue and a sysplex scope enqueue (or two sysplex scope enqueues with different scopes) existing for the same resource. (Because sysplex and region scope enqueues use separate namespaces, a region scope enqueue will never wait on a sysplex enqueue, nor will a sysplex scope enqueue wait on a region enqueue.)

enqueue EXEC interface program exits

Notes about the use of XNQEREQ to alter ENQ or DEQ scope.

1. XNQEREQ enables you to allow existing applications to be converted to use sysplex enqueues without changing the application.

Note: Use of either the ENQMODEL resource definition or the user exit allows this in most cases, but those applications where the resource name is determined dynamically and not known in advance can only be so converted by use of this exit.

2. Sysplex and region scope enqueues use separate namespaces. A region scope enqueue will never wait on a sysplex enqueue, nor will a sysplex scope enqueue wait on a region enqueue.

Note: This situation can only arise when you use the exit. Use of the ENQMODEL resource definitions as your only method of defining the SCOPE of an ENQ or DEQ avoids this potential risk.

3. Both region and sysplex scope are supported for string ENQs, but sysplex scope is not supported for address ENQs.

EXEC interface program exits XEIIIN, XEIOUT, XEISPIN, and XEISPOUT

There are four global user exit points in the EXEC interface program:

XEIIIN Invoked before the execution of any EXEC CICS application programming interface (API) or system programming interface (SPI) command.

XEISPIN

Invoked before the execution of any EXEC CICS SPI command *except*:

- EXEC CICS ENABLE
- EXEC CICS DISABLE
- EXEC CICS EXTRACT EXIT.

The sequence is:

TRACE – XEIIIN – XEISPIN – EDF – command

XEIOUT

Invoked after the execution of any EXEC CICS API or SPI command.

XEISPOUT

Invoked after the execution of any EXEC CICS SPI command *except* those listed for XEISPIN.

The sequence is:

command – EDF – XEISPOUT – XEIOUT – TRACE

Note: Asynchronous processing of these exits may occur if the transaction is suspended (for example, during file I/O wait). This situation may also occur under CEDF because CEDF issues its own EXEC CICS commands between the application's XEISPIN and XEISPOUT exits.

If, for example, the same GWA is shared between the XEIIIN and XEIOUT exits, you must allow for the possibility of asynchronous processing, in order to ensure integrity of the data and to prevent unpredictable results.

On entry to the exits, the exit-specific parameter UEPARG contains the address of the command parameter list.

The command parameter list

The first parameter in the list points to a string of data known as **argument 0**. The other parameters point to the values specified for the parameters passed on the command.

Argument 0 begins with a 2-byte function code that identifies the command. (Function codes are documented in Appendix A of the *CICS Application Programming Reference* manual and in Appendix B of the *CICS System Programming Reference* manual.) The function code is followed by a 2-byte field containing “existence bits” which indicate whether arguments are passed on the command. For example, consider the command:

```
EXEC CICS LINK PROGRAM('MYPROG')
```

Here, argument 0 begins with the function code X'0E02' (LINK). Existence bit 1 is set, indicating that there is an argument 1 (namely, 'MYPROG').

EXEC interface program exits

The correspondence between command parameters (such as PROGRAM) and their positions and values in the parameter list (in this case, argument 1, 'MYPROG') can be deduced from the translated code for the particular command.

Important

Modifying CICS commands by tampering with argument 0 is *not* supported, and leads to unexpected errors or results.

For example, if an application program is written in assembler or PL/I and you modify argument 0, you will be writing to program storage (that is, storage occupied by the program itself), which could cause 0C4 abends. Furthermore, modifying argument 0 not only alters the CICS command for *this execution* of the command in the application program, it changes the CICS command in the virtual storage copy of the application program. This means that the next task to invoke the same copy of the program will also execute the modified command.

This particular example of the danger of tampering with argument 0 does not apply to COBOL or C/370™ application programs, but nevertheless you should not modify CICS commands for application programs written in any supported language.

Bypassing commands

An XEIIIN or XEISPIN exit program can bypass execution of a command by setting the UERCBYP return code. If it does this, EDF is not invoked, but XEISPOUT, XEIOUT, and exit trace are invoked if they are active.

Bypassing an EXEC CICS command allows an exit program to replace the CICS function with its own processing, for example.

Before setting UERCBYP, your program should check the value pointed to by UEPPGM, to ensure that it is not bypassing an EXEC CICS command issued by CICS.

Exit XEIIIN

When invoked

Before the execution of any EXEC CICS API or SPI command.

Exit-specific parameters

UEPARG

Address of the EXEC command parameter list.

UEPEXECB

Address of the system EIB.

UEPUSID

Address of the 8-character userid.

UEPPGM

Address of the 8-character application program name.

UEPLOAD

Address of the application program's load-point.

UEPRSA

Address of the application's register save area. This contains the contents of the registers at the point when the program issued the EXEC CICS command.

Return codes

UERCNORM

Continue processing.

UERCBYBYP

Bypass the execution of this command.

UERCPURG

Task purged during XPI call.

XPI calls

All can be used.

Exit XEISPIN

When invoked

Before the execution of any EXEC CICS SPI command *except*:

- EXEC CICS ENABLE
- EXEC CICS DISABLE
- EXEC CICS EXTRACT EXIT.

Exit-specific parameters

UEPARG

Address of the EXEC command parameter list.

UEPEXECB

Address of the system EIB.

UEPUSID

Address of the 8-character userid.

UEPPGM

Address of the 8-character application program name.

UEPLOAD

Address of the application program's load-point.

UEPRSA

Address of the application's register save area. This contains the contents of the registers at the point when the program issued the EXEC CICS command.

Return codes

UERCNORM

Continue processing.

UERCBYBYP

Bypass the execution of this command.

UERCPURG

Task purged during XPI call.

XPI calls

All can be used.

EXEC interface program exits

Exit XEIOUT

When invoked

After the execution of any EXEC CICS API or SPI command.

Exit-specific parameters

UEPARG

Address of the EXEC command parameter list.

UEPEXECB

Address of the system EIB.

UEPUSID

Address of the 8-character userid.

UEPPGM

Address of the 8-character application program name.

UEPLOAD

Address of the application program's load-point.

UEPRSA

Address of the application's register save area. This contains the contents of the registers at the point when the program issued the EXEC CICS command.

Return codes

UERCNORM

Continue processing.

UERCPURG

Task purged during XPI call.

XPI calls

All can be used.

Exit XEISPOUT

When invoked

After the execution of any EXEC CICS SPI command *except*:

- EXEC CICS ENABLE
- EXEC CICS DISABLE
- EXEC CICS EXTRACT EXIT.

Exit-specific parameters

UEPARG

Address of the EXEC command parameter list.

UEPEXECB

Address of the system EIB.

UEPUSID

Address of the 8-character userid.

UEPPGM

Address of the 8-character application program name.

UEPLOAD

Address of the application program's load-point.

EXEC interface program exits

UEPRSA

Address of the application's register save area. This contains the contents of the registers at the point when the program issued the EXEC CICS command.

Return codes

UERCNORM

Continue processing.

UERCPURG

Task purged during XPI call.

XPI calls

All can be used.

File control EXEC interface API exits XFCREQ and XFCREQC

The XFCREQ exit allows you to intercept a file control **application programming interface (API)** request before any action has been taken on it by file control. The XFCREQC exit allows you to intercept a file control API request after file control has completed its processing.

Note: For information about the XFCAREQ and XFCAREQC exits that are invoked for file control **SPI** requests, see “File control EXEC interface SPI exits XFCAREQ and XFCAREQC” on page 83. The API commands affected are:

- READ
- WRITE
- REWRITE
- DELETE
- UNLOCK
- STARTBR
- READNEXT
- READPREV
- ENDBR
- RESETBR.

The XFCREQ and XFCREQC exits can be written only in assembler language.

Using XFCREQ, you can:

- Analyze the request, to determine its type, the keywords specified, and their values.
- Modify values specified by the request before the command is executed.
- Set return codes to specify that either:
 - CICS should continue with the (possibly modified) request.
 - CICS should bypass the request. (Note that if you set this return code, you must also set up return codes for the EXEC interface block (EIB), as if you had processed the request yourself.)

Using XFCREQC, you can:

- Analyze the request, to determine its type, the keywords specified, and their values.
- Set return codes for the EIB.

Both exits are passed nine parameters as follows:

- The address of the command-level parameter structure
- The address of a token (UEPFCTOK) used to pass 4 bytes of data from XFCREQ to XFCREQC
- The addresses of copies of four pieces of return code and resource information from the EIB
- The address of a token (UEPTSTOK) that is valid throughout the life of a task
- The address of a recursion count field
- The address of a 16-byte area that is used if the request has been function shipped.

The command-level parameter structure

The command-level parameter structure consists of a series of addresses. The first address points to the EXEC interface descriptor (EID), which consists of a bit string that describes the type of request and identifies each keyword specified with the request. The remaining addresses point to pieces of data associated with the request. (For example, the second address always points to the file name.)

Only the first 8 addresses and the last address can be referenced by the user exit. The ninth through eleventh addresses are reserved for CICS internal use.

You can examine the EID to determine the type of request and the keywords specified. You can examine the other parameters in the list to determine the values of the keywords. You can also modify values of keywords specified on the request. (For example, you could change the name of the file involved in the request.)

End of parameter list indicator

The high-order bit is set on in the last address set in the parameter list to indicate that it is the last one in the list. On return from your user exit program, CICS scans the parameter list for the high-order bit to find the last parameter. Therefore, if you modify the length of the parameter list, you must also reset the high-order bit to indicate which is the new last address.

The original parameter list, as it was before XFCREQ was invoked, is restored after the completion of XFCREQC. It follows that the execution diagnostic facility (EDF) displays the original command before **and** after execution. **EDF does not display any changes made by the exit.**

The UEPCLPS exit-specific parameter

The UEPCLPS exit-specific parameter is included in both exit XFCREQ and exit XFCREQC. It is the address of the command-level parameter structure. The command-level parameter structure contains 12 addresses, FC_ADDR0 through FC_ADDRB. It is defined in the DSECT FC_ADDR_LIST, which you should copy into your exit program by including the statement COPY DFHFCEDS.

The command-level parameter list is made up as follows:

FC_ADDR0

is the address of a 9-byte area called the EID, which is made up as follows:

FC_GROUP
FC_FUNCT
FC_BITS1
FC_BITS2
FC_EIDOPT5
FC_EIDOPT6
FC_EIDOPT7
FC_EIDOPT8

The name of the DSECT mapping the EID is FC_EID.

FC_GROUP

Always X'06', indicating that this is a file control request.

file control EXEC interface API exits

FC_FUNCT

One byte that defines the type of request:

- X'02' READ
- X'04' WRITE
- X'06' REWRITE
- X'08' DELETE
- X'0A' UNLOCK
- X'0C' STARTBR
- X'0E' READNEXT
- X'10' READPREV
- X'12' ENDBR
- X'14' RESETBR

FC_BITS1

Existence bits that define which keywords that contain values were specified. To obtain the value associated with a keyword, you need to use the appropriate address from the command-level parameter structure. Before using this address, you must check the associated existence bit. If the existence bit is set off, the keyword was not specified in the request and the address should not be used.

- X'80' Set if the request contains the keyword FILE. If set, **FC_ADDR1** is meaningful.
- X'40' Set if the request contains any of the keywords INTO, SET, or FROM. If set, **FC_ADDR2** is meaningful.
- X'20' Set if the request specifies LENGTH or NUMREC, or if a STARTBR, RESETBR, or ENDBR request specifies REQID. If set, **FC_ADDR3** is meaningful.
- X'10' Set if the request specifies RIDFLD. If set, **FC_ADDR4** is meaningful.
- X'08' Set if the request specifies KEYLENGTH. If set, **FC_ADDR5** is meaningful.
- X'04' Set if the request is READNEXT or READPREV and specifies REQID. If set, **FC_ADDR6** is meaningful.
- X'02' Set if the request specifies SYSID. If set, **FC_ADDR7** is meaningful.
- X'01' Not used by file control.

FC_BITS2

Second set of existence bits.

- X'20' Set if the request specifies TOKEN. If set, **FC_ADDRB** is meaningful.

FC_EIDOPT5

Indicates whether certain keywords that do not take values were specified on the request.

- X'04' MASSINSERT specified.
- X'02' RRR specified.

file control EXEC interface API exits

X'01' SET (and not INTO) was specified.

Note: Your program must test for keywords at the bit level, because there may be more than one of these keywords present.

FC_EIDOPT6

Indicates whether certain keywords that do not take values were specified on the request.

X'80' RBA specified.

X'40' GENERIC specified.

X'20' GTEQ specified.

X'10' UNCOMMITTED specified.

X'08' CONSISTENT specified.

X'04' REPEATABLE specified.

X'01' NOSUSPEND specified (on READ, READNEXT, READPREV, WRITE, DELETE, or REWRITE).

Notes:

1. If the read integrity bits (for UNCOMMITTED, CONSISTENT, and REPEATABLE) are off (zero) on the command, the read integrity options specified on the file resource definition are used. If you need to know what these are, you can issue an EXEC CICS INQUIRE FILE command.
2. Your program must test for keywords at the bit level, because there may be more than one of these keywords present.

FC_EIDOPT7

Indicates whether certain keywords that do not take values were specified on the request.

X'04' UPDATE specified. This setting is meaningful only for READ requests. For other requests, X'04' may or may not be set.

X'01' Either DEBREC or DEBKEY specified (see **FC_EIDOPT8**). This setting is meaningful only for READ requests. For other requests, X'01' may or may not be set.

Note: Your program must test for keywords at the bit level, because there may be more than one of these keywords present.

FC_EIDOPT8

Indicates whether certain keywords that do not take values were specified on the request.

X'80' DEBKEY specified.

X'40' DEBREC specified.

X'20' TOKEN specified.

FC_ADDR1

is the address of an 8-byte area containing the name specified on the FILE keyword.

FC_ADDR2

is the address of one of the following:

file control EXEC interface API exits

- A 4-byte address returned for SET (if the request is READ, READNEXT, or READPREV, and if **FC_EIDOPT5** indicates that this is SET).
- Data returned for INTO (if the request is READ, READNEXT, or READPREV, and if **FC_EIDOPT5** indicates that this is not SET).
- Data from FROM (if the request is WRITE or REWRITE).

FC_ADDR3

is the address of one of the following:

- The halfword value of LENGTH (if the request is READ, WRITE, REWRITE, READNEXT, or READPREV).

Warning: For requests that specify INTO, do not change the value of LENGTH to a value greater than that specified by the application. To do so causes a storage overlay in the application.

- The returned halfword value of NUMREC (if the request is DELETE).
- The halfword value of REQID (if the request is STARTBR, RESETBR, or ENDBR).

FC_ADDR4

is the address of an area containing the value of the RIDFLD keyword.

FC_ADDR5

is the address of the halfword value of KEYLENGTH.

FC_ADDR6

is the address of the halfword value of REQID (if the request is READNEXT or READPREV).

FC_ADDR7

is the address of an area containing the value of SYSID.

FC_ADDR8

is the address of a value intended for CICS internal use only. It must not be used.

FC_ADDR9

is the address of a value intended for CICS internal use only. It must not be used.

FC_ADDRA

is the address of a value intended for CICS internal use only. It must not be used.

FC_ADDRB

is the address of the fullword value of TOKEN (if the request is READ, READNEXT, READPREV, REWRITE, DELETE, or UNLOCK).

Modifying fields in the command-level parameter structure

Some fields that are passed to file control are used as input to the request, some are used as output fields, and some are used for both input and output. The method your user exit program uses to modify a field depends on the usage of the field.

A list of input and output fields

The following are always input fields:

FILE
FROM

KEYLENGTH
 REQID
 SYSID

The following are always output fields:

INTO
 NUMREC
 SET

Whether LENGTH and RIDFLD are input or output fields depends on the request, as shown in Table 4. A dash (—) means that the keyword cannot be specified on the request.

Table 4. LENGTH and RIDFLD as input and output fields

Request	LENGTH	RIDFLD
READ	Output	See Note 1.
WRITE	Input	See Note 2.
REWRITE	Input	—
DELETE	—	See Note 3.
UNLOCK	—	—
STARTBR	—	Input
READNEXT	Output	Output
READPREV	Output	Output
ENDBR	—	—
RESETBR	—	Input

Notes:

1. Normally, this is an input field. However, if UPDATE is specified and the file is a BDAM file using extended key search, RIDFLD is used for both input and output.
2. The use of RIDFLD on a WRITE request depends on the file type. For a VSAM KSDS or RRDS, or a fixed-format BDAM file, RIDFLD is an input field. For all other file types, it is used either for output only, or for both input and output, and should be treated like an output field.
3. RIDFLD is an input field on DELETE requests that are not preceded by a READ UPDATE. It is not specified on requests that are preceded by a READ UPDATE.

Modifying input fields

The correct method of modifying an input field is to create a new copy of it, and to change the address in the command-level parameter list to point to your new data.

Note: You must never modify an input field by altering the data that is pointed to by the command-level parameter list. To do so would corrupt storage belonging to the application program and would cause a failure when the program attempted to reuse the field.

file control EXEC interface API exits

Modifying output fields

The technique described in “Modifying input fields” on page 75 is not suitable for modifying output fields. (The results would be returned to the new area instead of the application’s area, and would be invisible to the application.)

An output field is modified by altering the data that is pointed to by the command-level parameter list. In the case of an output field, you can modify the application’s data in place, because the application is expecting the field to be modified anyway.

Modifying fields used for both input and output

An example of a field that is used for both input and output is LENGTH on a READ request that specifies INTO. You can treat such fields in the same way as output fields, and they are considered to be the same.

Modifying the EID

It is not possible to modify the EID to make major changes to requests. It is not possible, for example, to change a WRITE request to a READ request.

However, you can make minor changes to requests, such as to turn on the existence bit for SYSID so that the request can be changed into one that is shipped to a remote system.

The list that follows shows the bits in the EID that can be modified. Any attempt to modify any other part of the EID is ignored.

FC_BITS1

- X'20'** The existence bit for LENGTH, NUMREC, or (if the request is STARTBR, RESETBR, or ENDBR) REQID.
- X'08'** The existence bit for KEYLENGTH.
- X'04'** The existence bit for REQID if the request is READNEXT or READPREV.
- X'02'** The existence bit for SYSID.

FC_BITS2

- X'20'** Token specified.

FC_EIDOPT5

- X'04'** MASSINSERT specified.

FC_EIDOPT6

- X'40'** GENERIC specified.
- X'20'** GTEQ specified.
- X'10'** UNCOMMITTED specified.
- X'08'** CONSISTENT specified.
- X'04'** REPEATABLE specified.
- X'02'** UPDATE specified on READNEXT or READPREV.

X'01' NOSUSPEND specified (on READ, READNEXT, READPREV, WRITE, DELETE, or REWRITE).

Bits in the EID should be modified in place. You should not modify the pointer to the EID: any attempt to do so is ignored by CICS.

The EID is reset to its original value before return to the application program. That is, changes made to the EID are retained for the duration of the file control request only.

If more than one of UNCOMMITTED, CONSISTENT, or REPEATABLE is specified, CONSISTENT takes precedence over UNCOMMITTED, and REPEATABLE takes precedence over CONSISTENT and UNCOMMITTED.

Example of modifying read integrity bits

You might want all RLS read requests from all programs against a specific file to specify CONSISTENT read. You could code a user exit program that turns on the bit for CONSISTENT and turns off the other two read integrity bits in all requests to the file. You could partially achieve this effect by specifying CONSISTENT on the FILE definition. However, that would only override requests that did not explicitly specify a level of read integrity. Using a global user exit program for this purpose also overrides programs that explicitly specify UNCOMMITTED or REPEATABLE.

Warnings:

1. If a global user exit program changes a file request to request a higher level of read integrity (for example, it changes the request from UNCOMMITTED to REPEATABLE), this could cause CICS either to acquire extra read locks, or to keep its read locks for a longer period of time. This may degrade system throughput, by causing other transactions to wait, or introduce deadlocks.
2. If a global user exit program changes the request to one that requests a lower level of read integrity (for example, it changes the request from REPEATABLE to UNCOMMITTED), this could cause application logic errors to occur in the program that originated the request. The errors could occur because the application program may be relying on the record to remain unchanged while it reads a series of other, related, records. This can be guaranteed with REPEATABLE, but not if the option is changed to UNCOMMITTED.
3. Your user exit program is prevented from making major changes to the EID. However, you must take great care when making the minor modifications that **are** permitted. For instance, it is possible to change a DELETE into a GENERIC DELETE, but to make such a change may be dangerous.

Use of the task token UEPTSTOK

UEPTSTOK provides the address of a 4-byte area that you can use to pass information between successive file control requests in the same task. (By contrast, UEPFCTOK is usable only for the duration of a single file control request, because its contents may be destroyed at the end of the request.) For example, if you need to pass information between successive invocations of the XFCREQ exit, UEPTSTOK provides a means of doing this.

Use of the parameter UEPFSHIP

UEPFSHIP contains the address of a 16-byte area. This area consists of 4 characters, followed by 3 fullwords. If the first byte contains 'Y', this request has

file control EXEC interface API exits

been function shipped to this region. In this case, if your exit program wants to bypass file control (by setting a return code of UERCBYP), it must set the 3 fullwords as follows:

Fullword 1

The length of the buffer area

Fullword 2

The length of the record

Fullword 3

The length of the modified RIDFLD.

Doing this ensures that the data and RIDFLD are correctly shipped back.

The EIB

Copies of EIBRSRCE, EIBRCODE, EIBRESP, and EIBRESP2 are passed to the exit, so that you can:

- Modify or set completion and resource information in XFCREQ and XFCREQC
- Examine completion and resource information in XFCREQC.

You can update the copies of EIBRSRCE, EIBRCODE, EIBRESP, and EIBRESP2 that you are given in the parameter list. File Control copies your values into the real EIB after the completion of XFCREQC; or if you specify a return code of 'bypass' in XFCREQ.

You must set valid file control responses. You must set all three of EIBRCODE, EIBRESP, and EIBRESP2 to a consistent set of values, such as would be set by File Control to describe a valid completion. **File Control does not police the consistency of EIBRCODE, EIBRESP, and EIBRESP2.** To aid you in setting the values of EIBRCODE, EIBRESP, and EIBRESP2, the values used by File Control are specified in DFHFCEDS.

Example of how XFCREQ and XFCREQC can be used

XFCREQ and XFCREQC can be used for a variety of purposes. One example of a possible use is given below.

In this example, XFCREQ and XFCREQC are used to obtain a record containing compressed data, to decompress the data, and to return it to the area specified by the user program as INTO. The example shows only the capabilities of the exits; it is not intended to indicate an ideal way of achieving the function.

In XFCREQ:

1. Issue an EXEC CICS GETMAIN to obtain an area large enough to hold the decompressed data.
2. Change the INTO pointer to point to this new area, so that File Control uses it when it processes the request. (The decompressed data is copied to the *user's* INTO area, and the INTO pointer reset, before return to the application program—see stages 4 on page 79 and 7 on page 79 of the processing to be done by XFCREQC.)
3. Set UEPFCTOK to be the address of the new area so that XFCREQC can also use this area.
4. Return to CICS.

In XFCREQC:

1. Check 'UEPRCODE' to make sure that the file control request completed without error.
2. Use UEPFCTOK to find the address of the area. This area now holds the compressed data.
3. Decompress the data in place.
4. Copy the data from the new area to the user's INTO area. Use the user-specified LENGTH (from the command-level parameter list) to ensure that the data fits and that the copy does not cause a storage violation.
5. Set 'LENGERR' in UEPRESP, UEPRESP2, and UEPRCODE if the data does not fit.
6. Use EXEC CICS FREEMAIN to free the work area pointed to by UEPFCTOK.
7. At this point the command-level parameter list points to the now free area as the address for INTO. This is not a problem, because after completion of XFCREQC File Control restores this pointer to point to the area supplied by the user program.
8. Return to CICS.

Exit XFCREQ

When invoked

Before CICS processes a file control API request.

Exit-specific parameters

UEPCLPS

Address of the command-level parameter structure. See "The UEPCLPS exit-specific parameter" on page 71.

UEPFCTOK

Address of the 4-byte token to be passed to XFCREQC. This allows you, for example, to pass a work area to exit XFCREQC.

UEPRCODE

Address of a 6-byte hexadecimal copy of the EIB return code 'EIBRCODE'. For details of EIB return codes, refer to the *CICS Application Programming Reference* manual.

UEPRESP

Address of a 4-byte binary copy of the EIB response code 'EIBRESP'.

UEPRESP2

Address of a 4-byte binary copy of the EIB response code 'EIBRESP2'.

UEPTSTOK

Address of a 4-byte token that is valid throughout the life of a task. See "Use of the task token UEPTSTOK" on page 77.

UEPRECUR

Address of a halfword recursion counter. The counter is set to 0 when the exit is first invoked, and is incremented for each recursive call.

file control EXEC interface API exits

UEPFSHIP

Address of a 16 byte area. See “Use of the parameter UEPFSHIP” on page 77.

UEPRSRCE

Address of an 8-character copy of the EIB resource value, EIBRSRCE.

Return codes

UERCNORM

Continue processing.

UERCBYP

The file control EXEC interface program should ignore this request.

UERCPURG

Task purged during XPI call.

XPI calls

All can be used.

Although the exit permits the use of XPI GETMAIN and FREEMAIN calls, we recommend that you use the EXEC CICS GETMAIN and FREEMAIN commands instead.

API and SPI calls

All can be used.

Notes:

1. Take care when issuing recursive commands not to cause a loop. For example, it is your responsibility to avoid entering a loop when a file control request is issued from the XFCREQ exit. Use of the recursion counter UEPRECUR is recommended.
2. Exit programs that issue EXEC CICS commands must first address the EIB. See “Using CICS services” on page 5.
3. Exit programs that issue EXEC CICS commands, and that use the DFHEIENT macro, should use the DFHEIRET macro to set a return code and return to CICS. See “Returning values to CICS” on page 10.

Exit XFCREQC

When invoked

After a file control API request has completed, and before return from the file control EXEC interface program.

Exit-specific parameters

UEPCLPS

Address of the command-level parameter structure. See “The UEPCLPS exit-specific parameter” on page 71.

UEPFCTOK

Address of the 4 byte token passed from XFCREQ.

UEPRCODE

Address of a 6-byte hexadecimal copy of the EIB return code ‘EIBRCODE’. For details of EIB return codes, refer to the *CICS Application Programming Reference* manual.

UEPRES

Address of a 4-byte binary copy of the EIB response code 'EIBRESP'.

Note: If the file that has just been accessed is remote, the addressed field contains zeros (even if UEPRCODE is non-zero).

UEPRES2

Address of a 4-byte binary copy of the EIB response code 'EIBRESP2'.

Note: If the file that has just been accessed is remote, the addressed field contains zeros (even if UEPRCODE is non-zero).

UEPTSTOK

Address of a 4-byte token that is valid throughout the life of a task. See "Use of the task token UEPTSTOK" on page 77.

UEPRECUR

Address of a halfword recursion counter. The counter is set to 0 when the exit is first invoked, and is incremented for each recursive call.

UEPRSRCE

Address of an 8-character copy of the EIB resource value, EIBRSRCE.

Return codes

UERCNORM

Continue processing.

UERCPURG

Task purged during XPI call.

XPI calls

All can be used.

Although the exit permits the use of XPI GETMAIN and FREEMAIN calls, we recommend that you use the EXEC CICS GETMAIN and FREEMAIN commands instead.

API and SPI calls

All can be used.

Notes:

1. Take care when issuing recursive commands not to cause a loop. For example, it is your responsibility to avoid entering a loop when a file control request is issued from the XFCREQC exit. Use of the recursion counter UEPRECUR is recommended.
2. Exit programs that issue EXEC CICS commands must first address the EIB. See "Using CICS services" on page 5.
3. Exit programs that issue EXEC CICS commands, and that use the DFHEIENT macro, should use the DFHEIRET macro to set a return code and return to CICS. See "Returning values to CICS" on page 10.

file control EXEC interface API exits

Example program

CICS supplies, in CICSTS13.CICS.SDFHSAMP, an example program, DFH\$XTSE, that shows how to modify fields in the command-level parameter structure passed to EXEC interface exits. DFH\$XTSE is listed on page 807.

File control EXEC interface SPI exits XFCAREQ and XFCAREQC

The XFCAREQ exit allows you to intercept a file control **system programming interface (SPI)** request before any action has been taken on it by file control. The XFCAREQC exit allows you to intercept the response after a file control SPI request has completed.

Note: For information about the XFCAREQ and XFCAREQC exits that are invoked for file control **API** requests, see “File control EXEC interface API exits XFCAREQ and XFCAREQC” on page 70.

The SPI requests affected are:

- EXEC CICS INQUIRE FILE
- EXEC CICS SET FILE.

Using XFCAREQ, you can:

- Analyze the SPI parameter list (function, keywords, argument values, and responses)
- Modify any input parameter prior to execution of the request
- Prevent execution of a request and set appropriate responses.

Using XFCAREQC, you can:

- Analyze the SPI parameter list
- Modify any output parameter value and set responses after execution.

You can also:

- Pass data between your XFCAREQ and XFCAREQC exit programs when they are invoked for the same request.
- Pass data between your file control exit programs when they are invoked within the same task. You can pass data between successive invocations of XFCAREQ and XFCAREQC and also between invocations of other EXEC-enabled user exits.

If you make changes to file states (that is, if you open, close, enable, or disable a file) it is possible that exits in the file state change program (XFCSREQ and XFCSREQC) could modify situations set up by XFCAREQ. Therefore you must consider the order in which the exits are invoked. If all four exits are enabled, the order of invocation is as follows:

- For the SET FILE command:
 1. XFCAREQ
 2. XFCSREQ
 3. XFCSREQC
 4. XFCAREQC
- For the INQUIRE FILE command, only the XFCAREQ and XFCAREQC exits are invoked:
 1. XFCAREQ
 2. XFCAREQC

File control EXEC interface SPI exits XFCAREQ and XFCAREQC

Exit XFCAREQ

When invoked

Before CICS processes a file control SPI request.

Exit-specific parameters

UEPCLPS

Address of a copy of the SPI command parameter list. See “The command-level parameter structure” on page 86.

UEPFATOK

Address of a 4-byte area that can be used to pass information between XFCAREQ and XFCAREQC on a single file control SPI request.

UEPRCODE

Address of a 6-byte hexadecimal copy of the EIB return code EIBRCODE. For details of EIB return codes, see the *CICS Application Programming Reference* manual.

UEPRESP

Address of a 4-byte binary copy of the EIB response code EIBRESP.

UEPRESP2

Address of a 4-byte binary copy of the EIB response code EIBRESP2.

UEPTSTOK

Address of a 4-byte token which can be used to pass information between successive file control SPI requests within the same task (for example, between successive invocations of the XFCAREQC exit).

UEPRECUR

Address of a halfword recursion counter. The counter is set to zero when the exit is first invoked and is incremented for each recursive call.

Return codes

UERCIBYP

Bypass this request.

UERCNORM

Continue processing.

UERCPURG

Task purged during XPI call.

XPI commands

All can be used.

API and SPI commands

All can be used.

Note: Take care when using recursive commands. For example, you must avoid entering a loop when issuing a file control SPI request from the XFCAREQ exit. Use of the recursion counter UEPRECUR is recommended.

Exit XFCAREQC

When invoked

After a file control SPI request has completed, before return from the file control SPI EXEC interface program.

Exit specific parameters:

UEPCLPS

Address of a copy of the API command parameter list. See “The command-level parameter structure” on page 86.

UEPFATOK

Address of a 4-byte area that can be used to pass information between XFCAREQ and XFCAREQC on a single file control SPI request.

UEPRCODE

Address of a 6-byte hexadecimal copy of the EIB return code EIBRCODE. For details of EIB return codes, see the *CICS Application Programming Reference* manual.

UEPRESP

Address of a 4-byte binary copy of the EIB response code EIBRESP.

UEPRESP2

Address of a 4-byte binary copy of the EIB response code EIBRESP2.

UEPTSTOK

Address of a 4-byte token which can be used to pass information between successive file control SPI requests within the same task (for example, between successive invocations of the XFCAREQC exit).

UEPRECUR

Address of a halfword recursion counter. The counter is set to zero when the exit is first invoked and is incremented for each recursive call.

Return codes

UERCNORM

Continue processing.

UERCPURG

Task purged during XPI call.

XPI commands

All can be used.

API and SPI commands

All can be used.

You can update the copies of EIBRCODE, EIBRESP, and EIBRESP2 that you are given in the parameter list. If you update the values, file control copies the new values into the application program’s EXEC interface block (EIB) after the completion of XFCAREQC or if you specify a return code of UERCBYP in XFCAREQ.

You must set valid file control responses. You must set all three of EIBRCODE, EIBRESP, and EIBRESP2 to a consistent set of values, such as would be set by

File control EXEC interface SPI exits XFCAREQ and XFCAREQC

file control to describe a valid completion. CICS does not check the consistency of the values you set. If EIBRCODE is set to a non-zero value and EIBRESP is set to zero, CICS overrides EIBRESP with a non-zero value. To help you set values for EIBRCODE, EIBRESP, and EIBRESP2, the values used by file control for SPI requests are specified in DSECT DFHFAUED.

Note: Take care when using recursive commands. For example, you must avoid entering a loop when issuing a file control SPI request from the XFCAREQ exit. Use of the recursion counter UEPRECUR is recommended.

The command-level parameter structure

The command-level parameter structure consists of a series of addresses. The first address points to the EXEC interface descriptor (EID), which consists of a bit string that describes the type of request and identifies each keyword specified with the request. The remaining addresses point to pieces of data associated with the request.

You can examine the EID to determine the type of request and the keywords specified. You can examine the other parameters in the list to determine the values of the keywords. You can also modify values of keywords specified on the request.

Note: The relationship between arguments, keywords, data types, and input/output types on the file control SPI commands is summarized in the following tables:

- For INQUIRE FILE, see Table 5 on page 92.
- For SET FILE, see Table 6 on page 93.

The UEPCLPS exit-specific parameter

The UEPCLPS exit-specific parameter is passed to both XFCAREQ and XFCAREQC. It is the address of the command-level parameter structure. The command-level parameter list contains 53 addresses, FC_ADDR0 through FC_ADDR52. These are described in DSECT DFHFAUED, which you should copy into your program by including the statement COPY DFHFAUED.

The command-level parameter list is made up as follows:

FC_ADDR0

is the address of an 13-byte area called the EID which is made up as follows:

FC_GROUP
FC_FUNCT
FC_BITS1
FC_BITS2
FC_EIDOPT4
FC_EIDOPT5
FC_EIDOPT6
FC_BITS3
FC_BITS4
FC_BITS5
FC_BITS6
FC_BITS7

File control EXEC interface SPI exits XFCAREQ and XFCAREQC

FC_BITS8

FC_GROUP

Always X'4C', indicating that this is a file control SPI request.

FC_FUNCT

One byte that defines the type of request:

X'02' INQUIRE FILE

X'04' SET FILE.

FC_BITS1

Existence bits which specify which arguments were specified. To obtain the argument associated with a keyword, you need to obtain the appropriate address from the command-level parameter structure. Before using this address you must check the associated existence bit. If the existence bit is set off, the argument was not specified in the request and the address should not be used.

X'80' Set if the request contains an argument for the FILE keyword. If set, FC_ADDR1 is meaningful.

X'40' Set if the request contains an argument for the DSNAME keyword. If set, FC_ADDR2 is meaningful.

X'20' Set if the request contains an argument for the FWDRECSTATUS keyword. If set, FC_ADDR3 is meaningful.

X'10' Set if the request contains an argument for the STRINGS keyword. If set, FC_ADDR4 is meaningful.

X'08' Set if the request contains an argument for the BASEDSNAME keyword. If set, FC_ADDR5 is meaningful.

X'04' Set if the request contains an argument for the LSRPOOLID keyword. If set, FC_ADDR6 is meaningful.

X'02' Set if the request contains an argument for the READ keyword. If set, FC_ADDR7 is meaningful.

X'01' Set if the request contains an argument for the UPDATE keyword. If set, FC_ADDR8 is meaningful.

FC_BITS2

Existence bits which specify which arguments were specified. The comments below FC_BITS1 also apply to FC_BITS2.

X'80' Set if the request contains an argument for the BROWSE keyword. If set, FC_ADDR9 is meaningful.

X'40' Set if the request contains an argument for the ADD keyword. If set, FC_ADDR10 is meaningful.

X'20' Set if the request contains an argument for the DELETE keyword. If set, FC_ADDR11 is meaningful.

X'10' Set if the request contains an argument for the DISPOSITION keyword. If set, FC_ADDR12 is meaningful.

X'08' Set if the request contains an argument for the EMPTYSTATUS keyword. If set, FC_ADDR13 is meaningful.

X'04' Set if the request contains an argument for the OPENSTATUS keyword. If set, FC_ADDR14 is meaningful.

File control EXEC interface SPI exits XFCAREQ and XFCAREQC

X'02' Set if the request contains an argument for the ENABLESTATUS keyword. If set, FC_ADDR15 is meaningful.

X'01' Set if the request contains an argument for the RECOVSTATUS keyword. If set, FC_ADDR16 is meaningful.

FC_EIDOPT4

Not used by file control.

FC_EIDOPT5

Not used by file control.

FC_EIDOPT6

Not used by file control.

FC_BITS3

Existence bits which specify which arguments were specified. The comments below FC_BITS1 also apply to FC_BITS3.

X'80' Set if the request contains an argument for the ACCESSMETHOD keyword. If set, FC_ADDR17 is meaningful.

X'40' Set if the request contains an argument for the TYPE keyword. If set, FC_ADDR18 is meaningful.

X'20' Set if the request contains an argument for the OBJECT keyword. If set, FC_ADDR19 is meaningful.

X'10' Set if the request contains an argument for the REMOTESYSTEM keyword. If set, FC_ADDR20 is meaningful.

X'08' Set if the request contains an argument for the REMOTENAME keyword. If set, FC_ADDR21 is meaningful.

X'04' Set if the request contains an argument for the RECORDFORMAT keyword. If set, FC_ADDR22 is meaningful.

X'02' Set if the request contains an argument for the BLOCKFORMAT keyword. If set, FC_ADDR23 is meaningful.

X'01' Set if the request contains an argument for the KEYLENGTH keyword. If set, FC_ADDR24 is meaningful.

FC_BITS4

Existence bits which specify which arguments were specified. The comments below FC_BITS1 also apply to FC_BITS4.

X'80' Set if the request contains an argument for the KEYPOSITION keyword. If set, FC_ADDR25 is meaningful.

X'40' Set if the request contains an argument for the RECORDSIZE keyword. If set, FC_ADDR26 is meaningful.

X'20' Set if the request contains an argument for the RELTYPE keyword. If set, FC_ADDR27 is meaningful.

X'10' Set if the request contains an argument for the EXCLUSIVE keyword. If set, FC_ADDR28 is meaningful.

X'08' Set if the request contains an argument for the BLOCKKEYLEN keyword. If set, FC_ADDR29 is meaningful.

X'04' Set if the request contains an argument for the BLOCKSIZE keyword. If set, FC_ADDR30 is meaningful.

X'02' Not used by file control.

File control EXEC interface SPI exits XFCAREQ and XFCAREQC

X'01' Not used by file control.

FC_BITS5

Existence bits which specify which arguments were specified. The comments below FC_BITS1 also apply to FC_BITS5.

X'80' Set if the request contains an argument for the TABLE keyword. If set, FC_ADDR33 is meaningful.

X'40' Set if the request contains an argument for the MAXNUMRECS keyword. If set, FC_ADDR34 is meaningful.

X'20' Set if the request contains an argument for the READINTEG keyword. If set, FC_ADDR35 is meaningful.

X'10' Set if the request contains an argument for the RLSACCESS keyword. If set, FC_ADDR36 is meaningful.

X'08' Not used by file control.

X'04' Not used by file control.

X'02' Not used by file control.

X'01' Not used by file control.

FC_BITS6

Specifies whether certain keywords were specified on the File control SPI command.

X'80' Set if the request contains the START keyword.

X'40' Set if the request contains the NEXT keyword.

X'20' Set if the request contains the END keyword.

X'10' Set if the request contains the WAIT keyword.

X'08' Set if the request contains the NOWAIT keyword.

X'04' Set if the request contains the FORCE keyword.

X'02' Set if the request contains the ENABLED keyword.

X'01' Set if the request contains the DISABLED keyword.

FC_BITS7

Specifies whether certain keywords were specified on the File control SPI command. Also contains the existence bit for JOURNALNUM, which seems to be far from home.

X'80' Set if the request contains the OPEN keyword.

X'40' Set if the request contains the CLOSED keyword.

X'20' Set if the request contains the EMPTY keyword.

X'10' Set if the request contains an argument for the JOURNALNUM keyword. If set, FC_ADDR52 is meaningful.

X'08' Not used by file control.

X'04' Not used by file control.

X'02' Not used by file control.

X'01' Not used by file control.

FC_BITS8

This byte is not used by file control.

File control EXEC interface SPI exits XFCAREQ and XFCAREQC

FC_ADDR1

is the address of an 8-byte area containing the name from FILE.

FC_ADDR2

is the address of a 44-byte area containing the name from DSNAME.

FC_ADDR3

is the address of a 4-byte area containing the CVDA from FWDRECOVSTATUS.

FC_ADDR4

is the address of a 4-byte area containing the data from STRINGS.

FC_ADDR5

is the address of a 44-byte area containing the name from BASEDSNAME.

FC_ADDR6

is the address of a 4-byte area containing the data from LSRPOOLID.

FC_ADDR7

is the address of a 4-byte area containing the CVDA from READ.

FC_ADDR8

is the address of a 4-byte area containing the CVDA from UPDATE.

FC_ADDR9

is the address of a 4-byte area containing the CVDA from BROWSE.

FC_ADDR10

is the address of a 4-byte area containing the CVDA from ADD.

FC_ADDR11

is the address of a 4-byte area containing the CVDA from DELETE.

FC_ADDR12

is the address of a 4-byte area containing the CVDA from DISPOSITION.

FC_ADDR13

is the address of a 4-byte area containing the CVDA from EMPTYSTATUS.

FC_ADDR14

is the address of a 4-byte area containing the CVDA from OPENSTATUS.

FC_ADDR15

is the address of a 4-byte area containing the CVDA from ENABLESTATUS.

FC_ADDR16

is the address of a 4-byte area containing the CVDA from RECOVSTATUS.

FC_ADDR17

is the address of a 4-byte area containing the CVDA from ACCESSMETHOD.

FC_ADDR18

is the address of a 4-byte area containing the CVDA from TYPE.

FC_ADDR19

is the address of a 4-byte area containing the CVDA from OBJECT.

FC_ADDR20

is the address of a 4-byte area containing the name from REMOTESYSTEM.

FC_ADDR21

is the address of an 8-byte area containing the name from REMOTENAME.

FC_ADDR22

is the address of a 4-byte area containing the CVDA from RECORDFORMAT.

File control EXEC interface SPI exits XFCAREQ and XFCAREQC

FC_ADDR23

is the address of a 4-byte area containing the CVDA from BLOCKFORMAT.

FC_ADDR24

is the address of a 4-byte area containing the CVDA from KEYLENGTH.

FC_ADDR25

is the address of a 4-byte area containing the data from KEYPOSITION.

FC_ADDR26

is the address of a 4-byte area containing the data from RECORDSIZE.

FC_ADDR27

is the address of a 4-byte area containing the CVDA from RELTYPE.

FC_ADDR28

is the address of a 4-byte area containing the CVDA from EXCLUSIVE.

FC_ADDR29

is the address of a 4-byte area containing the data from BLOCKKEYLEN.

FC_ADDR30

is the address of a 4-byte area containing the data from BLOCKSIZE.

FC_ADDR31

is not used by file control.

FC_ADDR32

is not used by file control.

FC_ADDR33

is the address of a 4-byte area containing the CVDA from TABLE.

FC_ADDR34

is the address of a 4-byte area containing the data from MAXNUMRECS.

FC_ADDR35

is the address of a 4-byte area containing the CVDA from READINTEG.

FC_ADDR36

is the address of a 4-byte area containing the CVDA from RLSACCESS.

FC_ADDR37 to FC_ADDR51

are not used by file control.

FC_ADDR52

is the address of a 4-byte area containing the data from JOURNALNUM.

Modifying fields in the command-level parameter structure

Some fields that are passed to file control SPI requests are used as input to the request and some are used as output to the request. The method that your user exit program uses to modify a field depends on the usage of the field. As a general rule:

- On INQUIRE FILE requests, all fields except FILE are output fields.
- On SET FILE requests, all fields are input fields.

For a full description of the parameters to INQUIRE FILE, see Table 5 on page 92. For a full description of the parameters to SET FILE, see Table 6 on page 93.

File control EXEC interface SPI exits XFCAREQ and XFCAREQC

Table 5. INQUIRE FILE requests. The relationship between arguments, keywords, data types, and input/output types.

Argument	Keyword	Data Type	Input/Output
Arg1	FILE	CHAR(8)	See note.
Arg2	DSNAME	CHAR(44)	Output
Arg3	FWDRECSTATUS	BIN(31)	Output
Arg4	STRINGS	BIN(31)	Output
Arg5	BASEDSNAME	CHAR(44)	Output
Arg6	LSRPOOLID	BIN(31)	Output
Arg7	READ	BIN(31)	Output
Arg8	UPDATE	BIN(31)	Output
Arg9	BROWSE	BIN(31)	Output
Arg10	ADD	BIN(31)	Output
Arg11	DELETE	BIN(31)	Output
Arg12	DISPOSITION	BIN(31)	Output
Arg13	EMPTYSTATUS	BIN(31)	Output
Arg14	OPENSTATUS	BIN(31)	Output
Arg15	ENABLESTATUS	BIN(31)	Output
Arg16	RECOVSTATUS	BIN(31)	Output
Arg17	ACCESSMETHOD	BIN(31)	Output
Arg18	TYPE	BIN(31)	Output
Arg19	OBJECT	BIN(31)	Output
Arg20	REMOTESYSTEM	CHAR(4)	Output
Arg21	REMOTENAME	CHAR(8)	Output
Arg22	RECORDFORMAT	BIN(31)	Output
Arg23	BLOCKFORMAT	BIN(31)	Output
Arg24	KEYLENGTH	BIN(31)	Output
Arg25	KEYPOSITION	BIN(31)	Output
Arg26	RECORDSIZE	BIN(31)	Output
Arg27	RELTYPE	BIN(31)	Output
Arg28	EXCLUSIVE	BIN(31)	Output
Arg29	BLOCKKEYLEN	BIN(31)	Output
Arg30	BLOCKSIZE	BIN(31)	Output
Arg31	*	*	*
Arg32	*	*	*
Arg33	TABLE	BIN(31)	Output
Arg34	MAXNUMRECS	BIN(31)	Output
Arg35	READINTEG	BIN(31)	Output
Arg36	RLSACCESS	BIN(31)	Output
Arg37 to Arg50	*	*	*
Arg51	JOURNALNUM	BIN(15)	Output

File control EXEC interface SPI exits XFCAREQ and XFCAREQC

Note: The file parameter on INQUIRE FILE commands is:

- An input field if the request does not specify START, NEXT, or END
- An output field if the request specifies NEXT
- Omitted if the request specifies START or END.

Table 6. SET FILE requests. The relationship between arguments, keywords, data types, and input/output types.

Argument	Keyword	Data Type	Input/Output
Arg1	FILE	CHAR(8)	Input
Arg2	DSNAME	CHAR(44)	Input
Arg3	FWDRECSTATUS	BIN(31)	Input
Arg4	STRINGS	BIN(31)	Input
Arg5	*	*	*
Arg6	LSRPOOLID	BIN(31)	Input
Arg7	READ	BIN(31)	Input
Arg8	UPDATE	BIN(31)	Input
Arg9	BROWSE	BIN(31)	Input
Arg10	ADD	BIN(31)	Input
Arg11	DELETE	BIN(31)	Input
Arg12	DISPOSITION	BIN(31)	Input
Arg13	EMPTYSTATUS	BIN(31)	Input
Arg14	OPENSTATUS	BIN(31)	Input
Arg15	ENABLESTATUS	BIN(31)	Input
Arg16	RECOVSTATUS	BIN(31)	Input
Arg17	*	*	*
Arg18	*	*	*
Arg19	*	*	*
Arg20	*	*	*
Arg21	*	*	*
Arg22	*	*	*
Arg23	*	*	*
Arg24	*	*	*
Arg25	*	*	*
Arg26	*	*	*
Arg27	*	*	*
Arg28	EXCLUSIVE	BIN(31)	Input
Arg29	*	*	*
Arg30	*	*	*
Arg31	*	*	*
Arg32	*	*	*
Arg33	TABLE	BIN(31)	Input
Arg34	MAXNUMRECS	BIN(31)	Input
Arg35	READINTEG	BIN(31)	Input

File control EXEC interface SPI exits XFCAREQ and XFCAREQC

Table 6. SET FILE requests (continued). The relationship between arguments, keywords, data types, and input/output types.

Argument	Keyword	Data Type	Input/Output
Arg36	RLSACCESS	BIN(31)	Input

Modifying input fields

The correct method of modifying an input field is to create a new copy of it, and to change the address in the command-level parameter list to point to your new data.

Note: You must never modify an input field by altering the data that is pointed to by the command-level parameter list. To do so would corrupt storage belonging to the application program and would cause a failure when the program attempted to reuse the field.

Modifying output fields

The technique described in “Modifying input fields” is not suitable for modifying output fields. (The results would be returned to the new area instead of the application’s area, and would be invisible to the application.)

An output field is modified by altering the data that is pointed to by the command-level parameter list. In the case of an output field, you can modify the application’s data in place, because the application is expecting the field to be modified anyway.

Modifying the EID

It is not possible to modify the EID to make major changes to requests. It is not possible, for example, to change an INQUIRE FILE request to a SET FILE request. However, you can make minor changes to requests, such as to turn on the existence bit for a variable that had not been specified on the current request. The following paragraph lists the bits in the EID that can be modified. Any attempt to modify any other part of the EID is ignored.

Your exit program can modify any bit in FC_BITS1, FC_BITS2, FC_BITS3, FC_BITS4, FC_BITS5, FC_BITS6 and FC_BITS7, *except for*:

- The existence bit for the FILE keyword.
- The bits for the START, NEXT, and END keywords.
- Any bits described as “not used by file control”.
- Any bit corresponding to a keyword that is not applicable to the command being executed. For example, the bit for the CLOSED keyword can be modified on a SET FILE request but not on an INQUIRE FILE request, because CLOSED has meaning only for a SET FILE request. See the descriptions in Table 5 on page 92 and Table 6 on page 93.

Your program can provide its own command-level parameter structure and EID, in which case you should modify UEPCLPS and TS_ADDR0 respectively to point to the new structures.

The EID is reset to its original value before return to the application program. That is, changes to the EID are retained for the duration of the file control SPI request only.

File control EXEC interface SPI exits XFCAREQ and XFCAREQC

Note: If you modify the EID, you must be careful not to create inconsistent parameters. For example, if the original request specified SET FILE OPEN and your exit turned on the EID bit for CLOSED, the resulting SET FILE request would specify both OPEN and CLOSED. In this case, the results of the command would be unpredictable.

Use of the task token UEPTSTOK

UEPTSTOK provides the address of a 4-byte area that you can use to pass information between successive file control SPI requests in the same task. (By contrast, UEPFATOK is usable only for the duration of a single file control SPI request, because its contents may be destroyed at the end of the request.) For example, if you need to pass information between successive invocations of XFCAREQ exit, UEPTSTOK provides a means of doing this.

Modifying user arguments

User exit programs can modify user arguments as follows:

- For input arguments, your exit program should obtain sufficient storage to hold the modified argument, set up the required value, and set the associated pointer in the parameter list to the address of the newly acquired area.
- For output and input/output arguments, your exit program can update the argument in place, because the area of storage is represented in the application by a variable that is expected to receive a value from CICS.

Adding user arguments

Your exit program can add user arguments, provided that it is allowed to modify the corresponding existence bit in the EID. Assuming that the argument to be added does not already exist, your exit program must:

1. Obtain storage for the argument to be added
2. Initialize the storage to the required value
3. Select and set up the appropriate pointer from the parameter list
4. Select and set up the appropriate existence bit in Arg0
5. If necessary, modify the parameter list to reflect the new end-of-list indicator.

Removing user arguments

Your exit program can remove user arguments, provided that it is allowed to modify the corresponding existence bit in the EID. Assuming that the argument to be removed exists, your exit program must:

1. Switch the corresponding argument existence bit in Arg0 to zero
2. Modify the parameter list to reflect the new end-of-list indicator.

File control file state program exits XFCSREQ and XFCSREQC

Two user exits are provided in the file control state program. You can use XFCSREQ, which is invoked **before** a file ENABLE, DISABLE, OPEN, CLOSE, or CANCEL CLOSE request is acted on, to gather information about the state of the file—for example, which file requests (SERVREQs) are valid, which journaling options are set. Based on this information, you can suppress the request, if appropriate. (See return code UERCBYP on page 99.)

You can use XFCSREQC, which is invoked **after** the file request has been acted on, to gather information about the data set associated with the file—for example, which recovery options are set. Note that XFCSREQC is invoked even if you have used XFCSREQ to suppress the file request.

For ENABLE, DISABLE, OPEN, and CANCEL CLOSE requests, each exit is invoked only once. However, for CLOSE requests, because a file can be quiesced before actual closure, the exits might be invoked more than once, as described below.

For a single CLOSE request, XFCSREQ and XFCSREQC are invoked more than once if closure is attempted while the file is being accessed by other tasks. For example, the result of a CLOSE NOWAIT command in these circumstances is that XFCSREQ is invoked before the closure is attempted. Because there are still users of the file, the closure is delayed. However, because it specified NOWAIT, the CLOSE request completes, and invokes XFCSREQC with UEPFSRSP set to 'UEFSPEND', meaning closure is pending. When all activity against the file is complete, the file is closed, and XFCSREQ and XFCSREQC are invoked under the task that actually closed it.

For a CLOSE WAIT command, the exits are invoked as follows. XFCSREQ is invoked, the task requests a closure of the file and waits for the closure to happen. When all activity against the file is complete, the file is closed, and XFCSREQ and XFCSREQC are invoked under the task that closed it. Finally, because the closure has now been completed, the task that issued the CLOSE WAIT is resumed, completes its CLOSE request, and invokes XFCSREQC.

A CANCEL CLOSE request is issued by CICS in response to an UNQUIESCE command that cancels a pending QUIESCE command. A QUIESCE data set command immediately sets all files opened against the specified data set as unenabled, to prevent new tasks being allowed access to the data set. The close part of the operation, however, waits until the last user task finishes before a file is actually closed. (This is the same as any close operation against a file.) An UNQUIESCE issued while the close is still waiting causes a CANCEL CLOSE request and the invocation of the XFCSREQ and XFCSREQC exits. Note that a CANCEL CLOSE is issued only for close requests that were initiated by a QUIESCE command, not for any other close requests.

Note: There are two occasions when the user exits XFCSREQ and XFCSREQC are not invoked during a close request:

1. On a controlled, non-immediate shutdown of CICS, when CICS closes all files.
2. After loading a user maintained data table. When the data table load has completed the source data set is no longer required. CICS subsequently closes and de-allocates the file, leaving the data table open.

Exit XFCSREQ**When invoked**

Before a file ENABLE, DISABLE, OPEN, CLOSE, or CANCEL CLOSE is attempted.

Exit-specific parameters**UEPFSREQ**

Address of a 2-byte field that indicates the type of file request. The first byte contains one of the following values:

UEPFSOPN

Open request

UEPFSCLS

Close request

UEPFSENB

Enable request

UEPFSDIS

Disable request

UEPFSKAN

Cancel close file request.

If the first byte indicates an open request (UEPFSOPN), the second byte shows the type of open:

UEPFSNOP

Normal open

UEPFSOFB

Open for backout.

If the first byte indicates a close request (UEPFSCLS), the second byte shows the type of close:

UEPFSNC

Normal close

UEPFSKP

Close pending

UEPFSKLM

End of load mode close

UEPFSKIMM

Immediate close

UEPFSKICP

Immediate close pending

UEPFSQU

RLS quiesce close.

UEPFILE

Address of the 8-byte file name.

UEPFINFO

Address of a storage area containing information about the file. The area can be mapped using the DSECT DFHUEFDS, which contains the following fields:

file control file state program exits

UEFLNAME

The 8-character file name.

UEDSNAME

The 44-character dsname of the data set associated with the file, if this has been set before the file request was issued.

UEFSERV

One byte indicating the SERVREQ settings for this file. The possible values are:

UEFRDIM

Read valid

UEFUPDIM

Update valid

UEFADDIM

Add valid

UEFDELIM

Delete valid

UEFBRZIM

Browse valid.

UEFDSJL

One byte indicating the automatic journaling options set for this file. The possible values are:

UEFJRO

Journal read-only

UEFJRU

Journal read for update

UEFJWU

Journal write update

UEFJWA

Journal write add

UEFJDSN

Dsname has been journaled

UEFJSYN

Journal read synchronously

UEFJASY

Journal write asynchronously.

UEFDSVJL

One byte indicating a further automatic journaling option which applies to VSAM files only. The value is:

UEFJWAC

Write add complete.

UEFDSJID

One byte containing the number of the journal to be used for automatic journaling, if any.

file control file state program exits

UEFDSACC

One byte indicating the access method of the file. The possible values are:

UEFVSAM

VSAM file

UEFBDAM

BDAM file.

UEFBCRV

Set to nulls for this exit.

UEFFRLOG

Set to nulls for this exit.

UEFFRCLG

Set to blanks for this exit.

UEFCDATE

Set to nulls for this exit.

UEFCTIME

Set to nulls for this exit.

UEFBCAS

Set to nulls for this exit.

UEFACBCP

This field is set to nulls in this exit.

Note: Only the first seven fields of UEPFINFO are set for this exit. Of the remaining fields, URFFRCLG is set to blanks, and the others are set to nulls.

UEPRECUR

Address of a halfword recursion counter. The counter is set to 0 when the exit is first invoked, and is incremented for each recursive call.

Return codes

UERCNORM

Continue processing.

UERCBYP

Suppress the file request. You cannot use UERCBYP:

- To suppress a CLOSE request if the second byte of UEPFSREQ indicates it is one of the following types of close:
 - End of load-mode close (UEPFSELM)
 - Immediate close (UEPFSIMM)
 - Immediate close pending (UEPFSICP)
- To suppress an OPEN request if a file is being opened to carry out backout processing, because this would cause a backout failure. The second byte of UEPFSREQ is set to UEPFSOFB if the file is being opened for backout.

In the case of a valid suppression, CICS issues message DFHFC0996:

Open/Close/Enable/Disable/Cancel of close of file
filename suppressed due to intervention of user exit

file control file state program exits

UERC PURG

Task purged during XPI call.

XPI calls

All can be used.

API and SPI calls

All can be used.

Notes:

1. Take care when issuing recursive commands not to cause a loop. For example, it is your responsibility to avoid entering a loop when a file control request is issued from the XFCSREQ exit. Use of the recursion counter UEPRECUR is recommended.
2. Exit programs that issue EXEC CICS commands must first address the EIB. See "Using CICS services" on page 5.
3. Exit programs that issue EXEC CICS commands, and that use the DFHEIENT macro, should use the DFHEIRET macro to set a return code and return to CICS. See "Returning values to CICS" on page 10.

Exit XFCSREQC

When invoked

After a file ENABLE, DISABLE, OPEN, CLOSE, or CANCEL CLOSE command has completed.

Exit-specific parameters

UEPFSREQ

Address of a 2-byte field that indicates the type of file request. The first byte contains one of the following values:

UEPFSOPN

Open request

UEPFSCLS

Close request

UEPFSENB

Enable request

UEPFSDIS

Disable request

UEPFSCAN

Cancel file close request.

If the first byte indicates an open request (UEPFSOPN), the second byte shows the type of open:

UEPFSNOP

Normal open

UEPFSOFB

Open for backout.

If the first byte indicates a close request (UEPFSCLS), the second byte shows the type of close:

UEPFSNC

Normal close

file control file state program exits

UEPFSCP

Close pending

UEPFSELM

End of load mode close

UEPFSIMM

Immediate close

UEPFSICP

Immediate close pending

UEPFSQU

RLS quiesce close.

UEPFILE

Address of the 8-byte file name.

UEPFINFO

Address of a storage area containing information about the file. The area can be mapped using the DSECT DFHUEFDS, which contains the following fields:

UEFLNAME

The 8-character file name.

UEDSNAME

The 44-character dsname of the data set associated with the file.

UEFSERV

One byte indicating the SERVREQ settings for this file. The possible values are:

UEFRDIM

Read valid

UEFUPDIM

Update valid

UEFADDIM

Add valid

UEFDELIM

Delete valid

UEFBRZIM

Browse valid.

UEFDSJL

One byte indicating the automatic journaling options set for this file. The possible values are:

UEFJRO

Journal read-only

UEFJRU

Journal read for update

UEFJWU

Journal write update

UEFJWA

Journal write add

file control file state program exits

UEFJDSN

Dsname has been journaled

UEFJSYN

Journal read synchronously

UEFJASY

Journal write asynchronously.

UEFDSVJL

One byte indicating a further automatic journaling option which applies to VSAM files only. The value is:

UEFJWAC

Write add complete.

UEFDSJID

One byte containing the number of the journal to be used for automatic journaling, if any.

UEFDSACC

One byte indicating the access method of the file. The possible values are:

UEFVSAM

VSAM file

UEFBDAM

BDAM file.

UEFBCRV

One byte indicating the recovery attributes of the data set associated with this file. The possible values are:

UEFBCFR

Forward recovery specified

UEFBCLOG

Logging specified

UEFBCVAL

Flag indicating that recovery attributes are valid.

UEFFRLOG

A 1-byte field containing the forward recovery log identifier in the range 1—99, taken from the recovery attributes in the CICS file resource definition. This number corresponds to a CICS internal journal name of the form DFHJnn, where nn is the forward recovery log number. CICS maps this journal name to a forward recovery log stream.

The field is set to zero if forward recovery logging is not specified for the file, or if the forward recovery log stream name has been obtained from the ICF catalog.

UEFFRCLG

A 26-byte field containing the name of the forward recovery log stream taken from the ICF catalog, to be used for forward recovery. Set to blanks if not specified in the ICF catalog or if forward recovery is not being used for the file.

UEFCDATE

A date (YYYYDDD+) in packed decimal format. This field is set only when the file is the last file to close against the

file control file state program exits

VSAM sphere with which it is associated. It contains the date when activity against the VSAM sphere was brought to an end (quiesced).

UEFCTIME

A time (HHMMSSST+) in packed decimal format. This field is set only when the file is the last file to close against the VSAM sphere with which it is associated. It contains the time when activity against the VSAM sphere was brought to an end.

UEFBCAS

A flag-byte indicating the availability of this data set. If set, the value is:

UEPFBCAS

Data set marked unavailable.

UEFACBCP

Address of a read-only copy of the ACB for a VSAM file, or the DCB for a BDAM file. Set only after completion of a successful open.

UEPFSRSP

Address of a byte containing the return codes for the request. This has one of the following values:

UEFSNORM

Normal response.

UEFSWARN

Warning response.

UEFSFAIL

Failure response.

UEFSPEND

Pending response. The 'Pending' response can be returned only after a CLOSE request. It indicates that, as a result of the CLOSE request, a closure is pending on the file, the file is being quiesced. When all activity against the file has completed, it is closed. Note that, if enabled, the XFCSREQ and XFCSREQC exits are driven again, when the actual closure takes place.

UEPRECUR

Address of a halfword recursion counter. The counter is set to 0 when the exit is first invoked, and is incremented for each recursive call.

Notes:

1. The first seven fields of UEPFINFO (UEFLNAME through UEFDACC) are set for all requests; that is, following an OPEN, CLOSE, ENABLE, or DISABLE request.
2. The next three fields (UEFBCRV, UEFFRLOG, and UEFFRCLG) are valid only after a successful OPEN request.
3. The fields UEFCDATE through UEFCBCAS are set only after a successful CLOSE request. After all other requests, if the file is already closed, if the closure fails, or if the closure is pending, these fields are set to nulls.

file control file state program exits

Return codes

UERCNORM

Continue processing.

UERCPURG

Task purged during XPI call.

XPI calls

All can be used.

API and SPI calls

All can be used.

Notes:

1. Take care when issuing recursive commands not to cause a loop. For example, it is your responsibility to avoid entering a loop when a file control request is issued from the XFCSREQC exit. Use of the recursion counter UEPRECUR is recommended.
2. Exit programs that issue EXEC CICS commands must first address the EIB. See "Using CICS services" on page 5.
3. Exit programs that issue EXEC CICS commands, and that use the DFHEIENT macro, should use the DFHEIRET macro to set a return code and return to CICS. See "Returning values to CICS" on page 10.

File control open/close program exit XFCNREC

You can use XFCNREC to suppress the open failure that occurs when a mismatch is detected between the backout recovery setting for a file and its associated (non-RLS) data set.

Note: This exit is not invoked for RLS opens. For RLS, recovery is a property of the data set. Therefore it is not possible for files and their base data set to have unmatched recovery attributes.

XFCNREC is intended for those who want to continue with open processing even though the backout recovery settings for different files associated with the same base data set are not consistent.

After an open failure has been suppressed, CICS can no longer guarantee integrity for the data set and marks it accordingly. Any subsequent EXEC CICS INQUIRE DSNNAME OR CEMT INQUIRE DSNNAME RECOVSTATUS command returns NOTRECOVERABLE. Logging continues for the data set for requests via any file that has BACKOUT on its definitions, but not for those that do not have BACKOUT.

The mismatched state of the data set continues until an EXEC CICS or CEMT SET DSNNAME REMOVE command is issued, or until an initial or cold start of CICS. (if the associated data set is not in backout failed state).

At the point at which the mismatch is accepted, CICS issues a message to warn that integrity can no longer be guaranteed.

The order in which files are opened for the same base data set will determine the content of the message received on suppression of an open failure using XFCNREC. If the base cluster block is set as unrecoverable and a mismatch has been allowed, access may be allowed to the data set, via an unrecoverable file, before the data set is fully recovered.

To provide a means of selecting which mismatches to accept and which to reject, three parameters are passed to the exit. These are the address of the filename, the address of the base data set name, and the address of a byte containing the file backout indicator. Because the exit is driven only if there is a mismatch, the data set backout indicator can be derived from the setting for the file.

Note: If XFCNREC is used to suppress an open failure due to a mismatch, the global user exit XFCSREQC will pass the base data set backout setting as the exit parameter UEFBCRV, and not the file backout setting, which may be different.

For more information about writing an XFCNREC exit program, see the *CICS Recovery and Restart Guide*.

file control open/close program exit

Exit XFCNREC

When invoked

Before file open when a mismatch is detected between the backout recovery setting for the file and its associated non-RLS data set.

Exit-specific parameters

UEFILE

Address of the 8-bit file name. If the file name is less than 8 characters in length, it will be padded with blanks.

UEDSETN

Address of the 44-byte base data set name. If the data set name is less than 44 characters in length, it will be padded with blanks.

UEPFRCV

Address of a 1-byte field containing the backout recovery setting for the file, as specified in the FILE definition. The possible value is:

UEPFLOG

Backout logging specified.

If RECOV(NONE) is specified in the FILE definition, the addressed field contains hexadecimal zeros.

Note: In releases of CICS before 4.1, UEDSETN was called UEDSNAME, and UEPFLOG was called UEFBCLOG. If you are migrating exit programs from CICS/ESA 3.3 or earlier to CICS Transaction Server for OS/390 Release 3, all references to these parameters must be changed.

Return codes

UERCNORM

Fail open as normal.

UERCBYB

Bypass open failure—accept mismatch.

XPI calls

Must not be used.

SPI calls

Must not be used.

API and SPI calls

Must not be used.

File control quiesce receive exit, XFCVSDS

The XFCVSDS exit is invoked when VSAM RLS notifies CICS that processing is required as a result of some data set-related events occurring in the sysplex. XFCVSDS is invoked *before* CICS processing takes place, and only if a data set name block (DSNB) exists for the data set. The actions that cause XFCVSDS to be invoked are:

- **A data set is being quiesced throughout the sysplex.**

CICS is informed about this action only if it has files open in RLS mode against the data set.

If CICS is notified about a quiesce action, the XFCVSDS global user exit program can cancel the data set quiesce, in which case it cancels the quiesce throughout the sysplex, and the data set remains in the unquiesced state.

- **A data set is being unquiesced throughout the sysplex.**

All CICS regions in the sysplex that are registered with a VSAM RLS control ACB are informed about unquiesce actions.

- **DFSMSdss wants to start a non-BWO backup of a data set.**

CICS is notified about a non-BWO backup start action only if it has files open in RLS mode against the data set.

If CICS is notified about a non-BWO backup start action, XFCVSDS can be used to cancel the backup.

- **DFSMS™ has completed a non-BWO backup of a data set.**

All CICS regions in the sysplex that are registered with a VSAM RLS control ACB are informed about non-BWO backup complete actions.

- **DFSMS wants to start a BWO backup of a data set.**

CICS is notified about a BWO backup start action only if it has files open in RLS mode against the data set.

If CICS is notified about a BWO backup start action, XFCVSDS can be used to cancel the backup.

- **DFSMS has completed a BWO backup of a data set.**

All CICS regions in the sysplex that are registered with a VSAM RLS control ACB are informed about BWO backup complete actions.

file control quiesce receive exit

Exit XFCVSDS

When invoked

Invoked after VSAM RLS has informed CICS that processing is required as a result of a data set-related action occurring in the sysplex.

Exit-specific parameters

UEPDSNAM

Address of a 44-byte field containing the name of the data set to which the action applies

UEPVSACT

Address of a 1-byte field indicating the RLS action of which CICS has been informed. Possible values are:

UEQUIES

Quiesce

UEUNQUIS

Unquiesce

UENBWST

Non-BWO backup start

UENBWCMP

Non-BWO backup complete

UEBWOST

BWO backup start

UEBWOCMP

BWO backup complete.

UEPQUCLS

Address of a 1-byte field indicating, for UEQUIES only, how files open in RLS mode are to be closed. Possible values are:

UEORDCLO

Wait until all in-flight UOWs that are accessing the data set have completed syncpoint before closing.

UEIMMCLO

Abend all in-flight UOWs that are accessing the data set before closing.

UEPCPTEC

Address of a 1-byte field indicating, for UENBWST and UEBWOST only, whether the backup is to use the concurrent copy technique. Possible values are:

UEORDCOP

Concurrent copy is not being used.

UECONCOP

Concurrent copy is being used.

Return codes

UERCNORM

Continue processing—complete the actions required to support the VSAM RLS operation.

UERCBYP

This applies only to actions UEQUIES, UENBWST and UEBWOST.

file control quiesce receive exit

CICS is *not* to carry out the processing required for the VSAM RLS action, and is to cancel the action throughout the sysplex.

A return code of UERCPURG is not allowed.

XPI calls

All can be used.

API and SPI calls

You can use CICS API and SPI commands at this exit. In general all can be used, with the following restrictions:

- You should avoid the use of commands that cause the issuing task to suspend.
- You must not use the QUIESCESTATE option of EXEC CICS SET DSNAME for data set UEPDSNAM.
- You must not use the OPENSTATUS option of EXEC CICS SET FILE, or issue file control requests, for files that reference data set UEPDSNAM.

File control quiesce send exit XFCQUIS

The XFCQUIS global user exit is invoked on completion of a VSAM RLS quiesce or unquiesce of a data set that was requested either by a CEMT or EXEC CICS SET DSNAME QUIESCESTATE command.

The exit is invoked regardless of whether the QUIESCESTATE action has completed successfully or unsuccessfully. This enables you to perform, or schedule, any processing that cannot take place until quiesce or unquiesce processing has finished.

When invoked

On completion, successful or failed, of a SET DSNAME QUIESCESTATE command.

Exit-specific parameters

UEPQDSNM

Address of a 44-byte field containing the name of the data set that was being quiesced or unquiesced.

UEPQSTAT

Address of a 1-byte field indicating whether the data set was being quiesced or unquiesced. Possible values are:

UEQSD

Data set was being quiesced by QUIESCESTATE(QUIESCED). In-flight UOWs accessing the data set completed syncpoint before files open in RLS mode were closed.

UEIMQSD

Data set was being quiesced by QUIESCESTATE(IMMQUIESCED). In-flight UOWs accessing the data set were abended before files open in RLS mode were closed.

UEUNQSD

Data set was being unquiesced by QUIESCESTATE(UNQUIESCED).

UEPQRCDE

Address of a 1-byte field indicating the result of the quiesce or unquiesce. Possible values are:

UEQOK

Successful.

UEQREJEC

Rejected—see UEPQCONF for the reason code.

UEQUNKNO

Failed because data set not known to DFSMS as a VSAM data set.

UEQIOERR

Failed because of RLS error or SMSVSAM server not available.

UEQCANCL

Failed because quiesce was canceled by user (UEQSD and UEIMQSD only).

file control quiesce send exit

UEQTIMED

Failed because quiesce was canceled due to timeout (UEQSD and UEIMQSD only).

UEQMIGRT

Failed because the data set has been migrated.

UEPQCONF

Address of a 1-byte field indicating the reason why the quiesce or unquiesce was rejected (for UEQREJEC only). Possible values are:

UEQUIINP

Quiesce is in progress (UEQSD and UEIMQSD status only).

UEUNQINP

Unquiesce is in progress.

UENBWINP

Non-BWO copy is in progress.

UEBWOINP

BWO copy is in progress.

UEUNKINP

Unknown event is in progress.

Return codes

UERCNORM

Continue processing.

A return code of UERCPURG is not allowed.

XPI calls

All can be used.

API and SPI calls

You can use CICS API and SPI commands at this exit. In general, all can be used, but you must not use the QUIESCESTATE keyword of EXEC CICS SET DSNAME.

File control recovery program exits XFCBFAIL, XFCBOUT, XFCBOVER, and XFCLDEL

CICS provides four global user exits that you can use in connection with file control recovery operations. These are:

XFCBFAIL

Invoked when an error occurs during backout.

XFCBOUT

Invoked when CICS is about to back out a file update.

XFCBOVER

Invoked when CICS is about to skip unit-of-work (UOW) backout because a batch program has overridden RLS retained lock protection and opened a data set for batch processing.

XFCLDEL

Invoked when backing out a write to a BDAM or a VSAM ESDS data set.

Order of invocation

Each of the exits in the file control recovery program may or may not be invoked during an attempt to backout a file update. If the backout fails, each may (or may not) be reinvoked when the backout is retried. If an exit program needs to know whether it is being invoked during the original backout attempt, or during a retry, it can check the value of the RE_ATTACHED_TRANSACTION field returned by an XPI INQUIRE_TRANSACTION call.

The way in which the exits interact, and the order in which they are invoked, is shown in the following list. Assuming that all the exits are enabled, for each backout attempt or retried backout attempt:

1. If an open during backout fails, XFCBFAIL is invoked. **None of the other exits is invoked.**
2. If the SHCDS PERMITNONRLSUPDATE command has been issued for the data set being backed out, XFCBOVER is invoked. **If it returns UERCNORM (do not perform the backout), no further exits are invoked.**
3. Unless item 1 applies, or XFCBOVER has been invoked and returned UERCNORM, XFCBOUT is invoked.
4. Backout issues a read update request for the record being backed out. If the read update fails, XFCBFAIL is invoked, followed by **no further exits.**
5. If the update to be backed out was a write to a data set which does not support physical deletes (that is, a BDAM data set or a VSAM ESDS), XFCLDEL is invoked.
6. If a failure occurs after this point, XFCBFAIL is invoked.

Exit XFCBFAIL, file control backout failure exit

XFCBFAIL is invoked whenever there is a failure during backout of an update made to a file record.

If, within a given UOW, there are backout failures for more than one record in the same file, or for records in multiple files, the exit is invoked:

- For the first record in each data set for which backout fails.

file control recovery program exits

If more than one file is associated with a single data set, only the first record in the first of the files to fail backout within the UOW causes CICS to invoke the exit. All subsequent records are failed with the same error, but the exit is not invoked again.

- For the first record for each data set that fails during any retry of the backout for this UOW.

It is not invoked for backout failures to other (non-file-control) resources within the UOW.

For VSAM data sets, backout failure processing saves information that allows the backout to be retried later.

For BDAM data sets, the backout cannot be retried. If backout fails against a BDAM data set, you can use the XFCBFAIL exit to preserve data integrity by terminating CICS immediately. If the XFCBFAIL exit is not enabled, or does not terminate CICS, the BDAM data is committed and the locks are released. If the exit is enabled, you can use the XFCBFAIL global user exit program to save information that you can use to manually correct the data. However, you need to be careful that in doing this you do not back out other changes made between the time of the backout failure and the time of your own manual recovery action.

When invoked

If an error occurs during backout of a change made to a file (on the first failure in the UOW for the data set associated with the file).

Exit-specific parameters

UEPBLOGR

Address of the file control portion of the log record that represents the update that was being backed out when the file control failure occurred. The log record can be mapped using the DSECT DFHFCLGD.

UEPTRANS

Address of a 4-byte field containing the transaction id under which the update that is being backed out was made.

UEPTRMNL

Address of the 4-byte terminal id for the terminal or principal facility from which the update that is being backed out was made.

UEPTASK

Address of the 4-byte (packed decimal) field containing the task number for the task under which the update that is being backed out was made.

UEPFCRSP

Address of the file control response byte. This can have one of the following values:

UEAIXFUL

No space in non-unique alternate index.

UECACHE

RLS cache failure or cache connectivity failure.

UENBWBAK

Non-BWO backup in progress.

file control recovery program exits

UEDLOCK

Deadlock detected.

UEDUPREC

Duplicate key on unique alternate index.

UEIOEROR

I/O error.

UELCKFUL

RLS lock structure full.

UENOLDEL

Logical delete not carried out (XFCLDEL exit point is either not enabled or the XFCLDEL global user exit program chose not to perform the logical delete).

UENOSPAC

Data set out of storage.

UEOPENER

Error opening the file.

UERLSERR

SMSVSAM RLS server failure.

UERLSDIS

RLS access is currently disabled.

UERLSCON

Attempt to continue a thread with a new instance of the SMSVSAM RLS server.

UEUNEXP

Unexpected error.

UEPERR

Address of a one-byte field containing the error type. The values of the error-byte and their meanings are described in "Values of the error-type byte referenced by UEPERR" on page 115.

Return codes

UERCNORM

Continue processing and invoke CICS backout failure control.

This causes a backout failure error message to be issued (DFHFC4701 for a VSAM data set, and DFHFC4702 for a BDAM data set). For a VSAM data set CICS converts the record lock into a retained lock, and the log record is saved for a later retry of the backout.

UERCBYP

Ignore the error (do not invoke CICS backout failure control) and continue. Setting this return code could be damaging to the integrity of your data.

A return code of UERCPURG is not allowed. There is no need to set a UERCPURG return code, because the conditions under which this exit is invoked mean that a purged condition cannot be returned by any XPI or API calls.

XPI calls

All can be used, but subject to the same caution as for API and SPI calls.

API and SPI calls

Although this exit is allowed to issue API and SPI calls, you should be very careful about which commands you use because the exit is invoked during file backout, which is part of syncpoint phase 2.

It is recommended that you restrict EXEC CICS commands to inquiries, and avoid commands that update CICS resources, because the resources may themselves be in a state of recovery. In particular, the following restrictions apply:

1. Do not issue any recoverable operations.
2. Do not use operations that access systems or resource owners external to this CICS, even if the target resource is non-recoverable.
3. Do not disable or close files, because this could cause further error conditions.
4. It is possible for this exit to be invoked under a different transaction environment from that under which the updates that are being backed out were originally made. If your exit program wants to perform any actions (such as writing a message to the terminal) that require it to be running under the original transaction environment, it must first check the value returned in the RE_ATTACHED_TRANSACTION parameter of a transaction manager INQUIRE_TRANSACTION XPI call.

Values of the error-type byte referenced by UEPERR

The UEPERR field in the XFCBFAIL parameter list points to an error-type byte, which contains one of the following values:

XBFERU

An error response has been returned from the file control file-request-handler program while processing a READ UPDATE request. This request is issued by file control backout to retrieve the existing copy of the record before backing it out.

Use UEPFCRSP in combination with the type of record, shown in the file control portion of the log record addressed by parameter UEPBLOGR, to determine the specific problem. The storage area addressed by UEPBLOGR contains either the before-image of a “read-update” record or the new copy of a “write-add” to be deleted. The type-of-record field, FLJB_RECORD_TYPE, is defined in DSECT DFHFCLGD.

XBFERE

An error response has been returned from the file control file-request-handler program while processing a REWRITE request. This request is issued by file control backout to replace the existing copy of the record on the data set with the “before-image” held in the log record addressed by UEPBLOGR. Use parameter UEPFCRSP to determine which error occurred.

XBFEWR

An error response has been returned from the file control file-request-handler program while processing a WRITE request. This request is issued by file control backout to add the “before-image” of a deleted record. Use parameter UEPFCRSP to determine which error occurred.

XBFEDL

An error response has been returned from the file control file-request-handler program while processing a REWRITE DELETE

file control recovery program exits

request. This request is issued by file control backout to delete a new record added to a VSAM data set. Use parameter UEPFCRSP to determine which error occurred.

XBFENO

The failure that occurred during file control backout was not as a result of an error response from the file control file-request-handler program. Use parameter UEPFCRSP to determine which error occurred.

DFH\$FCBF sample global user exit program

DFH\$FCBF provides sample processing for the file control backout failure global user exit, XFCBFAIL. The exit program, if enabled at the XFCBFAIL exit point, is invoked if an error occurs during backout of a file control update.

There is more information about using the XFCBFAIL user exit, and the sample program, in the comments within the DFH\$FCBF source code. The comments also include some suggested extensions to the sample program.

In summary, DFH\$FCBF performs the following processing:

- If tracing is active for file control, makes a user trace entry. This has trace point id 'X'01D0' and traces:
 - An eye-catcher 'DFH\$FCBF ENTRY'
 - The file control response byte
 - The error type
 - The file control portion of the log record.
- Issues an EXEC CICS INQUIRE FILE command to check the access method to see if the data set is BDAM. If it is, CICS does not support backout retries. Therefore, a message is written to the console advising that either this file and any other files using the base data set (named in message DFHFC4702) should be closed, or CICS should be shut down to prevent further corruption. Sets a response of UERCNORM and takes the normal exit from the program.
- If the access method is neither BDAM nor VSAM, takes the error exit from the program.
- Checks whether the file is one for which it has been decided that backout failures will be ignored, by checking the filename (field FLJB_FILE_NAME in the log record). The sample program writes a message to the console to this effect, then sets a response of UERCBYP and takes the normal exit from the program. A return code of UERCBYP specifies that the error should be ignored. This causes CICS not to retry the backout; the result is as if the data were committed instead of being backed out.

The sample program takes this step to demonstrate the use of the UERCBYP return code. It is not recommended that you use UERCBYP with important data sets.

- Examines the file control response code and issues a message to the console describing the procedure to be followed for this error. The sample program provides slots for each possible file control response code, and includes suggested messages for some of them. The sample program should be customized by expanding the set of messages to describe procedures that are appropriate for your installation for each error, or to take other action within the exit program. If you do not add a message for any particular response code, the operator still sees message DFHFC4701, which advises on any action that needs to be taken. This is issued as part of CICS backout failure processing.

file control recovery program exits

- Sets a response code of UERCNORM and takes the normal exit from the program. A return code of UERCNORM specifies that CICS backout failure processing is to be carried out. This means that CICS issues a backout failure error message and, for a VSAM data set, ensures that the record remains locked until the backout can be retried and saves the log record for later retry.
- Normal exit from the program writes a user trace entry if tracing is active for file control and there were no errors during processing. This has trace point id X'01D1' and traces:
 - An eye-catcher 'DFH\$FCBF EXIT OK'
 - The file control portion of the log record
 - Some text: 'Handle backout failure' or 'Bypass backout failure' as appropriate.
- Error exit from the program (taken if errors occur during processing or if CICS functions fail):
 - Writes a user exception trace entry regardless of the trace setting. This has trace point id X'01D2' and traces:
 - An eye-catcher 'USEREXC'
 - An eye-catcher 'DFH\$FCBF EXIT FAIL'
 - The file control portion of the log record.
 - Returns a response of UERCNORM so that, although an error has occurred in the exit, CICS still performs its normal backout failure processing.

Exit XFCBOUT, file control backout exit

XFCBOUT is invoked when a file control update is about to be backed out. The log record containing the before-image of the record being backed out is passed to the exit program.

XFCBOUT does not provide a return code to allow your exit program to bypass the backout of the update, because this would result in data corruption.

Migration note

XFCBOUT replaces the function provided for file control, in releases before CICS Transaction Server for OS/390 Release 1, by the XDBIN and XRCINPT exits. In earlier releases:

- XDBIN was invoked when a dynamic log record was processed during dynamic backout. It was passed the log record being processed.
- XRCINPT was invoked when a log record from the restart data set was processed during backout of in-flight work at emergency restart. It was passed the log record, and the address of the FBO table entry.

Because the same backout code is executed following an emergency restart as at any other time, XFCBOUT replaces both XRCINPT and XDBIN for file data. The address of an FBO entry is not supplied (there is no FBO table in CICS Transaction Server for OS/390 Release 3). However, the file name is in the log record, so your exit program can use an EXEC CICS INQUIRE FILE command to get information about the file.

When invoked

Invoked when an update (represented by a before-image log record) is being backed out by File Control.

file control recovery program exits

Exit-specific parameters

UEPFLOGR

The address of the file control portion of the log record that is being presented for backout. This is mapped by the DSECT DFHFCLGD.

Return codes

UERCNORM

Continue processing.

A return code of UERCPURG is not allowed. There is no need to set a UERCPURG return code, because this exit is invoked during syncpoint phase 2, and therefore cannot get a purged response from any calls it makes.

XPI calls

All can be used, but subject to the same caution as for API and SPI calls.

API and SPI calls

Although this exit is allowed to issue API and SPI calls, you should be very careful about which commands you use because the exit is invoked during file backout, which is part of syncpoint phase 2.

It is recommended that you restrict EXEC CICS commands to inquiries, and avoid commands that update CICS resources, because the resources may themselves be in a state of recovery. In particular, the following restrictions apply:

1. Do not issue any recoverable operations.
2. Do not use operations that access systems or resource owners external to this CICS, even if the target resource is non-recoverable.
3. Do not disable or close files, because this could cause further error conditions.
4. It is possible for this exit to be invoked under a different transaction environment from that under which the updates that are being backed out were originally made. If your exit program wants to perform any actions (such as writing a message to the terminal) that require it to be running under the original transaction environment, it must first check the value returned in the RE_ATTACHED_TRANSACTION parameter of a transaction manager INQUIRE_TRANSACTION XPI call.

Because it is anticipated that XFCBOUT will be used for specific applications, no general-purpose sample exit program is provided. You could use any of samples for the other file control recovery exits—DFH\$FCBF, DFH\$FCBV, or DFH\$FCLD—as the basis for an XFCBOUT exit program.

Exit XFCBOVER, file control backout override exit

XFCBOVER is part of the support CICS file control provides for “batch windows” in a VSAM RLS environment.

VSAM RLS locks individual records within a data set, and these locks are converted to retained locks for those UOWs that are not completed because of backout or in-doubt failures, thus preserving data integrity. To avoid corruption of a data set by a non-RLS batch job, which is not aware of the retained record locks, a data set cannot normally be opened for update in non-RLS mode if it has any locked records.

Retained lock override for batch

There may be circumstances in which you want to override these locks and force the open of a data set for batch processing. For example, when:

- There is insufficient time available, before running the batch job, in which to resolve the situation that caused the records to be locked, or
- It is known that the batch job cannot harm data integrity (because it does not update existing records in the data set, or it does not update any records that CICS may have updated).

To override the open restriction, VSAM RLS provides the SHCDS PERMITNONRLSUPDATE command, to allow a non-RLS batch job to open a sphere for update even when there are retained locks.

Effect of retained lock override on CICS

VSAM records the use of the option to override retained locks, so that it can notify a CICS region when the region next opens the data set. Because data could have been altered by the non-RLS batch job, the results of CICS performing any recovery (on UOWs that were in a backout-failed or indoubt-failed state at the time of the batch job) are unpredictable. In this situation, therefore, the default CICS action is not to back out any updates that were outstanding at the time that locks were overridden, and to write diagnostic information about each backout ignored to the CSFL transient data queue.

The XFCBOVER global user exit is provided to enable you, for each UOW log record for which backout is being ignored, to:

- Write application-related diagnostics to supplement those provided by CICS
- To perform application-related recovery actions
- To reverse the default by requesting that the backout should be carried out after all. This option is required for the case where the batch job is known not to corrupt data integrity (for example, because it only inserts records).

file control recovery program exits

When invoked

Whenever CICS is about to ignore a UOW log record that is due to be backed out, because the lock that protected the updated record could have been overridden by a non-RLS batch program.

Exit-specific parameters

UEPOLOGR

Address of the file control portion of a shunted log record that represents an update to a data set for which retained locks may have been overridden. The file control portion of the log record can be mapped using the DSECT DFHFCLGD.

UEPODSN

Address of a 44-byte area of storage containing the name of the data set whose locks were overridden.

Return codes

UERCNORM

Do not perform the backout of this log record. Any updates performed by the batch run should take precedence.

UERCBCKO

Perform the backout. It is known that the actions of the batch job could not have affected this update.

A return code of UERCPURG is not allowed. There is no need to set a UERCPURG return code, because this global user exit is invoked during syncpoint phase 2, and therefore cannot get a purged response from any calls that it makes.

XPI calls

All can be used, but subject to the same caution as for API and SPI calls.

API and SPI calls

Although this exit is allowed to issue API and SPI calls, you should be very careful about which commands you use because the exit is invoked during file backout, which is part of syncpoint phase 2.

It is recommended that you restrict EXEC CICS commands to inquiries, and avoid commands that update CICS resources, because the resources may themselves be in a state of recovery. In particular, the following restrictions apply:

1. Do not issue any recoverable operations.
2. Do not use operations that access systems or resource owners external to this CICS, even if the target resource is non-recoverable.
3. Do not disable or close files, because this could cause further error conditions.
4. It is possible for this exit to be invoked under a different transaction environment from that under which the updates that are being backed out were originally made. If your exit program wants to perform any actions (such as writing a message to the terminal) that require it to be running under the original transaction environment, it must first check the value returned in the RE_ATTACHED_TRANSACTION parameter of a transaction manager INQUIRE_TRANSACTION XPI call.

DFH\$FCBV sample global user exit program

DFH\$FCBV provides sample processing for the file control backout override global user exit, XFCBOVER. The exit program, if enabled at the XFCBOVER exit point, is invoked when a log record is presented to file control for backing out an update to a data set in RLS access mode, after the data set has been used in a batch update despite the existence of retained locks. A consequence of running a batch program while there are retained locks is that a lock that protected a record updated by CICS could have been overridden by a non-RLS batch program.

There is more information about using the XFCBOVER exit, and about the DFH\$FCBV sample program, in the comments within the DFH\$FCBV source code. The comments also include some suggested extensions that you can make to the sample program to reflect the pattern of batch usage at your installation.

In summary, DFH\$FCBV performs the following processing:

- Makes a user trace entry if tracing is active for file control. This has trace point id X'01E0' and traces:
 - An eye-catcher 'DFH\$FCBV ENTRY'
 - The data set name
 - The file control portion of the log record.
- Checks the data set name to see if it is one of those for which it is known that batch programs never update existing records, but only insert new records, or do not make updates at all. The sample program contains a table of such data sets. If this data set is in the table, UERCCKO is returned. UERCCKO means that CICS is to perform the backout, despite the override option having been used, because the locked record cannot have been updated by a batch job.
- For all other data sets, it must be assumed that the batch job could have updated the record being backed out. The sample therefore returns UERCNORM, which instructs CICS to take the default action of not backing out the update.
- Exit from the program, making:
 - A user trace entry if tracing is active for file control. This has trace point id X'01E1' and traces:
 - An eye-catcher 'DFH\$FCBV EXIT'
 - The data set name
 - Some text: 'Update will be backed out', or 'Update will not be backed out' as appropriate.

file control recovery program exits

Exit XFCLDEL, file control logical delete exit

XFCLDEL is invoked whenever a WRITE to a VSAM ESDS, or to a BDAM data set, is being backed out. Because these types of data set do not support deletion, you can use XFCLDEL to perform a logical delete by amending the record in some way that flags it as deleted.

When invoked

Invoked when backing out a WRITE to a VSAM ESDS or a BDAM data set.

Exit-specific parameters

UEPBLOGR

Address of the file control portion of the log record representing the update that is to be backed out by logical deletion. The log record can be mapped using the DSECT DFHFCLGD.

UEPTRANS

Address of the 4-byte transaction id under which the update that is being backed out was made.

UEPTRMNL

Address of the 4-byte terminal id for the terminal or principal facility from which the update that is being backed out was made.

UEPTASK

Address of the 4-byte (packed decimal) task number for the task under which the update that is being backed out was made.

UEPFDATA

Address of a variable-length field containing the data in the file control request. The exit program can amend the record data addressed by this field, marking it in some way that applications can recognize as representing a logically deleted record.

UEPFLEN

Address of a fullword containing the length of the data in the file control request.

Return codes

UERCFAIL

Do not perform the logical delete, and treat this as a backout failure. This is the default action taken if the exit is not enabled.

UERCLDEL

Perform the logical delete by reapplying the updated record.

A return code of UERCPURG is not allowed. There is no need to set a UERCPURG return code, because the conditions under which this exit is invoked should mean that "purged" cannot be returned by any XPI or API calls.

XPI calls

All can be used, but subject to the same caution as for API and SPI calls.

API and SPI calls

Although this exit is allowed to issue API and SPI calls, you should be very careful about which commands you use because the exit is invoked during file backout, which is part of syncpoint phase 2.

file control recovery program exits

It is recommended that you restrict EXEC CICS commands to inquiries, and avoid commands that update CICS resources, because the resources may themselves be in a state of recovery. In particular, the following restrictions apply:

1. Do not issue any recoverable operations.
2. Do not use operations that access systems or resource owners external to this CICS, even if the target resource is non-recoverable.
3. Do not disable or close files, because this could cause further error conditions.
4. It is possible for this exit to be invoked under a different transaction environment from that under which the updates that are being backed out were originally made. If your exit program wants to perform any actions (such as writing a message to the terminal) that require it to be running under the original transaction environment, it must first check the value returned in the RE_ATTACHED_TRANSACTION parameter of a transaction manager INQUIRE_TRANSACTION XPI call.

DFH\$FCLD sample global user exit program

DFH\$FCLD provides sample processing for the file control logical delete global user exit, XFCLDEL. The exit program, if enabled at the XFCLDEL exit point, is invoked when a WRITE to a VSAM ESDS or BDAM data set is being backed out. Because these access methods do not support a physical delete operation, special action must be taken to provide a logical delete function. Normally this involves flagging the record in a way that application programs that use the data set recognize as meaning the record has been deleted.

There is more information about using the XFCLDEL user exit, and about the DFH\$FCLD sample program, in the comments within the DFH\$FCLD source code.

In summary, DFH\$FCLD performs the following processing:

- Makes a user trace entry if tracing is active for file control. This has trace point id X'01F0' and traces:
 - An eye-catcher 'DFH\$FCLD ENTRY'
 - The unmarked file control request data
 - The file control portion of the log record.
- Issues an EXEC CICS INQUIRE FILE command to check the access method and type to confirm that the file is a VSAM ESDS or BDAM data set. The logical delete exit should have been invoked only if the file is one of these types.
- For a VSAM ESDS:
 - Flags the record (whose address is passed to the exit in UEPFDATA) as logically deleted. The sample adopts what is probably the most common convention, which is to flag the first byte with a logical delete mark of X'FF'.
 - Takes the normal exit from the program.
- For BDAM:
 - Flags the record (whose address is passed to the exit in UEPFDATA) as logically deleted. The sample adopts a convention for BDAM of flagging the first byte with a logical delete mark of X'C0'.
 - Takes the normal exit from the program.
- For any other combination of access method and type:
 - Does not process the request, and the record is not flagged as deleted
 - Takes the error exit from the program.

file control recovery program exits

- Normal exit from the program:
 - Makes a user trace entry if tracing is active for file control. This has trace point id X'01F1' and traces:
 - An eye-catcher 'DFH\$FCLD EXIT OK'
 - An eye-catcher 'RECORD MARKED AS DELETED'
 - The marked file control request data
 - The file control portion of the log record.
 - Returns to CICS with return code UERCLDEL, which instructs CICS to rewrite the marked record and therefore to logically delete it.
- Error exit from the program:
 - Makes a user exception trace entry regardless of the trace setting. This has trace point id X'01F2' and traces:
 - An eye-catcher 'USEREXC'
 - An eye-catcher 'DFH\$FCLD EXIT FAIL'
 - The unmarked file control request data
 - The file control portion of the log record.
 - Returns to CICS with return code UERCFAIL, which instructs CICS to regard the logical delete as having failed. (The return code UERCNORM is not intended for use by this exit. Returning UERCNORM has the same effect as UERCFAIL.)

Front End Programming Interface exits XSZARQ and XSZBRQ

Exits XSZARQ and XSZBRQ are invoked from the CICS/ESA Front End Programming Interface (FEPI), if FEPI is installed. For details of these exits, see the *CICS Front End Programming Interface User's Guide*.

“Good morning” message program exit XGMTEXT

When invoked

Before the “good morning” message is transmitted.

Exit-specific parameters

UEPTCTTE

Address of the terminal control table terminal entry (TCTTE). The TCTTE can be mapped using the DSECT DFHTCTTE.

UEPTIOA

Address of the terminal input/output area (TIOA). The TIOA can be mapped using the DSECT DFHTIOA. However, fields TIOASAL and TIOASCA are **not** programming interfaces.

Return codes

UERCNORM

Continue processing.

UERCPURG

Task purged during XPI call.

XPI calls

All can be used.

Intersystem communication program exits XISCONA and XISLCLQ

The two exits in the intersystem communication program allow you to control the length of intersystem queues.

Note: There are several methods that you can use to control the length of intersystem queues. For a description of the available methods, see the *CICS Intercommunication Guide*.

The XISCONA exit

Important

It is recommended that you use the XZIQUE exit, in the VTAM working-set module, to control the length of intersystem queues, rather than XISCONA. (XZIQUE is described on page 237.) XZIQUE provides more functions, and is of more general use than XISCONA (it is driven for function shipping, DPL, transaction routing, and distributed transaction processing requests, whereas XISCONA is driven only for function shipping and DPL). If you enable both exits, XZIQUE and XISCONA could both be driven for function shipping and DPL requests, which is not recommended.

If you already have an XISCONA exit program, you may be able to modify it for use at the XZIQUE exit point.

The purpose of XISCONA is to help you prevent the performance problems that can occur when function shipping or DPL requests awaiting free sessions for a connection are queued in the issuing region. The exit permits you to control the number of outstanding ALLOCATE requests by allowing you to reject any function shipping or DPL request that would otherwise be queued.

Function shipping and DPL requests for a resource-owning region are queued by default if all bound contention winner⁴ sessions are busy, so that no sessions are immediately available. If the resource-owning region is unresponsive (for example, if it is a file-owning region, it may be waiting for a system journal to be archived), the queue can become so long that the performance of the issuing region is severely impaired. Further, if the issuing region is an application-owning region, its impaired performance can spread back to the terminal-owning region.

To control the queuing of function shipping and DPL requests, use the XISCONA exit to tell CICS, whenever a session cannot be allocated immediately, whether to queue the request, or to return 'SYSIDERR' to the application. The exit works like this:

1. If the XISCONA exit program is **not** active, CICS queues the request when necessary.
2. If the exit program is active, it is invoked *only if all bound contention winner sessions are in use*. For other failures (for example, 'Mode name not found' or 'Out of service'), CICS bypasses the exit and returns to the application.

4. "Contention winner" is the terminology used for LU6.2 connections. The XISCONA exit applies also to MRO and LU6.1 connections: in these, the SEND sessions (defined in the session definitions) are used first for ALLOCATE requests; when all SEND sessions are in use, queuing starts.

intersystem communication program exits

3. If it is invoked, your exit program must decide whether or not to queue the request by analyzing the statistics provided through the user exit parameter list. Your exit program could:

- Stipulate that queuing is never to be used. This is the simplest way to code the exit, and avoids complexities of tuning. It should be effective if you define enough contention winner sessions to handle the peak transaction load for the connection. If you suppress all queuing, you must specify AUTOCONNECT(YES) on the SESSIONS definition, because the queuing mechanism no longer binds sessions for you.

With this approach, a danger arises if you base your estimate of required sessions on average conditions and the transaction load subsequently varies widely; when CICS cannot use queuing to cope with the variation, users may suffer transaction abends when there is no significant problem in the resource-owning region.

- Examine the number of requests currently in the queue. The program could, for example, stop queuing when the number exceeds 120% of the maximum number of sessions. You could use this approach to cope with intermittent stoppages in the resource-owning region.

You could use a table of thresholds for the connections in your system, with values determined from previous experience of queuing problems.

Alternatively, you could use the EXEC CICS interface in a separate program to inquire about the state of the connection, and pass the information in a work area to the XISCONA exit program.

- Examine the type of request and the resource being accessed (which can be discovered by examining the request parameter list). The program could, for example, reject file read requests but queue file updates.

Note: Because a failure of the exit program could affect system availability, it is recommended that you make the logic of your program as simple as possible, thus reducing the possibility of errors.

There are some problems that XISCONA cannot solve. For example, if you have specified both a large number of sessions and a large value for MXT, CICS may develop the short-on-storage (SOS) condition *before* XISCONA is invoked because there are no further sessions available.

The sample XISCONA global user exit program, DFHXIS

Note that there is a CICS-supplied sample exit program, DFHXIS, that shows one way of limiting the queue of ALLOCATE requests, based on the information passed to the program. For more information about the sample global user exit programs, see “Sample global user exit programs” on page 14.

Exit XISCONA

When invoked

When a function shipping or DPL request is about to be queued because all bound contention winner sessions to the remote region are in use.

Note: For DPL requests that are routed dynamically, the dynamic routing program is invoked before XISCONA. If there are no free sessions the routing program may choose not to queue a DPL request; in these circumstances, XISCONA is not invoked. For information about the dynamic routing of DPL requests, see the *CICS Intercommunication Guide*.

Exit-specific parameters**UEPISPCA**

Address of a parameter list containing the following fields. You can map the parameter list using the DSECT DFHXISDS.

UEPCONST

Address of the Connection statistics record.

Connection statistics records are of type STICONSR (STID value 52). Your exit program can map the record using the DSECT DFHA14DS. See notes.

UEPMODST

Address of the Mode Entry statistics record, or zero. A Mode Entry statistics record is built *only* if:

- The connection-type is LU6.2 (see field UEPCONTY).
- The profile DFHCICSF (which is always used for function shipping) defines a specific MODENAME to be used in the allocation of LU6.2 sessions.

Mode Entry statistics records are of type STICONMR (STID value 76). Your exit program can map the record (if present) using the DSECT DFHA20DS.

UEPEIPPL

Address of the request parameter list.

UEPCONTY

A 1-byte field indicating the connection-type. Possible values are:

UEPMRO (X'80')

Request for an MRO connection

UEPLU6 (X'40')

Request for an LU6.1 connection

UEPLUC (X'20')

Request for an LU6.2 connection.

UEPNETNM

An 8-character field containing the NETNAME for the connection- that is, the identifier (applid) of the remote CICS region or system.

Notes:

1. The general format of statistics records is described in "CICS statistics record format" on page 682.
2. For a list of statistics record-types and their associated copy books, see Figure 97 on page 686.
3. For a description of the fields in Connection and Mode Entry statistics records, see the *CICS Performance Guide*.

Return codes**UERCAQUE**

Queue the request. This is the default.

UERCAPUR

Do not queue the request, unless local queuing is possible.

intersystem communication program exits

XPI calls

All can be used.

Important

There is no 'UERCNORM' return code at this exit point, because the exit is invoked after a failure. The choice is whether or not to take the system default action of queuing the request.

The XISLCLQ exit

XISLCLQ enables you to specify what action to take after a function shipping request fails to allocate a session with a remote system for one of the following reasons:

- The remote system is not in service.
- A connection to the remote system cannot be established.
- No sessions are immediately available, and your XISCONA exit program has specified that the request is not to be queued in the issuing region.

Note that this exit is invoked *only* if the request to be shipped is of type EXEC CICS START NOCHECK. For EXEC CICS requests other than those with the NOCHECK option (which is only available on START commands) the 'SYSIDERR' condition is raised in the application program.

You can use the exit to specify whether or not the failed request is to be locally queued, to be executed when the connection is reestablished.

Exit XISLCLQ

When invoked

After a function shipping request of type EXEC CICS START NOCHECK has failed because the remote system is not in service, a connection to the remote system cannot be established, or no sessions are immediately available, and your XISCONA exit program has specified that the request is not to be queued in the issuing region.

Exit-specific parameters

UEPISPP

Address of a parameter list that contains:

UEPTCTSE

Address of the relevant terminal control table system entry. The TCT system entry can be mapped using the DSECT DFHTCTTE.

UEPXXTE

Address of the local transaction name, or 0 if SYSID was specified in the command.

Note: Your program can use the transaction manager XPI call INQUIRE_TRANDEF to obtain details of the local transaction (see page 375).

UEPPLIST

Address of the parameter list for the command.

intersystem communication program exits

Note: No DSECT is provided for the above parameter list. You have to code your own DSECT to access the named fields.

Return codes

UERC SYS

Take the system action. This is determined by the value of the LOCALQ attribute in the local TRANSACTION definition for the remote transaction:

LOCALQ(YES)

The request is queued locally.

LOCALQ(NO)

'SYSIDERR' is returned to the application program.

UERC QUE

Queue the request locally (overriding the LOCALQ(NO) attribute, if specified).

UERC IGN

Override the LOCALQ(YES) attribute, if specified, and return with 'SYSIDERR'.

UERC PURG

Task purged during XPI call.

XPI calls

All can be used.

Important

There is no 'UERCNORM' return code at this exit point, because the exit is invoked after a failure. The choice is whether to take the system default action or to handle the error in some other way.

Interval control program exits XICREQ, XICEXP, and XICTENF

You can use some XPI calls in exit programs invoked from the interval control program. However, when any of these exits are invoked for expiry analysis, any actions that delay the execution of the interval control program can have adverse effects on other transactions that are waiting for intervals to expire. You can determine whether the exits have been invoked for expiry analysis by examining the type-of-request field, TCAICTR, a copy of which is pointed to by the UEPICRQ1 exit-specific parameter.

Note: The XICREQ exit is invoked by internal requests made by CICS code, as well as by requests made by applications. For example, if you use the CICS extended recovery facility (XRF), the XRF surveillance program uses interval control services. DFHXRSP issues an interval control WAIT every 2 seconds; this means that any interval control exit programs are also invoked every 2 seconds.

Exit XICREQ

When invoked

At the beginning of the interval control program, before request analysis.

Exit-specific parameters

UEPICQID

Address of an 8-byte field containing the request ID parameter on request. See notes below.

UEPICTID

Address of a 4-byte field containing the terminal ID, if any, specified on an EXEC CICS START command. See notes below.

UEPICTI

Address of 4 bytes containing the transaction ID specified on an EXEC CICS START command. See notes below.

UEPICRQ1

Address of a 1-byte field containing a copy of TCAICTR, the first request code field for requests to the interval control program.

UEPICRQ2

Address of a 1-byte field containing a copy of TCAICTR2, the second request code field for requests to the interval control program.

UEPICRT

Address of a 4-byte field containing the expiry time or interval, in packed decimal format. The value is in the form 0HHMMSSF, where H=hours, M=minutes, S=seconds, and F is a positive sign.

Notes:

1. The contents of the fields addressed by UEPICQID and UEPICTID are unpredictable if the associated data items were not specified on the request. You must test the copy of TCAICTR to determine whether they contain meaningful values.
2. Your exit program can change the values of the fields addressed by UEPICQID, UEPICTID, UEPICRT, and UEPICRT. Changing the values of the fields addressed by UEPICRQ1 or UEPICRQ2 has no effect.

Return codes

UERCNORM

Continue processing.

UERCPURG

Task purged during XPI call.

XPI calls

The following must not be used:

ADD_SUSPEND

DELETE_SUSPEND

DEQUEUE

ENQUEUE

RESUME

SUSPEND

WAIT_MVS.

Exit XICEXP

When invoked

After an interval control time interval has expired.

Exit-specific parameters

UEPICE

Address of the interval control element (ICE) that has just expired.
The ICE can be mapped using the DSECT DFHICEDS.

Return codes

UERCNORM

Continue processing.

UERCPURG

Task purged during XPI call.

XPI calls

The following must not be used:

ADD_SUSPEND

DELETE_SUSPEND

RESUME

SUSPEND

WAIT_MVS.

Exit XICTENF

When invoked

Exit XICTENF is also invoked from the interval control program. However, this exit relates to the 'terminal not known' condition and so is considered in detail in "Terminal not known' condition exits XALTENF and XICTENF" on page 208.

Interval control EXEC interface program exits XICEREQ and XICEREQC

XICEREQ is invoked on entry to the interval control program before CICS processes an interval control request. Using XICEREQ, you can:

- Analyze the request to determine its type, the keywords specified, and their values.
- Modify any value specified by the request before the command is executed.
- Set return codes to specify that either:
 - CICS should continue with the request, modified or unmodified.
 - CICS should bypass the request. (Note that if you set this return code, you must also set up return codes for the EXEC interface block (EIB), as if you had processed the request yourself.)

XICEREQC is invoked after the interval control program request is completed. Using XICEREQC, you can:

- Analyze the request, to determine its type, the keywords specified, and their values.
- Set return codes for the EIB.

CICS passes eight parameters to these exits as follows:

- The address of the command-level parameter structure (UEPCLPS)
- The address of a token (UEPICTOK) used to pass 4 bytes of data from XICEREQ to XICEREQC
- The addresses of copies of four pieces of return code and resource information from the EIB
- The address of a token (UEPTSTOK) that is valid throughout the life of a task
- The address of an exit recursion count (UEPRECUR).

Note: The XICEREQ exit is invoked by internal requests made by CICS code, as well as by requests made by applications.

Exit XICEREQ

When invoked

Before CICS processes an interval control API request.

Exit-specific parameters

UEPCLPS

Address of the command-level parameter structure. See “The UEPCLPS exit-specific parameter” on page 138.

UEPICTOK

Address of a 4-byte token to be passed to XICEREQC. This allows you, for example, to pass a work area to exit XICEREQC.

UEPRCODE

Address of a 6-byte hexadecimal copy of the EIB return code ‘EIBRCODE’. For details of EIB return codes, refer to the *CICS Application Programming Reference* manual.

UEPRESP

Address of a 4-byte binary copy of the EIB response code ‘EIBRESP’.

interval control EXEC interface program exits

UEPRESP2

Address of a 4-byte binary copy of the EIB response code 'EIBRESP2'.

UEPTSTOK

Address of a 4-byte token that is valid throughout the life of a task. See "Using the task token UEPTSTOK" on page 145.

UEPRECUR

Address of a halfword recursion counter. The counter is set to 0 when the exit is first invoked, and is incremented for each recursive call.

UEPRSRCE

Address of an 8-character copy of the EIB resource value, EIBRSRCE.

Return codes

UERCNORM

Continue processing.

UERCBYP

The interval control EXEC interface program should ignore this request.

UERCPURG

Task purged during XPI call.

XPI calls

All can be used. You can also use EXEC CICS API commands at this user exit.

Although the exit permits the use of XPI GETMAIN and FREEMAIN calls, you are recommended to use the EXEC CICS GETMAIN and FREEMAIN commands instead.

API and SPI commands

All can be used.

Note: Take care when issuing recursive commands not to cause a loop. For example, it is your responsibility to avoid entering a loop when an interval control request is issued from the XICEREQ exit. Use of the recursion counter UEPRECUR is recommended.

Exit XICEREQC

When invoked

After an interval control API request has completed, and before return from the interval control EXEC interface program.

Exit-specific parameters

UEPCLPS

Address of the command-level parameter structure. See "The UEPCLPS exit-specific parameter" on page 138.

UEPICTOK

Address of a 4-byte token passed from XICEREQ. This allows XICEREQ to, for example, pass a work area to XICEREQC.

UEPRCODE

Address of a 6-byte hexadecimal copy of the EIB return code

interval control EXEC interface program exits

'EIBRCODE'. For details of EIB return codes, refer to the *CICS Application Programming Reference* manual.

UEPRES

Address of a 4-byte binary copy of the EIB response code 'EIBRESP'.

UEPRES2

Address of a 4-byte binary copy of the EIB response code 'EIBRESP2'.

UEPTSTOK

Address of a 4-byte token that is valid throughout the life of a task. See "Using the task token UEPTSTOK" on page 145.

UEPRECUR

Address of a halfword recursion counter. The counter is set to 0 when the exit is first invoked, and is incremented for each recursive call.

UEPRSRCE

Address of an 8-character copy of the EIB resource value, EIBRSRCE.

Return codes

UERCNORM

Continue processing.

UERCPURG

Task purged during XPI call.

XPI calls

All can be used.

Although the exit permits the use of XPI GETMAIN and FREEMAIN calls, you are recommended to use the EXEC CICS GETMAIN and FREEMAIN commands instead.

API and SPI commands

All can be used.

Note: Take care when issuing recursive commands. For example, you must avoid entering a loop when issuing an interval control request from the XICEREQC exit. Use of the recursion counter UEPRECUR is recommended.

The command-level parameter structure

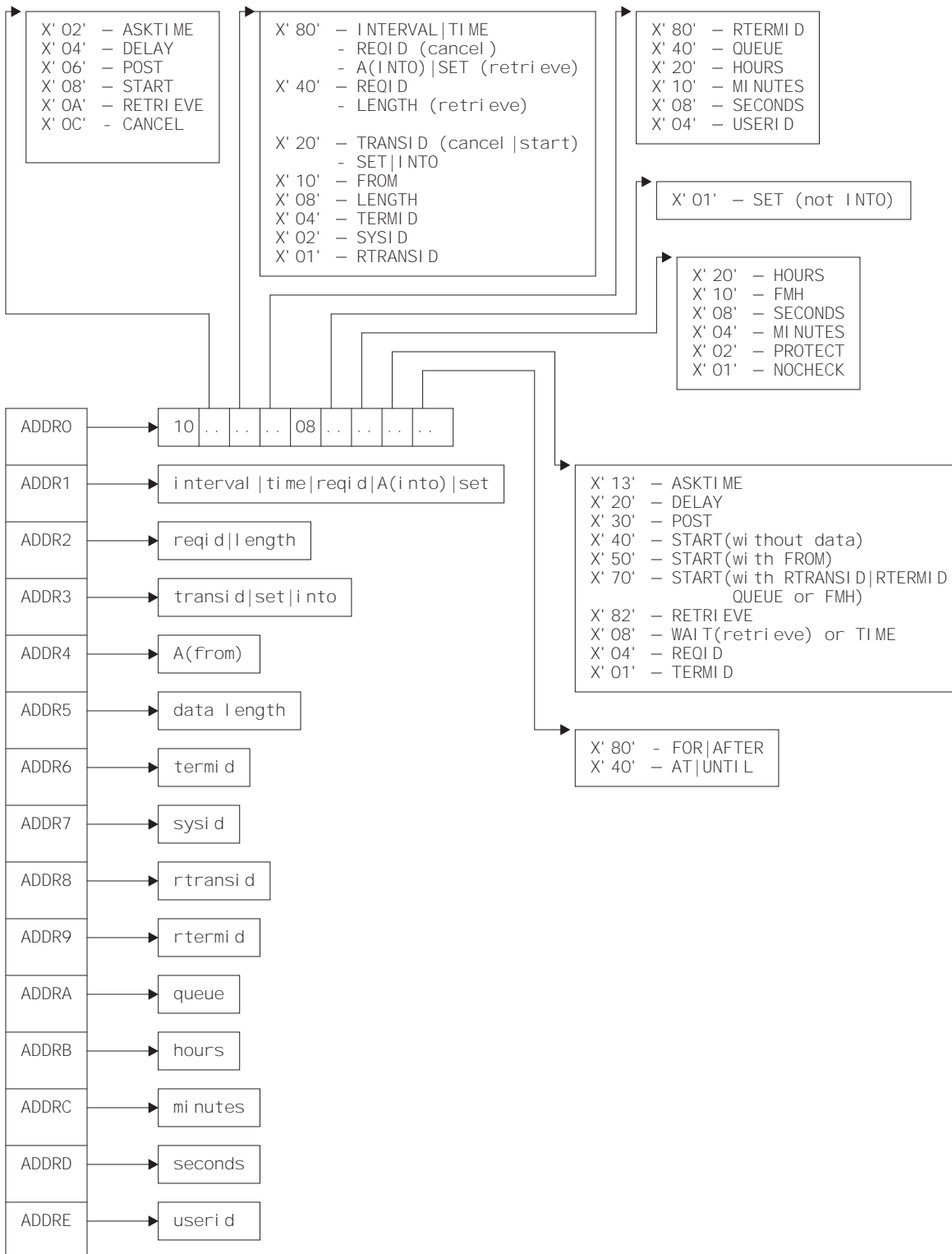

Figure 1. The command-level parameter structure for interval control

The command-level parameter structure consists of a series of addresses. The first address points to the EXEC interface descriptor (EID), which consists of a 9-byte

interval control EXEC interface program exits

area that describes the type of request and identifies each keyword specified with the request. The remaining addresses point to pieces of data associated with the request. For example, the second address points to the interval for START requests.

You can examine the EID to determine the type of request and the keywords specified. You can examine the other parameters in the list to determine the values of the keywords. You can also modify values of keywords specified on the request. For example, you could change the SYSID specified in the request.

End of parameter list indicator

The high-order bit is set on in the last address set in the parameter list to indicate that it is the last one in the list. On return from your user exit program, CICS scans the parameter list for the high-order bit to find the last parameter. Therefore, if you modify the length of the parameter list, you must also reset the high-order bit to indicate which is the new last address.

For example, if the parameter list specifies only the first four addresses (IC_ADDR0, the address of the EID, to IC_ADDR3, the address of the name of the transaction named in a START request), the high-order bit is set on in IC_ADDR3. If you extend the parameter list by setting the address of a SYSID in IC_ADDR7, you must unset the high-order bit in IC_ADDR3 and set it on in IC_ADDR7 instead.

The maximum size of parameter list is supplied to the exit, thus allowing your exit program to add any parameters not already specified without needing to first obtain more storage.

The original parameter list, as it was before XICEREQ was invoked, is restored after the completion of XICEREQC. It follows that the execution diagnostic facility (EDF) displays the original command before **and** after execution: **EDF does not display any changes made by the exit.**

The UEPCLPS exit-specific parameter

The UEPCLPS exit-specific parameter is included in both exit XICEREQ and exit XICEREQC. It is the address of the command-level parameter structure. The command-level parameter structure contains 15 addresses, IC_ADDR0 through IC_ADDRE. It is defined in the DSECT IC_ADDR_LIST, which you should copy into your exit program by including the statement COPY DFHICUED.

The command-level parameter list is made up as follows:

IC_ADDR0

is the address of a 9-byte area called the EXEC interface descriptor (EID), which is made up as follows:

IC_GROUP

IC_FUNCT

IC_BITS1

IC_BITS2

IC_BITS3

IC_EIDOPT5

IC_EIDOPT6

interval control EXEC interface program exits

IC_EIDOPT7

IC_EIDOPT8

IC_GROUP

Always X'10', indicating that this is an interval control request.

IC_FUNCT

One byte that defines the type of request:

X'02' ASKTIME

X'04' DELAY

X'06' POST

X'08' START

X'0A' RETRIEVE

X'0C' CANCEL

IC_BITS1

Existence bits that define which arguments were specified. To obtain the argument associated with a keyword, you need to use the appropriate address from the command-level parameter structure. Before using this address, you must check the associated existence bit. If the existence bit is set off, the argument was not specified in the request and the address should not be used.

X'80' Set if the request contains INTERVAL or TIME arguments, or if a CANCEL request specifies REQID, or if a RETRIEVE request specifies SET or INTO. If set, **IC_ADDR1** is meaningful.

X'40' Set if the request other than CANCEL specifies REQID or if a RETRIEVE request specifies LENGTH. If set, **IC_ADDR2** is meaningful.

X'20' Set if the request specifies TRANSID or if a request other than RETRIEVE specifies SET or INTO. If set, **IC_ADDR3** is meaningful.

X'10' Set if the request specifies FROM. If set, **IC_ADDR4** is meaningful.

X'08' Set if a request other than RETRIEVE specifies LENGTH. If set, **IC_ADDR5** is meaningful.

X'04' Set if the request specifies TERMID. If set, **IC_ADDR6** is meaningful.

X'02' Set if the request specifies SYSID. If set, **IC_ADDR7** is meaningful.

X'01' Set if the request specifies RTRANSID. If set, **IC_ADDR8** is meaningful.

IC_BITS2

Further argument existence bits.

X'80' Set if the request specifies RTERMID. If set, **IC_ADDR9** is meaningful.

X'40' Set if the request specifies QUEUE. If set, **IC_ADDR10** is meaningful.

interval control EXEC interface program exits

- X'20'** Set if the request specifies HOURS. If set, **IC_ADDRB** is meaningful.
- X'10'** Set if the request specifies MINUTES. If set, **IC_ADDRD** is meaningful.
- X'08'** Set if the request specifies SECONDS. If set, **IC_ADDRD** is meaningful.
- X'04'** Set if the request specifies USERID. If set, **IC_ADDRE** is meaningful.

IC_BITS3

One byte not used by interval control.

IC_EIDOPT5

Indicates whether certain keywords were specified on the request.

- X'01'** On a RETRIEVE command, SET (and not INTO) was specified. On a START command, ATTACH was specified. You cannot modify this field in your user exit.

IC_EIDOPT6

Existence bits that indicate whether certain keywords were specified on the request.

- X'20'** HOURS specified.
- X'10'** FMH specified.
- X'08'** SECONDS specified.
- X'04'** MINUTES specified.
- X'02'** PROTECT specified.
- X'01'** NOCHECK specified.

IC_EIDOPT7

Indicates whether certain functions or keywords were specified on the request.

- X'F0'** CANCEL specified.
- X'82'** RETRIEVE specified.
- X'40'** START specified.
- X'30'** POST specified.
- X'20'** DELAY, RTRANSID, RTERMID, or QUEUE specified, and/or FMH.
- X'13'** ASKTIME specified.
- X'10'** FROM, RTRANSID, or RTERMID specified, and/or QUEUE.
- X'08'** TIME or WAIT specified.
- X'04'** REQID specified.
- X'01'** TERMID specified.

IC_EIDOPT8

Indicates whether certain keywords were specified on the request.

- X'80'** FOR or AFTER specified.
- X'40'** AT or UNTIL specified.

interval control EXEC interface program exits

IC_ADDR1

is the address of one of the following:

- An 8-byte area containing the value of the INTERVAL keyword (or TIME keyword if **IC_EIDOPT7** indicates that TIME is specified).
- An 8-byte area containing the value of REQID (if the request is CANCEL).
- Data returned for INTO (if the request is RETRIEVE, and if **IC_EIDOPT5** indicates that this is not SET).
- A 4-byte address returned for SET (if the request is RETRIEVE and **IC_EIDOPT5** indicates that this is SET).

IC_ADDR2

is the address of one of the following:

- An 8-byte area containing the value of REQID (if the request is DELAY, POST or START).
- A halfword containing the value of LENGTH (if the request is RETRIEVE).

Warning: For requests that specify INTO, do not change the value of LENGTH to a value greater than that specified by the application. To do so causes a storage overlay in the application.

IC_ADDR3

is the address of one of the following:

- An area containing the value of TRANSID (if the request is CANCEL or START).
- A 4-byte address returned for SET (if the request is START or POST and **IC_EIDOPT5** indicates that this is SET).

IC_ADDR4

is the address of an area containing the data from FROM.

IC_ADDR5

is the address of the halfword value of LENGTH.

Warning: For requests that specify INTO, do not change the value of LENGTH to a value greater than that specified by the application. To do so causes a storage overlay in the application.

IC_ADDR6

is the address of an area containing the value of TERMID.

IC_ADDR7

is the address of an area containing the value of SYSID.

IC_ADDR8

is the address of an area containing the value of RTRANSID.

IC_ADDR9

is the address of an area containing the value of RTERMID.

IC_ADDRA

is the address of an area containing the value of QUEUE.

IC_ADDRB

is the address of an area containing the value of HOURS.

IC_ADDRD

is the address of an area containing the value of MINUTES.

IC_ADDRD

is the address of an area containing the value of SECONDS.

interval control EXEC interface program exits

IC_ADDRE

is the address of an area containing the value of USERID.

Modifying fields in the command-level parameter structure

Some fields that are passed to interval control are used as input to the request, some are used as output fields, and some are used for both input and output. The method your user exit program uses to modify a field depends on the usage of the field.

The following are always input fields:

INTERVAL
TIME
REQID
FROM
TERMID
SYSID
HOURS
MINUTES
SECONDS
USERID

The following are always output fields:

INTO
SET

The following are input fields on a START request and output fields on a RETRIEVE request:

RTRANSID
RTERMID
QUEUE

LENGTH is an input field on a START request, an output field on a RETRIEVE with SET specified, and an input/output field on a RETRIEVE with INTO specified.

Modifying input fields

The correct method of modifying an input field is to create a new copy of it, and to change the address in the command-level parameter list to point to your new data.

Note: You must never modify an input field by altering the data that is pointed to by the command-level parameter list. To do so would corrupt storage belonging to the application program and would cause a failure when the program attempted to reuse the field.

Modifying output fields

The technique described in "Modifying input fields" is not suitable for modifying output fields. (The results would be returned to the new area instead of the application's area, and would be invisible to the application.)

interval control EXEC interface program exits

An output field is modified by altering the data that is pointed to by the command-level parameter list. In the case of an output field, you can modify the application's data in place, because the application is expecting the field to be modified anyway.

Modifying the EID

It is not possible to modify the EID to make major changes to requests, such as changing a DELAY request to a START request.

However, you can make minor changes to requests, such as turning on the existence bit for SYSID so that the request can be changed into one that is shipped to a remote system.

Some interval control commands use 2 bits in the EID to indicate a single keyword; the EXEC CICS START command, for example, uses 2 bits to indicate TERMID. The first bit, in IC_BITS1, indicates that ADDR6 in the command parameter list is valid (ADDR6 points to TERMID) and the second, in IC_EIDOPT7, is the keyword existence bit to show that the TERMID keyword was specified on the command.

Where this occurs you must ensure that both bit settings are changed (consistently) if you wish to modify these commands from within a user exit program, or the results will be unpredictable.

The list that follows shows the bits in the EID that **can** be modified. Any attempt to modify any other part of the EID is ignored.

IC_BITS1

- X'80'** The existence bit for REQID (if the request is CANCEL)
- X'40'** The existence bit for LENGTH (if the request is RETRIEVE) or REQID
- X'10'** The existence bit for FROM
- X'08'** The existence bit for LENGTH
- X'04'** The existence bit for TERMID
- X'02'** The existence bit for SYSID
- X'01'** The existence bit for RTRANSID.

IC_BITS2

- X'80'** The existence bit for RTERMID
- X'40'** The existence bit for QUEUE
- X'20'** The existence bit for HOURS
- X'10'** The existence bit for MINUTES
- X'08'** The existence bit for SECONDS.

IC_EIDOPT6

- X'20'** The secondary existence bit for HOURS
- X'10'** The existence bit for FMH
- X'08'** The secondary existence bit for SECONDS
- X'04'** The secondary existence bit for MINUTES
- X'02'** The existence bit for PROTECT

interval control EXEC interface program exits

X'01' The existence bit for NOCHECK.

IC_EIDOPT7

Bits in IC_EIDOPT7 should only be modified within the same functional group - that is, only those existence bits defined as valid for a START request should be set on a START request.

ASKTIME requests

X'13' ASKTIME request. This value is fixed for all ASKTIME requests, and should not be modified.

DELAY requests

X'20' DELAY request

X'08' TIME specified

X'04' REQID specified.

POST requests

X'30' POST request

X'08' TIME specified

X'04' REQID specified.

START requests

X'40' START request (without DATA)

X'50' START with DATA request

X'70' START with one or more of RTRANSID, RTERMID, QUEUE, or FMH specified.

X'08' TIME specified

X'04' REQID specified

X'01' TERMID specified.

RETRIEVE requests

X'82' RETRIEVE request.

CANCEL requests

X'F0' CANCEL request

X'04' REQID specified.

The EID is reset to its original value before return to the application program. That is, changes made to the EID are retained for the duration of the interval control request only.

Note: Your user exit program is prevented from making major changes to the EID. However, you must take great care when making the minor modifications that **are** permitted.

Using the interval control request token UEPICTOK

UEPICTOK provides the address of a 4-byte area that you can use to pass information between the XICERREQ and XICEREQC user exits for the same interval control request. For example, the address of a piece of storage obtained by the XICERREQ user exit, which is to be freed by the XICEREQC exit, can be passed in the UEPICTOK field.

Using the task token UEPTSTOK

UEPTSTOK provides the address of a 4-byte area that you can use to pass information between successive interval control requests in the same task. (By contrast, UEPICTOK is usable only for the duration of a single interval control request, because its contents may be destroyed at the end of the request.) For example, if you need to pass information between successive invocations of the XICEREQ exit, UEPTSTOK provides a means of doing this.

The EIB

Copies of EIBRSRCE, EIBRCODE, EIBRESP, and EIBRESP2 are passed to the exit, so that you can:

- Modify or set completion and resource information in XICEREQ and XICEREQC
- Examine completion and resource information in XICEREQC.

You can update the copies of EIBRSRCE, EIBRCODE, EIBRESP, and EIBRESP2 that you are given in the parameter list. Interval control copies your values into the real EIB after the completion of XICEREQC; or if you specify a return code of 'bypass' in XICEREQ.

You must set valid interval control responses. You must set all three of EIBRCODE, EIBRESP, and EIBRESP2 to a consistent set of values, such as would be set by CICS interval control to describe a valid completion. **CICS does not police the consistency of EIBRCODE, EIBRESP, and EIBRESP2.** However, if EIBRCODE is set to a non-zero value and EIBRESP is set to zero, CICS overrides EIBRESP with a non-zero value. To aid you in setting the values of EIBRCODE, EIBRESP, and EIBRESP2, the values used by interval control are specified in DFHICUED.

Example of how XICEREQ and XICEREQC can be used

XICEREQ and XICEREQC can be used for a variety of purposes. One example of a possible use is given below.

In this example, XICEREQ and XICEREQC are used to route START requests to a number of different CICS regions to provide a simple load balancing mechanism. The example shows only the capabilities of the exits; it is not intended to indicate an ideal way of achieving the function.

In XICEREQ:

1. Scan the global work area (GWA) to locate a suitable CICS region (for example, the region currently processing the least number of START requests).
2. Having decided which system to route the request to, increment the use count for this system.
3. Obtain a 4-byte area in which to store the SYSID for this request. This can be allocated from the GWA to avoid issuing a GETMAIN. If the area is obtained by issuing a GETMAIN, set UEPICTOK to the address of the storage obtained.
4. Set IC_ADDR7 to be the address of the 4-byte area so that XICEREQC can also use this area.
5. If setting IC_ADDR7 now makes it the last address, set the high-order bit in the address, and reset the high-order bit in what was previously the last address.

interval control EXEC interface program exits

6. Set the X'02' existence bit on in IC_BITS1 to indicate that a SYSID is specified.
7. Return to CICS.

In XICEREQC:

1. Scan the global work area (GWA) and locate the entry for the CICS region specified in the SYSID parameter.
2. Decrement the use count for this system.
3. If a GETMAIN was issued in XICEREQC to obtain an area to hold the SYSID, issue a FREEMAIN for the address held in UEPICCTOK.
4. Return to CICS.

Example and sample programs

CICS supplies two programs for use at the XICEREQC exit:

- DFH\$XTSE, supplied in hardcopy only, is an example program that shows how to modify fields in the command-level parameter structure passed to all the EXEC interface exits. DFH\$XTSE is listed on page 807.
- DFH\$ICCN is a sample program for use in a distributed routing environment, where you want to cancel a previously-issued interval control request but have no way of knowing to which region to direct the CANCEL. For examples of situations which DFH\$ICCN is designed to cope with, see the *CICS Intercommunication Guide*.

Loader domain exits XLDLOAD and XLDELETE

There are two global user exits in the loader domain. XLDLOAD is invoked when a new instance of a program is loaded into storage, before the program is made available for use.

XLDELETE is invoked after an instance of a program is released by CICS and before the program is freed from storage.

For LPA-resident programs, the exits are still invoked when a program is acquired or released, even though the program is not physically loaded or freed.

These are both information-only exits. Any changes made to the exit parameters by the exit program are ignored by CICS, as is any return code which it sets.

Exit XLDLOAD

When invoked

After an instance of a program is brought into storage, and before the program is made available for use.

Exit-specific parameters

UEPPROGN

Address of an 8-character field containing the name of the program that is being loaded.

UEPPROGL

Address of a 4-byte field containing the length, in bytes, of the program that is being loaded.

UEPLDPT

Address of a 4-byte field containing the address at which the program has been loaded.

UEPENTRY

Address of a 4-byte field containing the address of the program's entry point.

UEPTRANID

Zero, or the address of a 4-byte field containing the transaction ID which applied when the exit was invoked.

UEPUSER

Zero, or the address of an 8-byte field containing the userid in control at the time the exit was invoked.

UEPTERM

Zero, or the address of a 4-byte field containing the terminal name associated with the transaction under which the exit was invoked.

UEPPROG

Zero, or the address of an 8-character field containing the name of the program that was in control at the time the exit was invoked.

Return codes

UERCNORM

Continue processing.

loader domain exits

XPI calls

Must not be used.

API and SPI calls

Must not be used.

Exit XLDELETE

When invoked

After an instance of a program is released by CICS, and before the program is freed from storage.

Exit-specific parameters

UEPPROGN

Address of an 8-character field containing the name of the program that is being freed.

UEPPROGL

Address of a 4-byte field containing the length, in bytes, of the program that is being freed.

UEPLDPT

Address of a 4-byte field containing the address at which the program resides in storage.

UEPENTRY

Address of a 4-byte field containing the address of the program's entry point.

UEPTRANID

Zero, or the address of a 4-byte field containing the transaction ID which applied when the exit was invoked.

UEPUSER

Zero, or the address of an 8-byte field containing the userid in control at the time the exit was invoked.

UEPTERM

Zero, or the address of a 4-byte field containing the terminal name associated with the transaction under which the exit was invoked.

UEPPROG

Zero, or the address of an 8-character field containing the name of the program that was in control at the time the exit was invoked.

Return codes

UERCNORM

Continue processing.

XPI calls

Must not be used.

API and SPI calls

Must not be used.

Log manager domain exit XLGSTRM

There is one exit point, XLGSTRM, in the log manager domain.

You can use XLGSTRM to modify a request to MVS to create a new log stream. You can change the model log stream name and other parameters before they are passed to the MVS system logger.

If a log stream connection request from CICS to the MVS system logger fails because the log stream is not defined to MVS, CICS issues a request to the MVS system logger to create the log stream dynamically, using a model log stream definition.

The model log stream name that CICS passes to MVS depends on whether the journal name refers to the system log or a CICS general log, as follows:

CICS system logs

sysname.DFHLOG.MODEL—for example, MV10.DFHLOG.MODEL.

CICS general logs

LSN_qualifier_1.LSN_qualifier2.MODEL. The defaults for these two qualifiers are the CICS region userid and the CICS region APPLID, but they can be user-defined values specified in a JOURNALMODEL resource definition.

For example, if the CICS region userid is CICSHT## and the APPLID is CICSHTA1, the default model name is CICSHT##.CICSHTA1.MODEL.

The following information is passed to an XLGSTRM global user exit program:

- Actual log stream name
- Default model log stream name
- System log flag
- MVS system logger IXGINVNT parameter list.

The exit can amend the model stream name by updating UEPMLSN. Use the IXGINVNT MF=M form which allows the exit to override other MVS system logger options from the model log stream, allowing for even greater flexibility.

Here is an example of how your exit program can change the structure name:

```

L      R9,UEPIXG
IXGINVNT REQUEST=DEFINE,
        TYPE=LOGSTREAM,
        STRUCTNAME=NEW_STRUCTURE,
        MF=(M,(R9),NOCHECK)
...
NEW_STRUCTURE DC CL16'LOG_SYSTEST_009'
```

Here is an example of how your exit program can change the model stream name:

```

L      R3,UEPMLSN          R3 = address of stream name
MVC   0(26,R3),=CL26'NEW.MODEL.NAME'
```

You do not need to code the list and execute forms of the macro or include the IXGCON or IXGANSAA macros in your exit—these are provided by the CICS code which actually issues the DEFINE request.

For information about the IXGINVNT service, see the *OS/390 MVS Authorized Assembler Services Reference ALE-DYN* manual.

log manager domain exit

An XLGSTRM global user exit program can set explicit attributes for the log stream definition, and can also set a return code that causes the log stream definition to be bypassed.

Exit XLGSTRM

When invoked

After the CICS log manager detects that a log stream does not exist and before calling the MVS system logger to define the log stream dynamically.

Exit-specific parameters

UEPTRANID

The address of the 4-byte transaction id.

UEPUSER

The address of the 8-byte userid associated with the transaction if the current task is a user task.

UEPTERM

The address of the 4-byte terminal id associated with the transaction, if any.

UEPPROG

The address of the 8-byte application program name for this transaction, if any.

UEPLSN

Address of a 26-character field specifying the log stream name that is to be defined.

UEPMLSN

Address of a 26-character field specifying the name of model log stream to be used to provide the attributes for the new log stream. This field is modifiable to allow the global user exit program to specify a different model log stream name from the one generated by CICS.

UEPIXG

Address of the IXGINVNT macro parameter list for use by the MVS system logger to define the log stream. Using the MF=M form of the IXGINVNT macro, the global user exit program can specify the log stream attributes to be used.

For details of the IXGINVNT macro, see the *OS/390 MVS Authorized Assembler Services Reference ALE-DYN* manual.

UEPLGTYP

Address of a 1-byte field indicating whether the log stream being created is for a system log or a general log. Valid values are:

UEPSYSLG

The log stream is for a CICS system log.

UEPGENLG

The log stream is for a general log (a forward recovery log, a user journal, or auto-journal).

Return codes

UERCNORM

CICS continues and attempts to define the log stream.

UERCBYD

CICS does not attempt to define the log stream. The process that was attempting to use the log stream may fail (for example, a data set open).

XPI calls

All can be used.

API and SPI commands

Must not be used.

An example of how XLGSTRM can be used

Imagine that you have 200 CICS regions, running on, say, 20 MVS images. To avoid having to define explicitly each log stream used by each CICS region, you decide to use model definitions. Log streams will be defined to MVS dynamically on their first usage, with an XLGSTRM exit program being used to select from alternative model log streams. This is how it might work:

1. On an initial start of a CICS region, the INITPARM system initialization parameter specifies:

```
INITPARM=(Exit_enabler_pgmname=nnn)
```

where:

- `Exit_enabler_pgmname` is the name of the program that enables the XLGSTRM user exit program.
 - `nnn` is a number that identifies the CICS region.
2. The program that enables the XLGSTRM user exit program issues an EXEC CICS ASSIGN INITPARM command to retrieve the value `nnn`, and places it in the exit program's global work area.
 3. When the region tries to connect to its system log, because the log stream is not defined the XLGSTRM exit program is invoked. The exit program selects model `CICS.DFHLOG.MODELnnn`.

Message domain exit XMEOUT

The XMEOUT exit allows you to suppress or reroute CICS messages that use the message domain.

Note that your exit program is subject to certain restrictions:

- It cannot suppress or reroute messages sent to terminal operators, but only those sent to the system console or to transient data queues. (XMEOUT is not invoked for the former type of message.)
- It can only suppress or reroute messages that use the message domain. You can deduce which messages this applies to from the *CICS Messages and Codes* manual: the description of each message that causes XMEOUT to be driven contains a list of “XMEOUT parameters”; if no XMEOUT parameters are listed for a message, the latter does not cause the exit to be driven. For example, message ‘DFHDX8320’ causes XMEOUT to be invoked, but message ‘DFHDU0205’ does not.
- It cannot change the text of a message, nor the message inserts. (If it tries to do so, CICS ignores the changes.)
- It cannot suppress or reroute messages issued during the early stages of CICS initialization (because the exit cannot be enabled then).
- It cannot reroute a message to transient data queues during CICS shutdown unless the original message destination included one or more transient data queues. If it attempts to do so, the message in question is routed to its original destination, and message DFHME0120I is issued to the console. Message DFHME0120I cannot be re-routed by the user exit program but it may be suppressed.

This restriction is necessary because the message domain is required to handle messages during CICS shutdown even after the transient data queue function has ended.

To discover whether CICS shutdown has started, your exit program can check for the first instance of message DFHME0120. It can stop rerouting messages to TD queues after DFHME0120 has been issued.

Note: If a message is being rerouted to a transient data queue and the transient data request fails, the message is lost. The MEME exception trace point ID X’0328’ is written. The interpretation string of this trace entry provides an explanation of why the transient data request failed.

Important

Because of the danger of recursion, your XMEOUT exit program should **not** try to reroute:

- Any DFHTDxxxx messages, produced by the transient data program.
- User domain messages in the range DFHUS0002-DFHUS0006, plus message DFHUS0150.
- Transaction manager messages DFHXM0212, DFHXM0213, DFHXM0304 and DFHXM0308.
- Application messages DFHAP0001, DFHAP0002, DFHAP0004, DFHAP0601, DFHAP0602, and DFHAP0603.
- *Any* user domain (DFHUSxxxx) messages to an intrapartition queue defined with a TRIGLEV value of anything other than zero, if the messages are produced while the user domain is performing error recovery processing.

The message definition template contains an indicator called “noreroute”. This indicator is set on if the message being issued cannot be rerouted to a transient data queue by the XMEOUT exit program. The address of the indicator is passed to XMEOUT in the UEPNRTE exit-specific parameter. Your exit program can check the value of the indicator before deciding whether or not to reroute a particular message.

Note: If the exit program tries to reroute an ineligible message, the message domain inhibits the rerouting and issues the message to the console instead, along with message DFHME0137.

Each of the messages affected by this restriction is identified by a note in the *CICS Messages and Codes* manual.

Your exit program can suppress or reroute messages by altering the values held in the addresses pointed to by the UEPMROU, UEPMNRC, UEPMTDQ, and UEPMNTD fields of the parameter list. These four sets of values (route codes, number of route codes, transient data queue names, and number of TDQs) are the only ones that your program can change.

Exit XMEOUT

When invoked

Before the message domain sends a CICS message to its destination.

Exit-specific parameters

UEPTRANID

Address of the 4-byte transaction ID.

UEPUSER

Address of the 8-byte user ID.

UEPTERM

Address of the 4-byte ID of the terminal under which the current transaction is running. If the current transaction is not associated with a terminal, the addressed field contains hexadecimal zeroes.

UEPPROG

Address of the 8-byte application program name, or nulls if there is no current application.

message domain exit

UEPNUM

Address of a 4-byte field containing the message number.

UEPMDOM

Address of a 2-byte field containing the domain identifier of the CICS message.

UEPMROU

Address of an array of up to 28 route codes. Route codes must be numbers in the range 1 through 28.

UEPMNRC

Address of a halfword containing the number of route codes in the route code array.

UEPMTDQ

Address of an array of up to 25 transient data queue names to which the message is to be sent. TD queue names must consist of 4 alphanumeric characters.

UEPMNTD

Address of a halfword containing the number of TDQs in the queues array.

UEPINSN

Address of a 2-byte field containing the number of message inserts.

UEPINSA

Address of an array, each element of which contains information about a single message insert. The size of the array depends on the number of inserts. Each array element has the following structure:

```
INSERT_FORMAT_P DS A Address of the 1-byte insert
                    type-code, which has one of
                    the following hexadecimal values:
                    0 Not present
                    1 Character
                    2 Hexadecimal
                    3 Decimal
                    4 The insert is a number
                      representing one item in
                      a list of options.
                      (See the example below.)
INSERT_P DS A Address of the message insert
INSERT_LENGTH_P DS A Address of a fullword contain-
                    ing the length of the insert
INSERT_TYPE_P DS A Reserved.
```

You can find the order of the inserts in the array from the entry for the particular message in the *CICS Messages and Codes* manual. For example,

```
DFHFC0531 date time applid Automatic journal journal
journalname, opened for file filename is not of
type MVS. Module module.
```

The XMEOUT inserts are *date*, *time*, *applid*, *journal*, *journalname*, *filename*, and *module*. The fourth insert (*journal*) is the number specified for JOURNAL on the file definition.

UEPNRTE

Address of 1-character flag indicating whether or not the message can be rerouted by XMEOUT. The possible values are:

C'0': The message can be routed.

C'1': The message cannot be routed.

Return codes

UERCNORM

Continue processing.

UERCBYD

Suppress the message for all destinations.

XPI calls

WAIT_MVS can be used. **Do not use any other calls.**

The sample XMEOUT global user exit programs

CICS supplies the following sample programs, which show you how to use the XMEOUT exit to suppress or reroute messages:

DFH\$XP1

Suppress a message by message number

DFH\$XP2

Suppress a message by destination route code

DFH\$XP3

Suppress a message destined for the CSCS transient data queue (which receives signon and sign-off messages)

DFH\$XP4

Reroute a console message to a TDQ

DFH\$XP5

Reroute a TDQ message to another TDQ

DFH\$XP6

Reroute a TDQ message to a console.

Monitoring domain exit XMNOUT

XMNOUT is invoked before an exception class monitoring record is passed to SMF, and before a performance class monitoring record is written to the performance record buffer. You can use this exit to examine the record, to suppress its output to SMF, or to change the data it contains. You must ensure that any changes you make do not conflict with the dictionary description of the data.

You can also add data to performance class data records. To do this you need to define dummy user event-monitoring points (EMPs) in the monitoring control table (MCT) to reserve data fields of the required size and type.

Exit XMNOUT

When invoked

Before an exception class monitoring record is written to SMF, and before a performance class monitoring record is buffered for a later write to SMF.

Exit-specific parameters

UEPTRANID

Address of the 4-byte transaction ID. This field is not available at task termination.

UEPUSER

Address of the 8-byte user ID. This field is not available at task termination.

UEPTERM

Address of the 4-byte terminal ID. This field is not available at task termination.

UEPPROG

Address of the 8-byte application program name. This field is not available at task termination.

UEPDICT

Address of the dictionary. The sequence of dictionary entries is mapped by the DSECT generated from the macro DFHMCTDR. This field only has meaning for performance class records. If the monitoring record type is exception class (see parameter UEPMRTYP), this field is set to 0.

UEPDICTE

Address of the fullword number of dictionary entries. This field only has meaning for performance class records. If the monitoring record type is exception class (see parameter UEPMRTYP), this field is set to 0.

UEPFCL

Address of the field connector list, containing a series of halfword connector values. This field only has meaning for performance class records. If the monitoring record type is exception class (see parameter UEPMRTYP), this field is set to 0.

UEPFCLNO

Address of the fullword number of field connectors. This field only has meaning for performance class records. If the monitoring record type is exception class (see parameter UEPMRTYP), this field is set to 0.

UEPMRTYP

Address of the halfword monitoring record type. If the value is 3, the type is performance class. If the value is 4, the type is exception class.

UEPMRLEN

Address of the fullword monitoring record length.

UEPMREC

Address of monitoring record, whose length is addressed by the parameter UEPMRLEN.

UEPSRCTK

Address of the MVS workload manager service reporting class token for the current transaction. If CICS support for MVS workload management is not available, this token is null.

UEMPREC

Address of the monitoring performance record. This field has meaning only for performance class records. If the monitoring record type is exception class (see the UEPMRTYP parameter), this field is set to 0. The performance record addressed by this parameter must be mapped using the DFHMNTDS dsect, and must not be mapped using the UEPDICT and UEPDICTE dictionary parameters.

Return codes

UERCNORM

Continue processing.

UERCBYB

Suppress monitor record output.

UERCPURG

Task purged during XPI call.

XPI calls

WAIT_MVS can be used. **Do not use any other calls.**

Program control program exits XPCREQ, XPCREQC, XPCFTCH, XPCHAIR, XPCTA, and XPCABND

There are six user exit points in the program control program.

XPCREQ and XPCREQC

XPCREQ is invoked by the EXEC interface program before a link request is processed. If the request is a distributed program link, the XPCREQ exit is driven on both sides of the link; that is, in both the client and the server regions. The exit program is passed the address of the application's parameter list (in UEPCPLPS), and can modify this as required. For example, you can use this exit to modify the SYSID at the time of a distributed program link request. One way you can achieve this is to write an application program to manage a list of SYSIDs in a global work area (GWA). The global user exit program can obtain access to the GWA, and use the information stored there to redirect DPL requests.

XPCREQC is invoked after the link request is completed. You can use this exit to pass back a response to the application via the EIBRESP or EIBRESP2 fields. Such responses could be used to keep status information about a link request up-to-date. For example, if a link request fails because a connection is unavailable, XPCREQC could set EIBRESP=500 (a response code not used by CICS) to indicate the failure, enabling the application, in conjunction with the other exit, XPCREQ, to determine a suitable course of action.

Exit XPCREQ

When invoked

By the EXEC interface program before a link request is processed.

Exit-specific parameters

UEPCPLPS

Address of the command parameter list.

UEPPCTOK

Address of a 4-byte token to be passed to XPCREQC. This allows you, for example, to pass a work area to exit XPCREQC.

UEPRCODE

Address of a 6-byte hexadecimal copy of EIBRCODE.

UEPRECUR

Address of a halfword recursion counter. The counter is set to 0 when the exit is first invoked, and is incremented for each recursive call.

UEPRES

Address of a 4-byte copy of EIBRESP.

UEPRES2

Address of a 4-byte copy of EIBRESP2.

UEPTSTOK

Address of a 4-byte token that is valid throughout the life of a task. See "Using the task token UEPTSTOK" on page 163.

UEPRSRCE

Address of an 8-character copy of the EIB resource value, EIBRSRCE.

Return codes

UERCBYP

Program control is to ignore the request.

UERCNORM

Continue processing.

UERCPURG

Task purged during XPI call.

XPI calls

All can be used.

Although the exit permits the use of XPI GETMAIN and FREEMAIN calls, we recommend that you use the EXEC CICS GETMAIN and FREEMAIN commands instead.

API and SPI calls

All can be used.

Exit XPCREQC

When invoked

On completion of a program control link request.

Exit-specific parameters

UEPCLPS

Address of the command parameter list.

UEPPCTOK

Address of a 4-byte token passed from XPCREQ. This allows XPCREQ to, for example, pass a work area to XPCREQC.

UEPRCODE

Address of a 6-byte hexadecimal copy of EIBRCODE.

UEPRECUR

Address of a halfword recursion counter. The counter is set to 0 when the exit is first invoked, and is incremented for each recursive call.

UEPRESP

Address of a 4-byte copy of EIBRESP.

UEPRESP2

Address of a 4-byte copy of EIBRESP2.

UEPTSTOK

Address of a 4-byte token that is valid throughout the life of a task. See "Using the task token UEPTSTOK" on page 163.

UEPRSRCE

Address of an 8-character copy of the EIB resource value, EIBRSRCE.

Return codes

UERCNORM

Continue processing.

UERCPURG

Task purged during XPI call.

program control program exits

XPI calls

All can be used.

Although the exit permits the use of XPI GETMAIN and FREEMAIN calls, we recommend that you use the EXEC CICS GETMAIN and FREEMAIN commands instead.

API and SPI calls

All can be used.

Note: Take care when issuing recursive commands not to cause a loop. For example, it is your responsibility to avoid entering a loop when a program control request is issued from the XPCREQ or XPCREQC exits.

Use of the recursion counter UEPRECUR is recommended.

The command parameter structure

The command parameter structure consists of a series of addresses. The first address points to the EXEC interface descriptor (EID), which consists of a bit string that describes the type of request and identifies each keyword specified with the request. The remaining addresses point to pieces of data associated with the request; for instance, the second address always points to the program name. You can examine the parameters in the list to determine the values of the keywords. You can also modify values of parameters specified on the request. For example, you could change the name of the program involved in the request, or add the SYSID to route the link request to a remote system.

End of parameter list indicator

The high-order bit is set on in the last address set in the parameter list to indicate that it is the last one in the list. On return from your user exit program, CICS scans the parameter list for the high-order bit to find the last parameter. Therefore, if you modify the length of the parameter list, you must also reset the high-order bit to indicate which is the new last address.

For example, if the parameter list specifies only the first two addresses (PC_ADDR0, the address of the EID, and PC_ADDR1, the address of the name of the program named in the link request), the high-order bit is set on in PC_ADDR1. If you extend the parameter list by setting the address of a SYSID in PC_ADDR7, you must unset the high-order bit in PC_ADDR1 and set it on in PC_ADDR7 instead.

The original parameter list, as it was before XPCREQ was invoked, is restored after the completion of XPCREQC. It follows that EDF will display the original command before and after execution: **EDF will not display any changes made by the exit.**

The UEPCLPS exit-specific parameter: The UEPCLPS exit-specific parameter is included in both exit XPCREQ and exit XPCREQC. It is the address of the command-level parameter structure. The command-level parameter structure contains 9 addresses, PC_ADDR0 through PC_ADDR8. It is defined in the DSECT PC_ADDR_LIST, which you should copy into your exit program by including the statement COPY DFHPCEDS.

The command-level parameter list is made up as follows:

PC_ADDR0

is the address of a 7-byte area called the EXEC interface descriptor (EID), which is made up as follows:

- PC_GROUP**
- PC_FUNCT**
- PC_BITS1**
- PC_BITS2**
- PC_EIDOPT5**
- PC_EIDOPT6**

PC_GROUP

Always X'0E', indicating that this is a program control request.

PC_FUNCT

One byte which defines the type of request, which for XPCREQ and XPCREQC is always X'02', indicating a LINK request.

PC_BITS1

Existence bits that define which keywords that contain values were specified. To obtain the value associated with a keyword, you need to use the appropriate address from the command-level parameter list. Before using this address you must check the associated existence bit to ensure that the address is valid. If the existence bit is set off, the keyword was not specified in the request and the address should not be used. The symbolic and hexadecimal values of the existence bits are as follows:

PC_EXIST1 (X'80')

Set if the request contains the keyword PROGRAM. If set, **PC_ADDR1** is meaningful. (This bit should always be set for a LINK request.)

PC_EXIST2 (X'40')

Set if the request specifies the COMMAREA parameter. If set, **PC_ADDR2** is meaningful.

PC_EXIST3 (X'20')

Set if the request specifies the LENGTH parameter. If set, **PC_ADDR3** is meaningful.

PC_EXIST4 (X'10')

Set if the request specifies the INPUTMSG parameter. If set, **PC_ADDR4** is meaningful.

PC_EXIST5 (X'08')

Set if the request specifies the INPUTMSGLEN parameter. If set, **PC_ADDR5** is meaningful.

PC_EXIST6 (X'04')

Set if the request specifies the DATALENGTH parameter. If set, **PC_ADDR6** is meaningful.

PC_EXIST7 (X'02')

Set if the request specifies the SYSID parameter. If set, **PC_ADDR7** is meaningful.

PC_EXIST8 (X'01')

Set if the request specifies the TRANSID parameter. If set, **PC_ADDR8** is meaningful.

program control program exits

PC_BITS2

Two bytes not used by program control.

PC_EIDOPT5

Not used by program control.

PC_EIDOPT6

Indicates whether the request specifies the SYNCONRETURN option. If it does, X'80' is set.

PC_ADDR1

is the address of an 8-byte area containing the program name from the PROGRAM parameter.

PC_ADDR2

is the address of the COMMAREA data.

PC_ADDR3

is the address of a 2-byte area containing the length of the COMMAREA, as a half-word binary value.

PC_ADDR4

is the address of the INPUTMSG data.

PC_ADDR5

is the address of a 2-byte area containing the length of the INPUTMSG, as a half-word binary value.

PC_ADDR6

is the address of a 2-byte area containing the length specified on the DATALENGTH parameter, defining how much data is to be sent from the COMMAREA. The length is held as a half-word binary value.

PC_ADDR7

is the address of the 4-byte name of the remote system the LINK request is to be shipped to, as specified on the SYSID parameter.

PC_ADDR8

is the address of the 4-byte name of the mirror transaction to be attached in the remote system, as specified on the TRANSID parameter.

Modifying fields in the command parameter structure

Some fields that are passed to program control are used as input to the request, some are used as output fields, and some are used for both input and output. The method your user exit program uses to modify a field depends on the usage of the field.

Modifying input fields: The correct method of modifying an input field is to create a new copy of it, and to change the address in the command parameter list to point to your new data.

Note: You must never modify an input field by altering the data that is pointed to by the command parameter list. To do so would corrupt storage belonging to the application program and could cause a failure when the program attempted to reuse the field.

Modifying output fields: The technique described in "Modifying input fields" is not suitable for modifying output fields. (The results would be returned to the new area instead of the application's area, and would be invisible to the application.)

program control program exits

An output field is modified by altering the data that is pointed to by the command-level parameter list. In the case of an output field you can modify the application's data in place, because the application is expecting the field to be modified anyway.

Modifying the EID

It is not possible to modify the EID to make major changes to requests. It is not possible, for example, to change a LINK request to a different type of Program Control request.

However, you can make minor changes to requests, such as to turn on the existence bit for SYSID so that the request can be changed into one that is shipped to a remote system.

The list that follows shows the bits in the EID that can be modified. Any attempt to modify any other part of the EID is ignored.

PC_BITS1

- X'40'** The existence bit for the COMMAREA
- X'20'** The existence bit for LENGTH
- X'10'** The existence bit for INPUTMSG
- X'08'** The existence bit for INPUTMSGLEN
- X'04'** The existence bit for DATALENGTH
- X'02'** The existence bit for SYSID
- X'01'** The existence bit for TRANSID.

PC_EIDOPT5

Not used for a PC link request.

Bits in the EID should be modified in place. You should not modify the pointer to the EID. (Any attempt to do so is ignored by CICS.)

The EID is reset to its original value before return to the application program. That is, changes made to the EID are retained for the duration of the program control request only.

Your user exit program is prevented from making major changes to the EID.

Using the program control request token, UEPPCTOK

UEPPCTOK provides the address of a 4-byte area that you can use to pass information between the XPCREQ and XPCREQC user exits for the same program control request. For example, the address of a piece of storage obtained by the XPCREQ user exit, which has to be freed by the XPCREQC user exit, can be passed in the UEPPCTOK field.

Using the task token UEPTSTOK

UEPTSTOK provides the address of a 4-byte area that you can use to pass information between successive program control requests in the same task. (By contrast, UEPPCTOK is usable only for the duration of a single program control request, because its contents may be destroyed at the end of the request.) For

program control program exits

example, if you need to pass information between successive invocations of the XPCREQ exit, UEPTSTOK provides a means of doing this.

The EIB

Copies of EIBRSRCE, EIBRCODE, EIBRESP, and EIBRESP2 are passed to the exit, so that you can:

- Modify or set completion or resource information in XPCREQ and XPCREQC.
- Examine completion information in XPCREQC.

You can update the copies of EIBRSRCE, EIBRCODE, EIBRESP and EIBRESP2 that you are given in the parameter list. Program Control copies your values into the real EIB after the completion of XPCREQC; or if you specify a return code of 'bypass' in XPCREQ.

You must set valid program control responses. You must set all three of EIBRCODE, EIBRESP and EIBRESP2 to a consistent set of values, such as would be set by Program Control to describe a valid completion. **Program Control does not police the consistency of EIBRCODE, EIBRESP, and EIBRESP2.** To aid you in setting the values of EIBRCODE, EIBRESP, and EIBRESP2, the values used by Program Control are specified in DFHPCEDS.

Example of how XPCREQ and XPCREQC can be used

XPCREQ and XPCREQC can be used for a variety of purposes. One example of a possible use is given below.

In this example, XPCREQ and XPCREQC are used to route LINK requests to a number of different CICS regions to provide a simple load balancing mechanism. The example shows only the capabilities of the exits; it is not intended to indicate an ideal way of achieving the load balancing function. For the purpose of this example, it is assumed that a global work area (GWA) already exists, and that it contains a list of available SYSIDs together with a count of the number of LINK requests currently being processed by each SYSID.

In XPCREQ:

1. Scan the global work area (GWA) to locate a suitable CICS region - for example, the region currently processing the least number of LINK requests.
2. Having decided which system to route the request to, increment the use count for this system.
3. Obtain a 4-byte area in which to store the SYSID for this request (this can be allocated from the GWA to avoid issuing a GETMAIN). If the area is obtained by issuing a GETMAIN, set UEPPCTOK to the address of the storage obtained.
4. Set PC_ADDR7 to the address of the 4-byte area.
5. If setting PC_ADDR7 now makes it the last address, set the high-order bit in the address, and unset the high-order bit in what was previously the last address.
6. Set the X'02' existence bit on in PC_BITS1 to indicate that a SYSID is specified.
7. Return to CICS.

In XPCREQC:

1. Scan the global work area (GWA) and locate the entry for the CICS region specified in the SYSID parameter.
2. Decrement the use count for this system.

3. If a GETMAIN was issued in XPCREQ to obtain an area to hold the SYSID, issue a FREEMAIN for the address held in UEPPCTOK.
4. Return to CICS.

Exit XPCFTCH

XPCFTCH is invoked before a PPT-defined program (including internal CICS modules) receives control, which could be because it is the first program in a transaction, or as a result of a LINK, XCTL, or HANDLE ABEND PROGRAM request. You can use this exit to modify the entry address used when linking to the program. If the exit sets a return code of zero, or a modified address of zero, the entry address of the original application program is used.

The exit is intended to allow you to pass control to an application program or routine *before the original program is invoked*. This first program, after it has finished its processing, should pass control back to the entry point of the original program. You should not use the exit to cause a program to be invoked *instead of* the original program. If you do so, the results are unpredictable.

If a modified entry address is supplied, the program that is invoked receives control in the execution key that the original application program would have received control in—that is, as specified on the EXECKEY option of the original program's resource definition.

When invoked

Before an application program receives control.

Exit-specific parameters

UEPPCDS

Address of a storage area that contains program- and terminal-related information, and that can be mapped using the DSECT DFHPCUE. When XPCFTCH is invoked, the following DFHPCUE fields are significant:

PCUE_CONTROL_BITS

1-byte flag field. A setting of PCUECBTE indicates that the transaction is linked to a terminal. A setting of PCUENOTX (X'40') indicates that the program is not command level.

PCUE_TASK_NUMBER

3-character packed decimal field containing the task number.

PCUE_TRANSACTION_ID

4-character field containing the ID of the original transaction. Note that this may differ from the current transaction ID.

PCUE_TERMINAL_ID

4-character field containing the terminal ID (if any).

PCUE_PROGRAM_NAME

8-character field containing the name of the program that is to receive control.

PCUE_PROGRAM_LANGUAGE

3-character field containing the language of the program that is to receive control.

program control program exits

PCUE_LOAD_POINT

The program's load point.

PCUE_ENTRY_POINT

The program's entry point.

PCUE_PROGRAM_SIZE

Fullword containing the size of the program, in bytes.

PCUE_COMMAREA_ADDRESS

Address of the program's communication area.

PCUE_COMMAREA_SIZE

Fullword containing the length of the program's communication area.

PCUE_LOGICAL_LEVEL

Fullword containing the number of chained DFHRSADS blocks (that is, logical level).

PCUE_BRANCH_ADDRESS

Fullword. Use this field to supply an alternative entry address. Set the top bit to specify that the alternative program is to run AMODE (31).

Return codes

UERCNORM

Continue processing.

UERCPURG

Task purged during XPI call.

UERCMEA

Entry address has been modified.

XPI calls

All can be used.

The sample XPCFTCH global user exit program, DFH\$PCEX

Note that there is a CICS-supplied sample exit program, DFH\$PCEX, that is designed to be driven by the XPCFTCH exit. For more information about DFH\$PCEX, see "Sample global user exit programs" on page 14.

Exit XPCHAIR

XPCHAIR is invoked before a HANDLE ABEND LABEL routine is given control. Note that this occurs only when a program abend causes a branch to an internal abend routine. (When the HANDLE ABEND request specifies PROGRAM, exit XPCFTCH is invoked, as described above.) You can use this exit to supply an alternative handle-abend address. If the exit sets a return code of zero, or an alternative address of zero, CICS passes control to the application program's specified internal routine.

If a modified entry address is supplied, the code that is invoked receives control in the execution key that the internal abend routine would have received control in—that is, the key in force when the EXEC CICS HANDLE ABEND LABEL command was issued.

When invoked

Before a HANDLE ABEND routine is given control.

Exit-specific parameters

UEPPCDS

Address of a storage area that contains program- and terminal-related information, and that can be mapped using the DSECT DFHPCUE. When XPCHAIR is invoked, the following DFHPCUE fields are significant:

PCUE_CONTROL_BITS

1-byte flag field. A setting of PCUECBTE indicates that the transaction is linked to a terminal.

PCUE_TASK_NUMBER

3-character packed decimal field containing the task number.

PCUE_TRANSACTION_ID

4-character field containing the transaction ID.

PCUE_TERMINAL_ID

4-character field containing the terminal ID (if any).

PCUE_PROGRAM_NAME

8-character field containing the name of the program that issued the HANDLE ABEND LABEL command.

PCUE_LOGICAL_LEVEL

Fullword containing the number of chained DFHRSADS blocks (that is, logical level).

PCUE_BRANCH_ADDRESS

Fullword. Use this field to supply the address of an alternate abend routine. Set the top bit to specify that the alternate abend routine is to run AMODE (31).

UEPTACB

Address of the transaction abend control block (TACB) for the abend. If the abend occurred because of a program check, the information in the TACB includes:

- The program status word (PSW)
- The registers at the time of the abend
- Details of the subspace and access registers current at the time of the abend.

You can map the TACB using the DFHTACB TYPE=DSECT macro.

Return codes

UERCNORM

Continue processing.

UERCPURG

Task purged during XPI call.

UERCMEA

The address of an alternate abend routine has been supplied.

XPI calls

All can be used.

program control program exits

Exit XPCTA

XPCTA is invoked immediately after a transaction abend, and before any processing that might modify the existing environment so that the task could not be resumed. You can use it to:

- Set a resume address, instead of letting CICS process the abend
- Specify the subspace that control is passed in.

If a resume address is passed back, registers 0 through 13 and 15 are restored to their values at the time of the abend. Register 14 is used to branch to the resume address. If the exit sets a return code of zero, or a resume address of zero, CICS processes the abend.

Note: If the transaction abend occurs as a result of a program check or an operating system abend, it is possible that the XDUREQ dump domain exit may be invoked before XPCTA. (For details of XDUREQ, see page “Exit XDUREQ” on page 49.)

When invoked

After an abend and before the environment is modified.

Exit-specific parameters

UEPPCDS

Address of a storage area that contains program- and terminal-related information, and that can be mapped using the DSECT DFHPCUE. When XPCTA is invoked, the following DFHPCUE fields are significant:

PCUE_CONTROL_BITS

1-byte flag field. A setting of PCUECBTE indicates that the transaction is linked to a terminal.

PCUE_TASK_NUMBER

3-character packed decimal field containing the task number.

PCUE_TRANSACTION_ID

4-character field containing the transaction ID.

PCUE_TERMINAL_ID

4-character field containing the terminal ID (if any).

PCUE_PROGRAM_NAME

8-character field containing the name of the failing program.

PCUE_LOGICAL_LEVEL

Fullword containing the number of chained DFHRSADS blocks (that is, logical level).

PCUE_BRANCH_ADDRESS

Fullword. You can use this field to supply a resume address. Set the top bit to specify that the resumed task is to run AMODE (31).

PCUE_BRANCH_EXECKEY

If storage protection is active, you can use this 1-byte field to specify the execution key of the resumed task. The possible values are:

PCUE_BRANCH_USER

User key

PCUE_BRANCH_CICS

CICS key.

If storage protection is active, and you do not specify a value, the resumed task executes in User key.

If storage protection is not active, the resumed task executes in CICS key.

UEPTACB

Address of the transaction abend control block (TACB) for the abend. If the abend occurred because of a program check, the information in the TACB includes:

- The program status word (PSW)
- The registers at the time of the abend
- The execution key at the time of the abend
- Details of the subspace and access registers current at the time of the abend.

You can map the TACB using the DFHTACB TYPE=DSECT macro.

Return codes

UERCNORM

Continue processing.

UERCPURG

Task purged during XPI call.

UERCMEA

A resume address has been supplied.

XPI calls

All can be used.

The sample XPCTA global user exit program, DFH\$PCTA

The sample program tests whether the abend was caused by the application program trying to overwrite CICS-key storage in the CDSA or ECDSA, while running in user key. If this was the case, the sample changes the execution key to CICS, and retries the failing instruction.

You can use the sample program to identify, without abending, those programs that need to be defined with EXECKEY(CICS), because they intentionally modify a CICS-key DSA. For details of how to do this, see the prolog of DFH\$PCTA.

DFH\$PCTA can be extended for transaction isolation.

Exit XPCABND

XPCABND is invoked before a transaction dump call: you can use it to suppress the dump.

When invoked

Before a transaction dump call is made.

program control program exits

Exit-specific parameters

UEPPCDS

Address of a storage area that contains program-related and terminal-related information. The storage area is mapped by the DSECT DFHPCUE.

When XPCABND is invoked, the following DFHPCUE fields are significant:

PCUE_CONTROL_BITS

A 1-byte flag field. A setting of PCUECBTE indicates that the transaction is linked to a terminal.

PCUE_TASK_NUMBER

A 3-character packed decimal field containing the task number.

PCUE_TRANSACTION_ID

A 4-character field containing the transaction ID.

PCUE_TERMINAL_ID

A 4-character field containing the terminal ID (if any).

PCUE_PROGRAM_NAME

An 8-character field containing the name of the program that is abending.

PCUE_LOGICAL_LEVEL

A fullword containing the number of chained DFHRSADS blocks (that is, the logical level).

UEPTACB

Address of the transaction abend control block (TACB) for the abend. If the abend occurred because of a program check, the information in the TACB includes:

- The program status word (PSW)
- The registers at the time of the abend.
- Details of the subspace and access registers current at the time of the abend.

You can map the TACB using the DFHTACB TYPE=DSECT macro.

Return codes

UERCNORM

Continue processing – make the dump call.

UERCBYB

Suppress the dump call.

UERCPURG

Task purged during XPI call.

XPI calls

All can be used.

Resource manager interface program exits XRMIIN and XRMIOUT

Exit XRMIIN

When invoked

Before a task-related user exit program is invoked due to an application program issuing an RMI API request.

Exit-specific parameters

UEPTRUEN

Address of the name of the task-related user exit program.

UEPTRUEP

Address of the parameter list to be passed to the task-related user exit program. See note.

UEPRECUR

Address of a halfword recursion counter. The counter is set to 0 when the exit is first invoked, and is incremented for each recursive call.

Note: The task-related user exit program's parameter list is mapped by a DFHUEPAR DSECT that shares common field names with the global user exit program's DFHUEPAR parameter list. To include both DSECT definitions in your exit program, you must code:

```
DFHUEXIT TYPE=EP, ID=XRMIIN
DFHUEXIT TYPE, TYPE=RM
```

The statements must be coded in this order.

The two DFHUEPAR parameter lists, the global user exit's and the task-related user exit's, occupy separate areas of storage. The task-related user exit's parameter list is provided for information only; you should not amend it in any way.

Return codes

UERCNORM

Continue processing.

UERCPURG

Task purged during XPI call.

XPI calls

All can be used.

API and SPI commands

All can be used. However, CALLDLI, EXEC DLI, or EXEC SQL commands must **not** be used.

resource manager interface program exits

Exit XRMIOUT

When invoked

After a task-related user exit program has returned from handling an RMI API request.

Exit-specific parameters

UEPTRUEN

Address of the name of the task-related user exit program.

UEPTRUEP

Address of the parameter list passed to the task-related user exit program. See note.

UEPRECUR

Address of a halfword recursion counter. The counter is set to 0 when the exit is first invoked, and is incremented for each recursive call.

Note: The task-related user exit program's parameter list is mapped by a DFHUEPAR DSECT that shares common field names with the global user exit program's DFHUEPAR parameter list. To include both DSECT definitions in your exit program, you must code:

```
DFHUEXIT TYPE=EP, ID=XRMIOUT  
DFHUEXIT TYPE, TYPE=RM
```

The statements must be coded in this order.

The two DFHUEPAR parameter lists, the global user exit's and the task-related user exit's, occupy separate areas of storage. The task-related user exit's parameter list is provided for information only; you should not amend it in any way.

Return codes

UERCNORM

Continue processing.

UERCPURG

Task purged during XPI call.

XPI calls

All can be used.

API and SPI commands

All can be used. However, CALLDLI, EXEC DLI, or EXEC SQL commands must **not** be used.

Note: It is not recommended that your exit program make calls to other external resource managers that use the RMI, because this causes recursion, and may result in a loop. It is your exit program's responsibility to avoid entering a loop. It could use the recursion counter field UEPRECUR to guard against this.

Resource management install and discard exit XRSINDI

The XRSINDI global user exit is driven, if it is enabled, immediately after CICS successfully installs or discards a resource definition.

The install and discard activities that drive the exit are as follows:

- The install function of the group list on an initial or cold start of CICS
- The CEDA INSTALL command
- All autoinstall operations, as follows:
 - The autoinstall of a terminal, connection, program, mapset, partitionset, or journal
 - The automatic discard of an unused terminal, controlled by the AILDELAY system initialization parameter and the SIGNOFF parameter on the TYPETERM resource definition.
- The connection to, and disconnection from, an MVS log stream
- A CEMT DISCARD and EXEC CICS DISCARD command
- The front-end programming interface (FEPI) install and discard operations: the EXEC CICS FEPI INSTALL command and EXEC CICS FEPI DISCARD command.

The parameter list is designed to pass the names of more than one resource installed or discarded, in field UEPIDNAM. When designing your global user exit program, do not assume that the number of resource names passed is always one. You are recommended to analyze the resources within a loop based on the value referenced by UEPIDNUM.

Note that the names of modegroups are prefixed with the corresponding connection name. There is no separator between the two names: the first four characters form the connection name, followed by eight characters for the modegroup. The parts of the concatenated name are fixed length—if connection names are defined with less than four characters, they are padded with blanks in the concatenated names. Similarly, the connection names for a front-end programming interface (FEPI) connection is a concatenation of a FEPI node name and a FEPI target name, each of which is 8 characters long (fixed length) with no separator.

The exit is driven once for each individual resource in a group list installed during a CICS initial or cold start. If you are concerned about the performance overhead on an initial or cold start, do not enable the exit until after the group list is installed. To obtain the information about resources installed prior to enabling the exit, you can write a program to scan the tables of installed resources, using the EXEC CICS INQUIRE *resource_name* browse function.

Exit XRSINDI

When invoked

Whenever CICS installs or discards a resource definition.

Exit-specific parameters

UEPTRANID

Address of the 4-byte transaction ID.

UEPUSER

Address of the 8-byte user ID.

resource management module exit

UEPTERM

Address of the 4-byte terminal ID.

UEPPROG

Address of the 8-byte application program name.

UEPIDREQ

Address of the 1-byte install or discard identifier. The values are:

UEIDINS

This request is for an install (or in the case of a log stream, it is a connection to a log stream).

UEIDDIS

This request is for a discard (or in the case of a log stream, it is a disconnection from a log stream).

UEPIDTYP

Address of the 1-byte type of resource. The values are:

UEIDAITM

An autoinstall terminal model

UEIDCONN

A connection

UEIDDB2C

A DB2® connection

UEIDDB2E

A DB2 entry (DB2ENTRY)

UEIDDB2T

A DB2 transaction (DB2TRAN)

UEIDDOCT

A DOCTEMPLATE

UEIDFECO

A FEPI connection

UEIDFENO

A FEPI node

UEIDFEPO

A FEPI pool

UEIDFEPS

A FEPI propertyset

UEIDFETA

A FEPI target

UEIDFILE

A file

UEIDJNMD

A journal model

UEIDJNNM

A journal name

UEIDMAP

A mapset

UEIDMODE

A modegroup

UEIDNQRN

An ENQMODEL

UEIDPART

A partner

UEIDPROF

A profile

UEIDPROG

A program

UEIDPRTY

A BTS process-type

UEIDPSET

A partitionset

UEIDRQMD

A request model (IIOp)

UEIDSESS

A session

UEIDSTRM

An MVS log stream

UEIDTCLS

A transaction class

UEIDTCPS

A TCP/IP service

UEIDTDQU

A transient data queue

UEIDTERM

A terminal

UEIDTRAN

A transaction

UEIDTSMD

A temporary storage queue model.

UEPIDLEN

Address of the length of an individual resource name, as a full-word binary value.

UEPIDNUM

Address of the number of resources reported by this call, as a full-word binary value.

UEPIDNAM

Address of a variable-length list containing the names of the individual resources reported by this call.

UEPIDREC

Address of a 1-byte identifier indicating whether resources are recovered at a warm or emergency restart. The values are:

resource management module exit

UEIDKEEP

The resources are recoverable at a warm or emergency restart.

UEIDLOSE

The resources are not recoverable.

Note: The exit is not driven during a CICS restart.

Return codes

UERCNORM

Continue processing. This is the default.

UERCPURG

Task purged during XPI call.

XPI calls

You can use all XPI calls.

Important

Abends in a program enabled at the XRSINDI exit point may cause CICS to terminate, because for some resources the exit is driven during syncpoint. If the exit returns code UERCPURG during syncpoint for these resources, abend code AUPE is produced and CICS terminates.

Signon and signoff exits XSNON and XSNOFF

Exit XSNON is invoked after a terminal user signs on, and exit XSNOFF is invoked after a terminal user signs off (whether the signon or sign-off is successful or not). XSNON and XSNOFF do not make any security decisions; they are merely a means of tracking users logging on and off a CICS system.

The activities which drive the exits are:

- Invocation of an EXEC CICS SIGNON command for a terminal (when, for example, the terminal user enters the CICS-supplied CESN, or an equivalent, user-written, signon transaction)
- Invocation of an EXEC CICS SIGNON command for a surrogate terminal (that is, a terminal attached by the CRTE routing transaction, or by dynamic transaction routing)
- Invocation of an EXEC CICS SIGNOFF command for a terminal
- When a 'CANCEL' command is entered to terminate a CRTE routing session
- A timeout sign-off.

Exit XSNON

When invoked

When a user signs on.

Exit-specific parameters

UEPUSRID

Address of the terminal userid.

UEPUSRLN

Address of the terminal userid length.

UEPGRPID

Address of the group ID. If the signon was successful, the group ID is that which the user is associated with in this signon session. If the signon was unsuccessful, it is that specified by the user when he or she tried to sign on.

UEPGRPLN

Address of the group ID length.

UEPNETN

Address of the terminal's netname.

UEPTRMID

Address of the terminal id.

UEPTCTUA

Address of the TCT user area.

UEPTCTUL

Address of the TCT user area length.

UEPTRMTY

Address of the terminal-type byte.

UEPSNFLG

Address of a 2-byte field containing flags:

UEPSNOK

Signon was successful

sign on and sign off exits

UEPSNFL

Signon failed.

Return codes

UERCNORM

Continue processing.

UERCPURG

Task purged during XPI call.

XPI calls

All can be used.

Exit XSNOFF

When invoked

When a user signs off.

Exit-specific parameters

UEPUSRID

Address of the terminal userid.

UEPUSRLN

Address of the terminal userid length.

UEPGRPID

Address of the group ID.

UEPGRPLN

Address of the group ID length.

UEPNETN

Address of the terminal's netname.

UEPTRMID

Address of the terminal id.

UEPTCTUA

Address of the TCT user area.

UEPTCTUL

Address of the TCT user area length.

UEPTRMTY

Address of the terminal-type byte.

UEPSNFLG

Address of a 2-byte field containing flags:

UEPSNOK

Sign-off was successful

UEPSNFL

Sign-off failed

UEPSNML

Normal sign-off

UEPSNTIM

Timeout sign-off.

Return codes

UERCNORM

Continue processing.

UERCPURG

Task purged during XPI call.

XPI calls

All can be used.

Statistics domain exit XSTOUT

On invocation, XSTOUT is passed the address of a buffer containing one or more statistics records. The buffer can contain records for various resource types (for example, connections and modenames), and both specific and global information (for example, loader statistics for individual programs, and loader statistics for all programs).

Your exit program can identify the types of records in the buffer by their STID values. (STID values are described in “CICS statistics data section” on page 685.)

You can use XSTOUT to prevent the contents of the statistics data buffer being written to SMF. Note that you cannot use it to selectively suppress individual records within the buffer. Your exit program should not modify the values of any of the exit-specific parameters.

Exit XSTOUT

When invoked

Before a statistics record is written to SMF.

Exit-specific parameters

Fields UEPTRANID, UEPUSER, UEPTERM, and UEPPROG have meaning **only** for requested statistics (when using CEMT PERFORM STATISTICS RECORD or the EXEC CICS PERFORM STATISTICS RECORD command).

UEPTRANID

Address of the 4-byte transaction ID.

UEPUSER

Address of the 8-byte user ID.

UEPTERM

Address of the 4-byte terminal ID.

UEPPROG

Address of the 8-byte application program name.

UEPSTATS

Address of a buffer containing one or more statistics records. For unsolicited statistics, the buffer always contains one record; for other types of statistics, it may contain several records. The length of the buffer is addressed by the UEPSRLEN parameter.

UEPSRLEN

Address of the 4-byte hexadecimal length of the statistics record.

UEPSTYPE

Address of the 3-byte character field statistics type. The values of the types are:

- INT** Interval statistics
- EOD** End-of-day statistics
- REQ** Requested statistics
- RRT** Requested reset statistics
- USS** Unsolicited statistics.

UEPSDATE

Address of a 6-byte character field containing the collection date (MMDDYY).

UEPSTIME

Address of a 6-byte character field containing the collection time (HHMMSS).

UEPSIVAL

Address of a 6-byte character field containing the interval time (HHMMSS). This field has meaning only for interval statistics.

UEPSIVN

Address of the 4-byte interval number. This field has meaning only for interval statistics.

UEPSCLD

Address of an 8-byte character field containing the collection date (MMDDYYYY).

Return codes

UERCNORM

Continue processing.

UERCBYP

Suppress output of statistics data buffer to SMF.

XPI calls

WAIT_MVS can be used. **Note, however, that the wait cannot be purged using CEMT or SPI. Do not use any other calls.**

System recovery program exit XSRAB

Exit XSRAB

When invoked

When the system recovery program (DFHSRP) finds a match in the SRT for an MVS/ESA™ abend code. For information about defining entries in the SRT, refer to the *CICS Resource Definition Guide*.

Note: The SRT table is only processed, and the exit driven, when an MVS abend occurs under a CICS essential TCB—that is, one of QR, RO, CO, SZ, RP, FO. For non-essential TCB types, such as L8, J8, SL, SO, or S8, the exit is not driven.

Exit-specific parameters

UEPERROR

Address of the error data structure, SRP_ERROR_DATA, which contains the following fields:

SRP_ERROR_TYPE

The 4-character error type—always 'ASRB'.

SRP_SYS_ABCODE

2 bytes containing the system abend code XXX in binary format (for example, D37).

SRP_USER_ABCODE

2 bytes containing the user abend code NNNN in binary format (for example, 0999).

SRP_ERROR_TRANID

4-character field containing the ID of the abending transaction.

SRP_ERROR_STACK_NAME

8-character field containing the name of the current kernel stack entry for the transaction at the time of the abend.

SRP_ERROR_PPT_NAME

8-character field containing the name of the current PPT entry for the transaction, if one exists. This field contains a value only if flag SRP_PPT_ENTRY is set.

SRP_ERROR_OFFSET

Fullword containing the offset into the program that abended, as follows:

- If flag SRP_PPT_ENTRY is set, gives the offset in SRP_ERROR_PPT_NAME
- Otherwise, gives the offset in SRP_ERROR_STACK_NAME.

This field contains a value only if flag SRP_VALID_OFFSET is set.

SRP_ERROR_FLAGS

1 byte containing flags:

SRP_CICS_CODE

The abend occurred while running CICS code.

system recovery program exit

SRP_USER_CODE

The abend occurred while running user application code.

SRP_PPT_ENTRY

The abend occurred while running SRP_ERROR_PPT_NAME. If this flag is not set, the abend occurred while running SRP_ERROR_STACK_NAME.

SRP_VALID_OFFSET

A meaningful offset could be determined.

SRP_VALID_REASON

MVS has supplied a reason code for the abend.

SRP_NOT_CICS_RB

CICS RB was not in control at the time of the abend (that is, the abend occurred in a system service invoked by CICS).

SRP_CICS_ERROR_REASON

4-character field containing the MVS abend reason code. It contains a value only if flag SRP_VALID_REASON is set.

SRP_CICS_ERROR_DATA

An area describing the last thing that CICS did, prior to the abend. It contains the following:

SRP_CICS_EC_PSW

8-character field containing the extended control (EC) mode program status word (PSW)

SRP_CICS_EC_INT

8-character field containing the interrupt code and ILC

SRP_CICS_REGST

64-character field containing the contents of the general-purpose (GP) registers

SRP_CICS_EXEC_KEY

1 byte containing the PSW key, in the form X'0n'.

SRP_SYSTEM_ERROR_DATA

An area describing the last thing "the system" did, prior to the abend. It contains the following:

SRP_SYSTEM_EC_PSW

8-character field containing the EC mode PSW

SRP_SYSTEM_EC_INT

8-character field containing the interrupt code and ILC

SRP_SYSTEM_REGST

64-character field containing the contents of the GP registers

SRP_SYSTEM_EXEC_KEY

1 byte containing the PSW key, in the form X'0n'.

system recovery program exit

SRP_ERROR_FP_REGS

An area describing the contents of the floating point registers at the time of the abend. It contains:

SRP_FP_REG_0

FP register 0

SRP_FP_REG_2

FP register 2

SRP_FP_REG_4

FP register 4

SRP_FP_REG_6

FP register 6.

Notes:

1. If flag SRP_NOT_CICS_RB is set, SRP_CICS_ERROR_DATA describes the last thing that CICS did, prior to the abend; SRP_SYSTEM_ERROR_DATA describes the last thing that the system service (for example, VTAM, VSAM, or MVS) did.
2. The format of SRP_ERROR_DATA is shown in the *CICS Data Areas* manual.

Return codes

UERCNOCA

Abnormally terminate the task with abend code 'ASRB'. Do not cancel any program-level abend exits that are associated with this task.

UERCCANC

Abnormally terminate the task with abend code 'ASRB'. Cancel any program-level abend exits that are associated with this task.

UERCCICS

Abnormally terminate CICS.

XPI calls

Because CICS invokes the exit XSRAB in an error environment, you can only use a subset of the XPI calls.

Only TRACE_PUT is available for general use.

You can use WAIT_MVS, but only after the exit program has determined (from the SRP_CICS_CODE and SRP_USER_CODE fields) that the abend has occurred in user application code, and not in CICS code.

Important

Notes:

1. Take care when coding a program to run at the XSRAB exit point. If your exit program causes the system recovery program to be reentered (if, for example, a program check occurs) then CICS terminates abnormally, with a DFHSR06xx message.
2. The default return code is 'UERCNOCA'. This ensures that the task abends if the exit is in error.
3. There is no 'UERCNORM' return code at this exit point, because the exit is invoked after a failure.
4. The exit should **not** set the return code 'UERCPURG'.

System termination program exit XSTERM

The XSTERM exit could be used to output final statistics to your statistics SMF data sets, and to close them. (Note that CICS VSAM and BDAM data sets have already been closed by CICS file control before the exit is invoked.)

Exit XSTERM

When invoked

During the second quiesce stage of a normal system shutdown, immediately before the transient data and temporary storage buffers are cleared. The exit is not invoked during an IMMEDIATE shutdown.

Exit-specific parameters

None.

Return codes

UERCNORM

Continue processing.

XPI calls

All XPI calls except WRITE_JOURNAL_DATA can be used. However, their use is not recommended, because they could cause the task to lose control, thus allowing another task to write more monitoring data.

Temporary storage domain exits XTSQRIN, XTSQROUT, XTSPTIN, and XTSPTOUT

The temporary storage domain exits XTSQRIN, XTSQROUT, XTSPTIN, and XTSPTOUT allow you to:

- Specify, for a request that creates a queue, whether the queue is to be held in main or auxiliary storage, and its recoverability
- Monitor the use of temporary storage
- Control security for temporary storage queues.

The temporary storage domain has two main gates, TSQR, and TSPT, which support the following functions:

TSQR Write, Rewrite, Read_into, Read_set, Read_next_into, Read_next_set, Delete.

TSPT Put, Put_replace, Get, Get_set, Get_release, Get_release_set, Release.

The TSQR functions correspond to those available through the EXEC CICS interface (or through DFHTS TYPE=PUTQ, GETQ, or PURGE). The TSPT functions are used by the interval control program in support of START and RETRIEVE functions (or DFHTS TYPE=PUT, GET, or RELEASE).

Exit XTSQRIN

When invoked

Before execution of a user temporary storage interface request for a user TS queue (for example, a WRITEQ TS, or READQ TS request).

Exit-specific parameters

UEPTRANID

Address of the 4-byte transaction ID.

UEPUSER

Address of the 8-byte user ID.

UEPTERM

Address of the 4-byte terminal ID.

UEPPROG

Address of the 8-byte application program name.

UEP_TS_FUNCTION

Address of a byte containing the function:

UEP_TS_FUN_WRITE

UEP_TS_FUN_REWRITE

UEP_TS_FUN_READ_INTRO

UEP_TS_FUN_READ_SET

UEP_TS_FUN_READ_NEXT_INTRO

UEP_TS_FUN_READ_NEXT_SET

UEP_TS_FUN_DELETE

UEP_TS_QUEUE_NAME

Address of a 16-byte field containing the queue name.

temporary storage domain exits

UEP_TS_DATA_P

Address of a fullword containing the address of the data. (Write and rewrite requests).

UEP_TS_DATA_L

Address of a fullword containing the length of the data. (Write and rewrite requests).

UEP_TS_ITEM_NUMBER

Address of a fullword containing the item number. (Rewrite, read_into and read_set requests).

UEP_TS_STORAGE_TYPE

Address of a byte containing the storage type. (Write requests).

On input to the exit, the parameter will be set to either UEP_TS_STORAGE_TYPE_MAIN or UEP_TS_STORAGE_TYPE_AUX_TST. This parameter may be modified by the exit to any of the values below.

Note that if CICS has been initialized with TS main-only support, setting this parameter has no effect.

UEP_TS_STORAGE_TYPE_MAIN

Main storage.

UEP_TS_STORAGE_TYPE_AUX_TST

Auxiliary storage (recoverability determined by the TST).

UEP_TS_STORAGE_TYPE_AUX_RECOV_YES

Auxiliary storage (recoverable).

UEP_TS_STORAGE_TYPE_AUX_RECOV_NO

Auxiliary storage (non-recoverable).

Return codes

UERCNORM

Normal.

UERCPURG

Purged.

XPI calls

All can be used.

API and SPI calls

None can be used.

Exit XTSQROUT

When invoked

After execution of a user temporary storage interface request for a user TS queue (for example, a WRITEQ TS, or READQ TS request).

Exit-specific parameters

UEPTRANID

Address of the 4-byte transaction ID.

UEPUSER

Address of the 8-byte user ID.

UEPTERM

Address of the 4-byte terminal ID.

UEPPROG

Address of the 8-byte application program name.

UEP_TS_FUNCTION

Address of a byte containing the function:

UEP_TS_FUN_WRITE

UEP_TS_FUN_REWRITE

UEP_TS_FUN_READ_INT0

UEP_TS_FUN_READ_SET

UEP_TS_FUN_READ_NEXT_INT0

UEP_TS_FUN_READ_NEXT_SET

UEP_TS_FUN_DELETE

UEP_TS_QUEUE_NAME

Address of a 16-byte field containing the queue name.

UEP_TS_DATA_P

Address of a fullword containing the address of the data. (All requests except delete).

UEP_TS_DATA_L

Address of a fullword containing the length of the data. (All requests except delete).

UEP_TS_ITEM_NUMBER

Address of a fullword containing the item number. (Rewrite, read_into and read_set requests).

UEP_TS_TOTAL_ITEMS

Address of a fullword containing the total number of items in the queue. (All requests except delete).

UEP_TS_RESPONSE

Address of a byte containing the response after a request has been completed.

UEP_TS_RESPONSE_OK

UEP_TS_RESPONSE_PURGED

UEP_TS_RESPONSE_EXCEPTION

UEP_TS_RESPONSE_DISASTER

UEP_TS_RESPONSE_INVALID

Return codes

UERCNORM

Normal response.

UERCPURG

A purged response was received from an XPI request.

XPI calls

All can be used.

API and SPI calls

None can be used.

temporary storage domain exits

Exit XTSPTIN

When invoked

Before execution of a temporary storage interface request for a CICS internal queue (for example, for interval control or BMS queues).

Exit-specific parameters

UEPTRANID

Address of the 4-byte transaction ID.

UEPUSER

Address of the 8-byte user ID.

UEPTERM

Address of the 4-byte terminal ID.

UEPPROG

Address of the 8-byte application program name.

UEP_TS_FUNCTION

Address of a byte containing the function:

UEP_TS_FUN_PUT
UEP_TS_FUN_PUT_REPLACE
UEP_TS_FUN_GET
UEP_TS_FUN_GET_SET
UEP_TS_FUN_GET_RELEASE
UEP_TS_FUN_GET_RELEASE_SET
UEP_TS_FUN_RELEASE

UEP_TS_QUEUE_NAME

Address of a 16-byte field containing the queue name.

UEP_TS_DATA_P

Address of a fullword containing the address of the data. (Put and put_replace).

UEP_TS_DATA_L

Address of a fullword containing the length of the data. (Put and put_replace).

UEP_TS_STORAGE_TYPE

Address of a byte containing the storage type. (Put requests).

On input to the exit, the parameter will be set to either UEP_TS_STORAGE_TYPE_MAIN or UEP_TS_STORAGE_TYPE_AUX_TST. This parameter may be modified by the exit to any of the values below.

Note that if CICS has been initialized with TS main-only support, setting this parameter has no effect.

UEP_TS_STORAGE_TYPE_MAIN

Main storage.

UEP_TS_STORAGE_TYPE_AUX_TST

Auxiliary storage (recoverability determined by the TST).

UEP_TS_STORAGE_TYPE_AUX_RECOV_YES

Auxiliary storage (recoverable).

temporary storage domain exits

UEP_TS_STORAGE_TYPE_AUX_RECOV_NO

Auxiliary storage (non-recoverable).

Return codes

UERCNORM

Normal.

UERCPURG

Task purged during XPI call.

XPI calls

All can be used.

API and SPI calls

None can be used.

Exit XTSPTOUT

When invoked

After execution of a temporary storage interface request for a CICS internal queue (for example, for interval control or BMS queues). After execution of a TSPT request. No parameters may be modified.

Exit-specific parameters

UEPTRANID

Address of the 4-byte transaction ID.

UEPUSER

Address of the 8-byte user ID.

UEPTERM

Address of the 4-byte terminal ID.

UEPPROG

Address of the 8-byte application program name.

UEP_TS_FUNCTION

Address of a byte containing the function:

UEP_TS_FUNCTION_PUT

UEP_TS_FUN_PUT_REPLACE

UEP_TS_FUN_GET

UEP_TS_FUN_GET_SET

UEP_TS_FUN_GET_RELEASE

UEP_TS_FUN_GET_RELEASE_SET

UEP_TS_FUN_RELEASE

UEP_TS_QUEUE_NAME

Address of a 16-byte field containing the queue name.

UEP_TS_DATA_P

Address of a fullword containing the address of the data. (All requests except release).

UEP_TS_DATA_L

Address of a fullword containing the length of the data. (All requests except release).

UEP_TS_RESPONSE

Address of a byte containing the response after a request has been completed.

temporary storage domain exits

UEP_TS_RESPONSE_OK
UEP_TS_RESPONSE_PURGED
UEP_TS_RESPONSE_EXCEPTION
UEP_TS_RESPONSE_DISASTER
UEP_TS_RESPONSE_INVALID

Return codes

UERCNORM

Normal response.

UERPURG

A purged response was received from an XPI request.

XPI calls

All can be used.

API and SPI calls

None can be used.

Temporary storage EXEC interface program exits XTSERREQ and XTSEREQC

The XTSERREQ exit allows you to intercept temporary storage API requests before any action has been taken on the request. The XTSEREQC exit allows you to intercept the response after a temporary storage API request has completed.

The API requests affected are:

- EXEC CICS WRITEQ TS
- EXEC CICS READQ TS
- EXEC CICS DELETEQ TS.

Using **XTSERREQ**, you can:

- Analyze the API parameter list (function, keywords, argument values, and responses)
- Modify any input parameter value prior to execution of a request
- Prevent execution of a request.

Using **XTSEREQC**, you can:

- Analyze the API parameter list
- Modify any output parameter value after request completion.

You can also:

- Pass data between your XTSERREQ and XTSEREQC exit programs when they are invoked for the same request
- Pass data between your temporary storage exit programs when they are invoked within the same task.

It is possible that programs invoked from the exits in the temporary storage domain (XTSQRIN, XTSQROUT, XTSPTIN, and XTSPTOUT) could modify situations set up by XTSERREQ; therefore you must consider the order in which the exits are invoked.

If all the temporary storage exits are enabled, the order of invocation is as follows:

1. XTSERREQ
2. XTSQRIN
3. XTSQROUT
4. XTSEREQC

temporary storage EXEC interface program exits

Exit XTSERREQ

When invoked

Before CICS processes a temporary storage API request.

Exit-specific parameters

UEPCLPS

Address of a copy of the command parameter list. See “The command-level parameter structure” on page 196.

UEPTQ TOK

Address of a 4-byte area which can be used to pass information between XTSERREQ and XTSERREQC for a single temporary storage request.

UEPRCODE

Address of a 6-byte hexadecimal copy of the EIB return code EIBRCODE. For details of EIB return codes, see the *CICS/ESA Application Programming Reference* manual.

UEPRESP

Address of a 4-byte binary copy of the EIB response code EIBRESP.

UEPRESP2

Address of a 4-byte binary copy of the EIB response code EIBRESP2.

UEPTSTOK

Address of a 4-byte token which can be used to pass information between successive temporary storage requests within the same task (for example, between successive invocations of the XTSERREQ exit).

UEPRECUR

Address of a halfword recursion counter. The counter is set to 0 when the exit is first invoked, and is incremented for each recursive call.

UEPRSRCE

Address of an 8-character copy of the EIB resource value, EIBRSRCE.

Return codes

UERC BYP

Bypass this request.

UERC NORM

Continue processing.

UERC PURG

Task purged during XPI call.

XPI calls

All can be used.

API and SPI commands

All can be used.

Note: Take care when issuing recursive commands. For example, you must avoid entering a loop when issuing a temporary storage request from the XTSERREQ exit. Use of the recursion counter UEPRECUR is recommended.

Exit XTSEREQC**When invoked**

After a temporary storage API request has completed, before return from the temporary storage EXEC interface program.

Exit-specific parameters**UEPCLPS**

Address of a copy of the command parameter list. See “The command-level parameter structure” on page 196.

UEPTQ TOK

Address of a 4-byte area which can be used to pass information between XTSEREQ and XTSEREQC for a single temporary storage request.

UEPRCODE

Address of a 6-byte hexadecimal copy of the EIB return code EIBRCODE. For details of EIB return codes, see the *CICS/ESA Application Programming Reference* manual.

UEPRESP

Address of a 4-byte binary copy of the EIB response code EIBRESP.

UEPRESP2

Address of a 4-byte binary copy of the EIB response code EIBRESP2.

UEPTSTOK

Address of a 4-byte token which can be used to pass information between successive temporary storage requests within the same task (for example, between successive invocations of the XTSEREQC exit).

UEPRECUR

Address of a halfword recursion counter. The counter is set to 0 when the exit is first invoked, and is incremented for each recursive call.

UEPRSRCE

Address of an 8-character copy of the EIB resource value, EIBRSRCE.

Return codes**UERCNORM**

Continue processing.

UERCPURG

Task purged during XPI call.

XPI calls

All can be used.

API and SPI commands

All can be used.

You can update the copies of EIBRSRCE, EIBRCODE, EIBRESP, and EIBRESP2 that you are given in the parameter list. If you update the values, temporary storage copies the new values into the application program’s EIB after the completion of XTSEREQC or if you specify a return code of UERCBYP in XTSEREQ.

temporary storage EXEC interface program exits

You must set valid temporary storage responses. You must set all three of EIBRCODE, EIBRESP, and EIBRESP2 to a consistent set of values, such as would be set by temporary storage to describe a valid completion. CICS does not check the consistency of EIBRCODE, EIBRESP, and EIBRESP2. If EIBRCODE is set to a non-zero value and EIBRESP is set to zero, CICS will override EIBRESP with a non-zero value. To help you set values for EIBRCODE, EIBRESP, and EIBRESP2, the values used by temporary storage are specified in DSECT DFHTSUED.

Note: Take care when issuing recursive commands not to cause a loop. For example, it is your responsibility to avoid entering a loop when issuing a temporary storage request from the XTSEREQC exit. Use of the recursion counter UEPRECUR is recommended.

The command-level parameter structure

The command-level parameter structure consists of a series of addresses. The first address points to the EXEC interface descriptor (EID), which consists of a bit string that describes the type of request and identifies each keyword specified with the request. The remaining addresses point to pieces of data associated with the request.

You can examine the EID to determine the type of request and the keywords specified. You can examine the other parameters in the list to determine the values of the keywords. You can also modify values of keywords specified on the request.

End of parameter list indicator

The high-order bit is set on in the last address set in the parameter list to indicate that it is the last one in the list. On return from your user exit program, CICS scans the parameter list for the high-order bit to find the last parameter. Therefore, if you modify the length of the parameter list, you must also reset the high-order bit to indicate which is the new last address.

The UEPCLPS exit-specific parameter

The UEPCLPS exit-specific parameter is included in both exit XTSEREQ and exit XTSEREQC. It is the address of the command-level parameter structure. The command-level parameter structure contains 8 addresses, TS_ADDR0 through TS_ADDR7. It is defined in the DSECT TS_ADDR_LIST, which you should copy into your exit program by including the statement COPY DFHTSUED.

The command-level parameter list is made up as follows.

Note: The relationship between arguments, keywords, data types, and input/output types is summarized for the temporary storage commands in the following tables:

Command	See
WRITEQ TS	Table 7 on page 200
READQ TS	Table 8 on page 200
DELETEQ TS	Table 9 on page 201

TS_ADDR0

is the address of a 9-byte area called the EID, which is made up as follows:

TS_GROUP

temporary storage EXEC interface program exits

TS_FUNCT

TS_BITS1

TS_BITS2

TS_EIDOPT5

TS_EIDOPT6

TS_EIDOPT7

TS_EIDOPT8

TS_GROUP

Always X'0A', indicating that this is a temporary storage request.

TS_FUNCT

One byte that defines the type of request:

X'02' WRITEQ

X'04' READQ

X'06' DELETEQ

TS_BITS1

Existence bits that define which arguments were specified. To obtain the argument associated with a keyword, you need to use the appropriate address from the command-level parameter structure. Before using this address, you must check the associated existence bit. If the existence bit is set off, the argument was not specified in the request and the address should not be used.

X'80' Set if the request contains an argument for the QUEUE or QNAME keyword. If set, **TS_ADDR1** is meaningful.

X'40' Set if the request contains an argument for any of the FROM, INTO, or SET keywords. If set, **TS_ADDR2** is meaningful.

X'20' Set if the request contains an argument for the LENGTH keyword. If set, **TS_ADDR3** is meaningful.

X'10' Set if the request contains an argument for the NUMITEMS keyword. If set, **TS_ADDR4** is meaningful.

X'08' Set if the request contains an argument for the NUMITEMS or ITEM keyword. If set, **TS_ADDR5** is meaningful.

X'02' Set if the request contains an argument for the SYSID keyword. If set, **TS_ADDR7** is meaningful.

TS_BITS2

Two bytes not used by temporary storage.

TS_EIDOPT5

Indicates whether certain keywords were specified on the request.

X'80' QNAME was specified (otherwise QUEUE). You can modify this bit in your user exit if you wish.

TS_EIDOPT6

One byte not used by temporary storage.

TS_EIDOPT7

Indicates whether certain functions and/or keywords were specified on the request.

X'10' WRITEQ NOSUSPEND specified.

temporary storage EXEC interface program exits

X'80' WRITEQ MAIN or READQ ITEM specified.

X'04' WRITEQ REWRITE or READQ NUMITEMS specified.

TS_EIDOPT8

Indicates whether certain keywords were specified on the request.

X'80' ITEM was specified (otherwise NUMITEMS).

TS_ADDR1

is the address of area containing 8-byte name from QUEUE. or 16-byte name from QNAME. To determine which of these is applied, see 197.

TS_ADDR2

is the address of one of the following:

- A 4-byte address from SET (if the request is READQ and **TS_EIDOPT5** indicates that this is SET).
- Data from INTO (if the request is READQ and **TS_EIDOPT5** indicates that this is not SET).
- Data from FROM (if the request is WRITEQ).

TS_ADDR3

is the address of the halfword value of LENGTH (if the request is READQ or WRITEQ).

Warning: For requests that specify INTO, do not change the value of LENGTH to a value greater than that specified by the application. To do so causes a storage overlay in the application.

TS_ADDR4

is the address of the halfword value of NUMITEMS (if the request is READQ).

TS_ADDR5

is the address of one of the following:

- The halfword value of NUMITEMS (if the request is WRITEQ)
- The halfword value of ITEM (if the request is READQ or WRITEQ).

TS_ADDR6

is the address of a value intended for CICS internal use only. It must not be used.

TS_ADDR7

is the address of an area containing the value of SYSID.

Modifying fields in the command-level parameter structure

Some fields that are passed to temporary storage are used as input to the request, some are used as output fields, and some are used for both input and output. The method your user exit program uses to modify a field depends on the usage of the field.

The following are always input fields:

QUEUE|QNAME
FROM
SYSID

The following are always output fields:

INTO

temporary storage EXEC interface program exits

NUMITEMS

SET

LENGTH is an input field on a WRITEQ request, and an output field on a READQ request that specifies SET. It is both an input and an output field on a READQ request that specifies INTO.

ITEM is an input field on a READQ request, and on a WRITEQ request that specifies REWRITE. It is both an input and an output field on a WRITEQ request that does not specify REWRITE.

Modifying input fields

The correct method of modifying an input field is to create a new copy of it, and to change the address in the command-level parameter list to point to your new data.

Note: You must never modify an input field by altering the data that is pointed to by the command-level parameter list. To do so would corrupt storage belonging to the application program and would cause a failure when the program attempted to reuse the field.

Modifying output fields

The technique described in “Modifying input fields” is not suitable for modifying output fields. (The results would be returned to the new area instead of the application’s area, and would be invisible to the application.)

An output field is modified by altering the data that is pointed to by the command-level parameter list. In the case of an output field, you can modify the application’s data in place, because the application is expecting the field to be modified anyway.

Modifying fields used for both input and output

An example of a field that is used for both input and output is LENGTH on a READQ request that specifies INTO. You can treat such fields in the same way as output fields, and they are considered to be the same.

Modifying the EID

It is not possible to modify the EID to make major changes to requests. It is not possible, for example, to change a READQ request to a WRITEQ request.

However, you can make minor changes to requests, such as to turn on the existence bit for SYSID so that the request can be changed into one that is shipped to a remote system.

The list that follows shows the bits in the EID that can be modified. Any attempt to modify any other part of the EID is ignored.

TS_BITS1

X'02' The existence bit for SYSID.

TS_EIDOPT7

A user exit program at XTSEREQ can set the following on or off for all WRITEQ TS commands:

temporary storage EXEC interface program exits

X'10' The existence bit for NOSUSPEND.

X'08' The existence bit for MAIN.

The EID is reset to its original value before return to the application program. That is, changes made to the EID are retained for the duration of the temporary storage request only.

Note: Your user exit program is prevented from making major changes to the EID. However, you must take great care when making the minor modifications that **are** permitted.

Use of the task token UEPTSTOK

UEPTSTOK provides the address of a 4-byte area that you can use to pass information between successive temporary storage requests in the same task. (By contrast, UEPTQTOK is usable only for the duration of a single temporary storage request, because its contents may be destroyed at the end of the request.) For example, if you need to pass information between successive invocations of the XTSEREQ exit, UEPTSTOK provides a means of doing this.

Table 7. WRITEQ TS: User arguments and associated keywords, data types, and input/output types

Argument	Keyword	Data type	Input/output type
Arg1	QUEUE	CHAR(8)	input
Arg1	QNAME	CHAR(16)	input
Arg2	FROM	DATA-AREA	input
Arg3	LENGTH	BIN(15)	input
Arg4	*	*	*
Arg5	ITEM	BIN(15)	input/output
Arg5	NUMITEMS	BIN(15)	output
Arg6	*	*	*
Arg7	SYSID	CHAR(4)	input

Note: The different uses of Arg5 are shown, because Arg5 is used by the ITEM and NUMITEMS keywords which are alternatives and the argument to the ITEM keyword is an input field when REWRITE is specified.

Table 8. READQ TS: User arguments and associated keywords, data types, and input/output types

Argument	Keyword	Data type	Input/output type
Arg1	QUEUE	CHAR(8)	input
Arg1	QNAME	CHAR(16)	input
Arg2	SET	DATA-AREA, PTR	output
Arg2	INTO	DATA-AREA	output
Arg3	LENGTH	BIN(15)	input/output
Arg4	NUMITEMS	BIN(15)	output
Arg5	ITEM	BIN(15)	input
Arg6	*	*	
Arg7	SYSID	CHAR(4)	input

temporary storage EXEC interface program exits

Table 9. DELETEQ TS: User arguments and associated keywords, data types, and input/output types

Argument	Keyword	Data type	Input/output type
Arg1	QUEUE	CHAR(8)	input
Arg1	QNAME	CHAR(16)	input
Arg2	*	*	*
Arg3	*	*	*
Arg4	*	*	*
Arg5	*	*	*
Arg6	*	*	*
Arg7	SYSID	CHAR(4)	input

Modifying user arguments

User exit programs can modify user arguments, as follows:

For input arguments, the user exit program should obtain sufficient storage to hold the modified argument, set up that storage to the required value, and set the associated pointer in the parameter list to the address of the newly acquired area.

For output arguments, and for input/output arguments, the user exit program can update the argument in place, because the area of storage is represented by a variable in the application which is expected to receive a value from CICS.

Notes:

1. CICS does not check changes to argument values, so any changes must be verified by the user exit program making the changes.
2. It is not advisable for XTSEREQ to modify output arguments or for XTSEREQC to modify input arguments.

Adding user arguments

Global user exit programs can add arguments associated with the SYSID keyword. You must ensure that the arguments you specify or modify in your exit programs are valid.

Assuming that the argument to be added does not already exist, the user exit program must:

1. Obtain storage for the argument to be added
2. Initialize the storage to the required value
3. Select and set up the appropriate pointer from the parameter list
4. Select and set up the appropriate argument existence bit in the EID
5. Modify the parameter list to reflect the new end of list indicator.

Removing user arguments

User exit programs can remove arguments (for which the program is totally responsible) associated with the SYSID keyword:

Assuming that the argument to be removed exists, the user exit program must:

1. Switch the corresponding argument existence bit to '0'b in the EID
2. Modify the parameter list to reflect the new end of list indicator.

temporary storage EXEC interface program exits

Example program

CICS supplies—in hardcopy only—an example program, DFH\$XTSE, that shows how temporary storage requests can be modified. See “Appendix E. The example program for the XTSERREQ global user exit, DFH\$XTSE” on page 807.

Terminal allocation program exit XALCAID

XALCAID is driven when an AID with data is canceled in one of the following ways:

- By means of the CEMT transaction
- During execution of a SET TERMINAL or SET CONNECTION command
- During reinstallation of a terminal or connection.

XALCAID is invoked only if there is data associated with the AID.

Exit XALCAID

When invoked

Whenever an AID with data is canceled.

Note: It is not possible for the exit to prevent the request from being canceled.

Exit-specific parameters

UEPALTSD

Address of a 4-byte field containing the symbolic identifier of the transaction which was to be started by this request.

UEPALTRM

Address of a 4-byte field containing the identifier of the terminal or connection to which this request was directed.

UEPALDAT

Address of an area of storage containing the data specified in the FROM option; or hexadecimal zeros, if the AID was created by a START request without a FROM option.

UEPALLEN

Address of a fullword binary field containing the length of the FROM data; or hexadecimal zeros, if the FROM option was not specified.

UEPALRQD

Address of an 8-byte field containing the value of the REQID associated with the FROM data. The data was stored in a temporary storage queue with this name. This value was either specified explicitly using the REQID option on the START command, or created internally by CICS.

UEPALQUE

Address of an 8-byte field containing the value specified in the QUEUE option on the START command, or hexadecimal zeros if QUEUE was not specified.

UEPALRTE

Address of a 4-byte field containing the value specified in the RTERMID option on the START command, or hexadecimal zeros if RTERMID was not specified.

UEPALRTA

Address of a 4-byte field containing the value specified in the RTRANSID option on the START command, or hexadecimal zeros if RTRANSID was not specified.

UEPALFMH

Address of a 1-byte field containing the value X'FF' if the data

terminal allocation program exit

contains FMHs, as specified by the FMH option on the associated START command; or hexadecimal zeros otherwise.

UEPALSTC

Address of a 2-byte field containing the start code. This is "SZ" for FEPI starts; otherwise it is "SD".

Return codes

UERCNORM

No other return codes are supplied. The value of the return code is not inspected.

XPI calls

You can use:

INQ_APPLICATION_DATA

INQUIRE_SYSTEM

No other XPI calls should be used.

API and SPI commands

No EXEC CICS commands can be used.

Note: The XALTENF exit, used to handle the "terminal not known" condition, is also invoked from the terminal allocation program. XALTENF is described on page 208.

Terminal control program exits XTCIN, XTCOUT, XTCATT, XTCTIN, and XTCTOUT

Exit XTCIN

When invoked

After an input event for a sequential device.

Exit-specific parameters**UEPTCTTE**

Address of the terminal control table terminal entry (TCTTE). The TCTTE can be mapped using the DSECT DFHTCTTE.

UEPTIOA

Address of the terminal input/output area (TIOA). Your exit program should not change the address. The TIOA can be mapped using the DSECT DFHTIOA. However, fields TIOASAL and TIOASCA are **not** programming interfaces.

UEPTCTLE

Address of the terminal control table line entry (TCTLE). The TCTLE can be mapped using the DSECT DFHTCTLE.

Return codes**UERCNORM**

Continue processing.

XPI calls

All can be used. However, note that you cannot use a GETMAIN call to obtain terminal-class storage for use as a replacement TIOA.

Exit XTCOUT

When invoked

Before an output event for a sequential device.

Exit-specific parameters**UEPTCTTE**

Address of the terminal control table terminal entry (TCTTE). The TCTTE can be mapped using the DSECT DFHTCTTE.

UEPTIOA

Address of the terminal input/output area (TIOA). Your exit program should not change the address. The TIOA can be mapped using the DSECT DFHTIOA. However, fields TIOASAL and TIOASCA are **not** programming interfaces.

UEPTCTLE

Address of the terminal control table line entry (TCTLE). The TCTLE can be mapped using the DSECT DFHTCTLE.

Return codes**UERCNORM**

Continue processing.

XPI calls

All can be used. However, note that you cannot use a GETMAIN call to obtain terminal-class storage for use as a replacement TIOA.

terminal control program exits

Exit XTCATT

When invoked

Before task attach.

Exit-specific parameters

UEPTCTTE

Address of the terminal control table terminal entry (TCTTE). The TCTTE can be mapped using the DSECT DFHTCTTE.

UEPTIOA

Address of the terminal input/output area (TIOA). The TIOA can be mapped using the DSECT DFHTIOA. However, fields TIOASAL and TIOASCA are **not** programming interfaces.

UEPTCTLE

Address of the terminal control table line entry (TCTLE). The TCTLE can be mapped using the DSECT DFHTCTLE.

UEPTRAN

Address of the 4-byte transaction id.

Return codes

UERCNORM

Continue processing.

XPI calls

All can be used.

Exit XTCTIN

When invoked

After a TCAM input event.

Exit-specific parameters

UEPTCTTE

Address of the terminal control table terminal entry (TCTTE). The TCTTE can be mapped using the DSECT DFHTCTTE.

UEPTIOA

Address of the terminal input/output area (TIOA). The TIOA can be mapped using the DSECT DFHTIOA. However, fields TIOASAL and TIOASCA are **not** programming interfaces.

UEPTCTLE

Address of the terminal control table line entry (TCTLE). The TCTLE can be mapped using the DSECT DFHTCTLE.

Return codes

UERCNORM

Continue processing – format the TCAM header.

UERCBYB

Suppress formatting of the TCAM header.

XPI calls

All can be used.

Exit XTCTOUT

When invoked

Before a TCAM output event.

Exit-specific parameters

UEPTCTTE

Address of the terminal control table terminal entry (TCTTE). The TCTTE can be mapped using the DSECT DFHTCTTE.

UEPTIOA

Address of the terminal input/output area (TIOA). The TIOA can be mapped using the DSECT DFHTIOA. However, fields TIOASAL and TIOASCA are **not** programming interfaces.

UEPTCTLE

Address of the terminal control table line entry (TCTLE). The TCTLE can be mapped using the DSECT DFHTCTLE.

Return codes

UERCNORM

Continue processing – format the TCAM header.

UERCBYB

Suppress formatting of the TCAM header.

XPI calls

All can be used.

'Terminal not known' condition exits XALTENF and XICTENF

The 'terminal not known' condition can occur when intercommunicating CICS regions use both SHIPPABLE terminal definitions and automatic transaction initiation (ATI). The condition is especially likely to arise if autoinstall is used.

SHIPPABLE attribute

Terminals defined with the SHIPPABLE attribute in a terminal-owning region (TOR) do not need a definition in a connected application-owning region (AOR). If necessary to support transaction routing, CICS ships a copy of the definition from the TOR to the AOR. For further information, refer to the *CICS Resource Definition Guide*.

Automatic transaction initiation (ATI)

ATI occurs when an internally generated request leads to the initiation of a transaction. For example, when:

- An application issues an EXEC CICS START command, or
- The transient data trigger level is reached.

Two CICS modules handle ATI requests:

The **interval control program** processes a START command, checks that the terminal is known in the local system, and (when any START time interval elapses) calls the terminal allocation program.

The **terminal allocation program** is called by the interval control program or by the transient data triggering mechanism, and checks that the terminal is known in the local system. If the requested terminal is remote, the terminal allocation program ships an ATI request to the remote system, which initiates transaction routing back to the local system.

For guidance information about ATI, refer to the *CICS Intercommunication Guide*.

'Terminal not known' condition

The 'terminal not known' condition arises when an ATI request is made for a terminal not known in the region. An ATI request can occur in the AOR for a SHIPPABLE terminal before any transaction routing has taken place for the terminal, and so before the definition of the terminal can have been shipped from the TOR to the AOR.

If the 'terminal not known' condition occurs, both the interval control program and the terminal allocation program reject the transaction-initiation request as 'TERMIDERR'.

The exits

To deal with the 'terminal not known' condition, CICS provides global user exits in the interval control and terminal allocation programs:

XICTENF

In the interval control program

XALTENF

In the terminal allocation program.

terminal not known condition exits

CICS drives the XICTENF exit when the 'terminal not known' condition occurs after the interval control program has been invoked by an EXEC CICS START command. CICS drives the XALTENF exit when the 'terminal not known' condition occurs after the terminal allocation program has been invoked by the transient data trigger level or the interval control program. Note that an EXEC CICS START command could result in both exits being invoked.

The exit program must indicate whether the terminal exists on another system and, if so, on which one. CICS passes data to the exit program to help establish this information. You can use the same exit program at both exit points. CICS supplies a sample exit program, DFHXTENF (see Figure 2 on page 214), that can be used at both exits and that can deal unchanged with some typical situations.

The exits are designed to deal with 'terminal not known' conditions that occur in CICS regions other than the TOR. For a TOR/AOR pair, enable the exit program in the AOR. The exits cannot deal with a 'terminal not known' condition in the TOR and the exit program should not normally be enabled there. However, if more than one TOR exists, you may need to enable the exit program in each TOR to deal with requests for terminals owned by other TORs. In this case, the exit program must recognize terminals that should be owned by this system and reject the requests ('UERCTEUN'). Although the exit provides as much data as possible, the logic of your program depends entirely on your system design. A simple solution to the most complex case would be to make the name of each terminal reflect the netname or sysid of its owning region.

Data returned by exit

The exit program must set a return code in register 15 as follows:

UERCTEUN

Terminal does not exist

UERCNETN

Netname of TOR returned

UERCYSYSI

Sysid of TOR returned.

For return codes UERCNETN and UERCYSYSI, the exit program must place the netname or sysid of the terminal-owning region in fields UEPxxNTO or UEPxxSYO (where xx is AL or IC).

If the terminal-owning region is a member of a VTAM generic resource, the exit program should place the netname of the terminal in field UEPxxNNO. For information about using ATI with VTAM generic resources, see the *CICS Intercommunication Guide*.

Exit XALTENF

When invoked

By the terminal allocation program when the terminal that an ATI request from transient data or interval control requires is unknown in this system. The exit program is expected to give a return code indicating whether the terminal exists on another connected CICS system and, if so, on which one.

terminal not known condition exits

Exit-specific parameters

UEPALEVT

Address of 2 bytes containing the type of request. The equated values of the types are:

UEPALESD

START command with data

UEPALES

START command without data

UEPALETD

Transient data trigger level reached.

UEPALTR

Address of 1 byte containing an indication of whether the task issuing the START command was started by transaction routing. The equated values are:

UEPALTY

A START command was being processed and the task issuing the command was transaction routed to.

UEPALTN

A START command was not being processed **or** a START command was being processed but the task issuing the command was not transaction routed to.

UEPALFS

Address of 1 byte containing an indication of whether the START command was function shipped. The equated values are:

UEPALFY

A START command was being processed and the START was function shipped.

UEPALFN

A START command was not being processed **or** a START was being processed but it was not function shipped.

UEPALTRN

Address of 4 bytes containing the name of the transaction to be run.

UEPALRTR

Address of 4 bytes containing the name of the terminal on which the transaction should run. (If a transient data trigger level was reached and the transient data queue definition specified a system, then this would contain a system identifier.)

UEPALCTR

Address of 4 bytes containing, for START commands, the name of the current terminal if the command was transaction routed, or the name of the session if the command was function shipped.

For other START commands and for transient data trigger events, the field pointed to contains blanks.

UEPALNTI

Address of 8 bytes containing, for function-shipped START commands, the netname of the last system from which the request came.

terminal not known condition exits

For START commands issued in this system by transaction routing to a task, the netname of the last system from which the task was routed.

For other START command situations and for transient data trigger level events, the field pointed to contains blanks.

UEPALSUI

Address of 4 bytes containing, if UEPALNTI contains a netname, the corresponding sysid.

If UEPALNTI does not contain a netname, the field pointed to is blank.

UEPALNTO

Address of 8 bytes containing the contents of UEPALNTI.

If it sets a return code of 'UERCNETN', your exit program must place in this field the netname of the system to which the ATI request should be sent.

UEPALSIO

Address of 4 bytes containing the contents of UEPALSUI.

If it sets a return code of 'UERCYSI', your exit program must place in this field the sysid of the system to which the ATI request should be sent.

UEPALNNI

Address of a 4-byte input field containing the netname of the terminal on which the transaction is to run, if this is known to CICS. If CICS does not know the netname, the addressed field contains blanks.

UEPALNNO

Address of a 4-byte input/output field containing, on invocation, the contents of UEPALNNI. Your exit program can use this field to supply the netname of the terminal on which the transaction is to run. It is important that your exit program supply a terminal netname if the TOR to which it directs the ATI request is a member of a VTAM generic resource.

Return codes

UERCTEUN

Terminal unknown, reject request.

UERCNETN

Terminal known, netname returned in UEPALNTO.

UERCYSI

Terminal known, sysid returned in UEPALSIO.

XPI calls

You can use:

INQ_APPLICATION_DATA
INQUIRE_SYSTEM.

No other XPI calls should be used.

terminal not known condition exits

Exit XICTENF

When invoked

By the interval control program when the terminal that an EXEC CICS START command requires is unknown in this system. The exit program is expected to give a return code indicating whether the terminal exists on another connected CICS system and, if so, on which one.

Exit-specific parameters

UEPICEVT

Address of 2 bytes containing the type of request. The equated values of the types are:

UEPICESD

START command with data

UEPICES

START command without data.

UEPICTR

Address of 1 byte containing an indication of whether the task issuing the START command was started by transaction routing. The equated values are:

UEPICTY

A START command was being processed and the task issuing the command was transaction routed to.

UEPICTN

A START command was not being processed **or** a START command was being processed but the task issuing the command was not transaction routed to.

UEPICFS

Address of 1 byte containing an indication of whether the START command was function shipped. The equated values are:

UEPICFY

A START command was being processed and the START was function shipped.

UEPICFN

A START command was not being processed **or** a START was being processed but it was not function shipped.

UEPICTRN

Address of 4 bytes containing the name of the transaction to be run.

UEPICRTR

Address of 4 bytes containing the name of the terminal on which the transaction should run.

UEPICCTR

Address of 4 bytes containing, for START commands, the name of the current terminal if the command was transaction routed, or the name of the session if the command was function shipped.

For other START commands, the field pointed to contains blanks.

UEPICNTI

Address of 8 bytes containing, for function-shipped START commands, the netname of the last system from which the request came.

For START commands issued in this system by transaction routing to a task, the netname of the last system from which the task was routed.

For other START command situations, the field pointed to contains blanks.

UEPICSYI

Address of 4 bytes containing, if UEPICNTI contains a netname, the corresponding SYSID.

If UEPICNTI does not contain a netname, the field pointed to is blank.

UEPICNTO

Address of 8 bytes containing the contents of UEPICNTI.

If it sets a return code of 'UERCNETN', your exit program must place in this field the netname of the system to which the ATI request should be sent.

UEPICSYO

Address of 4 bytes containing the contents of UEPICSYI.

If it sets a return code of 'UERCYSYSI', your exit program must place in this field the sysid of the system to which the ATI request should be sent.

UEPICNNI

Address of a 4-byte input field containing the netname of the terminal on which the transaction is to run, if this is known to CICS. If CICS does not know the netname, the addressed field contains blanks.

UEPICNNO

Address of a 4-byte input/output field containing, on invocation, the contents of UEPICNNI. Your exit program can use this field to supply the netname of the terminal on which the transaction is to run. It is important that your exit program supply a terminal netname if the TOR to which it directs the ATI request is a member of a VTAM generic resource.

Return codes

UERCTEUN

Terminal unknown, reject request.

UERCNETN

Terminal known, netname returned in UEPICNTO.

UERCYSYSI

Terminal known, sysid returned in UEPICSYO.

UERCPURG

Task purged during XPI call.

XPI calls

The following must not be used:

ADD_SUSPEND

terminal not known condition exits

```
DELETE_SUSPEND
DEQUEUE
ENQUEUE
RESUME
SUSPEND
WAIT_MVS.
```

The sample program for the XALTENF and XICTENF exits, DFHXTENF

One program can be used for both exits, or a separate program can be written for each. Figure 2 shows the executable code from the supplied sample program DFHXTENF, which can be used for both exits. DFHXTENF rejects transient data requests, because the action in this case is very much installation-dependent.

Important

The example is intended purely as a demonstration of some of the possibilities available, and would be impractical in a production environment.

```
DFHXTENF CSECT
          DFHVM XTENF
          ENTRY DFHXTENA
DFHXTENA DS    0H
          STM   R14,R12,12(R13)    save registers
          BALR  R11,0              set up base register
          USING *,R11

*
          USING DFHUEPAR,R1        DFHUEH parameter list
*
*      Could check the terminal ID at this point. In this
*      program we assume it is valid. We also choose to accept
*      START requests and reject Transient Data trigger level
*      events.
*
          L     R2,UEPICEVT         access type of request
          CLC   0(2,R2),START      START command?
          BE    STARTCMD           yes
*
          CLC   0(2,R2),STARTDAT   START command with data?
          BNE   NOTSTART           no, must be Transient Data
*
STARTCMD DS    0H
*
*      Accept the default netname if we are Function Shipping.
*      Otherwise build a netname.
*
          L     R2,UEPICFS         access FS information
          CLI   0(R2),UEPICFY      Function Shipping?
          BNE   BLDNETNM          no, build a netname
*
          LH   R15,NETNAME         accept the default netname
          B    EXIT
```

Figure 2. Sample program for XALTENF and XICTENF exits (Part 1 of 2)

terminal not known condition exits

```
*BLDNETNM DS    0H
*
*          Build a netname by taking the first character of the
*          terminal ID and appending it to the characters 'CICS'.
*
          L    R2,UEPICNTO      access the output netname field
          L    R3,UEPICRTR      access ID of requested terminal
          MVC  0(8,R2),=C'CICS  '
          MVC  4(1,R2),0(R3)    first character of terminal ID
          LH   R15,NETNAME      netname returned
          B    EXIT
*
NOTSTART DS    0H
          LH   R15,UNKNOWN      reject Transient Data trigger *
                                level events
*
EXIT      DS    0H
          L    R14,12(R13)      restore registers except 15
          LM   R0,R12,20(R13)   which contains the return code
          BR   R14
*
*****
*          Local constants
*****
START     DC    AL2(UEPICES)
STARTDAT  DC    AL2(UEPICESD)
NETNAME   DC    AL2(UERCNETN)
UNKNOWN   DC    AL2(UERCTEUN)
*
          DFHEND DFHXTEFN
```

Figure 2. Sample program for XALTENF and XICTENF exits (Part 2 of 2)

Transaction manager domain exit **XXMATT**

Exit **XXMATT**

When invoked

During transaction attach. This exit is able to change some of the attributes of the transaction that is being attached.

Exit-specific parameters

UEPTRANID

The address of transaction id (see Notes).

UEPUSER

The address of the userid associated with the transaction if the current task is a user task (see Notes).

UEPTERM

The address of the terminal id associated with the transaction, if any (see Notes).

UEPPROG

The address of the application program name for this transaction, if any (see Notes).

UEPATPTI

The address of a 4-byte field containing the primary transaction id. You can change the primary transaction id by modifying the addressed field.

UEPATOTI

The address of the 4-byte attach transaction id. A transid of X'00000000' indicates that a transid was not supplied on the attach.

UEPATTPL

The address of an area containing the length of the attach TPName. A length of zero indicates that a TPName was not supplied on the attach.

UEPATTPA

The address of a fullword containing the address of the attach TPName. The attach TPName can be 1 through 64 bytes long, as defined by UEPTTPL.

UEPATLOC

The address of a 1-byte field indicating whether the transaction was found. Equated values are:

UEATFND

The transaction was found.

UEATNFND

The transaction was not found.

UEPATTST

The address of a one-byte transaction definition state. Equated values for the definition state are:

UEATENAB

The transaction is enabled.

UEATDISA

The transaction is disabled.

UEPATTTK

The address of a doubleword containing a transaction token. Note that some of the transaction manager XPI calls require this token to identify the transaction that is being attached.

Return codes

UERCNORM

Continue attach processing.

XPI calls

The user exit can inquire on the transaction being attached, using the UEPATTTK transaction token as input to the XMIQ INQUIRE_TRANSACTION XPI call.

The exit can also set the total priority and TCLASS, using the XMIQ SET_TRANSACTION XPI call.

Most of the XPI calls can be used, but with caution since typically this exit is invoked under the TCP task. Thus it is advisable not to issue any XPI calls that might cause the TCP task to wait.

Notes:

1. The following XPI calls can be useful for obtaining information that could be used to modify the attach of a transaction:

INQUIRE_TRANSACTION

INQUIRE_MXT

INQUIRE_TCLASS

INQUIRE_TRANDEF

INQUIRE_SYSTEM

2. The fields UEPTRANID, UEPUSER, UEPTERM, and UEPPROG are common to many of the domain global user exit points, and normally return values associated with the current user task. In the case of XXMATT, however, the user task that is being attached is **not** the current task when the exit is invoked. Until task attach is complete, the current task is the CICS task that is performing the attach.

When the task being attached is for a task started by an immediate START command; that is, a START without an interval, the current task is the task that issues the START command, and the fields contain values associated with that task.

Transient data program exits XTDREQ, XTDIN, and XTDOUT

Exit XTDREQ

When invoked

Before request analysis.

Exit-specific parameters

UEPTDQUE

Address of 4-byte TD queue name.

UEPTDTYP

Address of 1-byte TD request type. Values are:

UEPTDPUT

PUT request

UEPTDGET

GET request

UEPTDPUR

PURGE request.

Return codes

UERCNORM

Continue TD processing.

UERCTDOK

Quit TD processing – returning 'NORMAL' to the caller.

UERCTDNA

Quit TD processing – returning 'NOTAUTH' to the caller.

UERPURG

Task purged during XPI call.

XPI calls

You can use:

INQ_APPLICATION_DATA

INQUIRE_SYSTEM

WAIT_MVS

Do not use any other calls.

Exit XTDIN

When invoked

After receiving data from QSAM (for extrapartition) or VSAM (for intrapartition).

Exit-specific parameters

UEPTDQUE

Address of the 4-byte TD queue name.

UEPTDAUD

Address of the unmodified TD data.

UEPTDLUD

Address of the fullword length of the unmodified TD data.

UEPTDAMD

Address of the TD data modified by the exit program.

UEPTDLMD

Address of the fullword length of the TD data modified by the exit program.

Return codes

UERCNORM

Continue TD processing.

UERCPURG

Task purged during XPI call.

XPI calls

You can use:

INQ_APPLICATION_DATA

INQUIRE_SYSTEM

WAIT_MVS

Do not use any other calls.

transient data program exits

Exit XTDOUT

When invoked

Before passing the data to a QSAM (for extrapartition) or VSAM (for intrapartition) user-defined transient data queue.

Exit-specific parameters

UEPTDQUE

Address of the 4-byte TD queue name.

UEPTDAUD

Address of the unmodified TD data.

UEPTDLUD

Address of the fullword length of the unmodified TD data.

UEPTDAMD

Address of the TD data modified by the exit program.

UEPTDLMD

Address of the fullword length of TD data modified by the exit program.

UEPTDNUM

Address of the fullword containing the number of items in the list.

UEPTDCUR

Address of the fullword containing the number of the current item.

Return codes

UERCNORM

Continue TD processing.

UERCTDOK

Quit TD processing – returning 'NORMAL' to the caller.

Note: If you return UERCTDOK to suppress the first line of a multiline message, the rest of the message is not presented to XTDOUT, but is also suppressed.

UERCPURG

Task purged during XPI call.

XPI calls

You can use:

INQ_APPLICATION_DATA

INQUIRE_SYSTEM

WAIT_MVS

Do not use any other calls.

Transient data EXEC interface program exits XTDEREQ and XTDEREQC

The XTDEREQ exit allows you to intercept a transient data request before any action has been taken on it by transient data. The XTDEREQC exit allows you to intercept a transient data request after transient data has completed its processing.

Using XTDEREQ, you can:

- Analyze the request to determine its type, the keywords specified, and their values.
- Modify any value specified by the request before the command is executed.
- Set return codes to specify that either:
 - CICS should continue with the (possibly modified) request.
 - CICS should bypass the request. (Note that if you set this return code, you must also set up return codes for the EXEC interface block (EIB), as if you had processed the request yourself.)

Using XTDEREQC, you can:

- Analyze the request, to determine its type, the keywords specified, and their values.
- Set return codes for the EIB.

Both exits are passed eight parameters as follows:

- The address of the command-level parameter structure
- The address of a token (UEPTDTOK) used to pass 4 bytes of data from XTDEREQ to XTDEREQC
- The addresses of copies of four pieces of return code and resource information from the EIB
- The address of a token (UEPTSTOK) that is valid throughout the life of a task
- The address of an exit recursion count (UEPRECUR).

Example program

CICS supplies—in hardcopy only—an example program, DFH\$XTSE, that shows how to modify fields in the command-level parameter structure passed to EXEC interface exits. DFH\$XTSE is listed on page 807.

Exit XTDEREQ

When invoked

Before CICS processes a transient data API request.

Exit-specific parameters

UEPCLPS

Address of the command-level parameter structure. See “The UEPCLPS exit-specific parameter” on page 225.

UEPTDTOK

Address of the 4-byte token to be passed to XTDEREQC. This allows you, for example, to pass a work area to exit XTDEREQC.

transient data EXEC interface program exits

UEPRCODE

Address of a 6-byte hexadecimal copy of the EIB return code 'EIBRCODE'. For details of EIB return codes, refer to the *CICS Application Programming Reference* manual.

UEPRES

Address of a 4-byte binary copy of the EIB response code 'EIBRESP'.

UEPRES2

Address of a 4-byte binary copy of the EIB response code 'EIBRESP2'.

UEPTSTOK

Address of a 4-byte token that is valid throughout the life of a task. See "Use of the task token UEPTSTOK" on page 228.

UEPRECUR

Address of a halfword recursion counter. The counter is set to 0 when the exit is first invoked, and is incremented for each recursive call.

UEPRSRCE

Address of an 8-character copy of the EIB resource value, EIBRSRCE.

Return codes

UERCNORM

Continue processing.

UERCBYP

The transient data EXEC interface program should ignore this request.

UERCPURG

Task purged during XPI call.

XPI calls

All can be used.

Although the exit permits the use of XPI GETMAIN and FREEMAIN calls, we recommend that you use the EXEC CICS GETMAIN and FREEMAIN commands instead.

API and SPI commands

All can be used.

Note: Take care when issuing recursive commands. For example, you must avoid entering a loop when issuing a transient data request from the XTDEREQ exit. Use of the recursion counter UEPRECUR is recommended.

Exit XTDEREQC

When invoked

After a transient data API request has completed, and before return from the transient data EXEC interface program.

Exit-specific parameters

UEPCLPS

Address of the command-level parameter structure. See “The UEPCLPS exit-specific parameter” on page 225.

UEPTDOK

Address of the 4 byte token to be passed to XTDEREQC. This allows you, for example, to pass a work area to exit XTDEREQC.

UEPRCODE

Address of a 6-byte hexadecimal copy of the EIB return code ‘EIBRCODE’. For details of EIB return codes, refer to the *CICS Application Programming Reference* manual.

UEPRESP

Address of a 4-byte binary copy of the EIB response code ‘EIBRESP’.

UEPRESP2

Address of a 4-byte binary copy of the EIB response code ‘EIBRESP2’.

UEPTSTOK

Address of a 4-byte token that is valid throughout the life of a task. See “Use of the task token UEPTSTOK” on page 228.

UEPRECUR

Address of a halfword recursion counter. The counter is set to 0 when the exit is first invoked, and is incremented for each recursive call.

UEPRSRCE

Address of an 8-character copy of the EIB resource value, EIBRSRCE.

Return codes

UERCNORM

Continue processing.

UERCPURG

Task purged during XPI call.

XPI calls

All can be used.

Although the exit permits the use of XPI GETMAIN and FREEMAIN calls, we recommend that you use the EXEC CICS GETMAIN and FREEMAIN commands instead.

API and SPI commands

All can be used.

Note: Take care when issuing recursive commands. For example, you must avoid entering a loop when issuing a transient data request from the XTDEREQC exit. Use of the recursion counter UEPRECUR is recommended.

transient data EXEC interface program exits

The command-level parameter structure

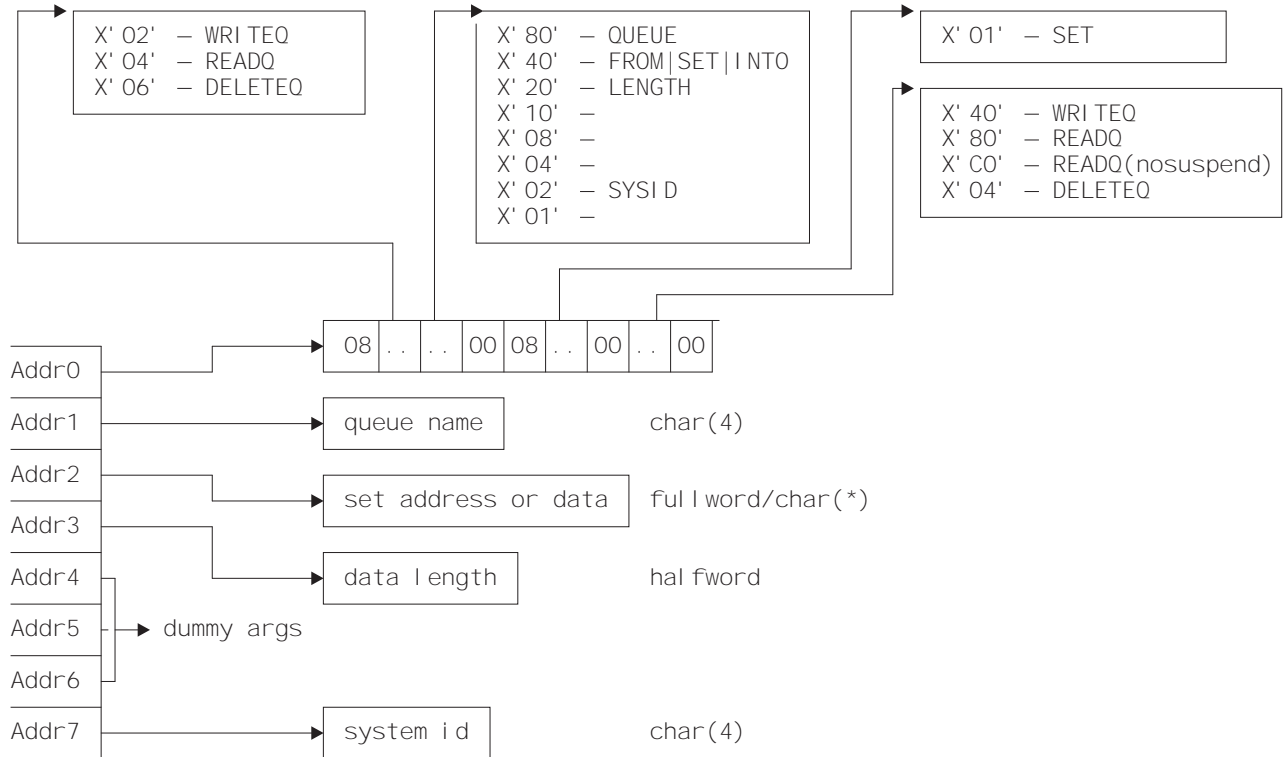

Figure 3. The command-level parameter structure for transient data

The command-level parameter structure consists of a series of addresses. The first address points to the EXEC interface descriptor (EID), which consists of an 8-byte area that describes the type of request and identifies each keyword specified with the request. The remaining addresses point to pieces of data associated with the request. (For example, the second address points to the queue name.)

You can examine the EID to determine the type of request and the keywords specified. You can examine the other parameters in the list to determine the values of the keywords. You can also modify values of keywords specified on the request. (For example, you could change the sysid specified in the request.)

End of parameter list indicator

The high-order bit is set on in the last address set in the parameter list to indicate that it is the last one in the list. On return from your user exit program, CICS scans the parameter list for the high-order bit to find the last parameter. Therefore, if you modify the length of the parameter list, you must also reset the high-order bit to indicate which is the new last address.

For example, if the parameter list specifies only the first two addresses (TD_ADDR0, the address of the EID, and TD_ADDR1, the address of the name of the queue named in a DELETEQ request), the high-order bit is set on in TD_ADDR1. If you extend the parameter list by setting the address of a SYSID in TD_ADDR7, you must reset the high-order bit in TD_ADDR1 and set it on in TD_ADDR7 instead.

The maximum size of parameter list is supplied to the exit, thus allowing your exit program to add any parameters not already specified without needing to first obtain more storage.

The original parameter list, as it was before XTDEREQ was invoked, is restored after the completion of XTDEREQC. It follows that the execution diagnostic facility (EDF) displays the original command before **and** after execution. **EDF does not display any changes made by the exit.**

The UEPCLPS exit-specific parameter

The UEPCLPS exit-specific parameter is included in both exit XTDEREQ and exit XTDEREQC. It is the address of the command-level parameter structure. The command-level parameter structure contains 8 addresses, TD_ADDR0 through TD_ADDR7. It is defined in the DSECT TD_ADDR_LIST, which you should copy into your exit program by including the statement COPY DFHTDUED.

The command-level parameter list is made up as follows:

TD_ADDR0

is the address of an 8-byte area called the EID, which is made up as follows:

TD_GROUP
TD_FUNCT
TD_BITS1
TD_BITS2
TD_EIDOPT5
TD_EIDOPT6
TD_EIDOPT7

TD_GROUP

Always X'08', indicating that this is a transient data request.

TD_FUNCT

One byte that defines the type of request:

X'02' WRITEQ
X'04' READQ
X'06' DELETEQ.

transient data EXEC interface program exits

TD_BITS1

Existence bits that define which arguments were specified. To obtain the argument associated with a keyword, you need to use the appropriate address from the command-level parameter structure. Before using this address, you must check the associated existence bit. If the existence bit is set off, the argument was not specified in the request and the address should not be used.

X'80' Set if the request contains an argument for the QUEUE keyword. If set, **TD_ADDR1** is meaningful.

X'40' Set if the request contains an argument for any of the INTO, SET, or FROM keywords. If set, **TD_ADDR2** is meaningful.

X'20' Set if the request contains an argument for the LENGTH keyword. If set, **TD_ADDR3** is meaningful.

X'02' Set if the request contains an argument for the SYSID keyword. If set, **TD_ADDR7** is meaningful.

TD_BITS2

Two bytes not used by transient data.

TD_EIDOPT5

Indicates whether certain keywords were specified on the request.

X'01' SET (and not INTO) was specified.

TD_EIDOPT6

One byte not used by transient data.

TD_EIDOPT7

Indicates whether certain functions and/or keywords were specified on the request:

X'40' WRITEQ specified

X'80' READQ specified

X'C0' READQ(nosuspend) specified

X'04' DELETEQ specified.

TD_ADDR1

is the address of a 4-byte area containing the name from QUEUE.

TD_ADDR2

is the address of one of the following:

- A 4-byte address from SET (if the request is READQ and **TD_EIDOPT5** indicates that this is SET).
- Data from INTO (if the request is READQ and **TD_EIDOPT5** indicates that this is not SET). You cannot modify this bit in your user exit.
- Data from FROM (if the request is WRITEQ).

TD_ADDR3

is the address of one of the following:

- The halfword value of LENGTH (if the request is READQ or WRITEQ).
Warning: For requests that specify INTO, do not change the value of LENGTH to a value greater than that specified by the application. To do so causes a storage overlay in the application.

TD_ADDR4

is the address of a value intended for CICS internal use only. It must not be used.

TD_ADDR5

is the address of a value intended for CICS internal use only. It must not be used.

TD_ADDR6

is the address of a value intended for CICS internal use only. It must not be used.

TD_ADDR7

is the address of an area containing the value of SYSID.

TD_ADDR8

is the address of a value intended for CICS internal use only. It must not be used.

Modifying fields in the command-level parameter structure

Some fields that are passed to transient data are used as input to the request, some are used as output fields, and some are used for both input and output. The method your user exit program uses to modify a field depends on the usage of the field.

The following are always input fields:

- QUEUE
- FROM
- SYSID

The following are always output fields:

- INTO
- SET

LENGTH is an input field on a WRITEQ request, and an output field on a READQ request that specifies SET. It is both an input and an output field on a READQ request that specifies INTO.

Modifying input fields

The correct method of modifying an input field is to create a new copy of it, and to change the address in the command-level parameter list to point to your new data.

Note: You must never modify an input field by altering the data that is pointed to by the command-level parameter list. To do so would corrupt storage belonging to the application program and would cause a failure when the program attempted to reuse the field.

Modifying output fields

The technique described in “Modifying input fields” is not suitable for modifying output fields. (The results would be returned to the new area instead of the application’s area, and would be invisible to the application.)

transient data EXEC interface program exits

An output field is modified by altering the data that is pointed to by the command-level parameter list. In the case of an output field, you can modify the application's data in place, because the application is expecting the field to be modified.

Modifying fields used for both input and output

An example of a field that is used for both input and output is LENGTH on a READQ request that specifies INTO. You can treat such fields in the same way as output fields, and they are considered to be the same.

Modifying the EID

It is not possible to modify the EID to make major changes to requests, such as changing a READQ request to a WRITEQ request.

However, you can make minor changes to requests, such as turning on the existence bit for SYSID so that the request can be changed into one that is shipped to a remote system.

The list that follows shows the bits in the EID that **can** be modified. Any attempt to modify any other part of the EID is ignored.

TD_BITS1

X'20' The existence bit for LENGTH.

X'02' The existence bit for SYSID.

TD_EIDOPT5

X'01' Existence bit for SET keyword. You cannot modify this bit from your user exit.

TD_EIDOPT7

Changes to TD_EIDOPT7 are limited to READQ requests. X'80'-READQ is interchangeable with X'C0'-READQ(nosuspend). No other changes may be made to this byte.

The EID is reset to its original value before return to the application program. That is, changes made to the EID are retained for the duration of the transient data request only.

Note: Your user exit program is prevented from making major changes to the EID. However, you must take great care when making the minor modifications that **are** permitted.

Use of the task token UEPTSTOK

UEPTSTOK provides the address of a 4-byte area that you can use to pass information between successive transient data requests in the same task. (By contrast, UEPTDTOK is usable only for the duration of a single transient data request, because its contents may be destroyed at the end of the request.) For example, if you need to pass information between successive invocations of the XTDEREQ exit, UEPTSTOK provides a means of doing this.

The EIB

Copies of EIBRSRCE, EIBRCODE, EIBRESP, and EIBRESP2 are passed to the exit, so that you can:

- Modify or set completion and resource information in XTDEREQ and XTDEREQC
- Examine completion and resource information in XTDEREQC.

You can update the copies of EIBRSRCE, EIBRCODE, EIBRESP, and EIBRESP2 that you are given in the parameter list. Transient data copies your values into the real EIB after the completion of XTDEREQC; or if you specify a return code of 'bypass' in XTDEREQ.

You must set valid transient data responses. You must set all three of EIBRCODE, EIBRESP, and EIBRESP2 to a consistent set of values, such as would be set by CICS transient data to describe a valid completion. **CICS does not police the consistency of EIBRCODE, EIBRESP, and EIBRESP2.** However, if EIBRCODE is set to a non-zero value and EIBRESP is set to zero then CICS will override EIBRESP with a non-zero value. To aid you in setting the values of EIBRCODE, EIBRESP, and EIBRESP2, the values used by transient data are specified in DFHTDUED.

User log record recovery program exits XRCINIT and XRCINPT

At warm and emergency restart, updates made to recoverable CICS resources that were not committed when the system terminated must be backed out. XRCINIT and XRCINPT are invoked from the user log record recovery program, which is used to back out, where necessary, user-written system log entries. XRCINIT is invoked at warm and emergency restart:

- Before the first user recovery record is delivered to XRCINPT
- When all such records have been delivered to XRCINPT.

XRCINPT is invoked whenever a user log record is read from the system log.

You can use XRCINPT to change the default actions taken by CICS at emergency restart for particular user-journaled records. Records passed to XRCINPT are those in UOWs that:

- Appeared in the last complete activity keypoint
- Were in flight when CICS terminated
- Committed, backed out, or went in-doubt after the start of the last complete activity keypoint. (However, this only applies to those records for which the leftmost bit of the JTYPEID specified in the WRITE JOURNALNAME(DFHLOG) request was a one.)

Records written by the activity keypoint exit XAKUSER are passed only if they appear in the last complete activity keypoint. They are passed after all other records. The order of presentation of records may therefore be different from their order in the reverse log stream sequence.

The format of records passed to the exit is:

Offset Field contents

0	JTYPEID
2	Reserved
4	Length of prefix data (L). (Zero if no prefix)
8	Prefix data (if any)
8 + L	Log data

The record is mapped by the DSECT CL_USER_HEADER in copybook DFHLGGFD.

When using XRCINIT and XRCINPT, you should bear in mind that the exits may be invoked before recovery of temporary storage and transient data resources is complete.

For further guidance information about exits for unit of work backout, refer to the *CICS Recovery and Restart Guide*.

Coding the exit programs

CICS services can be used in exit programs invoked from these exits using the XPI or EXEC CICS commands. However, you need to consider the following:

user log record recovery program exits

- There is a restriction on using the XPI early during initialization: do not invoke exit programs that use the XPI functions TRANSACTION_DUMP, WRITE_JOURNAL_DATA, MONITOR and INQUIRE_MONITOR_DATA until the second phase of the PLTPI.
- There are also restrictions on the use of EXEC CICS commands in these exits:
 - You cannot use EXEC CICS commands to access terminal control services.
 - You are strongly advised not to use temporary storage, transient data, file control, journal control, or DL/I services, because the resources that you try to access may also be in a state of recovery and therefore “not open for business”. Attempting to access resources in these circumstances causes, at best, serialization of the recovery tasks and, at worst, a deadlock.

If you do issue file control requests in programs invoked from these exits, note that:

- If an exit program acquires an area as a result of a file control request, it is the responsibility of the program to release that area.
 - An exit program must not attempt to make any file control requests to a file referring to a VSAM data set with a string number of 1, unless no action is specified for that file during the initialization exit.
 - Your exit program must not issue EXEC CICS commands if the recovery is as the result of an EXEC CICS SYNCPOINT ROLLBACK request.
 - Exit programs that issue EXEC CICS commands must first address the EIB. See “Using CICS services” on page 5.
 - Exit programs that issue EXEC CICS commands, and that use the DFHEIENT macro, should use the DFHEIRET macro to set a return code and return to CICS. See “Returning values to CICS” on page 10.
 - Exit programs invoked from these exits must be translated with the NOEDF option, if they issue EXEC CICS commands. See “Using EDF with global user exits” on page 6.
- Task-chained storage acquired in an exit program is released at the completion of emergency restart processing. However, the exit program should attempt to release the storage as soon as its contents are no longer needed.
 - No exit program should reset either the absent or no-action indicators set by the file control backout program.
 - Take care when issuing recursive commands not to cause a loop. For example, it is your responsibility to avoid entering a loop when an RC request is issued from these exits.

Enabling the exit programs

To enable these exits, you must do one of the following:

- Specify the system initialization parameter
TBEXITS=(name1,name2,name3,name4,name5,name6), where name1 through name6 are the names of your user exit programs for XRCINIT, XRCINPT, XFCBFAIL, XFCLDEL, XFCBOVER, and XFCBOUT.
- Enable the exits during the first stage of initialization using a PLTPI program.

If you use the TBEXITS parameter to enable the exits, a global work area of 4 bytes is provided. If you use a PLTPI program, you can select the size of the global work area. You can also enable more than one exit program for use at each exit point; the TBEXITS parameter allows only one exit program at each exit point. PLTPI processing is described in “Chapter 4. Writing initialization and shutdown

user log record recovery program exits

programs” on page 393.

Exit XRCINIT

When invoked

At warm and emergency restart:

- Before the first user recovery record is delivered to XRCINPT
- When all such records have been delivered to XRCINPT.

Exit-specific parameters

UEPTREQ

Address of a 1-byte flag indicating the reason for the call. When UEPTREQ has a value of UEUSINIT, the exit has been invoked at the start of user recovery, and when UEPTREQ has a value of UEUSTERM, the exit has been invoked at the end of user recovery.

UEPRSTRT

Address of a 1-byte flag that indicates how CICS was restarted:

UEPRWARM

Warm start

UEPREMER

Emergency start.

Return codes

UERCNORM

Continue processing. No other return codes are supported.

XPI calls

All can be used. See page 230 for restrictions.

Exit XRCINPT

When invoked

At warm and emergency restart, once for each user log record found in the system log.

Exit-specific parameters

UEPUOWST

Address of a 1-byte flag indicating the disposition of the UOW. The possible values are:

UEPUOWAK

Activity keypoint record

UEPUOWCM

UOW committed

UEPUOWBO

UOW backed out

UEPUOWIF

UOW was in-flight

UEPUOWID

UOW was in-doubt.

UEPLGREC

Address of the log record just read. The journal control record can

user log record recovery program exits

be mapped using the information supplied in “Chapter 23. CICS logging and journaling” on page 629.

UEPLGLEN

Address of a fullword containing the length of the log record.

UEPTAID

Address of a 4-byte field containing the task identifier.

UEPTRID

Address of a 4-byte field containing the transaction identifier.

UEPTEID

Address of a 4-byte field containing the terminal identifier.

Note: The values of the fields addressed by UEPTAID, UEPTRID, and UEPTEID are meaningless for activity keypoint records (that is, if the field addressed by UEPUOWST contains UEPUOWAK).

Return codes

UERCNORM

Continue processing.

UERCBYBYP

Bypass this record.

XPI calls

All can be used. See page 230 for restrictions.

VTAM terminal management program exit XZCATT

Exit XZCATT

When invoked

Before task attach for terminal tasks.

Exit-specific parameters

UEPTCTTE

Address of the terminal control table terminal entry (TCTTE). The TCTTE can be mapped using the DSECT DFHTCTTE.

UEPTIOA

Address of the terminal input/output area (TIOA). The TIOA can be mapped using the DSECT DFHTIOA. However, fields TIOASAL and TIOASCA are **not** programming interfaces.

UEPTPN

Address of the APPC transaction process name (TPN), or the LU6.1 process name (DPN), whose length is addressed by the parameter UEPTPNL.

UEPTPNL

Address of a 1-byte field containing the length of the TPN or DPN.

UEPTRAN

Address of the 4-byte transaction ID.

Note: The exit program must not change the TRANSID of tasks started by automatic transaction initiation (ATI). (This is because CICS needs to match the TRANSID in its program control table with the TRANSID in the automatic initiate descriptor (AID) that was created in the AOR.)

Return codes

UERCNORM

Continue processing.

XPI calls

All can be used.

VTAM working-set module exits XZCIN, XZCOUT, XZCOUT1, and XZIQUE

Note: None of the exits in the VTAM working-set module is available for advanced program-to-program communication (APPC, or LUTYPE6.2) links.

Exit XZCIN

When invoked

After an input event.

Exit-specific parameters

UEPTCTTE

Address of the terminal control table terminal entry (TCTTE). The TCTTE can be mapped using the DSECT DFHTCTTE.

UEPTIOA

Address of the terminal input/output area (TIOA). Your exit program should not change the address. The TIOA can be mapped using the DSECT DFHTIOA. However, fields TIOASAL and TIOASCA are **not** programming interfaces.

Return codes

UERCNORM

Continue processing.

XPI calls

All can be used. However, we do not recommend that you use a GETMAIN call to obtain terminal-class storage for use as a replacement TIOA. This is because there are several internal pointers to the TIOA, and if any one of these is not updated the application may experience problems.

Exit XZCOUT

When invoked

Before an output event.

Exit-specific parameters

UEPTCTTE

Address of the terminal control table terminal entry (TCTTE). The TCTTE can be mapped using the DSECT DFHTCTTE.

UEPTIOA

Address of the terminal input/output area (TIOA). Your exit program should not change the address. The TIOA can be mapped using the DSECT DFHTIOA. However, fields TIOASAL and TIOASCA are **not** programming interfaces.

Note: In certain circumstances—for example, when XZCOUT is invoked before the send of a NULL RU—UEPTIOA contains zeroes.

Return codes

UERCNORM

Continue processing.

VTAM working-set module exits

XPI calls

All can be used. However, we do not recommend that you use a GETMAIN call to obtain terminal-class storage for use as a replacement TIOA. This is because there are several internal pointers to the TIOA, and if any one of these is not updated the application may experience problems.

Exit XZCOUT1

When invoked

Before a message is broken into RUs.

Exit-specific parameters

UEPTCTTE

Address of the terminal control table terminal entry (TCTTE). The TCTTE can be mapped using the DSECT DFHTCTTE.

UEPTIOA

Address of the terminal input/output area (TIOA). Your exit program should not change the address. The TIOA can be mapped using the DSECT DFHTIOA. However, fields TIOASAL and TIOASCA are **not** programming interfaces.

Return codes

UERCNORM

Continue processing.

XPI calls

All can be used. However, we do not recommend that you use a GETMAIN call to obtain terminal-class storage for use as a replacement TIOA. This is because there are several internal pointers to the TIOA, and if any one of these is not updated the application may experience problems.

XZIQUE exit for managing intersystem queues

You can use the XZIQUE exit to control the number of queued requests for sessions on intersystem links (allocate queues).

Note: There are several methods that you can use to control the length of intersystem queues. For a description of the various methods, see the *CICS Intercommunication Guide*.

The XZIQUE exit enables you detect queuing problems (bottlenecks) early. It extends the function provided by the XISCONA global user exit (introduced in CICS/ESA 3.3 and described on page 127), which is invoked only for function shipping and DPL requests. XZIQUE is invoked for transaction routing, asynchronous processing, and distributed transaction processing requests, as well as for function shipping and DPL. Compared with XISCONA, it receives more detailed information on which to base its decisions.

XZIQUE enables allocate requests to be queued or rejected, depending on the length of the queue. It also allows a connection on which there is a bottleneck to be terminated and then re-established.

Interaction with the XISCONA exit

There is no interaction between the XZIQUE and XISCONA global user exits. If you enable both exits, XISCONA and XZIQUE could both be invoked for function shipping and DPL requests, which is not recommended. You should ensure that only one of these exits is enabled. Because of it provides more function and greater flexibility, it is recommended that you use XZIQUE rather than XISCONA.

If you already have an XISCONA global user exit program, you could possibly modify it for use at the XZIQUE exit point.

When the XZIQUE exit is invoked

The XZIQUE global user exit is invoked, if it is enabled, at the following times:

- Whenever CICS tries to acquire a session with a remote system and there is no free session available. It is invoked whether or not you have specified the QUEUELIMIT option on the CONNECTION definition, and whether or not the limit has been exceeded. It is not invoked if the allocate request specifies NOQUEUE or NOSUSPEND.
Requests for sessions can arise in a number of ways, such as explicit EXEC CICS ALLOCATE commands issued by DTP programs, or by transaction routing or function shipping requests.
- Whenever an allocate request succeeds in finding a free session, after the queue on the connection has been purged by a previous invocation of the exit program. In this case, your exit program can indicate that CICS is to continue processing normally, resuming queuing when necessary.

Using an XZIQUE global user exit program

When the exit is enabled, your XZIQUE global user exit program is able to check on the state of the allocate queue for a particular connection in the local system. Information is passed to the exit program in a parameter list, that is structured to provide data about non-specific allocate requests, or requests for specific

VTAM working-set module exits

modegroups, depending on the session request. Non-specific allocate requests are for MRO, LU6.1, and APPC sessions that do not specify a modegroup.

Using the information passed in the parameter list, your global user exit program can decide (based on queue length, for example) whether CICS is to queue the allocate request. Your program communicates its decision to CICS by means of one of the return codes CICS provides. These are:

UERCAQUE

This return code indicates that CICS is to queue the allocate request.

The total number of allocate requests queued against the connection is provided in field A14ESTAQ of the system entry statistics (for all non-specific allocates) or A20ESTAQ of the mode entry statistics (for specific modegroup allocates). See DSECTs DFHA14DS or DFHA20DS for details. CICS passes to the exit program, in the exit specific parameter UEPQUELIM, the QUEUELIMIT parameter from the connection definition.

If the limit has not been reached, you can return control to CICS with return code UERCAQUE.

UERCAPUR

This return code indicates that CICS is to reject the allocate request and return SYSIDERR to the application program, but leave the existing queue unchanged.

If the number of queued allocate requests has reached the limit set on the QUEUELIMIT parameter for the connection, you can request that CICS rejects the request. However, you should first check whether the state of the link is satisfactory. This means checking that the rate of allocation of sessions is acceptable. Use the time the queue was started, the current time, and the total number of allocates processed since the queue began, to determine the rate at which CICS is processing requests. The relevant fields are: UEPSAQTS and UEPSACNT for non-specific allocate requests; and UEPMAQTS and UEPMACNT for specific modegroup requests.

To determine whether CICS is allocating requests for sessions on this connection at an acceptable rate, you can compare the calculated time with either of the following:

1. The parameter from the connection definition, MAXQTIME, which is passed in the exit specific parameter UEPQMXQT
2. Some other preset time value.

If the processing time using this kind of formula is acceptable, return control to CICS with return code UERCAPUR to purge only this request.

UERCAKLL or UERCAKLM

These return codes indicate that you want CICS to deal with the request as follows:

- UERCAKLL—reject this request, purge all other queued allocate requests on this connection, and send an information message to the operator console.
- UERCAKLM—reject this request, purge all other queued modegroup allocate requests on this connection, and send an information message to the operator console.

VTAM working-set module exits

If the queue limit has been reached but the performance of allocate processing against the queue is below the acceptable limits defined in your user exit program, you can return control to CICS as follows:

- For non-specific allocate requests, use return code UERCAKLL. UERCAKLL also returns SYSIDERR to all application programs waiting on the purged allocate requests. CICS sets the UEPFLAG parameter to UEPRC8 on subsequent calls to your XZIQUE exit program to indicate that UERCAKLL was returned previously to purge the queue.
- For specific modegroup allocate requests, use return code UERCAKLM. UERCAKLM also returns SYSIDERR to all application programs waiting on the purged allocate requests. CICS sets the UEPFLAG parameter to UEPRC12 on subsequent calls to your XZIQUE exit program to indicate that UERCAKLM was returned previously to purge the queue.

Purging a queue that is causing congestion in the flow of tasks frees task slots that are needed to prevent the system becoming clogged. The more you allow a session queue to grow, the more likely you are to reach the task ceiling set by the MAXT parameter, and then cause a queue of incoming tasks in the local region that cannot be attached. Note that some internal CICS requests (such as those for the LU services model transactions CLS1, CLS2, and CLS3) are not purged by return codes UERCAKLL and UERCAKLM.

If a queue has been purged previously (with UERCAKLL or UERCAKLM) but there are no queued requests currently, check the number of successful allocates since the queue was last purged. For non-specific allocate requests, this number is in UEPSARC8, and for specific modegroup requests, this number is in UEPMAR12. If no requests of this type have been allocated on this connection since the queue was last purged, the problem that caused the purge previously has not been resolved, and this request should be rejected with UERCAPUR.

If the UEPSARC8 or UEPMAR12 parameters show that allocates are being processed, you should use UERCAQUE to resume queuing of requests. If you return with UERCAQUE in this case, CICS issues an information message to the console to signal that queuing has been resumed.

Note: The address of the system entry statistics record, UEPCONST, is supplied for both non-specific and specific modegroup allocate requests.

The address of the modegroup statistics record, UEPMODST, is set to zeros for non-specific allocate requests. This address is supplied only if the request is for a specific modegroup.

If the exit is invoked after a successful allocate following the suppression of queuing, you can use the following return code:

UERCNORM

This return code indicates that CICS is to resume normal processing on the link, including queuing of requests.

Statistics fields in DFHA14DS and DFHA20DS

There are some statistics fields that your XZIQUE global user exit program can use to control queues.

VTAM working-set module exits

A14EALRJ: Each time an XZIQUE global user exit program returns with a request to reject a request, CICS increments a new field in the system entry connection statistics. This is A14EALRJ (allocate rejected) in DSECT DFHA14DS. This field is provided to help you to tune the queue limit. Normally, if the number of sessions and the queue limit defined for a link are correctly balanced, and there has been no abnormal congestion on the link, the A14EALRJ should be zero. If the rejected allocates field is non-zero it probably indicates that some action is needed.

A14EQPCT and A20EQPCT: Each time an XZIQUE global user exit program returns with a request to purge a queue, CICS increments a new field in either the system entry or mode entry connection statistics. These fields are:

A14EQPCT

The count of the number of times the queue has been purged for the connection as a whole.

A20EQPCT

The count of the number of times the mode group queue has been purged.

For detailed information about statistics fields, what they contain and how they are updated, see the *CICS Performance Guide*.

Exit XZIQUE

When invoked

Whenever:

1. An allocate request for a session is about to be queued
2. An allocate request succeeds following previous suppression of queuing.

Exit-specific parameters

UEPZDATA

Address of the 70-byte area containing the information listed below. This area is mapped by the DSECT in copybook DFHXZIDS.

Area addressed by UEPZDATA

UEPSYSID

The 4-byte SYSID of the connection.

UEPREQ

A 2-byte origin-of-request code, which can have the following values:

- | | |
|-----------|--|
| TR | Transaction routing |
| FS | Function shipping (includes distributed program link) |
| AL | Other kinds of intercommunication (for example, distributed transaction processing (DTP) or CPI Communications). |

UEPREQTR

The 4-byte identifier of the requesting transaction (applicable only when the origin-of-request code is FS or AL).

UEPTRAN

The 4-byte identifier of the transaction being routed (applicable only when origin of request is TR).

UEPFLAG

A 1-byte flag indicating whether a return code 8 or return code 12 was issued last time the exit was invoked.

UEPRC8

The exit program returned control to CICS on the previous invocation with return code 8.

UEPRC12

The exit program returned control to CICS on the previous invocation with return code 12.

UEPPAD

A 1-byte padding field.

UEPFSPL

Address of the 10-byte function shipping parameter list.

UEPCONST

Address of the 158-byte system entry statistics record (this can be mapped using DSECT DFHA14DS).

UEPMODST

Address of the 84-byte modegroup statistics record for the modegroup specified in the relevant CICS profile. This field applies only to APPC connections for a specific allocate. For LU61, IRC, or non-specific APPC allocates, it contains zero.

The statistics record can be mapped using DSECT DFHA20DS. The modegroup name field (A20MODE) may contain blanks. The record is followed by a fullword of X'FFFFFFFF'.

UEPSTEX

A 6-byte area containing additional current statistics for APPC that are not already in the modegroup statistics record (DFHA20DS). For specific allocates, the numbers refer to the specified modegroup only. For non-specific allocates, they refer to the whole connection—that is, they are the totals of each modegroup.

The 6-byte area contains:

UEPEBND

A halfword binary field containing the number of bound sessions

UEPEWWT

A halfword binary field containing the number of contention winners with tasks

UEPELWT

A halfword binary field containing the number of contention losers with tasks.

UEPEMXQT

A halfword binary field containing the maximum queuing time specified for the connection (MAXQTIME on the CONNECTION resource definition).

UEPMDGST

Address of a set of 84-byte modegroup statistics records—one for each user modegroup for the connection. This field applies only to APPC connections for a non-specific allocate. For LU61, IRC, and APPC specific allocates, it contains zero.

Each statistics record can be mapped using DSECT DFHA20DS. The modegroup name field (A20MODE) may contain blanks. The end of the set of records is indicated by a fullword of X'FFFFFFFF'.

VTAM working-set module exits

Non-specific allocates data:The following three fields contain data relating to MRO, LU6.1, and non-specific APPC allocates:

UEPSAQTS

A double-word binary field containing the time stamp from the TCT system entry indicating the time the queue of non-specific requests was started.

UEPSACNT

A half-word binary field containing the number of all non-specific allocates processed since the queue was started (see UEPSAQTS for the start time).

UEPSARC8

A half-word binary field containing the number of sessions freed since the queue was last purged as a result of a UEPCAKLL return code to CICS.

Specific allocates data:The following three fields contain data relating to specific modegroup allocates. They are applicable only when UEPMODST is non-zero (that is, it contains the address of the relevant modegroup statistics).

UEPMAQTS

A double-word binary field containing the time stamp from the TCT mode entry indicating the time that the modegroup queue was started for this specific modegroup.

UEPMACNT

A half-word binary field containing the number of all specific allocates for this modegroup processed since the queue was started (see UEPMAQTS for the start time).

UEPMAR12

A half-word binary field containing the number of modegroup sessions freed since the queue was last purged as a result of a UEPCAKLL return code to CICS.

UEPQUELM

A half-word binary field containing the queue limit specified for this connection (QUEUELIMIT on the CONNECTION definition).

Return codes

In the case of an allocate that is about to be queued, use one of the following:

UERCAQUE

Queue the allocate request.

UERCAPUR

Reject the allocate request with SYSIDERR.

UEPCKALL

Reject this allocate request with SYSIDERR. Purge all other queued allocate requests and send an information message to the operator console. CICS also returns SYSIDERR to all application programs waiting on the purged allocate requests.

UEPCKALM

Reject this allocate request for the modegroup and return SYSIDERR. Purge all other queued allocate requests for the

VTAM working-set module exits

modegroup specified on this allocate request and send an information message to the operator console. Retry the modegroup after an interval.

UERPURG

Task purged during XPI call.

In the case of a successful allocate following the use of UERCAKLL or UERCAKLM, on a previous invocation of the exit, use one of the following:

UERNORM

Resume normal operation of the link or modegroup.

UERPUR

Reject the allocate request with SYSIDERR.

XPI calls

All can be used.

Designing an XZIQUE global user exit program

The functions of your XZIQUE exit should be designed:

1. To control of the number of tasks (and the amount of associated resource) that are waiting in a queue for a free intersystem session. Waiting tasks can degrade the performance of the local system.
2. To detect poor response from the receiving (remote) system and to notify the operator (or automatic operations program).
3. To cause CICS to issue a message when the link resumes normal operation.

The XZIQUE global user exit parameter list is designed to support these objectives.

Design considerations

The information passed at XZIQUE is designed to enable your XZIQUE global user exit program to:

- Avoid false diagnosis of problems on the connection by distinguishing poor response times from a complete bottleneck
- Ensure that a link resumes normal operation quickly and without operator intervention once any problem in a remote system is resolved.

Some guidance on the use of IRC/ISC statistics

CICS adds an entry for unsatisfied allocate requests to the following queues:

Non-specific (generic) allocate queue

All non-specific allocate requests are queued in this single queue. CICS makes the total number of entries in this queue available in the system entry statistics field A14ESTAQ, to which your global user exit program has access by means of the address of the system entry statistics, which is passed in UEPCONST.

Specific modegroup allocate queues

Specific allocate requests are queued in the appropriate modegroup queue—one queue for each specific modegroup name. CICS makes the total number of entries in all these queues available, as a single total, in the mode entry statistics field A20ESTAQ, to which your global user exit program has access by means of the address of the mode entry statistics, which is passed in UEPMODST.

VTAM working-set module exits

Sample exit program design

A sample XZIQUE exit program is provided with CICS Transaction Server for OS/390 Release 3 as a base for you to design your own global user exit program. It is called DFH\$XZIQ, and is supplied in the CICSTS13.CICS.SDFHSAMP library. The DSECT used by the sample program to map the area addressed by UEPZDATA is called DFHXZIDS, and this is supplied in the CICSTS13.CICS.SDFHMAC library.

As supplied, the sample exit program implements the same basic function as described for the QUEUELIMIT and MAXQTIME parameters on the connection resource definition. If the XZIQUE exit is not enabled, CICS uses these parameters to control the existence and length of the queue of allocate requests. If you enable the exit, the parameters from the connection definition are passed to your XZIQUE global user exit program, which can change the way in which these parameters are used.

The exit program also demonstrates how to control allocate requests for a particular modegroup, based on the same QUEUELIMIT and MAXQTIME parameters.

Overview of the sample exit program: The program uses the exit-specific parameters passed by CICS to determine the state of the connection, and to request the appropriate action, as follows:

1. The connection is operating normally; a queue may exist, but is of short length. In this case, the exit program returns with UERCAQUE to indicate that CICS is to **queue the request**.
2. The response from the partner system is slower than the rate of requests demands, and the queue length has grown to the limit specified on the QUEUELIMIT parameter. The partner system is still operating normally, but is overloaded. In this case, the exit program returns with UERCAPUR to indicate that CICS is to **purge the request**.
3. The queue has reached the limit specified by the QUEUELIMIT parameter, **and** requests that join the queue are expected to take longer to be satisfied than the time defined by the MAXQTIME parameter. (The estimated time for a request to complete is calculated by dividing the number of successful requests since the queue first formed by the time elapsed since it formed. These statistics are passed to the exit in the parameter list.)
These criteria are used to determine that the connection is not operating correctly, and that continued queuing of tasks is not helpful. In this case:
 - The exit returns with UERCAKLL requesting CICS to **purge all queued** user requests from the connection. The SYSIDERR condition is returned to the application program.
 - CICS issues message DFHZC2300 to warn that a connection is not performing as expected.
4. The queue has been purged as a result of a previous invocation of the global user exit program, there are still no free sessions, and the request is about to be queued. In this case, the exit program returns with UERCAPUR to indicate that CICS is to **purge the request**. This also leaves the UEPRC8 flag set.
5. The queue has been purged as a result of a previous invocation of the global user exit program. A new allocate request has been received and is about to be allocated because a session has become free.

VTAM working-set module exits

CICS invokes the exit program to enable it to indicate that normal processing can continue.

In this case, the exit program returns with UERCNORM to indicate that CICS is to **continue processing normally**. This also causes the UEPRC8 flag to be unset following this invocation, and CICS to issue message DFHZC2301.

The sample program also monitors the length of queues for modegroup-specific allocate requests and controls these—in the same way as the queue for the whole connection—using the QUEUELIMIT parameter and MAXQTIME parameters.

If both UEPRC8 and UEPRC12 are set, UERCNORM is required twice to resume normal operation. The UEPRC8 condition is reset first in this case.

Extensions to the sample program: The sample exit program does not attempt to control the queue length, or detect poor response for a particular modegroup differently from the whole connection. This kind of enhancement is something you might want to add to your own exit program if your applications request specific modegroups via the allocate command (or via a transaction profile) and you think it would be useful to control the modegroups individually.

You can also use more complex decisions (such as adding time delays to lessen the risk of false diagnosis) to decide when to issue the return codes that purge the queue, and allow queuing to restart.

XRF request-processing program exit **XXRSTAT**

XXRSTAT enables you to decide whether to terminate CICS when either of the following occurs:

- CICS is notified of a VTAM failure by the TPEND exit.
- A **predatory takeover**. A “predatory takeover” can occur, if you are using VTAM Release 3.4.0 or above, and a VTAM application with the same APPLID as that of the executing CICS system assumes control of all the sessions of the executing CICS system.

XXRSTAT gives you the choice of allowing the system which has suffered the takeover to continue or to terminate.

To avoid potential integrity exposures, CICS default action after a predatory takeover is to terminate without a dump. If you want CICS to terminate with a dump, your exit program should return UERCABDU. CICS terminates with the abend code specified by your exit program.

If you want CICS to continue after a predatory takeover, your exit program must return UERCCOIG. Message DFHZC0101 is issued and CICS continues processing without VTAM support. The predatory application assumes control of all VTAM sessions (all TCAM sessions remain bound to CICS).

Note: Allowing CICS to continue after a predatory takeover could cause integrity problems and is not recommended. You are also recommended to use RACF to protect your CICS APPLIDs.

For more information about this exit and the circumstances in which you can use it, refer to the *CICS/ESA 3.3 XRF Guide*.

Exit **XXRSTAT**

When invoked

After either of the following:

- CICS is notified of a VTAM failure by the TPEND exit.
- A predatory takeover.

Exit-specific parameters

UEPERRA

Address of parameter list containing:

UEPGAPLD

Address of the 8-byte generic applid

UEPSAPLD

Address of the 8-byte specific applid

UEPDOMID

Address of the 4-byte domain ID

UEPERRID

Address of the 4-byte error ID.

Notes:

1. No DSECT is provided for the above parameter list. You need to code your own DSECT to access the named fields.
2. When VTAM has failed, the domain ID is 'ZC ' (uppercase Z, uppercase C, and two blanks), and the error ID is the character string '3443'.

XRF request-processing program exit

Return codes

UERCNORM

Take the system action. The system action depends on the reason why the exit was invoked:

- For XRF, in the event of a VTAM failure: CICS continues processing as if the exit program had not been invoked.
- For VTAM persistent sessions, in the event of a predatory takeover: CICS abends without a dump.

UERCCOIG

Ignore.

UERCABNO

Abend CICS without a dump.

UERCABDU

Abend CICS with a dump.

UERCPURG

Task purged during XPI call.

XPI calls

All can be used.

XRF request-processing program exit

Chapter 2. Task-related user exit programs

This chapter describes a special kind of user exit called a **task-related user exit**. A task-related user exit allows you to write your own program to access a resource, such as a database, that would not otherwise be available to your CICS system. Such a resource is known as a non-CICS resource. The exit is said to be task-related because it becomes part of the task that invoked it and because, unlike a global user exit, it is not associated with an exit point. You do not have to use any of the task-related user exits, but you can use them to extend and customize the function of your CICS system according to your own requirements.

The most common use of a task-related user exit is to communicate with a resource manager external to CICS, for example, a file or database manager. The CICS interface modules that handle the communication between the task-related user exit and the resource manager are usually referred to as the resource manager interface (RMI) or the task-related user exit interface.

The chapter is divided into the following sections:

1. “**Introduction to the task-related user exit mechanism (the adapter)**”
2. “**The stub program**” on page 250
3. “**The task-related user exit program**” on page 252
4. “**Adapter administration**” on page 280.

Introduction to the task-related user exit mechanism (the adapter)

The task-related user exit mechanism is known as an **adapter** because it provides the connection between an application program that needs to access a non-CICS resource and the manager of that resource. Figure 4 on page 250 illustrates the adapter concept.

The adapter is made up of three or more locally-written programs. These are a “stub” program, a task-related user exit program, and one or more administration routines or programs.

The **stub program** intercepts a request (for example, to access data held on an external database manager) issued by the calling application program. The stub can be used to resolve a locally-defined high-level language command into a task-related user exit macro call, DFHRMCAL, which then causes CICS to pass control to the task-related user exit program.

The **task-related user exit program** translates commands for accessing a non-CICS resource into a form acceptable to the resource manager. The program must be written in assembler language, and can reside above or below the 16MB line. For more guidance information about addressing and residency modes, refer to “Addressing-mode implications” on page 267. The program must not alter the contents of any access registers. It is executed in response to a specific application program request, for example, to read data from an external database. In this instance, it may be passed application data, such as a search argument for a required record. Responses from the resource manager are passed back to the calling program by the task-related user exit program.

the adapter

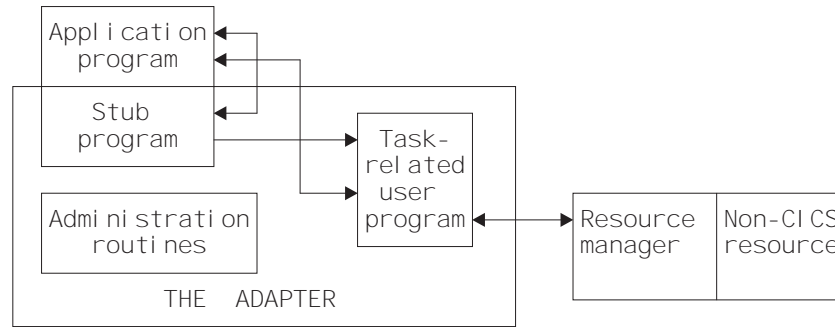

Figure 4. The adapter concept

The task-related user exit program is provided with a parameter list (DFHUEPAR) by the CICS management module that handles task-related user exits. This parameter list gives the task-related user exit access to information such as the addresses and sizes of its own work areas.

The task-related user exit program may be invoked by the CICS task manager and the CICS syncpoint manager, as well as by an application program. It may also be invoked at CICS termination or by the Execution Diagnostic Facility (EDF). The parameter list serves to distinguish between these various callers, and gives access to a register save area containing the caller's registers.

The **administration routines** contain the EXEC CICS ENABLE and DISABLE commands that you use to install and withdraw the task-related user exit program. The administration routines may also contain commands to retrieve information about one of the exit program's work areas (the EXEC CICS EXTRACT EXIT command), and to resolve any inconsistency between CICS and a non-CICS resource manager after a system failure (the EXEC CICS RESYNC command). For programming information about the EXEC CICS RESYNC command, refer to the *CICS System Programming Reference* manual.

The remainder of this chapter discusses each of these parts of the adapter in turn.

The stub program

The purpose of the stub program is to shield your application programmers from the mechanics of non-CICS resource managers. It is written in assembler language. After assembly, the stub is link-edited to each application program that wants to use it. See Figure 5 on page 251.

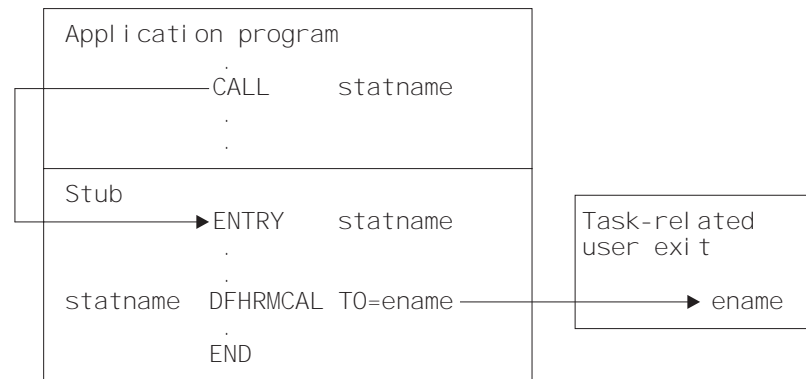

Figure 5. The stub concept

statname

is a label that can be referenced externally. It should conform to the requirements of an assembler-language ENTRY statement, and typically resolves a V-type address constant, or the target of a high-level language CALL. A single stub may contain several such labels.

ename

is the entry name (specified on the EXEC CICS ENABLE command) of the task-related user exit program that you want to handle resource manager requests.

You can define high-level language commands for your programmers to use when they want to access a non-CICS resource. If you do this, you must use a translator to convert a locally-defined high-level language command into a conventional CALL to the required entry point of the stub program. Alternatively, the application program can issue a CALL naming the stub entry point, as shown in Figure 5. For example, to read a record from a non-CICS resource, an application program can use the COBOL statement:

```
CALL 'XYZ' USING PARM1 PARM2...
```

XYZ is an entry point (the statname) in your stub program. The stub converts the command into a macro call (DFHRMCAL) to the task-related user exit program, specified in the TO= operand. Return from the task-related user exit program is to the calling application program, not to the stub program.

The application can use a parameter to determine whether the resource manager was called. For example, if the application sets a parameter to zero and the resource manager sets it to nonzero, the parameter value on return indicates whether the resource manager was invoked.

Returning control to the application program

If you specify RTNABND=YES in the DFHRMCAL macro, control returns to the application program when the task-related user exit is not available, for example, because it is not enabled or started. Note that for assembler-language application programs, a negative value in register 15 signals to the application program that control has returned because the exit is not available. The task-related user exit program can use positive values (including zero) in register 15 to pass resource manager response codes to the application program.

the stub program

If you do not specify RTNABND=YES and the task-related user exit is not available, the application program terminates abnormally with the abend code 'AEY9'.

Task-related user exits and EDF

When a task-related user exit (TRUE) is invoked for a call to a non-CICS resource manager from an application that is being monitored by EDF, EDF's default action is to display the parameters that are addressed by the parameter list passed by the DFHRMCAL macro. However, the parameter list can be transformed into a more meaningful display by the TRUE itself. This is done by specifying FORMATEDF on the EXEC CICS ENABLE command that enables the TRUE. The latter is then invoked several times, before and after the invocation to satisfy the call to the resource manager, to format the data to be displayed by EDF and to deal with any changes made by the user to the data on the EDF screen.

For more information about how to format screens for EDF, refer to "CICS EDF build parameters" on page 261 and "Using EDF with your task-related user exit program" on page 278.

If a task-related user exit program contains EXEC CICS commands, EDF may be useful in debugging the TRUE itself. If you want EDF to display commands from the TRUE, you must specify the EDF option when the TRUE program is translated. The standard EDF screens for the CICS commands are then displayed between the "About to Execute" and "Command Execution Complete" screens for the call to the resource manager. However, as EDF is primarily an application debugging tool and the CICS commands within the TRUE would not generally be of interest to the application programmer, the TRUE program is normally translated with the "NOEDF" option; in this case, screens for CICS commands within the TRUE are suppressed.

Note: If you specify SUPPEDF=YES on the DFHRMCAL macro, the "About to Execute" and "Command Execution Complete" screens relating to DFHRMCAL's invocation of the TRUE are suppressed; in other words, DFHRMCAL becomes "invisible" to EDF. (Specifying SUPPEDF=YES has no effect in determining whether EDF displays EXEC CICS commands within the TRUE—the factors governing this are as described above—but it **does** suppress the display of parameters passed to the TRUE.)

The task-related user exit program

The main function of the task-related user exit program is to translate the calling program's parameters into a form acceptable to your non-CICS resource manager, and then to pass control to the resource manager. You therefore need to be familiar with your resource manager's syntax requirements. The calling program's parameters are described on page 257.

This section describes the user exit parameter lists, the schedule flag word, which is used by the exit program to register its need to be invoked by CICS management services, and register-handling in the task-related user exit program. This section also discusses the use of the CICS syncpoint manager and the CICS task manager.

User exit parameter lists

When a task-related user exit is invoked, the CICS management module that handles task-related user exits provides the exit with a parameter list. The address of this parameter list is passed in register 1. The list contains the following information:

- The identity of the caller
- Addresses and sizes of any work areas that are available to the task-related user exit program
- The address of the register save area of the caller
- The address of an EXEC interface block (EIB) that is for use by the task-related user exit program during this invocation
- The address of the identifier of the current unit of recovery
- The address of the schedule flag word
- The address of the kernel stack entry
- The address of the APPC unit of work (UOW) identifier
- The address of the user security block flag
- The address of the user security block
- The address of the resource manager qualifier name
- The address of the resource manager's "single-update" and "read-only" indicator byte
- The address of the caller's AMODE indicator byte
- The address of the application's DATALOC and TASKDATAKEY indicator byte
- The address of the performance block token
- The address of a trace flag.

To enable your exit program to access this parameter list, you must include in it the macro:

```
DFHUEXIT TYPE=RM
```

The DFHUEXIT TYPE=RM macro causes the assembler to create the storage definitions (DSECTs) DFHUEPAR and DFHUERTR. If you want your task-related user exit to be able to format screens for EDF, you must include in it the macro:

```
DFHUEXIT TYPE=RM,DSECT=EDF
```

This causes the assembler to create the UEPEDFRM DSECT, which is described in "CICS EDF build parameters" on page 261. All of the user exit parameter lists are summarized in Figure 7 on page 264.

The format and the purpose of these definitions are described below.

DFHUEPAR

DFHUEPAR gives you the following symbolic names for address parameters:

UEPEXN

Address of the function definition, which tells the task-related user exit program why it is being called. See "DFHUERTR (the function definition)" on page 257 for more details.

UEPGAA

Address of the global work area requested in the EXEC CICS ENABLE

the task-related user exit program

command. The global work area is described on page “The global work area” on page 269. CICS initializes this work area to X'00' when the task-related user exit program is enabled.

UEPGAL

Address of a halfword containing the length (binary value) of the global work area.

UEPTCA

This field is retained for historical reasons. It should **not** be referenced by your exit program.

UEPCSA

This field is retained for historical reasons. It should **not** be referenced by your exit program.

UEPHMSA

Address of the register save area (RSA) of the caller. It is an 18-word save area, with the contents of registers 14 through 12 stored in the fourth and subsequent words. Its fifth word, representing the calling program's register 15, is cleared by CICS before the task-related user exit program is invoked, so that it can be used to convey response codes from the resource manager to the calling program. For this reason you cannot use register 15 to send data to the task-related user exit program. The seventh word of the save area contains the caller's register 1. Register 1 addresses the caller's parameter list if the exit program is being invoked by the CICS task manager or the CICS syncpoint manager, by EDF, or at CICS termination. When the caller is an application program, the contents of register 1 are determined by the linkage conventions of the adapter's language interface.

UEPTAA

Address of the local work area requested in the EXEC CICS ENABLE command. The local work area is described on page “The local work area” on page 269. CICS initializes the work area to X'00' throughout on first acquiring the area; that is, when the task first invokes the task-related user exit program.

UEPTAL

Address of a halfword containing the binary length of the local work area.

UEPEIB

Address of the EXEC interface block (EIB) created by CICS for the task-related user exit program. The EIB exists only for the duration of the call and it allows the task-related user exit program to request CICS services through the command-level interface. This is not the same EIB that is available to the calling program, so you cannot access the calling program's environment other than by UEPHMSA (see above), which provides the address of the calling program's register save area (RSA).

UEPURID

Address of CICS unit of recovery identifier. This field contains the 8-byte date and time value that is generated by an STCK instruction, and it identifies the current unit of work.

UEPFLAGS

Address of the schedule flag word. This is a fullword that the task-related user exit program uses to register its need for CICS management programs' services. For more information, see “The schedule flag word” on page 265.

UEPRMSTK

Address of the kernel stack entry.

the task-related user exit program

UEPUOWDS

Address of the APPC unit of work (UOW) identifier.

UEPSECFLG

Address of the user security flag. The user security flag is a 1-byte field that can take the following values:

UEPNOSEC (X'80')

Security is not active for this CICS system.

UEPSEC (X'20')

Security is active for this CICS system. Only in this case is the address of the “user security block” set.

UEPSECBLK

Address of a fullword that addresses the “user security block”—that is, the ACEE.

UEPRMQUA

Address of an 8-byte field into which the task-related user exit can move the qualifier name of the resource manager on each API request. This is useful where the same exit program is used to connect to more than one instance of a resource manager; the qualifier identifies the instance of the resource manager to which the exit is currently connected.

Where different resource manager qualifiers are returned on the responses to various API requests within a UOW, it is the resource manager qualifier returned on the final API request immediately before a prepare or backout invocation that is used when recording any in-doubt information.

UEPCALAM

Address of caller's AMODE indication byte.

X'80' Indicates that the original caller was in AMODE 31. If the top bit is not set, then the caller was in AMODE 24.

UEPSYNCA

Address of the single-update and read-only indication byte. This field contains flags that your exit program can set to indicate that the resource manager “understands” the single-update protocol, and to record the status of the current unit of work (UOW). See “Increasing efficiency – single-update and read-only protocols” on page 271.

UEPSUPDR (X'80')

The resource manager understands the single-update protocol. That is, your exit program can instruct the resource manager to perform a single-phase commit, in appropriate circumstances.

UEPREADO (X'40')

The resource manager understands the read-only protocol, and has been in read-only mode for this UOW so far. (If this flag is not set, it means either that the UOW contains updates for this resource manager, or that the UOW may be read-only but the resource manager does not understand the read-only protocol.)

UEPTIND

Address of a 3-byte field containing indicators.

The first indicator byte can take one of three symbolic values, UEPTANY, UEPTCICS, and UEPTUTCB, which you can test to determine: whether

the task-related user exit program

data locations can be above or below 16MB; whether the application's storage is in CICS-key or user-key storage; and whether the TRUE has been called by an unexpected TCB:

UEPTANY (X'80')

The application can accept addresses above 16MB. If the symbolic value is not UEPTANY, the application must be returned an address below 16MB.

UEPTCICS (X'40')

The application's working storage and task life-time storage are in CICS-key storage (TASKDATAKEY=CICS). If the symbolic value is not UEPTCICS, the application's working storage and the task's life-time storage are in user-key storage (TASKDATAKEY=USER).

UEPTUTCB (X'20')

Indicates an unexpected TCB. Set on a syncpoint or end-of-task call only, this indicates a failure to switch to the TCB expected by the task-related user exit. In these two cases, the task-related user exit is called on the QR TCB with the UEPTUTCB bit set. For all other calls, CICS abends the transaction without invoking the task-related user exit.

The second and third bytes contain a value indicating the TCB mode of it's caller. This is represented in DFHUEPAR as both a two-character code and a symbolic value, as follows:

Table 10. TCB indicators in DFHUEPAR. Description

Symbolic value	2-byte code	Description
UEPTQR	QR	The quasi-reentrant mode TCB
UEPTCO	CO	The concurrent mode TCB
UEPTFO	FO	The file-owning mode TCB
UEPTRO	RO	The resource-owning mode TCB
UEPTRP	RP	The ONC/RPC mode TCB
UEPTSZ	SZ	The FEPI mode TCB
UEPTJ8	J8	The JVM mode TCB
UEPTL8	L8	An open mode TCB
UEPTSL	SL	The sockets listener mode TCB
UEPTSO	SO	The sockets mode TCB
UEPTS8	S8	The secure sockets layer mode TCB

UEPPBTOK

Address of the performance block token used for workload management, to enable resource managers to relate their own performance blocks for the work request with the original CICS performance block. For example, DBCTL and DB2 need to correlate the work they do on behalf of CICS with the originating CICS task, so that MVS workload manager can measure the performance of the whole CICS task.

UEPTRCE

Address of a 1-byte trace flag indicating whether RMI tracing (the RI trace component) is active.

the task-related user exit program

UEPTRLV1 (X'80')

RMI level 1 trace is active.

UEPTRLV2 (X'40')

RMI level 2 trace is active.

Having tested this field, the task-related user exit could, for example, issue an EXEC CICS SET TRACETYPE command to reset the level of RMI tracing.

DFHUERTR (the function definition)

The function definition identifies the caller of the task-related user exit program. The DSECT contains two symbolic definitions (fields).

UERTFGP

A single byte that is set to X'00'. The zero setting shows that this is a task-related user exit invocation and that the parameter list therefore includes the fields UEPTAA, UEPTAL, UEPEIB, UEPURID, and UEPFLAGS.

UERTFID

A single-byte identifier that shows whether this call has been made by the CICS SPI, an application program, the CICS syncpoint manager, the CICS task manager, or EDF, or whether this is a CICS termination call. It can have one of the following six settings:

UERTSPI

(X'01') CICS SPI call.

UERTAPPL

(X'02') Application program call.

UERTSYNC

(X'04') CICS syncpoint manager call.

UERTTASK

(X'08') CICS task manager call.

UERTCTER

(X'0A') CICS termination call.

UERTFEDF

(X'0C') EDF call.

It is important to know which type of program has made the call because it affects how the calling program's parameter list is interpreted by the task-related user exit program.

Caller parameter lists

In addition to the DSECTs DFHUEPAR and DFHUERTR, the inclusion of DFHUEXIT TYPE=RM in the task-related user exit program provides some field definitions that are specific to the caller of the task-related user exit. The calling program's parameter list is normally addressed by R1 in the calling program's RSA. This RSA is addressed by field UEPHMSA of DFHUEPAR. These parameters are described below.

CICS SPI parameters: If you enable your task-related exit program with the SPI option of the EXEC CICS ENABLE PROGRAM command (or the program itself "expresses interest" in SPI calls—see "The schedule flag word" on page 265), the

the task-related user exit program

exit program can be invoked to satisfy EXEC CICS INQUIRE EXITPROGRAM commands on which the CONNECTST or QUALIFIER option is specified. This allows applications to query whether the exit program is connected to its resource manager, and its entryname-qualifier. For information about the INQUIRE EXITPROGRAM command, see the *CICS System Programming Reference* manual.

The CICS SPI parameter list contains two entries:

Parameter 1

The address of a 1-byte output field, which your task-related exit program should use to indicate whether it is connected to its external resource manager. The equated return code values are:

UERTCONN

(X'80') The exit is connected to its resource manager.

UERTNCONN

(X'40') The exit is not connected to its resource manager.

Parameter 2

The address of an 8-character output field, in which your task-related exit program should return the qualifier of the external resource manager, if known. See the UEPRMQUA parameter on page 255 for more information on qualifier names.

Application program parameters: If the caller is an application program, the format and addressing of its parameter list are decided locally.

CICS syncpoint manager parameters: The CICS syncpoint manager's parameter list contains ten entries, although on most invocations only parameters 1 and 10 contain values. The operation bytes pointed to by parameters 1 and 10 contain flags which, when combined, form an operation code that tells the TRUE why it has been invoked.

Parameters 2 through 9 contain values only when the syncpoint manager makes a "Commit Unconditionally" or "Backout" call to the TRUE, for resynchronization purposes after a session or system failure. These extra parameters point to fields that identify the task, the transaction that started the task, the terminal from which it was initiated, the identity of the terminal operator, the date and time of the failing syncpoint, and (if there are no further units of recovery associated with the task) the next transaction code. Typically, you would use these values to create meaningful messages for resource recovery. They are presented explicitly because, after a system failure, the task driving the exit is not the task that originally scheduled the recoverable work. These additional parameters describe the **original** task's environment and are accessed directly.

The full parameter list is as follows:

Parameter 1

The address of operation byte 1, which contains the following flags:

UERTPREP

(X'80') Prepare to commit (that is, perform the first phase of a two-phase commit).

UERTCOMM

(X'40') Commit unconditionally (perform the second phase of a two-phase commit).

UERTBACK

(X'20') Backout.

UERTDGCS

(X'10') Unit of recovery has been lost because of an initial start of CICS.

UERTDGNK

(X'08') Resource manager should not be in doubt about this unit of recovery.

UERTWAIT

(X'04') Resource manager must wait for the outcome of this unit of recovery. This value is set at phase two of a two-phase commit, if CICS is in-doubt about the outcome of a UOW. It occurs only if the task-related user exit is enabled with the INDOUBTWAIT option (see "Enabling for specific invocation-types" on page 280).

UERTRSYN

(X'02') This syncpoint request was generated as the result of an EXEC CICS RESYNC command.

UERTLAST

(X'01') There are no further units of recovery associated with this task. Note that when this bit is **not** set, there may or may not be further units of recovery. For this reason, it is not recommended that you rely on this bit to signal end-of-task. You should instead schedule the CICS task manager to drive you at end-of-task by setting the task manager bit in the schedule flag word. If you do use UERTLAST to signal end-of-task, and if at that stage you can complete your clean-up process, you can set the task manager bit off in the schedule flag word when the clean-up process is finished, to avoid an unnecessary invocation by the CICS task manager.

The only **valid bit combinations** are those produced by combining one of UERTPREP, UERTCOMM, UERTBACK, UERTDGCS, and UERTDGNK with either UERTLAST or UERTRSYN, or both; or by combining UERTWAIT and UERTLAST.

Your exit program should examine the flags set both in this byte and in operation byte 2 (see parameter 10), to determine what action is expected of it.

Parameter 2

If not zero, the address of a 4-byte, packed-decimal field identifying the original task. But note that, on many invocations of the exit program, parameters 2 through 9 do not contain values. See note 1 on page 260.

Parameter 3

Address of a 4-character field identifying the transaction that started the original task. See note 1 on page 260.

Parameter 4

Address of a 4-character field identifying the terminal from which the original task was initiated. See note 1 on page 260.

Parameter 5

Address of a 4-character field containing the identity of the terminal operator (OPID) who initiated the original task. See note 1 on page 260.

the task-related user exit program

Parameter 6

Address of a 4-byte, packed-decimal field containing the date of the failing syncpoint, in the format 00yyddd+. See note 1.

Parameter 7

Address of a 4-byte, packed-decimal field containing the time of the failing syncpoint, in the format 0hhmmss+. See note 1.

Parameter 8

Address of an 8-byte field containing the resource manager qualifier. See note 1.

To verify that this is a resync for this instance of the resource manager, your exit program should check that the qualifier passed is the one that is currently in use. If it is not, the exit program should ignore the resync and set a return code of UERFHOLD, to indicate that CICS should keep the disposition of the unit of work.

Parameter 9

Address of a 4-character field containing the next transaction code. If the transaction ended with an EXEC CICS RETURN without specifying the next transaction code, the addressed field is set to nulls; otherwise, it is set to the value specified by the application. See note 2.

Parameter 10

The address of operation byte 2, which contains the following flags:

UERTONLY

(X'80') Perform a single-phase commit. (No recoverable resources other than those owned by the resource manager being invoked have been updated during the current UOW.)

UERTELUW

(X'40') Perform a single-phase commit. (The resource manager was in read-only mode throughout the current UOW.)

Your exit program should examine the flags set both in this byte and in operation byte 1 (see parameter 1), to determine what action is expected of it.

Notes:

- Parameters 2 through 8 contain values only if the CICS syncpoint manager call is prompted by the issue of an EXEC CICS RESYNC command after a session or system failure, and operation byte 1 contains the bit settings UERTCOMM or UERTBACK. Otherwise, they are set to X'00' (hexadecimal zero). For programming information about the EXEC CICS RESYNC command and about the completion of the syncpointing procedure following a system failure, refer to the *CICS System Programming Reference* manual.
Note that parameters 2 through 8 describe the environment of the **original** task (not of the task that is currently driving the TRUE).
- Unless the UERTLAST bit is set in operation byte 1, parameter 9 is a zero address. Although for a call prompted by an EXEC CICS RESYNC call, the UERTLAST bit will be set on, in this case the next transaction code does not apply and so Parameter 9 addresses a field set to nulls.

CICS task manager parameters: There are either one or two entries in the CICS task manager's parameter list, depending on the reason for the call to the TRUE: on start-of-task calls, the parameter list contains one entry, while on end-of-task calls, it contains two. Each entry consists of an address, and the end of the parameter list is indicated by the top bit of the address being set.

the task-related user exit program

The significance of the parameters is as follows:

Parameter 1

The address of a single byte with bit definitions indicating the reason for the call:

UERTSOTR

(X'40') Start of CICS task

UERTEOTR

(X'80') End of CICS task.

Parameter 2

This parameter is passed only on end-of-task calls. It is the address of a 4-character field which contains the next transaction code specified on the EXEC CICS RETURN command. If the transaction ends with an EXEC CICS RETURN without specifying a next transaction, this field is set to nulls.

The schedule flag word should be set during the start-of-task call if you want your task-related user exit program to be invoked unconditionally by the CICS syncpoint manager.

CICS termination manager parameters: All task-related user exit programs that have been enabled with the SHUTDOWN option of the EXEC CICS ENABLE command, and started, are invoked at CICS termination to allow them to do the clean-up processing that is appropriate to the type of termination. At CICS termination, the address of a one-byte termination code is passed to your exit program. The code may consist of any of the following bit settings:

UERTCORD

(X'80') CICS orderly shutdown

UERTCIMM

(X'40') CICS immediate shutdown

UERTCABY

(X'20') CICS abend, retry possible, TCBs dispatchable

UERTCABN

(X'10') CICS abend, retry not possible, TCBs dispatchable

UERTOPCA

(X'01') CICS abend, retry not possible, TCBs not dispatchable.

For further information about shutdown TRUEs, see "Coding a program to be invoked at CICS termination" on page 275.

CICS EDF build parameters: On EDF invocations, the address contained in register 1 of the calling program's RSA points to the UEPEDFRM DSECT. This contains the following fields:

UEPEDFR1

The address of the application's R1 parameter list.

the task-related user exit program

UEPEDFFI

The input flag byte. When a task-related user exit is invoked by EDF, UEPEDFFI can take the following bit settings:

UEPEDFRQ

(X'80') "About to Execute" invocation.

UEPEDFRS

(X'40') "Command Execution Complete" invocation.

UEPEDFRA

(X'20') About to display command to EDF.

UEPEDFRC

(X'10') Command has been displayed to EDF.

UEPEDFSC

(X'08') EDF user has changed the screen.

UEPEDFWS

(X'04') EDF user has changed working storage.

UEPEDFNO

(X'01') EDF user has requested NOOP.

UEPEDFFO

The output flag byte. If the task-related user exit requires, it can set the UEPEDFFO flag byte to indicate to EDF what action the task-related user exit wants EDF to take. It can take the following values:

UEPEDDFD

(X'80') Take default CICS action. (EDF screen contains the uninterpreted caller's R1 parameter list.)

UEPEDFND

(X'40') Do not display command to EDF.

UEPEDFRD

(X'20') Redisplay command to EDF.

UEPEDFDL

EDF screen attributes. These are for information only: the task-related user exit program cannot change these fields.

UEPEDFPS (halfword binary)

Page size (number of lines).

UEPEDFLS (halfword binary)

Line size.

UEPEDFMP (halfword binary)

Maximum number of pages.

UEPEDFPA

The address of the EDF display data parameter list, supplied by the task-related user exit. The display data parameter list is composed of alternating pairs of attribute-byte addresses and data-field addresses. Attribute bytes refer to the line of display data pointed to by the data-field addresses. The data field must be the same size as the value specified in UEPEDFLS. The display data is in the format shown in Figure 6 on page 263.

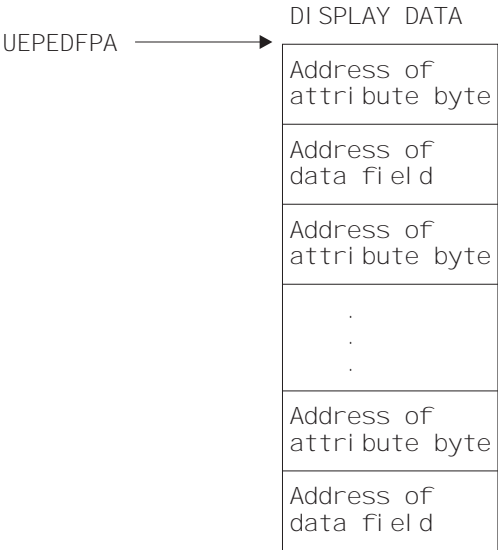

Figure 6. Display data parameter list

Notes:

1. CICS provides a list of named standard attribute bytes that you may want to use. These standard attribute bytes are contained within DFHBMSCA, which must be copied into your program. For programming information, including a list of the attribute bytes and their meanings, refer to the *CICS Application Programming Reference* manual.
2. The high-order bit must be set **on** in the last address, to indicate to EDF that this is the last address.

Summary of the task-related user exit parameter lists

Figure 7 on page 264 shows, in diagrammatic form, the relationships between the parameter lists that are discussed in the preceding sections.

the task-related user exit program

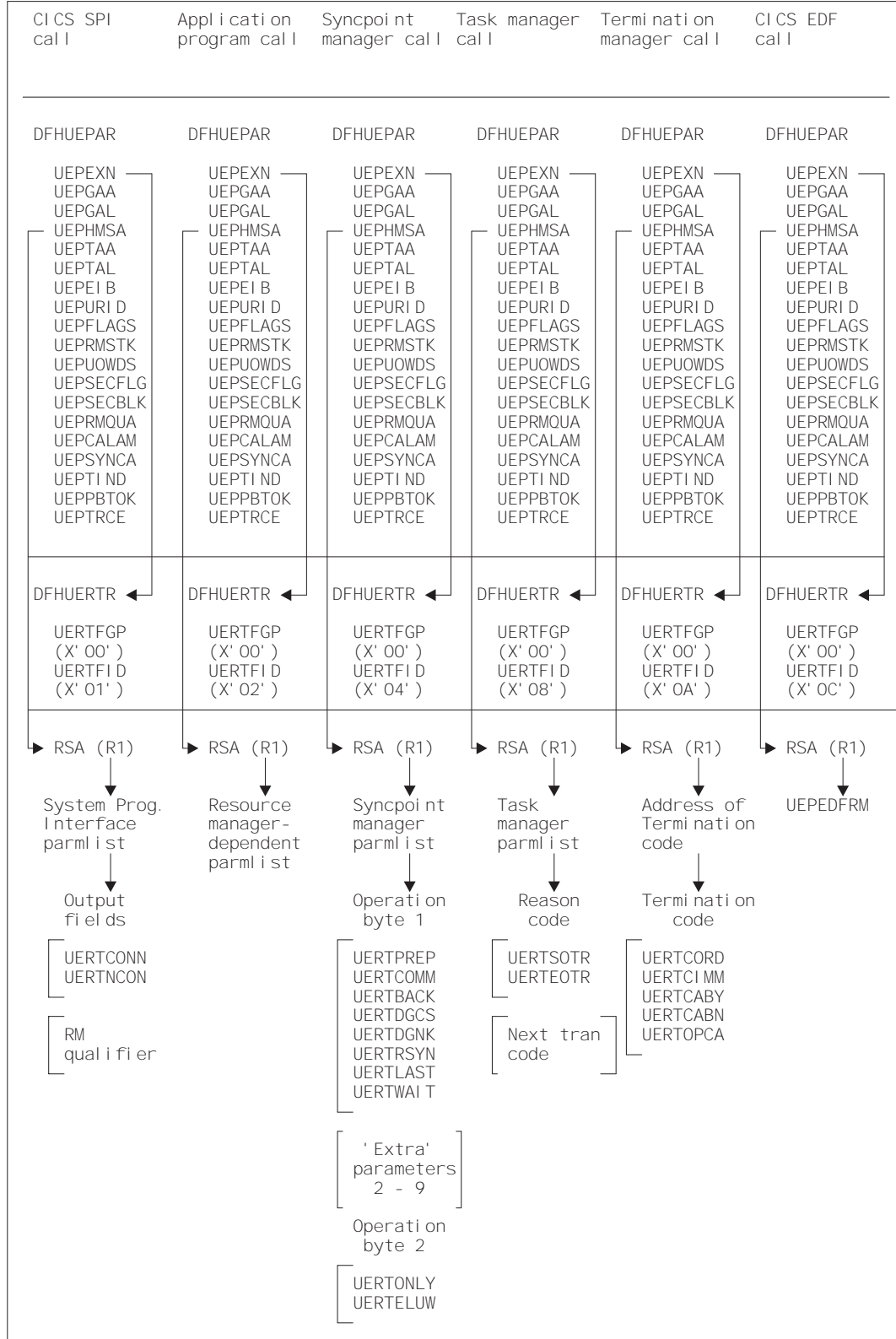

Figure 7. Task-related user exit parameter lists

The schedule flag word

The schedule flag word is a fullword indicator that the task-related user exit program uses to control its own invocation. It is also used by CICS to schedule the first invocation of a task-related user exit program. The schedule flag word is accessed by the address parameter UEPFLAGS of DFHUEPAR. There is a unique schedule flag word for each association between a CICS task and the ENTRYNAME specified when a task-related user exit program is enabled.

The default setting of the schedule flag word is for application program requests (that is, the last two bytes are set to X'0004').

The format of the schedule flag word is shown in Table 11.

Table 11. Format of the schedule flag word

Byte	Setting	Comments	
0	—	Reserved.	
1	—	Reserved.	
2	UEFDFEDF UEFDTASK	UEFMFEDF (X'10') UEFMTASK (X'01')	Bit mask for EDF invocation. Bit mask for task manager.
3	UEFDSYNC UEFDAPPL UEFDSPI	UEFM SYNC (X'10') UEFM APPL (X'04') UEFM SPI (X'02')	Bit mask for syncpoint manager. Bit mask for application program. Bit mask for SPI.

The bit settings of the schedule flag word show which programs invoke your task-related user exit program. For example, if an exit program is to be invoked by the CICS task manager, the CICS syncpoint manager, **and** an application program, then the last two bytes of the schedule flag word are set to X'0114'. If an exit program is to be called by the CICS task manager and an application program only, the last two bytes of the flag word are set to X'0104'. Before the exit program is first called by a task, CICS sets the API flag bit on.

Before returning from any call, the task-related user exit can change the bit settings of the flag word to register its need to be invoked by a different CICS management service, or to register lack of interest in a service by setting the relevant flag bit to zero.

For example, a task-related user exit may be called by an application program that needs to access a non-CICS recoverable resource. When the exit program is first called, the API bit is set on by CICS. If the calling program then issues a request to update a record, the exit program sets the syncpoint manager bit on in the schedule flag word. When the calling application program subsequently issues a syncpoint command, or when end-of-task is reached, the CICS syncpoint manager calls the exit program.

Note: CICS sets the syncpoint manager bit off after every call to the syncpoint manager. This is to avoid the CICS syncpoint manager invoking the task-related user exit program for a unit of recovery during which the exit program did no recoverable work. The syncpoint manager bit must therefore be set on whenever the exit program performs any recoverable work.

If you set the task manager bit in the schedule flag word on, CICS invokes your task-related exit program at the end of this task. (Note that, if you want your exit

the task-related user exit program

program to be called at the **start** as well as at the end of a task, you must specify TASKSTART on the EXEC CICS ENABLE command for the TRUE. This causes the TRUE to be invoked at the start and end of **every** task.)

If the last two bytes of the schedule flag word are set to X'1000', this indicates that the task-related user exit is interested in being invoked by EDF to format requests for display. This schedule flag bit UEFD FEDF is set **on** either by the EXEC CICS ENABLE FORMATEDF command, or by the task-related user exit. Unlike other schedule flag bits, there are restrictions on when the task-related user exit can register a lack of interest in EDF (that is, restrictions on when UEFD FEDF can be set off). Once a task-related user exit has formatted the initial screen for EDF to display on "About to Execute" or "Command Execution Complete", CICS does not allow it to set the EDF bit UEFD FEDF off until the screen build cycle is complete.

Register handling in the task-related user exit program

In this section, two sets of registers are discussed:

1. The registers belonging to the CICS management module that handles task-related user exits. These are referred to as the **CICS registers**.
2. The registers belonging to the calling program and that are addressed by parameter UEPHMSA of DFHUEPAR. These are referred to as the **calling program's registers**.

Saving CICS registers

Your task-related user exit program should begin by saving the contents of the CICS registers. Register 13 addresses an 18-word area into whose 4th and subsequent words your exit program should store registers 14 through 12. Three of the saved values have significance, as follows:

- The saved contents of register 14 contain the address within CICS to which the task-related user exit program returns control.
- The saved contents of register 15 contain the address at which the task-related user exit program has just been entered.
- The saved contents of register 1 address the parameter list (DFHUEPAR) that is provided by CICS for the task-related user exit program.

Note: As a general rule, if you fail to understand the origin or the purpose of a call, you should:

1. Restore any registers that you have used to the state they were in on entry to your code
2. Return to the address contained in CICS register 14.

The calling program's registers

The calling program's registers are stored at the address specified by UEPHMSA of DFHUEPAR. Where the calling program is a CICS management program, for example the syncpoint manager, the only caller registers that have significance are registers 1 and 15. Register 1 addresses the calling program's parameter list. CICS sets the calling program's register 15 to zero before the task-related user exit program is invoked. The calling program's register 15 can sometimes be used to pass responses back to the calling program from the task-related user exit program, depending on the identity of the caller. If the calling program is a CICS management program, and the register is still zero on return, CICS assumes that its call was not understood. If the calling program is an application program, the

significance of register settings on return are either described in your resource manager's documentation, or defined locally.

Addressing-mode implications

The task-related user exit is invoked in the AMODE of the caller, unless the exit has been enabled with the LINKEDITMODE option of the EXEC CICS ENABLE command. This option enables the task-related user exit in its link-edit AMODE. Therefore, if the TRUE has been link-edited AMODE 31 and is enabled with the LINKEDITMODE option, it can be placed above the 16MB line. For programming information about the LINKEDITMODE option of the EXEC CICS ENABLE command, refer to the *CICS System Programming Reference* manual.

Important

You should avoid the use of the LINKEDITMODE option where the TRUE has been link-edited AMODE 24. This combination forces the TRUE *always* to run AMODE 24, which is unwise because:

- An AMODE 24 TRUE cannot be invoked from a transaction running with TASKDATALOC(ANY). This results in an 'AEZB' abend.
- Enabling an AMODE 24 TRUE for task start causes CICS to force all transactions to run with TASKDATALOC(BELOW).
- On a CICS termination call, CICS ignores LINKEDITMODE and invokes the TRUE in AMODE 31, if it detects that the TCA it is running under is above the 16MB line. (This is because, for some types of termination, such as a cancel, the TCA under which the TRUE will run is not predetermined.)

It is recommended that TRUEs are:

- Written so that they can always run AMODE 31
- Link-edited AMODE 31
- Enabled with the LINKEDITMODE option.

If the task-related user exit has not been enabled with the LINKEDITMODE option of EXEC CICS ENABLE, it is invoked in the AMODE of the caller. For example, in the case of an application request, if the application is AMODE 24 at the time of the DFHRMCAL, the task-related user exit is invoked in AMODE 24. For this reason, task-related user exits which have been enabled without the LINKEDITMODE option must reside below the 16MB line.

Exit programs and the CICS storage protection facility

When you are running CICS with the storage protection facility, there are two points you need to consider for task-related user exits:

1. The execution key in which your task-related user exit programs run
2. The storage key of data storage obtained for your exit programs.

Execution key for task-related user exit programs

When you are running with storage protection active, CICS always invokes task-related user exit programs in CICS key. Even if you specify EXECKEY(USER) on the program resource definition, CICS forces CICS key when it passes control to the TRUE. However, if a task-related user exit program itself passes control to

the task-related user exit program

another program (via a link or transfer-control command), the program thus invoked executes according to the execution key (EXECKEY) defined in its program resource definition.

Important

You are strongly recommended to specify EXECKEY(CICS) when defining both task-related user exit programs, and programs to which an exit program passes control.

Data storage key for task-related user exit programs

The storage key of storage used by task-related user exit programs depends on how the storage is obtained:

- Global or local work areas specified when an exit program is enabled, are always in CICS key.
- Any working storage obtained for the exit program is in the key set by the TASKDATAKEY of the transaction under which the exit program is invoked.
- Task-related user exit programs can use EXEC CICS commands to obtain storage by issuing:
 - Explicit EXEC CICS GETMAIN commands
 - Implicit storage requests as a result of EXEC CICS commands that use the SET option.

The default storage key for storage obtained by EXEC CICS commands is set by the TASKDATAKEY of the transaction under which the exit program is invoked.

As an example, consider a transaction defined with TASKDATAKEY(USER) that causes a task-related user exit program to be invoked. In this case, any implicit or explicit storage acquired by the exit program by means of an EXEC CICS command is, by default, in user-key storage. However, on an EXEC CICS GETMAIN command, the exit program can override the TASKDATAKEY option by specifying either CICSDATAKEY or USERDATAKEY.

Recursion within a task-related user exit program

The task-related user exit has the ability to invoke itself recursively. It can do this, for example, by issuing a DFHRMCAL call to its own entry name (as specified on the EXEC CICS ENABLE command). It can also be entered recursively if it performs an EXEC CICS SYNCPOINT when it is interested in SYNCPOINT invocations.

Using CICS services in your task-related user exit program

You might find some CICS services useful in your exit program. These can be invoked using EXEC CICS commands. However, you should take note of the following:

- If your program is invoked because of a CICS abend, it must not use any CICS services. See “Coding a program to be invoked at CICS termination” on page 275.

the task-related user exit program

- DFHEIENT and DFHEIRET must be in your program. *But see the note about not using DFHEIENT inabend invocations, on page 276.* For further details of the DFHEIENT and DFHEIRET macros, see the *CICS Application Programming Reference* manual.
- If your exit program entry point is immediately followed by an occurrence of a DFHEIENT macro, inserted either implicitly by CICS or explicitly in the program, then the expansion of the DFHEIENT macro stores incorrect values at DFHEIBP and DFHEICAP. Your code can subsequently correct this by copying UEPEIB into DFHEIBP, reloading the EIB base register (DFHEIBR) from UEPEIB, and setting DFHEICAP to X'80000000'. For example,

```
TESTPROG DFHEIENT CODEREG=2,EIBREG=11,DATAREG=10
          USING DFHUEPAR,1
          MVC   DFHEIBP,UEPEIB           Get correct EIB address
          L     DFHEIBR,UEPEIB           Reload EIB base register
          MVC   DFHEICAP,=X'80000000'
```

Note that the entry point of a program does not have to be at the start of the program and can be positioned after the DFHEIENT macro.

- The DFHEIENT macro allocates dynamic storage to be mapped by the DFHEISTG DSECT. You must return to CICS by means of the DFHEIRET macro, which frees the dynamic storage.
- Command-level calls use registers 0, 1, 14, and 15.
- Do not issue a syncpoint in start-of-task, end-of-task, or syncpoint invocations.
- On each invocation of a task-related user exit program, a new EXEC environment is created, even when the program is being invoked from the same task. This means that CICS operations, such as browse of a resource definition table, cannot be continued from one invocation of the exit program to the next.

Work areas

When you use the EXEC CICS ENABLE command to identify a task-related user exit program to CICS, you may specify that the program must have access to one local and one global work area. The EXEC CICS ENABLE command allows you to specify the size, in bytes, of the work areas to be acquired for your task-related user exit program. CICS acquires storage for the areas and initializes pointers to them. The user exit parameter list, DFHUEPAR, gives you access to the pointers. For more information, see the description of DFHUEPAR under “User exit parameter lists” on page 253.

The global work area

A global work area is associated with an exit program. Whenever the exit program is invoked, it has access to the area through the parameter UEPGAA of DFHUEPAR. The global work area may be shared by a number of exit programs. You must have specified the size of the global work area using the GALENGTH parameter or the GAENTRYNAME parameter of the EXEC CICS ENABLE command.

The local work area

A local work area is associated with a single task and lasts only for the duration of the task. It is for the use of a single task-related user exit program. It can be thought of as a logical extension to the transaction work area (TWA, TWACOBAs)

the task-related user exit program

that is exclusively for the exit program's use. It is specified using the TALENGTH option of the EXEC CICS ENABLE command and is accessed using the UEPTAA parameter of DFHUEPAR.

Coding a program to be invoked by the CICS SPI

If you enable your task-related exit program with the SPI option of the EXEC CICS ENABLE PROGRAM command (or your program “expresses interest” in SPI calls by setting the SPI bit-mask in the schedule flag word), your program is invoked to satisfy EXEC CICS INQUIRE EXITPROGRAM commands that query whether the exit program is connected to its resource manager, and its entryname-qualifier. (For information about the INQUIRE EXITPROGRAM command, see the *CICS System Programming Reference* manual.)

When invoked for SPI calls, your exit program should:

- Indicate whether it is connected to its external resource manager, by returning the appropriate value in the first field addressed by the caller's parameter list. The equated values are:

UERTCONN

(X'80') The exit is connected to its resource manager.

UERTNCONN

(X'40') The exit is not connected to its resource manager.

- Return the resource manager qualifier—that is, the entryname-qualifier, as returned by the UEPRMQUA parameter of an API call, and used on an EXEC CICS RESYNC command—in the second field addressed by the caller's parameter list.

Typically, both the above pieces of information are kept in the exit program's global work area. The caller parameter list for SPI calls is described in “CICS SPI parameters” on page 257.

The RMI SPI call allows a task-related user exit to be called by long-running monitor tasks, even if it has been disabled and reenabled since it was last called by the task. (All other types of RMI call fail if this is the case.)

Note: When invoked for an SPI call, your exit program should not rely on the contents of the task local work area. If the exit has been disabled and reenabled, a new version may have been loaded, which may have a different mapping of the task local work area. The long-running task, however, is running with the original task local work area allocated to it on its first call.

Coding a program to be invoked by the CICS syncpoint manager

All task-related user exit programs can be invoked by the CICS syncpoint manager. An exit program must “schedule” the syncpoint manager by setting the syncpoint manager bit-mask in the schedule flag word. The bit-mask must be set after every piece of recoverable work to ensure that the CICS syncpoint manager calls the exit program during syncpoint processing. (The identification of the current unit of recovery—or unit of work—is addressed by the 8-byte field UEPURID. This is available on all invocations of your exit program in which recoverable actions are possible, for example, application calls and subsequent syncpoint manager calls.)

Increasing efficiency – single-update and read-only protocols

If your resource manager is capable of performing a single-phase commit, you can increase the efficiency of your system by means of CICS single-update and read-only protocols.

Single-update protocol: Many CICS transactions use only one external resource manager. In this case, a single-phase commit is in order. The benefits of a single-phase commit are:

- The resource manager can reduce from two to one the number of log forces required for transactions.
- The number of transaction-related log records written by CICS is reduced.
- A path length reduction is achieved, because the TRUE is invoked only once at the syncpoint, rather than twice.

To take advantage of these benefits, your task-related user exit program must indicate to CICS that the resource manager understands the single-update protocol, and that it (the TRUE) can process a syncpoint call to perform a single-phase commit. It indicates this by setting the UEPSUPDR flag in the field pointed to by UEPSYNCA in the DFHUEPAR parameter list. It must do this every time it sets the syncpoint manager bit in the schedule flag word.

If the exit program has set the UEPSUPDR flag, then, when the syncpoint manager next invokes the TRUE, it informs it whether the resource manager is the only one to have updated resources in the current UOW. It does this by means of the UERTONLY bit (in operation byte 2 of the syncpoint manager's parameter list); if this is set on, then the resource manager can be asked to perform a single-phase commit.

Read-only protocol: Similar gains in efficiency can be made if the resource manager is in read-only mode throughout the current UOW. Again, a single-phase commit is in order. To benefit, the resource manager must return to the TRUE a flag indicating whether the UOW is read-only or not. The flag may show either the "history" of the UOW so far (for example, so far it is read-only), or simply whether the current request is read-only. In turn, the TRUE must update the UEPREADO flag in the DFHUEPAR parameter list with the history of the UOW so far. That is, it must set UEPREADO initially, but unset it as soon as the UOW contains updates. (Once UEPREADO has been unset, CICS ignores any subsequent setting of the flag during the current UOW, and treats the UOW as containing updates.)

At the end of the UOW, if the UEPREADO flag is still set, the syncpoint manager invokes the TRUE with instructions to issue a single-phase commit to the resource manager (by setting the UERTELUW bit on).

Return codes

When a task-related user exit program is invoked by the CICS syncpoint manager, the return codes it is able to set depend on the reason for the invocation. Table 12 on page 272 shows the relationship between the request flags in the syncpoint manager's parameter list and the TRUE return codes. (The CICS syncpoint manager parameters are described on page 258.)

the task-related user exit program

Table 12. Valid return codes for a TRUE invoked by the CICS syncpoint manager

Request-type	Return codes	Meaning
UERTPREP	UERFPREP	Phase 1 of 2-phase commit successful
	UERFBACK	Phase 1 of 2-phase commit unsuccessful
UERTWAIT	None	Not applicable
UERTCOMM	UERFDONE	Phase 2 of 2-phase commit successful
	UERFHOLD	Phase 2 of 2-phase commit unsuccessful
UERTBACK	UERFDONE	Backout successful
	UERFHOLD	Backout unsuccessful
UERTONLY	UERFOK	Single-phase commit successful
	UERFBOUT	Single-phase commit failed and backed out
UERTELUW	None	Not applicable

What is expected of your resource manager

If every request from the syncpoint manager prompts a meaningful response from the resource manager, CICS ensures that changes to recoverable resources (such as databases) can be synchronized. That is, either all the changes take effect or all are backed out, even across system failures.

Limitations

Do not update a recoverable CICS resource during a syncpoint call because any changes will not be seen by the CICS syncpoint manager.

Sample code for a TRUE invoked by the CICS syncpoint manager

The pseudocode given in Figure 8 on page 273 is only an example. It is not complete, and includes only some of the conditions that a task-related user exit invoked at a syncpoint might be required to check.

the task-related user exit program

```
if UERTFID = UERTSYNC then      /* Caller is CICS syncpoint manager */
select;                          /* Type of syncpoint manager request */
  when (UERTONLY)                /* ONLY resource manager */
    invoke RM for single-phase commit /* Single-phase commit */
    if RM single-phase commit succeeded then
      give CICS syncpoint manager 'YES' vote (UERFOK)
    else
      /* Single-phase commit failed */
      /* If RM completed backout */
      if RM single-phase commit failed and backed out
        give CICS syncpoint manager 'NO' vote (UERFBOUT)
      else
        /* Don't know what happened */
        put out message and issue transaction abend
      endif
    endif
  when (UERTELUW)                /* RM read-only for current UOW */
    invoke RM for single-phase commit /* Single-phase commit */
  when (UERTPREP)                /* Not ONLY resource manager, nor read-only */
    invoke RM for PREPARE /* Prepare - phase 1 of 2-phase commit */
    select (resource manager vote)
      when (YES)                 /* Phase 1 completed */
        give CICS syncpoint manager 'YES' vote (UERFPREP)
      otherwise
        give CICS syncpoint manager 'NO' vote (UERFBACK)
    endselect
  when (UERTCOMM)                /* Commit - phase 2 of 2-phase commit */
    invoke RM for commit phase 2
    if RM commit succeeded then
      tell CICS sync manager OK (UERFDONE)
    else
      tell CICS sync manager remember could not commit (UERFHOLD)
    endif
  when (UERTBACK)                /* Backout request */
    invoke RM for backout
    if RM backout succeeded then
      tell CICS sync manager OK (UERFDONE)
    else
      tell CICS sync manager remember could not backout (UERFHOLD)
    endif
  when (UERTWAIT)                /* CICS in-doubt about UOW */
    invoke RM to free thread
    (but maintain locks for UOW and record UOW is in-doubt)
endselect
endif
```

Figure 8. Sample pseudocode for a task-related user exit program to be invoked by the CICS syncpoint manager

As described in “Increasing efficiency – single-update and read-only protocols” on page 271, if the UERTONLY bit is set (indicating that the resource manager is the only one to have updated resources) the exit program should cause the resource manager to perform a single-phase commit. If the commit is successful, the exit program should return ‘UERFOK’ in register 15; if not, it should return ‘UERFBOUT’, meaning that the commit was unsuccessful and the resources were backed out. If the exit program is unsure about the outcome of a single-phase commit, it must abend the task, having saved or displayed any diagnostic information that it considers necessary.

Note that “register 15” in this section refers to the syncpoint manager’s register 15, the fifth word of the area addressed by UEPHMSA.

Similarly, when the UERTELUW bit is set (indicating that the resource manager was in read-only mode throughout this UOW), the exit program should cause the resource manager to perform a single-phase commit. There are no return codes for

the task-related user exit program

a UERTELUW call. Because no updates were made, data integrity is not at risk, and therefore no action is taken if the commit fails.

On receiving a request to perform the first phase of a two-phase commit, the resource manager is expected to get into a state where recoverable changes made since the last syncpoint can be either committed or backed out on demand, even if there is an intervening system failure. For example, buffer contents must be moved to nonvolatile storage. If the resource manager is unable to get into this state, the exit program should return 'UERFBACK' in register 15, to request backout. Normally, it should return 'UERFPREP', to indicate a successful phase 1 of a 2-phase commit.

On receiving a request to wait (indicating that CICS is in-doubt about the outcome of the UOW), the resource manager should free any task-related resources, such as the thread. However, it should maintain any locks held by the UOW, and record that the UOW is in-doubt. See "Enabling for specific invocation-types" on page 280.

On receiving a request to perform the second phase of a two-phase commit, or a request to back out, the resource manager should take the corresponding irreversible step, and have the exit program send the syncpoint manager a return code: either 'UERFDONE', meaning that the commit or abend process is complete; or 'UERFHOLD', meaning that the commit or abend must be resolved later. These return code constants are available to you when you code the macro DFHUEXIT TYPE=RM in your exit program.

If a resource manager cannot understand a call, it should not change the contents of the caller's register 15 before returning to the caller, because it cannot anticipate how the caller will interpret the change.

Resynchronization

If a failure occurs between returning from the exit after performing phase 1 of a 2-phase commit and the subsequent phase 2 or back out call, the resource manager must be ready, on restart, to discover the state of the unit of recovery, and to act accordingly. For programming information about restart resynchronization using the EXEC CICS RESYNC command, see the *CICS System Programming Reference* manual.

If CICS is in-doubt about a unit of work, it sends the exit program a request to wait (UERTWAIT). When the status of the in-doubt UOW is resolved, CICS initiates a resynchronization task, to inform the exit program of the outcome of the unit of work.

Information about in-doubt units of work is retained across both warm and cold starts of CICS. CICS initialization and keypoint management routines recover from the system log all information associating resource managers with outstanding units of recovery, which are resolved automatically when CICS reconnects to the resource managers concerned.

Coding a program to be invoked by the CICS task manager

If your exit program sets the task manager bit in the schedule flag word, it is invoked at end-of-task. If you specify TASKSTART on the EXEC CICS ENABLE command for the TRUE, it is invoked at start-of-task, and (providing it does not unset the task manager bit), at end-of-task too. To determine whether a particular

the task-related user exit program

invocation is at start- or end-of-task, you can examine the CICS task manager parameters described in “CICS task manager parameters” on page 260. Typically, your program shows interest in task manager events if it needs to save task-related information, such as performance or accounting data, before the task ends.

Limitations

If your exit program is invoked at end-of-task, you must be alert to possible limitations on exit program activity at task-detach. For example:

- Do not update any CICS resources at all during a task-detach exit call, because the CICS syncpoint manager is not invoked again for that task. Note also that all resources (terminals, and so on) except task-storage have been released by end-of-task.

Note: You should also be aware that transactions with resource security or command security defined may not run successfully after the terminal has been released. See the *CICS RACF Security Guide* to determine which resources and commands are subject to security checking. Failure to observe these limitations can result in an ABENDAEY7 - NOTAUTH condition arising.

- It is possible to schedule a new CICS task from your exit program using the EXEC CICS START command and to pass data to a new task. However, you should note that EXEC CICS START uses a temporary storage queue to pass data to the new transaction. If this queue is recoverable (DFHTST TYPE=RECOVERY), it is locked to the detaching task. It is never unlocked, because, when the task-detach exit call is made, the resources of the detaching task have **already** been freed. Use of the PROTECT option would cause a different problem: the new task could not be scheduled until the next syncpoint of the detaching task, but there will be no such syncpoint.
- It is recommended that you do not access remote resources using a task-related user exit program. However, if you do so, then you must understand fully the circumstances in which the function shipping conversation may be terminated.

Coding a program to be invoked at CICS termination

If you specify the SHUTDOWN option when enabling your task-related user exit program, it is invoked at system termination. The CICS system termination manager passes the exit program the address of a one-byte code that identifies the type of termination (see “CICS termination manager parameters” on page 261). You can use this invocation of your program to do processing appropriate to the type of termination. For example, at an orderly shutdown you could use it, rather than a PLT program, to shut down the adapter; at a CICS abend you could use it to take special actions, related to the seriousness of the abend.

Limitations

Note that, due to the nature of CICS abends and operator cancels, there is no guarantee that CICS will be able to invoke your exit program at system termination, even if you have specified SHUTDOWN; it may be too impaired to do so.

the task-related user exit program

The limitations on what your program can do, if invoked, depend on the type of termination:

Orderly shutdown (UERTCORD)

Your exit program must follow the rules for programs that execute during the first quiesce stage of CICS shutdown—that is, all CICS services are available, but programs must not start any new tasks.

Immediate shutdown (UERTCIMM)

As for orderly shutdown, except that your exit program should do the minimum required and return control, so that shutdown can proceed.

CICS abend, retry possible, TCBs dispatchable (UERTCABY)

MVS has flagged the failure as being “eligible for retry”. Your exit program must follow the MVS rules for this type of failure, documented in the *OS/390 MVS Authorized Assembler Services Guide*.

Subtasks in the region (that is, task control blocks (TCBs) in addition to the CICS job-step TCB) are still dispatchable, and your exit program can execute code under them.

You must not use any CICS services.

CICS abend, retry not possible, TCBs dispatchable (UERTCABN)

MVS has flagged the failure as “not eligible for retry”. Your exit program must follow the MVS rules for this type of failure. Note that your exit program is invoked from code within the CICS extended subtask abend exit (ESTAE). MVS imposes more restrictions on ESTAE code than on non-ESTAE code.

Subtasks in the region are still dispatchable, and your exit program can execute code under them.

You must not use any CICS services.

CICS abend, retry not possible, TCBs not dispatchable (UERTOPCA)

As for UERTCABN, except that subtasks in the region are **not** dispatchable; your exit program must not try to execute code under any TCBs that it may have attached.

Important

In the abend invocations (UERTCABY through UERTOPCA), your exit program must not use any CICS services. This includes the DFHEIENT call, which performs a CICS GETMAIN. To prevent a DFHEIENT call being issued automatically on each invocation of your program, specify the NOPROLOG translator option; but include in the program source your own DFHEIENT call to be issued on non-abend invocations only. An example of how to code a task-related user exit program to be invoked at CICS termination is given in Figure 9 on page 277. For further information about coding a DFHEIENT call, see the *CICS Application Programming Reference* manual.

Sample code for a TRUE invoked at CICS termination

Note that the sample in Figure 9 on page 277 is a multipurpose program—that is, it is coded to be invoked at many task-related user exit points. However, to avoid the need to test for CICS abends in all of your multipurpose TRUES, it is recommended that you use a separate program for termination invocations.

the task-related user exit program

JTRUE1A	CSECT	TERMINATION TRUE ENTRYPOINT
	STM 14,12,12(13)	Save registers
	USING JTRUE1A,R3	
	LR R3,R15	Use R3 as base register
	USING DFHUEPAR,R1	Address DFHUEPAR parameter list
	L R2,UEPEXN	
	USING DFHUERTR,R2	
	CLI UERTFID,UERTCTER	CICS Termination call?
	BNE CONT	No, so continue
	L R10,UEPHMSA	Address Host register save area
	USING SA,R10	
	L R5,RSAR1	Get Caller's R1
	USING DFHCTERM,R5	
	L R5,CTERML	Get termination type
	USING CTERMLIST,R5	
	TM CTERMTYPE,UERTCORD	CICS orderly shutdown?
	BO CONT	Yes, so can use CICS services
	TM CTERMTYPE,UERTCIMM	CICS immediate shutdown?
	BO CONT	Yes, so can use CICS services
*	...	
*	...	
*	Insert code here for any processing when CICS is abending	
*	(No CICS services should be used)	
*	...	
*	...	
	LM 14,12,12(13)	Restore caller's registers
	BSM 0,14	Return to caller
CONT	DS 0H	Continue in new CSECT
	LM 14,12,12(13)	Restore callers's registers
	DROP R3	
	USING JTRUE1A,R15	Use R15 as temporary base register
	L R15,=V(JTRUE1B)	Get address of new CSECT
	BR R15	Branch to new CSECT
	DROP R15	
	LTORG	
JTRUE1B	CSECT	POST TEST CSECT
	DFHEIENT	
	LR R4,R1	Use R4 to address parm list
	USING DFHUEPAR,R4	Address parm list
	L R5,UEPEXN	
	USING DFHUERTR,R5	

Figure 9. Sample code for a task-related user exit program to be invoked at CICS termination (Part 1 of 2)

the task-related user exit program

```

        MVC   DFHEIBP,UEPEIB
        MVC   DFHEICAP,=X'80000000'
*
*   .....
*   Insert code here for all types of call other than when CICS
*   is abending
*   (CICS services can be used)
*   .....
EXIT    DS    0H
        DFHEIRET
*
        LTORG
*
DFHCTERM DSECT
CTERML  DS    A
*
CTERMLIST DSECT
CTERMTYPE DS  CL1
*
DFHEISTG DSECT
*
*   Local working storage for CSECT JTRUE1B
*
RSA     DS    18F                      Register save area
SA      DSECT                          Register save area DSECT
        DS    F
*
RSACB  DS    F      +004
RSACF  DS    F      +008
RSAR14 DS    F      +00C
RSAR15 DS    F      +010
RSAR0  DS    F      +014
RSAR1  DS    F      +018
RSAR2  DS    F
RSAR3  DS    F
RSAR4  DS    F
RSAR5  DS    F
RSAR6  DS    F
RSAR7  DS    F
RSAR8  DS    F
RSAR9  DS    F
RSAR10 DS    F
RSAR11 DS    F
RSAR12 DS    F
        DFHREGS
        DFHUEXIT TYPE=RM
        DFHEISTG
        DFHEIEND
        PRINT NOGEN
        PRINT GEN
        END
```

Figure 9. Sample code for a task-related user exit program to be invoked at CICS termination (Part 2 of 2)

Using EDF with your task-related user exit program

If your exit program sets the EDF bit in the schedule flag word and EDF is active, the exit program is invoked before and after each API request to format screens for EDF to display.

Communication between the task-related user exit and EDF is controlled by the task-related user exit interface. The command flow between this interface, EDF, and the task-related user exit is summarized in Figure 10 on page 279.

the task-related user exit program

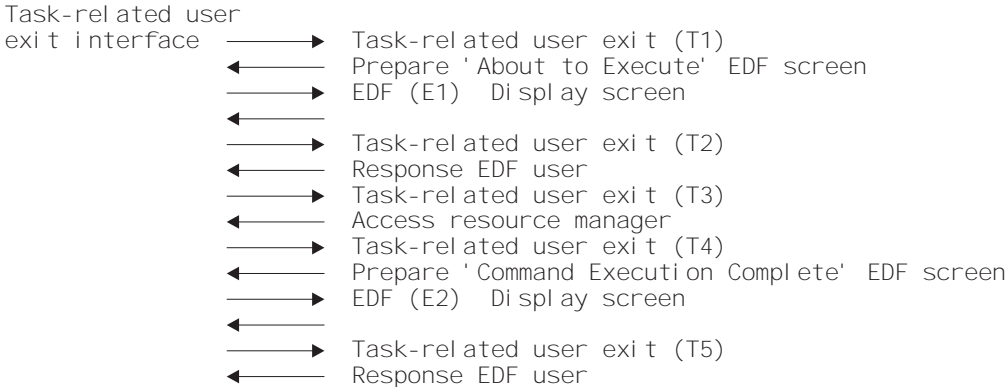

Figure 10. Interface between the task-related user exit and EDF

Table 13 describes each stage of the interface between the task-related user exit and EDF, relating the descriptions to the (Tn) and (En) expressions in Figure 10.

Table 13. Description of each stage of the task-related user exit/EDF interface

Invocation	Description
(T1)	Task-related user exit invoked to set up its EDF requirements. At this stage the task-related user exit prepares the “About to Execute” screen based on the application request.
(E1)	Using information passed back from the task-related user exit at invocation T1, the task-related user exit interface invokes EDF to display the “About to Execute” screen. EDF sets up the EDF user response, for example, if the user has changed the screen.
(T2)	Task-related user exit is invoked with the EDF user response to the “About to Execute” screen.
(T3)	Task-related user exit invoked to access external resource manager for application request.
(T4)	Task-related user exit invoked to prepare a “Command Execution Complete” screen, based on the result of the application request.
(E2)	Using information passed back from the task-related user exit at invocation T4, the task-related user exit interface invokes EDF to display the “Command Execution Complete” screen. EDF sets up the EDF user response, for example, if the user has changed the screen.
(T5)	Task-related user exit is invoked with the EDF user response to the “Command Execution Complete” screen.

the task-related user exit program

Important

The E1/T2 and E2/T5 cycles can be used repeatedly. This may occur, for example, if the EDF user changes the screen a number of times.

Adapter administration

Careful use of task-related user exits can allow your application programmers to be unaffected by the invocation of non-CICS resource managers from CICS application programs. Enabling and disabling task-related user exit programs for an installation should be the responsibility of one or more supervisory or master terminal operators. This section lists what you must do before you can use the adapter, and describes the commands used by the supervisor to administer task-related user exit programs.

For programming information about the use of commands in CICS application programs, see the *CICS Application Programming Reference* manual.

What you must do before using the adapter

1. A task-related user exit program must be defined to the system using the CEDA INSTALL PROGRAM command.
2. To enable the task-related user exit program and to define its working storage needs, you must use the EXEC CICS ENABLE command. A task-related user exit program must be both enabled and started before it is available for execution. For example:

```
EXEC CICS ENABLE PROGRAM('EP9')
      TALENGTH(750) GALENGTH(200) SHUTDOWN
EXEC CICS ENABLE PROGRAM('EP9')
      START
```

The first command loads the task-related user exit program EP9, and causes a 200-byte work area to be obtained and associated with it. The first command also schedules the allocation of a further 750-byte work area for each task that subsequently invokes EP9, and the invocation of EP9 at CICS termination. The second command starts the exit program, that is, it makes its entry point capable of being invoked.

Note: If a task-related user exit program is enabled before it has been installed, CICS scans the LPA for the program and may issue message DFHLD0107I, meaning that it was unable to find the program in the LPA and is using the DFHRPL version.

Enabling for specific invocation-types

Use the following options of the EXEC CICS ENABLE command to cause your exit program to be invoked at specific events:

INDOUBTWAIT

specifies that, at phase 2 syncpoint time, if CICS is in-doubt about the outcome of the UOW, the exit program is to be invoked with the UERTWAIT verb (wait), instead of a forced definition of UERTCOMM (commit) or UERTBACK (backout). UERTWAIT signifies that CICS does not yet know the outcome of the UOW. In response to a UERTWAIT call, the task-related

user exit should invoke its resource manager to free any task-related resources, such as the thread. However, the resource manager should maintain any locks held by the UOW, and record that the UOW is in-doubt.

When CICS receives the outcome of the UOW from its coordinator, a resynchronization task is attached to notify the task-related user exit about the outcome of the UOW.

If CICS is in-doubt about the outcome of a UOW for which an external resource manager has requested resynchronization (using the EXEC CICS RESYNC command), CICS waits until the in-doubt has been resolved before initiating a resynchronization task.

The effects of **not** enabling a task-related user exit with the INDOUBT keyword are:

- If CICS is in-doubt about a UOW, a forced decision is taken and the task-related user exit invoked with the forced decision.
- If CICS is forced to take a decision because a task-related user exit is not enabled with INDOUBTWAIT, it takes a forced decision for **all** resources updated by the UOW, even if all the other resources are capable of waiting for in-doubt resolution. This applies to local resources such as files, and also other RMCs, such as LU6.1, LU6.2, or MRO connections to other systems.
- An inbound RESYNC command from a resource manager that requests resynchronization for a UOW that CICS was in-doubt about, results in CICS invoking the task-related user exit with a forced decision.

SHUTDOWN

specifies that the exit program is to be invoked at CICS shutdown.

SPI specifies that the exit program is to be invoked to satisfy EXEC CICS INQUIRE EXITPROGRAM calls that specify the CONNECTST or QUALIFIER options. Use this option to enable user programs to discover whether the exit program is connected to its resource manager, and what its entryname qualifier is.

Note: The exit program can set this option dynamically, by setting the UEFMSPI bit-mask in the schedule flag word.

For programming information about the EXEC CICS ENABLE PROGRAM command, refer to the *CICS System Programming Reference* manual.◀

The administration routines

As well as being enabled before they can be used, task-related user exit programs should be disabled when you have finished using them. You should prepare procedures (the administration routines) for enabling and disabling your task-related user exit programs, using the EXEC CICS ENABLE and DISABLE commands, and for resynchronizing between sessions or after a system failure. Your enabling routines could be PLT initialization programs or online programs. Your disabling routines could, for example, be started by a TRUE invoked at CICS termination.

The EXTRACT EXIT command obtains the address and the length of a global work area that is owned by, or shared by, a named task-related user exit program.

For programming information about these commands and the rules governing them, and also about resynchronization, refer to the *CICS System Programming Reference* manual.

Tracing a task-related user exit program

CICS outputs a trace entry just before control is passed to the task-related user exit and just after returning from the exit. You can control these trace entries using the RI option of the CETR trace control transaction or the EXEC CICS SET TRACETYPE command.

Chapter 3. The user exit programming interface (XPI)

This chapter describes the user exit programming interface (XPI) of CICS Transaction Server for OS/390 Release 3. It is divided into the following sections:

- “**Overview**” is an introduction to the XPI.
- “**General form of an XPI call**” on page 286 contains information that applies to all the XPI calls.
- “**Global user exit XPI examples, showing the use of storage**” on page 292 contains two pieces of sample code.
- “**The XPI functions**” on page 298 describes the syntax of the individual XPI calls. The calls are grouped according to the type of function they perform (for example, dump control, storage control). The functional groups are ordered alphabetically.

Overview

The user exit programming interface provides global user exit programs with access to some CICS services. It consists of a set of macro function calls that you can use in your user exit programs. It provides opportunities to extend CICS functions beyond the facilities provided in the standard CICS system, but it must be used with care. Any exit programs you write that use the interface must be written following the guidance in this chapter, and they must be carefully tested to ensure that they cannot cause system errors.

The user exit programs must be in assembler language; the XPI is not provided for other languages. You should also note that programs containing XPI calls must be written to 31-bit standards, and must be reentrant.

You must be in primary-space translation mode when you invoke the XPI. (For information about translation modes, see the *IBM ESA/370 Principles of Operation* manual.)

- Using the XPI **dispatcher functions**, you can:
 - Obtain a suspend token for a task—see “The ADD_SUSPEND call” on page 302
 - Suspend execution of the issuing task—see “The SUSPEND call” on page 304
 - Resume execution of a suspended task—see “The RESUME call” on page 307
 - Release a suspend token associated with a task—see “The DELETE_SUSPEND call” on page 308
 - Request a wait on one or more MVS event control blocks (ECBs)—see “The WAIT_MVS call” on page 309
 - Change the priority of the issuing task—see “The CHANGE_PRIORITY call” on page 313.

user exit programming interface

- Using the XPI **dump control functions**, you can:
 - Request a system dump—see “The SYSTEM_DUMP call” on page 314
 - Request a transaction dump—see “The TRANSACTION_DUMP call” on page 316.
- Using the XPI **enqueue domain functions**, you can:
 - Enqueue on a named resource—see “The ENQUEUE function” on page 318
 - Release a resource previously enqueued by an ENQUEUE function call—see “The DEQUEUE function” on page 319.
- Using the XPI **kernel domain functions**, you can:
 - Inhibit purge for the current task—see “The START_PURGE_PROTECTION function” on page 320
 - Reenable purge for the current task—see “The STOP_PURGE_PROTECTION function” on page 320.
- Using the XPI **loader functions**, you can:
 - Define a new program to the loader domain—see “The DEFINE_PROGRAM call” on page 321
 - Load a program or, if it is already loaded, obtain its load and entry-point addresses—see “The ACQUIRE_PROGRAM call” on page 325
 - Release the storage occupied by a program, or decrement its use count by one—see “The RELEASE_PROGRAM call” on page 327
 - Delete a program definition from the list of current programs—see “The DELETE_PROGRAM call” on page 328.
- Using the XPI **log manager functions**, you can:
 - Retrieve information about the activity keypoint frequency of the system—see “The INQUIRE_PARAMETERS call” on page 329
 - Set the activity keypoint frequency of the system—see “The SET_PARAMETERS call” on page 329.
- Using the XPI **monitoring functions**, you can:
 - Process a user event-monitoring point—see “The MONITOR call” on page 330
 - Retrieve the current monitoring data for the issuing task—see “The INQUIRE_MONITORING_DATA call” on page 333.
- Using the XPI **program management functions**, you can:
 - Inquire about the attributes of a specified program—see “The INQUIRE_PROGRAM call” on page 335
 - Inquire about the attributes of the program that is currently running—see “The INQUIRE_CURRENT_PROGRAM call” on page 341
 - Set selected attributes in the definition of a specified program—see “The SET_PROGRAM call” on page 343
 - Browse through program definitions, optionally starting at the definition of a specified program—see “The START_BROWSE_PROGRAM call” on page 346, “The GET_NEXT_PROGRAM call” on page 347, and “The END_BROWSE_PROGRAM call” on page 349
 - Inquire about the settings of the autoinstall function for programs, mapsets, and partitionsets—see “The INQUIRE_AUTOINSTALL call” on page 350

user exit programming interface

- Change the settings of the autoinstall function for programs, mapsets, and partitionsets—see “The SET_AUTOINSTALL call” on page 350.
- Using the XPI **state data access functions**, you can:
 - Inquire on application system data in the AP domain—see “The INQ_APPLICATION_DATA call” on page 352
 - Inquire on CICS system data in the AP domain—see “The INQUIRE_SYSTEM call” on page 355
 - Set CICS system data values in the AP domain—see “The SET_SYSTEM call” on page 359.
- Using the XPI **storage control functions**, you can:
 - Obtain and initialize storage—see “The GETMAIN call” on page 361
 - Release storage—see “The FREEMAIN call” on page 364
 - Inquire about the access-key of an element of storage—see “The INQUIRE_ACCESS call” on page 364
 - Obtain the start address and length of an element of task-lifetime storage—see “The INQUIRE_ELEMENT_LENGTH call” on page 365
 - Discover whether CICS is short on storage—see “The INQUIRE_SHORT_ON_STORAGE call” on page 366
 - Inquire about a task’s task-lifetime storage—see “The INQUIRE_TASK_STORAGE call” on page 367
 - Cause CICS to switch from a subspace to base space—see “The SWITCH_SUBSPACE call” on page 368.
- Using the XPI **trace control function**, you can:
 - Write a trace entry to the active trace destinations—see “The TRACE_PUT call” on page 369.
- Using the XPI **transaction management functions**, you can:
 - Inquire about the environment in which a transaction is running—see “The INQUIRE_CONTEXT call” on page 370
 - Discover the name of the dynamic transaction routing transaction definition—see “The INQUIRE_DTRTRAN call” on page 371
 - Discover the current value of the MXT system initialization parameter—see “The INQUIRE_MXT call” on page 372
 - Inquire about a specified transaction class—see “The INQUIRE_TCLASS call” on page 374
 - Inquire about a specified transaction definition—see “The INQUIRE_TRANDEF call” on page 375
 - Inquire about an attached transaction—see “The INQUIRE_TRANSACTION call” on page 383
 - Change the task priority and transaction class of the current task—see “The SET_TRANSACTION call” on page 387.
- Using the XPI **user journaling function**, you can:
 - Write a record to a CICS journal—see “The WRITE_JOURNAL_DATA call” on page 388.

user exit programming interface

Note: Using the XPI feature table, you can register a CICS-supplied feature (such as ONC/RPC) to CICS. After it has been registered, you can inquire on the feature, update it, write a trace entry, and deregister it. For details of the XPI feature table, see the *CICS External Interfaces Guide*.

Important

1. You cannot use all of the XPI calls at every global user exit point. You will find an indication of when these calls **cannot** be used both with the description of each function call, and in the lists of exit points in “Chapter 1. Global user exit programs” on page 3.
XPI calls are used to invoke CICS services; using them in the wrong exits causes unpredictable errors in your CICS system.
2. There is a restriction on using the XPI early during initialization. Do not start exit programs that use the XPI functions INQUIRE_MONITOR_DATA, MONITOR, TRANSACTION_DUMP, and WRITE_JOURNAL_DATA until the second phase of the PLTPI. For further information about the PLTPI, refer to “Chapter 4. Writing initialization and shutdown programs” on page 393.
3. These XPI functions are likely to cause the task executing the user exit program to lose control to another task while the XPI function is being executed. Therefore the use of XPI functions must be very carefully considered, as interrupting the flow of CICS functions could cause problems, such as lockouts, to occur.

General form of an XPI call

If you make an XPI call, it must be in the form described below. It consists of two sets of parameters:

- Input parameters, including the XPI function call and the parameters passed to the call
- Output parameters, by which CICS can return values to you, including response and reason codes that tell you whether the call was successful.

To use an XPI macro call, you must include a copy book that defines the input and output parameters. The name of the macro is always of the form DFHxxyyX, and the associated copy book has the name DFHxxyyY. For example, the GETMAIN call is part of the storage control XPI. The macro you would use is DFHSMMCX and the associated copy book is DFHSMMCX.

The general format (omitting the assembler-language continuation character) of all XPI calls is:

```
macro-name [CALL],
           [CLEAR],
           [IN,
           FUNCTION(call_name),
           mandin1(value),
           mandin2(value),
           ...
           [optin1(value),]
           [optin2(value),]
           ...]
           [OUT,
           mandout1(value),
           mandout2(value),
           ...
           [optout1(value),]
           [optout2(value),]
           ...
           RESPONSE,
           REASON]
```

XPI calls follow assembler-language coding conventions:

- The “macro-name” must begin before column 16.
- The continuation lines must begin in column 16.
- There must be no embedded blanks apart from the blank between the macro-name and the first keyword (usually CALL).
- Entries on lines other than the final line must end with a comma.
- Lines other than the final line must have a continuation character in column 72.
- Parentheses around the input and output values are required—and if you use a register reference as an input or output value, it must be enclosed in an inner pair of parentheses, thus: ((R6)).
- For details about how to set the values of the XPI options, refer to “The XPI functions” on page 298.

There are three uses of these XPI functions. You can:

- Clear the parameter list used by the XPI call
- Set up the input parameters
- Make the call to the CICS function.

You can code all of these individually (see “An example showing how to build a parameter list incrementally” on page 297), or include them in a single statement.

Some options are common to all uses of the XPI. They are included in all of the syntax descriptions, but their explanation is given here. The options are CALL, CLEAR, IN, FUNCTION, OUT, RESPONSE, and REASON.

CALL causes code generation that issues a call to the XPI function. If you specify CALL, IN, FUNCTION, and OUT, then code is generated to perform the whole operation of building the parameter list, invoking the function, and receiving the result. You can omit the CALL, but specify IN to build your parameter list incrementally; later you can use CALL with that list, coding CALL, IN, FUNCTION, OUT, and all required options. You can then represent the values of the preset options by an asterisk (*) to show that the value is already present in the list.

form of an XPI call

Note: If you build your parameter list incrementally, do not specify CLEAR when you finally issue the call, because the CLEAR option sets the parameter list to zeros, which will cause you to lose the preset values.

CLEAR

sets the existence bits in the parameter list (both mandatory and optional parameters) to binary zeros. Each macro has a COPY code, which defines the parameter list by a DSECT consisting of a header section, followed by a set of existence bits, and the parameters themselves. For performance reasons, the header section and the existence bits only are cleared. The rest of the parameter list is left unchanged.

Important

Failure to clear the parameter list can cause unpredictable results, such as program checks or storage violations. If you are building the parameter list incrementally, specify CLEAR before specifying any parameters. If you are not building the parameter incrementally, specify CLEAR when the CALL is issued.

IN tells CICS that any parameter following the IN option and preceding the OUT option is an input value. It **must** be specified when CALL is specified. If you use the function without CALL to build a parameter list, you can specify IN and some parameter values to store values into your list.

FUNCTION

specifies which function of the macro you require; for instance, GETMAIN or FREEMAIN. It **must** be specified when CALL is specified, and unlike other options, it must always be explicit—you **cannot** code “FUNCTION(*)”.

mandin(value)

“mandin” represents an option that becomes mandatory if CALL is specified. “value” may be represented by an asterisk (*) to show that a previous use of the macro has already set the value in the parameter list (see above under “CALL”). For further details about how to complete “value”, refer to the specific function calls in “The XPI functions” on page 298.

OUT tells CICS that any parameter following the OUT option is a receiver field. It **must** be specified when CALL is specified.

Note: The use of the following output parameters with values other than an asterisk (*) is invalid if CALL is not specified.

mandout(value)

“mandout” represents an option that becomes mandatory if CALL is specified. The output is placed in the parameter list if an asterisk (*) is coded, or in the location that you have specified in “value”. RESPONSE is a special case of a mandout option (see below). For further details about how to complete “value”, refer to the specific function calls (see “The XPI functions” on page 298).

optin1,2...; optout1,2....

represent items that are completely optional for **all** forms of the macro; in particular, they do not have to be specified when CALL is specified.

RESPONSE

is a mandatory data area that you define to receive the response from your XPI call. You can use an asterisk (*) to indicate to CICS that the RESPONSE value is to be placed in the parameter list, or you can specify

the name of a field in which you want the RESPONSE value to be placed. You need not code the RESPONSE option if you are using the macro without CALL to build a parameter list.

The response from any XPI call is always one of 'OK', 'EXCEPTION', 'DISASTER', 'INVALID', 'KERNERROR', and 'PURGED'. There are standardized names (EQU symbols) for the response code values provided by CICS:

xyyy_OK, xyyy_EXCEPTION, xyyy_DISASTER, xyyy_INVALID,
xyyy_KERNERROR, and xyyy_PURGED,

where "xyyy" is a prefix derived from the four letters of the relevant macro-name following the string 'DFH'. Thus for DFHSMCMX the prefix is SMMC; for DFHLDLDX the prefix is LDLD. Equate values with these names are generated when you include the copy book DFHxyyyY for the macro DFHxyyyX. You cannot assume that the arithmetic values of corresponding RESPONSE codes are the same for all macro calls. The meanings of the RESPONSE codes are as follows:

OK The XPI request was completed successfully.

EXCEPTION

The function was not completed successfully for a reason which could be expected to happen, and which may be coded for by a program (for example, TRANSACTION_DUMP, EXCEPTION = SUPPRESSED_BY_DUMPTABLE). Any REASON value may provide more information.

DISASTER

The request has failed completely. You cannot recover from this failure within the user exit program. When this failure occurs, CICS takes a system dump, issues an error message, and sets a 'DISASTER' response. On receiving this, your user exit program should exit without attempting any further processing. The REASON value for this response, shown only in the trace, may provide more information. There is no REASON value returned to the calling program.

INVALID

You have omitted a mandatory value, or you have supplied an invalid value for an option. You cannot recover from this failure within the user exit program. When this failure occurs, CICS takes a system dump, issues an error message, and sets an 'INVALID' response. On receiving this response, your user exit program should return to the caller without attempting any further processing. The REASON value for this response, shown only in the trace, may provide more information. This may help you to correct any error in your exit program. There is no REASON value returned to the calling program.

KERNERROR

The kernel has detected an error with the CICS function you are trying to invoke. Either the function you have requested is unavailable or not valid, or there is an error within CICS.

PURGED

The task has been purged, or an interval specified on your XPI call has expired. Examine the REASON code.

form of an XPI call

Note that if an XPI call other than DFHDSSRX SUSPEND or WAIT_MVS gets this RESPONSE, your exit program should set the return code to 'UERCPURG' and return to the caller.

If a DFHDSSRX SUSPEND or WAIT_MVS call specifies an INTERVAL and gets this RESPONSE with a REASON of 'TIMED_OUT', it indicates that the INTERVAL you specified has passed. It is up to you to decide what you do next.

If a DFHDSSRX SUSPEND or WAIT_MVS call specifies an INTERVAL and gets this RESPONSE with a REASON of 'TASK_CANCELLED', this indicates that the INTERVAL you specified has not passed but that the task has been purged by an operator or an application. In this case, you must set a return code of 'UERCPURG' and return.

If a DFHDSSRX SUSPEND or WAIT_MVS call does **not** specify an INTERVAL, and gets this RESPONSE with a REASON of 'TASK_CANCELLED' or 'TIMED_OUT', it indicates that the task has been purged by an operator or an application, or by the deadlock time-out facility. In this case, you must set a return code of 'UERCPURG' and return.

You **must not** return the response code 'UERCPURG' to CICS for any other reason. If you attempt to do so, your program will have unpredictable results.

REASON

This is a mandatory data area that you define in order to receive more information about the RESPONSE value. You can use (*) to indicate to CICS that the REASON value is to be placed in the parameter list. On most XPI calls, standardized reason names (EQU symbols) are provided only for RESPONSE values of 'EXCEPTION' and 'PURGED'. The REASON values that accompany responses vary from one XPI function to another, so details are provided with the descriptions of the XPI calls.

REASON is not applicable where RESPONSE was 'OK'. In these circumstances, you should not test the REASON field.

Note: For examples of how to initialize the parameter list, set up parameters, make the call, and receive output parameters, refer to "Global user exit XPI examples, showing the use of storage" on page 292. That section includes both a complete example, and also an example in which each step is executed separately.

Setting up the XPI environment

The exit programming interface (XPI) does not require the usual CICS transaction environment, but you do need to set up a special exit programming environment before you can use any XPI calls. If you are going to use any of the XPI functions in an exit program, you must include in your program, at a point **before** you issue any XPI calls, the macro:

```
DFHUEXIT TYPE=XPIENV
```

The expansion of this macro provides the DSECTs that are used in all XPI calls. It also provides a list of register equates (R0 EQU 0, R1 EQU 1, and so on), that you can use in your exit program. The other fields generated by the macro are used by

CICS to perform the XPI call processing. You must not use any of these fields: if you do so, your user exit program will have unpredictable results.

The user exit program should be in 31-bit addressing mode.

XPI register usage

Before you can issue an XPI call from a global user exit program, you **must** move the contents of the parameter UEPSTACK (the kernel stack entry) of DFHUEPAR to the exit program's register 13.

The XPI function expansion uses registers 0, 1, 14, and 15, so the exit program must save and restore them if necessary around an XPI call.

For an example of how to use EXEC CICS commands and XPI calls in the same exit program, see "Appendix E. The example program for the XTSEREQ global user exit, DFH\$XTSE" on page 807.

The XPI copy books

There is a copy book for each XPI function, to provide the DSECTs associated with that function. These DSECTs allow you to map the parameters and the response and reason codes of an XPI call. You must include in your exit program a COPY statement for each XPI function that you are going to use. The copy book name is the same as the macro name, except that the final letter "X" becomes a letter "Y".

For example, to include the copy book for the XPI function DFHSMMCX, you must include the statement:

```
COPY DFHSMMCY
```

Trace entries for your XPI calls show these parameter lists if you have tracing on for the function you are using.

Reentrancy considerations resulting from XPI calls

During an XPI call, CICS may give control to another task while processing the XPI call. This second task could also cause the same exit program to be invoked and the same XPI call to be made, but perhaps this time with different parameter values. **It is your responsibility to ensure that lockout situations do not occur.**

While processing an XPI call, CICS may encounter another user exit point that uses the same user exit program. Therefore the XPI parameter lists must be built in storage associated with a single invocation of the exit program.

```
# If your exit program is a global user exit, CICS provides it with 320 bytes of LIFO
# storage, which is exclusive to a single invocation of your exit program. Your exit
# program can access this storage using parameter UEPXSTOR of the DFHUEPAR
# parameter list. Use this storage to base the DSECT provided by the DFHxxyyY
# copy book when building the XPI parameter list. In this way, the parameters are not
# corrupted if the exit program is reentered.
```

```
# Parameter lists for the XPI services provided here do not exceed 256 bytes. The
# remaining 64 bytes of the UEPXSTOR storage can be used by your exit program
# for its own purpose. It is expected that the 64 bytes of spare storage will, in most
# cases, avoid the need for your exit programs to obtain more storage. If you do need
```

form of an XPI call

```
# to to obtain more than the extra 64 bytes provided, obtain it by either a
# DFHSMDCX FUNCTION (GETMAIN) macro, or an MVS GETMAIN request.

# Information to be kept across invocations of an exit program can be stored in the
# global work area that you can define for an exit program (or group of exit
# programs). The 320 bytes of LIFO storage cannot be used for this purpose because
# it is dynamic.
```

Global user exit XPI examples, showing the use of storage

The example in Figure 11 on page 293 illustrates the use of the XPI and storage in a global user exit program. It is not a complete program, but merely an example of entry and exit code for any global user exit program, and the use of the XPI function.

The options of the DFHSMDCX macro used in the example are described in “Storage control functions” on page 361.

The example uses the technique of obtaining some storage for this invocation of the program using the XPI GETMAIN call, and then saving the address of this storage in the first 4 bytes of the LIFO storage addressed by UEPXSTOR. In this example, the initialization of the parameter list (using the CLEAR option), the building of the parameter list, and the GETMAIN call occur in a single macro. For details of how to build the parameter list incrementally, and how to separate the CLEAR and the GETMAIN call, refer to “An example showing how to build a parameter list incrementally” on page 297.

```

          TITLE 'GUEXPI - GLOBAL USER EXIT PROGRAM WITH XPI'
*****
* The first three instructions set up the global user exit      *
* environment, identify the user exit point, prepare for the use of *
* the exit programming interface, and copy in the definitions that *
* are to be used by the XPI function.                            *
*****
*
*           DFHUEXIT TYPE=EP,ID=XFCREQ       PROVIDE DFHUEPAR PARAMETER
*                                           LIST FOR XFCREQ IN THE FILE
*                                           CONTROL PROGRAM AND LIST
*                                           OF EXITID EQUATES
*
*           DFHUEXIT TYPE=XPIENV           SET UP ENVIRONMENT FOR
*                                           EXIT PROGRAMMING INTERFACE --
*                                           MUST BE ISSUED BEFORE ANY
*                                           XPI MACROS ARE ISSUED
*
*           COPY DFHSMMCY                  DEFINE PARAMETER LIST FOR
*                                           USE BY DFHSMMCX MACRO
*
*****
* The following DSECT maps a storage area you can use to make the *
* exit program reentrant by storing the address of the storage you *
* acquire in the first four bytes of the 260-byte area provided by *
* the user exit handler (DFHUEH) and addressed by UEPXSTOR.      *
*****
*
* TRANSTOR DSECT                                DSECT FOR STORAGE OBTAINED BY
* :                                               GETMAIN
* :
* storage declarations
* :
*

```

Figure 11. Global user exit program with XPI (Part 1 of 5)

XPI examples

```
*****
* The next seven instructions form the normal start of a global user *
* exit program, setting the program addressing mode to 31-bit, saving *
* the calling program's registers, establishing base addressing, and *
* establishing the addressing of the user exit parameter list.      *
*****
*
GXPI    CSECT
GXPI    AMODE 31                      SET TO 31-BIT ADDRESSING
*
        SAVE (14,12)                  SAVE CALLING PROGRAM'S REGISTERS
*
        LR   R11,R15                   SET UP USER EXIT PROGRAM'S
        USING GXPI,R11                 BASE REGISTER
*
        LR   R2,R1                      SET UP ADDRESSING FOR USER
        USING DFHUEPAR,R2              EXIT PARAMETER LIST -- USE
*                                     REGISTER 2 AS XPI CALLS USE
*                                     REGISTER 1
*
*****
* Before issuing an XPI function call, set up addressing to XPI *
* parameter list.                                               *
*****
*
        L    R5,UEPXSTOR                SET UP ADDRESSING FOR XPI
*                                     PARAMETER LIST
*
        USING DFHSMMC_ARG,R5           MAP PARAMETER LIST
*
*****
* Before issuing an XPI function call, you must ensure that register *
* 13 addresses the kernel stack.                                *
*****
*
        L    R13,UEPSTACK               ADDRESS KERNEL STACK
*
```

Figure 11. Global user exit program with XPI (Part 2 of 5)

```

*****
* Issue the DFHSMCX macro call, specifying:
*
* CALL --      the macro is to be called immediately
*
* CLEAR --    initialize the parameter list before inserting values.
*
* IN --       input values follow.
*
*             FUNCTION(GETMAIN) -- acquire storage
*             GET_LENGTH(120) -- 120 bytes of it
*             SUSPEND(NO) -- don't suspend if storage not available
*             INITIAL_IMAGE(X'00') -- clear acquired storage
*                               to hex zero throughout.
*             STORAGE_CLASS(USER) -- class of storage to be
*                               acquired is user storage
*                               above the 16MB line.
*
* OUT --      output values follow
*
*             ADDRESS((R6)) -- put address of acquired storage in
*                               register 6.
*             RESPONSE(*) -- put response at SMMC_RESPONSE in
*                               macro parameter list.
*             REASON(*) -- put reason at SMMC_REASON in macro
*                               parameter list.
*****
*
*             DFHSMCX CALL,
*             CLEAR,
*             IN,
*             FUNCTION(GETMAIN),
*             GET_LENGTH(120),
*             SUSPEND(NO),
*             INITIAL_IMAGE(X'00'),
*             STORAGE_CLASS(USER),
*             OUT,
*             ADDRESS((R6)),
*             RESPONSE(*),
*             REASON(*)
*

```

Figure 11. Global user exit program with XPI (Part 3 of 5)

XPI examples

```

*****
* Test SMMC_RESPONSE -- if OK, then branch round error handling.          *
*****
*
      CLI  SMMC_RESPONSE,SMMC_OK    CHECK RESPONSE AND...
      BE   STOK                    ...IF OK, BYPASS ERROR ROUTINES
*
:
:
      error-handling routines
:
:
*****
* The next section maps TRANSTOR on the acquired storage.                *
*****
STOK   DS    0H
      USING TRANSTOR,R6           MAP ACQUIRED STORAGE
      ST     R6,0(R5)            SAVE STORAGE ADDRESS IN FIRST
*                                4 BYTES OF STORAGE ADDRESSED
*                                BY UEPXSTOR
*
      LA    R5,4(R5)             ADDRESS 4-BYTE OFFSET
      DROP R5                    REUSE REGISTER 5 TO BASE ALL
      USING DFHxyy_ARG,R5       FOLLOWING XPI PARAMETER LISTS
*                                AT 4-BYTE OFFSET INTO STORAGE
*                                ADDRESSED BY UEPXSTOR
*
:
:
rest of user exit program
:
:
*
*****
* When the rest of the exit program is completed, free the storage
* and return.
*****
*
      DROP R5                    REUSE REGISTER 5 TO MAP DFHSMMC
      USING DFHSMMC_ARG,R5      XPI PARAMETER LIST
*
      L     R13,UEPSTACK        ADDRESS KERNEL STACK
*

```

Figure 11. Global user exit program with XPI (Part 4 of 5)

```

*****
* Issue the DFHSMCX macro call, specifying:
*
* CALL --      the macro is to be called immediately.
*
* CLEAR --    initialize the parameter list before inserting values.
*
* IN --       input values follow.
*
*             FUNCTION(FREEMAIN) -- release storage
*             ADDRESS((R6)) -- address of storage is in register 6.
*             STORAGE_CLASS(USER) -- class of acquired storage was
*                                 31-bit user storage.
*
* OUT --      output values follow
*
*             RESPONSE(*) -- put response at SMMC_RESPONSE in
*                           macro parameter list.
*             REASON(*) -- put reason at SMMC_REASON in macro
*                           parameter list.
*
*****
*
*             DFHSMCX CALL,
*             CLEAR,
*             IN,
*             FUNCTION(FREEMAIN),
*             ADDRESS((R6)),
*             STORAGE_CLASS(USER),
*             OUT,
*             RESPONSE(*),
*             REASON(*)
*
*****
* Test SMMC_RESPONSE -- if OK, then branch round error handling.
*****
*
*             CLI  SMMC_RESPONSE,SMMC_OK  CHECK RESPONSE AND...
*             BE   STEND                  ...IF OK, BYPASS ERROR ROUTINES
*
*
*             :
*             :
*             :
*             :
*             :
*
*****
* Restore registers, set return code, and return to user exit handler
*****
*
*             STEND  DS   0H
*                   L   R13,UEPEPSA
*                   RETURN (14,12),RC=UERCNORM
*                   LTORG
*                   END   GXPI

```

Figure 11. Global user exit program with XPI (Part 5 of 5)

An example showing how to build a parameter list incrementally

In the following example, the parameter list is built incrementally. The initialization of the parameter list (using the CLEAR option), the building of the parameter list, and the GETMAIN call are separated into discrete steps.

XPI examples

```
DFHSMCX CLEAR
:
DFHSMCX GET_LENGTH(100)
:
DFHSMCX CALL,
    IN,
    FUNCTION(GETMAIN),
    GET_LENGTH(*),
    SUSPEND(NO),
    INITIAL_IMAGE(X'00'),
    STORAGE_CLASS(USER),
    OUT,
    ADDRESS((R6)),
    RESPONSE(*),
    REASON(*)
```

Important

You must set your parameters using **only** the XPI functions.

The XPI functions

The following sections of the chapter provide details of the individual XPI function calls. The description of each function defines only the options that are specific to that call. Options that are applicable to all function calls are described in “General form of an XPI call” on page 286. The following argument types are used:

name1, name2,....

Each of these refers to the name of a field of the given size in bytes. “name1” means that the name you specify should be that of a 1-byte field.

literalconst

A number in the form of a literal, for example B'00000000', X'FF', X'FCF4', "0", or an equate symbol with a similar value.

expression

A valid assembler-language expression: a decimal integer, or any arithmetic expression (including symbolic values) valid in assembler language; for example:

```
20; L'AREA; L'AREA+10; L'AREA+X'22'; SYMB/3+20 .
```

(Rn) A register reference. The parentheses shown here are required in addition to those that surround the argument. For example: OPTION((R5)).

block-descriptor

Represents a source of both the data address and the data length fields. A block-descriptor can be either a single value or a double value. The following is the single-value form:

```
OPTION(blkname)
```

blkname

The name of a block-descriptor. A pair of contiguous fullwords, in which the first word contains the address of the data, and the second word contains the length in bytes of the data, as a fullword binary value. Register notation is not accepted for this single-value form.

The following is the double-value form:

OPTION(addr, len)

addr The data address as {namea | (Ra) | aliteral}:

namea

The name of a location containing the data address

(Ra) A register containing the data address

aliteral

An address constant literal; for example: A(data).

len The data length as {name1 | (Rn) | expression}:

name1 The name of a location containing a binary fullword giving the data length in bytes

(Rn) A register, the contents of which specify in fullword binary the number of bytes of data

expression

A decimal integer, or any arithmetic expression, including symbolic values, valid in assembler language; for example:

L'AREA ; L'AREA+10 ; L'AREA+X'22' ; SYMB/3+20 .

buffer-descriptor

Represents a source of both the data address and the maximum data length fields. Parts of the buffer-descriptor are also reserved to act as receiving fields for output information. A buffer-descriptor can be either a single value or a multiple value. The following is the single-value form:

OPTION(bufdname)

bufdname

The name of a buffer-descriptor. A group of four contiguous fullwords, in which:

- The first word contains the address of the data (input).
- The second word is reserved to receive the current length in bytes of the data, as a fullword binary value (output).
- The third word contains the maximum length in bytes of the data, as a fullword binary value (input).
- The fourth word is reserved for use by the XPI.

Register notation is not accepted for this single-value form.

The following is the multiple-value form:

OPTION(addr, maxlen, *)

addr The data address as {namea | (Ra) | aliteral}:

namea

The name of a location containing the data address

(Ra) A register containing the data address

aliteral

An address constant literal, for example, A(data).

the XPI functions

maxlen

The maximum data length as {name1 | (Rn) | expression}:

name1 The name of a location containing a binary fullword giving the maximum data length in bytes

(Rn) A register, the contents of which specify in fullword binary the maximum number of bytes of data

expression

A decimal integer, or any arithmetic expression, including symbolic values, valid in assembler language; for example:

L'AREA ; L'AREA+10 ; L'AREA+X'22' ; SYMB/3+20 .

* A required parameter to indicate that the parameter list is to be used for the reserved fields.

Dispatcher functions

There are six XPI dispatcher functions. These are the DFHDSSRX calls ADD_SUSPEND, SUSPEND, RESUME, DELETE_SUSPEND, and WAIT_MVS, and the DFHDSATX call CHANGE_PRIORITY.

Usage of these dispatcher calls is very limited. Check the details supplied for each exit in "Chapter 1. Global user exit programs" on page 3 before using any functions.

Notes:

1. You must issue an ADD_SUSPEND call to create a suspend token **before** you issue a SUSPEND or RESUME call.
2. If a suspended task is canceled, the SUSPEND fails with a RESPONSE value of 'PURGED' and a REASON value of 'TASK_CANCELLED'. A corresponding RESUME call returns with a RESPONSE value of 'EXCEPTION' and a REASON value of 'TASK_CANCELLED'.
3. If a suspended task is timed out, the SUSPEND fails with a RESPONSE value of 'PURGED' and a REASON value of 'TIMED_OUT'. A corresponding RESUME call returns with a RESPONSE value of 'EXCEPTION' and a REASON value of 'TIMED_OUT'.
4. Dispatcher protocols require that you issue a RESUME even if the SUSPEND was purged (due to task cancel or time-out). You must issue one and only one RESUME for each SUSPEND call.

Synchronization protocols for SUSPEND and RESUME processing

This section describes the protocols that must be observed by users of XPI SUSPEND and RESUME processing, so that task purging can be handled effectively.

The normal synchronization protocol

In the normal case, synchronization involves two tasks and three operations. In the following sample operations, the tasks are A (the task that requests a service) and B (the task that processes a request from task A).

1. Task A starts the request by:
 - Setting the parameters to be used by task B
 - Resuming task B

- Issuing the SUSPEND call.
2. Task B performs the action by:
 - Getting the parameters
 - Performing the action
 - Setting the results
 - Terminating (or waiting for new work).
 3. Task A ends the interaction by:
 - Getting the results left by task B.

This sequence looks like:

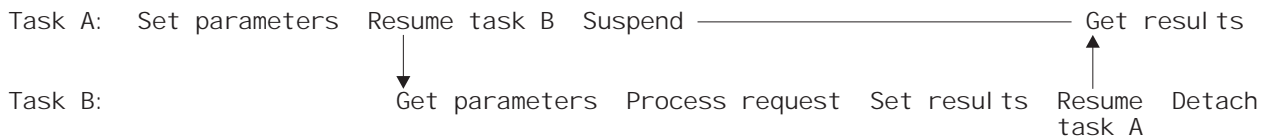

Ignoring the Resume and Suspend, the execution amounts to:

Set parameters; Get parameters; Process request; Set results; Get results

where these actions are always **sequential**.

The synchronization protocol and task purge

If one of the tasks is to be purged, it is task A, because task A is the one suspended. In this case, execution of task A after the failed SUSPEND would be in parallel with task B; the proper serialization would be lost. If the program were left unchanged, Process request and Set results would be taking place at the same time as Get results, with unpredictable results.

One way of preventing this problem is to ensure that **task A, if it is to be purged, does not do anything that could interfere with task B.** (This may well mean that A must not detach, if doing so releases storage that B needs to access.) Because the only task that is now involved is task B, B is left with the responsibility of cleaning up for both tasks.

The sequence is:

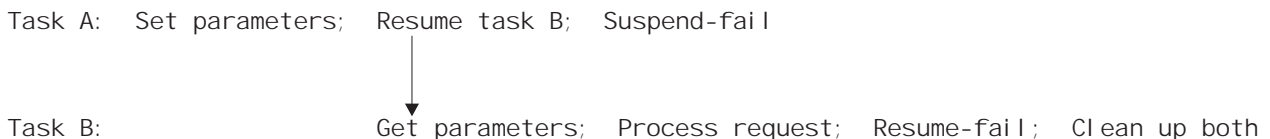

Because task-purging is effective only if performed between SUSPEND and RESUME, Suspend-fail precedes Resume-fail. This means that, with the same constraints on serialization as in the normal synchronization protocol, the task-purge protocol can be logically reduced to:

dispatcher functions

Set parameters; Get parameters; Process request; Clean up

The difference is that Set results and Get results are replaced by Clean up. It is vital that only these two sequences can happen; this means that both programs must be coded correctly. CICS ensures that both tasks are told either that SUSPEND and RESUME processing worked, or that it failed.

The following shows the programming steps that conform to these rules:

Program for Task A	Program for Task B
SET PARAMETERS;	
	GET PARAMETERS;
RESUME B;	PROCESS REQUEST;
SUSPEND A;	RESUME A;
if	if
RESPONSE = OK	RESPONSE /= OK
then	then
GET RESULTS;	CLEAN UP
endif	endif

If both the SUSPEND and RESUME return 'OK', the example follows the rules for the normal synchronization; processing finishes at Get results. If neither SUSPEND nor RESUME returns 'OK', the example follows the rules for the task-purge protocol, and processing finishes at Clean up.

For further information about SUSPEND and RESUME processing, see the *CICS Problem Determination Guide*.

Alternative approach to task purge

The sequence described above is one method for dealing with the problem of task purge. Using this method, task B does not know, when it is processing the request, whether or not task A has been purged; this means that B must take great care in its use of resources owned by A (in case A has been purged). In some situations, this restriction may cause difficulties.

A different approach is as follows; if task A is to be purged:

1. A communicates to B that it is no longer available, thus informing B not to use any resources owned by A.
2. A performs its own clean-up processing (including issuing the RESUME call for the purged SUSPEND, as required by the dispatcher protocols), and abends.
3. B performs its own clean-up processing.

The ADD_SUSPEND call

ADD_SUSPEND acquires a suspend token that can later be used to identify a SUSPEND/RESUME pair.

ADD_SUSPEND

```
DFHDSSRX [CALL,]
          [CLEAR,]
          [IN,
           FUNCTION(ADD_SUSPEND),
           [RESOURCE_NAME(name16 | string | 'string'),]
           [RESOURCE_TYPE(name8 | string | 'string'),]]
          [OUT,
           SUSPEND_TOKEN(name4 | (Rn)),
           RESPONSE(name1 | *),
           REASON(name1 | *)]
```

RESOURCE_NAME(name16 | string | "string")

specifies a 16-character string that can be used to document and trace the resource involved in suspend and resume processing. You cannot use register notation to specify the address of the string.

name16

The name of the location where a 16-byte value is stored.

string A string of characters without intervening blanks; if it is not 16 bytes long, it is extended with blanks or truncated as required.

"string"

A string of characters enclosed in quotation marks. Blanks are permitted in the enclosed string. If you want to document a name (label) in your program, use this form.

Note: RESOURCE_NAME on ADD_SUSPEND supplies a default value which is used if RESOURCE_NAME is not specified on a SUSPEND call.

RESOURCE_TYPE(name8 | string | "string")

specifies an 8-character string that can be used to document and trace the resource involved in suspend and resume processing. You cannot use register notation to specify the address of the string.

name8

The name of the location where an 8-byte value is stored.

string A string of characters without intervening blanks; if it is not 8 bytes long, it is extended with blanks or truncated as required.

"string"

A string of characters enclosed in quotation marks. Blanks are permitted in the enclosed string. If you want to document a name (label) in your program, use this form.

Note: RESOURCE_TYPE on ADD_SUSPEND supplies a default value which is used if RESOURCE_TYPE is not specified on a SUSPEND call.

SUSPEND_TOKEN(name4 | (Rn))

returns a token assigned by the system to identify the SUSPEND/RESUME pair of operations used on the task.

name4

The name of a 4-byte field where the token is stored

(Rn) A register into which the token value is loaded.

dispatcher functions

RESPONSE and REASON values for ADD_SUSPEND:

<i>RESPONSE</i>	<i>REASON</i>
OK	None
EXCEPTION	None
DISASTER	None
INVALID	None
KERNERROR	None
PURGED	None

Note: For more detail, refer to the explanation of RESPONSE and REASON in “General form of an XPI call” on page 286.

The SUSPEND call

SUSPEND suspends execution of a running task. The task can be resumed in one of two ways. You can issue the XPI RESUME call, or the task is resumed automatically if the INTERVAL value that you specify on the DFHDSSRX macro expires. Suspended tasks can also be purged by the operator, or by an application, or by the deadlock time-out facility.

SUSPEND

```
DFHDSSRX [CALL,]
  [CLEAR,]
  [IN,]
  FUNCTION(SUSPEND),
  PURGEABLE(YES|NO),
  SUSPEND_TOKEN(name4 | (Rn)),
  [INTERVAL(name4 | (Rn)),]
  [RESOURCE_NAME(name16 | string | 'string'),]
  [RESOURCE_TYPE(name8 | string | 'string'),]
  [TIME_UNIT(SECOND|MILLI_SECOND),]
  [WLM_WAIT_TYPE,]
  [OUT,]
  [COMPLETION_CODE(name1 | (Rn)),]
  RESPONSE(name1 | *),
  REASON(name1 | *)]
```

COMPLETION_CODE (name1 | (Rn))

returns a user-defined “reason for action” code during suspend and resume processing.

name1

The name of a 1-byte area to receive the code. The value in this field is user-defined, and is ignored by CICS.

(Rn) A register in which the low-order byte contains the completion code and the other bytes are zero.

INTERVAL(name4 | (Rn))

specifies in seconds or milliseconds the time after which the task is automatically resumed and given a RESPONSE value of ‘PURGED’ and a REASON value of ‘TIMED_OUT’. The time unit used on the INTERVAL option depends on the setting of the TIME_UNIT option. The INTERVAL value overrides any time-out (DTIMOUT) value specified for the transaction.

name4

The name of a 4-byte area, which is interpreted as a binary fullword.

(Rn) A register containing the interval value, a binary fullword.

PURGEABLE(YES|NO)

specifies whether your code can cope with the request being abnormally terminated as a result of a purge. There are four types of purge, as shown in Table 14. Specifying PURGEABLE(NO) tells the dispatcher:

- To reject any attempt to PURGE the task.
- To suppress the deadlock time-out (DTIMOUT) facility (if applicable to this task) for the duration of this request.

Table 14. SUSPEND call - RESPONSE(PURGED)

REASON	TASK_CANCELLED		TIMED_OUT	
CONDITION	PURGE	FORCEPURGE	DTIMOUT	INTERVAL
PURGEABLE (NO)	Canceled	Proceeds normally	Canceled	Proceeds normally
PURGEABLE (YES)	Proceeds normally	Proceeds normally	Proceeds normally	Proceeds normally

Note: A FORCEPURGE always assumes that the user wants the task to be purged, and so overrides the PURGEABLE(NO) option. If the user has set an INTERVAL, then this, too, overrides the PURGEABLE(NO) option.

RESOURCE_NAME(name16 | string | "string")

specifies a 16-character string that can be used to document and trace the resource involved in suspend and resume processing. You cannot use register notation to specify the address of the string.

name16

The name of the location where a 16-byte value is stored.

string A string of characters without intervening blanks; if it is not 16 bytes long, it is extended with blanks or truncated as required.

"string"

A string of characters enclosed in quotation marks. Blanks are permitted in the enclosed string. If you want to document a name (label) in your program, use this form.

Notes:

1. CICS does not use the RESOURCE_NAME information but includes it in trace entries, and displays it on appropriate CEMT screens to help you to see what your task is doing. CICS internal requests specify values, and you should use different values to avoid ambiguity. CICS internal request values are documented in the *CICS Problem Determination Guide*.
2. If RESOURCE_NAME is not specified, the default value, if any, from ADD_SUSPEND is used.

RESOURCE_TYPE(name8 | string | "string")

specifies an 8-character string that can be used to document and trace the resource involved in suspend and resume processing. You cannot use register notation to specify the address of the string.

name8

The name of the location where an 8-byte value is stored.

string A string of characters without intervening blanks; if it is not 8 bytes long, it is extended with blanks or truncated as required.

dispatcher functions

"string"

A string of characters enclosed in quotation marks. Blanks are permitted in the enclosed string. If you want to document a name (label) in your program, use this form.

Notes:

1. CICS does not use the RESOURCE_TYPE information but includes it in trace entries, and displays it on appropriate CEMT screens to help you to see what your task is doing. CICS internal requests specify values, and you should use different values to avoid ambiguity. CICS internal request values are documented in the *CICS Problem Determination Guide*.
2. If RESOURCE_TYPE is not specified, the default value, if any, from ADD_SUSPEND is used.

SUSPEND_TOKEN(name4 | (Rn))

specifies a token assigned by the system to identify the SUSPEND/RESUME pair of operations used on the task.

name4

The name of a location where you have a 4-byte token previously obtained as output from an ADD_SUSPEND call

(Rn) A register containing the token value.

TIME_UNIT(SECOND | MILLI_SECOND)

specifies the time unit used on the INTERVAL option.

SECOND

The INTERVAL option specifies the number of seconds before timeout.

MILLI_SECOND

The INTERVAL option specifies the number of milliseconds before timeout.

WLM_WAIT_TYPE(name1)

specifies, in a 1-byte location, the reason for suspending the task. This indicates the nature of the task's wait state to the MVS workload manager.

The equated values for the type of wait are as follows:

CMDRESP

Waiting on a command response.

CONV

Waiting on a conversation.

DISTRIB

Waiting on a distributed request.

IDLE

A CICS task, acting as a work manager, that has no work request that is allowed to service within the monitoring environment. For example, journaling code that suspends itself when there are no journaling I/O operations to perform.

IO Waiting on an I/O operation or indeterminate I/O-related operation (locks, buffer, string, and so on).

LOCK

Waiting on a lock.

MISC

Waiting on an unidentified resource.

dispatcher functions

Note: This is the default reason given to the wait if you suspend a task and do not specify the WLM_WAIT_TYPE parameter.

OTHER_PRODUCT

Waiting on another product to complete its function; for example, when the workload has been passed to DB2.

SESS_LOCALMVS

Waiting on the establishment of a session in the MVS image on which this CICS region is running.

SESS_NETWORK

Waiting on the establishment of a session elsewhere in the network (that is, not on this MVS image).

SESS_SYSPLEX

Waiting on establishment of a session somewhere in the sysplex (that is, not on this MVS image).

TIMER

Waiting on the timeout of a timer (for example, a task that puts itself to sleep).

If you are running CICS in an MVS goal-mode workload management environment (that is, you are using goal-oriented performance management), you are recommended to specify the reason for suspending the task on the WLM_WAIT_TYPE parameter.

RESPONSE and REASON values for SUSPEND:

<i>RESPONSE</i>	<i>REASON</i>
OK	None
EXCEPTION	None
DISASTER	None
INVALID	None
KERNERROR	None
PURGED	TASK_CANCELLED
	TIMED_OUT

Notes:

1. For more detail, refer to the explanation of RESPONSE and REASON in "General form of an XPI call" on page 286.
2. 'TASK_CANCELLED' means that the task has been canceled by operator action or by an application command.
3. After a 'PURGED' response, the suspend token must not be reused in another SUSPEND until it has been reset by a RESUME corresponding to the purged SUSPEND.
4. 'TIMED_OUT' means that the task has been automatically resumed because the specified INTERVAL (or the time-out value specified at task attach) has expired. The token, however, remains suspended and must be the object of a RESUME before it can be the object of a DELETE_SUSPEND.

The RESUME call

RESUME restarts execution of a task that is suspended or timed out. There must be only one RESUME request for each SUSPEND. However, because this is an asynchronous interface, a SUSPEND can be received either before or after its

dispatcher functions

corresponding RESUME. You must ensure that you keep account of the SUSPEND and RESUME requests issued from your exit program.

RESUME

```
DFHDSSRX [CALL,]
          [CLEAR,]
          [IN,
          FUNCTION(RESUME),
          SUSPEND_TOKEN(name4 | (Rn)),
          [COMPLETION_CODE(name1 | (Rn)),]]
          [OUT,
          RESPONSE(name1 | *),
          REASON(name1 | *)]
```

COMPLETION_CODE(name1 | (Rn))

specifies a user-defined “reason for RESUME” code during suspend and resume processing.

name1

The name of a 1-byte area to receive the code

(Rn) A register, in which the low-order byte contains the completion code and the other bytes are zero.

SUSPEND_TOKEN(name4 | (Rn))

specifies a token assigned by the system to identify the SUSPEND/RESUME pair of operations used on the task.

name4

The name of a location where you have a 4-byte token previously obtained as output from an ADD_SUSPEND call

(Rn) A register containing the token value.

RESPONSE and REASON values for RESUME:

<i>RESPONSE</i>	<i>REASON</i>
OK	None
EXCEPTION	TASK_CANCELLED
	TIMED_OUT
DISASTER	None
INVALID	None
KERNERROR	None
PURGED	None

Notes:

1. For more detail, refer to the explanation of RESPONSE and REASON in “General form of an XPI call” on page 286.
2. ‘TASK_CANCELLED’ means that the task was canceled by operator action while it was suspended, and that the suspend token is available for use.

The DELETE_SUSPEND call

DELETE_SUSPEND releases a suspend token associated with this task.

DELETE_SUSPEND

```
DFHSSRX [CALL,]
        [CLEAR,]
        [IN,
        FUNCTION(DELETE_SUSPEND),
        SUSPEND_TOKEN(name4 | (Rn)),]
        [OUT,
        RESPONSE(name1 | *),
        REASON(name1 | *)]
```

SUSPEND_TOKEN(name4 | (Rn))

specifies a token assigned by the system to identify the SUSPEND/RESUME pair of operations used on the task.

name4

The name of a 4-byte field, where the token obtained by an ADD_SUSPEND call has been stored

(Rn) A register containing the token value previously obtained.

RESPONSE and REASON values for DELETE_SUSPEND:

<i>RESPONSE</i>	<i>REASON</i>
OK	None
EXCEPTION	None
DISASTER	None
INVALID	None
KERNERROR	None
PURGED	None

Note: For more detail, refer to the explanation of RESPONSE and REASON in “General form of an XPI call” on page 286.

The WAIT_MVS call

WAIT_MVS requests a wait on an MVS event control block (ECB) or on a list of MVS ECBs. For example, you could issue the WAIT_MVS to wait for completion of an MVS task for which you have issued ATTACH and provided a task-completion ECB.

The dispatcher does not clear the ECBs when a WAIT_MVS request is received. If any ECB is already posted, control is returned immediately to the exit program with a response of 'OK'.

A single ECB must not be the subject of more than one wait at a time. If any ECB is already being waited on when a WAIT_MVS request is received, the request is rejected. The RESPONSE code is 'DSSR_INVALID', and the REASON code 'DSSR_ALREADY_WAITING'.

Note: ECBs used in WAIT_MVS requests must never be “hand posted”. They must be posted using the MVS POST macro.

dispatcher functions

WAIT_MVS

```
DFHDSSRX [CALL,]
  [CLEAR,]
  [IN,
  FUNCTION(WAIT_MVS),
  {ECB_ADDRESS(name4 | (Ra)) | ECB_LIST_ADDRESS(name4 | (Ra)),}
  PURGEABLE(YES|NO),
  [INTERVAL(name4 | (Rn)),]
  [RESOURCE_NAME(name16 | string | 'string'),]
  [RESOURCE_TYPE(name8 | string | 'string'),]
  [TIME_UNIT(SECOND|MILLI_SECOND),]
  [WLM_WAIT_TYPE,]
  [OUT,
  RESPONSE(name1 | *),
  REASON(name1 | *)]
```

ECB_ADDRESS(name4 | (Ra))

specifies the address of the ECB to be waited on.

name4

The name of a location that contains an ECB address.

(Ra) A register that contains the address of an ECB.

ECB_LIST_ADDRESS(name4 | (Ra))

specifies the address of a list of ECB addresses to be waited on.

name4

The name of a location that contains an ECB address, possibly followed by more ECB addresses. The last address word in the list has the high-order bit set to 1.

(Ra) A register pointing to an address list as described above.

INTERVAL(name4 | (Rn))

specifies in seconds or milliseconds the time after which the task is automatically resumed and given a RESPONSE value of 'PURGED' and a REASON value of 'TIMED_OUT'. The time unit used on the INTERVAL option depends on the setting of the TIME_UNIT option.

The INTERVAL value overrides any time-out (DTIMOUT) value specified for the transaction.

name4

The name of a 4-byte area, which is interpreted as a binary fullword

(Rn) A register containing the interval value, a binary fullword.

PURGEABLE(YES|NO)

specifies whether your code can cope with the request being abnormally terminated as a result of a purge. There are four types of purge, as shown in Table 15 on page 311. Specifying PURGEABLE(NO) tells the dispatcher:

- To reject any attempt to PURGE the task
- To suppress the deadlock time-out (DTIMOUT) facility (if applicable to this task) for the duration of this request.

Table 15. WAIT_MVS call - RESPONSE(PURGED)

REASON	TASK_CANCELLED		TIMED_OUT	
CONDITION	PURGE	FORCEPURGE	DTIMOUT	INTERVAL
PURGEABLE (NO)	Canceled	Proceeds normally	Canceled	Proceeds normally
PURGEABLE (YES)	Proceeds normally	Proceeds normally	Proceeds normally	Proceeds normally

Note: A FORCEPURGE always assumes that the user wants the task to be purged, and so overrides the PURGEABLE(NO) option. If the user has set an INTERVAL, then this, too, overrides the PURGEABLE(NO) option.

RESOURCE_NAME(name16 | string | "string")

specifies a 16-character string that can be used to document and trace the resource involved in suspend and resume processing. You cannot use register notation to specify the address of the string.

name16

The name of the location where a 16-byte value is stored.

string A string of characters without intervening blanks; if it is not 16 bytes long, it is extended with blanks or truncated as required.

"string"

A string of characters enclosed in quotation marks. Blanks are permitted in the enclosed string. If you want to document a name (label) in your program, use this form.

Note: CICS does not use the RESOURCE_NAME information but includes it in trace entries, and displays it on appropriate CEMT screens to help you to see what your task is doing. CICS internal requests specify values, and you should use different values to avoid ambiguity. CICS internal request values are documented in the *CICS Problem Determination Guide*.

RESOURCE_TYPE(name8 | string | "string")

specifies an 8-character string that can be used to document and trace the resource involved in suspend and resume processing. You cannot use register notation to specify the address of the string.

name The name of the location where an 8-byte value is stored.

string A string of characters without intervening blanks; if it is not 8 bytes long, it will be extended with blanks or truncated as required.

"string"

A string of characters enclosed in quotation marks. Blanks are permitted in the enclosed string. If you want to document a name (label) in your program, use this form.

Note: CICS does not use the RESOURCE_TYPE information but includes it in trace entries, and displays it on appropriate CEMT screens to help you to see what your task is doing. CICS internal requests specify values, and you should use different values to avoid ambiguity. CICS internal request values are documented in the *CICS Problem Determination Guide*.

TIME_UNIT(SECOND | MILLI_SECOND)

specifies the time unit used on the INTERVAL option.

SECOND

The INTERVAL option specifies the number of seconds before timeout.

dispatcher functions

MILLI_SECOND

The INTERVAL option specifies the number of milliseconds before timeout.

WLM_WAIT_TYPE(name1)

specifies, in a 1-byte location, the reason for suspending the task. This indicates the nature of the task's wait state to the MVS workload manager.

The equated values for the type of wait are as follows:

CMDRESP

Waiting on a command response.

CONV

Waiting on a conversation.

DISTRIB

Waiting on a distributed request.

IDLE

A CICS task, acting as a work manager, that has no work request that is allowed to service within the monitoring environment. For example, journaling code that suspends itself when there are no journaling I/O operations to perform.

IO Waiting on an I/O operation or indeterminate I/O-related operation (locks, buffer, string, and so on).

LOCK

Waiting on a lock.

MISC

Waiting on an unidentified resource.

Note: This is the default reason given to the wait if you suspend a task and do not specify the WLM_WAIT_TYPE parameter.

OTHER_PRODUCT

Waiting on another product to complete its function; for example, when the workload has been passed to DB2.

SESS_LOCALMVS

Waiting on the establishment of a session in the MVS image on which this CICS region is running.

SESS_NETWORK

Waiting on the establishment of a session elsewhere in the network (that is, not on this MVS image).

SESS_SYSPLEX

Waiting on establishment of a session somewhere in the sysplex (that is, not on this MVS image).

TIMER

Waiting on the timeout of a timer (for example, a task that puts itself to sleep).

If you are running CICS in an MVS goal-mode workload management environment (that is, you are using goal-oriented performance management), you are recommended to specify the reason for suspending the task on the WLM_WAIT_TYPE parameter.

RESPONSE and REASON values for WAIT_MVS:

<i>RESPONSE</i>	<i>REASON</i>
OK	None
EXCEPTION	None
DISASTER	None
INVALID	None
KERNERROR	None
PURGED	TASK_CANCELLED
	TIMED_OUT

Notes:

1. For more detail, refer to the explanation of RESPONSE and REASON in “General form of an XPI call” on page 286.
2. ‘TIMED_OUT’ is returned if the INTERVAL expires, or if a deadlock time-out interval expires.
3. ‘TASK_CANCELLED’ means that the task has been canceled by operator action or by an application command.

The CHANGE_PRIORITY call

CHANGE_PRIORITY allows the issuing task to change its own priority. It cannot be used to change the priority of another task. This command causes the issuing task to release control, and so provide other tasks with the opportunity to run.

CHANGE_PRIORITY

```
DFHDSATX [CALL,]
          [CLEAR,]
          [IN,
          FUNCTION(CHANGE_PRIORITY),
          PRIORITY(name1 | (Rn) | decimalint | literalconst),]
          [OUT,
          [OLD_PRIORITY(name1 | (Rn)),]
          RESPONSE(name1 | *),
          REASON(name1 | *)]
```

OLD_PRIORITY(name1 | (Rn))

returns the previous priority of the issuing task.

name1

The name of a 1-byte field where the task’s previous priority is stored

(Rn) A register in which the low-order byte receives the previous priority value and the other bytes are set to zero.

PRIORITY(name1 | (Rn) | decimalint | literalconst)

specifies the new priority to be assigned to the issuing task.

name1

The name of a 1-byte field, with a value in the range 0 through 255.

(Rn) A register with the low-order byte containing the new priority value.

decimalint

A decimal integer not exceeding 255 in value. Neither an expression nor hexadecimal notation is allowed.

dispatcher functions

literalconst

A number in the form of a literal, for example B'00000000', X'FF', X'FCF4', "0" or an equate symbol with a similar value.

RESPONSE and REASON values for CHANGE_PRIORITY:

RESPONSE	REASON
OK	None
DISASTER	None
INVALID	None
KERNERROR	None

Note: For more detail, refer to the explanation of RESPONSE and REASON in "General form of an XPI call" on page 286.

Dump control functions

There are two XPI dump control functions. These are the DFHDUDUX macro calls SYSTEM_DUMP and TRANSACTION_DUMP.

DFHDUDUX calls cannot be used in any exit program invoked from any global user exit point in the:

- Statistics domain
- Monitor domain
- Dump domain
- Dispatcher domain
- Transient data program.

The SYSTEM_DUMP call

SYSTEM_DUMP causes a system dump to be taken. If the system dump code that you supply on input is in the system dump code table, the dump may be suppressed. For information about the dump table and how it works, refer to the *CICS Problem Determination Guide* and the *CICS System Programming Reference* manual.

SYSTEM_DUMP

```
DFHDUDUX [CALL,]  
  [CLEAR,]  
  [IN,  
  FUNCTION(SYSTEM_DUMP),  
  SYSTEM_DUMPCODE(name8 | string | "string"),  
  [CALLER(block-descriptor),]  
  [TITLE(block-descriptor),]]  
  [OUT,  
  DUMPID(name9 | *),  
  RESPONSE(name1 | *),  
  REASON(name1 | *)]
```

CALLER(block-descriptor)

specifies the source of a system dump request. The information that you supply here appears in the dump header, so you could use it to identify the exit program that initiated the system dump request. For a description of valid block-descriptors, see page 298.

DUMPID(name9 | *)

returns the dump identifier.

name9

The name of a 9-byte field to receive the assigned ID.

SYSTEM_DUMPCODE(name8 | string | "string")

specifies the code corresponding to the error that caused this system dump call. System dump codes are held in the dump table; for information about the dump table and how it works, refer to the *CICS Problem Determination Guide* and the *CICS System Programming Reference* manual.

name8

The name of a location containing an 8-byte string.

string A string of characters without intervening blanks. The macro generates, from the string, a literal constant of length 8 bytes, extending with blanks or truncating as required.

"string"

A string, enclosed in quotation marks and possibly containing blanks. This value is processed in the same way as the "string" above.

TITLE(block-descriptor)

specifies an area containing the text you want to appear in the dump header when the system dump is printed.

RESPONSE and REASON values for SYSTEM_DUMP:

<i>RESPONSE</i>	<i>REASON</i>
OK	None
EXCEPTION	FESTAE_FAILED
	INSUFFICIENT_STORAGE
	IWMWQWRK_FAILED
	NO_DATASET
	PARTIAL_SYSTEM_DUMP
	SDUMP_BUSY
	SDUMP_FAILED
	SDUMP_NOT_AUTHORIZED
	SUPPRESSED_BY_DUMPOPTION
	SUPPRESSED_BY_DUMPTABLE
	SUPPRESSED_BY_USEREXIT
DISASTER	None
INVALID	INVALID_DUMPCODE
	INVALID_PROBDESC
	INVALID_SVC_CALL
KERNERROR	None
PURGED	None

Note: For more detail, refer to the explanation of RESPONSE and REASON in "General form of an XPI call" on page 286.

dump control functions

The TRANSACTION_DUMP call

TRANSACTION_DUMP causes a transaction dump to be taken. If the transaction dump code that you supply on input is in the transaction dump code table, the dump may be suppressed and, optionally, a system dump may be taken. For information about the dump table and how it works, refer to the *CICS Problem Determination Guide* and the *CICS System Programming Reference* manual.

Important

There is a restriction in using the XPI early during initialization. Do not start exit programs that use the XPI functions TRANSACTION_DUMP, WRITE_JOURNAL_DATA, MONITOR, and INQUIRE_MONITOR_DATA until the second phase of the PLTPI. For further information about the PLTPI, refer to “Chapter 4. Writing initialization and shutdown programs” on page 393.

TRANSACTION_DUMP

```
DFHDUDUX [CALL,]
  [CLEAR,]
  [IN,]
  FUNCTION(TRANSACTION_DUMP),
  TRANSACTION_DUMPCODE(name4 | string | 'string')
  [CSA(NO|YES),]
  [PROGRAM(NO|YES),]
  [SEGMENT(block-descriptor),]
  [SEGMENT_LIST(block-descriptor),]
  [TCA(NO|YES),]
  [TERMINAL(NO|YES),]
  [TRANSACTION(NO|YES),]
  [TRT(NO|YES),]
  [OUT,]
  DUMPID(name9 | *),
  RESPONSE(name1 | *),
  REASON(name1 | *)]
```

CSA(NO|YES)

specifies whether the common system area (CSA) is to be included in the transaction dump. The default is NO.

DUMPID(name9 | *)

returns the dump identifier.

name9

The name of a 9-byte field to receive the assigned ID.

PROGRAM(NO|YES)

specifies whether all program storage areas associated with this task are to be included in the transaction dump. The default is NO.

SEGMENT(block-descriptor)

specifies the address and the length of a single block of storage that is to be dumped. See page 298 for a description of valid block-descriptors. SEGMENT and SEGMENT_LIST are mutually exclusive.

SEGMENT_LIST(block-descriptor)

specifies the address and length of a set of contiguous word pairs. The first word in each pair specifies the **length** in bytes of a storage segment to be dumped; the second word contains the **address** of the storage segment. The end of the list must be marked by a word containing X'FFFFFFFF'. SEGMENT

and SEGMENT_LIST are mutually exclusive.

TCA(NO|YES)

specifies whether the task control area (TCA) is to be included in the transaction dump. The default is NO.

TERMINAL(NO|YES)

specifies whether all terminal storage areas associated with the task are to be included in the transaction dump. The default is NO.

TRANSACTION(NO|YES)

specifies whether all transaction storage areas associated with the task are to be included in the transaction dump. The default is NO.

TRANSACTION_DUMP CODE(name4 | string | "string")

specifies the code corresponding to the error that caused this transaction dump call. Transaction dump codes are held in the dump table; for information about the dump table and how it works, refer to the *CICS Problem Determination Guide* and the *CICS System Programming Reference* manual.

name4

The name of a location containing a 4-byte string.

string

A string of characters without intervening blanks. The macro generates a literal constant of length 4 bytes from the string, extending with blanks or truncating as required.

"string"

A string, enclosed in quotation marks and possibly containing blanks. This value is processed in the same way as the "string" above.

TRT(NO|YES)

specifies whether the trace table (TRT) is to be included in the transaction dump. The default is NO.

RESPONSE and REASON values for TRANSACTION_DUMP:

<i>RESPONSE</i>	<i>REASON</i>
OK	None
EXCEPTION	FESTAE_FAILED
	INSUFFICIENT_STORAGE
	IWMWQWRK_FAILED
	NOT_OPEN
	OPEN_ERROR
	PARTIAL_SYSTEM_DUMP
	PARTIAL_TRANSACTION_DUMP
	SDUMP_BUSY
	SDUMP_FAILED
	SDUMP_NOT_AUTHORIZED
	SUPPRESSED_BY_DUMPOPTION
	SUPPRESSED_BY_DUMPTABLE
	SUPPRESSED_BY_USEREXIT
DISASTER	None
INVALID	INVALID_DUMP CODE
	INVALID_PROBDESC
	INVALID_SVC_CALL
KERNERROR	None
PURGED	None

dump control functions

Notes:

1. For more detail, refer to the explanation of RESPONSE and REASON in “General form of an XPI call” on page 286.
2. ‘NOT_OPEN’ means that the CICS dump data set is closed.
3. ‘OPEN_ERROR’ means that an error occurred while a CICS dump data set was being opened.
4. ‘PARTIAL’ means that the transaction dump resulting from this request is incomplete.

Enqueue domain functions

There are two XPI enqueue domain functions. These are the DFHNQEDX macro calls ENQUEUE and DEQUEUE.

The ENQUEUE function

The ENQUEUE functions is provided on the DFHNQEDX macro call. It allows you to enqueue on a named resource.

ENQUEUE

```
DFHNQEDX [CALL,]
  [CLEAR,
  [IN,
  FUNCTION(ENQUEUE),
  ENQUEUE_NAME1(address,length),
  [ENQUEUE_NAME2(address,length),]
  MAX_LIFETIME(DISPATCHER_TASK),
  [WAIT(YES|NO),]
  [PURGEABLE(YES|NO),]
  [OUT,
  ENQUEUE_TOKEN,
  DUPLICATE_REQUEST,
  RESPONSE (name1 | *),
  REASON(name1 | *)]
```

DUPLICATE_REQUEST

indicates that the requesting dispatcher task already owns the resource being enqueued.

ENQUEUE_NAME1(address,length)

specifies the high-order part of name to be enqueued.

ENQUEUE_NAME2(address,length)

specifies the low-order part, if any, of name to be enqueued.

ENQUEUE_TOKEN

enables a subsequent DEQUEUE request to identify the resource by a token rather than enqueue name, allowing the NQ domain to locate the enqueue control block directly, and hence more efficiently.

MAX_LIFETIME(DISPATCHER_TASK)

MAX_LIFETIME(DISPATCHER_TASK) is required and specifies that all XPI enqueues are owned by the requesting dispatcher task.

If you use the ENQUEUE XPI call to ensure that your global user exit programs are threadsafe, you are recommended to free (dequeue) resources during the invocation of the global user exit program in which they were enqueued.

enqueue domain functions

However, as no recovery services are provided for abending global user exits, CICS ensures that any outstanding XPI enqueues are dequeued automatically when the dispatcher task terminates. Note that if the dispatcher task is running a CICS transaction, the dispatcher task terminates when the CICS transaction terminates (whether normally or abnormally).

Normally enqueues are owned by the requesting transaction, which contains units of work (UOWs), and these are used to anchor the enqueue control blocks. The XPI, however, does not require a transaction environment, and global user exits may be invoked under dispatcher tasks which have no transactions or UOWs.

PURGEABLE(YES|NO)

specifies whether a purge (or timeout) request against the task is to be honored if the requesting dispatcher task has to wait for the enqueue.

WAIT(YES|NO)

specifies whether the dispatcher task is to wait if the resource is currently enqueued to another dispatcher task.

RESPONSE and REASON values for ENQUEUE

<i>RESPONSE</i>	<i>REASON</i>
OK	None
EXCEPTION	ENQUEUE_BUSY ENQUEUE_LOCKED ENQUEUE_DISABLED LIMIT_EXCEEDED SYSENQ_FAILURE
PURGED	TASK_CANCELLED TIMED_OUT

The DEQUEUE function

The DEQUEUE function is provided on the DFHNQEDX macro call. It releases a resource previously enqueued by an ENQUEUE function call.

DEQUEUE

```
DFHNQEDX [CALL,]  
  [CLEAR,  
  [IN,  
  FUNCTION(DEQUEUE),  
  {ENQUEUE_TOKEN, |  
  ENQUEUE_NAME1(address,length) [ENQUEUE_NAME2(address,length)], }  
  [OUT,  
  RESPONSE (name1 | *),  
  REASON(name1 | *)]
```

The ENQUEUE_TOKEN, ENQUEUE_NAME1, and ENQUEUE_NAME2 parameters are the same as in the ENQUEUE function call.

RESPONSE and REASON values for DEQUEUE

<i>RESPONSE</i>	<i>REASON</i>
OK	None
EXCEPTION	ENQUEUE_NOT_OWNED ENQUEUE_LOCKED

Kernel domain functions

The START_PURGE_PROTECTION function

The START_PURGE_PROTECTION function is provided on the DFHKEDSX macro call. It inhibits purge, but not force-purge, for the current task. This function can be used by all global user exit programs if they want to inhibit purge during a global user exit call.

In general, each START_PURGE_PROTECTION call should have a corresponding STOP_PURGE_PROTECTION function call to end the purge protection period on completion of any program logic that needs such protection.

START_PURGE_PROTECTION

```
DFHKEDSX [CALL,]  
         [CLEAR,]  
         [IN,  
         FUNCTION(START_PURGE_PROTECTION),]  
         [OUT,  
         RESPONSE (name1 | *)]
```

There are no input or output parameters on this call, only a RESPONSE.

RESPONSE values for START_PURGE_PROTECTION:

<i>RESPONSE</i>	<i>REASON</i>
OK	None
DISASTER	None
INVALID	None

The STOP_PURGE_PROTECTION function

The STOP_PURGE_PROTECTION function is provided on the DFHKEDSX macro call. It re-enables purge for the current task after purge has been suspended by a preceding START_PURGE_PROTECTION function call.

STOP_PURGE_PROTECTION

```
DFHKEDSX [CALL,]  
         [CLEAR,]  
         [IN,  
         FUNCTION(STOP_PURGE_PROTECTION),]  
         [OUT,  
         RESPONSE (name1 | *)]
```

There are no input or output parameters on this call, only a RESPONSE.

RESPONSE values for STOP_PURGE_PROTECTION:

<i>RESPONSE</i>	<i>REASON</i>
OK	None
DISASTER	None
INVALID	None

Nesting purge protection calls

Note that the `START_` and `STOP_PURGE_PROTECTION` functions can be nested. You should ensure that, if multiple `START_PURGE_PROTECTION` calls are issued for a task, that the correct number of `STOP_PURGE_PROTECTION` calls are issued to cancel the purge protection. If you issue two starts and only one stop, purge protection is left on for the current task.

For example, for any current task, more than one global user exit program may be driven. You must design your exit programs to ensure that purge protection is correctly cancelled. An example of nesting is shown as follows:

```
XEIIN:
EXIT_PROG1: Call START_PURGE_PROTECTION

XFCREQ:
EXIT_PROG2: Call START_PURGE_PROTECTION

XFCREQ:
EXIT_PROG3: Call STOP_PURGE_PROTECTION

XEIOUT:
EXIT_PROG4: Call STOP_PURGE_PROTECTION
```

Loader functions

There are four XPI loader functions. These are the DFHLDLDX calls `ACQUIRE_PROGRAM`, `RELEASE_PROGRAM`, `DEFINE_PROGRAM`, and `DELETE_PROGRAM`.

DFHLDLDX calls cannot be used in any exit program invoked from any global user exit point in the:

- Statistics domain
- Monitor domain
- Dump domain
- Dispatcher domain
- Transient data program.

The `DEFINE_PROGRAM` call

`DEFINE_PROGRAM` allows you to define new programs to the loader domain, or to change the details of programs that have already been defined. The details that you provide are recorded on the local catalog, and become immediately available. They are used on all subsequent `ACQUIRE` requests for the named program. However, note that program definitions made in this way are **not** retained over an XRF takeover.

loader functions

DEFINE_PROGRAM

```
DFHLDLX [CALL,]
  [CLEAR,]
  [IN,
  FUNCTION(DEFINE_PROGRAM),
  PROGRAM_NAME(name8 | string | 'string' ),
  [EXECUTION_KEY(CICS|USER),]
  [PROGRAM_ATTRIBUTE(RELOAD|RESIDENT|REUSABLE|TRANSIENT),]
  [PROGRAM_TYPE(PRIVATE|SHARED|TYPE_ANY),]
  [REQUIRED_AMODE(24|31|AMODE_ANY),]
  [REQUIRED_RMODE(24|RMODE_ANY),]]
  [OUT,
  [NEW_PROGRAM_TOKEN(name4),]
  RESPONSE(name1 | *),
  REASON(name1 | *)]
```

EXECUTION_KEY(CICS|USER)

specifies, in conjunction with other program attributes, the type of dynamic storage area (DSA) into which the loader is to load the program.

CICS For non-reentrant programs, means that the program is to be loaded into a CICS DSA, above or below the 16MB line; that is, the CDSA or ECDSA. The choice of CICS DSA is dependent on the residence mode (RMODE) attribute of the program as defined to the linkage-editor.

For reentrant RMODE(24) programs, means that the program is to be loaded into the CDSA.

USER For non-reentrant programs, means that the program is to be loaded into a user DSA, above or below the 16MB line; that is, the UDSA or EUDSA. The choice of user DSA is dependent on the residence mode (RMODE) attribute of the program as defined to the linkage-editor.

For reentrant RMODE(24) programs, means that the program is to be loaded into the UDSA.

Reentrant programs eligible to reside above the 16MB line: If a program is link-edited as reentrant with AMODE(31),RMODE(ANY), the EXECUTION_KEY option is ignored, and it is loaded into a read-only DSA (the RDSA or ERDSA). For details of the type of storage allocated for the ERDSA, see the RENTPGM system initialization parameter.

See Table 16 for a summary of the effect of the EXECUTION_KEY option in conjunction with other factors.

Table 16. Summary of attributes defining DSA eligibility

EXECUTION_KEY option	Reentrant	Above or below 16MB line	Dynamic storage area (DSA)
CICS	No	Below	CDSA
CICS	Yes	Below	RDSA
CICS	No	Above	ECDSA
CICS	Yes	Above	ERDSA
USER	No	Below	UDSA
USER	Yes	Below	RDSA
USER	No	Above	EUDSA

Table 16. Summary of attributes defining DSA eligibility (continued)

EXECUTION_KEY option	Reentrant	Above or below 16MB line	Dynamic storage area (DSA)
USER	Yes	Above	ERDSA

NEW_PROGRAM_TOKEN(name4)

returns the token supplied for the newly-defined program.

name4

The name of a location to contain the 4-byte token obtained.

PROGRAM_ATTRIBUTE(RELOAD|RESIDENT|REUSABLE|TRANSIENT)

specifies the residency status of the program.

RELOAD

Every ACQUIRE_PROGRAM request for this program is satisfied by loading a new copy into storage. When a RELEASE request is issued for a copy, it is removed from storage.

Note: Do not use this attribute when defining an exit program.

RESIDENT

There is a single copy of the program that is not removed from storage unless deleted. RESIDENT programs must be at least quasireentrant.

REUSABLE

The program is at least quasireentrant; a single copy in storage can be used by several tasks in the system. A REUSABLE program becomes eligible for removal from storage as part of the normal dynamic program compression scheme when its use count reaches zero.

TRANSIENT

Similar to REUSABLE, except that the program is removed from storage immediately its use count reaches zero. This should be specified only for less-frequently used programs, or for programs in systems that are critically short on storage.

PROGRAM_NAME(name8 | string | "string")

specifies the name of the program to be defined.

name8

The name of a location where there is an 8-byte program name.

string A string of characters, without intervening blanks, naming the program.

"string"

A string of characters within quotation marks. The string length is set to 8 by padding with blanks or by truncation.

PROGRAM_TYPE(PRIVATE|SHARED|TYPE_ANY)

specifies where to load the program from.

PRIVATE

The program is in the relocatable program library (RPL). A PRIVATE program need not be reentrant, and is given only limited protection from unauthorized overwriting. The degree of protection depends on the type of dynamic storage area (DSA) into which the program is loaded (see the EXECUTION_KEY option):

DSA Protection from unauthorized overwriting

CDSA Cannot be overwritten by USER tasks

loader functions

ECDSA

Cannot be overwritten by USER tasks

ERDSA

Complete—cannot be overwritten by USER tasks or CICS tasks

EUDSA

None

RDSA

Complete—cannot be overwritten by USER tasks or CICS tasks

UDSA

None.

SHARED

The program is located in the link pack area (LPA), is reentrant, and is protected.

TYPE_ANY

Either the RPL or the LPA copy of the program may be used, though preference is given to the LPA copy.

REQUIRED_AMODE(24|31|AMODE_ANY)

specifies the addressing mode of the program. If, during subsequent ACQUIRE_PROGRAM processing, no copy of the program that meets the defined addressing requirement can be found, the ACQUIRE_PROGRAM call receives an 'EXCEPTION' response and the REASON value 'PROGRAM_NOT_FOUND'.

Notes:

1. AMODE_ANY and AMODE 31 have identical meanings for this function.
2. You cannot use this option to override the link-edited addressing mode of the program.

REQUIRED_RMODE(24|RMODE_ANY)

specifies the residency mode of the program. If, during subsequent ACQUIRE_PROGRAM processing, no copy of the program that meets the defined addressing requirement can be found, the ACQUIRE_PROGRAM call receives an 'EXCEPTION' response and the REASON value 'PROGRAM_NOT_FOUND'.

Note: You cannot use this option to override the link-edited residence mode of the program.

RESPONSE and REASON values for DEFINE_PROGRAM:

<i>RESPONSE</i>	<i>REASON</i>
OK	None
EXCEPTION	CATALOG_ERROR CATALOG_NOT_OPERATIONAL
DISASTER	None
INVALID	None
KERNERROR	None
PURGED	None

Note: For more detail, refer to the explanation of RESPONSE and REASON in "General form of an XPI call" on page 286.

The ACQUIRE_PROGRAM call

ACQUIRE_PROGRAM returns the entry and load point addresses, the length, and a new program token for a usable copy of the named program, which can be identified by either its name or a program token.

ACQUIRE_PROGRAM

```
DFHLDLX [CALL,]
        [CLEAR,]
        [IN,
        FUNCTION(ACQUIRE_PROGRAM),
        {PROGRAM_NAME(name8 | string | 'string')|
        PROGRAM_TOKEN(name4)},
        [SUSPEND(NO|YES),]
        [OUT,
        ENTRY_POINT(name4 | (Ra)),
        [LOAD_POINT(name4 | (Ra)),]
        [NEW_PROGRAM_TOKEN(name4),]
        [PROGRAM_ATTRIBUTE(name1 | (Rn)),]
        [PROGRAM_LENGTH(name4 | (Rn)),]
        RESPONSE(name1 | *),
        REASON(name1 | *)]
```

ENTRY_POINT(name4 | (Ra))

returns the program's entry point address.

name4

The name of a 4-byte location to receive the 31-bit entry address

(Ra) A register to receive the entry address.

LOAD_POINT(name4 | (Ra))

returns the program's load point address.

name4

The name of a 4-byte location to receive the loaded address

(Ra) A register that is to contain the load address.

NEW_PROGRAM_TOKEN(name4)

returns the new program token for a usable copy of the named program.

name4

The name of a location to receive a 4-byte token that identifies this program and instance.

PROGRAM_ATTRIBUTE(name1 | (Rn))

returns the program attribute.

name1

The name of a 1-byte location to receive the program attribute.

(Rn) A register in which the low-order byte receives the program attribute and the other bytes are set to zero. It can have the values RELOAD, RESIDENT, REUSABLE, or TRANSIENT.

RELOAD

The program is not reusable, and therefore several copies of the program may be loaded. A copy is removed from storage when a RELEASE_PROGRAM call (for that copy) is issued.

RESIDENT

There is a single copy of the program that is not removed from

loader functions

storage unless deleted. RESIDENT programs must be at least quasireentrant. Any program of PROGRAM_TYPE SHARED has the RESIDENT attribute by default. The DELETE_PROGRAM call has no effect on this type of RESIDENT program.

REUSABLE

Similar to RESIDENT, except that a REUSABLE program that is not in use can be removed from storage by CICS, for storage optimization reasons.

TRANSIENT

Similar to RESIDENT, except that a TRANSIENT program is removed from storage as soon as its use count drops to zero.

PROGRAM_LENGTH(name4 | (Rn))

returns the length of the named program.

name4

The name of a 4-byte location that is to receive the length in bytes, expressed in binary

(Rn) A register to contain the length in bytes, expressed in binary.

PROGRAM_NAME(name8 | string | "string")

specifies the name of the program to be acquired.

name8

The name of a location containing an 8-byte program name.

string A string of characters naming the program.

"string"

A string in quotation marks. The string length is set to 8 by padding with blanks or truncating.

PROGRAM_TOKEN(name4),

specifies a token identifying the program whose details are to be acquired.

name4

The name of a location containing a 4-byte token obtained by a previous DEFINE_PROGRAM or ACQUIRE_PROGRAM call.

SUSPEND(NO|YES)

specifies whether execution is to be suspended until the request can be granted.

RESPONSE and REASON values for ACQUIRE_PROGRAM:

<i>RESPONSE</i>	<i>REASON</i>
OK	None
EXCEPTION	NO_STORAGE PROGRAM_NOT_DEFINED PROGRAM_NOT_FOUND
DISASTER	None
INVALID	None
KERNERROR	None
PURGED	None

Notes:

1. For more detail, refer to the explanation of RESPONSE and REASON in "General form of an XPI call" on page 286.

2. A REASON of 'NO_STORAGE' with a RESPONSE of 'EXCEPTION' means that there was insufficient storage to satisfy this request, and SUSPEND(NO) was specified.
3. A REASON of 'PROGRAM_NOT_FOUND' is returned if the program has not been included in the library concatenation, or if the link-edit failed. In such a case, the program is marked as "not executable"; it must be re-linked before it can be successfully acquired.

The RELEASE_PROGRAM call

RELEASE_PROGRAM decrements the use count of a currently loaded program by one.

If the program has been defined with the RELOAD attribute, the storage occupied by this copy of the program is released.

You should issue the ACQUIRE_PROGRAM and RELEASE_PROGRAM requests for a single program during the same execution of the exit program. If you do not want to do this, you should acquire the program once during CICS initialization, and leave it resident until CICS termination.

RELEASE_PROGRAM

```
DFHLDLX [CALL,]
        [CLEAR,]
        [IN,
        FUNCTION(RELEASE_PROGRAM),
        ENTRY_POINT(pointer),
        {PROGRAM_NAME(name8 | string | 'string')|
        PROGRAM_TOKEN(name4)},,]
        [OUT,
        RESPONSE(name1 | *),
        REASON(name1 | *)]
```

ENTRY_POINT(pointer)

specifies the address of the entry point of this copy of the named program.

PROGRAM_NAME(name8 | string | "string")

specifies the name of the program to be released.

name8

The name of a location containing an 8-byte program name.

string A string of characters naming the program.

"string"

A string in quotation marks. The string length is set to 8 by padding with blanks or truncating.

PROGRAM_TOKEN(name4),

specifies a token identifying the program to be released.

name4

The name of a location containing an 4-byte token obtained by a previous DEFINE_PROGRAM or ACQUIRE_PROGRAM call.

RESPONSE and REASON values for RELEASE_PROGRAM:

RESPONSE
OK

REASON
None

loader functions

<i>RESPONSE</i>	<i>REASON</i>
EXCEPTION	PROGRAM_NOT_DEFINED PROGRAM_NOT_IN_USE
DISASTER	None
INVALID	None
KERNERROR	None
PURGED	None

Notes:

1. For more detail, refer to the explanation of RESPONSE and REASON in "General form of an XPI call" on page 286.
2. 'PROGRAM_NOT_DEFINED' is returned if the program that you name is not known to the system.
3. 'PROGRAM_NOT_IN_USE' is returned when the use count for the named program is already zero.

The DELETE_PROGRAM call

DELETE_PROGRAM removes the definition of a named program from the catalog and from the list of current programs. When this request executes successfully, subsequent ACQUIRE_PROGRAM requests fail with a REASON value of 'PROGRAM_NOT_DEFINED'.

DELETE_PROGRAM

```
DFHLDLX [CALL,]  
  [CLEAR,]  
  [IN,  
  FUNCTION(DELETE_PROGRAM),  
  PROGRAM_NAME(name8 | string | 'string' ),]  
  [OUT,  
  RESPONSE(name1 | *),  
  REASON(name1 | *)]
```

PROGRAM_NAME(name8 | string | "string")

specifies the name of the program to be deleted.

name8

The name of a location containing an 8-byte program name.

string A string of characters naming the program.

"string"

A string in quotation marks. The string length is set to 8 by padding with blanks or truncating.

RESPONSE and REASON values for DELETE_PROGRAM:

<i>RESPONSE</i>	<i>REASON</i>
OK	None
EXCEPTION	PROGRAM_NOT_DEFINED
DISASTER	None
INVALID	None
KERNERROR	None
PURGED	None

Note: For more detail, refer to the explanation of RESPONSE and REASON in "General form of an XPI call" on page 286.

Log manager functions

There are two XPI log manager functions. These are the DFHLGPAX calls:

INQUIRE_PARAMETERS
SET_PARAMETERS

These calls allow you to inquire upon, and set, the log manager parameter, KEYPOINT_FREQUENCY. The value in this parameter specifies the activity keypoint frequency of the CICS region.

The INQUIRE_PARAMETERS call

INQUIRE_PARAMETERS returns information about the activity keypoint frequency of the system.

INQUIRE_PARAMETERS

```
DFHLGPAX [CALL,]
         [CLEAR,]
         [IN,
         FUNCTION(INQUIRE_PARAMETERS),
         [OUT,
         [KEYPOINT_FREQUENCY(name4 | *),]
         RESPONSE(name1 | *),
         REASON(name1 | *)]
```

KEYPOINT_FREQUENCY(name4 | *)

returns the activity keypointing frequency of the CICS region.

name4

The name of a 4-byte location that is to receive the frequency value.

RESPONSE and REASON values for INQUIRE_PARAMETERS:

<i>RESPONSE</i>	<i>REASON</i>
OK	None
DISASTER	None
INVALID	None
KERNERROR	None

The SET_PARAMETERS call

SET_PARAMETERS allows you to set the activity keypoint frequency for the CICS region.

log manager functions

SET_PARAMETERS

```
DFHLGPAX [CALL,]
          [CLEAR,]
          [IN,
           FUNCTION(SET_PARAMETERS),
           [KEYPOINT_FREQUENCY(name4 | (Rn) ),]]
          [OUT,
           RESPONSE(name1 | *),
           REASON(name1 | *)]
```

KEYPOINT_FREQUENCY(name4 | *)

specifies the activity keypointing frequency of the CICS region.

Permitted values are 0, or any integer between 200 and 65535 inclusive.

name4

The name of a 4-byte location that contains the new frequency value.

(Rn) A register that contains the new frequency value.

RESPONSE and REASON values for SET_PARAMETERS:

<i>RESPONSE</i>	<i>REASON</i>
OK	None
EXCEPTION	OUT_OF_RANGE
DISASTER	None
INVALID	None
KERNERROR	None

Note: For more detail, refer to the explanation of RESPONSE and REASON in “General form of an XPI call” on page 286.

Monitoring functions

There are two XPI monitoring functions. These are the DFHMNMNX calls MONITOR and INQUIRE_MONITORING_DATA.

DFHMNMNX calls cannot be used in any exit program invoked from any global user exit point in the:

- Dispatcher domain
- Dump domain
- Monitor domain
- Statistics domain
- Transient data program.

INQUIRE_MONITORING_DATA calls cannot be used in any exit program invoked from any global user exit point in DFHTCP or DFHZCP (that is, at any of the exit points named “XTCx...” or “XZCx...”).

The MONITOR call

The MONITOR XPI call is similar to the EXEC CICS MONITOR command. It enables you to invoke user event-monitoring points (EMPs) in your exit programs.

The user event-monitoring points must be defined in the usual way in the monitoring control table (MCT). For more information about CICS monitoring, read “Chapter 24. CICS monitoring” on page 657.

At a user EMP, you can add your own data (up to 256 counters, up to 256 clocks, and a single character string of up to 256 bytes) to fields reserved unconditionally for you in performance class monitoring data records.

MONITOR

```
DFHMNMN [CALL,]
  [CLEAR,]
  [IN,
  FUNCTION(MONITOR),
  POINT(expression | name2 | (Rn)),
  [DATA1(expression | name4 | (Ra) | *),]
  [DATA2(expression | name4 | (Ra) | *),]
  [ENTRYNAME(name8 | string | 'string'),]]
  [OUT,
  RESPONSE(name1 | *),
  REASON(name1 | *)]
```

Important

There is a restriction in using the XPI early during initialization. Do not start exit programs that use the XPI functions TRANSACTION_DUMP, WRITE_JOURNAL_DATA, MONITOR, and INQUIRE_MONITOR_DATA until the second phase of the PLTPI. For further information about the PLTPI, refer to “Chapter 4. Writing initialization and shutdown programs” on page 393.

DATA1(expression | name4 | (Ra) | *)

specifies a fullword binary variable whose contents depend on the type of user EMP being used:

- If the MCT user EMP definition contains an ADDCNT, SUBCNT, NACNT, EXCNT, or ORCNT option, the DATA1 variable is an area used as defined by the user EMP definition.
- If the MCT user EMP definition contains an MLTCNT option, the DATA1 variable is an area with the address of a series of adjacent fullwords containing the values to be added to the user count fields defined in the user EMP definition.
- If the MCT user EMP definition contains a MOVE option, the DATA1 variable is an area with the address of the character string to be moved.

For details of the user EMP options, see the *CICS Resource Definition Guide*.

expression

A valid assembler-language expression giving the fullword binary variable for this EMP.

name4

The name of a 4-byte field containing the fullword binary variable for this EMP.

(Ra) A register containing the fullword binary variable for this EMP.

***** The value of this option is already present in the parameter list, or the option is not specified for this EMP.

monitoring functions

DATA2(expression | name4 | (Rn) | *)

specifies a fullword binary variable whose contents depend on the type of user EMP being used:

- If the MCT user EMP definition contains an ADDCNT, SUBCNT, NACNT, EXCNT, or ORCNT option, the DATA2 variable is an area used as defined by the user EMP definition.

- If the MCT user EMP definition contains an MLTCNT option, the DATA2 variable is an area with the number of user count fields to be updated. The number specified in DATA2 overrides the default value defined in the MCT for the operation. A value of 0 instructs monitoring to use the default. Not specifying a value for DATA2 does not prevent the MLTCNT operation from being successful; but, if it is, an exception response of 'DATA2_NOT_SPECIFIED' is returned. See note 5 on page 333.

- If the MCT user EMP definition contains a MOVE option, the DATA2 variable is an area with the length of the character string to be moved. The length specified in DATA2 overrides the default value defined in the MCT for the operation. A value of 0 instructs monitoring to use the default. Not specifying a value for DATA2 does not prevent the MOVE operation from being successful; but, if it is, an exception response of 'DATA2_NOT_SPECIFIED' is returned. See note 5 on page 333.

For details of the user EMP options, see the *CICS Resource Definition Guide*.

expression

A valid assembler-language expression giving the fullword binary variable for this EMP.

name4

The name of a 4-byte field containing the fullword binary variable for this EMP.

(Rn) A register containing the fullword binary variable for this EMP.

- * The value of this option is already present in the parameter list, or the option is not specified for this EMP.

ENTRYNAME(name8 | string | "string")

specifies the monitoring point entry name, which qualifies the POINT value and which is defined in the monitoring control table (MCT).

name8

The name of a location containing an 8-byte string.

string A string of characters without intervening blanks. The macro generates, from the string, a literal constant of length 8 bytes, extending with blanks or truncating as required.

"string"

A string, enclosed in quotation marks, and possibly containing blanks. This value is processed in the same way as the "string" above.

Note: If, when defining the EMP in the MCT, you do not specify an entry name, the entry name defaults to 'USER'. ENTRYNAME likewise defaults to 'USER' if not specified.

POINT(expression | name2 | (Rn))

specifies the monitoring point identifier as defined in the MCT, and is in the range 0 through 255. Note, however, that point identifiers in the range 200 through 255 are reserved for use by IBM program products.

expression

A valid assembler-language expression that can be expressed in 2 bytes.

name2

The name of a 2-byte source of point data

(Rn) A register containing the point data in the low-order 2 bytes

RESPONSE and REASON values for MONITOR:

<i>RESPONSE</i>	<i>REASON</i>
OK	None
EXCEPTION	DATA1_NOT_SPECIFIED DATA2_NOT_SPECIFIED POINT_NOT_DEFINED INVALID_DATA1_VALUE INVALID_DATA2_VALUE
DISASTER	None
INVALID	None
KERNERROR	None
PURGED	None

Notes:

1. For more detail, refer to the explanation of RESPONSE and REASON in “General form of an XPI call” on page 286.
2. ‘POINT_NOT_DEFINED’ means that the EMP you have specified was not defined in the MCT.
3. ‘INVALID_DATA1_VALUE’ and ‘INVALID_DATA2_VALUE’ are most likely to have been caused by provision of bad addresses; this causes a program check.
4. DATA1_NOT_SPECIFIED and DATA2_NOT_SPECIFIED mean that you have not specified DATA1 or DATA2 respectively when the operation required them. See the description of DATA2.
5. Any error response terminates processing of the EMP. Operations defined to execute before the point of failure will have done so; later operations are canceled.

The INQUIRE_MONITORING_DATA call

The INQUIRE_MONITORING_DATA function returns to the exit program the performance class monitoring data that has been accumulated for the issuing task.

The DFHMNTDS DSECT that maps the data is of fixed format. Note that:

- All the CICS system-defined fields in the performance records (including fields that you have specified for exclusion using the EXCLUDE option of the DFHMCT TYPE=RECORD macro) are listed.
- No user-defined data fields are listed.

monitoring functions

INQUIRE_MONITORING_DATA

```
DFHMNMN [CALL,]
        [CLEAR,]
        [IN,
        FUNCTION(INQUIRE_MONITORING_DATA),
        DATA_BUFFER(buffer-descriptor),]
        [OUT,
        RESPONSE(name1 | *),
        REASON(name1 | *)]
```

Important

There is a restriction in using the XPI early during initialization. Do not start exit programs that use the XPI functions TRANSACTION_DUMP, WRITE_JOURNAL_DATA, MONITOR, and INQUIRE_MONITORING_DATA until the second phase of the PLTPI. For further information about the PLTPI, refer to “Chapter 4. Writing initialization and shutdown programs” on page 393.

DATA_BUFFER(buffer-descriptor)

specifies the address and the length of a buffer to contain the returned monitoring data; see page 299 for a full definition of a buffer-descriptor. The DSECT DFHMNTDS maps the monitoring data.

RESPONSE and REASON values for INQUIRE_MONITORING_DATA:

<i>RESPONSE</i>	<i>REASON</i>
OK	None
EXCEPTION	LENGTH_ERROR MONITOR_DATA_UNAVAILABLE
DISASTER	None
INVALID	None
KERNERROR	None
PURGED	None

Notes:

1. For more detail, refer to the explanation of RESPONSE and REASON in “General form of an XPI call” on page 286.
2. ‘LENGTH_ERROR’ means that the length specified in the buffer-descriptor was too short for the monitoring data returned from the XPI call.

Program management functions

There are eight XPI program management functions. These are the DFHPGISX calls:

```
INQUIRE_PROGRAM
INQUIRE_CURRENT_PROGRAM
SET_PROGRAM
START_BROWSE_PROGRAM
GET_NEXT_PROGRAM
END_BROWSE_PROGRAM
```

and the DFHPGAQX calls:

INQUIRE_AUTOINSTALL
SET_AUTOINSTALL.

Used with the Loader functions DEFINE_PROGRAM, ACQUIRE_PROGRAM, RELEASE_PROGRAM, and DELETE_PROGRAM, these calls give you a comprehensive set of tools for manipulating programs. (Note, however, that the tokens returned in the NEW_PROGRAM_TOKEN fields of DFHPGISX calls are different from those returned by DFHLDLTX Loader calls. You should not use a token obtained from a DFHPGISX call in a DFHLDLTX call, or vice versa.)

The INQUIRE_PROGRAM call

INQUIRE_PROGRAM returns information about the attributes of a specified program.

INQUIRE_PROGRAM

```
DFHPGISX [CALL,]
  [CLEAR,]
  [IN,
  FUNCTION(INQUIRE_PROGRAM),
  {PROGRAM_NAME(name8 | string | 'string')|
  PROGRAM_TOKEN(name4)},]
  [OUT,
  [ACCESS(CICS|NONE|READ_ONLY|USER),]
  [AVAIL_STATUS(DISABLED|ENABLED),]
  [CEDF_STATUS(CEDF|NOCEDF|NOT_APPLIC),]
  [DATA_LOCATION(ANY|BELOW|NOT_APPLIC),]
  [DYNAMIC_STATUS(DYNAMIC|NOT_DYNAMIC),]
  [ENTRY_POINT(name4),]
  [EXECUTION_KEY(CICS|NOT_APPLIC|USER),]
  [EXECUTION_SET(DPLSUBSET|FULLAPI|NOT_APPLIC),]
  [HOLD_STATUS(CICS_LIFE|NOT_APPLIC|TASK_LIFE),]
  [INSTALL_TYPE(AUTO|CATALOG|GROUPLIST|MANUAL|RDO|SYSAUTO),]
  [LANGUAGE_DEDUCED(ASSEMBLER|C370|COBOL|
  COBOL2|LE370|NOT_APPLIC|NOT_DEDUCED|PLI),]
  [LANGUAGE_DEFINED(ASSEMBLER|C370|COBOL|
  LE370|NOT_APPLIC|NOT_DEFINED|PLI),]
  [LOAD_POINT(name4),]
  [LOAD_STATUS(LOADABLE|NOT_APPLIC|NOT_LOADABLE|NOT_LOADED),]
  [LOCATION(CDSA|ECDSA|ELPA|ERDSA|ESDSA|LPA|NONE|RDSA|SDSA),]
  [MODULE_TYPE(MAPSET|PARTITIONSET|PROGRAM),]
  [NEW_PROGRAM_TOKEN(name4),]
  [PROGRAM_ATTRIBUTE(RELOAD|RESIDENT|REUSABLE|TRANSIENT),]
  [PROGRAM_LENGTH(name4),]
  [PROGRAM_TYPE(NOT_APPLIC|PRIVATE|SHARED|TYPE_ANY),]
  [PROGRAM_USAGE(APPLICATION|NUCLEUS),]
  [PROGRAM_USE_COUNT(name4),]
  [PROGRAM_USER_COUNT(name4),]
  [REMOTE_DEFINITION(LOCAL|REMOTE),]
  [REMOTE_PROGID(name8),]
  [REMOTE_SYSID(name4),]
  [REMOTE_TRANID(name4),]
  [SPECIFIED_AMODE(24|31|AMODE_ANY|AMODE_NOT_SPECIFIED),]
  [SPECIFIED_RMODE(24|RMODE_ANY|RMODE_NOT_SPECIFIED),]
  RESPONSE(name1 | *),
  REASON(name1 | *)]
```

ACCESS(CICS|NONE|READ_ONLY|USER)

returns a value indicating the type of storage into which the program has been loaded.

program management functions

CICS CICS-key

NONE The program has not been loaded

READ_ONLY
Readonly

USER User-key.

AVAIL_STATUS(DISABLED|ENABLED)

returns a value indicating whether the program can be used—that is, whether or not it has been enabled.

CEDF_STATUS(CEDF|NOCEDF|NOT_APPLIC)

returns the EDF status of the program.

CEDF When the program is running under the control of the CICS execution diagnostic facility (EDF), EDF diagnostic screens are displayed.

NOCEDF
EDF diagnostic screens are not displayed.

NOT_APPLIC
Not applicable. This is a mapset, partitionset, or a remote program.

DATA_LOCATION(ANY|BELOW|NOT_APPLIC)

returns a value indicating whether or not the program can access data located above the 16MB line.

ANY The program can handle 31-bit addresses, and can therefore be passed data located above or below the 16MB line.

BELOW
The program can handle only 24-bit addresses, and must therefore only be passed data located below the 16MB line.

NOT_APPLIC
Not applicable. This is a mapset, partitionset, or a remote program.

DYNAMIC_STATUS(DYNAMIC|NOT_DYNAMIC)

returns a value indicating whether, if the program is the subject of a program-link request, the request can be dynamically routed.

DYNAMIC
If the program is the subject of a program-link request, the CICS dynamic routing program is invoked. Providing that a remote server region is not named explicitly on the SYSID option of the EXEC CICS LINK command, the routing program can route the request to the region on which the program is to execute.

NOT_DYNAMIC
If the program is the subject of a program-link request, the dynamic routing program is not invoked.

For a distributed program link (DPL) request, the server region on which the program is to execute must be specified explicitly on the REMOTESYSTEM option of the PROGRAM definition or on the SYSID option of the EXEC CICS LINK command; otherwise it defaults to the local region.

For information about the dynamic routing of DPL requests, see the *CICS Intercommunication Guide*.

ENTRY_POINT(name4)

returns the program's entry point address, as it would be returned by a Loader domain ACQUIRE_PROGRAM call.

EXECUTION_KEY(CICS|NOT_APPLIC|USER)

returns the key in which CICS gives control to the program, which determines whether the program can modify CICS-key storage.

CICS CICS gives control to the program in CICS key. The program is loaded into a CICS dynamic storage area (DSA), above or below the 16MB line; that is, the CDSA or ECDSA, depending on its residency mode (RMODE) attribute as defined to the linkage-editor.

NOT_APPLIC

Not applicable. This is a mapset, partitionset, or a remote program.

USER CICS gives control to the program in user key. The program is loaded into a user DSA, above or below the 16MB line; that is, the UDSA or EUDSA, depending on its residency mode (RMODE) attribute as defined to the linkage-editor.

EXECUTION_SET(DPLSUBSET|FULLAPI|NOT_APPLIC)

returns a value indicating whether CICS links to and runs the program as if it were running in a remote CICS region.

DPLSUBSET

CICS links to and runs the program with the API restrictions of a remote DPL program. The program can use only a subset of the CICS API.

FULLAPI

CICS links to and runs the program without the API restrictions of a remote DPL program. The program can use the full CICS API.

NOT_APPLIC

Not applicable. This is a mapset, partitionset, or a remote program. (The EXECUTIONSET option of DEFINE PROGRAM applies only to local program definitions. Its purpose is to test programs in a local CICS environment as if they were running as DPL programs.)

HOLD_STATUS(CICS_LIFE|NOT_APPLIC|TASK_LIFE)

returns a value indicating how long the program is to remain loaded.

CICS_LIFE

The program remains loaded until CICS is shut down.

NOT_APPLIC

Not applicable. The program is not loaded, or is remote.

TASK_LIFE

The program remains loaded for the lifetime of the task.

INSTALL_TYPE(AUTO|CATALOG|GROUPLIST|MANUAL|RDO|SYSAUTO)

returns the method that was used to install the PROGRAM resource definition.

AUTO Autoinstall.

CATALOG

The CICS global catalog, after a restart.

GROUPLIST

The CICS startup grouplist.

program management functions

MANUAL

The program is a CICS internal module explicitly defined to the Program Manager by another CICS component.

RDO RDO commands.

SYSAUTO

System autoinstall (that is, autoinstalled by CICS without calling the autoinstall user program). The program may be a CICS internal module or, for example, a first phase PLTPI program.

LANGUAGE_DEDUCED(ASSEMBLER|C370|COBOL|COBOL2|LE370|

NOT_APPLIC|NOT_DEDUCED|PLI)

returns the language deduced by CICS for the program.

LANGUAGE_DEFINED(ASSEMBLER|C370|COBOL|LE370|

NOT_APPLIC|NOT_DEFINED|PLI)

returns the programming language specified on the resource definition.

LOAD_POINT(name4)

returns the program's load point address, as it would be returned by a Loader domain ACQUIRE_PROGRAM call.

LOAD_STATUS(LOADABLE|NOT_APPLIC|NOT_LOADABLE|NOT_LOADED)

returns a value indicating whether or not the program can be loaded.

LOADABLE

The program is loadable.

NOT_APPLIC

Not applicable. The program is remote.

NOT_LOADABLE

CICS has tried to load the program and failed; the program is not in the library.

NOT_LOADED

CICS has not yet tried to load the program.

LOCATION(CDSA|ECDSA|ELPA|ERDSA|ESDSA|LPA|NONE|RDSA|SDSA)

returns a value indicating where the most recently loaded copy of the program resides.

CDSA The CICS dynamic storage area

ECDSA

The extended CICS dynamic storage area

ELPA The extended link pack area

ERDSA

The extended readonly dynamic storage area

ESDSA

The extended shared dynamic storage area

LPA The link pack area

NONE The program has not been loaded.

RDSA The readonly dynamic storage area

SDSA The shared dynamic storage area

program management functions

MODULE_TYPE(MAPSET|PARTITIONSET|PROGRAM)

returns the kind of program resource.

NEW_PROGRAM_TOKEN(name4)

returns a token that can be used to identify the named program.

name4

The name of a location to receive a 4-byte token that identifies this program.

If PROGRAM_NAME is specified on the request, NEW_PROGRAM_TOKEN is set to a program token that can be used on subsequent requests for the same program. If PROGRAM_TOKEN is specified on the request, NEW_PROGRAM_TOKEN is set to the same value.

PROGRAM_ATTRIBUTE(RELOAD|RESIDENT|REUSABLE|TRANSIENT)

returns the residency status of the program—that is, when its storage is released.

RELOAD

The program is not reusable, and therefore several copies may be loaded. A copy is removed from storage when a RELEASE_PROGRAM call (for that copy) is issued.

RESIDENT

There is a single copy of the program that is not removed from storage unless deleted. RESIDENT programs must be at least quasireentrant. Any program of PROGRAM_TYPE SHARED is RESIDENT by default.

REUSABLE

Similar to RESIDENT, except that a REUSABLE program that is not in use can be removed from storage by CICS, for storage optimization reasons.

TRANSIENT

Similar to RESIDENT, except that a TRANSIENT program is removed from storage as soon as its user count drops to zero.

PROGRAM_LENGTH(name4)

returns the length of the program, in bytes, expressed in binary.

PROGRAM_NAME(name8 | string | 'string')

specifies the name of the program to be queried.

name8

The name of a location containing an 8-byte program name.

string A string of characters naming the program.

'string'

A string of characters in quotation marks. The string length is set to 8 by padding with blanks or truncating.

PROGRAM_TOKEN(name4)

specifies a token identifying the program to be queried.

name4

The name of a location containing a 4-byte token obtained from a previous INQUIRE_PROGRAM call.

PROGRAM_TYPE(NOT_APPLIC|PRIVATE|SHARED|TYPE_ANY)

returns a value indicating where the next new copy of the program is to be loaded from.

program management functions

NOT_APPLIC

Not applicable. The program is remote.

PRIVATE

The program is to be loaded from the relocatable program library (RPL). A PRIVATE program need not be reentrant, and is given only limited protection against unauthorized overwriting. The degree of protection depends on the type of dynamic storage area into which the program is loaded (see the description of the PROGRAM_TYPE option of the DEFINE_PROGRAM call).

SHARED

The program is to be loaded from the link pack area (LPA). SHARED programs must be reentrant, and are protected.

The next time a NEWCOPY or PHASEIN is received, an LPA copy of the program is used if it is available. If no LPA version is available, the program is loaded from DFHRPL.

TYPE_ANY

Either the RPL or the LPA copy of the program can be used, though preference is given to the LPA copy.

PROGRAM_USAGE(APPLICATION|NUCLEUS)

returns a value indicating whether the program is used as a CICS nucleus program or as a user application program.

PROGRAM_USE_COUNT(name4)

returns the current number of users of the program.

PROGRAM_USER_COUNT(name4)

returns the number of different users that have invoked the program.

REMOTE_DEFINITION(LOCAL|REMOTE)

returns a value indicating whether this program is a local or a remote resource. If it is a remote resource, CICS treats requests to link to the program as distributed program link (DPL) requests, and ships them to the remote region.

REMOTE_PROGID(name8)

returns the name by which the program is known in the remote CICS region, if the program is a remote resource. If REMOTESYSTEM was specified on the PROGRAM definition, and REMOTENAME omitted, the remote name will be the same as the local name (that is, REMOTE_PROGID will default to the value of PROGRAM_NAME).

REMOTE_SYSID(name4)

returns the name of the remote CICS region that owns the program, if the program is a remote resource.

REMOTE_TRANID(name4)

returns the name of the transaction that the remote CICS attaches, and under which it runs the program, if the program is a remote resource.

SPECIFIED_AMODE(24|31|AMODE_ANY|AMODE_NOT_SPECIFIED)

returns the addressing mode specified on a DEFINE_PROGRAM call.

SPECIFIED_RMODE(24|RMODE_ANY|RMODE_NOT_SPECIFIED)

returns the residency mode (that is, whether the program should be loaded above or below the 16MB line) specified on a DEFINE_PROGRAM call.

RESPONSE and REASON values for INQUIRE_PROGRAM:

<i>RESPONSE</i>	<i>REASON</i>
OK	None
EXCEPTION	PROGRAM_NOT_DEFINED_TO_LD PROGRAM_NOT_DEFINED_TO_PG
DISASTER	ABEND LOCK_ERROR
INVALID	INVALID_PROGRAM_TOKEN
KERNERROR	None
PURGED	None

The INQUIRE_CURRENT_PROGRAM call

INQUIRE_CURRENT_PROGRAM returns information about the attributes of the program that is currently running. If this call is issued from within a global or task-related user exit, it returns the attributes of the global or task-related user exit program itself.

INQUIRE_CURRENT_PROGRAM

```
DFHPGISX [CALL,]
  [CLEAR,]
  [IN,
  FUNCTION(INQUIRE_CURRENT_PROGRAM),]
  [OUT,
  [AVAIL_STATUS(DISABLED|ENABLED),]
  [CEDF_STATUS(CEDF|NOCEDF|NOT_APPLIC),]
  [CURRENT_AMODE(24|31),]
  [CURRENT_CEDF_STATUS(CEDF|NOCEDF),]
  [CURRENT_ENTRY_POINT(name4),]
  [CURRENT_ENVIRONMENT(EXEC|GLUE|PLT|SYSTEM|TRUE|URM),]
  [CURRENT_EXECUTION_SET(DPLSUBSET|FULLAPI),]
  [CURRENT_LOAD_POINT(name4),]
  [CURRENT_PROGRAM_LENGTH(name4),]
  [CURRENT_PROGRAM_NAME(name8),]
  [DATA_LOCATION(ANY|BELOW|NOT_APPLIC),]
  [DYNAMIC_STATUS(DYNAMIC|NOT_DYNAMIC),]
  [EXECUTION_KEY(CICS|NOT_APPLIC|USER),]
  [EXECUTION_SET(DPLSUBSET|FULLAPI|NOT_APPLIC),]
  [HOLD_STATUS(CICS_LIFE|NOT_APPLIC|TASK_LIFE),]
  [INSTALL_TYPE(AUTO|CATALOG|GROUPLIST|MANUAL|RDO|SYSAUTO),]
  [INVOKING_ENVIRONMENT(EXEC|GLUE|PLT|SYSTEM|TRUE|URM),]
  [INVOKING_PROGRAM_NAME(name8),]
  [LANGUAGE_DEDEDUCED(ASSEMBLER|C370|COBOL|
    COBOL2|LE370|NOT_APPLIC|NOT_DEDEDUCED|PLI),]
  [LANGUAGE_DEFINED(ASSEMBLER|C370|COBOL|
    LE370|NOT_APPLIC|NOT_DEFINED|PLI),]
  [LOAD_STATUS(LOADABLE|NOT_APPLIC|NOT_LOADABLE|NOT_LOADED),]
  [MODULE_TYPE(MAPSET|PARTITIONSET|PROGRAM),]
  [NEW_PROGRAM_TOKEN(name4),]
  [REMOTE_DEFINITION(LOCAL|REMOTE),]
  [REMOTE_PROGID(name8),]
  [REMOTE_SYSID(name4),]
  [REMOTE_TRANID(name4),]
  [RETURN_PROGRAM_NAME(name8),]
  RESPONSE(name1 | *),
  REASON(name1 | *)]
```

Note: The options not described in the following list are identical to the equivalent options of the INQUIRE_PROGRAM call.

program management functions

CURRENT_AMODE(24|31)

returns the addressing mode which the running program is currently using.

CURRENT_CEDF_STATUS(CEDF|NOCEDF)

returns the EDF status of the current instance of the program. The value returned is the same as for CEDF_STATUS, which is the EDF status specified on the program definition. See the CEDF_STATUS option of INQUIRE_PROGRAM.

CURRENT_ENTRY_POINT(name4)

returns the entry point address of the current program.

CURRENT_ENVIRONMENT(EXEC|GLUE|PLT|SYSTEM|TRUE|URM)

returns the environment in which the current program is running—that is, the type of program it is.

EXEC User application program

GLUE Global user exit program

PLT Program list table program

SYSTEM

CICS system code

TRUE Task-related user exit program

URM User-replaceable program.

CURRENT_EXECUTION_SET(DPLSUBSET|FULLAPI)

returns the API execution set used by the current instance of the program. The value returned is the same as for EXECUTION_SET (which is the API execution set specified on the program definition) *unless* this is the first program in a transaction, when the value may be different. This is because the DPLSUBSET attribute applies only to linked-to programs. It is ignored for the first program in a transaction, because this cannot be the target of a DPL call. Therefore, for the first program in a transaction, if EXECUTION_SET returns DPLSUBSET, CURRENT_EXECUTION_SET nevertheless returns FULLAPI. See the EXECUTION_SET option of INQUIRE_PROGRAM.

CURRENT_LOAD_POINT(name4)

returns the load point address of the current program.

CURRENT_PROGRAM_LENGTH(name4)

returns the length of the current program, in bytes, expressed in binary.

CURRENT_PROGRAM_NAME(name8)

returns the name of the program that is currently running.

INVOKING_ENVIRONMENT (EXEC|GLUE|PLT|SYSTEM|TRUE|URM)

returns the environment from which the current program was invoked. The values are as described for CURRENT_ENVIRONMENT.

INVOKING_PROGRAM_NAME(name8)

returns the name of the most recent program *that was not a global user exit or task-related user exit program* to invoke the current program.

RETURN_PROGRAM_NAME(name8)

returns the name of the program to which control will be returned, after any intermediate global user exit or task-related user exit programs have completed.

RESPONSE and REASON values for INQUIRE_CURRENT_PROGRAM:

<i>RESPONSE</i>	<i>REASON</i>
OK	None
EXCEPTION	NO_CURRENT_PROGRAM
DISASTER	LOCK_ERROR
	ABEND
INVALID	None
KERNERROR	None
PURGED	None

The SET_PROGRAM call

SET_PROGRAM allows you to set selected attributes in the definition of a specified program.

```

SET_PROGRAM
DFHPGISX [CALL,]
    [CLEAR,]
    [IN,
    FUNCTION(SET_PROGRAM),
    {PROGRAM_NAME(name8 | string | 'string')|
    PROGRAM_TOKEN(name4)},]
    [AVAIL_STATUS(DISABLED|ENABLED),]
    [CEDF_STATUS(CEDF|NOCEDF),]
    [EXECUTION_KEY(CICS|USER),]
    [EXECUTION_SET(DPLSUBSET|FULLAPI),]
    [PROGRAM_ATTRIBUTE(RELOAD|RESIDENT|REUSABLE|TRANSIENT),]
    [PROGRAM_TYPE(PRIVATE|SHARED|TYPE_ANY),]
    [PROGRAM_USAGE(APPLICATION|NUCLEUS),]
    [REQUIRED_AMODE(24|31|AMODE_ANY),]
    [REQUIRED_RMODE(24|RMODE_ANY),]
    [OUT,
    RESPONSE(name1 | *),
    REASON(name1 | *)]
    
```

AVAIL_STATUS(DISABLED|ENABLED)

specifies whether the program can be used—that is, whether or not it is enabled.

CEDF_STATUS(CEDF|NOCEDF)

specifies whether, when the program is running under the control of the CICS execution diagnostic facility (EDF), EDF diagnostic screens are displayed.

EXECUTION_KEY(CICS|USER)

specifies the key in which CICS is to give control to the program. The key determines whether the program can modify CICS-key storage.

CICS CICS gives control to the program in CICS key. The program is loaded into a CICS dynamic storage area (DSA), above or below the 16MB line; that is, the CDSA or ECDSA, depending on its residency mode (RMODE) attribute as defined to the linkage-editor.

USER CICS gives control to the program in user key. The program is loaded into a user DSA, above or below the 16MB line; that is, the UDSA or EUDSA, depending on its residency mode (RMODE) attribute as defined to the linkage-editor.

program management functions

Note: If the program has been link-edited as reentrant with AMODE(31),RMODE(ANY), the EXECUTION_KEY option is ignored, and it is loaded into the extended readonly DSA (ERDSA). For details of the type of storage allocated for the ERDSA, see the RENTPGM system initialization parameter.

EXECUTION_SET(DPLSUBSET|FULLAPI)

specifies whether CICS is to link to and run the program as if it were running in a remote CICS region.

Note: EXECUTION_SET applies only to local program definitions. Its purpose is to test programs in a local CICS environment as if they were running as DPL programs.

DPLSUBSET

CICS links to and runs the program with the API restrictions of a remote DPL program. The program can use only a subset of the CICS API.

FULLAPI

CICS links to and runs the program without the API restrictions of a remote DPL program. The program can use the full CICS API.

PROGRAM_ATTRIBUTE(RELOAD|RESIDENT|REUSABLE|TRANSIENT)

specifies the residency status of the program—that is, when its storage is to be released.

RELOAD

The program is not reusable, and therefore several copies may be loaded. A copy is removed from storage when a RELEASE_PROGRAM call (for that copy) is issued.

RESIDENT

At any one time there will be no more than a single copy of the program in storage, and this will not be removed unless deleted. RESIDENT programs must be at least quasireentrant. Any program of PROGRAM_TYPE SHARED is RESIDENT by default.

REUSABLE

Similar to RESIDENT, except that a REUSABLE program that is not in use can be removed from storage by CICS, for storage optimization reasons.

TRANSIENT

Similar to RESIDENT, except that a TRANSIENT program is removed from storage as soon as its user count drops to zero.

PROGRAM_NAME(name8 | string | 'string')

specifies the name of the program whose attributes are to be changed.

name8

The name of a location containing an 8-byte program name.

string A string of characters naming the program.

'string'

A string of characters in quotation marks. The string length is set to 8 by padding with blanks or truncating.

PROGRAM_TOKEN(name4)

specifies a token identifying the program.

name4

The name of a location containing a 4-byte token obtained from a previous INQUIRE_PROGRAM, INQUIRE_CURRENT_PROGRAM, START_BROWSE_PROGRAM, or GET_NEXT_PROGRAM call.

PROGRAM_TYPE(PRIVATE|SHARED|TYPE_ANY)

specifies where the program is to be loaded from.

PRIVATE

The program is in the relocatable program library (RPL). A PRIVATE program need not be reentrant, and is given only limited protection against unauthorized overwriting. The degree of protection depends on the type of dynamic storage area into which the program is loaded (see the description of the PROGRAM_TYPE option of the DEFINE_PROGRAM call).

SHARED

The program is located in the link pack area (LPA), is reentrant, and is protected.

TYPE_ANY

Either the RPL or the LPA copy of the program can be used, though preference is given to the LPA copy.

PROGRAM_USAGE(APPLICATION|NUCLEUS)

specifies whether the program is used as a CICS nucleus program or as a user application program.

REQUIRED_AMODE(24|31|AMODE_ANY)

specifies the addressing mode of the program. If, during subsequent processing, no copy of the program that meets the defined addressing requirement can be found, an exception occurs.

Notes:

1. AMODE_ANY and 31 have identical meanings for this function.
2. You cannot use this option to override the link-edited addressing mode of the program.

REQUIRED_RMODE(24|AMODE_ANY)

specifies the residency mode of the program (that is, whether it is to be loaded above or below the 16MB line). If, during subsequent processing, no copy of the program that meets the defined residency requirement can be found, an exception occurs.

Note: You cannot use this option to override the link-edited residency mode of the program.

program management functions

RESPONSE and REASON values for SET_PROGRAM:

<i>RESPONSE</i>	<i>REASON</i>
OK	None
EXCEPTION	CEDF_STATUS_NOT_FOR_MAPSET CEDF_STATUS_NOT_FOR_PTNSSET CEDF_STATUS_NOT_FOR_REMOTE EXEC_KEY_NOT_FOR_MAPSET EXEC_KEY_NOT_FOR_PTNSSET EXEC_KEY_NOT_FOR_REMOTE EXEC_SET_NOT_FOR_MAPSET EXEC_SET_NOT_FOR_PTNSSET EXEC_SET_NOT_FOR_REMOTE PROGRAM_NOT_DEFINED_TO_LD PROGRAM_NOT_DEFINED_TO_PG
DISASTER	ABEND CATALOG_ERROR CATALOG_NOT_OPERATIONAL LOCK_ERROR
INVALID	INVALID_MODE_COMBINATION INVALID_PROGRAM_NAME INVALID_PROGRAM_TOKEN INVALID_TYPE_ATTRIB_COMBIN
KERNERROR	None
PURGED	None

The START_BROWSE_PROGRAM call

START_BROWSE_PROGRAM returns a token that enables you to begin browsing through program definitions, optionally starting at the definition of a specified program.

START_BROWSE_PROGRAM

```
DFHPGISX [CALL,]  
  [CLEAR,]  
  [IN,  
  FUNCTION(START_BROWSE_PROGRAM),  
  [PROGRAM_NAME(name8 | string | 'string'),]  
  [OUT,  
  BROWSE_TOKEN(name4)  
  RESPONSE(name1 | *),  
  REASON(name1 | *)]
```

BROWSE_TOKEN(name4)

returns a token to be used on a GET_NEXT_PROGRAM call, to initiate a sequential browse of program definitions.

name4

The name of a location to receive a 4-byte token.

PROGRAM_NAME(name8 | string | 'string')

specifies the name of the program whose definition you want to look at first. The browsing sequence is alphabetical. If there is no program with the specified name, CICS returns a token for the next definition in the alphabetic sequence. If you do not specify a program, CICS returns a token for the first definition.

name8

The name of a location containing an 8-byte program name.

program management functions

string A string of characters naming the program.

'string'

A string of characters in quotation marks. The string length is set to 8 by padding with blanks or truncating.

RESPONSE and REASON values for START_BROWSE_PROGRAM:

<i>RESPONSE</i>	<i>REASON</i>
OK	None
EXCEPTION	None
DISASTER	ABEND INVALID_DIRECTORY LOCK_ERROR
INVALID	None
KERNERROR	None
PURGED	None

The GET_NEXT_PROGRAM call

GET_NEXT_PROGRAM allows you to inquire on the next program definition during a browse sequence initiated by START_BROWSE_PROGRAM. The browsing sequence is alphabetical. The end of the alphabetic list of definitions is indicated by an 'END_LIST' exception response.

program management functions

GET_NEXT_PROGRAM

```
DFHPGISX [CALL,]
  [CLEAR,]
  [IN,
  FUNCTION(GET_NEXT_PROGRAM),
  BROWSE_TOKEN(name4),]
  [OUT,
  PROGRAM_NAME(name8),
  [ACCESS(CICS|NONE|READ_ONLY|USER),]
  [AVAIL_STATUS(DISABLED|ENABLED),]
  [CEDF_STATUS(CEDF|NOCEDF|NOT_APPLIC),]
  [DATA_LOCATION(ANY|BELOW|NOT_APPLIC),]
  [ENTRY_POINT(name4),]
  [EXECUTION_KEY(CICS|NOT_APPLIC|USER),]
  [EXECUTION_SET(DPLSUBSET|FULLAPI|NOT_APPLIC),]
  [HOLD_STATUS(CICS_LIFE|NOT_APPLIC|TASK_LIFE),]
  [INSTALL_TYPE(AUTO|CATALOG|GROUPLIST|MANUAL|RDO|SYSAUTO),]
  [LANGUAGE_DEDUCED(ASSEMBLER|C370|COBOL|
    COBOL2|LE370|NOT_APPLIC|NOT_DEDUCED|PLI),]
  [LANGUAGE_DEFINED(ASSEMBLER|C370|COBOL|
    LE370|NOT_APPLIC|NOT_DEFINED|PLI),]
  [LOAD_POINT(name4),]
  [LOAD_STATUS(LOADABLE|NOT_APPLIC|NOT_LOADABLE|NOT_LOADED),]
  [LOCATION(CDSA|ECDSA|ELPA|ERDSA|ESDSA|LPA|NONE|RDSA|SDSA),]
  [MODULE_TYPE(MAPSET|PARTITIONSET|PROGRAM),]
  [NEW_PROGRAM_TOKEN(name4),]
  [PROGRAM_ATTRIBUTE(RELOAD|RESIDENT|REUSABLE|TRANSIENT),]
  [PROGRAM_LENGTH(name4),]
  [PROGRAM_TYPE(NOT_APPLIC|PRIVATE|SHARED|TYPE_ANY),]
  [PROGRAM_USAGE(APPLICATION|NUCLEUS),]
  [PROGRAM_USE_COUNT(name4),]
  [PROGRAM_USER_COUNT(name4),]
  [REMOTE_DEFINITION(LOCAL|REMOTE),]
  [REMOTE_PROGID(name8),]
  [REMOTE_SYSID(name4),]
  [REMOTE_TRANID(name4),]
  [SPECIFIED_AMODE(24|31|AMODE_ANY|AMODE_NOT_SPECIFIED),]
  [SPECIFIED_RMODE(24|RMODE_ANY|RMODE_NOT_SPECIFIED),]
  RESPONSE(name1 | *),
  REASON(name1 | *)]
```

Note: The options not described in the following list are identical to the equivalent options of the INQUIRE_PROGRAM call.

BROWSE_TOKEN(name4)

specifies a token identifying the definition to be browsed. This can be either the token returned in the NEW_PROGRAM_TOKEN field of the last GET_NEXT_PROGRAM call, or that in the BROWSE_TOKEN field of the START_BROWSE_PROGRAM call (this token is updated after every GET_PROGRAM call).

name4

The name of a location containing a 4-byte token.

NEW_PROGRAM_TOKEN(name4)

returns a token that identifies the next definition in the browse sequence. You can use it in the BROWSE_TOKEN field of your next GET_NEXT_PROGRAM call (or END_BROWSE_PROGRAM call, if you want to end the sequence). You can also use it in the PROGRAM_TOKEN field of INQUIRE_PROGRAM and SET_PROGRAM calls.

name4

The name of a location to receive a 4-byte token that identifies the next program definition.

RESPONSE and REASON values for GET_NEXT_PROGRAM:

<i>RESPONSE</i>	<i>REASON</i>
OK	None
EXCEPTION	END_LIST
	INVALID_BROWSE_TOKEN
	PROGRAM_NOT_DEFINED_TO_LD
DISASTER	ABEND
	LOCK_ERROR
INVALID	None
KERNERROR	None
PURGED	None

The END_BROWSE_PROGRAM call

END_BROWSE_PROGRAM allows you to end a browse of program definitions initiated by START_BROWSE_PROGRAM.

END_BROWSE_PROGRAM

```
DFHPGISX [CALL,]
          [CLEAR,]
          [IN,
          FUNCTION(END_BROWSE_PROGRAM),
          BROWSE_TOKEN(name4),]
          [OUT,
          RESPONSE(name1 | *),
          REASON(name1 | *)]
```

BROWSE_TOKEN(name4)

specifies either the token returned in the NEW_PROGRAM_TOKEN field of the last GET_NEXT_PROGRAM call, or that in the BROWSE_TOKEN field of the START_BROWSE_PROGRAM call (this token is updated after every GET_NEXT_PROGRAM call).

RESPONSE and REASON values for END_BROWSE_PROGRAM:

<i>RESPONSE</i>	<i>REASON</i>
OK	None
EXCEPTION	INVALID_BROWSE_TOKEN
DISASTER	ABEND
	LOCK_ERROR
INVALID	None
KERNERROR	None
PURGED	None

program management functions

The INQUIRE_AUTOINSTALL call

INQUIRE_AUTOINSTALL returns information about the current settings of the autoinstall function for programs, mapsets, and partitionsets.

INQUIRE_AUTOINSTALL

```
DFHPGAQX [CALL,]
          [CLEAR,]
          [IN,
          FUNCTION(INQUIRE_AUTOINSTALL),]
          [OUT,
          [AUTOINSTALL_CATALOG (ALL|MODIFY|NONE),]
          [AUTOINSTALL_EXIT_NAME(name8),]
          [AUTOINSTALL_STATE (ACTIVE|INACTIVE),]
          RESPONSE(name1 | *),
          REASON(name1 | *)]
```

AUTOINSTALL_CATALOG(ALL|MODIFY|NONE)

returns the catalog status for autoinstalled program definitions.

ALL All autoinstalled program, map, and partitionset definitions are cataloged.

MODIFY

Autoinstalled program, map, and partitionset definitions are recorded on the CICS global catalog only if they are modified by a SET PROGRAM command after being autoinstalled.

NONE No autoinstalled program, map, or partitionset definitions are cataloged.

AUTOINSTALL_EXIT_NAME(name8)

returns the name of the user-replaceable autoinstall control program for programs, mapsets, and partitionsets.

AUTOINSTALL_STATE(ACTIVE|INACTIVE)

returns the status of the program autoinstall function.

ACTIVE

Autoinstall is enabled for programs, mapsets, and partitionsets.

INACTIVE

Autoinstall is not enabled for programs, mapsets, and partitionsets.

RESPONSE and REASON values for INQUIRE_AUTOINSTALL:

<i>RESPONSE</i>	<i>REASON</i>
OK	None
EXCEPTION	None
DISASTER	None
INVALID	INVALID_FUNCTION
KERNERROR	None
PURGED	None

The SET_AUTOINSTALL call

SET_AUTOINSTALL enables you to change the settings of the autoinstall function for programs, mapsets, and partitionsets.

SET_AUTOINSTALL

```
DFHPGAQX [CALL,]
          [CLEAR,]
          [IN,
           FUNCTION(SET_AUTOINSTALL),
           [AUTOINSTALL_CATALOG (ALL|MODIFY|NONE),]
           [AUTOINSTALL_EXIT_NAME(name8),]
           [AUTOINSTALL_STATE (ACTIVE|INACTIVE),]
           [LANGUAGES_AVAILABLE(NO|YES),]]
          [OUT,
           RESPONSE(name1 | *),
           REASON(name1 | *)]
```

AUTOINSTALL_CATALOG(ALL|MODIFY|NONE)

specifies the catalog status for autoinstalled program definitions.

ALL All autoinstalled program, map, and partitionset definitions are to be cataloged.

MODIFY

Autoinstalled program, map, and partitionset definitions are to be recorded on the CICS global catalog only if they are modified by a SET PROGRAM command after being autoinstalled.

NONE No autoinstalled program, map, or partitionset definitions are to be cataloged.

AUTOINSTALL_EXIT_NAME(name8)

specifies the name of the user-replaceable autoinstall control program for programs, mapsets, and partitionsets.

AUTOINSTALL_STATE(ACTIVE|INACTIVE)

specifies the status of the program autoinstall function.

ACTIVE

Enable autoinstall for programs, mapsets, and partitionsets.

INACTIVE

Disable autoinstall for programs, mapsets, and partitionsets.

LANGUAGES_AVAILABLE(NO|YES)

specifies whether the autoinstall control program can be called. It can only be called after language establishment.

NO The control program cannot be called.

YES The control program can be called.

RESPONSE and REASON values for SET_AUTOINSTALL:

<i>RESPONSE</i>	<i>REASON</i>
OK	None
EXCEPTION	None
DISASTER	None
INVALID	INVALID_FUNCTION
KERNERROR	None
PURGED	None

State data access functions

The state data access functions allow you to inquire on and set certain system data in the AP domain.

The INQ_APPLICATION_DATA call

The INQ_APPLICATION_DATA call enables you to inquire on application system data in the AP domain.

INQ_APPLICATION_DATA

```
DFHAPIQX [CALL,]
  [CLEAR,]
  [IN,
  FUNCTION(INQ_APPLICATION_DATA),]
  [OUT,
  [DSA(name4 | (Rn) | * ),]
  [EIB(name4 | (Rn) | * ),]
  [RSA(name4 | (Rn) | * ),]
  [SYSEIB(name4 | (Rn) | * ),]
  [TCTUA(name4 | (Rn) | * ),]
  [TCTUASIZE(name4 | * ),]
  [TWA(name4 | (Rn) | * ),]
  [TWASIZE(name4 | (Rn) | * ),]
  RESPONSE (name1 | * ),
  REASON (name1 | * )]
```

DSA(name4 | (Rn) | *)

returns the head of the chain of dynamic storage used by application programs to make them reentrant (for example, for assembler programs, the DFHEISTG storage).

name4

The name of a 4-byte area that is to receive the address of the head of the dynamic storage chain.

(Rn) A register that is to receive the DSA address.

* The parameter list itself, in name APIQ_DSA, is used to hold the address.

EIB(name4 | (Rn) | *)

returns the address of the EXEC interface block (EIB) for the current task.

name4

The name of a fullword area that is to receive the address of the EIB.

(Rn) A register that is to receive the address of the EIB.

* The parameter list itself, in name APIQ_EIB, is used to hold the address.

RSA(name4 | (Rn) | *)

returns the address of the register save area for the current task.

name4

The name of a fullword area that is to receive the address of the register save area.

(Rn) A register that is to receive the address of the register save area.

* The parameter list itself, name APIQ_RSA, is used to hold the address.

SYSEIB(name4 | (Rn) | *)

returns the address of the system EXEC interface block of the current task.

name4

The name of a fullword area that is to receive the address of the system EXEC interface block.

(Rn) A register that is to receive the address of the system EXEC interface block.

* The parameter list itself, name APIQ_SYSEIB, is used to hold the address.

TCTUA(name4 | (Rn) | *)

returns the address of the terminal control table user area (TCTUA) for the current task.

name4

The name of a fullword area that is to receive the address of the TCTUA.

(Rn) A register that is to receive the address of the TCTUA.

* The parameter list itself, name APIQ_TCTUA, is used to hold the address.

TCTUASIZE(name4 | (Rn) | *)

returns the length in bytes of the TCTUA for the current task.

name4

The name of a 4-byte area that is to receive the length in bytes of the TCTUA.

(Rn) A register that is to receive the length of the TCTUA.

* The parameter list itself, name APIQ_TCTUASIZE, is used to hold the length of the TCTUA.

TWA(name4 | (Rn) | *)

returns the address of the transaction work area.

name4

The name of a fullword area that is to receive the address of the TWA.

(Rn) A register that is to receive the address of the TWA.

* The parameter list itself, name APIQ_TWA, is used to hold the address of the TWA.

TWASIZE(name4 | (Rn) | *)

returns the length, in bytes, of the transaction work area (TWA).

name4

The name of a 4-byte area that is to receive the length, in bytes, of the TWA.

(Rn) A register that is to receive the length of the TWA.

* The parameter list itself, name APIQ_TWASIZE, is used to hold the length of the TWA.

state data access functions

RESPONSE and REASON values for INQ_APPLICATION_DATA:

<i>RESPONSE</i>	<i>REASON</i>
OK	None
EXCEPTION	DPL_PROGRAM
	NO_TRANSACTION_ENVIRONMENT
	TRANSACTION_DOMAIN_ERROR
DISASTER	ABEND
	LOOP
	INQ_FAILED
INVALID	INVALID_FUNCTION
KERNERROR	None
PURGED	None

The INQUIRE_SYSTEM call

The INQUIRE_SYSTEM call gives you access to CICS system data in the AP domain.

INQUIRE_SYSTEM

```
DFHSAIQX [CALL,]
  [CLEAR,]
  [IN,
  FUNCTION(INQUIRE_SYSTEM),
  [GMMTEXT(name4),]]
  [OUT,
  [CICSREL(name4 | *),]
  [CICSSTATUS(ACTIVE | FINALQUIESCE |
  FIRSTQUIESCE| INITIALIZING),]
  [CICSSYS(name1 | *),]
  [CICTSLEVEL(name6 | *),]
  [CWA(name4 | (Rn) | *),]
  [CWALENGTH(name2 | *),]
  [DATE(name4|*),]
  [DTRPRGRM(name8 | *),]
  [GMMLENGTH(name2 | *),]
  [GMMTRANID(name4 | *),]
  [INITSTATUS(FIRSTINIT | INITCOMPLETE | SECONDINIT |
  THIRDDINIT),]
  [JOBNAME(name8 | *),]
  [OPREL(name2 | *),]
  [OPSYS(name1 | *),]
  [OSLEVEL(name4 | *),]
  [PLTPI(name2 | *),]
  [SDTRAN(name4 | *),]
  [SECURITYMGR(EXTSECURITY | NOSECURITY),]
  [SHUTSTATUS(CONTROLSHUT | NOTSHUTDOWN | SHUTDOWN),]
  [STARTUP(COLDSTART | EMERGENCY | WARMSTART),]
  [STARTUPDATE(name4| *),]
  [TERMURM(name8 | *),]
  [TIMEOFDAY(name4 | *),]
  [XRFSTATUS(NOXRF | PRIMARY | TAKEOVER),]
  RESPONSE (name1 | * ),
  REASON (name1 | * )]
```

CICSREL(name4 | *)

returns the level number of the CICS code under which the CICS region is running.

name4

The name of a 4-byte location that is to receive the level number characters as hexadecimal values.

CICSSTATUS(ACTIVE|FINALQUIESE|FIRSTQUIESCE|INITIALIZING)

returns the status of the CICS region.

ACTIVE

The CICS region is active and ready to receive work.

FINALQUIESCE

The CICS region is shutting down, and is in the final stage of quiescing.

FIRSTQUIESCE

The CICS region is shutting down, and is in the first stage of quiescing.

INITIALIZING

The CICS region is initializing.

state data access functions

CICSSYS(name1 | *)

returns the operating system for which the running CICS has been built.

name1

The name of a 1-byte area that is to receive the hexadecimal character of the operating system. A value of "X" represents MVS/ESA.

CICSTSLEVEL(name6 | *)

returns the release of CICS Transaction Server under which CICS is running.

name6

The name of a 6-byte area that is to receive the release characters as hexadecimal values.

CWA(name4 | (Rn) | *)

returns the address of the common work area.

name4

The name of a 4-byte field that is to receive the address of the CWA.

(Rn) A register to receive the address of the CWA.

CWALENGTH(name2 | *)

returns the length in bytes of the CWA.

name2

The name of a 2-byte field that is to receive the length of the CWA.

DATE(name4 | *)

returns today's date in packed-decimal form—4-bytes **0iyydddc**, where:

i is a century indicator. (0=1900, 1=2000, 2=2100, and so on.)

yy=years.

ddd=days.

c is the sign.

name4

The name of a 4-byte location that is to receive the date.

DTRPRGRM(name8 | *)

returns the name of the dynamic routing program.

name8

The name of an 8-byte area that is to receive the name of the dynamic routing program.

GMMLENGTH(name2 | *)

returns the length in bytes of the "good morning" message.

name2

The name of a 2-byte area that is to receive the length of the good morning message.

GMMTEXT(name4)

specifies the address of an area of storage, at least 244 bytes in length and owned by the caller, into which CICS is to return the good morning message.

name4

The address of an area of storage that is to receive the good morning message.

Note: The GMMTEXT parameter must follow the IN statement as an input parameter.

GMMTRANID(name4 | *)

returns the transaction identifier of the CICS good morning transaction.

name4

The name of a 4-byte area that is to receive the CICS good morning transaction id.

INITSTATUS(FIRSTINIT|INITCOMPLETE|SECONDINIT|THIRDINIT)

returns a value indicating the stage reached during CICS initialization.

FIRSTINIT

The first stage of CICS initialization.

INITCOMPLETE

CICS initialization is complete.

SECONDINIT

The second stage of CICS initialization. This stage corresponds to the period when first phase PLTPI programs are run; that is those programs in a PLT that are defined **before** the DFHDELIM statement.

THIRDINIT

The third stage of CICS initialization. This stage corresponds to the period when second phase PLTPI programs are run; that is those programs in a PLT that are defined **after** the DFHDELIM statement.

JOBNAME(name8 | *)

returns the 8-character MVS job name under which the CICS region is running.

name8

The name of a 8-byte area that is to receive the MVS job name.

OPREL(name2 | *)

returns the last 2 digits of the level number of the MVS element of OS/390, under which the CICS region is running.

name2

The name of a 2-byte area that is to receive, as a half-word binary value, the level number of the MVS element of OS/390. For example, OS/390 Release 3 MVS is represented by 03.

Note: This field is supported for compatibility purposes only. The information is derived from the last two numbers held in the MVS CVTPRODN field. For example, CVTPRODN holds SP5.2.2 for MVS/ESA SP Version 5 Release 2.2 (in which case OPREL returns 22), and SP6.0.3 for OS/390 Release 3. You are recommended to use the OSLEVEL field for the full version and release number of the OS/390 product.

OPSYS(name1 | *)

returns the type of operating system on which the CICS regions is running.

name1

The name of a 1-byte area that is to receive the hexadecimal character of the operating system on which CICS is running. A value of "X" represents MVS/ESA.

OSLEVEL(name4 | *)

is the version, release, and modification level of the OS/390 product on which CICS is running.

state data access functions

name1

The name of a 4-byte area that is to receive the version and release number of OS/390 on which CICS is running. A value of "0240" represents OS/390 Release 4.

PLTPI(name2 | *)

returns the suffix that identifies the program list table (PLT) containing the list of programs to be run during CICS initialization—the program list table post initialization (PLTPI) list.

name2

The name of a 2-byte area that is to receive the suffix.

SDTRAN(name4 | *)

returns the name of the "shutdown assist" transaction to be run at the beginning of normal or immediate shutdown. The shutdown assist transaction is described on page 395.

name4

The name of a 4-byte area to receive the name.

SECURITYMGR(EXTSECURITY|NOSECURITY)

returns a value indicating whether security is active.

EXTSECURITY

CICS is using an external security manager (for example, RACF).

NOSECURITY

Security is not in use in the CICS region—SEC=NO is specified as a system initialization parameter.

SHUTSTATUS(CONTROLSHUT|NOTSHUTDOWN|SHUTDOWN)

returns the shutdown status of the CICS region.

CONTROLSHUT

CICS is performing a controlled shutdown; that is, a normal shutdown with a warm keypoint.

NOTSHUTDOWN

CICS is not in shutdown mode.

SHUTDOWN

CICS is performing an immediate shutdown.

STARTUP(COLDSTART|EMERGENCY|WARMSTART)

returns the type of startup the CICS region performed.

COLDSTART

CICS performed a cold start, either because this was explicitly specified on the system initialization parameter, or because CICS forced a cold start because of the state of the global catalog.

EMERGENCY

CICS performed an emergency restart because the previous run did not shut down normally with a warm keypoint.

WARMSTART

CICS performed a warm restart following the normal shutdown of the previous run.

STARTUPDATE(name4 | *)

returns the start-up-date of this CICS region, in packed decimal form (4-bytes **00yydddc** where **yy**=years, **ddd**=days, **c** is the sign).

name4

The name of a 4-byte location that is to receive the startup date of this CICS system.

TERMURM(name8 | *)

returns the name of the autoinstall user program for terminals.

name8

The name of an 8-byte area that is to receive the name of the autoinstall user program for terminals.

TIMEOFDAY(name4 | *)

returns the current time-of-day in packed decimal form (4-bytes **hhmmsstc** where **hh**=hours, **mm**=minutes, **ss**=seconds, **t**=tenths of a second, and **c** is the sign).

name4

The name of a 4-byte location that is to receive the time.

XRFSTATUS(NOXRF|PRIMARY|TAKEOVER)

returns the XRF status of the CICS region.

NOXRF

CICS was started with the system initialization parameter XRF=NO specified. XRF is not active.

PRIMARY

The CICS region was started as an active CICS in an XRF environment.

TAKEOVER

The CICS region was started as an alternate CICS, with the START=STANDBY system initialization parameter.

RESPONSE and REASON values for INQUIRE_SYSTEM

<i>RESPONSE</i>	<i>REASON</i>
OK	None
INVALID	INVALID_FUNCTION
EXCEPTION	LENGTH_ERROR
	UNKNOWN_DATA
DISASTER	INQ_FAILED
PURGED	None

The SET_SYSTEM call

The SET_SYSTEM call allows you to set CICS system data values in the AP domain.

state data access functions

SET_SYSTEM

```
DFHSAIQX [CALL,]
  [CLEAR,]
  [IN,
  FUNCTION(SET_SYSTEM),
  [DTRPRGRM(name8 | string | 'string'),]
  [GMMLNGTH(name2 | (Rn) | expression),]
  [GMMTEXT(name8 | (Rn)),]]
  [OUT,
  RESPONSE (name1 | * ),
  REASON (name1 | * )]
```

DTRPRGRM(name8 | string | 'string')

specifies the name of the dynamic routing program.

name8

The name of an 8-byte area that contains the name of the dynamic routing program.

string A string of character, without intervening blanks, that defines the name of the dynamic routing program being set.

'string'

A string of character without intervening blanks. If you want to document a name (label) in your program, use this form.

GMMLNGTH(name2 | (Rn))

specifies the length of the new "good morning" message supplied by the GMMTEXT parameter.

name2

The name of a 2-byte area that contains, as a half-word binary value, the length of the new good morning message.

(Rn) A register that contains the length of the new good morning message.

GMMTEXT(name4 | (Rn))

specifies the new good morning message.

name4

The name of a 4-byte location that contains the address of a storage area (up to a maximum of 246 bytes long) that contains the good morning message.

(Rn) A register that contains the address of a storage area (up to a maximum of 246 bytes long) that contains the good morning message.

RESPONSE and REASON values for SET_SYSTEM:

<i>RESPONSE</i>	<i>REASON</i>
OK	None
INVALID EXCEPTION	INVALID_FUNCTION
	AKP_SIZE_ERROR
	NO_KEYPOINT
DISASTER	SET_FAILED
PURGED	None

Storage control functions

There are seven XPI storage control functions. These are the DFHSMCX macro calls GETMAIN, FREEMAIN, INQUIRE_ELEMENT_LENGTH, and INQUIRE_TASK_STORAGE, and the DFHMSRX calls INQUIRE_ACCESS, INQUIRE_SHORT_ON_STORAGE, and SWITCH_SUBSPACE.

DFHSMCX calls cannot be used in any exit program invoked from any global user exit point in the:

- Dispatcher domain
- Dump domain
- Monitor domain
- Statistics domain
- Transient data program.

The GETMAIN call

GETMAIN acquires an element of storage for use by your exit program. You can ask for a particular CLASS of storage, and you can request that it be initialized to a single-byte value.

Storage in the following classes, acquired by a GETMAIN call, is released by CICS when the TCA being used at the time of the acquisition terminates:

CICS
CICS24
USER
USER24.

In contrast, storage in the following classes is **not** released automatically at task-end: you should use the FREEMAIN call to release it:

SHARED_CICS
SHARED_CICS24
SHARED_USER
SHARED_USER24
TERMINAL.

In addition, some user exits may be invoked from system tasks, and in these circumstances storage is not released until the next CICS shutdown. Therefore you should use FREEMAIN to release all storage areas acquired by GETMAIN as soon as you have finished using them.

storage control functions

GETMAIN

```
DFHSMCX [CALL,]
  [CLEAR,]
  [IN,
  FUNCTION(GETMAIN),
  GET_LENGTH(name4 | (Rn) | expression),
  STORAGE_CLASS(CICS|CICS24|SHARED_CICS|SHARED_CICS24|
    SHARED_USER|SHARED_USER24|USER|USER24|TERMINAL),
  SUSPEND(NO|YES),
  [INITIAL_IMAGE(name1 | literalconst),]
  [TCTTE_ADDRESS(name4 | (Ra)),]]
  [OUT,
  ADDRESS(name4 | (Rn) | *),
  RESPONSE(name1 | *),
  REASON(name1 | *)]
```

ADDRESS(name4 | (Rn) | *)

returns the address of the storage obtained by the call.

name4

The name of a fullword where the obtained storage address is saved

(Rn) A register that is set to point to the obtained storage

* The parameter list itself, name SMMC_ADDRESS, is used to keep the address.

GET_LENGTH(name4 | (Rn) | expression)

specifies the number of bytes of storage you want, expressed in any of the following ways:

name4

The name of a fullword specifying, in binary, the number of bytes

(Rn) A register containing, in binary, the number of bytes

expression

A valid assembler-language expression; for instance, a number, a symbolic expression, or a combination of the two.

If you request TERMINAL storage, the length you specify should not include the length of the storage accounting area (SAA). The maximum length you can specify is 65 515 bytes. CICS storage management adds an 8-byte SAA, and the address returned by the XPI call is that of the start of the SAA.

If you request CICS24, CICS, USER24, USER, SHARED_CICS24, SHARED_CICS, SHARED_USER24, or SHARED_USER storage, you need only specify the length needed by your program. The address returned is that of the start of your data storage. The maximum size of storage for these storage classes is the same as the size of the DSA from which they are allocated.

INITIAL_IMAGE(name1 | literalconst)

specifies the initializing pattern. For example, you might want to set the acquired storage to binary zeros.

name1

The name of a location where the one-byte initializing pattern is stored

literalconst

A number in the form of a literal, for example B'00000000', X'FF', X'FC', "0", or an equate symbol with a similar value.

STORAGE_CLASS(CICS|CICS24|SHARED_CICS|SHARED_CICS24|

SHARED_USER|SHARED_USER24|USER|USER24|TERMINAL)

specifies the class of the storage that is the subject of the call. The values you can assign to this option, and the type of storage each represents, are listed in Table 17.

Table 17. CICS storage classes

STORAGE_CLASS	Type of storage
CICS	Task-lifetime CICS-key storage above 16MB
CICS24	Task-lifetime CICS-key storage below 16MB
SHARED_CICS	Shared CICS-key storage above 16MB
SHARED_CICS24	Shared CICS-key storage below 16MB
SHARED_USER	Shared user-key storage above 16MB
SHARED_USER24	Shared user-key storage below 16MB
TERMINAL	This class of storage has an 8-byte SAA.
USER	Task-lifetime user-key storage above 16MB
USER24	Task-lifetime user-key storage below 16MB

You must specify a storage class on a GETMAIN request. On a FREEMAIN request it is an optional parameter, and any value that you specify is not checked by CICS.

SUSPEND(YES|NO)

specifies whether to suspend your request if there is less storage available than you have asked for on the GET_LENGTH option.

TCTTE_ADDRESS(name4 | (Ra))

specifies the address of the terminal control table terminal entry (TCTTE). On GETMAIN requests, you must code this option if, on the STORAGE_CLASS option, you specify a class of TERMINAL. On FREEMAIN requests, you must code it if you are freeing TERMINAL-class storage.

Note: Before obtaining TERMINAL class storage, check TCAFCI bit 7 to ensure that the TCA is running under a terminal.

name4

The name of a fullword containing the address

(Ra) A register that points to the TCTTE.

RESPONSE and REASON values for GETMAIN:

RESPONSE	REASON
OK	None
EXCEPTION	INSUFFICIENT_STORAGE
DISASTER	None
INVALID	None
KERNERROR	None
PURGED	None

Notes:

1. For more detail, refer to the explanation of RESPONSE and REASON in “General form of an XPI call” on page 286.

storage control functions

2. 'INSUFFICIENT_STORAGE' is returned if the GETMAIN request was specified with SUSPEND(NO), and there was not enough storage available to satisfy the request.
3. 'PURGED' is returned if the GETMAIN request was specified with SUSPEND (YES), there was not enough storage to satisfy the request, and the task was purged.

The FREEMAIN call

FREEMAIN releases an area of storage that is currently allocated to your exit program.

FREEMAIN

```
DFHSMCX [CALL,]  
  [CLEAR,]  
  [IN,  
  FUNCTION(FREEMAIN),  
  ADDRESS(name4 | (Rn) | *),  
  [STORAGE_CLASS(CICS|CICS24|SHARED_CICS|SHARED_CICS24|  
    SHARED_USER|SHARED_USER24|USER|USER24|TERMINAL),]  
  [TCTTE_ADDRESS(pointer),]  
  [OUT,  
  RESPONSE(name1 | *),  
  REASON(name1 | *)]
```

The explanation of the options is the same as that given above for the GETMAIN function.

RESPONSE and REASON values for FREEMAIN:

<i>RESPONSE</i>	<i>REASON</i>
OK	None
EXCEPTIONNone	None
DISASTER	None
INVALID	None
KERNERROR	None
PURGED	None

Note: For more detail, refer to the explanation of RESPONSE and REASON in "General form of an XPI call" on page 286.

The INQUIRE_ACCESS call

INQUIRE_ACCESS returns the access-key of an element of storage specified by start address and length. If the element is not wholly contained within one of the CICS dynamic storage areas (DSAs), CICS returns an exception response.

INQUIRE_ACCESS

```

DFHMSRX [CALL,]
        [CLEAR,]
        [IN,
        FUNCTION(INQUIRE_ACCESS),
        ELEMENT_ADDRESS(name4 | (Rn) | *),
        ELEMENT_LENGTH(name4 | (Rn) | *),]
        [OUT,
        ACCESS(CICS | READ_ONLY | USER),
        RESPONSE(name1 | *),
        REASON(name1 | *)]

```

ACCESS(CICS|READ_ONLY|USER)

returns the access-key of the storage element.

CICS CICS-key

READ_ONLY

Readonly storage

USER User-key.

ELEMENT_ADDRESS(name4 | (Rn) | *)

specifies the address of the storage element.

ELEMENT_LENGTH(name4 | (Rn) | *)

specifies the length of the storage element, in bytes. A length of zero is treated as a length of one.

RESPONSE and REASON values for INQUIRE_ACCESS:

<i>RESPONSE</i>	<i>REASON</i>
OK	None
EXCEPTION	INVALID_ELEMENT
DISASTER	None
INVALID	None
KERNERROR	None

The INQUIRE_ELEMENT_LENGTH call

INQUIRE_ELEMENT_LENGTH enables you to pass the address of any part of an element of task-lifetime storage, and to obtain from CICS the start address and the length of the storage element that contains the passed address.

storage control functions

INQUIRE_ELEMENT_LENGTH

```
DFHSMCX [CALL,]
        [CLEAR,]
        [IN,
        FUNCTION (INQUIRE_ELEMENT_LENGTH),
        ADDRESS (name4 | (Rn) | *),]
        [OUT,
        ELEMENT_ADDRESS(name4 | (Rn) | *),
        ELEMENT_LENGTH(name4 | (Rn) | *),
        RESPONSE (name1 | *),
        REASON (name1 | *)]
```

ADDRESS(name4 | (Rn) | *)

specifies an address that lies within an element of task-lifetime storage of the current task.

CICS accepts addresses that reference the leading or trailing check zones as being valid addresses for the element of storage you are inquiring upon.

ELEMENT_ADDRESS(name4 | (Rn) | *)

returns the start address of the element of task-lifetime storage referenced by the ADDRESS parameter. The start address returned does **not** include the leading check zone.

ELEMENT_LENGTH(name4 | (Rn) | *)

returns the length of the element of task-lifetime storage referenced by the ADDRESS parameter. The length returned does **not** include the leading or trailing check zones.

RESPONSE and REASON values for INQUIRE_ELEMENT_LENGTH:

<i>RESPONSE</i>	<i>REASON</i>
OK	None
EXCEPTION	INVALID_ADDRESS
DISASTER	None
INVALID	None
KERNERROR	None
PURGED	None

The INQUIRE_SHORT_ON_STORAGE call

INQUIRE_SHORT_ON_STORAGE enables you to determine whether CICS is short on storage either above or below the 16MB line.

INQUIRE_SHORT_ON_STORAGE

```
DFHMSRX [CALL,]
        [CLEAR,]
        [IN,
        FUNCTION(INQUIRE_SHORT_ON_STORAGE),]
        [OUT,
        SOS_ABOVE_THE_LINE(NO|YES),
        SOS_BELOW_THE_LINE(NO|YES),
        RESPONSE (name1 | *),
        REASON (name1 | *)]
```

SOS_ABOVE_THE_LINE(NO|YES),

returns YES if CICS is currently short-on-storage in any of the DSAs above the 16MB line, and NO if not.

SOS_BELOW_THE_LINE(NO|YES),

returns YES if CICS is currently short-on-storage in any of the DSAs below the 16MB line, and NO if not.

RESPONSE and REASON values for INQUIRE_SHORT_ON_STORAGE:

<i>RESPONSE</i>	<i>REASON</i>
OK	None
DISASTER	None
KERNERROR	None

The INQUIRE_TASK_STORAGE call

INQUIRE_TASK_STORAGE enables you to request details of all elements of task-lifetime storage belonging to a task. You can specify the transaction number of the task explicitly on the call, or let it default to the current task.

INQUIRE_TASK_STORAGE

```
DFHSMCX [CALL,]
        [CLEAR,]
        [IN,
        FUNCTION (INQUIRE_TASK_STORAGE),
        [TRANSACTION_NUMBER(name4 | (Rn) | *),]
        ELEMENT_BUFFER(buffer-descriptor),
        LENGTH_BUFFER(buffer-descriptor),]
        [OUT,
        NUMBER_OF_ELEMENTS(name4 | (Rn) | *),
        RESPONSE (name1 | *),
        REASON (name1 | *)]
```

ELEMENT_BUFFER(buffer-descriptor)

defines the address and length of a buffer into which CICS returns a list of start addresses of all the elements of task-lifetime storage belonging to either the specified task or, by default, the current task.

The start addresses returned do **not** include the leading check zone. For a description of a buffer descriptor, see 299.

LENGTH_BUFFER(buffer-descriptor)

defines the address and length of a buffer into which CICS returns a list of the

storage control functions

lengths of the elements of task-lifetime storage belonging to either the specified task or, by default, the current task. The lengths returned do **not** include the leading or trailing check zones.

For a description of a buffer descriptor, see 299.

NUMBER_OF_ELEMENTS(name4 | (Rn) | *)

returns the number of entries in each of the two buffers, ELEMENT_BUFFER and LENGTH_BUFFER, as a full-word binary value.

TRANSACTION_NUMBER(name4 | (Rn) | *)

specifies, as a 4 byte packed decimal value, the transaction number of the task to whom the storage belongs.

If you omit the transaction (task) number, CICS assumes the current task.

RESPONSE and REASON values for INQUIRE_TASK_STORAGE:

<i>RESPONSE</i>	<i>REASON</i>
OK	None
EXCEPTION	INSUFFICIENT_STORAGE NO_TRANSACTION_ENVIRONMENT
DISASTER	None
INVALID	None
KERNERROR	None
PURGED	None

The SWITCH_SUBSPACE call

SWITCH_SUBSPACE causes CICS to switch from a subspace to base space, if the task is not already executing in the base space. If the task is already in the base space, storage manager ignores the call.

This function can be used by global user exit programs that receive control in subspace and for some reason need to switch into basespace.

SWITCH_SUBSPACE

```
DFHMSRX [CALL,]  
        [CLEAR,]  
        [IN,  
        FUNCTION(SWITCH_SUBSPACE),  
        SPACE(BASESPACE),]  
        [OUT,  
        RESPONSE (name1 | *),  
        REASON (name1 | *)]
```

SPACE(BASESPACE)

specifies that CICS is to switch the task issuing the call to the basespace, if it is currently executing within a subspace. This enables the task to read and write to another task's user-key task-lifetime storage.

RESPONSE and REASON values for SWITCH_SUBSPACE:

<i>RESPONSE</i>	<i>REASON</i>
OK	None
DISASTER	None
KERNERROR	None

Trace control function

There is one XPI trace control function. This is the DFHTRPTX call TRACE_PUT.

DFHTRPTX calls cannot be used in any exit program invoked from any global user exit point in the:

- Dispatcher domain
- Dump domain
- Monitor domain
- Statistics domain
- Transient data program.

The TRACE_PUT call

TRACE_PUT writes a trace entry to the active trace destinations. You should only make a TRACE_PUT call when UEPTRON indicates that tracing is active for the function containing the exit program (see UEPTRON in DFHUEPAR). You may prefer to make “exception” trace entries, in case of serious errors, without testing UEPTRON.

If you use TRACE_PUT to write exception trace entries, you should identify these so they are highlighted as exception trace entries by the trace formatting utility program. To identify an exception trace entry, enter the literal string ‘USEREXC’ in the DATA1 block descriptor field on the DFHTRPTX call. See the *CICS Problem Determination Guide* for details of how an exception trace entry is interpreted.

TRACE_PUT

```
DFHTRPTX [CALL,]
          [CLEAR,]
          [IN,]
          FUNCTION(TRACE_PUT),
          POINT_ID(literalconst | name2 | (Rn)),
          [DATA1(block-descriptor),]
          [DATA2(block-descriptor),]
          [DATA3(block-descriptor),]
          [DATA4(block-descriptor),]
          [DATA5(block-descriptor),]
          [DATA6(block-descriptor),]
          [DATA7(block-descriptor),]
          [RETURN_ADDR(expression | name4 | (Ra)),]
          [OUT,]
          RESPONSE(name1 | *)]
```

DATA_n(block-descriptor)

specifies up to seven areas to be included in the data section of the trace entry. For a description of valid block-descriptors, see page 298. If you specify any given DATA_n, then DATA1 through DATA(_n-1) **must** be coded before DATA_n. The specified DATA items are printed in the trace output in the order specified, that is, in order of DATA1 through DATA_n. A 2-byte length field is printed before the data field itself. The maximum total length of the data that can be traced in one call is 4040 – (2 * *n*) bytes, where *n* is the number of data fields that you specify.

POINT_ID(literalconst|name2|(Rn))

specifies the trace entries made as a result of this request. Every TRACE_PUT

trace control function

call within a calling domain should specify a unique POINT_ID. This enables you to locate the origin of a trace call when examining a formatted trace. The POINT_IDs must be in the range decimal 256 through 511 (X'100' through X'1FF'). This range is not used in CICS modules, but is reserved for user exits.

literalconst

A number in the form of a literal, containing the ID

name2

The name of a 2-byte field containing the ID

(Rn) A register, the two low-order bytes of which contain the ID.

RETURN_ADDR(expression|name4|(Ra))

specifies the value that appears in the return address field of the trace entry.

expression

A valid assembler-language expression that results in the address

name4

The name of a fullword containing the address

(Ra) A register containing the address.

RESPONSE values for TRACE_PUT

The RESPONSE field is never set for the TRACE_PUT function. This is for performance reasons. It is not considered that any useful purpose could be served by testing for this value. Note, however, that the syntax requires that RESPONSE is always specified as a parameter on the call. It is recommended that RESPONSE(*) is always used.

Transaction management functions

This section describes the transaction management XPI calls.

The INQUIRE_CONTEXT call

INQUIRE_CONTEXT returns information about the environment in which a transaction is running. Specifically, it provides information for transactions running in a bridge environment.

INQUIRE_CONTEXT

```
DFHBRIQX [CALL,]
          [CLEAR,]
          [IN,
          FUNCTION(INQUIRE_CONTEXT),]
          [OUT,
          [BRIDGE_EXIT_PROGRAM(name8),]
          [BRIDGE_FACILITY_TOKEN(name4),]
          [BRIDGE_TRANSACTION_ID(name4),]
          [BRXA_TOKEN(name4),]
          [CONTEXT(byte1),]
          RESPONSE (name1 | *),
          REASON (name1 | *)]
```

BRIDGE_EXIT_PROGRAM(name8)

returns the name of the bridge exit program used by this task. If CONTEXT returns NORMAL, the contents of this field are meaningless.

name8

The name of an 8-byte location to receive the name of the bridge exit program.

BRIDGE_FACILITY_TOKEN(name4)

returns a token that contains the address of the bridge facility used by this task. This has the same format as a TCTTE and can be mapped using the DSECT DFHTCTTE. If CONTEXT returns NORMAL, the contents of this field are meaningless.

name4

The name of a 4-byte location to receive the token.

BRIDGE_TRANSACTION_ID(name4)

returns the name of the bridge monitor transaction that issued a START BREXIT TRANSID command to start this transaction. If CONTEXT returns NORMAL, the contents of this field are meaningless.

name4

The name of a 4-byte location to receive the name of the bridge monitor transaction.

BRXA_TOKEN(name4)

returns a token that contains the address of the bridge exit area (BRXA) used by this task. The format of BRXA is defined by the DFHBRARx copy books. If CONTEXT returns NORMAL, the contents of this field are meaningless.

name4

The name of a 4-byte location to receive the token.

CONTEXT(byte1)

returns, in a 1-byte location (*byte1*), the type of environment in which the transaction is running.

BRIDGE

A user transaction that was started using a bridge

BREXIT

A bridge exit program

NORMAL

A transaction that is not running in a bridge environment.

RESPONSE and REASON values for INQUIRE_CONTEXT:

<i>RESPONSE</i>	<i>REASON</i>
OK	None
DISASTER	ABEND
	LOOP
INVALID	None
EXCEPTION	NO_TRANSACTION_ENVIRONMENT
KERNERROR	None

The INQUIRE_DTRTRAN call

INQUIRE_DTRTRAN returns the name of the dynamic transaction routing (DTR) transaction definition.

transaction management functions

The DTR transaction definition provides common attributes for transactions that are to be dynamically routed and which do not have a specific transaction definition. It is specified on the DTRTRAN system initialization parameter; the CICS-supplied default definition is CRTX.

INQUIRE_DTRTRAN

```
DFHXMSRX [CALL,]
          [CLEAR,]
          [IN,
          FUNCTION(INQUIRE_DTRTRAN),]
          [OUT,
          DTRTRAN(name4),
          RESPONSE (name1 | *),
          REASON (name1 | *)]
```

DTRTRAN(name4)

returns the name of the DTR transaction definition to be used for routing transactions that are not defined by an explicit transaction resource definition.

name4

The name of a 4-byte location that is to receive the name of the DTR transaction definition. If 'NO' was specified on the DTRTRAN system initialization parameter, 'NO' will be placed in this field.

RESPONSE and REASON values for INQUIRE_DTRTRAN:

<i>RESPONSE</i>	<i>REASON</i>
OK	None
DISASTER	ABEND
	LOGIC_ERROR
	LOOP
INVALID	INVALID_FUNCTION
KERNERROR	None
PURGED	None

The INQUIRE_MXT call

The INQUIRE_MXT function is provided on the DFHXMSRX macro call. Its purpose is to provide current value of the MXT parameter.

INQUIRE_MXT

```
DFHXMSRX [CALL,]
          [CLEAR,]
          [IN,
          FUNCTION(INQUIRE_MXT),]
          [OUT,
          CURRENT_ACTIVE(name4 | (Rn) ),
          MXT_LIMIT(name4 | (Rn)),
          MXT_QUEUED(name4 | (Rn) ),
          TCLASS_QUEUED(name4 | (Rn) ),
          RESPONSE (name1 | *),
          REASON (name1 | *)]
```

CURRENT_ACTIVE(name4 | (Rn))

returns the current number of all active user tasks.

transaction management functions

name4

The name of a 4-byte location that is to receive the current number of active user tasks, expressed as a binary value.

(Rn) A register to receive the current number of active user tasks, expressed as a binary value.

MXT_LIMIT(name4 | (Rn))

returns the current number of the MXT parameter.

name4

The name of a 4-byte location that is to receive the maximum number of all user tasks currently allowed, expressed as a binary value.

(Rn) A register to receive the maximum number of all tasks currently allowed, expressed as a binary value.

MXT_QUEUED(name4 | (Rn))

returns the current number of user transactions that are queued as a result of the maximum tasks (MXT) being reached.

name4

The name of a 4-byte location that is to receive the current number of queued user tasks, expressed as a binary value.

(Rn) A register to receive the current number of queued user tasks, expressed as a binary value.

TCLASS_QUEUED(name4 | (Rn))

returns the current number of all transactions that are queued for transaction class membership.

name4

The name of a 4-byte location that is to receive the current number of queued transaction class members, expressed as a binary value.

(Rn) A register to receive the current number of queued transaction class members, expressed as a binary value.

RESPONSE and REASON values for INQUIRE_MXT:

<i>RESPONSE</i>	<i>REASON</i>
OK	None
DISASTER	LOGIC_ERROR
	ABEND
	LOOP
INVALID	INVALID_FUNCTION
KERNERROR	None
PURGED	None

transaction management functions

The INQUIRE_TCLASS call

The INQUIRE_TCLASS function is provided on the DFHXMCLX macro call. Its purpose is to provide current information about the specified transaction class (TCLASS).

INQUIRE_TCLASS

```
DFHXMCLX [CALL,]
          [CLEAR,]
          [IN,
          FUNCTION(INQUIRE_TCLASS),
          INQ_TCLASS_NAME(name8 | string | 'string'),]
          [OUT,
          [CURRENT_ACTIVE(name4 | (Rn)),]
          [CURRENT_QUEUED(name4 | (Rn)),]
          [MAX_ACTIVE(name4 | (Rn)),]
          [PURGE_THRESHOLD(name4 | (Rn)),]
          RESPONSE (name1 | *),
          REASON (name1 | *)]
```

CURRENT_ACTIVE(name4 | (Rn))

returns the current number of active user tasks in this transaction class.

name4

The name of a 4-byte location that is to receive the current number of active user tasks for this transaction class, expressed as a binary value.

(Rn) A register to receive the current number of active user tasks for this transaction class, expressed as a binary value.

CURRENT_QUEUED(name4 | (Rn))

returns the current number of queued user tasks.

name4

The name of a 4-byte location that is to receive the current number of queued user tasks in this transaction class, expressed as a binary value.

(Rn) A register to receive the current number of queued user tasks, expressed as a binary value.

INQ_TCLASS_NAME(name8 | string | 'string')

specifies the name of the transaction class for this inquiry.

name8

The name of an 8-byte location that contains the name of the transaction class being inquired on.

string A string of characters, without intervening blanks, naming the transaction class.

'string'

A string of characters, within quotation marks, naming the transaction class. The string length is set to 8 by padding with blanks within the quotation marks.

MAX_ACTIVE(name4 | (Rn))

returns the current maximum number of active tasks allowed for the transaction class.

transaction management functions

name4

The name of a 4-byte location that is to receive the current maximum number of active tasks currently allowed for this transaction class, expressed as a binary value.

(Rn) A register to receive the current maximum number of active tasks currently allowed for this transaction class, expressed as a binary value.

PURGE_THRESHOLD(name4 | (Rn))

returns the purge threshold limit for this transaction class.

name4

The name of a 4-byte location that is to receive the current purge threshold limit for this transaction class, expressed as a binary value.

(Rn) A register to receive the current purge threshold limit for this transaction class, expressed as a binary value.

RESPONSE and REASON values for INQUIRE_TCLASS:

<i>RESPONSE</i>	<i>REASON</i>
OK	None
DISASTER	LOGIC_ERROR
INVALID	None
EXCEPTION	UNKNOWN_CLASS

The INQUIRE_TRANDEF call

The INQUIRE_TRANDEF function is provided on the DFHXMIDX macro call. Its purpose is to allow you to obtain information about the specified transaction definition. In general, this function call is equivalent to the EXEC CICS INQUIRE TRANSACTION command, with some differences.

transaction management functions

INQUIRE_TRANDEF

```
DFHXMXXD [CALL,]
          [CLEAR,]
          [IN,]
          FUNCTION(INQUIRE_TRANDEF),
          INQ_TRANSACTION_ID(name4 | string | 'string'),]
          [OUT,]
          [BEXIT(name8),]
          [CMDSEC(name1),]
          [DTIMEOUT(name4 | (Rn)),]
          [DUMP(name1),]
          [DYNAMIC(name1),]
          [INDOUBT(name1),]
          [INDOUBT_WAIT(name1),]
          [INDOUBT_WAIT_TIME(name4),]
          [INITIAL_PROGRAM(name8),]
          [ISOLATE(name1),]
          [LOCAL_QUEUEING(name1),]
          [PARTITIONSET(name1),]
          [PARTITIONSET_NAME(name8),]
          [PROFILE_NAME(name8),]
          [REMOTE(name1),]
          [REMOTE_NAME(name8),]
          [REMOTE_SYSTEM(name4),]
          [RESSEC(name1),]
          [RESTART(name1),]
          [ROUTABLE_STATUS(ROUTABLE|NOT_ROUTABLE),]
          [RUNAWAY_LIMIT(name4 | (Rn)),]
          [SHUTDOWN(name1),]
          [SPURGE(name1),]
          [STATUS(name1),]
          [STORAGE_CLEAR(name1),]
          [STORAGE_FREEZE(name1),]
          [SYSTEM_ATTACH(name1),]
          [SYSTEM_RUNAWAY(name1),]
          [TASKDATAKEY(name1),]
          [TASKDATALOC(name1),]
          [TCLASS(name1), [TCLASS_NAME(name8),]]
          [TPURGE(name1),]
          [TRACE(name1),]
          [TRAN_PRIORITY(name4 | (Rn)),]
          [TRAN_ROUTING_PROFILE(name8),]
          [TRANSACTION_ID(name4),]
          [TWASIZE(name4 | (Rn)),]
          RESPONSE (name1 | *),
          REASON (name1 | *)]
```

The following parameter descriptions explain briefly the possible values that can be returned on an INQUIRE_TRANDEF call. For a more detailed explanation of some of these parameters, see the corresponding parameter descriptions for the TRANSACTION resource definition in the *CICS Resource Definition Guide*.

BEXIT(name8)

returns the name of the default bridge exit program specified for the named transaction. If no bridge exit is specified, blanks are returned.

name8

The name of an 8-byte location to receive the name of the bridge exit program.

CMDSEC(name1)

returns, in a 1-byte location (*name1*), a value indicating whether command security checking is required for the transaction.

YES Command security checking is required.

NO Command security checking is not required.

DTIMEOUT(name4)

returns the deadlock time-out value for the transaction.

name4

The name of a 4-byte location that is to receive the deadlock time-out value, expressed as a binary value.

(Rn) A register to receive the deadlock time-out value, expressed as a binary value.

Note that a value of zero means that the transaction resource definition specifies DTIMOUT(NO).

DUMP(name1)

returns, in a 1-byte location (*name1*), a value indicating whether CICS is to take a transaction dump if the transaction abends.

YES A transaction dump is required.

NO A transaction dump is not required.

DYNAMIC(name1)

returns, in a 1-byte location (*name1*), a value indicating whether the transaction is defined for dynamic transaction routing.

YES The transaction is to be dynamically routed to a remote CICS.

NO The transaction is not to be dynamically routed.

INDOUBT(name1)

returns, in a 1-byte location (*name1*), the action to be taken if the CICS region fails or loses connectivity with its coordinator while a unit of work is in the in-doubt period. (The action is based on the ACTION attribute of the TRANSACTION resource definition.)

The action is dependent on the values returned in INDOUBT_WAIT and INDOUBT_WAIT_TIME; if INDOUBT_WAIT returns YES, the action is not taken until the time returned in INDOUBT_WAIT_TIME expires.

BACKOUT

Any changes made by the transaction to recoverable resources are to be backed out.

COMMIT

Any changes made by the transaction to recoverable resources are to be committed.

INDOUBT_WAIT(name1)

returns, in a 1-byte location (*name1*), how a unit of work (UOW) is to respond if a failure occurs while it is in an in-doubt state.

NO The UOW is not to wait, pending recovery from the failure. CICS is to take immediately whatever action is specified on the ACTION attribute of the TRANSACTION definition.

transaction management functions

YES The UOW is to wait, pending recovery from the failure, to determine whether recoverable resources are to be backed out or committed.

INDOUBT_WAIT_TIME(name4)

returns the length of time, in minutes, after a failure during the in-doubt period, before the transaction is to take the action returned in the INDOUBT field. The returned value is valid only if the unit of work is in-doubt and INDOUBT_WAIT returns YES.

name4

The name of a 4-byte location that is to receive the delay time, expressed as a binary value.

See also INDOUBT and INDOUBT_WAIT.

INITIAL_PROGRAM(name8)

returns the name of the initial program to be given control for the transaction.

name8

The name of an 8-byte location to receive the initial program name.

INQ_TRANSACTION_ID(name4 | string | 'string')

specifies the transaction identifier for this transaction definition inquiry.

name4

The name of a 4-byte location that contains the name of the transaction identifier.

string A string of characters, without intervening blanks, naming the transaction identifier.

'string'

A string of characters, within quotation marks, naming the transaction identifier. The string length is set to 4 by padding with blanks within the quotation marks.

ISOLATE(name1)

returns, in a 1-byte location (*name1*), a value indicating whether transaction isolation is required for the transaction's task-lifetime user-key storage.

NO Transaction isolation is not required for task-lifetime user-key storage.

YES Transaction isolation is required for task-lifetime user-key storage.

LOCAL_QUEUEING(name1)

returns, in a 1-byte location (*name1*), a value indicating whether a start request for this transaction is eligible to queue locally if the transaction is to be started on another system, and the remote system is not available.

NO The request is not to be queued locally.

YES The request can be queued locally.

PARTITIONSET(name1)

returns, in a 1-byte location (*name1*), the partitionset specified on the transaction definition.

KEEP The reserved name KEEP is specified for the partitionset, which means tasks running under this transaction definition use the application partitionset for the terminal associated with the transaction.

NAMED

The partitionset is named specifically on the transaction definition. The name is returned on the PARTITIONSET_NAME parameter.

NONE There is no partitionset specified for the transaction definition.

OWN The reserved name OWN is specified for the partitionset, which means tasks running under this transaction definition perform their own partitionset management.

PARTITIONSET_NAME(name8)

returns the name of the partitionset defined on the transaction definition.

name8

The name of an 8-byte location that is to receive the name of the partitionset.

PROFILE_NAME(name8)

returns the name of the profile definition that is associated with the transaction definition.

name8

The name of an 8-byte location to receive the name of the profile definition associated with the transaction definition.

REMOTE(name1)

returns, in a 1-byte location (*name1*), a value indicating whether the transaction is defined as remote.

NO The transaction is not a remote transaction.

YES The transaction is a remote transaction.

REMOTE_NAME(name8)

returns the name by which the transaction is known in a remote system.

name8

The name of an 8-byte location to receive the transaction's remote name.

REMOTE_SYSTEM(name4)

returns the name of the remote system as specified on the transaction definition.

If the DYNAMIC parameter returns YES, REMOTE_SYSTEM returns the default name, which can be changed by the dynamic routing program.

If the DYNAMIC parameter returns NO, this is the actual remote system to which the transaction is to be routed.

name4

The name of a 4-byte location to receive the defined name of the remote system.

transaction management functions

RESSEC(name1)

returns, in a 1-byte location (*name1*), a value indicating whether resource security checking is required for the transaction.

NO Resource security checking is not required.

YES Resource security checking is required.

RESTART(name1)

returns, in a 1-byte location (*name1*), a value indicating whether the transaction is to be considered for transaction restart.

NO The transaction cannot be restarted.

YES The transaction can be restarted.

ROUTABLE_STATUS(ROUTABLE|NOT_ROUTABLE)

returns a value indicating whether, if the transaction is the subject of an eligible EXEC CICS START command, it will be routed using the enhanced routing method.

NOT_ROUTABLE

If the transaction is the subject of a START command, it will be routed using the “traditional” method.

ROUTABLE

If the transaction is the subject of an eligible START command, it will be routed using the enhanced method.

For details of the enhanced and “traditional” methods of routing transactions invoked by EXEC CICS START commands, see the *CICS Intercommunication Guide*.

RUNAWAY_LIMIT(name4 | (Rn))

returns the runaway-task time limit specified on the transaction definition. If SYSTEM_RUNAWAY is YES, the value returned is the value defined by the ICVR system initialization parameter.

name4

The name of a 4-byte location that is to receive the task runaway limit, expressed as a binary value.

(Rn) A register to receive the task runaway limit, expressed as a binary value.

SHUTDOWN(name1)

returns, in a 1-byte location (*name1*), a value indicating whether the transaction can be run during CICS shutdown.

DISABLED

The transaction is disabled from running during CICS shutdown.

ENABLED

The transaction is enabled to run during CICS shutdown.

SPURGE(name1)

returns, in a 1-byte location (*name1*), a value indicating whether the transaction is defined as system-purgeable.

NO The transaction is not system-purgeable.

YES The transaction is system-purgeable.

STATUS(name1)

returns, in a 1-byte location (*name1*), the status of the transaction definition.

DISABLED

The transaction definition is disabled.

ENABLED

The transaction definition is enabled.

STORAGE_CLEAR(name1)

returns, in a 1-byte location (*name1*), a value indicating whether task-lifetime storage, of tasks associated with this transaction definition, is to be cleared before it is freed by a FREEMAIN command.

NO Task-lifetime storage need not be cleared before it's freed.

YES Task-lifetime storage must be cleared before it's freed.

STORAGE_FREEZE(name1 | (Rn))

returns, in a 1-byte location (*name1*), a value indicating whether storage freeze is defined for the transaction by means of the STGFRZ option on the CICS-supplied field engineering transaction, CSFE.

NO Storage is freed normally during the running of the transaction.

YES Storage that is normally freed during the running of a transaction is frozen.

SYSTEM_ATTACH(name1)

returns, in a 1-byte location (*name1*), a value indicating whether the tasks attached with this tranid are always to be attached as system tasks.

NO A user task is being attached for this transaction.

YES A system task is being attached for this transaction.

SYSTEM_RUNAWAY(name1)

returns, in a 1-byte location (*name1*), a value indicating whether the transaction definition specifies the system default runaway-task time limit, which is specified on the ICVR system initialization parameter.

NO The transaction is not governed by the system runaway limit.

YES The transaction definition specifies the system default runaway limit.

TASKDATAKEY(name1)

returns, in a 1-byte location (*name1*), the storage key of task-lifetime storage for tasks associated with this transaction definition.

CICS CICS key is specified for task-lifetime storage.

USER USER key is specified for task-lifetime storage.

TASKDATALOC(name1)

returns, in a 1-byte location (*name1*), the data location of task-lifetime storage for tasks associated with this transaction definition.

ANY Task-lifetime storage can be located above 16MB in virtual storage.

BELOW

Task-lifetime storage must be located below 16MB in virtual storage.

TCLASS(name1)

returns, in a 1-byte location (*name1*), a value indicating whether the transaction belongs to a transaction class.

NO The transaction is not a member of a transaction class.

YES The transaction is a member of the transaction class named in the TCLASS_NAME parameter.

transaction management functions

TCLASS_NAME(name8)

returns the name of the transaction class to which the transaction belongs.

name8

The name of an 8-byte location to receive transaction class name to which the transaction belongs.

TPURGE(name1)

returns, in a 1-byte location (*name1*), a value indicating whether the transaction is defined as purgeable in the event of a VTAM terminal error.

NO The transaction can not be purged if a terminal error occurs.

YES The transaction can be purged if a terminal error occurs.

TRACE(name1)

returns, in a 1-byte location (*name1*), the level of tracing defined for the transaction:

SPECIAL

CICS special-level trace This is the result of special trace being set by means of an EXEC CICS SET TRANSACTION command.

STANDARD

CICS standard-level trace This equates to TRACE(YES) in the TRANSACTION resource definition.

SUPPRESSED

Tracing is suppressed for the transaction This equates to TRACE(NO) in the TRANSACTION resource definition.

TRAN_PRIORITY(name4 | (Rn))

returns the transaction priority specified on the transaction definition.

name4

The name of a 4-byte location to receive the transaction priority, expressed as a binary value.

(Rn) A register to receive the transaction priority, expressed as a binary value.

TRAN_ROUTING_PROFILE(name8)

returns the name of the profile that CICS is to use to route the transaction to a remote system.

name8

The name of an 8-byte location to receive the transaction-routing profile.

TRANSACTION_ID(name4)

returns the primary transaction identifier for this transaction definition inquiry.

name4

The name of a 4-byte location that contains the name of the transaction identifier.

TWASIZE(name4 | (Rn))

returns the size of the transaction work area specified on the transaction definition.

name4

The name of a 4-byte location to receive the size of the transaction work area, expressed as a binary value.

(Rn) A register to receive the size of the transaction work area, expressed as a binary value.

RESPONSE and REASON values for INQUIRE_TRANDEF:

<i>RESPONSE</i>	<i>REASON</i>
OK	None
EXCEPTION	UNKNOWN_TRANSACTION_ID
INVALID	None
DISASTER	LOGIC_ERROR
PURGED	None

The INQUIRE_TRANSACTION call

The INQUIRE_TRANSACTION function is provided on the DFHXMIQX macro call. Its purpose is to allow you to obtain information about a transaction that is attached (task). In general, this call is equivalent to the EXEC CICS INQUIRE TASK command, with some minor differences.

INQUIRE_TRANSACTION

```
DFHXMIQX [CALL,]
  [CLEAR,]
  [IN,
  FUNCTION(INQUIRE_TRANSACTION),
  TRANSACTION_TOKEN(name8),]
  [OUT,
  ATTACH_TIME(name8),]
  [CICS_UOW_ID(name8),]
  [DTIMEOUT(name4 | (Rn)),]
  [DYNAMIC(name1),]
  [FACILITY_NAME(name4),]
  [FACILITY_TYPE(name1),]
  [INITIAL_PROGRAM(name8),]
  [NETNAME(name8),]
  [ORIGINAL_TRANSACTION_ID(name4),]
  [OUT_TRANSACTION_TOKEN(name8),]
  [RE_ATTACHED_TRANSACTION(name1),]
  [REMOTE(name1),]
  [REMOTE_NAME(name8),]
  [REMOTE_SYSTEM(name4),]
  [RESOURCE_NAME(name8),]
  [RESOURCE_TYPE(name8),]
  [RESTART(name1),]
  [RESTART_COUNT(name2 | (Rn)),]
  [SPURGE(name1),]
  [START_CODE(name1),]
  [STATUS(name1),]
  [SUSPEND_TIME(name4 | (Rn)),]
  [SYSTEM_TRANSACTION(name1),]
  [TASK_PRIORITY(name1),]
  [TCLASS(name1), [TCLASS_NAME(name8),]]
  [TPURGE(name1),]
  [TRANNUM(name4 | string | 'string'),]
  [TRAN_PRIORITY(name1),]
  [TRAN_ROUTING_PROFILE(name8),]
  [TRANSACTION_ID(name4),]
  [USERID(name8),]
  RESPONSE (name1 | *),
  REASON (name1 | *)]
```

transaction management functions

The descriptions of the following parameters are the same as the corresponding parameters on the INQUIRE_TRANDEF function call.

DTIMEOUT
DYNAMIC
INITIAL_PROGRAM
REMOTE
REMOTE_NAME
REMOTE_SYSTEM
RESTART
SPURGE
STATUS
TCLASS
TRAN_ROUTING_PROFILE
TRANSACTION_ID

The parameter descriptions that follow explain briefly the possible values that can be returned on an INQUIRE_TRANSACTION call. For a more detailed explanation of these parameters, see the corresponding parameter descriptions for the TRANSACTION resource definition in the *CICS Resource Definition Guide*.

ATTACH_TIME(name8)

returns the time in milliseconds since the task was attached.

name8

The name of an 8-byte location to receive the time, in packed decimal ABSTIME format.

CICS_UOW_ID(name8)

returns the CICS unit of work identifier for the task.

name8

The name of an 8-byte location to receive the unit of work id.

FACILITY_NAME(name4)

returns the name of the principal facility associated with the task.

name4

The name of a 4-byte location to receive the name of the principal facility.

FACILITY_TYPE(name1)

returns, in a 1-byte location (*name1*), the type of principal facility associated with the task.

NONE There is no principal facility.

START

The principal facility is an interval control element.

TD

The principal facility is a transient data queue.

TERMINAL

The principal facility is a terminal.

NETNAME(name8)

returns the network name of the principal facility associated with this task.

name8

The name of an 8-byte location to receive the network name.

ORIGINAL_TRANSACTION_ID(name4)

returns the transaction id that was used to attach the transaction. For example, if an alias was used at a terminal, this field returns the alias.

name4

The name of a 4-byte location to receive the name of the original transaction identifier.

OUT_TRANSACTION_TOKEN(name8)

returns the token that represents the task.

name8

The name of an 8-byte location to receive the transaction token for the task.

RE_ATTACHED_TRANSACTION(name1)

returns, in a 1-byte location (*name1*), a value indicating whether the transaction has been re-attached.

NO The transaction has not been re-attached and the global user exit program is invoked in the same environment as the original transaction-attach.

YES The transaction has been re-attached and the global user exit program is invoked in a different environment from the original transaction-attach.

RESOURCE_NAME(name8)

returns the name of a resource that the (suspended) transaction waiting for.

name8

The name of an 8-byte location to receive the name of the resource on which the transaction is waiting.

RESOURCE_TYPE(name8)

returns the type of resource that the (suspended) transaction waiting for.

name8

The name of an 8-byte location to receive the type of resource on which the transaction is waiting.

RESTART_COUNT(name2 | (Rn))

returns the number of times this instance of the transaction has been restarted.

name2

The name of a 2-byte location to receive the number of times the transaction has been restarted, expressed as a half-word binary value.

(Rn) A register to receive the number of times the transaction has been restarted, expressed as a half-word binary value.

START_CODE(name1)

returns, in a 1-byte location (*name1*), a value indicating how the task was started:

C A CICS internal attach.

DF The start code isn't yet known—to be set later.

QD A transient data trigger level attach.

S A START command without any data.

SD A START command with data.

SZ A front end programming interface (FEPI) attach.

transaction management functions

T A terminal input attach.

TT A permanent transaction terminal attach.

SUSPEND_TIME(name4 | (Rn))

returns the length of time that the task has been in its current suspended state.

name4

The name of a 4-byte location to receive the number of seconds, rounded down, the task has been suspended, expressed as a binary value.

(Rn) A register to receive the number of seconds, rounded down, the task has been suspended, expressed as a binary value.

SYSTEM_TRANSACTION(name1)

returns, in a 1-byte location (*name1*), a value indicating whether the task is CICS system task.

NO The task is not a CICS system task.

YES The task is a CICS system task.

TASK_PRIORITY(name1)

returns the combined task priority, which is the sum of the priorities defined for the terminal, transaction, and operator.

name1

The name of a 1-byte location to receive the task priority, expressed as a binary number.

TRANNUM(name4)

returns the task number of the transaction.

name4

The name of a 4-byte location to receive the task number.

TRANSACTION_TOKEN(name8)

specifies the transaction token for the task being inquired upon. This parameter is optional, and if omitted, the current task is assumed.

If you issue this call within an XXMATT global user exit program, the current task may be a CICS system task. To inquire on the user task for which XXMATT is invoked, you must specify the transaction token passed on the XXMATT exit-specific parameter list.

name8

The name of an 8-byte location that contains the transaction token.

USERID(name8)

returns the userid associated with this task.

name8

The name of an 8-byte location to receive the userid.

RESPONSE and REASON values for INQUIRE_TRANSACTION:

<i>RESPONSE</i>	<i>REASON</i>
OK	None
DISASTER	ABEND
	LOOP
INVALID	None
EXCEPTION	NO_TRANSACTION_ENVIRONMENT
	BUFFER_TOO_SMALL
	INVALID_TRANSACTION_TOKEN
KERNERROR	None

The SET_TRANSACTION call

The SET_TRANSACTION function is provided on the DFHXMIQX macro call. Its purpose is to allow you to change the task priority and transaction class of the current task.

Note that you can use this call to change the TCLASS_NAME only when it is invoked from an XXMATT global user exit program.

SET_TRANSACTION

```
DFHXMIQX [CALL,]
          [CLEAR,]
          [IN,
          FUNCTION(SET_TRANSACTION),
          [TASK_PRIORITY(name4),]
          [TCLASS_NAME(name8),]
          [TRANSACTION_TOKEN(name8),]]
          [OUT,
          RESPONSE (name1 | *),
          REASON (name1 | *)]
```

TASK_PRIORITY(name4)

specifies the new task priority being set for the task identified by TRANSACTION_TOKEN.

name4

The name of a 4-byte location that contains the new task priority number, expressed as a binary value.

TCLASS_NAME(name8)

specifies the new transaction class name that you want to associate this task with. To specify that the task is not to be in any transaction class, specify the special default system name DFHTCL00.

name8

The name of an 8-byte location that contains the name of the new transaction class. Set this field to DFHTCL00 for no transaction class.

TRANSACTION_TOKEN(name8)

specifies the transaction token that represents the task being modified. If you omit this parameter, the call defaults to the current task.

name8

The name of an 8-byte location that contains the transaction token.

transaction management functions

RESPONSE and REASON values for SET_TRANSACTION:

<i>RESPONSE</i>	<i>REASON</i>
OK	None
EXCEPTION	NO_TRANSACTION_ENVIRONMENT UNKNOWN_TCLASS INVALID_TRANSACTION_TOKEN
DISASTER	ABEND LOOP
INVALID	None
KERNERROR	None

User journaling function

There is one XPI user journaling function, which is the DFHJCJCX call WRITE_JOURNAL_DATA.

DFHJCJCX calls cannot be used in any exit program invoked from any global user exit point in the:

- Statistics domain
- Monitor domain
- Dump domain
- Dispatcher domain
- Transient data program.

The WRITE_JOURNAL_DATA call

WRITE_JOURNAL_DATA writes a single journal record to the journal specified in the journal model definition that matches the journal name (either a journal on an MVS system logger log stream, an SMF data set, or no record is written where DUMMY is defined in the definition).

WRITE_JOURNAL DATA

```
DFHJCJCX [CALL,]
          [CLEAR,]
          [IN,
           FUNCTION(WRITE_JOURNAL_DATA),
           FROM(block-descriptor),
           JOURNALNAME(name8 | string | 'string' ) |
           JOURNAL_RECORD_ID(name2 | string | 'string'),
           WAIT(YES|NO),
           [RECORD_PREFIX(block-descriptor),]]
          [OUT,
           RESPONSE(name1 | *),
           REASON(name1 | *)]
```

Important

There is a restriction in using the XPI early during initialization. Do not start exit programs that use the XPI functions TRANSACTION_DUMP, WRITE_JOURNAL_DATA, MONITOR, and INQUIRE_MONITOR_DATA until the second phase of the PLTPI. For further information about the PLTPI, refer to “Chapter 4. Writing initialization and shutdown programs” on page 393.

FROM(block-descriptor)

specifies the address and the length of the journal record.

JOURNALNAME(name8 | string | "string")

specifies the name of the CICS journal or log to which the FROM data is to be written.

JOURNAL_RECORD_ID(name2 | string | "string")

specifies a 2-character value to be written to the journal record to identify its origin.

name2

The name of a 2-byte location

string A character string that is limited to a length of 2 in the generated code

"string"

A character string enclosed in quotation marks, limited to a length of 2 in the generated code.

RECORD_PREFIX(block-descriptor)

specifies the optional user prefix.

WAIT(YES|NO)

specifies whether CICS is to wait until the record is written to the journal or log before returning control to the exit program.

user journaling function

RESPONSE and REASON values for WRITE_JOURNAL_DATA:

<i>RESPONSE</i>	<i>REASON</i>
OK	None
EXCEPTION	IO_ERROR
	JOURNAL_NOT_FOUND
	JOURNAL_NOT_OPEN
	LENGTH_ERROR
	STATUS_ERROR
DISASTER	None
INVALID	None
KERNERROR	None
PURGED	None

Note: For more detail, refer to the explanation of RESPONSE and REASON in "General form of an XPI call" on page 286.

Part 2. Customizing with initialization and shutdown programs

Chapter 4. Writing initialization and shutdown programs

You can write programs to run during the initialization and shutdown phases of CICS processing. Any program that is to run at these times must be defined to CICS in a program list table (PLT). Information about how to code the PLT is provided in the *CICS Resource Definition Guide*.

The chapter is divided into the following sections:

1. “**Initialization programs**”
2. “**Shutdown programs**” on page 394
3. “**General considerations**” on page 396.

Initialization programs

Any program that is to execute during CICS initialization must be specified in a program list table (PLT), and the suffix of that PLT must be named on the program list table post initialization (PLTPI) system initialization parameter.

There are two phases of program list table (PLT) execution, separated by the DFHDELIM statement in the PLT.

First phase PLT programs

During the early stages of CICS initialization processing, the only PLT programs that can execute are those containing the enabling commands for global and task-related user exit programs. These programs are specified in the first part of the PLTPI list (before the DFHDELIM statement). This allows you to enable those exit programs that are needed during recovery.

The following points apply to all first phase PLTPI programs:

- The programs must be written in assembler language.
- They must run AMODE 31.
- The only EXEC CICS commands they should contain are:
 - ASSIGN INITPARM
 - ENABLE
 - EXTRACT EXIT

Because this stage occurs before recovery when initialization is incomplete, no other CICS services can be invoked.

- If a first phase PLTPI program enables an exit program that issues any of the XPI calls INQUIRE_MONITORING_DATA, MONITOR, TRANSACTION_DUMP, or WRITE_JOURNAL_DATA, it must not specify the START option on the EXEC CICS ENABLE COMMAND.
- First phase PLTPI programs must not enable any task-related user exit program with the TASKSTART option.
- You do not have to define first phase PLTPI programs to CICS. If you do not, default definitions are installed automatically by CICS. Note that this happens whether or not program autoinstall is specified as active on the PGAIPGM

initialization programs

system initialization parameter. The autoinstall user program is **not** invoked to allow the definitions to be modified. The programs are defined with the following attributes:

```
LANGUAGE(Assembler)
RELOAD(No)
STATUS(Enabled)
CEDF(No)
DATALOCATION(Below)
EXECKEY(CICS)
EXECUTIONSET(Fullapi)
```

If any of the default attributes are unsuitable, you must define the programs statically (by defining entries in the CSD and installing the definitions).

Second phase PLT programs

During the final stages of CICS initialization, most CICS services are available to PLT programs. These programs are specified in the second part of the PLTPI list (after the DFHDELIM entry). The limitations on the services that are available to second phase PLTPI programs are described below.

- Because interregion communication (IRC) and intersystem communication (ISC) have pseudo-terminal entries associated with their function, you cannot run any IRC or ISC functions during PLTPI processing. This includes performing inquiries on those ISC/IRC functions.
- PLTPI programs may request services that could suspend the issuing task. (But note that this affects the time at which control is given to CICS.) The SUSPEND must not require the decision to resume to be taken by another task.
- Although PLTPI programs can issue interval control START commands, the requested transactions are not attached before the initialization stages have completed. Because this cannot happen until after the PLTPI programs themselves have been completed, the latter must not be dependent on anything that the requested transactions might do.
- PLTPI programs must not issue dump requests.
- PLTPI programs must not use the EXEC CICS PERFORM SHUTDOWN command, or a severe error will occur in DFHDMMDM. The EXEC CICS PERFORM SHUTDOWN IMMEDIATE command is allowed.
- You must define second phase PLTPI programs to CICS. You can either define the programs statically, or use program autoinstall (program autoinstall is described in the *CICS Resource Definition Guide*).

Shutdown programs

Any program that is to execute during CICS shutdown must be defined in a program list table (PLT), and the PLT must be named on the program list table shutdown (PLTSD) system initialization parameter. You can override the PLTSD value by providing a PLT name on the CEMT PERFORM SHUTDOWN command, or on the EXEC CICS PERFORM SHUTDOWN command. If a PLTSD program abends, syncpoint rollback occurs.

First phase PLT programs

Programs that are to execute during the first quiesce stage of CICS shutdown are specified in the first half of the PLT (before the DFHDELIM statement).

You must define first stage PLTSD programs to CICS. You can either define the programs statically, or use program autoinstall.

Although terminals are still available during the first quiesce stage, tasks that are started by terminal input are rejected unless they are named in a shutdown transaction list table (XLT), or are CICS-supplied transactions, such as CEMT, CSAC, CSTE, and CSNE, that are defined as SHUTDOWN(ENABLED) in the supplied definitions.

The first quiesce stage is complete when all of the first-stage PLT programs have executed, and when there are no user tasks in the system.

PLT programs for the second quiesce stage

Programs that are to execute during the second quiesce stage of CICS shutdown are specified in the second half of the PLT (after the DFHDELIM statement).

You do not have to define second stage PLTSD programs to CICS. If you do not, default definitions are installed automatically by CICS, as described for first phase PLTPI programs. If any of the default attributes are unsuitable, you must define the programs statically.

During the second quiesce stage, no new tasks can start, and no terminals are available. Because of this, second phase PLT programs must not cause other tasks to be started, and they cannot communicate with terminals. Further, second phase PLT programs must not cause any resource security checking to be performed.

If a transaction abend occurs while the PLTSD program is running, CICS is left in a permanent wait state. To avoid this happening, ensure that your PLTSD program handles **all** abend conditions.

The second quiesce stage is complete when all of the second phase PLT programs have been executed.

The shutdown assist utility program, DFHCESD

CICS provides a *shutdown assist transaction*, that can be run during the first quiesce stage of shutdown. It can be run on a normal or an immediate shutdown.

You specify the name of the shutdown transaction on the SDTRAN system initialization parameter, or on the SDTRAN option of the PERFORM SHUTDOWN and PERFORM SHUTDOWN IMMEDIATE commands. You can also specify that no shutdown assist transaction is to be run. If you do specify that no shutdown assist transaction is to be run:

- On a normal shutdown, CICS waits for all running tasks to finish before entering the second stage of quiesce. Long running or conversational transactions can cause an unacceptable delay or require operator intervention.

shutdown programs

- On an immediate shutdown, CICS does not allow running tasks to finish and backout is not performed until emergency restart. This can cause an unacceptable number of units of work to be shunted, and locks to be retained unnecessarily.

The purpose of the shutdown assist transaction is to help solve these problems; that is, to ensure that as many tasks as possible commit or back out cleanly within a reasonable time.

The default shutdown assist transaction is CESD, which starts the CICS-supplied program DFHCESD. DFHCESD attempts to purge and back out long-running tasks using increasingly stronger techniques. It ensures that as many tasks as possible commit or back out cleanly, enabling CICS to shut down in a controlled manner. For information about DFHCESD, and about how to write your own shutdown assist transaction, see the *CICS Operations and Utilities Guide*.

General considerations

The comments in the remainder of the chapter apply to both initialization and shutdown programs.

- It is recommended that you terminate all PLT programs with an EXEC CICS RETURN command.
- PLT programs receive control in primary-space translation mode. (For information about translation modes, see the *IBM ESA/370 Principles of Operation* manual.) They must return control to CICS in the same mode, and must restore any general purpose registers or access registers that they use.
- All PLTPI programs run under the CICS internal transaction name CPLT. Therefore, because CICS internal transactions are defined with the WAIT indoubt attribute set to 'YES', an in-doubt failure that occurs while running a PLTPI program causes the relevant unit of work to be shunted. The PLTPI program abends ASP1, and CICS runs the next program defined in the PLTPI table, if any.
- PLTSD programs run under the transaction that issued the PERFORM SHUTDOWN command. The CEMT transaction is defined with WAIT(YES). Therefore, if shutdown is as the result of a CEMT PERFORM SHUTDOWN command, an in-doubt failure that occurs while running a PLTSD program causes the unit of work to be shunted. If, however, shutdown is as the result of a user transaction issuing an EXEC CICS PERFORM SHUTDOWN command, whether an in-doubt failure causes the unit of work to be shunted or a forced decision taken depends on the indoubt attributes of the user transaction. For details of the indoubt options of the CEDA DEFINE TRANSACTION command, see the *CICS Resource Definition Guide*.

Storage keys for PLT programs

You need to consider the following (whether or not you are running CICS with the storage protection facility):

- The execution key in which your PLT programs are invoked
- The storage key of data storage obtained for your PLT programs.

Execution key for PLT programs

CICS always gives control to PLT programs in CICS key. Even if you specify EXECKEY(USER) on the program resource definition, CICS forces CICS key when it passes control to any PLT programs invoked during initialization or shutdown.

However, if a PLT-defined *shutdown* program itself passes control to another program (via a link or transfer-control command), the program thus invoked executes according to the execution key (EXECKEY) defined in its program resource definition.

Important

You are strongly recommended to specify EXECKEY(CICS) when defining both PLT programs and programs to which a PLT program passes control.

Data storage key for PLT programs

The storage key of storage used by PLT programs depends on how the storage is obtained:

- Any working storage requested by the PLT program is in the key set by the TASKDATAKEY of the transaction under which the PLT program is invoked. In the case of those PLT programs that run during initialization (PLTPI programs), the transaction is always an internal CICS transaction, in which case the TASKDATAKEY is always CICS. In the case of those programs that run during shutdown (PLTSD programs), it depends on the transaction you use to issue the shutdown command. If you issue a CEMT PERFORM SHUTDOWN command, the TASKDATAKEY is always CICS. If you run a user-defined transaction, to invoke a program that issues an EXEC CICS PERFORM SHUTDOWN command, the TASKDATAKEY can be either USER or CICS.
- PLT programs can use EXEC CICS commands to obtain storage by issuing:
 - Explicit EXEC CICS GETMAIN commands
 - Implicit storage requests as a result of EXEC CICS commands that use the SET option.

The default storage key for storage obtained by EXEC CICS commands is set by the TASKDATAKEY of the transaction under which the PLT program is invoked, exactly as described for working storage.

As an example, consider a transaction defined with TASKDATAKEY(USER) that causes a PLT shutdown program to be invoked. In this case, any implicit or explicit storage acquired by the PLT program by means of an EXEC CICS command is, by default, in user-key storage. However, on an EXEC CICS GETMAIN command, the PLT program can override the TASKDATAKEY option by specifying either CICS DATAKEY or USER DATAKEY.

PLT programs—general

Part 3. Customizing with user-replaceable programs

Chapter 5. General notes about user-replaceable programs

The comments in this chapter apply to all the user-replaceable programs described in Part 3 of this book.

A user-replaceable program is a CICS-supplied program that is always invoked at a particular point in CICS processing, as if it were part of the CICS code. You can modify the supplied program by including your own logic, or replace it with a version that you write yourself.

The chapter is divided into the following sections:

1. “**Rewriting user-replaceable programs**”
2. “**Assembling and link-editing user-replaceable programs**” on page 402
3. “**User-replaceable programs and the storage protection facility**” on page 405.

Rewriting user-replaceable programs

There are some general considerations that you must bear in mind when creating your own versions of user-replaceable programs:

- User-replaceable programs are all command-level programs (not user exits).
- You can code user-replaceable programs in any of the languages supported by CICS (that is, in assembler language, COBOL, PL/I, or C). An assembler-language version of each program is provided, in source form, in the CICSTS13.CICS.SDFHSAMP library. In addition, COBOL, PL/I, or C versions are provided for some programs. The relevant chapter lists the sample programs, copy books, and macros supplied in each case.
- You can trap an abend in a user-replaceable program by making the program issue an EXEC CICS HANDLE ABEND command. However, if no HANDLE ABEND is issued, CICS does not abend the task but returns control to the CICS module that called the program. The action taken by the CICS module depends on the user-replaceable program concerned.
- Upon return from any user-replaceable program, CICS must always receive control in primary-space translation mode, with the original contents of all access registers restored, and with all general purpose registers restored (except for those which provide return codes or linkage information).

For information about translation modes, refer to the *IBM ESA/370 Principles of Operation* manual.

- User-replaceable programs, and any programs invoked by user-replaceable programs, can be RMODE ANY but **must** be AMODE 31.
- You must ensure that user-replaceable programs are defined as local. User-replaceable programs cannot be run in a remote region. This applies to all user-replaceable programs, including the autoinstall control program and the dynamic routing program.
- User-replaceable programs produce only system dumps when a program check occurs; they do not produce transaction dumps.
- You can use the CICS Execution Diagnostic Facility (EDF) to test user-replaceable programs. However, EDF does not work if the initial transaction is a CICS-supplied transaction.

Assembling and link-editing user-replaceable programs

The source for the CICS-supplied user-replaceable programs is installed in the CICSTS13.CICS.SDFHSAMP library. If you intend changing any of these programs, take a copy of the CICSTS13.CICS.SDFHSAMP library and update the copy only. If the original SDFHSAMP is serviced, and a user-replaceable program is modified, you may like to reflect the changes in your own version of the code.

To replace one of these CICS-supplied programs, assemble and link-edit your version of the program. All programs are supplied as command-level programs, and must be translated before assembly and link-edit. Note that the translator options NOPROLOG and NOEPILOG should be coded with your versions of DFHZNEP and DFHTEP.

If you have user-written versions of DFHZNEP, DFHPEP, or DFHTEP from an earlier release of CICS, and they use macros, recode the programs to use EXEC CICS commands.

To translate, assemble, and link-edit user-replaceable programs, you can use the CICS-supplied procedure DFHEITAL. For information about using DFHEITAL, see the *CICS System Definition Guide*. If you use SMP/E, you can give the object-deck output after translation and assembly to SMP/E for link-editing.

When link-editing a user-replaceable program, you must link-edit it with the EXEC interface module (stub). This stub enables the program to communicate with the EXEC interface program (DFHEIP). If you use the DFHEITAL procedure, it link-edits programs with the EXEC interface stub by default. For more information about the EXEC interface stub, see the *CICS System Definition Guide*.

The job stream in Figure 12 is an example of the assembly and link-edit of a user-replaceable program. The figure is followed by some explanatory notes.

```

//ASSEMBLE EXEC DFHASMVS,MOD='program_name',           1 2
//      INDEX='CICSTS13.CICS',ASMBLR=IEV90,
//      LIST='LIST,XREF(SHORT),RENT,ALIGN'
//ASSEM.SYSPUNCH DD DSN=yourtext_dataset(program_name),DISP=OLD  3
//ASSEM.SYSIN DD *
  TITLE 'CICS/ESA : V3.2.1 : ASSEMBLE AND LINK-EDIT OF program_name'
  COPY DFHGDEFS GLOBAL SYMBOL DEFINITIONS                4
&MVS      SETB 1      SET WHEN MVS
&MVS811   SETB 1      SET WHEN MVS/ESA
&VSDSECT  SETA 1      PRINT NO DSECTS
  DFHCOVER OS
//      DD DSN=your_dataset(program_name),DISP=SHR        5
/*
//LNKEDIT EXEC DFHLNKVS,
//      PARM='LIST,XREF,LET,RENT,REFR',
//      NAME=SDFHLOAD,
//      INDEX='CICSTS13.CICS',
//      INDEX2='CICSTS13.CICS'
//SDFHLOAD DD DSN=CICSTS13.CICS.SDFHLOAD,DISP=SHR
//USERTEXT DD DSN=yourtext_dataset,DISP=SHR
//SYSLIN DD *
/* link-edit statements, see Figure 13 on page 404          */ 6
/*

```

Figure 12. Job stream to assemble and link-edit a user-replaceable program

Notes:

1 This job stream uses the CICS-supplied procedure DFHASMVS to assemble and link-edit user-replaceable programs. The DFHASMVS procedure refers to the MVS library SYS1.MODGEN. If you have not yet restructured MVS/ESA (moving members from SYS1.AMODGEN to SYS1.MODGEN), change the SYS1.MODGEN reference to SYS1.AMODGEN in the DFHASMVS procedure, until you have restructured MVS/ESA. When you have restructured MVS/ESA, you must return the SYS1.AMODGEN reference to SYS1.MODGEN.

2 `program_name` is the name of the program (on `your_dataset`) being modified.

3 `yourtext_dataset` is the name of the data set containing the text after assembly.

4 The assembler statements perform the following functions:

- Define the global symbols for the assembly (by a copy statement for the DFHGDEFS module)
- Set the following global symbols to '1':

Statement	Description
&MVS SETB 1	CICS is to run under MVS.
&MVS811 SETB 1	CICS is to run under MVS/ESA.
&VSDSECT SETA 1	Stop printing of CICS dummy sections (DSECTS).

5 `your_dataset` is the name of the data set containing your version of the code.

6 The input to the linkage editor must include several statements specific to the user-replaceable module. The appropriate statements are given in Figure 13 on page 404.

notes about user-replaceable programs

Link-edit statements for DFHPEP.

```
ORDER DFHEAI      this CSECT is in SDFHLOAD(DFHEAI)
ORDER DFHPEP      this CSECT is in USERTEXT(DFHPEP)
ORDER DFHEAI0     this CSECT is in SDFHLOAD(DFHEAI0)
INCLUDE SDFHLOAD(DFHEAI)
INCLUDE USERTEXT(DFHPEP)
INCLUDE SDFHLOAD(DFHEAI0)
MODE AMODE(31),RMODE(ANY)
ENTRY DFHPEP
NAME DFHPEP(R)
```

Link-edit statements for DFHREST.

```
ORDER DFHEAI
ORDER DFHREST
ORDER DFHEAI0
INCLUDE SDFHLOAD(DFHEAI)
INCLUDE SDFHLOAD(DFHREST)
INCLUDE SDFHLOAD(DFHEAI0)
MODE AMODE(31),RMODE(ANY)
```

Link-edit statements for DFHTEP.

```
ORDER DFHEAI      this CSECT is in SDFHLOAD(DFHEAI)
ORDER DFHTEP      this CSECT is in USERTEXT(DFHXTEP)
ORDER DFHEAI0     this CSECT is in SDFHLOAD(DFHEAI0)
INCLUDE SDFHLOAD(DFHEAI)
INCLUDE USERTEXT(DFHXTEP)
INCLUDE SDFHLOAD(DFHEAI0)
MODE AMODE(31),RMODE(ANY)
ENTRY DFHTEPNA
NAME DFHTEP(R)
```

Link-edit statements for DFHZNEP.

```
ORDER DFHEAI      this CSECT is in SDFHLOAD(DFHEAI)
ORDER DFHZNEP0    this CSECT is in USERTEXT(DFHZNEP0)
ORDER DFHEAI0     this CSECT is in SDFHLOAD(DFHEAI0)
INCLUDE SDFHLOAD(DFHEAI)
INCLUDE USERTEXT(DFHZNEP0)
INCLUDE SDFHLOAD(DFHEAI0)
MODE AMODE(31),RMODE(ANY)
ENTRY DFHZNENA
NAME DFHZNEP(R)
```

Figure 13. Link-edit statements for user-replaceable programs (Part 1 of 2)

Link-edit statements for DFHZATDX.

```
ORDER DFHEAI      this CSECT is in SDFHLOAD(DFHEAI)
ORDER DFHZATDX   this CSECT is in USERTEXT(DFHZATDX)
ORDER DFHEAI0    this CSECT is in SDFHLOAD(DFHEAI0)
INCLUDE SDFHLOAD(DFHEAI)
INCLUDE USERTEXT(DFHZATDX)
INCLUDE SDFHLOAD(DFHEAI0)
MODE AMODE(31),RMODE(ANY)
NAME DFHZATDX(R)
```

Link-edit statements for DFHDYP.

```
ORDER DFHEAI      this CSECT is in SDFHLOAD(DFHEAI)
ORDER DFHDYP     this CSECT is in USERTEXT(DFHDYP)
ORDER DFHEAI0    this CSECT is in SDFHLOAD(DFHEAI0)
INCLUDE SDFHLOAD(DFHEAI)
INCLUDE USERTEXT(DFHDYP)
INCLUDE SDFHLOAD(DFHEAI0)
MODE AMODE(31),RMODE(ANY)
ENTRY DFHDYP
NAME DFHDYP(R)
```

Link-edit statements for DFHDBUEX.

```
ORDER DFHEAI      this CSECT is in SDFHLOAD(DFHEAI)
ORDER DFHDBUEX   this CSECT is in USERTEXT(DFHDBUEX)
ORDER DFHEAI0    this CSECT is in SDFHLOAD(DFHEAI0)
INCLUDE SDFHLOAD(DFHEAI)
INCLUDE USERTEXT(DFHDBUEX)
INCLUDE SDFHLOAD(DFHEAI0)
MODE AMODE(31),RMODE(ANY)
ENTRY DFHDBUEX
NAME DFHDBUEX(R)
```

Link-edit statements for DFHXCURM.

```
ORDER DFHEAI      this CSECT is in SDFHLOAD(DFHEAI)
ORDER DFHXCURM   this CSECT is in USERTEXT(DFHXCURM)
ORDER DFHEAI0    this CSECT is in SDFHLOAD(DFHEAI0)
INCLUDE SDFHLOAD(DFHEAI)
INCLUDE USERTEXT(DFHXCURM)
INCLUDE SDFHLOAD(DFHEAI0)
MODE AMODE(31),RMODE(ANY)
ENTRY DFHXCURM
NAME DFHXCURM(R)
```

Figure 13. Link-edit statements for user-replaceable programs (Part 2 of 2)

User-replaceable programs and the storage protection facility

When you are running CICS with the storage protection facility, there are two points you need to consider:

- The execution key in which your user-replaceable programs run
- The storage key of data storage obtained for your user-replaceable programs.

Execution key for user-replaceable programs

When you are running with storage protection active, CICS always gives control to user-replaceable programs in CICS key. Even if you specify EXECKEY(USER) on the program resource definition, CICS forces CICS key when it invokes the program. However, if a user-replaceable program itself passes control to another

notes about user-replaceable programs

program, the program thus invoked executes according to the execution key (EXECKEY) defined in its program resource definition.

Important

You are strongly recommended to specify EXECKEY(CICS) when defining both user-replaceable programs and programs to which a user-replaceable program passes control.

Data storage key for user-replaceable programs

The storage key of storage used by user-replaceable programs depends on how the storage is obtained:

- The communication area passed to the user-replaceable program by its caller is always in CICS key.
- Any working storage obtained for the user-replaceable program is in the key set by the TASKDATAKEY of the transaction under which the program is invoked.
- User-replaceable programs can use EXEC CICS commands to obtain storage, by issuing:
 - Explicit EXEC CICS GETMAIN commands
 - Implicit storage requests as a result of EXEC CICS commands that use the SET option.

The default storage key for storage obtained by EXEC CICS commands is set by the TASKDATAKEY of the transaction under which the user program is invoked.

As an example, consider a transaction defined with TASKDATAKEY(USER) that causes a user-replaceable program to be invoked. In this case, any implicit or explicit storage acquired by the user program by means of an EXEC CICS command is, by default, in user-key storage. However, on an EXEC CICS GETMAIN command, the user program can override the TASKDATAKEY option by specifying either CICS DATAKEY or USER DATAKEY.

Chapter 6. Writing a program error program

Considerations common to all user-replaceable programs

Note that the comments contained in “Chapter 5. General notes about user-replaceable programs” on page 401 apply to this chapter.

The CICS-supplied default program error program (DFHPEP) contains code to:

- Obtain program addressability
- Access the communication area
- Return control to CICS through an EXEC CICS RETURN command.

The source of DFHPEP is provided in assembler-language and C versions; you can modify one of these to include your own logic, or you can write your own program error program in any of the languages supported by CICS. There is a discussion of the reasons for using your own program error program in the *CICS Recovery and Restart Guide*. Note, however, that when writing a program error program you are subject to specific restrictions:

- Your program must be named DFHPEP.
- It must not issue any EXEC CICS commands that make use of MRO or ISC facilities (such as distributed transaction processing or function shipping).
- It must not issue any commands that access recoverable resources.
- It cannot influence the taking of a transaction dump.

The default DFHPEP module is a dummy module. If you want to customize it, you have to code the source yourself. To help you, a listing of DFHPEP is provided in Figure 14 on page 409. When you have written your program error program, translate and assemble it, and use it to replace the supplied dummy program. For information about the job control statements necessary to assemble and link-edit user-replaceable programs, refer to “Assembling and link-editing user-replaceable programs” on page 402.

Information available to DFHPEP in the communication area includes:

- The current abend code, at PEP_COM_CURRENT_ABEND_CODE.
- The original abend code, at PEP_COM_ORIGINAL_ABEND_CODE. The “original” and “current” abend codes are different if the transaction has suffered more than one abend—for example, if the failing program abended while handling a previous abend. In this case, the “original” abend is the first abend that the transaction suffered.
- The EIB at the time of the last EXEC CICS command, at PEP_COM_USERS_EIB.
- The name of the program that suffered the (current) abend, at PEP_COM_ABPROGRAM. PEP_COM_ABPROGRAM identifies the program as follows:
 - If the abend occurred in a distributed program link (DPL) server program running in a remote system, it identifies the server program.
 - If the abend is a local ‘ASRA’, ‘ASRB’, or ‘ASRD’, it identifies the program in which the program check or operating system abend occurred.
 - In all other cases, it identifies the current PPT entry.

the program error program

- The program status word (PSW) at the time of the (current) abend, at PEP_COM_PSW. The full contents of PEP_COM_PSW are significant for abend codes 'ASRA', 'ASRB', and 'ASRD' only; the last four characters (the PSW address) apply also to code 'AICA'.
- The GP registers (0-15) at the time of the (current) abend, at PEP_COM_REGISTERS.
- The execution key of the program at the time it suffered the (current) abend, at PEP_COM_KEY. The value of PEP_COM_KEY is significant for abend codes 'ASRA' and 'ASRB' only.
- Whether the (current) abend occurred as the result of a storage protection exception, at PEP_COM_STORAGE_HIT. The value of PEP_COM_STORAGE_HIT is significant for abend code 'ASRA' only, and indicates which of the protected dynamic storage areas (the CDSA, ECDSA, or ERDSA), if any, the failing program attempted to overwrite.
- The address of the task abend control block (TACB). This provides details of the subspace and access registers current at the time of the abend. The subspace value is in PEP_COM_SPACE.
- Program status word interrupt information, at PEP_COM_INT.

Note that information about the PSW, registers, execution key, and type of storage "hit" is meaningful only if the abend occurred in the local system; these fields are set to zeros if the abend occurred in a DPL server program running in a remote system.

In order to disable the transaction, you should assign the value 'PEP_COM_RETURN_DISABLE' to the field PEP_COM_RETURN_CODE. Otherwise, you should allow the field to default to zero, or set it to the value 'PEP_COM_RETURN_OK'. CICS does not allow CICS-supplied transactions to be disabled; you should not, therefore, attempt to disable transactions whose IDs begin with "C".

The assembler-language source code of the default program error program is shown in Figure 14 on page 409. The communication area is shown in Figure 15 on page 409.

the program error program

```

DFHEISTG DSECT ,
*
*       Insert your own storage definitions here
*
          DFHPCOM TYPE=DSECT
*****
* * * * *           P R O G R A M   E R R O R           * * * * *
* * * * *           P R O G R A M           * * * * *
*****
DFHPEP  CSECT                                PROGRAM ERROR PROGRAM CSECT
DFHPEP  RMODE ANY
          DFHREGS ,                            EQUATE REGISTERS
          XR    R1,R1
          ICM  R1,B'0011',EIBCALEN Get Commarea length
          BZ   RETURNX                          ...no Commarea; exit
          EXEC CICS ADDRESS COMMAREA(R2) ,
          USING DFHPEP_COMMAREA,R2

*
*       Insert your own code here
*
          LA   R1,PEP_COM_RETURN_OK
          B    RETURN
          DFHEJECT

*
RETURNER DS    0H                                Return for error cases
          LA   R1,PEP_COM_RETURN_DISABLE
RETURN   DS    0H
          ST   R1,PEP_COM_RETURN_CODE
RETURNX  DS    0H
          EXEC CICS RETURN ,
          END  DFHPEP

```

Figure 14. Source code of the default program error program (DFHPEP)

```

DFHPEP_COMMAREA DSECT
*
*       Standard header section
*
PEP_COM_STANDARD          DS    0F
PEP_COM_FUNCTION          DS    CL1          Always '1'
PEP_COM_COMPONENT        DS    CL2          Always 'PC'
PEP_COM_RESERVED         DS    C           Reserved
*
*       Abend codes and EIB
*
PEP_COM_CURRENT_ABEND_CODE DS    CL4          Current abend code
PEP_COM_ORIGINAL_ABEND_CODE DS    CL4          Original abend code
PEP_COM_USERS_EIB        DS    CL(EIBRLDBK-EIBTIME+L'EIBRLDBK)
*                               EIB at last EXEC CICS command

```

Figure 15. Source of DFHPEP communication area (assembler-language) (Part 1 of 2)

the program error program

```
*
* Debugging information (program, PSW, registers and execution key at
* time of abend, hit storage indicator). If the abend occurred in a
* DPL server program running remotely, only program is meaningful.
*
PEP_COM_DEBUG          DS    0F
PEP_COM_ABPROGRAM      DS    CL8    Program causing abend
PEP_COM_PSW            DS    CL8    PSW at abend
*                          (codes ASRA, ASRB, AICA, ASRD)

PEP_COM_REGISTERS      DS    CL64    GP registers at abend
*                          (registers 0-15)
PEP_COM_KEY            DS    X      Execution key at abend
*                          (ASRA and ASRB only)
PEP_COM_USER_KEY       EQU    9      User key
PEP_COM_CICS_KEY       EQU    8      CICS key
*
PEP_COM_STORAGE_HIT    DS    X      Storage type hit by 0C4
*                          (ASRA only)
PEP_COM_NO_HIT         EQU    0      No hit, or not 0C4
PEP_COM_CDSA_HIT       EQU    1      CDSA hit
PEP_COM_ECDSA_HIT      EQU    2      ECDSA hit
PEP_COM_ERDSA_HIT      EQU    3      ERDSA hit
PEP_COM_RDSA_HIT       EQU    4      RDSA hit
PEP_COM_EUDSA_HIT      EQU    5      EUDSA hit
PEP_COM_UDSA_HIT       EQU    6      EUDSA hit
*
PEP_COM_SPACE          DS    X      Subspace/basespace
PEP_COM_NOSPACE        EQU    0
PEP_COM_SUBSPACE       EQU    10     Abending task was in
*                          subspace
PEP_COM_BASESPACE      EQU    11     Abending task was in
*                          basespace
PEP_COM_PADDING        DS    CL2     Reserved
*
*                          Return code
*
PEP_COM_RETURN_CODE     DS    F
PEP_COM_RETURN_OK       EQU    0
PEP_COM_RETURN_DISABLE EQU    4      Disable transaction
*
*          Additional Program status word information
*
PEP_COM_INT             DS    CL8     PSW interrupt codes
*
*                          length of DFHPEP_COMMAREA
PEP_COM_LEN EQU *-PEP_COM_STANDARD
```

Figure 15. Source of DFHPEP communication area (assembler-language) (Part 2 of 2)

The sample programs and copy books

Two source-level versions of the default program are provided: DFHPEP, coded in assembler language, and DFHPEPD, coded in C. Both are in the CICSTS13.CICS.SDFHSAMP library. There is an assembler-language macro, DFHPCOM, and a corresponding C copy book, DFHPCOMD, that you can use to define the communication area. These are found in the CICSTS13.CICS.SDFHMAC and CICSTS13.CICS.SDFHC370 libraries, respectively.

You can code your program error program in any of the languages supported by CICS, but you must always name it DFHPEP.

Chapter 7. Writing a transaction restart program

The transaction restart user-replaceable program (DFHREST) enables you to participate in the decision as to whether a transaction should be restarted or not.

CICS invokes DFHREST when a transaction abends, if RESTART(YES) is specified in the transaction's resource definition (the default is RESTART(NO)).

The default program requests restart under certain conditions; for example, in the event of a program isolation deadlock (that is, when two tasks each wait for the other to release a particular DL/I database segment or file record), one of the tasks is backed out and automatically restarted, and the other is allowed to complete its update.

For general information about restarting transactions, see the *CICS Recovery and Restart Guide*.

Notes:

1. If your transaction restart program chooses to restart a transaction, a new task is attached that invokes the initial program of the transaction. This is true even if the task abended in the second or subsequent UOW, and DFHREST requested a restart.
2. Statistics on the total number of restarts against each transaction are kept.
3. Emergency restart does not restart any tasks.
4. In some cases, the benefits of transaction restart can be obtained instead by using the SYNCPOINT ROLLBACK command. Although use of the ROLLBACK command is not usually recommended, it does keep all the executable code in the application programs. For more information about the use of the ROLLBACK option when working in an ISC or MRO environment, see the *CICS Intercommunication Guide*.

When planning to replace the default DFHREST, check to see if the logic of any of your transactions is inappropriate for restart.

- Transactions that execute as a single unit of work are safe. Those that execute a loop, and on each pass reading one record from a recoverable destination, updating other recoverable resources, and closing with a syncpoint, are also safe.
- There are two types of transaction that need to be modified to avoid erroneously repeating work done in the units of work that precede an abend:
 1. A transaction in which the first and subsequent units of work change different resources
 2. A transaction where the contents of the input data area are used in several units of work.

the transaction restart program

All the following conditions must be true for CICS to invoke the transaction restart program:

- A transaction must be terminating abnormally.
- The transaction abend which caused the transaction to be terminating abnormally must have been detected before the commit point of the implicit syncpoint at the end of the transaction has been reached.
- The transaction must be defined as restartable in its transaction definition.
- The transaction must be related to a principal facility.

If these conditions are satisfied, CICS invokes the transaction restart program, which then decides whether or not to request that the transaction be restarted. CICS can subsequently override the decision (for example, if dynamic backout fails). Also, if the transaction restart program abends, the transaction is not restarted.

If the above conditions are not satisfied, CICS does not invoke the transaction restart program and the transaction is not restarted.

The DFHREST communications area

The CICS-supplied default transaction restart program is written in assembler and contains logic to:

- Address the communications area passed to it by CICS
- Decide whether or not to request transaction restart
- Send a message to CSMT if restart is requested
- Return control to CICS using the EXEC CICS RETURN command.

The communications area is mapped by the XMRS_COMMAREA DSECT, which is supplied in the DFHXMRS copybook. The equivalent structures for C/370, COBOL, VS COBOL II, and PL/1 are contained in the copybooks DFHXMRS, DFHXMRSO, and DFHXMRSR, respectively.

The information passed in the communications area is as follows:

XMRS_FUNCTION

Indicates, in a 1-byte field, the function code for this call to the restart program. This is always set to 1, which equates to XMRS_TRANSACTION_RESTART, which means that DFHREST is called to handle transaction restart.

XMRS_COMPONENT_CODE

Indicates, in a 2-byte field, the component code of the caller. This is always set to XM, which equates to XMRS_TRANSACTION_MANAGER. The transaction manager is the CICS component that coordinates the decision whether or not to restart a transaction.

XMRS_READ

Indicates, in a 1-byte field, whether the transaction has issued any terminal read requests, other than for initial input.

The equated values for this parameter are:

XMRS_READ_YES

Means a terminal read has been performed by the transaction.

XMRS_READ_NO

Means no terminal read has been performed.

XMRS_WRITE

Indicates, in a 1-byte field, whether the transaction has issued any terminal write requests.

The equated values for this parameter are:

XMRS_WRITE_YES

Means a terminal write has been performed by the transaction.

XMRS_WRITE_NO

Means a terminal write has not been performed by the transaction.

XMRS_SYNCPOINT

Indicates, in a 1-byte field, whether the transaction has performed any syncpoints.

The equated values for this parameter are:

XMRS_SYNCPOINT_YES

Means one or more syncpoints have been performed.

XMRS_SYNCPOINT_NO

Means no syncpoints have been performed.

XMRS_RESTART_COUNT

This indicates, as an unsigned, half-word binary value, the number of times the transaction has been restarted.

It is zero if the transaction has not been restarted. It is **not** the total number of restarts for the transaction definition. Rather it is the total number of restarts for transactions that are attempting, for example, to process a single piece of operator input.

XMRS_ORIGINAL_ABEND_CODE

Provides the first abend code recorded by the transaction.

XMRS_CURRENT_ABEND_CODE

Provides the current abend code. The values of the original abend code and the current abend code can be different if, for example, a transaction handles an abend and then abends later.

XMRS_RESTART

This is a 1-byte output field that the transaction restart program sets to indicate whether it wants CICS to restart the transaction.

The equated values for this field are:

XMRS_RESTART_YES

Requests a restart.

XMRS_RESTART_NO

Requests no restart.

The CICS-supplied transaction restart program

The CICS-supplied default transaction restart program requests that the transaction be restarted if:

1. The transaction has not performed a terminal read (other than reading the initial input data), terminal write or syncpoint, **and**
2. The restart count is less than 20 (to limit the number of restarts), **and**
3. The current abend code is one of the following:
 - ADCD, indicating that the transaction abended due to a DBCTL deadlock
 - AFCF, indicating that the transaction abended due to a file control-detected deadlock
 - AFCW, indicating that the transaction abended due to a VSAM-detected deadlock (RLS only).

The source of the CICS-supplied default transaction restart program, DFHREST, is supplied in assembler language only, in the CICSTS13.CICS.SDFHSAMP library.

The assembler copybook for mapping the communications area is in the CICSTS13.CICS.SDFHMAC library.

Chapter 8. Writing a terminal error program

Considerations common to all user-replaceable programs

Note that the comments contained in “Chapter 5. General notes about user-replaceable programs” on page 401 apply to this chapter.

This chapter contains information about the CICS terminal error program (TEP), which handles error conditions for devices that use the TCAM DCB interface or the sequential access method. **Note that node error programs, not terminal error programs, must be used for VTAM-supported devices.** The chapter is divided into three sections:

1. **“Background to error handling for TCAM and sequential devices”** is an overview.
2. **“The sample terminal error program”** on page 417 describes the CICS-supplied sample TEP. It contains:
 - “Components of the sample terminal error program” on page 418
 - “Structure of the sample terminal error program” on page 419
 - “Sample terminal error program messages” on page 423
 - “Generating the sample terminal error program” on page 425.
3. **“User-written terminal error programs”** on page 437 discusses factors you need to consider when writing your own terminal error program. It contains:
 - “Why write your own terminal error program?” on page 438
 - “Restrictions on the use of EXEC CICS commands” on page 438
 - “Addressing the contents of the communication area” on page 438
 - “Addressing the contents of the TACLE” on page 441
 - “Example of a user-written terminal error program” on page 445.

Background to error handling for TCAM and sequential devices

CICS terminal error handling is based on the assumption that most users want to modify CICS operations in response to terminal errors. Because CICS cannot anticipate all possible courses of action, the error-handling facilities have been designed to allow maximum freedom for users to create unique solutions for errors that occur within a terminal network.

The following CICS components are involved in the detection and correction of errors that occur when TCAM terminals or sequential devices are used:

- Terminal control program (DFHTCP)
- Terminal abnormal condition program (DFHTACP)
- Terminal error program (DFHTEP).

These components are discussed in the following sections. (The corresponding CICS components for logical units are discussed in “Chapter 9. Writing a node error program” on page 449.)

background

When an abnormal condition occurs

When an abnormal condition associated with a particular terminal or line occurs, the terminal control program puts the terminal out of service and passes control to the terminal abnormal condition program (DFHTACP) which, in turn, passes control to a version of the terminal error program (DFHTEP, either CICS-supplied or user-written), so that it can take the appropriate action.

Terminal control program

When the terminal from which the error was detected has been put out of service, the terminal control program creates a terminal abnormal condition line entry (TACLE), which is chained off the real entry, the terminal control table line entry (TCTLE) for the line on which the error occurred. The TACLE contains information about the error.

Terminal abnormal condition program

After the TACLE has been established, a task that executes DFHTACP is attached by the terminal control program and is provided with a pointer to the real line entry (TCTLE) on which the error occurred. After performing basic error analysis and establishing the default actions to be taken, DFHTACP gives control to DFHTEP, and passes a communication area (DFHTEPCA) so that DFHTEP can examine the error and provide an alternative course of action.

The communication area provides access to all the error information necessary for correct evaluation of the error; and contains special action flags that can be manipulated to alter the default actions previously set by DFHTACP.

After DFHTEP has performed the desired function, it returns control to DFHTACP by issuing an EXEC CICS RETURN command. DFHTACP then performs the actions dictated by the action flags within the communication area, and the error-handling task terminates.

Notes:

1. DFHTACP default actions, message codes, error codes, and conditions are listed in the *CICS Problem Determination Guide*.
2. If DFHTACP has more than eight errors on a line before action can be taken, the line is put out of service to avoid system degradation.

Terminal error program

The terminal error program analyzes the cause of the terminal or line error that has been detected by the terminal control program. The CICS-supplied version (the sample terminal error program, DFHXTEP) is designed to attempt basic and generalized recovery actions. A user-written version of this program can be provided to handle specific application-dependent recovery actions. The user-written terminal error program is linked-to in the same way as the CICS-supplied version, by the terminal abnormal condition program. Information relating to the error is carried in the communication area and the TACLE.

The macros that are provided for generating the sample terminal error program are described in the sections that follow. The main steps are generating the sample

DFHTEP module and tables by means of the DFHTEPM and DFHTEPT macros, respectively. You can select the appropriate options in this sample program, and you can base your own version on it.

There is a description of the CICS-supplied sample terminal error program (DFHXTEP), and advice about how to generate a user-written version, later in this chapter.

Note: If DFHTEP abends, then the default actions specified in DFHTACP are reinstated.

The communication area

The communication area is the basic interface used by the sample DFHTEP, and should be used by a user-written DFHTEP to:

- Address the TACLE
- Indicate the course of action to be taken on return to DFHTACP.

Before giving control to DFHTEP, DFHTACP establishes which default actions should be taken. This depends on the particular error condition that has been detected. The default actions are indicated by appropriate bit settings in the 1-byte communication area field TEPCAACT. For details about communication area fields, default actions, and bit settings, refer to “User-written terminal error programs” on page 437.

Terminal abnormal condition line entry (TACLE)

The TACLE contains further information about the type of error, and about the type of terminal that is in error.

The code indicating the detected error condition is passed to DFHTEP in the 1-byte field of the TACLE labeled TCTLEPFL. (These DFHTACP error codes, message codes, conditions, and default actions are also listed in the *CICS Problem Determination Guide*.)

A format description of the terminal abnormal condition line entry (TACLE) DSECT is provided under “User-written terminal error programs” on page 437.

The sample terminal error program

CICS provides a sample terminal error program that can be used as a generalized program structure for handling terminal errors. Note that, although the source code form of the sample TEP (DFHXTEP) is provided in assembler language only, you can write your own terminal error program in any of the languages supported by CICS.

After DFHXTEP has been assembled, it is link-edited as DFHTEP. For information about the job control statements necessary to assemble and link-edit user-replaceable programs, refer to “Assembling and link-editing user-replaceable programs” on page 402.

You can generate and use the sample terminal error program with the default options provided, or you can customize the terminal error support to the needs of

the sample terminal error program

the operating environment by selecting the appropriate generation options and variables. Because each error condition is processed by a separate routine, you can replace a CICS-provided routine with a user-written one when the sample TEP is generated.

Components of the sample terminal error program

The sample terminal error program consists of the terminal error program itself and two terminal error program tables:

- The TEP error table
- The TEP default table.

Both tables contain “thresholds” defined for the various error conditions to be controlled and accounted for by the sample DFHTEP. A “threshold” may be thought of as the number of error occurrences that are permitted for a given type of error on a given terminal before the sample DFHTEP accepts the DFHTACP default actions. Optionally, the number of occurrences can be controlled and accounted for over prescribed time intervals (for example, if more than three of a given type of error occur in an hour, the terminal is put out of service).

TEP error table

The terminal error program (TEP) error table maintains information about errors that have occurred on a terminal. The table consists of two parts (shown in Figure 16):

- The TEP error table header (TETH), which contains addresses and constants related to the location and size of the TEP error table components.
- Terminal error blocks (TEBs), which can be either:
 - Permanent (P-TEBs), each associated with a particular terminal
 - Reusable (R-TEBs), not permanently associated with any particular terminal.

TEP error table header (TETH)
Terminal error blocks (P-TEBs and R-TEBs)

Figure 16. TEP error table

TEBs maintain error information associated with terminals. You must specify the total number of TEBs to be generated. The maximum number needed is one per terminal. In this case the TEBs are permanent.

You can reduce the total amount of storage used for TEBs by allocating a pool of reusable TEBs, that are not permanently associated with a particular terminal. Reusable TEBs are assigned dynamically on the first occurrence of an error associated with a terminal, and are released for reuse when the appropriate error processor places the terminal out of service.

Note: Ensure that the pool is large enough to hold the maximum number of terminals for which errors are expected to be outstanding at any one time. If the pool limit is exceeded, handling of terminal errors may become intermittent. **No warning is given of this condition.**

the sample terminal error program

You should assign permanent TEBs to terminals that are critical to the network. For the remainder of the network, you can generate a pool of reusable TEBs.

Each TEB currently in use or permanently assigned contains the symbolic terminal identifier of the terminal, and one or more error status elements (ESEs), as shown in Figure 17.

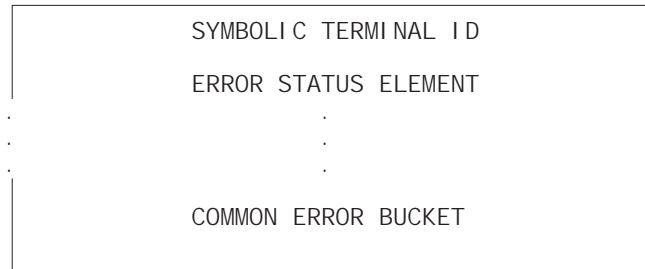

Figure 17. Terminal error block (TEB)

An ESE records the occurrence of a particular type of error associated with the terminal. The contents of an error status element are described in the TEP CD DSECT (generated by the DFHTEPM TYPE=INITIAL macro) under the comment “ERROR STATUS ELEMENT FORMAT”. The number of ESEs per TEB remains constant for all TEBs. You specify the number when the TEP tables are generated. If fewer than the maximum number of error types recognized by DFHTACP (25) are specified, one additional ESE, referred to as the “common error bucket”, is generated for each TEB.

You can permanently reserve ESE space in each TEB for specific error types. Those not permanently reserved are considered reusable, and are assigned dynamically on the first occurrence of a particular error type associated with the terminal. If an error type occurs that is not currently represented by an ESE, and if all reusable ESEs are assigned to other error types, the occurrence of this error is recorded in the common error bucket. DFHTACP can recognize far more error types than can occur in a typical terminal network. By specifying less than the maximum and allowing the sample DFHTEP to assign ESEs dynamically, you can minimize the table size, and still control and account for the types of errors relevant to the network.

TEP default table

The terminal error program (TEP) default table contains the “number and time” thresholds for each type of error to be controlled and accounted for. An index array at the beginning of the default table serves a dual function. If the value in the index is positive, then the error code has a permanently defined ESE in each TEB and the index value is the displacement to the reserved ESE. If the index value is negative, then an ESE must be assigned dynamically from a reusable ESE if one has not already been created by a prior occurrence. The complement of the negative index value is the displacement to the thresholds for the error type retained in the TEP default table.

Structure of the sample terminal error program

The structure of the sample terminal error program (DFHXTEP) can be broken down into six major areas as follows:

the sample terminal error program

1. Entry and initialization
2. Terminal identification and error code lookup
3. Error processor selection
4. Error processing execution
5. General exit
6. Common subroutines.

These areas are described in detail in the sections that follow.

Figure 18 on page 423 gives an overview of the structure of the sample terminal error program.

Entry and initialization

On entry, the sample TEP uses DFHEIENT to establish base registers and addressability to EXEC Interface components. It obtains addressability to the communication area passed by DFHTACP by means of an EXEC CICS ADDRESS COMMAREA, and addressability to the EXEC interface block with an EXEC CICS ADDRESS EIB command. It gets the address of the TACLE from the communication area, and establishes access to the TEP tables with an EXEC CICS LOAD. If time support has been generated, the error is time-stamped for subsequent processing. (Current time of day is passed in the communication area.) The first entry into the sample TEP after the system is initialized causes the TEP tables to be initialized.

Terminal ID and error code lookup

After the general entry processing, the TEP error table is scanned for a terminal error block (TEB) entry for the terminal associated with the error. If no matching entry is found, a new TEB is created. If all TEBs are currently in use (if no reusable TEBs are available), the processing is terminated and a RETURN request is issued, giving control back to DFHTACP, where default actions are taken.

After the terminal's TEB has been located or created, a similar scan is made of the error status elements (ESEs) in the TEB to determine whether the type of error currently being processed has occurred before, or if it has permanently reserved ESE space. If an associated ESE is not found, an ESE is assigned for the error type from a reusable ESE. If a reusable ESE does not exist, the error is accounted for in the terminal's common error bucket. The addresses of the appropriate control areas (TEB and ESE) are placed in registers for use by the appropriate error processor.

Error processor selection

User-specified message options are selected and the messages are written to a specified transient data destination. The type of error code is used as an index to a table to determine the address of an error processor to handle this type of error. If the error code is invalid, or the sample TEP was not generated to process this type of error, the address points to a routine that optionally generates an error message and returns control to DFHTACP, where default actions are taken. If an address of a valid error processor is obtained from the table, control is passed to that routine.

Error processing execution

The function of each error processor is to determine whether the default actions established by DFHTACP for a given error, or the actions established by the error

the sample terminal error program

processor, are to be performed. The common error bucket is processed by the specific error processor. However, the thresholds of the common error bucket are used in determining whether the limit has been reached. Subroutines are provided in the sample TEP to maintain count and time threshold totals for each error associated with a particular terminal to assist the error processor to make its decision. Also available are subroutines for logging the status of the error and any recovery action taken by the error processor.

You can replace any of the error processors supplied in the sample TEP with user-written ones. Register linkage conventions, error conditions, DFHTACP default actions, and sample TEP error processor actions are described in comments given in the sample DFHXTEP source listing. However, sample DFHXTEP actions, in many cases, can be altered by changing the thresholds when generating the TEP tables.

General exit

Control is passed to a general exit routine from each error processor. This routine determines whether the terminal is to remain in service. If the terminal is to be put out of service, the terminal error block and all error status elements for that terminal are deleted from the TEP error table unless the terminal was defined as a permanent entry. When the terminal is placed back in service, a new terminal error block is assigned if a subsequent error occurs.

Common subroutines

A number of subroutines are provided in the sample DFHXTEP for use by the error processors. Each subroutine entry has a label of the form "TEPxxxx" where "xxxx" is the subroutine name. All labels within a subroutine start with TEPx where "x" is the first character of the subroutine name. All subroutines are arranged within the module in alphabetical order in the subroutine section. Register conventions and use of the subroutine are given as comments at the beginning of each subroutine in the source listing.

The following subroutines are available for writing your own error processors:

TEPACT

Used to output the names of the action bits set by DFHTACP and the sample DFHTEP in the communication area field **TEPCA**ACT if appropriate PRINT options are selected when the program is generated.

TEPDEL

Used to delete the terminal error block and error status elements for a terminal from the TEP error table on exit from an error processor.

TEPHEXCN

Used by TEPPUTTD to convert a 4-bit hexadecimal value to its 8-bit printable equivalent.

TEPINCR

Used to update and test the count and time threshold totals maintained in the terminal's error status element.

TEPLOC

Used to locate or assign terminal error blocks and error status elements for a terminal ID.

the sample terminal error program

TEPPUTTD

Used to output character or hexadecimal data to a user-defined transient data destination.

TEPTMCHK

Used by TEPINCR to determine whether the time threshold has been passed.

TEPWGHT

Used to update the weight/time threshold values maintained in the terminal's error status elements.

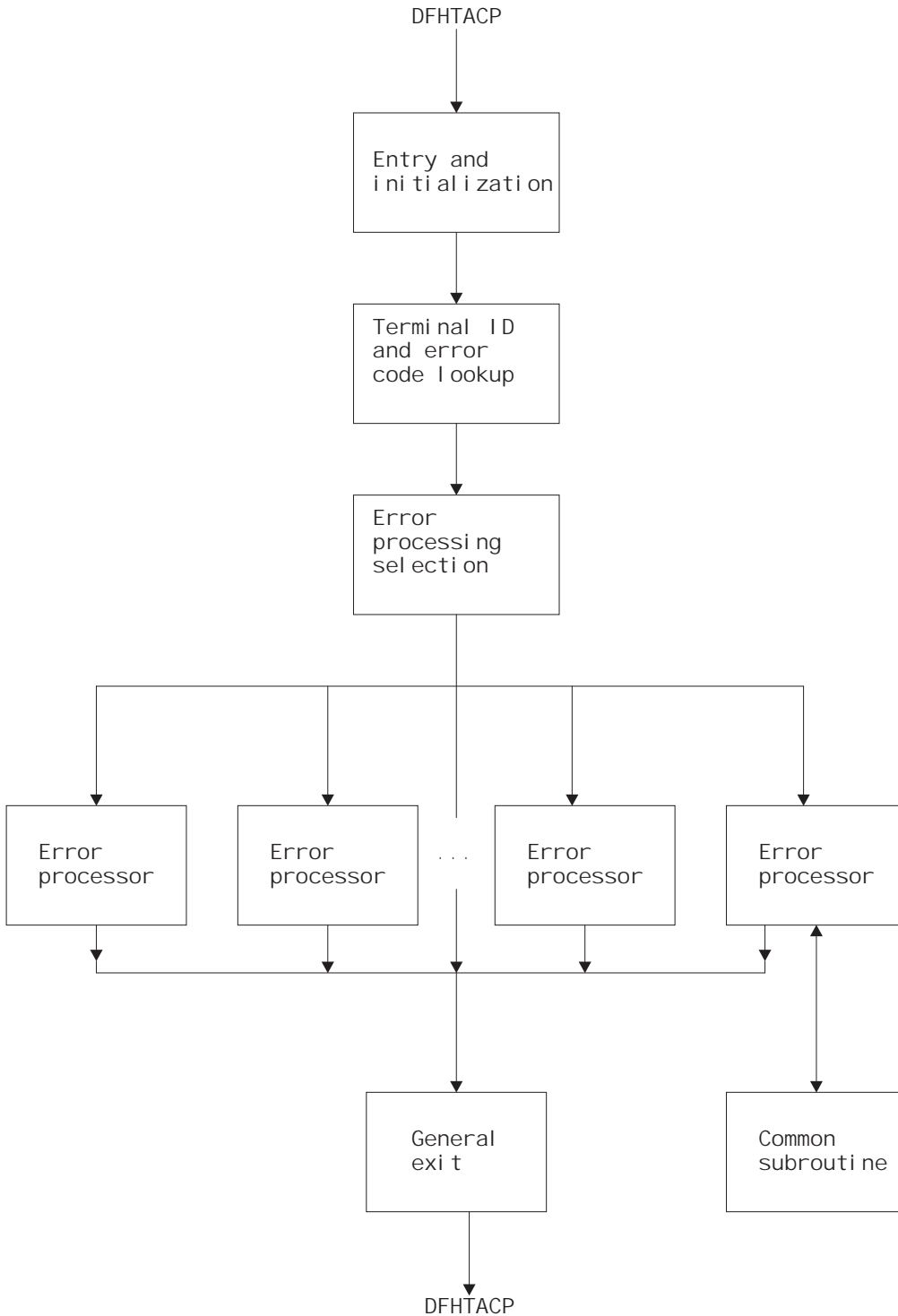

Figure 18. Overview of the sample terminal error program (DFHXTEP)

Sample terminal error program messages

The messages logged to the transient data destination CSMT (or, optionally, to the destination specified in the OPTIONS operand of DFHTPEM TYPE=INITIAL) are of

the sample terminal error program

six types, each identified by a unique message prefix. You can control the selection of each type of message by using the appropriate parameters specified on the PRINT operand of DFHTEPM TYPE=INITIAL.

These messages are:

DFHTEP, ERROR – error text

During DFHTEP module generation, the PRINT parameter specified ERRORS. This message can be suppressed by using the NOERRORS option. The error text is one of the following:

Unsupported error code, “xx”

The error code presented to DFHTEP by DFHTACP is unknown to DFHTEP.

“DFHTEPT” not defined in system

The DFHTEP table could not be loaded into storage.

Unknown error status message, “xxxx”

The error status message presented from a remote 3270 type device could not be decoded.

None of these errors should occur.

DFHTEP, ACTION – action flag names

During DFHTEP module generation, the PRINT parameter specified TACPATION or TEPACTION or both. If both are specified, this message is logged twice each time DFHTEP is called. The first message indicates the action flags as set by DFHTACP on entry to DFHTEP. The second message indicates the action flags as returned to DFHTACP by DFHTEP after error processing. These messages can be suppressed by using the NOTACPATION and NOTEPACTION options.

The action flag names and descriptions are listed below. For further information about the actions taken by DFHTACP, see the description of the TEPCAACT field in “Addressing the contents of the communication area” on page 438.

Flag name

Description

LINEOS

Place line out of service

NONPRGT

Nonpurgeable task exists on terminal

TERMOS

Place terminal out of service

ABENDT

Abend task on terminal

ABORTWR

Abort write, free terminal storage

RELTIOA

Release TCAM incoming message

SIGNOFF

Sign off terminal.

DFHTEP, TID - tid

During the DFHTEP module generation, the PRINT parameter specified TID.

the sample terminal error program

This message contains the symbolic terminal ID of the device associated with the error. This message can be suppressed by using the NOTID option.

DFHTEP, DECB - DECB information

During the DFHTEP module generation, the PRINT parameter specified DECB. This two-line message contains the DECB (printed in hexadecimal format) of the terminal causing the error. The DECB is contained in the TACLE (displacement +16 [decimal]). See the TACLE DSECT described in "User-written terminal error programs" on page 437. This message can be suppressed by using the NODECB option.

DFHTEP, TACLE - TACLE information

During the DFHTEP module generation, the PRINT parameter specified TACLE. This message (printed in hexadecimal format) contains the first 16 bytes of the TACLE passed to DFHTEP by DFHTACP. See the TACLE DSECT described in "User-written terminal error programs" on page 437. This message can be suppressed by using the NOTACLE option.

DFHTEP, ESE - ESE information

During the DFHTEP module generation, the PRINT parameter specified ESE. This message contains the error status element. The message can be suppressed by using the NOESE option.

An ESE is either 6 bytes or 12 bytes long, depending on whether the TIME option was specified when generating the TEP tables. The formats are as follows:

Table 18. Format of error status element on DFHTEP, ESE messages—NOTIME specified

NOTIME	Display	Length (bytes)	Significance
	0	2	Error threshold counter or weight value in binary format
	2	2	Current error count or weight value in binary
	4	1	Error code
	5	1	Not used.

Table 19. Format of error status element on DFHTEP, ESE messages—TIME specified

TIME	Display	Length (bytes)	Significance
	0	5	Error threshold counter or weight value in binary format
	5	3	Timed threshold value in hundredths of a second
	8	4	Time of first occurrence of this error. Time given as binary integer in hundredths of a second.

Generating the sample terminal error program

For information about how to generate the sample terminal error program and the sample terminal error table, refer to "Assembling and link-editing user-replaceable programs" on page 402.

The sample program and tables provide you with default error processing for terminal errors. If you want to replace the supplied error processors with user-written error processors, you must use the DFHTEPM and DFHTEPT macros

the sample terminal error program

to generate a sample error program and tables that include your user-written routines. Some of the parameters specified in the DFHTEPM and DFHTEPT macros are related and care must be taken to ensure compatibility. The parameters concerned are identified in the descriptions of the macros later in this chapter.

If you use the sample terminal error program (DFHXTEP), you can generate the required program and transaction definitions by using the CEDA INSTALL GROUP(DFHSTAND) command.

Job control for generating the sample terminal error program

The generation of the sample terminal error program consists of two separate assembly and link-edit steps, one to create the sample TEP module itself, and the other to create the TEP tables. The names under which the components must be link-edited are:

DFHTEP

Sample TEP module, assembled from DFHXTEP

DFHTEPT

Sample TEPT table, assembled from DFHXTEPT.

For information about the job control statements necessary to assemble and link-edit user-replaceable programs, refer to “Assembling and link-editing user-replaceable programs” on page 402.

DFHTEPM—generating the sample DFHTEP module

The sample DFHTEP module is generated by the following macros:

- DFHTEPM TYPE=USTOR—to indicate the start of user storage definitions.
- DFHTEPM TYPE=USTOREND—to indicate the end of user storage definitions.
- DFHTEPM TYPE=INITIAL—to control the printing of CICS DSECTs, provide optional routines, and indicate the type of information to be logged when errors occur.
- DFHTEPM TYPE=ENTRY—to code a user “ENTRY” routine.
- DFHTEPM TYPE=EXIT—to code a user “EXIT” routine.
- DFHTEPM TYPE=ERRPROC—to allow you to replace the error processors supplied with the sample terminal error program with user-written versions.
- DFHTEPM TYPE=FINAL—to indicate the end of the sample DFHTEP module.

Note: You must code the translator options NOPROLOG and NOEPILOG in your error processors if you use these macros.

```
DFHTEPM  TYPE=USTOR
```

This macro indicates the start of user storage definitions. It must be followed by your storage definitions, and then by DFHTEPM TYPE=USTOREND. If you use DFHTEPM TYPE=USTOR to define storage, then both it and DFHTEPM TYPE=USTOREND must be coded **before** DFHTEPM TYPE=INITIAL.

```
DFHTEPM  TYPE=USTOREND
```

the sample terminal error program

This macro indicates the end of user storage definitions. Its use is mandatory if DFHTEPM TYPE=USTOR has been coded. If you use DFHTEPM TYPE=USTOR to define storage, then both it and DFHTEPM TYPE=USTOREND must be coded **before** DFHTEPM TYPE=INITIAL.

```
DFHTEPM TYPE=INITIAL
[,DSECTPR={YES|NO}]
[,OPTIONS=([TD] (TD,destid)|NOTD)
           [,EXITS|,NOEXITS]
           [,TIME|,NOTIME]
           [,TCAM|,NOTCAM])]
[,PRINT=([ERRORS] |NOERRORS)
         [,TACPACTION|,NOTACPACTION]
         [,TEPACTION|,NOTEPACTION]
         [,TID|,NOTID]
         [,DECB|,NODECB]
         [,TACLE|,NOTACLE]
         [,ESE|,NOESE])]
```

TYPE=INITIAL

establishes the beginning of the generation of the sample DFHTEP module itself.

DSECTPR={YES|NO}

controls the printing of CICS DSECTs on the sample DFHTEP assembly listing. Its purpose is to reduce the size of the listing. The default is DSECTPR=YES.

YES

Printing of the DSECTs is allowed.

NO

Printing of selected CICS DSECTs is suppressed. This parameter should not be used under Assembler F.

OPTIONS=optional-routines

includes or excludes optional routines in the DFHTEP module. The parentheses are required even when only one option is specified. If this operand is omitted, all default options are generated.

TD(TD, destid)|NOTD

specifies whether information regarding the errors is to be written to a transient data destination.

TD

The transient data output routine is to be generated. The implied transient data destination is CSMT.

(TD, destid)

The transient data output routine is to be generated. The messages are sent to the destination specified by "destid", which must be defined in the destination control table.

NOTD

No messages are to be written to a transient data destination.

EXITS|NOEXITS

specifies whether "ENTRY" and "EXIT" user routine support is to be included.

EXITS

Branches are taken to ENTRY and EXIT routines before and after error processing. Dummy routines are provided if user routines are not used.

the sample terminal error program

NOEXITS

No branches are taken to user routines.

TIME|NOTIME

specifies whether threshold tests are to be controlled over prescribed time intervals. An example might be putting a terminal out of service if more than three instances of a given type of error occur in one hour. The parameter must be the same as the OPTIONS operand in the DFHTEPT TYPE=INITIAL macro.

TIME

This type of threshold testing is supported.

NOTIME

This type of threshold testing is not supported.

TCAM|NOTCAM

specifies whether optional TCAM support is to be included.

TCAM

TCAM error code '9F' is supported.

NOTCAM

TCAM error code '9F' is not supported.

PRINT=print-information

specifies which types of information are to be logged to the transient data destination each time an error occurs. If NOTD is specified on the OPTIONS operand, all PRINT parameters default to NO. All PRINT parameters require the transient data output routine. The parentheses are required even when only one parameter is specified.

ERRORS|NOERRORS

specifies whether unprocessable conditions detected by the sample DFHTEP are to be recorded on the transient data destination.

ERRORS

Error messages are to be logged.

NOERRORS

No error messages are to be logged.

TACPACTION|NOTACPACTION

specifies whether DFHTACP default actions are to be recorded on the transient data destination.

TACPACTION

The default actions are logged.

NOTACPACTION

No default actions are logged.

TEPACTION|NOTEPACTION

specifies whether the actions selected as a result of sample DFHTEP processing are to be recorded on the transient data destination.

TEPACTION

The final actions are logged.

NOTEPACTION

No final actions are logged.

TID|NOTID

specifies whether the symbolic terminal ID of the terminal associated with an error is to be recorded on the transient data destination.

TID

The terminal ID is to be logged.

NOTID

No terminal IDs are to be logged.

DECB|NODECB

specifies whether the DECB of the line associated with error is to be recorded on the transient data destination.

DECB

The DECB is logged. The hexadecimal representation of the DECB is logged as two 24-byte messages.

NODECB

No DECB logging occurs.

TACLE|NOTACLE

specifies whether the TACLE prefix is to be recorded on the transient data destination.

TACLE

The 16-byte TACLE prefix as received from DFHTACP is logged.

NOTACLE

No TACLE prefix logging occurs.

ESE|NOESE

specifies whether the ESE associated with the error is to be recorded on the transient data destination.

ESE

The ESE, after being updated, and before being deleted (if the action puts the terminal out of service) is logged.

NOESE

No ESE logging occurs.

DFHTEPM TYPE=ENTRY and EXIT—for user entry and exit routines

The sample DFHTEP provides guidance about how to prepare error processor routines, particularly with regard to register and subroutine linkage conventions. The routines must also observe the following restrictions:

- The error processor must be coded in assembler language.
- The first executable statement in the routine must be labeled TEPCDxx, where “xx” is the error code specified in the DFHTEPM TYPE=ERRPROC, CODE=errcode macro.
- Register usage conventions and restrictions are stated in the sample DFHTEP source.
- The error processor must exit to the sample DFHTEP symbolic label TEPRET.

the sample terminal error program

The macro required for a user “ENTRY” routine is:

```
DFHTEPM TYPE=ENTRY
```

This macro must be immediately followed by user “ENTRY” routine code, starting with the label “TEPENTRY” and ending with a BR 14 instruction.

The macro required for a user “EXIT” routine is:

```
DFHTEPM TYPE=EXIT
```

This macro must be immediately followed by user “EXIT” routine code, starting with the label “TEPEXIT” and ending with a BR 14 instruction.

DFHTEPM TYPE=ERRPROC—replacing error processors

The macro necessary to replace error processors supplied with the sample DFHTEP with user-written error processors is:

```
DFHTEPM TYPE=ERRPROC  
        ,CODE=errcode  
        (followed by the appropriate error  
         processor source statements)
```

TYPE=ERRPROC

indicates that a CICS-supplied error processor routine is to be replaced with the user-written error processor that immediately follows the macro. This macro is optional; if used, it must follow the DFHTEPM TYPE=INITIAL macro. One DFHTEPM TYPE=ERRPROC macro must precede each user-written error processor source routine.

CODE=errcode

is used to identify the error code assigned to the appropriate error condition. These codes are listed in Figure 22 on page 443. For example, the TCAM invalid destination would be entered as code ‘9F’.

DFHTEPM TYPE=FINAL—ending the sample DFHTEP module

The macro to terminate the sample DFHTEP module is:

```
DFHTEPM TYPE=FINAL
```

This is followed by an END DFHTEPNA statement.

DFHTEPM macro examples

1. The following is an example of the minimum number of statements required to generate a sample DFHTEP module:

```
DFHTEPM TYPE=INITIAL  
DFHTEPM TYPE=FINAL  
END DFHTEPNA
```

This example generates a sample DFHTEP module with CICS-supplied error processors and all default options. This is equivalent to the CICS-supplied sample terminal error program.

2. Figure 19 on page 431 is an example of a more tailored sample DFHTEP module. In this example no 3270 support is generated, but TCAM support is provided. All default types of information except for TACP and TEP actions are

the sample terminal error program

to be logged to the TEPQ transient data destination. The CICS DSECTs are not printed on the sample DFHTEP assembler-language listing. There are two error processor routines (codes '87' and '9F' respectively).

```
* GENERATE USER STORAGE

    DFHTEPM      TYPE=USTOR
USORFLD  DS     F
    DFHTEPM      TYPE=USTOREND

* MODULE SPECIFICATIONS

    DFHTEPM      TYPE=INITIAL,
                  OPTIONS=((TD,TEPQ),N03270,EXITS),
                  PRINT=(NOTEPACTION,NOTACPACTION),
                  DSECTPR=NO
*
*
* USER-SUPPLIED ERROR PROCESSORS

    DFHTEPM      TYPE=ERRPROC, CODE=87
TEPCD81  DS     0H
    -
    - error processor "87" source statements
    -
    B          TEPRET

    DFHTEPM      TYPE=ERRPROC, CODE=9F
TEPCD9C  DS     0H
    -
    - error processor "9F" source statements
    -
    B          TEPRET

* USER "EXIT" EXIT CODE

    DFHTEPM      TYPE=EXIT
TEPEXIT  DS     0H
    -
    -
Additional user source statements to be executed after
error processing:
    -
    -
    BR      R14

* CONCLUDE MODULE GENERATION

    DFHTEPM      TYPE=FINAL
END DFHTEPNA
```

Figure 19. Example of DFHTEPM macros used to generate a sample DFHTEP module

the sample terminal error program

DFHTEPT—generating the sample DFHTEP tables

The following macros are required to generate the terminal error program tables:

- DFHTEPT TYPE=INITIAL—to establish the control section.
- DFHTEPT TYPE=PERMTID—to define permanently reserved terminal error blocks (TEBs) for specific terminals.
- DFHTEPT TYPE=PERMCODE|ERRCODE—to define permanently reserved error status elements (ESEs).
- DFHTEPT TYPE=BUCKET—to define specific error conditions to be accounted for in the common error bucket.
- DFHTEPT TYPE=FINAL—to end the set of DFHTEPT macros.

DFHTEPT TYPE=INITIAL—establishing the control section

The DFHTEPT TYPE=INITIAL macro necessary to establish the control section for the TEP tables is:

```
DFHTEPT TYPE=INITIAL
        ,MAXTIDS=number
        [,MAXERRS={25|number}]
        [,OPTIONS={TIME|NOTIME}]
```

TYPE=INITIAL

establishes the beginning of the generation of the TEP tables.

MAXTIDS=number

specifies the total number of permanent and reusable terminal error blocks to be generated in the TEP error table. Permanent entries are defined by the DFHTEPT TYPE=PERMTID macro described later in this section. Any entries not defined as permanent are reused when the terminal is taken out of service, or are deleted at the request of an error processor. If an error occurs, and no TEB space is available, the error is not processed, and DFHTACP default actions are taken. The minimum number of blocks is 1. A maximum number is not checked for but should be no greater than the number of terminals in your network.

MAXERRS=25|number

specifies the number of errors to be recorded for each terminal. This value determines the number of permanent and reusable error status elements in each TEB. The maximum number that can be specified is 25 (the default value). If more are requested, only the maximum are generated. If fewer are requested, one extra ESE is generated for each TEB. The extra ESE is the common error bucket. Permanently reserved ESEs are defined by the DFHTEPT TYPE=PERMCODE macro described later in this section. Any ESEs not defined as permanent are dynamically assigned on the first occurrence of a nonpermanent error type associated with the terminal. By defining a number less than the maximum, and allowing the sample DFHTEP to assign ESEs dynamically, you can minimize the size of the table and still control and account for the error types relevant to the network. The minimum number that can be specified is zero. In this case only a common error bucket is generated.

OPTIONS={TIME|NOTIME}

specifies whether time threshold space is to be reserved in support of the TIME option specified in the DFHTEPM TYPE=INITIAL macro. The default is OPTIONS=TIME.

TIME

Time threshold space is reserved.

NOTIME

Time threshold space is not reserved.

DFHTEPT TYPE=PERMTID—assigning permanent terminal error blocks

The DFHTEPT TYPE=PERMTID macro to define permanently reserved terminal error blocks for specific terminals is:

```
DFHTEPT TYPE=PERMTID
        ,TRMIDNT=name
```

TYPE=PERMTID

defines permanently reserved terminal error blocks for specific terminals. Permanent TEBs are defined for terminals that are critical to system operation to ensure that error processors are always executed in the event of errors associated with that terminal. If no permanent TEBs are to be defined, this macro is not required. A separate macro must be issued for each permanently reserved TEB. The maximum number of permanent TEBs is the number specified in the MAXTIDS operand of the DFHTEPT TYPE=INITIAL macro.

TRMIDNT=name

is used to provide the symbolic terminal ID (1-4 characters) for a permanently defined TEB. Only one terminal can be specified in each macro.

DFHTEPT TYPE=PERMCODE|ERRCODE—defining error status elements

The DFHTEPT TYPE=PERMCODE|ERRCODE macro is used to change the default threshold constants of the sample DFHTEP, and to define permanently reserved error status elements:

```
DFHTEPT TYPE={PERMCODE|ERRCODE}
        ,CODE={errcode|BUCKET}
        [,COUNT=number]
        [,TIME=(number[,SEC|,MIN|,HRS])]
```

TYPE={PERMCODE|ERRCODE}

identifies whether the error code specified in the macro is to have a permanently reserved or a dynamically assigned ESE. These macros are required only if permanently reserved ESEs are to be defined, or if the sample DFHTEP default threshold constants are to be overridden. These are listed in Table 20 on page 435.

PERMCODE

Identifies the error code specified as having a permanently reserved ESE. Each permanently reserved ESE must be identified by a separate DFHTEPT TYPE=PERMCODE macro. All DFHTEPT TYPE=PERMCODE macros must precede all DFHTEPT TYPE=ERRCODE macros.

ERRCODE

Indicates that the error code specified does not require a permanently reserved ESE, but that the sample DFHTEP default threshold constants are to be changed. Each error code requiring a threshold constant change, other than those defined as permanently reserved, must be identified by a separate DFHTEPT TYPE=ERRCODE macro. All DFHTEPT TYPE=ERRCODE macros must follow all DFHTEPT TYPE=PERMCODE macros.

the sample terminal error program

CODE={errcode|BUCKET}

identifies the error code referred to by the TYPE=PERMCODE|ERRCODE parameter. These codes are listed in Figure 22 on page 443. CODE=BUCKET is only applicable to the DFHTEPT TYPE=ERRCODE macro. It is used to override the default threshold constants established for the common error bucket.

COUNT=number

can be used in either the DFHTEPT TYPE=PERMCODE or TYPE=ERRCODE macro to override the sample DFHTEP default count threshold (see Table 20 on page 435). When the number of occurrences of the error type specified reaches the threshold, an error processor normally takes a logic path that causes DFHTACP default actions to be taken. If the number of occurrences is less than the threshold, the error processor normally takes a logic path that overrides the DFHTACP default actions. The updating and testing of the current threshold counts are normally performed by a DFHTEP subroutine that sets a condition code that the error processor can test to determine whether the limit has been reached. **If you specify 0 as the number in the COUNT operand, you are not told when the threshold is reached.**

TIME=(number[,SEC],MIN],HRS])

can be used in either the DFHTEPT TYPE=PERMCODE or TYPE=ERRCODE macros to override the sample DFHTEP default time threshold (see Table 20 on page 435). This operand is only applicable when OPTIONS=TIME is specified on both the DFHTEPM and DFHTEPT TYPE=INITIAL macros. When the number of occurrences reaches the threshold specified on the COUNT operand (above) within the interval specified on this parameter, an error processor normally takes a logic path that causes DFHTACP default actions to be taken. If the number of occurrences within the interval is less than the threshold, the error processor normally takes a logic path that overrides the DFHTACP default actions. If the time interval has expired, the sample DFHTEP subroutine that normally updates and tests the current threshold count resets the occurrence counts, and establishes a new expiration time. In this case, the condition code set by the subroutine indicates that the thresholds had not been reached.

Time control in the sample DFHTEP starts with the first occurrence of an error type. Subsequent occurrences of the same error type **do not** establish new starting times, but are accounted for as having occurred within the interval started by the first occurrence. This continues until an error count reaches the threshold within the interval started by the first occurrence, or until the interval has expired. In the latter case, the error being processed becomes a first occurrence, and a new interval is started. A time interval of 0 means that the number of occurrences is to be accounted for and controlled without regard to a time interval. Zero is the implied time interval if the value of the COUNT operand is 0 or 1. It is also the implied time interval if the time options are not generated.

The time interval can be expressed in any one of four units; hours, minutes, seconds, or hundredths of a second. The maximum interval must be the equivalent of less than 24 hours. A practical minimum would be 1 to 2 minutes. This allows for access method retries and the time required to create the task to service each error. The four methods of expressing the threshold time interval are:

the sample terminal error program

number

The interval in units of one hundredth of a second. Parentheses are not required if this method is used. The maximum number must be less than 8 640 000 (24 hours).

(number,SEC)

The interval in whole seconds, which must be enclosed in parentheses. The maximum number must be less than 86 400 (24 hours).

(number,MIN)

The interval in whole minutes, which must be enclosed in parentheses. The maximum number must be less than 1440 (24 hours).

(number,HRS)

The interval in whole hours, which must be enclosed in parentheses. The maximum number must be less than 24.

Table 20 illustrates the default thresholds of the sample terminal error program, referred to in the TYPE, COUNT, and TIME operands of the DFHTEPT TYPE=PERMCODE|ERRCODE macro.

Table 20. Default thresholds of the sample TEP

CODE=	COUNT=	TIME=
81	3	(7,MIN)
84	1	0
85	1	0
87 (Note 1)	50 (Note 3)	0
88	1	0
8C	1	0
8D	1	0
8E	1	0
8F	1	0
90	0	0
91	0	0
94	7	(10,MIN)
95 (Note 2)	0	0
96	2	(1,MIN)
97 (Note 2)	0	0
99	1	0
9F (Note 2)	0	0
BUCKET	5	(5,MIN)

Notes:

1. For TCAM conditions without TACP defaults, TEP retries five times and releases the TIOA. Otherwise the default TACP actions are taken.
2. The error processor maintains an error count only. DFHTACP default actions are always taken regardless of the thresholds.
3. The error processor uses a threshold "weight" instead of a threshold count (see the source code of the sample DFHTEP).

the sample terminal error program

DFHTEPT TYPE=BUCKET—using the error bucket for specific errors

The DFHTEPT TYPE=BUCKET macro is used to ensure that specific error conditions are always accounted for in the common error bucket:

```
DFHTEPT TYPE=BUCKET  
        ,CODE=errcode
```

TYPE=BUCKET

generates the macro to account for specific error conditions in the common error bucket. If MAXERR=25 on the DFHTEPT TYPE=INITIAL macro, this macro cannot be used. This macro is not required if no error codes are to be specifically accounted for in the common error bucket. Each error code must be identified by a separate DFHTEPT TYPE=BUCKET macro.

CODE=errcode

identifies the error code to be specifically accounted for in the common error bucket. The error code must not be specified in the DFHTEPT TYPE=PERMCODE or TYPE=ERRCODE macro.

DFHTEPT TYPE=FINAL—terminating DFHTEPT entries

The DFHTEPT TYPE=FINAL macro terminates the generation of the DFHTEPT tables.

```
DFHTEPT TYPE=FINAL
```

DFHTEPT—examples of how the macros are used

1. The following is an example of the minimum number of statements required to generate the TEP tables:

```
DFHTEPT TYPE=INITIAL,MAXTIDS=10  
DFHTEPT TYPE=FINAL  
END
```

This example generates 10 reusable terminal error blocks, each capable of accounting for the maximum number of error types. Time threshold control is supported, and all threshold values are the defaults supported by the sample DFHTEPT. This is equivalent to the CICS-supplied sample terminal error program.

2. Figure 20 on page 437 is an example of a customized TEP table (continuation characters omitted).

```

* TABLE SPECIFICATIONS
      DFHTEPT    TYPE=INITIAL,MAXTIDS=10,
                MAXERRS=5

* PERMANENT TERMINAL DEFINITIONS
      DFHTEPT    TYPE=PERMTID,TRMIDNT=TM02

* PERMANENT ERROR CODE DEFINITIONS
      DFHTEPT    TYPE=PERMCODE, CODE=81
      DFHTEPT    TYPE=PERMCODE, CODE=87,
                COUNT=2, TIME=(1,MIN)

* OTHER THRESHOLD OVERRIDES
      DFHTEPT    TYPE=ERRCODE, CODE=BUCKET,
                COUNT=3, TIME=(3,MIN)

* CONCLUDE TABLE GENERATION
      DFHTEPT    TYPE=FINAL
      END
    
```

Figure 20. Example of the use of DFHTEPT macros to generate DFHTEP tables

This example generates 10 terminal error blocks, one of which is reserved for the terminal whose symbolic ID is TM02, and the other nine are reusable. Each TEB has space for five error status elements plus a common error bucket. Of the five ESEs, two are reserved for error codes '81' and '87'; the remaining ESEs are available to be assigned dynamically. The thresholds for error code '87' and the common error bucket are being changed. No specific error code is to be accounted for in the common error bucket.

User-written terminal error programs

You can write your own terminal error program in any of the languages supported by CICS. However, CICS-supplied code is provided in assembler language only. The names of the supplied source files and macros, and the libraries in which they can be found, are listed in Table 21.

Table 21. Supplied source files and macros

Name	Type	Description	Library
DFHXTEP	Source	Sample terminal error program (assembler language)	CICSTS13.CICS.SDFHSAMP
DFHXTEPT	CSECT	Sample terminal error tables (assembler language)	CICSTS13.CICS.SDFHSAMP
DFHTEPM	Macro	Sample TEP program generator (assembler language)	CICSTS13.CICS.SDFHMAC
DFHTEPT	Macro	TEP table generator (assembler language)	CICSTS13.CICS.SDFHMAC

user-written terminal error programs

Table 21. Supplied source files and macros (continued)

Name	Type	Description	Library
DFHTEPCA	Macro	Assembler-language communication area	CICSTS13.CICS.SDFHMAC

The user-written DFHTEP receives control in the same manner as the CICS-supplied sample DFHTEP, described in “The communication area” on page 417. It should therefore use the communication area as its basic interface with DFHTACP.

Why write your own terminal error program?

- There are some situations in which CICS may try to send a message to an input-only terminal; for example, an ‘invalid transaction ID’ message, or a message wrongly sent by an application program. You should provide a terminal error program to reroute these messages to a system destination such as CSMT or CSTL or other destinations, by means of transient data or interval control facilities.
- There could be application-related activity to be carried out when a terminal error occurs. For example, if a message is not delivered to a terminal because of an error condition, it may be necessary to notify applications that the message needs to be redirected.
- Not all errors represent communication-system failures - for example, SAM end-of-data conditions.

Restrictions on the use of EXEC CICS commands

There are certain restrictions on the commands that a TEP can issue. **The use of any commands that require a principal facility causes unpredictable results, and should be avoided.** In particular, you should not use commands that invoke the following functions:

- Terminal control (“CEMT-type” commands, such as EXEC CICS INQUIRE TERMINAL, *are* permissible)
- BMS (except routing)
- ISC communication (including function shipping).

Addressing the contents of the communication area

After your terminal error program receives control from DFHTACP, it should obtain the address of the communication area by means of an EXEC CICS ADDRESS COMMAREA command.

user-written terminal error programs

You generate the communication area DSECT by coding DFHTEPCA TYPE=DSECT in your program. The layout of the communication area is shown in Figure 21.

			IN/OUT PARM		
		0XL4		Standard Header	
TEPCALDS	DS	XL1	I	Function Code	Always '1'
TEPCAGDS	DS	XL2	I	Component Code	Always 'TC'
	DS	XL1		Reserved	
TEPCATCA	DS	A	I	Address of TACLE being processed	
TEPCECIA	DS	A	I	Address of TCTUA	
TEPCECIL	DS	H	I	Length of TCTUA	
TEPCAACT	DS	XL1	I/O	User action byte	
TEPCATID	DS	CL4	I	Terminal identity	
TEPCATDB	DS	F	I	Current time of day binary	

Figure 21. The DFHTACP/DFHTEP communication area

The parameter list contains the following information:

TEPCALDS

Function Code. The Function Code is a printable character representing the identity of the task within the TCP which invoked DFHTEP. It always has the value '1'.

TEPCAGDS

Component Code. This always has the value 'TC', representing a component of the TCP.

TEPCATCA

Contains the address of the TACLE being processed.

TEPCECIA

Contains the address of the terminal control table user area (TCTUA).

TEPCECIL

Contains the length of the TCTUA.

TEPCAACT

The User action byte. One of the main uses of the communication area is to transmit the actions that are to be taken for a terminal. TEPCAACT contains the following flags, which can be reset within DFHTEP:

LINEOS (X'80')

Place line out of service

NONPRGT (X'40')

Nonpurgeable task exists on the terminal

TERMOS (X'20')

Place terminal out of service

ABENDT (X'10')

Abend the task on the terminal

ABORTWR (X'08')

Abend write, free terminal storage

RELTTIOA (X'04')

Release TCAM incoming message

user-written terminal error programs

SIGNOFF (X'02')

Call sign-off program.

On entry to DFHTEP, the above flags represent the default actions set by DFHTACP. The write-abend bit (communication area field **ABORTWR**) and the abend-task bit (communication area field **ABENDT**) are always set if the place-line-out-of-service bit (X'80') is set; but both bits are suppressed if "dummy terminal" is indicated (see Resetting the flags in the user action byte, TEPCAAC).

On return to DFHTACP, the flags represent the actions as modified by DFHTEP.

TEPCATID

Contains the identity of the terminal in error.

TEPCATDB

Contains the time of day when the error occurred, in binary format.

Resetting the flags in the user action byte, TEPCAAC

The following factors should be considered when altering the action bits in TEPCAAC:

- You should consider how to preserve data security. For example, if a terminal is put out of service for some time (until the cause of the failure is removed) the signon information is still in the TCTTE when the terminal is put back into service, although the original operator may no longer be present. To prevent a possible security violation, you can set the **SIGNOFF** bit to sign off the terminal.
- For TCAM unsolicited input errors with either the terminal out of service or in receive-only state, a loop occurs if the default action of purging the incoming message does not occur and the status of the terminal is not altered.
- The dummy terminal indicator at TCTLEPF2 is set on errors from which no specific terminal is indicated. Therefore, if a dummy terminal is indicated, abend task and abend write are not set (see below). The dummy terminal is only used to identify the line.
- The abend-task bit (X'10' in TEPCAAC) is always associated with two other bits as part of TACP's abend transaction processing. These other bits are nonpurgeable task and abend write (X'40' and X'08' respectively, both in TEPCAAC).
- Abend write is always set on at the same time as abend task. It has the effect of clearing the TCTTE of the original write request indicators, if the error being processed occurred on a TC WRITE.
- Nonpurgeable task is set on if a transaction is currently associated with the terminal, and the transaction ID was specified with TPURGE=NO.

None of the abend-task, abend-write, or nonpurgeable-task bits is set if the dummy terminal indicator is on, even if DFHTACP would normally set abend task as the default for the error being processed. Therefore, the following remarks apply only to errors related to a real terminal.

- Abend task has no effect if no transaction is associated with the terminal; (except where a pseudoconversational task is associated with the terminal, in which case, the next transid is cleared). Otherwise, if nonpurgeable task is indicated, the transaction remains attached to the terminal (normally in SUSPEND state)

user-written terminal error programs

and DFHTACP writes the 'DFHTC2522 INTERCEPT REQUIRED' message to CSMT; if the task is not marked nonpurgeable, it is abended with code 'AEXY' or, rarely, 'AEXZ'.

- Abend write has no effect if the TCTTE was associated with a READ request. In this case the normal result is that, if the line and terminal remain in service, the read is retried.
- For TCAM pooled terminals, the DFHTACP default action of ABENDT is inappropriate for unsolicited input and 'invalid TCAM destination' types of error. Abend task results in the pooled terminal entry being placed out of service, which may lead to line lockouts as available in-service pooled entries become exhausted. You should therefore set the ABENDT action bit off in the TEP.

Addressing the contents of the TACLE

The TACLE is created by the terminal control program when the error occurs, and contains all the I/O error information provided by TCAM and BSAM.

To address the contents of the TACLE, the user-written terminal error program should contain the COPY DFHTACLE and COPY DFHTCTLE statements, in that order. These define the complete DFHTCTLE DSECT. The symbolic names in this DSECT are used to address fields in both the TACLE and the real line entry associated with the error.

The TACLE consists of a 16-byte prefix (defined by COPY DFHTACLE) and a further 48-byte section, which is a modified copy of the DECB of the real line entry at the time the TACLE was created.

To address the TACLE, the user-written terminal error program should therefore contain the statements:

```
COPY DFHTACLE
COPY DFHTCTLE

L TCTLEAR,TEPCATCA          POINT TO TACLE
USING DFHTCTLE,TCTLEAR
```

Note that fields normally part of the real line entry DECB have offsets increased by 16 in the TACLE.

The following fields in the DECB copy in the TACLE do **not** represent data copies from the real line entry:

```
TCTLEDCB                    (Offset 24 in TACLE,
                             8 in real TCTLE)
```

This field in the TACLE points to the real line entry; in the real line entry, it points to the TCAM/BSAM DCB for the line group.

```
TCTLECSW                    (Offsets 46, 48 in TACLE,
                             30, 32 in real TCTLE)
```

These are used in the TACLE for SAM error information.

The following statements give direct addressability to the **real** line entry:

```
COPY DFHTCTLE
COPY DFHTCTTE

L TCTLEAR,TEPCATCA          POINT TO TACLE
USING DFHTCTLE,TCTLEAR
```

user-written terminal error programs

```
L      TCTTEAR,TCTLEPTE      POINT TO ERROR TCTTE
USING  DFHTCTTE,TCTTEAR
DROP   TCTLEAR
L      TCTLEAR,TCTTELEA      POINT TO TCTLE
USING  DFHTCTLE,TCTLEAR
```

After you have carried out the required functions and, optionally, altered the default actions scheduled by DFHTACP, the user-written DFHTEP must return control to DFHTACP by issuing the EXEC CICS RETURN command. DFHTACP then performs the actions specified in the TACLE and causes the error processing task to terminate.

The format of the TACLE DSECT is shown in Figure 22 on page 443.

user-written terminal error programs

TERMINAL ABNORMAL CONDITION LINE ENTRY

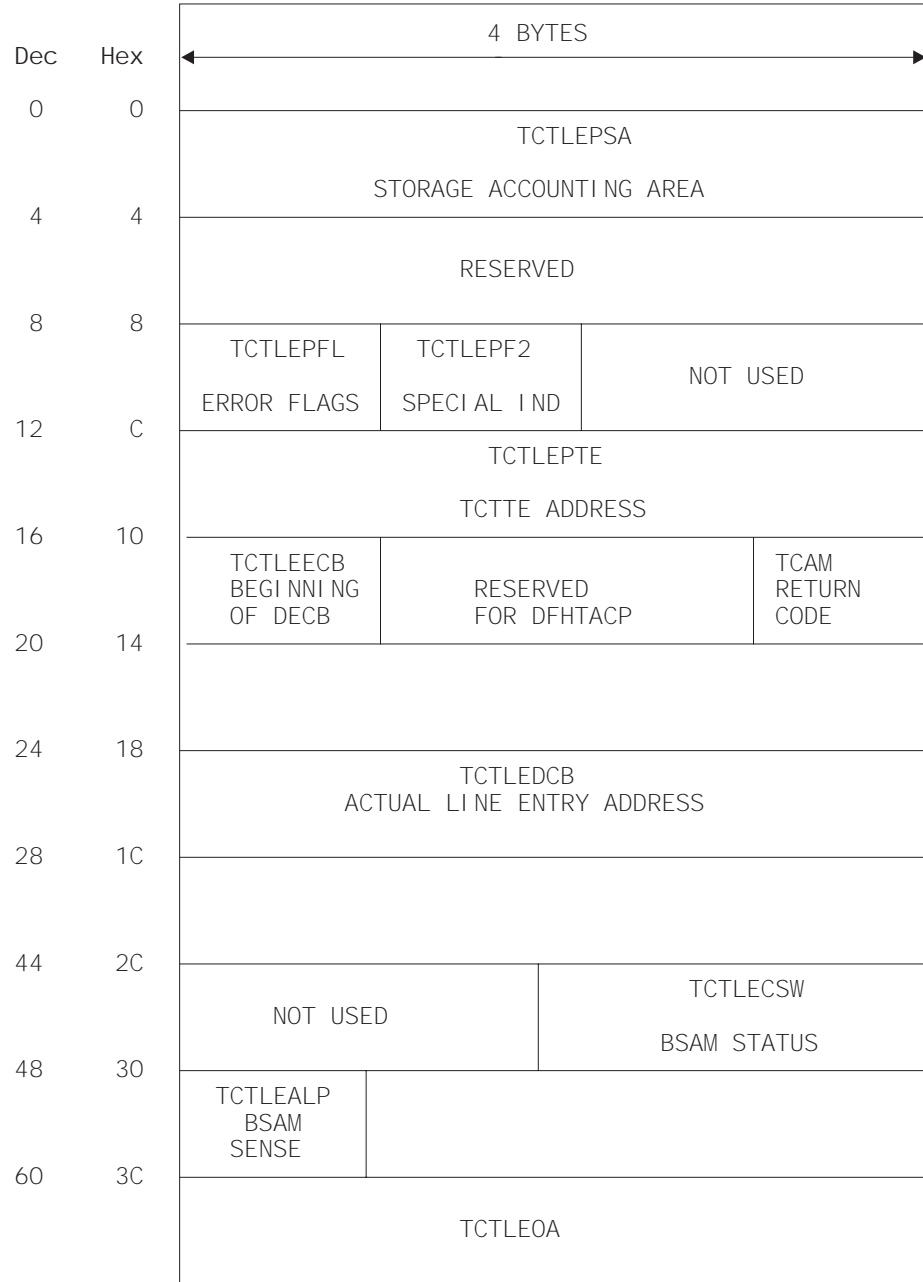

Figure 22. Format description of the TACLE DSECT (Part 1 of 2)

user-written terminal error programs

Displacement					
Dec	Hex	Code	Bytes	Label	Meaning
0	0		4	TCTLEPSA	Storage accounting
				RESERVED	
8	8	81	1	TCTLEPFL	Error flags Message too long
		84			TCT search error
		85			Write not valid
		87			Unsolicited input
		88			Input event rejected
		8C			Output event rejected
		8D			Output length of zero
		8E			No output area
		8F			Output area exceeded
		94			Unit check
		95			Unit check (should not occur)
		96			Unit exception
		97			Unit exception (should not occur)
		99			Undetermined I/O error
		9F			Invalid destination (TCAM)
		.			
		.			(All codes not listed are reserved and are not intended for use by DFHTEP)
		.			
		.			
9	9	01	1	TCTLEPF2	Special indicator dummy terminal
12	C		4	TCTLEPTE	Address of terminal entry for terminal in error
16	10		4	TCTLEECB	DECB/copy of line when error occurred
60	3C		4	TCTLEOA	For TCAM lines only. Address of the line I/O area containing the input or output message, or zero if none available.

Figure 22. Format description of the TACLE DSECT (Part 2 of 2)

Example of a user-written terminal error program

The “DFHTEP recursive retry routine” on page 446 is an example of the logic steps necessary to design a portion of the terminal error program. In Figure 23 on page 446, 10 retries are provided for each terminal; however, the logic could be used for any number of retries. The following assumptions are made:

USER FIELD A

(PCISAVE)

represents a 6-byte field in the process control information (PCI) area of the TCTTE. This field is used to preserve the count of input and output from the TCTTE when the first error occurs. These counts are contained in 3-byte fields located at TCTTENI and TCTTEN0 within the TCTTE.

USER FIELD B

(PCICNT)

represents a user-defined field used to accumulate the count of recursive errors. It should be in the process control information (PCI) area of the TCTTE.

SYSTEM COUNT

(TCTTENI)

represents the 6-byte field in the TCTTE that contains the terminal input and output counts (TCTTENI+TCTTEN0). In the example, these two adjacent fields are considered as one 6-byte field.

Because this example requires access to the TCT terminal entry (TCTTE) to examine the SYSTEM COUNT and to locate the process control information (PCI) area, the DFHTCTTE symbolic storage definition is included so that fields can be symbolically referenced.

Note that the code in Figure 23 on page 446 is intended only as an illustration of a recursive error handling technique and of the steps necessary to establish addressability to the applicable control blocks.

user-written terminal error programs

DFHTEP recursive retry routine

```
*ASM      XOPTS(NOPROLOG NOEPILOG SP)
*****
*
*                      DFHTEP RECURSIVE RETRY ROUTINE
*
*****
          DFHEISTG
          DFHEIEND
          DFHTEPCA TYPE=DSECT      COMMAREA passed by TACP
          COPY  DFHA06DS           Statistics DSECT
          USING DFHA06DS,STATBAR
PCIAREA  DSECT
PCISAVE  DS    XL6                 User Field A
PCICNT   DS    PL2                 User Field B
*
TCTLEAR  EQU   2                   Pointer to TACLE
STATBAR  EQU   4                   Pointer to statistics DSECT
TCTUABAR EQU   5                   Pointer to TCTUA
COMMABAR EQU  12                   Pointer to COMMAREA passed by TACP
          EJECT
DFHTEP   CSECT
*****
*      Establish addressability
*
*****
          DFHEIENT
*
          EXEC CICS ADDRESS EIB(11)
*
          EXEC CICS ADDRESS COMMAREA(COMMABAR)
*
          USING DFHTEPCA,COMMABAR
          L      TCTLEAR,TEPCATCA    Load TACLE address
*
          USING PCIAREA,TCTUABAR
          L      TCTUABAR,TEPCECIA   Load TCTUA address
*
*****
*      Start processing
*
*****
          TM      PCICNT+1,X'0C'      Has User Field B been initialized
*                                     to a packed decimal number?
          BO      CKCOUNT           YES ... so compare the system count
*                                     with the existing count in Field B
RESET     DS      0H
          MVC     PCICNT,=PL2'+0'    NO ... so initialize field B to
*                                     packed zero.
*
```

Figure 23. DFHTEP recursive retry routine (Part 1 of 2)

```

EXEC CICS COLLECT STATISTICS TERMINAL(TEPCATID) SET(STATBAR)
*
*           Get statistics for this terminal
*           using TERMID passed in Commarea
*
MVC  PCISAVE,A06TENI  Save the current system counts. This
*
*           is a new error, or first time
*           through.
INCR DS  0H
AP   PCICNT,=P'1'    Increment the number of times this
*
*           error has occurred (recursive count)
*
CP   PCICNT,=P'10'  Has the maximum recursive error
*
*           limit been reached?
BNE  RETRY          NO .... set action
*
ZAP  PCICNT,=P'0'   Clear and reset user fields for next
*
*           error set
EXEC CICS COLLECT STATISTICS TERMINAL(TEPCATID) SET(STATBAR)
*
*           Get statistics for this terminal
*           using TERMID passed in COMMAREA
*
MVC  PCISAVE,A06TENI  Get current system counts
B    NORETRY         Action indicators for no retry
*
CKCOUNT DS  0H
EXEC CICS COLLECT STATISTICS TERMINAL(TEPCATID) SET(STATBAR)
*
*           Get statistics for this terminal
*           using TERMID passed in COMMAREA
*
CLC  PCISAVE,A06TENI  Has system count changed since last
*
*           entry to TEP?
BNE  RESET          YES .... this is a new error since
*
*           some I/O activity has occurred on
*           terminal.
B    INCR           NO .... this is a recursive error,
*
*           so increment the recursive count and
*           check for retry.
RETRY DS  0H
*
*           The user would include here the code
*           necessary to alter the flags in the
*           COMMAREA so that a retry can be
*           performed on the terminal.
NORETRY DS  0H
*
*           The user would include here the code
*           necessary to allow DFHTACP to take
*           final actions on the terminal; that
*           is, abend task, put line out of
*           service, and others.
LTORG ,
END

```

Figure 23. DFHTEP recursive retry routine (Part 2 of 2)

Chapter 9. Writing a node error program

Considerations common to all user-replaceable programs

Note that the comments contained in “Chapter 5. General notes about user-replaceable programs” on page 401 apply to this chapter.

This chapter contains information about the node error program (NEP) of CICS Transaction Server for OS/390 Release 3. Node error programs, not terminal error programs, must be used for terminals and logical units supported via the ACF/VTAM interface.

The chapter is divided into the following sections:

1. “**Background to CICS-VTAM error handling**” is an overview. If you are not familiar with the node error program, you should read this section. If you are familiar with NEPs, you may be able to go straight to the detailed information in the following sections, and look at the subjects that particularly interest you.
2. “**When an abnormal condition occurs**” on page 457 describes the CICS components that are invoked when an abnormal condition is detected from a VTAM logical unit.
3. “**The sample node error program**” on page 465 describes the CICS-supplied sample NEP.
4. “**User-written node error programs**” on page 475 discusses the factors you need to consider when writing your own node error program.
5. “**Using the node error program with XRF or persistent sessions**” on page 480.

Notes:

1. Like the terminal error program for non-VTAM devices, the node error program for VTAM-attached terminals is available in three forms:
 - a. The default node error program
 - b. The CICS-supplied sample node error program
 - c. User-written versions.All three types are discussed in the following sections.
2. In this chapter, “VTAM 3270” refers to a non-SNA 3270 connected through VTAM, and “3270 compatibility mode” refers to an SNA 3270 connected through VTAM.
3. If you code an EXEC CICS HANDLE CONDITION TERMERR command in your application program, it is **sometimes** possible for the application program to handle exceptional cases, rather than using a node error program. The ‘TERMERR’ condition is driven if the node abnormal condition program (DFHZNAC) actions an ABTASK (‘ATNI’ abend). Note that ‘TERMERR’ is application-related, and is not an alternative to the node error program, which must be used for session-related problems. Dealing with errors in the application program is particularly useful in an intersystem communication (ISC) environment. For further information, refer to the *CICS Intercommunication Guide*.

Background to CICS-VTAM error handling

In general, errors detected by CICS-VTAM terminal control are queued for handling by a special task, the CICS node error handler (transid CSNE). (Note that CICS finds it convenient to use the same technique for some housekeeping work, such as sending “good morning” messages, and logging session starts and ends, which are not errors at all.)

In a few cases, exceptions signaled to CICS by VTAM are not treated as errors, and are not passed to the node error handler. For example, CICS often sends an SNA BID command as part of automatic transaction initiation. Rejection of the BID with exception code ‘0813’ (wait) is a standard response, and CICS handles the retry in terminal control without calling this an error. In the rest of this description, only the errors are considered.

The CSNE task runs as a “background” task, meaning that it is not associated with any one CICS terminal. At any time, there is at most one such task, working on the single node error queue.

All node errors on the queue are analyzed in turn by a table-driven, CICS-supplied program called DFHZNAC (node abnormal condition program). It is not intended that you should ever modify this.

DFHZNAC links to a module called DFHZNEP (if present in the CICS system) when processing most node errors. (It does **not** link to DFHZNEP for errors that are not related to a specific node—for example, those caused by a VTAM shutdown.) The interface for this link is described in “When an abnormal condition occurs” on page 457. This formal DFHZNAC-DFHZNEP interface gives you the opportunity to supply your own code to analyze error conditions, change default actions by setting various “action flags”, and take additional actions specific to your applications.

CICS supplies a pregenerated default DFHZNEP, which simply sets the “print TCTTE” action flag if a VTAM storage problem is detected, and returns control to DFHZNAC. Because it leaves all other action flags unchanged, DFHZNAC’s default actions are not otherwise affected. (DFHZNAC’s default actions for different error conditions are listed in “Appendix B. Default actions of the node abnormal condition program” on page 789.)

Why use a NEP to supplement CICS default actions?

The following list gives some of the reasons why you might want to write your own node error program to add to the default actions provided by CICS and VTAM.

- Not all errors represent communication system failures. Some errors (such as trying to write zero-length data) may reflect special situations in applications, needing special action.
- You might want to output extra data, in addition to the error messages sent by DFHZNAC. (Note that you cannot use the node error program to suppress messages from DFHZNAC.) All data output from DFHZNAC and DFHZNEP is written to the transient data queue CSNE.
- In other cases, you might want to change the amount of diagnostic information produced by CICS: the default varies with the error type. For example, the VTAM RPL associated with an error may be printed when you do not want it, or not printed when you do.

background to VTAM error handling

- There could be application-related activity to be performed when a node error occurs. For example, if a message fails to be delivered to a terminal, it may need redirecting to another. With messages sent with exception-response only, CICS may not have the data available to send it again, but the requesting application might be able to re-create it. For example, if an error were signaled during the sending of a document to a printer, it might be able to restart from the beginning, or from a specific page.
- Some devices, such as the 3650 Retail Store System, return application-type data in “User Sense Data” fields. This can only be retrieved in a NEP. The NEP has to catch and save data for further application programs.

An overview of writing a NEP

Your DFHZNEP module must conform to the defined interface: that is, it must be a linked-to program that uses defined communication area fields to analyze an error and then returns to DFHZNAC. The source code of the default NEP provided by CICS can be used as a skeleton on which to build a single NEP.

CICS also provides macros to help you generate more complex sample NEPs. These are **aids** to help you develop your own NEPs; you do not have to use any of them.

Your error-handling logic can be written as a number of modules, but the one that receives control from DFHZNAC must be called DFHZNEP.

DFHZNEP code can use standard CICS functions (LINK, XCTL) to invoke other user modules. Each module thus requested must, of course, have an installed CSD program definition. Installed definitions are also needed for DFHZNAC and DFHZNEP themselves; these are contained in the supplied CSD group DFHVTAM.

The key features of the DFHZNAC-DFHZNEP interface are as follows:

- DFHZNEP can be written in any of the CICS-supported languages.

Note: CICS-supplied NEP code is provided in assembler language only. The communication area parameter list is supplied in assembler-language and C versions.

- DFHZNEP is linked-to separately for each node-related error on the queue. (Note that, because sense codes are always associated with an error, DFHZNEP is not linked-to separately for these.)
- Communication between the two modules is through a communication area (DFHNEPCA).

The structure of the communication area is described in “The communication area” on page 458.

On each DFHZNEP invocation, one field in the communication area contains a 1-byte internal error code, assigned by DFHZNAC, which identifies the type of error. Other fields identify the CICS TCTTE (LU) associated with the error, and any SNA sense codes. There are also fields for DFHZNEP to pass back user messages for subsequent logging by DFHZNAC.

Further fields contain “action flags”. Each flag represents an action that DFHZNAC may take when DFHZNEP returns control to it. These actions are of different types:

- Reporting (dumps of control blocks, actions taken)

background to VTAM error handling

- Status changes (for example, of TCTTE)
- Clean-up work (cancel any associated transaction, end the VTAM session).

The action flags can be set or reset within DFHZNEP.

The action flags set by DFHZNAC for specific error codes and sense codes are listed in “Appendix B. Default actions of the node abnormal condition program” on page 789.

The default NEP

The CICS-supplied default NEP, DFHZNEP, sets the “print TCTTE” action flag (TWAOTCTE in the user option byte TWAOPT1—see page 461) if a VTAM storage problem is detected; otherwise it performs no processing, leaves the action flags set by DFHZNAC unchanged, and returns control to DFHZNAC.

The sample NEP

The CICS sample node error program is a generalized program structure for handling errors detected from logical units. None of its components is generated as part of the standard CICS generation process, but instead may be optionally generated as described in this section and in “The sample node error program” on page 465.

The sample NEP that CICS provides is designed with two main features:

- It sample assumes that you want to invoke separate user-supplied error processors to handle different “groups” of error types. You specify which of the DFHZNAC internal error codes are to be regarded as a “group” for processing by any one routine, and then supply the code for that routine. CICS has some standard cases to help you. More information is given about them below.
- The supplied error processors may work in association with a separately generated module called a node error table. This can be used to build up statistics for each error group that the NEP processes. This table is analogous to the terminal error table, DFHTEPT, used by the equivalent CICS-TCAM sample terminal error program.

Some of the CICS-supplied error processors use the node error table—for example, that for errors affecting 3270 LUs (GROUP=1) (see “DFHSNEP TYPE=DEF3270—including error processors for 3270 LUs” on page 470).

The node error table

To understand the sample NEP, first look at the node error table structure in more detail.

Node error table is often abbreviated to NET. You should not confuse this acronym with “net” (as in “network”), or with a NETNAME.

You can generate a node error table using the CICS macro DFHSNET. See “Node error table” on page 467 and “DFHSNET—generating the node error table” on page 473. You choose how complex this table is to be.

background to VTAM error handling

The node error table must be defined as a RESIDENT program. This makes it easy for the NEP to find it (using a CICS LOAD request), and ensures that any counters are not reset by reloading. You can give the table any name you like. The default is DFHNET.

The table consists of sets of error-recording areas. Each set is called a node error block (NEB) and is used to count node errors relating to a single LU. You can dedicate specific NEBs to specific LUs throughout a CICS run; and you can leave other, reusable NEBs for general use. If you expect to accumulate error statistics about 10 LUs concurrently, you need 10–12 NEBs.

Each NEB may contain multiple recording areas, one being used for each group of errors you want to distinguish. The error groups correspond to those in the NEP. That is, they are groups of error types requiring separate processing logic.

Each recording area is known as an error status block (ESB). You specify the space reserved for each ESB, and it typically includes space to count the errors, or record when the first of the present series occurred. Note that in any one NEB the counting is for one LU only.

Finally, you can specify a threshold count and a time limit in the table. These are constants that can be used by code in the NEP to test an ESB, to see if a given type of error has occurred more than the threshold number of times in the stated interval. The time limit also affects the interval between using a general NEB for one LU and then reusing it for another.

A minimal NET would simply consist of a handful of NEBs, each with just one ESB, grouping together all types of error that are of interest.

Note: If you write your own node error program, you must generate a NET, even if it contains no entries because your error processors do not use it.

Coding the sample NEP

The sample NEP is coded using the macro DFHSNEP. The basic form is as follows:

```
DFHSNEP TYPE=INITIAL
```

Specific error handling code. For example:

```
DFHSNEP TYPE=DEF3270
```

```
DFHSNEP TYPE=FINAL  
END      DFHNEPNA
```

By default, this generates a module called DFHZNEP, which works with a node error table called DFHNET. If you want to use another table, you could code NETNAME=MYTABLE after TYPE=INITIAL. Details of the DFHSNEP macro are given in “Generating the sample node error program” on page 469.

To understand the sample code, generate a standard NEP, as with TYPE=DEF3270, shown in “DFHSNEP TYPE=DEF3270—including error processors for 3270 LUs” on page 470, and look at the resulting assembler-language listing. Here is a description of the code.

The INITIAL and FINAL macros generate the basic skeleton of the NEP. This comprises some initialization code and some common routines. All the code is built round the assumption that you have a node error table as previously described.

background to VTAM error handling

The initial code first tests the internal error code passed from DFHZNAC to see if it belongs to a group that the NEP needs to handle. (The groups are identified by the code you supply between the DFHSNEP INITIAL and FINAL macros. This is described in “Generating the sample node error program” on page 469.) If the particular error code is not of interest to the NEP, control is returned at once to DFHZNAC, to take default actions.

Otherwise, the relevant node error table is located by a CICS LOAD request. (As previously explained, this table should be resident in virtual storage.) The NEP code will then locate the correct ESB within a selected NEB. The latter may be permanently dedicated to the LU in error (a named NEB), or may be one taken from the general pool.

The initial code then invokes the appropriate user logic for that error group. The initial code also sets up pointers to the communication area, the NEB, and the ESB. For details, see “Generating the sample node error program” on page 469.

The common routines in the NEP provide common services for your own logic. They count and time stamp errors in the ESB, and test whether error thresholds have been exceeded. They are not documented outside the sample listings. You can generate a NEP without them if you prefer.

Your own code is inserted between the DFHSNEP TYPE=INITIAL and TYPE=FINAL macros.

Note: If the user code you insert between the DFHSNEP macros contains EXEC CICS commands, you must translate the commands, and enter the *translated code* between the DFHSNEP macros.

Each section of user logic, intended to handle a particular group of error types, is headed by a macro of the type:

```
DFHSNEP TYPE=ERRPROC, CODE=(ab, cd, . . .), GROUP=n
```

where X'ab', X'cd',... are the DFHZNAC internal error codes you want to process, and n is the number of the error group, and therefore also of the corresponding ESB, within a NEB, in the node error table. Successive DFHSNEP TYPE=ERRPROC macros should use groups 1, 2, 3, and so on.

The DFHSNEP TYPE=ERRPROC macros serve several purposes. They:

- Inform the NEP generation how many error groups there are
- Show which error types are to be included in each group
- Introduce the code for each group.

Note that any one DFHZNAC error code should only figure in one error group, and that any code not mentioned is simply ignored by the NEP. You follow each DFHSNEP TYPE=ERRPROC macro with your own logic. This should begin with standard code to save registers, or set up addressability, which is best copied from sample NEP listings.

CICS provides some standard error processors to handle specific errors on two different types of LU. These are for non-SNA 3270s (BSC 3270s attached to CICS-VTAM), and for interactive SNA logical units like a 3767. More information is given in “When an abnormal condition occurs” on page 457.

background to VTAM error handling

The code for non-SNA 3270s can be generated by coding

```
DFHSNEP TYPE=DEF3270
```

where you would otherwise code a DFHSNEP TYPE=ERRPROC macro plus logic of your own. In effect, TYPE=DEF3270 defines two error groups, and associates each with an error processor. The first group comprises the four DFHZNAC error codes X'D9', X'DC', X'DD', and X'F2'. The second group contains only error code X'42', corresponding to the 'unavailable printer' condition, a specific exception condition signaled when CICS cannot allocate a printer in response to a 3270 print request.

The 3270 sample code is not intended to cover all error conditions. Note that the code is not suitable for SNA 3270s (LU session type 2). Error conditions arising from these result in different DFHZNAC error codes and may require different handling.

You may find that the CICS-supplied code is not sufficient for other, application-related, reasons. Perhaps you want to try to reacquire lost sessions after a time interval. The code supplied for the 3767 covers only one error group with one DFHZNAC error code, X'DC', which may occur under contention protocol.

You can use these CICS-supplied error processors to generate a valid DFHZNEP listing, for tutorial purposes, without having to write any user code.

You should be aware of the following limitations of this NEP design:

- Any error types you have not allowed for are ignored by the NEP, and not accumulated into error buckets.
- You may want to handle a particular situation whenever it arises, even though DFHZNAC may assign it different error codes in different situations. For example, on an SNA 3270, switching in and out of TEST state generates status X'082B' (presentation-space integrity lost). This might result in one of several DFHZNAC error codes.

In the sample NEP structure, you would need either to test for this last case in separate error processors, or group all the DFHZNAC error codes together. If you wrote your own NEP code from scratch, you would simply, on entry to your NEP, test the communication area field containing the status.

Multiple NEPs

CICS allows you to define a NEP transaction class that applies to every transaction that uses a particular profile, session, or terminal-type. To do this you use the NEPCCLASS option of the CEDA DEFINE PROFILE, CEDA DEFINE SESSIONS, or CEDA DEFINE TYPETERM command. (Note that any value of NEPCCLASS that you specify using CEDA DEFINE PROFILE overrides any specified using CEDA DEFINE SESSIONS or CEDA DEFINE TYPETERM.) NEPCCLASS is a 1-byte binary field containing a value in the range 0–255. The purpose of NEPCCLASS is that, while a transaction is running on the LU, you can obtain a special version of node error handling, suitable for that transaction. (This is sometimes called a "transaction-class error routine".) The default value NEPCCLASS(0) indicates that no NEPCCLASS is in effect.

The DFHZNEP that gets control from DFHZNAC must test the NEPCCLASS in effect at that time for the LU associated with the error. Then it either transfers control to a suitable module (the actual NEP), or branches to a specific bit of code within itself.

background to VTAM error handling

The DFHZNEPI macros (see “DFHZNEPI macros” on page 478) generate a DFHZNEP module that is purely a routing module. This inspects the NEPCCLASS in effect for the node error passed by DFHZNAC, and transfers control (links) to another module, the real NEP, according to a NEPCCLASS/name routing table built up by the macros.

If no NEPCCLASS is in effect (equivalent to CEDA DEFINE PROFILE NEPCCLASS(0)), or the NEPCCLASS is not in the routing table, a default module is invoked. You must specify the name of this in the DFHZNEPI TYPE=INITIAL macro. (See “DFHZNEPI TYPE=INITIAL—specifying the default routine” on page 479.) If you do not specify the name, no module is invoked.

You also have to provide the sub-NEPs for the various NEP transaction classes, including, of course, one for the default NEPCCLASS(0). Each of these sub-NEPs needs a separate program definition. You have the same choice in coding each sub-NEP as you had when there was just one; you can code your own, or use the CICS sample macro DFHSNEP. If you use DFHSNEP, note that there is another operand on the DFHSNEP TYPE=INITIAL macro, NAME=, which means that the generated module can be given any name you choose (to match the DFHZNEPI routing). You can use a different node error table with each sub-NEP.

Before you start using NEP routing, consider the following:

- The association of an LU (TCTTE) with a transaction NEPCCLASS is only valid for about the time that the CICS task exists. Errors detected after a CICS task has ended (for example, because of a problem with a delayed output message) may not be associated with the NEPCCLASS of the creating transaction.

Another problem can occur when CICS is about to start a new task for the LU as a result of an internal request from another CICS task (by an EXEC CICS START request, for example). This is usually called automatic transaction initiation. Before the task is started, CICS has to open a fresh session if none exists, by issuing a VTAM SIMLOGON request, and then, as mentioned earlier, send a BID command. The intended task is not attached until all this is completed successfully. The NEPCCLASS is not picked up from the transaction definition until then. This means that any errors arising in the ATI process (perhaps an error on BIND or BID) occur before the NEPCCLASS is correctly set, so they may get routed to the default NEP and not the one for the NEPCCLASS. This complicates the total node error handling for the application.

As an example, consider an application that contacts unattended programmable controllers overnight in order to read in the day's input. Recovery design in such an application is fundamental, and has to allow for errors both in ATI and in file transmission. To separate these into two NEPs could be an unnecessary complication.

- The extra development effort for a NEP split on a NEPCCLASS basis might not be justified. Generally, if logic is to be split, it is on an LU basis (programmable controllers may be running applications other than 3270).

To conclude this overview, remember that the CICS sample NEPs are a good source of ideas for you to write your own NEPs, but they might not be the ideal framework for your particular needs. It is recommended that you write straightforward NEPs at first.

When an abnormal condition occurs

The following CICS components are involved when an abnormal condition is detected from a logical unit:

- The terminal control program VTAM section: DFHZCA, DFHZCB, DFHZCC, DFHZCP, DFHZCQ, DFHZCW, DFHZCX, DFHZCY, and DFHZCZ.
- The node abnormal condition program, DFHZNAC.
- The CICS-supplied default node error program, DFHZNEP, or your own version of it.

For logical units, all information concerning the processing state of the terminal is contained in the TCTTE and the request parameter list (RPL). Consequently, when a terminal error must be handled for a logical unit, the TCTTE itself is placed onto the system error queue.

DFHZNAC assumes that system sense codes are available upon receipt of an exception response from the logical unit. Thus, analysis is performed to determine the reason for the response. Decisions, such as which action flags to set and which requests are needed, are made based upon the system sense codes received. If sense information is not available, default action flags are set, and DFHZEMW is scheduled to send a negative response, if a response is outstanding, with an error message to the terminal.

The action flags set by DFHZNAC on receipt of specific inbound system sense codes are listed in “Appendix B. Default actions of the node abnormal condition program” on page 789.

Before executing the specified routines, DFHZNAC links to DFHZNEP. You can use DFHZNEP to perform additional error processing beyond that performed by DFHZNAC; or to alter the default actions previously set by DFHZNAC. You need to code a node error program only if you want to do either of these things.

The action flags, set by DFHZNAC to assist the node error program, are in field TWAOPTL of the communication area.

If you want to modify DFHZNAC’s actions following an abnormal situation, DFHZNEP can interrogate field TWAOPTL and modify the bit settings. If you agree with DFHZNAC’s proposed actions, field TWAOPTL is left unaltered.

In most cases, DFHZNEP can modify DFHZNAC’s proposed actions. The only time that DFHZNAC overrides DFHZNEP’s modification of field TWAOPTL is when a logical unit is to be disconnected from CICS; that is, when DFHZNAC determines that the abnormal situation requires that CICS issue the ACF/VTAM CLSDST macro for a logical unit. In such a case, DFHZNAC disconnects the terminal and abnormally terminates the task, even if DFHZNEP tries to block such actions.

Resetting of the task termination flag by the node error program is also ignored if a negative response has been sent to a logical unit, or if DFHZEMW is to write an error message to the logical unit.

When the node error program has performed its functions, it returns control to DFHZNAC by an EXEC CICS RETURN command.

when an abnormal condition occurs

When control is returned from DFHZNEP, DFHZNAC performs the actions specified in field TWAOPTL (except when disconnecting logical units, as noted above), issuing messages and setting error codes, as necessary.

The communication area

After DFHZNEP receives control from DFHZNAC, it obtains the address of the communication area by means of an EXEC CICS ADDRESS COMMAREA command. Figure 24 illustrates the general structure of the communication area. The significance of each section of the communication area is described below:

Header
Error_being_processed
User option bytes
VTAM information
Additional information for NEP
Additional system parameters
XRF parameters

Figure 24. General structure of the communication area

Header

A 4-byte header common to all user-replaceable programs.

Error_being_processed

Identifiers of the error code and the terminal associated with the error.

User option bytes

Flags that indicate the default actions set by DFHZNAC, and that may be reset within DFHZNEP.

VTAM information

Sense and RPL codes.

Additional info. for NEP

Other useful information for the NEP.

Additional system parameters

Locations of indirect parameters, such as the TCTTE, and other system information.

XRF parameters

Recovery notification data.

A detailed listing of the communication area is given in Figure 25 on page 459.

when an abnormal condition occurs

```
*****
**                               Header                               **
**       These fields are READ ONLY                               **
*****
NEPCAHDR DS   0XL4                Standard Header
NEPCAFNC DS   XL1                  Function Code      Always '1'
NEPCACMP DS   XL2                  Component Code    Always 'ZC'
          DS   XL1                  Reserved
*****
**                               Error_being_processed              **
**       Identity of terminal and the error code associated with it **
**       These fields are READ ONLY                               **
*****
TWAEC   DS   XL1                Error Code
          DS   CL3                Reserved
TWANID  DS   CL4                Terminal identity
TWANETN DS   CL8                Netname
*****
**                               User option bytes                 **
**       Initially set to the default actions.                   **
**       DFHZNEP can change the defaults.                       **
*****
TWAOPTL DS   0XL3                User option bytes
TWAOPT1 DS   XL1                User option byte 1
TWAOPT2 DS   XL1                User option byte 2
TWAOPT3 DS   XL1                User option byte 3
          DS   XL1                Reserved
```

Figure 25. The DFHZNAC/DFHZNEP communication area (Part 1 of 3)

when an abnormal condition occurs

```

*****
**      VTAM information - Any VTAM sense and RPL codes      **
**      These fields are READ ONLY                          **
*****
TWAVTAM DS    0XL12          VTAM information
TWARPLCD DS    H            VTAM RPL feedback codes
          DS    H            Reserved
TWASENSS DS    0F          Sense codes to be sent
TWASS1 DS    XL1          System sense byte No 1
TWASS2 DS    XL1          System sense byte No 2
TWAUS1 DS    XL1          User sense byte No 1
TWAUS2 DS    XL1          User sense byte No 2
*
TWASENSR DS    0F          Sense codes received
TWASR1 DS    X            System sense byte No 1
TWASR2 DS    X            System sense byte No 2
TWAUR1 DS    X            User sense byte No 1
TWAUR2 DS    X            User sense byte No 2
*
*****
**      Additional information for the NEP                    **
**Except for TWANPFW, TWANLD, and TWANLDL these fields are READ ONLY**
*****
TWAADINF DS    0XL22
          DS    F            Reserved
TWACTLB DS    X            General use control byte
* EQU X'80'          Reserved
* EQU X'40'          Reserved
TWACSC EQU X'20'          Clear sense code indicator
TWAPSC EQU X'10'          Print VTAM sense codes
TWATIOA EQU X'08'          Print portion of I/O area
* EQU X'04'          Reserved
TWAVTRTC EQU X'02'          VTAM return code available
TWANEPR DS    XL1          NEP return code byte
TWANPFW EQU X'80'          Retry write with FORCE=YES
TWAREASN DS    XL1          VTAM reason code
TWASTAT DS    XL1          VTAM status code
TWAXRSN DS    H            Exception response seq number recd
TWAR EQU *
TWAPFLG DS    XL1          CLSDST pass flag
TWAPIP EQU X'80'          CLSDST pass in progress
TWANEPC DS    XL1          NEP class flag
TWAEISAB DS    XL1          Stand-alone begin bracket indicator
TWAESAB EQU X'04'          Stand-alone begin bracket
          DS    XL3          Reserved
TWANLD DS    A            Address of data to be logged
TWANLDL DS    H            Length of data to be logged

```

Figure 25. The DFHZNAC/DFHZNEP communication area (Part 2 of 3)

when an abnormal condition occurs

```

*****
**                               Additional system parameters                               **
**Except for TWAPNETN, TWAPNTID, TWAUPRRC these fields are READ ONLY**
*****
TWASYSM DS      0XL68
TWATCTA DS      AL4           Address of TCTTE being processed
TWARPL  DS      AL4           Address of VTAM RPL
TWATIOAA DS     AL4           Address of data portion of TIOA
TWATIOAL DS     H            Length of data portion of TIOA
TWACOMML DS     H            Length of commarea data for TCTTE
TWACOMMA DS     CL4          Address of commarea data for TCTTE
TWATECIA DS     AL4          Address of TCTTE user area
TWATECIL DS     H            Length of TCTTE user area
TWAPPNTN DS     CL8          Primary 3270 printer netname
TWAPPTID DS     CL4          Primary 3270 printer termid
TWAPPELG DS     X            Primary printer eligible indicator
TWAPPELY EQU    X'01'        Primary printer is eligible flag
TWASPNTN DS     CL8          Secondary 3270 printer netname
TWASPTID DS     CL4          Secondary 3270 printer termid
TWASPELG DS     X            Secondary printer eligible indicator
TWASPELY EQU    X'01'        Secondary printer is eligible flag
TWAPNETN DS     CL8          Selected 3270 printer netname
TWAPNTID DS     CL4          Selected 3270 printer termid
TWAUPRRC DS     B            Unavailable Printer return code
TWAUPRNP EQU    X'00'        No printer selected
TWAUPRPS EQU    X'01'        Printer selected
TWAUPRDD EQU    X'FF'        Data disposal complete
TWAUPRPE EQU    X'FE'        Error on Put request
TWAERRF1 DS     B            Error flag byte 1
TVALXS  EQU     X'80'        Logon crossed simlogon
                DS      XL2          Reserved
*****
**                               XRF parameters                               **
**                               XRF recovery notification data                       **
**                               DFHZNEP can change these default actions             **
*****
TWAXRNOT DS     X            Recovery notification options
TWAXRNON EQU    X'80'        Recov notification = none
TWAXRMSG EQU    X'40'        Recov notification = message
TWAXRTRN EQU    X'20'        Recov notification = transact.
                DS      XL3          Reserved
TWAXMSTN DS     CL8          Recovery mapset name
TWAXMAPN DS     CL8          Recovery map name
TWAXTRAN DS     CL4          Recovery transaction ID
*

```

Figure 25. The DFHZNAC/DFHZNEP communication area (Part 3 of 3)

The next sections describe fields in the parameter list that can be reset within DFHZNEP. See also “Coding for the 3270 ‘unavailable printer’ condition” on page 476, which describes the use of the flags in the “unavailable printer return code” field, and “Using the node error program with XRF or persistent sessions” on page 480, which describes how the flags in the XRF part of the parameter list can be manipulated.

The user option bytes (TWAOPTL)

TWAOPTL contains the user option bytes TWAOPT1, TWAOPT2, and TWAOPT3, each of which contains action flags. On entry to DFHZNEP, these flags represent the default actions previously set by DFHZNAC. They can be reset by DFHZNEP.

TWAOPT1

User option byte 1. TWAOPT1 contains flags which are principally debugging

when an abnormal condition occurs

aids. The first five flags cause DFHZNAC to write the desired information to the CSNE log if the appropriate bit is set. Setting the sixth flag (TWAODNTA) on causes CICS to take a system dump when there is no task attached to the terminal at the time of error detection, if the flag TWAOAT in TWAOPT2 is also set on.

The flags are:

TWAOAF (X'80')

Print action flags

TWAORPL (X'40')

Print VTAM RPL

TWAOTCTE (X'20')

Print TCTTE

TWAOTIOA (X'10')

Print TIOA

TWAOBIND (X'08')

Print BIND area

TWAODNTA (X'04')

System dump if no task attached.

TWAOPT2

User option byte 2. TWAOPT2 contains flags which are task-related.

The NEP can abend the task by setting TWAOAT, or cancel it by setting TWAOCT. The difference is that abend task does not take effect until the task requests or completes a terminal control operation: cancel task takes effect as soon as system and data integrity can be maintained. Setting TWAOAT to abend the task is normally sufficient, except where the task performs lengthy processing (such as a database browse) between terminal requests. If both TWAOAT and TWAOCT are set, TWAOCT (cancel task) takes priority.

If the task is to be abnormally terminated, sends and receives are purged. If TWAOGMM is set, the next transid is cleared and any communication area associated with the terminal is released—except in the case of permanent transids (specified on the TERMINAL definition as TRANSACTION(name)), when the communication area is not released. If the TYPETERM of the terminal indicates that the “good morning” message is supported (LOGONMSG(YES)), if TWAONINT is off, and if the terminal is not in a BMS paging session, then the “good morning” message transaction is initiated (the transaction specified by the system initialization parameter GMTRAN).

The flags are:

TWAOAS (X'80')

Abandon any SEND for this terminal

TWAOAR (X'40')

Abandon any RECEIVE for this terminal

TWAOAT (X'20')

Abend any task attached to TCTTE

TWAOCT (X'10')

Cancel any task attached to TCTTE

when an abnormal condition occurs

TWAOGMM (X'08')

“good morning” message to be sent

TWAOPBP (X'04')

Purge any BMS pages for this session

TWAOASM (X'02')

SIMLOGON required.

Notes:

1. If a definite response SEND has been performed, CICS has to issue a RECEIVE in order to obtain the response. If the response is negative, DFHZNAC is entered and sets flags TWAOAS (abandon the SEND) and TWAOAR (abandon the RECEIVE). TWAOAR must be left on to ensure that the RECEIVE for the response is abandoned.
2. If the request is to be retried, and the break connection action flag is off (that is, if TWAOCN in TWAOPT3 is off), then one or more of TWAOAS, TWAOAR, and TWAONEGR must be off as well as TWAOAT.
3. The abend code returned as a result of setting TWAOCN is unpredictable.
4. TWAOGMM forces TWAOAT only if set on by the node error program.
5. TWAOPBP forces TWAOAT to be set on.
6. For non-pipeline terminals, TWAOAT acts as a cancel request (TWAOCN) if the task has not yet been dispatched for the first time.

TWAOPT3

User option byte 3. TWAOPT3 contains flags which are node-related.

The flags are:

TWAOINT (X'80')

Internally generated logons (INTLOGs) allowed

TWAONINT (X'40')

No internally-generated logons allowed ⁵

TWAONCN (X'10')

Normal CLSDST (no reset allowed)

TWAOSCN (X'08')

Normal CLSDST (reset allowed)

TWAONEGR (X'04')

Send negative response

TWAOOS (X'02')

Keep node out of service

TWAOCN (X'01')

CLSDST node. ⁵

TWAONINT forces TWAOCN.

TWAONEGR forces TWAOAR and TWAOAT.

TWAOOS forces TWAOCN.

TWAOCN forces TWAOAR, TWAOAS, and TWAOAT.

5. Do not set this flag when processing error code X'49' (TCZCLSIN).

when an abnormal condition occurs

TWAOOS indicates that no further processing is to be done for this node. The node is logically out of service.

For an LU6.1 intersystem communication session, TWAOOS or TWAONINT causes the system entry to be put out of service if, as a result of the specified action, there are no allocatable sessions left. (A session can also be put out of service because of either an unknown modename being passed to VTAM during an attempt to bind an APPC session, or an invalid logmode name for a VTAM 3270-type terminal. However, the CICS default action resulting from this condition cannot be overridden in the NEP.)

If TWAOCN is set, the task is abnormally terminated and communication with the node is lost. Note that the NEP cannot reset this flag.

TWAOSCN provides the same function as TWAONCN, but the NEP can reset it if the session is not to be closed.

If DFHZNAC is scheduled because of the receipt of an exception response, the sense information in the TCTTE is available to DFHZNAC and DFHZNEP to determine any necessary actions.

If DFHZNAC is scheduled because of loss of the connection between CICS and a logical unit, DFHZNAC abnormally terminates any transaction in progress at the time of the failure. DFHZNEP and transaction-class error routine analysis and processing are permitted, but you should not attempt to retry the message.

However, if the application program handles the 'TERMERR' condition, the transaction is not abended. Control is returned to the program. In this circumstance, no further use can be made of the failed session.

Additional information for the NEP (TWAADINF)

Fields TWANPFW, TWANLD, and TWANLDL can be reset by the NEP. For information about the use of TWANPFW, see the supplied sample node error program, and "Optional error processor for interactive logical units" on page 469.

TWANLD and TWANLDL — using the DFHZNAC logging facility: You can use the logging facility available in DFHZNAC to aid in retrieving information. You specify the address of the data that you want to examine in field TWANLD of the communication area, and the length of the data in field TWANLDL. The data is logged to the CSNE transient data queue for future inspection.

Note: No data in excess of 220 bytes is logged.

You can also send user-written messages to the CSNE log using the transient data facility. To write your messages, you must code the EXEC CICS WRITEQ TD instruction directly into the node error program.

TWAPIP — and application routing failure: The EXEC CICS ISSUE PASS command passes control from CICS to another named VTAM application. For programming information about the EXEC CICS ISSUE PASS command, see the *CICS Application Programming Reference* manual. The ISSUE PASS command in turn invokes the VTAM macro CLSDST with OPTCD=PASS, and, in addition, if NOTIFY has been specified on the CLSDSTP system initialization parameter, with PARMS=(THRDPTY=NOTIFY). CICS is then notified of the outcome of any CLSDST request.

when an abnormal condition occurs

This notification results in an informative message being issued, and causes DFHZNAC to invoke your NEP, whether the CLSDST request has failed or succeeded. The NEP can discover that a CLSDST OPTCD=PASS request is in progress by examining field TWAPFLG for the pass-in-progress indicator, TWAPIP. The success or failure of the CLSDST OPTCD=PASS request can be determined by examining the error code at TWAEC.

If the pass operation fails, DFHZNAC sets up a default set of recovery actions that can be modified by your NEP. A possible recovery, when, for example, the target application program is not active, would be to reestablish the session with the initial application using a SIMLOGON request and for CICS to send its “good morning” message to the terminal. The default action is to leave the session disconnected and to make it NOCREATE.

If CLSDSTP=NONOTIFY has been specified, and autoinstall is being used, CICS takes no action, even if the ISSUE PASS fails.

If persistent sessions support is active, autoinstall terminals are deleted after the AIRDELAY, so any expected NEP processing as a result of CLSDSTP=NOTIFY being coded does not take place.

The additional system parameters (TWASYSPM)

If a data element referenced in this section of the parameter list (for example, the TIOA) does not exist when the NEP is driven, its address and length fields are set to zero.

Fields TWAPNETN, TWAPNTID, and TWAUPRRRC can be reset by the NEP. The use of these fields is discussed in “Data storage key for task-related user exit programs” on page 268.

XRF parameters (TWAXRNOT)

These fields can be reset by the NEP. See “Using the node error program with XRF or persistent sessions” on page 480.

The sample node error program

The sample node error program provides a general environment for the execution of error processing routines (error processors), each of which is specific to certain error codes generated by the node abnormal condition program. Sufficient optional error processors for normal operation of VTAM 3270 or interactive logical unit networks are provided; these can be easily supplemented or replaced by user-supplied error processors.

There are three types of error that may occur in a VTAM network:

- Errors in the host system
- Communication errors, such as session failures
- Abnormal conditions at the terminal, such as intervention required and invalid requests.

A sample node error program is supplied with CICS, and can be used as the basis of each subsequent node error program that you write. This provides you with:

the sample node error program

- A general environment within which your error processing programs can be added
- The default node error program in a system that has several node error programs.

The CICS-supplied sample node error program is described in greater detail below.

Compatibility with the sample terminal error program

Receipt of sense or status codes corresponds to error codes X'D9', X'DC', X'DD', and X'F2'. Weighted counts of these messages are maintained against numeric and time thresholds. If the numeric threshold is exceeded, default actions are taken. If the time threshold is reached, the count is reset. This is equivalent to the function in the sample TEP, except that sense or status arising out of the "from" device on a COPY command is now presented to the node error program as an error on the "to" device; this causes the threshold to be exceeded, resulting in the request being terminated, although the terminal remains in service. Some of the weights for errors that occur on the 3270 display device have been revised, but otherwise the weight and threshold values are the same as the defaults used in the sample TEP. Time threshold maintenance for the sample NEP is mandatory, and not optional as in the sample TEP.

For further information about time and threshold count limits, see the information about the sample terminal error program in "Chapter 8. Writing a terminal error program" on page 415.

The 3270 message 'unavailable printer' corresponds to error code X'42' (interval control PUT request has failed). The algorithm used for printer selection differs in VTAM support. The retry algorithm in the sample node error program is similar to this new selection algorithm.

Components of the sample node error program

The sample node error program comprises the following components:

- An entry section.
- The routing mechanism.
- The node error table.
- Optional common subroutines.
- Optional error processors for 3270 or interactive logical units. A node error program cannot be generated with both 3270 and interactive logical unit error processors.

The components are described in the sections that follow.

Entry section

On entry, the sample NEP uses DFHEIENT to establish base registers and addressability to the EXEC interface. It uses an EXEC CICS LOAD PROGRAM command to establish addressability to the node error table (NET) and, if included, the common subroutine vector table (CSVT). It uses an EXEC CICS ADDRESS COMMAREA command to obtain addressability to the communication area passed by DFHZNAC, and an EXEC CICS ADDRESS EIB command to obtain addressability to the EXEC interface block. If time support has been generated, the error is time-stamped for subsequent processing.

Routing mechanism

The routing mechanism invokes the appropriate error processor depending on the error code provided by the node abnormal condition program.

Groups of one or more error codes are defined in the DFHSNEP macro (see below). Each group is associated with an index (in the range X'01' through X'FF') and an error processor. A translate table is generated and the group index is placed at the appropriate offset for each error code. Error codes not defined in groups have a zero value in the table. An error processor vector table (EPVT) contains the addresses of the error group processors, positioned according to their indexes. The vector table extends up to the maximum index defined; undefined intermediate values are represented by zero addresses.

The error code is translated to obtain the error group index. A zero value causes the node error program to take no further action; otherwise the index is used to obtain the address of the appropriate error processor from the EPVT. A zero address causes the node error program to take no further action; otherwise a call is made to the error processor. This is entered with direct addressability to the NET and CSVN areas. When the error processor has been executed, the node error program returns control to the node abnormal condition program.

Node error table

The node error program may use a node error table (NET) that comprises the node error blocks (NEBs) used to maintain error status information for individual nodes (see Figure 26 on page 468). Some or all of the NEBs can be permanently reserved for specific nodes; others are dynamically assigned to nodes when errors occur. Dynamically assigned NEBs are used exclusively for the nodes to which they are assigned until they are explicitly released. All the NEBs have an identical structure of error status blocks (ESBs). Each ESB is reserved for one error processor and associated with it by means of the appropriate error group index. The ESB length and format can be customized to the particular error processor that it serves.

the sample node error program

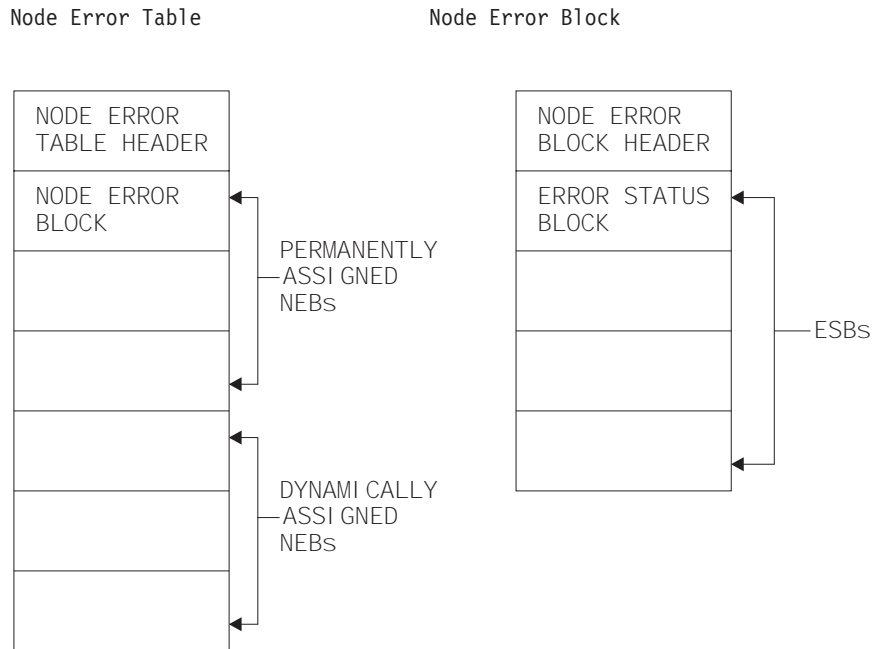

Figure 26. Format of node error table and node error block

Note: If you write your own node error program, you must generate a NET, even if it contains no entries because your error processors do not use it.

Optional common subroutines

The common subroutines are addressed via the CSV T and provide error processors with the following functions:

- Locate or assign NEBs and ESBs on the basis of node ID and error group index.
- Time stamp an error, update an error count, and test an error count against numeric and time threshold values.
- Release a dynamically assigned NEB from a particular node.

Optional error processors for 3270 logical units

Two error processors are supplied for 3270 LUs, as follows:

1. Group index 1, error codes X'D9', X'DC', X'DD', and X'F2'.

These error codes correspond to the receipt of sense or status bytes in the user sense fields of the RPL. The error processor locates an ESB of the standard format and updates a weighted error count. The weight, threshold, and timer values are based on those used by the sample terminal error program 3270 except as noted in the previous section. If the threshold is not exceeded, the abend SEND, abend RECEIVE, abend transaction flags, and all the print action flags are turned off. Otherwise the default actions are taken and the NEB is released if it is reusable.

2. Group index 2, error code X'42'.

This code means that no 3270 printer was available to satisfy a print request made at a 3270 screen. The error processor examines the printers defined for this screen to determine why they were unavailable. If either is busy on a previous PRINT or COPY request (that is, a task is attached with a transaction ID of CSPP or CSCY) or is no longer unavailable, that printer address is returned to the node abnormal condition program which retries the print request

the sample node error program

with an IC PUT command. Otherwise the default actions are taken. (For more details, see the section “Coding for the 3270 ‘unavailable printer’ condition” on page 476.)

Optional error processor for interactive logical units

Only one error processor is supplied for interactive LUs: group index 1, with error code X'DC'.

This error code, in combination with a user sense value of X'081B', indicates a 'receiver in transmit mode' condition. The action flags in TWANPFW are manipulated to allow the failing SEND request to be retried.

Generating the sample node error program

The routing mechanism, common subroutines, CICS-supplied error processors, and user-supplied error processors are generated by means of DFHSNEP macros.

The sample node error program and table need to be translated, assembled, and link-edited. For information about the job control statements required to assemble and link-edit user-replaceable programs, refer to “Assembling and link-editing user-replaceable programs” on page 402.

Note that you should code the translator options NOPROLOG and NOEPILOG in your node error program.

Note also that an extra 24 bytes are required for the common subroutines register save area, and further space is required for the error processor save area. The CICS sample processors use 4 bytes of this area.

The DFHSNEP macro to generate the sample node error program has seven types, as follows:

TYPE=USTOR

to indicate the start of user storage definitions.

TYPE=USTOREND

to indicate the end of user storage definitions.

TYPE=INITIAL

to generate the routing mechanism and, optionally, the common subroutines.

TYPE=DEF3270

to generate the default CICS-supplied error processors for 3270 devices.

TYPE=DEFILU

to generate the default CICS-supplied error processor for interactive logical units operating in contention mode.

TYPE=ERRPROC

to indicate the start of a user-supplied error processor.

TYPE=FINAL

to indicate the end of the sample node error program.

the sample node error program

DFHSNEP TYPE=USTOR and USTOREND—defining user storage

The DFHSNEP TYPE=USTOR macro has the following format:

This macro indicates the start of user storage definitions. It must be followed by
DFHSNEP TYPE=USTOR

your storage definitions, and then by DFHSNEP TYPE=USTOREND. If you use DFHSNEP TYPE=USTOR to define storage, then both it and DFHSNEP TYPE=USTOREND must be coded **before** DFHSNEP TYPE=INITIAL.

The DFHSNEP TYPE=USTOREND macro has the following format:

This macro indicates the end of user storage definitions. Its use is mandatory if
DFHSNEP TYPE=USTOREND

DFHSNEP TYPE=USTOR has been coded. If you use DFHSNEP TYPE=USTOR to define storage, then both it and DFHSNEP TYPE=USTOREND must be coded **before** DFHSNEP TYPE=INITIAL.

DFHSNEP TYPE=INITIAL—generating the routing mechanism

One DFHSNEP TYPE=INITIAL macro must appear immediately **after** DFHSNEP TYPE=USTOR and DFHSNEP TYPE=USTOREND (if they are coded) and **before** the remaining macros.

```
DFHSNEP TYPE=INITIAL  
        [,CS=NO]  
        [,NAME=name]  
        [,NETNAME=netname]
```

TYPE=INITIAL

indicates the start of the sample node error program and causes the routing mechanism to be generated.

CS=NO

specifies that the generation of the common subroutines is to be suppressed.

NAME=name

specifies the name of the node error program module identifier. The name must be a string of 1 through 8 characters. This operand is optional, and the default is DFHZNEP0. If you allow the NAME operand to default, you can use the examples on page 404 to create link-edit statements, but if you specify a different NAME, you must change the link-edit statements accordingly. If the interface module DFHZNEP (generated by the DFHZNEPI macro) is used, this operand must be specified (with a name other than DFHZNEP).

NETNAME=netname

specifies the name of the node error table to be loaded at initialization. The name must be a string of 1 through 8 characters. This operand is optional, and the default is DFHNET.

DFHSNEP TYPE=DEF3270—including error processors for 3270 LUs

The DFHSNEP TYPE=DEF3270 macro has the following format:

```
DFHSNEP TYPE=DEF3270
```

TYPE=DEF3270

specifies that the CICS-supplied error processors for 3270 logical units are to be included in the node error program. This macro causes the following source code to be generated:

```
DFHSNEP TYPE=ERRPROC, GROUP=1, CODE=(D9,DC,DD,F2)
Sense/status error processor code.
```

```
DFHSNEP TYPE=ERRPROC, GROUP=2, CODE=42
Unavailable printer error processor code.
```

DFHSNEP TYPE=DEFILU—including error processors for INTLUs

The DFHSNEP TYPE=DEFILU macro has the following format:

```
DFHSNEP TYPE=DEFILU
```

TYPE=DEFILU

specifies that the CICS-supplied error processor for interactive logical units is to be included in the node error program. This macro causes the following source code to be generated:

```
DFHSNEP TYPE=ERRPROC, GROUP=1, CODE=DC
(receiver in transmit mode error processor code)
```

DFHSNEP TYPE=FINAL—terminating DFHSNEP entries

One DFHSNEP TYPE=FINAL macro must follow all the other DFHSNEP macros. It has the following format:

```
DFHSNEP TYPE=FINAL
```

TYPE=FINAL

indicates the end of the node error program and causes the error processor vector table (EPVT) to be generated.

DFHSNEP TYPE=ERRPROC—specifying a user error processor

The DFHSNEP TYPE=ERRPROC macro is used to indicate the start of a user-supplied error processor. The actual error processor code should immediately follow this macro. The assembly should be terminated by the statement END DFHNEPNA.

The following operands can be used on the DFHSNEP TYPE=ERRPROC macro:

```
DFHSNEP TYPE=ERRPROC
        ,CODE=(error-code,...)
        ,GROUP=error-group-index
```

TYPE=ERRPROC

indicates the start of a user-supplied error processor.

CODE=(error-code,...)

specifies the error codes that make up the error group, and which are therefore handled by the error processor supplied. The operand is coded as a sublist of 2-character representations of 1-byte hexadecimal codes. (The parentheses can be omitted for a single code.) For each code specified, the error group index is placed at the equivalent offset in the translate table. Thus, when this code occurs, the appropriate error processor can be identified.

the sample node error program

GROUP=error-group-index

specifies an error group index for the error processor. This index is used to name the error processor, locate its address from the error processor vector table (EPVT), and optionally associate it with an ESB in each NEB. The index specified must be a 2-character representation of a 1-byte hexadecimal number in the range X'01' through X'FF' (a leading zero can be omitted). The error processor name has the form NEPROCxx, where "xx" is the error group index. A CSECT statement of this name is generated, which causes the error processor code to be assembled at the end of the node error program module and to have its own addressability.

If you intend to add your own error processors to the sample node error program, you should consider the following factors:

- The layout of the communication area. The communication area is described in detail in Figure 25 on page 459.
- The fact that certain functions cannot be used within DFHZNEP. (See "Restrictions on the use of EXEC CICS commands" on page 475.)
- The register conventions used by the sample node error program. These are described in Table 22.

Table 22. Register assignment

Register	Use
0	Work register
1	Address of the EXEC parameter list
2	NEB base register (DFHSNEP only)
3	ESB base register (DFHSNEP only) NEP error class register (DFHZNEPI only)
4	NEP name pointer register (DFHZNEPI only)
5	NEP interface base register (DFHZNEPI only)
6	Work register
7	Work register
8	Work register
9	Work register
10	Code base register
11	Address of the EIB
12	Address of the communication area
13	Address of DFHEISTG storage
14	CSVT base and error processor link register Common subroutine link register
15	Error processor branch register Common subroutine branch register.

Notes:

1. Register 14 must be saved for return from error processors. The common subroutine vector table (CSVT) is coded after the BALR to the error processor and so this register is also the CSVT base.
2. Registers 1, 10, 12, 13, 14, and 15 are set up on entry to error processors.
3. Registers 14 through 11 can be saved by error processors in an area reserved in EXEC interface storage at label NEPEPRS. Registers 15 through 11 do not need to be restored before return from error processors.

4. Registers 4 through 9 can be saved by common subroutines in an area reserved in EXEC interface storage at label NEPCSRs. They must be restored before return from the subroutines.

DFHSNET—generating the node error table

The DFHSNET macro is used to generate a node error table. Each node error table that you generate must be defined to CICS.

Note: If you write your own node error program, you must generate a NET, even if it contains no entries because your error processors do not use it.

```
DFHSNET  [NAME=DFHNET|name]
         [,COUNT=100|threshold]
         [,ESBS=1|(index,length,...)]
         [,NEBNAME=(name,...)]
         [,NEBS=10|number]
         [,TIME=(7,MIN)|(interval,units)]
```

NAME=DFHNET|name

specifies the identifier to be included in the NET header. It must be a string of one through eight characters. This operand is optional, and the default is DFHNET.

COUNT=100|threshold

specifies the error count threshold that is to be stored in the NET header for use by the common subroutines to update standard ESBs. If the threshold is exceeded, the error processor that invoked the subroutine is informed by a return code. The maximum value is 32 767. This operand is optional, and the default is 100.

ESBS=1|(index,length,...)

specifies the ESB structure for each NEB. This operand is coded as a sublist. Each element of the sublist comprises two values: “index” specifies an error group index for which an ESB is to be included in the NEB; “length” specifies the status area length, in bytes, for that ESB. The parentheses can be omitted for a single element. The “index” must be specified as a 2-character representation of a 1-byte hexadecimal number in the range X'01' through X'FF' (a leading 0 can be omitted). The “length” is constrained only because an 8-byte NEB header plus a 4-byte header for each ESB must be contained within the maximum NEB length of 32 767 bytes. If a null value is specified, a standard ESB with a status area length of 10 bytes is assumed. This is suitable for use by the common subroutines in maintaining a time-stamped error count.

This operand is optional and defaults to 1. This causes each NEB to be generated with one ESB for error group 1 with a status area length of 6 bytes.

NEBNAME=(name,...)

specifies the names of nodes that are to have a permanently assigned NEB. The names specified are assigned, in the order specified, to the set of NEBs requested by the NEBS operand. Any remaining NEBs are available for dynamic allocation to other nodes as errors occur. The name must be a string of 1 through 4 characters. The parentheses can be omitted for a single name. This operand is optional and has no default.

NEBS=10|number

specifies the number of NEBs required in the NET. The maximum valid number is 32 767; the default is 10.

the sample node error program

TIME=(7,MIN)|(interval,units)

specifies the time interval that is to be stored in the NET header for use by the common subroutines to maintain error counts in standard ESBs. If the threshold specified in the COUNT operand is not exceeded before this time interval elapses, the error count is reset to 0. Specify "units" as SEC, MIN, or HRS. The maximum values for "interval" are as follows: (86400,SEC), (1440,MIN), or (24,HRS). This operand is optional, and the default is set to (7,MIN).

DSECTs

The following DSECTs are provided:

Node Error Table Header: This contains the table name and common information relevant for all the node error blocks (NEBs) in the table.

DFHNETH	DSECT		
NETNAM	DS	CL8	Table name
NETHBN	DS	H	Number of NEBs in table
NETHBL	DS	H	Length of NEBs in table
NETHTIM	DS	PL8	Error count time interval
NETHECT	DS	H	Error count threshold
NETHFLG	DS	X	Flag byte
NETHINI	EQU	X'01'	Table initialized
	DS	X	Reserved
NETHFNB	DS	0F	First NEB

Node Error Block: The table contains node error blocks that are used for recording error information for individual nodes. These can be permanently assigned to specific nodes or dynamically assigned at the request of error processors.

DFHNETB	DSECT		
NEBNAM	DS	CL4	Node name
NEBFLG	DS	X	Flag byte
NEBPERM	EQU	X'01'	Permanently assigned NEB
	DS	XL3	Reserved
NEBFESB	DS	0X	First NEB

Error Status Block: The NEBs can contain error status blocks. These are reserved for specific error processors and are identified by the corresponding error group index. An ESB can have a format defined by you, or can have a standard format suitable for counting errors over a fixed time interval.

DFHNETE	DSECT		
ESBEGI	DS	X	Error group index
ESBFLG	DS	X	Flag byte
ESBSTAN	EQU	X'01'	Standard format ESB
ESBTTE	EQU	X'02'	Time threshold exceeded
ESBCTE	EQU	X'04'	Count threshold exceeded
ESBSLEN	DS	XL2	Status area length
ESBHLEN	EQU	*-DFHNETE	ESB header length
ESBSTAT	DS	0X	Status area

The following fields apply to the standard format:

ESBTIM	DS	PL8	Time stamp
ESBEC	DS	XL2	Error count

Common Subroutine Vector Table: The CSVT provides error processors with addressability to the common subroutines. The error processor link register gives addressability to the CSVT and so the first section of the DSECT overlies the code required to branch around the actual table.

DFHNEPC	DSECT		
	DS	F	Load instruction
	DS	F	Branch instruction
CSVNTEP	DS	A	Node error program base address
CSVTESBL	DS	A	NEPESBL - ESB locate routine
CSVTNEBD	DS	A	NEPNEBD - NEB delete routine
CSVTECUP	DS	A	NEPECUP - error count update routine

User-written node error programs

You can write your own NEP in any of the CICS-supported languages. However, CICS-supplied NEP code is provided in assembler language only. The communication area parameter list is supplied in assembler-language and C versions. The names of the supplied source files, copy books, and macros, and the libraries in which they can be found, are listed in Table 23.

Table 23. Supplied source files, copy books, and macros

Name	Type	Description	Library
DFHZNEP0	Program	Default node error program (assembler language)	CICSTS13.CICS.SDFHSAMP
DFHZNEPX	Source	Default NEP (embedded by DFHZNEP0 via COPY statement)	CICSTS13.CICS.SDFHSAMP
DFHSNEP	Macro	Sample NEP program generator (assembler language)	CICSTS13.CICS.SDFHMAC
DFHZNEPI	Macro	NEP interface generator (for multiple NEPs)	CICSTS13.CICS.SDFHMAC
DFHNEPCA	Macro	Assembler-language communication area	CICSTS13.CICS.SDFHMAC
DFHNEPCA	Copy book	C-language communication area	CICSTS13.CICS.SDFHC370

If you code in assembler language, you can use the sample NEP as a framework on which to construct your own node error program.

Restrictions on the use of EXEC CICS commands

There are certain restrictions on the commands that a NEP can issue. **The use of any commands which require a principal facility causes unpredictable results, and should be avoided.** In particular, you should not use commands which invoke the following functions:

- Terminal control (“CEMT-type” commands, such as EXEC CICS INQUIRE TERMINAL, are permissible)
- BMS (except routing)
- ISC communication (including function shipping). This includes START requests for remote transactions. Such requests are not recommended because CSNE (Node Abnormal Condition task) might become suspended while doing an ALLOCATE to the remote system.

If you need to start a remote transaction, start a local transaction which starts a remote one in turn.

user-written node error programs

- Updates to recoverable resources. If the resources are locked by another task, the CSNE unit of work could be suspended or shunted.

You should also note that you cannot use the NEP to suppress DFHZNAC messages.

Entry and addressability

On entry, your NEP should issue the commands:

```
EXEC CICS ADDRESS COMMAREA  
EXEC CICS ADDRESS EIB
```

These commands provide addressability to the communication area passed by DFHZNAC, and to the EXEC interface block, respectively.

If you write your node error program in assembler language, you generate the communication area DSECT by coding:

```
DFHNEPCA TYPE=DSECT
```

If you write your program in C/370, you include the communication area definitions by coding:

```
#include <dfhnePCA>
```

Coding for the 3270 'unavailable printer' condition

The 'unavailable printer' condition arises when a print request is made using the 3270 print request facility, and there are no printers on the control unit, or when the printers are in one of the following conditions:

- Out of service
- Not in TRANSCEIVE or RECEIVE status for automatic transaction initiation
- With a task currently attached
- Busy on a previous operation
- Requiring intervention.

The procedure is applicable to 3270 logical units or to the 3270 compatibility mode logical unit when using the PRINTER and ALTTPRINTER operands of the CEDA DEFINE TERMINAL command.

The terminal control program recognizes this condition, and issues a READ BUFFER request to collect the data into a terminal I/O area. The TIOA is of the same format as it is when an application program has issued a terminal control read buffer request.

The terminal control program VTAM section (DFHZCP) then queues the TCTTE to the node abnormal condition program with error code X'42' (TCZCUNPRT). The node abnormal condition program (DFHZNAC) writes to the CSNE transient data queue:

- DFHZC2497 UNAVAILABLE PRINTER (device types 3270P and LUTYPE3)
- DFHZC3493 INVALID DEVICE TYPE FOR A PRINT REQUEST (all other printer device types).

user-written node error programs

Before linking to the node error program, DFHZNAC inserts the primary and secondary printer netnames and terminal IDs into the communication area, indicating also whether either printer is eligible for a print request. DFHZNAC links to the node error program with no default actions set.

On return from the node error program, DFHZNAC checks the additional system parameter TWAUPRRRC in the communication area (see Figure 25 on page 459) and, based on its contents, performs one of the following actions:

- If your NEP sets TWAUPRRRC to X'FF' (-1), DFHZNAC assumes that the node error program has disposed of the data to be printed and therefore takes no further action.
- If your NEP sets TWAUPRRRC to zero, DFHZNAC assumes that no printer is available and takes no further action.
- If your NEP sets TWAUPRRRC to neither zero nor -1, DFHZNAC assumes that one of either field TWAPNETN or field TWAPNTID is set. (If both are set, TWAPNTID(termid) takes precedence.) An interval control PUT is performed to the provided terminal. The transaction to be initiated is CSPP (print program), and the time interval is zero.
 - If an error occurs on the interval control PUT, DFHZNAC writes the 'DFHZC2496 IC FAILURE' message to the destination CSNE. DFHZNAC then links to the node error program again with the TWAUPRRRC field set to -2. This is done to give the node error program a last chance to dispose of the data. On the second return from the node error program to DFHZNAC, the latter reexamines TWAUPRRRC. If TWAUPRRRC is -1, then the node error program has disposed of the data.
 - If no error occurs on the interval control PUT, DFHZNAC checks for the following printer conditions:
 - 'Out of service'
 - 'Intervention required'
 - Any condition other than RECEIVE or TRANSCEIVE status.

If one of these conditions is true, DFHZNAC issues the 'DFH2495 PRINTER OUTSERV/IR/INELIGIBLE-REQ QUEUED' message to the destination CSNE.

Finally, DFHZNAC terminates any print requests on the originating terminal and performs normal action flag processing on that terminal.

Coding for session failures

Following some categories of error associated with logical unit or path failures, the session between CICS and the logical unit may be lost. The default action taken by DFHZNAC may be to put the TCTTE out of service.

A method of automatically reacquiring the session is for your node error program to alter the default DFHZNAC actions and to keep the TCTTE in service. Your node error program can then issue an EXEC CICS START TERMID(name) command against that TCTTE for a transaction written in a similar manner to the CICS "good morning" signon message (CSGM). When the transaction is initiated using automatic transaction initiation (ATI), CICS tries to reacquire the session. If the session fails again, DFHZNAC is reinvoked and the process is repeated.

The time specified on the EXEC CICS START command is determined by installation-dependent expected-mean-time-to values.

user-written node error programs

If used in this way, the initiated transaction can write an appropriate signon message when the session has been acquired. Note, however, that if LOGONMSG=YES is specified on the CEDA DEFINE TYPETERM command, the CICS “good morning” message is also initiated when the session is opened. Refer to “Restrictions on the use of EXEC CICS commands” on page 475.

Coding for specific VTAM sense codes

Figure 27 shows how your NEP error processors could test for the presence of specific VTAM sense codes.

```
TEST1  EQU  *
        CLC  TWASNSR(2),SNS1          SENSE CODE EQUAL TO NNNN
        BNE  TEST2                    NO, THEN NEXT TEST
        NI   TWAOPT1,TWAOAF           PRINT ACTION MESSAGES ONLY
        OI   TWAOPT2,TWAOAS+TWAOAR+TWAOT ABANDON SEND,RECEIVE AND TASK
        NI   TWAOPT2,255-TWAOASM      SET SIMLOGON OFF
        OI   TWAOPT3,TWAOINT         SET INTLOG NOW ALLOWED
        NI   TWAOPT3,255-TWAOINT      OR RESET NOINTLOG
        B    END
        .
        .
        .
SNS1    DC   X'NNNN'
```

Figure 27. Sample code, showing how your node error program could test for specific VTAM sense codes

Writing multiple NEPs

You can write several node error programs, as described in “Multiple NEPs” on page 455. When an error occurs, the node abnormal condition program passes control to an interface module, DFHZNEPI, which determines the transaction class and passes control to the appropriate node error program.

If only one node error program is used, the interface module (DFHZNEPI) is not required. If the node error program is named DFHZNEP, the node abnormal condition program branches directly to that. If more than one node error program is used, the interface module (DFHZNEPI) is required. In this case, the node error programs must be given names other than DFHZNEP. There must be an installed program definition for every node error program generated.

DFHZNEPI macros

The following macros are required to generate the node error program interface module (DFHZNEPI):

- DFHZNEPI TYPE=INITIAL to specify the name of the default transaction-class routine.
- DFHZNEPI TYPE=ENTRY to associate a transaction-class with a transaction-class error handling routine.
- DFHZNEPI TYPE=FINAL to end the DFHZNEPI entries.

The DFHZNEPI interface module must be generated when you require the node abnormal condition program to pass control to the appropriate user-written node error program for resolution of the error.

DFHZNEPI TYPE=INITIAL—specifying the default routine

The DFHZNEPI TYPE=INITIAL macro specifies the name of the default transaction-class routine to be used for the DFHZNEPI module.

```
DFHZNEPI TYPE=INITIAL
        [,DEFAULT=name]
```

DEFAULT=name

specifies the name of the default transaction-class routine to be used. A link is made to this default routine if you specify for the transaction (using the CEDA DEFINE PROFILE, CEDA DEFINE SESSIONS, or CEDA DEFINE TYPETERM command) a NEPCCLASS value of 0 (the default) or higher than 255, or if you do not specify a transaction-class routine using the DFHZNEPI TYPE=ENTRY macro for the class specified on the NEPCCLASS operand.

If either of the preceding conditions is true, but you do not code the DEFAULT operand, then no routine is invoked.

The DFHZNEPI TYPE=INITIAL macro must always be specified, and must be placed before any other forms of the DFHZNEPI macro. Only one TYPE=INITIAL macro can be specified.

DFHZNEPI TYPE=ENTRY—specifying a transaction-class routine

You use the DFHZNEPI TYPE=ENTRY macro to associate a transaction class (NEPCCLASS) with a transaction-class error handling routine. The format of this macro is:

```
DFHZNEPI TYPE=ENTRY
        ,NEPCLAS=integer
        ,NEPNAME=name
```

NEPCLAS=integer

specifies the transaction-class, and must be in the range 1 through 255. No value should be specified that has been specified in a previous DFHZNEPI TYPE=ENTRY instruction.

NEPNAME=name

specifies a name for the transaction-class routine to be associated with the specified transaction-class. An error condition results if the name is specified either as DFHZNEP, or is longer than 8 characters.

Note: You can use the sample node error program (with a name other than DFHZNEP) as a transaction-class routine for the interface module, DFHZNEPI.

DFHZNEPI TYPE=FINAL—terminating DFHZNEPI entries

```
DFHZNEPI TYPE=FINAL
```

TYPE=FINAL

completes the definition of module DFHZNEPI and must be specified last. The assembly should be terminated by an END statement with no entry name specified, or by the statement: END DFHZNENA.

user-written node error programs

Handling shutdown hung terminals in the node error program

Error Code: X'6F'
Symbolic Name: TCZSDAS
Message Number: DFHZC2351

For error code X'6F', DFHZNAC passes the setting of TCSACTN and the DFHZC2351 reason code to DFHZNEP, and DFHZNEP can modify the force-close action for the current terminal.

How DFHZNAC passes the setting of TCSACTN to DFHZNEP

For error code X'6F', DFHZNAC passes the setting of the TCSACTN system initialization parameter to DFHZNEP by setting TWAOSCN. TWAOSCN off (B'0') indicates TCSACTN=NONE, and TWAOSCN on (B'1') indicates TCSACTN=UNBIND.

How DFHZNAC passes the DFHZC2351 reason code to DFHZNEP

For error code X'6F', the DFHZC2351 reason code is passed to DFHZNEP in the NEP communications area (NEPCA) field TWATRSN. TWATRSN is a 1-byte code field. Note that, currently, TWATRSN overlays TWAREASN (also a 1-byte field). The codes, and their meaning, are:

01 Request in progress	06 Waiting for RTR
02 Task still active	07 BID in progress
03 Waiting for SHUTC	08 Other TC work pending
04 Waiting for BIS	09 (X'63') Undetermined
05 Waiting for UNBIND	

See Terminal Control message DFHZC2351 for further details.

How DFHZNEP can modify the force-close action for the current terminal

For error code X'6F', DFHZNEP can modify the force-close action, for the current terminal, by setting TWAOSCN. If DFHZNEP sets TWAOSCN off (B'0'), DFHZNAC will not attempt to force-close the terminal (TCSACTN=NONE), however, if DFHZNEP sets TWAOSCN on (B'1'), DFHZNAC will attempt to force-close the terminal (TCSACTN=UNBIND). Internally, DFHZNAC achieves this by converting the TWAOSCN normal close to a TWAOCN forced close. DFHZNEP cannot modify either of the system initialization parameters TCSWAIT or TCSACTN.

Using the node error program with XRF or persistent sessions

This section contains guidance information about the NEP in an XRF or persistent sessions environment for CICS Transaction Server for OS/390 Release 3.

The node error program in an XRF environment

The CICS extended recovery facility (XRF) is described in the *CICS/ESA 3.3 XRF Guide*. If you are using XRF, a VTAM failure in your active CICS system may cause a takeover by the alternate CICS system. Each terminal from the failing system that is switched to the alternate system is passed to DFHZNAC for “conversation-restart” processing. This is similar to “session opened” processing for a normal session start.

One of the steps in the conversation-restart process is to link to the node error program with error code X'3F'. If you want to be able to change any of the system-wide recovery notification options (whether terminal users are notified of a recovery, the recovery message, or the recovery transaction) for some terminals, you should write your own error processor to handle code X'3F'. (For details of the recovery notification parameters passed to the NEP, see the listing of communication area fields in Figure 25 on page 459.)

The node error program with persistent session support

Persistent session support is described in the *CICS Recovery and Restart Guide*.

One of the steps in the conversation-restart process is to link to the node error program with error code X'FD'. If you want to be able to change any of the system-wide recovery notification options (whether terminal users are notified of a recovery, the recovery message, or the recovery transaction) for some terminals, you should write your own error processor to handle code X'FD'.

When using persistent sessions, note the following:

- When a session has been recovered, it may be a good idea to run NEP processing equivalent to your normal “session started” (code X'48') processing, because code X'48' is not passed on session recovery when persistent sessions are used.
- In certain situations where sessions have persisted over a failure but have been unbound on restart (for example, a COLD start occurs after a CICS failure), the NEP is not driven. (In systems without persistent session support, the NEP is always driven with code X'49', “session terminated”, when a VTAM session terminates.) Conditions leading to the issuing of the following messages do not drive the NEP. The messages appear on the system console:

```
DFHZC0120      DFHZC0124
DFHZC0121      DFHZC0129
DFHZC0122      DFHZC0130
DFHZC0123
```

Conditions leading to the issuing of messages DFHZC0125 and DFHZC0131 drive the NEP with codes X'FB' and X'FC' respectively. It is recommended that you run NEP processing equivalent to your normal “session terminated” NEP processing for these conditions.

- If zero is specified on the AIRDELAY system initialization parameter, autoinstalled terminals are not recovered after a restart. Similarly, if the delay period specified on AIRDELAY expires before an autoinstalled terminal is used after a restart, the terminal definition is deleted. In these circumstances, any expected NEP processing as a result of CLSDSTP=NOTIFY being coded does not take place.

Changing the recovery notification

The method of recovery notification for a terminal is defined using the RECOVNOTIFY option of the TYPETERM definition, which is described in the *CICS Resource Definition Guide*. This is the most efficient way to specify the recovery notification method for the whole network, because CICS initiates the notification procedure during the early stages of takeover.

You can use the node error program to change the recovery notification method for some of the switched terminals. For example, you may want most terminals of a particular type to receive the recovery message at takeover, but the rest to get no

the node error program and XRF

notification that service has been restored. To achieve this, you could code RECOVNOTIFY(MESSAGE) in the TYPETERM definition, and then use the node error program to change the recovery notification to NONE for the relatively few terminals that are not to be notified.

Changing the recovery message

If you define a terminal with RECOVNOTIFY(MESSAGE) in its TYPETERM definition, a recovery message is sent to the terminal after takeover. By default, for an XRF takeover, this is the following CICS-supplied message in BMS map DFHXRC1 of map set DFHXMSG:

```
CICS/ESA has recovered after a system failure.  
Execute recovery procedures.
```

For a persistent sessions recovery, BMS map DFHXRC3 is used; this map prefixes the above message with CICS/ESA message number DFHZC0199. You can specify your own map set in the node error program if you want to change the recovery message for some of the switched terminals. This could be useful, for example, if signon security is in force and you want to tell terminal users to sign on again. The map set that you specify must have an installed program definition. If you choose to change the recovery message for all terminals, it would be more efficient to replace the CICS-supplied map with your own.

Changing the recovery transaction

The recovery transaction, to be started at a terminal after takeover, is specified using the RMTRAN system initialization parameter. This is the most efficient way of specifying a recovery transaction for the network. You can specify a different transaction for some of the switched terminals by overwriting field TWAXTRAN in the communication area. The transaction that you specify must have an installed transaction definition, and the terminal must be defined with the option ATI(YES).

If the transaction specified in TWAXTRAN does not exist, CICS tries to start the CSGM transaction. If this also fails, CICS terminates the session.

Using the node error program with VTAM generic resources

The EXEC CICS ISSUE PASS command can be used (either from an application program, or by means of CECI) to disconnect a terminal from CICS, and transfer it to the VTAM application specified on the LUNAME option. For example, to transfer a terminal from this CICS to another terminal-owning region, you could issue the command:

```
CECI ISSUE PASS LUNAME(applid)
```

where applid is the APPLID of the TOR to which the terminal is to be transferred.

If your TORs are members of a VTAM generic resource group, you can transfer a terminal to any member of the group by specifying LUNAME as the generic resource name. For example:

```
CECI ISSUE PASS LUNAME(grname)
```

where grname is the generic resource name. VTAM chooses the most suitable group member to which to transfer the terminal. (If you need to transfer a terminal to a

the node error program and generic resources

specific TOR within the CICS generic resource group, you must specify LUNAME as the member name—that is, the CICS APPLID, as in the first example.)

Note that, if the system that issues an `ISSUE PASS LUNAME(gname)` command is the *only* CICS currently registered under the generic resource name (for example, the others have all been shut down), the `ISSUE PASS` command does **not** fail with an `INVREQ`. Instead, the terminal is logged off and message `DFHZC3490` is written to the CSNE log.

You may want to code your node error program to deal with the situation when message `DFHZC3490` (DFHZNAC error code X'C3') is issued.

Chapter 10. Writing a program to control autoinstall of terminals

Considerations common to all user-replaceable programs

Note that the comments contained in “Chapter 5. General notes about user-replaceable programs” on page 401 apply to this chapter.

This chapter describes how to write a program to control the automatic installation of locally-attached VTAM terminals (including APPC single-session devices). For information about controlling the automatic installation of local APPC connections that are initiated by BIND requests, see “Chapter 12. Writing a program to control autoinstall of APPC connections” on page 513. For information about controlling the installation of shipped terminals and connections, see “Chapter 13. Writing a program to control autoinstall of shipped terminals” on page 523. For information about controlling the installation of virtual terminals used by the CICS Client products, see “Chapter 14. Writing a program to control autoinstall of Client virtual terminals” on page 531.

The chapter is divided into the following sections:

1. “**Preliminary considerations**”.
2. “**The autoinstall control program at INSTALL**” on page 487. This contains:
 - “The communication area at INSTALL for terminals” on page 488
 - “How CICS builds the list of autoinstall models” on page 490
 - “Returning information to CICS” on page 491
 - “CICS action on return from the control program” on page 494.
3. “**The autoinstall control program at DELETE**” on page 495.
4. “**Naming, testing, and debugging your autoinstall control program**” on page 496.
5. “**The sample programs and copy books**” on page 497.

Preliminary considerations

You use the DEFINE TERMINAL(..) and DEFINE TYPETERM(..) commands to define VTAM devices to CICS. These commands define the resource definitions in the CICS system definition file (CSD). Your definitions can specify that they can be used as models for autoinstall purposes. Defining and installing model resource definitions for terminal control enables CICS to create required entries in the terminal control table (TCT) automatically, whenever unknown devices request connection to CICS. A particular advantage of automatic installation (autoinstall) is that the resource occupies storage in the TCT only while it is connected to CICS and for a specified delay period after last use.

You use the autoinstall control program to select some of the data needed to automatically install your terminals—notably the CICS terminal name and the model name to be used in each instance. You can use the CICS-supplied autoinstall program, or extend it to suit your own purposes.

the autoinstall control program for terminals

For an overview of autoinstall, see the *CICS Resource Definition Guide*. You should also read the sections in the same manual that describe the CEDA commands that create the environment in which your control program can work.

If you choose automatic installation for some or all of your terminals, you must:

- Create some model TERMINAL definitions.
- Define the terminals to VTAM, so that their definitions in VTAM match the model TERMINAL definitions in CICS.
- If you are using model terminal support (MTS), define the MTS tables to VTAM.
- Use the default autoinstall control program for terminals (DFHZATDX), or write your own program, using the source-code of the default program and the customization examples in this chapter as a basis. (You can write an entirely new program if the default program does not meet your needs, but you are recommended to try a default-based program first.) You can write your program in any of the languages supported by CICS—the source of the default program is provided in assembler language, COBOL, PL/I, and C. You can rename your user-written program.

Notes:

1. If you use the VS COBOL II compiler to compile your autoinstall control program (or to compile the supplied COBOL version, DFHZCTDX) you must run the program under the Language Environment®.
2. You can have only one active autoinstall control program to handle both terminals and APPC connections. You specify the name of the active program on the AIXIT system initialization parameter. The DFHZATDY program described in “Chapter 12. Writing a program to control autoinstall of APPC connections” on page 513 provides the same function for terminal autoinstall as DFHZATDX, but in addition provides function to autoinstall APPC connections initiated by BIND requests. Both DFHZATDX and DFHZATDY provide function to install shipped terminals and connections. So, for example, if you want to autoinstall APPC connections as well as VTAM terminals, you should use a customized version of DFHZATDY, rather than DFHZATDX.

Coding entries in the VTAM LOGON mode table

CICS uses the logmode data in the VTAM LOGON mode table when processing an autoinstall request. Autoinstall functions properly only if the logmode entries that you define to VTAM have matches among the model TERMINAL definitions that you specify to CICS.

The tables in “Appendix A. Coding entries in the VTAM LOGON mode table” on page 767 show, for a variety of possible terminal devices, what you must have coded on the VTAM MODEENT macros that define, in your logmode table, the terminals that you want to install automatically. Between them, the tables show the values that must be specified for each of the operands of the MODEENT macro.

Some of the examples in the appendix correspond exactly to entries in the IBM-supplied logon mode table called ISTINCLM. Where this is so, the table gives the name of the entry in ISTINCLM.

Using model terminal support (MTS)

CICS Transaction Server for OS/390 supports the model terminal support (MTS) function of VTAM 3.3 and above.

Using MTS, you can define the model name, the printer (PRINTER), and the alternate printer (ALTPRINTER) for each terminal in a VTAM table. This information is sent by VTAM in an extended CINIT RU. CICS captures it as part of autoinstall processing at logon, and uses it to create a TCTTE for the terminal.

Coding entries for MTS

You need to define model names (MDLTAB, MDLENT, and MDLPLU macros) and printer and associated printer names (ASLTAB, ASLENT, and ASLPLU macros) to VTAM.

The autoinstall control program for terminals, DFHZATDX

In addition to managing your resource definition, your autoinstall control program can perform any other processes that you want at this time. Its access to the command-level interface is that of a normal, nonterminal user task. Some possible uses are listed on page 498.

The control program is invoked when:

1. An autoinstall INSTALL request is being processed
2. An autoinstall DELETE request has just been completed
3. An autoinstall request has previously been accepted by the user program, but the subsequent INSTALL process has failed.

On each invocation of the autoinstall control program, a parameter list is passed (using a communication area), describing the function being performed (INSTALL or DELETE), and providing data relevant to the particular event. (In case 3 above, the control program is invoked as if for DELETE).

The INSTALL and DELETE events are now described in detail.

The autoinstall control program at INSTALL

If autoinstall is operative, the autoinstall control program is invoked at INSTALL for:

- Local VTAM terminals
- Local APPC single-session connections initiated by a CINIT
- Local APPC parallel-session connections initiated by a BIND
- Local APPC single-session connections initiated by a BIND
- Client virtual terminals
- Shipped terminals and connections.
- MVS consoles

On each invocation, CICS passes a parameter list to the control program by means of a communication area addressed by DFHEICAP. The parameter list passed at INSTALL of local APPC connections initiated by BIND requests is described in “The communication area at INSTALL for APPC connections” on page 516. The parameter list passed at INSTALL of shipped terminals and connections is

the autoinstall control program for terminals

described in “The communications area at INSTALL for shipped terminals” on page 526 . The parameter list passed at INSTALL of client virtual terminals is described in “The communications area at INSTALL for Client virtual terminals” on page 534. The parameter list passed at INSTALL of MVS consoles is described in “Chapter 11. Writing a program to control autoinstall of consoles” on page 505. This section describes only INSTALL of local terminals (including APPC single-session connections initiated by a CINIT).

The control program is invoked at INSTALL for terminals when both:

- A VTAM logon request has been received from a resource eligible for automatic installation whose NETNAME is not in the TCT.
- Autoinstall processing has been completed to a point where information (a terminal identifier and autoinstall model name) from the control program is required to proceed.

The communication area at INSTALL for terminals

The layout of the communication area is shown in Figure 28.

Fullword 1	Standard Header	
Byte 1	Function Code	(X'F0' for INSTALL)
Bytes 2 - 3	Component Code	Always 'ZC'
Byte 4	Reserved	Always X'00'
Fullword 2	Pointer to NETNAME_FIELD	
Fullword 3	Pointer to MODELNAME_LIST	
Fullword 4	Pointer to SELECTED_PARMS	
Fullword 5	Pointer to CINIT_RU	

Figure 28. Autoinstall control program's communication area at INSTALL

The parameter list contains the following information:

1. Standard Header. Byte 1 indicates the request type (this is character '0' for INSTALL).
2. Pointer to a 2-byte length field, followed by the NETNAME of the resource requesting LOGON.
3. Pointer to an array of names of eligible autoinstall models. The array is preceded by a 2-byte field describing the number of 8-byte name elements in the array. If there are no elements in the array, the number field is set to zero.
4. Pointer to the area of storage that you use to return information to CICS, and where the MTS information from the VTAM CINIT is stored.
5. Pointer to VTAM LOGON data (the CINIT request unit). The data is preceded by a 2-byte length field, indicating the length of the CINIT request unit, and includes the 3-character NS header. The format of the CINIT request unit is described in the *SNA Network Product Formats* manual.

CICS passes a list of eligible autoinstall models in the area addressed by fullword 3 of the parameter list.

If the model name is not supplied by MTS, the control program must select a model from this list that is suitable for the device logging on, and move the model name to the first 8 bytes of the area addressed by fullword 4 of the parameter list.

the autoinstall control program for terminals

For example, if a 3270 printer attempts to autoinstall, the subset of matching models includes all the types in VTAM category 2 that you have defined as models. This subset could include any of the following:

- DEVICE(3270) TERMMODEL(2)
- DEVICE(3270) TERMMODEL(1)
- DEVICE(3270P) TERMMODEL(2)
- DEVICE(3270P) TERMMODEL(1)
- DEVICE(3275) TERMMODEL(2)
- DEVICE(3275) TERMMODEL(1).

The control program selects one model from this list, and CICS uses this model to build the TCTTE for the device. The default autoinstall control program, DFHZATDX, always selects the first model name in the list.

If you are not using MTS but need a printer ID or NETNAME (or an alternative printer ID or NETNAME) associated with this terminal, then your control program can supply this in the area addressed by fullword 4.

If you are using MTS, CICS passes the control program the printer and alternative printer NETNAMEs specified on the VTAM ASLTAB macro.

Before returning to CICS, the control program must supply a CICS terminal name for the device logging on, and must set the return code field to X'00' if the autoinstall request is to be allowed.

Figure 29 on page 490 shows all of these fields in their required order.

the autoinstall control program for terminals

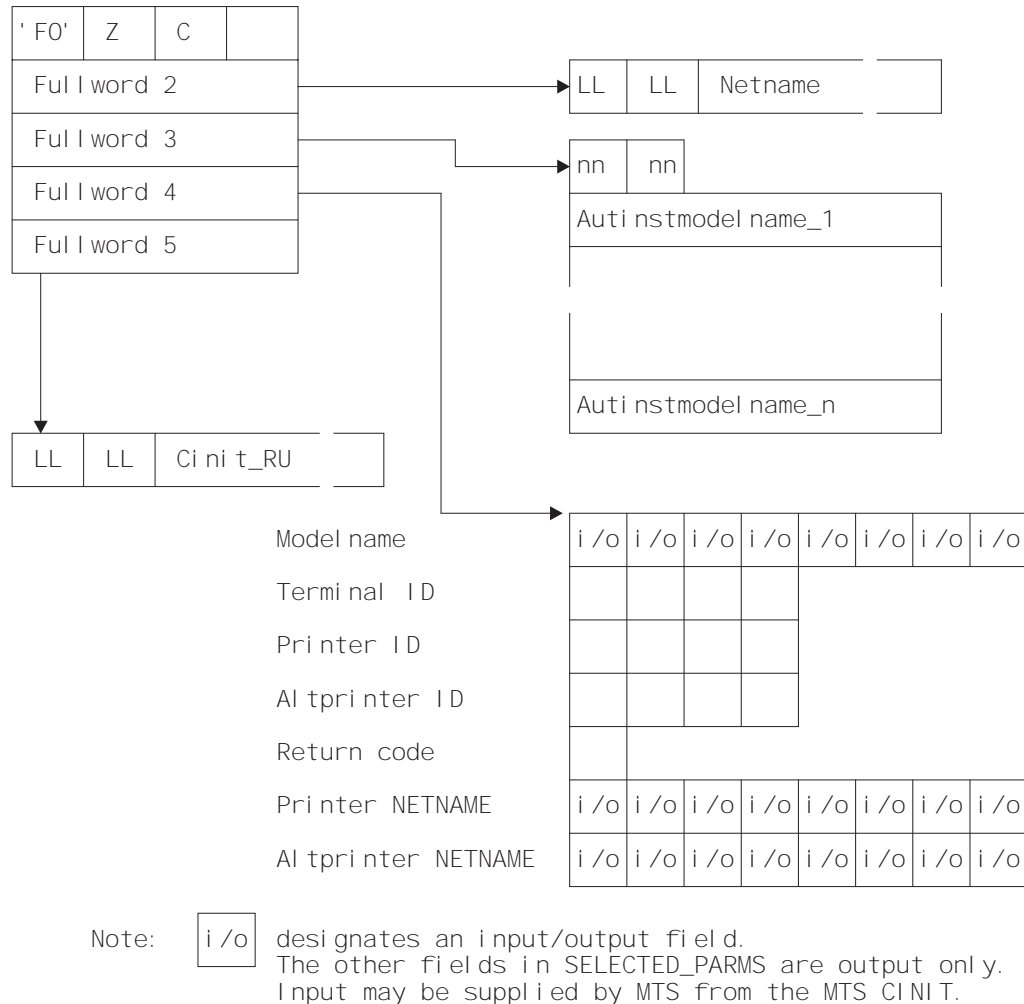

Figure 29. Autoinstall control program's parameter list at INSTALL

How CICS builds the list of autoinstall models

If CICS finds an MTS model name (and the model is defined to CICS and is compatible with the VTAM information describing the resource), CICS puts the model name into the model name list (Autinstmodelname_1), and also into the model name field (Modelname) in the selection list addressed by fullword 4 of the parameter list.

If CICS is unable to find an MTS model name in the MTS Control Vector, or the named model does not exist or is invalid, it builds the list of autoinstall models by selecting from the complete list of terminal models those models that are compatible with the VTAM information describing the resource. The complete list of autoinstall models available to CICS at any time comprises all the definitions with AUTINSTMODEL(YES) and AUTINSTMODEL(ONLY) that have been installed, both by the GRPLIST at a CICS initial or cold start, and by INSTALL GROUP commands issued by CEDA. The *CICS Resource Definition Guide* describes the definition of models.

Table 40 on page 768 gives you the information to work out which model types could be included in the subset of models passed to the autoinstall control program when a particular terminal attempts to install. The subset is determined by the

the autoinstall control program for terminals

VTAM characteristics of the device attempting to log on. The number in the right-hand column of the figure indicates the selection of the subset from the full list. When a terminal with a given combination of DEVICE, SESSIONTYPE, and TERMMODEL values attempts to logon, the subset of matching models passed to the control program includes all the models with DEVICE, SESSIONTYPE, and TERMMODEL values that have a corresponding VTAM category number in the right-hand column of the table.

If CICS finds no model that exactly matches the BIND, and if the return code in the area addressed by fullword 4 of the parameter list is nonzero, then CICS issues error message 'DFHZC6987'. This message contains a "best failure" model name, which is provided for diagnostic purposes only. It is described in detail in "CICS action on return from the control program" on page 494, and in the *CICS Messages and Codes*.

Returning information to CICS

At the INSTALL event, the autoinstall control program is responsible for allowing or denying the connection of a new terminal resource to the CICS system. This decision can be based on a number of installation-dependent factors, such as security, or the total number of connected terminals. CICS takes no part in any such checking. You decide whether any such checking takes place, and how it is done.

If the INSTALL request is to proceed, the control program **must** do the following:

- Return an autoinstall model name in the first 8 bytes of the area addressed by fullword 4 of the parameter list, unless this has already been set by MTS support.

If the control program returns a model name not in the subset passed to it by CICS, CICS cannot guarantee what will happen when further processing takes place. It is the user's responsibility to determine the effect of associating any particular logon request with a particular model name, because no interface is provided to the in-storage "model" objects.

- Supply a CICS terminal name (TERMID) in the next four bytes of the return area. DFHZATDX takes the last four nonblank characters of the NETNAME (addressed by fullword 2 of the parameter list) as the terminal name, so you must code your own autoinstall program if this does not match your installation's naming conventions. See "Setting the TERMINAL name" on page 493 for information on this.

Note that when processing an AUTOINSTALL request for an LU6.2 single session terminal the four byte terminal identifier returned by the user program is used to name a CONNECTION. It should therefore conform to the naming standards for a CONNECTION (rather than a TERMINAL) as defined in the *CICS Resource Definition Guide*. The user program could identify an LU6.2 AUTOINSTALL request in one of the following ways:

- Use a MODEL naming convention and examine the model name pointed to by fullword 3.
- Test bytes 14 and 15 of the CINIT BIND which is pointed to by fullword 5 for X'0602' (LU6.2).
- Set the return code to X'00'.

On entry to the autoinstall control program, the return code always has a nonzero value. If you do not change this, the autoinstall request is rejected.

If you are not using MTS, your control program can also supply or change any of the optional values, such as PRINTER and ALTPRINTER IDs or NETNAMEs,

the autoinstall control program for terminals

before returning to CICS. If you need information about the formats and acceptable character ranges for any of the return values, refer to the *CICS Resource Definition Guide*.

If you are using MTS, then VTAM supplies the PRINTER and ALTPRINTER NETNAMEs, if specified.

The printers need not be installed at this stage; however, they must be installed before you use Print Key support. PRINTER and ALTPRINTER IDs override PRINTER and ALTPRINTER NETNAMEs.

Note that TERMID, PRINTER, and ALTPRINTER are the only attributes of the TERMINAL definition that can be set by the autoinstall control program; all other attributes must come from one of these sources:

- The VTAM LOGMODE entry (MODEENT)
- The autoinstall model TERMINAL definition
- The TYPETERM definition that it refers to
- The QUERY function
- Model names from VTAM MDLTAB MDLENT and printers' NETNAMEs from VTAM ASLTAB ASLENT (if you are using MTS).

Notes:

1. The QUERY function overrides any extended attributes specified in the TYPETERM definition.
2. You cannot override information in the LOGMODE entry, with the model TERMINAL and TYPETERM; they must match.

If your control program decides to reject the INSTALL request, it should return to CICS with a nonzero value in the return code.

Having completed processing, the control program must return to CICS by issuing an EXEC CICS RETURN command.

Selecting the autoinstall model

If you are using model terminal support to supply the model name (and the named model exists and is valid), CICS passes the model name to your autoinstall control program—you do not need to make any further selection.

As a general rule, all the models in the list passed to your program match the VTAM data for the terminal. That is, a viable TCT entry usually results from the use of any of the models. (The exception to this rule involves the VTAM RUSIZE; if this value is incompatible, CICS issues an error message.) The default autoinstall control program merely picks the first model in the list. However, this model may not provide the attributes required in all cases. For instance, you do not want a 3270 display device definition for a 3270 printer. Your control program must be able to select the model that provides the characteristics you require for this terminal—for example, security characteristics.

To save on storage, you should try to minimize the number of different models available to the control program, and the number of different TYPETERM definitions referenced by those models. If you are migrating your definitions from DFHTCT macros, look carefully at them and eliminate those that are unnecessarily different from others. Use the QUERY function for all devices that can support it. For

the autoinstall control program for terminals

bisynchronous devices, which do not support QUERY, one approach is to make the definition as straightforward as possible, with no special features.

If you need special models for special cases, you can use a simple mapping of, for example, NETNAME (generic or specific) to AUTINSTNAME. Your control program could go through a table of special case NETNAMEs, choosing the specified model for each. The default model would be used for any terminal not in the table. (Note that the list of models presented to the control program is in alphabetical order with one exception which is described in the notes to Table 41 on page 770.)

Setting the TERMINAL name

The TERMINAL name must be unique, and one through four characters long. For a list of the acceptable characters, see the *CICS Resource Definition Guide*. (The TERMINAL name is the identifier CICS uses for the terminal. The NETNAME is the identifier VTAM uses for the terminal.)

You may have transactions that depend on the terminals from which they are initiated, or to which they will be attached, having particular TERMINAL names. Some transactions are restricted to particular terminals and others behave in different ways, depending on the terminal. In some cases, the transaction may gather statistics about terminal use, using the TERMINAL name as a reference. The TERMINAL name may have meaning to those managing, using, or maintaining the network: it may, for instance, denote geographical location or departmental function.

The NETNAME is really more suitable for these purposes than the TERMINAL name, because it is eight characters in length. If you can use the NETNAME, the TERMINAL name can be randomly assigned by the autoinstall control program, and it does not matter if a terminal has a different TERMINAL name every time the user logs on. The control program is required, in this case, only to make the TERMINAL name unique within the system in which the terminal is to be autoinstalled. If the control program attempts to install a TCT entry for a TERMINAL name that already has a TCT entry, the installation is rejected, despite the fact that the terminal is eligible and a suitable model has been found. (By contrast, if the NETNAME already has a TCT entry, the terminal uses it and autoinstall can never be invoked.)

The default autoinstall control program creates the TERMINAL name from the last four nonblank characters of the NETNAME. This may not satisfy the requirement for uniqueness. One way of overcoming this problem is to use the EXEC CICS INQUIRE command from the control program, to determine whether the TERMINAL name is already in use. If it is, modify the last character and check again.

However, you may be in a situation where you must continue to use unique and predictable TERMINAL names for your terminals. Your control program must be able to assign the right TERMINAL name to each terminal, every time the user logs on. Two possible approaches to this problem are:

- Devise another algorithm to generate predictable TERMINAL names from NETNAMEs
- Use a table or file to map TERMINAL names to NETNAMEs.

Devising an algorithm avoids the disadvantages of using a table or a file, but it might be difficult to ensure both uniqueness and predictability. If some of the information in the NETNAME is not needed by CICS, it can be omitted from the TERMINAL name. An algorithm is probably most appropriate in this situation.

the autoinstall control program for terminals

Using a table has two disadvantages, each of which loses you some of the benefits of autoinstall: it takes up storage and it must be maintained. You could create a table in main temporary storage, so that it is placed in extended storage, above the 16MB line. You could use a **VSAM file** rather than a table, to avoid the storage problem. However, this might be slower, because of the I/O associated with a file. The table or file can contain information such as PRINTER and ALTPRINTER, and you can add information such as AUTINSTNAME for devices that need particular autoinstall models. (See “Selecting the autoinstall model” on page 492.)

CICS action on return from the control program

When CICS receives control back from the autoinstall control program, it examines the return code field. If this is zero, and if the other required information supplied is satisfactory, CICS schedules the new resource for OPNDST in order to complete the logon request. If the installation process fails, then the control program is driven again, as though a DELETE had occurred. (See the section “The autoinstall control program at DELETE” on page 495 for details.) This is necessary to allow the program to free any allocations (for example, terminal identifiers) made on the assumption that this INSTALL request would succeed.

If the return code is not zero, then CICS rejects the connection request in the same way as it rejects an attempt by an unknown terminal to log on to CICS when autoinstall is not enabled.

For all autoinstall activity, messages are written to the transient data destination CADL. If an INSTALL fails, a message is sent to CADL, with a reason code. You can therefore check the output from CADL to find out why an autoinstall request failed.

If an autoinstall attempt fails for lack of an exact match, then details of the “best failure” match between a model and the BIND image are written to the CADL transient data destination.

The message takes the following form:

```
DFHZC6987 BEST FAILURE FOR NETNAME: nnnnnnnn,  
        WAS MODEL_NAME: mmmmmmmm,  
        CINIT BIND: cccccccc...,  
        MODEL BIND: bbbbbbbb...,  
        MISMATCH BITS: xxxxxxxx...
```

where

- ‘nnnnnnnn’ is the netname of the LU which failed to log on.
- ‘mmmmmmmm’ is the name of model that gave the best failure. (That is, the one that had the fewest bits different from the BIND image supplied by VTAM.)
- ‘ccccccc...’ is the CINIT BIND image.
- ‘bbbbbbb...’ is the model BIND image.
- ‘xxxxxxx...’ is a string of hexadecimal digits, where ‘xx’ represents one byte, and each byte position represents the corresponding byte position in the BIND image. A bit set to ‘1’ indicates a mismatch in that position between the BIND image from VTAM and the BIND image associated with the model.

the autoinstall control program for terminals

A suggested course of action is as follows:

1. Determine whether a model such as 'mmmmmmmm' is suitable. If there are several models that have identical BIND images, differing only in end-user options, then only the first such model is named in the above message. It will be up to your control program to make the choice, when the logmode table entry is corrected.
2. Identify the VTAM logmode table entry that is being used.
3. Check that this logmode table entry is not successfully in use with other applications, so that to change it might cause this other use of it to fail.
4. Amend the logmode table entry by switching the bits corresponding to 1-bits in the mismatch string. That is, if the bit in the VTAM BIND image corresponding to the bit position set to '1' in 'xxxxxxx...' above is '1', set it to '0'; if it is '0', set it to '1'.

More information about the meaning of the bits in a BIND image, and some more references, may be found in *ACF/VTAM Version 3 Programming*.

The autoinstall control program at DELETE

To provide symmetry of control over the autoinstall process, the autoinstall control program is also invoked when:

- A session with a previously automatically-installed resource has been ended
- An autoinstall request was accepted by the user program, but the subsequent INSTALL process failed for some reason.

To make it easier for you to write your control program, these two events can be considered to be identical. (There is no difference in the environment that exists, or in the actions that might need to be performed.)

Invoking the control program at DELETE enables you to reverse the processes carried out at the INSTALL event. For example, if the control program at INSTALL incremented a count of the total number of automatically installed resources, then the control program at DELETE would decrement that count.

The communication area at DELETE for terminals

Input to the program is via a communication area, addressed by DFHEICAP. The layout of the communication area is shown in Figure 30.

Fullword 1	Standard Header	
Byte 1	Function Code	(X'F1')
Bytes 2 - 3	Component Code	Always "ZC"
Byte 4	Reserved	Always X'00'
Fullword 2	Terminal ID of terminal to be deleted	
Fullword 3	NETNAME of terminal to be deleted	
Bytes 1-2	Delete netname length	
Bytes 3-4	Start of Delete netname ID	
Next 15 bytes	Remainder of Delete netname ID	

Figure 30. Autoinstall control program's communication area at DELETE. For terminals (including APPC single-session devices).

The parameter list contains the following information:

the autoinstall control program for terminals

1. Standard Header. Byte 1 indicates the request type. For deletion of local terminals (including APPC single-session devices installed via CINIT requests) the value is X'F1'.

Note: A value of X'F5' or X'F6' represents the deletion of a local APPC connection that was installed by a BIND request—see page 519. A value of X'FA' or X'FB' represents the deletion of a shipped terminal or connection—see page 528. A value of X'FC' represents the deletion of a client virtual terminal—see page 536.

2. The terminal identifier of the deleted resource, as shown in Table 24.

Table 24. Autoinstall control program's parameter list at DELETE

	1st byte	2nd byte	3rd byte	4th byte
First fullword	"F1"	"Z"	"C"	Reserved
Second fullword	ID of terminal to be deleted			
Third fullword	Length of netname to be deleted		First two bytes of netname	
Next 15 bytes	Remainder of netname			

Note that the named resource has been deleted by the time the control program is invoked, and is not therefore found by any TC LOCATE type functions.

Naming, testing, and debugging your autoinstall control program

Naming

The supplied, user-replaceable autoinstall control program for terminals and APPC single-session connections initiated by CINIT is named DFHZATDX. If you write your own version, you can name it differently.

After the system has been loaded, to find the name of the autoinstall control program currently identified to CICS, use either the EXEC CICS INQUIRE AUTOINSTALL command or the CEMT INQUIRE AUTOINSTALL command.

The default is DFHZATDX.

To change the current program:

- Use the AIXIT system initialization parameter. For guidance information about how to do this, refer to the *CICS System Definition Guide*.
- Make the change online using either the EXEC CICS SET AUTOINSTALL command or the CEMT SET AUTOINSTALL command. For further information about these commands, refer to the *CICS System Programming Reference* manual, and the *CICS Supplied Transactions* manual, respectively.

Testing and debugging

To help you test the operation of your autoinstall control program, you can run the program as a normal terminal-related application. Define your program and initiate it from a terminal. The parameter list passed to the program is described in “The autoinstall control program at INSTALL” on page 487. You can construct a dummy

naming and testing the control program

parameter list in your test program, upon which operations can be performed. Running your program on a terminal before you use it properly means that you can use the EDF transaction to help debug your program. You can also make the program interactive, sending and receiving data from the terminal.

If you find that CICS does not offer any autoinstall models to your program, you can create a test autoinstall program that forces the model name (AUTINSTNAME) you want. With a VTAM buffer trace running, try to log the device on to CICS. If CICS does not attempt to send a BIND, check the following:

- Does the model TERMINAL refer to the correct TYPETERM? (Or alternatively, is the TYPETERM in question referred to by the correct TERMINAL definition?)
- Is the TERMINAL definition AUTINSTMODEL(YES or ONLY)?
- Have you installed the group containing the autoinstall models (TERMINAL and TYPETERM definitions)?

If CICS attempts to BIND, compare the device's CINIT RU to the CICS BIND, and make corrections accordingly.

It is very important that you ensure that the VTAM LOGMODE table entries for your terminals are correct, rather than defining new autoinstall models to fit incorrectly coded entries. Bear in mind, while you are testing, that CICS autoinstall does not work if a LOGMODE entry is incorrectly coded.

Note that you cannot **force** device attributes by specifying them in the TYPETERM definition. For autoinstall, the attributes defined in the LOGMODE entry must **match** those defined in the model; otherwise the model will not be selected. You cannot define a terminal in one way to VTAM and in another way to CICS.

If your control program abends, CICS does not, by default, cause a transaction dump to be written. To cause a dump to be taken after an abend, your program must issue an EXEC CICS HANDLE ABEND command.

The sample programs and copy books

The CICS-supplied default autoinstall program is an assembler-language command-level program, named DFHZATDX. The source of the default program is provided in COBOL, PL/I, and C, as well as in assembler language. The names of the supplied programs and their associated copy books, and the CICSTS13.CICS libraries in which they can be found, are summarized in Table 25. Note that the COBOL, PL/I, and C copy books each have an alias of DFHTCUDS.

Table 25. Autoinstall programs and copy books

Language	Member name	Alias	Library
Programs:			
Assembler	DFHZATDX	None	SDFHSAMP
COBOL	DFHZCTDX	None	SDFHSAMP
PL/I	DFHZPTDX	None	SDFHSAMP
C/370	DFHZDTEX	None	SDFHSAMP

sample autoinstall programs

Table 25. Autoinstall programs and copy books (continued)

Language	Member name	Alias	Library
Copy books:			
Assembler	DFHTCUDS	None	SDFHMAC
COBOL	DFHTCUDO	DFHTCUDS	SDFHCOB
PL/I	DFHTCUDP	DFHTCUDS	SDFHPL1
C/370	DFHTCUDH	DFHTCUDS	SDFHC370

Note: If you use the COBOL version of the program, you must compile it using the VS COBOL II compiler.

The module generated from the assembler-language source program is part of the pregenerated library shipped in CICSTS13.CICS.SDFHLOAD. You can use it without modification, or you can customize it according to your own requirements. If you choose to alter the code in the sample program, take a copy of the sample and modify it. After modification, use the DFHEITAL procedure to translate, assemble, and link-edit your module. Then put the load module into a user library that is concatenated before CICSTS13.CICS.SDFHLOAD in the DFHRPL statement. (This method applies to completely new modules as well as modified sample modules.) For more guidance information about this procedure, refer to the *CICS System Definition Guide*. Do not overwrite the sample with your customized module, because subsequent service may overwrite your module. You must install a new resource definition for a customized user program.

The default action of the sample program, on INSTALL, is to select the first model in the list, and derive the terminal identifier from the last four nonblank characters of the NETNAME, set the status byte, and return to CICS. If there are no models in the list, it returns with no action.

The default action, on DELETE, is to address the passed parameter list, and return to CICS with no action.

You can customize the sample program to carry out any processing that suits your installation. Examples of customization are given in “Customizing the sample program” on page 499. Generally, your user program could:

- Count and limit the total number of logged-on terminals.
- Count and limit the number of automatically installed terminals.
- Keep utilization information about specific terminals.
- Map TERMINAL name and NETNAME.
- Do general logging.
- Handle special cases (for example, always allow specific terminals or users to log on).
- Send messages to the operator.
- Exercise network-wide control over autoinstall. A network-wide, global autoinstall control program can reside on one CICS system. When an autoinstall request is received by a control program on a remote CICS system, this global control program can be invoked and data transferred from one control program to another.

Customizing the sample program

Here are three pieces of code that customize the sample program.

Assembler language

Figure 31, in assembler language, limits logon to netnames L77A and L77B. The model names utilized are known in advance. A logon request from any other terminal, or a request for a model which cannot be found, is rejected.

```

* REGISTER CONVENTIONS =
* R0 used by DFHEICAL expansion
* R1 -----"-----"-----"-----"-----"-----
* R2 Base for Input parameters
* R3 Base for code addressability
* R4 Base for model name list
* R5 Base for output parameter list
* R6 Work register
* R7 -----"-----"-----"-----"-----
* R8 -----"-----"-----"-----"-----
* R9 free
* R10 Internal subroutine linkage return
* R11 Base for EIB
* R12 free
* R13 Base for dynamic storage
* R14 used by DFHEICAL expansion
* R15 -----"-----"-----"-----"-----
*
* SELECT MODEL
*
*          LH   R6, TABLEN           Number of valid netnames
*          LA   R7, TABLE           Address the table
*
* LOOP1   CLC   NETNAME(4), 0(R7)     Is this netname in table?
*         BE   VALIDT
*
*          LA   R7, 16(R7)           Next table entry
*          BCT  R6, LOOP1
*
*          Now we know its not a valid netname
*          simply return and the logon is rejected
*
*          B    RETURN
*

```

Figure 31. Example of how to customize the DFHZATDX sample program (Part 1 of 2)

sample autoinstall programs

```

*
VALIDT  CLI  SELECTED_MODELNAME,C' '      R7 now points to model name
        BNE  VALIDM1                      MTS model name supplied?
        LH   R6,MODELNAME_COUNT          Yes
        LTR  R6,R6                        Count of models
        BZ   RETURN                       Were any presented?
        LA   R8,MODELNAME                 No
                                           First model name
*
LOOP2   CLC  8(8,R7),0(R8)                Is this model name here?
        BE   VALIDM
*
        LA   R8,L'MODELNAME(R8)          Next model name
        BCT  R6,LOOP2
*
*
*      Now we know the required model name was not presented
*      to this exit by CICS, a return rejects the logon
*
        B    RETURN
*
*
*      At this point the model name was found in those presented
*      It is given to CICS and the new termid is
*      the netname
*
VALIDM  MVC  SELECTED_MODELNAME,0(R8)     R8 was left pointing at
*                                           model name
VALIDM1 DS   0H
        MVC  SELECTED_TERM_ID,NETNAME     Use netname for termid
*                                           (4 chars)
*
*
* SELECTIONS COMPLETE, RETURN
*
        MVI  SELECTED_RETURN_CODE,X'00'   Indicate all OK
        B    RETURN                       Exit program
*
*
*      Table of netnames allowed to log on and the model name
*      necessary for the logon to be successful
*
*      Format of table :
*      Bytes 1 to 8   Netname allowed to log on
*      Bytes 9 to 16  Model required for netname
*
        DS   0D
TABLE   DC   CL8'L77A',CL8'3270064'
        DC   CL8'L77B',CL8'3270065'
TABLEN DC   Y((*-TABLE)/16)
*

```

Figure 31. Example of how to customize the DFHZATDX sample program (Part 2 of 2)

COBOL

Figure 32 on page 501, in COBOL, redefines the NETNAME, so that the last four characters are used to select a more suitable model than that selected in the sample control program.

```

*
* Redefine the netname so that the last 4 characters (of 7)
* can be used to select the autoinstall model to be used.
*
* The netnames to be supplied are known to be of the form:
*
*       HVMXNNN
*
* HVM is the prefix
* X   is the system name
* NNN is the address of the terminal
*
01 NETNAME-BITS.
   02 FIRST-CHRS PIC X(3).
   02 NEXT-CHRS.
      03 NODE-LETTER PIC X(1).
      03 NODE-ADDRESS PIC X(3).
   02 LAST-CHR PIC X(1).
      .
      .
PROCEDURE DIVISION.
      .
      .
*
* Select the autoinstall model to be used according to the
* node letter (see above). The models to be used are user
* defined.
*
* (It is assumed that the netname supplied in the commarea by CICS
* has been moved to NETNAME-BITS).
*
* If the node letter is C then use model AUT02
* If the terminal netname is HVMC289 (a special case) then use
* model AUT01.
* Otherwise (node letters A,B,D...) use model AUT03.
*
   IF NODE-LETTER = 'C' THEN MOVE 'AUT02' TO SELECTED-MODELNAME.
   IF NEXT-CHRS = 'C289' THEN MOVE 'AUT01' TO SELECTED-MODELNAME.
   IF NODE-LETTER = 'A' THEN MOVE 'AUT03' TO SELECTED-MODELNAME.
   IF NODE-LETTER = 'B' THEN MOVE 'AUT03' TO SELECTED-MODELNAME.
   IF NODE-LETTER = 'D' THEN MOVE 'AUT03' TO SELECTED-MODELNAME.
      .
      .

```

Figure 32. Example of how to customize the DFHZCTDX sample program

PL/I

Figure 33 on page 502, in PL/I, extracts information from the VTAM CINIT RU, which carries the BIND image. Part of this information is the screen presentation services information, such as the default screen size and alternate screen size. The alternate screen size is used to determine the model of terminal that is requesting logon. The presented models are searched for a match, and if there is no match, the first model from those presented is used.

sample autoinstall programs

```
DCL 1 CINIT                BASED(INSTALL_CINIT_PTR),
  2 CINIT_LEN             FIXED BIN(15),
  2 CINIT_RU              CHAR(256);
DCL  SAVE_CINIT           CHAR(256);
                          /* Temp save area for CINIT RU */
DCL 1 SCRNSZ             BASED(ADDR(SAVE_CINIT)),
  2 SPARE                 CHAR(31),
                          /* Bypass first part of CINIT and reach */
                          /* into BIND image carried in CINIT */
  2 DHGT                 BIT(8),
                          /* Screen default height in BIND PS area */
  2 DWID                 BIT(8),
                          /* Screen default width in BIND PS area */
  2 AHGT                 BIT(8),
                          /* Screen alternate height in BIND PS area */
  2 AWID                 BIT(8);
                          /* Screen alternate width in BIND PS area */
DCL  NAME                CHAR(2);
                          /* Used to work up a screen model type */
DCL  TERMID              PIC'9999' INIT(1) STATIC;
                          /* Used to work up a unique termid */
DCL  ENQ                 CHAR(8) INIT('AUTOPRG');
                          /* Used to prevent multiple access to termid */
/* If model name supplied by MTS, bypass model name selection */
IF SELECTED_MODELNAME ^= ' '
  THEN GO TO MODEL_EXIT;
/* Clear the CINIT save area and move in the VTAM CINIT RU.*/
/* This is useful if you fail to recognize the model */
/* of terminal; provide a dump and analyze this data */
SAVE_CINIT = LOW(256);
SUBSTR(SAVE_CINIT,1,CINIT_LEN) = SUBSTR(CINIT_RU,1,CINIT_LEN);
```

Figure 33. Example of how to customize the DFHZPTDX sample program (Part 1 of 2)

```

/* Now access the screen PS area in the portion of the BIND
   image presented in the CINIT RU */
/* using the screen alternate height as a guide to the model
   of terminal attempting logon. If this cannot be determined
   then default to the first model in the table */
SELECT (AHGT);          /* NOW GET SCRN ALTERNATE HEIGHT */
WHEN (12) NAME = 'M1';  /* MODEL 1 */
WHEN (32) NAME = 'M3';  /*      3 */
WHEN (43) NAME = 'M4';  /*      4 */
WHEN (27) NAME = 'M5';  /*      5 */
OTHERWISE NAME = 'M2';  /*      2 */
END;
/* Search the model entries for a matching entry. */
/* The criterion here is that a model definition should */
/* contain the chars M2 for a model 2, and so on. */
/* For example, L3270M2, L3270M5 */
/*      TERMM2, TERMM5 */
IF MODELNAME_COUNT = 0
THEN GO TO EXIT;
DO I = 1 TO MODELNAME_COUNT;
  IF INDEX(MODELNAME(I),NAME)
  THEN GO TO FOUND_MODEL;
END;
NO_MODEL: /* Matching entry was not found, default to first model*/
SELECTED_MODELNAME = MODELNAME(1);
GO TO MODEL_EXIT;
FOUND_MODEL: /* Move the selected model name to the return area */
SELECTED_MODELNAME = MODELNAME(I);
MODEL_EXIT: /* ENQ to stop multiple updates of counter. */
/* A simple counter is used to generate unique */
/* terminal identities, so concurrent access to */
/* this counter is denied to ensure no two get */
/* the same identifier or update the counter. */

/* To use this method the program must be defined as resident.*/
EXEC CICS ENQ RESOURCE(ENQ);
SELECTED_TERMID = TERMID; /* Set SELECTED_TERMID to
                           count value */
TERMID = TERMID + 1; /* Increase the count value by 1 */
IF TERMID = 9999 THEN TERMID = 1; /* Reset if too large*/
EXEC CICS DEQ RESOURCE(ENQ);
NAME_EXIT:
INSTALL_RETURN_CODE = LOW(1);
/* Set stat field to X'00' to allow
   logon to be processed */
GO TO EXIT;
END INSTALL;

```

Figure 33. Example of how to customize the DFHZPTDX sample program (Part 2 of 2)

Chapter 11. Writing a program to control autoinstall of consoles

Considerations common to all user-replaceable programs

Note that the comments contained in “Chapter 5. General notes about user-replaceable programs” on page 401 apply to this chapter.

This chapter describes how to write a program to control the automatic installation of MVS console devices (including TSO consoles). For information about controlling the automatic installation of locally-attached VTAM terminals, see “Chapter 10. Writing a program to control autoinstall of terminals” on page 485.

The chapter is divided into the following sections:

1. “**Preliminary considerations**”.
2. “**The autoinstall control program at INSTALL**” on page 506
3. “**The autoinstall control program at DELETE**” on page 510
4. “**The sample programs and copy books**” on page 511

Preliminary considerations

The reasons for using autoinstall for MVS consoles are the same as those that apply to the autoinstall for VTAM devices: you don't have to define each device explicitly, and you save on storage (see “Preliminary considerations” on page 485).

Leaving it all to CICS

For consoles, in addition to the normal autoinstall support, you can also choose to let CICS autoinstall consoles without calling the autoinstall program. In this case, CICS uses either:

- A model console definition with an AUTINSTNAME (model name) that matches the MVS console name, or
- The first suitable console model it finds in alphanumeric sequence

If the autoinstall control program is not called, CICS generates a 4-character termid starting with the \neg (logical not) symbol.

If you want CICS to install your consoles automatically:

- Specify AICONS=AUTO (or issue a CEMT (or EXEC CICS) SET AUTOINSTALL CONSOLES(FULLAUTO) command).
- Create at least one model TERMINAL definition that references a TYPETERM definition specifying DEVICE(CONSOLE). You can use the IBM-supplied definition in group DFHTERM if it suits your needs.
- Install the model TERMINAL and TYPETERM definition.

the autoinstall control program for consoles

Using an autoinstall control program

If you choose to have your autoinstall control program invoked for consoles, follow these steps:

- Use the default autoinstall control program for terminals (DFHZATDX or DFHZATDY), or write your own program, using the source code of the default program and the customization examples in this chapter as a basis.

Notes:

1. If you use a VS COBOL II or later COBOL compiler to compile your autoinstall control program (or to compile the sample COBOL version, DFHZCTDX) run the program under Language Environment for MVS.
 2. You can have only one active autoinstall control program to handle terminals, consoles, and APPC connections. You specify the name of the active program on the AIXIT system initialization parameter.
 3. Your autoinstall program must be able to recognise the console INSTALL and DELETE parameter lists and return a model name, termid and return code.
- Enable the CICS AUTOINSTALL function for consoles. You can do this either by specifying AICONS=YES as a system initialization parameter, or by issuing a SET AUTOINSTALL CONSOLES(PROGAUTO) command.
 - Specify the AIXIT system initialization parameter to define your autoinstall control program to CICS.

If AICONS=YES is specified, or a CEMT (or EXEC CICS) SET AUTOINSTALL CONSOLES(PROGAUTO) has been issued, CICS invokes your autoinstall control program when:

- An autoinstall INSTALL request is being processed.
- An autoinstall request has previously been accepted by the autoinstall control program, but the subsequent INSTALL process has failed.
- The delay period since the console was last used has elapsed.

The autoinstall control program at INSTALL

If autoinstall is operative, you can specify that CICS is to invoke the autoinstall control program for MVS consoles, in addition to those devices listed on page 487. To enable CICS to invoke the autoinstall control program for consoles, specify AICONS=YES as a system initialization parameter, or issue a SET AUTOINSTALL CONSOLES(PROGAUTO) command.

On each invocation of the autoinstall control program, CICS passes a parameter list to the control program by means of a communication area addressed by DFHEICAP. This section describes only the install function of console definitions.

The control program is invoked at INSTALL for a console when:

- CICS has received a MODIFY command from an MVS console whose console name or console id is not defined in the TCT.
- CICS has completed autoinstall processing to a point where it needs a terminal identifier and autoinstall model name, from the autoinstall control program, in order to process the CICS transaction passed on the MVS modify command.

The communication area at INSTALL for consoles

The layout of the communication area is shown in Figure 34.

Fullword 1	Standard Header	
Byte 1	Function Code	(X'FD' for INSTALL)
Bytes 2 - 3	Component Code	Always 'ZC'
Byte 4	Reserved	Always X'00'
Fullword 2	Pointer to CONSOLENAME_FIELD	
Fullword 3	Pointer to MODELNAME_LIST	
Fullword 4	Pointer to SELECTED_PARMS	
Fullword 5	Reserved	

Figure 34. Autoinstall control program's communication area at INSTALL for consoles

The parameter list contains the following information:

1. A standard header. Byte 1 indicates the request type (this is hexadecimal character X'FD' for INSTALL), and bytes 2 to 3 contain the component code, which is always ZC for consoles. (Byte 4 is reserved.)
2. A pointer to a 2-byte length field, followed by the console name of the console which sent the message.
If no name exists this field contains a printable 3 character version of the console id instead.
3. A pointer to an array of names of eligible autoinstall models. The array is preceded by a 2-byte field containing the number of 8-byte name elements in the array. If there are no elements in the array, the number field is set to zero.
4. A pointer to the area of storage that you use to return information to CICS.

CICS passes a list of eligible autoinstall models in the area addressed by fullword 3 of the parameter list. From this list, the control program must select a model that is suitable for the console device, and move the model name to the first 8 bytes of the area addressed by fullword 4 of the parameter list. Before returning to CICS, the control program must supply a CICS 4-character terminal ID for the console being logged on, and set the return code field to X'00' if the autoinstall request is to be allowed. Your program can also set the delay period that is to follow the last use of a console before it is automatically deleted by CICS. On entry to your autoinstall control program, this value is set to a default value of 60 minutes. Override this by storing your own delay period, in minutes, as a fullword binary value. Setting this field to zero (0) means that CICS never deletes the console.

Figure 35 on page 508 shows all of these fields in their required order.

the autoinstall control program for consoles

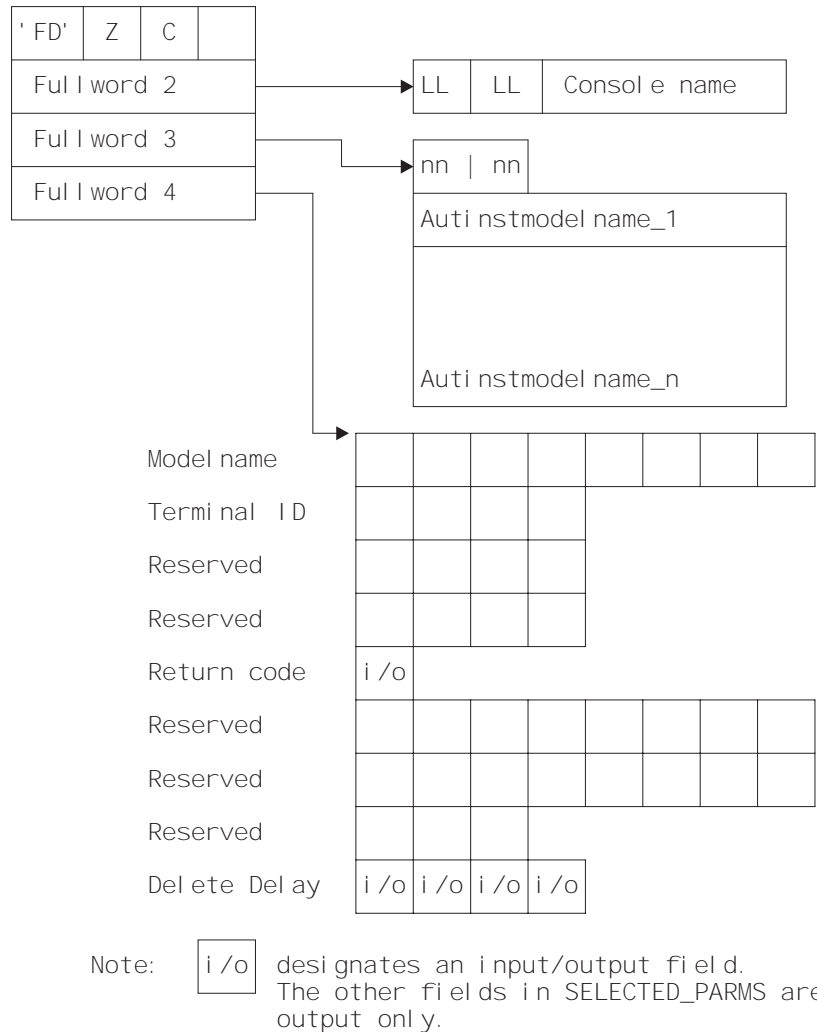

Figure 35. Autoinstall control program's parameter list at INSTALL

How CICS builds the list of autoinstall models

CICS builds the list of autoinstall models by selecting from its complete list of terminal models those models that define console devices. The complete list of autoinstall models available to CICS at any time comprises all the definitions with AUTINSTMODEL(YES) and AUTINSTMODEL(ONLY) that are installed, and which reference a TYPETERM definition that specifies DEVICE(CONSOLE). If CICS cannot find a model for consoles, it issues message DFHZC6902. If the return code in the area addressed by fullword 4 of the parameter list is nonzero, CICS issues error message DFHZC6987. You can obtain a list of autoinstall model definitions using the CEMT (or EXEC CICS) INQUIRE AUTINSTMODEL command.

Returning information to CICS

At the INSTALL event, the autoinstall control program is responsible for allowing or denying the installation of a new console resource in the CICS region. This decision can be based on a number of installation-dependent factors, such as security, or the total number of connected terminals. CICS takes no part in any such checking. You decide whether any such checking takes place, and how it is done.

the autoinstall control program for consoles

If you want an INSTALL request to proceed, perform these steps in your autoinstall control program:

- Return an autoinstall model name in the first 8 bytes of the area addressed by fullword 4 of the parameter list.
- Supply a CICS terminal name (TERMID) in the next four bytes of the return area. DFHZATDX and DFHZATDY take the last four non-blank characters of the console name (addressed by fullword 2 of the parameter list) as the terminal name. If this does not meet with your installation's naming conventions, code your own autoinstall program.
- Set the return code to X'00'. On entry to the autoinstall control program, the return code always has a nonzero value. If you do not change this, the autoinstall request is rejected.
- Set the delete delay period, or leave it set to the default value of 60 minutes.

Note that these are the only attributes of the TERMINAL definition that can be set by the autoinstall control program; all other attributes must come from one of the following sources:

- The MVS console interface block (CIB)
- The autoinstall model TERMINAL definition
- The TYPETERM definition to which it refers.

If your control program decides to reject the INSTALL request, it should return to CICS with a non-zero value in the return code. Having completed processing, the control program must return to CICS by issuing an EXEC CICS RETURN command.

Selecting the autoinstall model

All the models in the list passed to your program are for consoles. That is to say, a viable TCT entry usually results from the use of any one of them. The default autoinstall control program simply picks the first model in the list. However, this model may not provide the attributes required in all cases. Your control program must be able to select the model that provides the characteristics you require for the console—for example, one that has the required security characteristics.

Setting the TERMINAL name

The TERMINAL name must be unique, and be one- through four-characters long. The TERMINAL name is the identifier CICS uses for the console. The CONSNAME value is the identifier MVS uses for the console.

If the control program attempts to install a TCT entry for a TERMINAL name that already has a TCT entry, the installation is rejected, even if the terminal is eligible and a suitable model has been found. On the other hand, if a MODIFY command is received from an MVS console for which CICS already has an entry in the TCT with a matching CONSNAME, CICS uses that entry and does not invoke your autoinstall control program.

The default autoinstall control program creates the TERMINAL name from the last four non-blank characters of the CONSNAME. This may not satisfy the requirement for uniqueness. One way of overcoming this problem is to use the EXEC CICS INQUIRE command from the control program, to determine whether the TERMINAL name is already in use. If it is, modify the last character and check again.

the autoinstall control program for consoles

CICS action on return from the control program

When CICS receives control back from the autoinstall control program, it examines the return code field:

- If the return code is zero, and the other required information supplied is satisfactory, CICS schedules the transaction specified on the MODIFY command to complete the request. If the installation process fails, the autoinstall control program is driven again, as though a DELETE function is being processed.
- If the return code is not zero, CICS rejects the connection request in the same way that it rejects an attempt by an unknown console to send a modify request to CICS when autoinstall is not enabled.

For all autoinstall activity, messages are written to the transient data destination CADL. If an INSTALL fails, a message is sent to CADL, with a reason code. You can check the output from CADL to find out why an autoinstall request failed.

The autoinstall control program at DELETE

To provide symmetry of control over the autoinstall process, the autoinstall control program is also invoked when:

- A console autoinstall request was accepted by the user program, but the INSTALL process failed.
- The delete delay period has passed since the console was last used and CICS is running with AICONS=YES in effect. You can query this status of autoinstall for consoles by issuing a CEMT INQUIRE AUTOINSTALL command. If AICONS=YES is specified, CEMT INQUIRE AUTOINSTALL displays CONSOLES(PROGAUTO).

Input to the program is through a communication area, addressed by DFHEICAP. The layout of the communication area is shown in Figure 36.

Fullword 1	Standard Header	
Byte 1	Function Code	(X'FE')
Bytes 2 - 3	Component Code	Always 'ZC'
Byte 4	Reserved	Always X'00'
Fullword 2	Terminal ID of console being deleted	
Fullword 3	Consolename of console being deleted	
Bytes 1-2	Deleted consolename length	
Bytes 3-4	Start of deleted consolename ID	
Next 6 bytes	Remainder of deleted consolename ID	

Figure 36. Autoinstall control program's communication area at DELETE for consoles

The parameter list contains the following information:

1. A standard header, where byte 1 indicates the request type (this is hexadecimal character X'FE' for DELETE), and bytes 2 to 3 contain the component code, which is always ZC for consoles.
2. The second fullword contains the termid of the console that is being deleted.
3. The third fullword contains, in the first two bytes, the length of the deleted console name and, in the last two bytes, the first and second characters of the console name.
4. The last 6 bytes of the communications area contains the remainder of the console name (third to eighth characters).

The sample programs and copy books

IBM supplies a default autoinstall control program, written in each of the supported programming languages, all of which contain the necessary support for handling consoles. For details of these, see “The sample programs and copy books” on page 497.

Chapter 12. Writing a program to control autoinstall of APPC connections

Considerations common to all user-replaceable programs

Note that the comments contained in “Chapter 5. General notes about user-replaceable programs” on page 401 apply to this chapter.

This chapter describes how to write a program to control the automatic installation of local APPC connections. For information about controlling the automatic installation of local VTAM terminals, see “Chapter 10. Writing a program to control autoinstall of terminals” on page 485. For information about controlling the installation of shipped terminals and connections, see “Chapter 13. Writing a program to control autoinstall of shipped terminals” on page 523. For information about controlling the installation of virtual terminals used by the CICS Client products, see “Chapter 14. Writing a program to control autoinstall of Client virtual terminals” on page 531.

The chapter is divided into the following sections:

1. “**Preliminary considerations**”
2. “**The autoinstall control program at INSTALL**” on page 515
3. “**The autoinstall control program at DELETE**” on page 519
4. “**The sample autoinstall control program for APPC connections**” on page 520.

Note: In this chapter, “connection” and “session” are used as general terms when explaining autoinstall. The names “CONNECTION” and “SESSIONS” are used to indicate the CICS resource types used to create the definitions.

Preliminary considerations

In considering the autoinstall of local APPC connections, we need to distinguish between the following:

1. Local APPC single-session connections initiated by CINIT requests
2. Local APPC parallel- and single-session connections initiated by incoming bind requests. (By “incoming” we mean that the request is initiated by the partner system.)

Local APPC single-session connections initiated by CINIT

Autoinstall of local APPC single-session connections that are initiated by CINIT requests works in the same way as autoinstall for terminals. You must provide a TERMINAL—TYPETERM model pair, and a customized version of one of the supplied autoinstall control programs, DFHZATDX or DFHZATDY. See “Chapter 10. Writing a program to control autoinstall of terminals” on page 485.

the autoinstall control program for APPC connections

Local APPC parallel-session and single-session connections initiated by BIND

If autoinstall is enabled, and an incoming APPC BIND request is received for an APPC service manager (SNASVCMG) session (or for the only session of a single-session connection), and there is no matching CICS CONNECTION definition, a new connection is created and installed automatically.

Like autoinstall for other resources, autoinstall for APPC connections requires model definitions. However, unlike the model definitions used to autoinstall terminals, those used to autoinstall APPC links do not need to be defined explicitly as models. Instead, CICS can use any previously-installed connection definition as a “template” for a new definition. In order for autoinstall to work, you must have a template for each kind of connection you want to be autoinstalled.

Autoinstall templates for APPC connections

The purpose of a template is to provide CICS with a definition that can be used for all connections with the same properties. You customize the supplied autoinstall control program, DFHZATDY, to select an appropriate template for each new connection, depending on the information it receives from VTAM.

A template consists of a CONNECTION definition and its associated SESSIONS definitions. You should have a definition installed for each different set of session properties you are going to need.

Any installed connection definition can be used as a template, but for performance reasons, your template should be an installed connection definition that you do not actually use. The definition is locked while CICS is copying it, and if you have a very large number of sessions autoinstalling, the delay may be noticeable.

Benefits of autoinstall

Autoinstall support is likely to be beneficial if you have large numbers of APPC parallel session devices with identical characteristics. For example, if you had 1000 personal computers (PC)s, all with the same characteristics, you would set up one template to autoinstall all of them. If 500 of your PCs had one set of characteristics, and 500 had another set, you would set up two templates to autoinstall them.

Restart of any kind should be noticeably faster, especially when large numbers of terminals are involved.

Savings can also be made on systems management overheads, and on storage, as autoinstalled resources do not occupy space before they are used.

Requirements for autoinstall

Autoinstall of APPC connections works with any supported release of ACF/VTAM.

You can have only one active autoinstall control program for terminals and connections. You must specify the name of the active program on the AIEXIT system initialization parameter. As well as providing function to autoinstall APPC connections initiated by BIND requests, the sample program, DFHZATDY, provides the same function for terminal autoinstall as the default control program,

the autoinstall control program for APPC connections

DFHZATDX, described in “Chapter 10. Writing a program to control autoinstall of terminals” on page 485. Thus, you can use a customized version of DFHZATDY to autoinstall both terminals and APPC connections.

Note: Both DFHZATDX and DFHZATDY provide function to install shipped terminals and connections, and Client virtual terminals.

You may find the supplied version of DFHZATDY adequate for your purposes. If not, you can write a customized version of the supplied program, or create your own program to provide enhanced function.

The autoinstall control program for APPC connections

The purpose of the autoinstall control program is to provide CICS with any extra information it needs to complete an autoinstall request. For APPC connections, the control program selects the template to be used, and provides a name for the new connection.

If autoinstall is enabled, when CICS receives an APPC BIND request for an SNASVCMG session (or for the only session of a single-session connection), if there is no matching CONNECTION definition, CICS passes the partner's VTAM NETNAME to the autoinstall control program. The control program uses information from the BIND, which is passed in the communications area, to select the most appropriate template on which to base a new connection.

The control program needs to know the NETNAME or SYSID of all the templates, in order to return the name of the most suitable one. If it attempts to use an unsuitable template, message DFHZC6922 is issued, explaining why the template is unusable.

If the template is usable, CICS makes a copy of the definitions within it and attempts to install the new CONNECTION definition. If the installation is not successful, message DFHZC6903 is issued.

Recovery and restart

Autoinstalled connections are not cataloged by CICS, so they are not recovered at an emergency restart or a warm restart.

The autoinstall control program at INSTALL

The autoinstall control program is invoked at INSTALL for:

- Local VTAM terminals
- Local APPC single-session connections initiated by a CINIT
- Local APPC parallel-session connections initiated by a BIND
- Local APPC single-session connections initiated by a BIND
- Shipped terminals and connections
- Client virtual terminals.

On each invocation, CICS passes a parameter list to the control program by means of a communication area addressed by DFHEICAP. The parameter list passed at INSTALL of local terminals and APPC single-session connections initiated by CINIT is described in “The communication area at INSTALL for terminals” on page 488. The parameter list passed at INSTALL of shipped terminals and connections is

autoinstall control program at INSTALL

described in “The communications area at INSTALL for shipped terminals” on page 526 . The parameter list passed at INSTALL of Client virtual terminals is described in “The communications area at INSTALL for Client virtual terminals” on page 534. This section describes only INSTALL of local APPC connections initiated by BIND requests.

The communication area at INSTALL for APPC connections

The communications area is mapped by the DSECT for the assembler version of DFHZATDY, which is supplied in CICSTS13.CICS.SDFHMAC.

```

*-----*
* APPC Install parameter list - Functions 2, 3, and 4 *
*-----*
INSTALL_APPC_COMMAREA      DSECT      Install Parameter List
*
INSTALL_APPC_STANDARD      DS  F        Standard field
                                ORG INSTALL_APPC_STANDARD
INSTALL_APPC_EXIT_FUNCTION DS  XL1      Install request type
INSTALL_APPC_PS_CINIT      EQU X'F2'  Install PS via CINIT
INSTALL_APPC_PS_BIND      EQU X'F3'  Install PS via BIND
INSTALL_APPC_SS_BIND      EQU X'F4'  Install SS via BIND
INSTALL_APPC_EXIT_COMPONENT DS  CL2      Component ID 'ZC'
                                DS  XL1      Reserved
*
                                ORG ,
INSTALL_APPC_NETNAME_PTR   DS  A        -> NETNAME      Input
INSTALL_APPC_CINIT_PTR    DS  0A       -> CINIT_RU     Input
INSTALL_APPC_BIND_PTR     DS  A        -> BIND        Input
INSTALL_APPC_SELECTED_PTR DS  A        -> Return fields Output
INSTALL_APPC_SYNCLEVEL_PTR DS  A        -> Sync level   Input
*
INSTALL_APPC_TEMPLATE_NETNAME_PTR DS  A -> Template NETNAME I/O
INSTALL_APPC_TEMPLATE_SYSID_PTR DS  A -> Template SYSID Output
INSTALL_APPC_SYSID_PTR    DS  A        -> New SYSID    Output
INSTALL_APPC_NETNAME2_PTR DS  A        -> Generic or   Input
                                member NETNAME
*
INSTALL_APPC_NETID_PTR    DS  A        -> Network ID of Input
                                incoming bind
*
INSTALL_APPC_TYPE_PTR     DS  A        -> Generic     Input
                                resource type

*
TEMPLATE_NETNAME         DS  CL8      Put netname of template here
TEMPLATE_SYSID           DS  CL4      Put sysid of template here
SYSID                    DS  CL4      Put name of new connection here
SYNCLEVEL                DS  XL2      Synclevel of new connection
APPC_NETID               DS  CL8      NETID of incoming bind
APPC_GR_TYPE             DS  CL1      G = NETNAME is generic resource name
                                M = NETNAME is member name
                                blank = This CICS is not a generic
                                resource or the partner is not a
                                generic resource.

APPC_NETNAME2_FIELD      DSECT
APPC_NETNAME2_LENGTH     DS  XL2      Length of NETNAME
APPC_NETNAME2            DS  0X      Generic or member NETNAME

```

Figure 37. Autoinstall control program's communications area at INSTALL. For APPC connections initiated by BIND requests.

INSTALL_APPC_STANDARD header

A fullword input field comprising the following information:

autoinstall control program at INSTALL

INSTALL_APPC_EXIT_FUNCTION

A 1-byte field that defines the install request type. The equated values are:

INSTALL_APPC_PS_CINIT

X'F2' represents an install request for an APPC parallel-session connection from a secondary node via a CINIT request.

Note: These requests cannot be received by CICS Transaction Server for OS/390 Release 3.

INSTALL_APPC_PS_BIND

X'F3' represents an install request for an APPC parallel-session connection via a BIND.

INSTALL_APPC_SS_BIND

X'F4' represents an install request for an APPC single-session connection via a BIND.

Note: The values X'F0' and X'F1' represent, respectively, install and delete requests for terminals (including APPC single-session devices). See "Chapter 10. Writing a program to control autoinstall of terminals" on page 485.

INSTALL_APPC_EXIT_COMPONENT

A 2-byte component code, which is set to 'ZC'.

INSTALL_APPC_NETNAME_PTR

A fullword pointer to a 2-byte length field, followed by the NETNAME to be installed (input field).

For connections to CICS TORs where the partner is a generic resource, NETNAME can be the partner's generic resource name, or its member name, depending on the setting of APPC_GR_TYPE. (For introductory information about generic resources, see the *CICS Intercommunication Guide*.)

INSTALL_APPC_CINIT_PTR

A fullword pointer to an input field containing the incoming CINIT, if the incoming session is a secondary.

Note: Not applicable to CICS Transaction Server for OS/390 Release 3.

INSTALL_APPC_BIND_PTR

A fullword pointer to an input field containing the incoming BIND.

INSTALL_APPC_SELECTED_PTR

A fullword pointer to the return fields. These are in the same format as those for autoinstall of terminals.

Note that for APPC autoinstall (functions X'F3' and X'F4') only the return code is used. You return other information for APPC in other fields defined in the communications area.

INSTALL_APPC_SYNCLEVEL_PTR

A fullword pointer to a 2-byte input field specifying the syncpoint level for the connection, which is extracted from the BIND. The possible values are:

X'0000'

Synclevel 0

autoinstall control program at INSTALL

X'0001'

Synclevel 1

X'0002'

Synclevel 2.

INSTALL_APPC_TEMPLATE_NETNAME_PTR

A fullword pointer to an 8-byte input/output area (TEMPLATE_NETNAME). On invocation, TEMPLATE_NETNAME normally contains blanks. However, if both the partner and the local CICS are registered as generic resources, it contains the NETNAME of the generic resource name connection, if one is present. (Generic resource name connections are described in the *CICS Intercommunication Guide*.)

Your control program can use the TEMPLATE_NETNAME field to specify the NETNAME of the template. For connections between generic resources, your program can accept the suggested template passed by CICS, or specify a different one—either in this field or by overwriting the suggested template with blanks and putting a value in the TEMPLATE_SYSID field.

If the specified name is less than 8 bytes, it must be padded with trailing blanks. If, as an alternative to specifying the NETNAME of the template, your program specifies its CONNECTION name in TEMPLATE_SYSID, it should fill TEMPLATE_NETNAME with blanks.

INSTALL_APPC_TEMPLATE_SYSID_PTR

A fullword pointer to a 4-byte output area (TEMPLATE_SYSID) that your control program can use to specify the SYSID (connection name) of the template. If the name is less than 4 bytes, it must be padded with trailing blanks. If, as an alternative to specifying the SYSID of the template, your program specifies its NETNAME in TEMPLATE_NETNAME, it should fill TEMPLATE_SYSID with zeros.

INSTALL_APPC_SYSID_PTR

A fullword pointer to a 4-byte output area in which your program must put the SYSID for the new autoinstalled connection. The name you supply must be unique. You can use the same or similar logic to create it that you use for creating a terminal ID. If the name is less than 4 bytes, it must be padded with trailing blanks.

If you are using recoverable resources, the SYSID chosen for a connection after a restart must be the same as that chosen in the previous CICS run.

INSTALL_APPC_NETNAME2_PTR

A fullword pointer to a 2-byte length field, followed by an 8-byte input field (APPC_NETNAME2).

If both the partner and the local CICS are generic resources, APPC_NETNAME2 is the partner's generic resource name or member name, depending on the setting of APPC_GR_TYPE.

If the partner is not a generic resource, APPC_NETNAME2 contains the same value as NETNAME.

If the local CICS is not a generic resource, the value of APPC_NETNAME2 is meaningless.

INSTALL_APPC_NETID_PTR

A fullword pointer to an 8-byte input field containing the Network ID of the

autoinstall control program at INSTALL

partner. This field is set whenever the local CICS is registered as a generic resource. At all other times it has a value of 0.

INSTALL_APPC_GR_TYPE_PTR

A fullword pointer to a 1-byte input field indicating whether this is a connection between generic resources and, if so, whether the NETNAME passed on the BIND is the partner's generic resource name or its member name. The equated values are:

- G** NETNAME is the partner's generic resource name and APPC_NETNAME2 is its member name (applid).
- M** NETNAME is the partner's member name (applid) and APPC_NETNAME2 is its generic resource name.
- Blank** This CICS is not registered as a generic resource or the partner is not registered.

The autoinstall control program at DELETE

To provide symmetry of control over the autoinstall process, the autoinstall control program is also invoked when an autoinstalled APPC connection is deleted.

Invoking the control program at DELETE enables you to reverse the processes carried out at the INSTALL event. For example, if the control program at INSTALL incremented a count of the total number of automatically installed resources, then the control program at DELETE would decrement that count.

Input to the program is by a communication area, addressed by DFHEICAP. The layout of the communication area is shown in Figure 38.

Fullword 1	Standard Header
Byte 1	Function Code (X'F5' or X'F6')
Bytes 2 - 3	Component Code Always "ZC"
Byte 4	Reserved Always X'00'
Fullword 2	SYSID of deleted connection
Fullword 3	NETNAME of deleted connection
Bytes 1-2	NETNAME length
Bytes 3-10	NETNAME

Figure 38. Autoinstall control program's communication area at DELETE. For APPC connections initiated by BIND requests.

The Function Code byte (byte 1 of fullword 1) indicates why the user program has been invoked:

- X'F5'** After deletion of a parallel-session APPC connection that was initiated by a BIND.
- X'F6'** After deletion of a single-session APPC connection that was initiated by a BIND.

Note: The value X'F1' represents the deletion of a local terminal, or an APPC single-session device that was autoinstalled via a CINIT request—see page 495. The value X'FA' or X'FB' represents the deletion of a shipped terminal or connection—see page 528. The value X'FC' represents the deletion of a Client virtual terminal—see page 536.

autoinstall control program at DELETE

When autoinstalled APPC connections are deleted

Any autoinstalled APPC connection entry is deleted if the connection is discarded (using the CEMT DISCARD command). In addition, connection entries can be deleted when the terminal or system logs off, or is disconnected from CICS. This kind of “implicit deletion” occurs for the following types of APPC autoinstalled connection:

Single-session connections installed via a CINIT

These are deleted when the terminal user logs off, after the expiry of the AILDELAY system initialization value.

Synclevel 1 connections installed via a BIND

Synclevel 1-only APPC connections autoinstalled via a BIND request (*except* for limited resource connections installed on a CICS generic resource member—see next section) are implicitly deleted at the following times:

- When the connection is released
- If VTAM abends
- When the VTAM ACB is closed by CICS
- After the expiry of the AIRDELAY interval following a warm or emergency start (if the value of the AIRDELAY system initialization parameter is greater than zero).

Synclevel 2 connections installed via a BIND

Synclevel 2-capable APPC connections installed by a BIND request are implicitly deleted *only* if they are installed on a CICS generic resource member, and an affinity is ended. Otherwise, they are never implicitly deleted.

The same applies to synclevel 1-only, limited resource connections that are installed on a CICS generic resource member.

The sample autoinstall control program for APPC connections

The sample control program for autoinstall of APPC connections is DFHZATDY. The source code, in assembler-language only, is in library CICSTS13.CICS.SDFHSAMP.

As well as providing function to autoinstall APPC connections initiated by BIND requests, DFHZATDY provides the same function for terminal autoinstall as the DFHZATDX program described in “Chapter 10. Writing a program to control autoinstall of terminals” on page 485. Thus, you can use a customized version of DFHZATDY to autoinstall both terminals and APPC connections.

Default actions of the sample program

The role of DFHZATDY in installing APPC connections is to choose the template to be used (by supplying its NETNAME or SYSID), and to supply the name (SYSID) of the new connection.

The actions taken by the supplied version of the program are to:

1. Examine the request type passed in the `INSTALL_APPC_EXIT_FUNCTION` field:
 - X'F0'** An incoming CINIT for a terminal or APPC single-session device. Proceed as for DFHZATDX. See “Chapter 10. Writing a program to control autoinstall of terminals” on page 485.
 - X'F1'** A delete request for a terminal or APPC single-session device. Proceed as for DFHZATDX. See “Chapter 10. Writing a program to control autoinstall of terminals” on page 485.
 - INSTALL_APPC_PS_CINIT (X'F2')**

An incoming CINIT for an APPC parallel-session connection. Specify a template by setting the field pointed to by `INSTALL_APPC_TEMPLATE_SYSID` to 'CCPS'.

Note: This type of request cannot be received by CICS Transaction Server for OS/390 Release 3.
 - INSTALL_APPC_PS_BIND (X'F3')**

An incoming BIND for an APPC parallel-session connection. Specify a template. This is done in one of two ways:

 - For connections between two generic resources, by accepting the suggested template (the generic resource name connection) whose `NETNAME` is passed in `TEMPLATE_NETNAME`. If there is no generic resource name connection, set `TEMPLATE_SYSID` to 'CBPS'.
 - In all other cases, by setting `TEMPLATE_SYSID` to 'CBPS'.
 - INSTALL_APPC_SS_BIND (X'F4')**

An incoming BIND for an APPC single-session connection. Specify a template by setting the field pointed to by `INSTALL_APPC_TEMPLATE_SYSID` to 'CBSS'.
 - X'F5'** A delete request for an APPC parallel-session connection installed by a BIND. Establish addressability to the `COMMAREA` and return.
 - X'F6'** A delete request for an APPC single-session connection installed by a BIND. Establish addressability to the `COMMAREA` and return.
2. Specify a name for the new connection by copying the last 4 non-blank characters of the input `NETNAME` pointed to by `INSTALL_APPC_NETNAME_PTR` to the field pointed to by `INSTALL_APPC_SYSID_PTR`.
 3. Indicate that a selection has been made by setting the return code to `RETURN_OK`.

Resource definitions

CICS supplies a resource definition group called DFHAI62, which defines DFHZATDY, and contains CONNECTION definitions for CCPS, CBPS, and CBSS. If you want to use the supplied version of DFHZATDY, you should append DFHAI62 to your CICS startup grouplist. However, if you customize DFHZATDY you will probably need to create your own definitions.

sample autoinstall programs

DFHZATDY is defined as follows in DFHAI62:

```
DEFINE PROGRAM(DFHZATDY)
DESCRIPTION(Assembler definition for sessions autoinstall control program)
GROUP(DFHAI62)
LANGUAGE(ASSEMBLER) RELOAD(NO) RESIDENT(NO)
USAGE(NORMAL) STATUS(ENABLED) CEDF(NO)
DATALOCATION(ANY) EXECKEY(CICS) EXECUTIONSET(FULLAPI)
```

Chapter 13. Writing a program to control autoinstall of shipped terminals

Considerations common to all user-replaceable programs

Note that the comments contained in “Chapter 5. General notes about user-replaceable programs” on page 401 apply to this chapter.

This chapter describes how to write a program to control the installation of shipped terminals and connections. Both the supplied autoinstall control programs, DFHZATDX and DFHZATDY, provide function to install shipped definitions of remote terminals and connections. You can therefore base your customized control program on either DFHZATDX or DFHZATDY.

Just as you can use an autoinstall user program in a terminal-owning region (TOR) to control the automatic installation of *local* terminals and connections, so you can use a similar program in an application-owning region (AOR) to control the installation of shipped terminals and connections. (Bear in mind when reading this chapter that it assumes that your user program is installed in an AOR—or in a combined AOR/TOR—rather than in a TOR.)

The chapter is divided into the following sections:

1. “**Installing shipped terminals and connections**”
2. “**The autoinstall control program at INSTALL**” on page 525
3. “**The autoinstall control program at DELETE**” on page 528
4. “**Default actions of the sample programs**” on page 529.

Installing shipped terminals and connections

In releases of CICS before 4.1, the terminal identifiers (TERMIDs) of shippable terminals had to be unique in the transaction routing network. That is, you could not ship a terminal definition to an AOR on which a remote terminal of the same name was already installed. From CICS/ESA 4.1 onwards, this restriction does not apply. Because your autoinstall control program is invoked for shipped terminals and connections, you can use it to reset the TERMINAL (or CONNECTION) attribute of a shipped definition to an **alias**, thereby avoiding conflicts with names of remote terminals and connections already installed in the AOR. There is no need to reset the REMOTENAME attribute, which remains set to the name by which the terminal is known in the TOR; and autoinstall model names are not applicable to shipped definitions.

Note: If the name of a shipped definition clashes with the name of a *local* terminal or connection installed in the AOR, the install is rejected, and the autoinstall control program is not invoked.

For more information about using aliases on remote definitions, see the *CICS Intercommunication Guide*.

Note: The autoinstall control program is invoked for all shipped terminals and connections, including shipped definitions of the virtual terminals used by CICS Clients.

the autoinstall control program for shipped terminals

CICS-generated aliases

The autoinstall control program is invoked once for each shipped terminal or connection definition to be installed.

If CICS detects that the name on a shipped definition clashes with the name of a remote terminal or connection already installed in the AOR, it generates an alias TERMID and passes it to the control program in field `SELECTED_SHIPPED_TERMID` of the communications area.

If CICS detects that there is no clash of names, it passes in `SELECTED_SHIPPED_TERMID` the name by which the terminal or connection is known in the TOR—that is, the value of the `TERMINAL` or `CONNECTION` attribute on the shipped definition.

Your control program can accept the passed TERMID, change it, or reject the installation of the shipped definition.

CICS-generated aliases consist of a 1-character prefix and a 3-character suffix. The prefix is always '{'. The suffix can have the values 'AAA' through '999'. That is, each character in the suffix can have the value 'A' through 'Z' or '0' through '9'. The first suffix generated by CICS has the value 'AAA'. This is followed by 'AAB', 'AAC', ... 'AAZ', 'AA0', 'AA1', and so on, up to '999'.

Each time that it needs to create an alias, CICS generates a 3-character suffix that it has not recorded as being in use. If your autoinstall control program overrides a CICS-generated TERMID, CICS does not record the suffix as being in use, and supplies the same suffix for the next alias.

Resetting the terminal identifier

You need to think about the algorithm by which your control program allocates alias TERMIDs.

You must consider the consequences of a definition being deleted by the CICS timeout delete mechanism, and subsequently being re-shipped and re-installed. You must decide whether your autoinstall program should allocate the *same* TERMID as before (which implies a file mapping the name by which the terminal is known in the TOR to the alias allocated by the AOR), or whether allocation of a different TERMID is acceptable—in which case you could use the default aliases generated by CICS. This decision may depend on several factors. For example:

- How your application programs allocate temporary storage queue names. If they derive them from the TERMID (so as to associate the queue with a particular end-user), problems of data mismatch could occur if the queue is not emptied by transaction end (possibly due to a failure), and TERMIDs are not allocated to the same terminals consistently.

The best solution is for your application programs always to check before creating a temporary storage queue whether a queue of the same name already exists, and, if so, to delete it. This dispenses with the need for your autoinstall program to allocate TERMIDs consistently.

However, if your application programs do not already implement this check, it may not be possible to correct them all. In this case, your autoinstall program may need to use a mapping file, as described above.

the autoinstall control program for shipped terminals

- Whether your application programs record TERMIDs for later use. For example, an application might issue an EXEC CICS START TERMIID command, with a time interval after which the transaction is to be initiated against the named terminal. If, during the delay interval, the terminal definition is deleted, re-shipped, and re-installed with a different local TERMIID, the started transaction could fail because the TERMIID no longer exists.

If your application programs record TERMIDs in this way, your autoinstall program may need to use a mapping file.

Example

Assume that you have two terminal-owning regions, TORA and TORB, and that they use the same set of terminal identifiers, T001 through T500. TORA and TORB route transactions to the same application-owning region, AOR1. To prevent naming conflicts when terminals are shipped to AOR1, your control program in AOR1 could:

- Accept the TERMIDs allocated by TORA. That is, leave the TERMINAL attribute of the remote definition set to the same as the REMOTENAME attribute.
- Create aliases for the TERMIDs allocated by TORB. That is, reset the TERMINAL attribute of the remote definition, using a mapping file as described above. For example, TERMIDs of T001 through T500 could be mapped to aliases of A001 through A500.

This solution allows two TORs using the same set of TERMIDs to access the same AOR. However, even though the aliases created in the AOR are mapped consistently to TERMIDs in the TOR, the solution does not *guarantee* that data mismatch problems cannot occur if terminals are re-shipped. This is because it relies on TERMIDs being allocated consistently *in the TOR*—that is, on specific TERMIDs always being assigned to the same physical devices.

Note: Your control program could use the correlation identifier contained in each terminal and connection definition to check whether a definition has been re-installed in the TOR—see the description of the `INSTALL_SHIPPED_CORRID_PTR` parameter on page 528.

A better solution might be to map the terminal alias in the AOR to the **netname** of the terminal. This would at least guarantee that a specific alias always relates to the same physical device. But it would still require TERMIDs for which aliases are *not* created to be consistently allocated in the TOR.

The autoinstall control program at INSTALL

The autoinstall control program is invoked at INSTALL for:

- Local VTAM terminals
- Local APPC single-session connections initiated by a CINIT
- Local APPC parallel-session connections initiated by a BIND
- Local APPC single-session connections initiated by a BIND
- Client virtual terminals
- Remote shipped terminals and connections, including shipped definitions of Client virtual terminals.

On each invocation, CICS passes a parameter list to the control program by means of a communication area addressed by DFHEICAP. The parameter list passed at

the autoinstall control program for shipped terminals

INSTALL of local terminals and APPC single-session connections initiated by CINIT is described in "The communication area at INSTALL for terminals" on page 488. The parameter list passed at INSTALL of local APPC connections initiated by BIND requests is described in "The communication area at INSTALL for APPC connections" on page 516. The parameter list passed at INSTALL of Client virtual terminals is described in "The communications area at INSTALL for Client virtual terminals" on page 534. This section describes only INSTALL of shipped terminals and connections.

The communications area at INSTALL for shipped terminals

The communications area is mapped by the DSECT for the assembler version of DFHZATDX, which is supplied in CICSTS13.CICS.SDFHMAC.

```
*-----*
* Remote install parameter list - Shipped definition functions 7 & 8 *
*-----*
INSTALL_SHIPPED_COMMAREA      DSECT      Install Parameter List
*
INSTALL_SHIPPED_STANDARD     DS  F      Standard field
                                ORG INSTALL_SHIPPED_STANDARD
INSTALL_SHIPPED_EXIT_FUNCTION DS  XL1     Install type
INSTALL_SHIPPED_TERM         EQU X'F7'   Install terminal
INSTALL_SHIPPED_RSE          EQU X'F8'   Install remote system entry
INSTALL_SHIPPED_EXIT_COMPONENT DS  CL2     Component ID 'ZC'
INSTALL_SHIPPED_CLASH        DS  CL1     Install clash Y/N
                                ORG ,
INSTALL_SHIPPED_NETNAME_PTR   DS  A      Pointer to netname
INSTALL_SHIPPED_SELECTED_PTR  DS  A      Pointer to return fields
INSTALL_SHIPPED_TERMID_PTR    DS  A      Pointer to incoming TERMID
INSTALL_SHIPPED_APPLID_PTR    DS  A      Pointer to applid of TOR
INSTALL_SHIPPED_SYSID_PTR     DS  A      Pointer to sysid
INSTALL_SHIPPED_CORRID_PTR    DS  A      Pointer to correlation ID
INSTALL_SHIPPED_SELECTED_PARMS DSECT ,
                                DS  CL8     Reserved
SELECTED_SHIPPED_TERMID      DS  CL4     Selected TERMID
SELECTED_SHIPPED_RETURN_CODE DS  CL1     Selected return code
RETURN_OK                    EQU X'00'   Accept request
REJECT                       EQU X'01'   Reject request
*
```

Figure 39. Autoinstall control program's communications area at INSTALL. For shipped terminals and connections.

INSTALL_SHIPPED_STANDARD

A fullword input field containing the following information:

INSTALL_SHIPPED_EXIT_FUNCTION

A 1-byte field that indicates the type of resource being installed. For install of remote terminals and connections the equated values are:

INSTALL_SHIPPED_TERM (X'F7')

A shipped terminal

INSTALL_SHIPPED_RSE (X'F8')

A shipped connection (remote system entry).

INSTALL_SHIPPED_EXIT_COMPONENT

A 2-byte component code, which is set to 'ZC'.

the autoinstall control program for shipped terminals

INSTALL_SHIPPED_CLASH

A 1-character input field that indicates whether the TERMD of the shipped definition is already in use in the AOR.

Y The name by which the terminal or connection is known in the TOR (the value of the TERMINAL or CONNECTION attribute on the shipped definition) is already in use in the AOR to identify an installed remote terminal or connection.

N The name by which the terminal or connection is known in the TOR is not in use in the AOR to identify a remote terminal or connection.

INSTALLED_SHIPPED_NETNAME_PTR

A fullword pointer to an 8-character input field containing the netname of the terminal or connection to be installed.

INSTALL_SHIPPED_SELECTED_PTR

A fullword pointer to the return fields. The output fields, for use by your program, are:

SELECTED_SHIPPED_TERMID

A 4-character field used to specify the name by which the remote terminal or connection is to be known to this system. If the name is less than 4 characters long, it must be padded with trailing blanks. For a list of the characters you can use in terminal names, see the *CICS Resource Definition Guide*.

On invocation, if INSTALL_SHIPPED_CLASH is set to 'N' (indicating no conflict of terminal names), SELECTED_SHIPPED_TERMID contains the same value as the field pointed to by INSTALL_SHIPPED_TERMID_PTR (the value of the TERMINAL or CONNECTION attribute on the shipped definition). If INSTALL_SHIPPED_CLASH is set to 'Y', SELECTED_SHIPPED_TERMID contains a CICS-generated alias.

Your user program can use this field to override a CICS-generated alias. For advice on choosing terminal and connection names, see "Resetting the terminal identifier" on page 524.

SELECTED_SHIPPED_RETURN_CODE

The 1-character return code field. The equated values are:

RETURN_OK (X'00')

Install the remote terminal or connection. Your user program must return this value if the resource is to be autoinstalled.

REJECT (X'01')

Do not install the remote terminal or connection. This is the default value.

INSTALL_SHIPPED_TERMID_PTR

A fullword pointer to a 4-character input field containing the name by which the terminal or connection is known in the TOR. (This is the value of the TERMINAL or CONNECTION attribute on the shipped definition.)

INSTALL_SHIPPED_APPLID_PTR

A fullword pointer to an 8-character input field containing the netname (applid) of the TOR.

INSTALL_SHIPPED_SYSID_PTR

A fullword pointer to a 4-character input field containing the name (sysid) of the connection to the TOR.

the autoinstall control program for shipped terminals

INSTALL_SHIPPED_CORRID_PTR

A fullword pointer to an 8-character input field containing the shipped definition's *correlation identifier*. A correlation identifier is a unique "instance token" that is created when a CICS/ESA 4.1 or later terminal or connection definition is installed, and stored within the definition. Thus, if the definition is shipped to another region, the value of the token is shipped too. The correlation ID is used by CICS during attach processing, to check whether existing shipped definitions in an AOR are up-to-date, or whether they need to be deleted and reshipped because the terminal has been re-installed in the TOR. For further information about instance tokens, see the *CICS Intercommunication Guide*.

If your control program maps TOR-allocated TERMIDs to the aliases that it assigns in the AOR, by recording correlation IDs it could check whether a terminal has been re-installed in the TOR. If the terminal *has* been re-installed, it is possible that the TOR-allocated TERMID relates to a *different* physical device from that last installed under this TERMID.

The autoinstall control program at DELETE

The autoinstall control program is reinvoked when an autoinstalled resource is deleted. (The resources that can be autoinstalled are listed under "The autoinstall control program at INSTALL" on page 525.) Invoking the user program at DELETE enables you to reverse the processes carried out at INSTALL.

The parameter list passed to your user program at DELETE of local terminals is described on page 495. The parameter list passed at DELETE of local APPC connections is described on page 519. The parameter list passed at DELETE of Client virtual terminals is described on page 536. This section describes only DELETE of shipped terminals and connections.

Shipped terminal and connection definitions are deleted by the CICS Transaction Server for OS/390 Release 3 timeout delete mechanism. For details of the timeout delete mechanism, see the *CICS Intercommunication Guide*.

Figure 40 shows the communications area passed to the autoinstall user program at DELETE.

DELETE_SHIPPED_COMMAREA	DSECT ,	Delete parameter list
DELETE_SHIPPED_STANDARD	DS F	Standard field
DELETE_SHIPPED_EXIT_FUNCTION	DS XL1	Delete type
DELETE_SHIPPED_TERM	EQU X'FA'	Delete terminal
DELETE_SHIPPED_RSE	EQU X'FB'	Delete remote system entry
DELETE_SHIPPED_EXIT_COMPONENT	DS CL2	Component ID 'ZC'
	DS CL1	Reserved
DELETE_SHIPPED_TERMID	DS CL4	TERMID in TOR
DELETE_SHIPPED_APPLID	DS CL8	Applid of TOR
DELETE_SHIPPED_LTERMID	DS CL4	TERMID in AOR
DELETE_SHIPPED_NETNAME	DS CL8	Netname of terminal

Figure 40. Autoinstall control program's communications area at DELETE. For shipped terminals and connections.

At DELETE, all fields in the communications area are input only. Fields not listed below are as described for INSTALL.

the autoinstall control program for shipped terminals

DELETE_SHIPPED_EXIT_FUNCTION

A 1-byte field that indicates the type of resource being deleted. The equated values are:

DELETE_SHIPPED_TERM (X'FA')

A shipped terminal

DELETE_SHIPPED_RSE (X'FB')

A shipped connection (remote system entry).

Note: A value of X'F1' represents the deletion of a local terminal, or an APPC single-session device that was autoinstalled via a CINIT request—see page 495. A value of X'FC' represents the deletion of a Client virtual terminal—see page 536. A value of X'F5' or X'F6' represents the deletion of an APPC connection that was installed by a BIND request—see page 519.

DELETE_SHIPPED_TERMID

A 4-character field containing the identifier (TERMID) of the terminal or connection in the TOR.

DELETE_SHIPPED_APPLID

An 8-character field containing the netname (applid) of the TOR.

DELETE_SHIPPED_LTERMID

A 4-character field containing the name by which the terminal or connection is known in the AOR. This may or may not be the same as DELETE_SHIPPED_TERMID, depending on whether an alias has been used in the AOR.

DELETE_SHIPPED_NETNAME

An 8-character field containing the netname of the terminal being deleted.

Default actions of the sample programs

When DFHZATDX or DFHZATDY is invoked at INSTALL of a shipped terminal or connection, it:

1. Updates, if necessary, the SELECTED_SHIPPED_TERMID field, so that it contains the name by which the terminal or connection is known in the TOR.

Notes:

- a. If CICS detected a conflict with a currently-installed remote TERMID, on invocation of the sample programs SELECTED_SHIPPED_TERMID contains a CICS-generated alias. The sample programs overwrite this value.
- b. If CICS detected no conflict with a currently-installed remote TERMID, on invocation of the sample programs SELECTED_SHIPPED_TERMID contains the value of the TERMINAL attribute on the shipped definition (the value pointed to by INSTALL_SHIPPED_TERMID_PTR). The sample programs accept this value.

2. Permits the remote definition to be installed by setting the return code field to RETURN_OK, and returning.

When DFHZATDX or DFHZATDY is invoked at DELETE of a shipped terminal or connection, it takes no action and returns.

Chapter 14. Writing a program to control autoinstall of Client virtual terminals

Considerations common to all user-replaceable programs

Note that the comments contained in “Chapter 5. General notes about user-replaceable programs” on page 401 apply to this chapter.

This chapter describes how to write a program to control the installation of **virtual terminals**. Virtual terminals are used by the External Presentation Interface (EPI) and terminal emulator functions of the CICS Clients products. For an introduction to the CICS Clients products, and detailed information about CICS Transaction Server for OS/390 support for them, see the *CICS for MVS/ESA Server support for CICS Clients* manual.

Both the supplied autoinstall control programs, DFHZATDX and DFHZATDY, provide function to install definitions of Client virtual terminals. You can therefore base your customized control program on either DFHZATDX or DFHZATDY.

The chapter is divided into the following sections:

1. “**How Client virtual terminals are autoinstalled**”
2. “**The autoinstall control program at INSTALL**” on page 534
3. “**The autoinstall control program at DELETE**” on page 536
4. “**Default actions of the sample programs**” on page 537.

How Client virtual terminals are autoinstalled

Client virtual terminals are defined to CICS Transaction Server for OS/390 as remote 3270 datastream devices.

Autoinstall models

The autoinstall model used to install a virtual terminal is determined using the following sequence:

1. **For EPI programs:** From the **DevType** parameter of the **CICS_EpiAddTerminal** function, if specified by the Client EPI program. (For details of EPI calls, see the *CICS Family: Client/Server Programming* manual.)

For the Client terminal emulator: From the **/m** parameter of the **icstern** command used to start the emulator, if specified by the workstation user. (For details of the **icstern** command, see the *CICS Clients: Administration* manual.)

Note: Any autoinstall models specified by Clients must, of course, be defined to CICS. However, because VTAM definitions are not required for Client virtual terminals, there is no need to create matching entries in the VTAM LOGMODE table.

2. The CICS-supplied autoinstall model, DFHLU2.

The autoinstall control program cannot choose a different autoinstall model.

the autoinstall control program for virtual terminals

Terminal identifiers

The terminal identifier (TERMID) passed to the CICS autoinstall function at install of a virtual terminal is determined using the following sequence:

1. **For EPI programs:** From the **NetName** parameter of the **CICS_EpiAddTerminal** function, if specified by the Client EPI program.
For the Client terminal emulator: From the **/n** parameter of the **cicsterm** command used to start the emulator, if specified by the workstation user.
2. A name generated automatically by CICS.

TERMIDs generated by CICS for Client terminals consist of a 1-character prefix and a 3-character suffix. The default prefix is '\', but you can specify a different prefix using the VTPREFIX system initialization parameter. The suffix can have the values 'AAA' through '999'. That is, each character in the suffix can have the value 'A' through 'Z' or '0' through '9'. The first suffix generated by CICS has the value 'AAA'. This is followed by 'AAB', 'AAC', ... 'AAZ', 'AA0', 'AA1', and so on, up to '999'.

Each time a Client virtual terminal is autoinstalled, CICS generates a 3-character suffix that it has not recorded as being in use.

Note: By specifying a prefix, you can ensure that the TERMIDs of Client terminals autoinstalled on this system are unique in your transaction routing network. This prevents the conflicts that could occur if two or more regions ship definitions of virtual terminals to the same application-owning region (AOR).

For details of the VTPREFIX system initialization parameter, see the *CICS System Definition Guide*.

For brevity, we shall refer to the name specified by the Client or the CICS-generated “VTPREFIX” name as the *supplied name*. The Client always knows the virtual terminal by the supplied name. However, your autoinstall control program can allocate an alias, by which the virtual terminal will be known to CICS.

If the CICS autoinstall function detects that the supplied name clashes with the name of a remote terminal or connection already installed on this region, it generates an alias TERMID. CICS generates alias TERMIDs for virtual terminals in the same way as it generates aliases for shipped terminals—see “CICS-generated aliases” on page 524.

Note: If the supplied name clashes with the name of a *local* terminal or connection, the install of the virtual terminal is rejected, and the autoinstall control program is not invoked.

The autoinstall control program is invoked once for each virtual terminal definition to be installed. When it is invoked, field `INSTALL_SHIPPED_TERMID_PTR` of the communications area points to the supplied TERMID. Field `SELECTED_SHIPPED_TERMID` contains either the supplied TERMID, or a CICS-generated alias, depending on whether a clash of names has been detected.

Your control program can accept the TERMID passed in `SELECTED_SHIPPED_TERMID`, change it, or reject the installation of the virtual terminal.

Why override TERMIDs?

Why might you want to create an alias for the supplied TERMID (or, in the case of a clash of names, to override the alias generated by CICS)? You may not need to; it may depend on the way in which your server programs are written. By “server programs” we mean both the transaction programs started by Client EPI programs, and those started from the Client terminal emulator.

Overriding CICS-generated TERMIDs

If you are using CICS-generated TERMIDs (and have specified a different prefix, reserved for virtual terminals, on each region on which Client terminals can be installed), there should be no clash of names, either in the regions in which the virtual terminals are installed, or when different regions ship Client definitions to the same AOR. However, if you are using CICS-generated TERMIDs, your server programs must not rely on TERMIDs being allocated consistently to particular Client terminals.

A Client terminal can be deleted by a Client sending a **CICS_EpiDelTerminal** request, by an end user shutting down a Client terminal emulator or the Client itself, or if a connection failure occurs.⁶ When it is reinstalled, CICS does not necessarily generate the same TERMID as it had previously. This could create problems if, for example:

- Your server programs derive temporary storage queue names from the TERMID (to associate each queue with a particular end user). Problems of data mismatch could occur if the queue is not deleted by transaction end (possibly due to a failure).

The best solution is for your application programs always to check before creating a temporary storage queue whether a queue of the same name already exists, and, if so, to delete it. However, if you have a large number of server applications, it may not be possible to check or change them all.

- Your server programs record TERMIDs for later use. For example, an application might issue an EXEC CICS START TERMID command, with a time interval after which the transaction is to be initiated against the named terminal. If, during the delay interval, the virtual terminal is deleted, and re-installed with a different TERMID, the started transaction could fail because the TERMID no longer exists.

If your server programs cannot be rewritten, it may be necessary for your autoinstall control program to create aliases for the CICS-generated TERMIDs. It could, for example, use a mapping file to relate particular aliases to particular Client workstations (identified by connection name).

If your server programs are located on a back-end AOR, the autoinstall control program is invoked in the AOR when a virtual terminal is shipped in, just as for any other shipped definition. It can, if necessary, allocate an alias terminal identifier to the shipped definition. (For details of writing a control program to install shipped definitions, see “Chapter 13. Writing a program to control autoinstall of shipped terminals” on page 523.)

6. Definitions of Client virtual terminals are **not** deleted by the CICS Transaction Server for OS/390 Release 3 timeout delete mechanism that operates on shipped terminal definitions. That is, the timeout delete mechanism does not operate on the (remote) definitions of Client terminals on the CICS Transaction Server for OS/390 Release 3 system on which the install Client terminal transaction (CTIN) runs. It does operate on Client definitions that are shipped to a back-end CICS/ESA 4.1 or later system.

the autoinstall control program for virtual terminals

Overriding Client-specified TERMIDs

If TERMIDs are always nominated, in a consistent way, by your Client EPI programs, the problem of data mismatch due to server programs recording TERMIDs should not occur.

However, Client-specified TERMIDs could clash with non-Client remote TERMIDs; or, if several Clients are attached to the same CICS system, with each other. If this occurs in the region on which the CTIN transaction runs, for consistency your autoinstall control program may need to allocate alias TERMIDs, rather than relying on the aliases provided by CICS. (That is, it may need to relate particular TERMIDs to particular Client workstations, as previously described.)

If a name clash occurs in an AOR, the autoinstall control program is invoked in the AOR. It can resolve the conflict by allocating an alias terminal identifier to the shipped definition.

The autoinstall control program at INSTALL

The autoinstall control program is invoked at INSTALL for:

- Local VTAM terminals
- Local APPC single-session connections initiated by a CINIT
- Local APPC parallel-session connections initiated by a BIND
- Local APPC single-session connections initiated by a BIND
- Client virtual terminals
- Remote shipped terminals and connections (including shipped definitions of Client virtual terminals).

On each invocation, CICS passes a parameter list to the control program by means of a communication area addressed by DFHEICAP. The parameter list passed at INSTALL of local terminals and APPC single-session connections initiated by CINIT is described in “The communication area at INSTALL for terminals” on page 488. The parameter list passed at INSTALL of local APPC connections initiated by BIND requests is described in “The communication area at INSTALL for APPC connections” on page 516. The parameter list passed at INSTALL of shipped terminals and connections is described in “The communications area at INSTALL for shipped terminals” on page 526. This section describes only INSTALL of Client virtual terminals.

The communications area at INSTALL for Client virtual terminals

The communications area is mapped by the DSECT for the assembler version of DFHZATDX, which is supplied in CICSTS13.CICS.SDFHMAC.

Note: The communications area for INSTALL of virtual terminals is the same as that for INSTALL of shipped terminals and connections—that is why the field names contain the word “SHIPPED”.

the autoinstall control program for virtual terminals

```

*-----*
* Remote install parameter list - Client virtual terminal function 9 *
*-----*
INSTALL_SHIPPED_COMMAREA          DSECT          Install Parameter List
*
INSTALL_SHIPPED_STANDARD          DS  F          Standard field
                                ORG INSTALL_SHIPPED_STANDARD
INSTALL_SHIPPED_EXIT_FUNCTION     DS  XL1        Install type
INSTALL_SHIPPED_TERM              EQU X'F9'      Install virtual terminal
INSTALL_SHIPPED_EXIT_COMPONENT    DS  CL2        Component ID 'ZC'
INSTALL_SHIPPED_CLASH             DS  CL1        Install clash Y/N
                                ORG ,
INSTALL_SHIPPED_NETNAME_PTR       DS  A          Pointer to netname of Client
INSTALL_SHIPPED_SELECTED_PTR      DS  A          Pointer to return fields
INSTALL_SHIPPED_TERMID_PTR        DS  A          Pointer to incoming TERMID
INSTALL_SHIPPED_APPLID_PTR        DS  A          Pointer to applid of Client
INSTALL_SHIPPED_SYSID_PTR         DS  A          Pointer to sysid of Client
INSTALL_SHIPPED_CORRID_PTR        DS  A          Pointer to correlation ID
INSTALL_SHIPPED_SELECTED_PARMS    DSECT ,
                                DS  CL8          Reserved
SELECTED_SHIPPED_TERMID           DS  CL4        Selected TERMID
                                DS  CL4          Reserved
                                DS  CL4          Reserved
SELECTED_SHIPPED_RETURN_CODE      DS  CL1        Selected return code
RETURN_OK                         EQU X'00'        Accept request
REJECT                            EQU X'01'        Reject request
*

```

Figure 41. Autoinstall control program's communications area at INSTALL. For Client virtual terminals.

INSTALL_SHIPPED_STANDARD

A fullword input field containing the following information:

INSTALL_SHIPPED_EXIT_FUNCTION

A 1-byte field that indicates the type of resource being installed. For install of Client virtual terminals the equated value is INSTALL_SHIPPED_TERM (X'F7').

INSTALL_SHIPPED_EXIT_COMPONENT

A 2-byte component code, which is set to 'ZC'.

INSTALL_SHIPPED_CLASH

A 1-character input field that indicates whether the supplied TERMID is already in use in this region.

- Y** The name passed to the CICS autoinstall function is already in use in this region to identify an installed remote terminal or connection.
- N** The name passed to the CICS autoinstall function is not already in use in this region to identify a remote terminal or connection.

INSTALL_SHIPPED_NETNAME_PTR

A fullword pointer to an 8-character field containing the netname of the Client workstation. This field contains the same value as the field pointed to by INSTALL_SHIPPED_APPLID_PTR.

INSTALL_SHIPPED_SELECTED_PTR

A fullword pointer to the return fields. The output fields, for use by your program, are:

SELECTED_SHIPPED_TERMID

A 4-character field used to specify the name by which the virtual terminal will be known to CICS. If the name is less than 4 characters

the autoinstall control program for virtual terminals

long, it must be padded with trailing blanks. For a list of the characters you can use in terminal names, see the *CICS Resource Definition Guide*.

On invocation, if `INSTALL_SHIPPED_CLASH` is set to 'N' (indicating no conflict of terminal names), `SELECTED_SHIPPED_TERMID` contains the same value as the field pointed to by `INSTALL_SHIPPED_TERMID_PTR` (the supplied name). If `INSTALL_SHIPPED_CLASH` is set to 'Y', `SELECTED_SHIPPED_TERMID` contains a CICS-generated alias.

Your user program can override the suggested name.

SELECTED_SHIPPED_RETURN_CODE

The 1-character return code field. The equated values are:

RETURN_OK (X'00')

Install the virtual terminal. This is the default value. Your user program must return this value if the resource is to be autoinstalled.

REJECT (X'01')

Do not install the virtual terminal.

INSTALL_SHIPPED_TERMID_PTR

A fullword pointer to a 4-character input field containing the TERMID passed to the CICS autoinstall function (that is, the supplied name).

INSTALL_SHIPPED_APPLID_PTR

A fullword pointer to an 8-character input field containing the netname (applid) of the Client workstation.

INSTALL_SHIPPED_SYSID_PTR

A fullword pointer to a 4-character input field containing the name (sysid) of the connection to the Client workstation.

INSTALL_SHIPPED_CORRID_PTR

A fullword pointer to an 8-character input field that is not used for install of virtual terminals.

The autoinstall control program at DELETE

The autoinstall control program is reinvoked when an autoinstalled resource is deleted. (The resources that can be autoinstalled are listed under "The autoinstall control program at INSTALL" on page 534.) Invoking the user program at DELETE enables you to reverse the processes carried out at INSTALL.

The parameter list passed to your user program at DELETE of local terminals is described on page 495. The parameter list passed at DELETE of local APPC connections is described on page 519. The parameter list passed at DELETE of shipped definitions is described on page 528. This section describes only DELETE of Client virtual terminals.

Shipped terminal and connection definitions are deleted by the CICS Transaction Server for OS/390 Release 3 timeout delete mechanism. For details of the timeout delete mechanism, see the *CICS Intercommunication Guide*.

Figure 42 on page 537 shows the communications area passed to the autoinstall user program at DELETE.

the autoinstall control program for virtual terminals

DELETE_SHIPPED_COMMAREA	DSECT ,	Delete parameter list
DELETE_SHIPPED_STANDARD	DS F	Standard field
DELETE_SHIPPED_EXIT_FUNCTION	DS XL1	Delete type
DELETE_SHIPPED_TERM	EQU X'FC'	Delete virtual terminal
DELETE_SHIPPED_EXIT_COMPONENT	DS CL2	Component ID 'ZC'
	DS CL1	Reserved
DELETE_SHIPPED_TERMID	DS CL4	TERMID
DELETE_SHIPPED_APPLID	DS CL8	Applid of Client workstation
DELETE_SHIPPED_LTERMID	DS CL4	TERMID in this region
DELETE_SHIPPED_NETNAME	DS CL8	Netname of Client workstation

Figure 42. Autoinstall control program's communications area at DELETE. For Client virtual terminals.

At DELETE, all fields in the communications area are input only. Fields not listed below are as described for INSTALL.

DELETE_SHIPPED_EXIT_FUNCTION

A 1-byte field that indicates the type of resource being deleted. The equated value for Client virtual terminals is DELETE_SHIPPED_TERM (X'FC').

Note: A value of X'F1' represents the deletion of a local terminal, or an APPC single-session device that was autoinstalled via a CINIT request—see page 495. A value of X'F5' or X'F6' represents the deletion of an APPC connection that was installed by a BIND request—see page 519. A value of X'FA' or X'FB' represents the deletion of a shipped terminal or connection—see page 528.

DELETE_SHIPPED_TERMID

A 4-character field containing the name by which the virtual terminal is known to the Client.

DELETE_SHIPPED_APPLID

An 8-character field containing the netname (applid) of the Client workstation.

DELETE_SHIPPED_LTERMID

A 4-character field containing the name by which the virtual terminal is known in this region. This may or may not be the same as the value in DELETE_SHIPPED_TERMID, depending on whether an alias was used at install.

DELETE_SHIPPED_NETNAME

An 8-character field containing the netname of the Client workstation. This field contains the same value as DELETE_SHIPPED_APPLID.

Default actions of the sample programs

When DFHZATDX or DFHZATDY is invoked at INSTALL of a Client virtual terminal, it:

1. Accepts the terminal name placed by CICS in SELECTED_SHIPPED_TERMID. If CICS detected no conflict with a currently-installed remote TERMID, SELECTED_SHIPPED_TERMID contains the value pointed to by INSTALL_SHIPPED_TERMID_PTR (that is, the name specified by the Client, or the "VTPREFIX" name generated by CICS). If CICS detected a conflict with a currently-installed remote TERMID, SELECTED_SHIPPED_TERMID contains a CICS-generated alias.

the autoinstall control program for virtual terminals

2. Permits the remote definition to be installed by leaving the return code field set to its default value of RETURN_OK, and returning.

When DFHZATDX or DFHZATDY is invoked at DELETE of a Client virtual terminal, it takes no action and returns.

Chapter 15. Writing a program to control autoinstall of programs

Considerations common to all user-replaceable programs

Note that the comments contained in “Chapter 5. General notes about user-replaceable programs” on page 401 apply to this chapter.

This chapter describes the user-replaceable program that controls the automatic installation of programs, mapsets, and partitionsets.

Note: In this chapter, the term “program autoinstall” is used to mean autoinstall of all three program types (program, mapset, and partitionset) unless otherwise specified.

The chapter is divided into the following sections:

1. “**Preliminary considerations**”
2. “**Benefits of autoinstall**” on page 541
3. “**Requirements for autoinstall**” on page 542
4. “**The autoinstall control program at INSTALL**” on page 543
5. “**The sample autoinstall control program for programs, DFHPGADX**” on page 546.

Preliminary considerations

As well as terminals and APPC connections, you can autoinstall:

- User programs
- Mapsets
- Partitionsets.

If the autoinstall program function is enabled, and an implicit or explicit load request is issued for a previously undefined program, mapset, or partitionset, CICS dynamically creates a definition, and installs and catalogs it, as appropriate. An implicit or explicit load occurs when:

- CICS starts a transaction.
- An application program issues one of the following commands:
 - EXEC CICS LINK—see “Autoinstalling programs invoked by EXEC CICS LINK commands” on page 540
 - EXEC CICS XCTL
 - EXEC CICS LOAD
 - EXEC CICS ENABLE (for a global user exit, or task-related user exit, program)
 - EXEC CICS RECEIVE or SEND MAP
 - EXEC CICS SEND PARTNSET
 - EXEC CICS RECEIVE PARTN.
- A program abend occurs, and CICS transfers control to the program named on an EXEC CICS HANDLE ABEND command.

the autoinstall control program for programs

- CICS calls any user-replaceable program other than the program or terminal autoinstall program.
- A program is named in the PLTPI or PLTSD list.

Autoinstall model definitions

Like autoinstall for terminals, program autoinstall uses model definitions, together with a user-replaceable control program, to create explicit definitions for resources that need to be autoinstalled. The purpose of a model is to provide CICS with a definition that can be used for all programs with the same properties. CICS calls the autoinstall control program with a parameter list that includes the name of a CICS-supplied, default model definition appropriate to the program type (program, mapset, or partitionset). Your autoinstall control program can accept the default model, or specify another (any installed program definition can be used as a model). It can also specify explicitly any properties that are unique to a program, thus overriding those specified on the model definition. It can specify that a local or a remote definition should be installed.

On return from the control program, CICS creates a resource definition from the model and properties returned in the parameter list.

Note that CICS does not call your control program for CICS programs, mapsets, or partitionsets—that is, for any objects that begin with the letters “DFH”.

Autoinstalling programs invoked by EXEC CICS LINK commands

Distributed program link (DPL) requests can be dynamically routed. (For information about the dynamic routing of DPL requests, see the *CICS Intercommunication Guide*.) This section describes the relationship between the autoinstall control program and the dynamic routing program.

When the autoinstall control program is invoked because there is no installed definition of a program named on an EXEC CICS LINK command, it can install:

A local definition of the server program

CICS runs the server program on the local region.

A definition that specifies REMOTESYSTEM(remote_region) and DYNAMIC(NO)

CICS ships the LINK request to the remote region.

A definition that specifies DYNAMIC(YES)

CICS invokes the dynamic routing program to route the LINK request.

Note: The DYNAMIC attribute takes precedence over the REMOTESYSTEM attribute. Thus, a definition that specifies both REMOTESYSTEM(remote_region) and DYNAMIC(YES) defines the program as dynamic, rather than as residing on a particular remote region. (In this case, the REMOTESYSTEM attribute names the default server region passed to the dynamic routing program.)

No definition of the server program

CICS invokes the dynamic routing program to route the LINK request.

Note: This assumes that the autoinstall control program *chooses* not to install a definition. If no definition is installed because autoinstall fails, the dynamic routing program is not invoked.

Autoinstall processing of mapsets

Table 26 shows the differences in mapset processing between CICS regions with program autoinstall active and inactive.

Table 26. Differences in mapset processing between autoinstall and non-autoinstall

Program autoinstall INACTIVE	Program autoinstall ACTIVE
CSD definition is required. CICS attempts to load a referenced mapset with a suffix. If this fails, CICS tries an unsuffixed version. If that is unsuccessful, abend APCT is issued.	CSD definition is not required. Using autoinstall, CICS attempts to load the referenced suffixed mapset or partitionset, then the unsuffixed one. (In each case, a definition is autoinstalled.) The transaction requesting the resource abends only if no version of the resource exists in the library, either suffixed or unsuffixed. If the suffixed mapset was not found in the library, the definition is marked 'not loadable'.

System autoinstall

Some programs are autoinstalled automatically (if they have not been statically defined) by the CICS **system autoinstall** function, which does not require model definitions or the support of the autoinstall control program. Programs in this category include:

- First phase program list table post initialization (PLTPI) programs (that is, PLTPI programs that are defined *before* the PLT table delimiter DFHDELIM).
- Second phase program list table shutdown (PLTSD) programs (that is, PLTSD programs that are defined *after* the PLT table delimiter DFHDELIM).

Note: PLTPI programs that are defined *after* DFHDELIM, and PLTSD programs that are defined *before* DFHDELIM, are treated like any other user programs—they are eligible for program autoinstall.

Benefits of autoinstall

Program autoinstall reduces system administration, virtual storage usage, and, potentially, restart times.

Reduced system administration costs

Without autoinstall, you have to define all new programs, mapsets, and partitionsets to CICS before they can be used. Autoinstall eliminates this requirement, enabling these resources to be used without prior definition. Furthermore, the need to maintain predefined definitions also disappears, leading to a significant saving in system administration effort.

Saving in virtual storage

There is a saving in virtual storage within the CICS address space, as the definitions of autoinstalled resources do not occupy table space until they are generated.

the autoinstall control program for programs

Faster startup times

Warm and emergency starts

If you are using program autoinstall *with cataloging*, restart times are similar to those of restarting a CICS region that is not using program autoinstall. This is because, in both cases, resource definitions are reinstalled from the catalog during the restart. The definitions after the restart are those that existed before the system was terminated.

If you are using autoinstall *without cataloging*, CICS restart times are improved because CICS does **not** install definitions from the CICS global catalog. Instead, definitions are autoinstalled as required whenever programs, mapsets, and partitionsets are referenced following the restart.

See the *CICS Recovery and Restart Guide* for information on cataloging.

Initial and cold starts

Startup times are faster than for a region that does not use program autoinstall, because program definitions are installed singly, as required, rather than all together at startup.

Requirements for autoinstall

To use autoinstall with programs, mapsets, and partitionsets, you must:

1. Write a customized version of the autoinstall control program for programs, DFHPGADX (unless the supplied version is entirely suitable for your purposes).
2. Specify the name of your control program on the PGAEXIT system initialization parameter (the default name is DFHPGADX), or on a SET SYSTEM PROGAUTOEXIT command.
3. Make program autoinstall active by specifying 'ACTIVE' on the PGAIPGM system initialization parameter (or by issuing a SET SYSTEM PROGAUTOINST(AUTOACTIVE) command).
4. Specify whether you want autoinstalled program definitions to be recorded on the CICS global catalog, on the PGAICTLG system initialization parameter (or on a SET SYSTEM PROGAUTOCTLG command).
5. Include the DFHPGAIP resource definition group in your CICS startup grouplist. DFHPGAIP (which is already included in the CICS-supplied startup list, DFHLIST) contains the default program, mapset, and partitionset model definitions passed to the autoinstall control program, and a definition of DFHPGADX (that you may need to amend).
6. Create any additional program, mapset, and partitionset model definitions that you need, and add this group to your startup grouplist.
7. If you want to log messages associated with program autoinstall, define the CSPL transient data (TD) queue.

For information about coding system initialization parameters, see the *CICS System Definition Guide*. For information about defining programs, mapsets, partitionsets, and TD queues, see the *CICS Resource Definition Guide*.

The autoinstall control program at INSTALL

On invocation, CICS passes a parameter list to the autoinstall control program by means of a communication area addressed by DFHEICAP. The communications area is mapped by a copybook that is supplied in each of the languages supported by CICS.

The assembler form of the parameter list is as follows:

PGAC_PROGRAM

passes the 8-byte name of the object to be autoinstalled. This is an input-only field, which your user-replaceable program must not alter.

PGAC_MODULE_TYPE

passes a 1-byte indicator of the type of object to be installed. The equated values are:

PGAC_TYPE_PROGRAM

A program

PGAC_TYPE_MAPSET

A mapset

PGAC_TYPE_PARTITIONSET

A partitionset.

This is an input-only field, which your user-replaceable program must not alter.

PGAC_MODEL_NAME

allows your control program to specify the 8-byte autoinstall model name to be used. If you do not set this field, CICS uses the default model name for the type of object:

DFHPGAPG

For a program

DFHPGAMP

For a mapset

DFHPGAPT

For a partitionset.

PGAC_LANGUAGE

allows your control program to specify, in a 1-byte field, the language of the program to be autoinstalled. The equated values are:

PGAC_ASSEMBLER

Assembler

PGAC_COBOL

COBOL

PGAC_C370

C

PGAC_LE370

Language Environment/370

PGAC_PLI

PL/I.

the autoinstall control program for programs

If you do not set this field, the autoinstall routine uses the language defined in the model, if one is specified. However, when control is passed to the program, CICS determines the language from the program itself, and overrides any specification provided.

You should not need to specify the language of executable programs that have been translated using the EXEC CICS translator before compiling.

PGAC_CEDF_STATUS

allows you to specify, in a 1-byte field, the execution diagnostic facility (EDF) status of the program to be autoinstalled. The equated values are:

PGAC_CEDF_YES

EDF can be used with this program.

PGAC_CEDF_NO

EDF cannot be used with this program.

PGAC_DATA_LOCATION

allows you to specify, in a 1-byte field, the data location for task-lifetime storage. The equated values are:

PGAC_LOCATION_BELOW

Task-lifetime storage must be located below 16MB.

PGAC_LOCATION_ANY

Task-lifetime storage can be below or above 16MB.

PGAC_EXECUTION_KEY

allows you to specify, in a 1-byte field, the execution key for the program. The equated values are:

PGAC_CICS_KEY

The program is to execute in CICS key.

PGAC_USER_KEY

The program is to execute in user key.

PGAC_LOAD_ATTRIBUTE

allows you to specify, in a 1-byte field, the load attributes for the object. The equated values are:

PGAC_RELOAD

CICS is to load a fresh copy of the object for each request.

PGAC_RESIDENT

CICS is to make the object permanently resident.

PGAC_TRANSIENT

The storage for this object is to be released whenever the use count reaches zero.

PGAC_REUSABLE

CICS can use any copy of the object currently in storage.

PGAC_USE_LPA_COPY

allows you to specify, in a 1-byte field, whether CICS is to use an LPA-resident copy of the program. The equated values are:

PGAC_LPA_YES

CICS is to use a copy from the LPA.

the autoinstall control program for programs

PGAC_LPA_NO

CICS is to load a private copy from its own DFHRPL library concatenation.

PGAC_EXECUTION_SET

allows you to specify, in a 1-byte field, whether or not the program is restricted to using the distributed program link (DPL) subset of the CICS API. The equated values are:

PGAC_DPLSUBSET

The program is to be restricted to the DPL subset of the EXEC CICS API.

PGAC_FULLAPI

The program can use the full API.

PGAC_REMOTE_SYSID

allows you to specify, in a 4-byte field, the name of the remote system where the program is to execute. CICS function ships any request for this program to the specified remote CICS.

PGAC_REMOTE_PROGID

allows you to specify, in an 8-byte field, the name by which the program is known in the remote CICS region. For a remote program, the remote name defaults to the local name if you set this field to blank.

PGAC_REMOTE_TRANSID

allows you to specify, in a 4-byte field, the name of the CICS mirror transaction under which the program, if remote, is to run. By default, this is set to the name of the CICS mirror transaction, CSMI.

PGAC_RETURN_CODE

allows you to specify, in a 1-byte field, the autoinstall control program's return code to CICS. The equated values are:

PGAC_RETURN_OK

Install the program definition using the values returned in the communications area parameter list.

PGAC_RETURN_DONT_DEFINE_PROGRAM

Do not define the program.

PGAC_DYNAMIC_STATUS

allows you to specify, in a 1-byte field, whether, if the program is the subject of a program-link request, the request can be dynamically routed. The equated values are:

PGAC_DYNAMIC_NO

If the program is the subject of a program-link request, the dynamic routing program is not invoked.

For a distributed program link (DPL) request, the server region on which the program is to execute must be specified explicitly on the REMOTESYSTEM option of the PROGRAM definition or on the SYSID option of the EXEC CICS LINK command; otherwise it defaults to the local region.

PGAC_DYNAMIC_YES

If the program is the subject of a program-link request, the dynamic routing program is invoked. Providing that a remote server region is not

the autoinstall control program for programs

named explicitly on the SYSID option of the EXEC CICS LINK command, the routing program can route the request to the region on which the program is to execute.

The sample autoinstall control program for programs, DFHPGADX

The CICS-supplied default autoinstall program is an assembler-language command-level program, named DFHPGADX. The source of the default program is provided in COBOL, PL/I, and C, as well as in assembler language. The names of the supplied programs and their associated copy books, and the CICSTS13.CICS libraries in which they can be found, are summarized in Table 27.

Table 27. Sample programs and copy books for program autoinstall

Language	Member name	Library
Executable file:		
Assembler only	DFHPGADX	SDFHLOAD
Program source:		
Assembler	DFHPGADX	SDFHSAMP
COBOL	DFHPGAOX	SDFHSAMP
PL/I	DFHPGALX	SDFHSAMP
C/370	DFHPGAHX	SDFHSAMP
Copy books:		
Assembler	DFHPGACD	SDFHMAC
COBOL	DFHPGACO	SDFHCOB
PL/I	DFHPGACL	SDFHPL1
C/370	DFHPGACH	SDFHC370

Customizing the sample program

You can write your autoinstall control program in any of the languages supported by CICS, with full access to the CICS application and system programming interfaces.

If you customize the supplied control program, or write your own version, you should note the following:

- **Input:**The first two fields of the parameter list are input-only fields and should not be altered by your program.
- **Output:**The remaining fields on the parameter list are input/output or output only fields, which you can use to specify attributes that override those of the model definition.
- Some of the output fields in the parameter list are not applicable to mapsets or partitionsets. CICS ignores any parameters you specify that are not applicable to the type of object being installed.
- Any attributes you return to CICS in the parameter list are used to modify the model definition, and CICS installs the modified definition. Once installed, the definition can be modified normally using the EXEC CICS SET PROGRAM or CEMT SET PROGRAM commands.
- If you modify your control program, you can make the new version available by using the EXEC CICS SET PROGRAM NEWCOPY or CEMT SET PROGRAM NEWCOPY command.

sample autoinstall programs

- You can discard definitions after they have been installed; they are reinstalled when next referenced.
- You must ensure that the parameters you return to CICS are valid, and consistent with other system attributes in your CICS region. For example:
 - Do not return PGAC_LPA_YES on the PGAC_USE_LPA_COPY parameter if CICS is running with the system initialization parameter LPA=NO.
 - Do not return PGAC_USER_KEY (which is the default) on the PGAC_EXECUTION_KEY parameter if the task for which your control program is called is running with CICS-key task-lifetime storage.

You can determine the storage key for the task by testing the TASKDATAKEY option in its transaction definition by means of the following EXEC CICS commands:

```
EXEC CICS ADDRESS EIB
EXEC CICS INQUIRE TRANSACTION(eibtrans) TASKDATAKEY(...)
```

Important

When creating an autoinstalled program definition, CICS ignores the program language specified on the model program definition. CICS determines the language from the load module itself, when the autoinstalled program is invoked.

However, CICS does *not* deduce characteristics other than language from the load module. These other program characteristics must be explicitly defined by the autoinstall control program or by RDO. If your programs have varying characteristics (varying AMODE or DATALOCATION requirements, for example), you must be able to distinguish between the various types when using autoinstall. You could do this by keeping a list of exceptions to the default characteristics, and coding your autoinstall control program to refer to this list; or you might decide to install explicit RDO definitions of the exceptions.

Resource definition

The autoinstall control program cannot itself be autoinstalled, nor can any program it references. You must define a program resource definition in the CSD for the control program and for any other programs it references. You must also ensure these definitions are installed in the CICS region during startup by including the group containing the definitions in your startup grouplist. If you specify an invalid name for the control program, CICS disables the program, thus disabling the program autoinstall function.

The following program resource definitions are supplied by CICS for the autoinstall control program; the default is the assembler version, DFHPGADX. If these definitions are not suitable for your use, you can create your own, using RDO or the DFHCSDUP utility.

- Default autoinstall control program definition for DFHPGADX. This defines the assembler version, and its status is set to ENABLED:

GROUP(DFHPGAIP)	PROGRAM(DFHPGADX)	
DESCRIPTION(Assembler definition for program autoinstall exit)		
LANGUAGE(ASSEMBLER)	EXECKEY(CICS)	EXECUTIONSET(FULLAPI)
RELOAD(NO)	RESIDENT(NO)	USAGE(NORMAL)
STATUS(ENABLED)	CEDF(NO)	DATALOCATION(ANY)

sample autoinstall programs

- Autoinstall control program definition for DFHPGAOX. This defines the CICS-supplied COBOL version, and its status is set to DISABLED:

```
GROUP(DFHPGAIP)      PROGRAM(DFHPGAOX)
DESCRIPTION(COBOL definition for program autoinstall exit)
LANGUAGE(COBOL)      EXECKEY(CICS)      EXECUTIONSET(FULLAPI)
RELOAD(NO)           RESIDENT(NO)      USAGE(NORMAL)
STATUS(DISABLED)    CEDF(NO)           DATALOCATION(ANY)
```

- Autoinstall control program definition for DFHPGAHX. This defines the CICS-supplied C/370 version, and its status is set to DISABLED:

```
GROUP(DFHPGAIP)      PROGRAM(DFHPGAHX)
DESCRIPTION(C definition for program autoinstall exit)
LANGUAGE(C)          EXECKEY(CICS)      EXECUTIONSET(FULLAPI)
RELOAD(NO)           RESIDENT(NO)      USAGE(NORMAL)
STATUS(DISABLED)    CEDF(NO)           DATALOCATION(ANY)
```

- Autoinstall control program definition for DFHPGALX. This defines the CICS-supplied PL/I version, and its status is set to DISABLED:

```
GROUP(DFHPGAIP)      PROGRAM(DFHPGALX)
DESCRIPTION(PL/I definition for program autoinstall exit)
LANGUAGE(PLI)        EXECKEY(CICS)      EXECUTIONSET(FULLAPI)
RELOAD(NO)           RESIDENT(NO)      USAGE(NORMAL)
STATUS(DISABLED)    CEDF(NO)           DATALOCATION(ANY)
```

Testing and debugging your program

You can use the CICS execution diagnostic facility (EDF) to help you test your autoinstall control program. However, EDF is inhibited for programs with names that begin with the letters DFH; so to use EDF you must name your program something other than one of the default names.

Chapter 16. Writing a dynamic routing program

Considerations common to all user-replaceable programs

Note that the comments contained in “Chapter 5. General notes about user-replaceable programs” on page 401 apply to this chapter.

This chapter describes the CICS default dynamic routing program and tells you how to write your own version. It assumes you are familiar with the principles of transaction routing, distributed program link (DPL), and dynamic routing described in the *CICS Intercommunication Guide*.

You can use the dynamic routing program to route:

- Transactions initiated from user terminals
- Transactions initiated by a subset of terminal-related EXEC CICS START commands
- Program-link requests.

For detailed information about which transactions initiated by START commands, and which program-link requests, are eligible for dynamic routing, see the *CICS Intercommunication Guide*.

Notes:

1. You cannot use the *dynamic* routing program—that is, the program named on the DTRPGM system initialization parameter—to route transactions:
 - That implement CICS business transaction services activities
 - That are initiated by non-terminal-related EXEC CICS START commands.

To route these types of transactions you must use the *distributed* routing program named on the DSRTPGM system initialization parameter. How to write a distributed routing program is described in “Chapter 17. Writing a distributed routing program” on page 575.

2. The dynamic routing program and the distributed routing program may, of course, be the same program.

Important

If you use the CICSplex® System Manager (CICSplex SM) product to manage your CICSplex, you may not need to write a dynamic routing program. CICSplex SM provides a fully-functioning dynamic routing program that supports workload balancing and workload separation. All you have to do is to tell CICSplex SM, through its user interface, which regions in the CICSplex can participate in dynamic routing, and define any transaction affinities that govern the target regions to which particular transactions must be routed. For introductory information about CICSplex SM, see the *CICSplex SM Concepts and Planning* manual.

The rest of the chapter is divided into the following sections:

1. “**Dynamic transaction routing**”
2. “**Dynamic routing of DPL requests**” on page 557
3. “**Parameters passed to the dynamic routing program**” on page 562

the dynamic routing program

4. “**Naming your dynamic routing program**” on page 573
5. “**Testing your dynamic routing program**” on page 573
6. “**Dynamic transaction routing sample programs**” on page 574.

Dynamic transaction routing

This section refers to the dynamic routing of transactions initiated from user terminals or by eligible terminal-related EXEC CICS START commands.

When you define transactions to CICS, you can describe them as “remote” or “local”. Local transactions are always executed in the terminal-owning region; remote transactions can be routed to other regions connected to the terminal-owning region by MRO links, or to other systems that are connected by APPC (LUTYPE6.2) ISC links.

You can select both the system to which the transaction is to be routed and the transaction’s remote name dynamically, rather than when the transaction is defined to CICS. To do this you must use a **dynamic routing program**. The CICS-supplied default routing program is called DFHDYP. Its source-level code is supplied in assembler-language, COBOL, PL/I, and C versions. You can write your own program in any of these languages, using the default program as a model.

Dynamic transactions

When you want to route transactions dynamically, you must define them with the value DYNAMIC(YES). (The default value is DYNAMIC(NO).) You must also supply values for both the remote and the local options. This allows CICS to select the appropriate values when the transaction is routed, and to ignore those values that are not needed. For information about defining transactions for dynamic transaction routing, see the *CICS Intercommunication Guide*.

When the dynamic routing program is invoked

For transactions initiated from user terminals or by eligible terminal-related EXEC CICS START commands, CICS invokes the dynamic routing program as follows:

- When a transaction defined as DYNAMIC(YES) is initiated.

Notes:

1. If a transaction definition is not found, CICS uses the common transaction definition specified on the DTRTRAN system initialization parameter. (For information about DTRTRAN, see the *CICS System Definition Guide*.)
 2. If a transaction defined as DYNAMIC(YES) and initiated by a terminal-related EXEC CICS START command is ineligible for dynamic routing, the routing program is invoked for notification only—it cannot route the transaction.
- If an error occurs in route selection—for example, if the target region returned by the routing program on its initial (route selection) call is unavailable. This gives the routing program an opportunity to specify an alternate target. This process iterates until the routing program selects a target that is available or sets a non-zero return code.
 - After the routed transaction has completed, if the routing program has requested to be reinvoked at termination.

- If the routed transaction abends, if the routing program has requested to be reinvoked at termination.

Figure 43 shows the points at which the dynamic routing program is invoked.

Requesting region

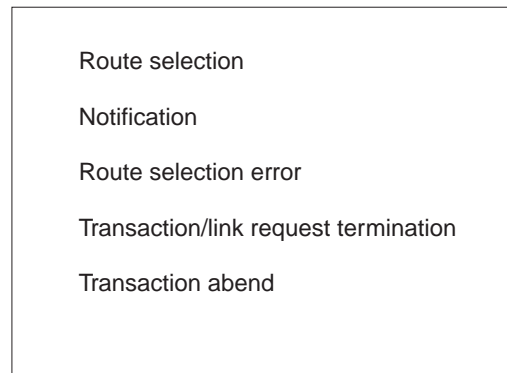

Figure 43. When the dynamic routing program is invoked

Information passed to the dynamic routing program

The CICS relay program, DFHAPRT, passes information to the dynamic routing program by means of a communications area. The communications area contains fields that are mapped by the DSECT DFHDYPDS, and is described in detail in “Parameters passed to the dynamic routing program” on page 562. For transaction routing, some of the data passed to the dynamic routing program in the communications area are:

- The SYSID of the remote CICS region specified when the transaction was installed
- The netname of the remote CICS region
- The name of the remote transaction
- The dispatch priority (MRO only) of the remote transaction
- Whether or not the request is to be queued if no sessions are immediately available to the remote CICS region
- The address of the remote transaction’s communications area
- The address of a copy of the transaction’s terminal input/output area (TIOA)
- A task-local user data area.

The communications area DSECT contains comments to describe the information passed.

The dynamic routing program can accept these values, or change them, or tell CICS not to continue routing the transaction. The values used depend on the function being performed; that is, some values may be ignored.

The information passed to the dynamic routing program indicates whether the transaction is being routed dynamically or statically. If the transaction is being routed dynamically, the dynamic routing program can change the SYSID or netname to determine where the transaction is to run.

dynamic transaction routing

Sometimes, the dynamic routing program may be invoked for transactions that are routed statically. This happens if a transaction defined as DYNAMIC(YES) is initiated by automatic transaction initiation (ATI)—for example, by the expiry of an interval control start request—but the transaction is ineligible for dynamic routing. In this case, the dynamic routing program is called only to notify it of where the transaction is going to run. It cannot change the remote system name, and any changes it makes to the SYSID or NETNAME fields in the communications area are ignored.

For transactions that are run remotely, either because they are defined as remote or because they are dynamically routed to a remote CICS region, CICS monitoring is informed of the SYSID of the remote CICS region. For transactions that the dynamic routing program routes locally, the monitoring field is set to nulls.

Changing the target CICS region

The communications area passed to the dynamic routing program initially contains the system identifier (sysid) and netname of the default CICS region to which the transaction is to be routed. These are derived from the value of the REMOTESYSTEM option of the installed transaction definition. If the transaction definition does not specify a REMOTESYSTEM value, the sysid and netname passed are those of the local CICS region.

The dynamic routing program can change the sysid and netname. If it does so when it is invoked for route selection, the region to which the transaction is routed is determined as follows:

- The NETNAME and the SYSID are not changed.
CICS tries to route to the SYSID as originally specified in the communications area.
- The NETNAME is not changed, but the SYSID is changed.
CICS updates the communications area with the NETNAME corresponding to the new SYSID, and tries to route to the new SYSID.
- The NETNAME is changed, but the SYSID is not changed.
CICS updates the communications area with a SYSID corresponding to the new NETNAME, and tries to route to the new SYSID.
- The NETNAME is changed **and** the SYSID is changed.
CICS overwrites the communications area with a SYSID corresponding to the new NETNAME, and tries to route to that new SYSID.

If the NETNAME specified is invalid, or cannot be found, SYSIDERR is returned to the dynamic routing program—which may deal with the error by returning a different SYSID or NETNAME—see “If the system is unavailable or unknown” on page 554.

If the routing program changes the SYSID or NETNAME when it is invoked for notification, the changes have no effect.

Using a common transaction definition in the TOR

The recommended method is to use a single, common definition for all remote transactions that are to be dynamically routed. The name of the common definition is specified on the DTRTRAN system initialization parameter. You can use the REMOTESYSTEM option of the common definition to specify a default AOR to

which transactions are to be routed. For information about defining remote transactions for dynamic transaction routing, see the *CICS Intercommunication Guide*.

Important

To route a transaction defined by the DTRTRAN definition, your dynamic routing program must set the DYRDTRRJ field of the communications area to 'N' (the default is 'Y'). If you leave DYTDTRRJ set to 'Y', the transaction is rejected.

You can test the DYRDTRXN field to check if the transaction passed to your routing program is defined by the DTRTRAN definition. Figure 44 contains skeleton code for routing transactions defined by DTRTRAN.

```

if DYRDTRXN='Y' then          /* Is DYP invoked because of DTRTRAN */
do                             /* .. Yes */
  Call Find_AOR(sysid)        /* Select the SYSID of the AOR */
  if rc=0 then                 /* Is AOR available? */
  do                             /* .. Yes */
    DYRRETC=RETCOD0           /* Set OK Return Code */
    DYRSYSID=sysid            /* Set the sysid */
    DYRDTRRJ='N'              /* Don't reject DTRTRAN defns */
    ...                        /* Set other commarea fields */
  end                           /* */
else                             /* .. No */
  ...                          /* AOR unavailable logic */
end                             /* */

```

Figure 44. Example pseudocode to route transactions defined by DTRTRAN

Changing the program name

For transactions defined as DYNAMIC, on invocation of the routing program the DYRLPROG field in the communications area contains the name of the initial program associated with the transaction to be routed. If you decide to route the transaction locally, you can use this field to specify an alternative program to be run. For example, if all remote CICS regions are unavailable and the transaction cannot be routed, you may want to run a program in the local CICS terminal-owning region to send an appropriate message to the user.

Telling CICS whether to route or terminate a transaction

When the routing program is invoked for routing, it can choose whether the transaction should be routed or terminated. If you want the transaction to be routed, whether you have changed any values or not, return a zero value to CICS in field DYRRETC of the communications area. When you return control to CICS with return code zero, CICS first compares the returned SYSID with its own local SYSID:

- If the SYSIDs are the same (or the returned SYSID is blank) CICS executes the transaction locally.
- If the two SYSIDs are not the same, CICS routes the transaction to the remote CICS region, using the remote transaction name.

If you want to terminate the transaction with a message or an abend, set a return code of X'8' (or any other non-zero return code other than X'4').

dynamic transaction routing

If you want to terminate the transaction without issuing a message or abend, set a return code of X'4'.

Warning: Setting a return code of X'4' for APPC transaction routing leads to unpredictable results, and should be avoided.

Returning a value in DYRRETC has no effect when the routing program is invoked for notification or at termination of the transaction.

If the system is unavailable or unknown

The dynamic routing program is invoked again if the remote system name that you specify on the route selection call is not known or is unavailable. When this happens, you have a choice of actions:

- You can tell CICS not to continue trying to route the transaction, by issuing a return code of '8' in DYRRETC. If the reason for the error is that the system is unavailable, CICS issues message 'DFHAC2014' or 'DFHAC2029' to the terminal user. If the reason for the error is that the system is unknown, DFHAPRT abends the transaction.
- You can tell CICS to terminate the transaction without issuing a message or abend by placing a return code of '4' in DYRRETC. However, note the above warning about setting return code '4'.
- If the reason for the error is that no sessions are immediately available to the remote system, you can reset field DYRQUEUE to 'Y' (it must previously have been set to 'N'—the request is **not** to be queued—for this error to occur), issue a return code of '0' in DYRRETC, and try to route the transaction again.

If you try to route the transaction again **without** resetting DYRQUEUE to 'Y' (and without changing the sysid), and the system is still unavailable, DFHDYP is reinvoked. If you then choose to set return code '8', CICS terminates the transaction with message 'DFHAC2030'.

- You can change the sysid, and issue a return code of '0' in DYRRETC to try to route the transaction again. Note that if you change the sysid, you may also need to supply a different remote transaction ID. You need to do this if, for example, the transaction has a different remote transaction name on each system.

A count of the times the routing program has been invoked for routing purposes for this transaction is passed in field DYRCOUNT. Use this count to help you decide when to stop trying to route the transaction.

Invoking the dynamic routing program at end of routed transactions

If you want your dynamic routing program to be invoked again when the routed transaction has completed, you must set the DYROPTER field in the communications area to 'Y' before returning control to CICS. You might want to do this, for example, if you are keeping a count of the number of transactions currently executing on a particular CICS region. However, during this reinvocation, the dynamic routing program should update only its own resources. This is because, at this stage, the final command to the terminal from the application program in the AOR may be pending, and the dynamic routing program is about to terminate.

Invoking the dynamic routing program on abend

If you have set DYROPTER to 'Y', and the routed transaction abends, the dynamic routing program is invoked again to notify it of the abend. You could use this invocation to initiate a user-defined program in response to the transaction abend.

If the routed transaction abends, the DFHAPRT program in the TOR:

1. Passes back a response to the CICS transaction manager indicating that a transaction abend has occurred
2. If the dynamic routing program requested to be reinvoked at termination of the transaction (by setting DYROPTER to 'Y' when invoked for routing), reinvokes the dynamic routing program
3. Returns to CICS transaction manager.

Modifying the initial terminal data

The dynamic routing program should **not** perform an EXEC CICS RECEIVE or an EXEC CICS GDS RECEIVE command, because this prevents the routed-to transaction from obtaining the initial terminal data.

The CICS relay program, DFHAPRT, places a *copy* of the user's initial terminal input into a separate buffer. This information includes SNA presentation services headers for APPC mapped and unmapped conversations. A pointer to this buffer (DYRBPNTNTR), and its length (DYRBLGTH), are provided in the communications area passed from DFHAPRT to the dynamic routing program.

Because the transaction profile has not been queried at this point, uppercase translation has not been performed on the input data unless UCTRAN(YES) is specified on the TYPETERM definition.

Sometimes you may want to modify the initial data input by the user. (It may be necessary to do this if, for example, you change the ID of the remote transaction, using field DYRTRAN of the communications area.) To modify the input data, your routing program should, when invoked for route selection:

1. Copy the input data pointed to by DYRBPNTNTR into a named variable, of length DYRBLGTH
2. Modify the data in the named variable
3. Use the INPUTMSG option of the EXEC CICS RETURN command to make the modified data available to the application program.

For guidance information about using INPUTMSG on EXEC CICS RETURN commands, see the other methods described in the *CICS Application Programming Guide*. For programming information about the INPUTMSG option, see the *CICS Application Programming Reference* manual.

Note: If, after modifying the input data, the dynamic routing program is reinvoked because an error occurs in routing to the selected transaction, it should “remember” that it has modified the original user-input.

Modifying the application's communications area

Sometimes you may want to modify the routed application's communications area. For example, if your routing program changes the ID of the remote transaction, it

dynamic transaction routing

may also need to change the input communications area passed to the routed application. Field DYRACMAA of the routing program's communications area enables you to do this; it is a pointer to the application's communications area.

Receiving information from a routed transaction

If your dynamic routing program chooses to be reinvoked at the end of a routed transaction, it can obtain information about the transaction by monitoring its output communications area and output TIOA.

Monitoring the output communications area

A routed transaction can pass information back to the dynamic transaction routing program in its output communications area. When invoked at transaction termination, your routing program can examine the output communications area (pointed to by DYRACMAA). The following is an example of how this facility could be used:

You have a CICSplex consisting of sets of functionally-equivalent TORs and AORs, and need to identify any intertransaction affinities that may affect transaction routing. You could use the Transaction Affinities Utility ⁷ to do this, but there are some affinities that the utility cannot detect (for example, those created by non-CICS functions). Also, some transactions may sometimes create affinities, and sometimes not.

However, the routed transactions themselves “know” when an affinity is created, and can communicate this to the dynamic transaction routing program. The routing program is then able to route such transactions accordingly.

Monitoring the output TIOA

When invoked at transaction termination, your routing program can examine the copy of the routed transaction's output TIOA pointed to by DYRBPNTNTR. This can be useful, for example, to guard against the situation where one AOR in a CICSplex develops software problems. These may be reported by means of a message to the end user, rather than by a transaction abend. If this happens, the routing program is unaware of the failure and cannot bypass the AOR that has the problem. By reading the output TIOA, your routing program can check for messages indicating specific kinds of failure, and bypass any AOR that is affected.

Some processing considerations

- Any of the EXEC CICS commands (except EXEC CICS RECEIVE—see “Modifying the initial terminal data” on page 555) can be issued from the routing program. You are likely to find the EXEC CICS INQUIRE CONNECTION and INQUIRE IRC commands particularly useful if you want to confirm that a link is available before routing a transaction. The EXEC CICS INQUIRE and SET commands are described in the *CICS System Programming Reference* manual.
- Although the routing program can issue any EXEC CICS command, you should consider carefully the effect of commands that alter protected resources, because changes to those resources may be committed or backed out inadvertently as a result of logic in the routed transaction. You should also consider carefully the effect of EXEC CICS SYNCPOINT and ABEND commands on APPC transaction routing.

7. For information about the Transaction Affinities Utility, see the *CICS Transaction Affinities Utility Guide*.

- If you want to keep information about how transactions are routed, it must be done in the user routing program, perhaps by writing the information to a temporary storage queue associated with this terminal.
- Several transactions can form a single conversation with the end user. At the start of the conversation, resources are allocated to record the state of the conversation. Because these resources are local to the system to which the first transaction in the conversation was routed, the routing program must be able to continue to route to this system until the end of the conversation.
- It is important to avoid creating “tangled daisychains”: for any transaction that is being dynamically routed, you must avoid routing back to a node that has previously been routed from.
- The dynamic routing program can be RMODE ANY but must be AMODE 31.

Unit of work considerations

Depending on the terminal type, the CICS relay program, the dynamic routing program, and the routed transaction may constitute a single unit of work. Any protected resources owned by the dynamic routing program could therefore be affected by the syncpoint activity of the routed transaction. This means that these resources may be committed or backed out inadvertently by the routed transaction. If you want to avoid this, you have to define the routing program’s resources as unprotected rather than protected.

Dynamic routing of DPL requests

For a program-link request to be eligible for dynamic routing, the remote program must either:

- Be defined to the local system as DYNAMIC(YES)

or

- Not be defined to the local system.

Note: If the program specified on an EXEC CICS LINK command is not currently defined, what happens next depends on whether program autoinstall is active:

- If program autoinstall is inactive, the dynamic routing program is invoked.
- If program autoinstall is active, the autoinstall user program is invoked. The dynamic routing program is then invoked only if the autoinstall user program:
 - Installs a program definition that specifies DYNAMIC(YES), or
 - Does not install a program definition.

See “Autoinstalling programs invoked by EXEC CICS LINK commands” on page 540.

As well as “traditional” CICS-to-CICS DPL calls instigated by EXEC CICS LINK PROGRAM commands, program-link requests received from outside CICS can also be dynamically routed. For example, all the following types of program-link request can be dynamically routed:

- Calls received from:
 - The CICS Web Interface

dynamic routing of DPL requests

- The CICS Gateway for Java™
- Calls from external CICS interface (EXCI) client programs
- External Call Interface (ECI) calls from any of the CICS Client workstation products
- Distributed Computing Environment (DCE) remote procedure calls (RPCs)
- ONC/RPC calls.

A program-link request received from outside CICS can be dynamically routed by:

- Defining the program to CICS Transaction Server for OS/390 as DYNAMIC(YES)
- Coding your dynamic routing program to route the request.

When the dynamic routing program is invoked

For eligible program-link requests, CICS invokes the dynamic routing program as follows:

- Before the linked-to program is executed, to either:
 - Obtain the SYSID of the region to which the link should be routed.

Note: The address of the caller's communications area (COMMAREA) is passed to the routing program, which can therefore route requests by COMMAREA contents if this is appropriate.
 - Notify the routing program of a statically-routed request. This occurs if the program is defined as DYNAMIC(YES)—or is not defined—but the caller specifies the name of a remote region on the SYSID option of the LINK command.

In this case, specifying the target region explicitly takes precedence over any SYSID returned by the dynamic routing program.
- If an error occurs in route selection—for example, if the SYSID returned by the dynamic routing program is unavailable or unknown, or the link fails on the specified target region—to provide an alternate SYSID. This process iterates until either the program-link is successful or the return code from the dynamic routing program is not equal to zero.

Special case—care!

If all the following are true, the route selection call fails *but the routing program is not reinvoked for a route selection error*:

1. The program is not defined on the local region.
2. Program autoinstall is not active on the local region.
3. On the route selection call, the routing program routes the link request to the local region.

Therefore, to dynamically route a program link request *that the routing program may route locally*, you should do either of the following:

1. Install a program definition on the local region, specifying DYNAMIC(YES).
2. Set program autoinstall active, using it to install a definition that specifies DYNAMIC(YES).

- After the link request has completed, if reinvocation was requested by the routing program.

- If an abend is detected after the link request has been shipped to the specified remote system, if reinvocation was requested by the routing program.

Figure 43 on page 551 shows the points at which the dynamic routing program is invoked.

Changing the target CICS region

The communications area passed to the dynamic routing program initially contains the system identifier (sysid) and netname of the default CICS region to which the link request is to be routed. These are derived from the value of the REMOTESYSTEM option of the installed program definition. If REMOTESYSTEM is not specified, or there is no program definition, the sysid and netname passed are those of the local CICS region.

The dynamic routing program can change the sysid and netname.⁸ If it does so when it is invoked for route selection, the region to which the link request is routed is determined as follows:

- The NETNAME and the SYSID are not changed.
CICS tries to route to the SYSID as originally specified in the communications area.
- The NETNAME is not changed, but the SYSID is changed.
CICS updates the communications area with the NETNAME corresponding to the new SYSID, and tries to route the request to the new SYSID.
- The NETNAME is changed, but the SYSID is not changed.
CICS updates the communications area with a SYSID corresponding to the new NETNAME, and tries to route the request to the new SYSID.
- The NETNAME is changed **and** the SYSID is changed.
CICS overwrites the communications area with a SYSID corresponding to the new NETNAME, and tries to route the request to that new SYSID.

If the NETNAME specified is invalid, or cannot be found, SYSIDERR is returned to the dynamic routing program—which may deal with the error by returning a different SYSID or NETNAME—see “If an error occurs in route selection” on page 561.

If the routing program changes the SYSID or NETNAME when it is invoked for notification, the changes have no effect.

Changing the program name

When the routing program is invoked for route selection or for notification of a program-link request, the DYRLPROG field in the communications area contains the name of the program to be linked, obtained using the following sequence:

1. From the REMOTENAME option of the installed program definition
2. If REMOTENAME is not specified, or there is no program definition, from the PROGRAM option of the EXEC CICS LINK command.

8. If the REMOTESYSTEM option of the program definition names a remote region, the routing program cannot route the request locally.

dynamic routing of DPL requests

When it is invoked for routing⁹ (not for notification of a statically-routed request), your routing program can, by overwriting the DYRLPROG field, specify that an alternative program is to be linked. You can specify a local or remote program, depending on the region to which the request is to be routed.

Care!

Be aware that, if you change the value of DYRLPROG, and the alternative program you choose is defined as DYNAMIC(YES), the dynamic routing program will be reinvoked for route selection.

Changing the transaction ID

A transaction identifier is always associated with each dynamic program-link request. CICS obtains the transaction ID using the following sequence:

1. From the TRANSID option on the LINK command
2. From the TRANSID option on the program definition
3. 'CSMI', the generic mirror transaction. This is the default if neither of the TRANSID options are specified.

When it is invoked for routing (not for notification of a statically-routed request), your routing program can change the remote transaction ID by overwriting the DYRTRAN field in the communications area.

Note: If you use CICSplex SM to route your program-link requests, the transaction ID becomes highly significant, because CICSplex SM's routing logic is transaction-based. CICSplex SM routes each DPL request according to the rules specified for its associated transaction.

The CICSplex SM system programmer can use the EYU9WRAM user-replaceable module to change the transaction ID associated with a DPL request.

Telling CICS whether to route or terminate a DPL request

When the routing program is invoked for routing, it can choose whether the link request should be routed or rejected. If you want the request to be routed, whether you have changed any values or not, return a zero value to CICS in field DYRRETC of the communications area. When you return control to CICS with return code zero, CICS first compares the returned SYSID with its own local SYSID:

- If the SYSIDs are the same (or the returned SYSID is blank) CICS executes the link request locally.
- If the two SYSIDs are not the same, CICS routes the request to the remote CICS region, using the returned program and transaction names.

To make CICS reject the link request, return a non-zero value. The program that issued the EXEC CICS LINK command receives a PGMIDERR condition, with a RESP2 value of 25.

Returning a value in DYRRETC has no effect when the routing program is invoked for notification or at termination of the request.

9. By "invoked for routing" we mean both "invoked for route selection" and "invoked because an error occurred in route selection".

If an error occurs in route selection

If an error occurs in route selection—for example, if the SYSID returned by the dynamic routing program is unavailable or unknown, or the link fails on the specified target region—the dynamic routing program is invoked again. When this happens, you have a choice of actions:

- You can tell CICS not to continue trying to route the request, by issuing a non-zero return code in DYRRETC.
- If the reason for the error is that no sessions are immediately available to the remote system, you can reset field DYRQUEUE to 'Y' (it must previously have been set to 'N'—the request is **not** to be queued—for this error to occur), issue a return code of '0' in DYRRETC, and try to route the request again.
- You can change the sysid, and issue a return code of '0' in DYRRETC to try to route the request again. Note that if you change the sysid, you may also need to supply a different remote program name or transaction ID.

A count of the times the routing program has been invoked for routing purposes for this request is passed in field DYRCOUNT. Use this count to help you decide when to stop trying to route the transaction.

Special case—care!

If all the following are true, the route selection call fails *but the routing program is not reinvoked for a route selection error*.

1. The program is not defined on the local region.
2. Program autoinstall is not active on the local region.
3. On the route selection call, the routing program routes the link request to the local region.

Therefore, to dynamically route a program link request *that the routing program may route locally*, you should do either of the following:

1. Install a program definition on the local system, specifying DYNAMIC(YES).
2. Set program autoinstall active, using it to install a definition that specifies DYNAMIC(YES).

Invoking the dynamic routing program at end of routed requests

If you want your dynamic routing program to be invoked again when the routed request has completed, you must set the DYROPTER field in the communications area to 'Y' before returning control to CICS. You might want to do this, for example, if you are keeping a count of the number of link requests currently executing on a particular CICS region.

If you have set DYROPTER to 'Y', and the linked program abends, the dynamic routing program is invoked to notify it of the abend.

Modifying the application's input communications area

Sometimes you may want to modify the routed application's communications area. For example, if your routing program changes the name of the remote program, it may also need to change the input communications area passed to the program. Field DYRACMAA of the routing program's communications area enables you to do

dynamic routing of DPL requests

this; it is a pointer to the application's communications area (or null, if no communications area was specified on the LINK command).

Monitoring the application's output communications area

A routed application can pass information back to the dynamic transaction routing program in its output communications area. If your dynamic routing program chooses to be reinvoked at the end of a routed DPL request, it can examine the output communications area (if any) pointed to by DYRACMAA.

Some processing considerations

- When invoked for program-link requests, the dynamic routing program should restrict its use of EXEC CICS commands to those in the DPL subset. For information about which commands constitute the DPL subset, see the *CICS Application Programming Reference* manual.
- Although the routing program can issue any EXEC CICS command in the DPL subset, you should consider carefully the effect of commands that alter protected resources, because changes to those resources may be committed or backed out inadvertently as a result of logic in the routed program.
- If you want to keep information about how link requests are routed, it must be done in the user routing program, perhaps by writing the information to a temporary storage queue.
- It is important to avoid creating "tangled daisychains": for any program-link request that is being dynamically routed, you should avoid routing back to a node that has previously been routed from. For definitive information about the "daisy-chaining" of DPL requests, see the *CICS Intercommunication Guide*.
- The dynamic routing program can be RMODE ANY but must be AMODE 31.

Unit of work considerations

The client program, the dynamic routing program, and possibly the server program constitute a single unit of work. Any recoverable resources owned by the dynamic routing program could therefore be affected by the syncpoint activity of the client program. This means that these resources may be committed or backed out inadvertently by the client program. If you want to avoid this, you have to define the routing program's resources as non-recoverable.

For information about the syncpoint activity of DPL client and server programs, see the *CICS Intercommunication Guide*.

Parameters passed to the dynamic routing program

Figure 45 on page 563 shows all the parameters passed from DFHAPRT, the CICS relay program, to the dynamic routing program by means of a communications area. The communications area is mapped by the copy book DFHDYPDS, which is in the appropriate CICS library for all the supported programming languages.

parameters passed to DFHDYP

	DS	0CL4	Standard header
DYRFUNC	DS	CL1	Function code
DYRCOMP	DS	CL2	Component code
DYRFILL1	DS	CL1	Reserved
DYRERROR	DS	CL1	Route selection error code
DYROPTER	DS	CL1	Transaction termination option
DYRQUEUE	DS	CL1	Queue-the-request indicator
DYRFILL2	DS	CL1	Reserved
DYRRETC	DS	F	Return code
DYRSYSID	DS	CL4	Default/Selected sysid
DYRVER	DS	H	Version of the interface
DYRTYPE	DS	CL1	Type of routing request
DYRFILL3	DS	H	Reserved
DYRTRAN	DS	CL8	Default/Selected remote tranid
DYRCOUNT	DS	F	Number of invocations count
DYRBPNTN	DS	F	Address of input buffer
DYRBLGTH	DS	F	Length of input buffer
DYRRTPRI	DS	CL1	Pass priority to AOR?
DYRFILL4	DS	CL1	Reserved
DYRPRTY	DS	H	Dispatch priority passed to AOR
DYRNETNM	DS	CL8	Netname matching sysid
DYRLPROG	DS	CL8	Run this program if routed locally
DYRDTRXN	DS	CL1	DTRTRAN indicator
DYRDTRRJ	DS	CL1	DTRTRAN reject?
DYRFILL5	DS	CL2	Reserved
DYRSRCK	DS	XL4	MVS WLM source token
DYRABNLC	DS	XL4	Abnormal event code
DYRABCDE	DS	CL4	Transaction abend code
DYRCABP	DS	CL1	Continue abend processing?
DYRFILL6	DS	CL1	Reserved
DYRFILL7	DS	CL2	Reserved
DYRACMAA	DS	F	Address of applications's commarea
DYRACMAL	DS	F	Length of application's commarea
* THE FOLLOWING 7 FIELDS APPLY ONLY TO BTS TRANSACTIONS			
DYRCBTS	DS	0CL176	
DYRPROCN	DS	CL36	BTS process name
DYRPROCT	DS	CL8	BTS process-type
DYRACTN	DS	CL16	BTS activity name
DYRACTID	DS	CL52	BTS activity ID
DYRPROCID	DS	CL52	BTS process ID
DYRACTCMP	DS	CL1	BTS activity completing?
DYRPROCCMP	DS	CL1	BTS process completing?
DYRFILL8	DS	CL2	Reserved
DYRFILL9	DS	CL8	Reserved
DYRUAPTR	DS	F	Address of user area
DYRUSER	DS	CL1024	User area

Figure 45. The communications area passed to a dynamic routing program

parameters passed to DFHDYP

Important

The same communications area is passed to both the dynamic routing program and the distributed routing program. Some parameters are meaningful to one routing program but not to the other. Some parameter-values may be passed to one routing program but never to the other. The following list describes in detail only the parameters that are significant to the dynamic routing program; parameter-values that are never passed to the dynamic routing program are not listed. For example, under the DYRFUNC parameter the value X'5' is not listed because it is never passed to the dynamic routing program—it occurs only on a route initiate call to the distributed routing program.

If you use the same program as both a dynamic routing program and a distributed routing program, for descriptions of the parameters and values that are significant on distributed routing calls refer to “Parameters passed to the distributed routing program” on page 585.

DYRABCDE

is the abend code returned when a routed transaction or program-link request abends.

DYRABNLC

is an abnormal event code, or null.

This field is significant when the dynamic routing program is invoked for termination of a routed request. Any value other than null indicates that an abnormal event, *other than a transaction abend*, has occurred in the region to which the request was routed. Your routing program should not route further requests to the same region until the cause of the error has been investigated and rectified.

This field is intended for use by CICSplex SM.

DYRACMAA

is the 31-bit address of the routed application's communications area. If there is no communications area, this field is set to null.

When your dynamic routing program is invoked for routing (DYRFUNC=0), the address is that of the input communications area (if any). Likewise, when your routing program is invoked because of a route-selection error or for notification (DYRFUNC=1 and 3, respectively), the address is that of the input communications area.

When your routing program is invoked because a previously-routed transaction or link request has terminated normally (DYRFUNC=2), the address is that of the output communications area (if any). Routed applications can use their output communications area to pass information to the dynamic routing program—see “Receiving information from a routed transaction” on page 556 and “Monitoring the application's output communications area” on page 562.

When your routing program is invoked because the routed transaction has abended (DYRFUNC=4), the information in the communications area is not meaningful.

parameters passed to DFHDYP

Your routing program can alter the data in the application's communications area.

DYRACMAL

is the length of the routed-to application's communications area. If there is no communications area, this field is set to zero.

DYRACTCMP

is not used by the dynamic routing program. On invocation, it is set to nulls.

DYRACTID

is not used by the dynamic routing program. On invocation, it is set to nulls.

DYRACTN

is not used by the dynamic routing program. On invocation, it is set to nulls.

DYRBLGTH

is the length of the copy of the TIOA/LUC buffer.

This field applies only to dynamic transaction routing (not to the the routing of program-link requests).

DYRBPNTR

is the 31-bit address of a copy of the TIOA/LUC buffer.

This field applies only to dynamic transaction routing (not to the the routing of program-link requests).

When your dynamic routing program is invoked for routing, because of a route-selection error, or for notification (DYRFUNC=0, 1, and 3, respectively), it is given a copy of the input TIOA. Your routing program can alter the terminal input data passed to the routed transaction—see “Modifying the initial terminal data” on page 555.

When your routing program is invoked because a previously-routed transaction has terminated normally (DYRFUNC=2), it is given a copy of the output TIOA. Your routing program can monitor the output TIOA to detect possible problems in the AOR—see “Receiving information from a routed transaction” on page 556.

DYRCABP

indicates whether or not you want CICS to continue standard abend processing.

Note: This field applies only to dynamic transaction routing, not to the the routing of program-link requests. (If a linked-to program abends on a remote region, the abend is mirrored in the local region—that is, it is passed to the program that issued the EXEC CICS LINK command.)

The possible values are:

Y Continue with CICS abend processing.

N Terminate the transaction, do not continue with CICS abend processing, and give control to the program specified by DYRLPROG.

This option enables you to pass control to a local program that can handle the condition in your own way, and issue appropriate messages to terminal users.

If you enter N, you must ensure that DYRLPROG specifies the name of a valid program on the local system.

parameters passed to DFHDYP

There is no default value.

DYRCOMP

is the CICS component code. For calls to the dynamic routing program, it is always set to 'RT'.

DYRCOUNT

is a count of the times the dynamic routing program has been invoked for this transaction or link request with DYRFUNC set to '0', '1', or '3'. This field allows you to limit the number of times your program tries to route a request.

DYRDTRRJ

indicates whether the transaction, which is defined by the common transaction definition specified on the DTRTRAN system initialization parameter, is to be rejected, or accepted for processing.

This field applies only to dynamic transaction routing (not to the the routing of program-link requests), and is only relevant when DYRTRXN is set to Y.

The possible values are:

- Y** The transaction is rejected. This is the default.
- N** The transaction is not rejected.

This indicator is always set to the reject condition when the dynamic routing program is invoked. To dynamically route a transaction defined by the DTRTRAN definition, you must change this to the accept condition.

If you reject the transaction, message DFHAC2001—"Transaction '*tranid*' is unrecognized"—is sent to the user's terminal.

DYRDTRXN

indicates whether the transaction to be routed is defined by the common transaction definition specified on the DTRTRAN system initialization parameter, or by a specific transaction definition.

This field applies only to dynamic transaction routing (not to the the routing of program-link requests).

The possible values are:

- Y** The transaction is defined by the definition specified by the system initialization parameter DTRTRAN. That is, there is no resource definition for the input transaction identifier (id).

The transaction is initiated in the terminal-owning region using the transaction id specified by the system initialization parameter, DTRTRAN. The input transaction id is passed to the dynamic routing program in the DYRTRAN field.

- N** The transaction is not defined by the definition specified by the system initialization parameter, DTRTRAN. There is an installed resource definition for the input transaction id.

The transaction is initiated in the terminal-owning region using the input transaction id. The transaction id passed to the dynamic routing program in the DYRTRAN field is the remote transaction id from the transaction resource definition (if this is different from the input transaction id).

parameters passed to DFHDYP

For an explanation of the DTRTRAN system initialization parameter, see the *CICS System Definition Guide*.

DYRERROR

has a value only when DYRFUNC is set to '1'. It indicates the type of error that occurred during the last attempt at route selection. The possible values are:

- 0** The selected sysid is unknown.
- 1** The selected system is not in service.
- 2** The selected system is in service, but no sessions are available.
- 3** An allocate request has been rejected, and SYSIDERR returned to the application program. This error occurs for one of the following reasons:
 - 1. An XZIQUE global user exit program requested that the allocate be rejected, or
 - 2. CICS rejected the allocate request automatically because the QUEUELIMIT value specified on the CONNECTION resource definition has been reached.
- 4** A queue of allocate requests has been purged, and SYSIDERR returned to all the waiting application programs. This error occurs for one of the following reasons:
 - 1. An XZIQUE global user exit program requested that the queue be purged, or
 - 2. CICS purged the queue automatically because the MAXQTIME limit specified on the CONNECTION resource definition has been reached.
- 5** The selected system does not support this function. This occurs if the routing program tries to:
 - 1. Route a transaction initiated by an EXEC CICS START command to a pre-CICS TS Release 3 region, or to a CICS TS Release 3 region that is not connected by an MRO or APPC parallel-session link.
 - 2. Route a program-link request across an LU6.1 connection.

The following values all apply to attempts to route program-link requests. For the meanings of these error conditions, see the *CICS Application Programming Reference* manual.

- 6** The EXEC CICS LINK command returned LENGERR.
- 7** The EXEC CICS LINK command returned PGMIDERR.
- 8** The EXEC CICS LINK command returned INVREQ.
- 9** The EXEC CICS LINK command returned NOTAUTH.
- A** The EXEC CICS LINK command returned TERMERR.
- B** The EXEC CICS LINK command returned ROLLEDBACK.

DYRFUNC

tells you the reason for this invocation of the dynamic routing program. The possible values are:

- 0** Invoked for route selection.
- 1** Invoked because an error occurred in route selection.

parameters passed to DFHDYP

- 2 Invoked because a previously routed transaction or program-link request has terminated successfully.
- 3 Invoked for notification of the destination of a statically-routed request. This applies in the following cases:

ATI requests

A transaction defined as DYNAMIC(YES) has been initiated by a terminal-related automatic transaction initiation (ATI) request—for example, by the expiry of an interval control start request—but the transaction is ineligible for dynamic routing.

For information about which transactions initiated by terminal-related EXEC CICS START commands are eligible for dynamic routing, see the *CICS Intercommunication Guide*.

Program-link requests

The program is defined as DYNAMIC(YES)—or is not defined—but the caller specified the name of a remote region on the SYSID option of the EXEC CICS LINK command.

In this case, specifying the target region explicitly takes precedence over any SYSID returned by the dynamic routing program.

- 4 Invoked because the routed transaction abended.

The DYRTYPE field tells you the type of routing or notification request.

DYRLPROG

is the name of the initial program of the transaction to be routed; or the name of the program specified on the link command to be routed.

Transaction routing

You can use this field to specify the name of an alternative program to be run if the transaction is routed locally. For example, if all remote CICS regions are unavailable, and the transaction cannot be routed, you may want to run a program in the local terminal-owning region to send an appropriate message to the user.

Note: DYRLPROG must not be set to blanks when you specify DYRCABP=N. If you specify DYRCABP=N, ensure you also specify a valid program name on DYRLPROG.

Program-link requests

When DYRFUNC is '0' or '3', DYRLPROG contains the name of the program to be linked, obtained using the following sequence:

1. From the REMOTENAME option of the installed program definition
2. If REMOTENAME is not specified, or there is no program definition, from the PROGRAM option of the EXEC CICS LINK command.

You can use this field to specify that an alternative program, other than that named on the program-link request, is to be linked. You can specify a local or remote program, depending on the region to which the request is to be routed.

Note: Be aware that, if you change the value of DYRLPROG, and the alternate program you choose is defined as DYNAMIC(YES), the dynamic routing program will be reinvoked for route selection.

parameters passed to DFHDYP

You can change DYRLPROG on any call to the dynamic routing program, but it is effective only when DYRFUNC is '0' or '1'.

DYRNETNM

is the netname of the CICS region identified in DYRSYSID.

If the DYRNETNM value is changed by the initial invocation of the dynamic routing program, CICS tries to route the request to the CICS region with the new netname.

DYROPTER

specifies whether the dynamic routing program is to be reinvoked when the routed transaction or link request terminates (successfully or unsuccessfully). The possible values are:

N The dynamic routing program is not to be reinvoked. This is the default.

Y The dynamic routing program is to be reinvoked.

You can specify this option for transactions or link requests that are routed to remote CICS regions and also for those that are executed locally.

DYRPROCCMP

is not used by the dynamic routing program. On invocation, it is set to nulls.

DYRPROCID

is not used by the dynamic routing program. On invocation, it is set to nulls.

DYRPROCN

is not used by the dynamic routing program. On invocation, it is set to nulls.

DYRPROCT

is not used by the dynamic routing program. On invocation, it is set to nulls.

DYRPRTY

can be used to set the dispatch priority of the task in the application-owning region, if the connection between the terminal-owning region and application-owning region is MRO.

Transaction routing

Before invoking the dynamic routing program, CICS sets this value to '0' (zero).

Program-link requests

Before invoking the dynamic routing program, CICS sets this value to the priority of the task that issued the program-link request.

On return from the initial invocation of the dynamic routing program, if the DYRRTPRI value is 'Y' CICS passes the DYPPRTY value to the application-owning region.

DYRQUEUE

identifies whether or not the request is to be queued if no sessions are immediately available to the remote system identified by DYRSYSID. The possible values are:

Y The request is to be queued if necessary. This is the default.

N The request is not to be queued.

DYRRETC

contains a return code that tells CICS how to proceed.

parameters passed to DFHDYP

Transaction routing

The possible values are:

- 0** Continue processing the transaction.
- 4** Terminate the transaction without message or abend.
- 8** Terminate the transaction with either a message or an abend.

Whenever the routing program is invoked, DYRRETC is set to '0'. When it is invoked for route selection or because an error occurs in route selection, if you want CICS to continue processing the transaction, you must leave it set to '0'.

To make CICS terminate the transaction (issuing a message or abend), return a value of '8'.

To make CICS terminate the transaction without issuing a message or abend (indicating that DFHDYP has done all the processing that is necessary), return a value of '4'.

Notes:

1. Setting a return code of '4' for APPC transaction routing leads to unpredictable results, and should be avoided.
2. Setting any non-zero return code other than X'4' is equivalent to setting X'8'.

Program-link requests

The possible values are:

- 0** Continue processing the link request.

Non-zero

Return an error condition to the program.

Whenever the routing program is invoked, DYRRETC is set to '0'. When it is invoked for route selection or because an error occurs in route selection, if you want CICS to continue processing the link request, you must leave it set to '0'.

To make CICS reject the link request, return a non-zero value. The program that issued the EXEC CICS LINK command receives a PGMIDERR condition, with a RESP2 value of 27.

You do not need to set a return code when the routing program is invoked for notification or at transaction termination. (Any code you set is ignored by CICS.)

DYRRTPRI

indicates whether or not the dispatch priority of the transaction or link request should be passed to the application-owning region, if the connection between the terminal-owning region and the application-owning region is MRO. The possible values are:

- N** The dispatch priority is not passed. This is the default.
- Y** The dispatch priority is passed.

DYRSRCTK

is the MVS workload management service and reporting class token for the routed transaction.

DYRSYSID

is the system identifier (sysid) of a CICS region. The exact meaning of this parameter depends on the values of DYRFUNC and DYRTYPE:

- When DYRFUNC is set to '0' (route selection):
 - If DYRTYPE is set to '0', '2', or '3' (any type of transaction routing), DYRSYSID contains:
 - The CICS region name specified on the REMOTESYSTEM option of the installed transaction definition, or,
 - If REMOTESYSTEM is not specified, the system name of the local CICS region.
 - If DYRTYPE is set to '4' (DPL routing), DYRSYSID contains one of the following:
 - The CICS region name specified on the REMOTESYSTEM option of the installed program definition.

Note: If the REMOTESYSTEM option names a remote region, the routing program cannot route the request locally.

- If REMOTESYSTEM is not specified, or there is no program definition, the system name of the local CICS region.

The dynamic routing program can accept the value of DYRSYSID or change it before returning to CICS.

If the SYSID you return to CICS is the same as the local sysid, CICS runs the transaction or program in the local region.

- When DYRFUNC is set to '1' (route selection error), DYRSYSID contains the CICS region name returned to CICS by the dynamic routing program on its previous invocation.

The action your dynamic routing program can take when DYRFUNC=1 depends on the DYRERROR parameter setting:

- If DYRERROR is set to '0' (unknown sysid) or '1' (CICS region not in service) and you want CICS to retry routing, you must change DYRSYSID before returning to CICS.
- If DYRERROR is set to '2' (no session available) and you want CICS to retry routing, you must change DYRSYSID or change the value of DYRQUEUE to 'Y' (queue the request until a session is available).
- When DYRFUNC is set to '2' (termination of a routed request), DYRSYSID contains the name of the CICS region on which the completed transaction or link request executed.
- When DYRFUNC is set to '3' (notification):
 - For **ATI requests**, DYRSYSID contains:
 - The remote CICS region name specified on the SYSID option of the EXEC CICS START command, or
 - If SYSID is not specified, the remote CICS region name specified on the REMOTESYSTEM option of the installed transaction definition, or
 - If REMOTESYSTEM is not specified, the system name of the local CICS region.
 - For **program-link requests**, DYRSYSID contains the remote CICS region name specified on the SYSID option of the EXEC CICS LINK command.

Any changes to the value of DYRSYSID, or to DYRNETNAME, are ignored.

parameters passed to DFHDYP

- When DYRFUNC is set to '4' (abend), DYRSYSID contains the name of the CICS region on which the transaction abended.

DYRTRAN

contains the remote transaction id.

Transaction routing

When DYRFUNC is set to '0' or '3', DYRTRAN contains the remote transaction id specified on the REMOTENAME option of the installed transaction definition.

Program-link requests

When DYRFUNC is set to '0' or '3', DYRTRAN contains the remote transaction id obtained using the following sequence:

1. From the TRANSID option on the LINK command
2. From the TRANSID option on the program definition
3. 'CSMI', the generic mirror transaction. This is the default if neither of the TRANSID options are specified.

Your dynamic routing program can accept this remote transaction id, or supply a different transaction name for forwarding to the remote CICS region. If the supplied name is longer than four characters, it is truncated by CICS.

You can change DYRTRAN on any call to the dynamic routing program, though it is effective only when DYRFUNC is set to '0' or '1'.

DYRTYPE

is the type of routing request for which the program is being invoked. For transaction routing, this field is meaningful only when DYRFUNC is set to '0' (route selection) or '3' (notify). The possible values are:

- 0** For routing a transaction initiated from a terminal.
- 1** For notification that an ATI request is to be statically routed.
- 2** For routing a transaction initiated by a terminal-related EXEC CICS START command, where there is no data associated with the START.
- 3** For routing a transaction initiated by a terminal-related EXEC CICS START command, where there is data associated with the START.
- 4** For routing, notification, or termination of a program-link request. (Whenever the dynamic routing program is invoked for a program-link request, DYRTYPE is set to '4'.)

DYRUAPTR

is the address of the user area (DYRUSER).

DYRUSER

is a 1024-byte user area.

CICS initializes this user area to zeroes before invoking the dynamic routing program for a given task. This user area can be modified by the dynamic routing program; the modified area is passed to subsequent invocations of the dynamic routing program for the same request.

DYRVER

is the version number of the dynamic routing program interface. For CICS Transaction Server for OS/390 Release 3, the number is "5".

Naming your dynamic routing program

The supplied, user-replaceable dynamic routing program is named DFHDYP. If you write your own version, you can name it differently.

After the system has been loaded, to find the name of the dynamic routing program currently identified to CICS, use the EXEC CICS INQUIRE SYSTEM command. Field DTRPROGRAM contains the name of the current program.

The default is DFHDYP.

To change the current program:

- Use the DTRPGM system initialization parameter. For more guidance information about how to do this, refer to the *CICS System Definition Guide*.
- Make the change online using the EXEC CICS SET SYSTEM DTRPROGRAM command. For programming information about this command, refer to the *CICS System Programming Reference* manual.

Note: A sample definition is provided for DFHDYP, but you must install a new resource definition for a customized dynamic routing program.

Testing your dynamic routing program

You can use the CICS execution diagnostic facility (EDF) to test your dynamic routing program. To do so, you must name your program something other than DFHDYP, because you cannot use EDF for programs that begin with “DFH”. For details of how to use EDF, see the *CICS Application Programming Guide*.

You can use EDF in either single- or dual-terminal mode. If you choose single-terminal mode, EDF displays screens for both the dynamic routing program and the application program that is invoked by the routed transaction. The screens relate to:

- The initial invocation of the dynamic routing program for route selection or notification (DYRFUNC=0 or DYRFUNC=3)
- The invocation of the dynamic routing program if an error occurs in route selection (DYRFUNC=1)
- The invocation of the application program
- The termination of the task
- The invocation of the dynamic routing program at termination of the routed transaction or link request (DYRFUNC=2), if you have specified DYROPTER=Y
- The invocation of the dynamic routing program if the routed transaction abends (DYRFUNC=4), if you have specified DYROPTER=Y.

If you want EDF to display the execution of your dynamic routing program only, either choose dual-terminal mode, or use one of the other methods described in the *CICS Application Programming Guide*.

Dynamic transaction routing sample programs

The CICS-supplied sample dynamic routing program is named DFHDYP. The corresponding copy book that defines the communications area is DFHDYPDS. There are assembler-language, COBOL, PL/I, and C source-level samples and copy books. The supplied programs and copy books, and the CICSTS13.CICS libraries in which they can be found, are summarized in Table 28.

Table 28. Dynamic transaction routing programs and copy books

Language	Member name	Library
Programs:		
Assembler	DFHDYP	SDFHSAMP
COBOL	DFHDYP	SDFHCOB
PL/I	DFHDYP	SDFHPL1
C/370	DFHDYP	SDFHC370
Copy books:		
Assembler	DFHDYPDS	SDFHMAC
COBOL	DFHDYPDS	SDFHCOB
PL/I	DFHDYPDS	SDFHPL1
C/370	DFHDYPDS	SDFHC370

You can write your own dynamic routing program in VS COBOL II, PL/I, C, or assembler language, and you can change the name of the program.

When invoked with DYRFUNC set to '0', the sample programs accept the sysid and remote transaction name that are passed in fields DYRSYSID and DYRTRAN of the communications area, and set DYRRETC to '0' before returning to CICS. When invoked with DYRFUNC set to '2' or '3', they set a return code of '0'. When invoked with DYRFUNC set to '1' or '4', they set a return code of '8'.

If you want to route transactions or DPL requests dynamically, you must customize DFHDYP, replace it completely with your own routing program, or use CICSplex SM.

Chapter 17. Writing a distributed routing program

Considerations common to all user-replaceable programs

Note that the comments contained in “Chapter 5. General notes about user-replaceable programs” on page 401 apply to this chapter.

This chapter describes the CICS default distributed routing program and tells you how to write your own version. It assumes you are familiar with the principles of dynamic and distributed routing described in the *CICS Intercommunication Guide*, and that you have read the *CICS Business Transaction Services* manual.

You can use the distributed routing program to route:

- CICS business transaction services (BTS) processes and activities
- Non-terminal-related EXEC CICS START requests.

For detailed information about which non-terminal-related START requests are eligible for distributed routing, see the *CICS Intercommunication Guide*.

Notes:

1. You cannot use the *distributed* routing program—that is, the program named on the DSRTPGM system initialization parameter—to route:
 - Transactions initiated from user terminals
 - Transactions initiated by terminal-related EXEC CICS START commands
 - Program-link requests.

To route these, you must use the *dynamic* routing program named on the DTRPGM system initialization parameter. How to write a dynamic routing program is described in “Chapter 16. Writing a dynamic routing program” on page 549.

2. The dynamic routing program and the distributed routing program may, of course, be the same program.

Important

If you use the CICSplex System Manager (CICSplex SM) product to manage your CICSplex, you may not need to write a distributed routing program. CICSplex SM provides a fully-functioning routing program that supports workload balancing and workload separation. All you have to do is to tell CICSplex SM, through its user interface, which regions in the CICSplex can participate in the workload, and define any transaction affinities that govern the regions to which particular requests must be routed. For introductory information about CICSplex SM, see the *CICSplex SM Concepts and Planning* manual.

The rest of the chapter is divided into the following sections:

1. “**Differences from the dynamic routing interface**” on page 576
2. “**Distributed routing of BTS activities**” on page 577
3. “**Routing of non-terminal-related START requests**” on page 581
4. “**Parameters passed to the distributed routing program**” on page 585
5. “**Naming your distributed routing program**” on page 593

the distributed routing program

6. “Distributed transaction routing sample programs” on page 593.

Differences from the dynamic routing interface

This section discusses some significant ways in which the distributed routing interface differs from the dynamic routing interface. If you have previously written a dynamic routing program, and are about to write a distributed routing program, bear in mind that:

1. The dynamic routing program is only invoked if the resource (the transaction or program) is defined as DYNAMIC(YES). The distributed routing program, on the other hand, is invoked (for BTS activities that are run asynchronously and eligible non-terminal-related START requests) even if the associated transaction is defined as DYNAMIC(NO); though it cannot route the request. What this means is that the distributed routing program is better able to monitor the effect of statically-routed requests on the relative workloads of the target regions.
2. Because the dynamic routing program uses the hierarchical “hub” routing model—one routing program controls access to resources on several target regions—the *routing program that is invoked at termination of a routed request is the same program that was invoked for route selection*.

The distributed routing program, on the other hand, uses the distributed model, which is a peer-to-peer system; the routing program itself is distributed. *The routing program that is invoked at initiation, termination, or abend of a routed transaction is not the same program that was invoked for route selection—it is the routing program on the target region.*

Because the dynamic routing program is invoked only on the requesting region, the order of its invocations is strictly defined:

- a. Route selection or notification
- b. Route selection error (if appropriate, and possibly repeated)
- c. Transaction termination or abend (if requested).

For a single request, the user area passed to each invocation of the dynamic routing program is the same piece of storage; any modifications made to the user area on one invocation are retained and passed to the next invocation.

The distributed routing program, on the other hand, may be invoked on the target region as well as on the requesting region; because of this, the order of its invocations is less strictly defined. For example, the final invocation on the requesting region (for “routing attempt complete”) may occur before or after the first invocation on the target region (for “transaction initiation”). To cope with this uncertainty, the user area passed to the distributed routing program on its first invocation on the target region is a *copy* of the user area on the requesting region. This means that any modifications to the user area made on the target region have no effect on the user area in the requesting region. For more details, see the description of the DYRUSER field of the communications area on page 592.

3. The distributed routing program is invoked at more points than the dynamic routing program. Figure 46 on page 578 shows the points at which the distributed routing program is invoked, and the region on which each invocation occurs.
4. Unlike the dynamic routing program, the distributed routing program **cannot**:

differences from the dynamic routing interface

- Select a target region by supplying a netname (any value set in the DYRNETNM field of the communications area is ignored). The target must be specified by its CICS system identifier (sysid).
- Change the remote transaction name passed to the target region. (Any value set in the DYRTRAN field of the communications area is ignored.)
- Change the initial program associated with a routed request. (Any value set in the DYRLPROG field of the communications area is ignored).
- Choose that the request is not to be queued if there are no MRO sessions to the target region. (The DYRQUEUE field of the communications area is always set to 'Y'.)
- Modify the routed application's communications area. (The routing program is not passed the address of the routed application's communications area in field DYRACMAA.)
- Pass the dispatch priority of the transaction to the target region. (The DYRRTPRI field of the communications area is always set to 'N'.)

These restrictions are documented more fully in the descriptions of the relevant fields in the DFHDYPDS communications area.

Distributed routing of BTS activities

This section describes how to use a distributed routing program to dynamically route CICS business transaction services (BTS) processes and activities. It assumes that you have read the introduction to the distributed routing of BTS processes and activities in the *CICS Business Transaction Services* manual.

Which BTS activities can be dynamically routed?

Not all activations of BTS processes and activities can be routed.

Processes and activities that are activated asynchronously with the requestor—by means of a RUN ASYNCHRONOUS command—can be routed either dynamically or statically.

Processes and activities that are activated synchronously with the requestor—by means of a RUN SYNCHRONOUS or LINK command—are always run locally. They cannot be routed, *neither dynamically nor statically*. A RUN SYNCHRONOUS or LINK command issued against an activity whose associated transaction is defined as DYNAMIC(YES), or as residing on a remote region, results in the activity being run locally.

Thus, to be eligible for dynamic routing:

1. A BTS process or activity must be run asynchronously with the requestor, by means of a RUN ASYNCHRONOUS command.
2. The TRANSACTION definition for the transaction associated with the process or activity must specify DYNAMIC(YES).

“Daisy-chaining” is not supported. That is, once a BTS activity has been routed to a target region it cannot be re-routed from the target to a third region, even though its associated transaction is defined as DYNAMIC(YES).

routing BTS activities

When the distributed routing program is invoked

For BTS processes and activities started by RUN ASYNCHRONOUS commands, CICS invokes the distributed routing program at the following points:

On the requesting region:

1. Either of the following:
 - For routing the activity. This occurs when the transaction associated with the activity is defined as DYNAMIC(YES).
 - For notification of a statically-routed request. This occurs when the transaction associated with the activity is defined as DYNAMIC(NO). The routing program is not able to route the activity. It could, however, do other things.
2. If an error occurs in route selection—for example, if the target region returned by the routing program on the route selection call is unavailable. This gives the routing program the opportunity to specify an alternate target. This process iterates until the routing program selects a target that is available or sets a non-zero return code.
3. After CICS has tried (successfully or unsuccessfully) to route the activity to the target region.

This invocation signals that (unless the requesting region and the target region are one and the same) the requesting region's responsibility for this transaction has been discharged. The routing program might, for example, use this invocation to release any resources that it has acquired on behalf of the transaction.

On the target region:

These invocations occur only if the routing program on the requesting region has specified that it should be reinvoked on the target region:

1. When the activation starts on the target region (that is, when the transaction that implements the activity starts).
2. If the routed activation (transaction) ends successfully.
3. If the routed activation (transaction) abends.

Figure 46 shows the points at which the distributed routing program is invoked, and the region on which each invocation occurs. Note that the “target region” is not necessarily remote—it could be the local (requesting) region, if the routing program chooses to run the activity locally.

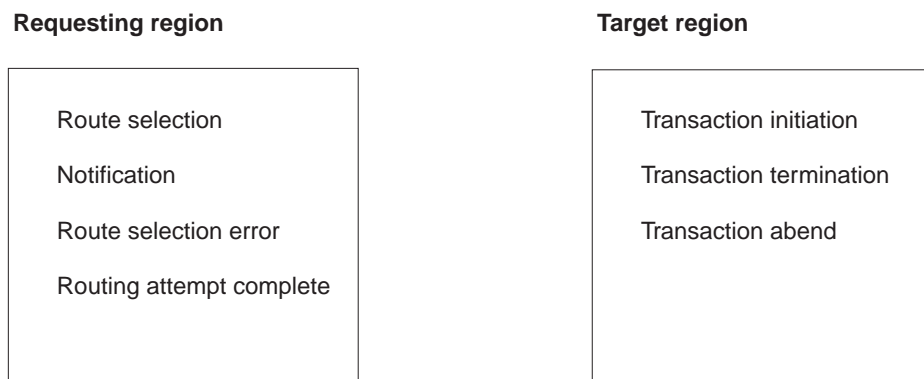

Figure 46. When and where the distributed routing program is invoked

Changing the target CICS region

The DYRSYSID field of the communications area passed to the distributed routing program initially contains the system identifier (sysid) of the default target region to which the process or activity is to be routed. This is derived from the value of the REMOTESYSTEM option of the installed transaction definition on the requesting region. If REMOTESYSTEM is not specified, the sysid passed is that of the local CICS region.

When it is invoked for route selection, the distributed routing program can change the target region by changing the value in DYRSYSID.

If the specified sysid is invalid, or cannot be found, SYSIDERR is returned to the distributed routing program—which may deal with the error by returning a different sysid—see “If an error occurs in route selection”.

If the routing program changes the sysid when it is invoked for notification, routing complete, transaction initiation, transaction termination, or abend, the change has no effect.

Telling CICS whether to route the activity

When the routing program is invoked for routing, if you want the process or activity to be routed (whether you have changed any values or not) return a zero value to CICS in field DYRRETC of the communications area. When you return control to CICS with return code zero, CICS first compares the returned sysid with its own local sysid:

- If the sysids are the same (or the returned sysid is blank) CICS executes the RUN request locally. When it executes the request locally, CICS writes message DFHSH0102 to the CSSH transient data queue.
- If the two sysids are not the same, CICS routes the request to the remote CICS region.

If you want CICS to treat the request as *unserviceable*, return a non-zero value. For information about unserviceable requests, see the *CICS Business Transaction Services* manual.

Returning a value in DYRRETC has no effect when the routing program is invoked for notification, routing complete, transaction initiation, transaction termination, or abend.

If an error occurs in route selection

If an error occurs in route selection—for example, if the sysid returned by the distributed routing program is unavailable or unknown—the distributed routing program is invoked again. When this happens, you have a choice of actions:

1. You can try to route the request to a different target region, by changing the sysid, and issuing a return code of '0' in DYRRETC.

If this region too is unavailable, the routing program is again invoked for a route selection error. A count of the times the routing program has been invoked for routing purposes for this request is passed in field DYRCOUNT. Use this count to help you decide when to stop trying to route the request.

routing BTS activities

2. You can tell CICS to treat the request as “unserviceable”, by issuing a non-zero return code in DYRRETC.

Sometimes, perhaps because of a transaction affinity, it is essential that an activity should execute on a particular target region, and on no other. If this is the case, and the target region is unavailable, classify the request as unserviceable. Instead of reinvoking the routing program for a route selection error, CICS:

- a. Tries repeatedly to route the request to the specified target region, at 1-minute intervals.

If one of these attempts is successful, CICS issues message DFHSH0108.

The routing program is invoked on the requesting region for “routing attempt complete”, and, if specified, on the target region for “transaction initiation”.

- b. Every hour, if the target region is still unavailable, issues message DFHSH0106.
- c. If the target region is still unavailable 24 hours after the request was issued, issues message DFHSH0107, and stops trying to route the request, which is discarded. The routing program is invoked on the requesting region for “routing attempt complete”.

Invoking the distributed routing program on the target region

The route selection, notification, route selection error, and routing complete invocations of the distributed routing program all occur on the requesting region. If the routing program wants to be re-invoked *on the target region*, it must set the DYROPTER field in the communications area to 'Y'. It must do this on its initial (route selection or notification) invocation—and again, if it is reinvoked for a route selection error.

If the routing program sets DYROPTER to 'Y', it is re-invoked on the target region:

- When the activation is about to be initiated on the target region
- If the routed activation (transaction) terminates successfully
- If the routed activation (transaction) abends.

Each time it is invoked on the target region, the routing program could update a count of BTS activities that are currently running on that region. When it is invoked for routing, the routing program could use the counts maintained by all the regions in the routing set (including itself) as input to its routing decision. This requires that each region in the routing set has access to a common data set on which the counts are recorded.

Some processing considerations

- When writing your routing program, you are likely to find the EXEC CICS INQUIRE CONNECTION and INQUIRE IRC commands particularly useful if you want to confirm that a link is available before routing an activity. The EXEC CICS INQUIRE and SET commands are described in the *CICS System Programming Reference* manual.
- Because the distributed routing program executes outside a unit of work environment, your program must not:
 - Alter any recoverable resources
 - Issue file control or temporary storage requests.
- If you want to keep information about how activities are routed, it must be done in the user routing program, perhaps by writing the information to a data set.

Note that, because the routing program is distributed, all the CICS regions in the transaction routing set must have access to the data set.

- The distributed routing program can be RMODE ANY but must be AMODE 31.

Routing of non-terminal-related START requests

This section describes how to use a distributed routing program to dynamically route non-terminal-related EXEC CICS START requests.

Which requests can be dynamically routed?

For a non-terminal-related START request to be eligible for dynamic routing, all of the following conditions must be met:

- The request is eligible for *enhanced* routing. For general information about the “enhanced” method of routing transactions invoked by EXEC CICS START commands, and for specific information about which non-terminal-related START requests are eligible for enhanced routing, see the *CICS Intercommunication Guide*.
- The transaction definition in the requesting region specifies both ROUTABLE(YES) and DYNAMIC(YES).
- The SYSID option of the START command does not specify the name of a remote region. (That is, the remote region on which the transaction is to be started must not be specified explicitly.)

If the request is fully eligible for dynamic routing, the distributed routing program is invoked for routing. The START request is function-shipped to the target region returned by the routing program.

Notes:

1. If the request is ineligible for enhanced routing, the distributed routing program is not invoked. Unless the SYSID option of the START command specifies a remote region explicitly, the START request is function-shipped to the target region named in the REMOTESYSTEM option; if REMOTESYSTEM is not specified, the START executes locally.
2. If the request is eligible for enhanced routing but not for dynamic routing (the transaction may, for example, be defined as DYNAMIC(NO)) the distributed routing program is invoked for notification only—it cannot route the request. Unless the SYSID option of the START command specifies a remote region explicitly, the START request is function-shipped to the target region named in the REMOTESYSTEM option; if REMOTESYSTEM is not specified, the START executes locally.

“Daisy-chaining” is not supported. That is, once a non-terminal-related START request has been dynamically routed to a target region it cannot be dynamically routed from the target to a third region, even though the transaction is defined as ROUTABLE(YES) and DYNAMIC(YES). The transaction may, however, be *statically* routed from the target region to a third region.

For definitive information about which non-terminal-related START requests are eligible for dynamic routing, see the *CICS Intercommunication Guide*.

routing of non-terminal-related STARTs

When the distributed routing program is invoked

For non-terminal-related START requests that are eligible for enhanced routing, CICS invokes the distributed routing program at the following points:

On the requesting region:

1. Either of the following:
 - For routing the request.
 - For notification of a statically-routed request. This occurs when a transaction defined as ROUTABLE(YES) is eligible for *enhanced* routing but not for *dynamic* routing because one or both of the following applies:
 - The transaction definition specifies DYNAMIC(NO).
 - The SYSID option of the START command names a remote region explicitly.

The routing program is not able to route the request. It could, however, do other things.

2. If an error occurs in route selection—for example, if the target region returned by the routing program on the route selection call is unavailable. This gives the routing program the opportunity to specify an alternate target. This process iterates until the routing program selects a target that is available or sets a non-zero return code.
3. After CICS has tried (successfully or unsuccessfully) to route the request to the target region.

This invocation signals that (unless the requesting region and the target region are one and the same) the requesting region's responsibility for this transaction has been discharged. The routing program might, for example, use this invocation to release any resources that it has acquired on behalf of the transaction.

On the target region:

These invocations occur only if the target region is CICS TS Release 3 or later and the routing program on the requesting region has specified that it should be reinvoked on the target region:

1. When the transaction associated with the request starts on the target region.
2. If the transaction ends successfully.
3. If the transaction abends.

Figure 47 on page 583 shows the points at which the distributed routing program is invoked, and the region on which each invocation occurs. Note that the “target region” is not necessarily remote—it could be the local (requesting) region, if the routing program chooses to execute the START request locally.

routing of non-terminal-related STARTs

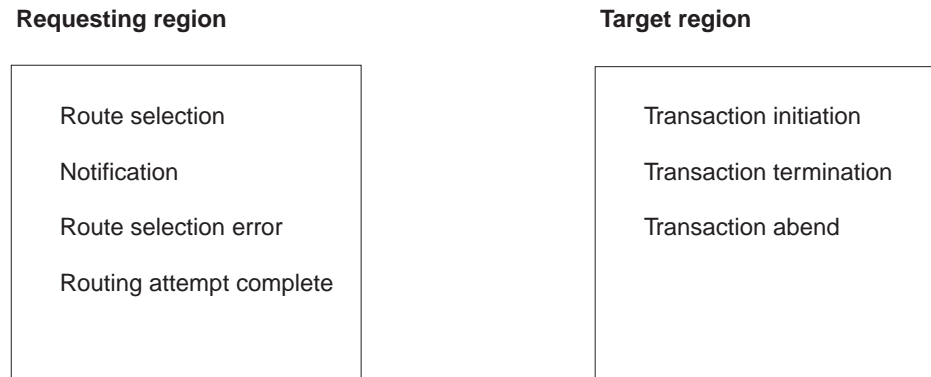

Figure 47. When and where the distributed routing program is invoked

Changing the target CICS region

The DYRSYSID field of the communications area passed to the distributed routing program initially contains the system identifier (sysid) of the default target region to which the request is to be routed. This is derived from the value of the REMOTESYSTEM option of the installed transaction definition on the requesting region. If REMOTESYSTEM is not specified, the sysid passed is that of the local CICS region.

When it is invoked for route selection, the distributed routing program can change the target region by changing the value in DYRSYSID.

If the specified sysid is invalid, or cannot be found, SYSIDERR is returned to the distributed routing program—which may deal with the error by returning a different sysid—see “If an error occurs in route selection” on page 584.

If the routing program changes the sysid when it is invoked for notification, routing complete, transaction initiation, transaction termination, or abend, the change has no effect.

Telling CICS whether to route the request

When the routing program is invoked for routing, if you want the request to be routed (whether you have changed any values or not) return a zero value to CICS in field DYRRETC of the communications area. When you return control to CICS with return code zero, CICS first compares the returned sysid with its own local sysid:

- If the sysids are the same CICS executes the request locally.
- If the two sysids are not the same, CICS routes the request to the remote CICS region.

If you want CICS to reject the START request, return a non-zero value. The EXEC CICS START command receives a SYSIDERR condition, with a RESP2 value indicating that the START request has been rejected by the routing program.

Returning a value in DYRRETC has no effect when the routing program is invoked for notification, routing complete, transaction initiation, transaction termination, or abend.

routing of non-terminal-related STARTs

If an error occurs in route selection

If an error occurs in route selection—for example, if the sysid returned by the distributed routing program is unavailable or unknown—the routing program is invoked again. When this happens, you have a choice of actions:

1. You can try to route the request to a different target region, by changing the sysid, and issuing a return code of '0' in DYRRETC.

If this region too is unavailable, the routing program is again invoked for a route selection error. A count of the times the routing program has been invoked for routing purposes for this request is passed in field DYRCOUNT. Use this count to help you decide when to stop trying to route the request.

2. You can tell CICS not to continue trying to route the request, by issuing a non-zero return code in DYRRETC.

Invoking the distributed routing program on the target region

The route selection, notification, route selection error, and routing complete invocations of the distributed routing program all occur on the requesting region. If the routing program wants to be re-invoked *on the target region*, it must set the DYROPTER field in the communications area to 'Y'. It must do this on its initial (route selection or notification) invocation—and again, if it is reinvoked for a route selection error.

If the routing program sets DYROPTER to 'Y', it is re-invoked on the target region:

- When the transaction associated with the routed request is about to be initiated on the target region
- If the transaction terminates successfully
- If the transaction abends.

This is effective only if the target region is CICS TS Release 3 or later.

Each time it is invoked on the target region, the routing program could update a count of transactions that are currently running on that region. When it is invoked for routing, the routing program could use the counts maintained by all the regions in the routing set (including itself) as input to its routing decision. This requires that each region in the routing set has access to a common data set on which the counts are recorded.

Some processing considerations

- Any of the EXEC CICS commands can be issued from the routing program. You are likely to find the EXEC CICS INQUIRE CONNECTION and INQUIRE IRC commands particularly useful if you want to confirm that a link is available before routing a request. The EXEC CICS INQUIRE and SET commands are described in the *CICS System Programming Reference* manual.
- Although the routing program can issue any EXEC CICS command, you should consider carefully the effect of commands that alter recoverable resources, because changes to those resources may be committed or backed out inadvertently as a result of logic in the program that issued the START command.
- If you want to keep information about how requests are routed, it must be done in the user routing program, perhaps by writing the information to a data set. Note that, because the routing program is distributed, all the CICS regions in the routing set must have access to the data set.

- The distributed routing program can be RMODE ANY but must be AMODE 31.

Parameters passed to the distributed routing program

Figure 48 shows the communications area passed to the distributed routing program. The communications area is mapped by the copy book DFHDYPDS, which is in the appropriate CICS library for all the supported programming languages.

	DS	OCL4	Standard header
DYRFUNC	DS	CL1	Function code
DYRCOMP	DS	CL2	Component code
DYRFILL1	DS	CL1	Reserved
DYRERROR	DS	CL1	Route selection error code
DYROPTER	DS	CL1	Transaction termination option
DYRQUEUE	DS	CL1	Queue-the-request indicator
DYRFILL2	DS	CL1	Reserved
DYRRETC	DS	F	Return code
DYRSYSID	DS	CL4	Default/Selected sysid
DYRVER	DS	H	Version of the interface
DYRTYPE	DS	CL1	Type of routing request
DYRFILL3	DS	H	Reserved
DYRTRAN	DS	CL8	Default/Selected remote tranid
DYRCOUNT	DS	F	Number of invocations count
DYRBPNTN	DS	F	Address of input buffer
DYRBLGTH	DS	F	Length of input buffer
DYRRTPRI	DS	CL1	Pass priority to AOR?
DYRFILL4	DS	CL1	Reserved
DYRPRTY	DS	H	Dispatch priority passed to AOR
DYRNETNM	DS	CL8	Netname matching sysid
DYRLPROG	DS	CL8	Run this program if routed locally
DYRDTRXN	DS	CL1	DTRTRAN indicator
DYRDTRRJ	DS	CL1	DTRTRAN reject?
DYRFILL5	DS	CL2	Reserved
DYRSRCK	DS	XL4	MVS WLM source token
DYRABNLC	DS	XL4	Abnormal event code
DYRABCDE	DS	CL4	Transaction abend code
DYRCABP	DS	CL1	Continue abend processing?
DYRFILL6	DS	CL1	Reserved
DYRFILL7	DS	CL2	Reserved
DYRACMAA	DS	F	Address of applications's commarea
DYRACMAL	DS	F	Length of application's commarea
* THE FOLLOWING 7 FIELDS APPLY ONLY TO BTS TRANSACTIONS			
DYRCBTS	DS	CL176	
DYRPROCN	DS	CL36	BTS process name
DYRPROCT	DS	CL8	BTS process-type
DYRACTN	DS	CL16	BTS activity name
DYRACTID	DS	CL52	BTS activity ID
DYRPROCID	DS	CL52	BTS process ID
DYRACTCMP	DS	CL1	BTS activity completing?
DYRPROCCMP	DS	CL1	BTS process completing?
DYRFILL8	DS	CL2	Reserved
DYRFILL9	DS	CL8	Reserved
DYRUAPTR	DS	F	Address of user area
DYRUSER	DS	CL1024	User area

Figure 48. The communications area passed to a distributed routing program

parameters passed to DFHDSRP

Important

The same communications area is passed to both the distributed routing program and the dynamic routing program. Some parameters are meaningful to one routing program but not to the other. Some parameter-values may be passed to one routing program but never to the other. The following list describes in detail only the parameters that are significant to the distributed routing program; parameter-values that are never passed to the distributed routing program are not listed. For example, under the DYRTYPE parameter the value X'4' is not listed because it is never passed to the distributed routing program—it occurs only on a program-link-related call to the dynamic routing program.

If you use the same program as both a distributed routing program and a dynamic routing program, for descriptions of the parameters and values that are significant on dynamic routing calls refer to “Parameters passed to the dynamic routing program” on page 562.

DYRABCDE

is the abend code returned when a routed transaction abends.

DYRABNLC

is an abnormal event code, or null.

This field is significant when the distributed routing program is invoked for termination of a routed request. Any value other than null indicates that an abnormal event, *other than a transaction abend*, has occurred in the region to which the request was routed (which, for the distributed routing program, is also the region in which the routing program is invoked). Your routing program should not route further requests to the same region until the cause of the error has been investigated and rectified.

This field is intended for use by CICSplex SM.

DYRACMAA

is not used by the distributed routing program. On invocation, it is set to zeroes.

DYRACMAL

is not used by the distributed routing program. On invocation, it is set to zeroes.

DYRACTCMP

indicates whether or not the BTS activity is completing. (When a process is being routed, DYRACTCMP indicates whether the root activity is completing.)

This field applies only to the routing of BTS processes and activities, *not* to the routing of non-terminal-related START requests. Its contents are significant on transaction termination calls.

The possible values are:

Y This is the final activation of the BTS activity.

N This is not the final activation of the BTS activity.

DYRACTID

is the CICS-assigned, 52-character activity identifier of the BTS activity being routed. (When a process is being routed, DYRACTID returns the identifier of the root activity.)

parameters passed to DFHDSRP

This field applies only to the routing of BTS processes and activities, *not* to the routing of non-terminal-related START requests.

DYRACTN

is the name of the BTS activity being routed. (When a process is being routed, DYRACTN returns the name of the root activity—that is, DFHROOT.)

This field applies only to the routing of BTS processes and activities, *not* to the routing of non-terminal-related START requests.

DYRBLGTH

is not used by the distributed routing program. On invocation, it is set to zeroes.

DYRBPNTR

is not used by the distributed routing program. On invocation, it is set to zeroes.

DYRCABP

indicates whether or not you want CICS to continue standard abend processing.

This field is not used by the distributed routing program. On invocation, it is set to 'Y'.

DYRCOMP

is the CICS component code. For calls to the distributed routing program, it is always set to 'SH'.

DYRCOUNT

is a count of the times the distributed routing program has been invoked for this request with DYRFUNC set to '0', '1', or '3'. This field allows you to limit the number of times your program tries to route a request.

DYRDTRRJ

indicates whether the transaction, which is defined by the common transaction definition specified on the DTRTRAN system initialization parameter, is to be rejected, or accepted for processing.

This field is not used by the distributed routing program. On invocation, it is set to 'N'.

DYRDTRXN

indicates whether the transaction to be routed is defined by the common transaction definition specified on the DTRTRAN system initialization parameter, or by a specific transaction definition.

This field is not used by the distributed routing program. On invocation, it is set to 'N'.

DYRERROR

has a value only when DYRFUNC is set to '1'. It indicates the type of error that occurred during the last attempt at route selection. The possible values are:

- 0** The selected sysid is unknown.
- 1** The selected system is not in service.
- 2** The selected system is in service, but no sessions are available.
- 3** An allocate request has been rejected, and SYSIDERR returned to the application program. This error occurs for one of the following reasons:
 - 1. An XZIQUE global user exit program requested that the allocate be rejected, or

parameters passed to DFHDSRP

2. CICS rejected the allocate request automatically because the QUEUELIMIT value specified on the CONNECTION resource definition has been reached.
- 4 A queue of allocate requests has been purged, and SYSIDERR returned to all the waiting application programs. This error occurs for one of the following reasons:
 1. An XZIQUE global user exit program requested that the queue be purged, or
 2. CICS purged the queue automatically because the MAXQTIME limit specified on the CONNECTION resource definition has been reached.
- 5 The selected system does not support this function. This occurs if the distributed routing program tries to route a request to a pre-CICS TS Release 3 region, or to a CICS TS Release 3 region that is not connected by an MRO or APPC parallel-session link.

The following values all apply to attempts to route START requests. For the meanings of these error conditions, see the *CICS Application Programming Reference* manual.

- C** The EXEC CICS START command returned TRANSIDERR.
D The EXEC CICS START command returned IOERR.
E The EXEC CICS START command returned USERIDERR.

DYRFUNC

tells you the reason for this invocation of the distributed routing program. The possible values are:

- 0 Invoked for route selection.
This invocation occurs on the requesting region.
- 1 Invoked because an error occurred in route selection.
This invocation occurs on the requesting region.
- 2 Invoked because the transaction associated with a previously routed request has terminated successfully.
This invocation occurs on the target region.
- 3 Invoked for notification of the destination of a statically-routed request.
This invocation occurs on the requesting region. It applies in the following cases:

BTS processes and activities

A RUN ASYNCHRONOUS command has been issued, but the transaction associated with the BTS process or activity is defined as DYNAMIC(NO).

Non-terminal-related START requests

A transaction defined as ROUTABLE(YES) is eligible for *enhanced* routing but not for *dynamic* routing because one or both of the following applies:

- The transaction definition specifies DYNAMIC(NO).
- The SYSID option of the START command names a remote region explicitly.

parameters passed to DFHDSRP

For detailed information about which non-terminal-related START requests are eligible for dynamic routing, see the *CICS Intercommunication Guide*.

- 4 Invoked because the transaction associated with the routed request abended.
This invocation occurs on the target region.
- 5 Invoked for transaction initiation. The transaction associated with the routed request is about to be started on the target region.
This invocation occurs on the target region.
- 6 Invoked because CICS has finished trying (successfully or unsuccessfully) to route the request to the target region.
This invocation occurs on the requesting region. It signals that (unless the requesting region and the target region are one and the same) the requesting region's responsibility for this transaction has been discharged. The routing program might, for example, use this invocation to release any resources that it has acquired on behalf of the transaction.

The DYRTYPE field tells you the type of routing or notification request.

DYRLPROG

is not used by the distributed routing program. On invocation, it is set to null characters.

DYRNETNM

is not used by the distributed routing program. On invocation, it is set to null characters.

Note: To set the target region, the distributed routing program must use the DYRSYSID field.

DYROPTER

specifies whether the distributed routing program is to be reinvoked *on the target region* when the transaction associated with the routed request:

1. Is to be started on the target region
2. Terminates (successfully or unsuccessfully).

This field is for use on route selection, notification, and route selection error calls. The possible values are:

- N** The distributed routing program is not to be invoked for transaction initiation, termination or abend—that is, it is *not to be invoked on the target region*. This is the default.
- Y** The distributed routing program is to be reinvoked on the target region. This is effective only if the target region is CICS TS Release 3 or later.

You can specify this option for requests that are routed to remote CICS regions and also for those that are executed locally.

DYRPROCCMP

indicates whether or not the BTS process is completing.

parameters passed to DFHDSRP

This field applies only to the routing of BTS processes and activities, *not* to the routing of non-terminal-related START requests. Its contents are significant on transaction termination calls.

The possible values are:

- Y** This is the final activation of the BTS process.
- N** This is not the final activation of the BTS process.

When it is invoked at transaction termination, the routing program could use the value of this field to decide whether to end any transaction affinities.

DYRPROCID

is the CICS-assigned, 52-character identifier of the BTS process to which the activity being routed belongs.

This field applies only to the routing of BTS processes and activities, *not* to the routing of non-terminal-related START requests.

DYRPROCN

is the name of the BTS process to which the activity being routed belongs.

This field applies only to the routing of BTS processes and activities, *not* to the routing of non-terminal-related START requests.

DYRPROCT

is the process-type of the BTS process to which the process or activity being routed belongs.

This field applies only to the routing of BTS processes and activities, *not* to the routing of non-terminal-related START requests.

DYRPRTY

is not used by the distributed routing program. On invocation, it is set to zeroes.

DYRQUEUE

identifies whether or not the request is to be queued if no sessions are immediately available to the remote system identified by DYRSYSID.

This field is not used by the distributed routing program. On invocation, it is set to 'Y'.

DYRRETC

contains a return code that tells CICS how to proceed. The possible values are:

0 Route the request.

Non-zero

Do not route the request. CICS treats BTS processes and activities as "unserviceable" (see page 580). START requests receive the SYSIDERR condition.

Whenever the routing program is invoked, DYRRETC is set to '0'. When it is invoked for route selection or because an error occurs in route selection, if you want CICS to route the request to the region specified in the DYRSYSID field, you must leave it set to '0'.

You do not need to set a return code when the routing program is invoked for notification, routing complete, transaction initiation, transaction termination, or abend. (Any code you set is ignored by CICS.)

DYR RTPRI

indicates whether or not the dispatch priority of the transaction should be passed to the application-owning region, if the connection between the terminal-owning region and the application-owning region is MRO.

This field is not used by the distributed routing program. On invocation, it is set to 'N'.

DYRSRCTK

is the MVS workload management service and reporting class token for the routed transaction.

DYRSYSID

is the system identifier (sysid) of a CICS region. The exact meaning of this parameter depends on the value of DYRFUNC:

- When DYRFUNC is set to '0' (route selection), DYRSYSID contains:
 - The CICS region name specified on the REMOTESYSTEM option of the installed transaction definition, or,
 - If REMOTESYSTEM is not specified, the system name of the local CICS region.

The distributed routing program can accept the value of DYRSYSID or change it before returning to CICS.

If the sysid you return to CICS is the same as the local sysid, CICS executes the request on the local region.

- When DYRFUNC is set to '1' (route selection error), DYRSYSID contains the CICS region name returned to CICS by the distributed routing program on its previous invocation. If you want CICS to retry routing, you must change DYRSYSID before returning to CICS.
- When DYRFUNC is set to '2' (termination of a routed request), DYRSYSID contains the name of the target region on which the completed transaction executed. (This is also the region on which the distributed routing program is invoked.)
- When DYRFUNC is set to '3' (notification):
 - For **BTS processes and activities**, DYRSYSID contains:
 - The CICS region name specified on the REMOTESYSTEM option of the installed transaction definition, or,
 - If REMOTESYSTEM is not specified, the system name of the local CICS region.
 - For **non-terminal-related START requests**, DYRSYSID contains:
 - The remote CICS region name specified on the SYSID option of the EXEC CICS START command, or
 - If SYSID is not specified, the remote CICS region name specified on the REMOTESYSTEM option of the installed transaction definition, or
 - If REMOTESYSTEM is not specified, the system name of the local CICS region.

Any change to the value of DYRSYSID is ignored.

- When DYRFUNC is set to '4' (transaction abend), DYRSYSID contains the name of the target region on which the transaction abended. (This is also the region on which the distributed routing program is invoked.)

parameters passed to DFHDSRP

- When DYRFUNC is set to '5' (transaction initiation), DYRSYSID contains the name of the target region on which the routed request is to be executed. (This is also the region on which the distributed routing program is invoked.)
- When DYRFUNC is set to '6' (routing completed), DYRSYSID contains the name of the target region to which CICS tried (successfully or unsuccessfully) to route the request.

DYRTRAN

contains the transaction name.

Note that this is *the name by which the transaction is known in the requesting region*. Unlike the dynamic routing program, the distributed routing program:

1. Is passed the local, not the remote, transaction name
2. Cannot specify an alternative remote transaction name, for forwarding to the target region.

DYRTYPE

is the type of routing request for which the program is being invoked. The possible values are:

- 5** For routing, notification, completion of routing, initiation, termination, or abend of a BTS process or activity.
- 6** For routing, notification, completion of routing, initiation, termination, or abend of a non-terminal-related START request.

DYRUAPTR

is the address of the user area (DYRUSER).

DYRUSER

is a 1024-byte user area.

CICS initializes this user area to nulls before invoking the distributed routing program for a given task. This user area can be modified by the distributed routing program; the modified area is passed to subsequent invocations of the distributed routing program for the same request.

However, note that:

1. The user area passed to the routing program on its first call on the target region ("transaction initiation") is a *copy* of the user area on the requesting region. This means that any modifications to the user area made on the target region have no effect on the user area in the requesting region. For example, a change to the user area made on the transaction initiation call has no effect on the user area passed to the routing complete call, even if the latter occurs after the transaction initiation call.
2. The user area passed to the first ("transaction initiation") call on the target region is a copy of that returned by *the call on the requesting region that caused the transaction initiation call to occur*. That is:
 - If there was no error in route selection, it is a copy of the user area returned by the route selection or notification call.
 - If there was a route selection error, it is a copy of the user area returned by the final route selection error call.
 - It is *never* a copy of the user area returned by the routing attempt complete call on the requesting region, even if the latter occurs before the transaction initiation call on the target region.

DYRVER

is the version number of the dynamic routing interface. For CICS Transaction Server for OS/390 Release 3, the number is "5".

Naming your distributed routing program

The supplied, sample distributed routing program is named DFHDSRP. If you write your own version, you can name it differently.

After the system has been loaded, to find the name of the distributed routing program currently identified to CICS, use the EXEC CICS INQUIRE SYSTEM command. Field DSRTPROGRAM contains the name of the current program.

To change the current program:

- Use the DSRTPGM system initialization parameter. For information about how to do this, refer to the *CICS System Definition Guide*.
- Make the change online using the EXEC CICS SET SYSTEM DSRTPROGRAM command. For programming information about this command, refer to the *CICS System Programming Reference* manual.

Note: A sample definition is provided for DFHDSRP, but you must install a new resource definition for a customized distributed routing program.

Distributed transaction routing sample programs

The CICS-supplied sample distributed routing program is named DFHDSRP. The corresponding copy book that defines the communications area is DFHDYPDS. There are assembler-language, COBOL, PL/I, and C source-level samples and copy books. The supplied programs and copy books, and the CICSTS13.CICS libraries in which they can be found, are summarized in Table 29.

Table 29. Distributed routing programs and copy books

Language	Member name	Library
Programs:		
Assembler	DFHDSRP	SDFHSAMP
COBOL	DFHDSRP	SDFHCOB
PL/I	DFHDSRP	SDFHPL1
C/370	DFHDSRP	SDFHC370
Copy books:		
Assembler	DFHDYPDS	SDFHMAC
COBOL	DFHDYPDS	SDFHCOB
PL/I	DFHDYPDS	SDFHPL1
C/370	DFHDYPDS	SDFHC370

You can write your own distributed routing program in VS COBOL II, PL/I, C, or assembler language, and you can change the name of the program.

When invoked with DYRFUNC set to '0', the sample programs accept the sysid that is passed in field DYRSYSID of the communications area, and set DYRRET to '0' before returning to CICS. When invoked with DYRFUNC set to '2', '3', '5', or '6', they set a return code of '0'. When invoked with DYRFUNC set to '1' or '4', they set a return code of '8'.

sample distributed routing programs

| If you want to route requests dynamically, you must customize DFHDSRP, or
| replace it completely with your own routing program.

Chapter 18. Writing a CICS–DBCTL interface status program

Considerations common to all user-replaceable programs

Note that the comments contained in “Chapter 5. General notes about user-replaceable programs” on page 401 apply to this chapter.

The CICS–DBCTL interface status program DFHDBUEX is a user-replaceable program forming part of the support for the CICS–DBCTL interface. It is designed to invoke user-supplied code whenever CICS successfully connects to or disconnects from DBCTL. It runs in a CICS application environment and is driven at specific points to allow you to enable and disable your CICS-DL/I transactions when the CICS–DBCTL interface initializes or terminates.

DFHDBUEX is invoked in the following case for the ENABLE command:

- CICS has connected to DBCTL successfully. This occurs after a connection request has been issued from CICS to DBCTL. The control exit (DFHDBCTX) is invoked by the database resource adapter (DRA) ¹⁰ for ‘initialization complete’. The control exit posts the control transaction (CDBO). The control program (DFHDBCT) then invokes DFHDBUEX.

DFHDBUEX is invoked in the following cases for the DISABLE command:

- A request has been issued to disconnect from DBCTL. The CICS–DBCTL menu program (DFHDBME) starts the disconnection transaction (CDBT) to disconnect from DBCTL. The disconnection program (DFHDBDSC) invokes DFHDBUEX before issuing the interface termination request to the adapter.
- The control transaction (CDBO) has been notified of one of the following events:
 - A checkpoint freeze request to DBCTL
 - DRA abnormal termination
 - DBCTL abnormal termination.

In each of these cases, the control program (DFHDBCT) invokes DFHDBUEX.

Input to DFHDBUEX is by means of a communication area addressed by DFHEICAP. The layout of the communication area is shown in Figure 49 on page 596.

10. The interface that enables DBCTL databases to be accessed from CICS.

the CICS–DBCTL interface status program

DBUSHEAD	DS	0CL4	Standard Header	
DBUREQT	DS	CL1	Function Code	
DBUCOMP	DS	CL2	Component Code	Always "DB"
DBURES	DS	CL1	Reserved	
DBUREAS	DS	CL1	Reason for disconnection	
DBUSUFF	DS	CL2	DRA startup table suffix	
DBUDBCTL	DS	CL4	DBCTL identifier	

Figure 49. The DFHDBUEX communication area

The parameter list contains the following information:

DBUREQT

Request Type. The function code has one of the following values:

DBUCONN (X'01')

Connected

DBUDISC (X'02')

Disconnected.

DBUREAS

Reason for Disconnection. Contains flags:

DBUMENU (X'01')

Disconnected from menu

DBUDBCC (X'02')

Checkpoint Freeze input to DBCTL

DBUDRAF (X'03')

DRA Failure has taken place

DBUDBCF (X'04')

DBCTL Failure has taken place.

DBUSUFF

DRA startup table suffix.

DBUDBCTL

DBCTL identifier.

The sample program and copy book

The source-code of the supplied CICS–DBCTL interface status program, DFHDBUEX, is provided, in assembler language only, in the CICSTS13.CICS.SDFHSAMP library. A corresponding copy book, DFHDBUCA, that maps the communication area, is in CICSTS13.CICS.SDFHMAC.

The sample program checks for the presence of the input parameters (passed in the communication area). If these do not exist, control returns to the calling program.

The type of request (CONNECTION|DISCONNECTION) is then determined, and a branch is taken to the appropriate function routine (CONPROC|DISPROC).

the CICS–DBCTL interface status program

The sample contains an example, as part of a comment, of how to enable and how to disable a transaction. To use the program, it is necessary for transactions using DBCTL to be defined in the CSD as DISABLED.

You can code your own CICS–DBCTL interface status program in any of the languages supported by CICS. For information about the job control statements necessary to assemble and link-edit user-replaceable programs, refer to “Assembling and link-editing user-replaceable programs” on page 402.

Chapter 19. Writing a 3270 bridge exit program

Considerations common to all user-replaceable programs

Note that the comments contained in "Chapter 5. General notes about user-replaceable programs" on page 401 apply to this chapter.

The 3270 bridge provides an interface so that you can run 3270-based CICS transactions without a 3270 terminal. In the bridge environment, terminal commands are intercepted by CICS and passed to a bridge exit user-replaceable program.

The bridge exit provides the mechanism by which data needed to run a 3270 transaction can be sent and received from an external resource. For example, you can use MQSeries® commands in a bridge exit so that CICS can GET and PUT messages to MQSeries queues.

For a detailed description of the 3270 bridge exit and its interfaces, see the *CICS External Interfaces Guide*.

Chapter 20. Writing a security exit program for IIOp

Considerations common to all user-replaceable programs

Note that the comments contained in "Chapter 5. General notes about user-replaceable programs" on page 401 apply to this chapter.

Incoming requests using the Internet Inter-Orb Protocol (IIOp) are processed by CICS under a default USERID, unless you provide a security user-replaceable program to assign a new USERID.

You can define the name of the program in the URM option of the TCPIP SERVICE resource definition for the IIOp port. If no name is specified, CICS will call DFHXOPUS for IIOp requests.

If present, the IIOp security program is called for all incoming IIOp requests, before processing by the CICS Object Request Broker (ORB) function. It is passed:

- The incoming IIOp message buffer
- The TRANSID defined in the TCPIP SERVICE resource definition for the TCP/IP port receiving the request

A USERID can be returned, and the TRANSID may be changed, but other fields are provided for information only.

For a detailed description of the DFHXOPUS user-replaceable program, and its interfaces, see the *CICS Internet Guide*.

Chapter 21. Writing a program to tailor JVM execution environment variables

Considerations common to all user-replaceable programs

Note that the comments contained in "Chapter 5. General notes about user-replaceable programs" on page 401 apply to this chapter.

This chapter describes how to write a user-replaceable program to tailor the environment variables that control the execution of the CICS Java® virtual machine (JVM). The supplied program is called DFHJVMAT.

CICS supplies default environment variable settings in a partitioned dataset called SDFHENV. You can edit this file with TSO, or you can write your own version of DFHJVMAT to change any of the default values. DFHJVMAT uses the MVS Language Edition (LE) commands `getenv` and `setenv` to change the variable values. For example, you could use the following command to replace the CLASSPATH environment variable with the specified value:

```
setenv(eclasspath, classpathval,1)
```

where:

```
char *eclasspath = "CLASSPATH";
char *classpathval =
  "/usr/lpp/jdk114/j1.1/lib/classes.zip:/u/jtill11/Java/test.:";
```

The JVM attributes JVMCLASS and JVMDEBUG must be defined using CEDA DEFINE PROGRAM. You can use EXEC CICS or CEMT INQUIRE PROGRAM and SET PROGRAM commands to modify them, as well as DFHJVMAT, before control is passed to the JVM. Note that the `setenv` command has no effect on the CICS PROGRAM definition and remains in effect only for the lifetime of the JVM.

If you write your own program to tailor JVM environment variables based on the supplied version, it must be named DFHJVMAT and must be written in C.

You can use EXEC CICS commands within DFHJVMAT but you should be aware that this might incur a processing overhead. DFHJVMAT must be defined as threadsafe in its program definition, because multiple invocations of this module may run in parallel.

Environment variables

You can reset the following environment variables in DFHJVMAT:

CHECKSOURCE

Tells the JVM to check the source file and **.class** file. If the **.class** file is out of date, the JVM recompiles the source. This variable is set to NO in SDFHENV.

CICS_HOME

specifies the HFS directory that is used by the CICS JVM interface when creating **stdin**, **stdout** and **stderr** files. A period is defined in SDFHENV, which means that the current directory will be used. If CICS_HOME is not set at all, then /tmp will be used as the directory.

the JVM execution options program

CICS_PROGRAM

Contains the name of the CICS program (1-8 characters) associated with the Java class to be run. No value is set in SDFHENV. This name is established at run-time; it is returned to DFHJVMAT for information only, any changes will be ignored by CICS.

CICS_PROGRAM_CLASS

Specifies the CICS user class name. This is the equivalent of the JVMCLASS attribute on the CICS PROGRAM resource definition. No value is set in SDFHENV.

CLASSPATH

Sets the directory path to be searched by the JVM for .class files. The default shipped in SDFHENV includes dfjcics.jar and dfjwrap.jar (required to support JCICS).

DEBUGPORT

Sets a TCP/IP port number to be used by the JVM in debugging mode. This variable is not set in SDFHENV. The default is to allow the JVM to choose a port number.

DISABLEASYNCGC

Indicates whether asynchronous garbage collection should be disabled. This variable is set to NO in SDFHENV (asynchronous garbage collection should be performed).

ENABLECLASSGC

Indicates whether the JVM should perform garbage collection on loaded classes that are not being used. This variable is set to YES in SDFHENV.

ENABLEVERBOSEGC

Indicates whether the JVM should issue a message when the garbage collector frees memory. This variable is set to NO in SDFHENV.

INVOKE_DFHJVMAT

Specifies whether the user replaceable module DFHJVMAT should be invoked before executing the JVM. This variable is set to NO in SDFHENV.

JAVASTACKSIZE

Sets the size of each thread's Java code stack, in bytes. A default value of 409600 bytes (400K) is set in SDFHENV. This is the recommended default for the MVS JVM.

JAVA_COMPILER

Specifies whether the Java just-in-time (JIT) compiler should be invoked by the JVM. This variable is set to OFF in DFHENV.

JAVA_HOME

Defines the installation directory prefix of the JDK.

JVM_DEBUG

Indicates whether the JVM should operate in debugging mode. This is the equivalent of the JVMDEBUG attribute on the CICS PROGRAM resource definition. No value is set in SDFHENV.

LIBPATH

Sets the directory path to be searched by the JVM for native C dll files. The default directory path set in SDFHENV includes the path to the native C dll files required to support JCICS.

MAXHEAPSIZE

Sets the maximum heap size for the JVM, in bytes. A default value of 8000000 bytes (8M) is set in SDFHENV. This is the recommended default for the MVS JVM. This is above-the-line storage.

MINHEAPSIZE

Sets the minimum heap size for the JVM, in bytes. A default value of 1000000 bytes (1M) is set in SDFHENV. This is the recommended default for the MVS JVM. This is above-the-line storage.

NATIVESTACKSIZE

Sets the size of each thread's stack, in bytes. A default value of 262144 bytes (256K) is set in SDFHENV. This is the recommended default for the MVS JVM.

Note: The initial process thread (IPT) stack is governed by the `STACK` run-time option on the `DFHCJVM C` program that invokes the JVM. This program sets the following value:

```
#pragma runopts(STACK(64K,16K,ANYWHERE,KEEP))
```

STDERR

specifies the name of the HFS file to be used for **stderr**. The default shipped in SDFHENV is `dfhjvmerr`. The file will be created if it does not exist. If the file already exists, output is appended at the end of the file. On completion of the JVM program, if the `stderr` file is empty, it is deleted.

STDIN

specifies the name of the HFS file to be used for **stdin**. The default shipped in SDFHENV is `dfhjvmin`. The will be created if it does not exist.

STDOUT

specifies the name of the HFS file to be used for **stdout**. The default shipped in SDFHENV is `dfhjvmout`. The file will be created if it does not exist. If the file already exists, output is appended at the end of the file. On completion of the JVM program, if the `stdout` file is empty, it is deleted.

VERBOSE

Indicates whether the JVM should issue a message each time it loads a class. This variable is set to `NO` in SDFHENV.

VERIFYMODE

Indicates whether the bytecode verifier should be run on all classes that are loaded. This variable is set to `NO` in SDFHENV.

The CICS supplied `DFHIVMAT`:

- Issues `getenv` requests for each variable.
- Issues a `printf` to destination `MSGUSR`, to record the setting of each variable.
- Contains sample code (commented out) demonstrating how to use the `setenv` command—including how to append `TASKnnnn` (where 'nnnn' is the CICS task number) to the supplied names for **stdout** and **stderr**. This shows how to make unique output and error files for each CICS task.

You can use the supplied `DFHIVMAT` as an example for your own program.

Part 4. Customizing the XRF overseer program

A general note about user-written programs

On return from any user-written program, CICS must always receive control in primary-space translation mode, with the original contents of all access registers restored, and with all general purpose registers restored (except for those which provide return codes or linkage information).

For information about translation modes, refer to the *IBM ESA/370 Principles of Operation* manual.

Chapter 22. The extended recovery facility overseer program

The information in this chapter is of interest only to users of the extended recovery facility (XRF). Details of XRF are provided in the *CICS/ESA 3.3 XRF Guide*. Guidance information about running the overseer, including a sample job stream, is provided in the *CICS Operations and Utilities Guide*.

The XRF overseer program has two major functions:

- To display the current status of active and alternate CICS regions
- To restart failed CICS regions in place without operator intervention.

There is a CICS-supplied sample overseer program that performs these two functions and which you may find adequate for your installation.

The chapter is divided into the following sections:

1. “**The sample overseer program**” contains:
 - “The functions of the sample program”
 - “How the sample overseer program interfaces with CICS” on page 613
 - “How to tell the overseer which actives and alternates to monitor” on page 613.
2. “**The DFHWOSM macros**” on page 614 describes the macros that you use to provide services to the overseer program.
3. “**Customizing the sample overseer program**” on page 623 describes how you can extend the functions of the sample program.

The sample overseer program

The CICS-supplied sample overseer is an assembler-language batch program that runs in its own address space. The source of the sample program is in four members of CICSTS13.CICS.SDFHSAMP:

- DFH\$AXRO
- DFH\$AGCB
- DFH\$ADSP
- DFH\$ARES.

The associated DSECTs are supplied in DFH\$XRDS in the same library. An assembled version of the sample program is supplied in CICSTS13.CICS.SDFHLOAD.

The functions of the sample program

The program acts on five commands entered by the console operator. (Minimum abbreviations are shown like this: D.) The commands are as follows:

Display

to display the current status of all active-alternate pairs being monitored by the overseer program

Restart

to enable or disable the restart-in-place function of the overseer program

the XRF overseer program

Snap

to take a snap dump of the sample program

End

to terminate the sample program

Open

to ask the overseer to try to open CICS availability manager (CAVM) data sets that it has previously failed to open.

The full format of the operator command entered at the MVS console is:

```
MODIFY overseer-jobname,command-identifier
```

where “command-identifier” is Display, Restart, Snap, End, or Open, or an abbreviation of any of these. The Display and Restart commands control the two major functions of the sample overseer program, which are described below. The Open command is described under “Opening CAVM data sets dynamically” on page 613.

The display function

When the operator enters the Display command at the MVS console, the sample overseer program issues a multiline write-to-operator (MLWTO) command showing the last known state of each of the active-alternate pairs that it is monitoring. The overseer retrieves this information from the control and message data sets, in which the CICS availability manager (CAVM) has been recording state and surveillance information. The display includes a title line and one line of status information for each active-alternate pair. The title line is as follows:

```
GEN-APP ACT-JOB ACT-APP ACPU A-ST BKP-JOB BKP-APP BCPU B-ST
```

Each line of status information provides the following:

- The generic applid of the active-alternate pair (GEN-APP)
- The CICS job name of the active (ACT-JOB) and of the alternate (BKP-JOB)
- The specific applid of the active (ACT-APP) and of the alternate (BKP-APP)
- The SMF IDs of the CPUs on which the active and the alternate were last known to be executing (ACPU and BCPU)
- The last known status of the active (A-ST) and of the alternate (B-ST). The status value can be one of the following:

ACT Active signed on normally and running the active CICS workload.

BACK Alternate signed on and running normally.

SOFN Signed off normally.

SOFA Signed off abnormally.

TKOV Taking over (alternate only).

INCA Incipient active, meaning that an alternate CICS is taking over from an active CICS. The active job has signed off abnormally, and the incipient active is waiting for the active job to terminate.

TKIP Takeover in progress. An alternate CICS is attempting a takeover of this active system. When the takeover is complete, the status is changed.

UNKN Unknown—the overseer has no current information about the status,

the XRF overseer program

which was in an intermediate state when the Display command was processed. Reissuing the Display command causes UNKN to be replaced by another status value.

OLD The information displayed for the alternate refers to out-of-date information about the system that was the alternate until a recent takeover. That system is the current active, and the information displayed for the alternate is marked as OLD until a new alternate is signed on and running normally.

An example of the status display is shown, for guidance purposes, in the *CICS Operations and Utilities Guide*.

Note: An 'X' following any of these status values indicates that the associated job is currently executing. However, because JES services are used to discover the execution state of a job, only those jobs that are running on the same JES as the overseer program (or on the same JES shared spool) show the correct execution state. Any job that is not on the same JES shared spool appears not to be executing.

There are two additional items that may appear on the status display. These are:

NO ACTIVE DATA
NO BACKUP DATA.

These are displayed instead of status data when no data was extracted from the CAVM data sets. This happens when newly-created data sets are used—CICS has not yet written any data to them—or when the overseer fails to open the data sets.

The restart-in-place function

The overseer program can restart failed CICS regions in place automatically, if they are in the same MVS image as the overseer. The alternatives to automatic restart are operator-initiated restart, automatic takeover to the alternate, and operator-initiated takeover.

Automatic restart in place of failed regions is most useful in the multi-MVS image MRO environment. Because related regions must operate in the same MVS image, a takeover of one region means that all related regions must also be taken over by their alternates. A region may not be important enough for you to want every failure to cause a takeover to the alternate MVS image. This could disrupt users who would not otherwise have been affected by the failure. Automatic restart in place of the failed region is therefore likely to be preferred to takeover in these circumstances.

If your system consists of one or more independent regions, with actives and alternates located in separate MVS images, you can:

- Allow the overseer to restart an active region in place automatically when it fails.
- Choose automatic takeover by the alternate.
- Leave the operator to decide what to do. The operator could decide to restart the failing region in place or to initiate a takeover by the alternate, and this decision is likely to depend on which part of your system has failed.

If you are operating an MRO system in a single MVS image, the failure of an active region can be handled by a takeover by the alternate, without causing all the

the XRF overseer program

related regions to be taken over, because the new active region can continue communication with the other active regions. Takeover is therefore likely to be your preferred course of action.

Enabling and disabling restart in place: The restart-in-place function of the overseer program can be enabled and disabled using the Restart command. When you enter this command, restart processing is enabled or disabled for all generic applids that the overseer is monitoring. You can also specify that particular active-alternate pairs are not to be automatically restarted in place, regardless of whether restart processing is enabled or disabled. This is described in “How to tell the overseer which actives and alternates to monitor” on page 613.

The Restart command works like an ON/OFF switch. Restart in place is enabled when the sample program is initialized. When the Restart command is first entered, restart in place is disabled. If you issue the command again, restart is enabled again, and so on. If a region fails while restart in place is disabled, no attempt to restart it is made, even if restart in place is enabled again.

Rules that control restart in place: The sample overseer program concludes that a region has failed if both:

- The region is not executing now, and was known to have been executing during the previous examination of the relevant CAVM data sets by the overseer.
- The region did not sign off normally from the CICS availability manager (CAVM).

The overseer program can restart a failed **active** region in place, if all the following conditions are met:

- Restart in place is enabled for this overseer.
- Restart in place is enabled for this active-alternate pair.
- There is no executing alternate region for this active, or the alternate region is currently defined with TAKEOVER=COMMAND. If the alternate region is defined with TAKEOVER=AUTO or TAKEOVER=MANUAL, the overseer assumes that the alternate will initiate a takeover or that the console operator will decide what action to take.
- The failing region was running in the same MVS image as the overseer.
- An attempt to restart the region in place is not already in progress.
- If the failing region belongs to a group of related regions (an MRO environment, for example), a takeover to another MVS image, perhaps initiated by another region, is not under way.

When a failed active region is restarted in place, whether by the operator or by the overseer, the corresponding alternate region cannot continue to support the new active region, and must be restarted. The overseer program restarts the **alternate** region automatically in these circumstances, if restart processing is enabled for both the failing region and the overseer.

If you want to be able to restart regions in place in both MVS images in a two-image environment, an overseer program must execute in each image.

If the failed region was started originally as a started task, the overseer program restarts it as a started task, and if the failed region was started as a job, the overseer restarts it as a job. For more guidance information about how the sample overseer program restarts failed regions in place, refer to the *CICS Operations and Utilities Guide*.

Opening CAVM data sets dynamically

When the overseer program is initialized, it is possible that some CAVM data sets have not yet been formatted by a CICS system. The overseer program obtains an 'open error' return code on these data sets, and subsequent attempts to display details about the associated CICS systems receive the response 'NO ACTIVE DATA AVAILABLE'.

This problem arises only if the overseer is initialized before all the CAVM data sets have been formatted. If it occurs, the operator can use the Open command (see page 610) to retry the opening of those CAVM data sets on which the Open previously failed. The overseer retries an Open only if the previous attempt failed with the return code X'C'. (See "DFHWOSM FUNC=OPEN macro" on page 618.)

The use of the Open command is indicated when:

- The overseer displays 'NO ACTIVE DATA AVAILABLE' for a system that the operator knows has successfully signed on to the CAVM.
- In an already established XRF environment, a new CICS/XRF system has just started up and formatted its CAVM data sets, and the operator wants future displays from the overseer to display information for the new job.

How the sample overseer program interfaces with CICS

The overseer service is made up of a CICS overseer module (name DFHWOS), which you cannot customize, and a CICS-supplied sample overseer program (module name DFH\$AXRO), which you can customize or replace with your own overseer program. DFHWOS loads the overseer program. DFHWOS and DFH\$AXRO are supplied in CICSTS13.CICS.SDFHAUTH.

The CICS overseer module DFHWOS provides a stable interface to the CAVM data sets and to those MVS-authorized services that the overseer program requires. The overseer program invokes those services by means of a CICS-supplied group of macros called the DFHWOSM macros, which are described, beginning on page 614.

DFHWOS therefore invokes the sample program, and is subsequently invoked by the sample program whenever the sample issues a DFHWOSM macro. The DFHWOSM macros do not interact directly with either the active or the alternate CICS address spaces.

How to tell the overseer which actives and alternates to monitor

The sample overseer program is written to handle active-alternate pairs and "related system names". A related system name identifies those regions or systems that cannot be considered in isolation by the overseer. The most common example of this is an MRO environment, where the overseer needs to be able to identify related regions when deciding whether to restart a failed region in place. Those regions or systems that are identified with a common related system name must be executed in the same MVS image.

The maximum number of active-alternate pairs that the overseer can monitor is 50.

The sample program discovers which active-alternate pairs it is monitoring from a VSAM key-sequenced data set called DFHOSD, which contains a single entry for

the XRF overseer program

each active-alternate pair. You create this data set and initialize it with information about active-alternate pairs before you use the overseer for the first time. You also have to redefine the DFHOSD data set whenever you want to change the information that it holds. CICS provides a sample job stream that you can use to:

- Delete and define the DFHOSD data set
- Initialize the DFHOSD data set with information about sample active-alternate pairs
- Execute the overseer code and the sample overseer program.

The sample job stream is called DFHIVXRO and is in CICSTS13.CICS.INSTLIB. Guidance information about this sample job stream is provided in the *CICS Operations and Utilities Guide*.

The sample overseer program reads the DFHOSD records in key sequence and builds a table of entries. Each active-alternate pair is known by its generic applid on this data set. Every entry on the data set contains the following information:

- A 12-byte key field, containing the 4-byte value 'GNbb' followed by the 8-byte generic applid of the active-alternate pair.
- The ddnames of the control data set and the message data set associated with this generic applid. Each of these is an 8-byte value.
- An optional 8-byte RELATEID, to identify related systems.
- A restart-in-place indicator to show whether a region can be restarted in place. The only value that prevents an attempt to restart in place is 'N'.

The data structure of the DFHOSD data set entries is provided in member DFH\$XRDS of CICSTS13.CICS.SDFHSAMP.

For a sample of the job log from an overseer job, refer to the *CICS Operations and Utilities Guide*.

The DFHWOSM macros

The DFHWOSM macros invoke the CICS module DFHWOS to provide services to the overseer program. The macros are the supported interface to the CAVM data sets, and are supplied to perform the following functions:

DFHWOSM FUNC=BUILD

Open communication with DFHWOS

DFHWOSM FUNC=CLOSE

Terminate access to the CAVM data sets for a named generic applid

DFHWOSM FUNC=DSECT

Generate required DSECTs

DFHWOSM FUNC=JJC

Issue a JES cancel for a named job

DFHWOSM FUNC={JJS|QJJS}

Discover current JES JOB status

DFHWOSM FUNC=OPEN

Initialize access to the CAVM data sets for a named generic applid

DFHWOSM FUNC=OSCMD

Issue MVS commands

DFHWOSM FUNC=READ

Retrieve status information for a named generic applid from the CAVM data sets

DFHWOSM FUNC=TERM

Close communication with DFHWOS.

The macros are described in detail in the following sections. For all the DFHWOSM macros, the following rules apply:

- The “label” field is optional.
- If the macro has an input parameter list, the address of that parameter list must be supplied as the value of the PARM operand. The address itself may be specified as a register number or as a label. Register 1 is the default value.
- If the macro has to supply either a BUILD TOKEN or an OPEN TOKEN to DFHWOS (as described in “The DFHWOSM tokens”), the token must be provided in the register specified in the TOKEN operand. Register 14 is the default value.

The DFHWOSM tokens

When DFHWOS first invokes the overseer program, it passes a value in register 1 which is known as the **ENTRY** token. The ENTRY token value is stored by the overseer program on entry and is passed back to DFHWOS as input to the BUILD, OSCMD, JJS, and JJC macros.

The DFHWOSM FUNC=BUILD macro must be the first macro issued by the overseer program and must complete successfully. The register 1 output from this macro is a second token called the **BUILD** token. The BUILD token value is stored by the overseer program and passed back to DFHWOS as input to the OPEN, CLOSE, READ, QJJS, and TERM macros.

DFHWOSM FUNC=BUILD macro

The DFHWOSM FUNC=BUILD macro must be issued by the overseer program to initialize its communication with DFHWOS. No other macro can be issued by the overseer program until DFHWOS FUNC=BUILD has completed successfully.

```
label      DFHWOSM FUNC=BUILD
           [,TOKEN={token register|14}]
```

Input

The TOKEN value is the ENTRY token that was passed to the sample overseer program when it was first invoked by DFHWOS.

Output**Register 1**

Contains the BUILD token value, which must be returned as an input value by the overseer program on certain subsequent requests. This value is returned to register 1 only if register 15 has a return code of '0'.

DFHWOSM macros

Register 15

Contains one of the following completion codes:

- 0 Communication successfully initialized between the overseer program and DFHWOS
- 4 Incorrect TOKEN value supplied
- 8 Insufficient storage.

DFHWOSM FUNC=CLOSE macro

The DFHWOSM FUNC=CLOSE macro terminates access to the CAVM data sets for a named generic applid.

```
label DFHWOSM FUNC=CLOSE  
      [,PARM={parm address|1}]  
      [,TOKEN={token register|14}]
```

Input

The PARM value is a pointer to the address of the generic applid whose associated CAVM data sets are no longer to be accessed by the overseer program.

The TOKEN value is the BUILD token.

Output

Register 15

Completion codes:

- 0 CLOSE request was successful and the CAVM data sets associated with this generic applid can no longer be accessed by the overseer program.
- 4 Incorrect TOKEN value supplied.
- 8 Access to CAVM data sets for the named generic applid had not been initialized.

DFHWOSM FUNC=DSECT macro

The DFHWOSM FUNC=DSECT macro generates a number of DSECTs, including the DSECT of the DBLID definitions.

```
DFHWOSM FUNC=DSECT
```

DFHWOSM FUNC=JJC macro

The DFHWOSM FUNC=JJC macro issues a JES cancel for a named job with a JES job identifier.

```
DFHWOSM FUNC=JJC  
      [,PARM={parm address|1}]  
      [,TOKEN={token register|14}]
```

Input

The PARM value is a pointer to the addresses of the following:

- An 8-byte job name

- An 8-byte JES job ID
- A 256-byte SSOB return area.

The TOKEN value is the ENTRY token.

Output

Register 15

Contains the following completion codes:

0 JES cancel completed; SSOB and status array returned from JES

Nonzero

Return code from JES.

DFHWOSM FUNC={JJS|QJJS} macro

Supplied with a job name and JES job identifier, both versions of the DFHWOSM FUNC={JJS|QJJS} macro return the current JES job status into a copy of the JES subsystem options block (SSOB).

The FUNC=JJS macro returns control when the JES call has completed successfully or unsuccessfully. The FUNC=QJJS macro returns control immediately and posts an event control block (ECB) once the JES request has completed.

```
label    DFHWOSM FUNC={JJS|QJJS}
          [,PARM={parm address|1}]
          [,TOKEN={token register|14}]
```

Input

For FUNC=JJS, the PARM value is a pointer to the addresses of the following:

- An 8-byte job name
- An 8-byte JES job ID
- A 256-byte SSOB return area.

The TOKEN value is the ENTRY token.

For FUNC=QJJS, the PARM value is a pointer to the addresses of the following:

- An 8-byte job name
- An 8-byte JES job ID
- A 256-byte SSOB return area
- A doubleword area to hold two ECBs.

The FUNC=QJJS macro requires 2 ECBs: the first is posted when the JES call completes; the second is posted if a time-out occurs before JES returns.

The TOKEN value is the BUILD token.

Output

Register 15

Contains the following completion codes:

0 JES status returned as requested in the SSOB return area

DFHWOSM macros

Nonzero

Return code from JES.

DFHWOSM FUNC=OPEN macro

The DFHWOSM FUNC=OPEN macro initializes access to the CAVM data sets for a named generic applid.

```
label    DFHWOSM FUNC=OPEN
          [,PARM={parm address|1}]
          [,TOKEN={token register|14}]
```

Input

The PARM value is a pointer to three further addresses, and these are:

1. The address of the generic applid
2. The address of the ddname of the control data set
3. The address of the ddname of the message data set.

The TOKEN value is the BUILD token.

Output

Register 15

Contains one of the following completion codes:

- | | |
|-----------|---|
| 0 | Access initialized, active and alternate signed on |
| 1 | Access initialized, active signed on |
| 2 | Access initialized, alternate signed on |
| 3 | Access initialized, nothing signed on |
| 4 | Same SMF MVS name; IPL time of active earlier than MVS IPL time |
| 5 | Same SMF MVS name; IPL time of alternate earlier than MVS IPL time |
| 6 | Insufficient storage |
| 7 | Generic applid is not associated with the named CAVM data sets |
| 8 | Access already initialized for this generic applid or for this ddname |
| 9 | Version numbers of the named CAVM data sets do not match |
| C | Data set open failure |
| 10 | SHOWCB failure. |

A register 15 return code value of '0' through '5' indicates that a DFHWOSM FUNC=READ macro can now be issued. A return code value of '6' or above indicates that the OPEN has failed and that the overseer program will not be able to access the CAVM data sets.

DFHWOSM FUNC=OSCMD macro

The DFHWOSM FUNC=OSCMD macro is used to issue MVS commands. (The overseer program restarts a failed region in place by issuing this macro.) The text of

the required MVS command is provided as input to the macro, and the OSCMD service issues an SVC 34 specifying this command text. In addition, the OSCMD service issues an MVS WTO request so that a copy of the command text appears on the MVS console to keep the operator informed of what is about to happen. This copy has the comment '(BY IOP)' appended to show that the command is going to be issued by an overseer program. A second copy of the command text is sent to the console when the MVS command is issued.

```
label      DFHWOSM FUNC=OSCMD
           [,PARM={parm address|1}]
           [,TOKEN={token register|14}]
```

Input

The PARM value is a single address that points to a "command area". The command area is made up of a 4-byte length field followed by the command data. The length field contains the length of the whole command area. The command data must be in write-to-operator (WTO) command format.

The TOKEN value is the ENTRY token.

Output

Register 0

Completion code set by SVC 34 as a response to the MVS command that was issued by the macro.

Register 15

Response to the macro itself. A return code of '16' indicates that the OSCMD has failed.

DFHWOSM FUNC=READ macro

The DFHWOSM FUNC=READ macro returns information about a named generic applid from its associated CAVM data sets.

```
label      DFHWOSM FUNC=READ
           [,PARM={parm address|1}]
           [,TOKEN={token register|14}]
```

Input

The PARM value is a pointer to a parameter list that contains the addresses of the generic applid and the "dbllist". The dbllist is a list of one or more doublewords.

In the first two bytes of the second word of each of these doublewords you supply the DBLID of the information you require. Each piece of information that you can request is identified by a DBLID, and a list of these is provided in Figure 51 on page 620.

The first word of each doubleword is an output area to contain the address of the requested information, and the last two bytes of the second word of each doubleword contain the length of the information. The end of the dbllist is signaled by setting the high-order bit of the last doubleword to '1'. Figure 50 on page 620 illustrates the input to and output from the READ macro.

The TOKEN value is the BUILD token.

DFHWOSM macros

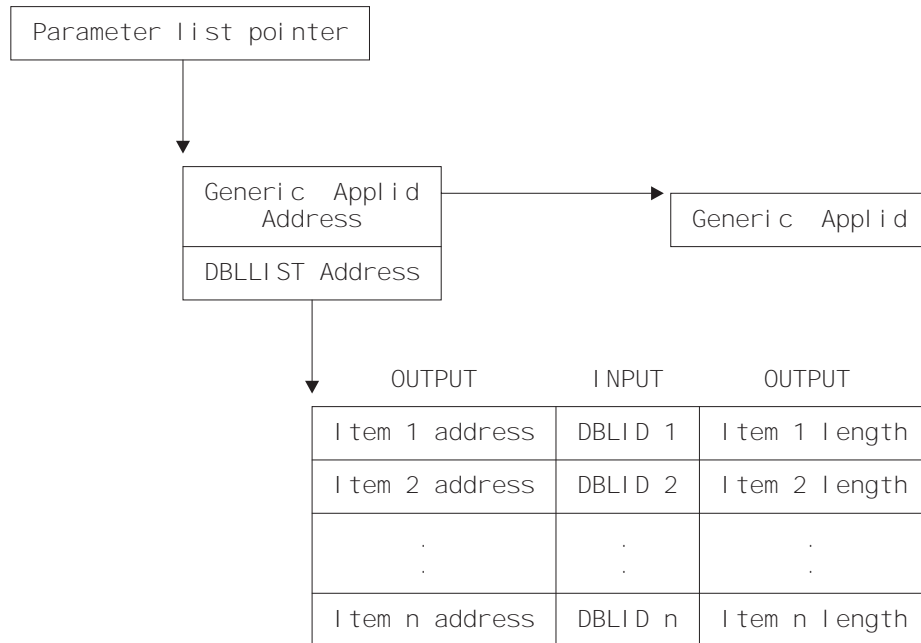

Figure 50. Input to and output from the DFHWOSM FUNC=READ macro

DBLIDs for the active:

DBLID1	EQU	X'0001'	JOB NAME
DBLID2	EQU	X'0002'	JES JOB ID
DBLID3	EQU	X'0003'	JOB SUBMISSION TIME (STIME)
DBLID4	EQU	X'0004'	JOB STEP TASK ATTACH TIME (ATIME)
DBLID5	EQU	X'0005'	CANCEL NAME
DBLID6	EQU	X'0006'	JES SSNAME
DBLID7	EQU	X'0007'	MVS SMF NAME
DBLID8	EQU	X'0008'	MVS IPL TIME
DBLID9	EQU	X'0009'	SPECIFIC APPL NAME
DBLID10	EQU	X'000A'	ADDRESS SPACE IDENTIFIER (ASID)
DBLID11	EQU	X'000B'	RESTART TYPE
DBLID12	EQU	X'000C' - X'001F'	SPARE FOR STATE CTL ITEMS
DBLID32	EQU	X'0020'	HEARTBEAT INTERVAL
DBLID33	EQU	X'0021'	HEARTBEAT COUNTER
DBLID34	EQU	X'0022'	MSG FILE CURSOR
DBLID35	EQU	X'0023'	STATUS VALUE (STATE)
DBLID36	EQU	X'0024'	INQUIRE HEALTH DATA
DBLID37	EQU	X'0025'	INQUIRE GLOBAL DATA
DBLID38	EQU	X'0026'	SYSPLEX NAME
DBLID39	EQU	X'0027'	MVS SYSTEM NAME
DBLID40	EQU	X'0028'	MVS SYSTEM TOKEN

Figure 51. DBLIDs for the DFHWOSM FUNC=READ macro (Part 1 of 2)

DBLIDs for the alternate:

DBLID257 EQU	X'0101'	JOB NAME
DBLID258 EQU	X'0102'	JES JOB ID
DBLID259 EQU	X'0103'	JOB SUBMISSION TIME (STIME)
DBLID260 EQU	X'0104'	JOB STEP TASK ATTACH TIME (ATIME)
DBLID261 EQU	X'0105'	CANCEL NAME
DBLID262 EQU	X'0106'	JES SSNAME
DBLID263 EQU	X'0107'	MVS SMF NAME
DBLID264 EQU	X'0108'	MVS IPL TIME
DBLID265 EQU	X'0109'	SPECIFIC APPL NAME
DBLID266 EQU	X'010A'	ADDRESS SPACE IDENTIFIER (ASID)
DBLID267 EQU	X'010B'	RESTART TYPE
DBLID268 EQU	X'010C' - X'011F'	SPARE FOR STATE CTL ITEMS
DBLID288 EQU	X'0120'	HEARTBEAT INTERVAL
DBLID289 EQU	X'0121'	HEARTBEAT COUNTER
DBLID290 EQU	X'0122'	MSG FILE CURSOR
DBLID291 EQU	X'0123'	STATUS VALUE (STATE)
DBLID292 EQU	X'0124'	INQUIRE HEALTH DATA
DBLID293 EQU	X'0125'	INQUIRE GLOBAL DATA
DBLID294 EQU	X'0126'	SYSPLEX NAME
DBLID295 EQU	X'0127'	MVS SYSTEM NAME
DBLID296 EQU	X'0128'	MVS SYSTEM TOKEN

Figure 51. DBLIDs for the DFHWOSM FUNC=READ macro (Part 2 of 2)

Notes:

1. The data structures of the status information pointed to by items X'0024' and X'0124' are provided in DSECT DFHXRHDS of CICSTS13.CICS.SDFHMAC.
2. The data structures of the status information pointed to by items X'0025' and X'0125' are provided in DSECT DFHXRGDS of CICSTS13.CICS.SDFHMAC.
3. The data structures of the status information pointed to by items X'000B' and X'010B' are mirrors of the field WSJRST in DSECT WSJDESC within DFHWSMDS.

Output

Register 15

Contains one of the following completion codes:

- | | |
|------------|--|
| 0 | Read successful, active and alternate signed on |
| 1 | Read successful, active signed on |
| 2 | Read successful, alternate signed on. |
| 3 | Read successful, nothing signed on |
| 4 | Same SMF MVS name; IPL time of active earlier than MVS IPL time |
| 5 | Same SMF MVS name; IPL time of alternate earlier than MVS IPL time |
| 8 | CAVM data set access not initialized |
| 10C | DBLID not known |
| 1xx | Read subtask problem. |

If a completion code of '0' through '5' is returned to register 15, each doubleword of the DBLLIST contains the address (4 bytes) and the length (2 bytes) of the output from this read. A completion code of '8', '10C', or '1xx' indicates a READ failure.

DFHWOSM macros

Reading DBCTL status information from the CAVM data sets

If you are using DBCTL and have active and alternate DBCTL subsystems, status information about the subsystem connected to the active CICS is written to the CAVM data sets. However, the supplied sample overseer program does not read the DBCTL information from the CAVM data set. If you want the overseer to retrieve this information and to display or use it, you must write your own overseer program.

The information in the CAVM data set about the connected DBCTL subsystem is updated when the active CICS:

- Establishes a connection to a DBCTL subsystem
- Disconnects normally from a DBCTL subsystem
- Loses a connection to a DBCTL subsystem.

If more than one active CICS is connected to a single DBCTL subsystem, the CAVM data set for each CICS contains information about the same DBCTL subsystem. The overseer can recognize this situation because in every case the DBCTL startup time stamp is the same.

Copy book DFHDXGHD contains the information shown in Figure 52.

DFHDXGHD	DSECT		
GHDDXADB	DS	CL4	DBCTL SSID
GHDDXRSE	DS	CL8	IMS RSE name
GHDDXCTM	DS	CL4	IMS connect time
GHDDXDTM	DS	CL4	IMS disconnect time
GHDDXJNM	DS	CL8	JES Job name of old active IMS
GHDDXJID	DS	CL8	JES Job ID of old active IMS
GHDDXASD	DS	H	ASID of old active IMS
GHDDXIRT	DS	X	IMS region type
DXRHTSBY	EQU	X'01'	region type is hot standby
DXRDBDC	EQU	X'02'	region type is IMS DB/DC
DXRDBCTL	EQU	X'04'	region type is DBCTL
GHDDXTYP	DS	X	GHD message type
DXMCNCT	EQU	X'01'	Message type = DBCTL connection
DXMDISC	EQU	X'02'	Message type = DBCTL disconnect
DXMDRAF	EQU	X'04'	Message type = DRA failure
DXMABEND	EQU	X'08'	Message type = DBCTL abend
DXMERROR	EQU	X'80'	Indicates severe error in DFHDBCT
DXGHDLEN	EQU	*-DFHDXGHD	length of CICS XRF/DBCTL GHD
ORG		,	

Figure 52. DFHDXGHD copy book

DFHWOSM FUNC=TERM macro

The DFHWOSM FUNC=TERM macro terminates communication between the overseer program and DFHWOS, and releases any associated storage. It must be issued before the overseer program completes to ensure an orderly termination.

```
label      DFHWOSM FUNC=TERM
           [,TOKEN={token register|14}]
```

Input

The TOKEN value is the BUILD token.

Output**Register 15**

Contains the following completion codes:

0 Communication terminated successfully

Nonzero
Request failed.

Customizing the sample overseer program

The sample overseer program consists of four modules link-edited together. The main module is **DFH\$AXRO**; the other three modules are subroutines, described below:

DFH\$AGCB

sets up request parameter lists (RPLs), access method control blocks (ACBs), and parameter lists.

DFH\$ADSP

displays status information.

DFH\$ARES

performs restart in place.

The associated DSECTs are provided in member **DFH\$XRDS** of **CICSTS13.CICS.SDFHSAMP**. There are several ways in which you can change the supplied code to make the overseer program more suitable for your installation.

Here are some customization suggestions:

- If the supplied display of status information (DSECT **DSPDS**) is not suitable, you can change the layout for your installation. You may also want to change the content of the status display if you are using **DBCTL**. The supplied sample overseer program does not read the **DBCTL**-related information from the **CAVM** data sets, and so cannot display **DBCTL** information on the **MVS** console. If you want this to be displayed, you have to issue a **DFHWOSM FUNC=READ** macro to retrieve the global data, and you have to change the status display to accommodate the extra information. **DFHWOSM FUNC=READ** is described on page 619.
- The CSECT **DFH\$ADSP** can be customized so that, for example, status information is displayed automatically at regular intervals, or whenever a region is in trouble, as well as when the console operator enters the **Display** command. This would require interpretation of the status information by the overseer.
- Any of the messages to the system console, which are listed in the prolog of the source module **DFH\$AXRO**, can be changed.
- You can change the format or the content of the **DFHOSD** data set (DSECT **OSDDS**) if, for example, you want it to contain more information.
- You can change the restart function so that, for example, a failed region is restarted only during periods of heavy use, while at other times a takeover to the alternate is initiated by the operator.
- When an active region fails and is taken over by the alternate, the old active region must be restarted as the new alternate. In those cases where the cause of the takeover was not an **MVS** failure, restart of the old active as an alternate region could be automated in the overseer program.

customizing the sample overseer

- To extend the function of the overseer program, you can incorporate the CEBT command, which is normally issued by the console operator to control the alternate. The CEBT command is described in the *CICS Supplied Transactions* manual.

All of the CEBT functions are available for use in the overseer program, though it is unlikely that you will find it helpful to automate all of them, and there would, in some cases, be difficulties in handling the responses from the INQUIRE commands. However, it might be helpful for you to be able to automate the takeover process in some circumstances. Here are two examples of situations in which you could use the CEBT command to influence or to initiate takeover from the overseer program:

- The active CICS may place error information in the CAVM data sets when a VTAM failure occurs, depending on whether you have coded an exit program at the global user exit point XXRSTAT, and, if so, how you have coded it. (An exit program at this point can be used to decide whether or not VTAM failure data is recorded in the CAVM data sets.) If such data is placed in the CAVM data sets, information about the last eight failures detected by the active CICS region is available to the overseer. The overseer can evaluate this information and, if necessary, initiate a takeover by issuing the following CEBT command:

```
MODIFY jobname,CEBT PERFORM TAKEOVER
```

In this case, you should ensure that the actions taken by the global user exit program at exit point XXRSTAT do not conflict with or duplicate those taken by the overseer program. For example, it would be possible for the global user exit program to request a CICS abend, and thereby initiate a takeover, and for the overseer program to issue the PERFORM TAKEOVER command while acting on the same information.

- At particular times of the day, perhaps when fewer operational staff are available than at other times, you may find it convenient to change the TAKEOVER setting for some, or all, of your regions. For example, you can change the TAKEOVER value for a region from COMMAND or MANUAL to AUTO, without shutting down the alternate, so that takeover is automatic until the setting is next changed. The CEBT command is as follows:

```
MODIFY jobname,CEBT SET TAKEOVER AUTO
```

In both of these examples, you would include takeover commands in the command list tables (CLTs) of these regions to ensure that their related regions are also switched when appropriate.

There is one optional section of code in the overseer program, which is described below.

Loop or wait detection

The sample overseer program includes some code that you can use to detect possible loops or waits in the active CICS region.

The sample program monitors the CICS task control block (TCB) time stamp. If this remains the same for a period defined by the variable LOOPTM, a message is sent to the console warning of a possible loop or wait. The value of LOOPTM is the number of seconds (wait time) before a loop is suspected, and may need to be changed to suit your requirements and to avoid the detection of “false” loops. It should be set to a value greater than the largest runaway task time interval (as specified on the ICVR system initialization parameter) to avoid detection of user transaction loops.

customizing the sample overseer

To include this LOOP WARNING code, set the variable &LOOPWARN to '1' and reassemble the sample.

Assembling and link-editing the overseer program

The non-specific job control statements required to assemble and link-edit the overseer program are the same as those required for user-replaceable programs, and are described in “Assembling and link-editing user-replaceable programs” on page 402.

The specific link-edit statements that you require are:

```
ORDER DFH$AXRO    this CSECT is in USERTEXT(DFH$AXRO)
ORDER DFH$AGCB    this CSECT is in DLOADLIB(DFH$AGCB)
ORDER DFH$ARES    this CSECT is in DLOADLIB(DFH$ARES)
ORDER DFH$ADSP    this CSECT is in DLOADLIB(DFH$ADSP)
INCLUDE USERTEXT(DFH$AXRO)
INCLUDE DLOADLIB(DFH$ADSP)
INCLUDE DLOADLIB(DFH$AGCB)
INCLUDE DLOADLIB(DFH$ARES)
ENTRY DFHXRONA
NAME DFH$AXRO(R)
```

If you change the overseer code in any way, note that the libraries SYS1.SDFHMAC and SYS1.AMODGEN are required for the assembly, and that the link-edit job step requires the entry name DFHXRONA. If you change any of the DSECTs used by the sample overseer program, you should reassemble the four modules.

Part 5. CICS journaling, monitoring, and statistics

A general note about user-written programs

The following comment applies to all user-written programs mentioned in Part 5 of this book:

- Upon return from any user-written program, CICS must always receive control in primary-space translation mode, with the original contents of all access registers restored, and with all general purpose registers restored (except for those which provide return codes or linkage information).

For information about translation modes, refer to the *IBM ESA/370 Principles of Operation* manual.

Chapter 23. CICS logging and journaling

The CICS log manager provides facilities for the creation, control, and retrieval of journals during real-time CICS execution. Journals are intended to record, in chronological order, any information that you may later need to reconstruct data or events. For example, you could create journals to act as audit trails; to record database updates, additions, and deletions for backup purposes; or to track transaction activity in the system.

The CICS log manager controls all logging and journaling using services provided by the MVS system logger. The CICS log manager supports:

- The CICS system log
- Forward recovery logs
- Auto-journals for file control and terminal control operations
- User journals.

The MVS system logger provides:

- Media management and archiving
- Log data availability through direct, and sequential, access to log records.

The chapter is divided into the following sections:

1. “**Log stream storage**”
2. “**Enabling, disabling, and reading journals**” on page 631
3. “**Structure and content of COMPAT41-format journal records**” on page 645
4. “**Format of journal records written to SMF**” on page 653.

Log stream storage

A log stream is a sequence of data blocks, with each log stream identified by its own log stream identifier—the log stream name (LSN). The CICS system log, forward recovery logs, and user journals map onto specific MVS log streams. CICS forward recovery logs and user journals are referred to as general logs, to distinguish them from system logs.

Each log stream is a sequence of blocks of data, which the MVS system logger internally partitions over three different types of storage:

1. Primary storage, which holds the most recent records written to the log stream. Primary storage can consist of either:
 - a. A structure within a coupling facility. (The use of a coupling facility allows CICS regions in different MVS images to share the same general log streams.) Log data written to the coupling facility is also copied to either a data space or a staging data set.
 - b. A data space in the same MVS image as the system logger. Log data written to the data space is also copied to a staging data set.
2. Secondary storage—when the primary storage for a log stream becomes full, the older records automatically spill into secondary storage, which consists of data sets managed by the storage management subsystem (SMS). Each log stream, identified by its log stream name (LSN), is written to its own log data sets.

journaling

3. Tertiary storage—a form of archive storage, used as specified in your hierarchical storage manager (HSM) policy. Optionally, older records can be migrated to tertiary storage, which can be either DASD data sets or tape volumes.

Figure 53 and Figure 54 on page 631 show the types of storage used by the MVS system logger.

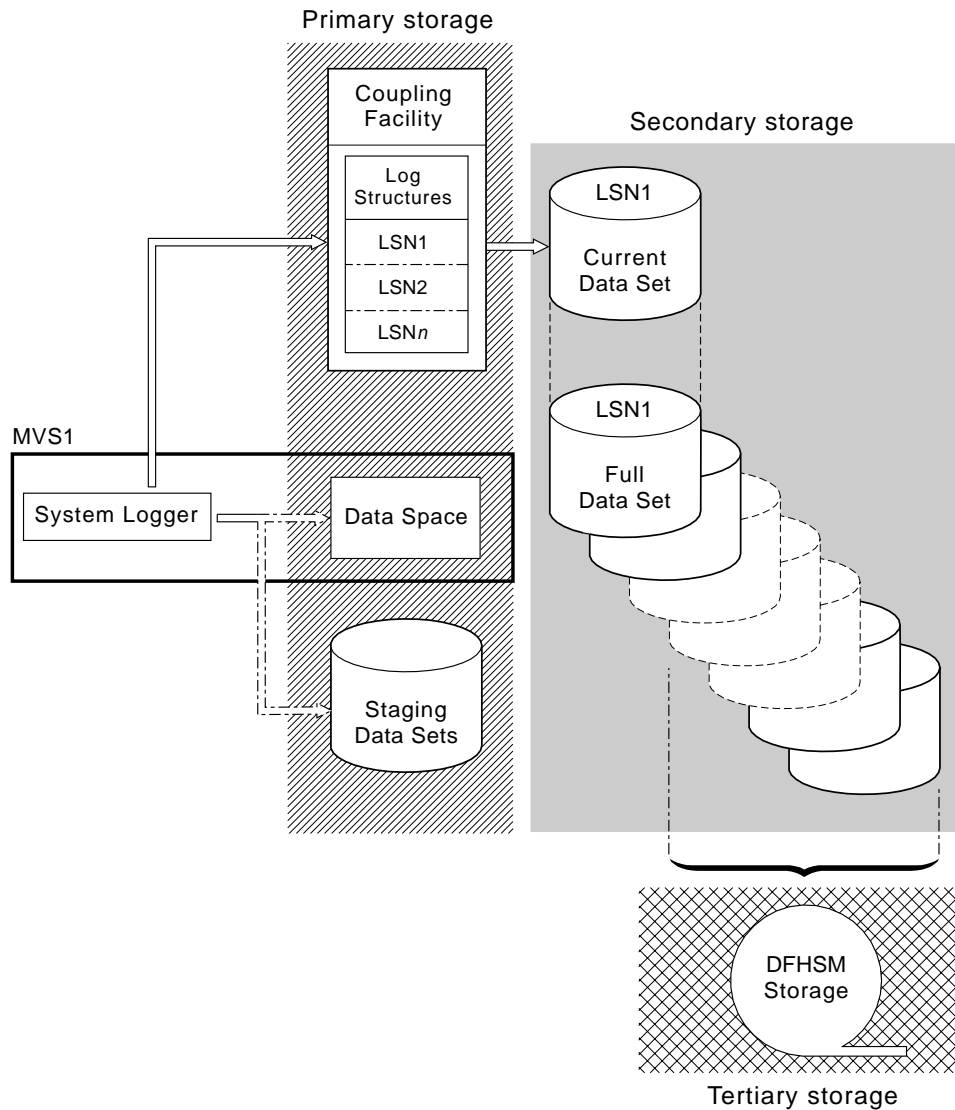

Figure 53. The types of storage used by the MVS system logger. This diagram shows a log stream that uses a coupling facility. Primary storage consists of space in a structure within the CF, and either staging data sets or a data space in the same MVS image as the system logger.

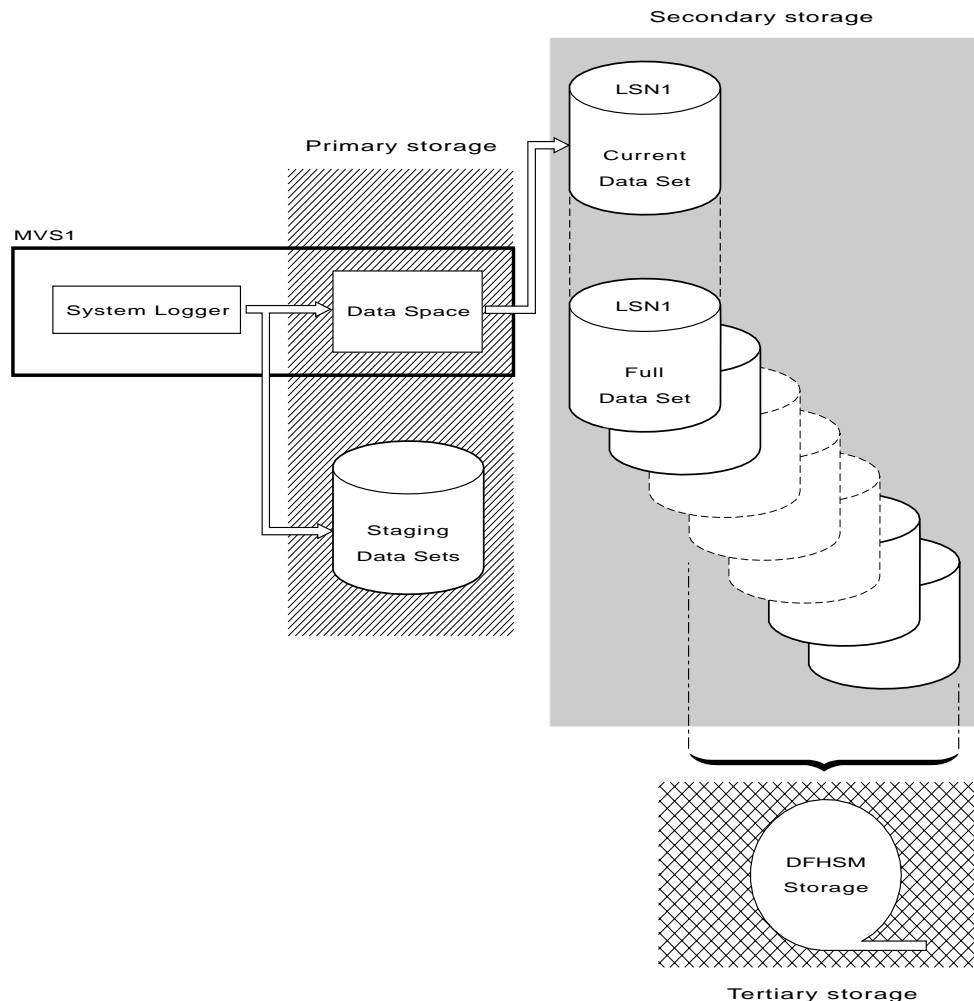

Figure 54. The types of storage used by the MVS system logger. This diagram shows a log stream that uses DASD-only logging. Primary storage consists of a data space in the same MVS image as the system logger, and a single staging data set.

Enabling, disabling, and reading journals

Journal records are written to a log stream either directly from a user application program, or from a CICS management program on behalf of a user application. Journal records can be written from a user application using the EXEC CICS WRITE JOURNALNAME command. For programming information about the EXEC CICS WRITE JOURNALNAME command, see the *CICS Application Programming Reference* manual.

This section describes the commands that you use for enabling and disabling journals, and for reading journals offline.

Enabling and disabling a journal

To enable or disable a journal from an application program, use the EXEC CICS SET JOURNALNAME command. For programming information about the EXEC CICS SET JOURNALNAME command, see the *CICS System Programming Reference* manual.

journaling

Reading journal records offline

Access to journaled data in log streams is provided through an MVS subsystem interface (SSI), LOGR. Your existing user programs can read the general log streams, providing you specify, in your batch job JCL, the SUBSYS parameter and supporting options on the DD for log streams. By specifying the LOGR subsystem name on the SUBSYS parameter, you enable LOGR to intercept data set open and read requests at the SSI, and convert them into log stream accesses.

Depending on the options specified on the SUBSYS parameter, general log stream journal records are presented either:

- In the record format used at CICS/ESA 4.1 and earlier, for compatibility with older utilities (selected by the COMPAT41 option), or
- In the CICS Transaction Server for OS/390 format (introduced at CICS Transaction Server for OS/390 Release 1), for newer or upgraded utilities needing to access log record information.

CICS system log records are only available in the CICS Transaction Server for OS/390 format, so you must ensure that any utilities that handled system log records in releases prior to CICS Transaction Server for OS/390 Release 1 are converted to handle this format.

Journal records can be read offline by user-written programs. You can generate the DSECTs that such programs need by including certain statements in the program code, as follows:

- For records in the CICS Transaction Server for OS/390 format on general logs, offline user-written programs can map journal records by including an INCLUDE DFHLGGFD statement. This generates the assembler version of the DSECT.
- For records formatted with the COMPAT41 option, offline user-written programs can map journal records by issuing the DFHJCR CICSYST=YES statement, which results in the DFHJCRDS DSECT being included in the program.

The DSECT thus generated is identical to that obtained for CICS programs by the COPY DFHJCRDS statement, except that the fields are not preceded by a CICS storage accounting area. The DSECT is intended to map journal records directly in the block, rather than in a CICS storage area.

The following section describes the structure of CICS Transaction Server for OS/390-formatted journal records. The structure and content of CICS/ESA 4.1-format journal records are described in “Structure and content of COMPAT41-format journal records” on page 645.

Structure and content of CICS Transaction Server for OS/390 format journal records

SMF records

The following description does not apply to journal records written to an SMF data set. These are described on page 653.

General logs (that is, those containing forward-recovery logs, auto-journals, and user journals) can be presented in the format introduced at CICS Transaction

Server for OS/390 Release 1. Each journal record in these logs, if presented in the newer format, contains more information than in the equivalent journal record presented in the CICS/ESA 4.1 format.

System logs are always presented in CICS Transaction Server for OS/390 format..

Each general log comprises a stream of contiguous blocks of journaled data. Each block comprises a block header followed by a variable number of CICS journal records. Each CICS journal record comprises a record header followed by caller data.

Figure 55 gives a graphical overview of a general log, showing the format of a complete block, and the format of a complete journal record.

The format of the caller data depends on the CICS component that is issuing the journal record, and also on the function being journaled at the time. Thus, for example, the format of caller data in journal records issued by file control differs from that of caller data in journal records issued by FEPI.

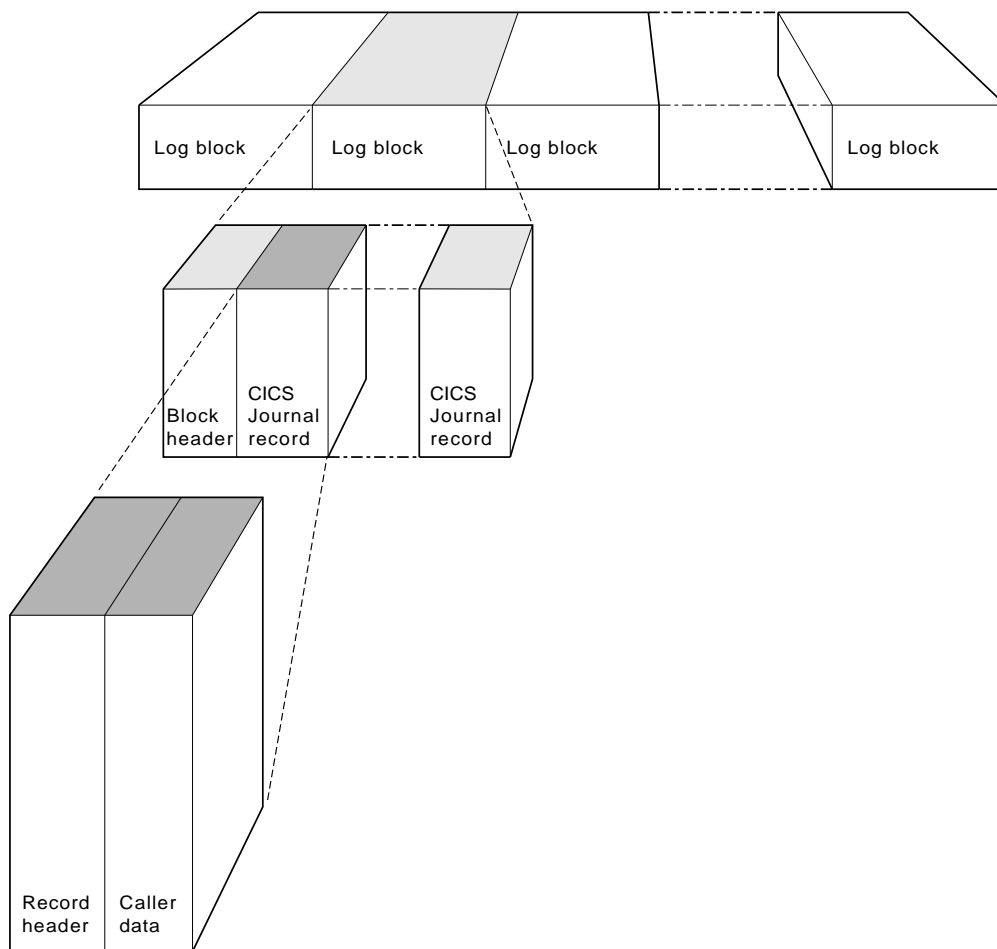
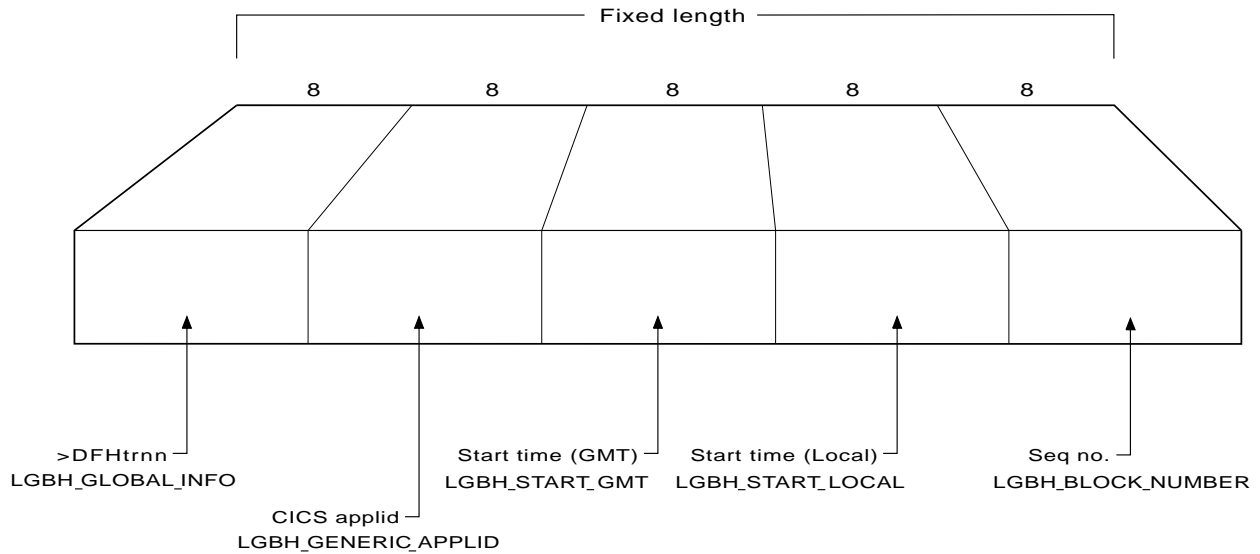

Figure 55. Layout of a general log

journaling

Format of general log block header

The log block header contains information of a general system-wide nature such as the CICS applid writing the journal block. Figure 56 shows the format of the log block header.



Where *t* = Log type

r = reserved

nn = block version number

Figure 56. Format of a general log block header

Format of general log journal record

The journal record comprises a record header followed by caller data. The record header contains information that describes some of the attributes of the record, such as the time it was written. Figure 57 shows the format of the record header. The caller data differs depending on the CICS component issuing the record, and

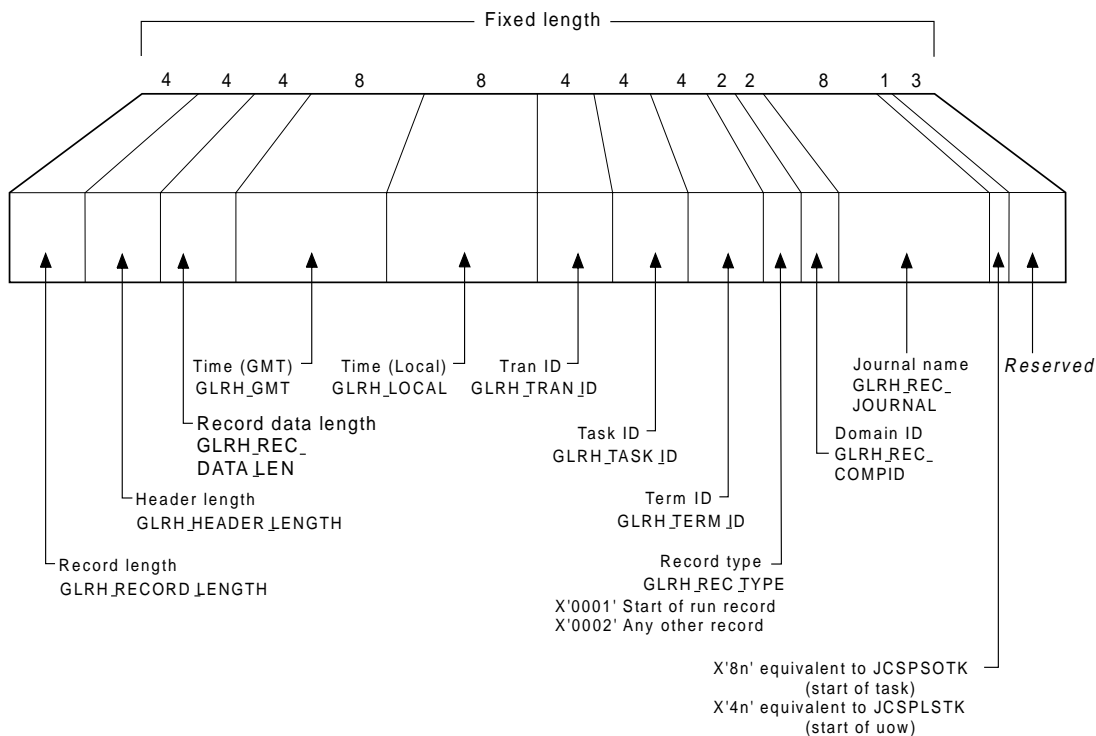

Figure 57. Format of a general log record header

on the function being journaled.

journaling

Start-of-run record

When CICS connects to a general log, it writes a start-of-run record to it as the first record for this run of CICS. This record comprises a record header (with the same format as that for any general log journal record) followed by a start-of-run body. Its format is shown in Figure 58.

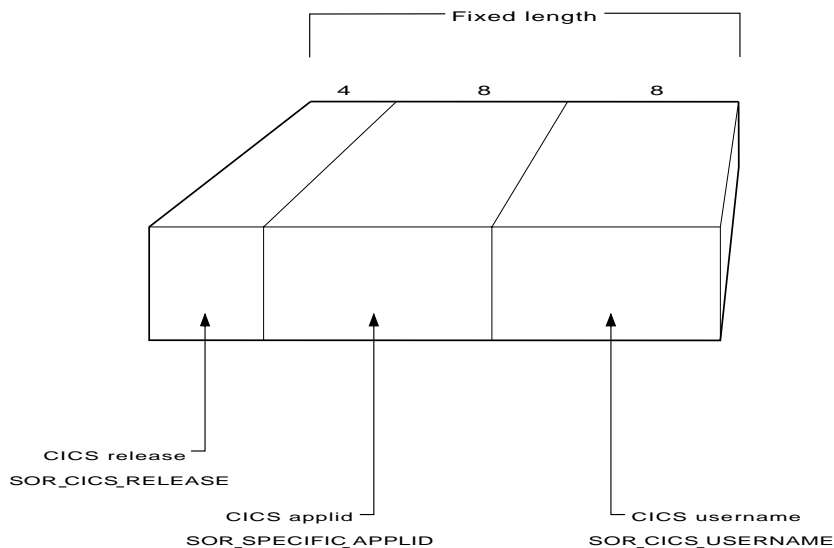

Figure 58. Format of the start-of-run record

Format of caller data

Caller data follows the record header.

The format of the caller data part of a general log journal record differs according to the CICS component writing the record, and the function being journaled.

Journal records can be written by any of the four following CICS components: journal control (in the case of a request issued by a user), file control, the front end programming interface (FEPI), and terminal control. The field GLRH_REC_COMPID in the record header tells you which component has written the record: UJ, FC, SZ, or TC respectively.

File control adds information to the start of the actual journaled data, and this is described in “Caller data written by file control” on page 637. The other components (journal control, FEPI, and terminal control) do not add any further information to the journaled data.

If the record has been written by the CICS API, the caller data section starts with an API user header, the format of which is shown in Figure 59 on page 637.

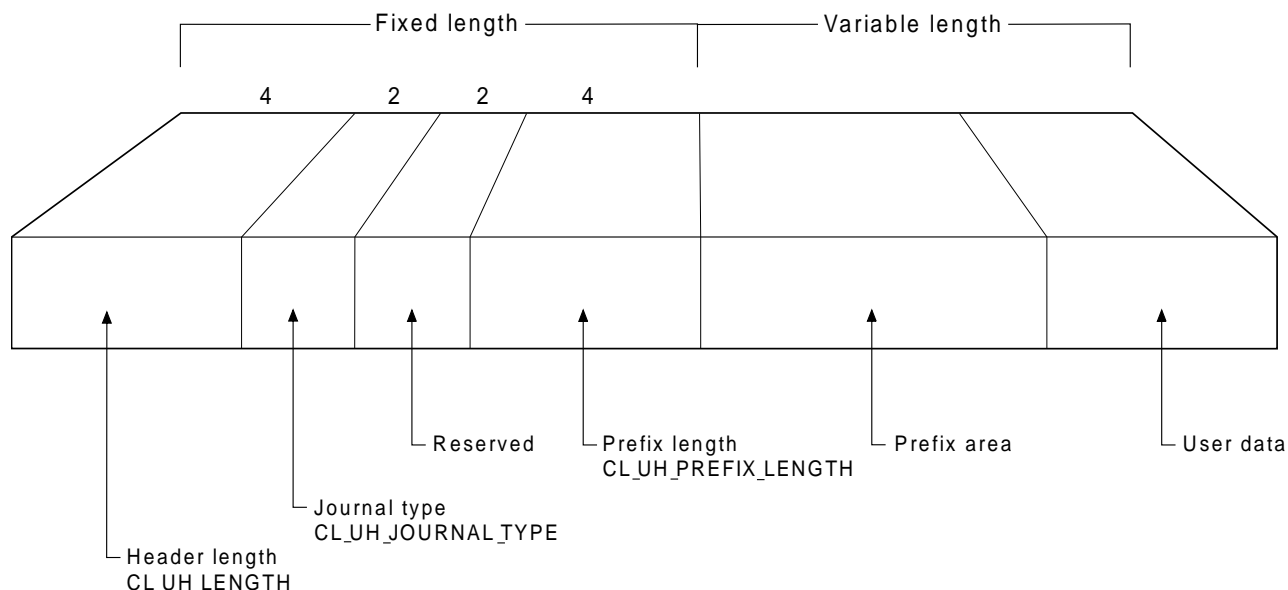

Figure 59. Format of the API user header

Caller data written by file control

The file log and journal block (FLJB) describes the caller data that file control writes as part of its journal records. The copybook DFHFCLGD defines the FLJB DSECT.

There are two sections in the FLJB: the first section contains data that is applicable to all journal records written by file control; the second section contains information specific to the record type. Both sections are of fixed length.

Some records have a third and fourth section which are of variable length.

Table 30 outlines the sections in a journal record written by file control.

Table 30. FLJB sections in journal records issued by file control

Record type	First section	Second section	Third section	Fourth section
Read-only Read-update Write-update Write-add Write-add complete	FLJB_GENERAL_DATA	FLJB_COMMON_DATA	FLJB_CD_KEY	FLJB_CD_DATA
Write delete	FLJB_GENERAL_DATA	FLJB_WRITE_DELETE_DATA	FLJB_WDD_BASE_KEY	FLJB_WDD_PATH_KEY
File close	FLJB_GENERAL_DATA	FLJB_FILE_CLOSE_DATA	None	None
Tie-up	FLJB_GENERAL_DATA	FLJB_TIE_UP_RECORD_DATA	None	None

A description of each of the structures, and the sections within them, now follows:

Read-only, read-update, write-update, write-add, write-add complete record types

There are four sections in the journal records written for read-only, read-update, write-update, write-add, and write-add complete record types:

- The FLJB_GENERAL_DATA section,

journaling

- The FLJB_COMMON_DATA section, and
- The caller data image sections which consist of the FLJB_CD_KEY (the length of which is given in FLJB_COMMON_DATA) and the FLJB_CD_DATA section. The FLJB_CD_DATA section (the length of which is given in FLJB_COMMON_DATA) contains the image of the caller data.

The format of such a record written for these record types is shown in Figure 60.

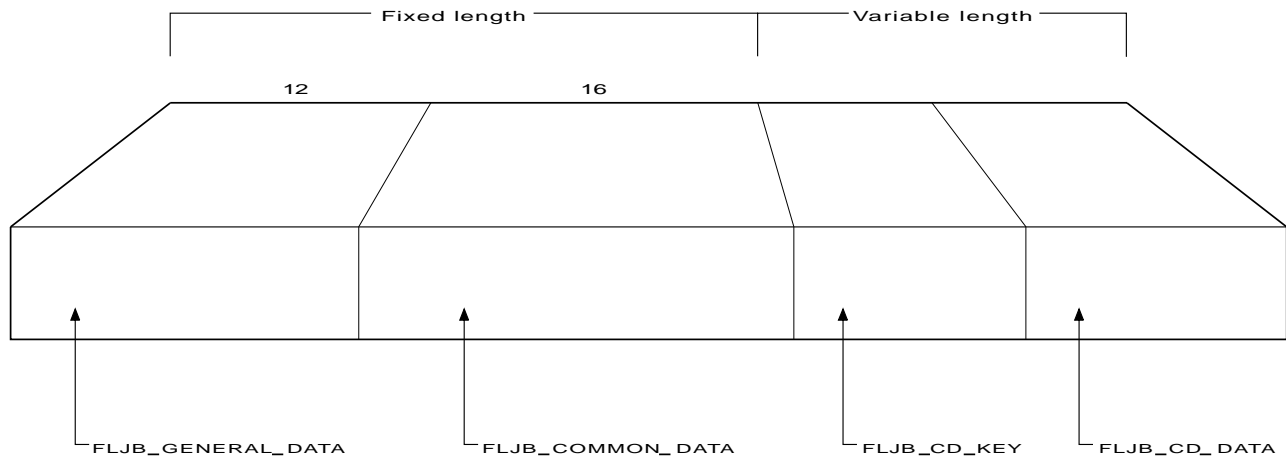

Figure 60. Layout of record written for read-only, read-update, write-update, write-add, and write-add-complete record types

The format of the FLJB_GENERAL_DATA section is shown in Figure 61 on page 639.

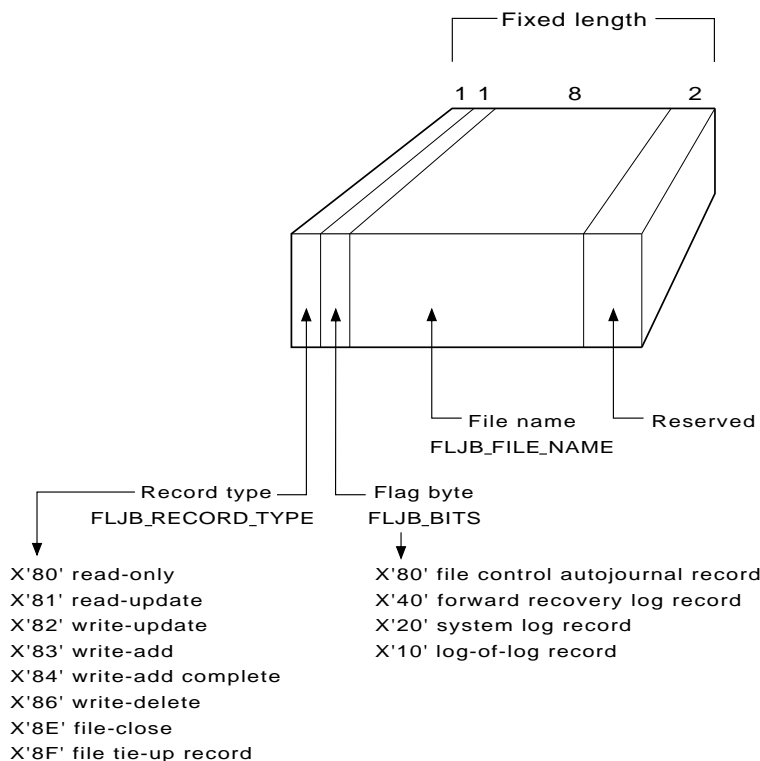

Figure 61. Format of `FLJB_GENERAL_DATA` section

The format of the `FLJB_COMMON_DATA` section is shown in Figure 62 .

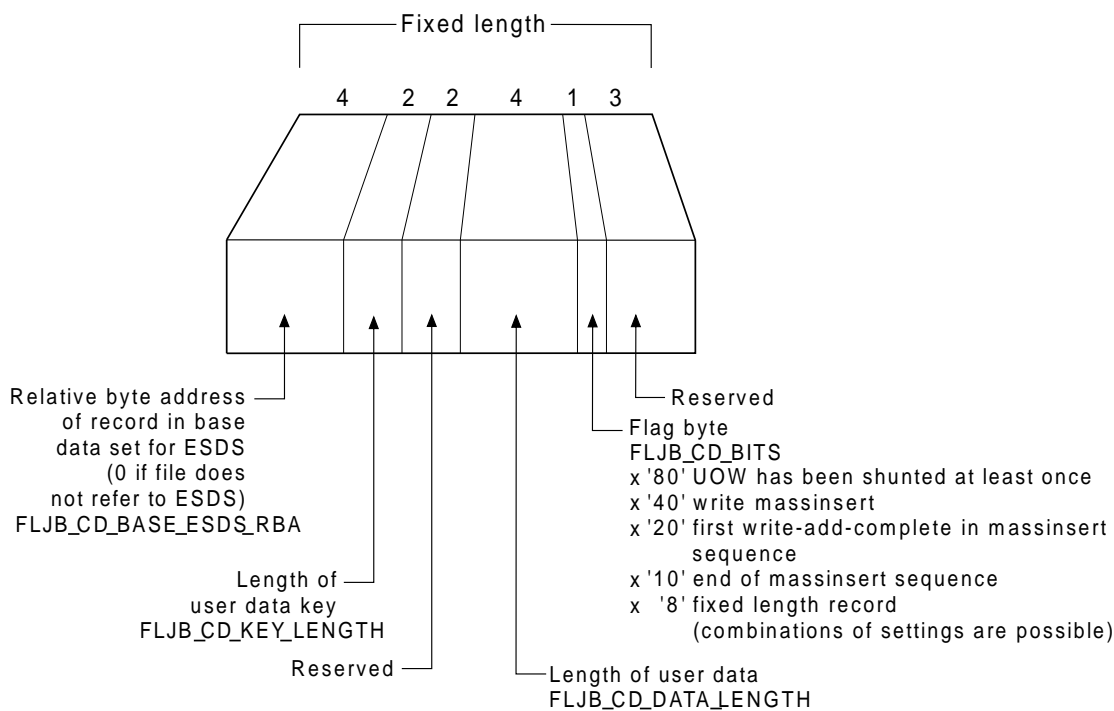

Figure 62. Format of `FLJB_COMMON_DATA` section

Write-delete record types

There are four sections in the journal records written for write-delete record types:

- The FLJB_GENERAL_DATA section,
- The FLJB_WRITE_DELETE_DATA section, and
- The two caller data image sections, which consist of:
 - FLJB_WDD_BASE_KEY (the length of which is given by FLJB_WDD_BASE_KEY_LENGTH in FLJB_WRITE_DELETE_DATA)
 - FLJB_WDD_PATH_KEY (the length of which is given by FLJB_WDD_PATH_KEY_LENGTH in FLJB_WRITE_DELETE_DATA).

These sections contain the image of the caller data as the base key, and, if the data set is a path, the path.

The format of such a record written for write-delete record types is shown in Figure 63.

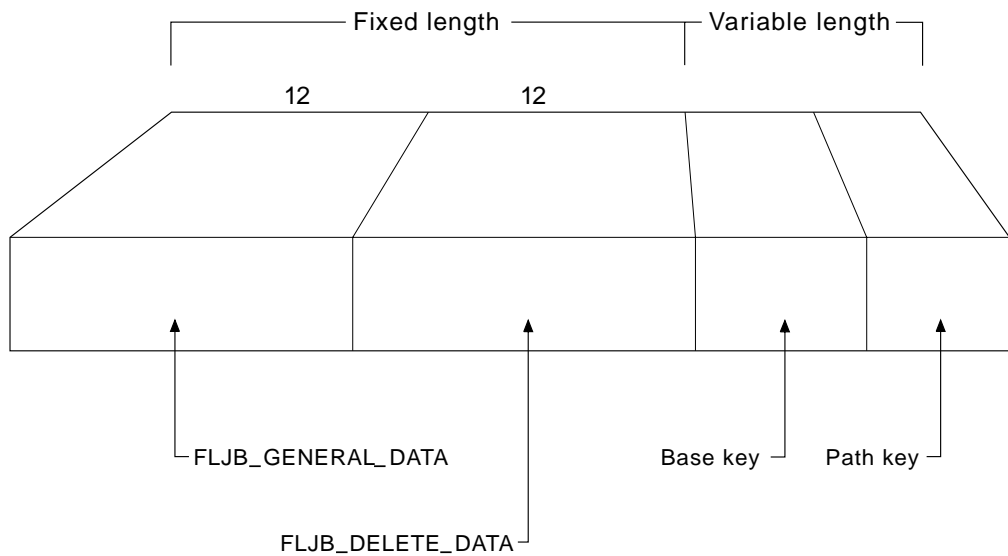

Figure 63. Layout of record written for write-delete record types

See Figure 61 on page 639 for the format of the FLJB_GENERAL_DATA section.

The format of the FLJB_WRITE_DELETE_DATA section is shown in Figure 64 on page 641.

journaling

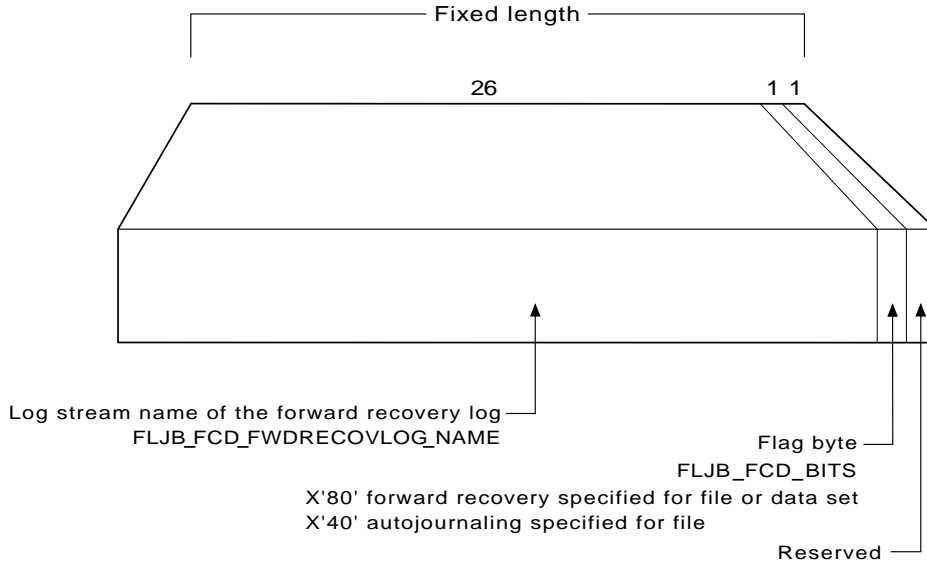

Figure 66. Format of the FILE_CLOSE_DATA section

Tie-up record types

There are two sections in the journal records written for tie-up record types:

- The FLJB_GENERAL_DATA section
- The TIE_UP_RECORD_DATA section.

The format of such a record written for tie-up record types is shown in Figure 67.

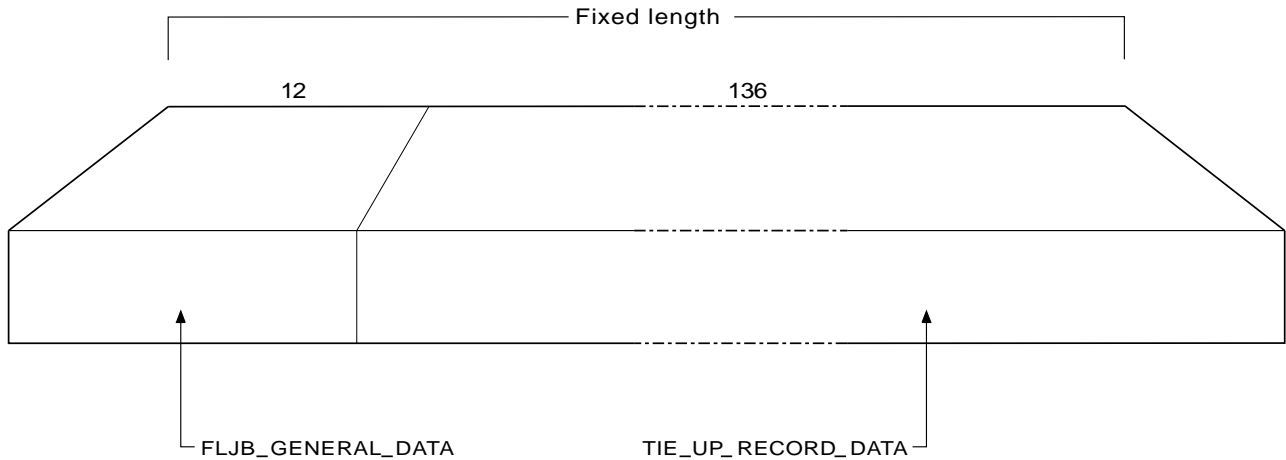

Figure 67. Layout of record written for tie-up record types

See Figure 61 on page 639 for the format of the FLJB_GENERAL_DATA section.

The format of the TIE_UP_RECORD_DATA section is shown in Figure 68 on page 643.

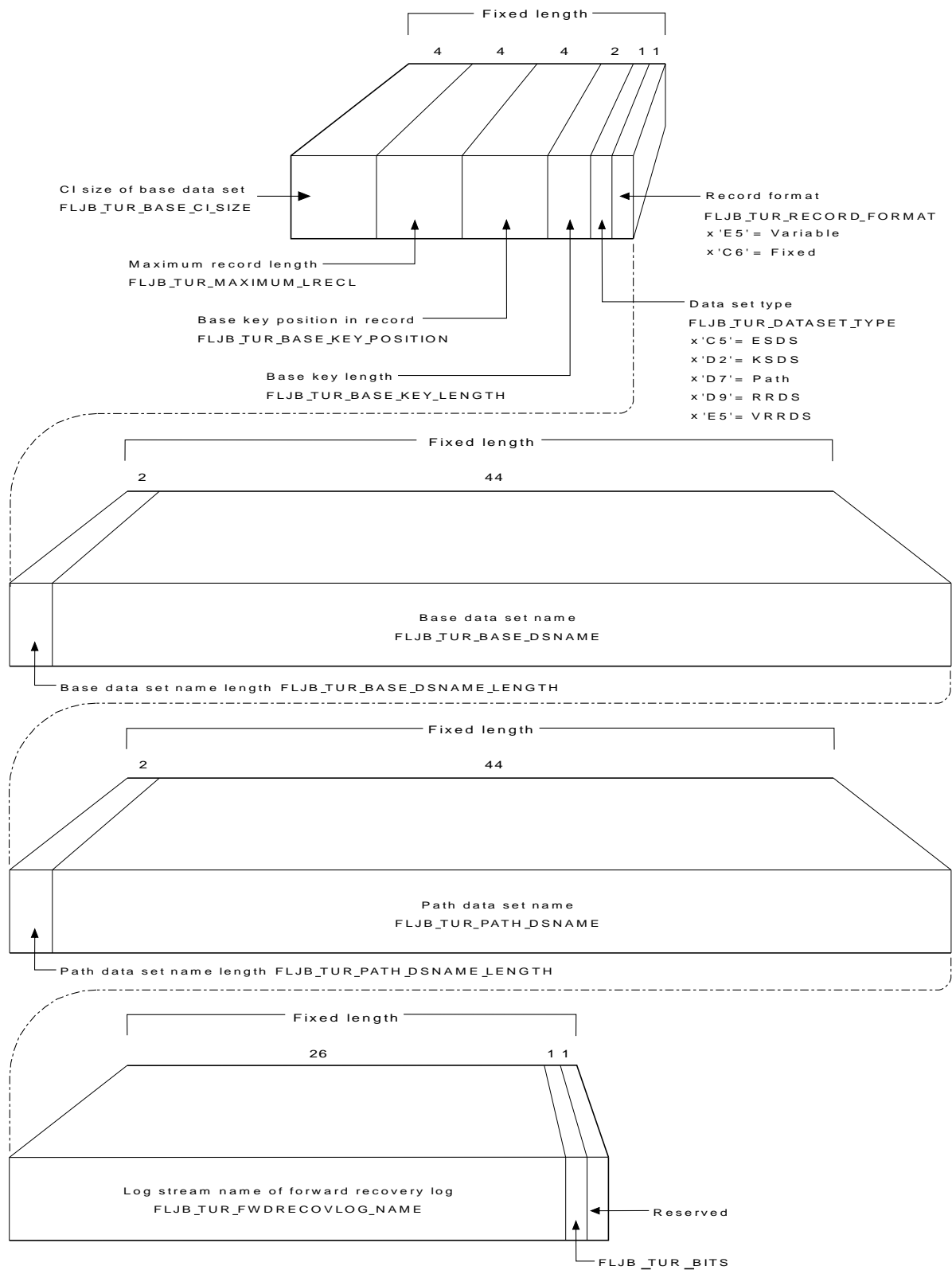

Figure 68. Format of TIE_UP_RECORD_DATA section

journaling

Note: The format of caller data in journal records written by file control in RLS mode is identical to that in journal records written by file control in non-RLS mode except for FLJB_TUR_BITS where a value of X'80' indicates RLS-access.

Terminal control prefix data

CICS terminal control (TC) writes journal records to track the messages it issues. Each TC journal record contains a prefix area, which lies in the position of the prefix area in the API user header. For LU6.1-related records only, the prefix area contains the VTAM physical sequence numbers at syncpoint time; for all other TC journal records, it contains binary zeros. The format of the TC prefix area is shown in Figure 69.

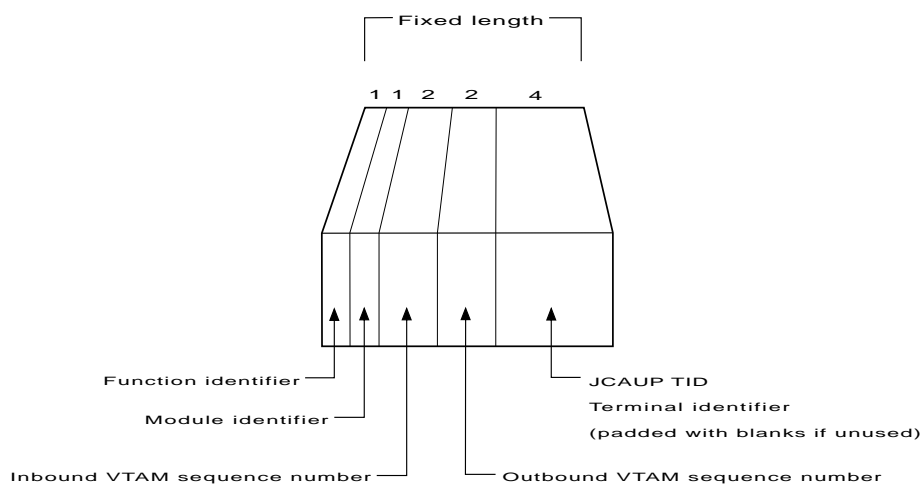

Figure 69. Format of the terminal control prefix area

FEPI prefix data

Each FEPI journal record contains a prefix area that allows you to identify the FEPI conversation for which the data was journaled. This prefix area lies in the position of the prefix area in the API user header. Its format is shown in Figure 70 on page 645.

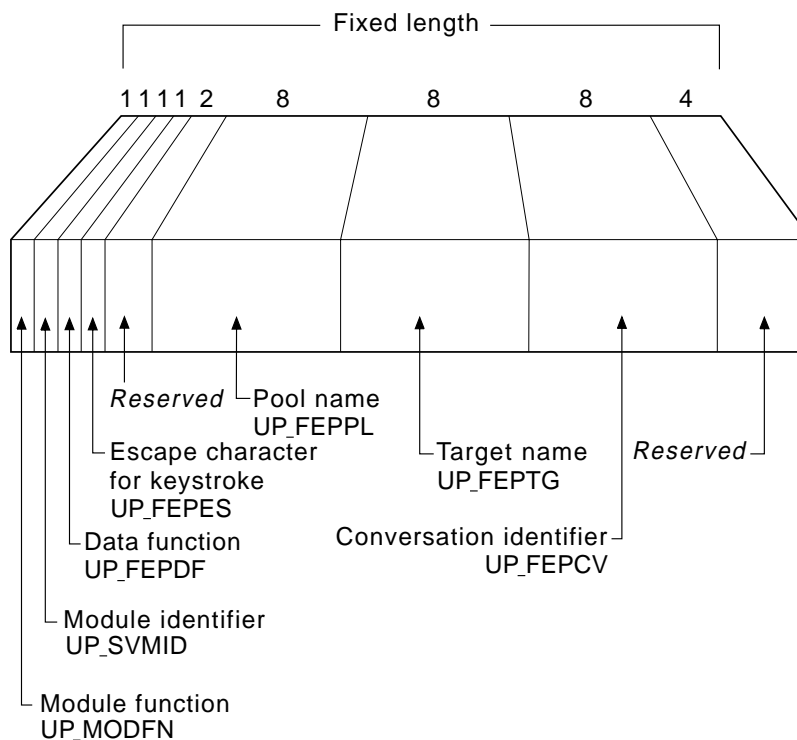

Figure 70. Format of the FEPI prefix area

See the *CICS Front End Programming Interface User's Guide* for more information about FEPI journaling.

Structure and content of COMPAT41-format journal records

SMF records

The following description does not apply to journal records written to an SMF data set. These are described on page 653.

CICS allows you to format journal records so that they are presented in the format used at CICS/ESA 4.1. Use the COMPAT41 option on the SUBSYS=(LOGR...) step of your JCL.

Within the data presented, certain fields are not presented at CICS Transaction Server for OS/390. They appear as X'00' in the formatted output. These fields are:

Table 31. Fields formatted as X'00'

JCLRJFID	JCLRTBAL	JCSPEMER
JCLRVCD	JCRBB	JCSPMIDT
JCLRVSN	JCSPFS	JCSPRRIF
JCLRLBW	JCSPDSP	

Each general log comprises a stream of contiguous blocks of journaled data. Each block comprises a journal control label header followed by a variable number of CICS journal records. Each CICS journal record comprises a system header, system prefix, user prefix, and journaled data.

journaling

A graphical overview of the format of a general log, showing the format of a complete block, is shown in Figure 71.

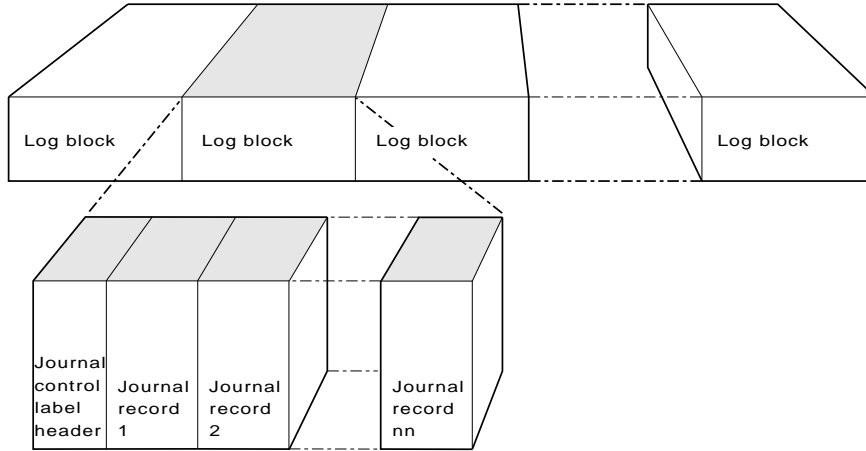

Figure 71. Format of general log formatted using the COMPAT41 option

Format of COMPAT41 journal control label header

Each log block starts with a journal control label header. There is one journal control label header per log block. It is 42 bytes long, and comprises a length field, label header, and label prefix. The format of the journal control label header is shown in Figure 72.

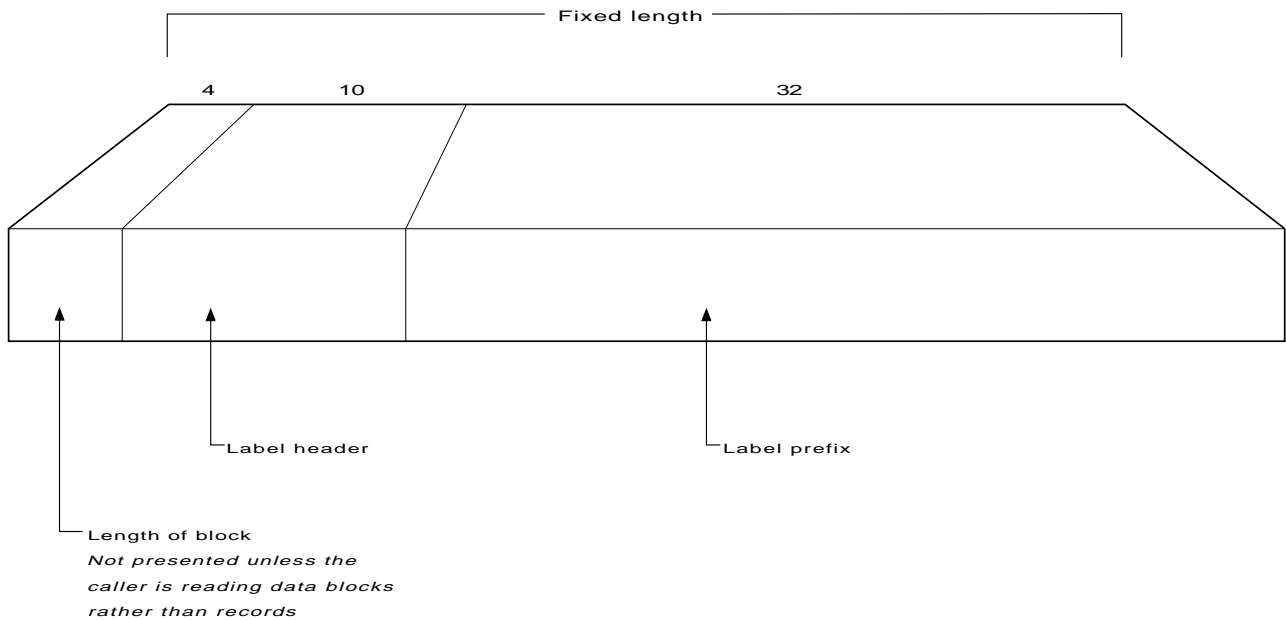

Figure 72. Format of journal control label header

The label header part of the journal control label header is 10 bytes long, and its format is shown in Figure 73 on page 647.

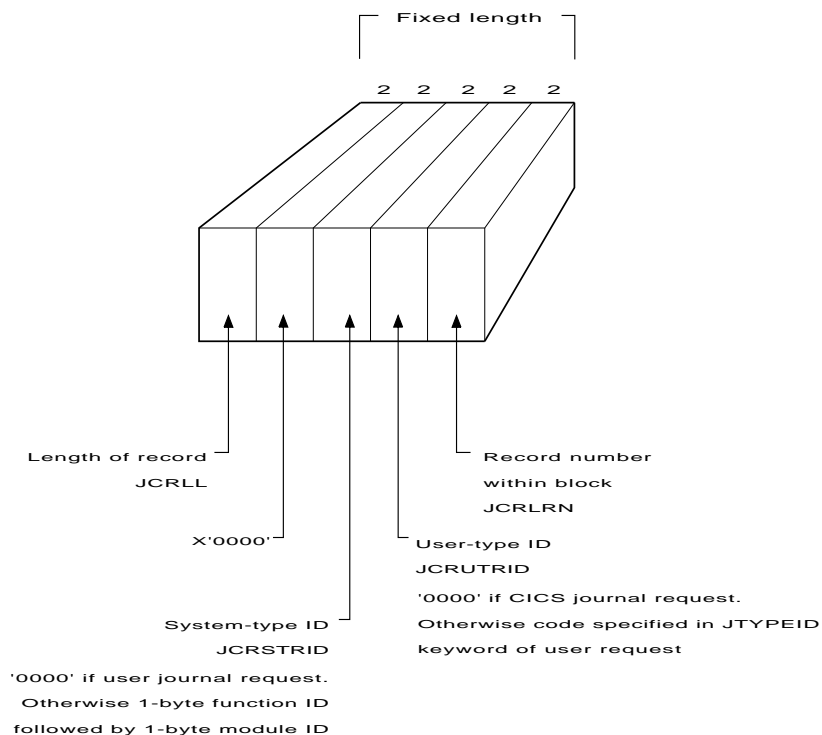

Figure 73. Format of label header part of journal control label header

The label prefix part of the journal control label header is 32 bytes long, and its format is shown in Figure 74.

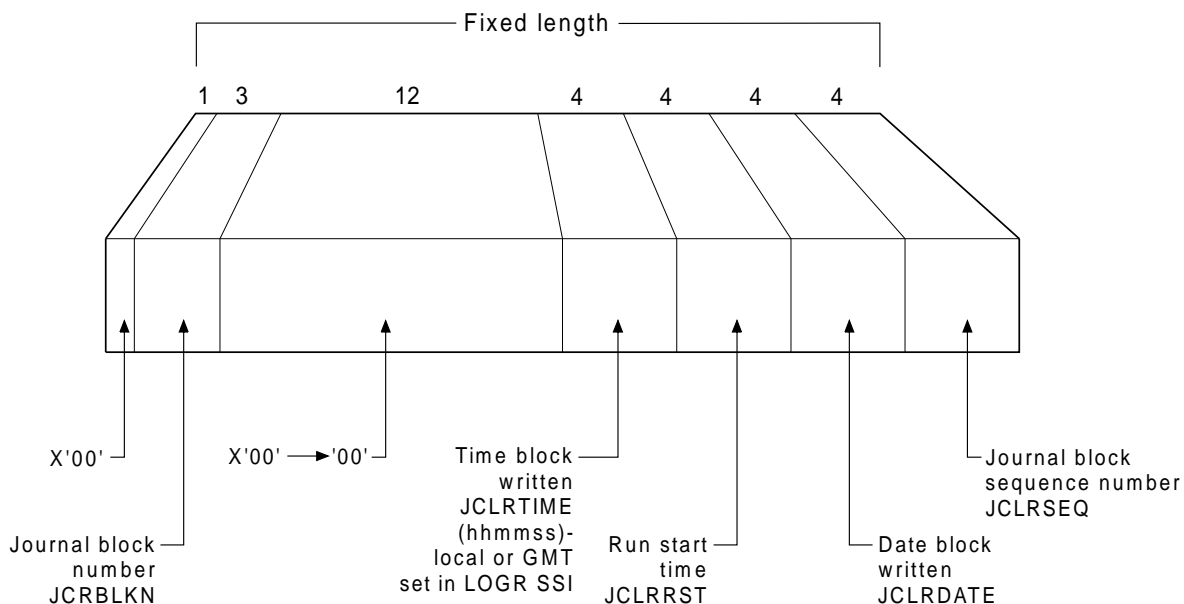

Figure 74. Format of label prefix part of journal control label header

journaling

Format of journal record

Each CICS journal record comprises a system header, system prefix, user prefix, and journaled data. The format of a journal record is shown in Figure 75.

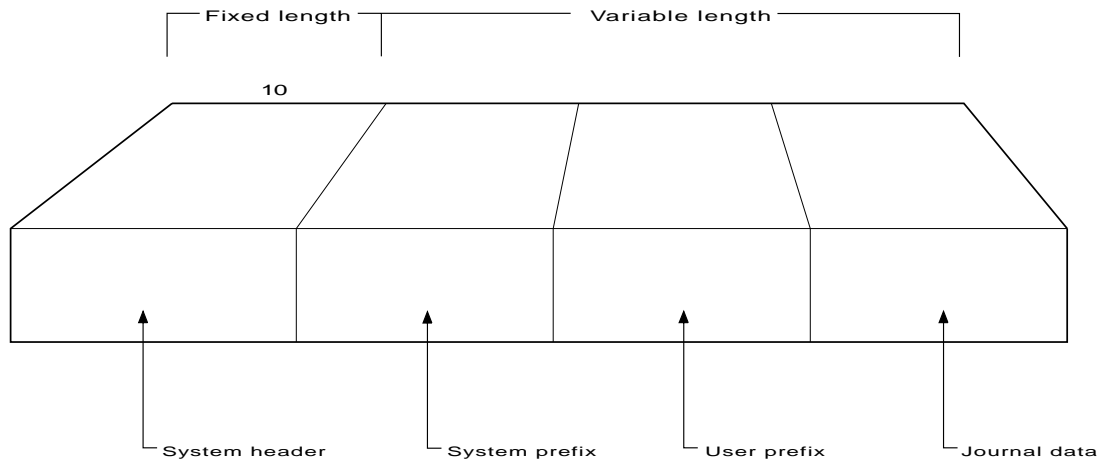

Figure 75. Format of COMPAT41 journal record

The system header is 10 bytes long. Its format is shown in Figure 76.

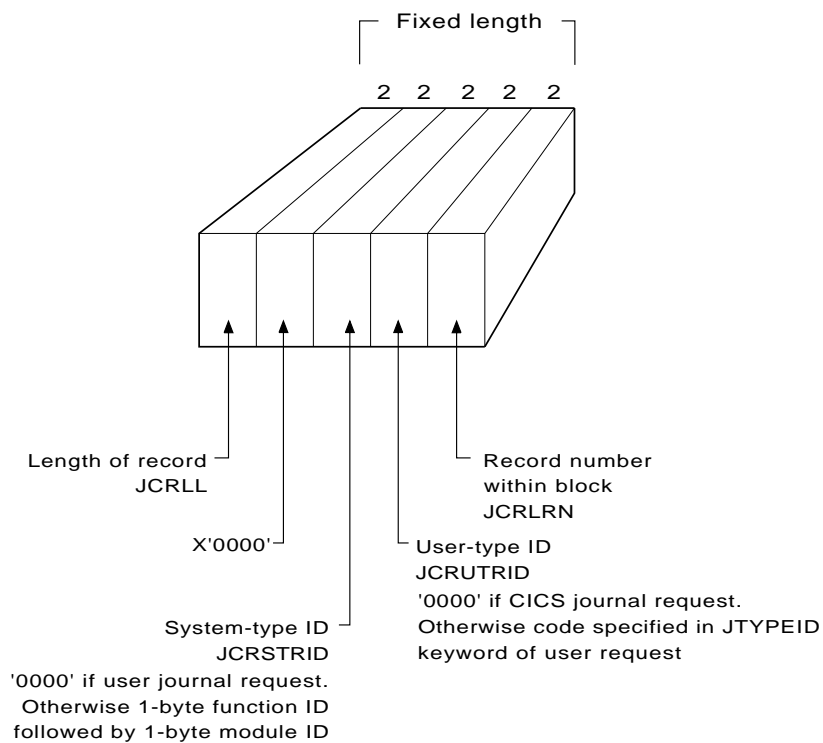

Figure 76. Format of the system header

The field JCRSTRID (the system-type ID) and the field JCRUTRID (the user-type ID) in the system header allow you to distinguish those journal records output by CICS (by such components as terminal control), from those issued by direct user requests.

For CICS journal requests, JCRUTRID contains binary zeros, and JCRSTRID contains a 1-byte function code followed by a 1-byte module code. The function code tells you which function was being journaled, and the module code shows which module caused the record to be written. Valid settings of these codes are contained in the member DFHFMIIDS of the CICS assembler-language macro library. Figure 79 on page 651 shows the valid function identifiers of those CICS components that issue journal requests. Figure 80 on page 652 shows the valid module identifiers.

For user journal requests, JCRSTRID always contains binary zeros, and JCRUTRID contains the 2-byte hexadecimal code specified by the JTYPEID keyword of the WRITE JOURNALNAME request in the application program.

The system prefix is 25 bytes long. Its format is shown in Figure 77.

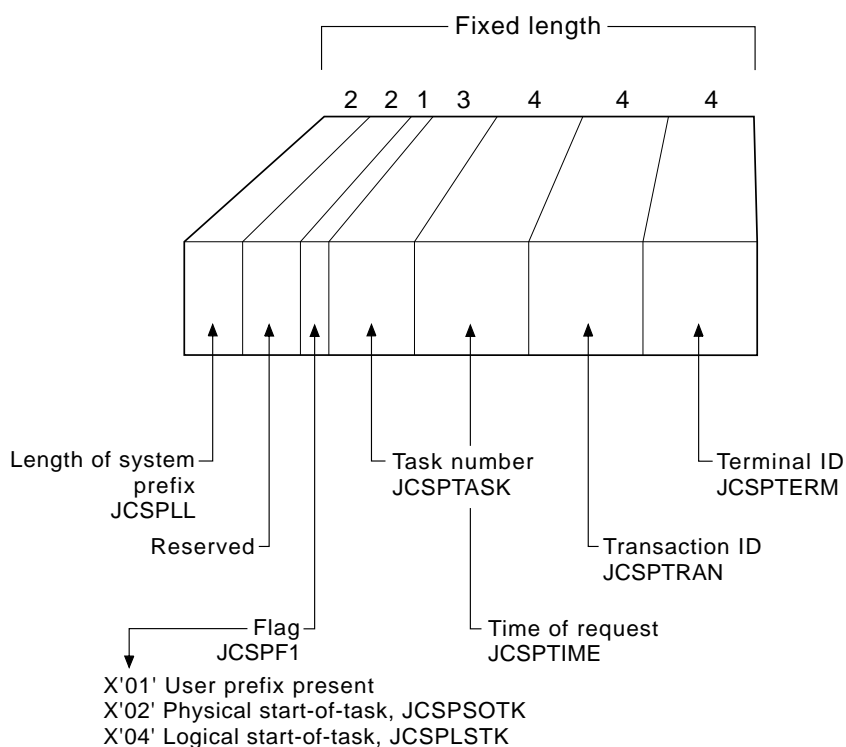

Figure 77. Format of the system prefix

For some CICS journal requests, additional data is included in the system prefix to identify more specifically the originator of the request. This extra data follows the common fields of the system prefix, and is usually variable in length; hence the need for the length field JCSPLL at the start of the system prefix. All the following have their own prefix layout, and these are described, for the purposes of diagnosis and recovery, in the *CICS Data Areas* manual.

The user prefix is a variable length area. It is present if this record has been written by a user request, an EXEC CICS WRITE JOURNALNAME command. The information contained in the record is set by the user within the terms of the

journaling

command via the JTYPEID, PREFIX, and PFXLENG parameters. Its format is shown in Figure 78.

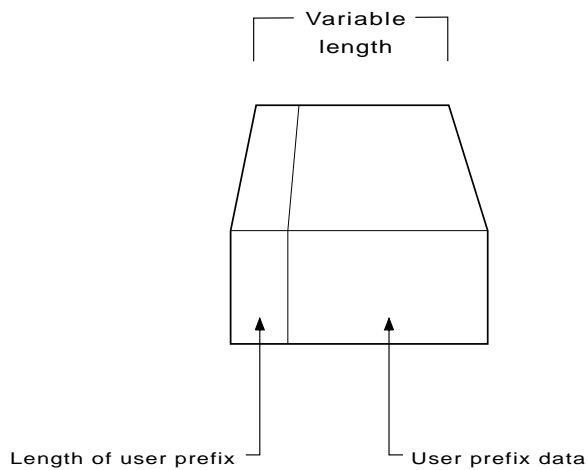

Figure 78. Format of the user prefix

Field JCSPUP is set in the system prefix area if a user prefix is present in a journal record.

The journaled data then follows. If you want a length field for the data, you must include it in the data. Alternatively, you can compute the length of the data portion of a journal record by taking the length of the system header (10 bytes), plus the length of the system prefix (JCSPLL), plus the length of the user prefix (in the field, if any, defined by yourself), and subtracting the total from the length of the journal record (JCRLI):

$$\text{JCRLI} - (\text{system header (10) bytes} + \text{JCSPLL} + \text{user prefix})$$

Not all journal records contain journaled data.

The CICS components that issue journaling requests are journal control, file control, FEPI, and terminal control.

```

*****
* *           F U N C T I O N   I D E N T I F I E R S           * *
*****
*
*       X'20' PLUS X'8-' ...USE FOR AUTOMATIC JOURNALING      *
*       X'40' PLUS X'8-' ...USE FOR AUTOMATIC LOGGING        *
*****
* *                               JOURNAL CONTROL                * *
*****
FIDJCLAB EQU  X'80'                ...JOURNAL CONTROL LABEL
*                               RECORD (DFHJCR)                  *
*****
* *                               F I L E   C O N T R O L        * *
*****
FIDALOG EQU  X'40'                ...AUTOMATICALLY LOGGED
FIDAJRN EQU  X'20'                ...AUTOMATICALLY JOURNALED
FIDMASS EQU  X'10'                ...MASSINSERT REQ. (FIDFCWA ONLY)
*                               PLUS ONE OF...                  *
FIDFCRO EQU  X'80'                ...FILE CONTROL READ-ONLY
FIDFCRU EQU  X'81'                ...FILE CONTROL READ-UPDATE
FIDFCWU EQU  X'82'                ...FILE CONTROL WRITE-UPDATE
FIDFCWA EQU  X'83'                ...FILE CONTROL WRITE-ADD
FIDFCWAC EQU  X'84'                ...FILE CONTROL WRITE-ADD-COMPLETE
FIDFCWD EQU  X'86'                ...FILE CONTROL WRITE DELETE
FIDFCBOF EQU  X'88'                ...BACKOUT FAILED LOG RECORD
FIDFCDSN EQU  X'8F'                ...DSNAME RECORD
*
*       NOTE THAT FID* VALUES (AS ABOVE) ARE OFTEN USED BOTH TO
*       IDENTIFY THE FUNCTION OF THE DWE AND THE FUNCTION OF THE
*       LOG RECORD.  IN THE CASE OF THE FIDFC* EQU'S ABOVE, THEY
*       ARE USED FOR LOG RECORDS ONLY.  THOSE BELOW APPLY ONLY
*       TO DWE'S
*
FIDFCVWA EQU  X'80'                THIS DWE ADDRESSES A VSWA.
FIDFCRVY EQU  X'40'                THIS DWE IS ASSOCIATED WITH A
*                               RECOVERABLE CHANGE.             *

```

Figure 79. Journal function identifiers (Part 1 of 2)

journaling

```

*****
*                               TERMINAL CONTROL FUNCTION IDENTIFIERS                               *
*                                                                                               *
FIDTCML EQU  X'F0'                SYNCPOINT - LOG SEQUENCE                               *
*                                                                                               *
*                                                                                               *
*                                                                                               *
FIDTCDWL EQU  X'01'                ...DEFERRED WRITE DATA                               *
FIDTCFMH EQU  X'02'                ...+ FUNCTION MANAGEMENT                               *
*                                                                                               *
FIDTCDIP EQU  X'04'                ...+ DIP REQUEST                                       *
*                                                                                               *
* EQU  X'08'                ...DYNAMIC BACKOUT MASK                                       *
*                                                                                               *
*                                                                                               *
FIDTCAL EQU  X'40'                AUTOMATIC LOGGING MASK...                               *
FIDTCAJ EQU  X'20'                AUTOMATIC JOURNALING MASK..                               *
*                                                                                               *
*                               ...THE ABOVE 2 PLUS 1 OF FOLLOWING SET                               *
FIDTCTL EQU  X'80'                ...SEQUENCE NUMBER ONLY                               *
*                                                                                               *
*                               (LOG ONLY)                                               *
FIDTCIM EQU  X'81'                ...INPUT MESSAGE (LOG AND                               *
*                                                                                               *
FIDTCOM EQU  X'82'                ...OUTPUT MESSAGE (JOURNAL                               *
*                                                                                               *
FIDTCWP EQU  X'83'                ...WRITE WAS PURGED (LOG                               *
*                                                                                               *
FIDTCPRR EQU  X'84'                ...POSITIVE RESPONSE                               *
*                                                                                               *
FIDTCIMF EQU  X'85'                ...INPUT MESSAGE (W/FMH,                               *
*                                                                                               *
FIDTCOMN EQU  X'86'                ...OUTPUT MESSAGE, (W/O                               *
*                                                                                               *
FIDTCON EQU  X'87'                ...OUTPUT MESSAGE, FMH,                               *
*                                                                                               *
FIDTCONN EQU  X'88'                ...OUTPUT MESSAGE, W/O FMH,                               *
*                                                                                               *
*                                                                                               *
FIDTCUA EQU  X'89'                ...INITIAL TCT USER AREA                               *
FIDTCEIB EQU  X'8A'                ...INITIAL EXEC COMM AREA                               *
FIDTCIMN EQU  X'8B'                INPUT MSG, NO FMH, COMPLETE                               *
FIDTCINN EQU  X'8C'                INPUT MSG, NO FMH, INCOMPLETE                               *
*****
*                               FRONT END PROGRAMMING INTERFACE IDENTIFIERS                               *
*                                                                                               *
FIDFEPIN EQU  X'F0'                FEPI INBOUND DATA   API <--- FEPI                               *
FIDFEPOU EQU  X'F1'                FEPI OUTBOUND DATA  API ---> FEPI                               *
*****

```

Figure 79. Journal function identifiers (Part 2 of 2)

```

*****
* *                               M O D U L E   I D E N T I F I E R S                               *
* *                                                                                               *
* *                                                                                               *
MODIDTC EQU  X'10'                ...TERMINAL CONTROL                               *
MODIDFC EQU  X'11'                ...FILE CONTROL                                       *
MODIDJC EQU  X'45'                ...JOURNAL CONTROL                                       *
MODIDFEP EQU  X'50'                ...FEPI                                               *
* *                                                                                               *
*****

```

Figure 80. Journal module identifiers

Identifying records for the start of tasks and UOWs

You can identify records written to mark the start of tasks by examining the value of the system prefix field JCSPF1. If the JCSPSOTK bit is set, the record has been written at the start of the task.

If the JCSPLSTK bit is set in field JCSPF1, then the record has been written at the start of the UOW.

Format of journal records written to SMF

This section describes the format of journaling records that are written to an SMF data set. You need this information if you write your own program to analyze the data. The three components of the journaling record are an SMF block header, a CICS product section, and a CICS data section. The layout of an MVS SMF log, showing log blocks and CICS sections, is in Figure 81.

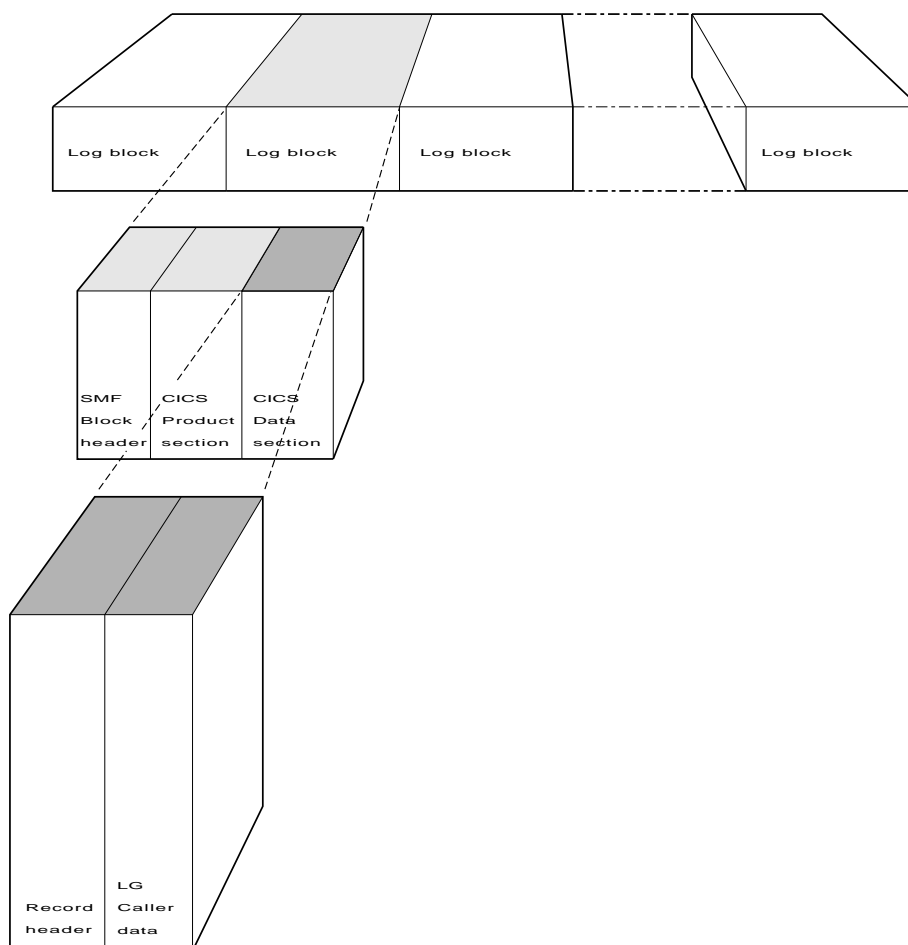

Figure 81. Layout of a CICS log written to MVS SMF

Journal records written to SMF can be read offline by user-written programs. Such programs can map journal records by including an INCLUDE DFHLGMSD statement. This generates the assembler version of the DSECT.

journaling

The SMF block header

This block describes the system creating the output. Its format is shown in Figure 82.

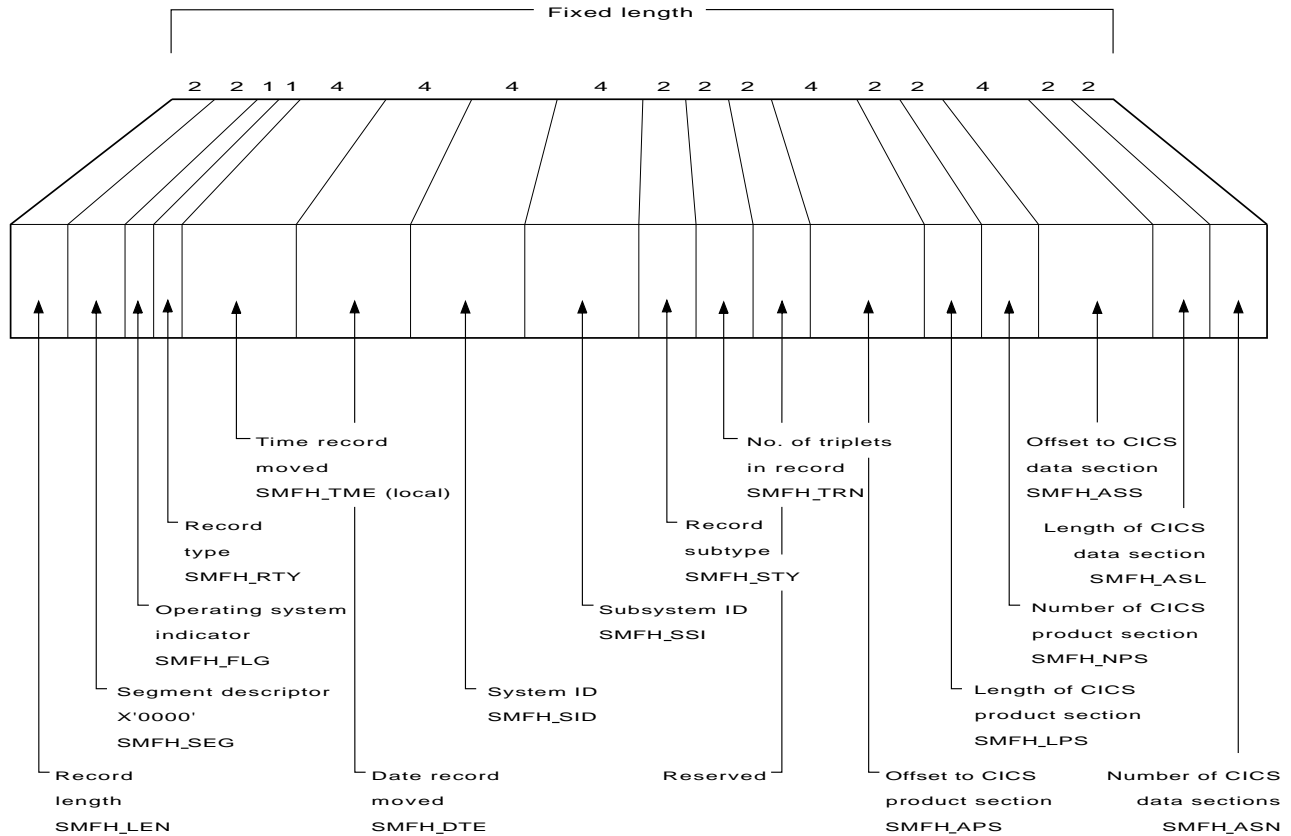

Figure 82. Format of the SMF block header

Note: CICS sets only the subsystem-related bits of the operating system indicator flag byte in the SMF header (SMFH_LG). SMF sets the remainder of the byte according to the operating system level and other factors. For an explanation of the setting of the other bits, refer to the *OS/390 MVS System Management Facilities (SMF)* manual.

The CICS product section

This section identifies the subsystem to which the journaling data relates. Its format is shown in Figure 83 on page 655.

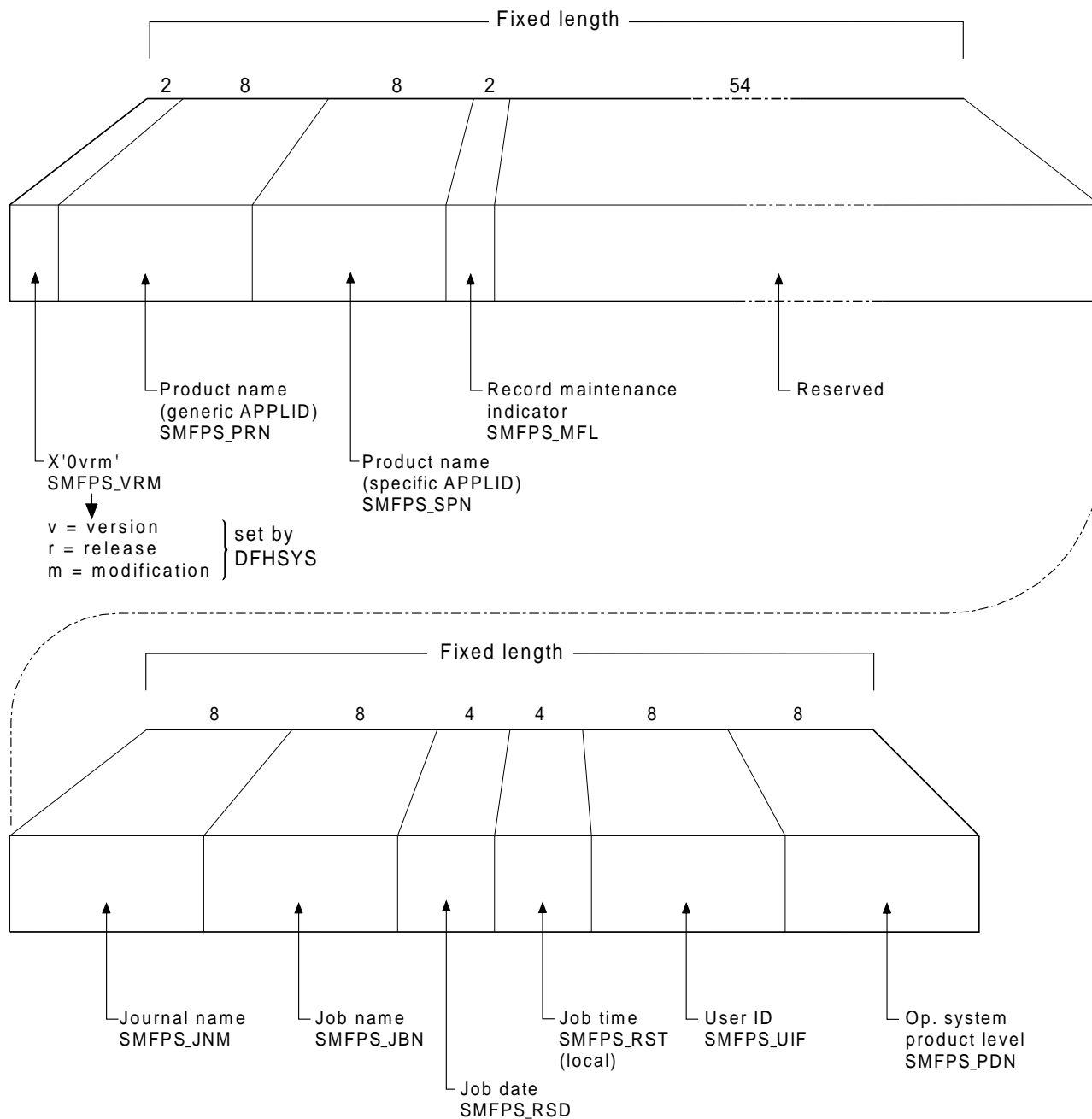

Figure 83. Format of the CICS product section

The CICS data section

This section contains a variable number of CICS journal records. Each record comprises a general log record header, the format of which is shown in Figure 57 on page 635. This is followed by a user header, the format of which is shown in Figure 59 on page 637. This is then followed by the caller data.

If this is the first record being written to the journal after CICS initialization, the record comprises the general log record header, followed by a start-of-run record, the format of which is shown in Figure 58 on page 636. Subsequent records then take the form already described.

Chapter 24. CICS monitoring

This chapter describes the monitoring facilities of CICS Transaction Server for OS/390, and tells you how to:

- Control the types of monitoring data collected by CICS
- Gather more performance data about specific transactions than is provided automatically by CICS.

The chapter is divided into the following sections:

1. “**Introduction to CICS monitoring**” describes the classes of monitoring data, event-monitoring points, and the use of the monitoring control table.
2. “**CICS monitoring record formats**” on page 663 describes the formats of CICS monitoring SMF type 110 records.

The *CICS Performance Guide* lists all the system-defined data that can be produced by CICS monitoring.

Introduction to CICS monitoring

CICS monitoring collects data about the performance of all user- and CICS-supplied transactions during online processing for later offline analysis. The records produced by CICS monitoring are of the MVS System Management Facility (SMF) type 110, and are written to an SMF data set.

Note: Statistics records and some journaling records are also written to the SMF data set as type 110 records. You might find it particularly useful to process the statistics records and the monitoring records together, because statistics provide resource and system information that is complementary to the transaction data produced by CICS monitoring. The contents of the statistics fields, and the procedure for processing them, are described in “Chapter 25. CICS statistics” on page 677.

Monitoring data is useful both for performance tuning and for charging your users for the resources they use.

The classes of monitoring data

Three types, or “classes”, of monitoring data can be collected. These are **performance class** data, **exception class** data, and **SYSEVENT** data.

Performance class data is detailed transaction-level information, such as the processor and elapsed time for a transaction, or the time spent waiting for I/O. At least one performance record is written for each transaction that is being monitored. See “Performance class monitoring data” on page 658 for further information.

Exception class data is information about exceptional conditions suffered by a transaction, such as queuing for file strings, or waiting for temporary storage. This data highlights possible problems in system operation. There is one exception record for each exception condition.

SYSEVENT class data is a special kind of transaction timing information. For more information about SYSEVENT data, see the *CICS Performance Guide*.

monitoring—introduction

You can choose which classes of monitoring data you want to be collected. How to do this is described in “Controlling CICS monitoring” on page 662.

Performance class monitoring data

CICS performance class monitoring data is collected at system-defined event-monitoring points (EMPs) in the CICS code. You cannot relocate these monitoring points, but you can create additional ones, at which user-defined performance data can be gathered.

Coding additional event-monitoring points

If you want to gather more performance class data than is provided at the system-defined EMPs, you can code additional EMPs in your application programs. You could use these additional EMPs to count the number of times a certain event occurs, or to time the interval between two events, for example. If the performance class was active when a transaction was started, but was not active when a user EMP was issued, the operations defined in that user EMP would still be executed on that transaction’s monitoring area. The DELIVER option would result in a loss of data at this point, because the generated performance record cannot be output while the performance class is not active. If the performance class was not active when a transaction was started, the user EMP would have no effect.

To code user EMPs in your application programs, you use the EXEC CICS MONITOR command. For programming information about this command, see the *CICS Application Programming Reference* manual.

Additional EMPs are provided in some IBM program products, such as IMS DBCTL. From a CICS point of view, these are like any other user-defined EMP. EMPs in user applications and in IBM program products are identified by a decimal number. The numbers 1 through 199 are available for EMPs in user applications, and the numbers 200 through 255 are for use in IBM program products. The numbers can be qualified with an entry name, so that you can use each number more than once. For example, ‘ENTRYA.4’, ‘ENTRYB.4’, and ‘4’ identify three different EMPs. Furthermore, any counts, clocks, or byte-strings updated at one of them are different objects from those updated at any of the others. If you do not specify an entry name, CICS assumes the default of ‘USER’.

For each EMP that you code in an application program, there must be a corresponding monitoring control table (MCT) definition, with the same entry name and identification number as the EMP that it describes. (The following sections refer to the combination of entry name and identification number as an “empid”.)

If you want to record the same type of data for different transactions, you can code the same empids in several application programs. This causes similar fields in the corresponding transaction performance records to be updated.

You do not have to assign empids to system-defined EMPs, and you do not have to code MCT entries for them.

The monitoring control table (MCT)

You use the monitoring control table (MCT):

- To tell CICS about the EMPs that you have coded in your application programs and about the data that is to be collected at these points. See “DFHMCT TYPE=EMP” on page 659.

- To tell CICS that you want specific system-defined performance data not to be recorded during a particular CICS run. See “DFHMCT TYPE=RECORD”.

Full details of the DFHMCT macros are provided in the *CICS Resource Definition Guide*, and you should refer to that book when reading the following sections.

DFHMCT TYPE=EMP

There must be a DFHMCT TYPE=EMP macro definition for every user-coded EMP. This macro has an ID operand, whose value must be made up of the ENTRYNAME and POINT values specified on the EXEC CICS MONITOR command. The PERFORM operand of the DFHMCT TYPE=EMP macro tells CICS which user count fields, user clocks, and character values to expect at the identified user EMP, and what operations to perform on them.

Note that, in a single run of CICS, the format of all performance records is identical, and that the length of records increases relative to the number of data fields in the user EMPs defined in the MCT.

The maximum amount of user data that can be added to performance records is 16384 bytes. The user data is divided into user areas. Each user area is defined by coding an entry name qualifier on the ID operand of the DFHMCT TYPE=EMP macro. If you code the same entry name when defining multiple EMPs, all the EMPs operate on fields in the same user area. Correspondingly, by coding different entry names you can append multiple user areas to the monitoring records. Provided that the overall maximum of 16384 bytes is not exceeded, each user area can contain:

- 0 through 256 counters
- 0 through 256 clocks
- A single 8192-byte character string.

Each user area is uniquely referenced by its entry name. For example:

```
DFHMCT TYPE=EMP, ID=ENTRYA.1, PERFORM=...
DFHMCT TYPE=EMP, ID=ENTRYA.2, PERFORM=...
DFHMCT TYPE=EMP, ID=ENTRYB.1, PERFORM=...
DFHMCT TYPE=EMP, ID=ENTRYB.1, PERFORM=...
DFHMCT TYPE=EMP, ID=1, PERFORM=...
```

In the above examples, in addition to the system-defined performance fields, three user areas, 'ENTRYA', 'ENTRYB', and 'USER', are defined (if no entry name is specified, the default is 'USER'). If the application codes an EMP invocation with ENTRYNAME(ENTRYA), only the ENTRYA user area is operated on. The only operation that spans all user areas is DELIVER, which operates across the whole monitoring area.

DFHMCT TYPE=RECORD

The DFHMCT TYPE=RECORD macro allows you to *exclude* specific system-defined performance data from a CICS run. (Each performance monitoring record is approximately 572 bytes long, without taking into account any user data that may be added, or any excluded fields.)

Each field of the performance data that is gathered at the system-defined EMPs belongs to a group of fields that has a group identifier. Each performance data field

monitoring—introduction

also has its own numeric identifier that is unique within the group identifier. For example, the transaction sequence number field in a performance record belongs to the group DFHTASK, and has the numeric identifier '031'. Using these identifiers, you can exclude specific fields or groups of fields, and reduce the size of the performance records.

Examples of MCT coding

The examples below show some EXEC CICS MONITOR commands with the MCT entries that must be coded for them.

Example 1:

EXEC CICS MONITOR command	MCT entry
EXEC CICS MONITOR POINT(11) ENTRYNAME(PROG3)	DFHMCT TYPE=EMP, * CLASS=PERFORM, * ID=(PROG3. 11), * CLOCK=(1, CLOCKA), * PERFORM=SCLOCK(1)

Example 1 shows a user clock being started by an application that is identified as PROG3. This is the eleventh EMP in this application. To prevent confusion with the eleventh EMP in another application, this EMP is uniquely identified by the empid PROG3.11. The clock that is being started is the first clock in a string, and has the identifier CLOCKA.

Example 2:

EXEC CICS MONITOR command	MCT entry
EXEC CICS MONITOR POINT(12) ENTRYNAME(PROG3)	DFHMCT TYPE=EMP, * CLASS=PERFORM, * ID=(PROG3. 12), * PERFORM=PCLOCK(1)

Example 2 shows the same user clock (CLOCKA) being stopped. Although this is the same clock being stopped by the same application as in example 1, it is being stopped from a different EMP. The EMP is uniquely identified by the empid PROG3.12.

Example 3:

EXEC CICS MONITOR command	MCT entry
EXEC CICS MONITOR POINT(13) DATA1(address of data) DATA2(length of data) ENTRYNAME(PROG3)	DFHMCT TYPE=EMP, * CLASS=PERFORM, * ID=(PROG3.13), * PERFORM=MOVE(0,32)

Example 3 shows 32 bytes of user data being updated in the character string reserved for that purpose. The updated data starts at offset 0, and the data is not more than 32 bytes in length.

DFHMCT TYPE=EMP entries for DBCTL

The following MCT entries make use of the two event-monitoring points in the performance class used by the CICS-DBCTL interface modules:

```
DFHMCT TYPE=EMP, ID=(DBCTL.1), CLASS=PERFORM, PERFORM=(MOVE(0,256)), *
FIELD=(1,RMIDATA)
DFHMCT TYPE=EMP, ID=(DBCTL.2), CLASS=PERFORM, PERFORM=(DELIVER)
```

These MCT entries are coded in the sample copy book DFH\$MCTD.

The DBCTL data recorded by these event monitoring points can be mapped using the IMS macro DFSDSTA DSECT=YES, which is available in the IMS genlibs.

For more information about monitoring in DBCTL, refer to the *CICS IMS Database Control Guide*.

Exception class data

Exception class data is information on exceptional conditions suffered by a transaction. This data highlights possible problems in system operation. There is one exception record for each exception condition. Exception records are produced after each of the following conditions encountered by a transaction has been resolved:

- Wait for storage in the CDSA
- Wait for storage in the UDSA
- Wait for storage in the SDSA
- Wait for storage in the RDSA
- Wait for storage in the ECDSA
- Wait for storage in the EUDSA
- Wait for storage in the ESDSA
- Wait for storage in the ERDSA
- Wait for auxiliary temporary storage
- Wait for auxiliary temporary storage string
- Wait for auxiliary temporary storage buffer
- Wait for auxiliary temporary storage write buffer
- Wait for temporary storage queue

monitoring—introduction

- Wait for temporary storage data set extension
- Wait for shared temporary storage
- Wait for shared temporary storage pool
- Wait for file string
- Wait for file buffer
- Wait for LSRPOOL string.

An exception record is created each time any of the resources covered by exception class monitoring becomes constrained by system bottlenecks. If performance data is also being recorded, it keeps a count of the number of exception records generated for each task. The exception records can be linked to the performance data by the transaction identifier in both records.

This data is intended to help you identify constraints that affect the performance of your transaction. The information is written to a SMF data set as soon as the task that was originally constrained has been released.

You can enable exception-class monitoring by coding MNEXC=ON (together with MN=ON) in the SIT. Alternatively you can use, either the CEMT command (CEMT SET MONITOR ON EXCEPT) or EXEC CICS SET MONITOR STATUS(ON) EXCEPTCLASS(EXCEPT).

How performance and exception class data is passed to SMF

Performance class records and exception class records are not written to SMF in the same way by CICS monitoring.

Performance data records are written to a performance record buffer, which is defined and controlled by CICS, as they are produced. The performance records are passed to SMF for processing when the buffer is full, when the performance class of monitoring is switched off, and when CICS itself quiesces. When Monitoring itself is deactivated or when there is an immediate shutdown of CICS, the performance records are not written to SMF and the data is lost.

Exception records are passed directly to SMF when the exception condition completes. Each exception record describes one exception condition. You can link performance records with their associated exception records by matching the value of the TRANNUM field in each type of record; each contains the same transaction number.

Controlling CICS monitoring

When CICS is initialized, you switch the monitoring facility on by specifying the system initialization parameter MN=ON. MN=OFF is the default setting. You can select the classes of monitoring data you want to be collected using the MNPER, MNEXC, and MNEVE system initialization parameters. You can request the collection of any combination of performance class data, exception class data, and SYSEVENT data. The class settings can be changed whether monitoring itself is ON or OFF. For guidance information about system initialization parameters, refer to the *CICS System Definition Guide*.

When CICS is running, you can control the monitoring facility dynamically. Just as at CICS initialization, you can switch monitoring on or off, and you can change the classes of monitoring data that are being collected. There are two ways of doing this:

1. You can use the master terminal CEMT INQ|SET MONITOR command, which is described in the *CICS Supplied Transactions* manual.
2. You can use the EXEC CICS INQUIRE MONITOR and EXEC CICS SET MONITOR commands, which are described in the *CICS System Programming Reference*.

If you activate a class of monitoring data in the middle of a run, the data for that class becomes available only for transactions that are started thereafter. You cannot change the classes of monitoring data collected for a transaction after it has started. It is often preferable, particularly for long-running transactions, to start all classes of monitoring data at CICS initialization.

CICS monitoring record formats

This section describes the formats of CICS monitoring SMF type 110 records in detail. You need this information if you write your own program to analyze the monitoring data. CICS writes several types of SMF 110 record. Each type, or subtype as it is known, can be identified using the record subtype field in the SMF header. The subtype values are as follows:

- X'0000' - CICS journaling
- X'0001' - CICS monitoring
- X'0002' - CICS statistics
- X'0003' - Shared temporary storage queue server
- X'0004' - Coupling facility data table server statistics
- X'0005' - Named counter sequence number server statistics.

For more information about SMF journaling records, refer to “Chapter 23. CICS logging and journaling” on page 629. For more information about SMF statistics records, refer to “Chapter 25. CICS statistics” on page 677.

The three components of a CICS monitoring record are an SMF header, an SMF product section, and a CICS data section. Each of these is described in the sections that follow.



Figure 84. Format of an SMF type 110 monitoring record

SMF header and SMF product section

The SMF header describes the system creating the output. The SMF product section identifies the subsystem to which the monitoring data relates, which, in the case of CICS monitoring (and also of CICS statistics), is the CICS region. Both the SMF header and the SMF product section can be mapped by the DSECT MNSMFDS, which you can generate using the DFHMNSMF macro as follows:

```
MNSMFDS DFHMNSMF PREFIX=SMF
```

monitoring record formats

The label 'MNSMFDS' is the default DSECT name, and SMF is the default PREFIX value, so you could also generate the DSECT simply by coding:

```
DFHMNSMF
```

The MNSMFDS DSECT has the format shown in Figure 85.

```
*          START OF THE SMF HEADER
*
MNSMFDS  DSECT
SMFMNLEN DS  XL2          RECORD LENGTH
SMFMNSEG DS  XL2          SEGMENT DESCRIPTOR
SMFMNFLG DS  X            OPERATING SYSTEM INDICATOR (see note 1)
SMFMNRTY DC  X'6E'        RECORD 110 FOR CICS
SMFMNTME DS  XL4          TIME RECORD MOVED TO SMF
SMFMNDTE DS  XL4          DATE RECORD MOVED TO SMF
SMFMNSID DS  CL4          SYSTEM IDENTIFICATION
SMFMNSSI DS  CL4          SUBSYSTEM IDENTIFICATION
SMFMNSTY DS  XL2          RECORD SUBTYPE - MONITORING USES TYPE 1
SMFMNTRN DS  XL2          NUMBER OF TRIPLETS
                   DS  XL2          RESERVED
SMFMNAPS DS  XL4          OFFSET TO PRODUCT SECTION
SMFMNLPS DS  XL2          LENGTH OF PRODUCT SECTION
SMFMNPS  DS  XL2          NUMBER OF PRODUCT SECTIONS
SMFMNASS DS  XL4          OFFSET TO DATA SECTION
SMFMNASL DS  XL2          LENGTH OF DATA SECTION
SMFMNASN DS  XL2          NUMBER OF DATA SECTIONS
*
*          THIS CONCLUDES THE SMF HEADER
*
```

Figure 85. Format of the SMF header and product section for monitoring records (Part 1 of 2)

```

*
*           START OF THE SMF PRODUCT SECTION
*
SMFMNRVN DS   XL2           RECORD VERSION (CICS)
SMFMNPRN DS   CL8           PRODUCT NAME (GENERIC APPLID)
SMFMNSPN DS   CL8           PRODUCT NAME (SPECIFIC APPLID)
SMFMNMFL DS   XL2           RECORD MAINTENANCE INDICATOR
                        DS   XL2           RESERVED
SMFMNCL  DS   XL2           CLASS OF DATA
*                               1 = DICTIONARY
*                               3 = PERFORMANCE
*                               4 = EXCEPTION
SMFMNDCA DS   XL4           OFFSET TO CICS FIELD CONNECTORS
SMFMNDCL DS   XL2           LENGTH OF EACH CICS FIELD CONNECTOR
SMFMNDCN DS   XL2           NUMBER OF CICS FIELD CONNECTORS
SMFMNDRA DS   XL4           OFFSET TO FIRST CICS DATA RECORD
SMFMNDRL DS   XL2           LENGTH OF EACH CICS DATA RECORD
SMFMNDRN DS   XL2           NUMBER OF CICS DATA RECORDS
*
                        DS   XL20          RESERVED
SMFMNTAD DS   XL4           LOCAL TOD CLOCK ADJUSTMENT VALUE
SMFMNLSO DS   XL8           LEAP SECOND OFFSET TOD FORMAT
SMFMNDTO DS   XL8           LOCAL TIME/DATE OFFSET
                        DS   XL2           RESERVED
SMFMNJBN DS   CL8           JOBNAME
SMFMNRSD DS   XL4           JOB DATE
SMFMSRST DS   XL4           JOB TIME
SMFMNUIF DS   CL8           USER IDENTIFICATION
SMFMNPDN DS   CL8           OPERATING SYSTEM PRODUCT LEVEL
*
*           THIS CONCLUDES THE SMF PRODUCT SECTION

```

Figure 85. Format of the SMF header and product section for monitoring records (Part 2 of 2)

Notes:

1. CICS sets only the subsystem-related bits of the operating system indicator flag byte in the SMF header (SMFMNFLG). SMF sets the remainder of the byte according to the operating system level and other factors. For an explanation of the setting of the other bits, refer to the *OS/390 MVS System Management Facilities (SMF)* manual.
2. For dictionary class monitoring records (described in “Dictionary data sections” on page 666), the fields SMFMNDRA, SMFMNDRL, and SMFMNDRN in the SMF product section have the following meaning:

SMFMNDRA

Offset to the first dictionary entry

SMFMNDRL

Length of a single dictionary entry

SMFMNDRN

Number of dictionary entries within the CICS data section.

3. The copy book DFHSMFDS is also provided and can be used to map the SMF header and the SMF product sections of all four subtypes of SMF 110 records written by CICS journaling, CICS monitoring, CICS statistics, and the shared temporary storage queue server.

monitoring record formats

CICS data section

The CICS data section can be made up of a dictionary data section, a performance data section, or an exception data section. You can identify which of these you are dealing with by looking at the value of field SMFMNCL in the SMF product section. Each of the data section types is described in the sections that follow.

Dictionary data sections

Dictionary data sections describe all the fields in the performance data records that are gathered during this CICS run. They describe **all** the system-provided data fields (whether you have excluded any or not), plus any user-provided data fields, which CICS takes at initialization time from the MCT entries you have coded. This means that the descriptions of the system-provided data fields never change, though the user data fields can be changed each time CICS is initialized. The contents of the dictionary data sections cannot be changed while CICS is running.

Dictionary data sections contain a variable number of 26-byte dictionary entries. Each dictionary entry provides the following information about a single performance record data field:

CMODNAME

The identifier of the group to which the field belongs

CMODTYPE

The field type

CMODIDNT

The field identifier

CMODLENG

The length of the field

CMODCONN

The connector value assigned to the field

CMODOFST

The offset of the field

CMODHEAD

The informal name of the field.

You can map the dictionary entries by generating a DSECT with the DFHMCTDR macro as shown in Figure 86 on page 667.

DFHMCTDR TYPE=(PREFIX,CMO)

CMO is the default label prefix. The DSECT is as follows:

```

CMODNAME DS   CL8   + 0   NAME OF OWNER (entry name)
CMODTYPE DS   C     + 8   OBJECT TYPE
*
*               'S' = STOPWATCH (CLOCK)
*               'A' = ACCUMULATOR (COUNT)
*               'C' = BYTE-STRING FIELD
*               'T' = TIMESTAMP (STCK FORMAT)
*               'P' = PACKED-DECIMAL FIELD
CMODIDNT DS   CL3   +9   ID WITHIN TYPE
*               CLOCK-, COUNT-, OR FIELD-NO.
CMODLENG DS   H     +12  LENGTH OF OBJECT
CMODCONN DS   XL2   +14  ASSIGNED CONNECTOR
CMODOFST DS   XL2   +16  ASSIGNED OFFSET
CMODHEAD DS   CL8   +18  INFORMAL NAME
CMODNEXT EQU   *
    
```

Figure 86. CICS monitoring dictionary entry DSECT

Whenever the monitoring of performance class data is switched on, whether at CICS initialization or while CICS is running, a dictionary data section is written. So, if the monitoring of performance class data is switched on and off three times during a single CICS run, there are three separate, but identical, dictionary data sections for that run. The dictionary data section is passed to SMF, together with any performance data sections, when the first buffer of performance data sections for a performance class data monitoring session is output to SMF. Any offline utility should use the most recent dictionary record encountered when processing CICS monitoring records.

The format of dictionary data sections is shown in Figure 87. A list of the default CICS dictionary entries is given in Figure 88 on page 668.

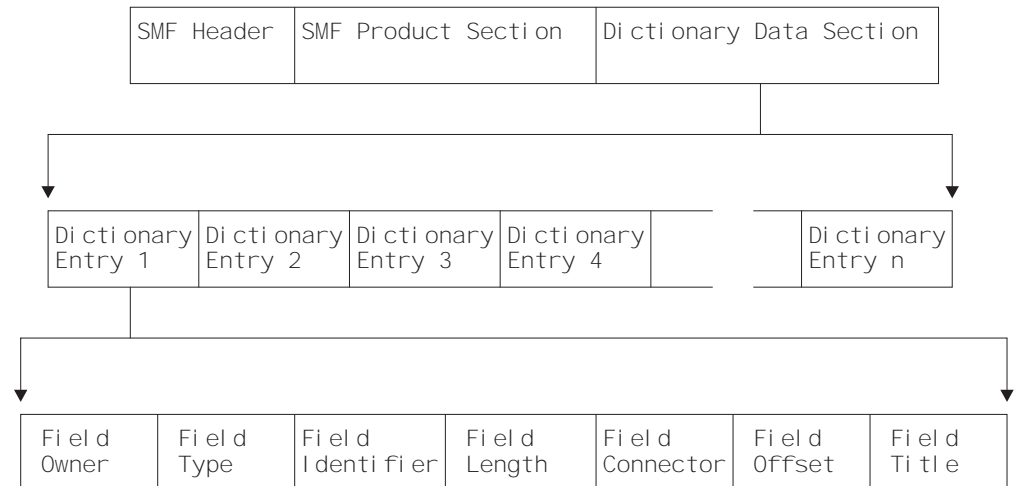

Figure 87. Format of the CICS monitoring dictionary data section

monitoring record formats

FIELD-NAME	SIZE	CONNECTOR	OFFSET	NICKNAME
DFHTASK C001	4	X'0001'	X'0000'	TRAN
DFHTERM C002	4	X'0002'	X'0004'	TERM
DFHCICS C089	8	X'0003'	X'0008'	USERID
DFHTASK C004	4	X'0004'	X'0010'	TTYTYPE
DFHCICS T005	8	X'0005'	X'0014'	START
DFHCICS T006	8	X'0006'	X'001C'	STOP
DFHTASK P031	4	X'0007'	X'0024'	TRANNUM
DFHTASK A109	4	X'0008'	X'0028'	TRANPRI
DFHTASK C166	8	X'0009'	X'002C'	TCLSNAME
DFHTERM C111	8	X'000A'	X'0034'	LUNAME
DFHPRG C071	8	X'000B'	X'003C'	PGMNAME
DFHTASK C097	20	X'000C'	X'0044'	NETUOWPX
DFHTASK C098	8	X'000D'	X'0058'	NETUOWSX
DFHCICS C130	4	X'000E'	X'0060'	RSYSID
DFHCICS A131	4	X'000F'	X'0064'	PERRECNT
DFHTASK T132	8	X'0010'	X'0068'	RMUOWID
DFHCICS C167	8	X'0011'	X'0070'	SRVCLSNM
DFHCICS C168	8	X'0012'	X'0078'	RPTCLSNM
DFHTASK C163	4	X'0013'	X'0080'	FCTYNAME
DFHTASK A164	8	X'0014'	X'0084'	TRANFLAG
DFHTERM A165	4	X'0015'	X'008C'	TERMINFO
DFHTERM C169	4	X'0016'	X'0090'	TERMCNNM
DFHTASK C124	4	X'0017'	X'0094'	BRDGTRAN
DFHTASK C190	16	X'0018'	X'0098'	RRMSURID
DFHCBTS C200	36	X'0019'	X'00A8'	PRCSNAME
DFHCBTS C201	8	X'001A'	X'00CC'	PRCSTYPE
DFHCBTS C202	52	X'001B'	X'00D4'	PRCSID
DFHCBTS C203	52	X'001C'	X'0108'	ACTVYID
DFHCBTS C204	16	X'001D'	X'013C'	ACTVYNM
DFH SOCK C244	16	X'001E'	X'014C'	CLIPADDR
DFHTASK C082	28	X'001F'	X'015C'	TRNGRPID
DFHTASK C064	4	X'0020'	X'0178'	TASKFLAG
DFHPRG C113	4	X'0021'	X'017C'	ABCODE0
DFHPRG C114	4	X'0022'	X'0180'	ABCODEC
DFHCICS C112	4	X'0023'	X'0184'	RTYPE
DFHTERM A034	4	X'0024'	X'0188'	TCMSGIN1
DFHTERM A083	4	X'0025'	X'018C'	TCCHRIN1
DFHTERM A035	4	X'0026'	X'0190'	TCMSGOU1
DFHTERM A084	4	X'0027'	X'0194'	TCCHROU1
DFHTERM A067	4	X'0028'	X'0198'	TCMSGIN2
DFHTERM A085	4	X'0029'	X'019C'	TCCHRIN2
DFHTERM A068	4	X'002A'	X'01A0'	TCMSGOU2
DFHTERM A086	4	X'002B'	X'01A4'	TCCHROU2
DFHTERM A135	4	X'002C'	X'01A8'	TCM62IN2
DFHTERM A137	4	X'002D'	X'01AC'	TCC62IN2
DFHTERM A136	4	X'002E'	X'01B0'	TCM62OU2
DFHTERM A138	4	X'002F'	X'01B4'	TCC62OU2
DFHTERM A069	4	X'0030'	X'01B8'	TCALLOCT
DFHSTOR A054	4	X'0031'	X'01BC'	SCUGETCT
DFHSTOR A105	4	X'0032'	X'01C0'	SCUGETCT

Figure 88. Default CICS dictionary entries (Part 1 of 4)

FIELD-NAME	SIZE	CONNECTOR	OFFSET	NICKNAME
DFHSTOR A117	4	X'0033'	X'01C4'	SCCGETCT
DFHSTOR A120	4	X'0034'	X'01C8'	SCCGETCT
DFHSTOR A033	4	X'0035'	X'01CC'	SCUSRHWM
DFHSTOR A106	4	X'0036'	X'01D0'	SCUSRHWM
DFHSTOR A116	4	X'0037'	X'01D4'	SC24CHWM
DFHSTOR A119	4	X'0038'	X'01D8'	SC31CHWM
DFHSTOR A095	8	X'0039'	X'01DC'	SCUSRSTG
DFHSTOR A107	8	X'003A'	X'01E4'	SCUSRSTG
DFHSTOR A118	8	X'003B'	X'01EC'	SC24COCC
DFHSTOR A121	8	X'003C'	X'01F4'	SC31COCC
DFHSTOR A144	4	X'003D'	X'01FC'	SC24SGCT
DFHSTOR A145	4	X'003E'	X'0200'	SC24GSHR
DFHSTOR A146	4	X'003F'	X'0204'	SC24FSHR
DFHSTOR A147	4	X'0040'	X'0208'	SC31SGHR
DFHSTOR A148	4	X'0041'	X'020C'	SC31GSHR
DFHSTOR A149	4	X'0042'	X'0210'	SC31FSHR
DFHSTOR A087	4	X'0043'	X'0214'	PCSTGHWM
DFHSTOR A139	4	X'0044'	X'0218'	PC31AHWM
DFHSTOR A108	4	X'0045'	X'021C'	PC24BHWM
DFHSTOR A142	4	X'0046'	X'0220'	PC31CHWM
DFHSTOR A143	4	X'0047'	X'0224'	PC24CHWM
DFHSTOR A122	4	X'0048'	X'0228'	PC31RHWM
DFHSTOR A162	4	X'0049'	X'022C'	PC24RHWM
DFHSTOR A161	4	X'004A'	X'0230'	PC31SHWM
DFHSTOR A160	4	X'004B'	X'0234'	PC24SHWM
DFHFILE A036	4	X'004C'	X'0238'	FCGETCT
DFHFILE A037	4	X'004D'	X'023C'	FCPUTCT
DFHFILE A038	4	X'004E'	X'0240'	FCBRWCT
DFHFILE A039	4	X'004F'	X'0244'	FCADDCT
DFHFILE A040	4	X'0050'	X'0248'	FCDELCT
DFHFILE A093	4	X'0051'	X'024C'	FCTOTCT
DFHFILE A070	4	X'0052'	X'0250'	FCAMCT
DFHDEST A041	4	X'0053'	X'0254'	TDGETCT
DFHDEST A042	4	X'0054'	X'0258'	TDPUTCT
DFHDEST A043	4	X'0055'	X'025C'	TDPURCT
DFHDEST A091	4	X'0056'	X'0260'	TDTOTCT
DFHTEMP A044	4	X'0057'	X'0264'	TSGETCT
DFHTEMP A046	4	X'0058'	X'0268'	TSPUTACT
DFHTEMP A047	4	X'0059'	X'026C'	TSPUTMCT
DFHTEMP A092	4	X'005A'	X'0270'	TSTOTCT
DFHMAPP A050	4	X'005B'	X'0274'	BMSMAPCT
DFHMAPP A051	4	X'005C'	X'0278'	BMSINCT
DFHMAPP A052	4	X'005D'	X'027C'	BMSOUTCT
DFHMAPP A090	4	X'005E'	X'0280'	BMSTOTCT
DFHPROG A055	4	X'005F'	X'0284'	PCLINKCT
DFHPROG A056	4	X'0060'	X'0288'	PCXCTLCT
DFHPROG A057	4	X'0061'	X'028C'	PCLOADCT
DFHPROG A072	4	X'0062'	X'0290'	PCLURMCT
DFHPROG A073	4	X'0063'	X'0294'	PCDPLCT
DFHJOUR A058	4	X'0064'	X'0298'	JNLWRTCT
DFHJOUR A172	4	X'0065'	X'029C'	LOGWRTCT

Figure 88. Default CICS dictionary entries (Part 2 of 4)

monitoring record formats

FIELD-NAME	SIZE	CONNECTOR	OFFSET	NICKNAME	
DFHTASK	A059	4	X'0066'	X'02A0'	ICPUINCT
DFHTASK	A066	4	X'0067'	X'02A4'	ICTOTCT
DFHSYNC	A060	4	X'0068'	X'02A8'	SPSYNCCT
DFHCICS	A025	4	X'0069'	X'02AC'	CFCAPICT
DFHFPEI	A150	4	X'006A'	X'02B0'	SZALLOCT
DFHFPEI	A151	4	X'006B'	X'02B4'	SZRCVCT
DFHFPEI	A152	4	X'006C'	X'02B8'	SZSENDCT
DFHFPEI	A153	4	X'006D'	X'02BC'	SZSTRCT
DFHFPEI	A154	4	X'006E'	X'02C0'	SZCHROUT
DFHFPEI	A155	4	X'006F'	X'02C4'	SZCHRIN
DFHFPEI	A157	4	X'0070'	X'02C8'	SZALLCTO
DFHFPEI	A158	4	X'0071'	X'02CC'	SZRCVTO
DFHFPEI	A159	4	X'0072'	X'02D0'	SZTOTCT
DFHCBTS	A205	4	X'0073'	X'02D4'	BARSYNCT
DFHCBTS	A206	4	X'0074'	X'02D8'	BARASYCT
DFHCBTS	A207	4	X'0075'	X'02DC'	BALKPACT
DFHCBTS	A208	4	X'0076'	X'02E0'	BADPROCT
DFHCBTS	A209	4	X'0077'	X'02E4'	BADACTCT
DFHCBTS	A210	4	X'0078'	X'02E8'	BARSPACT
DFHCBTS	A211	4	X'0079'	X'02EC'	BASUPACT
DFHCBTS	A212	4	X'007A'	X'02F0'	BARMPACT
DFHCBTS	A213	4	X'007B'	X'02F4'	BADCPACT
DFHCBTS	A214	4	X'007C'	X'02F8'	BAACQPCT
DFHCBTS	A215	4	X'007D'	X'02FC'	BATOTPCT
DFHCBTS	A216	4	X'007E'	X'0300'	BAPRCCT
DFHCBTS	A217	4	X'007F'	X'0304'	BAACDCCT
DFHCBTS	A218	4	X'0080'	X'0308'	BATOTCCT
DFHCBTS	A219	4	X'0081'	X'030C'	BARATECT
DFHCBTS	A220	4	X'0082'	X'0310'	BADFIECT
DFHCBTS	A221	4	X'0083'	X'0314'	BATIAECT
DFHCBTS	A222	4	X'0084'	X'0318'	BATOTECT
DFHWEBB	A231	4	X'0085'	X'031C'	WBRCVCT
DFHWEBB	A232	4	X'0086'	X'0320'	WBCHRIN
DFHWEBB	A233	4	X'0087'	X'0324'	WSENDCT
DFHWEBB	A234	4	X'0088'	X'0328'	WBCHROUT
DFHWEBB	A235	4	X'0089'	X'032C'	WBTOTCT
DFHWEBB	A236	4	X'008A'	X'0330'	WBREPRCT
DFHWEBB	A237	4	X'008B'	X'0334'	WBREPWCT
DFHDOCH	A226	4	X'008C'	X'0338'	DHCRECT
DFHDOCH	A227	4	X'008D'	X'033C'	DHINSCT
DFHDOCH	A228	4	X'008E'	X'0340'	DHSETCT
DFHDOCH	A229	4	X'008F'	X'0344'	DHRETCT
DFHDOCH	A230	4	X'0090'	X'0348'	DHTOTCT
DFHDOCH	A240	4	X'0091'	X'034C'	DHTOTDCL
DFH SOCK	A242	4	X'0092'	X'0350'	SOBYENCT
DFH SOCK	A243	4	X'0093'	X'0354'	SOBYDECT
DFHDATA	A179	4	X'0094'	X'0358'	IMSREQCT
DFHDATA	A180	4	X'0095'	X'035C'	DB2REQCT
DFHTASK	A248	4	X'0096'	X'0360'	CHMODECT
DFHTASK	A251	4	X'0097'	X'0364'	TCBATTCT
DFHTASK	S007	8	X'0098'	X'0368'	USRDISPT

Figure 88. Default CICS dictionary entries (Part 3 of 4)

FIELD-NAME	SIZE	CONNECTOR	OFFSET	NICKNAME
DFHTASK S008	8	X'0099'	X'0370'	USRCPUT
DFHTASK S014	8	X'009A'	X'0378'	SUSPTIME
DFHTASK S102	8	X'009B'	X'0380'	DISPWTT
DFHTASK S255	8	X'009C'	X'0388'	QRDISPT
DFHTASK S256	8	X'009D'	X'0390'	QRCPUT
DFHTASK S257	8	X'009E'	X'0398'	MSDISPT
DFHTASK S258	8	X'009F'	X'03A0'	MSCPUT
DFHTASK S259	8	X'00A0'	X'03A8'	L8CPUT
DFHTASK S260	8	X'00A1'	X'03B0'	J8CPUT
DFHTASK S261	8	X'00A2'	X'03B8'	S8CPUT
DFHTASK S249	8	X'00A3'	X'03C0'	QRMODDLY
DFHTASK S250	8	X'00A4'	X'03C8'	MAXOTDLY
DFHCICS S103	8	X'00A5'	X'03D0'	EXWTTIME
DFHTERM S009	8	X'00A6'	X'03D8'	TCIOWTT
DFHFILE S063	8	X'00A7'	X'03E0'	FCIOWTT
DFHJOUR S010	8	X'00A8'	X'03E8'	JCIOWTT
DFHTEMP S011	8	X'00A9'	X'03F0'	TSIOWTT
DFHTERM S100	8	X'00AA'	X'03F8'	IRIOWTT
DFHDEST S101	8	X'00AB'	X'0400'	TDIOWTT
DFHPROG S115	8	X'00AC'	X'0408'	PCLOADTM
DFHTASK S125	8	X'00AD'	X'0410'	DSPDELAY
DFHTASK S126	8	X'00AE'	X'0418'	TCLDELAY
DFHTASK S127	8	X'00AF'	X'0420'	MXTDELAY
DFHTASK S129	8	X'00B0'	X'0428'	ENQDELAY
DFHTASK S123	8	X'00B1'	X'0430'	GNQDELAY
DFHTERM S133	8	X'00B2'	X'0438'	LU61WTT
DFHTERM S134	8	X'00B3'	X'0440'	LU62WTT
DFHFPEI S156	8	X'00B4'	X'0448'	SZWAIT
DFHTASK S170	8	X'00B5'	X'0450'	RMITIME
DFHTASK S171	8	X'00B6'	X'0458'	RMISUSP
DFHSYNC S173	8	X'00B7'	X'0460'	SYNCTIME
DFHFILE S174	8	X'00B8'	X'0468'	RLSWAIT
DFHFILE S175	8	X'00B9'	X'0470'	RLSCLPUT
DFHTASK S128	8	X'00BA'	X'0478'	LMDELAY
DFHTASK S181	8	X'00BB'	X'0480'	WTEXWAIT
DFHTASK S182	8	X'00BC'	X'0488'	WTCEWAIT
DFHTASK S183	8	X'00BD'	X'0490'	ICDELAY
DFHTASK S184	8	X'00BE'	X'0498'	GVUPWAIT
DFHTEMP S178	8	X'00BF'	X'04A0'	TSSHWAIT
DFHFILE S176	8	X'00C0'	X'04A8'	CFDTPWAIT
DFHSYNC S177	8	X'00C1'	X'04B0'	SRVSYWTT
DFHTASK S191	8	X'00C2'	X'04B8'	RRMSWAIT
DFHTASK S195	8	X'00C3'	X'04C0'	RUNTRWTT
DFHSYNC S196	8	X'00C4'	X'04C8'	SYNCDLY
DFH SOCK S241	8	X'00C5'	X'04D0'	SOIOWTT
DFHDATA S186	8	X'00C6'	X'04D8'	IMSWAIT
DFHDATA S187	8	X'00C7'	X'04E0'	DB2RDYQW
DFHDATA S188	8	X'00C8'	X'04E8'	DB2CONWT
DFHDATA S189	8	X'00C9'	X'04F0'	DB2WAIT
DFHTASK S253	8	X'00CA'	X'04F8'	JVMTIME
DFHTASK S254	8	X'00CB'	X'0500'	JVMSUSP

Figure 88. Default CICS dictionary entries (Part 4 of 4)

Note: The “field types” in Figure 88 are:

- A** Count
- C** Byte-string
- P** Packed decimal number
- S** Clock
- T** Time stamp.

monitoring record formats

Performance data sections

Each performance data section is made up of a string of field connectors, followed by one or more performance data records. All of the performance records produced by a single CICS run have the same format, and each record is, by default, 664 bytes long. However, the length of the performance records changes if you add user data at user EMPs, or if you exclude any system-defined data from the monitoring process. All of the system-defined data fields in the performance records are described in the *CICS Performance Guide*. The format of the performance data section is shown in Figure 89.

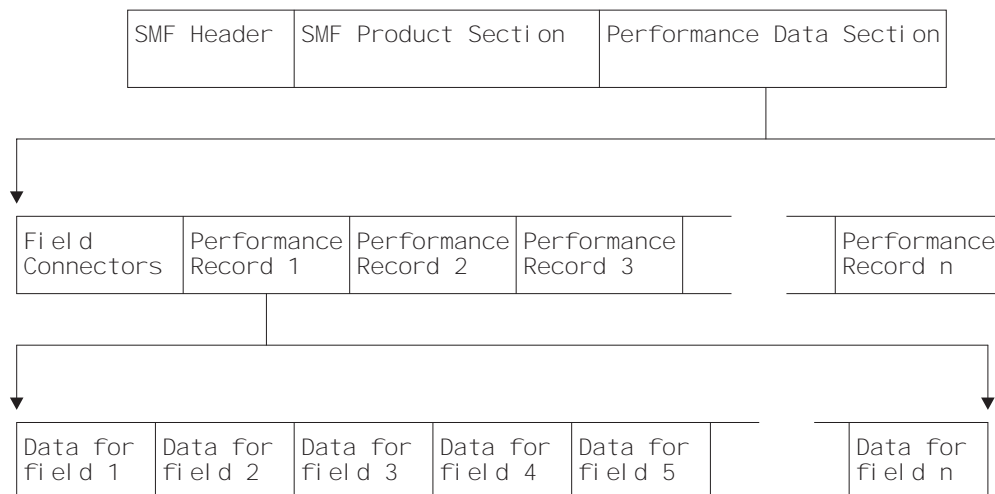

Figure 89. Format of the performance data section

Relationship of the dictionary record to the performance records

Following the performance records' SMF product section, and before the performance records themselves, is a string of **field connectors**. The purpose of the field connectors is to tell you which fields are going to occur in the performance records produced by this CICS run. Each field connector corresponds to one field in each of the succeeding performance records. The first field connector corresponds to the first field, the second to the second field, and so on. Each field connector also corresponds to a single dictionary entry in the associated dictionary record: the connector value is equal to the value of CMODCONN in the corresponding dictionary entry. In this way, each performance record field is connected to the dictionary entry that describes it. A useful technique for calculating the offset of a particular dictionary entry is to take the connector, subtract one, and multiply the result by the length of a single dictionary entry.

Thus, the string of field connectors is the key to the dictionary. And without the dictionary, reporting and analysis programs cannot interpret the performance data.

The successive performance records can be regarded as rows in a table, with each column corresponding to one type of field within the records. Each field connector then describes the contents of one column. This view of the data is helpful when designing tabular reports, which are often arranged in this way.

Figure 90 on page 673 illustrates the relationship between the dictionary record, the field connectors, and the performance records.

Dictionary Record

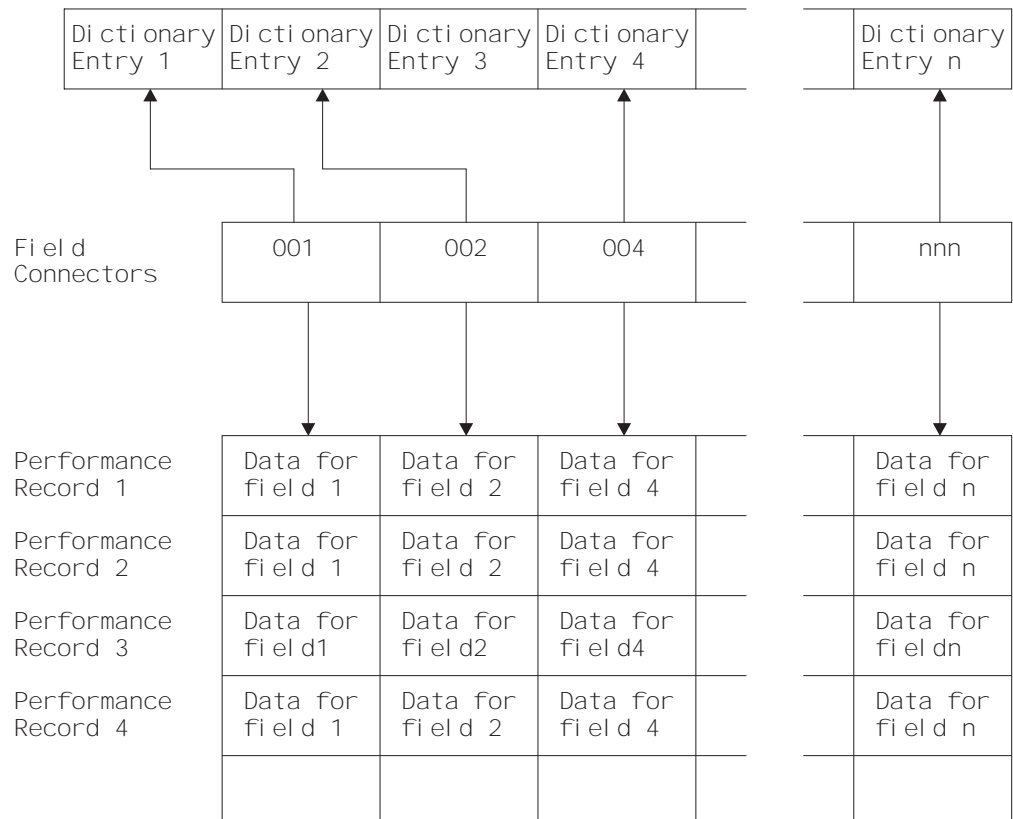

Figure 90. Relationship between the dictionary record and the performance records. In this example, the data that is defined by Dictionary Entry 3 has been excluded, so there is no field connector value for it and it does not appear in the performance records.

How the string of field connectors is constructed: When CICS is initialized, a unique connector value is assigned to every dictionary entry. CICS then examines the MCT entries for this run to see if you have excluded any system-defined performance data. If you have, the offset values for their corresponding dictionary entries are set to X'FFFF'. CICS then constructs a sequence of field connectors that excludes those with offsets of X'FFFF'. In this way, the connectors tell you which system- and user-data fields are going to occur in your performance records for this run. If you have not excluded any system-defined performance data, there is one field connector for every dictionary entry.

Please note the following:

Field connectors

link the fields in a performance record with their dictionary entries. They are unique values that are assigned at initialization time. They may, therefore, change from one run of CICS to the next.

Field identifiers

allow you to exclude specific system-defined performance data from being collected during a CICS run. They are unique within a group name and record type, and they do **not** change between CICS runs. There is more information about field identifiers in the *CICS Resource Definition Guide*.

Field offsets

in the performance record allow you to build a table for fast selection of required fields in your monitoring data processing programs.

monitoring record formats

Exception data sections

The format of an exception data record (including the SMF header and SMF product section) is shown in Figure 91. The exception data section contains a single exception record representing one exception condition.

SMF Header	SMF Product Section	Exception Data Section
------------	---------------------	------------------------

Figure 91. Format of an SMF exception data record

The format of the exception data section can be mapped by the DSECT MNEXCDS, which you can generate using the DFHMNEXC macro as follows:

```
MNEXCDS DFHMNEXC PREFIX=EXC
```

The label 'MNEXCDS' is the default DSECT name, and EXC is the default PREFIX value, so you could also generate the DSECT simply by coding
DFHMNEXC

The MNEXCDS DSECT has the format shown in Figure 92.

```
MNEXCDS DSECT
EXCMNTRN DS CL4 TRANSACTION IDENTIFICATION
EXCMNTER DS XL4 TERMINAL IDENTIFICATION
EXCMNUSR DS CL8 USER IDENTIFICATION
EXCMNTST DS CL4 TRANSACTION START TYPE
EXCMNSTA DS XL8 EXCEPTION START TIME
EXCMNSTO DS XL8 EXCEPTION STOP TIME
EXCMNTNO DS PL4 TRANSACTION NUMBER
EXCMNTPR DS XL4 TRANSACTION PRIORITY
DS CL4 RESERVED
EXCMNLUN DS CL8 LUNAME
DS CL4 RESERVED
EXCMNEXN DS XL4 EXCEPTION NUMBER
EXCMNRTY DS CL8 EXCEPTION RESOURCE TYPE
EXCMNRID DS CL8 EXCEPTION RESOURCE ID
EXCMNTYP DS XL2 EXCEPTION TYPE
EXCMNWT EQU X'0001' WAIT
EXCMNBWT EQU X'0002' BUFFER WAIT
EXCMNSWT EQU X'0003' STRING WAIT
DS CL2 RESERVED
EXCMNTCN DS CL8 TRANSACTION CLASS NAME
EXCMNSRV DS CL8 SERVICE CLASS NAME
EXCMNRPT DS CL8 REPORT CLASS NAME
EXCMNPNX DS CL20 NETWORK UNIT-OF-WORK PREFIX
EXCMNSX DS XL8 NETWORK UNIT-OF-WORK SUFFIX
EXCMNTRF DS XL8 TRANSACTION FLAGS
EXCMNFCN DS CL4 TRANSACTION FACILITY NAME
EXCMNCPN DS CL8 CURRENT PROGRAM NAME
EXCMNBTR DS CL4 BRIDGE TRANSACTION ID
EXCMNURI DS XL16 RRMS/MVS UNIT OF RECOVERY ID
EXCMNRIL DS F EXCEPTION RESOURCE ID LENGTH
EXCMNRIX DS XL256 EXCEPTION RESOURCE ID (EXTENDED)
* END OF EXCEPTION RECORD...
```

Figure 92. CICS monitoring exception record DSECT

monitoring record formats

For further information about exception class data, see the *CICS Performance Guide*, which lists all the system-defined data that can be produced by CICS monitoring.

Chapter 25. CICS statistics

This chapter is divided into the following sections:

1. “**Introduction to CICS statistics**” describes the types of statistics data, and the use of the EXEC CICS COLLECT STATISTICS command.
2. “**CICS statistics record format**” on page 682 describes the format of CICS statistics SMF type 110 records.
3. “**Global user exit in the CICS statistics domain**” on page 687 suggests ways in which you can use the XSTOUT statistics exit.
4. “**Processing the output from CICS statistics**” on page 688 lists the methods of processing statistics data.

Introduction to CICS statistics

CICS statistics contain information about the CICS system as a whole—for example, its performance and usage of resources. Statistics data is therefore useful both for performance tuning and for capacity planning.

Statistics are collected during CICS online processing for later offline analysis. The statistics domain writes statistics records to a System Management Facility (SMF) data set. The records are of SMF type 110, subtype 0002.¹¹

Statistics records are also written by:

- Temporary storage (TS) data sharing pool server regions. These records are of SMF type 110, subtype 0003.
- Coupling facility data table (CFDT) server regions. These records are of SMF type 110, subtype 0004.
- Named counter sequence number server regions. These records are of SMF type 110, subtype 0005.

Types of statistics data

CICS produces five types of statistics: **interval**, **end-of-day**, **requested**, **requested reset**, and **unsolicited**. The TS data sharing server only produces **interval** and **end-of-day** statistics.

Interval statistics

are gathered by CICS during a specified interval. CICS writes the interval statistics to the SMF data set automatically at the expiry of that interval if:

- Statistics recording status was set ON by the STATRCD system initialization parameter (and has not subsequently been set OFF by a CEMT SET STATISTICS or EXEC CICS SET STATISTICS RECORDING command). The default value of STATRCD is OFF.

or

- ON is specified on CEMT SET STATISTICS.

11. Monitoring records, and statistics records produced by the temporary storage shared-queue server, are also written to the SMF data set as type 110 records. (Some journaling type 110 records can be written there, too.) You might find it useful to process the statistics records and the monitoring records together, because statistics provide resource and system information that is complementary to the transaction data produced by CICS monitoring.

statistics—introduction

or

- The RECORDING option of the EXEC CICS SET STATISTICS command is set to ON.

The TS data sharing server writes interval statistics if statistics recording was set to SMF or BOTH by the STATSOPTIONS server initialization parameter, or by the server command SET STATSOPTIONS.

When interval statistics are written, the statistics counters are reset. See “Resetting statistics counters” on page 681.

You can change the interval duration for CICS using CEMT SET STATISTICS and the EXEC CICS SET STATISTICS command. The default interval duration is 3 hours for a cold start of CICS.

For the TS data sharing server, you can change the interval using the STATSINTERVAL server initialization parameter, or the server command SET STATSINTERVAL.

End-of-day statistics

are a special case of interval statistics. They are the statistics for the duration between the last time the statistics counters were reset and:

- The end-of-day expiry time, or
- When CICS quiesces (normal shutdown), or
- When CICS terminates (immediate shutdown), or
- When the TS data sharing server terminates.

For details of the events at which statistics counters are reset, see “Resetting statistics counters” on page 681.

The end-of-day value defines a logical point in the 24-hour operation of CICS. You can change the end-of-day value for CICS using CEMT SET STATISTICS or the EXEC CICS SET STATISTICS command. For the TS data sharing server, you can change the end-of-day value using the ENDOFDAY server initialization parameter, or the server command SET ENDOFDAY.

CICS writes end-of-day statistics to SMF even if, on one of the following, you have specified OFF:

- The STATRCD system initialization parameter
- The CEMT SET STATISTICS command
- The RECORDING option of the EXEC CICS SET STATISTICS command.

The TS data sharing server writes end-of-day statistics to the server print file even if the STATSOPTIONS parameter specifies NONE, but it does not write the statistics to SMF.

The default end-of-day value is 12 midnight. When end-of-day statistics are written, the statistics counters are reset.

Requested statistics

are statistics which the user has asked for using one of the following commands:

- CEMT PERFORM STATISTICS RECORD
- EXEC CICS PERFORM STATISTICS RECORD

- EXEC CICS SET STATISTICS ON|OFF RECORDNOW.

CICS writes requested statistics to SMF even if, on one of the following, you have specified OFF:

- The STATRCD system initialization parameter
- The CEMT SET STATISTICS command
- The RECORDING option of the EXEC CICS SET STATISTICS command.

Statistics counters are not reset.

Requested reset statistics

differ from requested statistics in that all statistics are collected, and all statistics counters are reset. They are invoked by either of the commands:

- CEMT PERFORM STATISTICS RECORD ALL(RESETNOW)
- EXEC CICS PERFORM STATISTICS RECORD ALL(RESETNOW).

You can also invoke requested reset statistics when setting statistics recording status ON or OFF, using either of the commands:

- CEMT SET STATISTICS ON|OFF RECORDNOW RESETNOW
- EXEC CICS SET STATISTICS ON|OFF RECORDNOW RESETNOW.

Note that it is valid to specify the RECORDNOW RESETNOW options only when there is a genuine change of recording status. For example, coding EXEC CICS SET STATISTICS ON RECORDNOW RESETNOW when STATISTICS is already set ON causes an error response.

CICS writes requested reset statistics to SMF even if, on one of the following, you have specified OFF:

- The STATRCD system initialization parameter
- The CEMT SET STATISTICS command
- The RECORDING option of the EXEC CICS SET STATISTICS command.

Unsolicited statistics

are automatically gathered by CICS for dynamically allocated and deallocated resources. CICS writes these statistics to SMF just before the resource is deleted if:

- Statistics recording status was set ON by the STATRCD system initialization parameter (and has not subsequently been set OFF by a CEMT SET STATISTICS or EXEC CICS SET STATISTICS RECORDING command).

or

- ON is specified on CEMT SET STATISTICS.

or

- The RECORDING option of the EXEC CICS SET STATISTICS command is set to ON.

CICS collects unsolicited statistics for:

Autoinstall

Whenever an autoinstalled terminal entry in the TCT is deleted, CICS collects statistics covering the autoinstalled period since the last interval. This period includes any delay interval specified on the system initialization parameters AILDELAY or AIRDELAY.

statistics—introduction

If an autoinstall terminal logs on again before the expiry of the delay interval, then the accumulation of statistics continues until the next interval. At that interval, the accumulation of statistics is restarted.

DBCTL

Whenever CICS disconnects from DBCTL, CICS collects the statistics covering the whole of the DBCTL connection period.

DB2

Whenever CICS disconnects from DB2, it collects the statistics for the DB2 connection and all DB2ENTRYs covering the period since the last interval.

Whenever a DB2ENTRY is discarded, CICS collects the statistics for that DB2ENTRY covering the period since the last interval.

FEPI nodes

Whenever an installed FEPI node definition is discarded, CICS collects the statistics covering the installed period since the last interval.

FEPI pools

Whenever an installed FEPI pool definition is discarded, CICS collects the statistics covering the installed period since the last interval.

FEPI targets

Whenever an installed FEPI target definition is discarded, CICS collects the statistics covering the installed period since the last interval.

Files

Whenever CICS closes a file, CICS collects statistics covering the period from the last interval.

Journalnames

Whenever an installed journalname definition is discarded, CICS collects the statistics covering the installed period since the last interval.

Log streams

Whenever CICS disconnects a log stream from the MVS Logger, it collects the statistics covering the installed period since the last interval.

LSRPOOL files

Whenever CICS closes a file which is in an LSRPOOL, it collects LSRPOOL file statistics (as well as the file statistics), covering the period from the last interval.

LSRPOOLS

When CICS closes the last file in an LSRPOOL, it collects the statistics for the LSRPOOL.

Note that the following peak values are reset at each interval collection:

- Peak number of requests waiting for a string
- Maximum number of concurrent active file control strings.

However, the other statistics, which are not reset at an interval collection, cover the entire period from the time the LSRPOOL is created (when the first file is opened) until the LSRPOOL is deleted (when the last file is closed).

Programs

Whenever an installed program definition is discarded, CICS collects the statistics covering the installed period since the last interval.

System dumps

Whenever a system dump table entry is deleted, CICS collects the statistics covering the period since the last interval.

TCP/IP services

Whenever a TCP/IP service is closed, CICS collects the statistics covering the installed period since the last interval.

Transaction classes

Whenever an installed transaction class definition is discarded, CICS collects the statistics covering the installed period since the last interval.

Transaction dumps

Whenever a transaction dump table entry is deleted, CICS collects the statistics covering the period since the last interval.

Transactions

Whenever an installed transaction definition is discarded, CICS collects the statistics covering the installed period since the last interval.

Transient data queues

Whenever an installed transient data queue definition is discarded, or an extrapartition transient data queue is closed, CICS collects the statistics covering the installed period since the last interval.

For information about how to use the CEMT statistics commands, refer to the *CICS Supplied Transactions* manual. For programming information about the EXEC CICS statistics commands, see the *CICS System Programming Reference* manual.

Resetting statistics counters

Statistics counters are reset in the following circumstances:

- At CICS startup
- When interval statistics are written (but **not** when an interval occurs and no statistics are written)
- At end of day
- When requested reset statistics are written.

However, you can cause statistics counters to be reset without writing records to the SMF data set. You do this by changing the statistics recording status, using either of the commands:

- CEMT SET STATISTICS ON|OFF RESETNOW
- EXEC CICS SET STATISTICS ON|OFF RESETNOW.

Note that it is valid to specify the RESETNOW option only when there is a genuine change of recording status. For example, coding EXEC CICS SET STATISTICS ON RESETNOW when STATISTICS is already set ON causes an error response.

Important

Statistics counters are reset in various ways. Specific counters may be reset to:

- 0
- 1
- A new peak value
- Not reset
- None of the above.

For information about the resetting of specific statistics counters, refer to the *CICS Performance Guide*.

The EXEC CICS COLLECT STATISTICS command

In addition to the types of statistics data described above, there is an online EXEC CICS COLLECT STATISTICS function. Online statistics are collected and returned to the invoking application.

The three sample programs DFH0STAT, DFH\$STCN, and DFH\$STAS show how you can use the EXEC CICS COLLECT STATISTICS and EXEC CICS INQUIRE commands to produce a useful analysis of a CICS system. The programs produce a report showing critical system parameters from the CICS dispatcher, together with loader statistics and an analysis of the CICS storage manager. DFH0STAT is provided in VS COBOL II; DFH\$STCN and DFH\$STAS are provided in assembler language.

For programming information about the EXEC CICS COLLECT STATISTICS command, see the *CICS System Programming Reference* manual.

For information about installing and operating the sample statistics programs, see the *CICS System Definition Guide*. For information about the data produced by the programs, see the *CICS Performance Guide*.

CICS statistics record format

This section describes the format of CICS statistics SMF type 110 records in detail. You need this information if you write your own program to analyze the statistics data. The three components of a CICS statistics record are an SMF header, an SMF product section, and a CICS data section, as shown in Figure 93. Each of these is described in the sections that follow.

SMF Header	SMF Product Section	CICS Data Section
------------	---------------------	-------------------

Figure 93. Format of an SMF type 110 statistics record

SMF header and SMF product section

The SMF header describes the system creating the output. The SMF product section identifies the subsystem to which the statistics data relates, which, in the case of CICS statistics, is the CICS region, or the TS data sharing server. Both the SMF header and the SMF product section can be mapped by the DSECT STSMFDS, which you can generate using the DFHSTSMF macro as follows:

```
STSMFDS DFHSTSMF PREFIX=SMF
```

The label 'STSMFDS' is the default DSECT name, and SMF is the default PREFIX value, so you could also generate the DSECT simply by coding DFHSTSMF.

The STSMFDS DSECT has the format shown in Figure 94 on page 684.

format of statistics records

```

*          START THE SMF HEADER
*
STSMFDS  DSECT
SMFSTLEN DS   XL2          RECORD LENGTH
SMFSTSEQ DS   XL2          SEGMENT DESCRIPTOR
SMFSTFLG DS   X           OPERATING SYSTEM INDICATOR (see note 1)
SMFSTRTY DC   X'6E'       RECORD TYPE 110 FOR CICS
SMFSTTME DS   XL4          TIME RECORD MOVED TO SMF
SMFSTDTE DS   XL4          DATE RECORD MOVED TO SMF
SMFSTSID DS   XL4          SYSTEM IDENTIFICATION
SMFSTSSI DS   CL4'CICS'   SUBSYSTEM IDENTIFICATION
SMFSTSTY DS   XL2          RECORD SUBTYPE X'0002' FOR STATISTICS
*                                     (see note 4)
SMFSTTRN DS   XL2          NUMBER OF TRIPLETS
          DS   XL2          RESERVED
SMFSTAPS DS   XL4          OFFSET TO PRODUCT SECTION
SMFSTLPS DS   XL2          LENGTH OF PRODUCT SECTION
SMFSTNPS DS   XL2          NUMBER OF PRODUCT SECTIONS
SMFSTASS DS   XL4          OFFSET TO DATA SECTION
SMFSTASL DS   XL2          LENGTH OF DATA SECTION
SMFSTASN DS   XL2          NUMBER OF DATA SECTIONS
*
*          THIS CONCLUDES THE SMF HEADER
*
*          START THE SMF PRODUCT SECTION
*
SMFSTRVN DS   XL2          RECORD VERSION
SMFSTPRN DS   CL8          PRODUCT NAME (GENERIC APPLID)
SMFSTSPN DS   CL8          PRODUCT NAME (SPECIFIC APPLID)
SMFSTMFL DS   XL2          RECORD MAINTENANCE INDICATOR
          DS   XL2          RESERVED
          DS   XL2          RESERVED
SMFSTDTK DS   XL4          DOMAIN TOKEN
SMFSTDID DS   CL2          DOMAIN ID
SMFSTRQT DS   CL3          USS/EOD/REQ/INT STATISTICS TYPE
SMFSTICD DS   CL3          YES IF INCOMPLETE DATA RECORDED
SMFSTDAT DS   CL8          COLLECTION DATE MMDDYYYY
SMFSTCLT DS   CL6          COLLECTION TIME HHMMSS
SMFSTINT DS   CL6          INTERVAL HHMMSS. See note 3.
SMFSTINO DS   XL4          INTERVAL NUMBER. See note 3.
SMFSTRTK DS   XL8          REQUEST TOKEN
SMFSTLRT DS   CL6          LAST RESET TIME HHMMSS
SMFSTCST DS   XL8          CICS START TIME
SMFSTJBN DS   CL8          JOBNAME
SMFSTRSD DS   XL4          JOB DATE
SMFSTRST DS   XL4          JOB TIME
SMFSTUIF DS   CL8          USER IDENTIFICATION
SMFSTPDN DS   CL8          OPERATING SYSTEM PRODUCT LEVEL
*
*          THIS CONCLUDES THE SMF PRODUCT SECTION

```

Figure 94. Format of the SMF header and product section for statistics records

Notes:

1. CICS sets only the subsystem-related bits of the operating system indicator flag byte in the SMF header (SMFSTFLG). SMF sets the remainder of the byte according to the operating system level and other factors. For an explanation of the setting of the other bits, refer to the *OS/390 MVS System Management Facilities (SMF)* manual.
2. The copy book DFHSMFDS is also provided and can be used to map the SMF header and the SMF product sections of all three subtypes of SMF 110 records written by CICS journaling, CICS monitoring, and CICS statistics.

format of statistics records

3. Fields SMFSTINT and SMFSTINO are only relevant if SMFSTRQT is 'INT'. Otherwise both values should be ignored.
4. For TS data sharing, the record subtype is X'0003' and certain fields are not set or are used in a different way. SMFSTPRN and SMFSTSPN contain the server prefix (DFHXQ) and the pool name.
5. For coupling facility data table (CFDT) servers, the record subtype is X'0004' and certain fields are not set or are used in a different way. SMFSTPRN and SMFSTSPN contain the server prefix (DFHCF) and the coupling facility data table pool name.
6. For named counter sequence number servers, the record subtype is X'0005' and certain fields are not set or are used in a different way. SMFSTPRN and SMFSTSPN contain the server prefix (DFHNC) and the pool name.

CICS statistics data section

The format of the CICS statistics data section is shown in Figure 95. If the data records are incomplete, the flag field SMFSTICD is set to 'YES'. In this

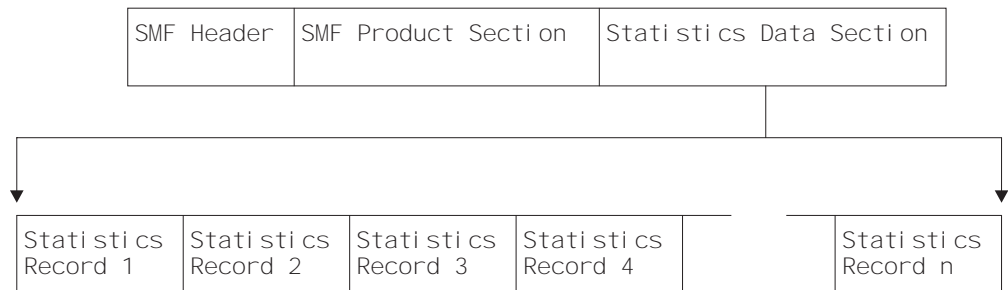

Figure 95. Format of the statistics data section

case, the statistics data section is not present.

For complete data records, the statistics data section is made up of one or more statistics data records. There are different formats of data records. Each has a common format for the first 5 bytes. These 5 bytes are described in the extract from copy book DFHSTIDS in Figure 96.

DFHSTIDS	DSECT		Statistics record header
*			
	DS	0F	Fullword alignment
STILEN	DS	H	Length of the record
STID	DS	AL2	Statistics identifier
STIVERS	DS	CL1	Statistics record version

Figure 96. Extract from copy book DFHSTIDS

STILEN

is the length of the data record.

STID

identifies which type of statistics record you have (see Figure 97 on page 686).

You can use the STID symbolic name or value to determine which copy book to use when processing the statistics data records. For details about the relationship between the STID name or value and the copy book, see Figure 97 on page 686

format of statistics records

on page 682. For further guidance information about the fields within the statistics data records, see the *CICS Performance Guide*.

STIVERS

takes the value '1' for this release of CICS.

STID Symbolic name	STID Value	Copy book	Type of record
STISMDSA	2	DFHSMDS	Storage manager DSA id
STISM	5	DFHSMDDS	Storage mgr domain subpool id
STISMT	6	DFHSMTDS	Storage manager task subpool id
STIXMG	10	DFHXMGDS	Transaction manager (Globals) id
STIXMR	11	DFHXMRRS	Transaction manager (Trans) id
STIXMC	12	DFHXMCRS	Transaction manager (Tclass) id
STIFEPIP	16	DFHA22DS	FEPI pool id
STIFEPIC	17	DFHA23DS	FEPI connection id
STIFEPIT	18	DFHA24DS	FEPI target id
STIVT	21	DFHA03DS	VTAM stats id
STIPAUTO	23	DFHPGGDS	Program Autoinstall id
STIAUTO	24	DFHA04DS	Terminal Autoinstall stats id
STILDR	25	DFHLDRDS	Loader (Resid) id
STIDBUSS	28	DFHDBUDS	DBCTL USS id
STILDG	30	DFHLDGDS	Loader (Globals) id
STITCR	34	DFHA06DS	Terminal control (resid) id
STILSRR	39	DFHA08DS	LSRPOOL pool stats (resid) id
STILSRFR	40	DFHA09DS	LSRPOOL File statistics (by file)
STITDQR	42	DFHTQRDS	TDQUEUE (Resid) id
STITDQG	45	DFHTQGDS	TDQUEUE (globals) id
STITSQ	48	DFHTSGDS	TSQUEUE statistics id
STICONSR	52	DFHA14DS	ISC/IRC system entry (resid) id
STICONSS	54	DFHA21DS	ISC connection - system security
STIDS	55	DFHDSGDS	Dispatcher stats id
STIUSG	61	DFHUSGDS	User domain stats id
STITM	63	DFHA16DS	Table manager statistics id
STIST	66	DFHSTGDS	Statistics statistics id
STIFCR	67	DFHA17DS	File Control (resid) id
STICONMR	76	DFHA20DS	ISC/IRC mode entry (resid) id
STIM	81	DFHMNGDS	Monitoring stats (global) id
STIMNR	82	DFHMNTDS	Monitoring stats (Resid) id
STITDR	85	DFHTDRDS	Transaction dump (resid) id
STITDG	87	DFHTDGDS	Transaction dump (global) id
STISDR	88	DFHSDRDS	System dump (resid) id
STISDG	90	DFHSDGDS	System dump (global) id
STILGR	93	DFHLGRDS	Logger stats (resid) id
STILGS	94	DFHLGSDS	Logstream stats (resid) id
STINQG	97	DFHNQGDS	Enqueue mgr stats (global) id
STIRMG	99	DFHRMGDS	Recovery mgr stats (global) id
STID2G	102	DFHD2GDS	DB2 connection stats (global) id
STID2R	103	DFHD2RDS	DB2 entry stats (resource) id
STISOR	108	DFHSORDS	TCPIP services (resource) id

Figure 97. Statistics data record copy books related to STID name and value

The TS data sharing statistics use no symbolic names, but relate to the STID values as follows:

STID Symbolic name	STID Value	Copy book	Type of record
-	121	DFHXQS1D	TS server list structure stats id
-	122	DFHXQS2D	TS buffer stats id
-	123	DFHXQS3D	TS storage stats id

Figure 98. TS data sharing statistics related to STID

The coupling facility data table server statistics use no symbolic names, but relate to the STID values as follows:

STID Symbolic name	STID Value	Copy book	Type of record
-	126	DFHCFS6D	CFDT server list stats
-	127	DFHCFS7D	CFDT buffer stats id
-	128	DFHCFS8D	CFDT request stats id
-	129	DFHCFS9D	CFDT storage stats id

Figure 99. Coupling facility data table server statistics related to STID

The named sequence number server statistics use no symbolic names, but relate to the STID values as follows:

STID Symbolic name	STID Value	Copy book	Type of record
-	124	DFHNCS4D	NC server list structure stats id
-	125	DFHNCS5D	NC server storage stats id

Figure 100. Named sequence server statistics related to STID

Global user exit in the CICS statistics domain

There is one global user exit point (XSTOUT) in the CICS statistics domain. The exit is invoked before the contents of a statistics data buffer are written to SMF. At this exit, the following information is available:

- The address of the statistics buffer
- The length of the statistics buffer
- The address of the statistics type.

This applies to all five types of statistics: interval, end-of-day, requested, requested reset, and unsolicited statistics.

If you write a global user exit program to be invoked at this exit, you can examine this information and tell CICS either to write the contents of the buffer to SMF or to suppress its output.

For more information about global user exits in general, and about the statistics exit in particular, refer to “Chapter 1. Global user exit programs” on page 3.

Processing the output from CICS statistics

There are several utilities to help you process statistics output. You can use:

The CICS-supplied DFHSTUP program

For information about how to run DFHSTUP, refer to the *CICS Operations and Utilities Guide*. For information about how to interpret the report produced by DFHSTUP, see the *CICS Performance Guide*.

Your own program

to report and analyze the data in the statistics records.

Performance Reporter for MVS

enables you to store CICS statistics (and other data) into a DB2 data set, and to present the data in a variety of forms. For information about the Performance Reporter for MVS, see the *CICS Performance Guide*.

Part 6. Customizing CICS compatibility interfaces

A general note about user-written programs

The following comment applies to all user-written programs mentioned in Part 6 of this book:

- Upon return from any customer-written program, CICS must always receive control in primary-space translation mode, with the original contents of all access registers restored, and with all general purpose registers restored (except for those which provide return codes or linkage information).

For information about translation modes, refer to the *IBM ESA/370 Principles of Operation* manual.

Chapter 26. Using TCAM with CICS

This chapter describes the use of the telecommunications access method (TCAM) with CICS Transaction Server for OS/390 Release 3.

Important

CICS Transaction Server for OS/390 Release 3 supports only the DCB interface to TCAM, and **not** the ACB interface. This means that, in order for CICS to use it, TCAM has to be run as a VTAM application—it cannot be used independently of ACF/VTAM.

The chapter is divided into the following sections:

1. “**CICS with TCAM SNA**” on page 692 describes the use of TCAM in an SNA network, with reference to protocol management, FMH processing, and error processing.
2. “**The TCAM application program interface**” on page 694 includes information about the process control block and the TPROCESS control block.
3. “**The CICS-TCAM interface**” on page 695 includes information about terminal entries (TCTTEs) and line entries (TCTLEs) data flow, logic flow, the terminal error program, message routing, pooling, and segment processing.
4. “**TCAM devices**” on page 704 deals with message formats for devices (in particular, the 3270-system devices) being used on a TCAM line.
5. “**TCAM user exits**” on page 707 describes the three TCAM exits that may be specified in the terminal control program.
6. “**Starting and terminating TCAM**” on page 707 describes the processes of starting up, restarting after an abend, and terminating TCAM under CICS.
7. “**CICS and TCAM: program interrelationship**” on page 709 describes the TCAM message control program (MCP) and its relationship to the application program (in this case, CICS).

The majority of independent teleprocessing applications require a dedicated network. The telecommunications access method (TCAM) permits multiple applications to share a single network, resulting in more efficient use of terminals and lines. The CICS-TCAM interface enables CICS to run as an application program under TCAM.

One practical use of the CICS-TCAM interface is to run a production CICS system in one region and a test CICS system in another. If they run in separate regions, the applications are protected from one another. Operating under TCAM, terminals and lines can be shared by the two CICS applications. Other TCAM applications, such as the time sharing option (TSO), can also run concurrently.

CICS user tasks that run under BTAM can, in general, run under TCAM without modification to the task code. This assumes that you have correctly designed and coded the TCAM message control program. However, to obtain the benefits of TCAM SNA and to maintain an acceptable operator interface, it is usually necessary to change the CICS application programs to use EXEC CICS CONVERSE and EXEC CICS SEND LAST facilities so that the MCP is provided with sufficient information about the transaction to maintain the optimum SNA message flows.

CICS with TCAM SNA

The CICS-TCAM interface has an enhanced data stream support that enables an appropriate TCAM message control program (MCP) to control the SNA session. The TCAMFET=SNA operand in DFHTCT TYPE=LINE allows TCTTEs to be specified for SNA devices. You must be prepared to write an appropriate TCAM SNA message control program to complement the CICS support and the SNA devices attached to the system. In order to obtain a good operator interface, the CICS application programs should be designed to inform the MCP of their intentions. Thus, it is better to design the MCP and the application programs together.

Sample TCAM SNA MCPs are provided in CICSTS13.CICS.SDFHSAMP. The second sample MCP (DFHSPTM2) uses the information passed in the CCB to optimize the message flows to the actual logical unit. This represents transaction-oriented processing.

TCAM provides data stream support for SNA devices running under CICS. Both the SNA character string (SCS) and the 3270 data streams are supported.

To understand how CICS works with TCAM in an SNA environment, it is important to understand the TCAM SNA structure. The device message handler (DMH) is the logical unit in SNA terms. All data flow control (DFC), session startup and shutdown, and response handling are provided in the DMH. There is no CICS control of these SNA functions, so the application programmer need not be concerned with them. For a more detailed discussion of the TCAM SNA functions provided, see the *ACF/TCAM System Programmer's Guide*.

Protocol management

There may be many different protocols in an SNA network. The various protocols are established on a session basis using the BIND image. You decide which protocols to use with which SNA session, and you should understand the requirements of the installation's application programs before deciding on a specific protocol.

Some of the more common of these SNA protocols are: bracket, half-duplex flip-flop (HDX-FF), and half-duplex contention (HDX-CON). The enforcement of these protocols is a function of the device message handler (DMH).

There are two methods of protocol management in a CICS-TCAM system:

- Device message handler control
- Transaction control.

These methods are discussed in the sections that follow.

Device message handler control

The device message handler method of protocol management is used when the transaction does not need to know which device it is communicating with. Although the communication control bytes (CCBs) are passed between CICS and TCAM, they are not used to control the SNA session. All the protocol control is provided in the DMH. You (the message handler writer, not the application programmer) choose the appearance at the outboard LU.

Transaction control

In the transaction control method of protocol management, the transaction controls the protocol. The SNA session should be bound with a protocol of HDX-FF with brackets when running this type of management.

When using transaction control, the communication control byte (CCB) is used to relay information from the transaction to the DMH. For example:

- EXEC CICS SEND LAST should be used to end a transaction. This causes an indicator to be set in the CCB requesting that the DMH send an end-of-bracket (EB) character.
- EXEC CICS CONVERSE should be used when terminal input is required after a SEND request. This causes an indicator to be set in the CCB requesting that the DMH send the CHANGE DIRECTION indicator to the device.
- EXEC CICS ISSUE DISCONNECT should be used to end the logical unit session. This causes an indicator to be set in the CCB requesting that the DMH terminate the LU-LU session (that is, issue the IEDHALT macro).

Function management header processing

The function management header (FMH) enables function management information to be directed to particular components within the logical unit. The FMH also provides a mechanism in which control information relating to the operation of those components may be passed. FMH processing is a BIND-time option (that is, a BIND parameter is available to indicate whether an FMH may or may not appear in the LU-LU session).

CICS-TCAM SNA provides support for the logical device code (LDC), which is transmitted in the FMH to the logical unit. The LDC provides for the communication of the logical disposition of output to the logical unit. It can represent any meaning that is useful to the installation.

There are two ways that FMH handling can be provided. The first is for the transaction to provide the FMH as part of the data passed to TCAM, by issuing an EXEC CICS SEND FMH command. An indicator is set in the CCB so that the DMH can set the "FMH included" indicator in the request handler (RH) by using the IEDRH macro. On input, the DMH should interrogate the RH (using the IEDRH macro) to determine whether an FMH is included in the data. If the FMH indicator is set in the RH, the DMH should set the FMH indicator in the CCB relating to the transaction in which the input data contains an FMH.

A second method of FMH handling is to provide the entire function in the DMH. The DMH should remove the FMH before passing the input data to the transaction, and insert the necessary FMH into the output data. For the DMH to build the correct FMH for output, some form of private interface must be established between the DMH and the application program. For example, the first byte of data following the CCB can contain unique values that request specific FMH functions such as begin data set, erase record, and so on.

It is recommended that if FMH processing is required, the transaction (or preferably BMS) be used to provide the appropriate FMH.

CICS with TCAM SNA

Batch processing

When running a batch logical unit, a point to consider is how to get the transaction identification to CICS on the “begin data set” condition. The alternative methods are discussed below.

The first method is for the DMH to recognize the “begin data set” condition by interrogating the FMH and by editing the transaction ID into the input data. This method is demonstrated in the sample message control programs DFHSPTM1 and DFHSPTM2.

The second method of providing the transaction ID is for the DMH to concatenate the “begin data set” chain with the first chain of the data set, using the SETEOM macro. When you use this method, the first chain of the data set must contain the transaction ID. Alternatively, the transaction ID could be set with the TCTTE beforehand by means of a permanent TRANSID or by using EXEC CICS RETURN TRANSID.

Error processing for batch logical units

During batch processing with a logical unit, there are some logical errors from which the DMH cannot recover (for example, ‘data set overflow’ or ‘incorrect data set name’). A transaction can be provided to handle these error conditions. If the transaction builds the data set on the TCAM queue and ends before the data set is transmitted, an error transaction should be created. The DMH should generate the appropriate error message or pass the SNA sense bytes to this error transaction, which then handles the error condition. If the transaction that builds the data set remains active throughout the transmission of that data set to the device, then the same transaction could be coded to recognize the error indicators passed to it from the DMH, rather than a separate error transaction created for that purpose.

Error processing

All error conditions, other than logical errors, are handled by the DMH. The *ACF/TCAM System Programmer's Guide* contains a discussion on the handling of the various sense codes returned by SNA devices. The transaction is not involved in error processing and recovery.

The TCAM application program interface

The TCAM application program interface is a portion of the TCAM message control program (MCP). It consists of two types of control blocks, the process control block (PCB) and the TPROCESS block.

The PCB defines the application program interface of a region in the system using TCAM. Its purpose is to control communication and storage protection across region boundaries. It also defines the user-written message handler (MH) responsible for processing messages to and from the application program. Because a PCB is required for each application program running with the MCP, one PCB is also required to define the CICS application program.

The TPROCESS control block controls communication to and from the application program. A separate block is required for both input and output to the application program. A TPROCESS block is required for each input queue to CICS, and for

each output queue from CICS. In CICS, there are corresponding terminal control table line entries (TCTLEs) for each input queue, and for each output queue (that is, for each TPROCESS block).

DD cards (such as those shown in Figure 101) are used to correlate the TCAM control blocks with the CICS control blocks. The CICS terminal control table contains the DCB. The DDNAME specified in the terminal control table macro (DFHTCT TYPE=SDSCI,DDNAME=name) names the DD card. In the DD card, the QNAME field names the TCAM TPROCESS block.

You do not need to make any exceptions for CICS to the TCAM application program interface described above. For more information, see the *ACF/TCAM Version 3 Application Programming* manual.

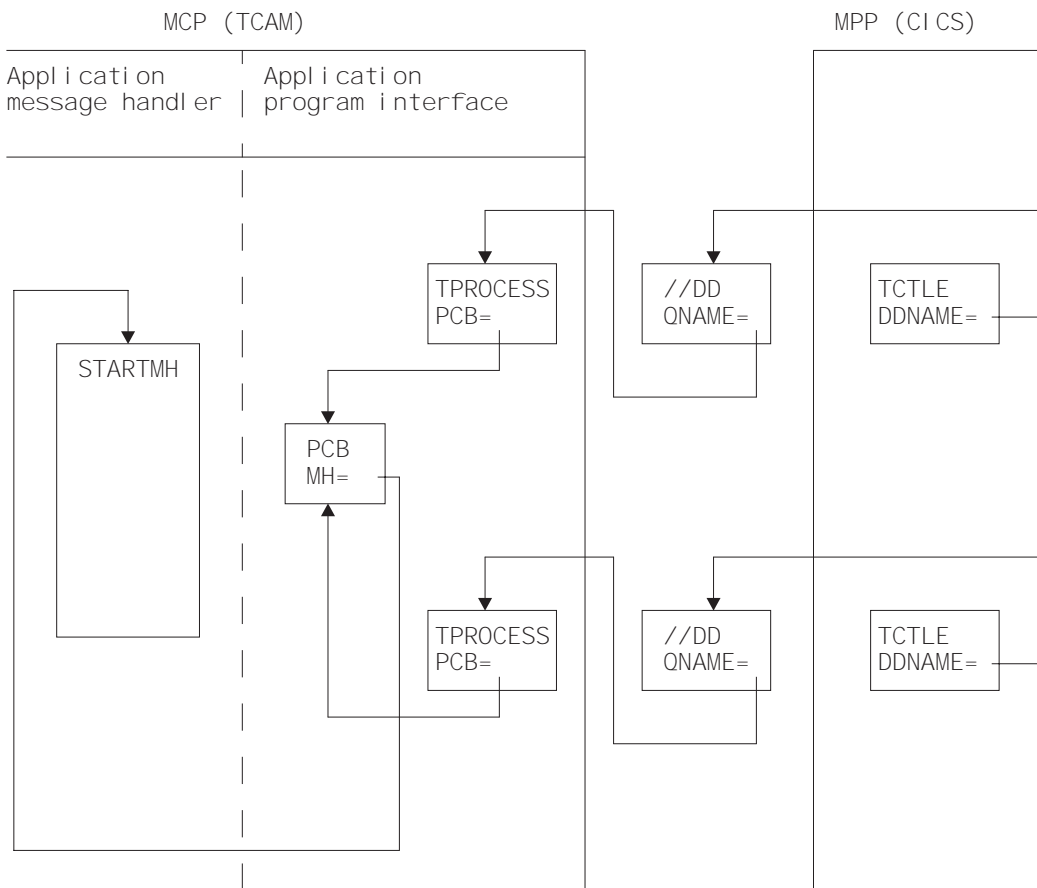

Figure 101. DD card correlation of TCAM and CICS control blocks

The CICS-TCAM interface

CICS treats a TCAM input process queue as a “line”. For each input process queue there is a CICS terminal control table line entry (TCTLE). Note that TCAM requires the application program (CICS) to have a DCB for each TPROCESS block; separate TPROCESS blocks are required for input to and output from the application program. Therefore, each TCAM output process queue is also treated as a line and has a corresponding CICS TCTLE. Each TCTLE references its own DCB, which is generated by the DFHTCT TYPE=SDSCI macro in CICS.

the CICS-TCAM interface

The CICS terminal control table terminal entries (TCTTEs) define the terminals associated with a particular line entry (TCTLE). For each physical terminal communicating with CICS through TCAM, a corresponding TCTTE containing the terminal identification must be associated with a TCTLE. Duplicating individual TCTTEs for both the input TCTLE and the output TCTLE is avoided by attaching a single, special TCTTE to the input TCTLE and attaching all the individual TCTTEs to the output TCTLE. Although attached to the output TCTLE, they are used for both input and output processing.

Each input record from TCAM must contain the source terminal identification. Using this identification as a search argument, the corresponding TCTTE can be located by CICS by comparing against the NETNAME value for each TCTTE.

Note: The usual way of ensuring that the input records contain the source terminal identification is to specify OPTCD=W in the CICS DFHTCT TYPE=SDSCI macro. If this specification is omitted, the TCAM user is responsible for ensuring that the record contains a suitable source terminal identification.

Using the POOL=YES operand of the DFHTCT TYPE=LINE macro, you can establish a pool of common TCTTEs on the output TCTLE that do not contain terminal identifiers. As required, terminal identifiers are assigned to the TCTTEs or removed from association with the TCTTEs. POOL=YES necessarily imposes a number of restrictions and should be thoroughly understood before being implemented. For additional information, see the discussion of the POOL operand in "Line pool specifications" on page 701.

Data format

When TCAM is specified, CICS assumes that the user transaction data passed to it from the TCAM queue is in the proper format to be passed directly to the user task. Except for the removal of the source terminal identification and the 2-byte CCB (if on a TCAM SNA line), CICS does not alter the data it receives. It is your responsibility (using your message control program (MCP)) to prepare the data, for example, by translating to EBCDIC, removing function management headers (FMHs), stripping line control characters, and deblocking. You may optionally bypass the CICS routine that removes the source terminal identification, by returning from the user-written input exit (XTCTIN) in TCP with a displacement of 0 bytes.

Similarly, CICS assumes that the user transaction data passed to it for TCAM has been properly formatted and can be placed directly on the TCAM output process queue. Except for the insertion of the destination identification, the CCB, and the data stream control characters, CICS does not alter the data it receives. It is your responsibility (using your MCP) to prepare the data for the destination terminal, for example, by translating and inserting line control characters.

Optionally, BMS can be used with TCAM to prepare the input data for the user task, and the output data for the specific terminal type. When BMS is required with TCAM, the TRMTYPE operand in DFHTCT TYPE=LINE or in DFHTCT TYPE=TERMINAL must indicate the specific terminal type for 3270 data streams. TRMTYPE=TCAM can be used to obtain EBCDIC data stream support. For BMS support within SNA, the TCAMFET=SNA and SESTYPE operands must also be specified in DFHTCT TYPE=LINE, and in DFHTCT TYPE=TERMINAL, respectively.

For information about the DFHTCT macros, see the *CICS Resource Definition Guide*.

Logic flow

The following is a generalized description of the sequence of events that occurs in CICS when interfacing with TCAM.

INPUT STEP

ACTION

- A** TCAM notifies CICS that it has data for a particular input TCTLE, by posting its ECB.
- B** CICS gets a TIOA and attaches it to the special input TCTTE in the TCTLE.
- C** CICS issues a READ to TCAM that results in TCAM passing the data over the region boundaries to the CICS TIOA. CICS then indicates that it has data to process. (See Figure 102 on page 698.)
- D** The input TCTLE points to the corresponding output TCTLE in response to the OUTQ specification of the DFHTCT TYPE=LINE macro.
- E** The individual TCTTEs on the output TCTLE are searched for a matching source terminal netname. If POOL=YES has been specified, a free TCTTE is assigned to this source terminal identification. (See Figure 103 on page 699.)
- F** If an input user exit (XTCTIN) has been specified, CICS links to the user exit routine where you may edit input data before passing it to a task (refer to page “Exit XTCTIN” on page 206). If no exit has been specified, CICS removes the 8-byte source terminal identification field inserted by TCAM. For SNA devices, the input communication control byte (CCB) is removed. No other editing of the data is performed.
- G** A check is made to determine whether a task is attached to the individual TCTTE. If there is no task attached, see Step H. If a task is attached, a check is made to see if the task has issued a READ. If a READ request exists, see Step J. If not, CICS halts the processing of data in the queue until the TCTTE is available or the attached task issues a READ.
- H** CICS attaches the appropriate task. A user exit is available before the actual attach (refer to page “Exit XTCATT” on page 206). If the task could not be attached (for example, if a ‘short on storage’ or ‘maximum tasks’ condition exists), CICS records that it has data to process, and exits from DFHTCP.
- I** After a task is attached, and if segment processing was specified by including the C parameter on the OPTCD operand of the DFHTCT TYPE=SDSCI macro, CICS stores the TCAM segment identifier in the TCTTE.
- J** CICS passes control to the attached task.

the CICS-TCAM interface

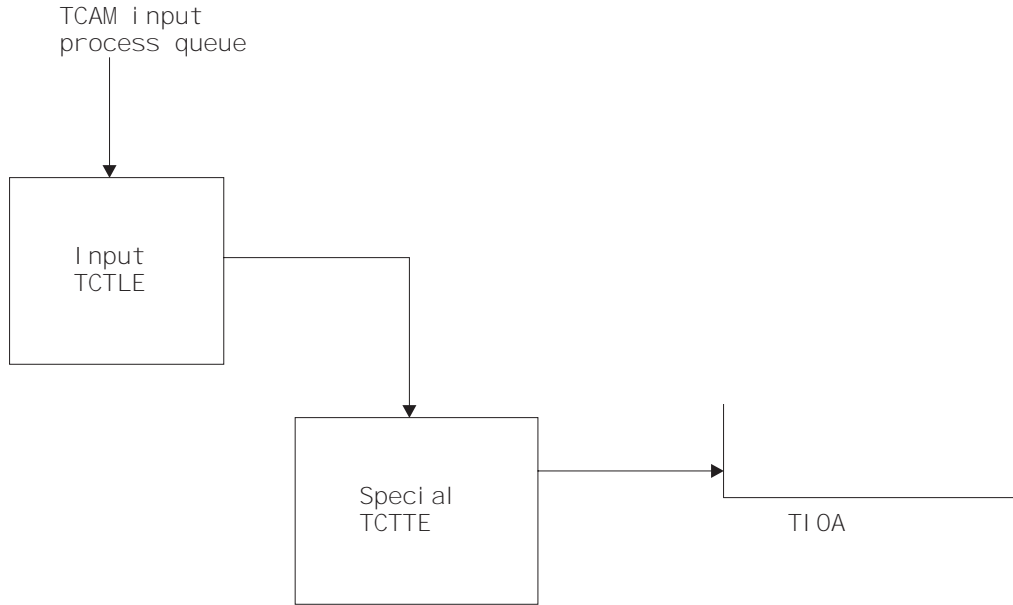

Figure 102. CICS issues a TCAM read

OUTPUT STEP ACTION

- A** You issue an EXEC CICS SEND request in your application program.
- B** The TCP terminal scan recognizes the SEND request.
- C** CICS checks whether an output user exit (XTCTOUT) has been specified. If it has, CICS links to the user exit routine, where you may edit your output data before passing it to TCAM. (See the discussion of XTCTOUT under “TCAM user exits” on page 707.)
- D** CICS checks the 4-byte TCTTE field TCTTEDES for a destination saved as a result of DEST(name) having been specified on the EXEC CICS SEND instruction. If it is present, CICS inserts it in the 8-byte destination field and left-aligns the field, padding blanks to the right. Otherwise, CICS moves the source terminal netname from the TCTTE to the destination field.
- E** CICS moves the communication control byte (or bytes in TCAM SNA) into the 9th byte (9th and 10th bytes in TCAM SNA) of the TCAM work area. (See “TCAM devices” on page 704.)
- F** CICS issues a TCAM WRITE to transfer the data to TCAM.
- G** After checking for successful completion of the WRITE to TCAM, CICS flags the user task “dispatchable” if a task is still attached to the TCTTE. Otherwise, CICS frees the TCTTE for a new task.

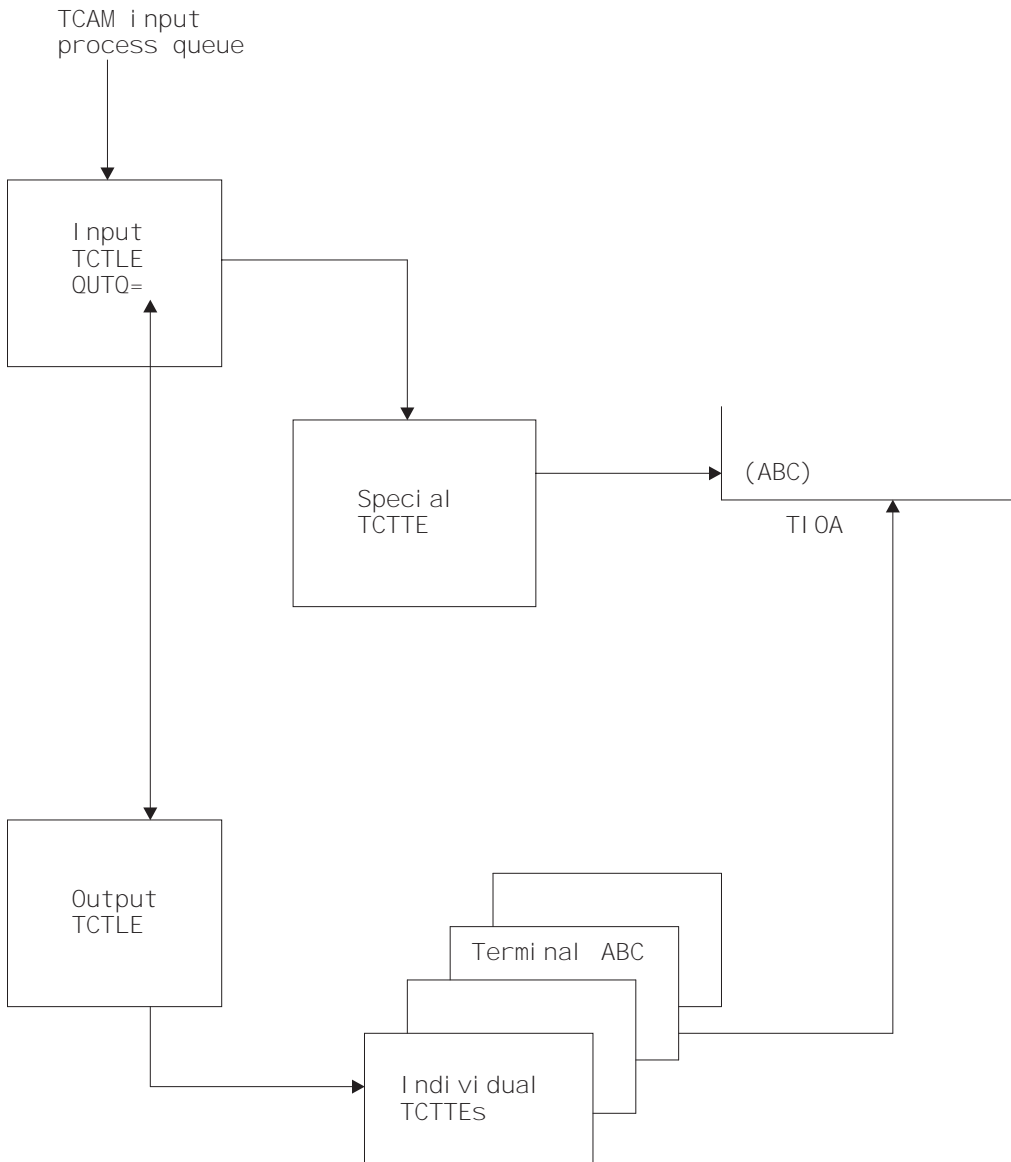

Figure 103. After a TCAM read, CICS attaches a TIOA to the corresponding TCTTE

Terminal error program

The CICS-TCAM interface implementation has resulted in the expansion of the CICS terminal error program (DFHTEP) error codes and conditions. The errors and actions shown in Table 32 on page 700 are unique to TCAM, and should be considered in DFHTEP.

the CICS-TCAM interface

Table 32. DFHTEP error codes and conditions unique to TCAM

Error code	Condition	Action
X'87'(TCEMCUI)	Unsolicited input Terminal 'receive only' Terminal 'out of service' Task has not issued a read No available TCTTE from pool.	a a, b No default No default
X'9F'(TCEMIDR)	TCAM has issued an invalid destination return code to CICS.	c

where:

- a = Release TCAM TIOA (X'04' in TEPCAACT)
- b = Terminal out of service (X'20' in TEPCAACT)
- c = Abend transaction (X'10' in TEPCAACT).

Message routing

The DEST option of the EXEC CICS SEND command can be used to route an output message to a destination that you defined in the TCAM MCP. This operand can be used to send a message to a destination other than the source terminal (such as to another terminal, a list of terminals, or another application program).

CICS moves the data from TCTTEDES into the destination identification field before placing the data on the TCAM output process queue. You may bypass the CICS routine that inserts the destination field by taking the XTTCMOUT user exit and returning to CICS from the exit with a displacement of zero. In this case, you must ensure that the TCAM header is correctly formatted for output.

If the DEST option is omitted, CICS inserts the source terminal NETNAME from the TCTTE into the destination identification field.

Segment processing

The CICS-TCAM interface supports TCAM segment processing, except when BMS is used. It permits segments of a message to be forwarded to CICS rather than waiting for the entire message to be received. If you specify segment processing (by including the parameter C on the OPTCD operand of the DFHTCT TYPE=SDSCI macro), CICS passes the segment to you, and places the position field control byte in the TCTTE field labeled TCTTETCM. Your application program can read the contents of TCTTETCM by means of an EXEC CICS INQUIRE TERMINAL command:

```
EXEC CICS INQUIRE TERMINAL(4-character data-value)
                    TCAMCONTROL(1-character data-area)
```

This returns a 1-byte hexadecimal value that indicates which segment of the message is being passed.

The possible values of TCTTETCM are:

Value	Message segment
X'00'	Null
X'40'	Intermediate portion of message
X'F1'	First portion of message
X'F2'	Last portion of message
X'F3'	Entire message
X'F4'	Intermediate portion of message, end of record
X'F5'	First portion of message, end of record
X'F6'	Last portion of message, end of record
X'F7'	Entire message, end of record
X'FE'	TCAM is not active
X'FF'	INQUIRE attempted on non-TCAM terminal.

On output, your application program must supply the control byte in TCTTETCM for CICS to pass to TCAM. The required command is:

```
EXEC CICS SET TERMINAL(4-character data-value)
          TCAMCONTROL(1-character data-value)
```

The possible values that can be passed are as listed above. For further information about EXEC CICS INQUIRE|SET TERMINAL commands, refer to the *CICS System Programming Reference* manual.

If multiple terminals have been defined for one output line (that is, multiple terminals related to one TPROCESS queue), you must ensure that an entire message is passed to TCAM for a specific destination before putting the first segment for another destination on the queue. In other words, an error is returned to you if a "PUT first segment to destination A" is followed by a "PUT first segment to destination B". For additional information about segment processing, see the discussion of the OPTCD operand of the application input and output DCB in the *ACF/TCAM Version 3 Application Programming* manual.

Line pool specifications

When generating the TCAM message control program, you define each physical terminal and logical unit to TCAM by means of a TCAM TERMINAL macro. Because CICS also requires terminal definitions, you must prepare a terminal control table terminal entry (TCTTE) for each terminal, or logical unit, in a DFHTCT TYPE=TERMINAL macro. As a result, there is a one-to-one correlation between terminal definitions in TCAM and in CICS.

In a highly restricted environment, this duplication of terminal definitions can be reduced by using the POOL feature (DFHTCT TYPE=LINE,POOL=YES), and by specifying LASTTRM=POOL in DFHTCT TYPE=TERMINAL on the last TCTTE. Instead of a one-to-one relationship, a "pool" of generalized TCTTEs is defined for a TCAM process queue (line). When a transaction is received over the TCAM line, a search is made for an available TCTTE in the pool. When one is found, it is assigned a source terminal identification and netname for the duration of the task. When the task has been completed, the TCTTE can be reassigned. If there are no available TCTTEs to handle the next transaction from the line, the line remains

the CICS-TCAM interface

locked until a TCTTE becomes available because the task has ended. The number of TCTTEs in the pool influences the degree of multitasking.

You should consider providing enough terminal entries in the pool to avoid an 'unsolicited input' condition (see "TCAM queues" on page 703), because there is no available entry in the pool. When DFHTCAM scans for a free entry, it does not scan the entire table because it carries a pseudo-end-of-table value. Therefore, unused entries at the end of the table can never be referred to.

Line pool restrictions

You must be aware of the following line pool restrictions:

- Because of device dependencies within CICS, only one terminal type is permitted for each TCAM line (process queue).
- Automatic transaction initiation (ATI), transaction routing, and BMS message routing are not applicable in the pool environment. If ATI is required for functions and you still want to use pooling, you should consider using a special queue of nonpooled entries suitable for ATI. For example, 3270 displays could be put on a pooled entry, and 3270 printers on a nonpooled queue to cause ATI to the printers.
- Statistics are accumulated for each TCTTE in the pool; however, the statistics cannot be correlated to the physical terminals or specific logical units.
- Only one signon can exist for all terminal entries in a given line pool at any one time. The first signon received by CICS is communicated to all terminals in the pool. Any subsequent signon is rejected. A sign-off clears the signon data from all terminal entries in the pool; a subsequent signon is then accepted.
- Terminal and line requests issued by the master terminal are not valid for pooled terminals.
- TCAM segment processing is not supported for pooled terminals.

Line locking

Two types of line locking can occur:

- A temporary lock that resolves itself in time
- A permanent lock that remains permanent unless you take action in the terminal error program.

A temporary line lock occurs when no TCTTEs are available in the pool and a new transaction appears on the input queue. CICS locks the queue until an existing task completes execution, thus freeing a TCTTE. In this case, the completion of existing tasks is not dependent upon additional input from the queue.

A permanent line lock can occur when multiple reads are required to complete a task. For example, suppose that there are two TCTTEs in the pool, that a task is attached to each, and that the messages in the input queue are in the following order:

1. Message 1 for a third transaction
2. Subsequent messages for the two active tasks.

Because no TCTTE is available in the pool for the third transaction, it must wait for a task to complete for a TCTTE to become available. Because the TCAM input queue is processed sequentially, the two active tasks are unable to receive their subsequent messages. Hence, they cannot complete, and the queue remains

permanently locked.

TCAM queues

Because a queue is a sequential data set, the second message on the queue cannot be retrieved until the first message has been processed. To keep messages flowing smoothly through the queue, it is essential that each message be processed as soon as it arrives. In the CICS-TCAM interface, “processing the message” means detaching the message from the special input TCTTE and attaching it to the individual TCTTE correlated to the actual physical terminal or logical unit. Each individual TCTTE may be considered to be a “destination” for the purpose of this discussion.

If a particular destination (TCTTE) is not ready to accept the current message on the queue, the queue locks until the destination can accept the message. Queue locks are only a problem when a queue is serving more than one destination. In this case, if a queue locks, any new transaction on the queue, or messages queued for existing tasks, are not processed until the required destination has accepted the current message.

Because queue locks can adversely affect system performance, it is important that you understand their cause and effect, as described below. Proper configuration of the TCAM process queue and CICS terminal control tables reduces the occurrence and duration of queue locks to a minimum.

The maximum number of terminals that can be attached to one queue is governed by the amount of activity expected, and by the response time required from the system. For high activity and low response times, you should not exceed 25 terminals. Note that only a real performance test can verify whether this figure is acceptable.

Because TCAM can read ahead from the terminals, it is possible for TCAM to present to CICS a new transaction message destined for a TCTTE that is already processing a task. Also, TCAM can present a message for an existing task before that task issues a READ request. In either case, CICS cannot process the message (as described above) until the TCTTE is ready to accept the new TIOA. Such input is called “unsolicited input”.

These conditions can produce unsolicited input:

1. The CICS TCTTE for which the data is destined is out of service.
2. The CICS TCTTE for which the data is destined is in RECEIVE status.
3. The CICS TCTTE for which the data is destined has an associated task that has not issued a READ, and for which the period of time indicated by the NPDELAY specification has expired.
4. A terminal in a pool has entered data and is unable to find an available TCTTE.

In all cases, the action taken by the CICS-TCAM interface is to place the input line out of service, and attach DFHTACP to process the error condition.

The default action taken by DFHTACP (which can be altered by a user-written DFHTEP) for conditions 1 and 2 is to discard the data and place the input line in service. No default action is taken by DFHTACP for condition 3 or 4; therefore, the input line is placed in service, but with the same message still to be processed, thereby preventing CICS from reading any subsequent messages from the input queue.

the CICS-TCAM interface

To allow processing of input to continue, DFHTEP may take either of the following steps:

- If the input line is placed in service by DFHTEP, the CICS-TCAM interface retries the operation. In this case, a count mechanism is recommended in DFHTEP to prevent a loop occurring if the task never issues a READ, or a TCTTE never becomes available.
- Perhaps when a count limit is reached, DFHTEP might abend the task, dispose of the data, and place the line in service.

For further information about DFHTEP, see “Terminal error program” on page 416.

The problem of unsolicited input caused by condition 4 can be eliminated entirely by having a separate TCAM input process queue for each CICS terminal (TCTTE). However, as the number of terminals increases, this solution may quickly use up too much main storage.

You should analyze the type of traffic that you anticipate over the queues. If a 2770 Data Communication System, or a 2780 Data Transmission Terminal, is to read in volumes of cards, you should consider having separate queues for these devices. However, devices can share queues if traffic is conversational with short-lived tasks. The same TCAM output process queue can be specified for multiple input process queues. (See the discussion of the DFHTCT TYPE=LINE,OUTQ=symbolic name specification in the *CICS Resource Definition Guide*.)

You need not be concerned with locking the TCAM output process queue, because TCAM requeues the data according to its final destination once it arrives over the output queue.

It is possible for the TCAM output process queue to become congested because of lack of queuing space. In this case, CICS has a WRITE to the queue outstanding until TCAM accepts the data.

If the length of a message passed to a TCAM queue exceeds the queue's block size (specified in the DCB), DFHTCAM causes DFHTACP to be attached with 'output area exceeded' (error code X'8F').

TCAM devices

In a non-TCAM environment, the CICS terminal control program is responsible for polling and addressing terminals, code translation, transaction initiation, task and line synchronization, and the line control necessary to read from or write to a terminal. When TCAM is specified, terminal control relinquishes responsibility to the TCAM MCP for polling and addressing terminals, code translation, and line control. To take advantage of TCAM facilities, code, in the MCP message handler, functions, such as code translation, that were previously handled by the CICS terminal control program.

For some terminal services, it is necessary for CICS to pass the user request on to the TCAM MCP message handler. A communication control byte (2 bytes in TCAM SNA) in the TCAM work area has been established for this purpose. It is passed to TCAM along with the 8-byte destination name field. You must execute the appropriate MCP message-handler macros according to the contents of the communication byte.

TCAM devices

The terminal services parameters that do not set bits in the communication control byte are SEND, WAIT TERMINAL, and SAVE. Bits in the communication control byte are set for the ISSUE DISCONNECT and CONVERSE parameters, and for the FMH and LAST parameters on the EXEC CICS SEND command.

The CICS-TCAM interface does not support the RESET parameter or the 3270 parameters READB and COPY.

All messages to TCAM from CICS are prefixed with the standard CICS-TCAM communication area. This is one byte for the non-SNA TCAM interface, and two-bytes for the TCAM SNA interface (that is, when TCAMFET=SNA is specified in DFHTCT TYPE=LINE). This area is used to convey to TCAM special requests and options that cannot be used within CICS.

The format of the communication area is:

First byte

- X'01'** FMH present in stream
- X'04'** Extended CCB (2-byte CCB)
- X'08'** DISCONNECT request
- X'10'** READL (read keyboard)
- X'20'** WRITEL (write keyboard).

Second byte (present if extended CCB is on)

- X'01'** Last output from transaction (WRITE, LAST)
- X'02'** READ requested after this WRITE (WRITE, READ request or CONVERSE).

All other flags are reserved and are set to 0.

Generalized TCAM message format

Messages passed between CICS and TCAM and *vice versa* have the format shown in Table 33.

Table 33. General format of TCAM messages

Destination	CCB	Device-dependent data	FMH	Message
8 bytes	2 bytes (optional) (SNA only)	x bytes (device-dependent)	y bytes (SNA only)	

Destination

Destination name (8 bytes) taken from TCTTE's netname parameter or from DEST specification on output.

CCB Communication control bytes. This determines the options specified for the message (for example, whether an FMH is present or not). The length of the CCB varies, and can be:

- 0 bytes (input message, non-SNA)
- 1 byte (output message, non-SNA)
- 2 bytes (input/output messages, SNA).

TCAM devices

Device-dependent data

Dependent on the device: 3270, or other. See the following sections on the relevant devices.

FMH Function management header.

SNA only = length in first byte

non-SNA = not applicable.

Message

User data.

TCAM with 3270 devices

The CCB and device-dependent data for an input message from TCAM to CICS have the following format:

CCB1 1 byte SNA only	CCB2 1 byte SNA only	Attention i d e n t i f i e r 1 byte	CURSOR 2 bytes
----------------------------	----------------------------	--	-------------------

The CCB is present for TCAM SNA lines only.

The CCB and device-dependent data for 3270 output messages from CICS to TCAM have the following format:

CCB1 1 byte	CCB2 1 byte	1 1 byte	2 1 byte	3 1 byte
----------------	----------------	-------------	-------------	-------------

(2 bytes - SNA) device-dependent data
(1 byte - non-SNA)

- 1 Escape character
- 2 Command
- 3 WCC (write control character)

All SOH% status messages input to CICS are passed to DFHTACP or DFHTEP.

Terminal control copy and read buffer requests are not supported by the CICS-TCAM interface.

In addition to normal read and write functions, the ERASEAUP, CTLCHAR, and UCTRAN operands are also valid for the 3270.

All 3270 printer scheduling and error handling is provided by the TCAM message handler.

Note: For 3270 SDLC devices, the escape character must be removed by the message handler.

TCAM user exits

There are three TCAM global user exit points:

1. **XTCATT**, invoked before issuing a transaction manager ATTACH for a transaction identification received in response to polling
2. **XTCTIN**, invoked following the completion of any TCAM input event, (that is, after the individual TCTTE has been located, but just before CICS checks to see if a task is attached to the TCTTE)
3. **XTCTOUT**, invoked for output events before placing data on the TCAM output process queue.

For more information about global user exits, you should read “Chapter 1. Global user exit programs” on page 3.

Starting and terminating TCAM

CICS-TCAM startup

The TCAM MCP must be in operation before completing CICS system initialization. When you start up CICS with the CICS-TCAM interface, CICS checks for the presence of a TCAM region and issues the operator message:

```
DFHSI1513 - CICS CHECKING FOR TCAM MCP
```

If CICS discovers the MCP is not operational, the following messages are issued:

```
DFHSI1520 - TCAM MCP NOT CURRENTLY AVAILABLE  
DFHSI1520 - REPLY 'RETRY' OR 'CANCEL' OR 'CONT'
```

The operator must then respond:

```
RETRY
```

when the TCAM region becomes active; or

```
CANCEL
```

to terminate CICS; or

```
CONTINUE
```

to continue initialization of CICS in the absence of the TCAM region.

If the operator responds CONTINUE, all DD cards that refer to a TCAM queue must have been previously removed from the startup deck to avoid an abnormal termination of CICS. The CONTINUE response is applicable to a mixed BTAM/TCAM mode of operation when TCAM lines are not being used during execution of CICS.

CICS-TCAM abend and restart

If the TCAM message control program (MCP) terminates abnormally, any TCAM application programs currently active are automatically terminated abnormally, if there is at least one open line group in the MCP. This also applies to the CICS application program. For further information, see the relevant sections in the *ACF/TCAM System Programmer's Guide* and the *ACF/TCAM Version 3 Application Programming* manual. CICS does not provide RESTART capability.

starting and terminating TCAM

CICS-TCAM termination

CICS is terminated in the normal manner. No modifications to termination procedures are required to support the CICS-TCAM interface. If both CICS and TCAM are being terminated, CICS should be terminated first, to avoid an abnormal termination of CICS.

CICS and TCAM: program interrelationship

Figure 104 illustrates the interrelationship between the TCAM message control program (MCP) and the TCAM application program. CICS is regarded as an application program by TCAM.

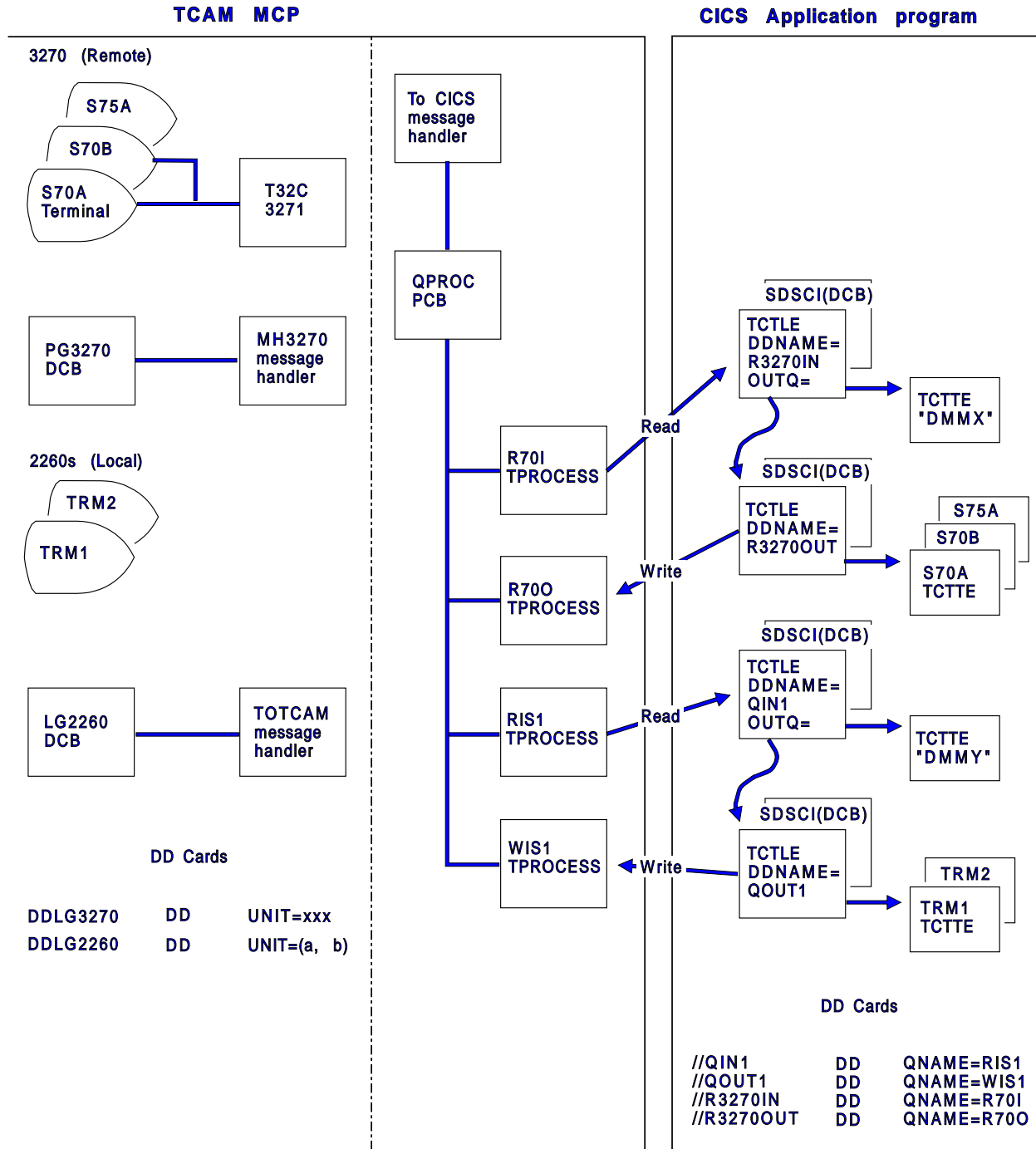

Figure 104. TCAM message control and application program

CICS-TCAM program interrelationship

TCAM message control program (non-SNA)

This section gives an example of a non-SNA TCAM message control program. This MCP shows the relationship between the MCP definition and the CICS terminal control table generation. It should not be construed as a typical or usable MCP for CICS. For further information about MCP definition for a variety of devices, see the *ACF/TCAM Installation and Migration Guide*. An example of a CICS terminal control table for TCAM is given in the *CICS Resource Definition Guide*.

Note: Two sample TCAM message control programs for use in an SNA network are provided in CICSTS13.CICS.SDFHSAMP. These are DFHSPTM1 (in which control of SNA sessions is independent of the CICS application programs), and DFHSPTM2 (in which control of SNA sessions is according to the requirements of the CICS application programs).

```
MCPCICS    CSECT
TCAMINIT   INTRO   DISK=NO,
                                *
                                PROGID=TCAM/CICS,
                                *
                                LUNITS=40,
                                *
                                MSUNITS=20,
                                *
                                KEYLEN=132,
                                *
                                CROSSRF=4,
                                *
                                DLQ=TRM1,
                                *
                                STARTUP=CY,
                                *
                                TRACE=10,
                                *
                                LINETYP=BOTH,
                                *
                                OLTEST=0
                                LTR    15,15
                                BZ    OPENLINE
NOEXEC     ABEND   123,DUMP
OPENLINE   OPEN    (PG3270,(INOUT))
TM         TM     PG3270+48,DCBOFLGS
BNO       BNO    NOEXEC
WTO       WTO    'TIME TO START APPLICATION PROGRAM'
READY
FINISH     CLOSE   (,PG3270)
L         L      13,4(13)
RETURN    RETURN  (14,12)
PG3270    DCB     DSORG=TX,MACRV=(G,P),CPRI=S,DDNAME=DDPG3270,
                                *
                                MH=MH3270,PCI=(N,N),BUFSIZE=464,
                                *
                                INVLIST=(POLL70R,,),TRANS=EBCD
QPROC     PCB     MH=TOCICS,
                                *
                                BUFSIZE=464,
                                *
                                RESERVE=(20)
TTABLE    TTABLE  LAST=TRM2
RIS1      TPROCESS PCB=QPROC,QUEUES=MO
WIS1      TPROCESS PCB=QPROC
R70I      TPROCESS PCB=QPROC,QUEUES=MO
R700      TPROCESS PCB=QPROC
T32C      TERMINAL QBY=T,DCB=LG3270R,RLN=1,TERM=327C,QUEUES=MO
S70A      TERMINAL QBY=T,DCB=PG3270,RLN=1,TERM=327R,QUEUES=MO,
                                *
                                ADDR=616140402D,NTBLKSZ=1856,SECTERM=YES
S70B      TERMINAL QBY=T,DCB=PG3270,RLN=1,TERM=327R,QUEUES=MO,
                                *
                                ADDR=6161C1C12D,NTBLKSZ=1856,SECTERM=YES
```

Figure 105. Example of a TCAM message control program (non-SNA) (Part 1 of 2)

```

S75A      TERMINAL QBY=T,DCB=PG3270,RLN=1,TERM=327R,QUEUES=MO,      *
          ADDR=E2E240402D,NTBLKSZ=1856
POLLST1   INVLIST ORDER=(TRM1+02)
POLLST2   INVLIST ORDER=(TRM2+02)
POLL70R   INVLIST ORDER=(T32C-C1C17F7F2D,S70A+C1C140402D,      *
          S70B+C1C1C1C12D,      *
          S75A+C2C27F7F2D,S75A+C2C240402D),      *
          EOT=37

*
TOTCAM    STARTMH LC=OUT                2260 MH
          INHDR                        PROCESS INCOMING MSG HEADER
          CODE
          FORWARD DEST=C'RIS1'
          INMSG                        PROCESS INCOMING COMPLETE MSG
          INEND                        END OF INCOMING SECTION
          OUTHDR                       PROCESS OUTGOING MSG HEADER
          OUTEND                       END OF OUTGOING SECTION

*
MH3270    STARTMH LC=OUT,CONV=YES,STOP=YES 3270 MH
          INHDR,                        PROCESS INCOMING MSG HEADER
          MSGTYPE X'6C'                 IS IT A STATUS MESSAGE
          B      SOH                    IF SO, BRANCH ROUND
          MSGTYPE                       ALL OTHER MSGS TO HERE
          MSGEDIT ((R,CONTRACT,SCAN,(2))),BLANK=NO REMOVE CUDV BYTES
SOH       EQU * or DS 0H
          CODE
          FORWARD DEST=C'R70I'
          INBUF                        INCOMING MSG SEGMENT SECTION
          INMSG                        SECTION FOR COMPLETE MSGS
          INEND                        END INCOMING SECTION
          OUTHDR
          SETSCAN 1
          MSGEDIT ((R,,SCAN))          REMOVE CCB
          MSGFORM                      SETS IN LINE CONTROL CHARS
          CODE
          OUTBUF,
          OUTMSG
          OUTEND                       END OUTPUT SECTION
TOCICS    STARTMH LC=OUT                MH FOR APPLICATION
          INHDR
          CODE                        TRANSLATE TO EBCDIC
          FORWARD DEST=PUT            WRITE TO CICS
          INEND
          OUTHDR
          OUTEND

DCBOFLGS  EQU      X'10'
          END

```

Figure 105. Example of a TCAM message control program (non-SNA) (Part 2 of 2)

Chapter 27. The dynamic allocation sample program

This chapter suggests ways in which you can customize the dynamic allocation sample application program, used to allocate or deallocate data sets dynamically. It is divided into the following sections:

1. “**Overview of the dynamic allocation program**”
2. “**Installing the program and transaction definitions**” on page 714
3. “**Terminal operation**” on page 714
4. “**Help feature**” on page 715
5. “**Values**” on page 715
6. “**The flow of control when a DYNALLOC request is issued**” on page 717.

Overview of the dynamic allocation program

The dynamic allocation (DYNALLOC) sample application program makes available to the CICS terminal operator most of the functions of DYNALLOC (SVC 99). These functions are described fully in the *MVS/ESA SPL: Application Development Guide*. Functions that require authorized program facility (APF) authorization are not supported.

The application consists of one command-level assembler-language program, DFH99, which is invoked by the transaction ADYN. The source code is provided in CICSTS13.CICS.SDFHSAMP.

Using DYNALLOC functions, the terminal operator can dynamically allocate or deallocate any data set that CICS can open and close. With suitable operating discipline and CEMT commands, these can include:

- Extrapartition transient data sets
- Journals
- Dump and trace data sets.

You should **not** use the dynamic allocation program to allocate and deallocate data sets that are to be associated with files managed by file control. You should use the dynamic allocation and deallocation facility which is part of CICS. If a file has not been allocated as part of CICS startup, CICS dynamic allocation occurs immediately before the file is opened, if sufficient information is in the file control table. The information needed is the data set name and disposition of the file. This information is set by the CEMT SET FILE master terminal transaction, described in the *CICS Supplied Transactions* manual, or the EXEC CICS INQUIRE FILE and EXEC CICS SET FILE commands, which provide additional inquiry and control facilities, and which are described in the *CICS System Programming Reference* manual.

To use the dynamic allocation sample program effectively, the terminal operator should:

- Have an understanding of MVS job control language, or TSO ALLOCATE and FREE commands.

the dynamic allocation sample program

- Have read the relevant sections of the *MVS/ESA SPL: Application Development Guide* and have that manual available for reference while using the sample program, in particular for looking up error and reason codes returned by DYNALLOC.

The application uses a 3270 display screen terminal, and adjusts its formatting to suit the screen size. BMS is not required. The program is designed so that the installation can easily modify the functions supported to suit installation standards.

Installing the program and transaction definitions

Transaction and program definitions for the dynamic allocation sample program are provided in the sample utilities group DFH\$UTIL on the CSD. These definitions are installed using the CEDA command:

```
CEDA INSTALL GROUP(DFH$UTIL)
```

Notes:

1. DFH99 **must** be defined with EXECKEY(CICS).
2. If you make any changes to the sample program, you must run the DFH99BLD procedure before using the ADYN transaction.

Terminal operation

When transaction ADYN is entered at a terminal, the operator is presented with a formatted display. The top part of the display is for entering commands, the bottom part for receiving messages from the program.

The operator types a command in TSO-like syntax, for example,

```
verb {keyword[{value...}]}...
```

and presses the ENTER key. The program checks the command for correct syntax, builds a DYNALLOC parameter list, and, if no serious errors are detected, issues a DYNALLOC SVC. Messages are then displayed to diagnose syntax errors, give the DYNALLOC return codes, and show any values returned by DYNALLOC information retrieval features. The command remains on the display, and the editing features of the terminal can be used to correct it for reentry, or to enter a different command.

If there are too many messages to fit into the message area of the screen, messages that cannot be displayed are queued, and the messages already on the screen are displayed with a brighter intensity to indicate that there are more messages to come. The operator can correct those errors that are being displayed, and reenter the command for further checking, when the queued messages, if any, are regenerated.

The program is terminated by entering a null command, which consists of pressing the ERASE INPUT key, followed by the ENTER key. PA keys 1 and 2 are ignored by the program. If you press the CLEAR key, you redisplay the last command entered. Pressing a program function key is equivalent to pressing ENTER.

Help feature

The program includes a limited “help” feature, driven by the program’s keyword table.

In response to “?”, the verb keywords are displayed. In response to “verb?”, all the operand keywords of that verb are displayed. For “verb operand(?)” a short description of the value expected for that operand is displayed. When a command containing “?” is entered, no DYNALLOC SVC is issued. “?” is recognized only in the positions specified above; the rest of the command is ignored.

Values

Values are classified as follows:

Keyword value

Keyword values must be specified for some keywords. For example, the STATUS keyword may have a keyword value of SHR, NEW, MOD, or OLD (which can be abbreviated).

String of key letters

The value can be a string of letters in any order. The program does not check that the combination of letters provided is meaningful. For example, for the RECFM keyword, the value can be a string of letters from A, B, D, F, G, M, R, S, T, U, and V.

Returned values

No value should be provided by the terminal operator, because this keyword requests a value to be returned by the DYNALLOC information retrieval features. The further description refers to the kind of value that will be returned. This is usually in the form in which the operator would enter it, although in a few cases the value is as a hexadecimal string.

Not allowed

Some keywords do not require a value, and you must not provide one.

Required

A value must be provided if the keyword coded is designated as requiring a value.

Optional

Specification of a value is optional for some keywords.

Single

Only one value may be provided for some keywords.

Multiple

For some keywords, more than one value is permitted. (In some cases, DYNALLOC requires more than one value, although the dynamic allocation sample program does not enforce this.)

Character string

Any characters are permitted in this type of value, although in most cases there will be additional rules to follow, for example, for the DSNNAME keyword.

Numeric string

Only numeric characters are allowed for this type of value, for example, for the EXPDT keyword.

keywords and values

Maximum and minimum lengths

For character and numeric values, the maximum and minimum lengths of the value are checked by the program. For a fixed-length string, these values are the same. The value is still passed to DYNALLOC as specified.

Convertible to n byte binary

A numeric value is required, of a magnitude representable in binary in the specified number of bytes. Values that are too large are truncated to the maximum possible for the width.

The dynamic allocation sample program does not support negative numbers. It does not cross-check operand keywords; errors of this type usually cause DYNALLOC to return error codes of the form 03xx.

Abbreviation rules for keywords

Keywords can be abbreviated. A word in the command matches a keyword if:

- The spelling is the same.
- The first letter is the same, and the remaining letters in the word appear in the same order as they do in the keyword.

If an ambiguity occurs, the program diagnoses the ambiguity, and lists the possible keywords.

System programming considerations

Keyword spellings are defined in the program's table, DFH99T, which is link-edited with the program. Where possible, these are the same as the corresponding job control or TSO keywords. Comments in the source code for DFH99T explain how the system programmer can:

- Change the spelling of keywords
- Define alternative spelling for keywords
- Divide the functions of a verb into subsets
- Add new verbs with subset function
- Add new operands as they become available in the SVC.

Member DFH99BLD in CICSTS13.CICS.SDFHINST is the job stream used to build the program. If part of the program has been modified, reassemble that part and link-edit the program again.

The macros IEFZB4D0 (DYNALLOC parameter list structure) and IEFZB4D2 (symbolic key equates), provided by MVS, are used in the dynamic allocation program and its keyword table. The meaning of each keyword in the table is defined in terms of a symbolic name, defined by one of the macros IEFZB4D0 or IEFZB4D2. The definitions of command keywords given in that manual should be regarded in preference to those from any other source. To obtain a list of command keywords and their symbolic values, for use as a cross-reference to the MVS manual, assemble DFH99T with option SYSPARM(LIST), and print the resulting object code. If the table is changed, repeat the assembly to obtain a new list.

The flow of control when a DYNALLOC request is issued

The flow in a normal invocation is as follows. The main program, DFH99M, receives control from CICS and carries out initialization. This includes determining the screen size, allocating input and output buffer sections, and issuing initial messages. It then invokes DFH99GI to get the input command from the terminal. Upon return, if the command was null, the main program terminates, issuing a final message.

The command obtained has its start and end addresses stored in the global communication area, COMM. The main program allocates storage for tokenized text, and calls DFH99TK to tokenize the command. If errors were detected at this stage, further analysis of the command is bypassed.

Following successful tokenizing, the main program calls DFH99FP to analyze the verb keyword. DFH99FP calls DFH99LK to look up the verb keyword in the table, DFH99T. DFH99LK calls DFH99MT if an abbreviation is possible. Upon finding the matching verb, DFH99FP puts the address of the operand section of the table into COMM, and puts the function code into the DYNALLOC request block.

The main program now calls DFH99KO to process the operand keywords. Each keyword in turn is looked up in the table by calling DFH99LK, and the value coded for the keyword is checked against the attributes in the table. DFH99KO then starts off a text unit with the appropriate code and, depending on the attributes the value should have, calls a conversion routine.

For character and numeric strings, DFH99CC is called. It validates the string, and puts its length and value into the text unit.

For binary variables, DFH99BC is called. It validates the value, converts it to binary of the required length, and puts its length and value into the text unit.

For keyword values, DFH99KC is called. It looks up the value in the description part of the keyword table using DFH99LK, and puts the coded equivalent value and its length into the text unit.

When a keyword specifying a returned value is encountered, DFH99KO makes an entry on the returned value chain, which is anchored in COMM. This addresses the keyword entry in DFH99T, the text unit where the value is returned, and the next entry. In this case the conversion routine is still called, but it only reserves storage in the text unit, setting the length to the maximum and the value to zeros.

When all the operand keywords have been processed, DFH99KO returns to the main program, which calls DFH99DY to issue the DYNALLOC request.

DFH99DY sets up the remaining parts of the parameter list and, if no errors too severe have been detected, a subtask is attached to issue the DYNALLOC SVC. A WAIT EVENT is then issued against the subtask termination ECB. When the subtask ends and CICS dispatches the program again, the DYNALLOC return code is captured from the subtask ECB and the error and reason codes from the DYNALLOC request block and a message is issued to give these values to the terminal.

DFH99DY then returns to the main program, which calls DFH99RP to process returned values. DFH99RP scans the returned value chain, and for each element issues a message containing the keyword and the value found in the text unit. If a

DYNALLOC flow of control

returned value corresponds to a keyword value, DFH99KR is called to look up the value in the description, and issue the message.

Processing of the command is now complete, and the main program is reinitialized for the next one, and loops back to the point where it calls DFH99GI.

Messages are issued at many places, using macros. The macro expansion ends with a call to DFH99MP, which ensures that a new line is started for each new message, and calls DFH99ML, the message editor. Input to the message editor is a list of tokens, and each one is picked up in turn and converted to displayable text. For each piece of text, DFH99TX is called, which inserts the text into the output buffer, starting a new line if necessary. This ensures that a word is never split over two lines.

At the end of processing the command, the main program calls DFH99MP with no parameters, which causes it to send the output buffer to the terminal, and initialize it to empty.

Part 7. Customizing CICS security processing

General notes

The following comments apply to the chapters in Part 7 of this book:

- The only aspects of CICS security processing covered are:
 - Invoking a user-written external security manager
 - Writing a “good night” transaction.

For a comprehensive view of security processing using the Resource Access Control Facility (RACF) product, see the *CICS RACF Security Guide*.

- Upon return from any customer-written program, CICS must always receive control in primary-space translation mode, with the original contents of all access registers restored, and with all general-purpose registers restored (except for those which provide return codes or linkage information).

For information about translation modes, refer to the *IBM ESA/370 Principles of Operation* manual.

Chapter 28. Invoking a user-written external security manager

CICS provides an interface to an external security manager (ESM), which may be user-written or may be the Resource Access Control Facility (RACF) program product. This chapter gives an overview of the CICS-ESM interface, and describes how you can use the MVS router exit to pass control to a user-written ESM. It describes how ESM exit programs can access CICS-related information. Finally, it lists the control points at which CICS invokes the ESM.

Note that this chapter is intended primarily for non-RACF users. For definitive information about security processing using RACF, you should refer to the *CICS RACF Security Guide*.

The chapter is divided into the following sections:

1. “**An overview of the CICS-ESM interface**”
2. “**The MVS router**”
3. “**How ESM exit programs access CICS-related information**” on page 724
4. “**CICS security control points**” on page 727
5. “**Early verification processing**” on page 729.

An overview of the CICS-ESM interface

CICS security uses, via the RACROUTE macro, the MVS system authorization facility (SAF) interface to route authorization requests to the ESM. Normally, if RACF is present, the MVS router passes control to it. However, you can modify the action of the MVS router by invoking the router exit. The router exit can be used, for example, to pass control to a user-written or vendor-supplied ESM. (If you want to use your own security manager, you **must** supply an MVS router exit routine.)

The control points at which CICS issues a RACROUTE macro to route authorization requests are described in “CICS security control points” on page 727.

The MVS router

SAF provides your installation with centralized control over security processing, by using a system service called the MVS router. The MVS router provides a common system interface for all products providing resource control. The resource-managing components and subsystems (such as CICS) call the MVS router as part of certain decision-making functions in their processing, such as access control checking and authorization-related checking. These functions are called **control points**. This single SAF interface encourages the use of common control functions shared across products and across systems.

If RACF is available in the system, the MVS router may pass control to the RACF router, which in turn invokes the appropriate RACF function. (The parameter information and the RACF router table, which associates router invocations with RACF functions, determine the appropriate function.) However, before calling the RACF router, the MVS router calls an optional, installation-supplied security-processing exit, if one has been installed.

the MVS router

The MVS router exit

The MVS router provides an optional installation exit that is invoked whether or not RACF is installed and active on the system. If your installation does not use RACF, you can use the router exit to pass control to your own ESM. If you do use RACF, you could use the exit for preprocessing before RACF is invoked.

The MVS router exit routine is invoked whenever CICS (or another component of your system) issues a RACROUTE macro. The router passes a parameter list (generated by the RACROUTE macro) to the exit routine. In addition, the exit receives the address of a 150-byte work area.

On entry to the exit routine, register 1 contains the address of the area described in Table 34.

Table 34. Area addressed by register 1, on entry to exit routine

Offset	Length	Description
0	4	Parameter list address: points to the MVS router parameter list. (See “The MVS router parameter list”.)
4	4	Work area address: points to a 150-byte work area that the exit can use.

The exit must be named ICHRTX00 and must be located in the link pack area (LPA).

Note: During signon processing, CICS Transaction Server for OS/390 Release 3 issues the RACROUTE REQUEST=VERIFY macro with the ENVIR=VERIFY option, in problem-program state. (For an explanation of why CICS does this, see “Early verification processing” on page 729.) RACF requires RACROUTE calls with the ACEE option to be issued in supervisor state. Therefore, if you use an ICHRTX00 exit that intercepts CICS RACROUTE calls, and replaces them with its own RACROUTE requests, your exit program should not assume that a REQUEST=VERIFY call was made in supervisor state.

When intercepting a REQUEST=VERIFY call, your exit program should check the settings of the two high-order bits of the byte at offset 3 in the RACINIT parameter list. If ENVIR=VERIFY was specified on the call (as in CICS early verification), these bits are both set on. If this is the case, your exit program should not issue any further RACROUTE macros. To do so could cause abends in RACF.

The MVS router parameter list

The MVS router parameter list is generated when the RACROUTE macro is issued, and describes the security processing request by providing the request type. If the router exit routine exists, the router passes the parameter list to this exit. (If it does not exist, and if RACF is active, the router passes the parameter list to the RACF router.)

You can map the MVS router parameter list using the ICHSAFP macro. Its format is shown in the *OS/390 Security Server External Security Interface (RACROUTE) Macro Reference* manual.

Router exit return codes

Your exit routine must return a return code in register 15. The hexadecimal values of the return code are shown in Table 35.

Table 35. MVS router exit return codes

Code	Meaning
0	The exit has completed successfully. Control proceeds to the RACF front-end routine for further security processing and an invocation of RACF.
C8	The exit has completed successfully. The MVS router translates this return code to a router return code of '0' and returns control to the issuer of the RACROUTE macro (CICS), bypassing RACF processing. (See the next section.)
CC	The exit has completed successfully. The MVS router translates this return code to a router return code of '4' and returns control to CICS, bypassing RACF processing. (See the next section.)
D0	The exit has completed successfully. The MVS router translates this return code to a router return code of '8' and returns control to CICS, bypassing RACF processing. (See the next section.)
Other	If the exit routine sets any return code other than those described above, the MVS router returns control directly to CICS and passes the untranslated code as the router return code. Further RACF processing is bypassed.

Passing control to a user-supplied ESM

Normally, a caller (such as CICS) invokes the MVS router and passes it request type, requester, and subsystem parameters via the RACROUTE exit parameter list. Using these parameters, the MVS router calls the router exit which, on completing its processing, passes a return code to the router. If the return code is '0', as defined above, the router invokes RACF. RACF reports the result of that invocation to the router by entering return and reason codes in register 15 and register 0 respectively. The router converts the RACF return and reason codes to router return and reason codes and passes them to the caller. The router provides additional information to the caller by placing the unconverted RACF return and reason codes in the first and second words of the router input parameter list.

If your installation does not use RACF, you can make the MVS router exit pass control to an alternative ESM. However, if you do so you must still provide CICS with the RACF return and reason codes that it expects to receive. You set the router exit return code, as defined in Table 35, so that RACF is not invoked; and you **simulate** the results of a RACF invocation by coding the exit so that it places the RACF return and reason codes in the first and second fullwords of the router input parameter list. RACF return and reason codes are documented in the *MVS Authorized Assembler Programming Reference* manual.

Note: Remember that it is possible for a subsystem other than CICS to call the MVS router by issuing a RACROUTE macro. (Application programs too, may issue RACROUTE macros directly.) Your router exit program can establish whether the caller is CICS by checking the “eyecatcher” fields (UXPARROW, UXPDFHXS, and UXPLKID) in the installation data parameter list—see “The installation data parameter list” on page 725.

How ESM exit programs access CICS-related information

When CICS invokes the ESM, it passes information about the current CICS environment, for use by an ESM exit program, in an **installation data parameter list**. How your exit programs access the installation data parameter list depends on whether or not your ESM is RACF.

For non-RACF users — the ESM parameter list

CICS (or another caller) passes information to your external security manager in the ESM parameter list, the address of which can be calculated using field SAFPRACP of the MVS router parameter list.

When the caller is CICS, the “INSTLN” field of the ESM parameter list points to the installation data parameter list, which contains CICS-related information that can be used by ESM exit programs.

The format of the ESM parameter list, and the actual name of the “INSTLN” field, vary, depending on which CICS security event is being processed. (The “request type” field (SAFPREQT) of the router parameter list shows why the ESM is being called by indicating the RACROUTE REQUEST type.) Table 36 shows how some formats of the ESM parameter list can be mapped using MVS macros.

Table 36. Mapping the ESM parameter list

RACROUTE REQUEST type	Parameter list mapping macro	INSTLN field name
VERIFY	IRRPRIPL	INITIPTR (X'10')
AUTH	ICHACHKL	ACHKIN31 (X'20')
FASTAUTH	Not available	Offset X'18'
LIST	Not available	Offset X'0C'
EXTRACT	Not available	None

Note: The INSTLN field points to the installation parameter list only if you specify INSTLN on the ESMEXITS system initialization parameter. The default value of this parameter is NOINSTLN, which means that no installation data is passed.

For RACF users — the RACF user exit parameter list

If you are a RACF user, you can find the address of the installation data parameter list directly from the RACF user exit parameter list. The name of the relevant field in the user exit parameter list varies according to the RACROUTE REQUEST type and the RACF user exit that is invoked. The relationships between REQUEST type, exit name, and field name are shown in Table 37 on page 725.

Table 37. Obtaining the address of the installation data parameter list

RACROUTE REQUEST type	RACF exit	Exit list mapping macro	Parameter list field name
VERIFY	ICHRIX01	ICHRIXP	RIXINSTL
	ICHRIX02	ICHRIXP	RIXINSTL
AUTH	ICHRCX01	ICHRCXP	RCXINSTL
	ICHRCX02	ICHRCXP	RCXINSTL
FASTAUTH	ICHRFX01	ICHRFXP	RFXANSTL
	ICHRFX02	ICHRFXP	RFXANSTL
LIST	ICHRLX01	ICHRLX1P	RLX1INST
	ICHRLX02	ICHRLX2P	RLX2PRPA See note 2.
EXTRACT	Not available	Not available	None

Notes:

1. The “xxxINSTL” field points to the installation parameter list only if you specify INSTLN on the ESMEXITS system initialization parameter. The default value of this parameter is NOINSTLN, which means that no installation data is passed.
2. RLX2PRPA contains the address of the ICHRLX01 user exit parameter list (RLX1P). Field RLX1INST of RLX1P in turn points to the installation data parameter list.

For full descriptions of the RACF exit parameter lists, see the *OS/390 Security Server (RACF) Security Administrator's Guide* manual. For more information about CICS security processing using RACF, see the *CICS RACF Security Guide*.

The installation data parameter list

The installation data parameter list gives your ESM exit programs access to the following information:

- The CICS security event being processed.
- Details of the current CICS environment. That is:
 - The applid of the CICS region
 - The common work area (CWA)
 - The transaction being invoked
 - The program being executed
 - The CICS terminal identifier
 - The VTAM LU name
 - The terminal user area.

You can map the installation parameter list using the macro DFHXSUXP. The DSECT DFHXSUXP contains the following fields:

UXPLEN

A halfword containing the length of this parameter list in bytes.

UXPARROW

Arrow “eyecatcher” (>).

UXPDFHXS

The name of the owning component (DFHXS).

ESM exit programs

UXPBLKID

The name of the block identifier (UXPARMS).

UXPPHASE

Address of a 1-byte code that indicates the reason for the call to the ESM (that is, the security event being processed). The code can have one of the following values:

DEFAULT_SIGN_ON (X'01')

Signon of default userid

PRESET_SIGN_ON (X'02')

Signon of preset security terminal

IRC_SIGN_ON (X'03')

Link signon for IRC (MRO) links

LU61_SIGN_ON (X'04')

Link signon for LUTYPE6.1 links

LU62_SIGN_ON (X'05')

Link signon for APPC links

XRF_SIGN_ON (X'06')

XRF tracking of signon

ATTACH_SIGN_ON (X'07')

Attach-time signon of link user

USER_SIGN_ON (X'10')

Normal user signon

DELETE_SIGN_OFF (X'22')

Sign-off when terminal deleted

LINK_SIGN_OFF (X'25')

Sign-off when link is closed

XRF_SIGN_OFF (X'26')

XRF tracking of sign-off

ATTACH_SIGN_OFF (X'27')

End-of-task sign-off of link user

USER_SIGN_OFF (X'30')

Normal user sign-off

ABNORMAL_SIGN_OFF (X'31')

Sign-off forced by the terminal abnormal condition program, or time-out by the CSSC transaction

USER_ATTACH_CHECK (X'40')

Transaction attach check for user

LINK_ATTACH_CHECK (X'41')

Transaction attach check for link

EDF_ATTACH_CHECK (X'42')

Transaction attach check for CEDF

USER_COMMAND_CHECK (X'50')

Command checking for user

LINK_COMMAND_CHECK (X'51')

Command checking for link

USER_RESOURCE_CHECK (X'60')

Resource checking for user

LINK_RESOURCE_CHECK (X'61')

Resource checking for link

USER_QUERY_CHECK (X'70')

Query checking for user

LINK_QUERY_CHECK (X'71')

Query checking for link

INITIALIZE_SECURITY (X'80')

Initialization of CICS security

REBUILD_SECURITY (X'81')

CEMT or command-level SECURITY REBUILD

XRF_TRACK_INITIALIZE (X'82')

XRF tracking of initial or rebuild.

UXPSUBSY

Address of an area containing the CICS subsystem identifier.

UXPAPPL

Address of an area containing the CICS application ID.

UXPCWA

Address of the Common Work Area.

UXPTRAN

Address of an area containing the transaction identifier.

UXPPROG

Address of an area containing the program name. The address may be zero if no program name can be identified.

UXPTERM

Address of an area containing the terminal identifier. The address may be zero if no terminal is associated with the request.

UXPLUNAM

Address of an area containing the VTAM LU name. The address may be zero if no terminal is associated with the request, or the area may be blank if the terminal is not a VTAM terminal.

UXPTCTUA

Address of the TCT user area.

UXPTCTUL

Address of a fullword containing the length of the TCTUA.

UXPCOMM

Address of a 2-word communication area.

CICS security control points

The following list summarizes the RACROUTE macros used by CICS to invoke the ESM, and the control points at which they are issued.

RACROUTE

The “front end” to the macros described below, it invokes the MVS router. If RACF is not present on the system, RACROUTE can route to an alternative ESM, via the MVS router exit.

CICS security control points

RACROUTE REQUEST=VERIFY

Issued at operator signon (with the parameter ENVIR=CREATE), and at sign-off (with the parameter ENVIR=DELETE). This macro creates or destroys an access control environment element (ACEE). It is issued at the following CICS control points:

- Normal signon through EXEC CICS SIGNON
- Signon of the default userid DFLTUSER
- Signon of preset security terminals
- Signon of MRO sessions
- Signon of LUTYPE6.1 sessions
- Signon of APPC sessions
- Signon for XRF tracking of the above
- Signon of the userid on attach requests (for all values of ATTACHSEC except LOCAL)
- Normal sign-off through EXEC CICS SIGNOFF
- Sign-off when deleting a terminal
- Sign-off when TIMEOUT expires
- Sign-off of MRO sessions
- Sign-off of LUTYPE6.1 sessions
- Sign-off of APPC sessions
- Sign-off for XRF tracking of the above
- Sign-off of the userid on attach requests (for all values of ATTACHSEC except LOCAL).

RACROUTE REQUEST=VERIFYX

This creates or deletes an ACEE in a single call. It is issued at the following CICS control points:

- Signon, as an alternative to VERIFY, when an optimized signon is performed for subsequent signons across an LU6.2 link with ATTACHSEC(VERIFY).
- When an invalid password, or a passticket is presented, or an EXEC CICS VERIFY PASSWORD command is issued.

RACROUTE REQUEST=FASTAUTH

Issued during resource checking, on behalf of a user who is identified by an ACEE. It is the high-performance form of REQUEST=AUTH, using in-storage resource profiles, and is issued at the following CICS control points:

- When attaching local transactions
- When checking link security for transaction attach
- Transaction validation for MRO tasks
- CICS resource checking
- Link security check for a CICS resource
- Transaction validation for EDF
- Transaction validation for the transaction being tested (by EDF)
- DBCTL PSB scheduling resource security check
- DBCTL PSB scheduling link security check
- Remote DL/I PSB scheduling resource check
- QUERY SECURITY with the RESTYPE option.

RACROUTE REQUEST=AUTH

This is a higher path length form of resource checking. It is used:

- After a call to FASTAUTH indicates an access failure that requires logging.
- When a QUERY SECURITY request with the RESCLASS option is used. This indicates a request for a resource for which CICS has not built in-storage profiles. (If CICS **has** in fact built in-storage profiles, REQUEST=AUTH uses them.)

RACROUTE REQUEST=LIST

Issued to create and delete the in-storage profile lists needed by REQUEST=FASTAUTH. (One REQUEST=LIST macro is required for each resource class.) It is issued at the following CICS control points:

When CICS security is being initialized

When an EXEC CICS REBUILD SECURITY is issued

When XRF tracks either of these events.

RACROUTE REQUEST=EXTRACT

Issued (with the parameters SEGMENT=SESSION,CLASS=APPCLU) during verification of APPC BIND security, at the following CICS control point:

BIND of APPC sessions.

It is also issued (with the parameters SEGMENT=CICS,CLASS=USER) during signon, at all the control points listed under RACROUTE REQUEST=VERIFY.

For a detailed description of these macros, see the *OS/390 Security Server External Security Interface (RACROUTE) Macro Reference* manual.

Early verification processing

The CICS signon routine invokes the SAF interface, using the RACROUTE REQUEST=VERIFY macro with the ENVIR=VERIFY option in problem-program state. Invoking this version of the macro has no effect if the ESM is RACF, but other external security manager products can get control through the SAF exit interface, and perform their own **early verification** routine.

CICS defers the creation of the accessor environment element until the RACROUTE REQUEST=VERIFY macro with the ENVIR=CREATE option is issued to perform the **normal verification** routine. The ENVIR=CREATE version of the macro is issued by the security manager domain running in supervisor state.

CICS passes the following information on the ENVIR=VERIFY version of the RACROUTE REQUEST=VERIFY macro:

USERID

The userid of the user signing on to the CICS region.

GROUP

The group name, if specified, of the group into which the user wants to sign on.

PASSWRD

The user's password to verify the userid.

NEWPASS

A new value, if specified, for the user's password. This changes the existing password and is to be used for subsequent signons.

OIDCARD

The contents, if supplied, of an operator identification card.

early verification processing

APPL

The APPLID of the CICS region on which the user is signing on. Which APPLID is passed depends on what is specified as system initialization parameters.

INSTLN

A pointer to a vector of CICS-related information, which you can map using the DFHXSUXP mapping macro. This pointer is valid only if ESMEXITS=INSTLN is specified as a system initialization parameter for the CICS region.

The installation data referenced by the INSTLN parameter includes a pointer, UXPCOMM, to a two-word communications area that can be used to pass information between the two phases of the signon verification process—between the early verification routine initiated by ENVIR=VERIFY, and the normal verification routine initiated by ENVIR=CREATE.

CICS maintains a separate communications area for each task, in CICS-key storage.

Writing an early verification routine

An early verification routine, written for the ENVIR=VERIFY option, receives control from SAF in the usual way from the external security manager whose entry point is addressed by field SAFVRACR in the SAF vector table. It receives control in the same state as its caller, as follows:

- Problem-program state
- Task mode (usually the CICS quasi-reentrant TCB)
- PSW storage key 8
- 31-bit addressing mode
- Primary address translation mode.

Register 13 points to a standard 18-word save area. Register 1 points to a 2-word parameter list, where:

- The first word is the address of the SAF parameter list for the VERIFY function.
- The second word is the address of a 152-byte work area.

Using CICS API commands in an early verification routine

An early verification routine can use CICS application programming interface (API) commands, provided it obeys the following interface rules:

- The routine must be written in assembler.
- Entry to the routine must be via the DFHEIENT macro, which saves the caller's registers and establishes a CICS early verification API environment.
- Exit from the routine must be via the DFHEIRET macro, which releases the CICS early verification API environment and restores the caller's registers.
- The routine *must* be link-edited with the special security domain API stub, DFHXSEAI, *instead of* the normal CICS API stub, DFHEAI0. The CICS early verification stub causes linkage to a special interface routine that is aware of the SAF interface linkage requirements, and saves the current CICS command environment. In addition, the standard EXEC interface stub DFHEAI should also be included, immediately before the early verification routine, with an ORDER statement:

```
INCLUDE SYSLIB(DFHXSEAI)
INCLUDE SYSLIB(DFHEAI)
ORDER DFHEAI,verify-program,DFHEAI0
ENTRY verify-program
```

The DFHEIENT and DFHEIRET macros are inserted by the CICS translator unless you specify

```
*ASM XOPTS(NOPROLOG,NOEPILOG)
```

as the first statement of the program. The DFHEIENT macro assumes that register 15 points to its first executable instruction.

Upon return from the DFHEIENT macro, a CICS storage area mapped by the DFHEISTG macro has been established. The pointer DFHEIBP (and the register specified in the EIBREG parameter of DFHEIENT) contains the address of an EXEC interface block (EIB). DFHEICAP contains the pointer to the original parameter list supplied by the SAF interface.

Return and reason codes from the early verification routine

Before returning control, the early verification routine should set a return code and reason code in fields SAFPRRET and SAFPRREA of the SAF parameter list. It should also pass a value to be returned as the SAF return code in a register that is specified in the RCREG keyword of the DFHEIRET macro that is used to exit the program. These return codes are examined by the CICS signon function, and any non-zero value in SAFPRRET is interpreted as a verification failure and causes the signon to fail. A zero return code allows the signon to proceed, and eventually CICS issues a RACROUTE REQUEST=VERIFY,ENVIR=CREATE macro in supervisor state and under control of the CICS resource-owning TCB. It is only at this invocation that CICS accepts an ACEE address from the external security manager.

Chapter 29. Writing a “good night” program

You can use the GNTRAN system initialization parameter to specify a “good night” transaction that you want CICS to invoke when a user’s terminal-timeout period expires. The default value for GNTRAN is 'NO', which means that CICS does not schedule a “good night” transaction, but instead tries to sign off the terminal user. (Whether or not the sign off is successful depends on the value of the SIGNOFF attribute on the terminal’s TYPETERM definition.)

Notes:

1. Any transaction that you specify on the GNTRAN parameter must be able to handle the type of communication area it is passed when terminal timeout occurs. The CICS sign-off transaction, CESF, can do this, but CESN and all other CICS-supplied transactions cannot.
2. GNTRAN=NO must be specified if TCAM terminals are being used and users’ terminal-timeout values are specified in their RACF profiles.

For further information about GNTRAN, see the *CICS System Definition Guide*.

Writing your own “good night” program allows you to include functions in addition to, or instead of, sign-off. For example, your program could prompt the terminal user to enter their password, and allow the session to continue if the correct response is received. CICS supplies a sample “good night” program, DFH0GNIT, that demonstrates this, and a sample transaction definition, GNIT, that points to DFH0GNIT.

CICS passes the “good night” program a parameter list in the communications area shown in Figure 106 on page 734. If a terminal times out during a pseudoconversational transaction, your program could, using information in the parameter list:

- Ask for and check a response from the user
- Restore the screen left by the timed-out transaction
- Restore the cursor position
- Receive the communications area of the timed-out transaction, which is passed to the “good night” transaction as an input message
- Return with the TRANSID of the next transaction in the conversation.

writing a good night program

DFHSNGS				
DFHSNGS_FIXED	DS	0CL64		Fixed part of parameter list
GNTRAN_START_TRANSID	DS	CL4		TRANSID that invoked GNTRAN
GNTRAN_PSEUDO_CONV_FLAG	DS	CL1		Pseudoconversational flag
GNTRAN_SCREEN_TRUNCATED	DS	CL1		Screen buffer truncation flag
GNTRAN_TRANSLATE_TIOA	DS	CL1		Uppercase translation flag
	DS	CL9		Reserved
GNTRAN_TIMEOUT_TIME	DS	CL8		Time of terminal timeout
GNTRAN_TIMEOUT_REASON	DS	CL1		Reason for timeout
	DS	CL11		Reserved
GNTRAN_PSEUDO_CONV_TRANSID	DS	CL4		Next transaction ID
GNTRAN_SCREEN_LENGTH	DS	FL2		Length of screen buffer
GNTRAN_CURSOR_POSITION	DS	FL2		Cursor position
GNTRAN_SCREEN_WIDTH	DS	FL2		Width of screen
GNTRAN_SCREEN_HEIGHT	DS	FL2		Height of screen
GNTRAN_USER_FIELD	DS	CL16		Available to user program
DFHSNGS_VARIABLE	DS	0X		Variable part of parameter list
GNTRAN_SCREEN_BUFFER	DS	0X		Contents of screen buffer

Figure 106. Communications area passed to the “good night” program (assembler)

GNTRAN_START_TRANSID

The identifier of the transaction that started the “good night” transaction. If it was started by CICS because of a terminal timeout, GNTRAN_START_TRANSID is set to 'CEGN'. Your program should examine this field to check that timeout processing is appropriate (that is, that the “good night” transaction was started because of a terminal timeout and for no other reason).

GNTRAN_PSEUDO_CONV_FLAG

A flag indicating whether the terminal timed out during a pseudoconversational transaction.

- Y** The terminal timed out between transactions that form part of a pseudoconversational application.
- N** The terminal did not time out between transactions that form part of a pseudoconversational application.

GNTRAN_SCREEN_TRUNCATED

A flag indicating whether the 3270 screen buffer had to be truncated.

- Y** The screen buffer was truncated.
- N** The screen buffer was not truncated.

GNTRAN_TRANSLATE_TIOA

An internal flag indicating whether DFHVSUP is to translate the TIOA to uppercase, if required by the TYPETERM or PROFILE setting:

- Y** The TIOA is to be translated.
- N** Uppercase translation is to be bypassed.

GNTRAN_TIMEOUT_TIME

The time that the terminal timed out, in CICS ABSTIME format.

GNTRAN_TIMEOUT_REASON

The reason for the timeout:

- T** No input from the terminal
- X** An XRF takeover.

GNTRAN_PSEUDO_CONV_TRANSID

The identifier of the next transaction, if the terminal timed out during a pseudoconversational sequence. (If the terminal did *not* time out during a pseudoconversational sequence, the value of this field is meaningless.)

GNTRAN_SCREEN_LENGTH

The length of the screen buffer.

GNTRAN_CURSOR_POSITION

The cursor position.

GNTRAN_SCREEN_WIDTH

The width of the screen in use when the terminal timed out.

GNTRAN_SCREEN_HEIGHT

The height of the screen in use when the terminal timed out.

You can use `GNTRAN_SCREEN_WIDTH` and `GNTRAN_SCREEN_HEIGHT` to decide whether to use the `ERASE DEFAULT` or `ERASE ALTERNATE` option when restoring the user's screen.

GNTRAN_USER_FIELD

This field is available for use by your “good night” user program. It is initialized to binary zeroes and is not changed by CICS. You can use it to help develop a pseudoconversational “good night” transaction.

GNTRAN_SCREEN_BUFFER

A variable length field containing the contents of the screen buffer.

The sample “good night” program, DFH0GNIT

The sample “good night” program is a pseudoconversational COBOL program named DFH0GNIT. Copy books of the communications area passed to the “good night” program are supplied in assembler language, COBOL, PL/I, and C/370. The names of the supplied program, copy books, and mapset, and the CICSTS13.CICS libraries in which they can be found, are summarized in Table 38.

Table 38. Sample “good night” program, copy books, and mapset

Language	Member name	Library
Program source:		
COBOL only	DFH0GNIT	SDFHSAMP
Copy books:		
Assembler	DFHSNGSD	SDFHMAC
COBOL	DFHSNGSO	SDFHCOB
PL/I	DFHSNGSL	SDFHPL1
C/370	DFHSNGSH	SDFHC370
Mapset:		
	DFH\$GMAP	SDFHSAMP

sample good night program

What the sample program does

The DFH0GNIT sample program:

1. Checks that it has been invoked for a terminal timeout, by testing the GNTRAN_START_TRANSID field of the communications area passed by CICS. If this contains anything other than 'CEGN', it quits.
2. If a flag within GNTRAN_USER_FIELD shows that this is the first invocation for this timeout:
 - a. If GNTRAN_PSEUDO_CONV_FLAG indicates that the terminal timed out during a pseudoconversation, issues EXEC CICS RECEIVE to retrieve the communications area.
 - b. Saves the length of the communications area in another field within GNTRAN_USER_FIELD.
 - c. Writes the communication area, if any, to a temporary storage queue.
 - d. Displays a screen asking the user to input his or her password, and sets the flag indicating that this has been done.
 - e. Issues EXEC CICS RETURN with TRANSID GNIT and the COMMAREA option, to continue the timeout process as a pseudoconversation.
3. If this is **not** the first invocation for this timeout:
 - a. Recovers the original communication area, if any, from the temporary storage queue.
 - b. Checks the password received from the user, and redisplay the timeout screen with an error message if it is incorrect.
4. If the number of incorrect responses exceeds the maximum specified to your external security manager, DFH0GNIT returns immediately with TRANSID CESF, which tries to sign off the userid.
5. If the correct password is entered, DFH0GNIT:
 - Restores the screen contents
 - Restores the cursor position.

If the terminal timed out during a pseudoconversational transaction, DFH0GNIT also:

- Restores the communications area of the timed-out transaction
- Returns with the TRANSID of the next transaction in the interrupted conversation.

Customizing the sample program

You can write your “good night” program in any of the languages supported by CICS, with full access to the CICS application and system programming interfaces.

If you customize the supplied program, or write your own “good night” program, note the following:

- Like the sample, your program should be pseudoconversational, because it could be invoked simultaneously for many users (if, for example, many terminals time out during the lunch period). If your program is conversational, CICS maximum number of tasks (MXT) could quickly be reached.

When you are continuing your timeout program’s pseudoconversation, always specify the name of your “good night” transaction (for example, GNIT) as the next TRANSID. If you do not, CICS does not know that you are still handling the timeout, and results may be unpredictable.

sample good night program

- Your program should always start, like the sample program, by testing the GNTRAN_START_TRANSID field of the communications area passed by CICS. If it finds that the “good night” transaction was started for any reason other than a terminal timeout (for example, by an EXEC CICS START request), timeout processing may not be appropriate.
- To obtain the communications area of the timed-out transaction in a pseudoconversation, your program must issue an EXEC CICS RECEIVE command. (The communication area passed to it on invocation is **not** that of the timed-out transaction, but contains information about the timed-out transaction.)
- If your program tries to sign off the terminal user, the result depends on what is specified on the SIGNOFF option of the terminal’s TYPETERM definition:

YES The terminal is signed off, but not logged off.

NO The terminal remains logged on and signed on.

LOGOFF

 The terminal is both signed off and logged off.

- Specify the identifier (TRANSID) of your “good night” transaction on the GNTRAN system initialization parameter.

If you have customized the sample program, DFH0GNIT, specify the supplied sample transaction definition, GNIT.

If you have written your own “good night” program, named something other than DFH0GNIT, you must create and install a transaction definition that points to your program, and specify this definition on the GNTRAN SIT parameter.

sample good night program

Part 8. Examining and modifying resource attributes

A general note about user-written programs

The following comment applies to all user-written programs mentioned in Part 8 of this book:

- Upon return from any customer-written program, CICS must always receive control in primary-space translation mode, with the original contents of all access registers restored, and with all general purpose registers restored (except for those which provide return codes or linkage information).

For information about translation modes, refer to the *IBM ESA/370 Principles of Operation* manual.

Chapter 30. User programs for the system definition utility program (DFHCSDUP)

This chapter tells you how to write programs for use with the CICS system definition utility program (DFHCSDUP). It is divided into the following sections:

1. **“An overview of DFHCSDUP”** contains background information.
2. **“DFHCSDUP as a batch program”** on page 742 describes the DFHCSDUP EXTRACT command, and tells you how to write a user program to be invoked from DFHCSDUP.
3. **“Invoking DFHCSDUP from a user program”** on page 751 tells you how to write a program from which DFHCSDUP itself can be invoked.

An overview of DFHCSDUP

The CICS system definition utility program (DFHCSDUP) is a component of resource definition online (RDO). DFHCSDUP is an offline utility program that allows you to read from and write to a CICS system definition (CSD) file, either while CICS is running or while it is inactive.

Using DFHCSDUP, you can do the following:

- Add a group to the end of a named list in a CSD file
- Alter the definition of a single resource, on the CSD
- Append a group list from one CSD file to a group list in another, or in the same, CSD file
- Copy all of the resource definitions in one group to another group in the same, or in a different, CSD file
- Define a single resource, or a group of resources, on the CSD
- Delete from the CSD a single resource definition, all of the resource definitions in a group, or all of the group names in a list
- Extract requested data from the CSD and pass it to a named user program for processing
- Initialize a new CSD file, and add to it the CICS-supplied resource definitions
- List selected resource definitions, groups, and lists
- Migrate the contents of a table from a CICS load library to a CSD file
- Process an APAR—that is, apply maintenance for a specific APAR to the CSD
- Remove a single group from a list on the CSD file
- Scan all IBM-supplied and user-defined groups for a resource
- Service a CSD file when necessary
- Upgrade the CICS-supplied resource definitions in a primary CSD file for a new release of CICS
- Verify a CSD file by removing internal locks on groups and lists.

You can invoke DFHCSDUP in two ways:

- As a batch program. The next section refers to this method.
- From a user program running either in batch mode or in a TSO environment. “Invoking DFHCSDUP from a user program” on page 751 describes this method.

user programs for DFHCSDUP

DFHCSDUP as a part of the resource definition process is described in the *CICS Resource Definition Guide*. Guidance information about the execution JCL for DFHCSDUP, and the formats of the DFHCSDUP commands, are given in the *CICS Operations and Utilities Guide*.

DFHCSDUP as a batch program

This section refers to DFHCSDUP as a batch program. It describes the DFHCSDUP EXTRACT command, and the three sample programs that can be invoked during EXTRACT processing.

Writing a program to be invoked during EXTRACT processing

The DFHCSDUP LIST command produces reports about the current status of the CSD file that vary only according to the input parameters you provide. Another DFHCSDUP command, EXTRACT, causes the CSD data you select to be passed unformatted to a user program. The user program can then create reports of the CSD data that meet local requirements. For example, you could cross-refer related definitions (such as TERMINALs and TYPETERMs), or you could sort the data by attribute values, such as security keys or processing priorities. The user program could also write the requested resource attributes to a data set to be used as input to a database product, such as SQL, DB2, or the Data Extract program product.

The user program must be linked RMODE(24), AMODE(24). It receives control in 24-bit primary-space translation mode. (For information about translation modes, see the *IBM ESA/370 Principles of Operation* manual.) The contents of the access registers are unpredictable. The program must return control in 24-bit primary-space translation mode, and it must restore any access registers that it modifies (in addition to restoring the general purpose registers).

There are three sample programs that can be invoked from DFHCSDUP during EXTRACT processing. The sample programs, and how to replace them with your own versions, are described on page 744.

The EXTRACT command

The EXTRACT command takes requested data from the CSD and passes it to a user program for processing. The command has the following format:

```
EXTRACT {GROUP(name)|LIST(name)} USERPROGRAM(name) [OBJECTS]
```

GROUP

selects only those resource definitions within the named group. You can specify a generic group name, as on the DFHCSDUP LIST command.

LIST

selects only those resource definitions within the groups contained in the named list. You can specify a generic list name only if you do not specify the OBJECTS option.

OBJECTS

returns the detail of each resource definition. You can extract resource definition data at two levels of detail:

1. If you omit the OBJECTS option, the command extracts one of the following:

DFHCSDUP as a batch program

- The names of all the resource definitions within the specified group
 - The names of all the groups within the specified list.
2. If you specify the OBJECTS option, all the attributes of the resource definitions are also extracted.

USERPROGRAM

is the name of the user-written program that is to process the data retrieved by the EXTRACT command. You must supply a USERPROGRAM value.

When the user program is invoked

The user program can be invoked at nine different points during the processing of the EXTRACT command by DFHCSDUP. However, your program is invoked at all of these points only if you specify both LIST and OBJECTS on the EXTRACT command. The invocation points are as follows:

1. At the beginning of EXTRACT processing. This is to allow for activities such as file opening and storage acquisition.
2. At the beginning of LIST processing, but only if you have specified a LIST value on the EXTRACT command.
3. At the start of every group being processed by the EXTRACT command.
4. At the start of each object (that is, resource type—TERMINAL, PROGRAM, and so on) that is being processed, to allow for selection on an object or group basis.

Note: If you have specified LIST but not OBJECTS on the EXTRACT command, this invocation does not occur.

5. For every keyword (attribute) in the extracted object, but only if you have specified OBJECTS on the EXTRACT command. This is to allow for the detailed processing that may be necessary for cross-referencing.
6. At the end of every object—that is, when all of the keywords within an object have been processed. This is to allow for the processing of data built up from the detailed items, and it occurs once for each object.
7. At the end of every group, to allow for processing of the accumulated data.
8. At the end of LIST processing, if you have specified a LIST value on the EXTRACT command.
9. When EXTRACT processing is complete, to allow for closing of files, release of storage, and so on.

Parameters passed from DFHCSDUP to the user program

On every invocation of the user program, DFHCSDUP passes a parameter list addressed by general register 1. The parameter list consists of a series of fullwords that address the fields described in more detail below. The addresses set in the parameter list vary, depending on the point that EXTRACT processing has reached.

The parameter list contains the following fields:

Function Type Ptr

The address of a halfword field that contains a code defining the point in EXTRACT processing reached.

The function codes are as follows:

DFHCSDUP as a batch program

0	Initial call
2	List start call
4	Group start call
6	Object start call
8	Keyword detail call
10	Object end call
12	Group end call
14	List end call
16	Final call.

Workarea Ptr

This is the address of a field containing the address of a fullword to be used by the user application to store the address of any user-acquired work area.

Back translated command Ptr

The address of a fullword that contains the address of a 75-byte area of storage that contains the EXTRACT command that is being processed.

List name Ptr

The address of an 8-byte field that identifies the RDO list from which the current object is taken. This value is set only on the 'list start' and 'list end' calls.

Group name Ptr

The address of an 8-byte field that identifies the RDO group from which the current object is taken. This value is set on the 'group start', 'group end', 'object start', 'object end', and 'keyword' calls.

Object type Ptr

The address of a 12-byte field that identifies the type of object (such as TRANSACTION, PROGRAM, and so on), and is set only on the 'object start', 'object end', and 'keyword' calls.

Object name Ptr

The address of an 8-byte field that contains the name of the object, and is set only on the 'object start', 'object end', and 'keyword' calls.

Keyword name Ptr

The address of a 12-byte field that contains the name of the keyword being processed, and is set only on 'keyword' calls.

Keyword length Ptr

The address of a halfword field that contains the length of the value associated with the keyword, and is set only on 'keyword' calls.

Keyword Value Ptr

The address of the storage area that contains the value associated with the keyword, and is set only on 'keyword' calls.

Note: Fields not set with a pointer value contain a null value.

The sample EXTRACT programs

There are three CICS-supplied sample programs that can be invoked during DFHCSDUP EXTRACT processing. Two of these are provided in VS COBOL II, PL/I, and assembler language, and the third is provided in VS COBOL II only. They are outlined in Table 39 on page 745.

DFHCSDUP as a batch program

Table 39. Sample EXTRACT user programs for the DFHCSDUP utility program

Program names	Languages	Description
DFH\$CRFA DFH0CRFC DFH\$CRFP	Assembler VS COBOL II PL/I	Produces a cross-reference listing of the resource definitions defined in the group or list you specify on the EXTRACT command.
DFH\$FORA DFH0FORC DFH\$FORP	Assembler VS COBOL II PL/I	Formats the group or list of resource definitions you specify on the EXTRACT command into a form suitable for the DB2 table load utility.
DFH0CBDC	VS COBOL II	Writes the list or group of resource definitions you specify on the EXTRACT command in the form of DEFINE commands, suitable for use as a backup copy of the resources extracted.

You can use the sample programs as supplied, or as models on which to base your own programs.

Only the assembler-language versions of DFH\$CRFx and DFH\$FORx are supplied in executable form in CICSTS13.CICS.SDFHLOAD, but for each of these programs the source statements are supplied in CICSTS13.CICS.SDFHSAMP.

The CICS-supplied sample DB2 formatting programs (DFH\$FORx) cannot be used when the CSD compatibility option (COMPAT) is specified on the DFHCSDUP utility program. The output from the CSD cross-reference listing and CSD backup utility programs depends on whether the compatibility option is specified. If the compatibility option is specified, the output includes obsolete keywords from releases before CICS Transaction Server for OS/390 Release 3; if the option is not specified, only keywords from CICS Transaction Server for OS/390 Release 3 are output. For further information about running the DFHCSDUP utility program with the compatibility option, see the *CICS Resource Definition Guide*.

Note that the sample programs require you to specify the OBJECTS keyword on the DFHCSDUP EXTRACT command.

The output data definition names (ddnames) for the sample programs are as follows:

CRFOUT

CSD cross-referencing program

FOROUT

DB2 formatting program

CBDOUT

CSD backup utility program.

The sample programs are discussed in the next three sections.

The CSD cross-referencing program

The CICS-supplied sample CSD cross-referencing program produces a cross-reference listing of objects and keywords on the CSD. The data gathered by the EXTRACT command is passed to the sample program, where it is saved in a cross-reference table. On the final call to this sample program, the contents of the table are printed in collating sequence.

DFHCSDUP as a batch program

The program must be run against an EXTRACT command of the form:

```
EXTRACT GROUP(group name) OBJECTS USERPROGRAM(program-name)
```

or:

```
EXTRACT LIST(list name) OBJECTS USERPROGRAM(program-name)
```

Note that the sample program requires you to specify the OBJECTS keyword.

For this program only, in addition to the EXTRACT command, you must define, in a sequential data set, the objects and keywords for which you want a cross-reference listing. The data set is read by the sample program using the ddname CRFINPT.

CRFINPT is a sequential file containing 80-byte records. Each record contains one object or keyword to be cross-referenced. You can cross-reference any valid resource type or attribute known to CEDA. For example, your CRFINPT file may contain the following entries (one per line):

```
PROGRAM  
TRANSACTION  
TYPETERM  
DSNAME
```

For each record in the file, a report is produced detailing the different values assigned to the keyword, where they are defined, and where they are used. Note that keyword values longer than 44 characters are truncated.

You should define the DCB subparameters for CRFINPT as DSORG=PS, RECFM=F, LRECL=80, and BLKSIZE=80.

The DB2 formatting program

The CICS-supplied sample DB2 formatting program organizes the CSD data passed to it from DFHCSDUP into a format suitable for the DB2 table load utility. The data is organized into columns that correspond to the columns defined in the load utility's input. Each selected resource causes a record to be written to this program's output file, with the first 4 characters identifying the resource type.

The program must be run against an EXTRACT command of the form:

```
EXTRACT GROUP(group name) OBJECTS USERPROGRAM(program-name)
```

or:

```
EXTRACT LIST(list name) OBJECTS USERPROGRAM(program-name)
```

Note that the sample program requires you to specify the OBJECTS keyword.

The CSD backup utility program

The CICS-supplied sample CSD backup utility program produces a file of DFHCSDUP DEFINE control statements. The file can be used:

- For later editing and commenting to document CSD resources
- For distribution, in part or as a whole, to other CICS installations
- To recreate or add resource definitions to any CSD using DFHCSDUP.

DFHCSDUP as a batch program

The program must be run against an EXTRACT command of the form:

```
EXTRACT GROUP(group name) OBJECTS USERPROGRAM(program-name)
```

or:

```
EXTRACT LIST(list name) OBJECTS USERPROGRAM(program-name)
```

Note that the sample program requires you to specify the OBJECTS keyword.

Note the following points when using DFH0CBDC:

- It can deal with only one set of data during each invocation of DFHCSDUP; if two EXTRACT commands are issued, the second set of data overwrites the first.
- In the file produced by DFH0CBDC, any DEFINE statements that relate to CICS-supplied resources are preceded by an asterisk (*) in column 1; in other words, they are commented out. This is important if you use the file as input to define resources to a CSD. (The CICS-supplied definitions are already present in the CSD, having been produced automatically when it was initialized.)
- If you remove an asterisk from column 1 (to reinstate the DEFINE statement), do so by deleting it, **not** by overtyping it with a blank. This ensures that the resulting command is no more than 72 characters long; if it is longer than this, errors occur when the output is passed back through DFHCSDUP.

Assembling and link-editing EXTRACT programs

You must assemble (or compile) and link-edit DFHCSDUP user programs as batch programs, not as CICS applications, and you need link-edit control statements appropriate to the language in which they are written.

Note: DFHCSDUP user programs should not be translated, or unpredictable results could occur.

When you compile the COBOL versions of the sample programs, you must specify the compiler attributes NORENT and NORES.

When you link-edit the programs, you must specify the following link-edit control statements:

- An ENTRY statement that defines the entry name as DFHEXTRA
- An INCLUDE statement for a CICS-supplied stub that must be included in your user program
- A CHANGE statement to change the dummy CSECT name in the CICS-supplied stub from EXITEP to the name of your user program.

These requirements are explained in more detail for each of the languages (assembler, VS COBOL II, and PL/I) shown in the following sample job streams.

DFHCSDUP as a batch program

An assembler-language version

The sample job in Figure 107 shows the link-edit statements you need for an assembler-language version of a DFHCSDUP user program.

```
//DFHCRFA JOB (accounting information),CLASS=A,MSGCLASS=A,NOTIFY=userid
//* .
//* Assembler job step here
//* .
//LINK EXEC PGM=IEWL,PARM='XREF,LIST,LET'
//OBJLIB DD DSN=object.module.library,DISP=SHR
//SYSLIB DD DSN=CICSTS13.CICS.SDFHLOAD,DISP=SHR
//SYSLMOD DD DSN=user.library,DISP=SHR
//SYSUT1 DD UNIT=SYSDA,SPACE=(1024,(100,10))
//SYSPRINT DD SYSOUT=A
//SYSLIN DD *
ENTRY DFHEXTRA
CHANGE EXITEP(csectname)
INCLUDE SYSLIB(DFHEXAI)
INCLUDE OBJLIB(obj-name)
NAME progname(R)
```

1
2
3
4
5

Figure 107. Link-edit control statements for a DFHCSDUP user program (assembler-language)

Notes for the assembler job:

- 1 Specify the entry name as DFHEXTRA, which is the entry name in the CICS-supplied stub, DFHEXAI. (See 3.)
- 2 The CICS-supplied stub, DFHEXAI, is generated with a link to the user program using a dummy CSECT name (EXITEP). Use the link-edit CHANGE statement to change the CSECT name from EXITEP to the name of the CSECT in the user program. In the two CICS-supplied assembler-language sample programs, these names are:

CREFCSD

The CSECT name in DFH\$CRFA, the cross-reference listing user program.

FORMCSD

The CSECT name in DFH\$FORA, the DB2-formatting user program.

- 3 Include DFHEXAI in any assembler-language user program that you write for use with the DFHCSDUP EXTRACT command. DFHEXAI is the interface stub between DFHCULIS, a module in DFHCSDUP, and the user program.
- 4 obj-name is the name of the library member that contains the assembled object module.
- 5 progname is the name you want to call the load module; this is the name that you specify on the USERPROGRAM parameter of the EXTRACT command.

A VS COBOL II version

The sample job in Figure 108 shows the link-edit statements you need for a VS COBOL II version of a DFHCSDUP user program.

```
//DFHCRFC JOB (accounting information),CLASS=A,MSGCLASS=A,NOTIFY=userid
// .
// COBOL compile job step here
// .
//LINK EXEC PGM=IEWL,PARM='XREF,LIST,LET'
//SYSLIB DD DSN=SYS1.COBOL2.COB2LIB,DISP=SHR
//CICSLIB DD DSN=CICSTS13.CICS.SDFHLOAD,DISP=SHR
//OBJLIB DD DSN=object.module.library,DISP=SHR
//SYSLMOD DD DSN=user.library,DISP=SHR
//SYSUT1 DD UNIT=SYSDA,SPACE=(1024,(100,10))
//SYSPRINT DD SYSOUT=A
//COBLIB DD DSN=SYS1.COBOL2.COB2LIB,DISP=SHR
//SYSLIN DD *
ENTRY DFEXTRA
CHANGE EXITEP(prog-id)
INCLUDE CICSLIB(DFHEXCI)
INCLUDE SYSLIB(ILBOSRV)
INCLUDE SYSLIB(ILBOCMM)
INCLUDE SYSLIB(ILBOBEG)
INCLUDE OBJLIB(obj-prog)
NAME progname(R)
//
```

1
2
3
4
4
5
6

Figure 108. Link-edit control statements for a DFHCSDUP user program (COBOL)

Notes for the VS COBOL II job:

1 Specify the entry name as DFEXTRA, which is the entry name in the CICS-supplied stub, DFHEXCI. (See **3**.)

2 The CICS-supplied stub, DFHEXCI, is generated with a link to the user program using a dummy CSECT name (EXITEP). Use the link-edit CHANGE statement to change the CSECT name from EXITEP to the name specified on the PROGRAM-ID statement in the user program. In the three CICS-supplied COBOL sample programs, these names are:

CREFCSD

The PROGRAM-ID in DFH0CRFC, the cross-reference listing user program.

FORMCSD

The PROGRAM-ID in DFH0FORC, the DB2-formatting user program.

BDEFCS

The PROGRAM-ID in DFH0CBDC, the CSD backup definitions user program.

3 Include DFHEXCI in any COBOL language user program that you write for use with the DFHCSDUP EXTRACT command. DFHEXCI is the interface stub between DFHCULIS, a module in DFHCSDUP, and the COBOL user program.

4 Specify the COBOL routines on the INCLUDE statements as shown.

5 obj-prog is the name of the object program.

6 progname is the name you want for the load module; this is the name that you specify on the USERPROGRAM parameter of the EXTRACT command.

DFHCSDUP as a batch program

A PL/I version

The sample job in Figure 109 shows the link-edit statements you need for a PL/I version of a DFHCSDUP user program.

```
//DFHCRFP JOB (accounting information),CLASS=A,MSGCLASS=A,NOTIFY=userid
//* .
//* PL/I compile job step here
//* .
//LINK EXEC PGM=IEWL,PARM='XREF,LIST,LET'
//SYSLIB DD DSN=object.module.library,DISP=SHR
// DD DSN=SYS1.PLI.PLIBASE,DISP=SHR
// DD DSN=CICSTS13.CICS.SDFHLOAD,DISP=SHR
//OBJLIB DD DSN=object.module.library,DISP=SHR
//SYSLMOD DD DSN=user.library,DISP=SHR
//SYSUT1 DD UNIT=SYSDA,SPACE=(1024,(100,10))
//SYSPRINT DD SYSOUT=A
//SYSLIN DD *
ENTRY DFHEXTRA
CHANGE EXITEP(CREFCSD)
INCLUDE SYSLIB(DFHEXPI)
INCLUDE SYSLIB(DFH$PDUM)
INCLUDE SYSLIB(DFH$CRFP)
INCLUDE OBJLIB(obj-prog)
NAME progname(R)
```

1
2
3
4
5
6

Figure 109. Link-edit control statements for a DFHCSDUP user program (PL/I)

Notes for the PL/I job:

1 Specify the entry name as DFHEXTRA, which is the entry name in the CICS-supplied stub, DFHEXPI (see **3**).

2 The CICS-supplied stub, DFHEXPI, is generated with a link to the user program using a dummy CSECT name (EXITEP). Use the link-edit CHANGE statement to change the CSECT name from EXITEP to the name specified on the PROC statement in the PL/I user program. In the two CICS-supplied PL/I sample programs, these names are:

CREFCSD

The PROC name in DFH\$CRFP, the cross-reference listing user program.

FORMCSD

The PROC name in DFH\$FORP, the DB2-formatting user program.

3 Include DFHEXPI in any PL/I language user program that you write for use with the DFHCSDUP EXTRACT command. DFHEXPI is the interface stub between DFHCULIS, a module in DFHCSDUP, and the PL/I user program.

4 Include the PL/I dummy program, DFH\$PDUM, to establish the PL/I environment, and enable the PL/I user program to run as a subroutine. Before you can include DFH\$PDUM, by specifying it on the INCLUDE statement as shown, you must compile it using your PL/I compiler. The compiled version of the dummy program must be included in one of the libraries available to the linkage editor (for example, SYS1.PLI.PLIBASE).

5 obj-prog is the name of the object program.

6 progname is the name you want for the load module; this is the name that you specify on the USERPROGRAM parameter of the EXTRACT command.

A Language Environment version

The sample job in Figure 110 shows the link-edit statements you need for a DFHCSDUP user program written in a Language Environment/370 (LE)-conforming high-level language.

```
//DFHCRFA JOB (accounting information),CLASS=A,MSGCLASS=A,NOTIFY=userid
//* .
//* Compile job step here
//* .
//LINK EXEC PGM=IEWL,PARM='XREF,LIST,LET'
//SYSLIB DD DSN=PP.ADLE370.OS39025.SCEELKED
//CICSLIB DD DSN=CICSTS13.CICS.CICS.SDFHLOAD,DISP=SHR
//OBJLIB DD DSN=object.module.library,DISP=SHR
//SYSLMOD DD DSN=user.library,DISP=SHR
//SYSUT1 DD UNIT=SYSDA,SPACE=(1024,(100,10))
//SYSPRINT DD SYSOUT=A
//SYSLIN DD *
ENTRY DFHEXTRA
CHANGE EXITEP(prof-id)
INCLUDE CICSLIB(DFHEXLE)
INCLUDE OBJLIB(obj-prog)
NAME progname(R)
```

1
2
3
4
5

Figure 110. Link-edit control statements for a DFHCSDUP user program (LE)

Notes for the LE job:

1 Specify the entry name as DFHEXTRA, which is the entry name in the CICS-supplied stub, DFHEXLE (see **3**).

2 The CICS-supplied stub, DFHEXLE, is generated with a link to the user program using a dummy CSECT name (EXITEP). Use the link-edit CHANGE statement to change the CSECT name from EXITEP to the name specified on the PROC statement in the user program.

3 Include DFHEXLE in any LE-conforming user program that you write for use with the DFHCSDUP EXTRACT command. DFHEXLE is the interface stub between DFHCULIS, a module in DFHCSDUP, and the LE user program.

4 obj-prog is the name of the object program.

5 progname is the name you want for the load module; this is the name that you specify on the USERPROGRAM parameter of the EXTRACT command.

Invoking DFHCSDUP from a user program

It is possible to invoke DFHCSDUP from a user program. This method enables you to create a flexible interface to the utility. By specifying the appropriate entry parameters, your program can cause DFHCSDUP to pass control to an exit routine at any of five exit points. The exits can be used, for example, to pass commands to DFHCSDUP, or to respond to messages produced by DFHCSDUP processing.

You can run your user program:

- In batch mode
- Under TSO.

invoking DFHCSDUP from a user program

Notes:

1. In a TSO environment, it is normally possible for the terminal operator to interrupt processing at any time by means of an ATTENTION interrupt. In order to protect the integrity of the CSD file, DFHCSDUP does not respond to such an interrupt until after it has completed the processing associated with the current command. It then writes message number 'DFH5618' to the put-message exit (see "The put-message exit" on page 759), where this is available, and also to the default output file:

```
AN ATTENTION INTERRUPT WAS  
REQUESTED DURING DFHCSDUP PROCESSING
```

Your put-message exit routine can terminate DFHCSDUP, if desired. (Note that you **must** supply a put-message routine if you want your operators to regain control after an ATTENTION interrupt.)

2. Suitably authorized TSO operators can use the CEDA INSTALL transaction to install resources that have previously been defined with DFHCSDUP. For information about the CEDA INSTALL command, see the *CICS Resource Definition Guide*.

Entry parameters for DFHCSDUP

When invoking DFHCSDUP, your program passes a parameter list addressed by register 1. It may pass up to five parameters, as described below:

OPTIONS

A list of character strings, separated by commas. (The information passed here is that which would otherwise be passed on the PARM keyword of the EXEC statement of JCL.) A maximum of four options can be specified:

CSD({READWRITE|READONLY})

specifies whether you require read-write or read-only access to the CSD.

PAGESIZE(nnnn)

specifies the number of lines per page on output listings. Valid values for nnnn are 4 through 9999. The default value is 60.

NOCOMPAT|COMPAT

specifies whether DFHCSDUP is to be invoked in compatibility mode. By default, it is invoked in noncompatibility mode. For details of compatibility mode, see the *CICS Resource Definition Guide*.

UPPERCASE

specifies that output listings are to be printed entirely in uppercase characters. The default is to print in mixed case.

DDNAMES

A list of ddnames that, if specified, are substituted for those normally used by DFHCSDUP.

HDING

The starting page number of any listing produced by DFHCSDUP. You can use this parameter to ensure that subsequent invocations produce logically numbered listings. If this parameter is not specified, the starting page number is set to 1.

invoking DFHCSDUP from a user program

The length of the page number data (field 'bb' in Figure 111) must be 0 or 4. The page number, if supplied, must be four numeric EBCDIC characters. The field, if present, is updated upon exit from DFHCSDUP with a number one greater than that of the last page printed.

DCBS

The addresses of a set of data control blocks for use internally by DFHCSDUP. Any DCBs (or ACBs) that you specify are used internally, instead of those normally used by DFHCSDUP.

Note that if you specify both replacement ddnames and replacement DCBs, the alternative DCBs are used, but the alternative ddnames are disregarded.

EXITS

The addresses of a set of user exit routines to be invoked during processing of DFHCSDUP.

The structure of the parameter list is shown in Figure 111.

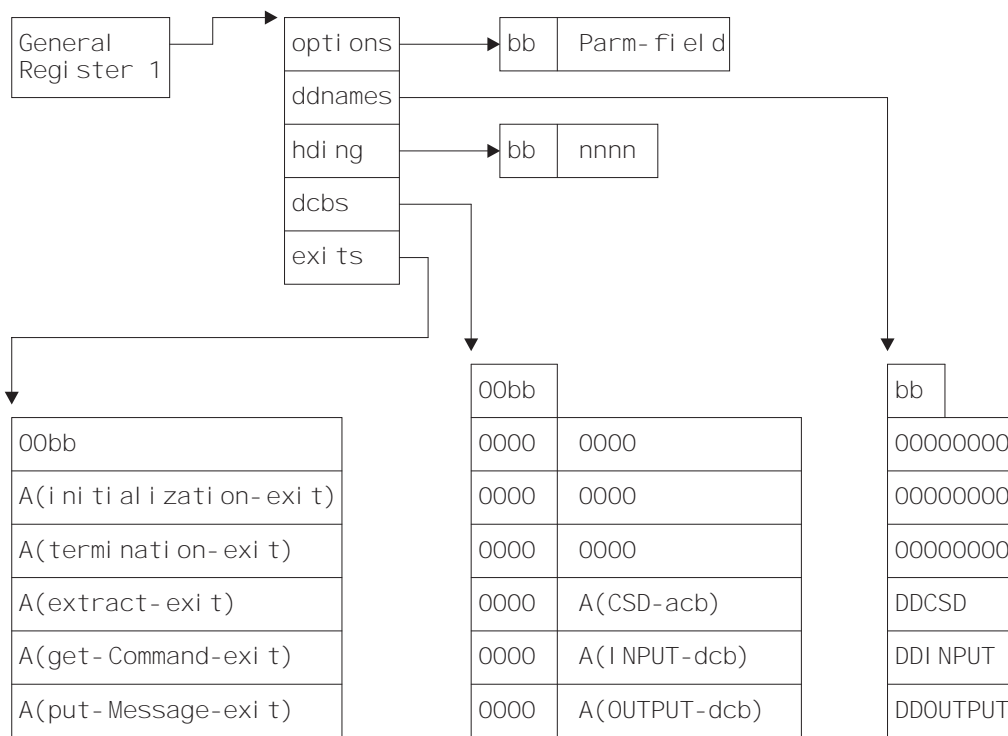

bb is a two-byte field containing the length of the functional data
 00 represents two bytes of binary zeros
 A() means "address of"

Figure 111. Entry parameters for DFHCSDUP

You should note the following:

- Each parameter contains a length field, followed by some functional data.
- The functional data for the DDNAMES, DCBS, and EXITS parameters contains multiple subentries.
- The parameters OPTIONS, DDNAMES, and HDING are aligned on a halfword boundary, and the first two bytes 'bb' contain the binary number of **bytes** in the following functional data.

invoking DFHCSDUP from a user program

- The parameters DCBS and EXITS are aligned on a fullword boundary, and the first four bytes '00bb' contain the binary number of **fullwords** in the following functional data.
- If the 'bb' field for any parameter is zero, the parameter is ignored.
- If a subentry in the functional data is all binary zeros, it is ignored.
- If any subentry is not within the length indicated by 'bb', it is ignored.
- In the DDNAMES functional data, each subentry consists of an 8-byte ddname to replace a default ddname used by DFHCSDUP. DFHCSDUP does not use the first three subentries of the DDNAMES parameter. The fourth, fifth, and sixth subentries, if present, replace the ddnames of DFHCSD, SYSIN, and SYSPRINT, respectively.
- In the DCBS functional data, each subentry consists of two fullwords. The first word is not used by CICS. The second word contains the address of an open DCB or ACB. You must ensure that the DCB or ACB has been opened with the correct attributes, which are:

PRIMARY CSD

AM=VSAM,MACRF=(KEY,DIR,SEQ,IN,OUT)

INPUT FILE

DSORG=PS,MACRF=GL,LRECL=80,RECFM=FB

The address of any end-of-data routine (EODAD) or I/O error routine (SYNAD) in the DCB is overlaid by DFHCSDUP.

OUTPUT FILE

DSORG=PS,MACRF=PL,LRECL=125,RECFM=VBA

DFHCSDUP does not use the first three subentries of the DCBS parameter. The fourth, fifth, and sixth subentries, if present, are used instead of the internal DCBs or ACBs for DFHCSD, SYSIN, and SYSPRINT, respectively.

- In the EXITS parameter, each subentry consists of a single fullword containing the address of an exit routine. You must specify the exit routines in the order shown in Figure 111 on page 753. (The user exits are described in "The user exit points in DFHCSDUP" on page 755.)

Responsibilities of the user program

Before invoking DFHCSDUP, your calling program must ensure that:

- AMODE(24) and RMODE(24) are in force
- System/370™ register conventions are obeyed
- If the EXITS parameter is passed, any programming environment needed by the exit routines has been initialized
- Any ACBs or DCBs passed for use by DFHCSDUP are OPEN.

The user exit points in DFHCSDUP

There are five user exit points in DFHCSDUP. By specifying the appropriate entry parameters, you can cause DFHCSDUP to pass control to an exit routine at any of these points.

None of the user exits supports XPI calls.

Parameters passed to the user exit routines

The address of a parameter list is passed to the user exit routine in register 1. The list contains some standard parameters that are passed to all of the exit routines, and may also contain some exit-specific parameters that are unique to the exit point from which the exit routine is being invoked.

The format of the parameter list is identical to that used by CICS global user exits. For a description of the standard parameters, see “DFHUEPAR standard parameters” on page 8. Explanations of the exit-specific parameters are included in the descriptions of the individual exits, which follow.

The initialization exit

The initialization exit is invoked once during DFHCSDUP initialization. Its purpose is to allow a routine to perform exit-related initialization. For example, the routine may obtain its own global work area and save its address in UEPGAA and its length in the halfword pointed to by UEPGAL. These values are retained by DFHCSDUP and become available at the other exit points.

When invoked

Invoked once, on entry to DFHCSDUP.

Exit-specific parameters

None.

Return codes

UERCNORM (X'00')

Continue processing.

UERCERR

Irrecoverable error. This causes DFHCSDUP to terminate with a return code of '8'.

XPI calls

Must not be used.

invoking DFHCSDUP from a user program

The get-command exit

The purpose of the get-command exit is to read in command lines. If it is specified, no commands are read from SYSIN.

On invocation, your exit routine must supply the address and length of a **complete** command. It must return control with either the normal return code 'UERCNORM' or with the code 'UERCDONE', signifying that it has no more commands to pass. After it has processed each command, DFHCSDUP reinvokes the exit until return code 'UERCDONE' is received.

When invoked

Invoked multiple times, at the point where DFHCSDUP would otherwise read commands from SYSIN.

Exit-specific parameters

UEPCMDA

Address of a fullword containing a pointer to a command

UEPCMDL

Address of a halfword containing the length of the command text. The maximum length that can be specified is 1536 bytes.

Return codes

UERCNORM (X'00')

Continue processing.

UERCDONE (X'04')

No more commands to process. (This is equivalent to reaching end-of-file on the SYSIN file.)

UERCERR

Irrecoverable error. This causes DFHCSDUP to terminate with a return code of '8'.

XPI calls

Must not be used.

The extract exit

The extract exit is invoked at various points during processing of the EXTRACT command. The points are listed on page 743.

Notes:

1. If you do not specify an EXTRACT user exit routine on the entry linkage to DFHCSDUP, or on the USERPROGRAM keyword, a syntax error occurs.
2. A user exit routine specified on the USERPROGRAM keyword is used in preference to one specified on the entry linkage.

When invoked

Invoked multiple times during processing of the EXTRACT command.

Exit-specific parameters

EXTRACT_FUNCTION_CODE_PTR

Address of a halfword containing a code that defines the point in EXTRACT processing reached. The EXTRACT function codes are listed on page 743.

EXTRACT_WORK_AREA_PTR

Address of a fullword containing the address of the EXTRACT work area.

EXTRACT_BACKTRAN_COMMAND_PTR

Address of a fullword containing the address of the EXTRACT command being processed.

EXTRACT_CSD_LIST_NAME_PTR

Address of an 8-byte field containing the name of the list whose data is being extracted. This value is set only on 'list start' and 'list end' calls.

EXTRACT_CSD_GROUP_NAME_PTR

Address of an 8-byte field containing the name of the group whose data is being extracted. This value is set on 'group start', 'group end', 'object start', 'object end', and 'keyword' calls.

EXTRACT_CSD_OBJECT_TYPE_PTR

Address of a 12-byte field that identifies the type of object (such as TRANSACTION, PROGRAM, and so on). This value is set only on 'object start', 'object end', and 'keyword' calls.

EXTRACT_CSD_OBJECT_NAME_PTR

Address of an 8-byte field containing the name of the object. This value is set only on 'object start', 'object end', and 'keyword' calls.

EXTRACT_KEYWORD_NAME_PTR

Address of a 12-byte field containing the name of the keyword being processed. This value is set on 'keyword' calls only.

EXTRACT_KEYWORD_LENGTH_PTR

Address of a halfword containing the length of the value associated with the keyword. This value is set on 'keyword' calls only.

EXTRACT_KEYWORD_VALUE_PTR

Address of a character string which contains the value associated with the keyword. This value is set on 'keyword' calls only.

Note that these parameters are similar to those passed when DFHCSDUP is invoked as a batch program. (See "Parameters passed from DFHCSDUP

invoking DFHCSDUP from a user program

to the user program” on page 743.) However, when DFHCSDUP is invoked from a user program, the parameter list also includes the standard parameters mentioned under “Parameters passed to the user exit routines” on page 755.

Return codes

UERCNORM (X'00')

Continue processing.

UERCERR

Irrecoverable error. This causes DFHCSDUP to terminate with a return code of '8'.

XPI calls

Must not be used.

The put-message exit

The put-message exit is invoked whenever a message is to be issued. If you are running under TSO, you could use this exit to terminate DFHCSDUP after the operator inputs an ATTENTION interrupt. (See “Invoking DFHCSDUP from a user program” on page 751.) Or you could use it to provide messages in the operator’s national language.

Even if this exit is supplied, messages are always additionally written to the default output file (that is, to SYSPRINT, or to the replacement ddname specified on the entry linkage to DFHCSDUP).

When invoked

Invoked when a message is to be issued.

Exit-specific parameters

UEPMNUM

Address of a 4-character field containing the message number

UEPMDOM

Reserved

UEPINSN

Address of a 2-byte field containing the number of insert fields

UEPINSA

Address of the following message structure:

	DS	F	Reserved
INS_1_TEXT_PTR	DS	A	Address of insert 1
INS_1_LEN_PTR	DS	A	Address of a fullword containing the length of insert 1
	DS	F	Reserved
	DS	F	Reserved
INS_2_TEXT_PTR	DS	A	Address of insert 2
INS_2_LEN_PTR	DS	A	Address of a fullword containing the length of insert 2
	DS	F	Reserved
	...		
	DS	F	Reserved
INS_n_TEXT_PTR	DS	A	Address of insert n
INS_n_LEN_PTR	DS	A	Address of a fullword containing the length of insert n
	DS	F	Reserved

The exit-specific parameters provide a message number and insert fields only, to enable you to provide messages in the language of your TSO operators. The structure pointed to by UEPINSA is repeated as many times as UEPINSN requires.

Return codes

UERCNORM (X'00')

Continue processing.

UERCERR

Irrecoverable error. This causes DFHCSDUP to terminate with a return code of '8'.

XPI calls

Must not be used.

invoking DFHCSDUP from a user program

The termination exit

The purpose of the termination exit is to allow you to perform final housekeeping duties. It is invoked before a normal or an abnormal termination of DFHCSDUP.

When invoked

Invoked once, before termination of DFHCSDUP.

Exit-specific parameters

UEPTRMFL

Address of a 1-byte field that indicates the mode of termination. Its possible values are:

X'00' Normal termination

X'F0' Abnormal termination.

Your exit program cannot reset the value in this field.

Return codes

UERCNORM (X'00')

Continue processing.

UERCERR

Irrecoverable error. This causes DFHCSDUP to terminate with a return code of '8'.

XPI calls

Must not be used.

The sample program, DFH\$CUS1

The CICS-supplied sample program, DFH\$CUS1, illustrates how DFHCSDUP can be invoked from a user program. It is written as a command processor (CP) for execution under the TSO/E operating system.

Note that DFH\$CUS1 uses different DCB and ACB names from those normally used by DFHCSDUP. Ensure that these are allocated before running the program under TSO/E.

Chapter 31. The programmable interface to the RDO transaction, CEDA

This chapter describes a programmable interface to the resource definition online (RDO) transaction, CEDA. The functions provided by RDO can be invoked from application programs, by a command such as:

```
EXEC CICS LINK PROGRAM('DFHEDAP')
          COMMAREA(CEDAPARM)
```

where DFHEDAP is the name of the entry point in the RDO program, and CEDAPARM is a user-defined name of a parameter list consisting of five 31-bit addresses (each contained in a fullword) as follows:

1. Address of a field containing the RDO command in source form.
2. Address of a halfword binary field specifying the length of the command. The maximum length of the input command is 1022 bytes.
3. Address of a 1-byte indicator field defined as follows:
 - X'80'** Display output at terminal instead of returning it to caller.
 - X'00'** Do not display output at terminal.
4. Address of a field in which output is to be placed by DFHEDAP.
5. Address of a halfword binary field specifying the maximum length of output that the application can handle.

If the indicator in address 3 is X'80', output is displayed at the terminal. In this case, you can enter any number of CEDA commands at the terminal, in response to the output displayed on your screen. Control is returned to your application program when you press PF3.

However, if the indicator is X'00' (output is not to be displayed at the terminal), DFHEDAP returns control to your application program immediately after processing the RDO command specified in the first address. At the same time, DFHEDAP returns the output as one or two concatenated, structured fields. The output from a single request comprises one field for the translation stage and one or none for the execution stage. Each field has the format:

- Binary halfword containing inclusive length of field.
- Binary halfword containing the number of messages produced.
- Binary halfword containing the highest message-severity: '0' and '4' continue to execution; '8' and '12' do not continue to execution.
- Variable-length data containing:
 - For the translation stage: diagnostic messages if there are any.
 - For the execution stage: data that would normally appear on the CEDA screen, including messages. Each line begins with a new line (NL) character and, otherwise, consists of blanks and uppercase alphanumeric characters.

The format of this data is not guaranteed from release to release, but it is the same as that displayed by CEDA. (Analysis of this data should not normally be necessary. Typically, your program is interested only in whether or not the command was successful.) If the total output is longer than the maximum length specified by the user, it is truncated.

the programmable interface to CEDA

Notes:

1. An attempt to start CEDA from an application program by an EXEC CICS START command must fail. This is because CEDA's first action is to request input from its associated terminal, whereas an automatically initiated transaction must first send data to the terminal.
An attempt to start CEDA under CECL by an EXEC CICS START command fails for similar reasons.
2. The RDO command passed in address 1 of the CEDAPARM parameter list must be valid. (For example, spelling errors such as PRORGAM for PROGRAM are not corrected automatically when you use the programmable interface.)
3. You cannot use the programmable interface to change the values of CEDA keywords that are obsolete in this release of CICS, but which are retained for compatibility with earlier releases. That is, the interface does not support *compatibility mode*.
4. CEDA issues various syncpoints as part of its processing. Therefore, when your program links to DFHEDAP the current unit of work (UOW) of the transaction is completed. This may result in problems if, for example, there are outstanding browse operations against VSAM datasets.

Use of the programmable interface

Remember that you can use the offline utility program, DFHCSDUP, to examine and amend CSD files; and that DFHCSDUP can be invoked from a user program, running either in batch mode or under TSO. (See "Chapter 30. User programs for the system definition utility program (DFHCSDUP)" on page 741.)

Using DFHCSDUP is the recommended method for updating CSD files in bulk.

You should only use the interface described in this chapter where the required function includes the INSTALL command, which is not available from DFHCSDUP.

Using DFHEDAP in a DTP environment

The LINK DFHEDAP function is intended to be used in a single environment. It is not supported within a distributed transaction programming (DTP) environment—using it in such an environment can result in abends.

In a DTP environment, CICS may attempt to propagate SYNCPOINT and SYNCPOINT ROLLBACK requests across sessions to other systems. These requests are issued by CEDA modules that are invoked by the use of LINK DFHEDAP. Note that the issuing of SYNCPOINT ROLLBACK means that LINK DFHEDAP cannot be used in a DTP environment that owns LU6.1 links.

Generally, a session should be in SEND state to initiate a SYNCPOINT, but the session may not remain in SEND state once a LINK DFHEDAP command is issued. (For information about valid commands and states, see the *CICS Distributed Transaction Programming Guide*. This book also explains the APPC architecture rules on a session's state after SYNCPOINT and SYNCPOINT ROLLBACK requests are made.)

The code invoked by LINK DFHEDAP can result in wrong sequence of commands. For example, if the code invoked by DFHEDAP issues a SYNCPOINT ROLLBACK

DFHEDAP in a DTP environment

from a back-end application program whose session is in SEND state (and which has never issued a SYNCPOINT), the session will be put into RECEIVE state. If the code invoked by DFHEDAP then issues a SYNCPOINT, an abend occurs. This can be prevented by all DTP applications issuing a SYNCPOINT request when they get into SEND state (on all of their sessions) and before they issue the LINK DFHEDAP command.

Do not attempt to use LINK DFHEDAP when more than a pair of DTP application programs are involved—that is, one front end and one back end.

The general rules for using LINK DFHEDAP within a simple DTP environment (one front end and one back end) are that all sessions in a DTP environment should be in SEND state when the LINK DFHEDAP command is issued, and they should revert to SEND state in the event of a SYNCPOINT ROLLBACK being issued by the DFHEDAP code.

Part 9. Appendixes

Appendix A. Coding entries in the VTAM LOGON mode table

This appendix shows you what to code in your VTAM LOGON mode table for a terminal to be automatically installed. It is divided into the following sections:

1. **“Overview”**
2. **“TYPETERM device types and pointers to related LOGON mode data”** on page 768
3. **“VTAM MODEENT macro operands”** on page 770
4. **“PSERVIC screen size values for LUTYPEx devices”** on page 775
5. **“Matching models and LOGON mode entries”** on page 776
6. **“LOGON mode definitions for CICS-supplied autoinstall models”** on page 786.

Overview

CICS uses the data that to code in your VTAM LOGON mode table when processing an automatic installation (autoinstall) request. Automatic installation functions properly only if the logmode entries that you define to VTAM have matches among the TYPETERMs and model TERMINAL definitions that you specify to CICS. “Matching models and LOGON mode entries” on page 776 and “LOGON mode definitions for CICS-supplied autoinstall models” on page 786 show examples of matching definitions.

The following tables show, for a variety of possible terminal devices, what you must code on the VTAM MODEENT macros that define your logmode table if you want to use autoinstall. Between them they show the values that must be specified for each of the operands of the MODEENT macro. Where all bit settings of an operand’s value have significance for CICS, the data is shown in hexadecimal form. If some of an operand’s bit settings are not significant to CICS, its data bytes are shown as bit patterns. The bit settings that have significance for CICS are shown set to the values that CICS expects. Those bits that have no significance to CICS are shown as periods. Thus, for example:

01..0011

shows that six bits in the subject byte must be given specific values; the remaining two have no significance.

Some of the examples shown here correspond exactly to entries in the CICS-supplied LOGON mode table called ISTINCLM. Where this is so, the table gives the name of the entry in ISTINCLM.

The PSERVIC setting shows fields called aaaaaaaa, bbbbbbbb, and so on. The contents of these vary for LUTYPE0, LUTYPE2, and LUTYPE3 devices, according to how you specify certain attributes of the terminals. You can work out the values you need by looking at “PSERVIC screen size values for LUTYPEx devices” on page 775.

TYPETERM device types and pointers to related LOGON mode data

Search Table 40 for the TYPETERM device type that corresponds to the terminal you want to autoinstall. When you find the right one, use the number to its right to locate, in Table 41 on page 770, what has to be coded on the VTAM MODEENT macros.

Note that Table 40 is a complete list of TYPETERM device types; not all of these can be used with autoinstall. Those that cannot are marked with an asterisk (*). For details about coding TYPETERM definitions, and for a list of terminals that can be autoinstalled, see the *CICS Resource Definition Guide*.

Table 40. TYPETERM device types, with cross-references to VTAM logmode entries

TYPETERM device type	Reference number in Table 41 on page 770
DEVICE(APPC)	24
DEVICE(BCHLU)	17
DEVICE(BCHLU) SESSIONTYPE(BATCHDI)	15
DEVICE(BCHLU) SESSIONTYPE(USERPROG)	16
DEVICE(CONTLU)	10
DEVICE(INTLU)	11
DEVICE(LUTYPE2)	18
DEVICE(LUTYPE2) TERMMODEL(1)	18
DEVICE(LUTYPE3)	19
DEVICE(LUTYPE3) TERMMODEL(1)	19
DEVICE(LUTYPE4)	12
DEVICE(SCSPRINT)	11, 13
DEVICE(TLX)	8
DEVICE(TLX) SESSIONTYPE(CONTLU)	8
DEVICE(TLX) SESSIONTYPE(INTLU)	9
DEVICE(TWX)	8
DEVICE(TWX) SESSIONTYPE(CONTLU)	8
DEVICE(TWX) SESSIONTYPE(INTLU)	9
DEVICE(3270)	2
DEVICE(3270) BRACKET(NO)	1
DEVICE(3270) TERMMODEL(1)	2
DEVICE(3270) TERMMODEL(1) BRACKET(NO)	1
DEVICE(3270P)	2
DEVICE(3270P) BRACKET(NO)	1
DEVICE(3270P) TERMMODEL(1)	2
DEVICE(3270P) TERMMODEL(1) BRACKET(NO)	1
DEVICE(3275)	2
DEVICE(3275) BRACKET(NO)	1
DEVICE(3275) TERMMODEL(1)	2

TYPETERM device types

Table 40. TYPETERM device types, with cross-references to VTAM logmode entries (continued)

TYPETERM device type	Reference number in Table 41 on page 770
DEVICE(3275) TERMMODEL(1) BRACKET(NO)	1
DEVICE(3600)	16, 22, 23
DEVICE(3600) SESSIONTYPE(PIPELINE) *	21
DEVICE(3600) SESSIONTYPE(PIPELN) *	21
DEVICE(3614) *	3
DEVICE(3650) SESSIONTYPE(PIPELINE) *	21
DEVICE(3650) SESSIONTYPE(PIPELN) *	21
DEVICE(3650) SESSIONTYPE(USERPROG) BRACKET(YES)	6
DEVICE(3650) SESSIONTYPE(USERPROG) BRACKET(NO)	7
DEVICE(3650) SESSIONTYPE(3270)	5
DEVICE(3650) SESSIONTYPE(3270) BRACKET(NO)	4
DEVICE(3650) SESSIONTYPE(3653)	5
DEVICE(3650) SESSIONTYPE(3653) BRACKET(NO)	4
DEVICE(3767)	11
DEVICE(3767C)	10
DEVICE(3767I)	11
DEVICE(3770)	17
DEVICE(3770) SESSIONTYPE(BATCHDI)	15
DEVICE(3770) SESSIONTYPE(USERPROG)	16
DEVICE(3770B)	17
DEVICE(3770B) SESSIONTYPE(BATCHDI)	15
DEVICE(3770B) SESSIONTYPE(USERPROG)	16
DEVICE(3770C)	10
DEVICE(3770I)	11
DEVICE(3790)	20
DEVICE(3790) SESSIONTYPE(BATCHDI)	14
DEVICE(3790) SESSIONTYPE(SCSPRT)	13
DEVICE(3790) SESSIONTYPE(SCSPRINT)	13
DEVICE(3790) SESSIONTYPE(USERPROG)	16
DEVICE(3790) SESSIONTYPE(3277CM)	18
DEVICE(3790) SESSIONTYPE(3284CM)	19
DEVICE(3790) SESSIONTYPE(3286CM)	19

VTAM MODEENT macro operands

Table 41 VTAM LOGON mode table entry for each TYPETERM you might define. You should have reached this table by looking up the TYPETERM device types in Table 40 on page 768.

Look down the left hand side of the table for the reference number (RN) that brought you here from Table 40 on page 768. When you find it, look across to the middle column. This shows the macro operands that affect the way CICS handles automatic installation. Your MODEENT macro entries for devices to be installed must match what is specified there. Any MODEENT macro entries not shown in the table, such as PSERVIC for some reference numbers, are not tested by CICS. Any bit settings that do not matter to CICS during bind analysis for autoinstalled terminals appear as periods (.).

Note: Some fields in the PSERVIC data for LUTYPE0, LUTYPE2, and LUTYPE3 devices have values that depend on the ALTSCREEN and DEFSCREEN characteristics of the device. For this reason, you have to consult “PSERVIC screen size values for LUTYPEx devices” on page 775 to find out the values you need to specify instead of aaaaaaaaa, bbbbbbbb, ccccccc, dddddddd, and eeeeeeee.

The right-hand column in the table names entries in the CICS-supplied LOGON mode table that could meet your needs. The CICS-supplied table is called ISTINCLM. For further VTAM information, refer to *ACF/VTAM Network Implementation Guide*.

Table 41. LOGON mode table and ISTINCLM entries

RN	VTAM MODEENT macro entries that are needed for related CICS TYPETERM definitions	Suitable supplied entries
1	FMPROF=X'02' TSPROF=X'02' PRIPROT=X'70' SECPROT=X'40' COMPROT=B'0000.000 00000.00'	
2	FMPROF=X'02' TSPROF=X'02' PRIPROT=X'71' SECPROT=X'40' COMPROT=B'0010.000 00000.00'	DSILGMOD D4B32781 D4B32782 D4B32783 D4B32784 D4B32785 NSX32702 S3270
3	FMPROF=X'04' TSPROF=X'04' PRIPROT=X'B0' SECPROT=X'B0' COMPROT=B'0000.000 00000.00'	
4	FMPROF=X'04' TSPROF=X'03' PRIPROT=X'B0' SECPROT=X'90' COMPROT=B'0100.000 00000.00'	

VTAM MODEENT macro operands

Table 41. LOGON mode table and ISTINCLM entries (continued)

RN	VTAM MODEENT macro entries that are needed for related CICS TYPETERM definitions	Suitable supplied entries
5	FMPROF=X'04' TSPROF=X'03' PRIPROT=X'B1' SECPROT=X'90' COMPROT=B'0110.000 00000.00'	
6	FMPROF=X'04' TSPROF=X'04' PRIPROT=X'31' SECPROT=X'30' COMPROT=B'0110.000 00000.00'	INTRUSER
7	FMPROF=X'04' TSPROF=X'04' PRIPROT=X'B0' SECPROT=X'30' COMPROT=B'0100.000 00000.00'	
8	FMPROF=X'03' TSPROF=X'03' PRIPROT=X'B1' SECPROT=X'90' COMPROT=B'0011.000 01000.00' PSERVIC=B'00000001 00000000 00000000 00000000. 00000000 00000000 00000000 00000000 00000000 00000000'	
9	FMPROF=X'03' TSPROF=X'03' PRIPROT=X'B1' SECPROT=X'90' COMPROT=B'0011.000 10000.00' PSERVIC=B'00000001 00000000 00000000 00000000. 00000000 00000000 00000000 00000000 00000000 00000000'	SCS
10	FMPROF=X'03' TSPROF=X'03' PRIPROT=X'B1' SECPROT=X'90' COMPROT=B'0011.000 01000.00' PSERVIC=X'01'	
11	FMPROF=X'03' TSPROF=X'03' PRIPROT=X'B1' SECPROT=X'90' COMPROT=B'0011.000 10000.00' PSERVIC=X'01'	SCS See note 2
12	FMPROF=X'07' TSPROF=X'07' PRIPROT=X'B1' SECPROT=X'B0' COMPROT=B'0101.000 10000.01' PSERVIC=B'00000100 10101000 01000000 10100000 10101000 01000000 10100000 00000000 00001100 00000000'	

VTAM MODEENT macro operands

Table 41. LOGON mode table and ISTINCLM entries (continued)

RN	VTAM MODEENT macro entries that are needed for related CICS TYPETERM definitions	Suitable supplied entries
13	FMPROF=X'03' TSPROF=X'03' PRIPROT=X'B1' SECPROT=X'B0' COMPROT=B'0011.000 10000.00' PSERVIC=X'01'	SCS3790 See note 2
14	FMPROF=X'03' TSPROF=X'04' PRIPROT=X'B1' SECPROT=X'B0' COMPROT=B'0111.000 10000.00' PSERVIC=B'00000001 00110001 00011000 0100000. 00000000 10010010 00000000 00000000 00000000 01010000'	
15	FMPROF=X'03' TSPROF=X'03' PRIPROT=X'B1' SECPROT=X'B0' COMPROT=B'0111.000 10000.00' PSERVIC=B'00000001 00110001 00001100 0111000. 00000000 11010010 00000000 00000000 00000000 11010000'	
16	FMPROF=X'04' TSPROF=X'04' PRIPROT=X'B1' SECPROT=X'B0' COMPROT=B'0111.000 10000.00'	See note 3
17	FMPROF=X'03' TSPROF=X'03' PRIPROT=X'B1' SECPROT=X'90' COMPROT=B'0111.000 10000.00' PSERVIC=B'00000001 00100000 00000000 0000000. 00000000 11000010 00000000 00000000 00000000 11000000'	

VTAM MODEENT macro operands

Table 41. LOGON mode table and ISTINCLM entries (continued)

RN	VTAM MODEENT macro entries that are needed for related CICS TYPETERM definitions	Suitable supplied entries
18	FMPROF=X'03' TSPROF=X'03' PRIPROT=X'B1' SECPROT=B'10..0000' COMPROT=B'0011.000 10000.00' PSERVIC=B'00000010 10000000 00000000 00000000 00000000 00000000 aaaaaaaaa bbbbbbbb ccccccc dddddddd eeeeeeee'	D329001 D4A32771 D4A32772 D4A32781 D4A32782 D4A32783 D4A32784 D4A32785 D4C32771 D4C32772 D4C32781 D4C32782 D4C32783 D4C32784 D4C32785 D6327801 D6327802 D6327803 D6327804 D6327805 EMUDPCX EMU3790 SNX32702 See note 1
19	FMPROF=X'03' TSPROF=X'03' PRIPROT=X'B1' SECPROT=B'10..0000' COMPROT=B'0011.000 10000.00' PSERVIC=B'00000011 10000000 00000000 00000000 00000000 00000000 aaaaaaaaa bbbbbbbb ccccccc dddddddd eeeeeeee'	BLK3790 DSC2K DSC4K D6328902 D6328904 See note 1
20	FMPROF=X'04' TSPROF=X'03' PRIPROT=X'31' SECPROT=X'B0' COMPROT=B'0111.000'	
21	FMPROF=X'04' TSPROF=X'04' PRIPROT=X'50' SECPROT=X'10' COMPROT=B'0000.000 00000.00'	
22	FMPROF=X'04' TSPROF=X'04' PRIPROT=X'B0' SECPROT=X'B0' COMPROT=B'0100.000 00000.00'	IBMS3650

VTAM MODEENT macro operands

Table 41. LOGON mode table and ISTINCLM entries (continued)

RN	VTAM MODEENT macro entries that are needed for related CICS TYPETERM definitions	Suitable supplied entries
23	FMPROF=X'04' TSPROF=X'04' PRIPROT=X'B1' SECPROT=X'B0' COMPROT=B'0111.000 00000.00'	
24	TYPE=X'00' FMPROF=X'13' TSPROF=X'07' PRIPROT=X'B0' SECPROT=X'B0' COMPROT=B'101.000 10110.01' PSERVIC='00000110 00000010 00000000 00000000 00000000 00000000 00000000 00000000 0010..00 00000000'	
<p>Notes:</p> <ol style="list-style-type: none"> 1. PSERVIC (RN 18 and 19): BYTE 2 BIT 0 should be set on where extended data stream (EXTDS) support is required. 2. RN 11 or 13 is used to determine the MODEENT macro operands for device SCSPRINT. However, if you have specified any of the attributes EXTENDED DS, COLOR, PROGSYMBOLS, HIGHLIGHT, SOSI, OUTLINE, QUERY(COLD), or QUERY(ALL) for the TYPETERM, then the COMPROT parameter of RN 13 should be modified to read COMPROT=B'0111.000 10000.00'. 3. This LOGMODE may be used for either device type 4700 in half duplex mode or device types BCHLU, 3770, 3770B and 3790 with SESSIONTYPE(USERPROG). To enable these devices to be autoinstalled with the correct model, the model names list supplied to the autoinstall exit will list the names of models defined as DEVICE(3600) after the names of all other eligible models. The exit can be coded to select a name from the end of the list for a 4700 half duplex device. 		

PSERVIC screen size values for LUTYPEx devices

Table 42 is to help you decide what screen size values you should specify on the PSERVIC operand of the VTAM MODEENT macro, for LUTYPE0, LUTYPE2, and LUTYPE3 devices.

If, on your CICS TYPETERM definition, you code the values shown in columns 1 through 4 of Table 42, the screen size values in the CICS model bind image are as shown in column 5. The values you code for screen sizes on the PSERVIC operand must match this.

Table 42. Autoinstall model device definition options

Device-type	DEFSCRN	ALTSCRN	QUERY	MODEL BIND
0,2,3	00,00	?	?	INVALID
0,2,3	12,40	,	?	000000001
0,2,3	12,40	00,00	?	0C2800007E
0,2,3	12,40	YY,YY	?	0C28YYYY7F
0,2,3	24,80	,	NO	000000002
3	24,80	,	COLD/ALL	000000002
0,2	24,80	,	COLD/ALL	000000003
0,2,3	24,80	00,00	?	185000007E
0,2,3	24,80	YY,YY	?	1850YYYY7F
0,2,3	XX,XX	,	?	XXXX00007E
0,2,3	XX,XX	00,00	?	XXXX00007E
0,2,3	XX,XX	YY,YY	?	XXXXYYYY7F

Where:

- 0** indicates local non-SNA 3270
- 2** indicates LUTYPE2
- 3** indicates LUTYPE3
- ,** indicates the default
- XX,XX** indicates a screen size that is not 12,40 or 24,80
- YY,YY** indicates a screen size that is not 00,00 or blanks
- ?** means any (that is, QUERY=ALL|COLD|NO, and ALTSCRN=any)

CICS treats some differently-coded PSERVIC screen size specifications as equivalent. See Table 43 on page 776.

PSERVIC screen size values

Table 43. Equivalent PSERVIC screen size values

Bytes 20—24 of CICS model bind	Valid screen size values on PSERVIC definition
0000 0000 01	0000 0000 00 0000 0000 01 0C28 0000 7E
0000 0000 02	0000 0000 00 0000 0000 02 1850 0000 7E
0000 0000 03	0000 0000 00 0000 0000 03 1850 0000 03
xxxx 0000 7E	0000 0000 00 xxxx 0000 7E
Plus, if xxxx=1850	0000 0000 02
xxxx yyyy 7F	0000 0000 00 xxxx yyyy 7F
Where:	
xxxx	indicates 2 bytes containing the default screen size, in hexadecimal
yyyy	indicates 2 bytes containing the alternate screen size, in hexadecimal

Matching models and LOGON mode entries

This section contains a set of VTAM LOGON mode table definitions, and their matching CICS autoinstall definitions. Each entry consists of a VTAM logmode definition, the matching CICS TYPETERM and model TERMINAL definitions, and (for information) the BIND that CICS sends based on the specified model definition.

Note that the CICS-specific attributes are purely arbitrary. Only device attributes affect the match algorithm. It is the responsibility of the autoinstall user program to distinguish between matching models.

```

*****
1) LOCAL NON-SNA 3277 / 3278 / 3279 (without special features)
*****
MT32772  MODEENT LOGMODE=MT32772, 3277/8      MODEL 2
        TYPE=1,
        FMPROF=X'02',
        TSPROF=X'02',
        PRIPROT=X'71',
        SECPROT=X'40',
        COMPROT=X'2000',
        PSERVIC=X'00000000000000000000200'

OR

        PSERVIC=X'00000000000018502B507F00' Others

OR

        PSERVIC=X'000000000000185000007E00' Model 2, no AltScreen

TERMINAL definition
*****
AUTINSTNAME  ==> M3278A

```

matching models and LOGON mode entries

```

AUTINSTMODEL ==> ONLY
GROUP        ==> PDATD
TYPETERM     ==> T3278
INSERVICE    ==> YES

TYPETERM definition
*****
TYPETERM     ==> T3278
GROUP        ==> PDATD
DEVICE       ==> 3270
TERMMODEL    ==> 2
LIGHTPEN     ==> YES
AUDIBLEALARM ==> YES
UCTRAN       ==> YES
IOAREALEN    ==> 2000,2000
ERRLASTLINE  ==> YES
ERRINTENSIFY ==> YES
USERAREALEN  ==> 32
ATI          ==> YES
TTI          ==> YES
AUTOCONNECT  ==> NO
LOGONMSG     ==> YES

BIND SENT BY CICS depends on PSERVIC value on LOGMODE definition above:
EITHER       : 01020271 40200000 00000080 00000000
              : 00000000 00000002 00009300 00300000
OR           : 01020271 40200000 00000080 00000000
              : 00000018 502B507F 00009300 00300000
OR           : 01020271 40200000 00000080 00000000
Real Model 2 : 00000018 5000007E 00009300 00300000

*****
2) LOCAL SNA 3277/78/79 (without special features) LUTYPE2
*****
S32782  MODEENT LOGMODE=S32782,  SNA LUTYPE2 3270
        TYPE=1,
        FMPROF=X'03',
        TSPROF=X'03',
        PRIPROT=X'B1',
        SECPROT=X'B0',
        COMPROT=X'3080',
        RUSIZES=X'8585',
        PSERVIC=X'028000000000185018507F00'

TERMINAL definition
*****
AUTINSTNAME  ==> M32782
AUTINSTMODEL ==> ONLY
GROUP        ==> PDATD
TYPETERM     ==> T32782
INSERVICE    ==> YES

TYPETERM definition
*****
TYPETERM     ==> T32782
GROUP        ==> PDATD
DEVICE       ==> LUTYPE2
TERMMODEL    ==> 2
LIGHTPEN     ==> YES
AUDIBLEALARM ==> YES
UCTRAN       ==> YES
IOAREALEN    ==> 256,256
ERRLASTLINE  ==> YES
ERRINTENSIFY ==> YES
USERAREALEN  ==> 32
ATI          ==> YES
TTI          ==> YES

```

matching models and LOGON mode entries

```
LOGONMSG      ==> YES
DISCREQ       ==> YES
RECEIVESIZE   ==> 256
BUILDCHAIN    ==> YES

BIND SENT BY CICS :          010303B1 B0308000 0085C780 00028000
                              00000018 5018507F 00000000 00000000

*****
3) 3770 BATCH LU (3777)
*****
BATCH      MODEENT LOGMODE=BATCH,    3770 BATCH
           TYPE=1,
           FMPROF=X'03',
           TSPROF=X'03',
           PRIPROT=X'B1',
           SECPROT=X'B0',
           COMPROT=X'7080',
           PSERVIC=X'01310C70E100D20000E100D0'

TERMINAL definition
*****
AUTINSTNAME  ==> M3770
AUTINSTMODEL ==> ONLY
GROUP        ==> PDATD
TYPETERM     ==> T3770
INSERVICE    ==> YES

TYPETERM definition
*****
TYPETERM     ==> T3770
GROUP        ==> PDATD
DEVICE       ==> 3770
SESSIONTYPE  ==> BATCHDI
PAGESIZE     ==> 12,80
DISCREQ      ==> YES
AUTOPAGE     ==> YES
RECEIVESIZE  ==> 256
SENDSIZE     ==> 256
IOAREALEN    ==> 256,2048
BUILDCHAIN   ==> YES
BRACKET      ==> YES
ATI          ==> YES
TTI          ==> YES
AUTOCONNECT  ==> NO
HORIZFORM    ==> YES
VERTFORM     ==> YES
LDCLIST      ==> LDC2

Needs LDC declaration in TCT :
LDC2  DFHTCT TYPE=LDC,LOCAL=INITIAL
      DFHTCT TYPE=LDC,LDC=BCHLU
      DFHTCT TYPE=LDC,LOCAL=FINAL

BIND SENT BY CICS :          010303B1 B0708000 00000080 0001310C
                              70E100D2 0000E100 D0000000 00000000

*****
4) 6670 LUTYPE4
*****
S6670      MODEENT LOGMODE=S6670,    6670 LUTYPE4
           TYPE=1,
           FMPROF=X'07',
           TSPROF=X'07',
           RUSIZES=X'8585',
           PRIPROT=X'B1',
           SECPROT=X'B0',
           COMPROT=X'5081',
           PSERVIC=X'04A840A000A840A0000000C00'
```

matching models and LOGON mode entries

TERMINAL definition

```
*****
AUTINSTNAME ==> M6670
AUTINSTMODEL ==> ONLY
GROUP ==> PDATD
TYPETERM ==> T6670
INSERVICE ==> YES
```

TYPETERM definition

```
*****
TYPETERM ==> T6670
GROUP ==> PDATD
DEVICE ==> LUTYPE4
BUILDCHAIN ==> YES
DISCREQ ==> YES
RECEIVESIZE ==> 256
UCTRAN ==> YES
IOAREALEN ==> 256,4096
FORMFEED ==> YES
HORIZFORM ==> YES
VERTFORM ==> YES
ATI ==> YES
TTI ==> YES
PAGESIZE ==> 50,80
AUTOPAGE ==> YES
LOGONMSG ==> NO
LDCLIST ==> LDC1
```

Needs LDC declaration in TCT :

```
LDCS DFHTCT TYPE=LDC,LDC=SYSTEM
LDC1 DFHTCT TYPE=LDC,LOCAL=INITIAL
DFHTCT TYPE=LDC,DVC=(BLUCON,01),PROFILE=DEFAULT,LDC=PC,
PGESIZE=(50,80),PGESTAT=AUTOPAGE
DFHTCT TYPE=LDC,DVC=(BLUPRT,02),PROFILE=BASE,LDC=PP,
PGESIZE=(50,80),PGESTAT=AUTOPAGE
DFHTCT TYPE=LDC,DVC=(BLUPRT,08),PROFILE=BASE,LDC=P8,
PGESIZE=(50,80),PGESTAT=AUTOPAGE
DFHTCT TYPE=LDC,DVC=(BLUPRT,08),PROFILE=DEFAULT,LDC=DP,
PGESIZE=(50,80),PGESTAT=AUTOPAGE
DFHTCT TYPE=LDC,DVC=(BLUPCH,03),PROFILE=JOB,LDC=PM,
PGESIZE=(50,80),PGESTAT=AUTOPAGE
DFHTCT TYPE=LDC,DVC=(BLUPCH,03),PROFILE=DEFAULT,LDC=DM,
PGESIZE=(50,80),PGESTAT=AUTOPAGE
DFHTCT TYPE=LDC,DVC=(WPMED1,04),PROFILE=WPRAW,LDC=P1,
PGESIZE=(50,80),PGESTAT=AUTOPAGE
DFHTCT TYPE=LDC,DVC=(WPMED1,04),PROFILE=DEFAULT,LDC=D1,
PGESIZE=(50,80),PGESTAT=AUTOPAGE
DFHTCT TYPE=LDC,DVC=(WPMED2,05),PROFILE=OII1,LDC=P2,
PGESIZE=(50,80),PGESTAT=AUTOPAGE
DFHTCT TYPE=LDC,DVC=(WPMED2,05),PROFILE=DEFAULT,LDC=D2,
PGESIZE=(50,80),PGESTAT=AUTOPAGE
DFHTCT TYPE=LDC,DVC=(WPMED3,06),PROFILE=OII2,LDC=P3,
PGESIZE=(50,80),PGESTAT=AUTOPAGE
DFHTCT TYPE=LDC,DVC=(WPMED4,07),PROFILE=OII3,LDC=P4,
PGESIZE=(50,80),PGESTAT=AUTOPAGE
DFHTCT TYPE=LDC,LOCAL=FINAL
```

```
BIND SENT BY CICS : 010707B1 B0508100 00858580 0004A840
A000A840 A000000C 00000000 00000000
```

```
*****
```

5) 3790 FULL FUNCTION LU

```
*****
```

```
S3790A MODEENT LOGMODE=S3790A, 3790 FULL FUNCTION LU
TYPE=1,
FMPROF=X'04',
TSPROF=X'04',
```

matching models and LOGON mode entries

```
PRIPROT=X'B1',  
SECPROT=X'B0',  
RUSIZES=X'8585',  
COMPROT=X'7080'
```

TERMINAL definition

```
*****
```

```
AUTINSTNAME ==> M3790A  
AUTINSTMODEL ==> ONLY  
GROUP ==> PDATD  
TYPETERM ==> T3790A  
INSERVICE ==> YES
```

TYPETERM definition

```
*****
```

```
TYPETERM ==> T3790A  
GROUP ==> PDATD  
DEVICE ==> 3790  
SENDSIZE ==> 256  
RECEIVESIZE ==> 256  
SESSIONTYPE ==> USERPROG  
BRACKET ==> YES  
IOAREALEN ==> 256  
ATI ==> YES  
TTI ==> YES
```

```
BIND SENT BY CICS : 010404B1 B0708000 00858580 00000000
```

```
*****
```

6) 3790 BATCH DATA INTERCHANGE

```
*****
```

```
S3790B MODEENT LOGMODE=S3790B, 3790 BATCH
```

```
TYPE=1,  
FMPPROF=X'03',  
TSPROF=X'04',  
PRIPROT=X'B1',  
SECPROT=X'B0',  
COMPROT=X'7080',  
RUSIZES=X'8585',  
PSERVIC=X'013118400000920000E10050'
```

TERMINAL definition

```
*****
```

```
AUTINSTNAME ==> M3790B  
AUTINSTMODEL ==> ONLY  
GROUP ==> PDATD  
TYPETERM ==> T3790B  
INSERVICE ==> YES  
TERMPRIORITY ==> 50
```

TYPETERM definition

```
*****
```

```
TYPETERM ==> T3790B  
GROUP ==> PDATD  
DEVICE ==> 3790  
SESSIONTYPE ==> BATCHDI  
AUTOPAGE ==> YES  
BUILDCHAIN ==> YES  
OBOPERID ==> YES  
IOAREALEN ==> 256,2048  
RELREQ ==> YES  
SENDSIZE ==> 256  
RECEIVESIZE ==> 256  
ATI ==> YES  
TTI ==> YES  
LDCLIST ==> LDC2
```

Needs LDC declaration in TCT :

```
LDC2 DFHTCT TYPE=LDC,LOCAL=INITIAL  
DFHTCT TYPE=LDC,LDC=BCHLU  
DFHTCT TYPE=LDC,LOCAL=FINAL
```

matching models and LOGON mode entries

BIND SENT BY CICS : 010304B1 B0708000 00858580 00013118
 40000092 0000E100 50000000 00000000

7) 3790 SCSVRT

S3790C MODEENT LOGMODE=S3790C, 3790 WITH SCS
 TYPE=1,
 FMPROF=X'03',
 TSPROF=X'03',
 PRIPROT=X'B1',
 SECPROT=X'B0',
 COMPROT=X'3080',
 RUSIZES=X'8585',
 PSERVIC=X'0100000000000000000000'

TERMINAL definition

AUTINSTNAME ==> M3790C
AUTINSTMODEL ==> ONLY
GROUP ==> PDATD
TYPETERM ==> T3790C
INSERVICE ==> YES

TYPETERM definition

TYPETERM ==> T3790C Note that CEDA changes DEVICE=3790,
GROUP ==> PDATD SESSIONTYPE=SCSPRT to DEVICE=SCSPRINT,
DEVICE ==> 3790 SESSIONTYPE=blanks, PRINTERTYPE=3284.
SESSIONTYPE ==> SCSVRT
BRACKET ==> YES
SENDSIZE ==> 256
RECEIVESIZE ==> 256
ATI ==> YES
TTI ==> YES

BIND SENT BY CICS : 010303B1 B0308000 00858580 00010000

8) 3767 INTERACTIVE (FLIP-FLOP) LU

S3767 MODEENT LOGMODE=S3767, 3767 INTERACTIVE
 TYPE=1,
 FMPROF=X'03',
 TSPROF=X'03',
 PRIPROT=X'B1',
 SECPROT=X'90',
 COMPROT=X'3080',
 PSERVIC=X'0100000000000000000000'

TERMINAL definition

AUTINSTNAME ==> M3767
AUTINSTMODEL ==> ONLY
GROUP ==> PDATD
TERMPRIORITY ==> 60
TYPETERM ==> T3767
INSERVICE ==> YES

TYPETERM definition

TYPETERM ==> T3767
GROUP ==> PDATD
DEVICE ==> 3767
VERTFORM ==> YES
HORIZFORM ==> YES
RELREQ ==> YES
DISCREQ ==> YES
IOAREALEN ==> 256
AUTOPAGE ==> NO
PAGESIZE ==> 12,80

matching models and LOGON mode entries

```
ATI          ==> YES
TTI          ==> YES
BRACKET      ==> YES
RECEIVESIZE ==> 256
SENDSIZE     ==> 256

BIND SENT BY CICS :          010303B1 90308000 00000080 00010000
*****
9) 3650 INTERPRETER LU
   (SESTYPE = USERPROG BRACKET = YES)
*****
S3650A  MODEENT LOGMODE=S3650A,  3650 SESTYPE=USERPROG
        TYPE=1,                  BRACKET=YES
        FMPROF=X'04',
        TSPROF=X'04',
        PRIPROT=X'31',
        SECPROT=X'30',
        COMPROT=X'6000'

TERMINAL definition
*****
AUTINSTNAME  ==> M3650A
AUTINSTMODEL ==> ONLY
GROUP        ==> PDATD
TYPETERM     ==> T3650A
INSERVICE    ==> YES

TYPETERM definition
*****
TYPETERM     ==> T3650A
GROUP        ==> PDATD
DEVICE       ==> 3650
SESSIONTYPE  ==> USERPROG
ROUTEDMSGS  ==> SPECIFIC
FMHPARM     ==> YES
RELREQ      ==> YES
DISCREQ     ==> YES
BRACKET     ==> YES
RECEIVESIZE ==> 256
IOAREALEN   ==> 256,256
ATI         ==> YES
TTI         ==> YES
AUTOCONNECT ==> NO

BIND SENT BY CICS :          01040431 30600000 00000080 00000000
*****
10) 3650 HOST CONVERSATIONAL (3270) LU
*****
S3650B  MODEENT LOGMODE=S3650B,  3650 SESTYPE=3270
        AND SESTYPE=3653
        TYPE=1,
        FMPROF=X'04',
        TSPROF=X'03',
        PRIPROT=X'B1',
        SECPROT=X'90',
        COMPROT=X'6000'

TERMINAL definition
*****
AUTINSTNAME  ==> M3650B1
AUTINSTMODEL ==> ONLY
GROUP        ==> PDATD
TYPETERM     ==> T3650B1
INSERVICE    ==> YES

TYPETERM definition
*****
TYPETERM     ==> T3650B1
GROUP        ==> PDATD
DEVICE       ==> 3650
OBFORMAT     ==> YES
```

matching models and LOGON mode entries

```

SESSIONTYPE ==> 3270
RELREQ      ==> YES
DISCREQ    ==> YES
IOAREALEN  ==> 256
BRACKET    ==> YES
RECEIVESIZE ==> 240
ATI        ==> NO
TTI        ==> YES

BIND SENT BY CICS :          010403B1 90600000 00000080 00000000
*****
11) 3650 HOST CONVERSATIONAL (3653) LU
    (N.B. LOGMODE SAME AS HC (3270) LU)
*****
S3650B  MODEENT LOGMODE=S3650B,   3650 SESTYPE=3270
        TYPE=1,                   AND SESTYPE=3653
        FMPROF=X'04',
        TSPROF=X'03',
        PRIPROT=X'B1',
        SECPROT=X'90',
        COMPROT=X'6000'

TERMINAL definition
*****
AUTINSTNAME ==> M3650B2
AUTINSTMODEL ==> ONLY
GROUP       ==> PDATD
TYPETERM   ==> T3650B2
INSERVICE  ==> YES

TYPETERM definition
*****
TYPETERM   ==> T3650B2
GROUP      ==> PDATD
DEVICE     ==> 3650
SESSIONTYPE ==> 3653
RELREQ     ==> YES
DISCREQ    ==> NO
BRACKET    ==> YES
IOAREALEN  ==> 256
RECEIVESIZE ==> 240
ROUTEDMSGS ==> NONE
ATI        ==> NO
TTI        ==> YES

BIND SENT BY CICS :          010403B1 90600000 00000080 00000000
*****
12) 3650 HOST COMMAND PROCESSOR LU
    (SESTYPE = USERPROG BRACKET = NO)
*****
S3650C  MODEENT LOGMODE=S3650C,   3650 SESTYPE=USERPROG
        TYPE=1,                   BRACKET=NO
        FMPROF=X'04',
        TSPROF=X'04',
        PRIPROT=X'B0',
        SECPROT=X'30',
        COMPROT=X'4000'

TERMINAL definition
*****
AUTINSTNAME ==> M3650C
AUTINSTMODEL ==> ONLY
GROUP       ==> PDATD
TYPETERM   ==> T3650C
INSERVICE  ==> YES

TYPETERM definition
*****
TYPETERM   ==> T3650C
GROUP      ==> PDATD

```

matching models and LOGON mode entries

```
DEVICE          ==> 3650
SESSIONTYPE    ==> USERPROG
BRACKET        ==> NO
RELREQ         ==> NO
DISCREQ        ==> NO
RECEIVESIZE    ==> 256
IOAREALEN      ==> 256
ATI            ==> YES
TTI            ==> YES

BIND SENT BY CICS :          01040430 30400000 00000080 00000000
*****
13) 8815 SCANMASTER (APPC SINGLE SESSION)
*****
SIN62  MODEENT LOGMODE=SIN62,      8815 SCANMASTER.
      TYPE=0,
      FMPROF=X'13',
      TSPROF=X'07',
      PRIPROT=X'B0',
      SECPROT=X'B0',
      COMPROT=X'50B1',
      PSNDPAC=X'00',
      SRCVPAC=X'00',
      SSNDPAC=X'00',
      RUSIZES=X'8585',
      PSERVIC=X'060200000000000000002C00'

TERMINAL definition
*****
AUTINSTNAME    ==> MLU62
AUTINSTMODEL   ==> ONLY
GROUP          ==> PDATD
TYPETERM       ==> SINLU62
INSERVICE      ==> YES

TYPETERM definition
*****
TYPETERM       ==> SINLU62
GROUP          ==> PDATD
DEVICE         ==> APPC
RECEIVESIZE    ==> 2048
SENDSIZE       ==> 2048
ATI            ==> YES
TTI            ==> YES

Note: There is no RDO keyword equivalent of the MACRO
keyword 'FEATURE=SINGLE', because this is assumed with
RDO DEFINE TYPETERM when DEVICE=APPC.

BIND SENT BY CICS :          001307B0 B050B100 00858580 00060200
                              00000000 0000002C 00000080 00000000
                              0000001D 00090240 40404040 40404009
                              03006765 71D98A6C 300704C3 C9C3E2E6
                              F1000000 00000000 00000000 00000000
*****
14) 3290 (SDLC)
*****
S3290  MODEENT LOGMODE=S3290,      3290 SDLC
      TYPE=1,
      FMPROF=X'03',
      TSPROF=X'03',
      PRIPROT=X'B1',
      SECPROT=X'90',
      COMPROT=X'3080',
      RUSIZES=X'8787',
      PSERVIC=X'02800000000018503EA07F00'

TERMINAL definition
*****
AUTINSTNAME    ==> M3290
```

matching models and LOGON mode entries

```
AUTINSTMODEL ==> ONLY
GROUP        ==> PDATD
TYPETERM     ==> T3290
INSERVICE    ==> YES
```

TYPETERM definition

```
*****
```

```
TYPETERM     ==> T3290
GROUP        ==> PDATD
DEVICE       ==> LUTYPE2
TERMMODEL    ==> 2
ALTSCREEN    ==> 62,160
DEFSCREEN    ==> 24,80
AUDIBLEALARM ==> YES
UCTRAN       ==> YES
IOAREALEN   ==> 2000,2000
ERRLASTLINE ==> YES
ERRINTENSIFY ==> YES
USERAREALEN ==> 32
ATI          ==> YES
TTI          ==> YES
LOGONMSG     ==> YES
ERRHILIGHT  ==> BLINK
RECEIVESIZE ==> 1024
```

```
BIND SENT BY CICS :      010303B1 90308000 00878780 00028000
                        00000018 503EA07F 00000000 00000000
```

```
*****
```

```
15) 3601 WITH A 3604 ATTACHED
```

```
*****
```

```
S3600  MODEENT LOGMODE=S3600,  3601
                TYPE=1,
                FMPROF=X'04',
                TSPROF=X'04',
                PRIPROT=X'B1',
                SECPROT=X'B0',
                COMPROT=X'7000',
                RUSIZES=X'0000'
```

TERMINAL definition

```
*****
```

```
AUTINSTNAME  ==> M3600
AUTINSTMODEL ==> ONLY
GROUP        ==> PDATD
TERMPRIORITY ==> 50
TYPETERM     ==> T3600
INSERVICE    ==> YES
```

TYPETERM definition

```
*****
```

```
TYPETERM     ==> T3600
GROUP        ==> PDATD
DEVICE       ==> 3600
AUTOPAGE     ==> NO
PAGESIZE     ==> 6,40
RELREQ       ==> YES
DISCREQ      ==> NO
IOAREALEN   ==> 256
SENDSIZE     ==> 224
RECEIVESIZE ==> 256
USERAREALEN ==> 100
ATI          ==> NO
TTI          ==> YES
BRACKET      ==> YES
LDCLIST      ==> BMSLLDC1
```

Needs LDC declaration in TCT :

```
BMSLLDC1 DFHTCT TYPE=LDCLIST,
          LDC=(DS,JP,PB=5,LP,MS)
          DFHTCT TYPE=LDC,
```

matching models and LOGON mode entries

```
LDC=(DS=1),
DVC=3604,
PGESIZE=(6,40),
PGESTAT=PAGE
DFHTCT TYPE=LDC,LDC=SYSTEM
BIND SENT BY CICS :          010404B1 B0700000 00000080 00000000
```

LOGON mode definitions for CICS-supplied autoinstall models

This section contains VTAM LOGON mode table definitions that match the CICS-supplied TYPETERM and model TERMINAL definitions for autoinstall. The first six entries are example definitions; that is, they are not supplied with VTAM.

```
DFHLU3  MODEENT LOGMODE=DFHLU3, LU TYPE 3 PRINTER.
        TYPE=1,
        FMPROF=X'03',
        TSPROF=X'03',
        PRIPROT=X'B1',
        SECPROT=X'B0',
        COMPROT=X'3080',
        RUSIZES=X'8585',
        PSERVIC=X'03800000000000000000200'

DFHSCSP MODEENT LOGMODE=DFHSCSP, LU TYPE 1 SCS PRINTER
        TYPE=1,
        FMPROF=X'03',
        TSPROF=X'03',
        PRIPROT=X'B1',
        SECPROT=X'B0',
        COMPROT=X'7080',
        RUSIZES=X'8585',
        PSERVIC=X'010000010000000000000000'

DFHLU62T MODEENT LOGMODE=DFHLU62T, APPC SINGLE-SESSION
        TYPE=0,
        FMPROF=X'13',
        TSPROF=X'07',
        PRIPROT=X'B0',
        SECPROT=X'B0',
        COMPROT=X'50B1',
        RUSIZES=X'8888',
        PSERVIC=X'060200000000000000002C00'

DFH3270 MODEENT LOGMODE=DFH3270, 3270
        TYPE=1,
        FMPROF=X'02',
        TSPROF=X'02',
        PRIPROT=X'71',
        SECPROT=X'40',
        COMPROT=X'2000',
        RUSIZES=X'0000'

DFH3270P MODEENT LOGMODE=DFH3270P, 3284/3286 BISYNC 3270P (QUERY)
        TYPE=1,
        FMPROF=X'02',
        TSPROF=X'02',
        PRIPROT=X'71',
        SECPROT=X'40',
        COMPROT=X'2000',
        RUSIZES=X'0000'
```

matching models and LOGON mode entries

```
DFHFLU2  MODEENT LOGMODE=DFHFLU2,   SNA LUTYPE2 3270
          TYPE=1,
          FMPROF=X'03',
          TSPROF=X'03',
          PRIPROT=X'B1',
          SECPROT=X'B0',
          COMPROT=X'3080',
          RUSIZES=X'85C7',
          PSERVIC=X'028000000000000000000000300'
```

The following entries are those LOGMODE definitions supplied by VTAM that match CICS-supplied TYPETERM definitions.

```
DFHFLU0E2 MODEENT LOGMODE=NSX32702, LU0 model 2 queryable
          FMPROF=X'02',
          TSPROF=X'02',
          PRIPROT=X'71',
          SECPROT=X'40',
          COMPROT=X'2000',
          RUSIZES=X'0000',
          PSERVIC=X'00800000000000185000007E00'
```

```
DFHFLU0M2 MODEENT LOGMODE=D4B32782, LU0 model 2 nonqueryable
          FMPROF=X'02',
          TSPROF=X'02',
          PRIPROT=X'71',
          SECPROT=X'40',
          COMPROT=X'2000',
          RUSIZES=X'0000',
          PSERVIC=X'00000000000000185000007E00'
```

```
DFHFLU0M3 MODEENT LOGMODE=D4B32783, LU0 model 3 nonqueryable
          FMPROF=X'02',
          TSPROF=X'02',
          PRIPROT=X'71',
          SECPROT=X'40',
          COMPROT=X'2000',
          RUSIZES=X'0000',
          PSERVIC=X'00000000000000185020507F00'
```

```
DFHFLU0M4 MODEENT LOGMODE=D4B32784, LU0 model 4 nonqueryable
          FMPROF=X'02',
          TSPROF=X'02',
          PRIPROT=X'71',
          SECPROT=X'40',
          COMPROT=X'2000',
          RUSIZES=X'0000',
          PSERVIC=X'0000000000000018502B507F00'
```

```
DFHFLU0M5 MODEENT LOGMODE=D4B32785, LU0 model 5 nonqueryable
          FMPROF=X'02',
          TSPROF=X'02',
          PRIPROT=X'71',
          SECPROT=X'40',
          COMPROT=X'2000',
          RUSIZES=X'0000',
          PSERVIC=X'0000000000000018501B847F00'
```

```
DFHFLU2E2 MODEENT LOGMODE=SNX32702, LU2 model 2 queryable
          FMPROF=X'03',
          TSPROF=X'03',
          PRIPROT=X'B1',
          SECPROT=X'90',
          COMPROT=X'3080',
          RUSIZES=X'87F8',
          PSERVIC=X'02800000000000185000007E00'
```

matching models and LOGON mode entries

```
DFHLU2E3 MODEENT LOGMODE=SNX32703, LU2 model 3 queryable
    FMPROF=X'03',
    TSPROF=X'03',
    PRIPROT=X'B1',
    SECPROT=X'90',
    COMPROT=X'3080',
    RUSIZES=X'87F8',
    PSERVIC=X'028000000000185020507F00'
DFHLU2E4 MODEENT LOGMODE=SNX32704, LU2 model 4 queryable
    FMPROF=X'03',
    TSPROF=X'03',
    PRIPROT=X'B1',
    SECPROT=X'90',
    COMPROT=X'3080',
    RUSIZES=X'87F8',
    PSERVIC=X'02800000000018502B507F00'
DFHLU2M2 MODEENT LOGMODE=D4A32782, LU2 model 2 nonqueryable
    FMPROF=X'03',
    TSPROF=X'03',
    PRIPROT=X'B1',
    SECPROT=X'90',
    COMPROT=X'3080',
    RUSIZES=X'87C7',
    PSERVIC=X'020000000000185000007E00'
DFHLU2M3 MODEENT LOGMODE=D4A32783, LU2 model 3 nonqueryable
    FMPROF=X'03',
    TSPROF=X'03',
    PRIPROT=X'B1',
    SECPROT=X'90',
    COMPROT=X'3080',
    RUSIZES=X'87C7',
    PSERVIC=X'020000000000185020507F00'
DFHLU2M4 MODEENT LOGMODE=D4A32784, LU2 model 4 nonqueryable
    FMPROF=X'03',
    TSPROF=X'03',
    PRIPROT=X'B1',
    SECPROT=X'90',
    COMPROT=X'3080',
    RUSIZES=X'87C7',
    PSERVIC=X'02000000000018502B507F00'
DFHLU2M5 MODEENT LOGMODE=D4A32785, LU2 model 5 nonqueryable
    FMPROF=X'03',
    TSPROF=X'03',
    PRIPROT=X'B1',
    SECPROT=X'90',
    COMPROT=X'3080',
    RUSIZES=X'87C7',
    PSERVIC=X'02000000000018501B847F00'
```

Appendix B. Default actions of the node abnormal condition program

This appendix describes the default actions of the node abnormal condition program, DFHZNAC. The actions vary, depending on the terminal error code and system sense codes received from VTAM. In most cases, DFHZNAC issues messages and sets one or more “action flags” in the communication area passed to the node error program, DFHZNEP. DFHZNEP then has the opportunity to change the default actions (though not the messages) by setting or resetting flags. (Note, however, that in some circumstances, the actions actually taken can vary from the actions set, depending on the state of the node at the time of the error.)

For more information about DFHZNAC and DFHZNEP, see “Chapter 9. Writing a node error program” on page 449.

The appendix is divided into the following sections:

1. “Default actions for terminal error codes”
2. “CICS messages associated with VTAM errors” on page 795
3. “Default actions for system sense codes” on page 800
4. “Action flag settings and meanings” on page 802.

Default actions for terminal error codes

Terminal error codes from VTAM are put in a 1-byte field (TWAEC) of the communications area passed to DFHZNEP.

Table 44 shows the message issued and action flags set by DFHZNAC for each terminal error code.

For error codes with CICS messages associated with them, see the *CICS Messages and Codes* manual for descriptions of the corresponding error conditions.

The figures in the “Action flags set” column are translated into bit settings and explained in Table 47 on page 802.

Table 44. Messages issued and flags set by DFHZNAC for specific error codes

Error code	Symbolic label	Message	Action flags set
X'10'	TCZSRCTU	DFHZC2405	18
X'11'	TCZSRCBF	DFHZC2403	2 5 18 24
X'13'	TCZSRCVH	DFHZC2416	18 24
X'14'	TCZLRCER	DFHZC2404	2 3 9 10 11 23 24
X'15'	TCZSRCPF	DFHZC2407	2 3 9 10 11 24
X'16'	TCZDMIT	DFHZC3492	None
X'18'	TCZLRCNR	DFHZC2404	2 3 9 10 11 23 24
X'19'	TCZSRCTS	DFHZC2406	9 10 11 18
X'1A'	TCZSRCVE	DFHZC2408	2 3 9 10 11 24
X'1D'	TCZSRCVI	DFHZC2417	2 24

default actions of DFHZNAC

Table 44. Messages issued and flags set by DFHZNAC for specific error codes (continued)

Error code	Symbolic label	Message	Action flags set
X'1E'	TCZSRCV2	DFHZC2408	2 3 9 10 11 24
X'20'	TCZVTAMI	DFHZC2417	None
X'21'	TCZLUCF1	DFHZC4902	3 9 10 11 24
X'22'	TCZLUCF2	DFHZC4903	3 9 10 11 24
X'23'	TCZFSMBE	DFHZC4904	3 9 10 11 24
X'24'	TCZFSMCS	DFHZC4905	3 9 10 11 24
X'25'	TCZFSMCR	DFHZC4906	3 9 10 11 24
X'26'	TCZSDLER	DFHZC4907	3 9 10 11 24
X'28'	TCZRVLER	DFHZC4909	3 9 10 11 24
X'29'	TCZRVLRB	DFHZC4910	3 9 10 11 24
X'2A'	TCZRLPEX	DFHZC4911	2 3 9 10 11 24
X'2B'	TCZRLPBD	DFHZC4912	2 3 9 10 11 24
X'2C'	TCZRLPDR	DFHZC4913	2 3 9 10 11 24
X'2D'	TCZRLPIL	DFHZC4914	2 3 9 10 11 24
X'2E'	TCZRLPEC	DFHZC4915	2 3 9 10 11 24
X'2F'	TCZRLPRR	DFHZC4916	2 3 9 10 11 24
X'30'	TCZRLPIF	DFHZC4917	2 3 9 10 11 24
X'31'	TCZRLPIR	DFHZC4918	2 3 9 10 11 24
X'32'	TCZRLXCL	DFHZC4922	20
X'33'	TCZIVIND	DFHZC4919	2 3 9 10 11 24
X'34'	TCZIVDAT	DFHZC4920	2 3 9 10 11 24
X'35'	TCZRTMT	DFHZC4930	2 3 9 10 11 24
X'36'	TCZXSBL	None	24
X'37'	TCZXSHRA	DFHZC3470	9 10 11 24
X'38'	TCZXSWAS	DFHZC6596	2 3 15 24
X'39'	TCZXSABN	DFHZC6595	2 3 5 24
X'3A'	TCZXSHR	DFHZC6594	24
X'3B'	TCZXSBC	DFHZC6593	None
X'3C'	TCZXUVAR	DFHZC3488	2 3 9 10 11 24
X'3D'	TCZXMSG	None	None
X'3E'	TCZXERR	DFHZC6591	9 10 11 15 24
X'3F'	TCZXRST	DFHZC6590	None
X'40'	TCZINCPY	DFHZC2489	3 9 11
X'41'	TCZTOLRQ	DFHZC2490	2 3 9 10 11 15 24
X'42'	TCZUNPRT	DFHZC2497 ¹	None
X'43'	TCZCPYNS	DFHZC2434	3 11
X'44'	TCZSRCDE	DFHZC2456	2 3 9 10 11 24
X'45'	TCZCHMX	DFHZC3400	3 10 11 22
X'46'	TCZOCIR	DFHZC3402	3 9 10 11
X'47'	TCZGMMS	None ²	13

default actions of DFHZNAC

Table 44. Messages issued and flags set by DFHZNAC for specific error codes (continued)

Error code	Symbolic label	Message	Action flags set
X'48'	TCZOPSIN	DFHZC3461	None
X'49'	TCZCLSIN	DFHZC3462	None
X'4A'	TCZOPACB	DFHZC3463	None
X'4B'	TCZICPUT	DFHZC2498	None
X'4C'	TCZDSPCL	DFHZC3481	2 3 9 10 11 24
X'4D'	TCZSLRSL	DFHZC3473	None
X'4E'	TCZUNBFE	DFHZC3479	2 3 9 10 11 24
X'4F'	TCZCNOS0	None	None
X'50'	TCZSDRE3	DFHZC3417	3 9 10 11 24
X'51'	TCZBDPRI	DFHZC3418	3 9 10 11 24
X'52'	TCZBDUAC	DFHZC3419	2 3 5
X'53'	TCZBDTOS	DFHZC3420	20
X'54'	TCZUNBIS	DFHZC3434	2 3 9 10 11 24
X'55'	TCZEMWBK	DFHZC3440	None
X'56'	TCZXRFS	DFHZC6598	None
X'57'	TCZRELIS	DFHZC3464	20
X'58'	TCZERMGR	DFHZC3433	None
X'59'	TCZROCT	DFHZC2443	2 3 9 10 11 24
X'5A'	TCZSBIRV	DFHZC3421	20
X'5B'	TCZNSP01	DFHZC3422	2 3 9 10 11 24
X'5C'	TCZNSP02	DFHZC3424	9 10 11 15 24
X'5D'	TCZPRDTC	DFHZC0101	None
X'5E'	TCZBRUAC	DFHZC3454	2 3 5 18 24
X'5F'	TCZBDSQP	DFHZC3455	2 3 5 18 24
X'60'	TCZUNCMD	DFHZC2421	2 3 9 10 11 24
X'62'	TCZVTAMQ	None ³	24
X'63'	TCZVTAMO	DFHZC3441	None
X'64'	TCZVTAMA	DFHZC3443	None
X'65'	TCZINVR	DFHZC2448	2 3 10 11 22 23 24
X'66'	TCZSISR	DFHZC3452	None
X'67'	TCZVTAMK	DFHZC3442	None
X'69'	TCZSEXOS	DFHZC3466	20 23
X'6A'	TCZTIOAE	DFHZC3444	1 2 3 9 10 11 24
X'6B'	TCZNOTNA	DFHZC3495	24
X'6C'	TCZPSAF	DFHZC0155	3 6 9 10 11 24
X'6D'	TCZPSAR	DFHZC0156	None
X'70'	TCZCLRRV	DFHZC3468	9 10 11 15 24
X'71'	TCZPSLE	DFHZC0147	3 6 9 10 11 24
X'72'	TCZPSVF	DFHZC0148	9 10 11 24
X'73'	TCZSDSE4	DFHZC2437	3 9 11

default actions of DFHZNAC

Table 44. Messages issued and flags set by DFHZNAC for specific error codes (continued)

Error code	Symbolic label	Message	Action flags set
X'74'	TCZSDSE5	DFHZC2423	3 9 10 11 24
X'75'	TCZSESE1	DFHZC2424	3 9 10 11 15 24
X'76'	TCZLGNA	DFHZC2487	3
X'77'	TCZDMRY	DFHZC2488	None
X'78'	TCZSDRE2	DFHZC2430	3 9 11 22
X'79'	TCZPSRAF	DFHZC0145	3 6 9 10 11 24
X'7A'	TCZPSRAC	DFHZC0144	11
X'7D'	TCZRABUS	DFHZC4949	2 3 9 10 11 24
X'80'	TCZSRCSP	DFHZC2414	None
X'81'	TCZSSXNR	DFHZC2432	None
X'82'	TCZSSXUC	DFHZC2419	2 3 9 10 11 23 24
X'83'	TCZSSXAR	DFHZC2450	None
X'84'	TCZSSXIB	DFHZC2446	2 3 9 10 11 23 24
X'85'	TCZUNEGR	DFHZC3409	2 3 9 10 11 23 24
X'88'	TCZLEXCI	DFHZC2467	2 3 9 10 11 23 24
X'89'	TCZLEXUS	DFHZC2468	2 3 9 10 11 24
X'8A'	TCZLUSRR	DFHZC4937	2 3 5 24
X'8B'	TCZLUSRF	DFHZC4938	2 3 5 24
X'8C'	TCZLUPUN	DFHZC4939	2 3 5 24
X'8D'	TCZLUPLK	DFHZC4941	2 3 5 24
X'8E'	TCZLUPEX	DFHZC4942	2 3 5 24
X'8F'	TCZLUSKN	DFHZC4940	2 3 5 24
X'90'	TCZLGCER	DFHZC2422	1 2 3 6 9 10 11 23 24
X'91'	TCZRSTLE	DFHZC2429	3 10 11
X'92'	TCZSDSE6	DFHZC2428	3 9 11
X'93'	TCZRACET	DFHZC2455	2 3 9 10 11
X'94'	TCZRACES	DFHZC2426	2 3 9 10 11 22
X'95'	TCZSDSE8	DFHZC2445	3 9 11
X'96'	TCZRVSZ1	DFHZC2435	3 10 11 24
X'97'	TCZRVSZ3	DFHZC2436	3 10 11
X'98'	TCZACT01	DFHZC2439	2 18
X'99'	TCZSDSE7	DFHZC2459	3 9 11
X'9A'	TCZDOMCF	DFHZC2447	3 9 10 11 23
X'9B'	TCZRACNL	DFHZC2486	3
X'9D'	TCZRSPER	DFHZC3465	1 2 3 9 10 11 23
X'9E'	TCZDEVND	DFHZC3472	None
X'A0'	TCZNOISC	DFHZC3480	23 24
X'A1'	TCZRVSZ2	DFHZC2438	3 10 11
X'A2'	TCZPRGE	DFHZC4945	3 9 10 11 24
X'A3'	TCZBKTSE	DFHZC2444	2 3 9 10 11 24

default actions of DFHZNAC

Table 44. Messages issued and flags set by DFHZNAC for specific error codes (continued)

Error code	Symbolic label	Message	Action flags set
X'A7'	TCZBOEB	DFHZC2449	2 3 11 18 22 24
X'A8'	TCZFMHLE	DFHZC2471	2 3 4 10 11 22 24
X'A9'	TCZRACRF	DFHZC2472	11
X'AA'	TCZSDSE9	DFHZC2473	3 9 11
X'AB'	TCZLUERR	DFHZC3470	9 10 11 24
X'AC'	TCZVRDAC	DFHZC3474	9 10 11 24
X'AD'	TCZNRLUF	DFHZC3475	9 10 11 24
X'AE'	TCZRCLUF	DFHZC3476	9 10 11 24
X'AF'	TCZCLEAN	DFHZC3477	9 10 11 24
X'B0'	TCZEXRO	DFHZC3491	15 24
X'B1'	TCZRPLAC	DFHZC2401	2 3 9 10 11 23 24
X'B2'	TCZSDAUC	DFHZC2425	3 9 10 11 15 24
X'B3'	TCZBDBND	DFHZC4929	2 3 5 24
X'B4'	TCZRSNE	DFHZC2402	3 11
X'B5'	TCZSAXUC	DFHZC2420	2 3 9 10 11 23 24
X'B6'	TCZNSEED	DFHZC4924	2 3 5 24
X'B7'	TCZASINC	DFHZC4925	2 3 5 24
X'B8'	TCZEVBAD	DFHZC4926	2 3 5 24
X'B9'	TCZFMH12	DFHZC4927	2 3 5 24
X'BB'	TCZSEXUC	DFHZC2418	2 3 9 10 11 23 24
X'BC'	TCZINIIR	DFHZC3410	2 3 9 10 11
X'BD'	TCZDESGM	DFHZC4928	24
X'BE'	TCZBFAIL	DFHZC4944	2 3 5 24
X'BF'	TCZCPFAL	DFHZC3490	24
X'C0'	TCZDWEGF	DFHZC3499	None
X'C1'	TCZSRCAT	DFHZC2400	2 3 9 10 11 23 24
X'C2'	TCZLUINP	DFHZC3486	24
X'C3'	TCZCPFAL	DFHZC3490	24
X'C5'	TCZSRCNA	DFHZC2427	2
X'C6'	TCZPASSD	DFHZC3484	None
X'C7'	TCZPSPRE	DFHZC3485	24
X'C8'	TCZLUINH	DFHZC3489	18 24
X'C9'	TCZNPSAU	DFHZC3487	24
X'CB'	TCZSRCTC	DFHZC2431	2 3 9 10 11
X'CC'	TCZSRCCI	DFHZC2451	2 3 9 10 11
X'CD'	TCZSRCCX	DFHZC2454	2 3 9 10 11
X'CE'	TCZVHOLD	DFHZC3469	9 10 11 24
X'CF'	TCZVRNOP	DFHZC3471	9 10 11 24
X'D0'	TCZTXCS	DFHZC2409	2 3 9 10 11 15 24
X'D1'	TCZTXCU	DFHZC2410	2 3 9 10 11 24

default actions of DFHZNAC

Table 44. Messages issued and flags set by DFHZNAC for specific error codes (continued)

Error code	Symbolic label	Message	Action flags set
X'D3'	TCZDMPD	DFHZC2463	None
X'D4'	TCZCXRR	DFHZC2453	1 2 3 9 10
X'D5'	TCZCXE2	DFHZC2452	3 9 10 11 18 24
X'D6'	TCZSXC2	DFHZC2441	None
X'D7'	TCZSXC1	DFHZC2440	None
X'D8'	TCZRNCH	DFHZC2457	2 3 9 10 11 24
X'D9'	TCZYX43	DFHZC2469	2 3 9 10 11
X'DA'	TCZSXC3	DFHZC2470	9 10 11 24
X'DB'	TCZPIPL	DFHZC2117	9 10 11 23 24
X'DC'	TCZPXE1	DFHZC2442	None
X'DD'	TCZPXE2	DFHZC2458	None
X'DF'	TCZDMGF	DFHZC3482	None
X'E0'	TCZDMSN	DFHZC2411	None
X'E1'	TCZDMRA	DFHZC2412	None
X'E2'	TCZDMCL	DFHZC2413	2
X'E3'	TCZCNCL	DFHZC2485	3 9 10 11
X'E4'	TCZAIER	DFHZC2433	None
X'E6'	TCZDMLG	DFHZC2404	None
X'E8'	TCZDMSLE	DFHZC3416	2 3
X'E9'	TCZSTIND	DFHZC2102	3
X'EA'	TCZSTLER	DFHZC3432	2 3
X'EB'	TCZSTRMH	DFHZC3428	3
X'EC'	TCZSTRMM	DFHZC3429	2 3
X'ED'	TCZSTON	DFHZC3430	2 3
X'EF'	TCZSTIN	DFHZC3431	2 3
X'F1'	TCZBDMOD	DFHZC4931	18 24
X'F2'	TCZEXRVT	DFHZC2469	2 3 9 10 11
X'F3'	TCZICTYP	DFHZC4932	2 3 24
X'F4'	TCZIDBA	DFHZC4933	2 3 24
X'F5'	TCZISYNL	DFHZC4934	2 3 24
X'F6'	TCZIUOW	DFHZC4935	2 3 24
X'F7'	TCZIFMHL	DFHZC4936	2 3 24
X'F8'	TCZFMRB	DFHZC4943	3 9 10 11 24
X'F9'	TCZINVAT	DFHZC4946	2 3 24
X'FA'	TCZLUSEC	DFHZC4947	2 3 24
X'FB'	TCZPSUNB	DFHZC0125	None
X'FC'	TCZPSOPN	DFHZC0131	None
X'FD'	TCZPSRC	DFHZC0146	None
X'FE'	TCZPSRF	DFHZC0150	3 6 9 10 11 15 24
X'FF'	TCZPSPE	DFHZC0149	None

Notes:

1. See message DFHZC2497 or DFHZC3493, depending on the device type.
2. "Good morning" message to be sent.
3. Cancel task, and close VTAM session owing to quick close or abend.

CICS messages associated with VTAM errors

Table 45. CICS messages associated with VTAM errors

Message	Symbolic label	Error code	Action flags set
DFHZC0101	TCZPRDTO	X'5D'	None
DFHZC0125	TCZPSUNB	X'FB'	None
DFHZC0131	TCZPSOPN	X'FC'	None
DFHZC0144	TCZPSRAC	X'7A'	11
DFHZC0145	TCZPSRAF	X'79'	3 6 9 10 11 24
DFHZC0146	TCZPSRC	X'FD'	None
DFHZC0147	TCZPSLE	X'71'	3 6 9 10 11 24
DFHZC0148	TCZPSVF	X'72'	9 10 11 24
DFHZC0149	TCZPSPE	X'FF'	None
DFHZC0150	TCZPSRF	X'FE'	3 6 9 10 11 15 24
DFHZC0155	TCZPSAF	X'6C'	3 6 9 10 11 24
DFHZC0156	TCZPSAR	X'6D'	None
DFHZC2102	TCZSTIND	X'E9'	3
DFHZC2400	TCZSRCAT	X'C1'	2 3 9 10 11 23 24
DFHZC2401	TCZRPLAC	X'B1'	2 3 9 10 11 23 24
DFHZC2402	TCZRSNE	X'B4'	3 11
DFHZC2403	TCZSRCBF	X'11'	2 5 18 24
DFHZC2404	TCZLRCER	X'14'	2 3 9 10 11 23 24
DFHZC2404	TCZLRCNR	X'18'	2 3 9 10 11 23 24
DFHZC2404	TCZDMLG	X'E6'	None
DFHZC2405	TCZSRCTU	X'10'	18
DFHZC2406	TCZSRCTS	X'19'	9 10 11 18
DFHZC2407	TCZSRCPF	X'15'	2 3 9 10 11 24
DFHZC2408	TCZSRCVE	X'1A'	2 3 9 10 11 24
DFHZC2408	TCZSRCV2	X'1E'	2 3 9 10 11 24
DFHZC2409	TCZTXCS	X'D0'	2 3 9 10 11 15 24
DFHZC2410	TCZTXCU	X'D1'	2 3 9 10 11 24
DFHZC2411	TCZDMSN	X'E0'	None
DFHZC2412	TCZDMRA	X'E1'	None
DFHZC2413	TCZDMCL	X'E2'	2
DFHZC2414	TCZSRCSP	X'80'	None
DFHZC2416	TCZSRCVH	X'13'	18 24
DFHZC2417	TCZSRCVI	X'1D'	2 24
DFHZC2417	TCZVTAMI	X'20'	None

default actions of DFHZNAC

Table 45. CICS messages associated with VTAM errors (continued)

Message	Symbolic label	Error code	Action flags set
DFHZC2418	TCZSEXUC	X'BB'	2 3 9 10 11 23 24
DFHZC2419	TCZSSXUC	X'82'	2 3 9 10 11 23 24
DFHZC2420	TCZSAXUC	X'B5'	2 3 9 10 11 23 24
DFHZC2421	TCZUNCMD	X'60'	2 3 9 10 11 24
DFHZC2422	TCZLGCER	X'90'	1 2 3 6 9 10 11 23 24
DFHZC2423	TCZSDSE5	X'74'	3 9 10 11 24
DFHZC2424	TCZSESE1	X'75'	3 9 10 11 15 24
DFHZC2425	TCZSDAUC	X'B2'	3 9 10 11 15 24
DFHZC2426	TCZRACES	X'94'	2 3 9 10 11 22
DFHZC2427	TCZSRCNA	X'C5'	2
DFHZC2428	TCZSDSE6	X'92'	3 9 11
DFHZC2429	TCZRSTLE	X'91'	3 10 11
DFHZC2430	TCZSDRE2	X'78'	3 9 11 22
DFHZC2431	TCZSRCTC	X'CB'	2 3 9 10 11
DFHZC2432	TCZSSXNR	X'81'	None
DFHZC2433	TCZAIER	X'E4'	None
DFHZC2434	TCZCPYNS	X'43'	3 11
DFHZC2435	TCZRVSZ1	X'96'	3 10 11 24
DFHZC2436	TCZRVSZ3	X'97'	3 10 11
DFHZC2437	TCZSDSE4	X'73'	3 9 11
DFHZC2438	TCZRVSZ2	X'A1'	3 10 11
DFHZC2439	TCZACT01	X'98'	2 18
DFHZC2440	TCZSXC1	X'D7'	None
DFHZC2441	TCZSXC2	X'D6'	None
DFHZC2442	TCZPXE1	X'DC'	None
DFHZC2443	TCZROCT	X'59'	2 3 9 10 11 24
DFHZC2444	TCZBKTSE	X'A3'	2 3 9 10 11 24
DFHZC2445	TCZSDSE8	X'95'	3 9 11
DFHZC2446	TCZSSXIB	X'84'	2 3 9 10 11 23 24
DFHZC2447	TCZDOMCF	X'9A'	3 9 10 11 23
DFHZC2448	TCZINVRR	X'65'	2 3 10 11 22 23 24
DFHZC2449	TCZBOEB	X'A7'	2 3 11 18 22 24
DFHZC2450	TCZSSXAR	X'83'	None
DFHZC2451	TCZSRCCI	X'CC'	2 3 9 10 11
DFHZC2452	TCZCXE2	X'D5'	3 9 10 11 18 24
DFHZC2453	TCZCXRR	X'D4'	1 2 3 9 10
DFHZC2454	TCZSRCCX	X'CD'	2 3 9 10 11
DFHZC2455	TCZRACET	X'93'	2 3 9 10 11
DFHZC2456	TCZSRCDE	X'44'	2 3 9 10 11 24
DFHZC2457	TCZRNCH	X'D8'	2 3 9 10 11 24

default actions of DFHZNAC

Table 45. CICS messages associated with VTAM errors (continued)

Message	Symbolic label	Error code	Action flags set
DFHZC2458	TCZPX2	X'DD'	None
DFHZC2459	TCZSDSE7	X'99'	3 9 11
DFHZC2463	TCZDMPD	X'D3'	None
DFHZC2467	TCZLEXCI	X'88'	2 3 9 10 11 23 24
DFHZC2468	TCZLEXUS	X'89'	2 3 9 10 11 24
DFHZC2469	TCZYX43	X'D9'	2 3 9 10 11
DFHZC2469	TCZEXRVT	X'F2'	2 3 9 10 11
DFHZC2470	TCZSXC3	X'DA'	9 10 11 24
DFHZC2117	TCZPIPL	X'DB'	9 10 11 23 24
DFHZC2471	TCZFMHLE	X'A8'	2 3 4 10 11 22 24
DFHZC2472	TCZRACRF	X'A9'	11
DFHZC2473	TCZSDSE9	X'AA'	3 9 11
DFHZC2485	TCZCNCL	X'E3'	3 9 10 11
DFHZC2486	TCZRACNL	X'9B'	3
DFHZC2487	TCZLGNA	X'76'	3
DFHZC2488	TCZDMRY	X'77'	None
DFHZC2489	TCZINCPY	X'40'	3 9 11
DFHZC2490	TCZTOLRQ	X'41'	2 3 9 10 11 15 24
DFHZC2497	TCZUNPRT	X'42'	None
DFHZC2498	TCZICPUT	X'4B'	None
DFHZC3400	TCZCHMX	X'45'	3 10 11 22
DFHZC3402	TCZOCIR	X'46'	3 9 10 11
DFHZC3409	TCZUNEGR	X'85'	2 3 9 10 11 23 24
DFHZC3410	TCZINIIR	X'BC'	2 3 9 10 11
DFHZC3416	TCZDMSLE	X'E8'	2 3
DFHZC3417	TCZSDRE3	X'50'	3 9 10 11 24
DFHZC3418	TCZBDPRI	X'51'	3 9 10 11 24
DFHZC3419	TCZBDUAC	X'52'	2 3 5
DFHZC3420	TCZBDTOS	X'53'	20
DFHZC3421	TCZSBIRV	X'5A'	20
DFHZC3422	TCZNSP01	X'5B'	2 3 9 10 11 24
DFHZC3424	TCZNSP02	X'5C'	9 10 11 15 24
DFHZC3428	TCZSTRMH	X'EB'	3
DFHZC3429	TCZSTRMM	X'EC'	2 3
DFHZC3430	TCZSTON	X'ED'	2 3
DFHZC3431	TCZSTIN	X'EF'	2 3
DFHZC3432	TCZSTLER	X'EA'	2 3
DFHZC3433	TCZERMGR	X'58'	None
DFHZC3434	TCZUNBIS	X'54'	2 3 9 10 11 24
DFHZC3440	TCZEMWBK	X'55'	None

default actions of DFHZNAC

Table 45. CICS messages associated with VTAM errors (continued)

Message	Symbolic label	Error code	Action flags set
DFHZN3441	TCZVTAMO	X'63'	None
DFHZN3442	TCZVTAMK	X'67'	None
DFHZN3443	TCZVTAMA	X'64'	None
DFHZN3444	TCZTIOAE	X'6A'	1 2 3 9 10 11 24
DFHZN3452	TCZSIGR	X'66'	None
DFHZN3454	TCZBRUAC	X'5E'	2 3 5 18 24
DFHZN3455	TCZBDSQP	X'5F'	2 3 5 18 24
DFHZN3461	TCZOPSIN	X'48'	None
DFHZN3462	TCZCLSIN	X'49'	None
DFHZN3463	TCZOPACB	X'4A'	None
DFHZN3464	TCZRELIS	X'57'	20
DFHZN3465	TCZRSPER	X'9D'	1 2 3 9 10 11 23
DFHZN3466	TCZSEXOS	X'69'	20 23
DFHZN3468	TCZCLRRV	X'70'	9 10 11 15 24
DFHZN3469	TCZVHOLD	X'CE'	9 10 11 24
DFHZN3470	TCZXSHRA	X'37'	9 10 11 24
DFHZN3470	TCZLUERR	X'AB'	9 10 11 24
DFHZN3471	TCZVRNOP	X'CF'	9 10 11 24
DFHZN3472	TCZDEVND	X'9E'	None
DFHZN3473	TCZSLRSL	X'4D'	None
DFHZN3474	TCZVRDAC	X'AC'	9 10 11 24
DFHZN3475	TCZNRLUF	X'AD'	9 10 11 24
DFHZN3476	TCZRCLUF	X'AE'	9 10 11 24
DFHZN3477	TCZCLEAN	X'AF'	9 10 11 24
DFHZN3479	TCZUNBFE	X'4E'	2 3 9 10 11 24
DFHZN3480	TCZNOISC	X'A0'	23 24
DFHZN3481	TCZDSPCL	X'4C'	2 3 9 10 11 24
DFHZN3482	TCZDMGF	X'DF'	None
DFHZN3484	TCZPASSD	X'C6'	None
DFHZN3485	TCZPSPRE	X'C7'	24
DFHZN3486	TCZLUINP	X'C2'	24
DFHZN3487	TCZNPSAU	X'C9'	24
DFHZN3488	TCZXUVAR	X'3C'	2 3 9 10 11 24
DFHZN3489	TCZLUINH	X'C8'	18 24
DFHZN3490	TCZCPFAL	X'C3'	24
DFHZN3491	TCZEXRO	X'B0'	15 24
DFHZN3492	TCZDMIT	X'16'	None
DFHZN3495	TCZNOTNA	X'6B'	24
DFHZN3499	TCZDWEGF	X'C0'	None
DFHZN4902	TCZLUCF1	X'21'	3 9 10 11 24

default actions of DFHZNAC

Table 45. CICS messages associated with VTAM errors (continued)

Message	Symbolic label	Error code	Action flags set
DFHZC4903	TCZLUCF2	X'22'	3 9 10 11 24
DFHZC4904	TCZFMSBE	X'23'	3 10 11 9 24
DFHZC4905	TCZFSMCS	X'24'	3 10 11 9 24
DFHZC4906	TCZFSMCR	X'25'	3 10 11 9 24
DFHZC4907	TCZSDLER	X'26'	3 10 11 9 24
DFHZC4909	TCZRVLER	X'28'	3 10 11 9 24
DFHZC4910	TCZRVLRB	X'29'	3 10 11 9 24
DFHZC4911	TCZRLPEX	X'2A'	2 3 9 10 11 24
DFHZC4912	TCZRLPBD	X'2B'	2 3 9 10 11 24
DFHZC4913	TCZRLPDR	X'2C'	2 3 9 10 11 24
DFHZC4914	TCZRLPIL	X'2D'	2 3 9 10 11 24
DFHZC4915	TCZRLPEC	X'2E'	2 3 9 10 11 24
DFHZC4916	TCZRLPRR	X'2F'	2 3 9 10 11 24
DFHZC4917	TCZRLPIF	X'30'	2 3 9 10 11 24
DFHZC4918	TCZRLPIR	X'31'	2 3 9 10 11 24
DFHZC4919	TCZIVIND	X'33'	2 3 9 10 11 24
DFHZC4920	TCZIVDAT	X'34'	2 3 9 10 11 24
DFHZC4922	TCZRLXCL	X'32'	20
DFHZC4924	TCZNSEED	X'B6'	2 3 5 24
DFHZC4925	TCZASINC	X'B7'	2 3 5 24
DFHZC4926	TCZEVBAD	X'B8'	2 3 5 24
DFHZC4927	TCZFMH12	X'B9'	2 3 5 24
DFHZC4928	TCZDESGM	X'BD'	24
DFHZC4929	TCZBDBND	X'B3'	2 3 5 24
DFHZC4930	TCZRTMT	X'35'	2 3 9 10 11 24
DFHZC4931	TCZBDMOD	X'F1'	18 24
DFHZC4932	TCZICTYP	X'F3'	2 3 24
DFHZC4933	TCZIDBA	X'F4'	2 3 24
DFHZC4934	TCZISYNL	X'F5'	2 3 24
DFHZC4935	TCZIUOW	X'F6'	2 3 24
DFHZC4936	TCZIFMHL	X'F7'	2 3 24
DFHZC4937	TCZLUSRR	X'8A'	2 3 5 24
DFHZC4938	TCZLUSRF	X'8B'	2 3 5 24
DFHZC4939	TCZLUPUN	X'8C'	2 3 5 24
DFHZC4940	TCZLUSKN	X'8F'	2 3 5 24
DFHZC4941	TCZLUPLK	X'8D'	2 3 5 24
DFHZC4942	TCZLUPEX	X'8E'	2 3 5 24
DFHZC4943	TCZFSMRB	X'F8'	3 10 11 9 24
DFHZC4944	TCZBFAIL	X'BE'	2 3 5 24
DFHZC4945	TCZPRGE	X'A2'	3 9 10 11 24

default actions of DFHZNAC

Table 45. CICS messages associated with VTAM errors (continued)

Message	Symbolic label	Error code	Action flags set
DFHZC4946	TCZINVAT	X'F9'	2 3 24
DFHZC4947	TCZLUSEC	X'FA'	2 3 24
DFHZC4949	TCZRABUS	X'7D'	2 3 9 10 11 24
DFHZC6590	TCZXRST	X'3F'	None
DFHZC6591	TCZXERR	X'3E'	9 10 11 15 24
DFHZC6593	TCZXSBC	X'3B'	None
DFHZC6594	TCZXSHR	X'3A'	24
DFHZC6595	TCZXSABN	X'39'	2 3 5 24
DFHZC6596	TCZXSWS	X'38'	2 3 15 24
DFHZC6598	TCZXFVS	X'56'	None

Default actions for system sense codes

Table 46 shows the message issued and action flags set by DFHZNAC for each inbound system sense code received. See the *CICS Messages and Codes* manual for a description of the conditions that correspond to the system sense codes. The figures in the “**Action flags set**” column are translated into bit settings and explained in Table 47 on page 802.

Table 46. Messages issued and flags set by DFHZNAC for specific sense codes

Sense code	Message	Action flags set
X'0001' ¹	DFHZC3401	2
X'0002' ¹	DFHZC3415	2, 3, 10, 11
X'0003' ¹	DFHZC3449	None
X'0004' ¹	DFHZC3450	None
X'0007' ¹	DFHZC3451	None ²
X'00FF'	DFHZC3446	2, 3, 9, 10, 11, 23, 24
X'0801'	DFHZC2476	3, 9, 10, 11
X'0802'	DFHZC2461	None
X'0806'	DFHZC3426	None
X'0807'	DFHZC3411	None
X'080B'	DFHZC2462	2, 3, 9, 10, 11, 15, 24
X'080E'	DFHZC3448	23
X'080F'	DFHZC3436	9, 10, 11
X'0811'	DFHZC2464	9, 10, 11
X'0812'	DFHZC2465	2, 3
X'081B'	DFHZC2483	2, 3 ³
X'081C'	DFHZC2466	2, 3, 9, 10, 11
X'0824'	DFHZC2475	3, 9, 10, 11
X'0825'	DFHZC2484	2, 3, 9, 10, 11
X'0826'	DFHZC3423	2, 3, 9, 10, 11
X'0827'	DFHZC2480	3

default actions for system sense codes

Table 46. Messages issued and flags set by DFHZNAC for specific sense codes (continued)

Sense code	Message	Action flags set
X'0829'	DFHZNAC3407	1, 2, 3, 10, 11, 24
X'082A'	None ⁴	9
X'082B'	DFHZNAC3408	2, 3, 10, 11, 13
X'082D'	DFHZNAC3413	None
X'082E'	DFHZNAC3412	None
X'082F'	DFHZNAC3414	2, 3, 9, 10, 11
X'0831'	DFHZNAC3438	None
X'0833'	DFHZNAC3427	None
X'0847'	DFHZNAC3439	None
X'084A'	None ⁵	None
X'084C'	DFHZNAC3467	9, 10, 11
X'0860'	DFHZNAC3459	None
X'0863'	DFHZNAC3460	9, 10, 11
X'0864'	DFHZNAC2475	3, 9, 10, 11
X'0865'	DFHZNAC2465	3, 9, 10, 11
X'0866'	DFHZNAC2475	3, 9, 10, 11
X'0867'	None ⁶	9, 10, 11
X'0868'	DFHZNAC3456	2, 9, 10, 11
X'0869'	DFHZNAC3457	2, 9, 10, 11
X'08FF'	DFHZNAC3447	2, 3, 9, 10, 11, 24
X'1000'	DFHZNAC3494	2, 3, 9, 10, 11
X'1001'	DFHZNAC2481	2, 3, 9, 10, 11, 14
X'1002'	DFHZNAC2481	2, 3, 9, 10, 11, 14
X'1003'	DFHZNAC2479	2, 3, 9, 10, 11, 14
X'1005'	DFHZNAC3406	2, 3, 4, 9, 10, 11, 14
X'1008'	DFHZNAC2478	None
X'1009'	DFHZNAC3458	2, 9, 10, 11
X'10FF'	DFHZNAC3446	2, 3, 9, 10, 11, 23, 24
X'2003'	DFHZNAC3405	2, 3, 9, 10, 11, 15, 24
X'20FF'	DFHZNAC3445	2, 3, 9, 10, 11, 23, 24
X'400B'	DFHZNAC2477	1, 3, 11
X'40FF'	DFHZNAC3453	2, 3, 9, 10, 11, 23, 24
X'8000'	DFHZNAC3435	2, 3, 9, 10, 11, 18, 24
X'8005'	DFHZNAC3435	2, 3, 9, 10, 11, 18, 24
X'80FF'	DFHZNAC3435	2, 3, 9, 10, 11, 18, 23, 24
X'FFFF'	DFHZNAC2460	2, 3, 9, 10, 11, 23, 24

Notes:

1. The system sense code is in the form of an LUSTATUS command code.
2. No action flags are set if a task is attached or if outstanding operations are to complete. Otherwise, flag 21 is set.

default actions for system sense codes

3. Action flags 2 and 3 are set for negative response received for a SEND that requested a definite response.
4. Presentation space error.
5. Presentation error on read. Display buffer alteration, due to operator intervention, detected on a READ command to a compatibility-mode logical unit.
6. Function abend received from a device. A negative response to a chain was sent, but purged.

Action flag settings and meanings

Table 47 shows the “action flags” that can be set by DFHZNAC in the communication area passed to DFHZNEP. The flags set by DFHZNAC represent the default actions that will be taken if the settings are not changed by DFHZNEP.

The figures in the “**Flag**” column refer to those in columns 3 of Table 44 on page 789 and Table 46 on page 800.

Table 47. Meanings of action flags set by DFHZNAC

Flag	Field	Bit mask	Hex bit setting	Action
1	TWAOPT1	1... ..	X'80'	Print action flags
2		.1.. ..	X'40'	Print VTAM RPL
3		..1.	X'20'	Print TCTTE
4		...1	X'10'	Print TIOA
5	 1...	X'08'	Print BIND area
6	1..	X'04'	System dump if no task attached
9	TWAOPT2	1... ..	X'80'	Abort any send for this terminal
10		.1.. ..	X'40'	Abort any receive for this terminal
11		..1.	X'20'	Abend any task attached to TCTTE
12		...1	X'10'	Cancel any task attached to TCTTE
13	 1...	X'08'	Good Morning message to be sent
14	1..	X'04'	Purge any BMS pages for this TCTTE
151.	X'02'	SIMLOGON required	
17	TWAOPT3	1... ..	X'80'	Set INTLOG now allowed
18		.1.. ..	X'40'	Set no internal general logons
20		...1	X'10'	Normal CLSDST (no reset allowed)
21	 1...	X'08'	Normal CLSDST (reset allowed)
22	1..	X'04'	Send negative response
23	1.	X'02'	AOS - keep node out of service
24	1	X'01'	CLSDST node

Appendix C. Transient data write-to-terminal program (DFH\$TDWT)

DFH\$TDWT is a sample program that sends transient data messages to a terminal or printer. You can use it to send messages from a single transient data queue, or from several queues, to one terminal.

In the definition for the transient data queue, you can specify that particular categories of message (for example, those from the abnormal condition program and signon and sign-off messages) should be sent to destinations defined as indirect. If these indirect destinations are defined so that they refer to the same intrapartition queue with a transaction identifier and a trigger level of 1, the receipt of a single message in any of the specified categories causes the transaction to be started. The program thus invoked displays or prints the message. The transaction that invokes the DFH\$TDWT sample program is TDWT.

To use the sample program, your CICS system must include automatic transaction initiation and an intrapartition transient data set. The source code for the DFH\$TDWT sample program is provided in CICSTS13.CICS.SDFHSAMP, and the object code is provided in CICSTS13.CICS.SDFHLOAD.

For detailed information about defining transient data queues, see the *CICS Resource Definition Guide*.

Resource definitions required

To use the DFH\$TDWT sample program as supplied, you need the following resource definitions installed on your CICS region:

- A program definition for the DFH\$TDWT program
- A transaction definition for the TDWT transaction
- A terminal definition for the L86P terminal
- A definition for the intrapartition queue, L86P
- Definitions for the indirect intrapartition queues pointing to the L86P queue.

These required resource definitions are provided in the CICS-supplied group, DFH\$UTIL. Add DFH\$UTIL to your CICS startup group list.

However, you must define the other resources. Add a terminal definition for the L86P terminal to the CSD, and install it in your CICS region.

Appendix D. Uppercase translation

This appendix describes how to translate lower- and mixed-case characters to uppercase. "Uppercase translation of national characters" describes how to translate national characters that CICS cannot handle by standard means. "TS data sharing messages" on page 806 describes how to translate operator messages produced by CICS temporary storage data sharing.

Uppercase translation of national characters

In CICS, translation of terminal user-input to uppercase characters can be done either by using the UCTRAN option on the PROFILE and TYPETERM definitions, or by using the EXEC CICS SET TERMINAL(termid) UCTRANST command.

However, some languages have characters which are not part of the set of EBCDIC characters translated by UCTRAN, and so are never translated to uppercase, regardless of what you have specified on your resource definitions. To translate these national characters, you have two options:

- Use the XZCIN exit
- Modify the translation table in DFHTCTDY.

Whichever method you use, the *Character Data Representation Architecture Level 1 - Registry* manual, SC09-1391-00, is a useful reference for information on code pages.

Using the XZCIN exit

XZCIN is described on page 121. To use it for uppercase translation, you must supply your own translation routine, which is then invoked when terminal input occurs.

Using DFHTCTDY

CICS provides the source for DFHTCTDY in CICS321.SDFHSAMP; you can use this to modify the translation table to translate your national characters. Figure 112 on page 806 shows a suggested way to code the assembler source statements used to generate DFHTCTDY.

uppercase translation

```
MACRO
NATLANG
DFHUCTRT CSECT                               Resume UCTRAN table CSECT
.*
.* This example translates lowercase 'a' ( EBCDIC X'81') to
.* uppercase 'A' (EBCDIC X'C1') for a US code page.
.*
      ORG TCZUCTAB+X'81'                       Reset the counter to the
                                          character to be translated.
      DC  X'C1'                               Declare the replacement
                                          character as a constant.
.*
.* Repeat the above two statements for each extra character you wish
.* to be translated.
.*
      ORG ,                                     Reset the location counter
&SYSLOC LOCTR                               Resume previous location counter
      MEND                                     End of macro definition
      DFHTCT TYPE=INITIAL,SUFFIX=DY,          *
          MIGRATE=COMPLETE,                  *
          ACCMETH=(VTAM),                    *
          DUMMY=DUMMY
      NATLANG                               Execute NATLANG
      DFHTCT TYPE=FINAL
      END DFHTCTBA
```

Figure 112. Suggested coding for national language character translation

If you use this method, you must reassemble your modified copy of DFHTCTDY, keeping the 'DY' suffix. The 'DY' suffix is necessary because, even if you use RDO for all your terminals and have TCT=NO specified in your SIT or its overrides, CICS uses DFHTCTDY by default to create control blocks for RDO-defined and autoinstalled terminals.

If you specify a suffix other than 'DY' on the SIT TCT parameter, you must add your translation code to the TCT you are using.

TS data sharing messages

CICS temporary storage (TS) data sharing uses AXM services to write operator messages. These messages are in mixed-case English; table AXMMSTAB is used to remove unprintable characters. If necessary, you can modify AXMMSTAB to convert the messages to uppercase English.

The modules that use AXM message services are AXMSI, AXMSC, and DFHXQMN. AXMSI and AXMSC are both in a linklist library; DFHXQMN is in the CICS authorized library. To convert TS data sharing messages to uppercase, modify the copy of AXMMSTAB used by each of these modules by using SPZAP with the following input (for each module):

```
NAME modulename AXMMSTAB VER 0081
818283848586878889 VER 0091 919293949596979899 VER 00A2 A2A3A4A5A6A7A8A9 REP
0081 C1C2C3C4C5C6C7C8C9 REP 0091 D1D2D3D4D5D6D7D8D9 REP 00A2 E2E3E4E5E6E7E8E9
```

Appendix E. The example program for the XTSERREQ global user exit, DFH\$XTSE

This appendix lists the example global user exit program, DFH\$XTSE. The example shows you how to:

- Use EXEC CICS commands in a global user exit program
- Use EXEC CICS commands and XPI calls in the same exit program
- Modify the command parameter list in EXEC interface exits such as XTSERREQ, XICERREQ, and XFCREQ
- Modify Temporary Storage (TS) requests.

```
*****
*
* MODULE NAME = DFH$XTSE
*
* FUNCTION =
* Example global user exit program to run at the XTSERREQ and
* XTSEREQC exits.
*
* DESCRIPTION =
* The program gives examples of:
* 1) Coding Exec Interface global user exits, showing how to
* modify and add parameters to the Command Parameter List.
* 2) Issuing a mixture of EXEC CICS API and XPI calls within
* the same global user exit program.
* 3) Modifying Temporary Storage requests, by renaming the queue
* name and allowing the SYSID to be added so that the request
* is routed to a queue-owning region (QOR).
*
* -----
* NOTE that this program is only intended to DEMONSTRATE the use
* of the TS request user exit XTSERREQ, and to show the sort of
* information which can be obtained from the exit parameter list.
* IT SHOULD BE TAILORED BEFORE BEING USED IN A PRODUCTION ENVIRONMENT.*
* -----
*
* NOTES =
* The important notes to remember when coding similar global user
* exits are:
*
* 1) If the exit program modifies the Command Parameter List, you
* MUST ensure that the storage used for additional fields such
* as the SYSID is non-volatile. Here are examples of storage
* that is safe:
* a) Shared storage obtained by GETMAIN. This should be
* obtained in the Request exit, and freed in the Request
* Complete exit.. The shared storage address can be passed
* using the 4-byte token in the DFHUEPAR parameter list.
* b) Shared global work area storage.
* c) Storage obtained by using the LOAD HOLD option.
* d) TCTUA or CWA storage.
```

Figure 113. Example exit program for the XTSERREQ exit (Part 1 of 16)

example XTSERREQ global user exit program

```

*
*   It is not safe to use the following storage:
*   Program storage (DFHEISTG) since this is freed as soon
*   as the exit program returns control to CICS.
*
*
* 2) When adding or removing a field in the command parameter list,
* you must remember:
*   a) To set/clear the field's existence bit in the EID
*   b) To set/clear the appropriate address in the Addr_List
*   c) To set the hi-order bit in the LAST address in the
*       Addr_List.
*
* 3) If you are planning to use the CICS API in the exit, you
* must:
*   a) Use the DFHEIENT macro to control module entry.
*   b) Use the DFHEIRET macro to return control to CICS. However,
*       the exit return code MUST be set in Register 15.
*   c) Issue an ADDRESS EIB command before issuing any EXEC CICS
*       commands.
*
* 4) If you are planning to use the API and XPI in the same
* global user exit program, take care to ensure that Register
* 13 points to the kernel stack entry (UEPSTACK) for XPI calls,
* and is restored for API calls if necessary.
*
*
*****
EJECT ,
*-----*
*
* Copybook and DSECTS required by the exit program
*
*-----*
          DFHUEXIT TYPE=EP,ID=(XTSEREQ,XTSEREQC)
          DFHUEXIT TYPE=XPIENV      Exit programming interface (XPI)
          COPY  DFHTRPTY            Trace XPI definitions
          COPY  DFHTSUED            Command Level Plist definitions
*
*-----*
* The following DSECT maps the shared storage obtained by the
* EXEC CICS GETMAIN API call. This storage is used to store the
* modified SYSID and/or TS QNAME that is passed to CICS on return
* from the exit program.
*-----*
SHARED_STORAGE  DSECT
SHARED_EYECATCHER DS CL16
SHARED_NAME     DS CL8
SHARED_SYSID    DS CL4
*

```

Figure 113. Example exit program for the XTSERREQ exit (Part 2 of 16)

example XTSERREQ global user exit program

```

*-----*
* The TS Routing table is made up of a set of entries. Each entry
* can be mapped by the TABLE_ENTRY DSECT
*-----*
TABLE_ENTRY DSECT
ENTRY_NAME DS CL8
NEW_NAME DS CL8
NEW_SYSID DS CL4
ENTRY_ACTION DS XL1
FILLER DS CL3
*
*-----*
* The following definitions are for program working storage.
*-----*
DFHEISTG DSECT
RETCODE DS XL4 Program Return Code
TR_ERROR_N DS X Error Number for Trace Entry
RESP DS X API Response
EJECT ,
*****
* PROGRAM REGISTER USAGE :
* R0 - Work Register
* R1 - Points to DFHUEPAR plist on entry
* Work Register
* R2 - DFHUEPAR parameter List
* R3 - Code Base Register
* R4 - <unused>
* R5 - <unused>
* R6 - Subroutine Linkage Register
* R7 - Address of TS Queue Name from Command Plist
* R8 - Command Parameter list UEPLPS
* R9 - Address of Table_Entry in TS_Routing_Table
* R10- <unused>
* R11- EIB Register
* R12- Work Register
* R13- DFHEISTG for API calls
* Kernel Stack for XPI calls
* R14- Work Register
* R15- Work Register
*****
EJECT ,
*****
* DFH$XTSE - Main Routine
* This is the entry point for the exit program. Control is passed
* to the TS_REQUEST or TS_REQUEST_COMPLETE routines depending
* on whether the exit was invoked at the XTSERREQ or XTSERREQC exit
* points.
*

```

Figure 113. Example exit program for the XTSERREQ exit (Part 3 of 16)

example XTSERREQ global user exit program

```

* Registers:
* R1 = UEPAR plist (set on entry)
*   = Work register
* R2 = UEPAR plist
* R3 = Program base register (set by DFHEIENT)
* R6 = Linkage register
* R11= EIB register
* R13= EISTG register (set by DFHEIENT)
* R15= Work register
*   User Exit Return Code
*
* Logic:
* DFH$XTSE:
*   Exec Interface Entry
*   Address DFHUEPAR plist
*   Set OK Return Code
*   Address the EIB
*   Trace entry
*   Select Exitid
*     When(XTSERREQ) then call TS_Request
*     When(XTSERREQC) then call TS_Request_Complete
*     Otherwise call Error(Invalid_Exit)
*   End Select
*   Trace exit
*   Set Exit return code
*   Return
*****
DFH$XTSE DFHEIENT
DFH$XTSE AMODE 31
DFH$XTSE RMODE ANY
          LR   R2,R1                DFHUEPAR plist provided by caller
          USING DFHUEPAR,R2        Use R2 to address UEPAR PLIST
*
          LA   R15,UERCNORM         Set OK Response
          ST   R15,RETCODE          in working storage
*
          EXEC CICS ADDRESS EIB(R11)
          USING DFHEIBLK,R11
*
          BAL  R6,TRACE_ENTRY       Trace program entry
*
          L    R1,UEPEXN            Address of the 1 byte Exit Id
          CLI  0(R1),XTSERREQ       Is this XTSERREQ exit?
          BE   TS_REQUEST           ..Yes Branch to routine
          CLI  0(R1),XTSEREQC      Is this XTSERREQC exit?
          BE   TS_REQUEST_COMPLETE .. Yes Branch to routine
          B    ERROR1              Otherwise Branch to error routine
*
RETURN    DS   0H                  Return point
          BAL  R6,TRACE_EXIT       Trace program exit
*
          L    R15,RETCODE         Fetch return code
          DFHEIRET RCREG=15        Return to CICS
          EJECT ,

```

Figure 113. Example exit program for the XTSERREQ exit (Part 4 of 16)

example XTSERREQ global user exit program

```

*=====
* TS_REQUEST - Invoked at XTSERREQ exit point
* Determine the TS Queue Name and scan the TS_Routing_Table for
* a match. If an entry exists in the table, then check the action
* field and call the ROUTE_REQUEST or LOCAL_REQUEST routines.
*
* The TS_Routing_Table is made up of entries with the following
* structure:
*
* TABLE_ENTRY:
*
* -----
* | Entry_Name | New_Name | QOR_Sysid | Action | *filler* |
* | Char 8    | Char 8   | Char 4    | Bin 1  | Char 3    |
* -----
* Last Entry is indicated by special TS_Queue Name
*
* Registers:
* R1 = Work register
* R7 = Set to the TS Queue Name
* R8 = Command Parameter List (CLPS)
* R9 = Points to the next entry in the TS_Routing_Table
* R15= Work register
*
* Logic:
* TS_Request:
*   If called recursively then
*     call Error(Recursive_Call1)
*   Else
*     If the Command GROUP code is not a TS request then
*       call Error(Invalid_Group_Code1)
*     Else
*       Clear the UEPTQOK
*       Address the Command Plist UEPCPLS
*       Fetch tsq_name
*       Fetch start of TS_Routing_Table
* Check_Next_Entry:
*   Get the next table entry
*   Select (entry_name)
*     When (last_entry) call Entry_Not_Found
*     When (tsq_name)
*       Select (entry_action)
*         When (Route) call Route_Request
*         When (Local) call Local_Request
*         Otherwise call Error(Invalid_Table_Action)
*       End Select
*     Otherwise
*       Goto Check_Next_Entry
*   End Select
* End If
* End If
* Return
*

```

Figure 113. Example exit program for the XTSERREQ exit (Part 5 of 16)

example XTSERREQ global user exit program

```

*=====*
TS_REQUEST DS 0H
*
*   Check for possible recursion
*   L   R1,UEPRECUR      Address of recursive count
*   LH  R1,0(R1)        Fetch count
*   LTR R1,R1           Has exit been invoked recursively?
*   BNZ ERROR2          ..Yes Branch to error routine
*
*
*   Extract pointer to the EID and TS queue name from CLPS
*   L   R8,UEPCLPS      Fetch address of Command Plist
*   USING TS_ADDR_LIST,R8 Use R8 to address CLPS
*   L   R1,TS_ADDR0     Address the EID..
*   L   R7,TS_ADDR1     Fetch address of TS QUEUE
*   DROP R8            Drop addressability to CLPS
*
*
*   Check that the Command GROUP code corresponds to a TS request
*   USING TS_EID,R1     ..with Register 1
*   CLI TS_GROUP,TS_TEMPSTOR_GROUP Is this a TS request?
*   BNE ERROR3          ..No Branch to error routine
*   DROP R1            Drop addressability to EID
*
*
*   Clear the TS Request token
*   L   R1,UEPTQOK      Fetch address of token
*   XC  0(4,R1),0(R1)   Clear Token for XTSEREQ
*
*
*-----*
* Start scan of TS_Routing Table *
*-----*
*   LA   R9,TS_ROUTING_TABLE Fetch address of routing table
*   USING TABLE_ENTRY,R9    Address entries from R9
*
*   CHECK_NEXT_ENTRY DS 0H
*   CLC  ENTRY_NAME,ENTRY_NAME_LAST Is this the last entry
*   BE   ENTRY_NOT_FOUND ..Yes Take default routing action
*   CLC  ENTRY_NAME,0(R7) Is this the wanted TS queue name?
*   BE   ENTRY_FOUND ..Yes Check for the action required
*   LA   R9,24(R9) Point to next entry
*   B    CHECK_NEXT_ENTRY Start search again
*
*   ENTRY_FOUND DS 0H
*   CLI  ENTRY_ACTION,ROUTE Is the action to route request?
*   BE   ROUTE_REQUEST ..Yes Branch to Route routine
*   CLI  ENTRY_ACTION,LOCAL Is the action to rename queue?
*   BE   LOCAL_REQUEST ..Yes Branch to Local routine
*   B    ERROR4 Otherwise Branch to error routine
*   DROP R9 Drop addressability to Entry
*   EJECT ,
*
*

```

Figure 113. Example exit program for the XTSERREQ exit (Part 6 of 16)

example XTSEREQ global user exit program

```

*=====*
* TS_REQUEST_COMPLETE - Invoked at XTSEREQC exit point *
* Free any shared storage that was acquired during previous *
* invocation at XTSEREQ. *
* *
* Registers: *
* R1 = Work register *
* R6 = Linkage register *
* R8 = Command Parameter List (CLPS) *
* *
* Logic: *
* TS_Request_Complete: *
* If called recursively then *
* call Error(Recursive_Call2) *
* Else *
* If the Command GROUP code is not a TS request then *
* call Error(Invalid_Group_Code2) *
* Else *
* If UEPTQTOK->token ^= 0 then Call Freemain_Shared_Plist *
* End If *
* End If *
* Return *
*=====*
TS_REQUEST_COMPLETE DS 0H
* Check for possible recursion
L R1,UEPRECUR Address of recursive count
LH R1,0(R1) Fetch count
LTR R1,R1 Has exit been invoked recursively?
BNZ ERROR5 ..Yes Branch to error routine
*
* Check that the Command GROUP code corresponds to a TS request
L R8,UEPCLPS Fetch address of Command Plist
USING TS_ADDR_LIST,R8 Use R8 to address CLPS
L R1,TS_ADDR0 Address the EID..
USING TS_EID,R1 ..with Register 1
CLI TS_GROUP,TS_TEMPSTOR_GROUP Is this a TS request?
BNE ERROR6 ..No Branch to error routine
DROP R1 Drop addressability to EID
DROP R8 Drop addressability to CLPS
*
L R1,UEPTQTOK Fetch address of Token
L R1,0(R1) Fetch actual token
LTR R1,R1 Did XTSEREQ GETMAIN any storage?
BZ RETURN ..No Return to caller
BAL R6,FREEMAIN_SHARED ..Yes Issue FREEMAIN
B RETURN Return to caller
EJECT ,
*

```

Figure 113. Example exit program for the XTSEREQ exit (Part 7 of 16)

example XTSERREQ global user exit program

```

*=====*
* LOCAL_REQUEST: Process Local TS Queues *
* An entry has been found in the TS_Routing Table for this TS *
* Queue Name. If required, rename the TS Queue Name, but do not *
* modify the SYSID. *
* *
* Registers: *
* R1 = Work register *
* R6 = Link Register *
* R7 = Address of current Queue name (Set on entry) *
* R8 = Command Parameter List (CLPS) *
* R9 = Address of table entry (Set on entry) *
* R12= Work register (Shared_storage) *
* *
* Logic: *
* Local_Request: *
* If entry_name ^= new_name then *
* Call Getmain_Shared *
* Copy new_name into shared storage *
* Address the command plist *
* Update ADDR1 to point to address of the new TS QUEUE name *
* Set the Hi-order bit if last address in CLPS *
* End If *
* Return *
*=====*
LOCAL_REQUEST DS 0H
        USING TABLE_ENTRY,R9      R9 points to the table entry
        CLC NEW_NAME,0(R7)         Is the new_name=current_queue name?
        BE RETURN                  ..Yes Return
*
* Obtain Shared storage to hold the new queue name
        BAL R6,GETMAIN_SHARED      GETMAIN SHARED storage
        L R12,UEPTQTOK            Fetch address of token
        L R12,0(R12)              Fetch shared storage pointer
        USING SHARED_STORAGE,R12   Address using R12
        MVC SHARED_NAME,NEW_NAME   Copy QNAME into shared storage
*
* Update the Queue Name in CLPS
        L R8,UEPCLPS              Address the CLPS.
        USING TS_ADDR_LIST,R8     ..with Register 8
        LA R1,SHARED_NAME         Fetch address of the new QNAME
        TM TS_ADDR1,X'80'         Is the hi-order bit on?
        BZ LOCAL1                 ..No continue
        O R1,=X'80000000'         Indicate ADDR1 is last parameter
LOCAL1  DS 0H
        ST R1,TS_ADDR1           Store address in TS_ADDR1
        B RETURN                  Return
        DROP R8                   Drop TS_ADDR_LIST
        DROP R12                  Drop SHARED_STORAGE
        DROP R9                   Drop addressability to Entry
        EJECT ,
*

```

Figure 113. Example exit program for the XTSERREQ exit (Part 8 of 16)

example XTSEREQ global user exit program

```

*=====
* ROUTE_REQUEST: Ship request to remote system
* An entry has been found in the TS_Routing Table for this TS
* Queue Name. The request is modified by adding a SYSID to the
* command and renaming the queue if required.
*
* Registers:
* R1 = Work register
* R6 = Link Register
* R7 = Address of current Queue name (Set on entry)
* R8 = Command Parameter List (CLPS)
* R9 = Address of table entry (Set on entry)
* R12= Work register (Shared_storage)
*
* Logic:
* Route Request:
* Call Getmain_Shared
* If entry_name ^= new_name then
* Copy new_name into shared storage
* Address the command plist
* Update ADDR1 to point to address of the new TS QUEUE name
* End If
* Copy new_sysid into shared storage
* Address the command plist
* Update ADDR7 to point to the address of the new SYSID
* Set the SYSID existence bit in the EID
* Set the Hi-order bit in last address in CLPS
* Return
*=====
ROUTE_REQUEST DS 0H
        BAL  R6,GETMAIN_SHARED  GETMAIN SHARED storage
        L    R12,UEPTQTOK       Fetch address of token
        L    R12,0(R12)         Fetch Shared storage address
        USING SHARED_STORAGE,R12 Address using R12
*
* Update the Queue Name in CLPS
        USING TABLE_ENTRY,R9   R9 points to the table entry
        CLC  NEW_NAME,0(R7)     Is the new_name=current_queue name?
        BE   ROUTE1             ..Yes No need to update Queue Name
        MVC  SHARED_NAME,NEW_NAME Copy QNAME into shared storage
        L    R8,UEPCLPS         Address the CLPS..
        USING TS_ADDR_LIST,R8   ..with Register 8
        LA  R1,SHARED_NAME     Fetch address of the new QNAME
        ST  R1,TS_ADDR1        Store address in TS_ADDR1
        DROP R8                 Drop TS_ADDR_LIST
*

```

Figure 113. Example exit program for the XTSEREQ exit (Part 9 of 16)

example XTSERREQ global user exit program

```

*      Update the Sysid in CLPS
ROUTE1 DS    0H
      MVC  SHARED_SYSID,NEW_SYSID Copy SYSID into shared storage
      L   R8,UEPCLPS           Address the CLPS..
      USING TS_ADDR_LIST,R8    ..with Register 8
      L   R1,TS_ADDR0          Address the EID..
      USING TS_EID,R1         ..with Register 1
      OI  TS_BITS1,TS_SYSID_V  Indicate SYSID now present in CLPS
      DROP R1                  Drop addressability to EID
      LA  R1,SHARED_SYSID      Fetch address of the new SYSID
      ST  R1,TS_ADDR7          Store address in TS_ADDR7
      OI  TS_ADDR7,X'80'       Indicate SYSID is end of plist
*
*      Clear hi-order bits in ARGs 1 to 5
      NI  TS_ADDR1,X'7F'       Indicate not last parameter in CLPS
      NI  TS_ADDR2,X'7F'       Indicate not last parameter in CLPS
      NI  TS_ADDR3,X'7F'       Indicate not last parameter in CLPS
      NI  TS_ADDR4,X'7F'       Indicate not last parameter in CLPS
      NI  TS_ADDR5,X'7F'       Indicate not last parameter in CLPS
      B   RETURN              Return
      DROP R8                  Drop TS_ADDR_LIST
      DROP R12                 Drop SHARED_STORAGE
      DROP R9                  Drop addressability to Entry
      EJECT ,
*
*-----*
* ENTRY_NOT_FOUND - No entry was found in the TS_Routing_Table *
* No entry found in Routing Table for this TS Queue Name. In the *
* sample program, all such requests are routed. *
* *
* Registers: *
* R1 = Work register *
* R6 = Link Register *
* R8 = Command Parameter List (CLPS) *
* R12= Work register (Shared_storage) *
* *

```

Figure 113. Example exit program for the XTSERREQ exit (Part 10 of 16)

example XTSERREQ global user exit program

```

* Logic:
* Entry_Not_Found:
*   Call Getmain_Shared
*   Copy default_sysid into shared storage
*   Address the command plist
*   Update ADDR7 to point to the address of the default SYSID
*   Set the SYSID existence bit in the EID
*   Set the Hi-order bit in last address in CLPS
*   Return
*=====
ENTRY_NOT_FOUND DS 0H
    BAL  R6,GETMAIN_SHARED  GETMAIN SHARED storage
    L    R12,UEPTQTOK       Fetch address of token
    L    R12,0(R12)         Fetch shared storage address
    USING SHARED_STORAGE,R12 Address using R12
*
*   Update the Sysid in CLPS
MVC  SHARED_SYSID,DEFAULT_SYSID Copy SYSID to shared storage
L    R8,UEPCLPS           Address the CLPS..
USING TS_ADDR_LIST,R8    ..with Register 8
L    R1,TS_ADDR0          Address the EID..
USING TS_EID,R1         ..with Register 1
OI   TS_BITS1,TS_SYSID_V Indicate SYSID now present in CLPS
DROP R1                  Drop addressability to EID
LA   R1,SHARED_SYSID     Fetch address of the new SYSID
ST   R1,TS_ADDR7         Store address in TS_ADDR7
OI   TS_ADDR7,X'80'      Indicate SYSID is end of plist
*
*   Clear hi-order bits in ARGs 1 to 5
NI   TS_ADDR1,X'7F'       Indicate not last parameter in CLPS
NI   TS_ADDR2,X'7F'       Indicate not last parameter in CLPS
NI   TS_ADDR3,X'7F'       Indicate not last parameter in CLPS
NI   TS_ADDR4,X'7F'       Indicate not last parameter in CLPS
NI   TS_ADDR5,X'7F'       Indicate not last parameter in CLPS
B    RETURN              Return
DROP R8                  Drop TS_ADDR_LIST
DROP R12                 Drop SHARED_STORAGE
EJECT ,
*

```

Figure 113. Example exit program for the XTSERREQ exit (Part 11 of 16)

example XTSERREQ global user exit program

```

*=====*
* GETMAIN_SHARED - Obtain Shared storage *
* * *
* Registers: *
* R0 = Used by EXEC CICS call *
* R1 = Used by EXEC CICS call *
* Work Register *
* R6 = Link Register - Return Address *
* R11= EIB register (set on entry) *
* R12= Work register *
* R14= Used by EXEC CICS call *
* R15= Used by EXEC CICS call *
* * *
* Logic: *
* Getmain_Shared: *
* EXEC CICS GETMAIN LENGTH(32) SET(UEPTQ TOK) SHARED RESP(resp) *
* If resp ^= OK then *
* Call Error(Getmain_Failed) *
* Else *
* Address shared storage *
* Set eyecatcher 'XTSERREQ Storage' *
* End If *
* Return *
*=====*
GETMAIN_SHARED DS 0H
L R12,UEPTQ TOK Fetch address of token
L R12,0(R12) Fetch shared storage anchor
LTR R12,R12 Is the storage already present?
BNZR R6 ..Yes Return
EXEC CICS GETMAIN LENGTH(32) SET(R12) SHARED X
INITIMG(X'00') RESP(RESP)
CLC RESP,DFHRESP(NORMAL) GETMAIN worked OK?
BNE ERROR7 ..No Goto Error routine
L R1,UEPTQ TOK Fetch address of token
ST R12,0(R1) Save address of storage
USING SHARED_STORAGE,R12
MVC SHARED_EYECATCHER,EYE_CATCHER Set Eyecatcher
DROP R12 Drop R12
BR R6 Return to caller
EJECT ,
*

```

Figure 113. Example exit program for the XTSERREQ exit (Part 12 of 16)

example XTSERREQ global user exit program

```

*=====
* FREEMAIN_SHARED - Free shared storage
* Free the shared storage associated with this command.
* Registers:
* R0 = Used by EXEC CICS call
* R1 = Used by EXEC CICS call
* R6 = Link Register - Return Address
* R11= EIB register (set on entry)
* R12= Work register
* R14= Used by EXEC CICS call
* R15= Used by EXEC CICS call
* Logic:
*   Freemain_Shared:
*     Address shared storage
*     If eyecatcher ^= 'XTSERREQ Storage' then
*       Call Error(Freemain_Logic_Error)
*     Else
*       EXEC CICS FREEMAIN DATAPOINTER(UEPTQTOK) RESP(resp)
*       If resp ^= OK then
*         Call Error(Freemain_Failed)
*       End If
*     End If
*   Return
*=====
FREEMAIN_SHARED DS 0H
      L    R12,UEPTQTOK           Fetch token address
      L    R12,0(R12)            Address shared storage address
      USING SHARED_STORAGE,R12   ..Using R12
      CLC  SHARED_EYECATCHER,EYE_CATCHER Is this our storage?
      BNE  ERROR8                ..No Goto Error routine
      DROP R12                   Drop R12
      EXEC CICS FREEMAIN DATAPOINTER(R12) RESP(RESP)
      CLC  RESP,DFHRESP(NORMAL)  FREEMAIN worked OK?
      BNE  ERROR9                ..No Goto Error routine
      L    R12,UEPTQTOK           Fetch token address
      XC  0(4,R12),0(R12)         Clear token address
      BR   R6                    Return to caller
      EJECT ,
*=====
* Trace Routines
* Issue a Trace XPI call
*
* Registers:
* R0 = Used by XPI call
* R1 = DFHTRPT plist
* R6 = Link Register - Return Address
* R12= Work register
* R13= EISTG register (set by DFHEIENT)
* Kernel Stack entry
* R14= Used by XPI call
* R15= Used by XPI call
*=====

```

Figure 113. Example exit program for the XTSERREQ exit (Part 13 of 16)

example XTSERREQ global user exit program

```

        USING DFHTRPT_ARG,R1
TRACE_ENTRY DS 0H
        L    R1,UEPXSTOR          Prepare for XPI call
        DFHTRPTX CLEAR,
        POINT_ID(TR_ENTRY)
        B    ISSUE_TRACE
TRACE_EXIT DS 0H
        L    R1,UEPXSTOR          Prepare for XPI call
        DFHTRPTX CLEAR,
        POINT_ID(TR_EXIT)
        B    ISSUE_TRACE
TRACE_ERROR DS 0H
        L    R1,UEPXSTOR          Prepare for XPI call
        DFHTRPTX CLEAR,
        POINT_ID(TR_ERROR),
        DATA1(TR_ERROR_N,1)
        BAL  R6,ISSUE_TRACE
        B    RETURN
*
*-----*
* Issue the Trace XPI call
*-----*
ISSUE_TRACE DS 0H
        L    R8,UEPTRACE          Address of trace flag
        TM   0(R8),UEPTRON        Is trace on?
        BZ   NO_TRACE             No - do not issue trace then
        LR   R12,R13              Save R13 round XPI call
        L    R13,UEPSTACK
        DFHTRPTX CALL,
        IN,
        FUNCTION(TRACE_PUT),
        POINT_ID(*),
        OUT,
        RESPONSE(*),
        REASON(*)
        LR   R13,R12              Restore R13 (DFHEISTG)
NO_TRACE DS 0H
        BR   R6                    Return to caller
        DROP R1
*
*-----*
* ERRORn
* Error has occurred during processing
* Issue a trace point and return to the CICS
*-----*
ERROR1 DS 0H
        MVI  TR_ERROR_N,1
        B    TRACE_ERROR
ERROR2 DS 0H
        MVI  TR_ERROR_N,2
        B    TRACE_ERROR
ERROR3 DS 0H
        MVI  TR_ERROR_N,3
        B    TRACE_ERROR

```

Figure 113. Example exit program for the XTSERREQ exit (Part 14 of 16)

example XTSERREQ global user exit program

```

ERROR4 DS 0H
      MVI TR_ERROR_N,4
      B TRACE_ERROR
ERROR5 DS 0H
      MVI TR_ERROR_N,5
      B TRACE_ERROR
ERROR6 DS 0H
      MVI TR_ERROR_N,6
      B TRACE_ERROR
ERROR7 DS 0H
      MVI TR_ERROR_N,7
      B TRACE_ERROR
ERROR8 DS 0H
      MVI TR_ERROR_N,7
      B TRACE_ERROR
ERROR9 DS 0H
      MVI TR_ERROR_N,7
      B TRACE_ERROR
      EJECT ,
      DROP R2 Drop DFHUEPAR
      DROP R11 Drop EIB
      LTORG ,

*****
* CONSTANTS *
*****
      DS 0D
EYE_CATCHER DC CL16'XTSEREQ Storage '
DEFAULT_SYSID DC CL4'MQ1 '
LOCAL EQU X'01'
ROUTE EQU X'02'
*
* Trace point ids
TR_ENTRY DC XL2'120'
TR_EXIT DC XL2'121'
TR_ERROR DC XL2'122'
*
*-----*
* TABLE_ENTRY: *
*-----*
* | Entry_Name | New_Name | QOR_Sysid | Action | *filler* | *
* | Char 8 | Char 8 | Char 4 | Bin 1 | Char 3 | *
* |-----|-----|-----|-----|-----| *
* Last Entry is indicated by special TS_Queue Name *
*-----*

```

Figure 113. Example exit program for the XTSERREQ exit (Part 15 of 16)

```

TS_ROUTING_TABLE DS 0D
ENTRY_NAME_1     DC CL8'AAAAAAA'      Rename Queue AAAAAAA as
NEW_NAME_1       DC CL8'BBBBBBBB'    BBBBBBBBBB
QOR_SYSID_1      DC CL4' '
ACTION_1         DC XL1'01'          Local request
FILLER_1         DC CL3' '
ENTRY_NAME_2     DC CL8'A1 '          Rename Queue A1 as
NEW_NAME_2       DC CL8'B1 '          B1
QOR_SYSID_2      DC CL4' '
ACTION_2         DC XL1'01'          Local request
FILLER_2         DC CL3' '
ENTRY_NAME_3     DC CL8'A2 '          Rename Queue A2 as
NEW_NAME_3       DC CL8'B2 '          B2
QOR_SYSID_3      DC CL4' '
ACTION_3         DC XL1'01'          Local request
FILLER_3         DC CL3' '
ENTRY_NAME_4     DC CL8'RRRRRRR'      Rename Queue RRRRRRRR as
NEW_NAME_4       DC CL8'REMOTE '      REMOTE and ship request
QOR_SYSID_4      DC CL4'MQ1 '        to System MQ1
ACTION_4         DC XL1'02'
FILLER_4         DC CL3' '
ENTRY_NAME_5     DC CL8'R1 '          Don't rename Queue R1, but
NEW_NAME_5       DC CL8'R1 '          ship request to System MQ1
QOR_SYSID_5      DC CL4'MQ1 '
ACTION_5         DC XL1'02'
FILLER_5         DC CL3' '
ENTRY_NAME_LAST  DC XL8'FFFFFFFFFFFFFF'
NEW_NAME_LAST    DC CL8' '
QOR_SYSID_LAST   DC CL4' '
ACTION_LAST      DC XL1'00'
FILLER_LAST      DC CL3' '
                END DFH$XTSE

```

Figure 113. Example exit program for the XTSEREQ exit (Part 16 of 16)

Index

Special Characters

- “good night” transaction
 - customizing the sample program 736
 - overview 733
 - sample program, DFH0GNIT 735

Numerics

- 3270 bridge
 - bridge exit 599
 - bridge exit program 599
- 3270 information display system
 - error processors (optional) 468
 - TCAM 706
 - unavailable printer
 - DFHZNEP 476

A

- abends
 - abend and restart, TCAM 707
 - transaction bit 440
- abnormal conditions
 - in terminal error programs 437
 - sample node error program 465
 - sample terminal error program 417
 - user-written node error programs 475
- abort write bit 440
- ACF/VTAM
 - application routing failure 464
 - automatic installation 485
 - CINIT request unit 488
 - CLSDST PASS function 464
 - default DFHZNEP 450
 - DFHZNAC logging facility 464
 - entries in LOGON mode table 767
 - error-handling 450
 - DFHZNAC/DFHZNEP interface 450
 - DFHZNAC/DFHZNEP interface action flags 451
 - generic resources 517
 - node error program 482
 - ISTINCLM values 770
 - node error program (DFHZNEP) 465
 - PSERVIC values 775
 - session failures
 - user-written NEPs 477
 - transaction-class error-handling routine 457
 - VTAM LOGON mode table 486
- ACQUIRE PROGRAM function of the XPI 325
- action flag names, DFHTEP 424
- adapter, task-related user exits 249
- ADD SUSPEND function of the XPI 302
- addressing mode implications 267
- ADYN, dynamic allocation transaction 714
- AIEXIT, system initialization parameter 486, 514
- AILDELAY, system initialization parameter 173, 679
- AIRDELAY, system initialization parameter 481, 679

- allocate queues
 - controlling the length of
 - using the XISCONA global user exit 127
 - using the XZIQUE global user exit 237
- APPC connections, automatic installation of 513
 - assembling and link-editing a user-replaceable program 402
- autoinstall user-replaceable programs
 - for APPC connections (DFHZATDY) 513
 - for programs (DFHPDADX) 539
 - for shipped terminals
 - DFHZATDX 523
 - DFHZATDY 523
 - for terminals (DFHZATDX) 497
 - for virtual terminals
 - DFHZATDX 531
 - DFHZATDY 531
- link-edit statements 405
- automatic installation of APPC connections
 - benefits of 514
 - control program
 - at delete 519
 - parameter list at install 515
 - purpose of 515
 - introduction 513
 - model definitions 514
 - parallel-session 514
 - recovery and restart 515
 - requirements for 514
 - single-session
 - initiated by BIND 514
 - initiated by CINIT 513
 - supplied resource definitions 521
 - templates 514
 - the sample program 520
 - default actions 520
- automatic installation of programs
 - benefits of 541
 - control program
 - parameter list at install 543
 - testing 548
 - installation of mapsets 541
 - introduction 539
 - model definitions 540
 - requirements for 542
 - supplied resource definitions 547
 - system autoinstall 541
 - the sample programs
 - customizing 546
 - DFHPGADX 546
 - DFHPGAHX 546
 - DFHPGALX 546
 - DFHPGAOX 546
- automatic installation of shipped terminals
 - control program
 - parameter list at delete 528
 - parameter list at install 526
 - introduction 523

- automatic installation of terminals
 - control program
 - action at delete 495
 - action at install 487
 - action on return 494
 - information returned to CICS 491
 - link-edit statements 405
 - naming 496
 - testing and debugging 496
 - parameter list at logon 488
 - the sample programs
 - customizing 499
 - DFHZATDX 497
 - DFHZCTDX 497
 - DFHZDTPDX 497
 - DFHZPTDX 497
 - VTAM LOGON mode table 486
- automatic installation of virtual terminals
 - control program
 - parameter list at delete 536
 - parameter list at install 534
 - introduction 531

B

- Basic Mapping Support (BMS)
 - global user exit points 27
- batch processing, TCAM SNA 694
- bridge (3270)
 - bridge exit 599

C

- CAVM data sets, opening by overseer program 613
- CEBT function in the overseer program 624
- CEDA transaction
 - programmable interface to 761
- CEMT INQUIRE AUTOINSTALL 496
- CEMT INQUIRE MONITOR 662
- CEMT PERFORM STATISTICS 679
- CEMT SET AUTOINSTALL 496
- CEMT SET MONITOR 662
- CESD, default shutdown assist transaction 396
- CHANGE PRIORITY function of the XPI 313
- CICS-DBCTL interface status program (DFHDBUEX)
 - link-edit statements 405
- CICS-DBCTL interface status program (DFHDBUEX)
 - communications area 596
 - introduction to 595
 - sample program 596
- CICS system definition utility program (DFHCSDUP)
 - EXTRACT command 742
 - invocation from a user program 751
 - running under TSO 751
 - sample programs 744
 - DFH\$CRFA 745
 - DFH\$CRFP 745
 - DFH\$FORA 745
 - DFH\$FORP 745
 - DFH0CBDC 745
 - DFH0CRFC 745

- CICS system definition utility program (DFHCSDUP)
 - (continued)
 - sample programs 742 (continued)
 - DFH0FORC 745
 - user exits 755
 - writing a user program 742
 - invocation points 743
 - link-edit statements 747
 - parameters passed from DFHCSDUP 743
 - sample JCL, assembler-language 748
 - sample JCL, LE 751
 - sample JCL, PL/I 750
 - sample JCL, VS COBOL II 749
 - CINIT, VTAM 497
 - CINIT request unit 488
 - CLSDSTP, system initialization parameter 464
 - CODE operand
 - DFHSNEP TYPE=ERRPROC 471
 - DFHTEPM TYPE=ERRPROC 430
 - DFHTEPT TYPE=BUCKET 436
 - DFHTEPT TYPE=PERMCODE|ERRCODE 434
 - common subroutine vector table (CSVT) 466, 474
 - communication area
 - terminal error program 417
 - communication control bytes 692, 704
 - communications area
 - autoinstall control program
 - APPC connections 516
 - programs 543
 - terminals 488
 - CICS-DBCTL interface status program 596
 - distributed routing program 585
 - dynamic routing program 562
 - node error program 458
 - program error program 409
 - terminal error program 439
 - transaction restart program 412
 - consoles, automatic installation 505
 - COUNT operand
 - DFHSNET macro 473
 - DFHTEPT TYPE=PERMCODE|ERRCODE 434
 - limits, default threshold for TEP 434
 - CS operand
 - DFHSNEP TYPE=INITIAL 470
 - CSD utility program (DFHCSDUP) 746
 - CSNE transaction 450
 - CSVT (common subroutine vector table) 466
 - customizing the overseer program 623

D

- data format
 - TCAM 696
- data tables 33
- database control (DBCTL)
 - DBCTL information about the CAVM data sets 622
 - DFHDBUEX 595
 - DFHMCT TYPE=EMP entries 661
 - in an XRF environment 623
 - interface status 595
- DBCTL (database control)
 - DBCTL information about the CAVM data sets 622

DBCTL (database control) *(continued)*
 DFHDBUEX 622
 DFHMCT TYPE=EMP entries 661
 in an XRF environment 623
 interface status 595
 DBLID values 620
 DD card correlation TCAM 694
 DECB, terminal error program
 information 425
 operand 425
 DEFAULT operand
 DFHZNEPI TYPE=INITIAL 479
 default threshold count limits
 DFHTEP (terminal error program) 434
 DEFINE PROGRAM function of the XPI 321
 defining terminal error blocks 433
 DELETE PROGRAM function of the XPI 328
 DELETE SUSPEND function of the XPI 308
 DEQUEUE function of the XPI 319
 device message handler (DMH) 692
 DFH\$AXRO, sample overseer program 613
 DFH\$CRFA, cross-reference program,
 assembler-language 745
 DFH\$CRFP, cross-reference program, PL/I 745
 DFH\$DTAD, sample global user exit program 17
 DFH\$DTLC, sample global user exit program 17
 DFH\$DTRD, sample global user exit program 17
 DFH\$FCBF, sample global user exit program 116
 DFH\$FCBV, sample global user exit program 121
 DFH\$FCLD, sample global user exit program 123
 DFH\$FORA, formatting program, assembler-
 language 745
 DFH\$FORP, formatting program, PL/I 745
 DFH\$ICCN, sample global user exit program 146
 DFH\$PCEX, sample global user exit program 166
 DFH\$PCPI, sample program for global user exits 15
 DFH\$PCTA, sample global user exit program 169
 DFH\$SXPn, sample global user exit programs 155
 DFH\$TDWT, transient data write-to-terminal
 program 803
 DFH\$XTSE, example program for XTSEREQ exit 807
 DFH\$XZIQ, sample global user exit program 244
 DFH\$ZCAT, sample global user exit program 15
 DFH0CBDC program, write DEFINE commands for VS
 COBOL II 745
 DFH0CRFC, cross-reference program, VS COBOL
 II 745
 DFH0FORC, formatting program, VS COBOL II 745
 DFH0GNIT, sample "good night" program 735
 DFHAPIQX macro 352
 DFHBRIQX macro 370
 DFHCESD, shutdown assist program 396
 DFHDBUEX, CICS-DBCTL interface status program
 link-edit statements 405
 DFHDBUEX, CICS-DBCTL interface status program
 communications area 596
 introduction to 595
 sample program 596
 DFHDSATX macro 300
 DFHDSRP, distributed routing program
 changing the target region 579, 583
 communications area 579
 differences from dynamic routing program 576
 error handling 579, 584
 invoking on abend 580, 584
 overview 575
 processing considerations 580, 584
 renaming customized version 593
 routing a BTS activity 579
 routing non-terminal-related START requests 583
 sample program 593
 when invoked 578, 582
 DFHDSSRX macro 300
 DFHDUDUX macro 314
 DFHDXGHD DSECT 622
 DFHDYP, dynamic routing program
 changing the program name 553, 559
 changing the target region 552, 559
 communications area 562
 error handling 554, 561
 information passed to 551
 invoking on abend 555, 561
 link-edit statements 405
 modifying application's communications area 555,
 561
 modifying initial terminal data 555
 overview 549
 processing considerations 556, 562
 receiving information from routed DPL request
 monitoring the output COMMAREA 562
 receiving information from routed transaction
 monitoring the output COMMAREA 556
 monitoring the output TIOA 556
 renaming customized version 573
 routing a program-link request 560
 routing a transaction 553
 sample program 574
 testing customized version 573
 UOW considerations 557, 562
 when invoked 550, 558
 DFHEIP, EXEC interface program 402
 DFHJCJCX macro 388
 DFHJVMAT, JVM environment variables program 603
 variables 603
 DFHKEDSX macro 320
 DFHLDLDX macro 321
 DFHLGPAX macro 329
 DFHMCTDR, monitoring dictionary DSECT 666
 DFHMNMNX macro 330
 DFHNET DSECTs 474
 DFHNQEDX macro 318
 DFHOSD data set 613
 DFHPEP, program error program
 communication area for assembler-language
 programs 409
 link-edit statements 404
 source code 409
 writing 407
 DFHPGADX, user-replaceable autoinstall program
 customizing 546
 installation of mapsets 541

DFHPGADX, user-replaceable autoinstall program
(*continued*)
 introduction to 546
 parameter list at install 543
 sample program 546
 supplied definition of 547
 use of model definitions 540
 when invoked 539

DFHPGAQX macro 334

DFHPGISX macro 334

DFHREST, transaction restart program
 communications area 412
 default program 414
 introduction 411
 link-edit statements 404
 transactions suitable for restart 411
 when invoked 411

DFHRMCAL macro 249

DFHSAIQX macro 355, 359

DFHSIT (system initialization table)
 entries for CICS monitoring 662

DFHSMFDS, SMF header DSECT 663

DFHSMMCX macro 361

DFHSMRX macro 366

DFHSNEP, sample node error program 469

DFHSNEP macro
 TYPE=DEF3270 471
 TYPE=DEFILU 471
 TYPE=ERRPROC 454, 471
 TYPE=FINAL 471
 TYPE=INITIAL 453, 470
 TYPE=USTOR 470
 TYPE=USTOREND 470

DFHSNET macro 473
 COUNT operand 473
 ESB structure 473
 ESBS operand 473
 NAME operand 473
 NEBNAME operand 473
 NEBS operand 473
 TIME operand 474

DFHSTUP, statistics processing program 688

DFHTACP, terminal abnormal condition program 416
 terminal error-handling 416

DFHTACP (terminal abnormal condition program)
 default actions (TCAM) 703

DFHTEPM macro
 examples 430
 TYPE=ENTRY 429
 TYPE=ERRPROC 430
 TYPE=EXIT 430
 TYPE=FINAL 430
 TYPE=INITIAL 427

DFHTEPT macro
 examples 436
 TYPE=BUCKET 436
 TYPE=FINAL 436
 TYPE=INITIAL 432
 TYPE=PERMCODE|ERRCODE 433
 TYPE=PERMTID 433

DFHTRPTX macro 369

DFHUEPAR DSECT 8, 253

DFHUERTR DSECT 257

DFHUEXIT macro 7

DFHWOS, overseer module 613

DFHWOSM macros
 FUNC=BUILD 615
 FUNC=CLOSE 616
 FUNC=DSECT 616
 FUNC=JJC 616
 FUNC=JJS 617
 FUNC=OPEN 618
 FUNC=OSCMD 618
 FUNC=QJJS 617
 FUNC=READ 619, 620
 FUNC=TERM 622
 token values 614

DFHXIS, sample global user exit program 128

DFHXMCLX macro 374

DFHXMIQX macro 383, 387

DFHXMSRX macro 371, 372

DFHXMIDX macro 375

DFHXTENF, sample global user exit program 19

DFHXTEP, sample terminal error program 417

DFHZATDX, user-replaceable autoinstall program
 action at delete 495
 action at install 487
 communications area 495
 customizing 499
 for consoles 505
 introduction 485
 link-edit statements 405
 sample control program 498
 source code 497
 suggestions for use 498
 used to install shipped terminals 523
 used to install virtual terminals 531

DFHZATDY, user-replaceable autoinstall program
 communications area 516
 default actions 520
 for APPC single-session connections
 initiated by CINIT 513
 for parallel-session APPC connections 514
 for single-session APPC connections
 initiated by BIND 514
 introduction to 513
 purpose of 515
 supplied definition of 521
 the sample program 520
 used to install shipped terminals 523
 used to install virtual terminals 531
 when invoked 515

DFHZNAC, node abnormal condition program 450
 action flag settings 802
 default actions
 for system sense codes 800
 for terminal error codes 789
 execution after XRF takeover 480
 execution with persistent session support 481
 execution with VTAM generic resources 482
 logging facility 464
 terminal error-handling 457

DFHZNEP, user-replaceable node error program 449

DFHZNEPI macros

- TYPE=ENTRY 479
- TYPE=FINAL 479
- TYPE=INITIAL 479

dictionary data section, CICS monitoring records 666, 672

disabling journals 631

dispatcher functions of the XPI 300

display function of the overseer program 610

distributed program link (DPL)

- dynamic routing of requests
 - changing the program name 559
 - changing the target region 559
 - eligibility for routing 557
 - error handling 561
 - terminating a request 560
 - when the routing program is invoked 558

distributed routing

- of BTS activities
 - changing the target region 579
 - eligibility for routing 577
 - error handling 579
 - running the activity locally 579
 - when the routing program is invoked 578
- of non-terminal-related START requests
 - changing the target region 583
 - eligibility for routing 581
 - error handling 584
 - running the transaction locally 583
 - when the routing program is invoked 582
- overview 575
- sample programs 593
- the user program
 - error handling procedure 579, 584
 - naming of 593
 - parameters 585
 - when invoked 578, 582

distributed routing of BTS activities

- eligibility for routing 577

distributed routing program, DFHDSRP

- differences from dynamic routing program 576
- overview 575

distributed routing program (DFHDSRP)

- changing the target region 579, 583
- communications area 585
- error handling 579, 584
- invoking on abend 580, 584
- processing considerations 580, 584
- renaming customized version 593
- routing a BTS activity 579
- routing non-terminal-related START requests 583
- sample program 593
- when invoked 578, 582

DMH (device message handler) 692

DSECTPR operand

- DFHTEPM TYPE=INITIAL 427

DSRTPGM, system initialization parameter 593

DTRPGM, system initialization parameter 573

DTRTRAN, system initialization parameter 552

dump control functions of the XPI 314

dynamic allocation sample program (DYNALLOC)

- flow of control 717
- help feature 715
- introduction 713
- keywords, abbreviation rules 716
- system programming considerations 716
- terminal operation 714
- values 715

DYNAMIC option 550

dynamic routing

- of program-link requests
 - changing the program name 559
 - changing the target region 559
 - eligibility for routing 557
 - error handling 561
 - terminating a request 560
 - when the routing program is invoked 558
- of transactions
 - changing the program name 553
 - changing the target region 552
 - error handling 554
 - information passed to routing program 551
 - overview 550
 - resource definition 550
 - terminating a transaction 553
 - the user program 550
- overview 549
- sample programs 574
- the user program
 - error handling procedure 554, 561
 - link-edit statements 405
 - naming of 573
 - parameters 562
 - testing of 573
 - when invoked 550, 558

dynamic routing of DPL requests

- eligibility for routing 557
- when the routing program is invoked 558

dynamic routing program (DFHDYP)

- changing the program name 553, 559
- changing the target region 552, 559
- communications area 562
- error handling 554, 561
- information passed to 551
- invoking on abend 555, 561
- link-edit statements 405
- modifying application's communications area 555, 561
- modifying initial terminal data 555
- overview 549
- processing considerations 556, 562
- receiving information from routed DPL request
 - monitoring the output COMMAREA 562
- receiving information from routed transaction
 - monitoring the output COMMAREA 556
 - monitoring the output TIOA 556
- renaming customized version 573
- routing a program-link request 560
- routing a transaction 553
- sample program 574
- testing customized version 573

dynamic routing program (DFHDYP) *(continued)*
 UOW considerations 553, 562
 when invoked 550, 558
dynamic transactions 550

E

EDF (Execution Diagnostic Facility)
 with global user exits 6
 with task-related user exits 252
EMP (event-monitoring point) 658
END_BROWSE_PROGRAM function of the XPI 349
ENQUEUE 318
enqueue domain functions of the XPI 318
error group index 467, 473
error groups 452
error processing
 in node error program (NEP) 465
 in terminal error program (TEP) 415
error status block (ESB) 473
error status element (ESE) 419, 425
 DFHTEPT TYPE=PERMCODE|ERRCODE 433
ESB (error status block) 473
ESBS operand
 DFHSNET macro 473
ESE (error status element) 419, 425
 DFHTEPT TYPE=PERMCODE|ERRCODE 433
ESM (external security manager) 721
ESMEXITS, system initialization parameter 724
event-monitoring point (EMP) 658
exception class monitoring 661
exception class monitoring records 657
exception class statistics records 677
exception data section format 674
EXEC CICS HANDLE command
 as alternative to node error program 449
EXEC CICS INQUIRE command
 for autoinstall 496
EXEC CICS PERFORM command
 for requested statistics 679
EXEC CICS SET command
 for autoinstall 496
 for enabling and disabling journals 631
EXEC CICS WRITE JOURNALNAME command 631
EXEC interface program (DFHEIP) 402
Execution Diagnostic Facility (EDF)
 with global user exits 6
 with task-related user exits 252
 with user-replaceable programs 401
Exit XTSPTOUT 191
Exit XTSQRIN 187
extended recovery facility (XRF)
 node error program 480
 overseer program 609
external CICS interface
 the user program
 link-edit statements 405
external security manager (ESM) 721
EXTRACT command
 for task-related user exits 281
 of DFHCSDUP 742

F

FEPI
 journal records
 prefix area 644
field connectors, CICS monitoring 672, 673
field identifiers, CICS monitoring 673
FILE_CLOSE_DATA section, journal records 641
file control
 journal records
 FILE_CLOSE_DATA section 641
 file-close record types 641
 FLJB 637
 FLJB_COMMON_DATA section 639
 FLJB_GENERAL_DATA section 638
 FLJB_WRITE_DELETE_DATA section 640
 read-only record type 637
 read-update record type 637
 TIE_UP_RECORD_DATA section 642
 tie-up record types 642
 write-add complete record type 637
 write-add record type 637
 write-delete record types 640
 write-update record type 637
FLJB, file control journal block 637
FLJB_COMMON_DATA section, journal records 639
FLJB_GENERAL_DATA section, journal records 638
FLJB_WRITE_DELETE_DATA section, journal records 640
FMH processing 693
FREEMAIN function of the XPI 364

G

generalized message format, TCAM 705
generic resources, VTAM 517
 node error program 482
GET_NEXT_PROGRAM function of the XPI 347
GETMAIN function of the XPI 362
global user exits
 example programs 19
 for EXEC interface exits 807
 for mixing API and XPI calls 6, 807
 for modifying TS requests 202, 807
 for XFCREQ 78, 82
 for XFCREQC 78, 82
 for XICREQ 145, 146
 for XICREQC 145, 146
 for XPCREQ 164
 for XPCREQC 164
 for XTDREQ 221
 for XTDREQC 221
 for XTSREQ 202, 807
 for XTSREQC 202, 807
 exit points
 bridge facility creation 32
 bridge facility deletion 32
 for 'terminal not known' condition 208
 in activity keypoint program 25
 in BMS 27
 in data tables management 33
 in data tables programs 33

global user exits (*continued*)

- in DBCTL interface control program 19
- in DBCTL tracking program 40
- in dispatcher domain 42
- in DL/I interface program 44
- in dump domain 49
- in enqueue EXEC interface program 57
- in EXEC interface program 65
- in file control EXEC interface program 70, 83
- in file control file state program 96
- in file control open/close program 105
- in file control quiesce receive program 107
- in file control quiesce send program 110
- in file control recovery program 112
- in Front End Programming Interface 125
- in good-morning message program 126
- in intersystem communication program 127
- in interval control EXEC interface program 134
- in interval control program 132
- in loader domain 147
- in log manager domain 149
- in message domain 152
- in monitoring domain 156
- in program control program 158
- in resource management modules 173
- in resource manager interface program 171
- in security manager domain 177
- in statistics domain 180, 687
- in system recovery program 182
- in system termination program 186
- in temporary storage domain 187
- in temporary storage EXEC interface program 193
- in terminal allocation program 203
- in terminal control program 205
- in transaction manager domain 216
- in transient data EXEC interface program 221
- in transient data program 218
- in user log record recovery program 230
- in VTAM terminal management program 234
- in VTAM working-set module 235
- in XRF request-processing program 246

exit programs

- addressing implications 5
- defining, enabling, and disabling 13
- errors 12
- global work area 6
- multiple at one exit 13
- one at several exits 14
- parameters passed 7
- programming interface restrictions 11
- register conventions 4
- returning values to CICS 10
- using CICS services 5
- using EDF 6

overview 3

sample programs

- DFH\$BMXT 17
- DFH\$DTAD 17
- DFH\$DTLC 17
- DFH\$DTRD 17

global user exits (*continued*)

sample programs (*continued*)

- DFH\$FCBF 17
- DFH\$FCBV 18
- DFH\$FCLD 18
- DFH\$ICCN 146
- DFH\$PCEX 15, 166
- DFH\$PCPI 15
- DFH\$PCTA 19, 169
- DFH\$SXP1 155
- DFH\$SXP2 155
- DFH\$SXP3 155
- DFH\$SXP4 155
- DFH\$SXP5 155
- DFH\$SXP6 155
- DFH\$SXPN set 18
- DFH\$XDRQ 17
- DFH\$XNQE 17, 63
- DFH\$XZIQ 18
- DFH\$ZCAT 15
- DFHXIS 128
- DFHXTENF 214
- summary of 14
- trace table entries 7
- with storage protection
 - data storage key 12
 - execution key 11

GMTRAN, system initialization parameter 462

GNTRAN, system initialization parameter 733, 737

GROUP operand

- DFHSNEP TYPE=ERRPROC 472

I

IEDRH macro 693

IIOPI

- DFHXOPUS 601

IIOPI inbound to Java

- security exit program 601

initialization programs

- considerations when writing 393
- INITPARMS, system initialization parameter 15
- INQ_APPLICATION_DATA function of the XPI 352
- INQUIRE_ACCESS function of the XPI 364
- INQUIRE_AUTOINSTALL function of the XPI 350
- INQUIRE_CONTEXT function of the XPI 370
- INQUIRE_CURRENT_PROGRAM function of the XPI 341
- INQUIRE_DTRTRAN function of the XPI 371
- INQUIRE_ELEMENT_LENGTH function of the XPI 365
- INQUIRE_MONITOR command 662
- INQUIRE_MONITORING_DATA function of the XPI 334
- INQUIRE_MXT function of the XPI 372
- INQUIRE_PARAMETERS function of the XPI 329
- INQUIRE_PROGRAM function of the XPI 335
- INQUIRE_SHORT_ON_STORAGE function of the XPI 366
- INQUIRE_SYSTEM function of the XPI 355
- INQUIRE_TASK_STORAGE function of the XPI 367
- INQUIRE_TCLASS function of the XPI 374

INQUIRE_TRANDEF function of the XPI 375
INQUIRE_TRANSACTION function of the XPI 383
interactive logical unit error processor 469
intersystem queues
 controlling the length of
 using the XISCONA global user exit 127
 using the XZIQUE global user exit 237
INTLU error processor 469
ISSUE PASS command 464
ISTINCLM entries for automatic installation 770

J

job control for sample DFHTEP generation 426
journal control label header 646
journal module identifiers 652
journal record, old format 648
journal record formats
 caller data, file control 637
 CICS Transaction Server for OS/390 format 632
 FEPI prefix 644
 journal control label header 646
 label header 646
 label prefix 647
 log block header 634
 new format journal record 635
 old format 645
 old format journal record 648
 start-of-run record 636
 system header 648
 system prefix 649
 terminal control prefix 644
 user prefix 649
journal records
 data section format 655
 module identifiers 652
 written to SMF 653
journals
 disabling 631
 enabling 631
 reading 631
 offline 632
JVM environment variables program, DFHJVMAT 603

K

kernel domain functions of the XPI 320

L

label header 646
label prefix 647
line locking
 permanent lock, TCAM 702
 temporary lock, TCAM 702
line pool specifications (TCAM)
 POOL feature 701
 restrictions 702
loader functions of the XPI 321
log block header, journal records 634
log manager functions of the XPI 329

logic flow, TCAM 697
logical units (LUs)
 node error program 457
LOGON mode table, VTAM 767

M

MAXERRS operand
 DFHTEPT TYPE=INITIAL 432
MAXTIDS operand
 DFHTEPT TYPE=INITIAL 432
MCT (monitoring control table)
 entries for DBCTL 661
 entries for EMPs 658
messages, TCAM
 control program 704, 710
 DEST operand 700
 format 705
 handler 694
 MCP (message control program) 710
 routing 700
MN, system initialization parameter 662
MNEVE, system initialization parameter 662
MNEXC, system initialization parameter 662
MNPER, system initialization parameter 662
model definitions
 for autoinstall of APPC connections 514
 for automatic installation of programs 540
model terminal support
 coding entries 487
MONITOR function of the XPI 331
monitoring
 control commands 662
 control table (MCT) 658
 data section format 666
 DFHMCT entries for DBCTL 661
 DFHMCTDR, the dictionary DSECT 666
 DFHSIT entries 662
 DFHSMFDS, SMF header DSECT 663
 dictionary data section 666, 672
 event-monitoring point (EMP) 658
 exception class data 657
 exception data section format 674
 exception data sections 674
 field connectors 672, 673
 field identifiers 673
 functions of the XPI 330
 monitoring control table 658
 overview 657
 passing the data to SMF 662
 performance class data 657
 performance record format 672
 purpose 657
 record formats 663
 record types 657
 SMF 662
 SMF header 663
 SMF product section 663
monitoring control table (MCT) 658
MVS consoles
 automatic installation 505
MVS router exit 722

N

- NAME operand
 - DFHSNEP TYPE=INITIAL 470
 - DFHSNET macro 473
- national characters
 - uppercase translation 805
- NEB (node error block) 474
- NEBNAME operand
 - DFHSNET macro 473
- NEBS operand
 - DFHSNET macro 473
- NEP (node error program)
 - 3270 unavailable printer 476
 - ACF/VTAM error handling
 - background 450
 - application routing failure 464
 - common subroutine vector table (CSVT) 474
 - communication area 458
 - conventions for registers 472
 - default actions of DFHZNAC
 - for system sense codes 800
 - for terminal error codes 789
 - default node error program 452
 - default transaction-class routine 479
 - DFHNET DSECT 474
 - DFHSNET 473
 - DFHZNAC 457
 - DFHZNAC action flag settings 802
 - DFHZNAC/DFHZNEP interface 450
 - DFHZNAC logging facility 464
 - DFHZNEP 450, 457
 - DFHZNEPI interface module 478
 - DFHZNEPI macros 478
 - DFHZNEPI TYPE=INITIAL 479
 - DSECTs 474
 - error groups 452
 - error status blocks 474
 - error table header 474
 - in an XRF environment 480
 - changing the recovery message 482
 - changing the recovery notification 481
 - changing the recovery transaction 482
 - link-edit statements 404
 - multiple NEPs 455
 - NEPCLASS 455
 - NET generation 452
 - node abnormal condition program 457
 - node error block, format 468
 - node error blocks 474
 - node error table 467
 - format 468
 - generation 452
 - reasons for writing your own 450
 - routing considerations 456
 - sample 452, 465
 - addressability 466
 - coding description 453
 - common subroutine vector table (CSVT) 466
 - compatibility with sample TEP 466
 - components 466
 - conditions 455
 - NEP (node error program) (*continued*)
 - sample 476, 465 (*continued*)
 - CSVT (common subroutine vector table) 466
 - DFHSNEP TYPE=INITIAL macro 470
 - DFHSNEP TYPE=USTOR macro 470
 - DFHSNEP TYPE=USTOREND macro 470
 - error processor vector table (EPVT) 467, 471
 - error processors, DFHSNEP
 - TYPE=DEF3270 470
 - error processors for INTLU, DFHSNEP
 - TYPE=DEFILU 471
 - error status information 467
 - generating by DFHSNEP 469
 - node error table 467
 - optional common subroutines 468
 - optional error processor for INTLU 469
 - optional error processors for 3270 468
 - routing mechanism (ACF/VTAM) 467
 - session failures 477
 - TERMERR condition 449
 - terminal control program (ACF/VTAM section) 457
 - user-supplied error processors, DFHSNEP
 - TYPE=ERRPROC 471
 - user-written 475
 - addressability 476
 - restrictions on use 475
 - user-written error processors 471
 - when abnormal condition occurs 457
 - with persistent session support 481
 - with VTAM generic resources 482
 - writing overview 451
 - NEPCLAS operand
 - DFHZNEPI TYPE=ENTRY 479
 - NEPCLASS operand
 - for CEDA 455
 - NEPNAME operand
 - DFHZNEPI TYPE=ENTRY 479
 - NET (node error table) 452
 - NETNAME operand
 - DFHSNEP TYPE=INITIAL 470
 - node abnormal condition program (NACP) 457
 - node error block (NEB) 474
 - node error handler (CSNE transaction) 450
 - node error program (NEP)
 - 3270 unavailable printer 476
 - ACF/VTAM error handling
 - background 450
 - application routing failure 464
 - common subroutine vector table (CSVT) 474
 - communication area 458
 - conventions for registers 472
 - default actions of DFHZNAC
 - for system sense codes 800
 - for terminal error codes 789
 - default node error program 452
 - default transaction-class routine 479
 - DFHNET DSECT 474
 - DFHSNET 473
 - DFHZNAC 457
 - DFHZNAC action flag settings 802
 - DFHZNAC/DFHZNEP interface 450

- node error program (NEP) *(continued)*
 - DFHZNAC logging facility 476
 - DFHZNEP 450, 457
 - DFHZNEPI interface module 478
 - DFHZNEPI macros 478
 - DFHZNEPI TYPE=INITIAL 479
 - DSECTs 474
 - error groups 452
 - error status blocks 474
 - error table header 474
 - in an XRF environment 480
 - changing the recovery message 482
 - changing the recovery notification 481
 - changing the recovery transaction 482
 - link-edit statements 404
 - multiple NEPs 455
 - NEPCLASS 455
 - NET generation 452
 - node abnormal condition program 457
 - node error block, format 468
 - node error blocks 474
 - node error table 467
 - format 468
 - generation 452
 - reasons for writing your own 450
 - routing considerations 456
 - sample 452, 465
 - addressability 466
 - coding description 453
 - common subroutine vector table (CSVT) 466
 - compatibility with sample TEP 466
 - components 466
 - conditions 455
 - CSVT (common subroutine vector table) 466
 - DFHSNEP TYPE=INITIAL macro 470
 - DFHSNEP TYPE=USTOR macro 470
 - DFHSNEP TYPE=USTOREND macro 470
 - error processor vector table (EPVT) 467, 471
 - error processors, DFHSNEP
 - TYPE=DEF3270 470
 - error processors for INTLU, DFHSNEP
 - TYPE=DEFILU 471
 - error status information 467
 - generating by DFHSNEP 469
 - node error table 467
 - optional common subroutines 468
 - optional error processor for INTLU 469
 - optional error processors for 3270 468
 - routing mechanism (ACF/VTAM) 467
 - session failures 477
 - TERMERR condition 449
 - terminal control program (ACF/VTAM section) 457
 - user-supplied error processors, DFHSNEP
 - TYPE=ERRPROC 471
 - user-written 475
 - addressability 476
 - restrictions on use 475
 - user-written error processors 471
 - when abnormal condition occurs 457
 - with persistent session support 481
 - with VTAM generic resources 482

- node error program (NEP) *(continued)*
 - writing overview 476
- node error table (NET) 452
- nonpurgeable task 440

O

- OPTCD operand 700
- OPTIONS operand
 - DFHTEPM TYPE=INITIAL 427
 - DFHTEPT TYPE=INITIAL 432
- overseer program
 - customizing the sample program 623
 - including the CEBT command 624
 - loop or wait detection in the active 624
- DFH\$AXRO 613
- DFHOSD data set 613
- DFHWOSM macros 614
 - FUNC=BUILD 615
 - FUNC=CLOSE 616
 - FUNC=DSECT 616
 - FUNC=JJC 616
 - FUNC=JJS 617
 - FUNC=OPEN 618
 - FUNC=OSCMD 618
 - FUNC=QJJS 617
 - FUNC=READ 619
 - FUNC=TERM 622
- display function 610
- interface with CICS 613
- module DFHWOS 613
- opening CAVM data sets dynamically 613
- restart-in-place function 611
 - enabling and disabling 612
 - rules governing restart in place 612

P

- PEP (program error program)
 - communication area for assembler-language programs 409
 - source code 409
 - writing 407
- performance class monitoring records 657
- performance class statistics records 677
- performance record format 672
- permanent line lock, TCAM 702
- persistent session support
 - node error program 481
- PGAICTLG, system initialization parameter 542
- PGAEXIT, system initialization parameter 542
- PGAIPGM, system initialization parameter 394, 542
- PLT programs 396
- PLTPI, system initialization parameter 393
- PLTPI programs
 - first phase 393
 - general considerations 396
 - introduction 393
 - second phase 394
- PLTSD, system initialization parameter 394
- PLTSD programs
 - first phase 395

PLTSD programs (*continued*)
 general considerations 395
 introduction 394
 second phase 395
 POOL feature, TCAM 701
 pool of common TCTTEs 696
 PRINT operand
 DFHTEPM TYPE=INITIAL 428
 processing output from CICS statistics 688
 program error program (PEP)
 communication area for assembler-language programs 409
 link-edit statements 404
 source code 409
 writing 407
 program list table (PLT) programs
 general considerations 396
 PLTPI programs
 first phase 393
 introduction 393
 second phase 394
 PLTSD programs
 first phase 395
 introduction 394
 second phase 395
 with storage protection
 data storage key 397
 execution key 396
 program management functions of the XPI 334
 programmable interface to RDO transactions 761
 programs, automatic installation of 539
 protocol management, TCAM 692
 PSERVIC values for automatic installation 775

Q

queue considerations, TCAM 703
 queues for intersystem sessions
 controlling the length of
 using the XISCONA global user exit 127
 using the XZIQUE global user exit 237

R

RACROUTE macros 727
 RDO transactions
 EXEC CICS LINK to DFHEDAP 761
 programmable interface to 761
 reading DBCTL information from the CAVM data sets 622
 recovery and restart
 node error program (DFHZNEP) 449
 program error program (PEP) 407
 routing mechanism (ACF/VTAM) 467
 recursive retry routine, in DFHTEP
 example 446
 RELEASE PROGRAM function of the XPI 327
 RENTPGM, system initialization parameter 322, 344
 resource definition online transactions
 EXEC CICS LINK to DFHEDAP 761
 programmable interface to 761
 resource manager interface (RMI) 249

restart-in-place function of the overseer program 611
 RESUME function of the XPI 308
 RMI (resource manager interface) 249
 RMTRAN, system initialization parameter 482
 routing mechanism, VTAM 467

S

sample programs
 “good night” transaction (DFH0GNIT) 735
 CICS–DBCTL interface status program (DFHDBUEX) 596
 for automatic installation of APPC connections 520
 for automatic installation of programs 546
 for automatic installation of terminals 497
 for distributed routing 593
 for dynamic allocation (DYNALLOC) 713
 for dynamic routing 574
 for global user exits
 DFH\$DTAD, for the XDTAD exit 17
 DFH\$DTLC, for the XD TLC exit 17
 DFH\$DTRD, for the XDTRD exit 17
 DFH\$FCBF, for the XFCFAIL exit 116
 DFH\$FCBV, for the XFCFAIL exit 121
 DFH\$FCLD, for the XFCFAIL exit 123
 DFH\$ICCN 18
 DFH\$PCEX, for the XPCFTCH exit 166
 DFH\$PCPI, description of 15
 DFH\$PCTA, for the XPCTA exit 169
 DFH\$SXPN, for the XMEOU T exit 155
 DFH\$XZIQ, for the XZIQUE exit 244
 DFH\$ZCAT, for the XZCATT exit 15
 DFHXIS 18
 DFHXIS, for the XISCONA exit 128
 DFHXTENF, for the XALTENF exit 19, 214
 DFHXTENF, for the XICTENF exit 19
 for the system definition utility program, DFHCSDUP 744
 node error program (DFHSNEP) 465
 program error program (DFHPEP) 410
 terminal error program (DFHXTEP) 417
 transaction restart program (DFHREST) 414
 transient data write-to-terminal program (DFH\$TDWT) 803
 schedule flag word 265
 SCS (SNA character string) 692
 security
 interface to external manager 721
 MVS router 721
 MVS router exit 722
 RACROUTE macros 727
 system authorization facility (SAF) 721
 the CICS-ESM interface 721
 segment processing, TCAM 700
 sequence of events, TCAM 697
 session failures, user actions 477
 SET_AUTOINSTALL function of the XPI 350
 SET_MONITOR command 662
 SET_PARAMETERS function of the XPI 329
 SET_PROGRAM function of the XPI 343
 SET_SYSTEM function of the XPI 359
 SET_TRANSACTION function of the XPI 387

- SETEOM macro 694
- shipped terminals, automatic installation of 523
- shutdown (PLTSD) programs
 - considerations when writing 394
- shutdown assist program, DFHCESD 396
- shutdown assist transaction 396
- SMF (system management facility) 662
 - header 654, 663, 683
 - product section 654, 683
- SNA character string (SCS) 692
- specifying processing at EMPs
 - MCT entries for DBCTL 661
- START_BROWSE_PROGRAM function of the XPI 346
- start-of-run record, journal records 636
- START_PURGE_PROTECTION function of the XPI 320
- startup, TCAM 707
- state data access functions of the XPI 352
- statistics
 - control commands 679
 - data section format 685
 - exception class data 677
 - global user exit 687
 - overview 677
 - performance class data 677
 - processing output from 688
 - purpose 677
 - record formats 682
 - record types 677
 - SMF header 683
 - SMF product section 683
- STATRCD, system initialization parameter 677
- STOP_PURGE_PROTECTION function of the XPI 320
- storage control functions of the XPI 361, 366
- storage protection facility
 - with global user exit programs 11
 - with PLT programs 396
 - with task-related user exit programs 267
 - with user-replaceable programs 405
- stub program, for task-related user exits 249, 250
- SUSPEND function of the XPI 304
- SWITCH_SUBSPACE function of the XPI 368
- syncpoint management
 - syncpoint manager parameters 258
- system autoinstall 541
- system-defined event-monitoring point 658
- SYSTEM DUMP function of the XPI 314
- system header, journal records 648
- system initialization parameters
 - AIEXIT 486, 514
 - AILDELAY 173, 679
 - AIRDELAY 481, 679
 - CLSDSTP 464
 - DSRTPGM 593
 - DTRPGM 573
 - DTRTRAN 552
 - ESMEXITS 724
 - GMTRAN 462
 - GNTRAN 733, 737
 - INITPARMS 15
 - MN 662

system initialization parameters (*continued*)

- MNEVE 486
- MNEXC 662
- MNPER 662
- PGAICTLG 542
- PGAIXIT 542
- PGAIPGM 394, 542
- PLTPI 393
- PLTSD 394
- RENTPGM 322, 344
- RMTRAN 482
- STATRCD 677
- TBEXITS 13, 231
- system initialization table (DFHSIT)
 - entries for CICS monitoring 662
- system management facility (SMF) 662
 - header 654, 663
 - product section 654, 663
- system prefix, journal records 649

T

- TACLE (terminal abnormal condition line entry)
 - address contents 441
 - DSECT, format description 442
 - terminal error program 417
- task manager parameters in task-related user exits 260
- task-related user exits 249
 - adapter
 - installing and withdrawing 280
 - responses to the caller 266
 - structure and components 249
 - addressability of the parameter list 253
 - addressing mode implications 267
 - administration 250, 280
 - application program parameters 258
 - caller parameter lists 257
 - CEDA 280
 - CICS termination calls 275
 - limitations 275
 - sample code 276
 - use of DFHEIENT 276
 - DFHEIENT macros 269
 - DFHUEPAR DSECT 253
 - DFHUERTR, function definition 257
 - DFHUEXIT TYPE=RM macro 253
 - EDF 252
 - enabling and disabling
 - EXEC CICS DISABLE command 281
 - EXEC CICS ENABLE command 281
 - EXTRACT command 281
 - global work area 269, 281
 - local work area 269
 - parameter lists 253
 - PPT entries 280
 - protocols
 - read-only 271
 - single-update 271
 - recovery considerations 270
 - sample code for CICS termination call 276
 - sample code for syncpoint manager calls 272

task-related user exits 280 (*continued*)

- schedule flag word 280
- SPI parameters 257
- stub program 249, 250
 - ename 251
 - statname 251
- syncpoint manager calls 270
 - backing out changes 274
 - committing changes 274
 - restart resynchronization 274
 - sample pseudocode 272
- syncpoint manager parameters 258
- table entries 280
- task manager calls 274
 - limitations 275
- task manager parameters 260
- UEPCALAM, address of the caller's AMODE
 - indication byte 255
- UEPEIB, address of EIB 254
- UEPEXN, address of function definition 253
- UEPFLAGS, address of schedule flag word 254
- UEPGAA, address of global work area 253
- UEPGAL, length of global work area 254
- UEPHMSA, address of register save area 254
- UEPPBTOK, address of performance block
 - token 256
- UEPRMQUA, address of the resource manager
 - qualifier name 255
- UEPRMSTK, address of the kernel stack entry 254
- UEPSECBLK, address of a fullword addressing the
 - user security block 255
- UEPSECFLG, address of the user security flag 255
- UEPSYNCA, address of the single-update indication
 - byte 255
- UEPTAA, address of local work area 254
- UEPTAL, length of local work area 254
- UEPTIND, address of the caller's task
 - indicators 255
- UEPUOWDS, address of the APPC unit of work
 - identifier 255
- UEPURID, address of unit of recovery identifier 254
- UERTFGP, function group indicator 257
- UERTFID, caller identifier 257
- using CICS commands 269
- using EDF 278
- with storage protection
 - data storage key 268, 397
 - execution key 267
- work areas 269

TBEXITS, system initialization parameter 13, 231

TCAM (telecommunications access method)

- 3270 706
- abend and restart 707
- application program 709
- application program interface 694
- attach TIOA 698
- communication control bytes 704
- data format 696
- DD card correlation 694
- default actions taken by DFHTACP 703
- devices 704

TCAM (telecommunications access method) (*continued*)

- generalized message format 706
- input process queue 695
- line locking 702
- line pool restrictions 702
- line pool specifications 701
- logic flow 697
- message control program (MCP) 694, 710
- message handler 694
- message routing 700
- OPTCD operand 700
- permanent line lock 702
- POOL feature 701
- pool of common TCTTEs 696
- queue considerations 703
- queue locks 703
- read 697
- segment processing 700
- sequence of events 697
- startup 707
- temporary line lock 702
- terminal abnormal condition program
 - (DFHTACP) 415
- terminal control program 415
- terminal entries 696
- terminal error program 699
- terminal error program (DFHTEP) 415
- termination 708
- TPROCESS block 694
- unsolicited input 703
- user exits 707

TCAM SNA

- batch processing 694
- communication control bytes 692
- device message handler (DMH) 692
- error processing 694
 - batch logical units 694
- FMH processing 693
- IEDRH macro 693
- protocol management 692
- SETEOM macro 694
- SNA character string (SCS) 692
- TCAMFET=SNA operand 692
- transaction control 693
 - with CICS 692

TCP (terminal control program)

- ACF/VTAM section 457
- TACLE (terminal abnormal condition line entry) 416

TEB (terminal error block) 418

templates, for autoinstall of APPC connections 514

temporary line lock 702

TEP (terminal error program)

- abnormal conditions 416
- CICS components 415
- communication area 417
 - address contents 438
- default table 419
- define terminal error blocks
 - tables, DFHTEPT TYPE=PERMTID 433
- DFHTEP recursive retry routine 445
- example 446

- TEP (terminal error program) *(continued)*
 - system count (TCTTENI) 416
 - user field a (PCISAVE) 445
 - user field b (PCICNT) 445
- DFHTEP tables 432
- DFHTEPM TYPE=ENTRY 429
- DFHTEPM TYPE=EXIT 430
- DFHTEPT TYPE=PERMCODE|ERRCODE 433
- error processor source 429
- error table 418
- errors and actions unique to TCAM 699
- generating 425
- job control for sample DFHTEP generation 426
- link-edit statements 404
- replace error processors, DFHTEPM TYPE=ERRPROC 430
- sample
 - action flag names 424
 - common subroutines 421
 - components 418
 - DECB information 425
 - DECB operand 425
 - DFHTEPM TYPE=INITIAL 426
 - entry and initialization 420
 - error processing execution 420
 - error processor selection 420
 - error status element (ESE) 419
 - ESE information 425
 - exit 421
 - generate sample module 426
 - messages 423
 - overview 420
 - TACLE information 425
 - terminal error block (TEB) 418
 - terminal identification and error-code lookup 420
- tables
 - default threshold count limits 435
 - DFHTEPT macro examples 436
 - DFHTEPT TYPE=BUCKET 436
 - DFHTEPT TYPE=INITIAL 432
- TCAM 699
- terminal abnormal condition line entry (TACLE) 417
- user-written program
 - abend-transaction bit 440
 - abnormal conditions 437
 - abort write bit 440
 - address contents of communication area 438
 - address contents of TACLE 441
 - dummy terminal indicator 440
 - example 445
 - format description of TACLE DSECT 442
 - nonpurgeable task 440
- TERMERR condition 449
- terminal abnormal condition line entry (TACLE) 417
- terminal abnormal condition program (DFHTACP) 416
- terminal control
 - journal records
 - prefix area 644
- terminal entries, TCAM 696
- terminal error block (TEB) 418

- terminal error program (TEP)
 - abnormal conditions 416
 - CICS components 415
 - communication area 417
 - address contents 438
 - default table 419
 - define terminal error blocks
 - tables, DFHTEPT TYPE=PERMTID 433
 - DFHTEP recursive retry routine 445
 - example 446
 - system count (TCTTENI) 445
 - user field a (PCISAVE) 445
 - user field b (PCICNT) 445
 - DFHTEP tables 432
 - DFHTEPM TYPE=ENTRY 429
 - DFHTEPM TYPE=EXIT 430
 - DFHTEPT TYPE=PERMCODE|ERRCODE 433
 - error processor source 429
 - error table 418
 - generating 425
 - job control for sample DFHTEP generation 426
 - link-edit statements 404
 - replace error processors, DFHTEPM TYPE=ERRPROC 430
 - sample
 - action flag names 424
 - common subroutines 421
 - components 418
 - DECB information 425
 - DECB operand 425
 - DFHTEPM TYPE=INITIAL 426
 - entry and initialization 420
 - error processing execution 420
 - error processor selection 420
 - error status element (ESE) 419
 - ESE information 425
 - exit 421
 - generate sample module 426
 - messages 423
 - overview 420
 - TACLE information 425
 - terminal error block (TEB) 418
 - terminal identification and error-code lookup 420
 - tables
 - default threshold count limits 435
 - DFHTEPT macro examples 436
 - DFHTEPT TYPE=BUCKET 436
 - DFHTEPT TYPE=INITIAL 432
 - terminal abnormal condition line entry (TACLE) 417
 - user-written program
 - abend-transaction bit 440
 - abnormal conditions 437
 - abort write bit 440
 - address contents of communication area 438
 - address contents of TACLE 441
 - dummy terminal indicator 440
 - example 445
 - format description of TACLE DSECT 442
 - nonpurgeable task 440
- terminal identification and error-code lookup 420
- terminals, automatic installation 485

termination, TCAM 708
 TIE_UP_RECORD_DATA section, journal records 642
 TIME operand
 DFHNET macro 474
 of DFHTEPT TYPE=PERMCOE|ERRCODE
 macro 434
 TPROCESS block 694
 trace control functions of the XPI 369
 TRACE_PUT function of the XPI 369
 trace table entries, global user exit interface 7
 transaction abends
 program error program (PEP) 407
 transaction-class error-handling routine 457, 479
 transaction control
 TCAM SNA 693
 TRANSACTION DUMP function of the XPI 316
 transaction management functions of the XPI 370
 transaction restart program (DFHREST) 411
 communications area 412
 default program 414
 introduction 411
 link-edit statements 404
 transactions suitable for restart 411
 when invoked 411
 transient data write-to-terminal program
 (DFH\$TDWT) 803
 TRMIDNT operand
 DFHTEPT TYPE=PERMTID 433
 TSO
 DFHCSDUP 751

U

unsolicited input
 TCAM 703
 uppercase translation
 of national characters 805
 user event-monitoring points 658
 user exits
 DFHCSDUP 755
 global 3
 task-related 249
 TCAM 707
 user journaling functions of the XPI 388
 user prefix, journal records 649
 user-replaceable programs 405
 3270 bridge exit 599
 assembling and link-editing 402
 DBCTL interface status program (DFHDBUEX) 595
 distributed routing program (DFHDSRP) 575
 dynamic routing program (DFHDYP) 549
 for automatic installation of APPC connections
 (DFHZATDY) 513
 for automatic installation of consoles
 (DFHZATDX) 505
 for automatic installation of programs
 (DFHPGADX) 539
 for automatic installation of shipped terminals
 DFHZATDX 523
 DFHZATDY 523

user-replaceable programs 485 (*continued*)
 for automatic installation of terminals
 (DFHZATDX) 599
 for automatic installation of virtual terminals
 DFHZATDX 531
 DFHZATDY 531
 general rules 401
 IIOF security program 601
 JVM environment variables program
 (DFHJVMAT) 603
 node error program (DFHZNEP) 449
 program error program (DFHPEP) 407
 rewriting 401
 terminal error program (DFHTEP) 415
 testing with EDF 401
 transaction restart program (DFHREST) 411
 with storage protection
 data storage key 406
 execution key 405
 user-supplied error processors, DFHSNEP
 TYPE=ERRPROC 471
 user-written node error programs 475
 utility programs
 shutdown assist, DFHCESD 396

V

virtual terminals, automatic installation of 531

W

work areas in task-related user exits 269
 WRITE JOURNAL DATA function of the XPI 388

X

XAKUSER, global user exit 25
 XALCAID, global user exit 203
 XALTENF, global user exit 209
 XBMIN, global user exit 28
 XBMOU, global user exit 28
 XDLIPOST, global user exit 47
 XDLIPRE, global user exit 45
 XDSAWT, global user exit 42
 XDSBWT, global user exit 42
 XDTAD, global user exit 36
 XDTLC, global user exit 37
 XDTRD, global user exit 33, 34
 XDUCLSE, global user exit 55
 XDUOUT, global user exit 55
 XDUREQ, global user exit 49
 XDUREQC, global user exit 52
 XEIIIN, global user exit 66
 XEIOU, global user exit 68
 XEISPIN, global user exit 67
 XEISPOU, global user exit 68
 XFAINTU, global user exit 32
 XFCAREQ, global user exit
 description 83
 parameter list and return codes 84
 XFCAREQC, global user exit
 description 83

XFCAREQC, global user exit (*continued*)
 parameter list and return codes 83

XFCBFAIL, global user exit 112

XFCBOUT, global user exit 117

XFCBOVER, global user exit 119

XFCFAIL, global user exit
 DFH\$FCBF sample program 116

XFCLDEL, global user exit 122

XFCNREC, global user exit
 description 105
 parameter list and return codes 106

XFCQUIS, global user exit
 description 110

XFCREQ, global user exit
 command parameter structure 71
 description 70
 example of use 78
 parameter list and return codes 79
 UEPCLPS parameter 71

XFCREQC, global user exit
 command parameter structure 71
 description 70
 example of use 78
 parameter list and return codes 80
 UEPCLPS parameter 71

XFCSREQ, global user exit 97

XFCSREQC, global user exit 100

XFCVSDS, global user exit
 description 107

XGMTEXT, global user exit 126

XICEREQ, global user exit
 command parameter structure 137
 example of use 145
 parameter list and return codes 134
 UEPCLPS parameter 138

XICEREQC, global user exit
 command parameter structure 137
 example of use 145
 parameter list and return codes 135
 UEPCLPS parameter 138

XICEXP, global user exit 133

XICREQ, global user exit 132

XICTENF, global user exit 212

XISCONA, global user exit 127, 128

XISLCLQ, global user exit 130

XLDELETE, global user exit 148

XLDLOAD, global user exit 147

XLGSTRM, global user exit 149

XMEOUT, global user exit 153

XMNOUT, global user exit 156

XNQEREQ, global user exit 57
 command parameter structure 59
 UEPCLPS parameter 60

XNQEREQC, global user exit 58
 command parameter structure 59
 UEPCLPS parameter 60

XPCABND, global user exit 169

XPCFTCH, global user exit 165

XPCHAIR, global user exit 166

XPCREQ, global user exit
 command parameter structure 160

XPCREQ, global user exit (*continued*)
 description 160
 example of use 164
 parameter list and return codes 158
 UEPCLPS parameter 160

XPCREQC, global user exit
 command parameter structure 160
 description 158
 example of use 164
 parameter list and return codes 159
 UEPCLPS parameter 160

XPCTA, global user exit 168

XPI (exit programming interface)
 dispatcher functions
 ADD SUSPEND 302
 CHANGE PRIORITY 313
 DELETE SUSPEND 308
 RESUME 308
 SUSPEND 304
 WAIT_MVS 309

dump control functions
 SYSTEM DUMP 314
 TRANSACTION DUMP 316

enqueue domain functions
 DEQUEUE 319
 ENQUEUE 318

format of an XPI call 286

journaling function
 WRITE JOURNAL DATA 388

kernel domain functions
 START_PURGE_PROTECTION 320
 STOP_PURGE_PROTECTION 320

loader functions
 ACQUIRE PROGRAM 325
 DEFINE PROGRAM 321
 DELETE PROGRAM 328
 RELEASE PROGRAM 327

log manager functions
 INQUIRE_PARAMETERS 329
 SET_PARAMETERS 329

mixing API and XPI calls 6, 807

monitoring functions
 INQUIRE MONITORING DATA 334
 MONITOR 331

overview 283

program management functions
 END_BROWSE_PROGRAM 349
 GET_NEXT_PROGRAM 347
 INQUIRE_AUTOINSTALL 350
 INQUIRE_CURRENT_PROGRAM 341
 INQUIRE_PROGRAM 335
 SET_AUTOINSTALL 350
 SET_PROGRAM 343
 START_BROWSE_PROGRAM 346

programming examples 292, 807

state data access functions
 INQ_APPLICATION_DATA 352
 INQUIRE_SYSTEM 355
 SET_SYSTEM 359

storage control functions
 FREEMAIN 364

XPI (exit programming interface) *(continued)*

- GETMAIN 302
- INQUIRE_ACCESS 364
- INQUIRE_ELEMENT_LENGTH 365
- INQUIRE_SHORT_ON_STORAGE 366
- INQUIRE_TASK_STORAGE 367
- SWITCH_SUBSPACE 368
- trace control function
 - TRACE_PUT 369
- transaction management functions
 - INQUIRE_CONTEXT 370
 - INQUIRE_DTRTRAN 371
 - INQUIRE_MXT 372
 - INQUIRE_TCLASS 374
 - INQUIRE_TRANDEF 375
 - INQUIRE_TRANSACTION 383
 - SET_TRANSACTION 387
- XRCINIT, global user exit 232
- XRCINPT, global user exit 232
- XRF (extended recovery facility)
 - node error program 480
 - overseer program 609
- XRF overseer program
 - customizing the sample program 623
 - including the CEBT command 624
 - loop or wait detection in the active 624
 - DFH\$AXRO 613
 - DFHOSD data set 613
 - DFHWOSM macros 614
 - FUNC=BUILD 615
 - FUNC=CLOSE 616
 - FUNC=DSECT 616
 - FUNC=JJC 616
 - FUNC=JJS 617
 - FUNC=OPEN 618
 - FUNC=OSCMD 618
 - FUNC=QJJS 617
 - FUNC=READ 619
 - FUNC=TERM 622
 - display function 610
 - interface with CICS 613
 - module DFHWOS 613
 - opening CAVM data sets dynamically 613
 - restart-in-place function 611
 - enabling and disabling 612
 - rules governing restart in place 612
- XRMIOU, global user exit 172
- XRMMI, global user exit 171
- XRSINDI, global user exit 173
- XSNOFF, global user exit 178
- XSNON, global user exit 177
- XSRAB, global user exit 182
- XSTERM, global user exit 186
- XSTOUT, global user exit 180
- XSZARQ, global user exit 125
- XSZBRQ, global user exit 125
- XTCATT, global user exit 206, 707
- XTCIN, global user exit 205
- XTCOUT, global user exit 205
- XTCTIN, global user exit 206
- XTCTOUT, global user exit 207
- XTDEREQ, global user exit
 - command parameter structure 224
 - parameter list and return codes 221
 - UEPCLPS parameter 225
- XTDEREQC, global user exit
 - command parameter structure 224
 - parameter list and return codes 223
 - UEPCLPS parameter 225
- XTDIN, global user exit 219
- XTDOUT, global user exit 220
- XTDREQ, global user exit 218
- XTSREQ, global user exit 194
 - command parameter structure 196
 - example program 202, 807
 - UEPCLPS parameter 196
- XTSREQC, global user exit 195
 - command parameter structure 196
 - example program 202, 807
 - UEPCLPS parameter 196
- XTSPTIN global user exit 190
- XTSQROUT, global user exit 188
- XXDFA, global user exit 39
- XXDFB, global user exit 40
- XXDTO, global user exit 41
- XXMATT, global user exit 216
- XXRSTAT, global user exit 246
- XZCATT, global user exit 234
- XZCIN, global user exit 235
- XZCOUT, global user exit 235
- XZCOUT1, global user exit 236
- XZIQUE, global user exit 237, 240
 - designing your exit program 243
 - how to use 237
 - interaction with XISCONA 237
 - overview 237
 - the sample program, DFH\$XZIQ 244
 - using IRC/ISC statistics 243
 - when invoked 237

Sending your comments to IBM

If you especially like or dislike anything about this book, please use one of the methods listed below to send your comments to IBM.

Feel free to comment on what you regard as specific errors or omissions, and on the accuracy, organization, subject matter, or completeness of this book.

Please limit your comments to the information in this book and the way in which the information is presented.

To request additional publications, or to ask questions or make comments about the functions of IBM products or systems, you should talk to your IBM representative or to your IBM authorized remarketer.

When you send comments to IBM, you grant IBM a nonexclusive right to use or distribute your comments in any way it believes appropriate, without incurring any obligation to you.

You can send your comments to IBM in any of the following ways:

- By mail, to this address:
Information Development Department (MP095)
IBM United Kingdom Laboratories
Hursley Park
WINCHESTER,
Hampshire
United Kingdom
- By fax:
 - From outside the U.K., after your international access code use 44-1962-870229
 - From within the U.K., use 01962-870229
- Electronically, use the appropriate network ID:
 - IBM Mail Exchange: GBIBM2Q9 at IBMMAIL
 - IBMLink™: HURSLEY(IDRCF)
 - Internet: idrcf@hursley.ibm.com

Whichever you use, ensure that you include:

- The publication number and title
- The topic to which your comment applies
- Your name and address/telephone number/fax number/network ID.



Program Number: 5655-147



Printed in the United States of America
on recycled paper containing 10%
recovered post-consumer fiber.

SC33-1683-02



Spine information:



CICS TS for OS/390

CICS Customization Guide

Release 3