



CICS® Family

Interproduct Communication



CICS® Family

Interproduct Communication

Note!

Before using this information and the products it supports, be sure to read the general information under "Notices" on page 87.

Sixth edition (March 1999)

This edition applies to the following IBM licensed programs, and to all subsequent versions, releases, and modifications of these programs until otherwise indicated in new editions. Consult the latest edition of the applicable IBM system bibliography for current information on these products.

- CICS Transaction Server for OS/390, program number 5655-147
- IBM Transaction Server for Windows NT, Version 4, program number 5622-990
- CICS/ESA Version 4, program number 5655-018
- CICS/ESA Version 3, program number 5685-083
- CICS/VSE Version 2, program number 5686-026
- IBM Transaction Server for OS/2 Warp, Version 4, program number 5622-808
- IBM CICS for OS/2 Version 2.0.1, program number 5648-036
- IBM CICS for Windows NT, Version 2, program number 5622-347
- IBM AIX CICS/6000, program number 5765-148
- IBM Transaction Server for AIX, program number 5697-251
- CICS/400 Version 3, program number 5763-DFH
- IBM CICS Clients Version 2, program number 5622-543
- IBM CICS for the Solaris Operating Environment, program number 5697-A01
- IBM CICS for SINIX, program number 5765-633
- IBM CICS for HP-UX, Version 2, program number 5697-B90
- CICS Transaction Server for VSE/ESA, program number 5648-054

This book is based on the fifth edition of *CICS Family: Interproduct Communication*, SC33-0824 .

Changes from that edition are marked by vertical lines to the left of the changes.

Order publications through your IBM representative or the IBM branch office serving your locality. Publications are not stocked at the address given below.

At the back of this publication is a page entitled "Sending your comments to IBM". If you want to make comments, but the methods described are not available to you, please address them to:

IBM United Kingdom Laboratories Limited, Information Development, Mail Point 095, Hursley Park, Winchester, Hampshire, England, SO21 2JN.

When you send information to IBM, you grant IBM a non-exclusive right to use or distribute the information in any way it believes appropriate without incurring any obligation to you.

© Copyright International Business Machines Corporation 1992, 1999. All rights reserved.

Note to U.S. Government Users — Documentation related to restricted rights — Use, duplication or disclosure is subject to restrictions set forth in GSA ADP Schedule Contract with IBM Corp.

Contents

Preface	v	The External Presentation Interface	14
What this book is about	v	Terminal emulation	14
Who this book is for	v	IBM CICS Clients	15
What you need to know to understand this book	vi	Supported functions and protocols	15
Terminology	vi	Clients for CICS on Open Systems	17
		Supported protocols.	17
Summary of changes	vii	Chapter 4. Data conversion.	19
Changes for the fifth edition	vii	Numeric data	19
Changes for the fourth edition	vii	Character data	20
Changes for the third edition.	vii	Code pages	20
Changes for the second edition	viii		
<hr/>			
Part 1. Introduction to CICS interproduct communication	1	Chapter 5. Configuring CICS for SNA communications	23
		Introduction to SNA terminology	24
Chapter 1. CICS interproduct communication	3	SNA concepts	24
The documentation plan	3	SNA products	26
		Preparing for SNA configuration	26
Chapter 2. CICS communication support	5	Matching parameters	27
What is a product's communication ability?	5	Platform specific implementation	27
The CICS intersystem communication		The scenario	27
functions	5	Configuration details	28
Communication protocols	6	Mainframe host configuration	28
Synchronization	6	OS/2 workstation configuration.	29
Data conversion	8	AIX machine configuration	30
CICS product communication support	8	Where to next?	32
CICS on System/390 interproduct			
communication	8		
CICS for OS/2 interproduct			
communication	9		
CICS for Windows NT Version 2			
interproduct communication	9		
IBM Transaction Server for Windows NT			
Version 4 interproduct communication	10		
CICS on Open Systems interproduct			
communication	11		
CICS on OS/400 interproduct			
communication	12		
Chapter 3. IBM CICS clients	13	Part 2. CICS intercommunication functions	33
What functions do the clients provide?	13		
The External Call Interface	13	Chapter 6. Introduction to the CICS intercommunication functions.	35
		Summary of CICS intercommunication	
		functions	35
		Function shipping	35
		Transaction routing	36
		Distributed program link	37
		Distributed transaction programming	37
		Which intercommunication function?	37
		Chapter 7. Function shipping	39
		Transparency to application	40
		Remote resources that can be accessed	40
		CICS file control data sets.	40

IMS databases	41	System programming considerations	68
Temporary storage and transient data	42	Asynchronous processing example (with	
How function shipping works	42	NOCHECK)	68
The transformer programs	43		
The mirror transaction	44	Chapter 11. Distributed transaction	
Synchronization	45	programming.	71
Function shipping examples	46	Why use distributed transaction	
		programming?	71
Chapter 8. Transaction routing	47	Limitations of function shipping	71
Initiating transaction routing	48	Advantages of distributed transaction	
Terminal-initiated transaction routing	49	programming	73
Automatic transaction initiation	51	Conversations	74
The relay program	53	Conversation initiation and transaction	
Basic mapping support	54	hierarchy	74
The routing transaction (CRTE)	54	Application design	76
		Control flows	76
Chapter 9. Distributed program link	57	Conversation state and error detection	77
Why use DPL?	58	Synchronization	77
Synchronization	58	EXEC CICS or CPI Communications?	79
DL/I and SQL databases	58	Additional notes on the two APIs	80
Restrictions when using DPL	59		
Abends when using DPL	59		
		<hr/>	
Chapter 10. Asynchronous processing	61	Part 3. Appendixes	83
Example	62	Bibliography	85
Asynchronous processing methods	62	CICS books	85
Asynchronous processing using		SNA books	85
START/RETRIEVE commands	63	VTAM books	85
Starting and canceling remote		Communications Manager/2 books	85
transactions	63	Communication Server for AIX books	85
Passing information with the START		Multi-platform connectivity books	86
command	63		
Improving performance of intersystem		Notices	87
START requests	64	Trademarks	88
Including start request delivery in a			
logical unit of work	65	Glossary	89
Deferred sending of START requests		Index	97
with NOCHECK option	65		
Local queuing of START commands for		Sending your comments to IBM	101
remote transactions	66		
Data retrieval by a started transaction	67		
Terminal acquisition by a			
remotely-initiated CICS transaction.	67		

Preface

What this book is about

This book introduces the subject of intercommunication between CICS® family members. It shows what functions are available, and how the systems are configured.

The CICS products covered by this book are:

- CICS on System/390, which comprises:
 - CICS Family
 - CICS Transaction Server for VSE/ESA
 - CICS/ESA® Version 4
 - CICS/ESA Version 3
 - CICS/VSE® Version 2
- IBM® Transaction Server for Windows NT, Version 4
- IBM Transaction Server for OS/2® Warp, Version 4
- IBM CICS for OS/2 Version 2.0.1
- IBM CICS for Windows NT, Version 2
- CICS on Open Systems Version 2, which comprises:
 - IBM Transaction Server for AIX®
 - IBM CICS for HP-UX, Version 2
 - CICS for HP 9000
 - CICS for Digital UNIX
 - CICS for Siemens Nixdorf SINIX
 - CICS for the Solaris Operating Environment
- IBM CICS/6000® Version 1
- IBM CICS for OS/400® Version 3
- IBM CICS Clients

Who this book is for

This book is for anyone who is involved in the planning and implementation of communication between different CICS products.

What you need to know to understand this book

You should have a general knowledge of the facilities of CICS, and of the communication functions of the operating environments of your CICS systems. To implement CICS interproduct communication, you will also need the detailed product-specific information that is in the Intercommunication Guide for your local CICS product. The documentation plan for the individual CICS products is explained in “Chapter 1. CICS interproduct communication” on page 3.

Terminology

Throughout this book, when the term “CICS” is used without specifying any particular product or version level, it can be taken as a generic term for all the CICS family products.

CICS on System/390 is a generic name for all the CICS System/370™ and System/390 products, as listed in “What this book is about” on page v.

CICS on Open Systems is a generic name for all the CICS products that run on the various implementations of UNIX, as listed in “What this book is about” on page v.

Where it is necessary to identify a particular CICS product, it will be identified by name (such as CICS for MVS/ESA), and (if necessary) its version and release level

Summary of changes

In this edition, references to CICS Transaction Server for VSE/ESA have been added.

Changes for the fifth edition

The major change for the fifth edition was to include support for the following products:

- CICS for HP-UX
- Transaction Server for Windows NT, version 4

Changes for the fourth edition

The major changes for the fourth edition were in support for the following products:

- CICS Transaction Server for OS/390 Release 1
- CICS for OS/2 Version 3.0
- CICS on Open Systems Version 2 Release 1.

There was a new chapter, “Chapter 5. Configuring CICS for SNA communications” on page 23, which introduced the concepts and practice of configuring CICS for SNA communications.

Changes for the third edition

The major change for the third edition was that information about the following new CICS products was included:

- IBM CICS clients
- CICS for OS/2 Version 2.0.1
- CICS on Open Systems. This comprises:
 - IBM AIX CICS/6000 Version 1 Release 2
 - CICS for DEC OSF/1 AXP
 - CICS for HP 9000.
- CICS for Windows NT Version 2
- CICS/VSE Version 2 Release 3.

Changes for the second edition

The major changes for the second edition were:

- Information about the following new CICS products was included:
 - CICS/ESA Version 4
 - CICS OS/2 Version 2
 - CICS/400 Version 3.
- References to the following products were removed, because they are no longer supported:
 - CICS/DOS/VS
 - CICS OS/2 Version 1.
- Over-detailed information about implementing data conversion was removed from “Chapter 4. Data conversion” on page 19.

Part 1. Introduction to CICS interproduct communication

This part includes the following chapters:

- “Chapter 1. CICS interproduct communication” on page 3 introduces CICS interproduct communication, and describes the documentation plan used for each CICS product.
- “Chapter 2. CICS communication support” on page 5 describes the CICS intercommunication functions, and shows what functions are supported between any pair of CICS systems.
- “Chapter 3. IBM CICS clients” on page 13 introduces the CICS client products, and shows what functions are supported with each CICS server.
- “Chapter 4. Data conversion” on page 19 explains why data conversion is necessary, explaining its concepts and terminology.
- “Chapter 5. Configuring CICS for SNA communications” on page 23 introduces the concepts and practice of system configuration for SNA communications.

2 Interproduct Communication

Chapter 1. CICS interproduct communication

This manual describes how you can connect CICS systems, and explains what functions those connected CICS systems can use. The following groups of CICS systems are discussed:

- CICS on System/390®
- CICS for OS/2
- CICS for Windows NT Version 2
- Transaction Server for Windows NT Version 4
- CICS on Open Systems
- CICS for OS/400
- CICS Clients

The documentation plan

This manual provides an overview of how all the CICS products communicate. Each CICS product has its own intercommunication manual which provides greater detail on how that product is configured and what functions are available to it.

The configurations with all the CICS products, and the associated documentation, is illustrated in Figure 1 on page 4. This shows each CICS product in communication with another product of the same type, and then all products being interconnected. The highlighted numbers in the figure refer to the following manuals:

1. *CICS Transaction Server for OS/390 CICS Intercommunication Guide*
2. *CICS Family: Communicating from CICS on System/390*
3. *CICS for OS/2 Intercommunication*
4. *CICS for Windows NT Version 2 Intercommunication*
5. *CICS on Open Systems Intercommunication Guide*
6. *CICS/400 Intercommunication*

Connecting the IBM CICS Client is described in:

- *CICS Clients: Administration*

The order numbers of these manuals are listed in “Bibliography” on page 85.

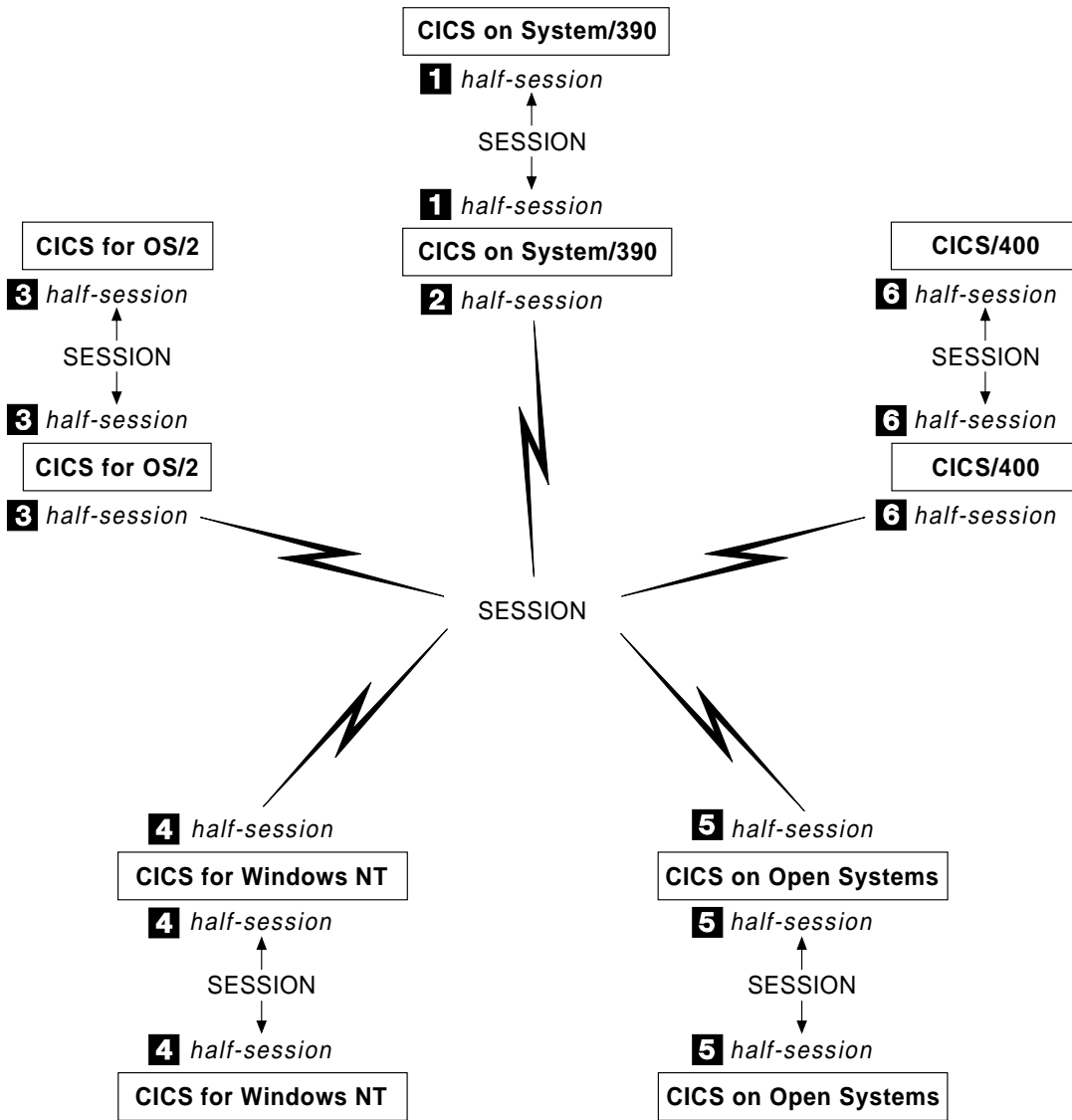

Figure 1. Sessions between CICS systems. This figure shows the coverage of each of the CICS intercommunication books. The numbers refer to the list of books in the list in page 1 on page 3.

Chapter 2. CICS communication support

This chapter has two sections:

- “What is a product’s communication ability?” is an introduction to intersystem communication terminology, and to the CICS communication functions.
- “CICS product communication support” on page 8 shows the ways in which any pair of CICS products can communicate.

What is a product’s communication ability?

When planning your communication functions between different CICS systems you must consider:

- The intersystem communication functions that the CICS products support
- The communication protocols that are supported
- The synchronization levels that are supported
- What data conversion support will be required

These questions are examined in the following sections.

The CICS intersystem communication functions

CICS intersystem communication supports five basic functions:

Function shipping

enables an application program running in one CICS system to access data resources (such as files and queues) that are owned by another CICS system.

Transaction routing

enables a terminal connected to one CICS system to run a transaction in another CICS system.

Distributed program link (DPL)

enables an application program executing in one CICS system to link (pass control) to a program in a different CICS system. The linked-to program executes and returns a result to the linking program.

Asynchronous processing

enables a transaction executing in one CICS system to start a transaction in a different system. The two transactions then execute independently of each other.

Distributed transaction programming

enables a transaction running in one CICS system to communicate with transactions running in other systems. The transactions are designed and coded specifically to communicate with each other.

For more information about these functions, see “Part 2. CICS intercommunication functions” on page 33.

Communication protocols

If two systems are to communicate successfully they must use a common set of rules that both understand. A communications protocol is such a set of rules that defines, for example, a set of standard requests and responses, and the order in which they can be sent.

For CICS products, three communication protocols are important:

SNA LU TYPE 6.2

LU TYPE 6.2 (LU 6.2) is a Systems Network Architecture (SNA) protocol that supports both system-to-system communication and system-to-device communication. LU 6.2 is also known as Advanced Program-to-Program Communications (APPC).

CICS can make use of the AnyNet® product, which allows SNA flows to be transmitted over a TCP/IP network.

All CICS products support the LU 6.2 protocol.

NetBIOS

The Network Basic Input/Output System (NetBIOS) is a local area network (LAN) protocol for personal computers. It is supported by CICS for OS/2 and CICS for Windows NT Version 2.

You can use IBM NetBIOS, or another NetBIOS emulator. For example, Novell's NetBIOS emulator provides NetBIOS flows over its Internetwork Packet eXchange (IPX) protocol.

TCP/IP

The Transmission Control Protocol/Internet Protocol (TCP/IP) is a set of protocols that are used for both LANs and Wide Area Networks (WANs).

TCP/IP is supported by CICS for OS/2, CICS for Windows NT Version 2, IBM Transaction Server for Windows NT Version 4, and CICS on Open Systems.

Synchronization

During CICS interproduct communication, partner transactions may make logically-related updates to their data stores — data sets, databases, temporary

storage, transient data, and so on. Data integrity would be lost if both transactions did not commit (or back out) the updates they made to their resources.

The process used to ensure data integrity is called synchronization. Synchronization has to prevent one transaction completing normally and committing its updates while its partner transaction abends and backs out its updates. Synchronization must also handle situations when network problems prevent the transactions from communicating and informing each other of their actions.

Synchronization levels

SNA APPC architecture defines three levels of synchronization, which it calls NONE, CONFIRM, and SYNCPOINT. CICS refers to these as synchronization levels 0, 1, and 2, respectively.

Level 0

Provides no synchronization support.

Level 1

Allows transactions to exchange confirmation requests which they may use to provide some degree of synchronization. CICS is not involved in this process.

Level 2

Provides system-level syncpoint exchanges.

Synchronization level 2 provides **two-phase commit**. In a two-phase commit process, one CICS system initiates the syncpointing and acts as coordinator for the operation. The coordinating system:

1. Asks each connected system to **prepare** to commit
2. When each system has signalled readiness, it tells each to **commit**, *or*, if any resource manager signals that it cannot commit, it tells each to **back out**.

The synchronization level that two connected CICS systems can use is established when they first establish the connection. A connection established at synchronization level 2 can support a synchronization level 0, 1, or 2 conversation, and a connection established at synchronization level 1 can support a synchronization level 0 or 1 conversation.

The synchronization level you can use depends upon the capabilities of the particular CICS systems, and the capability of the network that they are using for the connection. The synchronization levels for all pairings of CICS systems is summarized in “CICS product communication support” on page 8.

Data conversion

CICS products use two interchange codes for character data representation, EBCDIC “Glossary” on page 89 and ASCII “Glossary” on page 89. Data in CICS on System/390 products and CICS for OS/400 is held in EBCDIC format. Data in CICS for OS/2, CICS for Windows NT Version 2, IBM Transaction Server for Windows NT Version 4, and CICS on Open Systems is held in ASCII format.

Support of an intersystem communication function between two products requires support for any necessary data conversion. For further information, see “Chapter 4. Data conversion” on page 19.

CICS product communication support

This section summarizes the support each CICS product provides when it is in communication with another CICS product of the same type, and when it is communicating with each of the other CICS family products.

CICS on System/390 interproduct communication

Functions supported

CICS on System/390 supports all CICS intersystem communication functions.

Communication protocols supported

CICS on System/390 supports only SNA.

Synchronization level supported

CICS on System/390 can support synchronization levels 0, 1, and 2. The synchronization level used depends upon the support available in the partner system. This is summarized in Table 1.

Table 1. CICS on System/390 synchronization level support

	CICS on System/390	CICS on Open Systems	CICS for OS/400	CICS for OS/2	CICS for Windows NT V2	Transaction Server for Windows NT V4
Maximum synchronization level supported:	2	2	2	1	1	2

CICS for OS/2 interproduct communication

Functions supported

CICS for OS/2 supports all CICS intersystem communication functions.

Communication protocols supported

CICS for OS/2 supports SNA, TCP/IP, and NetBIOS. The communication protocol that can be used is dependent upon the support available in the partner system. This is summarized in Table 2.

Table 2. CICS for OS/2 communication protocol support

	CICS for OS/2	CICS for Windows NT V2	Transaction Server for Windows NT V4	CICS on Open Systems	CICS on System/390	CICS for OS/400
Communication protocols supported:	SNA TCP/IP NetBIOS	SNA TCP/IP NetBIOS	SNA TCP/IP	SNA TCP/IP	SNA	SNA
Note: Distributed transaction processing is supported only by SNA.						

Synchronization level supported

CICS for OS/2 supports only synchronization levels 0 and 1, and either level can be used with any partner CICS system.

CICS for Windows NT Version 2 interproduct communication

Functions supported

CICS for Windows NT Version 2 supports all CICS intersystem communication functions.

Communication protocols supported

CICS for Windows NT Version 2 supports SNA, TCP/IP, and NetBIOS. The communication protocol that can be used depends upon the support available in the partner system. This is summarized in Table 3 on page 10.

Table 3. CICS for Windows NT Version 2 communication protocol support

	CICS for Windows NT V2	Transaction Server for Windows NT V4	CICS for OS/2	CICS on Open Systems	CICS on System/390	CICS for OS/400
Communication protocols supported:	SNA TCP/IP NetBIOS	SNA TCP/IP	SNA TCP/IP NetBIOS	SNA TCP/IP	SNA	SNA
Note: Distributed transaction processing is supported only by SNA.						

Synchronization level supported

CICS for Windows NT V2 supports only synchronization levels 0 and 1, and either level can be used with any partner CICS system.

IBM Transaction Server for Windows NT Version 4 interproduct communication

Functions supported

IBM Transaction Server for Windows NT Version 4 supports all CICS intersystem communication functions.

Communication protocols supported

IBM Transaction Server for Windows NT Version 4 supports SNA and two types of TCP/IP:

- **CICS family TCP/IP** for communication with other IBM Transaction Server for Windows NT Version 4 systems, and to CICS on Open Systems regions, CICS for OS/2, CICS for Windows NT Version 2 systems, and CICS Clients
CICS family TCP/IP supports only synchronization levels 0 and 1, and it cannot be used for distributed transaction processing.
- **Encina PPC TCP/IP** for communication with other CICS on Open Systems regions
Encina PPC TCP/IP supports synchronization levels 0, 1, and 2, and can be used for distributed transaction processing.

The choice of communication protocol depends upon the function supported by the partner system, and is summarized in Table 4 on page 11.

Table 4. IBM Transaction Server for Windows NT Version 4 communication protocol, and synchronization level support

	Transaction Server for Windows NT V4	CICS for Windows NT V2	CICS on Open Systems	CICS for OS/2	CICS on System/390	CICS for OS/400
Communication protocols supported:	SNA TCP/IP (1) TCP/IP (2)	SNA TCP/IP (1)	SNA TCP/IP (1)	SNA TCP/IP (1) TCP/IP (2)	SNA	SNA
Maximum synchronization level supported:	2	1	2	1	2	2
Note: 1. TCP/IP (1) - CICS family TCP/IP support 2. TCP/IP (2) - Encina PPC TCP/IP support						

Synchronization level supported

IBM Transaction Server for Windows NT Version 4 supports synchronization levels 0, 1, and 2 when using SNA and Encina PPC TCP/IP, and levels 0 and 1 when using CICS family TCP/IP. The synchronization level that the IBM Transaction Server for Windows NT Version 4 supports with other CICS systems is summarized in Table 4.

CICS on Open Systems interproduct communication

Functions supported

CICS on Open Systems supports all CICS intersystem communication functions.

Communication protocols supported

CICS on Open Systems supports SNA and two types of TCP/IP:

- **CICS family TCP/IP** for communication with other CICS on Open Systems regions, and to CICS for OS/2, CICS for Windows NT, and CICS Clients
CICS family TCP/IP supports only synchronization levels 0 and 1, and it cannot be used for distributed transaction processing.
- **Encina PPC TCP/IP** for communication with other CICS on Open Systems regions
Encina PPC TCP/IP supports synchronization levels 0, 1, and 2, and can be used for distributed transaction processing.

The choice of communication protocol depends upon the function supported by the partner system, and is summarized in Table 5 on page 12.

Table 5. CICS on Open Systems communication protocol, and synchronization level support

	CICS on Open Systems	CICS for OS/2	CICS for Windows NT V2	Transaction Server for Windows NT V4	CICS on System/390	CICS for OS/400
Communication protocols supported:	SNA TCP/IP (1) TCP/IP (2)	SNA TCP/IP(1)	SNA TCP/IP(1)	SNA TCP/IP (1) TCP/IP (2)	SNA	SNA
Maximum synchronization level supported:	2	1	1	2	2	2
Note: 1. TCP/IP (1) - CICS family TCP/IP support 2. TCP/IP (2) - Encina PPC TCP/IP support						

Synchronization level supported

CICS on Open Systems can support synchronization levels 0, 1, and 2 when using SNA and Encina PPC TCP/IP, and levels 0 and 1 when using CICS family TCP/IP. The synchronization level CICS on Open Systems supports with other CICS systems is summarized in Table 5.

CICS on OS/400 interproduct communication

Functions supported

CICS on OS/400 supports all CICS intersystem communication functions.

Communication protocols supported

CICS on OS/400 supports only SNA.

Synchronization level supported

CICS on OS/400 supports synchronization levels 0, 1, and 2. The synchronization level you use depends upon the support available in the partner system. This is summarized in Table 6.

Table 6. CICS on OS/400 synchronization level support

	CICS for OS/400	CICS on System/390	CICS on Open Systems	CICS for OS/2	CICS for Windows NT V2	Transaction Server for Windows NT V4
Maximum synchronization level supported:	2	2	2	1	1	2

Chapter 3. IBM CICS clients

The IBM CICS Client and clients for CICS on Open Systems allow a workstation to access the transactions and resources in a CICS system.

The IBM CICS Client and clients for CICS on Open Systems are not themselves full-function CICS systems, but they contain functions that enable them to access the resources of CICS systems running on other machines in the network. The CICS systems to which clients are connected are known as **CICS servers**.

There is an IBM CICS Client product for many different PC operating systems. These are described in “IBM CICS Clients” on page 15.

CICS on Open Systems has clients for a number of different UNIX operating systems. These are described in “Clients for CICS on Open Systems” on page 17.

What functions do the clients provide?

IBM CICS Clients and clients for CICS on Open Systems provide a set of functions for client/server computing. This section gives an overview of the most important functions; it is not meant to be exhaustive.

The External Call Interface

The External Call Interface (ECI) is an application programming interface (API) that allows a non-CICS program running on a workstation to call a CICS program located on a CICS server. This enables the program to make use of existing server routines that could be used, for example, to make enquiries on a database.

The client program can make the following types of call to a CICS server:

- Program link calls, which can be **synchronous** (that is, the calling program waits for a response from the linked-to program), or **asynchronous** (that is, the two programs continue to execute independently). The client program can issue a number of such calls, which can all run within the same unit of work (UOW), or they may run as individual units of work.
- Calls to retrieve a response from a previous asynchronous call.

- Calls that return a value indicating the status of the CICS system. This allows an application to test for availability of the CICS server or to monitor it by waiting for a change in its status.

The External Presentation Interface

The External Presentation Interface (EPI) is an API that allows a client program to appear to a CICS server as a 3270 terminal. You could, for example, use the EPI to enable workstation users to access CICS server transactions written for 3270 terminals, without changing the server code.

The client program can start CICS transactions and send and receive standard 3270 data streams to and from the transactions. It can present the 3270 data to the user by emulating a 3270 terminal, or by means of a graphical user interface such as Presentation Manager® (OS/2 clients) or Windows (Windows clients).

The EPI consists of a set of calls that can be made from an application program. The calls are provided in a library that is linked to the application. Among the functions available are calls to:

- Initialize the EPI.
- Terminate the EPI.
- Obtain a list of CICS servers to which a “terminal” may attach.
- Attach a pseudo-terminal.
- Detach a pseudo-terminal.
- Start a transaction for a “terminal”.
- Send data from a “terminal” to a transaction.
- Obtain details of an “event” that has occurred for a terminal. An example of an event is when the transaction is expecting a reply from the terminal.
- Obtain detailed error information for the last error that occurred for a terminal.

Terminal emulation

IBM CICS Clients and clients for CICS on Open Systems can run 3270 terminal emulators. A client terminal emulator transmits or receives standard CICS transaction routing flows to or from a CICS server. This allows a user to interact with the server, and run transactions, as if the client were a locally-attached 3270 terminal.

It is possible to run multiple terminal emulators on a single client. The emulators can be connected to the same CICS server, or to different servers.

Users can customize the colors and keyboard mapping of their emulators. Double-byte character sets (DBCS) are supported but note that CICS clients attached to CICS/400® servers do not support double-byte character sets.

IBM CICS Clients

There is an IBM CICS Client product for each of the following workstation operating systems:

- DOS
- Windows 3.1
- Windows NT
- Windows 95
- OS/2
- Macintosh.

Each client can attach to any or all of the following CICS servers, using a variety of protocols:

- IBM Transaction Server for OS/2 Warp
- CICS for OS/2 Version 2.0.1
- CICS OS/2™ Version 2.0 multi-user *
- CICS for Windows NT Version 2
- IBM Transaction Server for Windows NT Version 4
- CICS/400 Version 3
- CICS on Open Systems Version 2
- CICS Transaction Server for OS/390®
- CICS/ESA Version 4.1
- CICS/ESA Version 3.3 *
- CICS/VSE Version 2.3
- CICS/VSE Version 2.2 *
- CICS Transaction Server for VSE/ESA

Note: In the above list, the CICS products marked with a star (*) offer limited server support. These products support the client External Call Interface (ECI), but not the External Presentation Interface (EPI), nor the Terminal Emulation function.

Supported functions and protocols

Table 7 on page 16 shows the functions and communication protocols that are supported on each IBM CICS Client – CICS server link.

Table 7. IBM CICS Client function and protocol support

CICS Servers	Function				Protocol		
	ECI	EPI	Terminal Emulator	Auto install	LU 6.2	NetBIOS	TCP/IP
OS/2 Warp V4	Y	Y	Y	Y	Y	Y ¹	Y
OS/2 V2.0.1	Y	Y	Y	Y	-	Y ¹	Y
OS/2 V2.0 multi-user	Y	-	-	-	-	Y ¹	-
Windows NT V2	Y	Y	Y	Y	-	Y ¹	Y
Windows NT V4	Y	Y	Y	Y	Y	-	Y
Open Systems	Y	Y	Y	Y	Y	-	Y
400® V3.1	Y	Y	Y	Y	Y	-	-
OS/390	Y	Y	-	Y	Y	-	-
ESA V4.1	Y	Y	-	Y	Y	-	-
ESA V3.3	Y	-	-	Y ²	Y	-	-
MVS V2.1.2	Y	-	-	Y ²	Y	-	-
VSE V2.3	Y	-	-	Y ²	Y	-	-
VSE V2.2	Y	-	-	Y ²	Y	-	-
CICS TS for VSE/ESA™	Y	Y	Y	Y	Y	-	-

Notes:

- Y Function or protocol is supported
- Function or protocol not supported
- ECI External Call Interface
- EPI External Presentation Interface

Autoinstall

User does not need to predefine the client connection to the server

1. NetBIOS is not supported by the Macintosh client. You can use IBM NetBIOS, or a third-party NetBIOS emulator. For example, Novell's NetBIOS emulator provides NetBIOS flows over its Internetwork Packet eXchange (IPX) protocol.
2. Only single-session LU6.2 connections can be autoinstalled.

Clients for CICS on Open Systems

There is a client for CICS on Open Systems for each of the following operating systems:

Operating system	Client name
AIX	IBM AIX Client for CICS/6000
Digital UNIX	CICS for Digital UNIX Client
HP-UX	CICS for HP 9000 Client, CICS for HP-UX Client
SunOS	IBM CICS Client for Sun Systems
Solaris	IBM CICS for the Solaris Operating Environment Client

Each client for CICS on Open Systems can attach to any or all of the following CICS servers:

- IBM AIX CICS/6000 Version 1 Release 2
- IBM CICS for AIX Version 2
- CICS for Digital UNIX
- CICS for HP 9000
- CICS for HP-UX
- IBM CICS for the Solaris Operating Environment

Note: Clients for CICS on Open Systems cannot attach to any other CICS servers.

Supported protocols

The clients for CICS on Open Systems communicate only with the CICS on Open Systems servers. Any client for CICS on Open Systems can communicate with any CICS on Open Systems server except the IBM CICS Client for Sun Systems, which can communicate only with IBM AIX CICS/6000 Version 1.2.

The clients for CICS on Open Systems use only TCP/IP as their communications protocol.

The clients for CICS on Open Systems support the use of the ECI, EPI, terminal emulation, and autoinstall.

Chapter 4. Data conversion

The CICS family of products runs on a variety of operating system and hardware platforms. Numeric and character data can be held in different ways in different systems. When intercommunication between CICS products requires the transfer of data, data conversion may be necessary.

This chapter gives an overview of data conversion that serves as an introduction to the task-oriented information in the CICS Intercommunication manual for your CICS product. It does not describe the mechanics of the process.

CICS products do most of the necessary data conversion automatically. Some conversion requires no setup by the user, for example, file names in function shipping requests. For other data, such as file records, you supply resource definitions that identify the types of conversion to be applied to specified fields in data records. For non-automatic conversion, exits or user-replaceable conversion programs are available in some products.

Numeric data

The main ways of holding numeric data are binary and packed decimal. If these types of data are held differently in two CICS systems, resource definitions in each system may be sufficient to cause automatic data conversion.

In some cases, you can arrange that one system holds data in a way that is compatible with the other, avoiding the need for conversion. For example, if a CICS for OS/2 COBOL II application program is compiled with the IBMCOMP and SIGN EBCDIC directives, packed decimal data is held in System/390-compatible format.

Automatic data conversion is not available in some cases. For example, conversion between workstation packed decimal data and System/390 packed decimal data requires user-written conversion code. This code can be inserted in a user-replaceable conversion program in the CICS on System/390 product.

You should refer to the platform-specific CICS intercommunication guides for detailed explanation of which CICS system is responsible for converting the data when two systems are exchanging data.

Character data

The smallest unit of computer data is a **bit**, or binary digit. A bit has only two possible values, 0 or 1. To represent character data, bits must be grouped. The most common grouping is the 8-bit **byte**, providing up to 256 different characters.

A **single-byte character set** (SBCS) allows the representation of up to 256 characters, each character being represented by a single byte.

A **double-byte character set** (DBCS) allows the representation of more than 256 characters, each character being represented by a pair of bytes. Some languages require characters to be represented by multiple bytes in what is called a **multi-byte character set** (MBCS).

The different languages in some countries (such as Japan) may use both SBCS and DBCS.

A computer must assign a byte, 2-byte, or multi-byte value to each character that it wants to represent. Several conventions exist for character representation. In this chapter, these conventions are called interchange codes. Two different interchange codes are used in the hardware platforms on which CICS products run:

- Extended Binary-Coded Decimal Interchange Code (EBCDIC), used on System/370 System/390 and AS/400® machines.
- American National Standard Code for Information Interchange (ASCII) used in personal computers and RISC System/6000® (RS/6000) machines.

Code pages

A **code page** is a list of byte values or 2-byte values and the characters they represent. The EBCDIC and ASCII interchange codes include more than one code page, so data conversion can be necessary even between two systems that use the same interchange code.

Most CICS products use in-built conversion tables to handle conversion between common code pages. Some products allow you to define your own conversion tables. For nonstandard conversion, you can supply a user-written conversion program.

For detailed information about data conversion, see the CICS Intercommunication manuals for your CICS products.

Notes:

1. **CICS for OS/400** uses a comprehensive set of conversion tables provided by AS/400, and does not support user-defined tables.

2. **CICS on Open Systems** uses the operating system's *iconv* routines, which provide data conversion by both table-driven and algorithmic methods. A comprehensive set of converters is supplied. A CICS on Open Systems user can create or customize a converter.

Chapter 5. Configuring CICS for SNA communications

Before two systems can communicate, they each need to know:

- The identity of the other system
- The characteristics of the other system
- The communication methods to be used
- The services and functions to be used

This chapter shows how you specify that information when configuring CICS systems for SNA communication.

There are a number of stages in the process of configuring a system for communication:

1. Establish a basic connection between the two systems that can be used by a simple test application.
2. Build on that initial configuration to enable support for your own applications.
3. Refine that working configuration to expand facilities and enhance performance.

This chapter gives you the information on SNA and CICS that you will need to establish that first basic configuration. You should not consider proceeding beyond that first stage until you have completed and successfully tested a basic, simple SNA connection.

There are other manuals that give broader and more detailed information about SNA. There are manuals that explain the SNA architecture, manuals that explain how individual products have implemented the architecture, and manuals that explain how to configure various combinations of different systems. There is a list of useful books in “SNA books” on page 85.

The scenario chosen for the discussion is based on an established SNA network of interconnected CICS on System/390 systems. To this we will be adding a CICS for OS/2 system and a CICS for AIX system, which will use SNA to connect to one of the CICS on System/390 systems.

Introduction to SNA terminology

IBM's System Network Architecture (SNA) defines a set of rules that systems use to communicate. These rules define the layout of the data that flows between the systems and the action the systems take when they receive the data. The layout of the data is known as the **format**, and the action the systems take when they receive that data is known as the **protocol**. Together, formats and protocols constitute the architecture.

SNA does not specify how a system should implement the architecture. Indeed, a fundamental objective of SNA is to allow systems that have very different internal hardware and software design to communicate. The only requirement is that the network flows meet the rules of the architecture.

One consequence of this independent implementation is that each system brings its own terminology into its SNA implementation, and this can lead to a confusion of terminology when you start to establish a connection between two different systems. This section introduces those particular SNA concepts and terms that you will encounter when configuring CICS systems.

SNA concepts

A **network** is a collection of interconnected computers and devices, together with the physical and logical connections that connect them.

A **network address** is a unique code that is assigned to every device in a network. With a personal computer, for example, it is likely to be the medium access control (MAC) address in its network adapter card.

A **link** connects two **nodes**, where a node is any device in a network that transmits and receives data.

A **logical unit (LU)** represents the logical destination of a communication data flow. The formal definition of an LU is that it is the means by which an end user gains entry into a network, and an end user is defined as the ultimate source, or destination, of data flow in a network. SNA supports several different types of LUs. These are grouped together in numbered **LU types**, such as LU type 2 for 3270 display terminals, and LU type 4 for printers. The LU type for CICS-to-CICS communication is LU type 6.2, and is frequently referred to as **advanced program-to-program communication (APPC)**. Each LU is given a unique name that identifies it in the network, and this is referred to as the **LU name**.

Sometimes the name of the network that the LU is in is appended to the name of the LU. It is then known as the **network-qualified LU name**, or the **fully qualified LU name**, and it takes the form *network-name.LU-name*.

A **physical unit** (PU) is the hardware and software components in a device that manage its network resources. LUs reside within a PU, and one PU may hold many LUs. There are several different types of PU. VTAM running in a mainframe host is a PU type 5, and NCP running in a 37x5 network controller is a PU type 4. When workstations connect together in a peer-to-peer manner they act as PU type 2.1. When a workstation connects to a mainframe host in a hierarchical manner, it acts as a PU type 2.0. The PU type 2.1 is described as an independent node (because it is independent of a mainframe host), and the PU type 2.0 is a dependent node.

The SNA concept that relates LUs to PUs is a **control point** (CP). A CP can be thought of as that part of a PU that manages the LU.

Associated with the PU and CP is the **exchange identification** (XID). XID is actually the name of a data flow that PUs exchange during the early stages of their attempt to establish a connection, but, in the context of SNA configuration, XID refers to one of the fields within that XID flow. It is a hexadecimal field which the PUs use to confirm the identity of each other.

SNA uses the term **session** to refer to various types of data flow in a network. To avoid ambiguity, it should always be qualified by a description of the type of data flow, for example CP-CP session. However, when used by CICS for APPC, it can be assumed to refer to data flow between LUs, and so is an LU-LU session. There will usually be several sessions between any two LUs, and these are known as **parallel sessions**. CICS uses the term **connection** to refer to a group of sessions that connect two CICS systems.

In SNA, the term **transaction program** (TP) refers to the application program in an APPC environment. The TP uses the LU to gain access to the network. When CICS is using APPC, the TP is a CICS transaction.

In SNA, the term **conversation** describes the communication between two TPs. That is, when two APPC TPs are in communication, they are said to be holding a conversation. Conversations flow on LU-LU sessions. Each conversation is allocated a session for its own private use. When the conversation ends, the session will be free to be used by another conversation. There can only be one conversation between any two TPs, but one TP could have multiple conversations with different TPs.

There may be a choice of many routes and paths in the network that an LU-LU session could use. One route might be suitable for large volumes of batch data, another might be reserved for smaller, high speed exchanges. SNA allows for these different route types to be grouped into **modes**. A TP can select an appropriate mode when it first establishes a conversation. The conversation will flow on an LU-LU session that follows the route defined by the node.

Three SNA terms that are used in many contexts are **local**, **remote**, and **partner**. For example, you could refer to the local system, the remote system, and the partner system. To explain these terms, consider the case when you are at a workstation. You would regard the workstation as the local system, the machine your workstation is communicating with would be the remote system, and that remote system would be your partner. However, these terms are all relative to your point of reference, so the remote system will regard itself as being a local system with your workstation being its remote system, and each system is a partner of the other.

In summary, it may help you to understand these terms if you visualize a session as being like a pipe that links LUs. When the LU inserts data into the pipe it is inevitable that the data will be passed to the LU at the other end of the pipe. Pipes with similar characteristics are grouped together in a mode. These pipes are created when the systems are first initialized and SNA is started, or when a TP first requests the use of one. There will usually be several pipes running in parallel between two CICS systems. When a CICS transaction wants to hold a conversation with a transaction on another system, it requests the use of a pipe. It is given the sole use of a pipe. When the transaction ends, the pipe is returned to the pool and can be allocated to the next transaction.

SNA products

CICS does not provide its own SNA support. That is, CICS does not structure the network data flows into the SNA format, nor is it responsible for initiating the SNA protocol when a data flow is received. These SNA functions are provided by a separate SNA product, and CICS uses the services of that product. On a mainframe host, the SNA product is VTAM, on an OS/2 workstation it is Communications Manager/2 (CM/2), and on an AIX machine, it is AIX SNA Server/6000 (AIX SNA).

When you configure your systems, you have to configure both the CICS product and the associated SNA product.

Preparing for SNA configuration

To establish a SNA connection, each system must:

1. Define itself to the network
2. Define the connection to its partner
3. Ensure that the remote system has a definition of the local system

You could regard the first step as the system registering its name and address with the network; the second step as a system specifying its intended partner's name and address so that the network can establish a link to it; and

the third step as the your partner registering your system's name so that it will recognize your system's requests when it receives them.

Matching parameters

The names that are used to define system resources include the network name, LU name, PU name, CP name and XID.

Some of these names are used as parameters when configuring the CICS product, and others are used as parameters when configuring the SNA product. Some are used in both products. Some are used in one product on the local system and in another product on the remote system. When a parameter is used in more than one place, it is important that the same name is used. That is, the parameters must match.

Mode name

The partners must use matching mode names. Any mode may be used, but a convenient one is the #INTER architected mode.

Alias names

Some resources (typically the LU) may have an alias or local name as well as a real name. The alias is only used internally within a local system. The partner system recognizes only the real name, and it is that name that must match across the systems.

Platform specific implementation

Depending upon the particular network configurations and SNA products being used, you may find that not all the parameters are needed. For example, the XID may be used rather than the CP name to identify the partner. In other circumstances when, for example, there is only one LU in the PU, the CP may have to have the same name as the LU. You should refer to the product-specific manuals for clarification of these points when you are ready to proceed beyond this first basic configuration.

The scenario

In the scenario chosen for this discussion, we assume that there is an established SNA network of interconnected CICS on System/390 systems into which we are adding a CICS for OS/2 system and a CICS for AIX system. This chapter is written from the perspective of the OS/2 and AIX systems administrator who connects the workstations to the mainframe host.

To avoid the potential problem of duplicate names being used, and to assist management of the network, the VTAM® system administrator may act as

coordinator for the network resource names. You therefore need to agree the network names of your workstations with the VTAM systems administrator.

Configuration details

The tables in the following sections show where the resource names are configured in the CICS and SNA products. The information is generally given by naming the attribute in which the resource name is specified as a parameter, and giving the name of the definition statement or front-end panel in which that attribute appears. If you need further information on the configuration tools used by the different product you should refer to the product-specific manuals listed in “SNA books” on page 85.

If the tables show that a name is specified in both CICS and the SNA product, then the same matching name must be used in both. When a name is not defined in one of the products, this is indicated by a dash (-).

There is not complete symmetry in the configuration details in the mainframe host and the workstations. For example, the workstation configuration requires that it knows the address of the mainframe host, but the mainframe is not given the address of the workstation. This is because the workstations are regarded as the *calling* system, and the mainframe the *listener*. This means that the session will be initiated by the workstation calling the mainframe. Therefore the information the workstation needs about the mainframe is different from the information the mainframe needs about the workstation.

Mainframe host configuration

CICS Transaction Server and VTAM will have already defined their network name and LU name to the network. Table 8 shows where these names are defined in CICS Transaction Server and VTAM. Here they refer to the mainframe’s local resources. You use these names when you later configure the workstations where they refer to the workstation’s partner resources.

The workstations need to know the address of the mainframe host. This is a 12-character hexadecimal code assigned to the front-end processor. This code is not used in the configuration of CICS Transaction Server or VTAM and so is not shown in the table. The network administrator will be able to tell you the address.

Table 8. Defining local resources to CICS Transaction Server and VTAM.

	CICS Transaction Server	VTAM
Network name	-	NETID= attribute in VTAM startup procedure

Table 8. Defining local resources to CICS Transaction Server and VTAM. (continued)

	CICS Transaction Server	VTAM
LU name	APPLID= attribute in the SIT	The label on the APPL statement that defines CICS to VTAM

Defining the workstations to CICS Transaction Server and VTAM

You now have to agree with the CICS and VTAM system administrator on the resource names that you use for your workstations. The workstations have to be defined to CICS Transaction Server and VTAM so that the mainframe recognizes and accepts session initiation requests from them. For each workstation the system administrator creates a new CONNECTION definition in CICS, and new PU, LU, and MODEENT definition statements in VTAM.

Table 9 shows where the LU, PU, CP and XID names are defined. Remember that these are the names of the mainframe's partner resources. You use these same names when configuring the workstations, where they refer to those workstation's local resources (see Table 10 on page 30 and Table 12 on page 31).

Table 9. Defining the workstation to CICS Transaction Server and VTAM.

	CICS Transaction Server	VTAM
LU name	NETNAME attribute in the CONNECTION definition	The label on the LU statement
PU name	-	The label on the PU statement
CP name	-	CPNAME= attribute in the PU statement
XID	-	IDBLK= and IDNUM= attributes in the PU statement
Mode	MODENAME attribute in the SESSIONS definition	LOGMODE= attribute in the MODEENT statement
Note: The workstation is in the same network as the mainframe, and so the network name it uses is the same as that defined to VTAM in Table 8 on page 28.		

OS/2 workstation configuration

To configure the OS/2 workstation, you must:

1. Define it to the network
2. Define a connection to its partner

Defining the OS/2 workstation to the network

Table 10 shows where the local resources are defined to CICS for OS/2 and CM/2. You use the names you have previously agreed with the mainframe system administrator that are shown in Table 9 on page 29.

Table 10. Defining local resources in CICS for OS/2 and CM/2

	CICS for OS/2	CM/2
Network name	-	Network ID attribute in the Local Node Characteristics panel
LU name	LU alias attribute in the APPC TCS panel	Alias and LU name attributes in the Local logical unit panel
CP name	-	Local Node Name attribute in the Local Node Characteristics panel
XID	-	Local Node ID attribute in the Local Node Characteristics panel
Mode	Mode name attribute in the APPC TCS panel	Mode name attribute in the Mode panel

Defining the connection to the mainframe

Table 11 shows how you define the connection to the mainframe. The table shows that all you have to provide is the LU name (which is effectively the name of the CICS system), and the hardware address.

Table 11. Defining the connection to the mainframe host

	CICS for OS/2	CM/2
LU name	Partner LU alias attribute in the APPC TCS panel	Alias and Fully qualified LU name attributes in the Partner LU panel
Address	-	LAN destination address attribute in the Connection to a Host panel

AIX machine configuration

To configure the AIX machine, you must:

1. Define it to the network
2. Define a connection to its partner

AIX is a more versatile platform than OS/2, and offers many ways of connecting CICS to the network. The AIX SNA product can be in a different machine from the CICS for AIX product. It can be using an Encina PPC

Gateway, with CICS using TCP/IP to communicate with the gateway before gaining access to the SNA network. The machines can be in different networks. The example shown here describes the basic case of a single machine, that is running both CICS for AIX and AIX SNA, and that is in the same network as the mainframe.

Defining the AIX machine to the network

Table 12 shows where the local resources are defined to CICS for AIX and AIX SNA. You use the names you have previously agreed with the mainframe system administrator that are shown in Table 9 on page 29.

Table 12. Defining local resources in CICS for AIX and AIX SNA

	CICS for AIX	AIX SNA
Network name	LocalNetworkName= attribute in the Region Definition	Local network name attribute in the Initial Node Setup panel
LU name	LocalLUName= attribute in the Region Definition	Local LU name attribute in the Add LU 6.2 Local LU Profile and the Side Information Profile panels
CP name	-	control point name attribute in the Initial Node Setup panel
XID	-	XID node ID attribute in the Initial Node Setup panel
Mode	DefaultSNAModeName= attribute in the Communication Definition	Profile name attribute in the Add LU 6.2 Mode Profile panel

Defining the connection to the mainframe

Table 13 shows how you define the connection to the mainframe. All you have to provide is the LU name (which is effectively the name of the mainframe CICS system), and the hardware address.

Table 13. Defining the connection to the mainframe host

	CICS for AIX	AIX SNA
LU name	RemoteLUName attribute in the Communications Definition	Fully qualified partner LU name attribute in the Add LU 6.2 Partner LU Profile panel
Address	-	Link address attribute in Link station information in the Initial Node Setup panel

Where to next?

The information given in this chapter shows what has to be done to configure your workstations for SNA communications.

Only information on the logical connections has been given. You will need to add information on the particular physical connections you are using (such as whether you are using a Token Ring or Ethernet LAN, or a SDLC connection to the mainframe).

CICS for OS/2 Intercommunication, the *CICS on Open Systems Intercommunication Guide*, and *IBM Transaction Server for Windows NT Version 4 Intercommunication Guide* give complete configuration examples for various types of connections.

As stated in the introduction, your first aim must be to configure a basic setup and test it with a simple application. For instance:

- APING is the APPC equivalent of the TCP/IP PING program. It can be used independently of CICS as a stand-alone APPC application and so will test the configuration of your SNA products.
- The CICS Server ISC PING Transaction is available as SupportPac™ CC02 at the following URL:
<http://www.hursley.ibm.com/cics/txppacs/cc02.html>

Only after you are satisfied that you have a working APPC link should you expand the configuration to include your own applications.

Part 2. CICS intercommunication functions

This part describes the CICS intercommunication functions. The information is intended for planners and analysts, and as an introduction for programmers. This part includes the following chapters:

- “Chapter 6. Introduction to the CICS intercommunication functions” on page 35
- “Chapter 7. Function shipping” on page 39
- “Chapter 8. Transaction routing” on page 47
- “Chapter 9. Distributed program link” on page 57
- “Chapter 10. Asynchronous processing” on page 61
- “Chapter 11. Distributed transaction programming” on page 71

Chapter 6. Introduction to the CICS intercommunication functions

This chapter gives a simple description of the CICS intercommunication functions.

In “Summary of CICS intercommunication functions”, the figures and explanations deliberately gloss over technical details, but present the functions as seen by an application programmer. The important point is that function shipping, asynchronous processing, transaction routing, and distributed program link (DPL) are powerful distributed functions that are transparent to the application programmer. Applications can access local or remote resources and programs entirely under the control of definitions created by the systems programmer.

Distributed transaction programming is a more complex facility and application programmers need to be aware that a dialog is taking place with a remote transaction. The program logic must react to the current state of the dialog.

“Which intercommunication function?” on page 37 gives some guidelines for the selection of the correct intercommunication function for particular requirements.

Summary of CICS intercommunication functions

As an introduction for new CICS users, this section presents deliberately simplified definitions of the CICS intercommunication functions.

Function shipping

A program in system CICS A accesses resources (such as files or transient data queues) that are owned by remote system CICS B as though they were locally

owned. The diagram shows a data-access request.

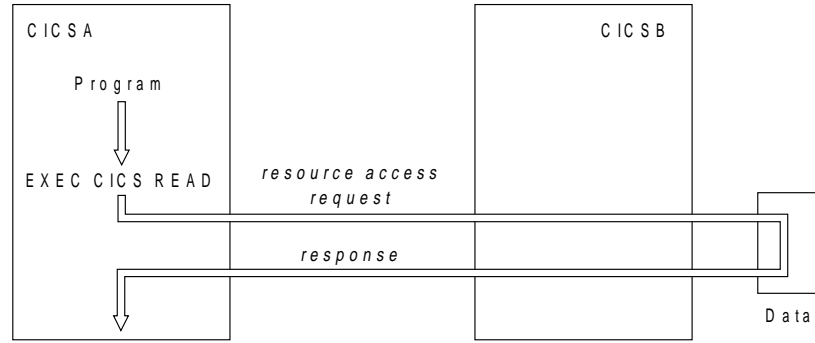

Asynchronous processing is an example of function shipping that does not access data – the shipped request is an EXEC CICS START command for a remote transaction.

Transaction routing

A terminal attached to system CICS A runs a transaction in remote system CICS B as though it were a local transaction.

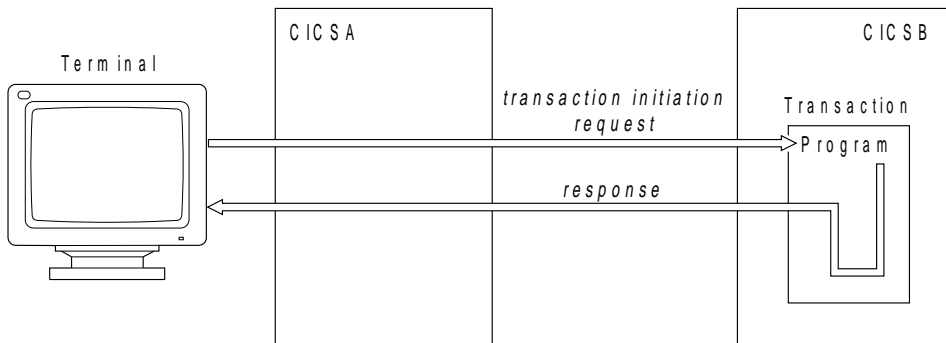

Distributed program link

A program in system CICSA links a program in remote system CICSB as though it were running in the local system.

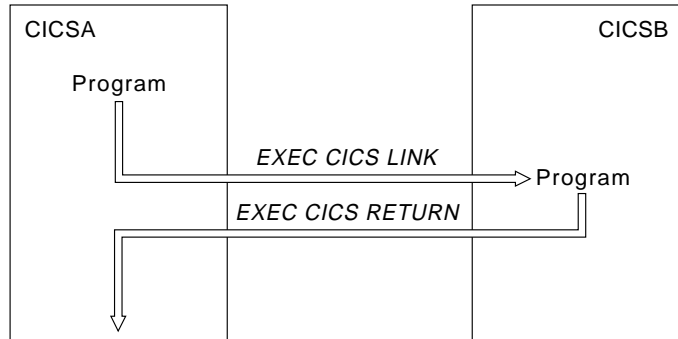

Distributed transaction programming

Two programs, one in system CICSA and one in system CICSB, communicate synchronously with each other. This dialog is called a conversation.

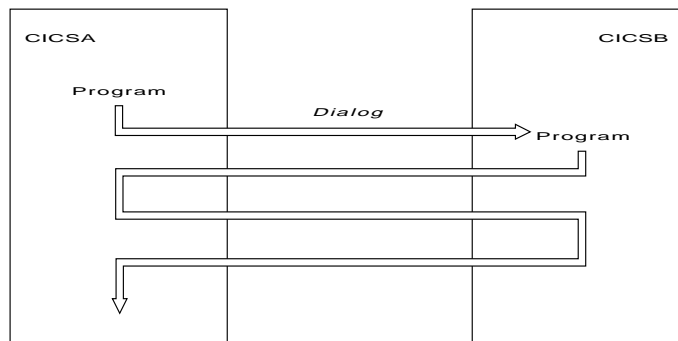

Which intercommunication function?

To help you choose the right intercommunication function, the list below gives typical requirements and the functions that meet them:

- **A terminal user needs to run a transaction owned by a different system than the one to which he or she is connected.**

Use transaction routing.

- **A transaction wants to read/write data owned by another system.**

Use function shipping. However, function shipping has higher overheads than transaction routing, so it is better to use transaction routing unless the transaction accesses data in the local system as well as data in the remote system.

- **A transaction wants to read/write IMS™ or DL/I data to which another system has access.**

Use distributed program link.

- **A transaction needs to signal a remote system that it should start a named transaction.**

Use asynchronous processing.

- **A transaction wants several accesses to remote data, possibly with some processing between the accesses.**

Use distributed program link if possible. This requirement can be met with several function shipping requests, but DPL minimizes the data flows on the network. If DPL cannot meet the whole requirement, a mixture of DPL and function shipping is more efficient use of the network than total reliance on function shipping.

- **An application requires communication between two or more systems with interdependent resource updates based on data exchanges.**

Use distributed transaction programming.

Chapter 7. Function shipping

CICS function shipping enables CICS application programs to use EXEC CICS commands to:

- Access CICS files owned by other CICS systems by shipping file control requests.
- Transfer data to or from transient data and temporary storage queues in other CICS systems by shipping requests for transient data and temporary storage functions.
- Initiate transactions in other CICS systems, or other non-CICS systems that implement SNA LU Type 6 protocols, such as IMS, by shipping START requests. This form of communication is described in “Chapter 10. Asynchronous processing” on page 61.

An illustration of a shipped file control request is given in Figure 2. In this figure, a transaction running in a CICS system, CICA, issues a file control READ command against a file called NAMES. From the resource definition table, CICA discovers that this file is owned by a remote CICS system called CICB. CICA changes the READ request into a suitable transmission format, and then ships it to CICB for execution.

In CICB, the request is passed to a special transaction known as the **mirror transaction**. The mirror transaction recreates the original request, issues it on CICB, and returns the acquired data to CICA.

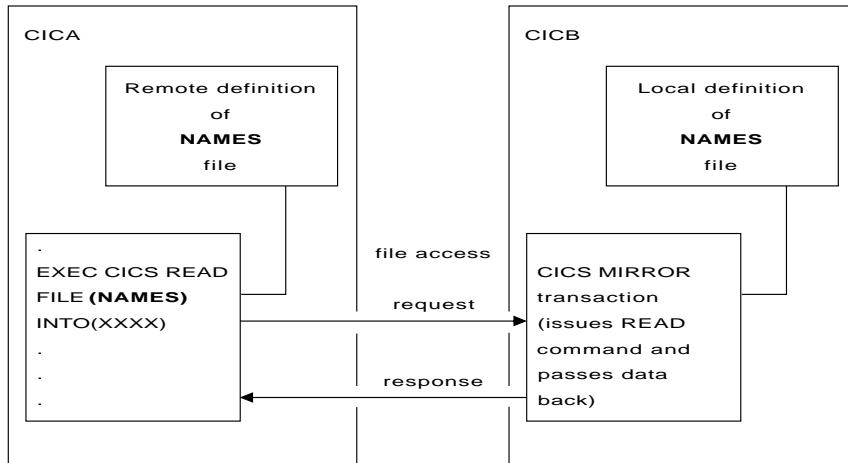

Figure 2. Function shipping

Transparency to application

An application that uses function shipping need not know the location of the requested resources; it uses file control commands, temporary storage commands, and so on, as if all resources are owned by the system in which the application runs. Entries in the CICS resource definition tables allow the system programmer to specify that the named resource is not on the local (or requesting) system but on a remote (or owning) system.

The definition of a remote resource can include both the name by which the resource is known in the remote system, and a different name by which it is known locally. When the resource is requested by its local name, CICS substitutes the remote name before sending the request. This facility is useful when resources exist with the same name on more than one system, but each contains data peculiar to the system on which it is located.

Application programs can use the SYSID option of various EXEC CICS commands to name remote systems explicitly. If this option is specified, the request is routed directly to the named system, and the resource definition tables on the local system are not used. Using SYSID in this way destroys the program's independence of the resource's location. The advantage is that *any* system, including the local system, can be named in the SYSID option. The decision whether to access a local resource or a remote one can be taken at execution time.

Remote resources that can be accessed

Function shipping requests can access the following remote resources:

- CICS file control data sets
- Temporary storage
- Transient data
- IMS and DOS DL/I databases (from CICS on System/390 systems).

CICS file control data sets

Function shipping allows access to files located on a remote CICS system. The following EXEC CICS commands are not supported:

- INQUIRE FILE
- INQUIRE DSNAME
- SET FILE
- SET DSNAME

Both read-only and update requests are allowed. Protection of data depends on the security facilities available to the different CICS products. Updates to

remote recoverable files are not committed until the application program issues a syncpoint request or terminates successfully. Logically-related updates of local and remote files can be performed within the same logical unit of work, even if the remote files are located on more than one connected CICS system.

Care should be taken when designing systems that use remote file requests containing physical record identifier values (examples include BDAM, VSAM RBA, and files with keys not embedded in the record). Application programs in remote systems must have access to the correct values following updating or reorganization of such files.

IMS databases

Function shipping allows a CICS on System/390 transaction to access IMS/ESA® DM and IMS/VS DB databases associated with a remote CICS/ESA or CICS/MVS® system, or DL/I for VSE/ESA databases associated with a remote CICS/VSE system.

CICS for OS/2, CICS for Windows NT, CICS for OS/400, and CICS on Open Systems systems cannot access IMS or DL/I databases by function shipping, but can do so by distributed program link (see “Chapter 9. Distributed program link” on page 57). The following discussion applies to CICS on System/390 systems only.

The IMS/ESA DM (DL/I) database associated with a remote CICS system can be a **local** database owned by the remote system, or a database accessed using IMS database control (DBCTL). To the CICS system that is doing the function shipping, this database is simply **remote**.

As with file control, updates to remote DL/I databases are not committed until the application reaches a syncpoint. In IMS/ESA DM, it is not possible to schedule more than one PSB for a single logical unit of work, even when the PSBs are defined to be on different remote systems. For this reason, logically-related DL/I updates on different systems cannot be made in a single logical unit of work.

The PSB directory list (PDIR or DLZACT) is used to define a PSB as being on a remote system. The remote system owns the database and the associated PCB definitions. When DL/I access requests are made to another processor system by a CICS system but no local requests are made, it is not necessary to install IMS on the requesting system.

Temporary storage and transient data

Many of the uses made of transient data and temporary storage queues in a single CICS system can be extended to an interconnected system environment. For example, a queue of records can be created in a remote system for processing overnight. Queues also provide a means of handling responses from remote systems, while keeping local terminals free to enter other requests. A response can be returned to a terminal when it is ready, and delivered to the operator when there is a lull in entering transactions.

Temporary storage

Function shipping enables application programs to send data to, or retrieve data from, temporary storage queues located on remote systems. A recoverable queue must be defined as recoverable in its local (resource-owning) system.

Transient data

An application program can access intrapartition or extrapartition transient data queues on remote systems. The resource definition in the requesting system defines the named queue as being on the remote system. The queue definition in the remote system specifies whether the queue is recoverable, and whether it has a trigger level and associated terminal.

If a transient data destination has an associated transaction, the named transaction must be defined to execute in the system owning the queue; it cannot be defined as remote. If a terminal is associated with the transaction, it can be connected to another CICS system and used through the transaction routing facility of CICS.

The remote naming capability enables a program to send data to the CICS service destinations, such as CSMT, in both local and remote systems.

How function shipping works

Two CICS components implement function shipping:

- The CICS transformer programs
- The CICS mirror transaction.

Figure 3 on page 44 illustrates how these components work together.

The transformer programs

If a CICS transaction issues a request to access a resource, the command level EXEC interface program determines whether the resource is owned by the local CICS system. If the resource is on another system, control passes to the function-shipping transformer program.

DL/I (EXEC DL/I or CALL DLI) requests use the DL/I interface, which also provides part of the transformer program's function.

A transformer program converts the request to a form suitable for transmission, and calls the intercommunication component to send the request to the resource-owning system.

The CICS intercommunication component sends the request to the remote system. On the first request to a particular remote system on behalf of a transaction, the communication component in the local system precedes the formatted request with the mirror-transaction identifier, in order to attach this transaction in the remote system. The local transformer program keeps track of whether the remote mirror transaction terminates, and reinvokes it as required.

When a reply is received from the remote system, a second transformer program decodes it. CICS uses the decoded reply to complete the original command-level request.

The remote system uses its own transformer programs in dealing with the request (see next section).

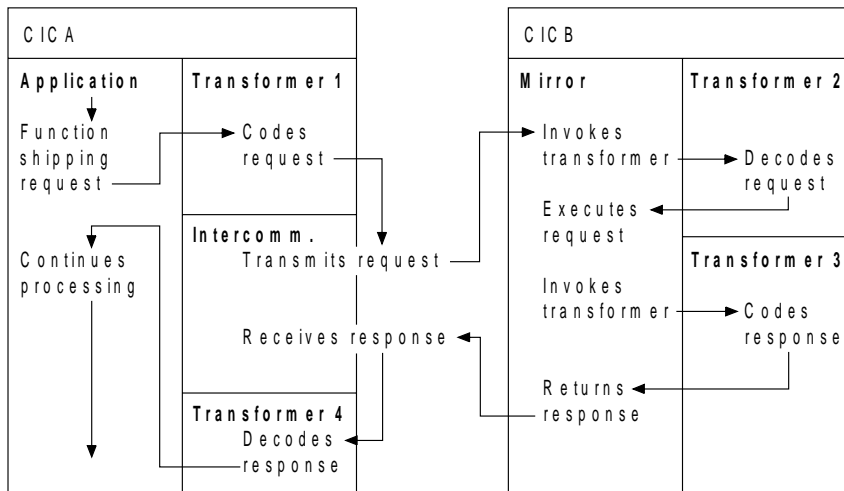

Figure 3. Relationship of mirror and transformers

The mirror transaction

A resource-owning system passes an incoming function-shipping request to the mirror transaction. The first request from a particular remote transaction causes the initiation of a new instance of the mirror transaction, which uses CICS intercommunication facilities to communicate with the requesting system.

Using a CICS transformer program, the mirror transaction decodes the formatted request, and executes the command. On completion of the command the mirror transaction uses a transformer program to construct a formatted reply, and returns this to the requesting system.

The mirror transaction remains active after sending its reply to the current command in any of the following cases:

- Execution of a future command depends on the retention of system-specific information established during execution of the current command, for example:
 - REWRITE depends on prior READ UPDATE
 - READNEXT depends on prior STARTBR
- Execution of a future command may depend on the retention of application-specific information established during execution of the current command, for example when a recoverable resource has been updated.
- The mirror remained active after replying to a previous command for one of the reasons above (the mirror then remains active until the end of the logical unit of work in the requesting system).

In other cases, the mirror terminates after replying to the current command.

An active mirror always terminates when the requesting transaction issues a synchronization request or terminates successfully. The mirror always terminates after executing a LINK command with the SYNCONRETURN option. For a further explanation of SYNCONRETURN, please refer to “Synchronization” on page 58.

Multiple mirrors

A transaction can access recoverable and nonrecoverable resources in any order, and is not affected by the location of recoverable resources (they could all be in different remote systems, for example). When a local transaction accesses resources in more than one remote system, the intercommunication component invokes a mirror transaction in each remote system to execute requests for the local transaction. Each mirror transaction follows the above rules for termination, and when the transaction reaches a synchronization point, the intercommunication component exchanges synchronization point messages with those mirror transactions that have not yet terminated (if any).

Chained mirrors

The mirror transaction uses the EXEC CICS interface to execute CICS requests and the DL/I CALL or the EXEC DLI interface to execute DL/I requests. The request is thus processed as for any other transaction and the requested resource is located in the appropriate resource table. If its entry defines the resource as being remote, the mirror transaction’s request is formatted for transmission and sent to the specified remote system, which activates its own mirror transaction. This is called a **chained-mirror**.

Synchronization

CICS recovery and restart facilities ensure that when the requesting transaction reaches a synchronization point, any mirror transactions that are updating recoverable resources also take a synchronization point, so that changes to recoverable resources in remote and local systems are consistent. The CICS master terminal (or, with CICS for OS/400, the control region) receives notification of any failures in this process, so that suitable corrective action can be taken. This action can be taken manually or by user-written code.

When a transaction issues a synchronization point request, or terminates successfully, the intercommunication component sends a message to the mirror transaction that causes it also to issue a synchronization point request and terminate. The successful synchronization point by the mirror transaction

is indicated in a response sent back to the requesting system, which then completes its synchronization point processing, so committing changes to any recoverable resources.

Function shipping examples

Figure 4 and Figure 5 on page 47 give examples to illustrate the lifetime of the mirror transaction. In Figure 5 on page 47 the mirror is long-running.

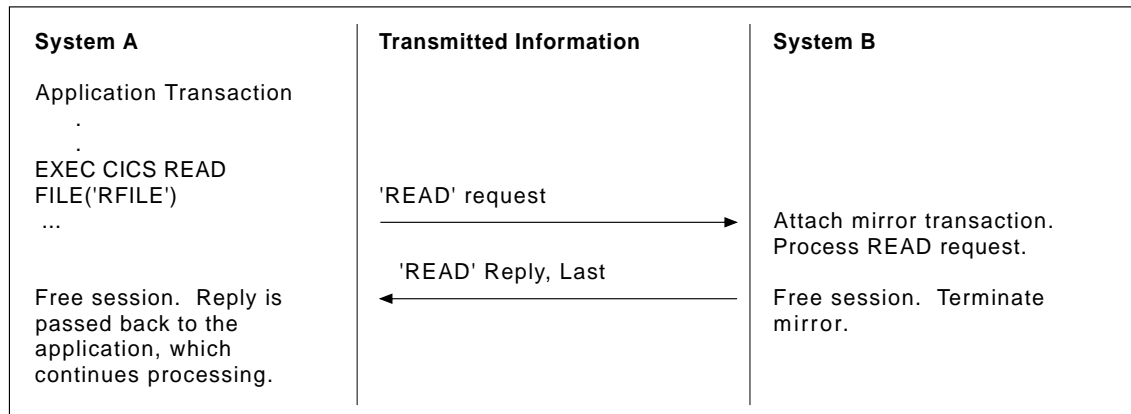

Figure 4. Function shipping—simple inquiry. Here, no resource is being changed; the session is freed and the mirror task is terminated immediately.

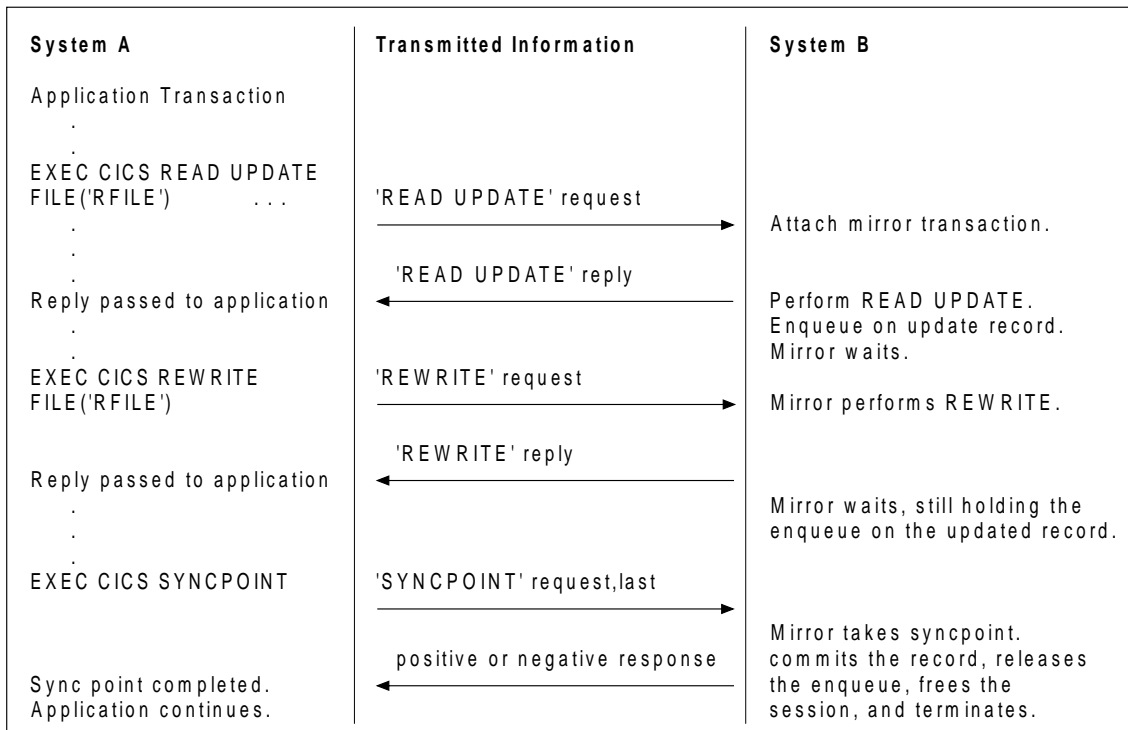

Figure 5. Function shipping—update. Because the mirror must wait for the REWRITE, it does not terminate until SYNCPOINT is received. Note that the enqueue on the updated record would not be held beyond the REWRITE command if the file was not recoverable.

Chapter 8. Transaction routing

CICS transaction routing allows terminals connected to one CICS system to run with transactions in another, connected, CICS system. This means that you can distribute terminals and transactions around your CICS systems and still have the ability to run any transaction with any terminal.

Figure 6 shows a terminal connected to one CICS system running with a user transaction in another CICS system. Communication between the terminal and the user transaction is handled by a CICS-supplied transaction called the **relay transaction**.

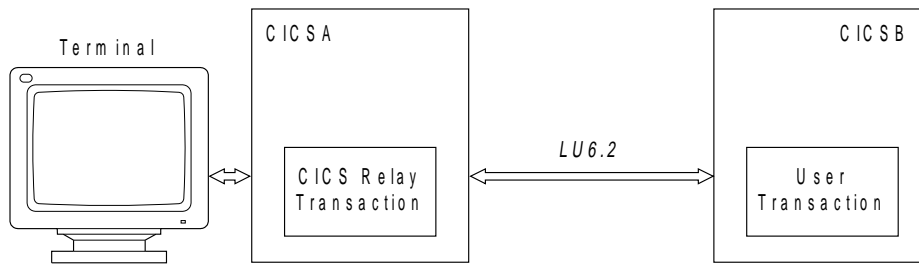

Figure 6. The elements of transaction routing

Two different CICS products must be connected by an LU6.2 link. Transaction routing over LU6.1 links is not supported.

In transaction routing, the term *terminal* is used in a general sense to mean such things as an IBM 3270, or a single-session APPC device, or an APPC session to another CICS system, and so on. **All** terminal and session types supported by CICS on System/390 are eligible for transaction routing, **except** those given in the following list:

- LUTYPE6.1 connections and sessions
- Pooled 3600 or 3650 pipeline logical units
- MVS system consoles.

CICS for OS/2, CICS for Windows NT, CICS for OS/400, and CICS on Open Systems support minimum BMS. Only CICS on System/390 systems support batch data interchange, standard BMS, and full BMS. Depending on these product capabilities, a user transaction can use CICS terminal control, BMS, or batch data interchange facilities to communicate with the terminal, as appropriate for the terminal or session type. Mapping and data interchange functions are performed in the application-owning system (CICS B in Figure 6). BMS paging operations are performed in the terminal-owning system (CICS A in Figure 6).

Pseudoconversations are supported (except when the terminal is an APPC session), and the various transactions that make up a pseudoconversation can be in different systems.

Initiating transaction routing

Transaction routing can be initiated in the following three ways:

1. A terminal sends a request to the CICS terminal-owning system to start a transaction. On the basis of an installed resource definition for the transaction (and possibly, in CICS on System/390, CICS for OS/2, and CICS for Windows NT, on decisions made by a user-written dynamic

- routing program), the request is routed to an appropriate transaction-owning system, and the transaction runs as if the terminal were attached to the transaction-owning system.
2. A transaction started by automatic transaction initiation (ATI) acquires a terminal that is owned by another CICS system.
 3. A CICS/ESA or CICS/VSE transaction issues an ALLOCATE command for a session to an APPC terminal or connection that is owned by another CICS system.
 4. The CICS-supplied transaction CRTE is used to invoke transactions in other systems. See “The routing transaction (CRTE)” on page 54.

Terminal-initiated transaction routing

When a terminal requests transaction initiation, CICS examines the installed transaction definition. If the transaction is defined with a remote system named in the REMOTESYSTEM option (or REMOTESYSID in CICS on Open Systems), CICS initiates the relay transaction, which passes control to the relay program to drive transaction routing.

Static transaction routing

Static transaction routing is a term used to distinguish standard transaction routing from dynamic transaction routing. In CICS for OS/400, all transaction routing is static. In CICS on System/390 and CICS on Open Systems, static transaction routing occurs when DYNAMIC(NO) is specified in the transaction definition.

In static transaction routing, the request is routed to the system named in the REMOTESYSTEM option. If REMOTESYSTEM is unspecified, or if it names the local CICS system, the transaction is a local transaction, and transaction routing is not involved.

Dynamic transaction routing

Dynamic transaction routing allows a user-written program to select the system to which a transaction routing request is to be directed. Dynamic transaction routing is provided by CICS on System/390, CICS on Open Systems, CICS for OS/2, CICS for Windows NT Version 2, and IBM Transaction Server for Windows NT Version 4. The implementations are different (see following descriptions). CICS for OS/400 does not support dynamic transaction routing.

CICS on System/390, CICS on Open Systems, and IBM Transaction Server for Windows NT Version 4: In a CICS on System/390, CICS on Open Systems, or IBM Transaction Server for Windows NT Version 4 system, you

can use the DYNAMIC option when defining a transaction. This includes a remote definition of a CICS for OS/2, CICS for Windows NT Version 2, or CICS/400 transaction.

Specifying DYNAMIC(YES) means that you want the opportunity to route the terminal data to an alternative transaction at the time the defined transaction is invoked. CICS enables this by allowing a user-supplied program, called the **dynamic transaction routing program**, to examine the terminal input data and redirect it to any transaction and system it chooses. In CICS on System/390, this program has the default name of DFHDYP, but an alternative name may be defined by using the DTRPGM system initialization parameter.

Parameters are passed in a communications area between CICS and the routing program. The program may change some of these to influence subsequent CICS action. For example, in CICS on System/390, some of the parameters are:

- Invocation reason. The routing program can be reinvoked after an unsuccessful routing attempt or when the target transaction has terminated.
- Error information.
- The SYSID of the target system. Initially, the one specified on the REMOTESYSTEM option for the installed transaction (or REMOTESYSID in CICS on Open Systems).
- The name of the target transaction. Initially, the name specified on the REMOTENAME option for the installed transaction.
- A pointer to a data area containing the initial input data from the terminal.

The dynamic transaction routing program can issue most EXEC CICS commands.

Dynamic transaction routing enables you to make transaction routing decisions based on such factors as input to the transaction, available CICS systems, relative loading of the available systems, and so on.

CICS for OS/2 and CICS for Windows NT Version 2: CICS for OS/2 and CICS for Windows NT provide a user exit in which a user program can change the target system of a transaction routing request. This exit can also change the target system for *any* shipped function request and provide a target system for a transaction not defined in the local system.

The exit, if defined, is called before processing any of the following:

- An undefined transaction code
- A transaction routing request
- A function shipping request

- A DPL request
- Any command with a SYSID option.

Shipping terminal definitions

Terminals defined as shippable do not need a definition in the transaction-owning system. If necessary to support transaction routing, the terminal-owning system sends the terminal definition to the transaction-owning system.

Automatic transaction initiation

Automatic transaction initiation (ATI) is the process whereby a transaction request made internally within a CICS system or systems network leads to the scheduling of the transaction.

An ATI request can cause the initiation of a transaction in a remote system (see Figure 7 on page 52).

ATI also allows a request for a transaction owned by a particular CICS system to name a terminal that is owned by another, connected system (see Figure 7). Although the original ATI request occurs in the application-owning system, it is sent by CICS to the terminal-owning system, where it causes the relay transaction to be initiated in conjunction with the specified terminal.

The user transaction in the application-owning system is then initiated as described on page 49 for terminal-initiated transaction routing, with one important difference. The extra factor in this case is the AID (automatic initiate descriptor) associated with an ATI request. The AID specifies the names of the remote transaction and system, (**P1** and **S1** in Figure 7). In Figure 7, the terminal-owning system (**S2**) must find a transaction definition that specifies REMOTENAME (**P1**) and REMOTESYSTEM (**S1**) (or REMOTESYSID on CICS on Open Systems).

In a CICS on System/390 system, an alternative to REMOTESYSTEM is DYNAMIC(YES). In all CICS on System/390 systems except CICS/ESA 4.1, if DYNAMIC(YES) is coded, the dynamic routing program is *not* driven and the remote system name is taken from the AID. In CICS/ESA 4.1, if DYNAMIC(YES) is coded, the dynamic routing program is driven, but the remote system name is still taken from the AID; the routing program can do other things—for example, update counts of requests routed to various remote systems.

In summary, if **S2** finds a transaction definition that specifies REMOTENAME (**P1**) and either REMOTESYSTEM (**S1**) or DYNAMIC(YES), the START command is routed back to **S1**; otherwise the START command is rejected.

ATI requests are queued:

- If the link to the terminal-owning system is not available, in the application-owning system.
- If the terminal is not available, in the terminal-owning system.

The overall effect is to create a “single-system” view of ATI as far as the application-owning system is concerned; the fact that the terminal is remote does not affect the way in which ATI appears to operate.

In the transaction-owning system, the normal rules for ATI apply. The transaction can be initiated from a transient data queue when the trigger level is reached, or on expiry of an interval control START request. Note particularly that, for transient data initiation, the transient data queue must be in the same system as the transaction.

Figure 7 shows an example of ATI involving three systems:

- S0** The initiating system
- S1** The transaction-owning system
- S2** The terminal-owning system.

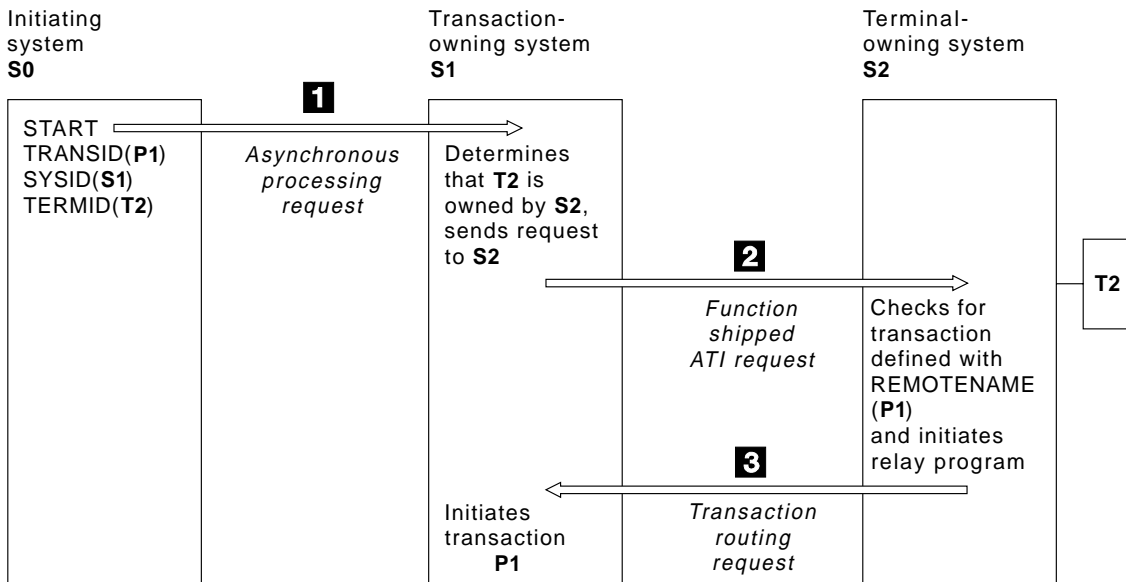

Figure 7. Automatic transaction initiation involving three CICS systems

Terminal definitions not shipped with ATI requests

As mentioned in “Shipping terminal definitions” on page 51, CICS ships a copy of the terminal definition to the transaction-owning system when necessary to support transaction routing. This definition is available for use with ATI requests received subsequently by the transaction-owning system.

However, terminal definitions are *not* shipped at the time an ATI request is received. If an ATI request names a terminal not already known in the transaction-owning system, the terminal-not-known condition occurs.

User exits for terminal-not-known condition: In CICS on System/390 systems only, two global user exits, XALTENF and XICTENF, help you to deal with the terminal-not-known condition.

The relay program

When a terminal operator enters a transaction code, and CICS determines that the transaction is in a remote system, a local relay transaction is attached to execute a CICS-supplied program known as the **relay program**. The **relay program** provides the communication mechanism between the terminal and the remote transaction. Note that in CICS on Open Systems, the relay is a function running in a shared library.

Although CICS determines the program to be associated with the relay transaction, the user’s definition for the remote transaction determines the other attributes of the relay transaction. These are usually those of the “real” transaction in the remote system.

When the relay transaction is attached, it acquires an intersystem session and sends a request to the application-owning system, to cause the “real” user transaction to be started. In the application-owning system, the terminal is represented by a control block known as the **surrogate TCTTE** (in CICS on Open Systems, terminal surrogate). This TCTTE becomes the transaction’s principal facility, and is indistinguishable by the transaction from a “real” terminal entry. If the transaction issues a request to its principal facility, the request is shipped back to the relay transaction over the intersystem session. The relay transaction then issues the request or output to the terminal. In a similar way, terminal status and input are shipped through the relay transaction to the user transaction.

Automatic transaction initiation is handled in a similar way. If a transaction that is initiated by ATI requires a terminal that is connected to another system, a request to start the relay transaction is sent to the terminal-owning system. When the terminal is free, the relay transaction is connected to it.

The relay transaction remains in existence for the life of the user transaction and has exclusive use of the session to the remote system during this period. When the user's transaction terminates, an indication is sent to the relay transaction, which terminates and frees the terminal and the intersystem session.

Basic mapping support

CICS for OS/2, CICS for Windows NT, CICS on Open Systems, and CICS for OS/400 support only the minimum level of BMS. (CICS for OS/2, CICS for Windows NT, and CICS for OS/400 support SEND TEXT.)

The mapping operations of BMS are performed in the system on which the user's transaction is running; that is, the application-owning system. The mapped information is routed between the terminal and this transaction via the relay transaction, as for terminal control operations.

When transaction routing with BMS, you should be aware of the limitations of BMS, and of the possible different levels of support in the application owning region and the terminal owning region when they are running on CICS systems on different platforms.

The routing transaction (CRTE)

The routing transaction (CRTE) is a CICS-provided transaction that enables a terminal operator to invoke transactions that are owned by a connected CICS system. It differs from normal transaction routing in that the remote transactions do not have to be defined in the local system. However, the terminal through which CRTE is invoked must be defined on the remote system (or defined as "shippable" in the local system), and the terminal operator needs security authorization if the remote system is protected. For the security support available, see the CICS Intercommunication manual for each product.

CRTE can be used from any 3270 display device.

To use CRTE, the terminal operator enters:

```
CRTE SYSID=xxxx
```

where xxxx is the local name of the remote system. The transaction then indicates that a routing session has been established, and the user enters input of the form:

```
yyyyzzzzzz
```

where *yyyy* is the name by which the required remote transaction is known on the remote system, and *zzzzz* is the initial input to that transaction. Subsequently, the remote transaction can be used as if it had been defined locally and invoked in the ordinary way. All further input is directed to the remote system until the operator terminates the routing session.

In secure systems, operators are normally required to sign on before they can invoke transactions. The first transaction that is invoked in a routing session is therefore usually the sign-on transaction CESN; that is, the operator signs on to the remote system. The use of CRTE itself can also be restricted by security.

Although the routing transaction is implemented as a pseudoconversational transaction, the terminal from which it is invoked is held by CICS until the routing session is terminated. Any ATI requests that name the terminal are therefore queued until the CANCEL command is issued.

The CRTE facility is particularly useful for invoking the master terminal transaction, CEMT, on a particular remote system. It is an alternative to installing a definition of the remote CEMT in the local system. CRTE is also useful for testing remote transactions before final installation.

Chapter 9. Distributed program link

When a CICS application program issues an EXEC CICS LINK command, control passes to a second program, named in the command. The second program executes and, when it completes, control returns to the first program at the instruction following the LINK command. The linked-to program can return data to the linking program if the LINK command has used the COMMAREA option to pass the address of a communication area.

Distributed program link (DPL) extends the use of the EXEC CICS LINK command so that the linking and linked-to programs can be in different CICS systems. The systems can be copies of the same CICS product or of different CICS products.

In certain circumstances, the use of DPL can improve performance by reducing the number of data flows between connected CICS systems.

You can specify that the linked program is to run on a connected CICS system by coding the SYSID option in the LINK command, or by specifying the remote system name in the local definition of the program.

In Figure 8, program A links to a program B, which is in a different CICS system. The arrowed line represents the flow of control. To program A, program B appears as a called subroutine.

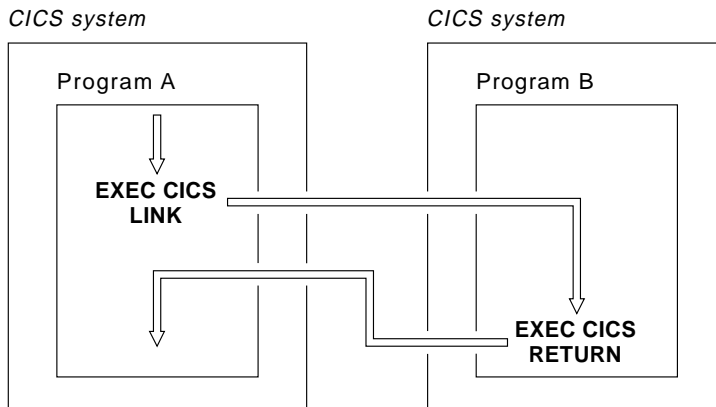

Figure 8. Distributed program link

Why use DPL?

The following are some reasons why you use might use DPL:

- To separate the end-user interface (for example, BMS screen handling) from the application business logic (for example, accessing and processing data). This makes it easier to port part of an application between systems; an example would be moving the end-user interface from a 370/390 system to a workstation.
- To obtain performance benefits from running programs closer to the resources they access, reducing the need for function shipping requests.
- Where applicable, to provide a simpler solution than distributed transaction programming (DTP).

Synchronization

DPL provides two ways to handle synchronization:

1. If you code SYNCONRETURN, the linked-to program commits its resource updates immediately before returning control to the linking program. There are separate units of work in the two communicating systems.

The linked-to program may take one or more syncpoints during its execution. However, the response the linking program is given (which maybe Normal or Rollback) corresponds to the outcome of the syncpoint taken by CICS on return from the linked-to program, and does not relate to the outcome of any of the syncpoints the linked-to program may have initiated.

SYNCONRETURN was first implemented in CICS/ESA 3.3 and CICS/VSE 2.2.

2. If you do not code SYNCONRETURN, the linking program initiates commitment in both systems, either by issuing a SYNCPOINT command or implicitly at task end.

Data integrity considerations govern the decision whether or not to use the SYNCONRETURN option.

DL/I and SQL databases

DPL is an easy way for a CICS for OS/2, CICS for Windows NT, CICS on Open Systems, or CICS for OS/400 application program to access DL/I and SQL databases and BDAM files on a remote CICS system. The program simply links to an application program (in the data-owning system) that reads and updates the databases or files.

Another way to access this data is to use distributed transaction programming (DTP) as described in “Chapter 11. Distributed transaction programming” on page 71. DTP is more difficult and therefore more costly to develop, but, if well designed, should be more efficient in use.

Because OS/2 EE Data Base Manager (DBM) has no implicit commit process, there is no automatic coordination of recovery when accessing SQL from CICS for OS/2. To coordinate CICS and SQL activity, a CICS for OS/2 program must issue an explicit commit.

Restrictions when using DPL

There are a number of restrictions on the programs that you can link to using DPL.

You should not link to programs that issue syncpoints (unless SYNCONRETURN is coded in the LINK command). See “Taking syncpoints” on page 78.

Because there is no terminal involved, you should not link to programs that issue:

- Terminal control commands to the system in which the linking program is running
- Commands that inquire on terminal attributes (such as ASSIGN commands)
- BMS commands
- Batch data interchange commands
- Commands that address the TCTUA (programs can use the communication area to pass data).

Abends when using DPL

If the linked-to program terminates abnormally, the mirror transaction returns the last abend code to the linking system. The abend code returned is the *last* abend to occur in the linked-to program, which may have handled other abends before terminating.

Chapter 10. Asynchronous processing

Asynchronous processing is a way of distributing the processing of an application between connected systems. In contrast to distributed transaction programming, the processing is **asynchronous**.

In distributed transaction programming, a session is held by two transactions for the period of a “conversation” between them, and requests and replies (if any) can be directly correlated.

In asynchronous processing, requests and replies are transmitted on different sessions. No processing dependency exists between a request and a reply, and no assumptions are made about the timing of the reply. The differences between synchronous and asynchronous processing are illustrated in Figure 9. The starting of TRAN4 can be time-dependent and can be delayed by scheduling constraints in System B.

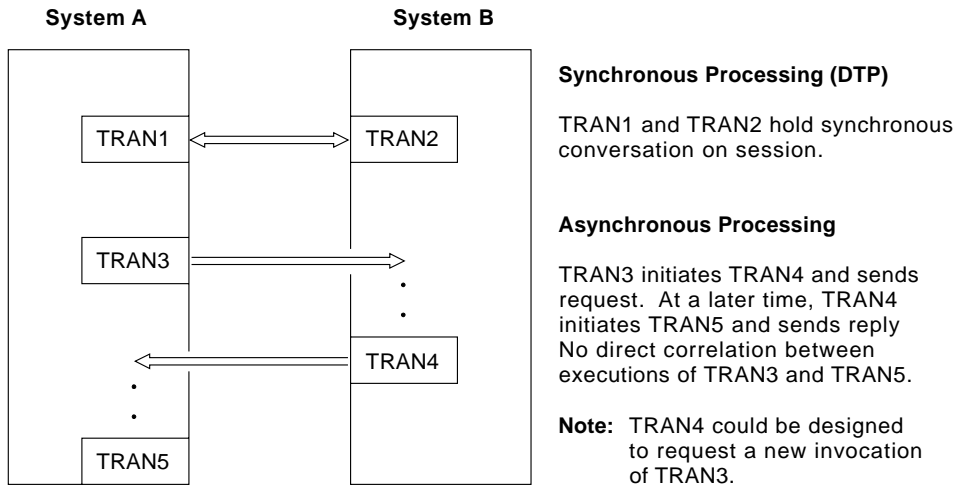

Figure 9. Synchronous and asynchronous processing compared

In general, asynchronous processing is applicable to any situation in which it is not necessary or desirable to tie up local resources while a remote request is being processed.

Asynchronous processing is not suitable for applications that require synchronized changes to local and remote resources; for example, it cannot be used to process concurrent logically-related updates to data in different systems.

Example

A typical asynchronous processing application is online inquiry on remote databases; for example, a credit rating check application. A terminal operator uses a local transaction to enter a succession of inquiries without waiting for replies. For each inquiry, the local transaction initiates a remote transaction to process the request, so that many copies of the remote transaction can be executing concurrently. The remote transactions send their replies by initiating a local transaction (possibly the same transaction) to deliver the output to the operator terminal. The replies may not arrive in the same order as the inquiries were issued; correlation between the inquiries and the replies must be made by means of fields in the user data.

Asynchronous processing methods

In CICS, asynchronous processing can be done in two ways:

1. By using the interval control commands `START` and `RETRIEVE`.

You can use the `START` command to schedule a transaction in a remote system in much the same way as you would in a single CICS system. This type of asynchronous processing is essentially a form of CICS function shipping, and as such, is usually transparent to the application. CICS recognizes that a transaction is remote in one of two ways:

- The transaction resource definition specifies that it is remote
- The `START` command includes the `SYSID` option to specify a remote CICS system.

A CICS transaction that is initiated by a remotely-issued start request can use the `RETRIEVE` command to retrieve any data associated with the request. Data transfer is restricted to a single record passing from the initiating transaction to the initiated transaction.

A CICS transaction can use the `EXEC CICS ASSIGN STARTCODE` command to determine how it was initiated.

Asynchronous processing is more fully discussed under “Asynchronous processing using `START/RETRIEVE` commands” on page 63.

2. By using distributed transaction programming (DTP), a cross-system method with no single-system equivalent.

When you use DTP to attach a remote transaction, you also allocate a session and start a conversation. This permits you to send data directly and, if you want, to receive data from the remote transaction. Your transaction design determines the format and volume of the data you exchange. For example, you can use repeated `SEND` commands to pass

multi-record files. However short the conversation, during the time it is in progress, the processing is synchronous. Error recovery and syncpoint functions are available using the normal DTP commands.

When you have exchanged data, you terminate the conversation and quit the local transaction, leaving the remote transaction to continue processing asynchronously.

Distributed transaction programming is more fully discussed under “Chapter 11. Distributed transaction programming” on page 71.

Asynchronous processing using START/RETRIEVE commands

The interval control commands that can be used for asynchronous processing are:

- START
- CANCEL
- RETRIEVE.

Starting and canceling remote transactions

The interval control START command is used to queue a transaction-initiation request in a remote CICS system. The command is effectively function shipped. In the remote system, the mirror transaction is invoked to issue the START command.

You can include time-control information on the shipped START command, using the INTERVAL or TIME option. Before a command is shipped, a TIME specification is converted by CICS to a time interval relative to the local clock. If the ends of a link are in different time zones, use the INTERVAL option.

The time interval specified in a START command is ***the time at which the remote transaction is to be initiated***, not the time at which the request is to be shipped to the remote system.

A START command shipped to a remote CICS system can be canceled, ***before the expiry of the time interval***, by shipping a CANCEL command to the same system. The START command to be canceled is uniquely identified by the REQID value specified on the START command and on the associated CANCEL command. Any task can issue the CANCEL command.

Passing information with the START command

The START command has a number of options that enable information to be made available to the remote transaction when it is started. If the remote

transaction is in a CICS system, the information is obtained by using the RETRIEVE command. The information that can be specified is summarized in the following list:

- User data specified in the FROM option. This is the principal way in which data can be passed to the remote transaction.
- Additional user data maybe located by using the QUEUE option, which could (for example) identify a temporary storage queue.
- A terminal name—specified in the TERMID option. This is the name of a terminal that is to be associated with the remote transaction when it is initiated. If a terminal is defined in the system that owns the remote transaction but is not owned by that system, it is acquired by transaction routing. This is illustrated in Figure 7 on page 52.

In a CICS on System/390 system, the global user exits XICTENF and XALTENF can be coded to cover the case where the terminal is shippable but not defined in the application-owning system.

- The transaction name and terminal name to be used for replies—specified in the RTRANSID and RTERMID options. These options provide a means for the remote transaction to pass a reply to the local system. (That is, the TRANSID and TERMID specified by the remote transaction on its reply are the RTRANSID and RTERMID specified by the local transaction on the initial request.)

Passing an APPLID with the START command

If you have a transaction that can be started from several different systems, and that is required to issue a START command to the system that initiated it, you can arrange for each invoking transaction to send its local system APPLID as part of the user data in the START command. A transaction can obtain its local APPLID by using an ASSIGN APPLID command.

Improving performance of intersystem START requests

In some inquiry-only applications, sophisticated error-checking and recovery procedures may not be justified. When the transactions make inquiries only, the terminal operator can retry an operation if no reply is received within a specific time. In such a situation, the number of data flows to and from the remote system can be substantially reduced by using the NOCHECK option of the START command. When the connection between the two systems is through VTAM, this can result in considerably improved performance. The trade-off is between performance and sophisticated recovery procedures.

A typical use for the START NOCHECK command is in the remote inquiry application described in “Example” on page 62.

The transaction attached as a result of the terminal operator's inquiry issues an appropriate START command with the NOCHECK option, which causes a single message to be sent to the appropriate remote system to start, asynchronously, a transaction that makes the inquiry. The command should specify the operator's terminal identifier. The transaction attached to the operator's terminal can now terminate, leaving the terminal available for either receiving the answer or initiating another request.

The remote system performs the requested inquiry on its local database, then issues a start request for the originating system. This command passes back the requested data, together with the operator's terminal identifier. Again, only one message passes between the two systems. The transaction that is then started in the originating system must format the data and display it at the operator's terminal.

If a system or session fails, the terminal operator must reenter the inquiry, and be prepared to receive duplicate replies. To aid the operator, either a correlation field must be shipped with each request, or all replies must be self-describing.

An example of intercommunication using the NOCHECK option is given in Figure 10 on page 69.

The NOCHECK option is always required when shipping of the START command is queued pending the establishment of links with the remote system (see "Local queuing of START commands for remote transactions" on page 66).

Including start request delivery in a logical unit of work

The delivery of a start request to a remote system can be made part of a logical unit of work by specifying the PROTECT option on the START command. The PROTECT option indicates that the remote transaction must not be scheduled until the local one has successfully completed a synchronization point. (It can take the synchronization point either by issuing a SYNCPOINT command or by terminating.)

Successful completion of the syncpoint guarantees that the start request has been delivered to the remote system. It does not guarantee that the remote transaction has completed, or even that it will be initiated.

Deferred sending of START requests with NOCHECK option

For START commands with the NOCHECK option, CICS defers transmission of the request to the remote system.

START requests with NOCHECK are deferred until one of the following events occurs:

- The transaction issues a syncpoint.
- The transaction terminates with an implicit syncpoint.
- The transaction issues any other type of function shipping request—for example, a WRITE TS, or a START without the NOCHECK option.
- A sufficient number of START NOCHECK requests for the same remote system have accumulated on the local system to make transmission efficient.

There are exceptions to the above rules:

- In CICS on System/390 MRO intercommunication, START commands with NOCHECK are not deferred.
- In CICS on Open Systems, a START NOCHECK with the PROTECT option causes the buffer to be flushed.

The first, or only, start request transmitted from a transaction to a remote system carries the begin-bracket indicator; the last, or only, request carries the end-bracket indicator. Also, if any of the start requests issued by the transaction specifies PROTECT, the last request carries the syncpoint-request indicator. Deferred sending allows the indicators to be added to the deferred data, and thus reduces the number of transmissions required. The sequence of requests is transmitted within a single SNA bracket and all the requests are handled by the same mirror task.

Local queuing of START commands for remote transactions

When a local transaction is ready to ship a START command, the intersystem facilities may be unavailable, either because the remote system is not active or because a connection cannot be established. The normal CICS action in these circumstances is to raise the SYSIDERR condition. This can be avoided by using the NOCHECK option, and arranging for CICS to queue the request locally and forward it when the required link is in service.

If the required connection is out of service, CICS queues a START NOCHECK command for a remote transaction when two conditions are satisfied:

1. The SYSID option is not coded in the START command
2. The local definition of the transaction specifies LOCALQ(YES).

CICS on System/390 products support the XISLCLQ global user exit, which allows flexibility by enabling a user-written program to make a decision about local queueing, overriding the LOCALQ option.

Data retrieval by a started transaction

A CICS transaction that is started by a start request can get user data and other information associated with the request by using the RETRIEVE command.

In accordance with the normal rules for interval control, CICS queues a start request for a transaction that carries both user data and a terminal identifier if the transaction is already active and associated with the same terminal. During the waiting period, the data associated with the queued request can be accessed by the active transaction by using a further RETRIEVE command. Such an access automatically cancels the queued start request.

Thus, it is possible to design a transaction that can handle the data associated with multiple start requests. Typically, a long-running transaction could be designed to accept multiple inquiries from a terminal and ship start requests to a remote system. From time to time, the transaction could issue RETRIEVE commands to receive the replies, the absence of further replies being indicated by the ENDDATA condition.

The WAIT option of the RETRIEVE command can be used to put the transaction into a WAIT state pending the arrival of the next start request from the remote system. Overall application design should ensure that a transaction cannot get into a permanent wait state due to the absence of further start requests — for example, the transaction can be defined with a timeout interval. (Note that this option is not supported by CICS on Open Systems.)

Terminal acquisition by a remotely-initiated CICS transaction

When a CICS transaction is started by a start request that names a terminal (TERMID), CICS makes the terminal available to the transaction as its principal facility. It makes no difference whether the start request was issued by a user transaction in the local CICS system or was received from a remote system and issued by the mirror transaction.

Starting transactions

You can name a system, rather than a terminal, in the TERMID option of the START command.

If CICS finds that the “terminal” named in a start request is a system, it selects an available session to that system and makes it the principal facility of the started transaction. If no session is available, the request is queued until there is one.

System programming considerations

Resources must be defined for asynchronous processing, as briefly indicated below. Detailed information on how to define the resources is given in the resource definition guide for your CICS product.

- A link to a remote system must be defined.
- Remote transactions that are to be initiated by start requests must be defined as remote resources to the local CICS system. This is not necessary, however, for transactions that are initiated only by START commands that name the remote system explicitly in the SYSID option.
- If the QUEUE option is used, the additional user data located by that option must be accessible from the system to which the START command is shipped.
- In a START command, the RTRANSID option specifies a transaction identifier that can be retrieved by the started transaction and used in a subsequent START command. The transaction named by the RTRANSID option must be defined in the remote system.

For example, in Figure 9 on page 61, the START command in TRAN3 would include the options TRANSID(TRAN4) and RTRANSID(TRAN5). These options cause TRAN4 to be started, and indicate to TRAN4 that it in turn should start TRAN5. This is the intended use of the RTRANSID option; its actual use is application-dependent. TRAN5 must be defined to System B.

Asynchronous processing example (with NOCHECK)

Figure 10 on page 69 shows an example of asynchronous processing using the NOCHECK option of the START command.



Figure 10. Asynchronous processing—remote transaction initiation using NOCHECK

Chapter 11. Distributed transaction programming

When CICS arranges function shipping, asynchronous transaction processing, transaction routing, or distributed program link, it establishes a logical data link with a remote system. A data exchange between the two systems follows. CICS-supplied programs control this exchange, issuing commands to allocate conversations, and send and receive data between the systems.

CICS supplies equivalent commands to enable application programs to converse under their own control across intercommunication links. Using these commands, you can distribute the functions of a business transaction over several transaction programs within a network. This technique is called **distributed transaction programming (DTP)**.

DTP is the most flexible and the most powerful of the CICS intercommunication facilities, but it is also the most complex. This chapter introduces you to the basic concepts.

Why use distributed transaction programming?

Distributed transaction programming is needed because of the possible costs of other intercommunication functions (see “Limitations of function shipping”) and because of its own advantages (see “Advantages of distributed transaction programming” on page 73).

Limitations of function shipping

Function shipping gives you access to remote resources, and transaction routing lets a terminal communicate with remote transactions. From a functional point of view, these two facilities are probably sufficient for most intercommunication needs. However, design criteria go beyond pure function. Machine loading, response time, continuity of service, line traffic, and economic use of all resources are factors that affect transaction design.

The following two examples describe cases where function shipping is an obvious but not ideal solution.

Example 1

You are browsing a remote file to select a record that satisfies some criteria.

Solution 1: Use function shipping. CICS ships each GETNEXT request across the link, and the mirror reads the record and ships it back to the requester.

There are two network data flows per record; the data flow can be quite significant. For a browse on a large file, the overhead can be unacceptably high.

Solution 2: Use distributed program link. CICS links to a program that is running in the system that owns the file.

Solution 3: Use a DTP conversation. The local transaction sends the selection criteria. The remote transaction returns the keys and relevant fields from the selected records. This drastically reduces both the number of flows and the amount of data sent over the link.

Example 2

A supermarket chain has many branches, which are served by several distribution centers, each stocking a different range of goods. Local stock records at the branches are updated online from point-of-sale terminals. Sales information has to be sorted for the separate distribution centers, and transmitted to them to enable reordering and distribution.

Solution 1: Use function shipping to write each reorder record to a remote file as it arises. This method is simple, but has several drawbacks:

- Data is transmitted to the remote systems irregularly in small packets. This means inefficient use of busy links.
- The transactions associated with the point-of-sale devices are competing for sessions with the remote systems. This could mean unacceptable delays at point-of-sale.
- Failure of a link causes a catastrophic suspension of operations at a branch.
- Intensive intercommunications activity (for example, at peak periods) causes reduction in performance at the point-of-sales terminals.

Solution 2: Each sales transaction writes its reorder records to a transient data queue, and continues its conversation with the terminal.

Restocking requests are not urgent, so sorting and sending the data is delayed until an off-peak period. Alternatively, the transient data queue can be set to trigger the sender transaction when a predefined data level is reached. Either way, the sender transaction has the same job to do.

The sender transaction can use function shipping to transmit the reorder records. After the sort process, each record is written to a remote file in the relevant remote system.

This method is not ideal either. The sender transaction must wait after writing each record to make sure that it gets the right response. Apart from using the link inefficiently, waiting between records makes the whole process very slow.

Solution 3: Using distributed transaction programming, a transaction in the branch:

1. Sorts the reorder records and creates a file for each distribution center.
2. Sends each file to a partner transaction at the appropriate distribution center.

Each distribution center then processes the reorder records like any other local file. This solution is a much more efficient use of the link.

Advantages of distributed transaction programming

In a multisystem environment, data transfers between systems are necessary because end users need access to remote resources. In managing these resources, network resources are used. But performance suffers if the network is used excessively. There is, therefore, a performance gain if application design places the processing associated with a resource in the resource-owning region.

DTP (like asynchronous processing and distributed program link) lets you process data at the point where it arises, instead of overworking network resources by assembling it at a central processing point. However, DTP is much more flexible than either asynchronous processing or DPL. For example, it:

- Enables synchronous communication and data transfer between applications running on different systems.
- Can provide a common interface to transactions owned by different systems.
- Allows some measure of parallel processing to shorten response times.
- Provides a buffer between a security-sensitive file or database and applications, so that no application need know the format of the file records.
- Enables batching of less urgent data destined for a remote system.

Conversations

In DTP, transactions pass data to each other directly. While one sends, the other receives. The exchange of data between two transactions is called a **conversation**. Although several transactions can be involved in a single distributed process, communication between them breaks down into a number of self-contained conversations between pairs. Each such conversation uses a CICS resource known as a **session**.

Conversation initiation and transaction hierarchy

A transaction starts a conversation by requesting the use of a session to a remote system. Having obtained the session, it causes an *attach* request to be sent to the other system to activate the transaction that is to be the conversation partner.

A transaction can initiate any number of other transactions, and hence, conversations. In a complex process, a distinct hierarchy emerges, with the terminal-initiated transaction at the very top. Figure 11 on page 75 shows a possible configuration. Transaction TRAA is attached over the terminal session. Transaction TRAA attaches transaction TRBB, which, in turn, attaches transactions TRCC and TRDD. Both these transactions attach the same transaction, SUBR, in system CICSE. This gives rise to two different tasks running SUBR.

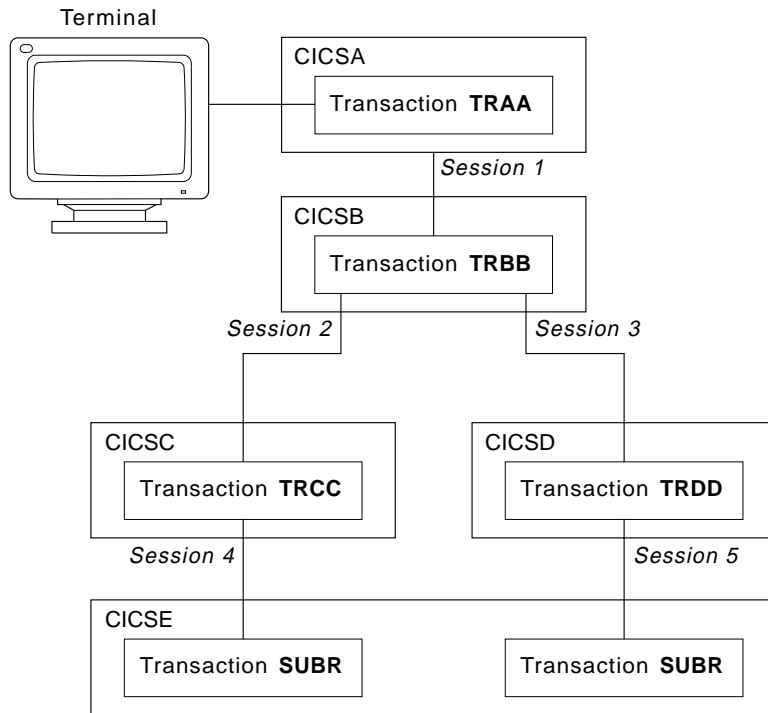

Figure 11. DTP in a multisystem configuration

Structure of a distributed process

The structure of a distributed process is determined dynamically; it cannot be specified beforehand in transaction definitions. For each transaction, there is only one inbound attach request, but there can be any number of outbound attach requests. The session that activates a transaction is called its **principal facility**. A session that is allocated by one transaction to activate another transaction is called the **alternate facility** of the allocating transaction. In Figure 11, session 1 is the principal facility of transaction TRBB and an alternate facility of transaction TRAA. A transaction has only one principal facility, but can have any number of alternate facilities. Transaction TRBB has two alternate facilities, sessions 2 and 3.

When a transaction initiates a conversation, it is the **front end** on that conversation. Its conversation partner is the **back end** on the same conversation. In Figure 11, transaction TRBB is the front end of the conversations on sessions 2 and 3, and the back end of the conversation on session 1. (Some publications refer to the front end as the initiator and the back end as the recipient.) It is normally the front end that dominates, and determines the way the conversation goes. You can arrange for the back end

to take over if you want, but, in a complex process, this can cause unnecessary complication. This is further explained in the discussion on synchronization later in this chapter.

Application design

DTP has none of the transparency of function shipping or transaction routing. A conversation transfers data from one transaction to another. For this to function properly, each transaction must know what the other intends. It is therefore necessary to design, code, and test front end and back end as one software unit. The same applies when there are several conversations and several transaction programs. Each new conversation adds to the complexity of the overall design.

In “Example 2” on page 72, the DTP solution (Solution 3) is to transfer a file of data from one transaction to another—in this case, transmit the entire contents of the transient data queue from the front end to the back end. The next stage of complexity is to cause the back end to return data to the front end, perhaps the result of some processing. Here, the front end is programmed to request conversation turnaround at the appropriate point.

Control flows

During a conversation, data passes over the link in both directions. A single transmission is called a **flow**. Issuing a SEND command does not always cause a flow. This is because the transmission of user data can be deferred; that is, held in a buffer until some event takes place. The APPC architecture defines data formats and packaging. CICS handles these things for you, and they concern you only if you need to trace flows for debugging.

The APPC architecture defines a data header for each transmission, which holds information about the purpose and structure of the data following. The header also contains bit indicators to convey control information to the other side. For example, if one side wants to tell the other that it can start sending, CICS sets a bit in the header that signals a change of direction in the conversation.

To keep flows to a minimum, non-urgent control indicators are accumulated until it is necessary to send user data. Then they are added to the header.

In complex procedures, such as establishing syncpoints, it is often necessary to send control indicators when there is no user data available to send. This is called a **control flow**.

Conversation state and error detection

As a conversation progresses, it moves from one state to another within both conversing transactions. The conversation state determines the commands that may be issued. For example, it is no use trying to send or receive data if there is no session linking the front end to the back end. Similarly, if the back end signals end of conversation, the front end cannot be in a state to receive more data.

Either end of the conversation can cause a change of state, usually by issuing a particular command from a particular state. CICS tracks these changes, and stops a transaction from issuing a command that is wrong for its current state.

Synchronization

Many things can go wrong during the running of a transaction. The conversation protocol helps you to recover from errors and ensures that the two sides remain in step with each other. This use of the protocol is called **synchronization**.

Synchronization allows you to protect resources such as transient data queues and files. Whatever goes wrong during the running of a transaction should not leave the associated resources in an inconsistent state.

Example

A transaction is transmitting a queue of data to another system to be written to a file. The receiving transaction is abended.

Even if a further abend can be prevented, there is the problem of how to continue the process without loss of data. It is uncertain how many queue items have been received and how many have been correctly written to the file. The only safe way of continuing is to go back to a point where you know that the contents of the queue are consistent with the contents of the file. The sending system must restore the queue entries that have been sent, and the receiving system must delete any entries made in the file. CICS helps you to do this (see “Taking syncpoints” on page 78).

Rollback and backout

The cancellation by an application program of all changes to recoverable resources since the last known consistent state is called **rollback**. The physical process of recovering resources is called **backout**. For the most part, the two terms are used interchangeably. The condition that exists as long as there is no loss of consistency between distributed data resources is called **data integrity**.

Application-initiated rollback: There are cases where you want to recover resources, even though there are no error conditions detectable by CICS. Consider an order entry system. While entering an order for a customer, an operator is told by the system that the customer's credit limit would be exceeded if the order went through. Because there is no use continuing until the customer is consulted, the operator presses a PF key to abandon the order. The transaction can be programmed to respond by restoring the data resources to the state they were in at the start of the order. At synchronization level 2 (see "Synchronization levels" on page 7), rollback occurs automatically in all remote partner transactions.

Taking syncpoints

If you log your own data movements, you can arrange backout of your files and queues. However, this involves very complex programming. To save you the trouble, CICS arranges resource recovery for you.

A point in the process where resources are declared to be in a known consistent state is called a **synchronization point**, often shortened to **syncpoint**. Synchronization points are implied at the beginning and end of a transaction. A transaction can define other syncpoints by program command. All processing between two syncpoints belongs to a **unit of work** (UOW).

Taking a syncpoint, if successful, **commits** all changes to recoverable resources. This means that all systems involved in a distributed process erase all the information they have been keeping about data movements on recoverable resources. Now backout is no longer possible, and all changes to the resources since the last syncpoint are made irreversible.

An unsuccessful syncpoint causes rollback. Recoverable resources are restored to their state at the start of the UOW.

CICS can commit and back out changes to resources, but the service has a performance trade-off. Some transactions do not need such facilities. If the recovery of resources is not a problem, use simpler methods of synchronization.

The three synchronization levels

The APPC architecture defines three levels of synchronization:

Level 0 – NONE

Level 1 – CONFIRM

Level 2 – SYNCPOINT

At synchronization level 0, there is no system support for synchronization. It is nevertheless possible to achieve some degree of synchronization through the interchange of data, using the SEND and RECEIVE commands.

If you select synchronization level 1, you can use specific commands for communication between the two conversation partners. One transaction can *confirm* the continued presence and readiness of the other. The user is responsible for preserving the data integrity of recoverable resources.

The level of synchronization described earlier in this section corresponds to synchronization level 2. Here, system support is available for maintaining the data integrity of recoverable resources.

CICS implies a syncpoint when it starts a transaction; that is, it initiates logging of changes to recoverable resources, but no control flows take place. CICS takes a full syncpoint when a transaction is normally terminated. Transaction abend causes rollback. The transactions themselves can initiate syncpoint or rollback requests. However, a syncpoint or rollback request is propagated to another transaction only when the originating transaction is in conversation with the other transaction, and synchronization level 2 has been selected for the conversation between them.

Remember that syncpoint and rollback are not peculiar to any one conversation within a transaction. They are propagated on every current synchronization level 2 conversation within the transaction.

A transaction specifies the required synchronization level in the CONNECT PROCESS command that initiates a conversation. The requested level must not be higher than that supported between the two products. Support for the different synchronization levels varies between products. Refer to “CICS product communication support” on page 8.

EXEC CICS or CPI Communications?

Some CICS products give you a choice of two application programming interfaces (APIs) for coding your DTP conversations on APPC sessions. The first, the **CICS API**, is the end-user interface of the CICS implementation of the APPC architecture. It consists of EXEC CICS commands and can be used with all CICS-supported languages. The second, **Common Programming Interface for Communications** (CPI Communications) is the communications interface defined by Systems Application Architecture (SAA). It consists of a set of defined verbs, in the form of program calls, which are adapted for the language being used.

Table 14 compares the two methods to help you to decide which API to use for a particular application.

Table 14. CICS API compared with CPI Communications

CICS API	CPI Communications
Portability between different members of the CICS family.	Portability between systems that support SAA.
Synchronization levels 0, 1, and 2 supported.	Synchronization levels 0, 1, and 2 supported, <i>except for transaction routing, for which only synchronization levels 0 and 1 are supported.</i>
Program initialization parameter (PIP) data supported (CICS on System/390 and CICS on Open Systems only).	PIP data not supported.
Only a few conversation characteristics are programmable. The rest are defined by resource definition.	Most conversation characteristics can be changed dynamically by the transaction program.
Can be used on the principal facility to a transaction started by ATI.	Cannot be used on the principal facility to a transaction started by ATI.
Mapped conversations (see note 3) can be programmed in any of the languages supported by CICS.	Mapped conversations can be programmed in any of the languages supported by CICS.
Basic conversations (see note 3) can be programmed only in assembler language or C, and only on a CICS on System/390 system.	Basic conversations can be programmed in any of the languages supported by CICS, but only on a CICS on System/390 system.

Additional notes on the two APIs

1. You can mix CPI Communications calls and EXEC CICS commands in the same transaction, but not on the same side of the same conversation. ***In other words, each half-session can use only one application interface.***
2. One partner in a conversation can use CPI Communications calls while the other uses the CICS API. ***In other words, the half-sessions at either end of the same conversation can use different application interfaces.***
To correctly coordinate a conversation that is using a different API in each half-session, the programmers must know the details of how both APIs map to the APPC architecture.
3. Both interfaces, CICS API and CPI Communications, support APPC **mapped conversations**, in which the systems provide and interpret protocol headers, and the application programs deal only with user data. In an APPC **basic conversation**, the sending application must prefix the data with the header required by the communications protocol. The receiving application must interpret this header.

- 4. CICS/VSE, CICS on Open Systems, and IBM Transaction Server for Windows NT Version 4 do not support the CPI Communications API. CICS Transaction Server for VSE/ESA does support the CPI Communications API.

Part 3. Appendixes

Bibliography

CICS books

CICS Clients: Administration, SC3-1436
CICS Family: Client/Server Programming, SC33-1435
CICS Family: Using IBM Communications Server for AIX with CICS, SC33-1898
CICS Family: Using IBM Communications Server for Windows NT with CICS, SC33-1898
CICS Family: Using Microsoft SNA Server V2 with CICS, SC33-1899
CICS Family: Using Microsoft SNA Server V3 with CICS, SC33-1715
CICS Family: Communicating from CICS on System/390, SC33-1697
CICS Intercommunication Guide, SC33-1695
CICS/VSE Intercommunication Guide, SC33-0701
CICS for OS/2 Intercommunication, SC33-1583
CICS for Windows NT Version 2 Intercommunication, SC33-1423
IBM Transaction Server for Windows NT Version 4 Intercommunication Guide, SC33-1882
CICS on Open Systems Intercommunication Guide, SC33-1564
CICS/400 Intercommunication, SC33-1388

SNA books

Systems Network Architecture Technical Overview, GC30-3073
Systems Network Architecture Transaction Programmer's Reference Manual for LU Type 6.2, GC30-3084

Systems Network Architecture--Sessions Between Logical Units, GC20-1868

Systems Network Architecture Format and Protocol Reference Manual: Architecture Logic for LU Type 6.2, SC30-3269

Systems Network Architecture LU 6.2 Reference--Peer Protocols, SC31-6808

VTAM books

VTAM Resource Definition Reference Version 4 Release 2 for MVS/ESA, VM/ESA, and VSE/ESA, SC31-6498

VTAM Resource Definition Samples Version 4 Release 2 for MVS/ESA, VM/ESA, and VSE/ESA, SC31-6499

Communications Manager/2 books

IBM Communications Manager/2 Version 1.1 User's Guide, SC31-6108

IBM Communications Manager/2 Version 1.1 Scenarios, SC31-6174

IBM Communications Manager/2 Version 1.1 Host Connection Reference, SC31-6170

Communication Server for AIX books

AIX SNA Server/6000: User's Guide, SC31-7002

AIX SNA Server/6000: Configuration Reference, SC31-7014

AIX SNA Server/6000: Command Reference, SC31-7100

AIX SNA Server/6000: Diagnosis Guide and Messages, SC31-7101

Multi-platform connectivity books

Multi-platform APPC Configuration Guide,
SV40-0089

*CICS Cross Platform Intersystem
Communications Sample Definitions,*
GG24-4320

CICS Clients Unmasked, GG24-2534

Notices

This information was developed for products and services offered in the U.S.A. IBM may not offer the products, services, or features discussed in this document in other countries. Consult your local IBM representative for information on the products and services currently available in your area. Any reference to an IBM product, program, or service is not intended to state or imply that only that IBM product, program, or service may be used. Any functionally equivalent product, program, or service that does not infringe any IBM intellectual property right may be used instead. However, it is the user's responsibility to evaluate and verify the operation of any non-IBM product, program, or service.

IBM may have patents or pending patent applications covering subject matter described in this document. The furnishing of this document does not give you any license to these patents. You can send license inquiries, in writing, to:

IBM Director of Licensing
IBM Corporation
North Castle Drive
Armonk, NY 10504-1785
U.S.A.

For license inquiries regarding double-byte (DBCS) information, contact the IBM Intellectual Property Department in your country or send inquiries, in writing, to:

IBM World Trade Asia Corporation
Licensing
2-31 Roppongi 3-chome, Minato-ku
Tokyo 106, Japan

The following paragraph does not apply in the United Kingdom or any other country where such provisions are inconsistent with local law:
INTERNATIONAL BUSINESS MACHINES CORPORATION PROVIDES THIS PUBLICATION "AS IS" WITHOUT WARRANTY OF ANY KIND, EITHER EXPRESS OR IMPLIED, INCLUDING, BUT NOT LIMITED TO, THE IMPLIED WARRANTIES OF NON-INFRINGEMENT, MERCHANTABILITY, OR FITNESS FOR A PARTICULAR PURPOSE. Some states do not allow disclaimer of express or implied warranties in certain transactions, therefore this statement may not apply to you.

This publication could include technical inaccuracies or typographical errors. Changes are periodically made to the information herein; these changes will be incorporated in new editions of the publication. IBM may make improvements and/or changes in the product(s) and/or the program(s) described in this publication at any time without notice.

Licensees of this program who wish to have information about it for the purpose of enabling: (i) the exchange of information between independently created programs and other programs (including this one) and (ii) the mutual use of the information which has been exchanged, should contact IBM United Kingdom Laboratories, MP151, Hursley Park, Winchester, Hampshire, England, SO21 2JN. Such information may be available, subject to appropriate terms and conditions, including in some cases, payment of a fee.

The licensed program described in this document and all licensed material available for it are provided by IBM under terms of the IBM Customer Agreement, IBM International Programming License Agreement, or any equivalent agreement between us.

Trademarks

The following terms are trademarks of International Business Machines Corporation in the United States, or other countries, or both:

400	CICS/VSE	Operating System/400
AIX	DB2	Presentation Manager
AS/400	IBM	RACF
AnyNet	IBMLink	RISC System/6000
Application System/400	IMS	SQL/DS
CICS	IMS/ESA	SupportPac
CICS OS/2	MVS/ESA	System/370
CICS/400	OS/2	System/390
CICS/6000	OS/390	VSE/ESA
CICS/ESA	OS/400	VTAM
CICS/MVS	Operating System/2	

Other company, product, and service names may be trademarks or service marks of others.

Glossary

This glossary gives the meanings of terms as they are used in this book. In a definition, a word printed in italics is itself defined in a separate entry.

A

Advanced Program-to-Program Communications (APPC). An implementation of the *SNA LU6.2* protocol that allows programs to intercommunicate.

alternate facility. A session that is obtained by a transaction by means of an *ALLOCATE* command. Contrast with *principal facility*.

API. *Application programming interface.*

APPC. *Advanced Program-to-Program Communications.*

application. A particular use to which an information processing system is put. For example, a payroll application, an airline reservation application, a network application.

application program. A program written for or by a user that applies to the user's work, such as inventory control or payroll. An application program can be all or part of the implementation of an *application*.

application programming interface (API). In CICS, the command-level programming interface supported by CICS for user application programs. The formally-defined programming language interface between an IBM system control program or a licensed program and the user of the program.

ASCII. American National Standard for Information Interchange.

asynchronous processing. A series of operations done separately from the *task* in which they were requested. For example a print job requested by

a *transaction*. Contrast with *synchronous processing*. In CICS, an intercommunication function that allows a *transaction* executing on one CICS system to start a *transaction* on another system. The two *transactions* execute independently of each other. Contrast with *distributed transaction programming*.

B

back end. In a *conversation* between two *transactions*, the participating *transaction* that did not initiate the conversation.

backout. The physical process of recovering a resource by canceling changes made since its last known consistent state. The order of removing the changes is the reverse of the order in which they were made. See also *dynamic transaction backout*.

C

CI. Communications Interface.

CICS clients. A family of CICS products that provide a standard set of functions for *client/server* computing. Each CICS client is designed to run on a particular operating system. Each can attach to a range of CICS *server* systems, and provides access to resources owned by the servers. See *External Call Interface* and *External Presentation Interface*.

client. See *client/server* and *CICS clients*.

client/server. A distributed application design model in which the front-end transaction (the one that initiates the conversation) is called the client and controls the course of the conversation. The server receives a request from the client, processes it, and returns the results

commit. A process in which a *transaction* confirms (makes irreversible) all changes to recoverable resources since the last *syncpoint*.

commitment control. A data management function that commits or backs out *resource* updates when a *transaction* completes or fails respectively.

Common Programming Interface (CPI). An SAA standard that specifies the languages, commands, and calls that can be used in an *SAA application program*.

Communications Interface (CI). Part of the *SAA CPI* that specifies interfaces, conventions, and protocols for *SAA* communications programming.

Communications Manager. An intercommunications component of the *OS/2* operating system. CICS for *OS/2* uses Communications manager for intercommunications with CICS family systems outside the LAN.

connection. In CICS, the definition of a remote system. A connection definition is necessary for each remote system with which CICS wishes to communicate. Each CICS session definition identifies a remote system by naming a connection definition. In SNA, the network path that links together logical units to enable communications.

conversation. In distributed transaction processing, a sequence of exchanges over a session, delimited by SNA brackets. A dialog between two programs in which each program alternately sends and receives data. A dialog between CICS and a terminal user in which CICS alternately accepts input and responds.

cooperative processing. A subset of *distributed processing*, in which at least the user interface (presentation) aspect of the application runs on a programmable workstation.

CPI. Common Programming Interface.

D

database. A collection of interrelated or independent data items stored together without unnecessary redundancy, to serve one or more *applications*. See *hierarchical database* and *relational database*.

Database Control (DBCTL). An IMS/ESA facility providing an interface between CICS/ESA and IMS/ESA that allows access to IMS *DL/I* full function *databases* and to data entry *databases* (DEDBs) from one or more CICS/ESA systems.

data integrity. The state of a data resource that exists as long as there is no loss of consistency between it and other logically-related data resources.

DBM. Data Base Manager. A relational database manager that is a component of *OS/2 EE*.

distributed processing. The processing of different parts of the same application in different systems, on one or more processors.

distributed program link (DPL). A form of *function shipping* that allows a CICS *application program* to call a server program in a connected CICS system, and to pass and receive data in a communications area. For example, it allows CICS for *OS/2 applications* to access *DL/I* and *DB2® databases* on a CICS/ESA system.

distributed transaction programming. A technique for splitting an *application* so that different parts are processed in different *transaction processing* systems. In CICS, an intercommunication function that allows a *transaction* executing on one CICS system to communicate with *transactions* executing on other systems. The *transactions* are designed and coded specifically to communicate with each other.

DL/I. The programming language for accessing the IBM hierarchical databases, *IMS* and *DOS DL/I*. The term "DL/I database" is often used, as in the preceding definition, to denote both types of hierarchical database.

DOS DL/I. An IBM licensed program that runs under VSE/ESA. DOS DL/I is a database management and data communication system capable of managing complex *databases* and terminal networks.

DPL. Distributed program link.

DTP. Distributed transaction programming.

dynamic transaction backout. The process of canceling changes made to stored data by a *transaction* following the failure of that *transaction*.

E

EBCDIC. Extended Binary-Coded Decimal Interchange Code.

ECI. External Call Interface.

EPI. External Presentation Interface.

extended recovery facility (XRF). A set of IBM-supplied programs that improve the availability of a system by controlling the provision of a backup system by duplication of hardware or software components.

External Call Interface. An *application programming interface* that allows a non-CICS program running on a *CICS client* to call a CICS program located on a *CICS server*, and to pass and retrieve data from it.

External Presentation Interface. An *application programming interface* that allows a non-CICS program running on a *CICS client* to appear to a *CICS server* as one or more standard 3270 terminals.

F

front end. In a conversation, the participating *transaction* that initiated the conversation.

function shipping. An intercommunication function that allows *application programs* in one CICS system to access *resources* owned by

another CICS system. Contrast with *transaction routing*, *distributed transaction programming*.

H

half-session. That part of a *session* for which one *partner* is responsible.

hierarchical database. A *database* whose physical organization consists of a single master file and one or more linked files which are subordinate to it. The master file is often referred to as the parent file or root file, and the subordinate files as child files. Data in a child file can only be accessed by first locating a record in the master file, and then locating child records which are linked to it. Contrast with *relational database*.

I

IMS. Information Management System.

Information Management System (IMS). An IBM licensed program. IMS/ESA runs under MVS/ESA. IMS is a *database* management and data communication system capable of managing complex *databases* and terminal networks. IMS/ESA consists of two products, IMS/ESA TM and IMS/ESA DB, which can run together or independently.

integrity. The quality of a data *resource* that exists if accidental or deliberate destruction, alteration, loss of consistency, or loss of data are prevented.

IPX. Internetwork Packet eXchange.

L

LAN. Local area network.

LAN server. A *workstation* or other system that is connected to a *LAN* and that provides access to data (a “file server”) or interconnection to a *WAN* (a “communications server”) on behalf of all workstations in the *LAN*. A *LAN server* is

typically a PS/2 Model 80 or 90, and often combines the functions of file server and communications server.

local area network (LAN). A data network used for direct data communication between data stations physically close to each other, usually all located in a single building. Compare *wide area network (WAN)*.

local system. In CICS intercommunication, the CICS system from whose point of view communication is being discussed.

lock. A serialization mechanism by means of which a *resource* is restricted for use by the holder of the lock.

logical unit. In SNA, a port through which a user gains access to the services of a network. Data is transmitted from one logical unit (LU) to another LU. A terminal can be an LU; a CICS or *IMS* system can be an LU.

LUs are divided into types, depending on their data stream. The following LU types have been defined:

- LU Type 0. This is used for *application*—application communication with 3790 and 8100 systems.
- LU Type 1. This is used for communicating with printers, printer keyboards, and remote files.
- LU Type 2. This is used for communicating with 3270 displays.
- LU Type 3. This is a slight extension of LU Type 2 used for sending data to 3270 printers.
- LU Type 4. This is used for communicating with office systems terminals.
- LU Type 6. This is used for processor-to-processor communication. See *LU6.2*.

LU. Logical unit.

LU6.2. An *SNA* protocol for communication between processors. LU6.2 defines a number of IBM-provided processes that are used in CICS intersystem communication.

M

Multiple Virtual Storage/Enterprise Systems Architecture (MVS/ESA). The latest version of the MVS operating system. MVS/ESA™ exploits the latest System/390 and System/370 hardware, including expanded storage.

MVS/ESA. Multiple Virtual Storage/Enterprise Systems Architecture.

N

NCP. Network Control Program.

NetBIOS. A communication *protocol* used in client/server links to a CICS for OS/2 or CICS for Windows NT system, and also in peer-to-peer links between CICS for OS/2 and CICS for Windows NT systems.

network. A configuration of data processing devices and software connected for information interchange.

Network Basic Input/Output System. See *NetBIOS*.

Network Control Program (NCP). An IBM licensed program that provides communication controller support for single-domain, multiple-domain, and interconnected *network* capabilities.

O

open system. A system with specified standards that can be readily connected to other systems that comply with the same standards.

Open Systems Interconnection (OSI). The interconnection of *open systems* in accordance with specific standards of the International Organization for Standardization (ISO).

Operating System/Virtual Storage (OS/VS). A family of operating systems that have controlled System/360, System/370, and System/390

computing systems. Overtime, OS/VS have included VS1, VS2, MVS/370, MVS/XA, and MVS/ESA.

Operating System/2® (OS/2). An operating system for IBM Personal System/2 (PS/2) and IBM-compatible personal computers.

Operating System/400® (OS/400). An operating system for the IBM Application System/400® (AS/400) machines. OS/400 includes integrated *transaction processing* facilities.

OSI. *Open Systems Interconnection*

OS/2. *Operating System/2.*

OS/2 EE Data Base Manager (DBM). A relational database manager that is a component of OS/2 EE.

OS/400. *Operating System/400*

P

partner. In distributed processing, it is any one of the separate communicating parts of an application. In CICS intercommunication, it is the transaction in the remote system with which the transaction in the local system is communicating.

PIP. Program initialization parameters.

principal facility. To a *transaction*, the session that activates it.

program initialization parameters. In CICS *distributed transaction programming*, specially formatted data passed to a back-end transaction on the CONNECT PROCESS command.

protocol. In SNA, the meanings of, and the sequencing rules for, requests and responses used for managing a network, transferring data, and synchronizing the states of network components. A set of semantic and syntax rules that determine the behavior of functional units in achieving communications.

pseudoconversation. A CICS *application* that is designed to appear to the user as a continuous *conversation*, but that consists internally of multiple *tasks*.

R

RACF®. *Resource Access Control Facility.*

recoverability. The attribute of a *resource* that exists if its *integrity* can be restored after a *transaction* or system failure that occurs while the *resource* is being updated.

recoverable resource. A *resource* with the attribute of *recoverability*.

relational database. A database whose physical organization consists of a collection of files. Relationships between these files are specified only by the use of data values that appear in two or more files. To optimize processing, the files in a relational database should be normalized, that is, each record should contain only a key field and a number of secondary fields that are directly related to the key field. Contrast with *hierarchical database*.

remote resource. In CICS intercommunication, a *resource* that is owned by a *remote system*.

remote system. In CICS intercommunication, a system that the *local system* accesses via intersystem connections.

resource. Any facility of a computing system required by a job or *task* and including main storage, input/output devices, processors, data sets, *databases*, application programs, and control or processing programs. As used in this book, the term usually refers to data sets and *databases*.

Resource Access Control Facility (RACF). An IBM licensed program that provides for access control by identifying and verifying the users to the system, authorizing access to protected *resources*, logging any detected unauthorized attempts to enter the system, and logging the detected accesses to protected *resources*.

rollback. The cancelation by a *transaction* of all changes it has made to recoverable resources since the last *syncpoint*. The process applied to each resource is called *backout*.

routing transaction. A CICS-supplied *transaction* (CRTE) that enables an operator at a terminal owned by one CICS system to sign on to another CICS system that is connected to the first.

S

SAA. *Systems Application Architecture.*

server. The member of the *client/server* partnership that executes the request and returns the results to the client.

session. In SNA, a logical connection between two network-addressable units that can be activated and deactivated as requested. In CICS intersystem, a resource that is used by the transaction to communicate with its partner.

shippable terminal . A terminal whose definition can be shipped to another CICS system as and when the other system requires a remote definition of that terminal.

SNA. Systems Network Architecture.

SNA Server. An intercommunications component of the Windows NT operating system. CICS for Windows NT uses the SNA Server for intercommunication with CICS family systems outside the LAN.

SQL/DS™. Structured Query Language/Data System.

Structured Query Language/Data System (SQL/DS). An IBM licensed program for using a *database* in an interactive or batch environment.

synchronization point. In the processing of a *transaction*, a point at which resources are declared to be in a consistent state.

synchronous processing. A series of operations performed as part of the application in which they are requested. For example, *function*

shipping, distributed transaction programming. Compare with *asynchronous processing.*

syncpoint. Abbreviation of *synchronization point.*

Systems Application Architecture (SAA). A set of common standards and procedures for working with IBM systems and data.

Systems Network Architecture (SNA). A description of a logical structure, formats, protocols, and operational sequences for transmitting information units through a network, and for controlling the configuration and operation of the network.

T

task. The basic unit of work to be done by a computer. For example, a single execution of a *transaction*.

TCP/IP. *Transmission Control Protocol/Internet Protocol (TCP/IP).*

transaction. A unit of processing (consisting of one or more *application programs*) initiated by a single request, often from a terminal. A *transaction* may require the initiation of one or more *tasks* for its execution.

A user *transaction* is the processing of a single logical entity in an *application*, for example, an order in an order entry system. A user *transaction* can correspond to one or more system *transactions* as defined in the first paragraph. For example, a *pseudo-conversation* comprises one user *transaction* and several system *transactions*.

transaction processing. A style of computing that supports interactive *applications* in which requests submitted by terminal users are processed as soon as they are received. Results are returned to the requester in a relatively short period of time. A *transaction* processing system supervises the sharing of *resources* for processing multiple *transactions* at the same time.

transaction routing. A type of CICS intercommunication in which terminal operators

of a CICS system can run *transactions* in any connected CICS system. Contrast with *function shipping*.

Transmission Control Protocol (TCP). A full duplex (OSI transport level) *protocol*, widely used for program-to-program communications.

Transmission Control Protocol/Internet Protocol (TCP/IP). A set of communication *protocols* that include conventions for interconnecting *networks* based on different hardware technologies.

two-phase commit. A *protocol* for the coordination of *commitment control* when more than one *resource manager* is used by a single *transaction*. Within a single *transaction processing system*, the system can provide two-phase commit. When communicating *transactions* in different systems update their respective data *resources*, the network protocols must support two-phase commit.

U

unit of work (UOW). A sequence of processing actions (*database changes* for example) that must be completed before any of the individual actions can be regarded as *committed*. When changes are *committed* (by successful completion of the UOW and recording of the *syncpoint* on the system log), they do not need to be backed out after a subsequent failure of the *task* or system. The end of a UOW is marked in a *transaction* by a *syncpoint*—issued either by the user program or by the system at the end of *task*. In the absence of user *syncpoints*, the entire *transaction* is a UOW.

In simple terms, a UOW is the processing done by a *transaction* between two *syncpoints*.

UOW. Unit of work.

V

Virtual Storage Extended/Enterprise Systems Architecture (VSE/ESA). An operating environment for commercial processing. VSE/ESA is primarily the operating system for IBM mid-range processors. It offers a

pregenerated system that can be tailored to meet particular business needs.

Virtual Telecommunications Access Method (VTAM). A set of programs that maintain control of the communication between terminals and *applications* running under an operating system.

VM. Virtual Machine operating system.

VSAM. Virtual Storage Access Method.

VSE/ESA. Virtual Storage Extended/Enterprise Systems Architecture.

VTAM. Virtual Telecommunications Access Method.

W

WAN. Wide area network.

wide area network (WAN). A network that provides communication services to a geographic area larger than that served by a *local area network (LAN)*.

Windows NT. An operating system from Intel Corp. for IBM-compatible personal computers.

workstation. A personal computer or intelligent terminal with some local processing capabilities.

X

XRF. Extended Recovery Facility.

Index

A

- allocating APPC terminal or connection 49
- alternate facility 75
- American National Standard Code for Information Interchange (ASCII) 20
- APIs 79
- APPC, communication protocol 6
- APPC terminals, transaction routing 49
- application design, DTP 76
- application programming interfaces 79
- APPLID passed with START command 64
- ASCII 20
- asynchronous processing 61, 69
 - compared with synchronous processing (DTP) 61
 - initiated by DTP 62
 - initiating asynchronous processing 62
 - START/RETRIEVE interface 63, 68
 - "terminal" is a system 67
 - canceling remote transactions 63
 - information passed with START command 63
 - information retrieval 67
 - local queuing of START requests 66
 - NOCHECK option, START command 64
 - performance improvement 64
 - PROTECT option, START command 65
 - RETRIEVE command 67
 - starting remote transactions 63
 - terminal acquisition 67
 - system programming considerations 68
 - typical application 62
- ATI (automatic transaction initiation) 51

- ATI (automatic transaction initiation) 55 (*continued*)
 - restricted by CRTE routing transaction 55
 - with transaction routing 51

B

- back end 75
- backout 77
- basic conversation 80
- basic mapping support (BMS), transaction routing 48, 54

C

- CANCEL command 63
- CEMT master terminal transaction, invoked by CRTE 55
- choosing an intercommunication function 37
- CICS clients
 - CICS on Open Systems servers supported 17
 - for AIX 6000 17
 - for Digital UNIX 17
 - for DOS 15
 - for HP 9000 17
 - for HP-UX 17
 - for Macintosh 15
 - for Microsoft Windows 15
 - for OS/2 15
 - for Sun Systems 17
 - functions provided
 - External Call Interface 13
 - External Presentation Interface 14
 - Terminal Emulation 14
 - workstation servers supported 15
- CICS for OS/2 dynamic transaction routing 50
- CICS for Windows NT dynamic transaction routing 50
- CICS on System/390 dynamic transaction routing 49
- client/server computing 13
- clients, CICS
 - CICS on Open Systems servers supported 17
 - for AIX 6000 17
 - for Digital UNIX 17

- clients, CICS (*continued*)
 - for DOS 17
 - for HP 9000 17
 - for HP-UX 17
 - for Macintosh 15
 - for Microsoft Windows 15
 - for OS/2 15
 - for Sun Systems 17
 - functions provided
 - External Call Interface 13
 - External Presentation Interface 14
 - Terminal Emulation 14
 - overview 13
 - workstation servers supported 15
- code pages 20
- committing changes to resources 78
- communication functions
 - functions listed 5
 - product support for 5, 13
- communication protocols
 - APPC 6
 - IPX 6
 - LU6.2 6
 - NetBIOS 6
 - TCP/IP 6
- configuring CICS for SNA 23
- control flows 76
- conversation 74, 79
 - alternate facility 75
 - back end 75
 - basic 80
 - control flows 76
 - data header 76
 - error detection 77
 - front end 75
- Conversation
 - initiation 74
- conversation
 - principal facility 75
 - session 74
 - state 77
 - synchronization 77, 79
- CPI Communications 79
- CRTE transaction 54

D

- data conversion 19, 23
 - ASCII 20

- data conversion 20, 23 (*continued*)
 - character data 20, 23
 - code pages 20
 - EBCDIC 20
 - numeric data 19
- data header, APPC architecture 76
- data integrity 6, 77
- DBCS, double-byte character set 20
- deferred sending, START
 - NOCHECK 65
- distributed program link 37, 57, 59
- distributed transaction
 - programming 37
- DL/I databases
 - accessed by DPL 58
 - accessed by function shipping 41
- double-byte character set (DBCS) 20
- DPL (distributed program link) 57, 59
- DTP (distributed transaction programming) 71, 83
 - advantages of 73
 - application design 76
 - compared with asynchronous processing 61
 - conversation 74, 79
 - synchronization 77, 79
 - why it is needed 71
- dynamic transaction routing 49, 50
- E**
 - EBCDIC 20
 - ECI (External Call Interface) 13
 - EPI (External Presentation Interface) 14
 - error detection, conversation 77
 - examples
 - ATI 52
 - function shipping 46
 - EXEC CICS, API 79
 - exits, user
 - XALTENF 64
 - XICTENF 64
 - Extended Binary-Coded Decimal Interchange Code (EBCDIC) 20
 - External Call Interface (ECI) 13
 - External Presentation Interface (EPI) 14
- F**
 - file control 40
 - front end 75
 - function shipping 35, 39, 47
 - DL/I databases 41
- function shipping 46, 39, 47 (*continued*)
 - examples 41
 - file control 40
 - how it works 42
 - IMS databases 41
 - interval control 39
 - limitations 71
 - mirror transaction 39, 44
 - synchronization 45
 - temporary storage 42
 - transformer program 43
 - transient data 42
 - transparency to application 40
- H**
 - hierarchy, transaction 74
- I**
 - IBM CICS Clients and clients for CICS on Open Systems
 - overview 13
 - IMS databases, function shipping 41
 - initiator, conversation 75
 - intercommunication functions 35
 - brief definitions 35
 - choosing between 37
 - interproduct communication
 - defining a product's communication ability 5
 - how each pair of products can communicate 8
 - interval control, function shipping 39
 - IPX, communication protocol 6
- L**
 - local queuing of START requests 66
 - LU6.2, communication protocol 6
- M**
 - MBCS, multi-byte character set 20
 - mirror transaction 39, 44, 45
 - chained mirrors 45
 - multiple mirrors 45
 - multi-byte character set (MBCS) 20
- N**
 - NetBIOS, communication protocol 6
 - NOCHECK option, START
 - command
 - deferred sending 65
 - improving performance 64, 65
 - local queuing 66
- P**
 - principal facility 75
 - PROTECT option, START
 - command 65
 - protocols, for communication
 - APPC 6
 - IPX 6
 - LU6.2 6
 - NetBIOS 6
 - TCP/IP 6
 - pseudoconversation 48
- R**
 - recipient, conversation 75
 - relay program (DFHCRP) 53
 - relay transaction 47
 - RETRIEVE command 62
 - RETRIEVE command, WAIT
 - option 67
 - retrieving data sent with START
 - command 67
 - rollback 77
 - routing transaction, CRTE 54
- S**
 - SBCS, single-byte character sets 20
 - session
 - used by a conversation 74
 - shippable terminal 94
 - shipping terminal definitions 51, 53
 - SNA configuration 23
 - CICS for AIX 30
 - CICS for OS/2 29
 - CICS on System/390 28
 - SNA terminology 24
 - SQL databases, accessed by DPL 58
 - START command 62
 - deferred sending 65
 - local queuing 66
 - NOCHECK option 64
 - PROTECT option 65
 - START/RETRIEVE, asynchronous
 - processing 63
 - state, conversation 77
 - synchronization 6
 - DPL 58
 - DTP 77, 79
 - backout 77
 - committing changes to resources 78
 - data integrity 77
 - rollback 77
 - syncpoints 78
 - unit of work (UOW) 78
 - function shipping 45
 - synchronization levels 7

- synchronization 58 (*continued*)
 - two-phase commit 58
- synchronization levels 7, 78
- syncpoints 78

T

- TCP/IP, communication protocol 6
- temporary storage, function
 - shipping 42
- terminal-not-known condition 53
- terminals, shipping definitions 53
- transaction hierarchy 74
- transaction routing 36, 47, 55
 - ATI (automatic transaction initiation) 51
 - basic mapping support (BMS) 48, 54
 - dynamic transaction routing 50
 - eligible sessions 48
 - eligible terminals 48
 - initiating transaction routing 48
 - pseudoconversation 48
 - relay program 53
 - routing transaction, CRTE 54
 - shipping terminal definitions 53
 - static transaction routing 49
 - terminal-initiated transaction routing 49
- transformer program 43
- transient data, function shipping 42
- two-phase commit 7

U

- unit of work (UOW) 78
- UOW (unit of work) 78
- user exits
 - XALTENF 64
 - XICTENF 64

W

- WAIT option, RETRIEVE command 67

X

- XALTENF, user exit 64
- XICTENF, user exit 64

Sending your comments to IBM

If you especially like or dislike anything about this book, please use one of the methods listed below to send your comments to IBM.

Feel free to comment on what you regard as specific errors or omissions, and on the accuracy, organization, subject matter, or completeness of this book.

Please limit your comments to the information in this book and the way in which the information is presented.

To request additional publications, or to ask questions or make comments about the functions of IBM products or systems, you should talk to your IBM representative or to your IBM authorized remarketer.

When you send comments to IBM, you grant IBM a nonexclusive right to use or distribute your comments in any way it believes appropriate, without incurring any obligation to you.

You can send your comments to IBM in any of the following ways:

- By mail, to this address:

Information Development Department (MP095)
IBM United Kingdom Laboratories
Hursley Park
WINCHESTER,
Hampshire
United Kingdom

- By fax:

- From outside the U.K., after your international access code use 44-1962-870229
- From within the U.K., use 01962-870229

- Electronically, use the appropriate network ID:

- IBM Mail Exchange: GBIBM2Q9 at IBMMAIL
- IBMLink™: HURSLEY(IDRCF)
- Internet: idrcf@hursley.ibm.com

Whichever you use, ensure that you include:

- The publication number and title
- The topic to which your comment applies
- Your name and address/telephone number/fax number/network ID.



Printed in the United States of America
on recycled paper containing 10%
recovered post-consumer fiber.

SC33-0824-05



Spine information:



CICS® Family

Interproduct Communication