

CICS<sup>®</sup> Transaction Server for OS/390<sup>®</sup>



# CICS Recovery and Restart Guide

*Release 3*



CICS<sup>®</sup> Transaction Server for OS/390<sup>®</sup>



# CICS Recovery and Restart Guide

*Release 3*

**Note!**

Before using this information and the product it supports, be sure to read the general information under "Notices" on page xi.

**Fourth edition (November 2000)**

This edition applies to Release 3 of CICS Transaction Server for OS/390, program number 5655-147, and to all subsequent versions, releases, and modifications until otherwise indicated in new editions. Make sure you are using the correct edition for the level of the product.

This edition replaces and makes obsolete the previous edition, SC33-1698-01. Changes since that edition are indicated by a # sign to the left of a change. Any vertical lines in the left margin indicate a change made between Version 1 Release 2 and Version 1 Release 3 of CICS Transaction Server for OS/390.

Order publications through your IBM representative or the IBM branch office serving your locality. Publications are not stocked at the address given below.

At the back of this publication is a page entitled "Sending your comments to IBM". If you want to make comments, but the methods described are not available to you, please address them to:

IBM United Kingdom Laboratories, Information Development,  
Mail Point 95, Hursley Park, Winchester, Hampshire, England, SO21 2JN.

When you send information to IBM, you grant IBM a nonexclusive right to use or distribute the information in any way it believes appropriate without incurring any obligation to you.

© **Copyright International Business Machines Corporation 1982, 1999. All rights reserved.**

US Government Users Restricted Rights – Use, duplication or disclosure restricted by GSA ADP Schedule Contract with IBM Corp.

---

# Contents

<b>Notices</b> . . . . .	xi
Trademarks . . . . .	xii
<b>Preface</b> . . . . .	xiii
What this book is about . . . . .	xiii
Who should read this book . . . . .	xiii
What you need to know to understand this book . . . . .	xiii
How to use this book . . . . .	xiii
Determining if a publication is current . . . . .	xiii
<b>Bibliography</b> . . . . .	xv
CICS Transaction Server for OS/390 . . . . .	xv
CICS books for CICS Transaction Server for OS/390 . . . . .	xv
CICSplex SM books for CICS Transaction Server for OS/390 . . . . .	xvi
Other CICS books . . . . .	xvi
<b>Summary of changes</b> . . . . .	xvii
Changes for CICS Transaction Server for OS/390 Release 3. . . . .	xvii
Changes for CICS Transaction Server for OS/390 Release 2. . . . .	xvii
Changes for CICS Transaction Server for OS/390 Release 1. . . . .	xvii

---

## Part 1. CICS recovery and restart concepts. . . . . 1

<b>Chapter 1. Introduction</b> . . . . .	3
Faults and their effects . . . . .	3
Comparison of batch and online systems. . . . .	3
Recovery requirements in a transaction processing system . . . . .	3
Maintaining the integrity of data . . . . .	4
Minimizing the effect of failures . . . . .	4
The role of CICS. . . . .	4
Recoverable resources . . . . .	5
CICS backward recovery (backout) . . . . .	6
Dynamic transaction backout . . . . .	6
Emergency restart backout . . . . .	7
CICS forward recovery . . . . .	7
Forward recovery of CICS data sets . . . . .	8
Forward recovery of other (non-VSAM) resources . . . . .	8
Failures that require CICS recovery processing . . . . .	8
CICS recovery processing following a communication failure . . . . .	9
CICS recovery processing following a transaction failure . . . . .	10
CICS recovery processing following a system failure . . . . .	11
<b>Chapter 2. Resource recovery in CICS</b> . . . . .	13
Unit of work concepts . . . . .	13
Unit of work . . . . .	13
Unit of work states . . . . .	13
Synchronization points . . . . .	15
CICS recovery manager . . . . .	17
Managing the state of each unit of work. . . . .	18
Coordinating updates to local resources. . . . .	19
Coordinating updates in distributed units of work . . . . .	20
Resynchronization after system or connection failure . . . . .	20
CICS system log . . . . .	21

Information recorded on the system log . . . . .	21
System activity keypoints . . . . .	21
Forward recovery logs . . . . .	22
User journals and automatic journaling . . . . .	22
<b>Chapter 3. Shutdown and restart recovery . . . . .</b>	<b>25</b>
Shutdown . . . . .	25
Normal shutdown processing. . . . .	25
Immediate shutdown processing (PERFORM SHUTDOWN IMMEDIATE)	28
Shutdown requested by the operating system . . . . .	29
Uncontrolled termination . . . . .	30
The shutdown assist transaction . . . . .	30
Cataloging CICS resources . . . . .	31
Global catalog . . . . .	31
Local catalog . . . . .	32
Reconstructing the state of the CICS region . . . . .	33
Overriding the type of start indicator . . . . .	33
Warm restart. . . . .	33
Emergency restart. . . . .	33
Cold start . . . . .	34
Dynamic RLS restart. . . . .	35
VTAM persistent sessions recovery . . . . .	36
Multi-node persistent sessions . . . . .	37
Single-node persistent sessions. . . . .	38
Unbinding sessions . . . . .	38
Sessions not retained . . . . .	38

---

**Part 2. Recovery and restart processes . . . . . 39**

<b>Chapter 4. CICS cold start . . . . .</b>	<b>41</b>
Starting CICS with the START=COLD parameter . . . . .	41
A local cold start (START=COLD) . . . . .	42
Starting CICS with the START=INITIAL parameter . . . . .	46
<b>Chapter 5. CICS warm restart . . . . .</b>	<b>49</b>
Rebuilding the CICS state after a normal shutdown . . . . .	49
Files. . . . .	49
Temporary storage . . . . .	50
Transient data . . . . .	51
Transactions. . . . .	52
Programs . . . . .	52
Start requests . . . . .	52
Monitoring and statistics . . . . .	53
Journal names and journal models . . . . .	53
Terminal control resources. . . . .	53
Distributed transaction resources . . . . .	54
<b>Chapter 6. CICS emergency restart . . . . .</b>	<b>55</b>
Recovering after a CICS failure . . . . .	55
Overview . . . . .	55
Rebuilding the CICS state after an abnormal termination . . . . .	56
Files. . . . .	56
Temporary storage . . . . .	57
Transient data . . . . .	57
Transactions. . . . .	57
Programs . . . . .	58

Start requests . . . . .	58
Monitoring and statistics . . . . .	58
Journal names and journal models . . . . .	58
Terminal control resources. . . . .	58
Distributed transaction resources . . . . .	59
<b>Chapter 7. Automatic restart management . . . . .</b>	<b>61</b>
Overview . . . . .	61
CICS ARM processing . . . . .	61
Registering with ARM . . . . .	62
Waiting for predecessor subsystems . . . . .	62
De-registering from ARM . . . . .	62
Failing to register . . . . .	62
ARM couple data sets . . . . .	63
CICS restart JCL and parameters . . . . .	63
CICS START options. . . . .	63
Workload policies . . . . .	64
MVS automatic restart management definitions . . . . .	64
Connecting to VTAM. . . . .	65
The COVR transaction . . . . .	65
Messages associated with automatic restart . . . . .	65
<b>Chapter 8. Unit of work recovery and abend processing . . . . .</b>	<b>67</b>
Unit of work recovery . . . . .	67
Transaction backout . . . . .	69
Backout-failed recovery. . . . .	73
Commit-failed recovery . . . . .	77
In-doubt failure recovery . . . . .	78
Investigating an in-doubt failure. . . . .	80
Recovery from failures associated with the coupling facility. . . . .	82
Cache failure support . . . . .	82
Lost locks recovery . . . . .	83
Connection failure to a coupling facility cache structure . . . . .	85
Connection failure to a coupling facility lock structure . . . . .	85
MVS system recovery and sysplex recovery . . . . .	85
Transaction abend processing . . . . .	86
How CICS handles transaction abends . . . . .	86
Exit code . . . . .	86
Abnormal termination of a task . . . . .	87
Actions taken at transaction failure . . . . .	88
Processing operating system abends and program checks . . . . .	89
<b>Chapter 9. Communication error processing . . . . .</b>	<b>91</b>
Terminal error processing . . . . .	91
Node error program (DFHZNEP) . . . . .	91
Terminal error program (DFHTEP). . . . .	91
Intersystem communication failures . . . . .	92

---

**Part 3. Implementing recovery and restart. . . . . 93**

<b>Chapter 10. Planning considerations . . . . .</b>	<b>95</b>
Application design considerations . . . . .	95
Questions relating to recovery requirements . . . . .	95
Validate the recovery requirements statement . . . . .	97
Designing the end user's restart procedure . . . . .	97
End user's standby procedures . . . . .	97

Communications between application and user . . . . .	97
Security . . . . .	98
System definitions for recovery-related functions . . . . .	98
System recovery table (SRT). . . . .	98
CICS-required resource definitions. . . . .	98
Definition of system log streams and general log streams . . . . .	99
System initialization parameters. . . . .	99
Files. . . . .	99
Transient data queues. . . . .	100
Temporary storage table (TST) . . . . .	100
Program list table (PLT) . . . . .	100
Transaction list table (XLT) . . . . .	100
Documentation and test plans . . . . .	100
<b>Chapter 11. Defining system and general log streams . . . . .</b>	<b>103</b>
MVS log streams . . . . .	104
Defining system log streams . . . . .	104
Specifying a JOURNALMODEL resource definition . . . . .	105
Model log streams for CICS system logs . . . . .	105
Activity keypointing . . . . .	108
Defining forward recovery log streams . . . . .	112
Defining recoverable data sets. . . . .	112
Model log streams for CICS general logs . . . . .	112
Merging data on shared general log streams . . . . .	113
Defining the log of logs . . . . .	114
Log of logs failure . . . . .	114
Reading log streams offline . . . . .	114
Effect of day-light saving time changes. . . . .	115
Adjusting local time . . . . .	115
Time stamping log and journal records. . . . .	115
<b>Chapter 12. Defining recoverability for CICS-managed resources . . . . .</b>	<b>117</b>
Recovery for transactions . . . . .	117
Defining transaction recovery attributes . . . . .	117
Recovery for files . . . . .	118
VSAM files . . . . .	119
Basic direct access method (BDAM) . . . . .	120
Defining files as recoverable resources . . . . .	120
File recovery attribute consistency checking (non-RLS). . . . .	123
Implementing forward recovery with user-written utilities . . . . .	124
Implementing forward recovery with CICS VSAM Recovery MVS/ESA . . . . .	125
Recovery for intrapartition transient data . . . . .	125
Backward recovery . . . . .	125
Forward recovery . . . . .	126
Recovery for extrapartition transient data . . . . .	127
Input extrapartition data sets . . . . .	127
Output extrapartition data sets. . . . .	128
Using post-initialization (PLTPI) programs . . . . .	128
Recovery for temporary storage . . . . .	128
Backward recovery . . . . .	128
Forward recovery . . . . .	129
<b>Chapter 13. Programming considerations . . . . .</b>	<b>131</b>
Application design . . . . .	131
Splitting the application into transactions . . . . .	131
SAA-compatible applications . . . . .	132



Program design . . . . .	133
Dividing transactions into units of work. . . . .	133
Processing dialogs with users . . . . .	133
Mechanisms for passing data between transactions . . . . .	134
Designing to avoid transaction deadlock . . . . .	136
Implications of interval control START requests . . . . .	137
Implications of automatic task initiation (TD trigger level) . . . . .	137
Implications of presenting large amounts of data to the user. . . . .	137
Coping with transaction and system failures. . . . .	138
Transaction failures . . . . .	138
System failures . . . . .	140
Handling abends and program level abend exits . . . . .	140
Processing the IOERR condition . . . . .	142
START TRANSID commands . . . . .	142
PL/I programs and error handling. . . . .	142
Locking (enqueueing on) resources in application programs . . . . .	143
Implicit locking for files . . . . .	143
Implicit enqueueing on logically recoverable TD destinations . . . . .	146
Implicit enqueueing on recoverable temporary storage queues . . . . .	146
Implicit enqueueing on DL/I databases with DBCTL . . . . .	147
Explicit enqueueing (by the application programmer) . . . . .	147
Possibility of transaction deadlock . . . . .	147
User exits for transaction backout . . . . .	149
Where you can add your own code . . . . .	149
Exit details . . . . .	149
Coding transaction backout exits . . . . .	151
<b>Chapter 14. Using a program error program (PEP) . . . . .</b>	<b>153</b>
The CICS-supplied PEP . . . . .	153
Your own PEP . . . . .	153
Omitting the PEP . . . . .	154
<b>Chapter 15. Resolving retained locks on recoverable resources . . . . .</b>	<b>155</b>
Quiescing RLS data sets. . . . .	155
The RLS quiesce and unquiesce functions . . . . .	155
The CICS RLS quiesce support . . . . .	156
Switching from RLS to non-RLS access mode . . . . .	162
What can prevent a switch to non-RLS access mode? . . . . .	163
Resolving retained locks before opening data sets in non-RLS mode . . . . .	164
Resolving retained locks and preserving data integrity . . . . .	166
Choosing data availability over data integrity . . . . .	167
The batch-enabling sample programs . . . . .	168
CEMT command examples . . . . .	168
A special case: lost locks. . . . .	170
Overriding retained locks. . . . .	170
Coupling facility data table retained locks. . . . .	171
<b>Chapter 16. Moving recoverable data sets that have retained locks . . . . .</b>	<b>173</b>
Procedure for moving a data set with retained locks. . . . .	173
Using the REPRO method . . . . .	173
Using the EXPORT and IMPORT functions . . . . .	176
Rebuilding alternate indexes . . . . .	176
<b>Chapter 17. Forward recovery procedures . . . . .</b>	<b>177</b>
Forward recovery of data sets accessed in RLS mode . . . . .	177
Recovery of data set with volume still available . . . . .	178

Recovery of data set with loss of volume . . . . .	179
Forward recovery of data sets accessed in non-RLS mode . . . . .	188
Procedure for failed RLS mode forward recovery operation . . . . .	189
Procedure for failed non-RLS mode forward recovery operation . . . . .	191
<b>Chapter 18. Forward recovery with CICSVR . . . . .</b>	<b>193</b>
Why should you have a forward recovery utility? . . . . .	193
CICSVR features . . . . .	193
CICSVR benefits. . . . .	194
How CICSVR protects your data . . . . .	194
Storing information in the recovery control data set . . . . .	194
Automated job creation . . . . .	195
CICSVR and 24-hour CICS availability. . . . .	195
Planning for CICSVR . . . . .	195
Establishing backup procedures . . . . .	195
Journaling considerations . . . . .	196
Which VSAM spheres to protect . . . . .	196
CICSVR exit considerations. . . . .	196
Considerations for operational procedures and responsibilities . . . . .	197
Running CICSVR . . . . .	197
Using the main menu . . . . .	198
Selecting from the VSAM sphere list . . . . .	198
Using the VSAM sphere list Utilities pull-down . . . . .	199
CICSVR reports . . . . .	208
Forward recovery reports. . . . .	208
Archive reports . . . . .	210
<b>Chapter 19. Backup-while-open (BWO) . . . . .</b>	<b>215</b>
Benefits of BWO. . . . .	215
BWO and concurrent copy . . . . .	215
What is needed to use BWO . . . . .	216
Hardware requirements . . . . .	217
Which data sets are eligible for BWO . . . . .	217
How you request BWO . . . . .	218
Specifying BWO using access method services . . . . .	218
Specifying BWO on CICS file resource definitions . . . . .	219
Systems administration . . . . .	219
BWO processing. . . . .	220
File opening . . . . .	221
File closing (non-RLS mode) . . . . .	223
Shutdown and restart . . . . .	224
Data set backup and restore . . . . .	225
Forward recovery logging . . . . .	227
Forward recovery . . . . .	228
Recovering VSAM spheres with AIXs . . . . .	229
An assembler program that calls DFSMS callable services . . . . .	230
<b>Chapter 20. Disaster recovery . . . . .</b>	<b>235</b>
Why have a disaster recovery plan? . . . . .	235
Disaster recovery testing . . . . .	236
Six tiers of solutions for off-site recovery . . . . .	237
Tier 0—no off-site data . . . . .	237
Tier 1—physical removal . . . . .	238
Tier 2—physical removal with hot site . . . . .	240
Tier 3—electronic vaulting . . . . .	241
Tier 0–3 solutions . . . . .	242

Tier 4—active secondary site . . . . .	243
Tier 5—two-site, two-phase commit . . . . .	244
Tier 6—minimal to zero data loss. . . . .	245
Tier 4–6 solutions . . . . .	246
Disaster recovery and high availability . . . . .	247
Peer-to-peer remote copy (PPRC) and extended remote copy (XRC) . . . . .	247
Remote Recovery Data Facility . . . . .	249
Choosing between RRDF and 3990-6 solutions . . . . .	250
Disaster recovery personnel considerations . . . . .	251
Returning to your primary site . . . . .	251
Disaster recovery further information . . . . .	251
Disaster recovery facilities . . . . .	251
MVS system logger recovery support . . . . .	251
CICS VSAM Recovery QSAM copy . . . . .	252
Remote Recovery Data Facility support . . . . .	252
CICSVR 2.3 shadowing . . . . .	252
CICS emergency restart considerations . . . . .	252
In-doubt and backout failure support . . . . .	252
Remote site recovery for RLS-mode data sets . . . . .	253
Final summary . . . . .	253
<b>Glossary . . . . .</b>	<b>255</b>
<b>Index . . . . .</b>	<b>259</b>
<b>Sending your comments to IBM . . . . .</b>	<b>267</b>



---

## Notices

This information was developed for products and services offered in the U.S.A. IBM may not offer the products, services, or features discussed in this document in other countries. Consult your local IBM representative for information on the products and services currently available in your area. Any reference to an IBM product, program, or service is not intended to state or imply that only that IBM product, program, or service may be used. Any functionally equivalent product, program, or service that does not infringe any IBM intellectual property right may be used instead. However, it is the user's responsibility to evaluate and verify the operation of any non-IBM product, program, or service.

IBM may have patents or pending patent applications covering subject matter described in this document. The furnishing of this document does not give you any license to these patents. You can send license inquiries, in writing, to:

IBM Director of Licensing  
IBM Corporation  
North Castle Drive  
Armonk, NY 10504-1785  
U.S.A.

For license inquiries regarding double-byte (DBCS) information, contact the IBM Intellectual Property Department in your country or send inquiries, in writing, to:

IBM World Trade Asia Corporation  
Licensing  
2-31 Roppongi 3-chome, Minato-ku  
Tokyo 106, Japan

**The following paragraph does not apply in the United Kingdom or any other country where such provisions are inconsistent with local law:**

INTERNATIONAL BUSINESS MACHINES CORPORATION PROVIDES THIS PUBLICATION "AS IS" WITHOUT WARRANTY OF ANY KIND, EITHER EXPRESS OR IMPLIED, INCLUDING, BUT NOT LIMITED TO, THE IMPLIED WARRANTIES OF NON-INFRINGEMENT, MERCHANTABILITY, OR FITNESS FOR A PARTICULAR PURPOSE. Some states do not allow disclaimer of express or implied warranties in certain transactions, therefore this statement may not apply to you.

This publication could include technical inaccuracies or typographical errors. Changes are periodically made to the information herein; these changes will be incorporated in new editions of the publication. IBM may make improvements and/or changes in the product(s) and/or the program(s) described in this publication at any time without notice.

Licensees of this program who wish to have information about it for the purpose of enabling: (i) the exchange of information between independently created programs and other programs (including this one) and (ii) the mutual use of the information which has been exchanged, should contact IBM United Kingdom Laboratories, MP151, Hursley Park, Winchester, Hampshire, England, SO21 2JN. Such information may be available, subject to appropriate terms and conditions, including in some cases, payment of a fee.

The licensed program described in this document and all licensed material available for it are provided by IBM under terms of the IBM Customer Agreement, IBM International Programming License Agreement, or any equivalent agreement between us.

---

## Trademarks

The following terms are trademarks of International Business Machines Corporation in the United States, or other countries, or both:

ACF/VTAM	BookManager	CICS
CUA	DB2	DFSMS
DFSMS/MVS	DFSMSdfp	DFSMSdss
DFSMShsm	ESCON	IBM
IMS	MVS/DFP	MVS/ESA
OS/390	Parallel Sysplex	RACF
VTAM		

NetView is a trademark of Tivoli Systems Inc. in the United States, or other countries, or both.

Other company, product, and service names may be trademarks or service marks of others.

---

## Preface

---

### What this book is about

This book contains guidance about determining your CICS® recovery and restart needs, deciding which CICS facilities are most appropriate, and implementing your design on your CICS region.

The information in this book is generally restricted to a single CICS region. For information about ISC and MRO, see the *CICS Intercommunication Guide*. For information about XRF systems, see the *CICS/ESA 3.3 XRF Guide*.

**FEPI:** This book does not describe recovery and restart for the CICS front end programming interface. For information on this topic, see the *CICS Front End Programming Interface User's Guide*.

---

### Who should read this book

This book is for those responsible for restart and recovery planning, design, and implementation—either for a complete system, or for a particular function or component.

---

### What you need to know to understand this book

To understand this book, you should have experience of installing and generating a CICS system and the products with which it is to work, or of writing CICS application programs, or of writing exit programs. You should also understand your application requirements well enough to be able to make decisions about realistic recovery and restart needs, and the trade-offs between those needs and the performance overhead they incur.

---

### How to use this book

This book deals with a wide variety of topics, all of which contribute to the recovery and restart characteristics of your system. It's unlikely that any one reader would have to implement all the possible techniques discussed in this book. By using the table of contents, you should be able to find the sections relevant to your work. Readers new to recovery and restart should find Part 1 helpful, because it introduces the concepts of recovery and restart.

---

### Determining if a publication is current

IBM regularly updates its publications with new and changed information. When first published, both hardcopy and BookManager® softcopy versions of a publication are in step, but subsequent updates will probably be available in softcopy before they are available in hardcopy.

For CICS Transaction Server books, these softcopy updates appear regularly on the *Transaction Processing and Data Collection Kit* CD-ROM, SK2T-0730-xx. Each reissue of the collection kit is indicated by an updated order number suffix (the -xx part). For example, collection kit SK2T-0730-06 is more up-to-date than SK2T-0730-05. The collection kit is also clearly dated on the cover.

Here's how to determine if you are looking at the most current copy of a publication:

- A publication with a higher suffix number is more recent than one with a lower suffix number. For example, the publication with order number SC33-0667-02 is more recent than the publication with order number SC33-0667-01. (Note that suffix numbers are updated as a product moves from release to release, as well as for hardcopy updates within a given release.)
- When the softcopy version of a publication is updated for a new collection kit the order number it shares with the hardcopy version does not change. Also, the date in the edition notice remains that of the original publication. To compare softcopy with hardcopy, and softcopy with softcopy (on two editions of the collection kit, for example), check the last two characters of the publication's filename. The higher the number, the more recent the publication. For example, DFHPF104 is more recent than DFHPF103. Next to the publication titles in the CD-ROM booklet and the readme files, asterisks indicate publications that are new or changed.
- Updates to the softcopy are clearly marked by revision codes (usually a “#” character) to the left of the changes.



---

# Bibliography

---

## CICS Transaction Server for OS/390

<i>CICS Transaction Server for OS/390: Planning for Installation</i>	GC33-1789
<i>CICS Transaction Server for OS/390: Release Guide</i>	GC34-5352
<i>CICS Transaction Server for OS/390: Migration Guide</i>	GC34-5353
<i>CICS Installation Guide</i>	GC33-1681
<i>CICS Transaction Server for OS/390: Program Directory</i>	GC33-1706
<i>CICS Transaction Server for OS/390: Licensed Program Specification</i>	GC33-1707

## CICS books for CICS Transaction Server for OS/390

### General

<i>CICS Master Index</i>	SC33-1704
<i>CICS User's Handbook</i>	SX33-6104
<i>CICS Glossary (softcopy only)</i>	GC33-1705

### Administration

<i>CICS System Definition Guide</i>	SC33-1682
<i>CICS Customization Guide</i>	SC33-1683
<i>CICS Resource Definition Guide</i>	SC33-1684
<i>CICS Operations and Utilities Guide</i>	SC33-1685
<i>CICS Supplied Transactions</i>	SC33-1686

### Programming

<i>CICS Application Programming Guide</i>	SC33-1687
<i>CICS Application Programming Reference</i>	SC33-1688
<i>CICS System Programming Reference</i>	SC33-1689
<i>CICS Front End Programming Interface User's Guide</i>	SC33-1692
<i>CICS C++ OO Class Libraries</i>	SC34-5455
<i>CICS Distributed Transaction Programming Guide</i>	SC33-1691
<i>CICS Business Transaction Services</i>	SC34-5268

### Diagnosis

<i>CICS Problem Determination Guide</i>	GC33-1693
<i>CICS Messages and Codes</i>	GC33-1694
<i>CICS Diagnosis Reference</i>	LY33-6088
<i>CICS Data Areas</i>	LY33-6089
<i>CICS Trace Entries</i>	SC34-5446
<i>CICS Supplementary Data Areas</i>	LY33-6090

### Communication

<i>CICS Intercommunication Guide</i>	SC33-1695
<i>CICS Family: Interproduct Communication</i>	SC33-0824
<i>CICS Family: Communicating from CICS on System/390</i>	SC33-1697
<i>CICS External Interfaces Guide</i>	SC33-1944
<i>CICS Internet Guide</i>	SC34-5445

### Special topics

<i>CICS Recovery and Restart Guide</i>	SC33-1698
<i>CICS Performance Guide</i>	SC33-1699
<i>CICS IMS Database Control Guide</i>	SC33-1700
<i>CICS RACF Security Guide</i>	SC33-1701
<i>CICS Shared Data Tables Guide</i>	SC33-1702
<i>CICS Transaction Affinities Utility Guide</i>	SC33-1777
<i>CICS DB2 Guide</i>	SC33-1939

## CICSplex SM books for CICS Transaction Server for OS/390

### General

<i>CICSplex SM Master Index</i>	SC33-1812
<i>CICSplex SM Concepts and Planning</i>	GC33-0786
<i>CICSplex SM User Interface Guide</i>	SC33-0788
<i>CICSplex SM Web User Interface Guide</i>	SC34-5403
<i>CICSplex SM View Commands Reference Summary</i>	SX33-6099

### Administration and Management

<i>CICSplex SM Administration</i>	SC34-5401
<i>CICSplex SM Operations Views Reference</i>	SC33-0789
<i>CICSplex SM Monitor Views Reference</i>	SC34-5402
<i>CICSplex SM Managing Workloads</i>	SC33-1807
<i>CICSplex SM Managing Resource Usage</i>	SC33-1808
<i>CICSplex SM Managing Business Applications</i>	SC33-1809

### Programming

<i>CICSplex SM Application Programming Guide</i>	SC34-5457
<i>CICSplex SM Application Programming Reference</i>	SC34-5458

### Diagnosis

<i>CICSplex SM Resource Tables Reference</i>	SC33-1220
<i>CICSplex SM Messages and Codes</i>	GC33-0790
<i>CICSplex SM Problem Determination</i>	GC33-0791

## Other CICS books

<i>CICS Application Programming Primer (VS COBOL II)</i>	SC33-0674
<i>CICS Application Migration Aid Guide</i>	SC33-0768
<i>CICS Family: API Structure</i>	SC33-1007
<i>CICS Family: Client/Server Programming</i>	SC33-1435
<i>CICS Family: General Information</i>	GC33-0155
<i>CICS 4.1 Sample Applications Guide</i>	SC33-1173
<i>CICS/ESA 3.3 XRF Guide</i>	SC33-0661

If you have any questions about the CICS Transaction Server for OS/390 library, see *CICS Transaction Server for OS/390: Planning for Installation* which discusses both hardcopy and softcopy books and the ways that the books can be ordered.

---

## Summary of changes

This book is a new edition of the *CICS Recovery and Restart Guide* for CICS Transaction Server for OS/390. Changes for this edition are marked by vertical bars to the left of the text.

---

### Changes for CICS Transaction Server for OS/390 Release 3

There are only minor changes to this book for CICS TS Release 3:

- A new topic dealing with coupling facility data table retained locks is added to “Chapter 15. Resolving retained locks on recoverable resources” on page 155.
- Changes arising from APARs and reader comments.

---

### Changes for CICS Transaction Server for OS/390 Release 2

The major changes to CICS that affect this book are:

- Changes affecting the log manager in connection with the log stream retention period parameter introduced in OS/390 Release 3.
- Service changes since the previous edition, as a result of APARs and Reader's Comment Forms (for example, information added to “VTAM persistent sessions recovery” on page 36 in connection with multi-node persistent sessions support—APAR PQ01878).

---

### Changes for CICS Transaction Server for OS/390 Release 1

The book was revised and reorganized, and changed substantially from the CICS/ESA 4.1 edition. The major changes in this edition are a result of introducing:

- The CICS recovery manager domain
- The CICS log manager domain
- VSAM RLS support, which introduces new failure situations from which recovery may be necessary

The new topics in this edition are covered in the following chapters:

- “Chapter 8. Unit of work recovery and abend processing” on page 67
- “Chapter 11. Defining system and general log streams” on page 103, which replaces the obsolete “Logging and journaling” chapter
- “Chapter 15. Resolving retained locks on recoverable resources” on page 155
- “Chapter 16. Moving recoverable data sets that have retained locks” on page 173
- “Chapter 17. Forward recovery procedures” on page 177
- “Chapter 20. Disaster recovery” on page 235

Because of the extensive changes and additions to this edition, new material is not marked, and you should regard this as a new book.



---

## Part 1. CICS recovery and restart concepts

This part of the book covers:

- “Chapter 1. Introduction” on page 3, describing some of the recovery and restart facilities provided by CICS
- “Chapter 2. Resource recovery in CICS” on page 13, describing CICS unit of work concepts and giving an introduction to the CICS recovery manager
- “Chapter 3. Shutdown and restart recovery” on page 25, describing the types of shutdown and restart



---

## Chapter 1. Introduction

It is very important that a transaction processing system such as CICS can restart and recover following a failure. This chapter describes some of the basic concepts of the recovery and restart facilities provided by CICS.

The principal topics discussed are:

- Faults and their effects
- Recovery requirements in a transaction processing system
- The role of CICS
- Backward recovery (backout)
- Forward recovery
- Failures that require CICS recovery processing

---

### Faults and their effects

Among the problems that can occur in a data processing system are failures with:

- Communication in online systems
- Data sets or databases
- Application or system programs
- Processors
- Power supplies

### Comparison of batch and online systems

All these problems are potentially more severe in an online system than in a system that performs only batch processing.

In batch systems, input data is usually prepared before processing begins, and jobs can be rerun, either from the start of the job or from some intermediate checkpoint.

In online systems, input is usually created dynamically by terminal operators, and arrives in an unpredictable sequence from many different sources. If a failure occurs, it is generally not possible simply to rerun the application, because the content and sequence of the input data is unknown. And, even if it is known, it is usually impractical for operators to reenter a day's work.

Online applications therefore require a system with special mechanisms for recovery and restart which batch systems do not require. These mechanisms ensure that each resource associated with an interrupted online application returns to a known state so that processing can restart safely.

In mixed systems, where both batch and online processing can occur against data at the same time, the recovery requirements for batch processing and online systems are similar.

---

### Recovery requirements in a transaction processing system

An online system requires mechanisms that, together with suitable operating procedures, provide **automatic** recovery from failures and allow the system to restart with the minimum of disruption.

The two main recovery requirements of an online system are:

- To maintain the integrity and consistency of data
- To minimize the effect of failures

## Maintaining the integrity of data

“Data integrity” means that the data is in the form you expect and has not been corrupted. The objective of recovery operations on files, databases, and similar data resources is to maintain and restore the integrity of the information. Recovery must also ensure consistency of related changes, whereby they are made as a whole or not at all. (The term **resources** used in this book, unless stated otherwise, refers to data resources.)

### Logging changes

One way of maintaining the integrity of a resource is to keep a record, or log, of all the changes made to a resource while the system is executing normally. If a failure occurs, the logged information can help recover the data.

An online system can use the logged information in two ways:

1. It can be used to back out incomplete or invalid changes to one or more resources. This is called **backward recovery**, or **backout**. For backout, it is necessary to record the contents of a data element *before* it is changed. These records are called **before-images**. In general, backout is applicable to **processing failures** that prevent one or more transactions (or a batch program) from completing.
2. It can be used to reconstruct changes to a resource, starting with a backup copy of the resource taken earlier. This is called **forward recovery**. For forward recovery, it is necessary to record the contents of a data element *after* it is changed. These records are called **after-images**.

In general, forward recovery is applicable to **data set failures**, or failures in similar data resources, which cause data to become unusable because it has been corrupted or because the physical storage medium has been damaged.

## Minimizing the effect of failures

An online system should limit the effect of any failure. Where possible, a failure that affects only one user, one application, or one data set should not halt the entire system. Furthermore, if processing for one user is forced to stop prematurely, it should be possible to back out any changes made to any data sets as if the processing had not started.

If processing for the entire system stops, there may be many users whose updating work is interrupted. On a subsequent startup of the system, only those data set updates in process (in-flight) at the time of failure should be backed out. Backing out only the in-flight updates makes restart quicker, and reduces the amount of data to reenter.

Ideally, it should be possible to restore the data to a consistent, known state following any type of failure, with minimal loss of valid updating activity.

---

## The role of CICS

The CICS recovery manager provides the recovery and restart functions needed in an online system.

Automatic backout is provided for most CICS resources (such as databases, files, and auxiliary temporary storage queues), either following a transaction failure or during an emergency restart of CICS. The logging functions necessary to support backout are performed for you by the CICS recovery manager and the log manager. If the backout of a VSAM file fails, CICS backout failure processing ensures that all



locks on the backout-failed records are retained, and the backout-failed parts of the unit of work (UOW) are **shunted** to await retry. The VSAM file remains open for use. (For an explanation of shunted units of work and retained locks, see “The shunted state” on page 13.)

If the cause of the backout failure is a physically damaged data set, and provided the damage affects only a localized section of the data set, you can choose a time when it is convenient to take the data set offline for recovery. You can then use the forward recovery log with a forward recovery utility, such as CICSVR, to restore the data set and re-enable it for CICS use.

**Note:** In many cases, a data set failure also causes a processing failure. In this event, forward recovery must be followed by backward recovery.

You don't need to shut CICS down to perform these recovery operations. For data sets accessed by CICS in VSAM record-level sharing (RLS) mode, you can **quiesce** the data set to allow you to perform the forward recovery offline. On completion of forward recovery, setting the data set to **unquiesced** causes CICS to perform the backward recovery automatically.

For files accessed in non-RLS mode, you can issue an EXEC CICS or CEMT SET DSNAME RETRY after the forward recovery, which causes CICS to perform the backward recovery online.

Another way is to shut down CICS with an immediate shutdown and perform the forward recovery, after which a CICS **emergency restart** performs the backward recovery.

## Recoverable resources

In CICS, a **recoverable** resource is any resource with recorded recovery information that can be recovered by backout.

The following resources can be made recoverable:

- CICS files that relate to:
  - VSAM data sets
  - BDAM data sets
- Data tables (but user-maintained data tables are not recovered after a CICS failure, only after a transaction failure)
- Coupling facility data tables
- The CICS system definition (CSD) file
- Intrapartition transient data destinations
- Auxiliary temporary storage queues
- Resource definitions dynamically installed using resource definition online (RDO)

### Backing up your data while it is in use

In some environments, a VSAM file managed by CICS file control might need to remain online and open for update for extended periods. You can use a backup manager, such as DFSMSdss™, in a separate job under MVS, to back up a VSAM file at regular intervals while it is open for update by CICS applications. This operation is known as **backup-while-open (BWO)**. Even changes made to the VSAM file while the backup is in progress are recorded.

DFSMSdss is a functional component of DFSMS/MVS<sup>®</sup>, and is the primary data mover. When used with supporting hardware, DFSMSdss also provides concurrent copy capability. Concurrent copy lets you copy or back up data while that data is being used.

If a data set failure occurs, you can use a backup of the data set and a forward recovery utility, such as CICS VSAM Recovery MVS/ESA<sup>™</sup> (CICSVR), to recover the VSAM file.

---

## CICS backward recovery (backout)

Backward recovery, or **backout**, is a way of undoing changes made to resources such as files or databases.

Backout is one of the fundamental recovery mechanisms of CICS. It relies on recovery information recorded while CICS and its transactions are running normally.

Before a change is made to a resource, the recovery information for backout, in the form of a **before-image**, is recorded on the CICS system log. A before-image is a record of what the resource was like before the change. These before-images are used by CICS to perform backout in two situations:

- In the event of failure of an individual in-flight transaction, which CICS backs out dynamically at the time of failure (**dynamic transaction backout**)
- In the event of an emergency restart, when CICS backs out all those transactions that were in-flight at the time of the CICS failure (**emergency restart backout**).

**Note:** Although these occur in different situations, CICS uses the same backout process in each case—CICS does not distinguish between dynamic backout and emergency restart backout. See “Chapter 6. CICS emergency restart” on page 55 for an explanation of how CICS re-attaches failed in-flight units of work in order to perform transaction backout following an emergency restart.

Each CICS region has only one system log, which cannot be shared with any other CICS region. The system log is written to a unique MVS system logger log stream. The CICS system log is intended for use only for recovery purposes—for example, during dynamic transaction backout, or during emergency restart. It is not meant to be used for any other purpose.

**Note:** CICS actually supports two physical log streams—a primary and a secondary log stream. CICS uses the secondary log stream for storing log records of failed units of work, and also some long running tasks that have not caused any data to be written to the log for two complete activity key points. Failed units of work are moved from the primary to the secondary log stream at the next activity keypoint. Logically, both the primary and secondary log stream form one log, and as a general rule are simply referred to as the **system log**.

## Dynamic transaction backout

In the event of a transaction failure (or if an application explicitly requests a syncpoint rollback), the CICS recovery manager uses the system log data to drive the resource managers to back out any updates made by the current UOW. (See “Unit of work concepts” on page 13 for a description of units of work.) This process, known as dynamic transaction backout, takes place while the rest of CICS continues normally.

For example, when any updates made to a recoverable data set are to be backed out, file control uses the system log records to reverse the updates. When all the updates made in the unit of work have been backed out, the unit of work is completed. The locks held on the updated records are freed if the backout is successful.

For data sets open in RLS mode, CICS requests VSAM RLS to release the locks; for data sets open in non-RLS mode, the CICS enqueue domain releases the locks automatically.

## Emergency restart backout

If a CICS region fails, you restart CICS with an emergency restart to back out any transactions that were in-flight at the time of failure.

During emergency restart, the recovery manager uses the system log data to drive backout processing for any UOWs that were in-flight at the time of the failure. The backout of UOWs during emergency restart is the same as a dynamic backout; there is no distinction between the backout that takes place at emergency restart and that which takes place at any other time. At this point, while recovery processing continues, CICS is ready to accept new work for normal processing.

The recovery manager also drives:

- The backout processing for any UOWs that were in a backout-failed state at the time of the CICS failure
- The commit processing for any UOWs that had not finished commit processing at the time of failure (for example, for resource definitions that were being installed when CICS failed)
- The commit processing for any UOWs that were in a commit-failed state at the time of the CICS failure

See “Unit of work recovery” on page 67 for an explanation of the terms “commit-failed” and “backout-failed”.

The recovery manager drives these backout and commit processes because the condition that caused them to fail may be resolved by the time CICS restarts. If the condition that caused a failure has not been resolved, the UOW remains in backout- or commit-failed state. See “Backout-failed recovery” on page 73 and “Commit-failed recovery” on page 77 for more information.

---

## CICS forward recovery

Some types of data set failure cannot be corrected by backward recovery; for example, failures that cause physical damage to a database or data set. Recovery from failures of this type is usually based on the following actions:

1. Take a backup copy of the data set at regular intervals.
2. Record an after-image of every change to the data set on the forward recovery log (a general log stream managed by the MVS system logger).
3. After the failure, restore the most recent backup copy of the failed data set, and use the information recorded on the forward recovery log to update the data set with all the changes that have occurred since the backup copy was taken.

These operations are known as **forward recovery**.

On completion of the forward recovery, as a fourth step, CICS also performs backout of UOWs that failed in-flight as a result of the data set failure.

## Forward recovery of CICS data sets

CICS supports forward recovery of VSAM data sets updated by CICS file control (that is, by files or CICS-maintained data tables defined by a CICS file definition).

CICS writes the after-images of changes made to a data set to a forward recovery log, which is a general log stream managed by the MVS system logger.

CICS obtains the log stream name of a VSAM forward recovery log in one of two ways:

1. For files opened in VSAM record level sharing (RLS) mode, the explicit log stream name is obtained directly from the VSAM ICF catalog entry for the data set.
2. For files in non-RLS mode, the log stream name is derived from:
  - The VSAM ICF catalog entry for the data set if it is defined there (and if RLS=YES is specified as a system initialization parameter). In this case, CICS file control manages writes to the log stream directly.
  - A journal model definition referenced by a forward recovery journal name specified in the file resource definition.

Forward recovery journal names are of the form DFHJnn where *nn* is a number in the range 1–99 and is obtained from the forward recovery log id (FWDRECOVLOG) in the FILE resource definition.

In this case, CICS creates a journal entry for the forward recovery log, which can be mapped by a JOURNALMODEL resource definition. Although this method enables user application programs to reference the log, and write user journal records to it, you are recommended *not* to do so—you should ensure that forward recovery log streams are reserved for forward recovery data only.

**Note:** You cannot use a CICS system log stream as a forward recovery log.

The VSAM recovery options or the CICS file control recovery options that you require to implement forward recovery are explained further in “Defining files as recoverable resources” on page 120.

For details of procedures for performing forward recovery, see “Chapter 17. Forward recovery procedures” on page 177.

## Forward recovery of other (non-VSAM) resources

CICS does not provide forward recovery logging for other resources, such as BDAM files. However, you can provide this support yourself by ensuring that the necessary information is logged to a suitable log stream. In the case of BDAM files, you can use the CICS autojournaling facility to write the necessary after-images to a log stream.

---

## Failures that require CICS recovery processing

The following sections briefly describe CICS recovery processing after:

- Communication failure
- Transaction failure
- System failure

Whenever possible, CICS attempts to contain the effects of a failure—typically by terminating only the offending task while all other tasks continue normally. The updates performed by a prematurely terminated task can be backed out automatically (see “CICS recovery processing following a transaction failure” on page 10).

## CICS recovery processing following a communication failure

Causes of communication failure include:

- Terminal failure
- Printer terminal running out of paper
- Power failure at a terminal
- Invalid SNA status
- Network path failure
- Loss of an MVS image that is a member of a sysplex

There are two aspects to processing following a communications failure:

1. If the failure occurs during a conversation that is not engaged in syncpoint protocol, CICS must terminate the conversation and allow customized handling of the error, if required. An example of when such customization is helpful is for 3270 device types. This is described below.
2. If the failure occurs during the execution of a CICS syncpoint, where the conversation is with another resource manager (perhaps in another CICS region), CICS handles the resynchronization. This is described in the *CICS Intercommunication Guide*.

If the link fails and is later reestablished, CICS and its partners use the SNA set-and-test-sequence-numbers (STSN) command to find out what they were doing (backout or commit) at the time of link failure. For more information on link failure, see the *CICS Intercommunication Guide*.

When communication fails, the communication system access method either retries the transmission or notifies CICS. If a retry is successful, CICS is not informed. Information about the error can be recorded by the operating system. If the retries are not successful, CICS is notified.

When CICS detects a communication failure, it gives control to one of two programs:

- The node error program (NEP) for VTAM® logical units
- The terminal error program (TEP) for non-VTAM terminals

Both dummy and sample versions of these programs are provided by CICS. The dummy versions do nothing; they simply allow the default actions selected by CICS to proceed. The sample versions show how to write your own NEP or TEP to change the default actions.

The types of processing that might be in a user-written NEP or TEP are:

- Logging additional error information. CICS provides some error information when an error occurs.
- Retrying the transmission. This is not recommended because the access method will already have made several attempts.
- Leaving the terminal out of service. This means that it is unavailable to the terminal operator until the problem is fixed and the terminal is put back into service by means of a master terminal transaction.

- Abending the task if it is still active (see “CICS recovery processing following a transaction failure”).
- Reducing the amount of error information printed.

For more information about NEPs and TEPs, see “Chapter 9. Communication error processing” on page 91.

### **XCF/MRO partner failures**

Loss of communication between CICS regions can be caused by the loss of an MVS image in which CICS regions are running. If the regions are communicating over XCF/MRO links, the loss of connectivity may not be immediately apparent because XCF waits for a reply to a message it issues.

The loss of an MVS image in a sysplex is detected by XCF in another MVS, and XCF issues message IXC402D. If the failed MVS is running CICS regions connected through XCF/MRO to CICS regions in another MVS, tasks running in the active regions are initially suspended in an IRLINK WAIT state.

XCF/MRO-connected regions do not detect the loss of an MVS image and its resident CICS regions until an operator replies to the XCF IXC402D message. When the operator replies to IXC402D, the CICS interregion communication program, DFHIRP, is notified and the suspended tasks are abended, and MRO connections closed. Until the reply is issued to IXC402D, an INQUIRE CONNECTION command continues to show connections to regions in the failed MVS as in service and normal.

When the failed MVS image and its CICS regions are restarted, the interregion communication links are reopened automatically.

## **CICS recovery processing following a transaction failure**

Causes of a transaction failure include:

- A program check in the application program. CICS intercepts operating system calls for an abend (provided the abend code is included in the system recovery table (SRT)) and, in turn, abends the task.
- An invalid request to CICS from an application, causing an abend.
- A task issuing an ABEND request.
- I/O errors on a data set that is being accessed by the transaction

During normal execution of a transaction working with recoverable resources, CICS stores recovery information in the system log. If the transaction fails, CICS uses the information from the system log to back out the changes made by the interrupted UOW. Recoverable resources are thus not left in a partially updated or inconsistent state. Backing out an individual transaction is called **dynamic transaction backout**.

After dynamic transaction backout has completed, the transaction can restart automatically without the operator being aware of it happening. This function is especially useful in those cases where the cause of transaction failure is temporary and an attempt to rerun the transaction is likely to succeed (for example, DL/I program isolation deadlock). The conditions when a transaction can be automatically restarted are described under “Abnormal termination of a task” on page 87.

If dynamic transaction backout fails, perhaps because of an I/O error on a VSAM data set, CICS backout failure processing shunts the UOW and converts the locks that are held on the backout-failed records into retained locks. The data set remains

open for use, allowing the shunted UOW to be retried. If backout keeps failing because the data set is damaged, you can create a new data set using a backup copy and then perform forward recovery, using a utility such as CICSVR. When the data set is recovered, retry the shunted unit of work to complete the failed backout and release the locks.

“Chapter 8. Unit of work recovery and abend processing” on page 67 gives more details about CICS processing of a transaction failure.

## **CICS recovery processing following a system failure**

Causes of a system failure include:

- Processor failure
- Loss of electrical power supply
- Operating system failure
- CICS failure

During normal execution, CICS stores recovery information on its **system log stream**, which is managed by the MVS system logger. If you specify `START=AUTO`, CICS automatically performs an **emergency restart** when it restarts after a system failure.

During an emergency restart, the CICS log manager reads the system log backward and passes information to the CICS recovery manager.

The CICS recovery manager then uses the information retrieved from the system log to:

- Back out recoverable resources.
- Recover changes to terminal resource definitions. (All resource definitions installed at the time of the CICS failure are initially restored from the CICS global catalog.)

A special case of CICS processing following a system failure is covered in “Chapter 6. CICS emergency restart” on page 55.





---

## Chapter 2. Resource recovery in CICS

This chapter describes CICS resource recovery concepts. It covers the following topics:

- “Unit of work concepts”
- “Managing the state of each unit of work” on page 18
- “CICS system log” on page 21
- “Forward recovery logs” on page 22
- “User journals and automatic journaling” on page 22

---

### Unit of work concepts

When resources are being changed, there comes a point when the changes are complete and do not need backout if a failure occurs later.

### Unit of work

The period between the start of a particular set of changes and the point at which they are complete is called a **unit of work** (UOW). The unit of work is a fundamental concept of all CICS backout mechanisms.

From the application designer’s point of view, a UOW is a sequence of actions that needs to be complete before any of the **individual** actions can be regarded as complete. To ensure data integrity, a unit of work must be atomic, consistent, isolated, and durable (see ACID properties in the *CICS Glossary*).

The CICS recovery manager operates with units of work. If a transaction that consists of multiple UOWs fails, or the CICS region fails, committed UOWs are not backed out.

### Unit of work states

A unit of work can be in one of the following states:

- Active (in-flight)
- Shunted following a failure of some kind
- Completed and no longer of interest to the recovery manager

The CICS recovery manager (see page 17) shunts a UOW from the primary system log stream to the secondary log stream if it cannot be successfully completed or backed out.

#### The shunted state

A shunted UOW is one awaiting resolution of an in-doubt failure, a commit failure, or a backout failure. (See “Unit of work recovery” on page 67 for descriptions of these types of UOW failure.) The CICS recovery manager attempts to complete a shunted UOW when the failure that caused it to be shunted has been resolved.

A UOW can be unshunted and then shunted again (in theory, any number of times). For example, a UOW could go through the following stages:

1. A UOW fails in-doubt and is shunted.
2. After resynchronization, CICS finds that the decision is to back out the in-doubt UOW.
3. Recovery manager unshunts the UOW to perform backout.
4. If backout fails, it is shunted again.
5. Recovery manager unshunts the UOW to retry the backout.
6. Steps 4 and 5 can occur several times until the backout succeeds.

These situations can persist for some time, depending on how long it takes to resolve the cause of the failure. Because it is undesirable for transaction resources to be held up for too long, CICS attempts to release as many resources as possible while a UOW is shunted. This is generally achieved by abending the user task to which the UOW belongs, resulting in the release of the following:

- Terminals
- User programs
- Working storage
- Any LU6.2 sessions
- Any LU6.1 links
- Any MRO links

The resources CICS retains include:

- Locks on recoverable data. If the UOW is shunted in-doubt, all locks are retained. If it is shunted because of a commit- or backout-failure, only the locks on the failed resources are retained.
- System log records, which include:
  - Records written by the resource managers, which they need to perform recovery in the event of transaction or CICS failures. Generally, these records are used to support transaction backout, but the RDO resource manager also writes records for rebuilding the CICS state in the event of a CICS failure.
  - CICS recovery manager records, which include identifiers relating to the original transaction such as:
    - The transaction ID
    - The task ID
    - The CICS terminal ID
    - The VTAM LUNAME
    - The user ID
    - The operator ID.

## Locks

For files opened in RLS mode, VSAM maintains a single central lock structure using the lock-assist mechanism of the MVS coupling facility. This central lock structure provides sysplex-wide locking at a record level—control interval (CI) locking is not used.

The locks for files accessed in non-RLS mode, the scope of which is limited to a single CICS region, are CI locks. However, the CICS enqueue domain also holds a record lock for the record accessed within the CI.

For coupling facility data tables updated under the locking model, the coupling facility data table server stores the lock with its record in the CFDT. As in the case of RLS locks, storing the lock with its record in the coupling facility list structure that holds the coupling facility data table ensures sysplex-wide locking at record level.

For both RLS and non-RLS recoverable files, CICS releases all locks on completion of a unit of work. For recoverable coupling facility data tables, the locks are released on completion of a unit of work by the CFDT server.

**Active and retained states for locks:** CICS supports **active** and **retained** states for locks.

When a lock is first acquired, it is an active lock. It remains an active lock until successful completion of the unit of work, when it is released, or is converted into a retained lock if the unit of work fails, or for a CICS or SMSVSAM failure:

- If a unit of work fails, RLS VSAM or the CICS enqueue domain continues to hold the record locks that were owned by the failed unit of work for recoverable data sets, but converted into retained locks. Retaining locks ensures that data integrity for those records is maintained until the unit of work is completed.
- If a CICS region fails, locks are converted into retained locks to ensure that data integrity is maintained while CICS is being restarted.
- If an SMSVSAM server fails, locks are converted into retained locks (with the conversion being carried out by the other servers in the sysplex, or by the first server to restart if all servers have failed). This means that a UOW that held active RLS locks will hold retained RLS locks following the failure of an SMSVSAM server.

Converting active locks into retained locks not only protects data integrity. It also ensures that new requests for locks owned by the failed unit of work do not wait, but instead are rejected with the LOCKED response.

## Synchronization points

The end of a UOW is indicated to CICS by a **synchronization point** (usually abbreviated to **syncpoint**).

A syncpoint arises in the following ways:

- Implicitly at the end of a transaction as a result of an EXEC CICS RETURN command at the highest logical level. This means that a UOW cannot span tasks.
- Explicitly by EXEC CICS SYNCPOINT commands issued by an application program at appropriate points in the transaction.
- Implicitly through a DL/I program specification block (PSB) termination (TERM) call or command. This means that only one DL/I PSB can be scheduled within a UOW.

Note that an explicit EXEC CICS SYNCPOINT command, or an implicit syncpoint at the end of a task, implies a DL/I PSB termination call.

- Implicitly through one of the following CICS commands:  
EXEC CICS CREATE TERMINAL  
EXEC CICS CREATE CONNECTION COMPLETE  
EXEC CICS DISCARD CONNECTION  
EXEC CICS DISCARD TERMINAL
- Implicitly by a program called by a distributed program link (DPL) command if the SYNCONRETURN option is specified. When the DPL program terminates with an EXEC CICS RETURN command, the CICS mirror transaction takes a syncpoint.

It follows from this that a unit of work starts:

- At the beginning of a transaction
- Whenever an explicit syncpoint is issued and the transaction does not end
- Whenever a DL/I PSB termination call causes an implicit syncpoint and the transaction does not end
- Whenever one of the following CICS commands causes an implicit syncpoint and the transaction does not end:  
EXEC CICS CREATE TERMINAL  
EXEC CICS CREATE CONNECTION COMPLETE  
EXEC CICS DISCARD CONNECTION  
EXEC CICS DISCARD TERMINAL

A UOW that does not change a recoverable resource has no meaningful effect for the CICS recovery mechanisms. Nonrecoverable resources are never backed out.

A unit of work can also be ended by backout, which causes a syncpoint in one of the following ways:

- Implicitly when a transaction terminates abnormally, and CICS performs dynamic transaction backout
- Explicitly by EXEC CICS SYNCPOINT ROLLBACK commands issued by an application program to backout changes made by the UOW

### Examples

In Figure 1, task A is a nonconversational (or pseudoconversational) task with one UOW, and task B is a multiple UOW task (typically a conversational task in which each UOW accepts new data from the user). The figure shows how UOWs end at syncpoints. During the task, the application program can issue syncpoints explicitly, and, at the end, CICS issues a syncpoint.

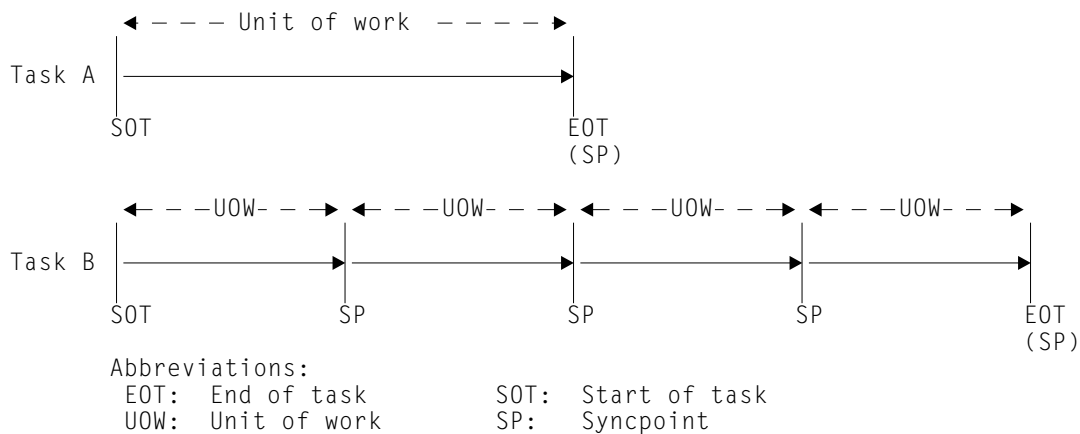

Figure 1. Units of work and syncpoints

Figure 2 on page 17 shows that database changes made by a task are not committed until a syncpoint is executed. If task processing is interrupted because of a failure of any kind, changes made within the abending UOW are automatically backed out.

If there is a system failure at time X:

- The change(s) made in task A have been committed and are therefore not backed out.
- In task B, the changes shown as Mod 1 and Mod 2 have been committed, but the change shown as Mod 3 is **not** committed and is backed out.
- All the changes made in task C are backed out.

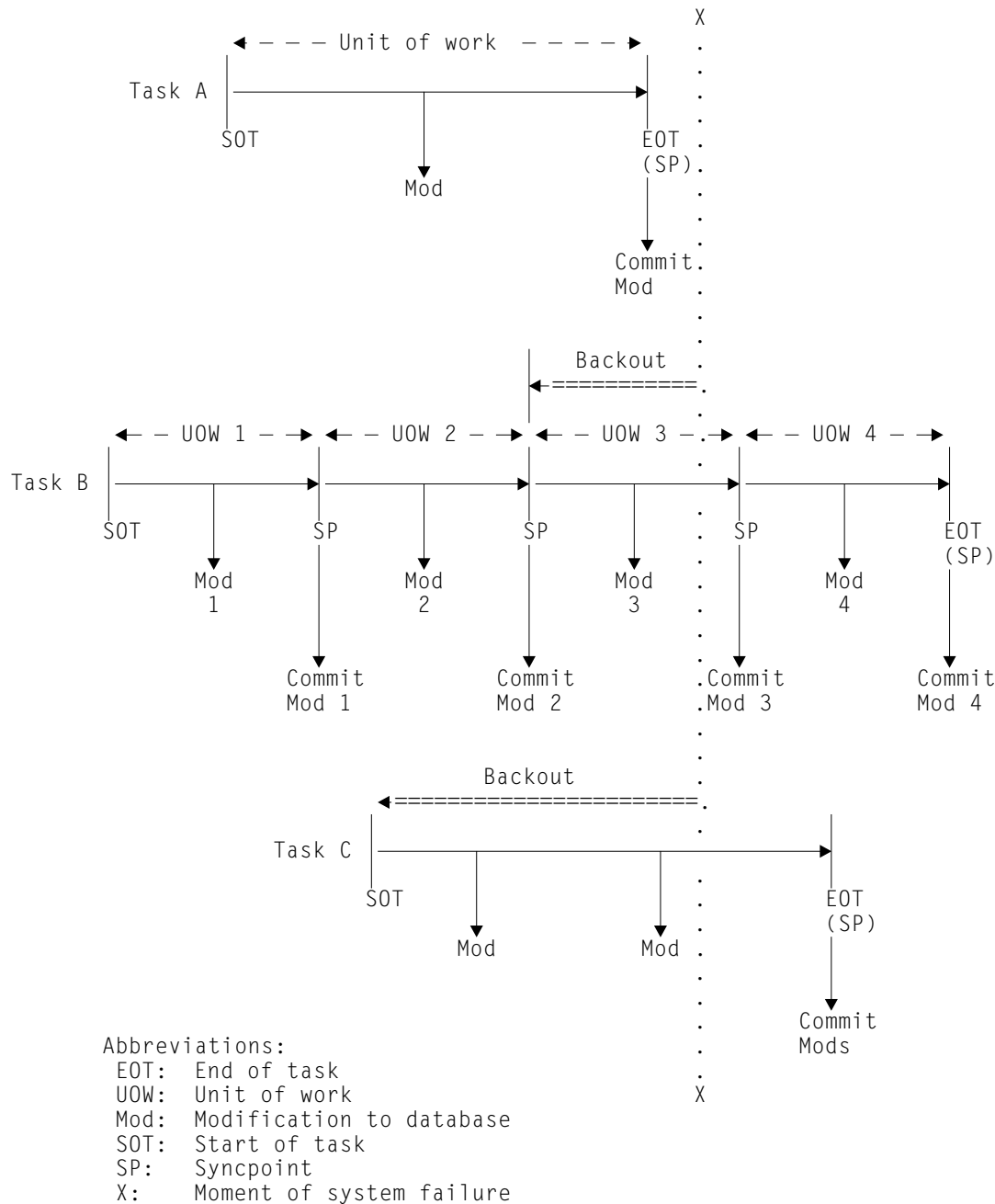

Figure 2. Backout of units of work

## CICS recovery manager

The recovery manager ensures the integrity and consistency of resources (such as files and databases) both within a single CICS region and distributed over interconnected systems in a network. Figure 3 on page 18 shows the resources with which the CICS recovery manager works.

The main functions of the CICS recovery manager are:

- Managing the state, and controlling the execution, of each UOW
- Coordinating UOW-related changes during syncpoint processing for recoverable resources

- Coordinating UOW-related changes during restart processing for recoverable resources
- Coordinating recoverable conversations to remote nodes
- Temporarily suspending completion (**shunting**), and later resuming completion (**unshunting**), of UOWs that cannot immediately complete commit or backout processing because the required resources are unavailable, because of system, communication, or media failure

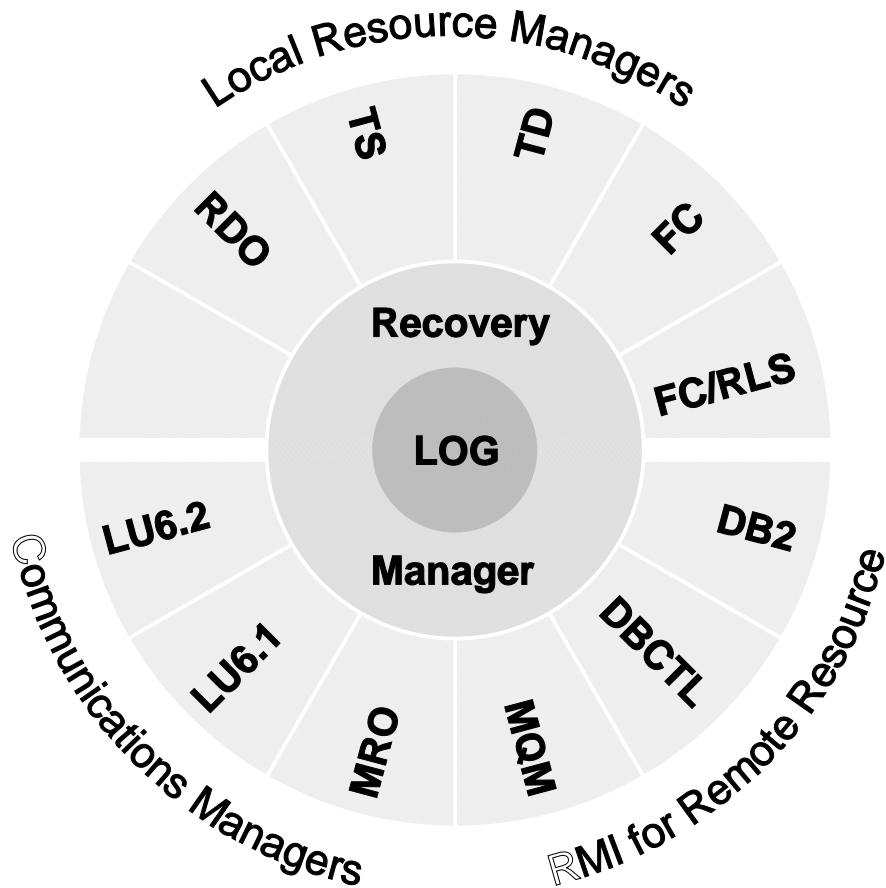

Figure 3. CICS recovery manager and resources it works with

## Managing the state of each unit of work

The CICS recovery manager maintains, for each UOW in a CICS region, a record of the changes of state that occur during its lifetime. Typical events that cause state changes include:

- Creation of the UOW, with a unique identifier
- Premature termination of the UOW because of transaction failure
- Receipt of a syncpoint request
- Entry into the in-doubt period during **two-phase commit** processing (see the *CICS Glossary* for a definition of two-phase commit)
- Notification that the resource is not available, requiring temporary suspension (shunting) of the UOW
- Notification that the resource is available, enabling retry of shunted UOWs
- Notification that a connection is reestablished, and can deliver a commit or rollback (backout) decision

- Syncpoint rollback
- Normal termination of the UOW

The identity of a UOW and its state are owned by the CICS recovery manager, and are recorded in storage and on the system log. The system log records are used by the CICS recovery manager during emergency restart to reconstruct the state of the UOWs in progress at the time of the earlier system failure.

The execution of a UOW can be distributed over more than one CICS system in a network of communicating systems.

The CICS recovery manager supports SPI commands that provide information about UOWs.

## Coordinating updates to local resources

The recoverable local resources managed by a CICS region are files, temporary storage, and transient data, plus resource definitions for terminals, typeterms, connections, and sessions.

Each local resource manager can write UOW-related log records to the local system log, which the CICS recovery manager may subsequently be required to re-present to the resource manager during recovery from failure.

To enable the CICS recovery manager to deliver log records to each resource manager as required, the CICS recovery manager adds additional information when the log records are created. Therefore, all logging by resource managers to the system log is performed through the CICS recovery manager.

During syncpoint processing, the CICS recovery manager invokes each local resource manager that has updated recoverable resources within the UOW. The local resource managers then perform the required action. This provides the means of coordinating the actions performed by individual resource managers.

If the commit or backout of a file resource fails (for example, because of an I/O error or the inability of a resource manager to free a lock), the CICS recovery manager takes appropriate action with regard to the failed resource:

- If the failure occurs during commit processing, the UOW is marked as commit-failed and is shunted awaiting resolution of whatever caused the commit failure.
- If the failure occurs during backout processing, the UOW is marked as backout-failed, and is shunted awaiting resolution of whatever caused the backout to fail.

Note that a commit failure can occur during the commit phase of a completed UOW, or the commit phase that takes place after successfully completing backout.<sup>1</sup>Note also that a UOW can be backout-failed with respect to some resources and commit-failed with respect to others. This can happen, for example, if two data sets are updated and the UOW has to be backed out, and the following happens:

- One resource backs out successfully
- While committing this successful backout, the commit fails
- The other resource fails to back out

---

1. Commit phase. The two types (or 'directions') of commit processing—commit after normal completion and commit after backout—are sometimes referred to as 'forward commit' and 'backward commit' respectively.

These events leave one data set commit-failed, and the other backout-failed. In this situation, the overall status of the UOW is logged as backout-failed.

During emergency restart following a CICS failure, each UOW and its state is reconstructed from the system log. If any UOW is in the backout-failed or commit-failed state, CICS automatically retries the UOW to complete the backout or commit.

## Coordinating updates in distributed units of work

If the execution of a UOW is distributed across more than one system, the CICS recovery managers (or their non-CICS equivalents) in each pair of connected systems ensure that the effects of the distributed UOW are atomic<sup>2</sup>. Each CICS recovery manager (or its non-CICS equivalent) issues the requests necessary to effect two-phase syncpoint processing to each of the connected systems with which a UOW may be in conversation.

**Note:** In this context, the non-CICS equivalent of a CICS recovery manager could be the recovery component of a database manager, such as DBCTL or <sup>®</sup>, or any equivalent function where one of a pair of connected systems is not CICS.

In each connected system in a network, the CICS recovery manager uses interfaces to its local recovery manager connectors (RMCs) to communicate with partner recovery managers. The RMCs are the communication resource managers (LU6.2, LU6.1, MRO, and RMI) which have the function of understanding the transport protocols and constructing the flows between the connected systems.

As remote resources are accessed during UOW execution, the CICS recovery manager keeps track of data describing the status of its end of the conversation with that RMC. The CICS recovery manager also assumes responsibility for the coordination of two-phase syncpoint processing for the RMC.

### Managing in-doubt units of work

During the syncpoint phases, for each RMC, the CICS recovery manager records the changes in the status of the conversation, and also writes, on behalf of the RMC, equivalent information to the system log.

If a session fails at any time during the running of a UOW, it is the RMC's responsibility to notify the CICS recovery manager, which takes appropriate action with regard to the unit of work as a whole. If the failure occurs during syncpoint processing, the CICS recovery manager may be in doubt and unable to determine immediately how to complete the UOW. In this case, the CICS recovery manager causes the UOW to be shunted awaiting UOW resolution, which follows notification from its RMC of successful resynchronization on the failed session.

During emergency restart following a CICS failure, each UOW and its state is reconstructed from the system log. If any UOW is in the in-doubt state, it remains shunted awaiting resolution.

## Resynchronization after system or connection failure

Units of work that fail while in an in-doubt state remain shunted until the in-doubt state can be resolved following successful resynchronization with the coordinator.

---

2. Atomic. A unit of work is said to be atomic when the changes it makes to resources within the UOW are either all committed or all backed out. See also ACID properties in the Glossary.



Resynchronization takes place automatically when communications are next established between subordinate and coordinator. (For an explanation and illustration of the roles played by subordinate and coordinator CICS regions, see the *CICS Intercommunication Guide*.) Any decisions held by the coordinator are passed to the subordinate, and in-doubt units of work complete normally. If a subordinate has meanwhile taken a unilateral decision following the loss of communication, this decision is compared with that taken by the coordinator, and messages report any discrepancy.

For more information about recovery and resynchronization of distributed units of work, see the *CICS Intercommunication Guide*.

---

## CICS system log

CICS system log data is written to two MVS system logger log streams, the primary log stream and secondary log stream, which together form a single logical log stream.

The system log is the only place where CICS records information for use when backing out transactions, either dynamically or during emergency restart processing. CICS automatically connects to its system log stream during initialization, unless you have specified a journal model definition that defines the system log as DUMMY (in which case CICS can perform only an initial start).

The *CICS System Definition Guide* tells you how to specify CICS system log streams, and how you can use journal model definitions to map the CICS journal names for the primary system log stream (DFHLOG) and the secondary system log stream (DFHSHUNT) to specific log stream names. If you don't specify journal model definitions, CICS uses default log stream names.

## Information recorded on the system log

The information recorded on the system log is sufficient to allow backout of changes made to recoverable resources by transactions that were running at the time of failure, and to restore the recoverable part of CICS system tables. Typically, this includes before-images of database records and after-images of recoverable parts of CICS tables—for example, transient data cursors or TCTTE sequence numbers. You cannot use the system log for forward recovery information, or for terminal control or file control autojournaling.

Your application programs can write user-defined recovery records to the system log using EXEC CICS WRITE JOURNALNAME commands. Any user-written log records to support your own recovery processes are made available to global user exit programs enabled at the XRCINPT exit point.

CICS also writes “backout-failed” records to the system log if a failure occurs in backout processing of a VSAM data set during dynamic backout or emergency restart backout.

In the event of an uncontrolled termination of CICS, records on the system log are used as input to the emergency restart process.

## System activity keypoints

The recovery manager controls the recording of keypoint information, and the delivery of the information to the various resource managers at emergency restart. The recovery manager provides the support that enables activity keypoint

information to be recorded at frequent intervals on the system log. You specify the activity keypoint frequency on the AKPFREQ system initialization parameter. (See the *CICS System Definition Guide* for details.) Activity keypoint information is of two types:

1. A list of all the UOWs currently active in the system
2. Image-copy type information allowing the current contents of a particular resource to be rebuilt

During an initial phase of CICS restart, recovery manager uses this information, together with UOW-related log records, to restore the CICS system to its state at the time of the previous shutdown. This is done on a single backward scan of the system log.

**Frequency of taking activity keypoints:** You are strongly recommended to specify a nonzero activity keypoint frequency—see the parameter description in the *CICS System Definition Guide*. Choose an activity keypoint frequency that is suitable for the size of your system log stream. Note that writing activity keypoints at short intervals improves restart times, but at the expense of extra processing during normal running.

The following additional actions are taken for files accessed in non-RLS mode that use backup while open (BWO):

- Tie-up records are recorded on the forward recovery log stream. A tie-up record associates a CICS file name with a VSAM data set name.
- Recovery points are recorded in the integrated catalog facility (ICF) catalog. These define the starting time for forward recovery. Data recorded on the forward recovery log before that time does not need to be used.

---

## Forward recovery logs

CICS writes VSAM forward recovery logs to a general log stream defined to the MVS system logger. You can merge forward recovery log data for more than one VSAM data set to the same log stream, or you can dedicate a forward recovery log stream to a single data set.

See “Defining forward recovery log streams” on page 112 for information about the use of forward recovery log streams.

---

## User journals and automatic journaling

User journals and autojournals are written to a general log stream defined to the MVS system logger.

- User journaling is entirely under your application programs’ control. You write records for your own purpose using EXEC CICS WRITE JOURNALNAME commands. See “Flushing journal buffers” on page 28 for information about CICS shutdown considerations.
- Automatic journaling means that CICS automatically writes records to a log stream, referenced by the journal name specified in a journal model definition, as a result of:
  - Records read from or written to files. These records represent data that has been read, or data that has been read for update, or data that has been written, or records to indicate the completion of a write, and so on, depending on what types of request you selected for autojournaling.

You specify that you want autojournaling for VSAM files using the autojournaling options on the file resource definition in the CSD. For BDAM files, you specify the options on a file entry in the file control table.

- Input or output messages from terminals accessed through VTAM.

You specify that you want terminal control autojournaling on the JOURNAL option of the profile resource definition referenced by your transaction definitions. These messages could be used to create audit trails.

Automatic journaling is used for user-defined purposes; for example, for an audit trail. Automatic journaling is not used for CICS recovery purposes.



---

## Chapter 3. Shutdown and restart recovery

This chapter describes the various ways in which CICS can shut down, both normally and abnormally, and how CICS restarts following a shutdown. It covers the following topics:

- Shutdown
- Cataloging CICS resources
- Reconstructing CICS state at restart during:
  - Warm restart
  - Emergency restart
  - Cold start
  - Initial start
  - Dynamic RLS restart (which takes place while CICS is running)
- VTAM persistent sessions recovery

---

### Shutdown

CICS can stop executing as a result of:

- A normal (warm) shutdown initiated by a CEMT, or EXEC CICS, PERFORM SHUT command
- An immediate shutdown initiated by a CEMT, or EXEC CICS, PERFORM SHUT IMMEDIATE command
- An abnormal shutdown caused by a CICS system module encountering an irrecoverable error
- An abnormal shutdown initiated by a request from the operating system (arising, for example, from a program check or system abend)
- A machine check or power failure

### Normal shutdown processing

Normal shutdown is initiated by issuing a CEMT PERFORM SHUTDOWN command, or by an application program issuing an EXEC CICS PERFORM SHUTDOWN command. It takes place in three quiesce stages, as follows:

#### First quiesce stage

During the first quiesce stage of shutdown, all terminals are active, all CICS facilities are available, and the following activities are performed concurrently:

- CICS invokes the **shutdown assist transaction** specified on the SDTRAN system initialization parameter or on the shutdown command.

Because all user tasks must terminate during the first quiesce stage, it is possible that shutdown could be unacceptably delayed by long-running tasks (such as conversational transactions). The purpose of the shutdown assist transaction is to allow as many tasks as possible to commit or back out cleanly, while ensuring that shutdown completes within a reasonable time.

CICS obtains the name of the shutdown assist transaction as follows:

1. If SDTRAN(*tranid*) is specified on the PERFORM SHUTDOWN command, or as a system initialization parameter, CICS invokes that *tranid*.
2. If NOSDTRAN is specified on the PERFORM SHUTDOWN command, or as a system initialization parameter, CICS does not start a shutdown transaction. Without a shutdown assist transaction, all tasks that are already running are allowed to complete.
3. If the SDTRAN (or NOSDTRAN) options are omitted from the PERFORM SHUTDOWN command, and omitted from the system initialization

parameters, CICS invokes the default shutdown assist transaction, CESD, which runs the CICS-supplied program DFHCESD.

The SDTRAN option specified on the PERFORM SHUT command overrides any SDTRAN option specified as a system initialization parameter.

- The DFHCESD program started by the CICS-supplied transaction, CESD, attempts to purge and back out long-running tasks using increasingly stronger methods (see “The shutdown assist transaction” on page 30).
- Tasks that are automatically initiated are run—if they start before the second quiesce stage.
- Any programs listed in the first part of the shutdown program list table (PLT) are run sequentially. (The shutdown PLT suffix is specified in the PLTSD system initialization parameter, which can be overridden by the PLT option of the CEMT or EXEC CICS PERFORM SHUTDOWN command.)
- A new task started as a result of terminal input is allowed to start only if its transaction code is listed in the current transaction list table (XLT) or has been defined as SHUTDOWN(ENABLED) in the transaction resource definition. The XLT list of transactions restricts the tasks that can be started by terminals and allows the system to shut down in a controlled manner. The current XLT is the one specified by the XLT=xx system initialization parameter, which can be overridden by the XLT option of the CEMT or EXEC CICS PERFORM SHUTDOWN command.

Certain CICS-supplied transactions are, however, allowed to start whether their code is listed in the XLT or not. These transactions are CEMT, CESF, CLR1, CLR2, CLQ2, CLS1, CLS2, CSAC, CSTE, and CSNE.

- Finally, at the end of this stage and before the second stage of shutdown, CICS unbinds all the VTAM terminals and devices.

The first quiesce stage is complete when the last of the programs listed in the first part of the shutdown PLT has executed **and** all user tasks are complete. If the CICS-supplied shutdown transaction CESD is used, this stage does not wait indefinitely for all user tasks to complete.

### **Second quiesce stage**

During the second quiesce stage of shutdown:

- Terminals are not active.
- No new tasks are allowed to start.
- Programs listed in the second part of the shutdown PLT (if any) run sequentially. These programs cannot communicate with terminals, or make any request that would cause a new task to start.

The second quiesce stage ends when the last of the programs listed in the PLT has completed executing.

### **Third quiesce stage**

During the third quiesce stage of shutdown:

- CICS closes all files that are defined to CICS file control. However, CICS does not catalog the files as UNENABLED; they can then be opened implicitly by the first reference after a subsequent CICS restart.

Files that are eligible for BWO support have the BWO attributes in the ICF catalog set to indicate that BWO is not supported. This prevents BWO backups being taken in the subsequent batch window.

- All extrapartition TD queues are closed.

- CICS writes statistics to the system management facility (SMF) data set.
- CICS recovery manager sets the type-of-restart indicator in its domain state record in the global catalog to “warm-start-possible”. If you specify START=AUTO when you next initialize the CICS region, CICS uses the status of this indicator to determine the type of startup it is to perform. See “Reconstructing the state of the CICS region” on page 33.
- CICS writes warm keypoint records to:
  - The global catalog for terminal control and profiles
  - The CICS system log for all other resources.

See “Warm keypoints”.

- CICS deletes all completed units of work (log tail deletion), leaving only shunted units of work and the warm keypoint.

**Note:** Specifying no activity keypointing (AKPFREQ=0) only suppresses log tail deletion while CICS is running, not at shutdown. CICS always performs log cleanup at shutdown unless you specify RETPD=dddd on the MVS definition of the system log. See “Activity keypointing” on page 108 for more information.

- CICS stops executing.

### Warm keypoints

The CICS-provided warm keypoint program (DFHWKP) writes a warm keypoint to the global catalog, for terminal control and profile resources only, during the third quiesce stage of shutdown processing when all system activity is quiesced. The remainder of the warm keypoint information, for all other resources, is written to the CICS system log stream, under the control of the CICS recovery manager. This system log warm keypoint is written by the activity keypoint program as a special form of activity keypoint that contains information relating to shutdown.

The warm keypoints contain information needed to restore the CICS environment during a subsequent warm or emergency restart. Thus CICS needs both the global catalog and the system log to perform a restart. If you run CICS with a system log that is defined by a journal model specifying TYPE(DUMMY), you cannot restart CICS with START=AUTO following a normal shutdown, or with START=COLD.

### Shunted units of work at shutdown

If there are shunted units of work of any kind at shutdown, CICS issues message DFHRM0203. This message displays the numbers of indoubt, backout-failed, and commit-failed units of work held in the CICS region’s system log at the time of the normal shutdown. It is issued only if there is at least one such UOW. If there are no shunted units of work, CICS issues message DFHRM0204.

DFHRM0203 is an important message that should be logged, and should be taken note of when you next restart the CICS region. For example, if you receive DFHRM0203 indicating that there is outstanding work waiting to be completed, you should not perform a cold or initial start of the CICS region. You are recommended to always restart CICS with START=AUTO, and especially after message DFHRM0203, otherwise recovery data is lost.

See “Chapter 4. CICS cold start” on page 41 for information about a cold start if CICS has issued message DFHRM0203 at the previous shutdown.

## Flushing journal buffers

During a successful normal shutdown, CICS calls the log manager domain to flush all journal buffers, ensuring that all journal records are written to their corresponding MVS system logger log streams.

During an immediate shutdown, the call to the log manager domain is bypassed and journal records are not flushed. This also applies to an immediate shutdown that is initiated by the shutdown-assist transaction because a normal shutdown has stalled. Therefore, any user journal records in a log manager buffer at the time of an immediate shutdown are lost. This does not affect CICS system data integrity. The system log and forward recovery logs are always synchronised with regard to I/O and unit of work activity. If user journal data is important, you should take appropriate steps to ensure that journal buffers are flushed at shutdown.

These situations and possible solutions are summarized as follows:

- In a controlled shutdown that completes normally, CICS ensures that user journals are flushed.
- In a controlled shutdown that is forced into an immediate shutdown by a shutdown-assist transaction, CICS does not flush buffers. To avoid the potential loss of journal records in this case, you can provide a PLTSD program that issues a SET JOURNAL FLUSH command to ensure that log manager buffers are written to the corresponding log streams. PLTSD programs are invoked before an immediate shutdown is initiated by the shutdown-assist transaction.
- In an uncontrolled shutdown explicitly requested with the SHUT IMMEDIATE command, CICS does not flush buffers. To avoid the potential loss of journal records in this case, you can issue an EXEC CICS WAIT JOURNALNAME command at appropriate points in the application program, or immediately before returning control to CICS. (Alternatively, you could specify the WAIT option on the WRITE JOURNALNAME command.) See the description of the WAIT JOURNALNAME command in the *CICS Application Programming Reference* for information about the journaling WAIT option.

## Immediate shutdown processing (PERFORM SHUTDOWN IMMEDIATE)

### **PERFORM IMMEDIATE not recommended**

As a general rule when terminating CICS, you are recommended to use a normal shutdown with a shutdown assist transaction, specifying either your own or the CICS-supplied default, CESD.

You should resort to using an immediate shutdown only if you have a special reason for doing so. For instance, you might need to stop and restart CICS during a particularly busy period, when the slightly faster immediate shutdown may be of benefit. Also, you can use VTAM persistent sessions support with an immediate shutdown.

You initiate an immediate shutdown by a CEMT, or EXEC CICS, PERFORM SHUTDOWN IMMEDIATE command. Immediate shutdown is different from a normal shutdown in a number of important ways:

1. If the shutdown assist transaction is not run (that is, the SDTRAN system initialization parameter specifies NO, or the PERFORM SHUTDOWN command specifies NOSDTRAN), user tasks are not guaranteed to complete. This can lead to an unacceptable number of units of work being shunted, with locks being retained.



2. If the default shutdown assist transaction CESD is run, it allows as many tasks as possible to commit or back out cleanly, but within a shorter time than that allowed on a normal shutdown. See “The shutdown assist transaction” on page 30 for more information about CESD, which runs the CICS-supplied program DFHCESD.
3. None of the programs listed in the shutdown PLT is executed.
4. CICS does **not** write a warm keypoint or a warm-start-possible indicator to the global catalog.
5. CICS does not close files managed by file control. It is left to VSAM to close the files when VSAM is notified by MVS that the address space is terminating. This form of closing files means that a VSAM VERIFY is needed on the next open of the files closed in this way, but this is done automatically.
6. VTAM sessions wait for the restarted region to initialize or until the expiry of the interval specified in the PSDINT system initialization parameter, whichever is earlier.

The next initialization of CICS *must* be an emergency restart, in order to preserve data integrity. An emergency restart is ensured if the next initialization of CICS specifies START=AUTO. This is because the recovery manager’s type-of-restart indicator is set to “emergency-restart-needed” during initialization and is not reset in the event of an immediate or uncontrolled shutdown. See “Reconstructing the state of the CICS region” on page 33.

**Note:** A PERFORM SHUTDOWN IMMEDIATE command can be issued, by the operator or by the shutdown assist transaction, while a normal or immediate shutdown is already in progress. If this happens, the shutdown assist transaction is not restarted; the effect is to force an immediate shutdown with no shutdown assist transaction.

If the original PERFORM SHUTDOWN request specified a normal shutdown, and the restart manager (ARM) was active, CICS is **not** restarted (because CICS de-registers from the automatic restart manager at the beginning of a normal shutdown).

## Shutdown requested by the operating system

This type of shutdown can be initiated by the operating system as a result of a program check or an operating system abend. A program check or system abend can cause either an individual transaction to abend or CICS to terminate. (For further details, see “Processing operating system abends and program checks” on page 89.)

A CICS termination caused by an operating system request:

- Does not guarantee that user tasks will complete.
- Does not allow shutdown PLT programs to execute.
- Does **not** write a warm keypoint or a warm-start-possible indicator to the global catalog.
- Takes a system dump (unless system dumps are suppressed by the DUMP=NO system initialization parameter).
- Does not close any open files. It is left to VSAM to close the files when VSAM is notified by MVS that the address space is terminating. This form of closing files means that a VSAM VERIFY is needed on the next open of the files closed in this way, but this is done automatically.

The next initialization of CICS *must* be an emergency restart, in order to preserve data integrity. An emergency restart is ensured if the next initialization of CICS specifies START=AUTO. This is because the recovery manager's type-of-restart indicator is set to "emergency-restart-needed" during initialization, and is not reset in the event of an immediate or uncontrolled shutdown.

## Uncontrolled termination

An uncontrolled shutdown of CICS can be caused by:

- Power failure
- Machine check
- Operating system failure

In each case, CICS cannot perform any shutdown processing. In particular, CICS does **not** write a warm keypoint or a warm-start-possible indicator to the global catalog.

The next initialization of CICS *must* be an emergency restart, in order to preserve data integrity. An emergency restart is ensured if the next initialization of CICS specifies START=AUTO. This is because the recovery manager's type-of-restart indicator is set to "emergency-restart-needed" during initialization, and is not reset in the event of an immediate or uncontrolled shutdown.

## The shutdown assist transaction

On an immediate shutdown, CICS does not allow running tasks to finish; and backout is not performed until emergency restart. This can cause an unacceptable number of units of work to be shunted, with locks being retained. On the other hand, on a normal shutdown, CICS waits indefinitely for running transactions to finish, which can delay shutdown to a degree that is unacceptable. The CICS shutdown assist transaction improves both these forms of shutdown and, to a large degree, removes the need for an immediate shutdown.

The operation of CESD, for both normal and immediate shutdowns, takes place over a number of stages. CESD controls these stages by sampling the number of tasks present in the system, and proceeds to the next stage if the number of in-flight tasks is not reducing quickly enough.

The stages of a normal shutdown CESD are as follows:

- In the initial stage of assisted shutdown, CESD attempts to complete a normal shutdown in a reasonable time.
- After a time allowed for transactions to finish normally (that is, after the number of tasks has not reduced over a period of eight samples), CESD proceeds to issue a normal purge for each remaining task. The transaction dump data set is closed in this stage.
- If there are still transactions running after a further eight samples (except when persistent sessions support is being used), VTAM is force-closed and IRC is closed immediately.
- Finally, if there are still transactions running, CICS shuts down abnormally, leaving details of the remaining in-flight transactions on the system log to be dealt with during an emergency restart.

The operation of CESD is quicker for an immediate shutdown, with the number of tasks in the system being sampled only four times instead of eight.

You are recommended always to use the CESD shutdown-assist transaction when shutting down your CICS regions. You can use the DFHCESD program “as is”, or use the supplied source code as the basis for your own customized version (CICS supplies versions in assembler, VS COBOL II, and PL/I). For more information about the operation of the CICS-supplied shutdown assist program, see the *CICS Operations and Utilities Guide*.

---

## Cataloging CICS resources

CICS uses two catalog data sets:

- The global catalog data set (DFHGCD)
- The local catalog data set (DFHLCD)

The *CICS System Definition Guide* tells you how to create and initialize these CICS catalog data sets.

While CICS is running, the catalogs (and the system log) receive information passed from one execution of CICS, through a shutdown, to the next execution of CICS. This information is used for warm and emergency restarts, and to a lesser extent for cold starts also. If the global catalog fails (for reasons other than filling the available space), the recovery manager control record is lost. Without this, it is impossible to perform a warm, emergency, or cold start, and the only possibility is then an initial start. For example, if the failure is due to an I/O error, you can't restart.

Usually, if the global catalog fills, CICS abnormally terminates, in which case you could define more space and attempt an emergency restart.

Consider putting the catalog data sets on the most reliable DASD available—RAID or dual-copy devices—to ensure maximum protection of the data. Taking ordinary copies is not recommended because of the risk of getting out of step with the system log.

**From a restart point of view, the system log and the CICS catalog (both data sets) form one logical set of data, and all of them are required for a restart.**

## Global catalog

The global catalog contains information needed at restart, and CICS uses it to store the following information:

- The names of the system log streams.
- Copies of tables of installed resource definitions, and related information, for the following:
  - Transactions and transaction classes
  - DB2 resource definitions
  - Programs, mapsets, and partitionsets (including autoinstalled programs, subject to the operand you specify on the PGAICTLG system initialization parameter)
  - Terminals and typeterms (for predefined and autoinstalled resources)
  - Autoinstall terminal models
  - Profiles
  - Connections, sessions, and partners
  - BDAM and VSAM files (including data tables) and
    - VSAM LSR pool share control blocks

- Data set names and data set name blocks
- File control recovery blocks (only if a SHCDS NONRLSUPDATEPERMITTED command has been used).
- Transient data queue definitions
- Dump table information
- Interval control elements and automatic initiate descriptors at shutdown
- APPC connection information so that relevant values can be restored during a persistent sessions restart
- Logname information used for communications resynchronization
- Monitoring options in force at shutdown
- Statistics interval collection options in force at shutdown
- Journal model and journal name definitions
- Enqueue model definitions
- Temporary storage model definitions.

Most resource managers update the catalog whenever they make a change to their table entries. Terminal and profile resource definitions are exceptions (see the next list item about the catalog warm keypoint). Because of the typical volume of changes, terminal control does not update the catalog, except when:

- Running a VTAM query against a terminal
  - A generic connection has bound to a remote system
  - Installing a terminal
  - Deleting a terminal.
- A partial warm keypoint at normal shutdown. This keypoint contains an image copy of the TCT and profile resource definitions at shutdown for use during a warm restart.

**Note:** The image copy of the TCT includes all the permanent devices installed by explicit resource definitions. Except for some autoinstalled APPC connections, it does *not* include autoinstalled devices. Autoinstalled terminal resources are cataloged initially, in case they need to be recovered during an emergency restart, but only if the AIRDELAY system initialization parameter specifies a nonzero value. Therefore, apart from the APPC exceptions mentioned above, autoinstalled devices are excluded from the warm keypoint, and are thus not recovered on a warm start.

- Statistics options.
- Monitoring options.
- The recovery manager's control record, which includes the type-of-restart indicator (see "Reconstructing the state of the CICS region" on page 33).

All this information is essential for a successful restart following any kind of shutdown.

## Local catalog

The CICS local catalog data set represents just one part of the CICS catalog, which is implemented as two physical data sets. The two data sets are logically one set of cataloged data managed by the CICS catalog domain. Although minor in terms of the volume of information recorded on it, the local catalog is of equal importance with the global catalog, and the data should be equally protected when restarts are performed.

If you ever need to redefine and reinitialize the CICS local catalog, you should also reinitialize the global catalog. After reinitializing both catalog data sets, you must perform an initial start.

---

## Reconstructing the state of the CICS region

CICS recovery manager uses the type-of-restart indicator in its domain state record from the global catalog to determine which type of restart it is to perform. This indicator operates as follows:

- Before the end of initialization, on all types of startup, CICS sets the indicator in the control record to “emergency restart needed”.
- If CICS terminates normally, this indicator is changed to “warm start possible”.
- If CICS terminates abnormally because the system log has been corrupted and is no longer usable, this indicator is changed to “no restart”. After fixing the system log, perform an initial start of the failed CICS region.
- For an automatic start (START=AUTO):
  - If the indicator says “warm start possible”, CICS performs a warm start.
  - If the indicator says “emergency restart needed”, CICS performs an emergency restart.

## Overriding the type of start indicator

The operation of the recovery manager’s control record can be modified by running the recovery manager utility program, DFHRMUTL. This can set an autostart record that determines the type of start CICS is to perform, effectively overriding the type of start indicator in the control record. See the *CICS Operations and Utilities Guide* for information about using DFHRMUTL to modify the type of start performed by START=AUTO.

## Warm restart

If you shut down a CICS region normally, CICS restarts with a warm restart if you specify START=AUTO. For a warm start to succeed, CICS needs the information stored in the CICS catalogs at the previous shutdown, and the information stored in the system log.

In a warm restart, CICS:

- Restores the state of the CICS region to the state it was in at completion of the normal shutdown. All CICS resource definitions are restored from the global catalog, and the GRPLIST, DCT, FCT, and CSDxxxx system initialization parameters are ignored.

CICS also uses information from the warm keypoint in the system log.

- Reconnects to the system log.
- Retries any backout-failed and commit-failed units of work.
- Rebuilds indoubt-failed units of work.

For more information about the warm restart process, see “Chapter 5. CICS warm restart” on page 49.

## Emergency restart

If a CICS region fails, CICS restarts with an emergency restart if you specify START=AUTO. An emergency restart is similar to a warm start but with additional recovery processing—for example, to back out any transactions that were in-flight at the time of failure, and thus free any locks protecting resources.

If the failed CICS region was running with VSAM record-level sharing, SMSVSAM converts into retained locks any active exclusive locks held by the failed system, pending the CICS restart. This means that the records are protected from being updated by any other CICS region in the sysplex. Retained locks also ensure that other regions trying to access the protected records do not wait on the locks until the failed region restarts. See the *CICS Application Programming Guide* for information about active and retained locks.

For non-RLS data sets (including BDAM data sets), any locks (ENQUEUEES) that were held before the CICS failure are re-acquired.

### **Initialization during emergency restart**

Most of CICS initialization following an emergency restart is the same as for a warm restart, and CICS uses the catalogs and the system log to restore the state of the CICS region. Then, after the normal initialization process, emergency restart performs the recovery process for work that was in-flight when the previous run of CICS was abnormally terminated.

### **Recovery of data during emergency restart**

During the final stage of emergency restart, the recovery manager uses the system log data to drive backout processing for any UOWs that were in-flight at the time of the failure. The backout of UOWs during emergency restart is the same as a dynamic backout; there is no distinction between the backout that takes place at emergency restart and that which takes place at any other time.

The recovery manager also drives:

- The backout processing for any UOWs that were in a backout-failed state at the time of the CICS failure
- The commit processing for any UOWs that were in a commit-failed state at the time of the CICS failure
- The commit processing for UOWs that had not completed commit at the time of failure (resource definition recovery, for example).

The recovery manager drives these backout and commit processes because the condition that caused them to fail may be resolved by the time CICS restarts. If the condition that caused a failure has not been resolved, the UOW remains in backout- or commit-failed state. See “Backout-failed recovery” on page 73 and “Commit-failed recovery” on page 77 for more information.

For more information about the emergency restart process, see “Chapter 6. CICS emergency restart” on page 55.

## **Cold start**

On a cold start, CICS reconstructs the state of the region from the previous run for remote resources only. For all resources, the region is built from resource definitions specified on the GRPLIST system initialization parameter and those resources defined in control tables.

The following is a summary of how CICS uses information stored in the global catalog and the system log on a cold start:

- CICS preserves, in both the global catalog and the system log, all the information relating to distributed units of work for partners linked by:
  - APPC
  - MRO connections to regions running under CICS Transaction Server for OS/390 Release 1

- The resource manager interface (RMI) (for example, to DB2 and DBCTL).
- CICS does not preserve any information in the global catalog or the system log that relates to local units of work.

Generally, to perform a cold start you specify START=COLD, but CICS can also force a cold start in some circumstances when START=AUTO is specified. See the table in the *CICS System Definition Guide* for details of the effect of the START parameter in conjunction with various states of the global catalog and the system log.

### **An initial start of CICS**

If you want to initialize a CICS region without any reference to a previous run, perform an initial start. You can do this by specifying START=INITIAL as a system initialization parameter, or by running the recovery manager's utility program (DFHRMUTL) to override the type of start indicator to force an initial start.

See the *CICS Operations and Utilities Guide* for information about the DFHRMUTL utility program.

## **Dynamic RLS restart**

If a CICS region is connected to an SMSVSAM server when the server fails, CICS continues running, and recovers using a process known as **dynamic RLS restart**. An SMSVSAM server failure does not cause CICS to fail, and does not affect any resource other than data sets opened in RLS mode.

When an SMSVSAM server fails, any locks for which it was responsible are converted to retained locks by another SMSVSAM server within the sysplex, thus preventing access to the records until the situation has been recovered. CICS detects that the SMSVSAM server has failed the next time it tries to perform an RLS access after the failure, and issues message DFHFC0153. The CICS regions that were using the failed SMSVSAM server defer in-flight transactions by abending UOWs that attempt to access RLS, and shunt them when the backouts fail with "RLS is disabled" responses. If a unit of work is attempting to commit its changes and release RLS locks, commit failure processing is invoked when CICS first detects that the SMSVSAM server is not available (see "Commit-failed recovery" on page 77).

RLS mode open requests and RLS mode record access requests issued by new units of work receive error responses from VSAM when the server has failed. The SMSVSAM server normally restarts itself without any manual intervention. After the SMSVSAM server has restarted, it uses the MVS event notification facility (ENF) to notify all the CICS regions within its MVS image that the SMSVSAM server is available again.

CICS performs a dynamic equivalent of emergency restart for the RLS component, and drives backout of the deferred work.

Recovery after the failure of an SMSVSAM server is usually performed automatically by CICS. CICS retries any backout-failed and commit-failed UOWs. In addition to retrying those failed as a result of the SMSVSAM server failure, this also provides an opportunity to retry any backout failures for which the cause has now been resolved. Manual intervention is required only if there are units of work which, due to the timing of their failure, were not retried when CICS received the ENF signal. This situation is extremely unlikely, and such units of work can be detected using the INQUIRE UOWDSNFAIL command.

Note that an SMSVSAM server failure causes commit-failed or backout-failed units of work only in the CICS regions registered with the server in the same MVS image. Transactions running in CICS regions in other MVS images within the sysplex are affected only to the extent that they receive LOCKED responses if they try to access records protected by retained locks owned by any CICS regions that were using the failed SMSVSAM server.

---

## VTAM persistent sessions recovery

Persistent session support improves the availability of CICS. It benefits from VTAM persistent LU-LU session support to provide restart-in-place of a failed CICS without re-binding.

CICS support of persistent sessions includes the support of all LU-LU sessions, except LU0 pipeline and LU6.1 sessions. CICS determines for how long the sessions should be retained from the time on the PSDINT system initialization parameter. This is a user-defined time interval. If a failed CICS is restarted within this time, it can use the retained sessions immediately—there is no need for network flows to re-bind them.

You can change the interval using the CEMT SET VTAM command, or the EXEC CICS SET VTAM command, but the changed interval is not stored in the CICS global catalog, and therefore is not restored in an emergency restart.

If CICS is terminated by means of a CEMT PERFORM SHUTDOWN IMMEDIATE command or if CICS fails, the CICS sessions are held by VTAM in “recovery pending” state, and may be recovered during startup by a newly starting CICS region.

During emergency restart, CICS restores those sessions pending recovery from the CICS global catalog and the CICS system log to an “in session” state. This happens when CICS opens its VTAM ACB.

Before specific terminal types and levels of service are discussed, note that many factors can affect the performance of a terminal at takeover, including:

- The type of terminal
- The total number of terminals connected
- What the end user is doing at the time of takeover
- The type of failure of the CICS system
- How the terminal is defined by the system programmer

Subsequent processing is LU-dependent: cleanup and recovery for non-LU6 persistent sessions are similar to those for non-LU6 backup sessions under XRF. Cleanup and recovery for LU6.2 persistent sessions maintain the bound session when possible, but there are cases where it is necessary to unbind and re-bind the sessions; for example, where CICS fails during a session resynchronization.

The end user of a terminal sees different symptoms of a CICS failure following a restart, depending on whether CICS is initialized with VTAM persistent sessions support or XRF support:

- If CICS is running without VTAM persistent sessions or XRF, and fails, the terminal user sees the VTAM logon panel followed by the “good morning” message (if AUTOCONNECT(YES) is specified for the TYPETERM resource definition).



- If CICS does not have persistent session support and fails, and the terminal user enters data while CICS is recovering, it appears as if CICS is “hanging”; the screen on display at the time of the failure remains until persistent session recovery is complete. You can use the RECOVOPTION and RECOVNOTIFY keywords to customize CICS so that either a successful emergency restart can be transparent to terminal users, or terminal users can be notified of the CICS failure, allowing them to take the appropriate recovery actions.

If APPC sessions are active at the time CICS fails, persistent sessions recovery appears to APPC partners as CICS “hanging”. VTAM saves requests issued by the APPC partner, and passes them to CICS when the persistent recovery is complete. After a successful emergency restart, recovery of terminal sessions is determined by the options defined in PSRECOVERY of the CONNECTION definition and RECOVOPTION of the session definition. If the appropriate recovery options have been selected (see the *CICS Resource Definition Guide*), and the APPC sessions are in the correct state, CICS performs an ISSUE ABEND (see the *CICS Distributed Transaction Programming Guide*) to inform the partner that the current conversation has been abnormally terminated.

## Multi-node persistent sessions

If you are using multi-node persistent sessions (MNPS) support, sessions can be retained across a VTAM failure. After VTAM has been restarted, sessions are restored when the ACB is reopened (either automatically by the COVR transaction or by a CEMT, or EXEC CICS, SET VTAM OPEN command). To ensure that CICS retains its sessions and restores them when the ACB is reopened, code PSTYPE=MNPS as a system initialization parameter.

APPC synclevel 2 sessions are not restored. They are unbound when the ACB is opened.

When the VTAM failure occurs and the TPEND failure exit is driven, the autoinstalled terminals that are normally deleted at this point are retained by CICS. If the session is not restored and the terminal is not reused within the AIRDELAY interval, CICS deletes the TCTTE when the AIRDELAY interval expires after the ACB is re-opened successfully.

Table 1 indicates whether sessions are restored or unbound in a number of recovery scenarios: (1) a CICS emergency restart with persisting sessions; (2) a VTAM restart after a VTAM failure, where CICS continues running and the ACB is reopened; (3) CICS cold and warm starts; and (4) the dynamic open of the VTAM ACB by a CICS operator command.

Table 1. Effect of VTAM persistent sessions support on CICS terminals and sessions

Recovery scenario	Terminal	LU62 (synclevel 1)	LU62 (synclevel 2)	LU61
CICS emergency restart	Restored	Restored	Restored	Unbound
VTAM_RESTART (MNPS only)	Restored	Restored	Unbound	Unbound
CICS COLD start	Unbound	Unbound	Unbound	Unbound
CICS WARM start	Unbound	Unbound	Unbound	Unbound
Dynamic open of VTAM ACB	Unbound	Unbound	Unbound	Unbound

---

## Single-node persistent sessions

If you are not running with VTAM MNPS then you do not need a PSTYPE system initialization parameter and sessions are not retained or recovered after a VTAM abend and subsequent opening of the VTAM ACB (CEMT SET VTAM OPEN).

## Unbinding sessions

CICS does not always reestablish sessions held by VTAM in a recovery pending state. CICS (or VTAM) unbinds recovery pending sessions in the following situations:

- If CICS does not restart within the specified persistent session delay interval
- If you perform a COLD start after a CICS failure
- If CICS restarts with XRF=YES (when the failed CICS was running with XRF=NO)
- If CICS cannot find a terminal control table terminal entry (TCTTE) for a session (for example, because the terminal was autoinstalled with AIRDELAY=0 specified)
- If a terminal or session is defined with the recovery option (RECOVOPT) set to UNCONDREL or NONE
- If CICS determines that it cannot recover the session without unbinding and re-binding it
- If a connection is defined with the persistent session recovery option (PSRECOVERY) set to NONE

In all these situations, the sessions are unbound, and the result is as if CICS has restarted following a failure without VTAM persistent session support.

There are some other situations where APPC sessions are unbound. For example, if a bind was in progress at the time of the failure, sessions are unbound.

## Sessions not retained

There are some circumstances in which VTAM does not retain LU-LU sessions:

- VTAM does not retain sessions after a VTAM, MVS, or processor (CPC) failure.
- VTAM does not retain CICS sessions if you close VTAM with any of the following CICS commands:
  - SET VTAM FORCECLOSE
  - SET VTAM IMMCLOSE
  - SET VTAM CLOSED
- VTAM does not retain CICS sessions if you close the CICS node with the VTAM command VARY NET INACT ID=applid.
- VTAM does not retain CICS sessions if your CICS system performs a normal shutdown (with a PERFORM SHUTDOWN command).

For more information about persistent session support, see the *CICS System Definition Guide*.

---

## Part 2. Recovery and restart processes

This part of the book describes the CICS recovery and restart processes, and indicates where to add user processing to influence these processes. The way you design for, implement, and extend these functions is described in the later parts of this book.

This part contains the following chapters:

- “Chapter 4. CICS cold start” on page 41
- “Chapter 5. CICS warm restart” on page 49
- “Chapter 6. CICS emergency restart” on page 55
- “Chapter 7. Automatic restart management” on page 61
- “Chapter 8. Unit of work recovery and abend processing” on page 67
- “Chapter 9. Communication error processing” on page 91



---

## Chapter 4. CICS cold start

This chapter describes the CICS startup processing specific to a cold start. It covers the two forms of cold start:

- “Starting CICS with the START=COLD parameter”
- “Starting CICS with the START=INITIAL parameter” on page 46

---

### Starting CICS with the START=COLD parameter

START=COLD performs a dual type of startup, performing a cold start for all local resources while preserving recovery information that relates to remote systems or resource managers connected through the resource manager interface (RMI). This ensures the integrity of the CICS region with its partners in a network that manages a distributed workload. You can use a cold start to install resource definitions from the CSD (and from macro control tables). It is normally safe to cold start a CICS region that does not own any local resources (such as a terminal-owning region that performs only transaction routing). For more information about performing a cold start, and when it is safe to do so, see the *CICS Intercommunication Guide*.

If you specify START=COLD, CICS either discards or preserves information in the system log and global catalog data set, as follows:

- CICS deletes all cataloged resource definitions in the CICS catalogs and installs definitions either from the CSD or from macro control tables. CICS writes a record of each definition in the global catalog data set as each resource definition is installed.
- CICS preserves the recovery manager control record, which contains the CICS logname token used in the previous run. CICS also preserves the log stream name of the system log.
- CICS discards any information from the system log that relates to *local* resources, and resets the system log to begin writing at the start of the primary log stream.

**Note:** If CICS detects that there were shunted units of work at the previous shutdown (that is, it had issued message DFHRM0203) CICS issues a warning message, DFHRM0154, to let you know that local recovery data has been lost, and initialization continues. The only way to avoid this loss of data from the system log is *not* to perform a cold start after CICS has issued DFHRM0203.

If the cold start is being performed following a shutdown that issued message DFHRM0204, CICS issues message DFHRM0156 to confirm that the cold start has not caused any loss of local recovery data.

- CICS releases *all* retained locks:
  - CICS requests the SMSVSAM server, if connected, to release all RLS retained locks.
  - CICS does not rebuild the non-RLS retained locks.
- CICS requests the SMSVSAM server to clear the RLS sharing control status for the region.
- CICS does not restore the dump table, which may contain entries controlling system and transaction dumps.
- CICS preserves resynchronization information about distributed units of work—information regarding unit of work obligations to remote systems, or to non-CICS resource managers (such as DB2) connected through the RMI. For

example, the preserved information includes data about the outcome of distributed UOWs that is needed to allow remote systems (or RMI resource managers) to resynchronize their resources.

**Note:** The system log information preserved does *not* include before-images of any file control data updated by a distributed unit of work. Any changes made to local file resources are not backed out, and by freeing all locks they are effectively committed. To preserve data integrity, perform a warm or emergency restart (using START=AUTO).

- CICS retrieves its logname token from the recovery manager control record for use in the “exchange lognames” process during reconnection to partner systems. Thus, by using the logname token from the previous execution, CICS ensures a warm start of those connections for which there is outstanding resynchronization work.

To perform these actions on a cold start, CICS needs the contents of the catalog data sets and the system log from a previous run.

See the *CICS System Definition Guide* for details of the actions that CICS takes for START=COLD in conjunction with various states of the global catalog and the system log.

## A local cold start (START=COLD)

This section discusses the process of a cold start initiated by START=COLD in terms of the following resources:

- Files
- Temporary storage queues
- Transient data queues
- Transactions
- Journals and journal models
- Programs, including mapsets and partitionsets
- Start requests
- Resource definitions dynamically installed
- Monitoring and statistics
- Terminal control resources
- Distributed transaction resources
- Dump table

### Files

All previous file control state data, including file resource definitions, is lost.

If RLS support is specified, CICS connects to the SMSVSAM, and when connected requests the server to:

- Release all RLS retained locks
- Clear any “lost locks” status
- Clear any data sets in “non-RLS update permitted” status

For non-RLS files, the CICS enqueue domain does not rebuild the retained locks relating to shunted units of work.

File resource definitions are installed as follows:

**VSAM** Except for the CSD itself, all VSAM file definitions are installed from the CSD. You specify these in groups named in the CSD group list, which you

specify on the GRPLIST system initialization parameter. The CSD file definition is built and installed from the CSDxxxx system initialization parameters.

### **Data tables**

As for VSAM file definitions.

**BDAM** File definitions are installed from file control table entries, specified by the FCT system initialization parameter.

**Attention:** If you use the SHCDS REMOVESUBSYS command for a CICS region that uses RLS access mode, ensure that you perform a cold start the next time you start the CICS region. The SHCDS REMOVESUBSYS command causes SMSVSAM to release all locks held for the region that is the subject of the command, allowing other CICS regions and batch jobs to update records released in this way. If you restart a CICS region with either a warm or emergency restart, after specifying it on a REMOVESUBSYS command, you risk losing data integrity. See the *DFSMS/MVS Access Method Services for ICF*, SC26-4906 for more information about the REMOVESUBSYS parameter.

You are recommended to use the REMOVESUBSYS command only for those CICS regions that you do not intend to run again, and therefore you need to free any retained locks that SMSVSAM might be holding.

### **Temporary storage**

All temporary storage queues from a previous run are lost, including CICS-generated queues (for example, for data passed on START requests).

If the auxiliary temporary storage data set was used on a previous run, CICS opens the data set for update. If CICS finds that the data set is newly initialized, CICS closes it, reopens it in output mode, and formats all the control intervals (CIs) in the primary extent. When formatting is complete, CICS closes the data set and reopens it in update mode. The time taken for this formatting operation depends on the size of the primary extent, but it can add significantly to the time taken to perform a cold start.

**Temporary storage data sharing server:** Any queues written to a shared temporary storage pool normally persist across a cold start.

Shared TS pools are managed by a temporary storage server, and stored in the coupling facility. Stopping and restarting a TS data sharing server does not affect the contents of the TS pool, unless you clear the coupling facility structure in which the pool resides.

If you want to cause a server to reinitialize its pool, use the MVS SETXCF FORCE command to clean up the structure:

```
SETXCF FORCE,STRUCTURE,STRNAME(DFHXQLS_poolname)
```

The next time you start up the TS server following a SETXCF FORCE command, the server initializes its TS pool in the structure using the server startup parameters specified in the DFHXQMN job.

## Transient data

All transient data queues from a previous run are lost.

Transient data resource definitions are installed from:

1. Destination control table (DCT) entries if the DCT system initialization parameter specifies the suffix of the table to be loaded. If you specify DCT=NO, CICS does not load a DCT.

DCT-defined queues are installed and any extrapartition TD queues that need to be opened are opened; that is, any that specify OPEN=INITIAL.

2. Resource groups defined in the CSD, as specified in the CSD group list (named on the GRPLIST system initialization parameter). Any extrapartition TD queues that require opening are opened; that is, any that specify OPEN(INITIAL).

CSD definitions are installed later than the macro-defined entries because of the position of CSD group list processing in the initialization process. If the CSD contains duplicates of definitions installed earlier from the DCT, CICS issues a warning message to indicate that the install of duplicates from the CSD has failed.

Finally, all the newly-installed TD queue definitions are written to the global catalog. All TD queues are installed as enabled.

The TDINTRA system initialization parameter has no effect in a cold start.

**Note:** If, during the period when CICS is installing the TD queues, an attempt is made to write a record to a CICS-defined queue that has not yet been installed (for example, CSSL), CICS writes the record to the CICS-defined queue CXRF.

## Transactions

All transaction and transaction class resource definitions are installed from the CSD, and are cataloged in the global catalog.

## Journal names and journal models

All journal model definitions are installed from the CSD, and are cataloged in the global catalog. Journal name definitions (including the system logs DFHLOG and DFHSHUNT) are created using the installed journal models and cataloged in the global catalog.

**Note:** The CICS log manager retrieves the system log stream name from the global catalog, ensuring that, even on a cold start, CICS uses the same log stream as on a previous run.

## Programs

All programs, mapsets, and partitionsets are installed from the CSD, and are cataloged in the global catalog.

## Start requests (with and without a terminal)

All forms of start request recorded in a warm keypoint (if the previous shutdown was normal) are lost. This applies both to START requests issued by a user application program and to START commands issued internally by CICS in support of basic mapping support (BMS) paging.

Any data associated with START requests is also lost, even if it was stored in a recoverable TS queue.



## Resource definitions dynamically installed

Any resource definitions dynamically added to a previous run of CICS are lost in a cold start, unless they are included in the group list specified on the GRPLIST system initialization parameter. If you define new resource definitions and install them dynamically, ensure the group containing the resources is added to the appropriate group list.

## Monitoring and statistics

The initial status of CICS monitoring is determined by the monitoring system initialization parameters (MN and MNxxxx).

The initial recording status for CICS statistics is determined by the statistics system initialization parameter (STATRCD). If STATRCD=YES is specified, interval statistics are recorded at the default interval of every three hours.

## Terminal control resources

All previous terminal control information stored in the global catalog warm keypoint is lost.

Terminal control resource definitions are installed as follows:

### VTAM devices

All VTAM terminal resource definitions are installed from the CSD. The definitions to be installed are specified in groups named in the CSD group list, which is specified by the GRPLIST system initialization parameter. The resource definitions, of type TERMINAL and TYPETERM, include autoinstall model definitions as well as explicitly defined devices.

### Connection, sessions, and profiles

All connection and sessions definitions are installed from the CSD. The definitions to be installed are specified in groups named in the CSD group list, which is specified by the GRPLIST system initialization parameter. The connections and sessions resource definitions include those used for APPC autoinstall of parallel and single sessions, as well as explicitly defined connections.

### TCAM and sequential devices

All TCAM and sequential (BSAM) device terminal resource definitions are installed from the terminal control table specified by the TCT system initialization parameter. CICS loads the table from the load library defined in the DFHRPL library concatenation.

Resource definitions for TCAM and BSAM terminals are not cataloged at install time. They are cataloged only in the terminal control warm keypoint during a normal shutdown.

### Remote BTAM terminals

All BTAM terminal resource definitions are installed from the terminal control table specified by the TCT system initialization parameter. CICS loads the table from the load library defined in the DFHRPL library concatenation.

Resource definitions for remote BTAM terminals are never cataloged, either at install time or in the warm keypoint at shutdown.

**Committing and cataloging resources installed from the CSD:** CICS has two ways of installing and committing terminal resource definitions:

- Some VTAM terminal control resource definitions must be installed in groups and are committed in “installable sets” (for example, connections and sessions).

- Other resource definitions can be installed in groups or individually, and are committed at the individual resource level.

If the install of a resource (or of an installable set, such as a CONNECTION and its associated SESSIONS definitions) is successful, CICS writes the resource definitions to the global catalog during commit processing.

*Single resource install:* All except the resources that are installed in installable sets are committed individually. CICS writes each single resource definition to the global catalog as the resource is installed. If a definition fails, it is not written to the catalog (and therefore is not recovered at a restart).

*Installable set install:* The following VTAM terminal control resources are committed in installable sets:

- Connections and their associated sessions
- Pipeline terminals—all the terminal definitions sharing the same POOL name

If one definition in an installable set fails, the set fails. However, each installable set is treated independently within its CSD group. If an installable set fails as CICS installs the CSD group, it is removed from the set of successful installs. Logical sets that are not successfully installed do not have catalog records written and are not recovered.

## Distributed transaction resources

Unlike all other resources in a cold start, CICS preserves any information (units of work) about *distributed* transactions. This has no effect on units of work that relate only to the local CICS—it applies only to distributed units of work. The CICS recovery manager deals with these preserved UOWs when resynchronization with the partner system takes place, just as in a warm or emergency restart.

This is effective only if both the system log stream and the global catalog from the previous run of CICS are available at restart.

See the *CICS Intercommunication Guide* for information about recovery of distributed units of work.

## Dump table

The dump table that you use for controlling system and transaction dumps is not preserved in a cold start. If you have built up over a period of time a number of entries in a dump table, which is recorded in the CICS catalog, you have to recreate these entries following a cold start.

---

## Starting CICS with the START=INITIAL parameter

If you specify START=INITIAL, CICS performs an initial start as if you are starting a new region for the first time. This initial start of a CICS region is different from a CICS region that initializes with a START=COLD parameter, as follows:

- The state of the global catalog is ignored. It can contain either data from a previous run of CICS, or it can be newly initialized. Any previous data is purged.
- The state of the system log is ignored. It can contain either data from a previous run of CICS, or it can reference new log streams. CICS does not keep any information saved in the system log from a previous run. The primary and secondary system log streams are purged and CICS begins writing a new system log.

- Because CICS is starting a new catalog, it uses a new logname token in the “exchange lognames” process when connecting to partner systems. Thus, remote systems are notified that CICS has performed a cold start and cannot resynchronize.

**Note:** An initial start can also result from a START=COLD parameter if the global catalog is newly initialized and does not contain a recovery manager control record. If the recovery manager finds that there is no control record on the catalog, it issues a message to the console prompting the operator to reply with a GO or CANCEL response. If the response is GO, CICS performs an initial start as if START=INITIAL was specified.

For more information about the effect of the state of the global catalog and the system log on the type of start CICS performs, see the *CICS System Definition Guide*.



---

## Chapter 5. CICS warm restart

This chapter describes the CICS startup processing specific to a warm restart.

If you specify `START=AUTO`, which is the recommended method, CICS determines which type of start to perform using information retrieved from the recovery manager's control record in the global catalog. If the type-of-restart indicator in the control record indicates "warm start possible", CICS performs a warm restart.

See "Chapter 6. CICS emergency restart" on page 55 for the restart processing performed if the type-of-restart indicates "emergency restart needed".

---

### Rebuilding the CICS state after a normal shutdown

During a warm restart, CICS initializes using information from the catalogs and system log to restore the region to its state at the previous normal shutdown.

**Note:** CICS needs both the catalogs and the system log from the previous run of CICS to perform a warm restart—the catalogs alone are not sufficient. If you run CICS with the system log defined as `TYPE(DUMMY)`, CICS appears to shut down normally, but only the global catalog portion of the warm keypoint is actually written. Therefore, without the warm keypoint information from the system log, CICS cannot perform a warm restart. CICS startup fails unless you specify an initial start with `START=INITIAL`.

Recovering their own state is the responsibility of the individual resource managers (such as file control) and the CICS domains. This section discusses the process of rebuilding their state from the catalogs and system log, in terms of the following resources:

- Files
- Temporary storage queues
- Transient data queues
- Transactions
- Programs, including mapsets and partitionsets
- Start requests
- Monitoring and statistics
- Journals and journal models
- Terminal control resources
- Distributed transaction resources

### Files

File control information from the previous run is recovered from information recorded in the CICS catalog only.

File resource definitions for VSAM and BDAM files, data tables, and LSR pools are installed from the global catalog, including any definitions that were added dynamically during the previous run. The information recovered and reinstalled

in this way reflects the state of all file resources at the previous shutdown. For example:

- If you manually set a file closed (which changes its status to UNENABLED) and perform a normal shutdown, it remains UNENABLED after the warm restart.
- Similarly, if you set a file DISABLED, it remains DISABLED after the warm restart.

**Note:** An exception to the above rule occurs when there are updates to a file to be backed out during restarts, in which case the file is opened regardless of the OPENTIME option. At a warm start, there cannot be any in-flight units of work to back out, so this backout can only occur when retrying backout-failed units of work against the file.

CICS closes all files at shutdown, and, as a general rule, you should expect your files to be re-installed on restart as either:

- OPEN and ENABLED if the OPENTIME option is STARTUP
- CLOSED and ENABLED if the OPENTIME option is FIRSTREF.

The FCT and the CSDxxxx system initialization parameters are ignored.

File control uses the system log to reconstruct the internal structures, which it uses for recovery.

### **Data set name blocks**

Data set name blocks (DSNBs), one for each data set opened by CICS file control, are recovered during a warm restart. If you have an application that creates many temporary data sets, with a different name for every data set created, it is important that your application removes these after use. If applications fail to get rid of unwanted name blocks they can, over time, use up a considerable amount of CICS dynamic storage. See the *CICS System Programming Reference* for information about using the SET DSNAME REMOVE command to remove unwanted data set name blocks.

### **Reconnecting to SMSVSAM for RLS access**

CICS connects to the SMSVSAM server, if present, and exchanges RLS recovery information. In this exchange, CICS finds out whether SMSVSAM has lost any retained locks while CICS has been shut down. This could happen, for example, if SMSVSAM could not recover from a coupling facility failure that caused the loss of the lock structure. If this has happened, CICS is notified by SMSVSAM to perform **lost locks recovery**. See “Lost locks recovery” on page 83 for information about this process.

### **Recreating non-RLS retained locks**

For non-RLS files, the CICS enqueue domain rebuilds the retained locks relating to shunted units of work.

## **Temporary storage**

Auxiliary temporary storage queue information (for both recoverable and non-recoverable queues) is retrieved from the warm keypoint. Note that TS READ pointers are recovered on a warm restart (which is not the case on an emergency restart).

CICS opens the auxiliary temporary storage data set for update.

## Temporary storage data sharing server

Any queues written to a shared temporary storage pool, even though non-recoverable, persist across a warm restart.

## Transient data

Transient data initialization on a warm restart depends on the TDINTRA system initialization parameter, which specifies whether or not TD is to initialize with empty intrapartition queues. The different options are discussed as follows:

### **TDINTRA=NOEMPTY (the default)**

All transient data resource definitions are installed from the global catalog, including any definitions that were added dynamically during the previous run. Any destination control table (DCT) specified by the DCT system initialization parameter is ignored (CICS loads the DCT only on a cold start). TD queues are always installed as enabled.

CICS opens any extrapartition TD queues that need to be opened—that is, any that specify OPEN=INITIAL.

**Note:** If, during the period when CICS is installing the TD queues, an attempt is made to write a record to a CICS-defined queue that has not yet been installed (for example, CSSL), CICS writes the record to the CICS-defined queue CXRF.

The recovery manager returns log records and keypoint data associated with TD queues. CICS applies this data to the installed queue definitions to return the TD queues to the state they were in at normal shutdown. Logically recoverable, physically recoverable, and non-recoverable intrapartition TD queues are recovered from the warm keypoint data.

**Trigger levels (for TERMINAL and SYSTEM only):** After the queues have been recovered, CICS checks the trigger level status of each intrapartition TD queue that is defined with FACILITY(TERMINAL|SYSTEM) to determine whether a start request needs to be rescheduled for the trigger transaction. If a trigger transaction failed to complete during the previous run (that is, did not reach the empty queue (QZERO) condition) or the number of items on the queue is greater than the trigger level, CICS schedules a start request for the trigger transaction.

This does not apply to trigger transactions defined for queues that are associated with files (FACILITY(FILE)).

### **TDINTRA=EMPTY**

The transient data queues are 'cold started', but the resource definitions are 'warm started':

- All intrapartition TD queues are initialized empty.
- The queue resource definitions are installed from the global catalog, but they are not updated by any log records or keypoint data. They are always installed enabled.

This option is intended for use when initiating remote site recovery (see “Chapter 6. CICS emergency restart” on page 55), but you can also use it for a normal warm restart. For example, you might want to 'cold start' the intrapartition queues when switching to a new data set if the old one is corrupted, while preserving all the resource definitions from the catalog.

You cannot specify a general cold start of transient data while the rest of CICS performs a warm restart, as you can for temporary storage.

## Transactions

All transaction and transaction class resource definitions are installed from the CSD, and updated with information from the warm keypoint in the system log. The resource definitions installed from the catalog include any that were added dynamically during the previous run.

## Programs

The recovery of program, mapset, and partitionset resource definitions depends on whether you are using program autoinstall and, if you are, whether you have requested autoinstall cataloging (specified by the system initialization parameter `PGAICTLG=ALL|MODIFY`).

### No autoinstall for programs

If program autoinstall is disabled (`PGAIPGM=INACTIVE`), all program, mapset, and partitionset resource definitions are installed from the CSD, and updated with information from the warm keypoint in the system log.

The resource definitions installed from the catalog include any that were added dynamically during the previous run.

### Autoinstall for programs

If program autoinstall is enabled (`PGAIPGM=ACTIVE`), program, mapset, and partitionset resource definitions are installed from the CSD only if they were cataloged; otherwise they are installed at first reference by the autoinstall process. All definitions installed from the CSD are updated with information from the warm keypoint in the system log.

CICS catalogs program, mapset, and partitionset resource definitions as follows:

- If they are installed from predefined definitions in the CSD, either during a cold start or by an explicit `INSTALL` command, CICS catalogs the definitions.
- If the `PGAICTLG` system initialization parameter specifies `ALL`, CICS catalogs all the autoinstalled program-type definitions, and these are reinstalled during the warm restart.
- If the `PGAICTLG` system initialization parameter specifies `MODIFY`, CICS catalogs only those autoinstalled program-type definitions that are modified by a `SET PROGRAM` command, and these are reinstalled during the warm restart.

## Start requests

In general, start requests are recovered together with any associated start data. Recovery can, however, be suppressed by specifying explicit cold start system initialization parameters for temporary storage, interval control, or basic mapping support (on the `TS`, `ICP`, and `BMS` system initialization parameters respectively). Any data associated with suppressed starts is discarded.

The rules governing the operation of the explicit cold requests on system initialization parameters are:

- `ICP=COLD` suppresses all starts that do not have both data and a terminal associated with them. It also suppresses any starts that had not expired at shutdown. This includes `BMS` starts.
- `TS=COLD` (or `TS` main only) suppresses all starts that had data associated with them.



- BMS=COLD suppresses all starts relating to BMS paging.

Start requests that have not been suppressed for any of the above reasons either continue to wait if their start time or interval has not yet expired, or they are processed immediately. For start requests with terminals, consider the effects of the CICS restart on the set of installed terminal definitions. For example, if the terminal specified on a start request is no longer installed after the CICS restart, CICS invokes an XALTENF global user exit program (if enabled), but not the XICTENF exit.

## Monitoring and statistics

The CICS monitoring and statistics domains retrieve their status from their control records stored in the global catalog at the previous shutdown.

This is modified by any run-time system initialization parameters.

## Journal names and journal models

The CICS log manager restores the journal name and journal model definitions from the global catalog. Journal name entries contain the names of the log streams used in the previous run, and the log manager reconnects to these during the warm restart.

## Terminal control resources

Terminal control information is installed from the warm keypoint in the global catalog, or installed from the TCT, depending on whether the resources are CSD-defined or TCT-defined.

### CSD-defined resource definitions

CICS installs the following terminal control resource definitions from the global catalog:

- All permanent terminal devices, originally installed from explicit resource definitions, and profiles.
- The following autoinstalled APPC connections:
  - Synclevel-2-capable connections (for example, CICS-to-CICS connections)
  - Synclevel-1-capable, limited resource connections installed on a CICS that is a member of a VTAM generic resource.

Apart from the above, autoinstalled terminals are not recovered, because they are removed from the warm keypoint during normal shutdown. This ensures that their definitions are installed only when terminal users next log on after a CICS restart that follows a normal shutdown.

Only the global catalog is referenced for terminals defined in the CSD.

To add a terminal after initialization, use the CEDA INSTALL or EXEC CICS CREATE command, or the autoinstall facility. To delete a terminal definition, use the DISCARD command or, if autoinstalled, allow it to be deleted by the autoinstall facility after the interval specified by the AILDELAY system initialization parameter.

### TCAM and sequential (BSAM) devices

CICS installs TCAM and sequential terminal resource definitions as follows:

- **Same TCT as last run.** CICS installs the TCT and then modifies the terminal entries in the table by applying the cataloged data from the terminal control warm

keypoint from the previous shutdown. This means that, if you reassemble the TCT and keep the same suffix, any changes you make could be undone by the warm keypoint taken from the catalog.

- **Different TCT from last run.** CICS installs the TCT only, and does not apply the warm keypoint information, effectively making this a cold start for these devices.

### **Remote BTAM terminals**

CICS always recovers remote BTAM terminal resource definitions from the TCT. This is because remote BTAM terminal definitions are never cataloged, either when they are first installed, or later in the terminal control warm keypoint. Thus, remote BTAM terminals are effectively always cold started.

## **Distributed transaction resources**

CICS retrieves its logname from the recovery manager control record in the global catalog for use in the “exchange lognames” process with remote systems. Resynchronization of in-doubt units of work takes place after CICS completes reconnection to remote systems.

See the *CICS Intercommunication Guide* for information about recovery of distributed units of work.

---

## Chapter 6. CICS emergency restart

This chapter describes the CICS startup processing specific to an emergency restart.

If you specify START=AUTO, CICS determines what type of start to perform using information retrieved from the recovery manager's control record in the global catalog. If the type-of-restart indicator in the control record indicates "emergency restart needed", CICS performs an emergency restart.

See "Chapter 5. CICS warm restart" on page 49 for the restart processing performed if the type-of-restart indicates "warm start possible".

---

### Recovering after a CICS failure

CICS initialization for an emergency restart after a CICS failure is the same as initialization for a warm restart, plus some additional processing. (See "Chapter 5. CICS warm restart" on page 49 for the warm restart details.)

#### Overview

The additional processing performed for an emergency restart is mainly related to the recovery of in-flight transactions. There are two aspects to the recovery operation:

1. Recovering information from the system log
2. Driving backout processing for in-flight units of work

#### Recovering information from the system log

At some point during initialization (and before CICS performs program list table post-initialization (PLTPI) processing), the recovery manager scans the system log backwards. CICS uses the information retrieved to restore the region to its state at the time of the abnormal termination.

For non-RLS data sets and other recoverable resources, any locks (ENQUEUEES) that were held before the CICS failure are re-acquired during this initial phase.

For data sets accessed in RLS mode, the locks that were held by SMSVSAM for in-flight tasks are converted into retained locks at the point of abnormal termination.

#### Driving backout processing for in-flight units of work

When initialization is almost complete, and after the completion of PLTPI processing, the recovery manager starts backout processing for any UOWs that were in-flight at the time of the failure of the previous run. Starting recovery processing at the end of initialization means that it occurs concurrently with new work.

#### Concurrent processing of new work and backout

The backout of UOWs that occurs after an emergency restart is the same process as dynamic backout of a failed transaction. Backing out in-flight transactions continues after "control is given to CICS", which means that the process takes place concurrently with new work arriving in the region.

Any non-RLS locks associated with in-flight (and other failed) transactions are acquired as active locks for the tasks attached to perform the backouts. This means that, if any new transaction attempts to access non-RLS data that is locked by a backout task, it waits normally rather than receiving the LOCKED condition.

Retained RLS locks are held by SMSVSAM, and these do not change while backout is being performed. Any new transactions that attempt to access RLS resources locked by a backout task receive a LOCKED condition.

For both RLS and non-RLS resources, the backout of in-flight transactions after an emergency restart is indistinguishable from dynamic transaction backout.

**Effect of delayed recovery on PLTPI processing:** Because recovery processing does not take place until PLTPI processing is complete, PLT programs may fail during an emergency restart if they attempt to access resources protected by retained locks. If PLT programs are not written to handle the LOCKED exception condition they abend with an AEX8 abend code.

If successful completion of PLTPI processing is essential before your CICS applications are allowed to start, consider alternative methods of completing necessary PLT processing. You may have to allow emergency restart recovery processing to finish, and then complete the failed PLTPI processing when the locks have been released.

### **Other backout processing**

The recovery manager also drives:

- The backout processing for any UOWs that were in a backout-failed state at the time of the CICS failure
- The commit processing for any UOWs that were in a commit-failed state at the time of the CICS failure

The recovery manager drives these backout and commit processes because the condition that caused them to fail may be resolved by the time CICS restarts. If the condition that caused a failure has not been resolved, the UOW remains in backout- or commit-failed state. See “Backout-failed recovery” on page 73 and “Commit-failed recovery” on page 77 for more information.

---

## **Rebuilding the CICS state after an abnormal termination**

The individual resource managers (such as file control) and the CICS domains are responsible for recovering their state as it was at an abnormal termination. The process of rebuilding their state is much the same as for a warm restart. This section discusses the process of rebuilding their state from the catalogs and system log, describing the differences between a warm and emergency restart, in terms of the following resources:

- Files
- Temporary storage queues
- Transient data queues
- Transactions
- Programs, including mapsets and partitionsets
- Start requests
- Monitoring and statistics
- Journals and journal models
- Terminal control resources
- Distributed transaction resources

### **Files**

All file control state data and resource definitions are recovered in the same way as on a warm start.

## Reconnecting to SMSVSAM for RLS access

As on a warm restart, CICS connects to the SMSVSAM server. In addition to notifying CICS about lost locks, VSAM also informs CICS of the units of work belonging to the CICS region for which it holds retained locks. See “Lost locks recovery” on page 83 for information about the lost locks recovery process for CICS.

CICS uses the information it receives from SMSVSAM to eliminate orphan locks.

## RLS restart processing and orphan locks

CICS emergency restart performs CICS-RLS restart processing during which **orphan locks** are eliminated. An orphan lock is one that is held by VSAM RLS on behalf of a specific CICS but unknown to the CICS region, and a VSAM interface enables CICS to detect UOWs that are associated with such locks.

Orphan locks can occur if a CICS region acquires an RLS lock, but then fails before logging it. Records associated with orphan locks that have not been logged cannot have been updated, and CICS can safely release them.

**Note:** Locks that fail to be released during UOW commit processing cause the UOW to become a commit-failed UOW. CICS automatically retries commit processing for these UOWs, but if the locks are still not released before the CICS region terminates, these also are treated as orphan locks during the next restart.

## Recreating non-RLS retained locks

As for warm restart.

## Temporary storage

Auxiliary temporary storage queue information for recoverable queues only is retrieved from the warm keypoint. The TS READ pointers are not recovered and are set to zero.

If a nonzero TSAGE parameter is specified in the temporary storage table (TST), all queues that have not been referenced for this interval are deleted.

## Transient data

Recovery of transient data is the same as for a warm start, with the following exceptions:

- Non-recoverable queues are not recovered.
- Physically recoverable queues are recovered, using log records and keypoint data. Generally, backing out units of work that were in-flight at the time of the CICS failure does not affect a physically recoverable TD inpartition data set. Changes to physically recoverable TD queues are committed immediately, with the result that backing out a unit of work does not affect the physical data set. An exception to this is the last read request from a TD queue by a unit of work that fails in-flight because of a CICS failure. In this case, CICS backs out the last read, ensuring that the queue item is not deleted by the read. A further exception occurs when the read is followed by a “delete queue” command. In this case, the read is not backed out, because the whole queue is deleted.

## Transactions

As for warm restart.

## Programs

As for warm restart.

## Start requests

In general, start requests are recovered if, and only if:

- They are associated with recoverable data
- They are protected (by the PROTECT option on the START command) and the issuing UOW is in-doubt

Recovery can, however, be further limited by the use of the specific COLD option on the system initialization parameter for TS, ICP, or BMS. If you suppress start requests by means of the COLD option on the appropriate system initialization parameter, any data associated with the suppressed starts is discarded. The rules are:

- ICP=COLD suppresses all starts including BMS starts.
- TS=COLD (or TS main only) suppresses all starts that had data associated with them.
- BMS=COLD suppresses all starts relating to BMS paging.

Start requests that have not been suppressed for any of the above reasons either continue to wait if their start time or interval has not yet expired, or are processed immediately.

For start requests with terminals, consider the effects of the CICS restart on the set of installed terminal definitions. For example, if the terminal specified on a start request is no longer installed after the CICS restart, CICS invokes an XALTENF global user exit program (if enabled), but not the XICTENF exit.

## Monitoring and statistics

As for warm restart.

## Journal names and journal models

As for warm restart.

## Terminal control resources

Terminal control information is installed from the warm keypoint in the global catalog, or installed from the TCT, depending on whether the definitions are CSD-defined or TCT-defined.

### CSD-defined resource definitions

CICS retrieves the state of the CSD-eligible terminal control resources from the catalog entries that were written:

- During a previous cold start
- When resources were added with EXEC CICS CREATE or CEDA INSTALL
- When resources were added with autoinstall (subject to the AIRDELAY system initialization parameter)
- Rewritten to the catalog at an intervening warm shutdown

The state of the catalog may have been modified for some of the above resources by their removal with a CEMT, or an EXEC CICS DISCARD, command.

CICS uses records from the system log, written when any terminal resources were being updated, to perform any necessary recovery on the cataloged data. This may be needed if terminal resources are installed or deleted while CICS is running, and CICS fails before the operation is completed.

Some terminal control resources are installed or deleted in “installable sets” as described under “Committing and cataloging resources installed from the CSD” on page 45. If modifications are made to terminal resource definitions while CICS is running, CICS writes the changes in the form of forward recovery records to the system log. If the installation or deletion of installable sets or individual resources is successful, but CICS abnormally terminates before the catalog can be updated, CICS recovers the information from the forward recovery records on the system log.

If the installation or deletion of installable sets or individual resources is unsuccessful, or has not reached commit point when CICS abnormally terminates, CICS does not recover the changes.

In this way, CICS ensures that the terminal entries recovered at emergency restart consist of complete logical sets of resources (for connections, sessions, and pipelines), and complete terminal resources and autoinstall models, and that the catalog reflects the real state of the system accurately.

### **TCAM and sequential (BSAM) devices**

CICS installs TCAM and sequential terminal resource definitions from the TCT. Because there is no warm keypoint if the previous run terminated abnormally, the TCT cannot be modified as on a warm start. Whatever is defined in the TCT is installed, and the effect is the same whether or not it is a different TCT from the last run.

### **Remote BTAM terminals**

CICS always recovers remote BTAM terminal resource definitions from the TCT, as in a warm restart.

## **Distributed transaction resources**

CICS retrieves its logname from the recovery manager control record in the global catalog for use in the “exchange lognames” process with remote systems. Resynchronization of in-doubt units of work takes place when CICS completes reconnection to remote systems.

See the *CICS Intercommunication Guide* for information about recovery of distributed units of work.





---

## Chapter 7. Automatic restart management

This chapter describes how CICS uses the automatic restart manager (ARM) component of MVS to increase the availability of your systems.

The main benefits of the MVS automatic restart manager are that it:

- Enables CICS to preserve data integrity automatically in the event of any system failure.
- Eliminates the need for operator-initiated restarts, or restarts by other automatic packages, thereby:
  - Improving emergency restart times
  - Reducing errors
  - Reducing complexity.
- Provides cross-system restart capability. It ensures that the workload is restarted on MVS images with spare capacity, by working with the MVS workload manager.
- Allows all elements within a restart group to be restarted in parallel. Restart levels (using the ARM WAITPRED protocol) ensure the correct starting sequence of dependent or related subsystems.

---

### Overview

MVS automatic restart management is a sysplex-wide integrated automatic restart mechanism that:

- Restarts an MVS subsystem in place if it abends (or if a monitor program notifies ARM of a stall condition)
- Restarts all the elements of a workload (for example, CICS TORs, AORs, FORs, DB2, and so on) on another MVS image after an MVS failure
- Restarts a failed MVS image

**Note:** CICS reconnects to DBCTL and VTAM automatically if either of these subsystems restart after a failure, and to DB2 if you specify AUTO on the STRTWT parameter in the resource control table (RCT). There is no dependency on the MVS automatic restart manager for this reconnection support, which is provided automatically on any CICS region.

You cannot use MVS automatic restart for CICS regions running with XRF—it is available only to non-XRF CICS regions. If you specify XRF=YES, CICS de-registers from ARM and continues initialization with XRF support.

MVS automatic restart management is available only to those MVS subsystems that register with ARM. CICS regions register with ARM automatically as part of CICS system initialization. If a CICS region fails before it has registered for the first time with ARM, it will not be restarted. After a CICS region has registered, it is restarted by ARM according to a predefined policy for the workload.

---

### CICS ARM processing

A prime objective of CICS support for the MVS automatic restart manager (ARM) is to preserve data integrity automatically in the event of any system failure. If CICS is restarted by ARM with the same (**persistent**) JCL, CICS forces START=AUTO to ensure data integrity.

## Registering with ARM

During initialization CICS registers with ARM automatically.

CICS always registers with ARM because CICS needs to know whether it is being restarted by ARM and, if it is, whether or not the restart is with persistent JCL. (The ARM registration response to CICS indicates whether or not the same JCL that started the failed region is being used for the ARM restart.) You indicate whether MVS is to use the same JCL or command text that previously started CICS by specifying PERSIST as the *restart\_type* operand on the RESTART\_METHOD parameter in your automatic restart management policy.

When it registers with ARM, CICS passes the value 'SYSCICSb' as the element type, and the string 'SYSCICS\_aaaaaaa' as the element name, where *aaaaaaa* is the CICS applid. Using the applid in the element name means that only one CICS region can successfully register with ARM for a given applid. If two CICS regions try to register with the same applid, the second register is rejected by ARM.

## Waiting for predecessor subsystems

During initialization CICS issues an ARM WAITPRED (**wait predecessor**) request to wait, if necessary, for predecessor subsystems (such as DB2 and DBCTL) to become available. This is indicated by message DFHKE0406. One reason for this wait is to ensure that CICS can resynchronize with its partner resource managers for recovery purposes before accepting new work from the network.

## De-registering from ARM

During normal shutdown, CICS de-registers from ARM to ensure that it is not automatically restarted. Also, if you want to perform an immediate shutdown and do not want ARM to cause an automatic restart, you can specify the NORESTART option on the PERFORM SHUT IMMEDIATE command.

CICS also de-registers during initialization if it detects XRF=YES is specified as a system initialization parameter—XRF takes precedence over ARM.

Some error situations that occur during CICS initialization cause CICS to issue a message, with an operator prompt to reply GO or CANCEL. If you reply CANCEL, CICS de-registers from ARM before terminating, because if CICS remained registered, an automatic restart would probably encounter the same error condition.

For other error situations, CICS does not de-register, and automatic restarts follow. To control the number of restarts, specify in your ARM policy the number of times ARM is to restart a failed CICS region.

## Failing to register

If ARM support is present but the register fails, CICS issues message DFHKE0401. In this case, CICS does not know if it is being restarted by ARM, and therefore it doesn't know whether to override the START parameter to force an emergency restart to preserve data integrity.

If START=COLD or START=INITIAL is specified as a system initialization parameter and CICS fails to register, CICS also issues message DFHKE0408. When CICS is restarting with START=COLD or START=INITIAL, CICS relies on ARM to determine whether to override the start type and change it to AUTO. Because the REGISTER has failed, CICS cannot determine whether the region is being restarted by ARM,

and so does not know whether to override the start type. Message DFHKE0408 prompts the operator to reply ASIS or AUTO, to indicate the type of start CICS is to perform:

- A reply of ASIS means that CICS is to perform the start specified on the START parameter.
- A reply of AUTO means that CICS is being restarted by ARM, and the type of start is to be resolved by CICS. If the previous run terminated abnormally, CICS will perform an emergency restart.

**Note:** A CICS restart can have been initiated by ARM, even though CICS registration with ARM has failed in the restarted CICS.

## ARM couple data sets

You must ensure that you define the couple data sets required for ARM, and that they are online and active before you start any CICS region for which you want ARM support:

- CICS automatic ARM registration fails if the couple data sets are not active at CICS startup. When CICS is notified by ARM that registration has failed for this reason, CICS assumes this means that you do not want ARM support, and CICS initialization continues.
- If ARM loses access to the couple data sets, the CICS registration is lost. In this event, ARM cannot restart a CICS region that fails.

See *OS/390 MVS Setting Up a Sysplex* for information about ARM couple data sets and ARM policies.

---

## CICS restart JCL and parameters

Each CICS restart can use the previous startup JCL and system initialization parameters, or can use a new job and parameters.

You cannot specify XRF=YES if you want to use ARM support. If the XRF system initialization parameter is changed to XRF=YES for a CICS region being restarted by ARM, CICS issues message DFHKE0407 to the console, then terminates.

## CICS START options

You are recommended to specify START=AUTO, which causes a warm start after a normal shutdown, and an emergency restart after failure.

You are also recommended always to use the same JCL, even if it specifies START=COLD or START=INITIAL, to ensure that CICS restarts correctly when restarted by the MVS automatic restart manager after a failure. With automatic restart management support:

- If your start-up system initialization parameter specifies START=COLD (or INITIAL), and
- Your ARM policy specifies that the automatic restart manager is to use the same JCL for a restart following a CICS failure

CICS overrides the start parameter when restarted by ARM and enforces START=AUTO. This is reported by message DFHPA1934, and ensures the resultant emergency restart handles recoverable data correctly.

If the ARM policy specifies different JCL for an automatic restart, and that JCL specifies START=COLD, CICS obeys this parameter but risks losing data integrity. Therefore, if you need to specify different JCL to ARM, specify START=AUTO to ensure data integrity.

---

## Workload policies

Workloads are started initially by scheduling or automation products.

The components of the workload, and the MVS images capable of running them, are specified as part of the policies for MVS workload manager and ARM. The MVS images must have access to the databases, logs, and program libraries required for the workload.

Administrative policies provide ARM with the necessary information to perform appropriate restart processing. You can define one or more administrative policies, but can have only one active policy for all MVS images in a sysplex. You can modify administrative policies by using an MVS-supplied utility, and can activate a policy with the MVS SETXCF command.

## MVS automatic restart management definitions

To use the MVS automatic restart management facility to implement a sysplex-wide integrated automatic restart mechanism, you:

1. Implement automatic restart management on the MVS images that the CICS workload is to run on.
2. Ensure that CICS startup JCL used to restart CICS regions is suitable for MVS automatic restart management.

### Implementing MVS automatic restart management

The task of implementing ARM support is part of the overall task of planning for and installing MVS sysplex support. For information about MVS automatic restart management, see *OS/390 MVS Setting Up a Sysplex*.

Implementing ARM support for CICS generally involves the following steps:

- Ensure that the MVS images available for automatic restarts have access to the databases, logs, and program libraries required for the workload.
- Define ARM policies for your CICS regions:
  - Allow the RESTART\_ORDER LEVEL to default to 2 (CICS regions should generally be level 2 in the ARM restart order, after DB2 and DBCTL).
  - Define restart options, such as the number of times automatic restart is to be attempted by ARM.
  - If there are some CICS regions for which you do not want ARM support, specify 0 for the number of restart attempts. For example:

```
DEFINE POLICY NAME(CICSARM1) REPLACE(YES)
/*          Prevent all except GROUP CICSREST restarting */
RESTART_GROUP(DEFAULT)
  ELEMENT(*)
  RESTART_ATTEMPTS(0)
/* Provide ARM support for all CICS regions named in CICSREST */
/* RESTART_ATTEMPTS is default number (3) */
RESTART_GROUP(CICSREST)
  ELEMENT(SYSCICS_CICSHT*)
  ELEMENT(SYSCICS_CICSHA*)
  ELEMENT(SYSCICS_CICSHF*)
```

- Ensure that XRF=NO is specified as a system initialization parameter.

---

## Connecting to VTAM

VTAM is at restart level 1, the same as DB2 and DBCTL. However, VTAM is not restarted when failed subsystems are being restarted on another MVS, because ARM expects VTAM to be running on all MVS images in the sysplex. For this reason, CICS and VTAM are not generally part of the same restart group.

In a VTAM network, the session between CICS and VTAM is started automatically if VTAM is started before CICS. If VTAM is not active when you start (or restart) CICS, you receive the following messages:

```
+DFHSI1589D 'applid' VTAM is not currently active.  
+DFHSI1572 'applid' Unable to OPEN VTAM ACB - RC=xxxxxxx, ACB CODE=yy.
```

CICS provides a new transaction, COVR, to open the VTAM ACB automatically when VTAM becomes available. See “The COVR transaction” for more information about this.

## The COVR transaction

To ensure that CICS reconnects to VTAM in the event of a VTAM abend, CICS keeps retrying the OPEN VTAM ACB using a time-delay mechanism via the non-terminal transaction COVR. After CICS has completed clean-up following the VTAM failure, it invokes the CICS open VTAM retry (COVR) transaction. The COVR transaction invokes the terminal control open VTAM retry program, DFHZCOVR, which performs an OPEN VTAM retry loop with a 5-second wait. CICS issues a DFHZC0200 message every minute, while the open is unsuccessful, and each attempt is recorded on the CSNE transient data queue. After ten minutes, CICS issues a DFHZC0201 message and terminates the transaction. If CICS shutdown is initiated while the transaction is running, CICS issues a DFHZC0201 message and terminates the transaction.

You cannot run the COVR transaction from a terminal. If you invoke COVR from a terminal, it abends with an AZCU transaction abend.

## Messages associated with automatic restart

There are some CICS messages for ARM support, which CICS can issue during startup if problems are encountered when CICS tries to connect to ARM.

The message numbers are:

DFHKE0401	DFHKE0407
DFHKE0402	DFHKE0408
DFHKE0403	DFHKE0410
DFHKE0404	DFHKE0411
DFHKE0405	DFHZC0200
DFHKE0406	DFHZC0201

For the text of these messages, see the *CICS Transaction Server for OS/390: Migration Guide*.



---

## Chapter 8. Unit of work recovery and abend processing

This chapter describes unit of work recovery and abend processing under the following headings:

- “Unit of work recovery”
- “Investigating an in-doubt failure” on page 80
- “Recovery from failures associated with the coupling facility” on page 82
- “Transaction abend processing” on page 86
- “Actions taken at transaction failure” on page 88
- “Processing operating system abends and program checks” on page 89

The following events can cause the abnormal termination of transactions, all of which cause CICS to initiate:

- A transaction ABEND request issued by a CICS management module.
- A program check or operating system abend (this is trapped by CICS and converted into an ASRA or ASRB transaction abend).
- An ABEND request issued by a user application program.
- A CEMT, or EXEC CICS, command such as SET TASK PURGE or FORCEPURGE.

**Note:** Unlike the EXEC CICS ABEND command above, these EXEC CICS commands cause *other* tasks to abend, not the one issuing the command,

- A transaction abend request issued by DFHZNEP or DFHTEP following a communication error. This includes the abnormal termination of a remote CICS during processing of in-flight distributed UOWs on the local CICS.
- An abnormal termination of CICS, in which all in-flight transactions are effectively abended as a result of the CICS region failing.

In-flight transactions are recovered during a subsequent emergency restart to enable CICS to complete the necessary backout of recoverable resources, which is performed in the same way as if the task abended while CICS was running.

---

### Unit of work recovery

#### Units of work and transactions

A unit of work in CICS is also the “unit of recovery”—that is, it’s the atomic component of the transaction in which any changes made either must all be committed, or must all be backed out.

A transaction can be composed of a single unit of work or multiple units of work. In CICS, recovery is managed at the unit of work level.

For recovery purposes, CICS recovery manager is concerned only with the units of work that have not yet completed a syncpoint because of some failure. This section discusses how CICS handles these failed units of work.

The CICS recovery manager has to manage the recovery of the following types of unit of work failure:

#### **In-flight-failed**

The transaction fails before the current unit of work reaches a syncpoint, as a result either of a task abend, or the abnormal termination of CICS. The transaction is abnormally terminated, and recovery manager initiates backout of any changes made by the unit of work.

See “Transaction backout” on page 69.

#### **Commit-failed**

A unit of work fails during commit processing while taking a syncpoint. A partial copy of the unit of work is shunted to await retry of the commit process when the problem is resolved.

This does *not* cause the transaction to terminate abnormally.

See “Commit-failed recovery” on page 77.

#### **Backout-failed**

A unit of work fails while backing out updates to file control recoverable resources. (The concept of backout-failed applies in principle to any resource that performs backout recovery, but CICS file control is the only resource manager to provide backout failure support.) A partial copy of the unit of work is shunted to await retry of the backout process when the problem is resolved.

**Note:** Although the failed backout may have been attempted as a result of the abnormal termination of a transaction, the backout failure itself does *not* cause the transaction to terminate abnormally.

For example, if a transaction initiates backout through an EXEC CICS SYNCPOINT ROLLBACK command, CICS returns a normal response (not an exception condition) and the transaction continues executing. It is up to recovery manager to ensure that locks are preserved until backout is eventually completed.

If some resources involved in a unit of work are backout-failed, while others are commit-failed, the UOW as a whole is flagged as backout-failed.

See “Backout-failed recovery” on page 73.

#### **In-doubt-failed**

A distributed unit of work fails while in the in-doubt state of the two-phase commit<sup>3</sup> process. The transaction is abnormally terminated. If there are normally more units of work that follow the one that failed in-doubt, these will not be executed as a result of the abend.

A partial copy of the unit of work is shunted to await resynchronization when CICS re-establishes communication with its coordinator. This action happens only when the transaction resource definition specifies that units of work are to wait in the event of failure while in-doubt. If they are defined with WAIT(NO), CICS takes the action specified on the ACTION parameter, and the unit of work cannot become failed in-doubt.

See “In-doubt failure recovery” on page 78.

---

3. Two-phase commit. The protocol used by CICS when taking a syncpoint in a distributed unit of work, where the first **prepare** phase is followed by the actual **commit** phase. See two-phase commit in the *Glossary*.



## Transaction backout

If the resources updated by a failed unit of work are defined as recoverable, CICS automatically performs transaction backout of all uncommitted changes to the recoverable resources. Transaction backout is mandatory and automatic—there isn't an option on the transaction resource definition allowing you to control this. You can, however, control backout of the resources on which your transactions operate by defining whether or not they are recoverable.

In transaction backout, CICS restores the resources specified as recoverable to the state they were in at the beginning of the interrupted unit of work (that is, at start of task or completion of the most recent synchronization point). The resources are thus restored to a consistent state.

In general, the same process of transaction backout is used for individual units of work that abend while CICS is running and for in-flight tasks recovered during emergency restart. One difference is that dynamic backout of a **single** abnormally terminating transaction takes place immediately. Therefore, it does not cause any active locks to be converted into retained locks. In the case of a CICS region abend, in-flight tasks have to wait to be backed out when CICS is restarted, during which time the locks are retained to protect uncommitted resources.

To restore the resources to the state they were in at the beginning of the unit of work, CICS preserves a description of their state at that time:

- For tables maintained by CICS, information is held in the tables themselves.
- For recoverable auxiliary temporary storage, CICS maintains information on the system log about all new items written to TS queues. CICS maintains information about TS queues for backout purposes in main storage.
- For transient data, CICS maintains cursors that indicate how much has been read and written to the queue, and these cursors are logged. CICS does not log before- or after-images for transient data.
- For CICS files, the before-images of deleted or changed records are recorded in the system log. Although they are not strictly “before-images”, CICS also logs newly added records, because CICS needs information about them if they have to be removed during backout.

This section discusses the way the individual resource managers handle their part of the backout process in terms of the following resources:

- Files
- Intrapartition transient data
- Auxiliary temporary storage
- Start requests
- Cancel START requests
- Basic mapping support (BMS) messages

### Files

CICS file control is presented with the log records of all the recoverable files that have to be backed out. File control:

- Restores the before-images of updated records
- Restores deleted records
- Removes new records added by the unit of work

If backout fails for any file-control-managed resources, file control invokes backout failure support before the unit of work is marked as backout-failed. See “Backout-failed recovery” on page 73.

**BDAM files and VSAM ESDS files:** In the special case of the file access methods that do not support delete requests (VSAM ESDS and BDAM) CICS cannot remove new records added by the unit of work. In this case, CICS invokes the global user exit program enabled at the XFCLDEL exit point whenever a WRITE to a VSAM ESDS, or to a BDAM data set, is being backed out. This enables your exit program to perform a logical delete by amending the record in some way that flags it as deleted.

If you do not have an XFCLDEL exit program, CICS handles the unit of work as backout-failed, and shunts the unit of work to be retried later (see “Backout-failed recovery” on page 73). For information about resolving backout failures, see “Logical delete not performed” on page 75.

Such flagged records can be physically deleted when you subsequently reorganize the data set offline with a utility program.

**CICS data tables:** For CICS-maintained data tables, the updates made to the source VSAM data set are backed out. For user-maintained data tables, the in-storage data is backed out.

### **Intrapartition transient data**

Intrapartition destinations specified as **logically recoverable** are restored by transaction backout. Read and write pointers are restored to what they were before the transaction failure occurred.

**Physically recoverable** queues are recovered on warm and emergency restarts.

Transient data does not provide any support for the concept of transaction backout, which means that:

- Any records retrieved by the abending unit of work are not available to be read by another task, and are therefore lost.
- Any records written by the abending unit of work are not backed out. This means that these records **are** available to be read by other tasks, although they might be invalid.

CICS does not support recovery of extrapartition queues.

### **Auxiliary temporary storage**

CICS transaction backout backs out updates to auxiliary temporary storage queues if they are defined as recoverable in a temporary storage table. Read and write pointers are restored to what they were before the transaction failure occurred.

CICS does not back out changes to temporary storage queues held in main storage or in a TS server temporary storage pool.

### **START requests**

Recovery of EXEC CICS START requests during transaction backout depends on some of the options specified on the request. The options that affect recoverability are:

#### **PROTECT**

This option effectively causes the start request to be treated like any other recoverable resource, and the request is committed only when the task issuing the START takes a syncpoint. It ensures that the new task cannot be attached for execution until the START request is committed.

## **FROM, QUEUE, RTERMID, RTRANSID**

These options pass data to the started task using temporary storage.

When designing your applications, consider the recoverability of data that is being passed to a started transaction.

Recovery of START requests during transaction backout is described below for different combinations of these options.

### **START with no data (no PROTECT)**

Transaction backout does not affect the START request. The new task will start at its specified time (and could already be executing when the task issuing the START command is backed out). Abending the task that issued the START does not abend the started task.

### **START with no data (PROTECT)**

Transaction backout of the task issuing the START command causes the START request also to be backed out (canceled). If the abended transaction is restarted, it can safely reissue the START command without risk of duplication.

### **START with recoverable data (no PROTECT)**

Transaction backout of the task issuing the START also backs out the data intended for the started task, but does **not** back out the START request itself. Thus the new task will start at its specified time, but the data will not be available to the started task, to which CICS will return a NOTFND condition in response to the RETRIEVE command.

### **START with recoverable data (PROTECT)**

Transaction backout of the task issuing the START command causes the START request and the associated data to be backed out. If the abended transaction is restarted, it can safely reissue the START command without risk of duplication.

### **START with nonrecoverable data (no PROTECT)**

Transaction backout of the task issuing the START does **not** back out either the START request or the data intended for the (canceled) started task. Thus the new task will start at its specified time, and the data will be available, regardless of the abend of the issuing task.

### **START with nonrecoverable data (PROTECT)**

Transaction backout of the task issuing the START command causes the START request to be canceled, but not the associated data, which is left stranded in temporary storage.

**Note:** Recovery of temporary storage (whether or not PROTECT is specified) does not cause the new task to start immediately. (It may qualify for restart like any other task, if RESTART(YES) is specified on the transaction resource definition.) On emergency restart, a started task is restarted only if it was started with data written to a **recoverable** temporary storage queue.

**Restart of started transactions:** Started transactions that are defined with RESTART(YES) are eligible for restart only in certain circumstances. The effect of RESTART(NO) and RESTART(YES) on started transactions is shown in Table 2 on page 72.

Table 2. Effect of RESTART option on started transactions

Description of START command	Events	Effect of RESTART(YES)	Effect of RESTART(NO)
Specifies either recoverable or nonrecoverable data	Started task ends normally, but does <i>not</i> retrieve data.	START request and its data (TS queue) are discarded at normal end.	START request and its data (TS queue) are discarded at normal end.
Specifies recoverable data	Started task abends <i>after</i> retrieving its data	START request and its data are recovered and restarted, up to $n^1$ times.	START request and its data are discarded.
	Started task abends <i>without</i> retrieving its data	START request and its data are recovered and restarted, up to $n^1$ times.	START request and its data are discarded.
Specifies nonrecoverable data	Started task abends <i>after</i> retrieving its data	START request is discarded and not restarted.	Not restarted.
	Started task abends <i>without</i> retrieving its data	Transaction is restarted with its data still available, up to $n^1$ times.	START request and its data are discarded.
Without data	Started task abends	Transaction is restarted up to $n^1$ times.	—

<sup>1</sup>  $n$  is defined in the transaction restart program, DFHREST, where the CICS-supplied default is 20.

### EXEC CICS CANCEL requests

Recovery from CANCEL requests during transaction backout depends on whether:

- Data is being passed to the started task and
- The temporary storage queue used to pass the data is defined as recoverable.

During transaction backout of a failed task that has canceled a START request that has recoverable data associated with it, CICS recovers both the temporary storage queue and the start request. Thus the effect of the recovery is as if the CANCEL command had never been issued.

If there is no data associated with the START command, or if the temporary storage queue is not recoverable, neither the canceled started task nor its data is recovered, and it stays canceled.

### Basic mapping support (BMS) messages

Recovery of BMS messages affects those BMS operations that store data on temporary storage. They are:

- BMS commands that specify the PAGING operand
- The BMS ROUTE command
- The message switching transaction (CMSG)

Backout of these BMS operations is based on backing out START requests because, internally, BMS uses the START mechanism to implement the operations listed above. You request backout of these operations by making the BMS temporary storage queues recoverable, by defining their DATAIDs in the temporary storage table. For more information about the temporary storage table, see the *CICS Resource Definition Guide*.

Application programmers can override the default temporary storage DATAIDs by specifying the following operands:

- REQID operand in the SEND MAP command
- REQID operand in the SEND TEXT command
- REQID operand in the ROUTE command
- PROTECT operand in the CMSG transaction

**Note:** If backout fails, CICS does not try to restart regardless of the setting of the restart program.

## Backout-failed recovery

In principle, backout failure support can apply to any resource that performs backout, but the support is currently provided only by CICS file control.

### Files

If backout to a VSAM data set fails for any reason, CICS:

- **Invokes the backout failure global user exit program** at XFCBFAIL, if this exit is enabled. If the user exit program chooses to bypass backout failure processing, the remaining actions below are not taken.
- Issues message DFHFC4701, giving details of the update that has failed backout, and the type of backout failure that has occurred.
- **Converts the active exclusive locks** into retained locks. This ensures that no other task in any CICS region (including the region that owns the locks) waits for a lock that cannot be granted until the failure is resolved. (In this situation, CICS returns the LOCKED condition to other tasks that request a lock.) Preserving locks in this way also prevents other tasks from updating the records until the failure is resolved.
  - For data sets open in RLS mode, CICS requests SMSVSAM to retain the locks.
  - For VSAM data sets open in non-RLS mode, the CICS enqueue domain provides an equivalent function.

Creating retained locks also ensures that other requests do not have to wait on the locks until the backout completes successfully.

- **Keeps the log records** that failed to be backed out (by shunting<sup>4</sup> the unit of work) so that the failed records can be presented to file control again when backout is retried. (See “The shunted state” on page 13 for more information about shunted units of work.

If a unit of work updates more than one data set, the backout may fail for only one, or some, of the data sets. When this occurs, CICS converts to retained locks only those locks held by the unit of work for the data sets for which backout has failed. When the unit of work is shunted, CICS releases the locks for records in data sets that are backed out successfully. The log records for the updates made to the data sets that fail backout are kept for the subsequent backout retry. CICS does not keep the log records that are successfully backed out.

For a given data set, it is not possible for some of the records updated by a unit of work to fail backout and for other records not to fail. For example, if a unit of work updates several records in the same data set, and backout of one record fails, they are all deemed to have failed backout. The backout failure exit is invoked once only within a unit of work, and the backout failure message is issued once only, for each

---

4. Shunting. The process of suspending a unit of work in order to allow time to resolve the problem that has caused the suspension. Shunting releases the user's terminal, virtual storage, and CP resources, and allows completion of the unit of work to be deferred for as long as necessary.

data set that fails backout. However, if the backout is retried and fails again, the exit is reinvoked and the message is issued again.

For BDAM data sets, there is only limited backout failure support: the backout failure exit, XFCBFAIL, is invoked (if enabled) to take installation-defined action, and message DFHFC4702 is issued.

**Retrying backout-failed units of work:** Backout retry for a backout-failed data set either can be driven manually (using the SET DSNAME RETRY command) or in many situations occurs automatically when the cause of the failure has been resolved (see “Possible reasons for VSAM backout failure”). When CICS performs backout retry for a data set, any backout-failed UOWs that are shunted because of backout failures on that data set are unshunted<sup>5</sup>, and the recovery manager passes the log records for that data set to file control. File control attempts to back out the updates represented by the log records and, if the original cause of the backout failure is now resolved, the backout retry succeeds. If the cause of a backout failure is not resolved, the backout fails again, and backout failure support is reinvoked.

**Disposition of data sets after backout failures:** Because individual records are locked when a backout failure occurs, CICS need not set the entire data set into a **backout-failed** condition. CICS may be able to continue using the data set, with only the locked records being unavailable. Some kinds of backout failure can be corrected without any need to take the data set offline (that is, without needing to stop all current use of the data set and prevent further access). Even for those failures that cannot be corrected with the data set online, it may still be preferable to schedule the repair at some future time and to continue to use the data set in the meantime, if this is possible.

### **Possible reasons for VSAM backout failure**

There are many reasons why back out can fail, and these are described in this section. In general, each of these descriptions corresponds with a REASON returned on an INQUIRE UOWDSNFAIL command.

#### **I/O error**

You must take the data set offline to repair it, but there may be occasions when the problem is localized and use of the data set can continue until it is convenient to carry out the repair.

Message DFHFC4701 with a failure code of X'24' indicates that an I/O error (a physical media error) has occurred while backing out a VSAM data set. This indicates that there is some problem with the data set, but it may be that the problem is localized. A better indication of the state of a data set is given by message DFHFC0157 (followed by DFHFC0158), which CICS issues whenever an I/O error occurs (not just during backout). Depending on the data set concerned, and other factors, your policy may be to repair the data set:

- After a few I/O errors
- After the first backout failure
- After a number of I/O errors that you consider to be significant
- After a significant number of backout failures
- Not at all

It might be worth initially deciding to leave a data set online for some time after a backout failure, to evaluate the level of impact the failures have on users.

---

5. Unshunting. The process of attaching a transaction to provide an environment under which to resume the processing of a shunted unit of work.

To recover from a media failure, recreate the data set by applying forward recovery logs to the latest backup. The steps you take depend on whether the data set is opened in RLS or non-RLS mode:

- For data sets opened in non-RLS mode, set the data set offline to all CICS applications by closing all open files against the data set.

Perform forward recovery using a forward recovery utility.

When the new data set is ready, use the CEMT (or EXEC CICS) SET DSNAME RETRY command to drive backout retry against the data set for all the units of work in backout-failed state.

- For data sets opened in RLS mode, use the CEMT (or EXEC CICS) SET DSNAME QUIESCED command to quiesce the data set.

Perform forward recovery using CICSVR as your forward recovery utility.

CICS regions are notified through the quiesce protocols when CICSVR has completed the forward recovery. This causes backout to be automatically retried. The backout retry fails at this attempt because the data set is still quiesced, and the UOWs are again shunted as backout-failed.

Unquiesce the data set as soon as you know that forward recovery is complete. Completion of the unquiesce is notified to the CICS regions, which causes backout to be automatically retried again, and this time it should succeed.

This mechanism, in which the backout retry is performed within CICS, supersedes the batch backout facility supported by releases of CICSVR earlier than CICSVR 2.3. You do not need a batch backout utility.

#### **Logical delete not performed**

This error occurs if, during backout of a write to an ESDS, the XFCLDEL logical delete exit was either not enabled, or requested that the backout be handled as a backout failure.

You can correct this by enabling a suitable exit program and manually retrying the backout. There is no need to take the data set offline.

#### **Open error**

Investigate the cause of any error that occurs in a file open operation. A data set is normally already open during dynamic backout, so an open error should occur only during backout processing if the backout is being retried, or is being carried out following an emergency restart. Some possible causes are:

- The data set has been quiesced, in which case the backout is automatically retried when the data set is unquiesced.
- It is not possible to open the data set in RLS mode because the SMSVSAM server is not available, in which case the backout is automatically retried when the SMSVSAM server becomes available.

For other cases, manually retry the backout after the cause of the problem has been resolved. There is no need to take the data set offline.

#### **SMSVSAM server failure**

This error can occur only for VSAM data sets opened in RLS access mode. The failure of the SMSVSAM server might be detected by the backout request, in which case CICS file control starts to close the failed SMSVSAM control ACB and issues a console message. If the failure has already been detected by some other (earlier) request, CICS has already started to close the SMSVSAM control ACB when the backout request fails.

The backout is normally retried automatically when the SMSVSAM server becomes available. (See “Dynamic RLS restart” on page 35.) There is no need to take the data set offline.

#### **SMSVSAM server recycle during backout**

This error can occur only for VSAM data sets opened in RLS access mode.

This is an extremely unlikely cause of a backout failure. CICS issues message DFHFC4701 with failure code X'C2'. Retry the backout manually: there is no need to take the data set offline.

#### **Coupling facility cache structure failure**

This error can occur only for VSAM data sets opened in RLS access mode. The cache structure to which the data set is bound has failed, and VSAM has been unable to rebuild the cache, or to re-bind the data set to an alternative cache.

The backout is retried automatically when a cache becomes available again. (See “Cache failure support” on page 82.) There is no need to take the data set offline.

#### **DFSMSdss non-BWO backup in progress**

This error can occur only for VSAM data sets opened in RLS access mode.

DFSMSdss makes use of the VSAM quiesce protocols when taking non-BWO backups of data sets that are open in RLS mode. While a non-BWO backup is in progress, the data set does not need to be closed, but updates to the data set are not allowed. This error means that the backout request was rejected because it was issued while a non-BWO backup was in progress.

The backout is retried automatically when the non-BWO backup completes.

#### **Data set full**

The data set ran out of storage during backout processing.

Take the data set offline to reallocate it with more space. (See “Chapter 16. Moving recoverable data sets that have retained locks” on page 173 for information about preserving retained locks in this situation.) You can then retry the backout manually, using the CEMT, or EXEC CICS, SET DSNAME(...) RETRY command.

#### **Non-unique alternate index full**

Take the data set offline to rebuild the data set with a larger record size for the alternate index. (See “Chapter 16. Moving recoverable data sets that have retained locks” on page 173 for information about preserving retained locks in this situation.) You can then retry the backout manually, using the CEMT, or EXEC CICS, SET DSNAME(...) RETRY command.

#### **Deadlock detected**

This error can occur only for VSAM data sets opened in non-RLS access mode.

This is a transient condition, and a manual retry should enable backout to complete successfully. There is no need to take the data set offline.

#### **Duplicate key error**

The backout involved adding a duplicate key value to a unique alternate index. This error can occur only for VSAM data sets opened in non-RLS access mode.

This situation can be resolved only by deleting the rival record with the duplicate key value.



**Lock structure full error**

The backout required VSAM to acquire a lock for internal processing, but it was unable to do so because the RLS lock structure was full. This error can occur only for VSAM data sets opened in RLS access mode.

To resolve the situation, you must allocate a larger lock structure in an available coupling facility, and rebuild the existing lock structure into the new one. The failed backout can then be retried using SET DSNAME RETRY.

**None of the above**

If any other error occurs, it indicates a possible error in CICS or VSAM code, or a storage overwrite in the CICS region. Diagnostic information is given in message DFHFC4700, and a system dump is provided.

If the problem is only transient, a manual retry of the backout should succeed.

**Auxiliary temporary storage**

All updates to recoverable auxiliary temporary storage queues are managed in main storage until syncpoint. TS always commits forwards; therefore TS can never suffer a backout failure.

**Transient data**

All updates to logically recoverable intrapartition queues are managed in main storage until syncpoint, or until a buffer must be flushed because all buffers are in use. TD always commits forwards; therefore, TD can never suffer a backout failure on DFHINTRA.

## Commit-failed recovery

Commit failure support is provided only by CICS file control, because it is the only CICS component that needs this support.

**Files**

A commit failure is one that occurs during the commit stage of a unit of work (either following the prepare phase of two-phase commit, or following backout of the unit of work). It means that the unit of work has not yet completed, and the commit must be retried successfully before the recovery manager can forget about the unit of work.

When a failure occurs during file control's commit processing, CICS ensures that all the unit of work log records for updates made to data sets that have suffered the commit failure are kept by the recovery manager. Preserving the log records ensures that the commit processing for the unit of work can be retried later when conditions are favorable.

The most likely cause of a file control commit failure, from which a unit of work can recover, is that the SMSVSAM server is not available when file control is attempting to release the RLS locks. When other SMSVSAM servers in the sysplex detect that a server has failed, they retain all the active exclusive locks held by the failed server on its behalf. Therefore, CICS does not need to retain locks explicitly when a commit failure occurs. When the SMSVSAM server becomes available again, the commit is automatically retried.

However, it is also possible for a file control commit failure to occur as a result of some other error when CICS is attempting to release RLS locks during commit processing, or is attempting to convert some of the locks into retained locks during the commit processing that follows a backout failure. In this case it may be

necessary to retry the commit explicitly using the SET DSNAME RETRY command. Such failures should be rare, and may be indicative of a more serious problem.

It is possible for a unit of work that has not performed any recoverable work, but which has performed repeatable reads, to suffer a commit failure. If the SMSVSAM server fails while holding locks for repeatable read requests, it is possible to access the records when the server recovers, because all repeatable read locks are released at the point of failure. If the commit failure is not due to a server failure, the locks are held as active shared locks. The INQUIRE UOWDSNFAIL command distinguishes between a commit failure where recoverable work was performed, and one for which only repeatable read locks were held.

## In-doubt failure recovery

The CICS recovery manager is responsible for maintaining the state of each unit of work in a CICS region. For example, typical events that cause a change in the state of a unit of work are temporary suspension and resumption, receipt of syncpoint requests, and entry into the in-doubt period during two-phase commit processing.

The CICS recovery manager shunts a unit of work if all the following conditions apply:

- The unit of work has entered the in-doubt period.
- The recovery manager detects loss of connectivity to its coordinator for the unit of work.
- The in-doubt attribute on the transaction resource definition under which the unit of work is running specifies WAIT(YES).
- The conditions exist that allow shunting. For example, recovery manager does not shunt a UOW that has an MRO link to a CICS region running under CICS for MVS/ESA 4.1 or earlier. See the *CICS Intercommunication Guide* for a complete list of conditions.

### Files

When file control shunts its resources for the unit of work, it detects that the shunt is being issued during the first phase of two-phase commit, indicating an **in-doubt failure**. Any active exclusive lock held against a data set updated by the unit of work is converted into a retained lock. The result of this action is as follows:

- No CICS region, including the CICS region that obtained the locks, can update the records that are awaiting in-doubt resolution because the locks have not been freed.
- Other UOWs do not wait on these locked records, because the locks are not active locks but retained locks, requests for which cause CICS to return the LOCKED response.

For information about types of locks, see “Locks” on page 14.

For data sets opened in RLS mode, interfaces to VSAM RLS are used to retain the locks. For VSAM data sets opened in non-RLS mode, and for BDAM data sets, the CICS enqueue domain provides an equivalent function. It is not possible for some of the data sets updated in a particular unit of work to be failed in-doubt and for the others not to be.

It is possible for a unit of work that has not performed any recoverable work, but which has performed repeatable reads, to be shunted when an in-doubt failure occurs. In this event, repeatable read locks are released. Therefore, for any data set against which only repeatable reads were issued, it is possible to access the records, and to open the data set in non-RLS mode for batch processing, despite

the existence of the in-doubt failure. The INQUIRE UOWDSNFAIL command distinguishes between an in-doubt failure where recoverable work has been performed, and one for which only repeatable read locks were held. If you want to open the data set in non-RLS mode in CICS, you need to resolve the in-doubt failure before you can define the file as having RLSACCESS(NO). If the unit of work has updated any other data sets, or any other resources, you should try to resolve the in-doubt correctly, but if the unit of work has only performed repeatable reads against VSAM data sets and has made no updates to other resources, it is safe to force the unit of work using the SET DSNAME or SET UOW commands.

CICS saves enough information about the unit of work to allow it to be either committed or backed out when the in-doubt unit of work is unshunted when the coordinator provides the resolution (or when the transaction wait time expires). This information includes the log records written by the unit of work.

When CICS has re-established communication with the coordinator for the unit of work, it can resynchronize all in-doubt units of work. This involves CICS first unshunting the units of work, and then proceeding with the commit or backout. All CICS enqueues and VSAM RLS record locks are released, unless a commit failure or backout failure occurs.

For information about the resynchronization process for units of work that fail in-doubt, see the *CICS Intercommunication Guide*.

### **Intrapartition transient data**

When a UOW that has updated a logically recoverable intrapartition transient data queue fails in-doubt, CICS converts the locks held against the TD queue to retained locks. Until the UOW is unshunted, the default action is to reject with the LOCKED condition further requests of the following types:

- **READQ**, if the in-doubt UOW had issued READQ or DELETEDQ requests
- **WRITEQ**, if the in-doubt UOW had issued WRITEQ or DELETEDQ requests
- **DELETEDQ**, if the in-doubt UOW had issued READQ, WRITEQ, or DELETEDQ requests

You can use the WAITACTION option on the TD queue resource definition to control the action that CICS takes when an update request is made against a shunted in-doubt UOW that has updated the queue. In addition to the default option, which is WAITACTION(REJECT), you can specify WAITACTION(Queue) to queue further requests while the queue is locked by the failed-in-doubt UOW.

After resynchronization, the shunted updates to the TD queue are either committed or backed out, and the retained locks are released.

### **Auxiliary temporary storage**

When a UOW that has updated a recoverable temporary storage queue fails in-doubt, the locks held against the queue are converted to retained locks. Until the UOW is unshunted, further update requests against the locked queue items are rejected with the LOCKED condition.

After resynchronization, the shunted updates to the TS queue are either committed or backed out, and the retained locks are released.

---

## Investigating an in-doubt failure

This example shows how to investigate a unit of work (UOW) that has failed in-doubt. For the purposes of the example, the CICS-supplied transaction CIND has been used to create the failure—one of the FILEA sample application transactions, UPDT, has been made to fail in-doubt. For more information about CIND, see the *CICS Supplied Transactions* manual.

To retrieve information about a unit of work (UOW), you can use either the CEMT, or EXEC CICS, INQUIRE UOW command. For the purposes of this illustration, the CEMT method is used. You can filter the command to show only UOWs that are associated with a particular transaction. For example, Figure 4 shows one UOW (AC0CD65E5D990800) associated with transaction UPDT.

```
INQUIRE UOW TRANS(UPDT)
STATUS:  RESULTS - OVERTYPE TO MODIFY
Uow(AC0CD65E5D990800) Ind Shu Tra(UPDT) Tas(0003155)
      Age(00000680) Ter(S233) Netn(IGBS233 ) Use(CICSUSER) Con Lin(DFHINDSP)
```

Figure 4. The CEMT INQUIRE UOW command showing UOWs associated with a transaction

Each UOW identifier is unique within the local CICS system. To see more information about the UOW, move the cursor to the UOW row and press ENTER. This display the following screen:

```
INQUIRE UOW TRA(UPDT)
RESULT - OVERTYPE TO MODIFY
Uow(AC0CD65E5D990800)
Uowstate( Indoubt )
Waitstate(Shunted)
Transid(UPDT)
Taskid(0003155)
Age(00000826)
Terminid(S233)
Netname(IGBS233)
Userid(CICSUSER)
Waitcause(Connection)
Link(DFHINDSP)
Sysid()
Netuowid(..GBIBMIYA.IGBS233 .0;)r...)
```

Figure 5. CEMT INQUIRE UOW—details of UOW AC0CD65E5D990800

The UOWSTATE for this UOW is **Indoubt**. The TRANSACTION definition attribute WAIT(YES|NO) controls the action that CICS takes when a UOW fails in-doubt. CICS does one of two things:

- Makes the UOW wait, pending recovery from the failure. (In other words, the UOW is shunted.) Updates to recoverable resources are suspended,
- Takes an immediate decision to commit or backout the recoverable resource updates.

The WAITSTATE of **Shunted** shows that this UOW has been suspended.

Figure 5 on page 80 reveals other information about the UOW:

- The original transaction was UPDT, the taskid was 3155, and the termid was S233. Any of these can be used to tie this particular failure with messages written to CSMT.
- The UOW has been in-doubt for **826** seconds (AGE).
- The cause of the in-doubt failure was a **Connection** failure. (The connection is the dummy connection used by CIND **DFHINDSP**.)

When a UOW has been shunted in-doubt, CICS retains locks on the recoverable resources that the UOW has updated. This prevents further tasks from changing the resource updates while they are in-doubt. To display CICS locks held by a UOW that has been shunted in-doubt, use the CEMT INQUIRE UOWENQ command. You can filter the command to show only locks that are associated with a particular UOW. (Note that the INQUIRE UOWENQ command operates only on non-RLS resources on which CICS has enqueued, and for RLS-accessed resources you should use the INQUIRE UOWDSNFAIL command.) For example:

```
INQUIRE UOWENQ UOW(*0800)
STATUS: RESULTS
Uow(AC0CD65E5D990800) Tra(UPDT) Tas(0003155) Ret Dat Own
Res(DCXISCG.IYLX.FILEA ) Rle(018) Enq(00000003)
```

Figure 6. CEMT INQUIRE UOWENQ—used to display locks associated with a UOW

To see more information about this UOWENQ, put the cursor alongside it and press ENTER:

```
INQUIRE UOWENQ UOW(*0800)
RESULT
Uowenq
Uow(AC0CD65E5D990800)
Transid(UPDT)
Taskid(0003155)
State(Retained)
Type(Dataset)
Relation(Owner)
Resource(DCXISCG.IYLX.FILEA)
Rlen(018)
Enqfails(00000003)
Netuowid(..GBIBMIYA.IGBS233 .0;)r...)
Qualifier(000001)
Qlen(006)
```

Figure 7. CEMT INQUIRE UOWENQ—details of a lock associated with a UOW

We can now see that:

- This UOW is the **Owner** of a **Retained** lock on a **Dataset**. Retained locks differ from active locks in that a further task requiring this lock is not suspended;

instead, the transaction receives the LOCKED condition—if the condition is not handled by the application, this results in an AEX8 abend.

- The dataset is **DCXISCG.IYLX.FILEA**, and the **Qualifier** (in this case, the key of the record which is in-doubt) is **000001**.
- Three other tasks have attempted to update the in-doubt record (ENQFAILS).

Because CIND was used to create this in-doubt failure, it can also be used to resolve the in-doubt UOW. For an example of how to resolve a real in-doubt failure, see the *CICS Intercommunication Guide*.

---

## Recovery from failures associated with the coupling facility

This section deals with recovery from failures arising from the use of the coupling facility, and which affect CICS units of work. It covers:

- SMSVSAM cache structure failures
- SMSVSAM lock structure failures (lost locks)
- Connection failure to a coupling facility cache structure
- Connection failure to a coupling facility lock structure
- MVS system recovery and sysplex recovery

### Cache failure support

This type of failure affects only data sets opened in RLS mode.

SMSVSAM supports **cache set** definitions that allow you to define multiple cache structures<sup>6</sup> within a cache set across one or more coupling facilities. To insure against a cache structure failure, use at least two coupling facilities and define each cache structure, within the cache set, on a different coupling facility.

In the event of a cache structure failure, SMSVSAM attempts to rebuild the structure. If the rebuild fails, SMSVSAM switches data sets that were using the failed structure to use another cache structure in the cache set. If SMSVSAM is successful in either rebuilding or switching to another cache structure, processing continues normally, and the failure is transparent to CICS regions. Because the cache is used as a store-through cache, no committed data has been lost.

The support for rebuilding cache structures enables coupling facility storage to be used effectively. It is not necessary to reserve space for a rebuild to recover from a cache structure failure—SMSVSAM uses any available space.

If RLS is unable to recover from the cache failure for any reason, the error is reported to CICS when it tries to access a data set that is bound to the failed cache, and CICS issues message DFHFC0162 followed by DFHFC0158. CICS defers any activity on data sets bound to the failed cache by abending UOWs that attempt to access the data sets. When “cache failed” responses are encountered during dynamic backout of the abended UOWs, CICS invokes backout failure support (see “Backout-failed recovery” on page 73). RLS open requests for data sets that must bind to the failed cache, and RLS record access requests for open data sets that are already bound to the failed cache, receive error responses from SMSVSAM.

---

6. Cache structure. One of three types of coupling facility data structure supported by MVS. SMSVSAM uses its cache structure to perform buffer pool management across the sysplex. This enables SMSVSAM to ensure that the data in the VSAM buffer pools in each MVS image remains valid.

When either the failed cache becomes available again, or SMSVSAM is able to connect to another cache in a data set's cache set, CICS is notified by the SMSVSAM quiesce protocols. CICS then retries all backouts that were deferred because of cache failures.

Whenever CICS is notified that a cache is available, it also drives backout retries for other types of backout failure, because this notification provides an opportunity to complete backouts that may have failed for some transient condition.

CICS recovers after a cache failure automatically. There is no need for manual intervention (other than the prerequisite action of resolving the underlying cause of the cache failure).

## Lost locks recovery

The failure of a coupling facility lock structure that cannot be rebuilt by VSAM creates the **lost locks condition**. The lost locks condition can occur only for data sets opened in RLS mode. A data set can be made available for general use only after all the CICS regions that were accessing the data set at the time of the lock structure failure have completed the process known as **lost locks recovery**.

### Rebuilding the lock structure

When a coupling facility lock structure fails, the SMSVSAM servers attempt to rebuild their locks in the lock structure from their own locally-held copies of the locks. If this is successful, the failure is transparent to CICS.

If the rebuild fails, all SMSVSAM servers abend and restart, but they are not available for service until they can successfully connect to a new coupling facility lock structure. Thus a lock structure failure is initially detected by CICS as an SMSVSAM server failure, and CICS issues message DFHFC0153.

When the SMSVSAM servers abend because of this failure, the sharing control data set is updated to reflect the lost locks condition. The sharing control data set records:

- The data sets whose locks have been lost.
- The CICS regions that must complete lost locks recovery for each data set. These are the CICS regions that had a data set open for update (in RLS-mode) for which the locks have been lost.

### Notifying CICS of SMSVSAM restart

When the SMSVSAM servers are able to connect to a new lock structure, they use the MVS ENF to notify the CICS regions that their SMSVSAM server is available again. CICS is informed during dynamic RLS restart about those data sets for which it must perform lost locks recovery. CICS issues a message (DFHFC0555) to inform you that lost locks recovery is to be performed for one or more data sets.

If a lost-locks condition occurs and is not resolved when a CICS restart (warm or emergency) occurs, CICS is notified during file control restart about any data sets for which it must perform lost locks recovery. On a cold start, CICS does not perform any lost locks recovery, and the information in the sharing control data set, which records that CICS must complete lost locks recovery, is cleared for each data set. This does not affect the information recorded for other CICS regions.

Only UOWs performing lost locks recovery can use data sets affected by lost locks. Error responses are returned on open requests issued by any CICS region that was

not sharing the data set at the time the lost locks condition occurred, and on RLS access requests issued by any new UOWs in CICS regions that were sharing the data set.

### **Performing lost locks recovery for failed UOWs**

Lost locks recovery requires that any UOWs that had been updating the data set at the time of the failure must complete before the data set can be made available for general use. This is because their updates are no longer protected by the record locks, so access by other UOWs and other CICS regions cannot be permitted until the updates have been either committed or backed out. Therefore, each CICS region performing lost locks recovery must complete all UOWs before notifying VSAM that it has completed all affected units of work.

CICS takes the following actions during dynamic RLS restart to expedite lost locks recovery:

- It drives backout-failed UOWs for backout retry. If backout retry for a data set in the lost locks condition fails, lost locks recovery cannot complete until either:
  - The backout is completed successfully (by resolving the condition that caused it), or
  - The SET DSNAME RESETLOCKS command is used to abandon the backout, with consequent loss of data integrity.
- CICS drives commit-failed UOWs for commit retry. Because the failure of an SMSVSAM server is the only cause of commit-failed units of work, retrying them succeeds when the server becomes available.
- CICS purges in-flight transactions that have updated a data set that is in a lost locks condition.

Following any failure of the SMSVSAM server, CICS abends and backs out any UOWs that had made RLS requests before the failure, and which then attempt further RLS requests when the restarted SMSVSAM server is available. They are not backed out until they make a further request to RLS.

In the case of an SMSVSAM server failure that is caused by a lock structure failure, this would mean that in-flight units of work could delay the recovery from the lost locks condition until the UOWs make further RLS updates. To avoid this potential delay, CICS purges the transactions to expedite lost locks recovery. CICS issues message DFHFC0171 if any in-flight transactions cannot be purged, warning that lost locks recovery could potentially be delayed.

- For in-doubt UOWs that have updated a data set that is in a lost locks condition, CICS must wait for in-doubt resolution before it can complete lost locks recovery, unless the unit of work is forced to complete using the SET DSNAME or SET UOW commands with the BACKOUT, COMMIT, or FORCE options. (See “Choosing data availability over data integrity” on page 167 for the reason why the BACKOUT option has advantages for UOWs that have updated CICS files.)

When a CICS region has completed lost locks recovery for a data set, it informs SMSVSAM. This is done once for each data set. When all CICS regions have informed SMSVSAM that they have completed their lost locks recovery for a particular data set, that data set is no longer in a lost locks condition, and is made available for general access. Although the lost locks condition affects simultaneously all data sets in use when the lock structure fails, each data set can be restored to service individually as soon as all its sharing CICS regions have completed lost locks recovery.



## Connection failure to a coupling facility cache structure

If connection to a coupling facility cache structure is lost, DFSMS™ attempts to rebuild the cache in a structure to which all the SMSVSAM servers have connectivity. If the rebuild is successful, the failure is transparent to CICS.

If DFSMS is unable to recover transparently from a connectivity failure to a coupling facility cache structure, CICS issues message DFHFC0163 (followed by DFHFC0158) on detecting the condition. The recovery process from this failure is the same as for a cache structure failure:

- Errors are returned to CICS when it attempts to access data sets bound to the cache, as a result of which:
  - CICS attempts to back out the unit of work, fails, and shunts the unit of work so that backout can be retried later.
  - CICS converts any locks held by the unit of work against records in the data set to retained locks.
  - CICS is informed by the quiesce protocols when the connectivity is restored.
  - CICS retries backout of the shunted units of work.

## Connection failure to a coupling facility lock structure

If an SMSVSAM server loses connectivity to the coupling facility lock structure, and it is not possible to rebuild locks in another lock structure to which all the SMSVSAM servers in the sysplex have access, the SMSVSAM server abends and restarts itself. CICS issues message DFHFC0153 when it detects that the server is not available for service.

The restarted SMSVSAM is not available for service until it is successfully connected to its coupling facility lock structure. When it does become available, recovery follows dynamic RLS restart in the same way as for any other server failure, because no lock information has been lost.

## MVS system recovery and sysplex recovery

When an MVS image fails, all CICS regions and the SMSVSAM server in that image also fail. All RLS locks belonging to CICS regions in the image are retained by SMSVSAM servers in the other MVS systems.

When the MVS image restarts, recovery for all resources is through CICS emergency restart. If any CICS region completes emergency restart before the SMSVSAM server becomes available, it performs dynamic RLS restart as soon as the server is available.

The surviving MVS images should be affected by the failure only to the extent that more work is routed to them. Also, tasks that attempt to access records that are locked by CICS regions in the failed MVS image receive the LOCKED response.

If all the MVS images in a sysplex fail, the first SMSVSAM server to restart reconnects to the lock structure in the coupling facility and converts all the locks into retained locks for the whole sysplex.

Recovery from the failure of a sysplex is just the equivalent of multiple MVS failure recoveries.

---

## Transaction abend processing

If, during transaction abend processing, another abend occurs and CICS continues, there is a risk of a transaction abend loop and further processing of a resource that has lost integrity (because of uncompleted recovery). If CICS detects that this is the case, the CICS system abends with message DFHPC0402, DFHPC0405, DFHPC0408, or DFHPC0409.

## How CICS handles transaction abends

The action taken by CICS on the abend exit code can:

- Terminate the task normally
- Terminate the task abnormally

“Abnormal termination of a task” on page 87 describes the processing that may follow the abnormal termination of a task.

## Exit code

Exit code can be written either in **programs** (separate modules defined in the CSD) or in **routines** within the application program. Exit code, if activated, can gain control when a task abend occurs.

Exit code can be activated, deactivated, or reactivated by HANDLE ABEND commands. For information about HANDLE ABEND commands, see the *CICS Application Programming Reference*.

Only one abend exit can be active at any given logical level <sup>7</sup> within a task. This means that:

1. When one program LINKs to another program, the LINKed-from program **and** the LINKed-to program can each have one active exit.
2. When an exit is activated (at a particular program level), any other exit that may already be active at the same level automatically becomes deactivated.

Reasons that an application programmer might have for coding a program level abend exit, and functions that might be incorporated, are discussed in “Handling abends and program level abend exits” on page 140.

When an abend request is issued for a task, CICS immediately passes control to the exit that is active at the current logical level:

- If no exit is active at the current logical level, CICS checks progressively up through higher logical levels and passes control to the first exit code found to be active.
- If CICS finds no active exit at, or higher than, the current logical level, the task terminates abnormally (see “Abnormal termination of a task” on page 87).

When control is transferred to any exit code, CICS deactivates the exit before any of its code is executed. (This means that, in the event of another abend request, the exit will not be reentered, and control is passed to activated exit code (if any) at the next higher level.)

---

7. Logical level. A LINKed-to program is said to be at a **lower logical level** than the program that issues the LINK command. The concept of logical levels is explained in the *CICS Application Programming Guide*.

The exit code then executes as an extension of the abending task, and runs at the same level as the program that issued the HANDLE ABEND command that activated the exit.

After any program-level abend exit code has been executed, the next action depends on how the exit code ends:

- If the exit code ends with an ABEND command, CICS gives control to the next higher level exit code that is active. If no exit code is active at higher logical levels, CICS terminates the task abnormally. The next section describes what may happen after abnormal termination of a task.
- If the exit code ends with a RETURN command, CICS returns control to the next higher logical level at the point following the LINK command (not to any exit code that may be active) just as if the RETURN had been issued by the lower level application program. This leaves the task in a normal processing state, and it does **not** terminate at this point.

In the special case of a RETURN command being issued by exit code at the highest logical level, CICS regains control and terminates the task normally. This means that:

1. Dynamic transaction backout is **not** performed.
2. An end-of-task syncpoint record is written to the system log.

**Note:** If a transaction updates recoverable resources and, therefore, requires transaction backout to be performed in the event of a task abend, the exit code **must** end with an ABEND command to preserve data integrity. If your exit code simply returns to CICS without an ABEND command, CICS gives control to the next higher logical level as described above, transaction backout is not performed, and changes to recoverable resources are committed.

## Abnormal termination of a task

If the exit code ends with an ABEND command, or if there is no active exit code, abnormal termination of a task starts after all active program-level abend exits (if any) have executed. The sequence of actions during abnormal termination of a task depends on the following factors:

- Code in the transaction restart program (DFHREST)
- Whether the transaction has freed the principal facility
- Whether backout was successful

### Transaction restart

The transaction restart user-replaceable module (DFHREST) enables you to participate in the decision as to whether a transaction should be restarted or not. The default program requests restart under certain conditions; for example, in the event of a program isolation deadlock (for instance, when two tasks each wait for the other to release a particular DL/I database segment), one of the tasks is backed out and automatically restarted, and the other is allowed to complete its update.

For programming information about how to write your own code for DFHREST, see the *CICS Customization Guide*.

#### Notes:

1. CICS invokes DFHREST only when RESTART(YES) is specified in a transaction's resource definition.
2. Ensure that resources used by restartable transactions, such as files, temporary storage, and intrapartition transient data queues, are defined as recoverable.

3. When transaction restart occurs, a new task is attached that invokes the initial program of the transaction. This is true even if the task abended in the second or subsequent unit of work, and DFHREST requested a restart.
4. CICS keeps statistics on the total number of restarts against each transaction.
5. Emergency restart does not restart any user tasks that were in-flight when CICS abnormally terminated. Instead, recovery manager attaches a special task for each in-flight task that had recovery records in the system log at abnormal termination. This task invokes each resource manager to backout recoverable resources.
6. Making a transaction restartable can involve slightly more overhead, because copies of the TCTUA, COMMAREA, and terminal input/output area (TIOA) have to be kept in case the transaction needs to be restarted. For more information about making transactions restartable, see the *CICS Customization Guide*.
7. In some cases, the benefits of transaction restart can be obtained instead by using the SYNCPOINT ROLLBACK command. For more information about the use of the ROLLBACK option when working in an ISC or MRO environment, see the *CICS Intercommunication Guide*.

---

## Actions taken at transaction failure

The CICS transaction failure program (TFP) is invoked during abnormal transaction termination, unless the transaction is to be restarted, for transactions that:

- Fail during execution and before syncpoint processing is begun
- Fail during syncpoint processing

The principal action of the transaction failure program is to send, if possible, an abend message to the terminal connected to the abending transaction. It also sends a message to the CSMT transient data queue.

Except for transaction failures that occur during syncpoint processing, and before sending the message to the CSMT queue, the transaction failure program links to the user-replaceable program error program (DFHPEP). DFHPEP is given control through a LINK from the CICS transaction failure program. This occurs after all program-level abend exit code has been executed by the task that abnormally terminates, and after dynamic transaction backout (if any) has been performed.

### Notes:

1. DFHPEP is not given control when the task abend is part of the processing done by CICS to avoid a system stall.
2. DFHPEP is not given control if transaction manager detects that the abended transaction is to be restarted by DFHREST.
3. DFHPEP processing takes place after a transaction dump has been taken. DFHPEP cannot prevent a dump being taken.
4. DFHPEP is not given control if the transaction failure occurs during syncpoint processing.
5. DFHPEP is not given control when the conditions causing the task to be terminated are handled by the CICS abnormal condition program (ACP). The conditions handled by ACP are some kind of attach failure; for instance, when the transaction does not exist, or when a security violation is detected.
6. DFHPEP is not given control when a task has abended and CICS is short on storage.

The CICS-provided DFHPEP program executes no functions, but you can include in it your own code to carry out installation-level action following a transaction abend (see “The CICS-supplied PEP” on page 153). There is only one program error program for the whole system.

All CICS facilities are available to the DFHPEP program. You can, for example:

- Send messages to the terminal
- Send messages to the master terminal
- Record information or statistics about the abend
- Request the disabling of the transaction entry associated with this task

---

## Processing operating system abends and program checks

There is a limit to the processing you can attempt after an operating system abend or a program check.

If the program check or abend is associated with any domain other than the application domain, you have no further part in processing the error.

If the program check or abend is in the application domain, one of the following can occur:

- CICS remains operational, but the task currently in control terminates.
- CICS terminates (see “Shutdown requested by the operating system” on page 29).

If a program check occurs when a user task is processing, the task abends with an abend code of ASRA. If a program check occurs when a CICS system task is processing, CICS terminates.

If an operating system abend has occurred, CICS searches the system recovery table, DFHSRT. The SRT contains a set of operating system abend codes that you want CICS to recover from. CICS searches the SRT looking for the system abend code issued by the system:

- If a match is not found, CICS is terminated.
- If a match is found, and a CICS system task is processing, CICS is terminated.
- If a match is found, and a user task is processing, the default action is to abend the task with an abend code of ASRB. However, you can change this action by coding a global user exit program at exit point XSRAB. The value of the return code from XSRAB determines which of the following happens next:
  - The task terminates with the ASRB abend code.
  - The task terminates with the ASRB abend code and CICS cancels any program-level abend exits that are active for the task.
  - CICS terminates.

For programming information about the XSRAB exit point, see the *CICS Customization Guide*.

CICS supplies a sample SRT, DFHSRT1\$, that has a default set of abend codes. You can modify the sample table to define abend codes that suit your own requirements. The source of DFHSRT1\$ is supplied in the CICSTS13.CICS.SDFHSAMP library. For more information about the SRT, see the *CICS Resource Definition Guide*.

**Note:** Because it is possible to introduce recursions between program checks and abends, take great care when coding a global user exit program at the XSRAB exit point.

---

## Chapter 9. Communication error processing

This chapter discusses:

- Terminal error processing
- Intersystem communication failures

---

### Terminal error processing

This section covers briefly the main CICS programs that participate in terminal error processing:

- Node error program (DFHZNEP)
- Terminal error program (DFHTEP)

CICS controls terminals by using VTAM (in conjunction with NCP for remote terminals) and TCAM. These communication access methods detect transmission errors between the central processing complex (CPC) and a remote terminal, and automatically invoke error recovery procedures, if specified. These error recovery procedures generally involve:

- Retransmission of data a defined number of times or until data is transmitted error-free.
- Recording of information about the error on a data set, or internally in control blocks. You can, at times, access data recorded in control blocks using communication system commands.

If the data is not transmitted successfully after the specified number of retries:

- CICS terminal management is notified.
- One of the following CICS terminal error transactions is initiated:
  - Control can pass to a user-written node error program (DFHZNEP).
  - Control can pass to a user-written terminal error program (DFHTEP).

For programming information about coding your own NEPs and TEPs, see the *CICS Customization Guide*.

### Node error program (DFHZNEP)

You can specify your own processing for VTAM errors in a node error program (NEP). You can use the sample NEP supplied, change the sample, or write your own.

The NEP is entered once for each terminal error; therefore it should be designed to process only one error for each invocation.

In some circumstances, VTAM communication system errors can be passed to an application program. If you issue an EXEC CICS HANDLE command with the TERMERR condition specified, the application program can decide on the action to take in response to the error condition. The TERMERR condition is raised if the DFHZNEP program, if you have one, schedules an ABTASK action (ATNI abend) for a terminal error while the task is attached. It is raised for the current or next terminal control request.

### Terminal error program (DFHTEP)

You can specify your own processing for non-VTAM communication errors in a terminal error program (TEP). You can use the sample TEP supplied with CICS (DFHXTEP), change the sample, or write your own.

The TEP is entered once for each terminal error, and therefore should be designed to process only one error for each invocation.

---

## Intersystem communication failures

An intersystem communication failure can be caused by:

- The failure of a CICS region, or the remote system to which it is connected
- A network failure causing the loss of the connection between CICS and a remote system

If the failure occurs between syncpoints, CICS and the remote system can back out any updates of recoverable resources either dynamically or following an emergency restart.

If a failure occurs during the syncpointing process while a distributed unit of work is in-doubt, CICS handles the unit of work according to the in-doubt attributes defined on the transaction resource definition. One possible course of action is to shunt the UOW as failed-indoubt to await resynchronization when communications are restored. When designing applications, remember that if a communications failure occurs and units of work are shunted as failed-indoubt, resources remain locked until after resynchronization.

For information about the resolution of in-doubt units of work, see the *CICS Intercommunication Guide*.



---

## Part 3. Implementing recovery and restart

This part describes the way you implement recovery and restart for CICS regions.

It contains the following chapters:

- “Chapter 10. Planning considerations” on page 95
- “Chapter 11. Defining system and general log streams” on page 103
- “Chapter 12. Defining recoverability for CICS-managed resources” on page 117
- “Chapter 13. Programming considerations” on page 131
- “Chapter 14. Using a program error program (PEP)” on page 153
- “Chapter 15. Resolving retained locks on recoverable resources” on page 155
- “Chapter 16. Moving recoverable data sets that have retained locks” on page 173
- “Chapter 17. Forward recovery procedures” on page 177
- “Chapter 18. Forward recovery with CICSVR” on page 193
- “Chapter 19. Backup-while-open (BWO)” on page 215
- “Chapter 20. Disaster recovery” on page 235.



---

## Chapter 10. Planning considerations

This chapter discusses some aspects of recovery to consider when planning your applications. It also covers briefly the basic CICS system definition parameters for recovery facilities that you may need to specify in support of your applications' needs.

---

### Application design considerations

Think about recoverability as early as possible during the application design stages. This section covers a number of aspects of design planning to consider.

### Questions relating to recovery requirements

For ease of presentation, the following questions assume a single application.

**Note:** If a new application is added to an existing system, the effects of the addition on the whole system need to be considered.

*Question 1: Does the application update data in the system?* If the application is to perform **no** updating (that is, it is an inquiry-only application), recovery and restart functions are not needed within CICS. (But you should take backup copies of non-updated data sets in case they become unreadable.) The remaining questions assume that the application does perform updates.

*Question 2: Does this application update data sets that other online applications access?* If yes, does the business require updates to be made **online**, and then to be immediately available to other applications—that is, as soon as the application has made them? This could be a requirement in an online order entry system where it is vital for inventory data sets<sup>8</sup> to be as up-to-date as possible for use by other applications at all times.

Alternatively, can updates be stored temporarily and used to modify the data set(s) later—perhaps using offline batch programs? This might be acceptable for an application that records only data not needed immediately by other applications.

*Question 3: Does this application update data sets that batch applications access?* If yes, establish whether the batch applications are to access the data sets concurrently with the online applications. If accesses made by the batch applications are limited to read-only, the data sets can be shared between online and batch applications, although read integrity may not be guaranteed. If you intend to update data sets concurrently from both online and batch applications, consider using DL/I or DB2, which ensure both read and write integrity.

*Question 4: Does the application access any confidential data?* Files that contain confidential data, and the applications having access to those files, must be clearly identified at this stage. You may need to ensure that only authorized users may access confidential data when service is resumed after a failure, by asking for re-identification in a sign-on message.

---

8. In the context of these questions, the term “data sets” includes databases.

*Question 5: If a data set becomes unusable, should all applications be terminated while recovery is performed?* If degraded service to any application must be preserved while recovery of the data set takes place, you will need to include procedures to do this.

*Question 6: Which of the files to be updated are to be regarded as vital?* Identify any files that are so vital to the business that they must always be recoverable.

*Question 7: How important is data integrity, compared to availability?* Consider how long the business can afford to wait for a record that is locked, and weigh this against the risks to data integrity if the normal resynchronization process is overridden.

The acceptable waiting time will vary depending on the value of the data, and the number of users whom you expect to be affected. If the data is very valuable or infrequently accessed, the acceptable waiting time will be longer than if the data is of low value or accessed by many business-critical processes.

*Question 8: How long can the business tolerate being unable to use the application in the event of a failure?* Indicate (approximately) the maximum time that the business can allow the system to be out of service after a failure. Is it minutes or hours? The time allowed may have to be negotiated according to the types of failure and the ways in which the business can continue without the online application.

*Question 9: How is the user to continue or restart entering data after a failure?* This is an important part of a recovery requirements statement because it can affect the amount of programming required. The terminal user's restart procedure will depend largely on what is feasible—for example:

- Must the user be able to continue business by other means—for example, manually?
- Does the user still have source material (papers, documents) that allow the continued entry (or reentry) of data? If the source material is transitory (received over the telephone, for example), more complex procedures may be required.
- Even if the user still has the source material, does the quantity of data preclude its reentry?

Such factors define the point where the user restarts work. This could be at a point that is as close as possible to the point reached before the system failure. The best point could be determined with the aid of a progress transaction<sup>9</sup>). Or it could be at some point earlier in the application—even at the start of the transaction.

These considerations should be in the external design statement.

*Question 10: During what periods of the day do users expect online applications to be available?* This is an important consideration when applications (online and batch) require so much of the available computer time that difficulties can arise in scheduling precautionary work for recovery (taking backup copies, for example). See “The RLS quiesce and unquiesce functions” on page 155.

---

9. A progress transaction here means one that enables users to determine the last actions performed by the application on their behalf.

## Validate the recovery requirements statement

After considering the above questions, produce a formal statement of application and recovery requirements. Before any design or programming work begins, all interested parties should agree on the statement—including:

- Those responsible for **business management**
- Those responsible for **data management**
- Those who are to **use** the application—including the end users, and those responsible for computer and online system operation

## Designing the end user's restart procedure

Decide how the user is to restart work on the application after a system failure.

Points to consider are:

- The need for users to re-identify themselves to the system in a sign-on message (dictated by security requirements, as discussed under question 4 in “Questions relating to recovery requirements” on page 95).
- The availability of appropriate information for users, so that they know what work has and has not been done. Consider the possibility of a progress transaction.
- How much or how little rekeying will be needed when resuming work (dictated by the feasibility of rekeying data, as discussed under question 9 in “Questions relating to recovery requirements” on page 95).

When designing the user's restart procedure (including the progress transaction, if used) include precautions to ensure that each input data item is processed once only.

## End user's standby procedures

Decide how application work might continue in the event of a prolonged failure of the system. For example, for an order-entry application, it might be practical (for a limited time) to continue taking orders offline—by manual methods. If you plan such an approach, specify how the offline data is to be subsequently entered into the system; it might be necessary to provide a catch-up function.

**Note:** If the user is working with an intelligent workstation or a terminal attached to a programmable controller, it may be possible to continue gathering data without access to a CICS region on an MVS host system.

## Communications between application and user

For each application, specify the type of terminal the user is to work with.

Decide if you will provide special procedures to overcome communication problems; for example:

- Allow the user to continue work on an alternative terminal (but with appropriate security precautions, such as signing on again).
- In cases where the user's terminal is attached to a programmable controller, determine the recovery actions that controller (or the program in it) is capable of providing.
- If a user's printer becomes unusable (because of hardware or communication problems), consider the use of alternatives, such as the computer center's printer, as a standby.

## Security

Decide the security procedures for an emergency restart or a break in communications. For example, when confidential data is at risk, specify that the users should sign on again and have their passwords rechecked.

Bear in mind the security requirements when a user needs to use an alternative terminal if a failure is confined to one terminal (or to a few terminals).

**Note:** The sign-on state of a user is not retained after a persistent sessions restart.

---

## System definitions for recovery-related functions

This section covers the system definitions needed to ensure that CICS regions provide the required recovery and restart support for your CICS applications. The information is a starting point, so that you know what to look for in the appropriate book in the CICS library.

For information about individual resource recoverability, see “Chapter 12. Defining recoverability for CICS-managed resources” on page 117.

### System recovery table (SRT)

See “Processing operating system abends and program checks” on page 89 for a brief overview of the system recovery program and table.

You are recommended to specify a system recovery table on the SRT system initialization parameter. If you do not specify a table suffix on this system initialization parameter, it defaults to YES, which means that CICS tries to load an un-suffixed table (which probably won't exist in your load libraries). There is a pre-generated sample table, DFHSRT1\$, supplied in CICSTS13.CICS.SDFHLOAD, and if this is adequate for your needs, specify SRT=1\$. This table adds some extra system abend codes to the built-in list that CICS handles automatically, even if you define only the basic DFHSRT TYPE=INITIAL and TYPE=FINAL macros.

If you want to add additional system or user entries of your own, modify the sample table. For information about modifying an SRT, see the *CICS Resource Definition Guide*.

### CICS-required resource definitions

CICS provides a number of required groups of resource definitions. All these CICS-required groups are included in the CICS-supplied startup group list, DFHLIST.

Included in DFHLIST are the following groups, which provide basic recovery functions:

- DFHRSEND
- DFHSTAND
- DFHVTAM

Ensure that your CICS region includes all these CICS-required groups by including DFHLIST as one of the lists specified on the GRPLIST system initialization parameter. For information about the contents of these groups, see the *CICS Resource Definition Guide*.

## Definition of system log streams and general log streams

Defining system log streams for each CICS region is the most fundamental of all the recovery requirements. A system log is mandatory to maintain data integrity in the event of transaction or system abends, and to enable CICS to perform warm and emergency restarts.

CICS uses the services of the MVS system logger for all its system and general logging requirements. The CICS log manager writes system log and general log data to log streams defined to the MVS system logger. For more information, see “Chapter 11. Defining system and general log streams” on page 103.

## System initialization parameters

The following list summarizes the system initialization parameters that you need to consider for recovery and restart purposes. For more information about these, see the *CICS System Definition Guide*.

```
AILDELAY={0-hhmmss}
AIRDELAY={700-hhmmss}
AKPFREQ={4000-65535|0}
CSDBKUP={STATIC|DYNAMIC} (Valid only for CSDRLS=NO)
CSDFRLOG={NO|1-99} (Valid only for CSDRLS=NO)
CSDRECOV={NONE|ALL|BACKOUTONLY} (Valid only for CSDRLS=NO)
FCT={YES|xx|NO}
ICP=COLD
NEWSIT={YES|NO}
PGAICTLG={MODIFY|NONE|ALL}
PGAIXIT={DFHPGADX|name}
PGAIPGM={INACTIVE|ACTIVE}
PLTPI={YES|xx|NO}
PLTSD={YES|xx|NO}
PSDINT={0-hhmmss}
RST={YES|NO}
SDTRAN={CESD|name_of_shutdown_tran|NO}
SRT={YES|xx|NO}
START={AUTO (AUTO,ALL) |COLD|INITIAL|STANDBY}
STGRVCY={NO|YES}
TBEXITS=( [name1] [,name2] [,name3] [,name4] [,name5] )
TS=COLD
TST={YES|xx|NO}
UOWNETQL=user_defined_value
```

Activity keypoints are strongly recommended to reduce the time take to perform an emergency restart. Therefore, you should specify a nonzero value for AKPFREQ (the default is 4000.) For a discussion about how to set the activity keypoint frequency, see “Activity keypointing” on page 108.

If you code NEWSIT=YES at a warm start, the values in the SIT that would normally be ignored on a warm restart take effect, overriding any system initialization parameters stored in the warm keypoint at normal shutdown. The SIT is still modified, even with NEWSIT, by run-time system initialization parameters specified in the PARM string, from SYSIN, or at the console.

## Files

For VSAM files defined to be accessed in RLS mode, define the recovery attributes in the ICF catalog, using IDCAMS.

For VSAM files defined to be accessed in non-RLS mode, you can define the recovery attributes in the CSD file resource definition, or, optionally, in the ICF catalog, providing your level of DFSMS supports this.

For BDAM files, you define the recovery attributes in the FCT.

## Transient data queues

If you want your intrapartition queues to be recoverable, specify the recovery option in the definition for each queue. See the *CICS Resource Definition Guide* for information about the destinations that must be recoverable.

## Temporary storage table (TST)

If you want your temporary storage queues to be recoverable, define them in a temporary storage table (TST) using the DFHTST TYPE=RECOVERY macro. When you define your temporary storage queues in a TST, note that the TSAGE parameter influences the recovery characteristics of that temporary storage.

Use the TST system initialization parameter to specify the suffix of the temporary storage table that you want CICS to load at initialization.

## Program list table (PLT)

Use the DFHPLT macro to create program list tables that name each program executed during initialization or controlled shutdown of CICS. You specify the PLTPI system initialization parameter for the PLT to be used at initialization, and the PLTSD system initialization parameter for the PLT to be used at shutdown. You can also specify the shutdown PLT on the CICS shutdown command.

If you have global user exit programs that are invoked for recovery purposes, they must be enabled during the second stage of CICS initialization. You can enable these global user exit recovery programs in application programs specified in the first part of the PLTPI.

See the *CICS Resource Definition Guide* for information about defining program list tables.

## Transaction list table (XLT)

There are two ways you can specify transactions that can be initiated from a terminal during the first quiesce stage of normal shutdown:

1. Use the DFHXLT macro to create a transaction list table that names the transactions.
2. Specify the SHUTDOWN(ENABLED) attribute on the transaction resource definition.

---

## Documentation and test plans

During internal design, consider how to document and test the defined recovery and restart programs, exits, and procedures.

Recovery and restart programs and procedures usually relate to exceptional conditions, and can therefore be more difficult to test than those that handle normal conditions. They should, nevertheless, be tested as far as possible, to ensure that they handle the functions for which they are designed.

CICS facilities, such as the execution diagnostic facility (CEDF) and command interpreter (CECI), can help to create exception conditions and to interpret program and system reactions to those conditions.



The ability of the installed CICS system, application programs, operators, and terminal users to cope with exception conditions depends on the designer and the implementer being able to:

- Forecast the exceptional conditions that can be expected
- Document what operators and users should do in the process of recovery, and include escape procedures for problems or errors that persist

Conditions that need documented procedures include:

- Power failure in the processor
- Failure of CICS
- Physical failure of data set(s)
- Transaction abends
- Communication failures—such as the loss of telephone lines, or a printer being out of service
- Shunted units of work, caused by communication or backout failures

**It is essential that recovery and restart procedures are tested and rehearsed in a controlled environment by everyone who might have to cope with a failure.** This is especially important in installations that have temporary operators.



---

## Chapter 11. Defining system and general log streams

This chapter describes the definition of system and general log streams under the following headings:

- “MVS log streams” on page 104
- “Defining system log streams” on page 104
- “Defining forward recovery log streams” on page 112
- “Defining the log of logs” on page 114

All CICS system logging and journaling is controlled by the CICS log manager, which uses MVS system logger log streams to store its output.

CICS logging and journaling can be divided into four broad types of activity:

### System logging

CICS maintains a system log to support transaction backout for recoverable resources. CICS implements system logging automatically, but you can define the log stream as DUMMY to inhibit this function. However, if you specify TYPE(DUMMY) for the system log, you are running without any transaction backout facilities and without any restart capability, and you can start CICS with START=INITIAL only.

CICS also supports programming interfaces that enable you to write your own data to the system log, but **user-written records should be for recovery purposes only.**

See “Defining system log streams” on page 104.

### Forward recovery logging

CICS supports forward recovery logs for VSAM data sets.

Forward recovery logging is not automatic—you must specify that you want this facility for your files, and also define the forward recovery log streams.

See “Defining forward recovery log streams” on page 112.

### Autojournaling

CICS supports autojournaling of file control data and terminal control messages. Autojournaling is generally used for audit trails.

Autojournaling is not automatic—you must specify that you want this facility for your files and terminal messages, and also define the general log streams to be used.

See the *CICS Resource Definition Guide* for information about specifying autojournaling on file and terminal resource definitions.

### User journaling

CICS supports programming interfaces to enable CICS applications to write user-defined records to user journals, which are held on general log streams.

See the *CICS System Definition Guide* for information about defining general log streams for user journals.

Autojournaling and user journals play no part in CICS recovery and therefore are not discussed here.

The CICS log manager writes the data associated with these logging and journaling activities to two types of MVS log stream:

### 1. System log streams

These are used by the CICS log manager and the CICS recovery manager exclusively for unit of work recovery purposes. Each system log is unique to a CICS region, and must not be merged with any other system log.

### 2. General log streams

These are used by the CICS log manager for all other types of logging and journaling. You can merge forward recovery records, autojournal records, and user journal records onto the same general log stream, from the same, or from different, CICS regions.

For information on how CICS handles the different error conditions detected by the CICS log manager, see the *CICS Problem Determination Guide*.

---

## MVS log streams

Log streams are MVS resources that reside in the coupling facility (if one is used), and in data sets.

All log streams needed by CICS must be defined to the MVS system logger before CICS can use them. You can either define log streams explicitly, or you can let CICS create them dynamically when they are first used. To enable CICS to create log streams dynamically, you first define model log streams to the MVS system logger. To define explicit log streams and model log streams, use the MVS IXCMIAPU utility.

For information about defining coupling facility log streams and DASD-only log streams, see the *CICS Installation Guide*. For more information about the coupling facility and defining log structures generally, see *OS/390 MVS Setting Up a Sysplex*.

---

## Defining system log streams

You must define a system log if you want to preserve data integrity in the event of unit of work failures and CICS failures (see “Chapter 8. Unit of work recovery and abend processing” on page 67). A system log is mandatory for:

- The backout of recoverable resources changed by failed units of work
- Cold starts, to enable CICS to restore units of work that were shunted at the time of the shutdown
- Warm restarts, to enable CICS to restore the region to its state at the previous shutdown, including units of work that were shunted at the time of the shutdown
- Emergency restarts, to enable CICS to:
  - Restore the region to its state at the previous shutdown, including units of work that were shunted at the time of the shutdown
  - Recover units of work that were in-flight at the time of the CICS failure, and perform backout of recoverable resources that were updated before the failure

CICS log manager connects to its log stream automatically during system initialization, unless it is defined as TYPE(DUMMY) in a CICS JOURNALMODEL resource definition.

**Note:** Although the CICS system log is logically a single logical log stream, it is written to two physical log streams—a primary and a secondary. In general, it is not necessary to distinguish between these, and most references are simply to the system log stream. Using a primary and a secondary log

stream for its single system log enables CICS to optimize its use of log stream storage through its shunting and deletion process.

## Specifying a JOURNALMODEL resource definition

During a cold start, and a warm and emergency restart, CICS retrieves the names of its system log streams from the global catalog, ensuring that it reconnects to the same log streams that were used on the previous run.

During an initial start, CICS uses default log stream names, unless you specify otherwise on a JOURNALMODEL resource definition. The process of selecting and connecting to a system log stream is as follows:

### Without a JOURNALMODEL definition

If CICS can't find a JOURNALMODEL resource definition for DFHLOG and DFHSHUNT, it issues calls to the MVS system logger to connect to its system log streams using default names. These are:

```
region_userid.applid.DFHLOG  
region_userid.applid.DFHSHUNT
```

where *region\_userid* is the RACF® userid under which the CICS address space is running, and *applid* is the region's VTAM APPL name (taken from the APPLID system initialization parameter). The CICS-supplied JOURNALMODEL definitions for default DFHLOG and DFHSHUNT log streams are in the CSD group DFHLGMOD, which is included in DFHLIST.

If you use these default log stream names, ensure that

- The default log streams are defined explicitly to the MVS system logger, or
- Suitable model log streams are defined for dynamic creation.

### With a JOURNALMODEL definition

If CICS finds a JOURNALMODEL definition with JOURNALNAME(DFHLOG) and JOURNALNAME(DFHSHUNT), it issues calls to the MVS system logger to connect to the system log streams named in the definitions. Ensure that the system log stream names are unique to the CICS region.

If you define JOURNALMODEL resource definitions for your system logs, ensure that:

- The log streams named in the JOURNALMODEL are defined to the MVS system logger, or
- Suitable model log streams are defined that enable them to be created dynamically.

If you don't want to use a system log (for example, in a CICS test region), specify JOURNALMODEL resource definitions for DFHLOG and DFHSHUNT with TYPE(DUMMY). Note that running CICS with the system log defined as TYPE(DUMMY) forces you to perform an initial start, and CICS does not support dynamic transaction backout.

## Model log streams for CICS system logs

If CICS fails to connect to its system log streams because they have not been defined, CICS attempts to have them created dynamically using model log streams. To create a log stream dynamically, CICS must specify to the MVS system logger all the log stream attributes needed for a new log stream. To determine these otherwise unknown attributes, CICS requests the MVS system logger to create the

log stream using attributes of an existing model log stream definition. If you decide to allow CICS to create log streams dynamically, you are responsible for creating the required model log stream definitions to ensure that dynamic creation succeeds.

It is generally worthwhile setting up model log streams only if:

- Each model log stream will be used to create several log streams
- Each log stream created using a model log stream has similar characteristics consistent with the use of the same coupling facility structure
- You don't know in advance how many CICS regions are going to run in a given MVS image (for example, in a development and test environment).

Otherwise, it is probably less work to define the log streams explicitly using IXCMIAPI. Generally, dynamic creation using model log streams is best suited for test and development purposes, and explicit definition for production regions.

The model log stream names that CICS uses for dynamic creation of its system log streams are of the form `&sysname.LSN_last_qualifier.MODEL`, where:

- `&sysname` is the MVS symbol that resolves to the system name of the MVS image
- `LSN_last_qualifier` is the last qualifier of the log stream name as specified on the JOURNALMODEL resource definition.

If you do not provide a JOURNALMODEL resource definition for DFHLOG and DFHSHUNT, or if you use the CICS-supplied definitions in group DFHLGMOD, the model names default to `&sysname.DFHLOG.MODEL` and `&sysname.DFHSHUNT.MODEL`.

**Example:** If a CICS region issues a request to create a log stream for its primary system log, and CICS is running in an MVS image with a sysid of MV10 and using the default JOURNALMODEL definition, the system logger expects to find a model log stream named MV10.DFHLOG.MODEL.

CICS invokes the XLGSTRM global user exit immediately before calling the MVS system logger to create a log stream. If you don't want to use CICS default values for the creation of a log stream, you can write an XLGSTRM global user exit program to modify the request details, including the model log stream name (in parameter UEPMLSN).

## Recovery considerations

If you are using coupling facility log streams, sharing structures between MVS images provides some recovery advantages. If an MVS image or logger address space fails, another surviving MVS image using the same log stream structures (not necessarily the same log streams) is notified of the failure and can start immediate log stream recovery for the log streams used by the failing MVS. Otherwise, recovery is delayed until the next time a system connects to a log stream in the affected structures, or until the failed system logger address space restarts.

However, using model log streams defined with the CICS default name are always assigned to the same structure within an MVS image. This may not give you the best allocation in terms of recovery considerations if you are using structures defined across two or more coupling facilities.

For example, consider a two-way sysplex that uses two coupling facilities, each with one log structure defined for use by CICS system logs, structures LOG\_DFHLOG\_001 and LOG\_DFHLOG\_002. In this situation, it is better from a

recovery point of view for the CICS regions in each MVS to balance log stream allocations across both log structures. This scenario is illustrated in Figure 8, which shows a 2-way sysplex comprising MVSA and MVSB, with four CICS regions in each MVS. Each MVS is using two coupling facilities, CF1 and CF2, each of which has one log structure referenced by model log streams. In our scenario, each MVS image has a partner to recover its log streams in the event of an MVS failure.

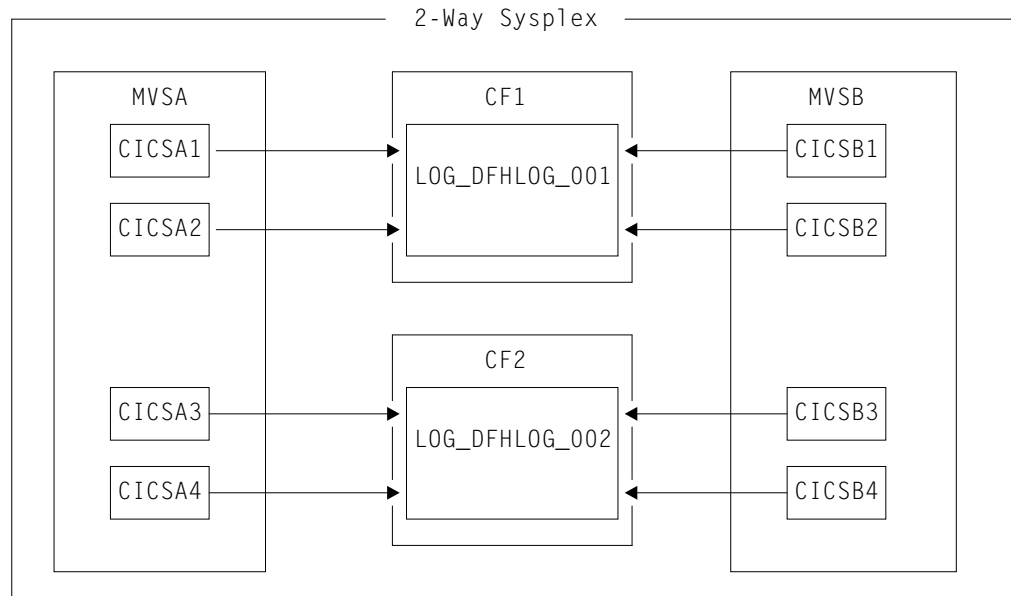

Figure 8. Sharing system logger structures between MVS images

Another example, shown in Figure 9 on page 108, is based on a 4-way sysplex comprising MVSA, MVSB, MVSC, and MVSD. In this case, ensure that the CICS regions that normally run on MVSA and MVSB use structure LOG\_DFHLOG\_001, and that the regions that run on MVSC and MVSD use structure LOG\_DFHLOG\_002. Thus each MVS image has a partner to recover its log streams in the event of an MVS failure. If a structure fails, the two MVS images using the other structure can take over the workload.

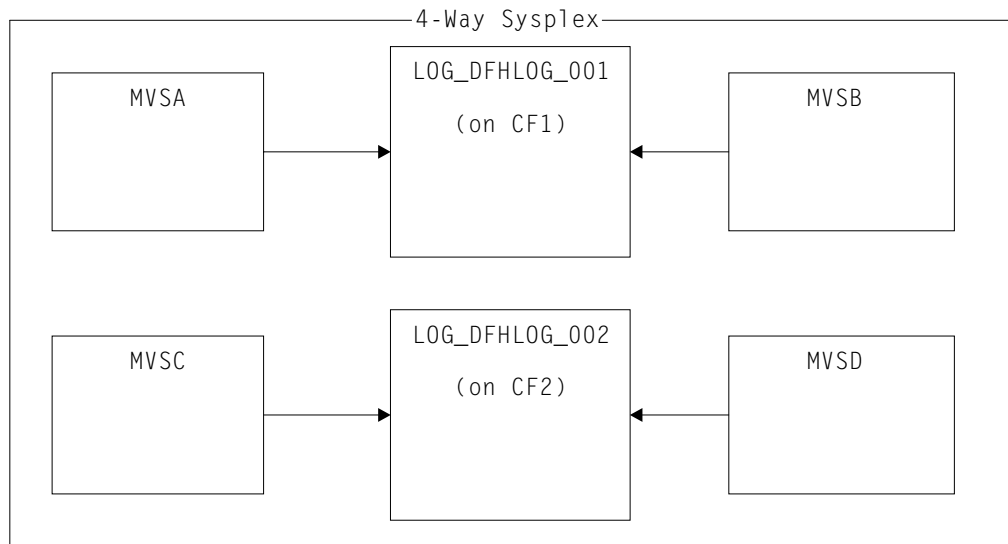

Figure 9. Sharing system logger structures between MVS images

**Varying the model log stream name:** To balance log streams across log structures as shown in Figure 8 on page 107 using model log streams means customizing the model log stream names. You cannot achieve the distribution of log streams shown in this scenario using the CICS default model name.

You can use an XLGSTRM global user exit program to vary, in a number of ways, the model log stream name to be passed to the system logger. One such way is to store appropriate values in the exit's global work area. For example, you can use the INITPARM system initialization parameter to specify a parameter string for use by the exit. This can be retrieved, using the EXEC CICS ASSIGN INITPARM command, in the first-phase PLT program that you use to enable the XLGSTRM global user exit program. Having obtained the relevant model log stream information from the INITPARM command, you can store this in the global work area for later use by your XLGSTRM global exit program. Varying the model log stream details in this way enables you to balance log streams across different log structures in a coupling facility.

See the *CICS Customization Guide* for information about writing an XLGSTRM global user exit program, and for information about PLT initialization programs.

## Activity keypointing

During a restart, the CICS log manager scans the log backwards to recover unit of work information. The log is scanned backwards as follows:

1. To begin with, CICS reads all records sequentially as far back as the last complete activity keypoint written before termination. To minimize the time taken for this scan, it is important that you do not specify an activity keypoint frequency zero. For information about setting a suitable activity keypoint frequency for your CICS region, see the *CICS System Definition Guide*.
2. When CICS reaches the last-written complete activity keypoint, it extracts all the information relating to in-flight units of work, including in-doubt units of work. With this information, CICS continues reading backwards, but this time reading only the records for units of work that are identified in the activity keypoint. Reading continues until CICS has read all the records for the units of work identified by the activity keypoint.



This process means that completed units of work, including shunted backout-failed and commit-failed units of work, are ignored in this part of the log scan. This is significant for the retrieval of user-written log records. User-written records cannot be presented at the XRCINPT global user exit program (see “Writing user-recovery data” on page 110) if they are part of units of work that CICS skips in this part of the log scan process.

Figure 10 illustrates the way CICS performs log processing during a CICS restart.

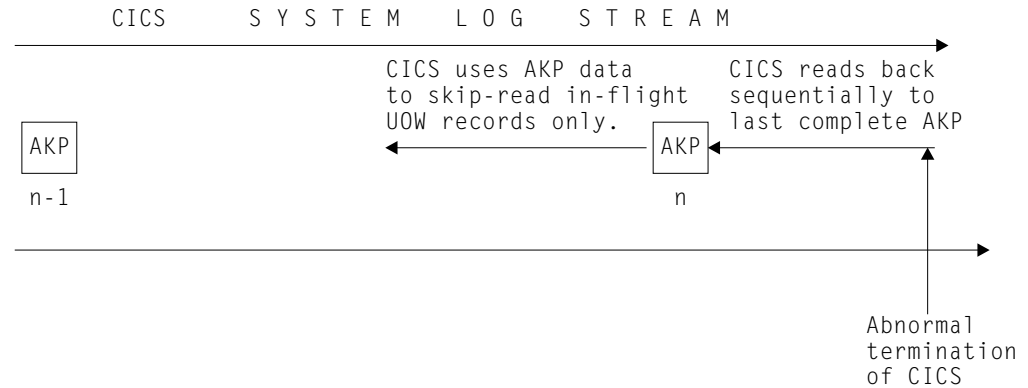

Figure 10. System log scan during restart

Here are some steps you can take to ensure that system log stream sizes, and thus restart times, are kept to a minimum:

- Keep to a minimum the amount of data that has to be read. This means specifying an activity keypoint frequency that is non-zero, and which is:
  - Long enough to avoid excessive keypointing
  - Short enough to avoid large volumes of data between keypoints.

For information about calculating system log stream structure sizes, see the *CICS Installation Guide*.

- Except for your own recovery records that you need during emergency restart, do not write your own data to the system log (for example, audit trail data).
- In particular, do not write information to the system log that needs to be kept. (See “Avoiding retention periods on the system log” on page 111).
- If you write a long-running transaction that updates recoverable resources, ensure that it takes a syncpoint at regular intervals.

The rest of this section expands on these points.

### Keeping system log data to a minimum

CICS log manager controls the size of the system log stream by regularly deleting the oldest completed unit of work records (**log-tail deletion**).

This operation is associated with activity keypoints. It is important, therefore, that you choose the correct activity keypoint frequency (AKPFREQ)—that is, one that allows CICS to keep the system log down to a reasonable size and to keep it within the coupling facility (if one is used):

- If a system log stream exceeds the primary storage space allocated, it spills onto DASD. (For a definition of primary storage, see the *CICS Installation Guide*.) The resulting I/O can adversely affect system performance.

- If the interval between activity keypoints is long, the volume of data could affect restart times. In general, an activity keypoint interval should be longer than the elapsed time of most transactions (excluding those that are in the category of long-running transactions).

**Note:** Do not specify AKPFREQ=0, because without activity keypoints CICS cannot perform log tail deletion until shutdown, by which time the system log will have spilled onto DASD.

### Log-tail deletion

The log tail is the oldest end of the log. At each activity keypoint, the CICS recovery manager requests the log manager to delete the tail of the system log by establishing a point on the system log before which all older data blocks can be deleted. Thus, if the oldest “live” unit of work is in data block **x**, the CICS log manager requests the system logger to delete all data blocks older than **x** (**x-1** and older).

**Note:** Long-running units of work that regularly initiate writes to the system log can prevent CICS from deleting completed units of work stretching back over many activity keypoints. See “Long-running transactions” on page 111.

**Moving units of work to the secondary log:** All units of work start on the primary log stream. From this, they are either deleted by the log-tail deletion mechanism, or shunted to the secondary log stream. Eligible long-running units of work, including failed units of work, are shunted to the secondary log during activity keypointing, leaving a pointer in front of the latest activity keypoint in the primary log stream. For the purpose of log management, a long-running unit of work is eligible for shunting if it exists for 2 complete activity keypoints without initiating any writes to the system log.

After it has been shunted, a unit of work remains on the secondary log until it is completed. Note that, after a unit of work is shunted to the secondary log, subsequent writes to the system log by the unit of work are directed to the primary log.

### Writing user-recovery data

You should write only recovery-related records to the system log stream. You can do this using the commands provided by the application programming interface (API) or the exit programming interfaces (XPI). This is important because user recovery records are presented to a global user exit program enabled at the XRCINPT exit point.

User-written recovery records are managed in the same way as recovery manager records, and do not prevent CICS from performing log-tail deletion:

- User-written recovery records written by user transactions are treated as part of the unit of work in which they are written—that is, they form part of the UOW chain. CICS shunts user-written recovery records as part of the unit of work, if the unit of work fails for any reason. These are:
  - Recovered by in-flight unit of work recovery during an emergency restart
  - Recovered by shunted unit of work recovery during both warm and emergency restarts.
- User recovery records written by an XAKUSER global user exit program are written as part of an activity keypoint.

**Retrieving user records from the system log:** During warm and emergency restarts, CICS scans the system log backwards. If, during this backwards scan, CICS finds active user records, they are presented to a global user exit program enabled at the XRCINPT exit point.

Active user log records are those that are:

- Written by an XAKUSER global user exit program during the last completed activity keypoint.
- Written by a user transaction through an API command.

These user records, which form part of a unit of work chain, are deemed to be active only if:

- The high-order bit of the JTYPEID field is set to 1.

These records are presented to your XRCINPT global user exit program, regardless of the state of the unit of work, provided the unit of work lies within the scope of the backward scan of the system during restart. This category includes units of work that are in a backout-failed or commit-failed state.

- The unit of work in which the command was issued was in-flight or failed in-doubt when the previous run of CICS terminated.

These user records are always presented to your XRCINPT global user exit program, regardless of the state of the high-order bit in the JTYPEID field.

If CICS completes its scan of the system log and finds there are no active user records, it issues message DFHER5731.

### **Avoiding retention periods on the system log**

CICS log tail deletion, which ensures that completed log records are retained for two complete activity key points only, is inhibited if you specify a retention period (RETPD=dddd) when you define the system log to MVS. The dddd value specifies the minimum number of days for which data is to be retained on the log.

You are strongly recommended *not* to use the system log for records that need to be kept. Any log and journal data that needs to be preserved should be written to a general log stream. See the *CICS System Definition Guide* for advice on how to manage log stream data sets.

### **Long-running transactions**

Do not design long-running transactions in such a way that they write frequently to the system log stream, in a single unit of work, across multiple activity keypoints.

If a long-running transaction does not take regular syncpoints while regularly initiating writes to the system log, CICS is prevented from purging units of work that completed after the long-running task started.

**Example:** In Figure 11 on page 112, the long-running transaction is updating recoverable resources, causing writes to the system log. All the updates are in the same unit of work because it does not take explicit syncpoints. The oldest deletion point is earlier than activity keypoint number 5, preventing CICS from deleting any completed units of work that lie between activity keypoints 5 and 8. In this example, the long-running transaction will eventually cause the system log stream to spill onto disk.

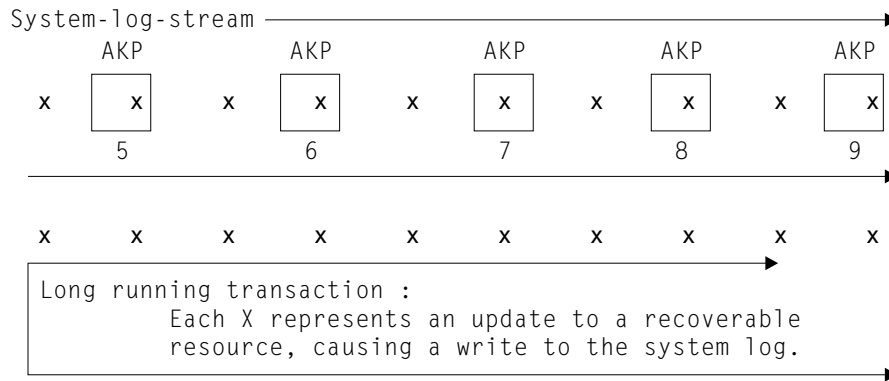

Figure 11. The effect of a 'bad' long-running transaction

## Defining forward recovery log streams

VSAM data sets defined as recoverable files must have associated forward recovery logs. In the event of physical failure or corruption, restore the most recent backup, and use a forward recovery utility such as CICSVR to re-apply updates.

To recover from a DASD failure, first restore the most recent backup to a new data set. Then use a forward recovery utility, such as CICS VSAM Recovery (CICSVR), to apply all the updates that were written to a forward recovery log stream after the backup date.

**Note:** Define a data set as recoverable if you want forward recovery logging. Neither CICS nor VSAM provides any support for forward recovery logging for a nonrecoverable data set.

## Defining recoverable data sets

You specify recovery attributes, including forward recovery, in either the integrated catalog facility (ICF) catalog (if you are using DFSMS 1.3 or later), or in the CICS file resource definition. See "Defining files as recoverable resources" on page 120 for details.

## Model log streams for CICS general logs

If CICS fails to connect to a general log stream because it has not been defined, CICS attempts to have it created dynamically. To create a log stream dynamically, CICS must specify to the MVS system logger all the log stream attributes needed for the new log stream. To determine these otherwise unknown attributes, CICS requests the MVS system logger to create the log stream using attributes of an existing model log stream definition. If you decide to allow CICS to create log streams dynamically, you are responsible for creating the required model log stream definitions to ensure that dynamic creation succeeds.

It is generally worthwhile setting up model log streams only if:

- Each model log stream will be used to create several log streams
- Each log stream created using a model log stream has similar characteristics consistent with the use of the same coupling facility structure
- You don't know in advance the journal names that will be used by CICS applications.

Otherwise, it is probably less work to define the log streams explicitly using IXCMIAPU.

The default model log stream names that CICS uses for dynamic creation of a general log stream are of the form *LSN\_qualifier1.LSN\_qualifier2.MODEL* where the first and second qualifiers are the CICS region userid and the CICS APPLID, respectively.

**Example:** If a CICS region, running under userid CICSHA## with APPLID=CICSHAA1, issues a request to create a general log stream that is not defined by a JOURNALMODEL resource definition, CICS specifies CICSHA##.CICSHAA1.MODEL as the model log stream name.

See “Model log streams for CICS system logs” on page 105 for information about using an XLGSTRM global user exit program to modify requests to create a log stream.

## Merging data on shared general log streams

Unlike system log streams, which are unique to one CICS region, general log streams can be shared between many CICS regions. This means that you can merge forward recovery data from a number of CICS regions onto the same forward recovery log stream:

- You can use the same forward recovery log stream for more than one data set—you do not have to define a log stream for each forward-recoverable data set.
- You can share a forward recovery log stream between multiple CICS regions. If the regions are accessing a data set in RLS mode, the use of the same forward recovery log stream is forced.

Your decision on how to define and allocate forward recovery log streams is a trade-off between transaction performance, fast recovery, and having a large number of log streams to manage.

Some things to consider are:

- You can share a coupling facility log stream across multiple CICS regions that run in the same or in different MVS images. You can share a DASD-only log stream only across CICS regions that run in the same MVS image.
- All data sets used by one transaction should use the same log stream (to reduce the number of log streams written to at syncpoint).
- Share a forward recovery log stream between data sets that:
  - Have similar security requirements
  - Have similar backup frequency
  - Are likely to need restoring in their entirety at the same time.
- The last qualifier of the stream name is used as the CICS resource name for dispatcher waits. Therefore, a self-explanatory qualifier can be helpful when you are interpreting monitoring information and CICS trace entries.
- Don't mix frequently updated data sets with infrequently updated data sets on the same forward recovery log, because this causes a disproportionate amount of unwanted log data to be read during recovery of infrequently updated data sets.
- Don't put all frequently updated data sets on a single log stream because you could exceed the throughput capacity of the log stream.
- If you define too many data sets to a single log stream, you could experience frequent structure-full events when the log stream can't keep up with data flow.

- Delete redundant data from log streams periodically, to preserve secondary storage and so that the system logger does not exceed its limit of data sets per log stream. (In versions of MVS from OS/390 Release 3 onwards, the limit is several million—in normal circumstances, it is not likely to be exceeded.) See the *CICS Installation Guide* for information about managing log stream data sets.
- Relate log stream names to the data sets. For example, PAYROLL.data\_sets could be mapped to a forward recovery log named PAYROLL.FWDRECOV.PAYLOG.
- Avoid having too many forward recovery log streams, because of coupling facility log structure limits.

---

## Defining the log of logs

Define a log of logs log stream that is shared between all CICS regions in the Parallel Sysplex<sup>®</sup>. Also define a JOURNALMODEL resource definition that references the log of logs log stream. The CICS-supplied group, DFHLGMOD, specifies a JOURNALMODEL for the log of logs, called DFHLGLOG, and has a log stream name of *region\_userid.CICSVR.DFHLGLOG*.

The log of logs contains records that are written each time a file is opened or closed. At file-open time, a tie-up record is written that identifies:

- The name of the file
- The name of the underlying VSAM data set
- The name of the forward recovery log stream
- The name of the CICS region that performed the file open.

At file-close time, a tie-up record is written that identifies:

- The name of the file
- The name of the CICS region that performed the file close.

The log of logs assists forward recovery utilities to maintain an index of log data sets.

## Log of logs failure

If a log of logs fails, CICS issues a message, but ignores the error. Further attempts to write to the log of logs are ignored. Forward recovery programs that use the log of logs for performance optimization must not use the log of logs following a failure. The most likely cause of a log of logs failure is a definition error, in which case the failure is unlikely to affect production data sets.

## Reading log streams offline

Access to MVS system logger log stream data is provided through the subsystem interface (SSI) with the LOGR subsystem. To use the SSI to gain access to the log stream data, specify LOGR on the SUBSYS parameter on the log stream DD statement. Specifying the LOGR subsystem name on the SUBSYS parameter enables LOGR to intercept data set open and read requests at the SSI, and convert them into log stream accesses.

Depending on the options specified on the SUBSYS parameter, general log stream records are presented either:

- In a record format compatible with utility programs written for releases of CICS that use the journal control program, DFHJUP, for logging and journaling
- In a format compatible with utility programs written for versions of CICS that use the log manager for logging and journaling.

See the *CICS Operations and Utilities Guide* for more information about using the LOGR SSI to access log stream data, and for sample JCL.

If you plan to write your own utility program to read log stream data, see the *CICS Customization Guide* for information about log stream record formats.

---

## Effect of day-light saving time changes

Many countries operate a policy of adjusting clocks by one hour at the beginning and end of Summer to effect what is commonly referred to as 'day-light saving'. These time changes are also applied to the local time held in computers. Generally, most hardware (TOD) clocks are set to Greenwich Mean Time (GMT), with an offset value to indicate local time. It is this offset value that is adjusted when making day-light saving time changes, while the hardware clock remains unaltered.

## Adjusting local time

When setting clocks forward or back an hour to adjust for Summer and Winter time, use the CEMT PERFORM RESET (or EXEC CICS RESETTIME) command to ensure that CICS immediately resynchronizes its local time with that of the MVS TOD clock.

CICS generally obtains and stores the *local time offset* at specific times of day only (for example, at startup, and midnight). Thus you should execute this command whenever you change the system date or time-of-day while CICS is running, to ensure that the correct local time is used by all CICS functions, including the API. For example, whenever an application program issues an EXEC CICS ASKTIME command, CICS obtains the current time from the MVS TOD clock, and modifies this by the stored local time difference. CICS then updates the EIBTIME field in the exec interface block with the local time.

## Time stamping log and journal records

A local time change, forwards or backwards, has no effect on CICS logging or journaling, or on CICS restarts, but could affect the operation of utility programs such as DFHJUP.

CICS time-stamps the data it writes to the system log as follows:

- System log block headers are time-stamped with both the machine clock (STCK) value and local time
- System log records are time-stamped with the machine clock (STCK) value only.

For general logs, in addition to time-stamping as in system logs, CICS also includes local time in the journal records.

During a restart, for system recovery purposes, CICS reads the youngest—most recently written—record from the primary log stream. Thereafter, CICS uses only direct reads using block ids and does not rely upon time stamps. CICS also uses direct read with block ids to retrieve the logged data for transaction backout purposes, again without any dependence on time stamps.

Operating a recovery process that is independent of time-stamps in the system log data ensures that CICS can restart successfully after an abnormal termination, even if the failure occurs shortly after local time has been put back.

## **Offline utility program, DFHJUP**

Changing the local time forward has no effect on the processing of system log streams or general log streams by the CICS utility program, DFHJUP.

Changing local time backwards will not affect the operation of DFHJUP provided you specify the GMT option on the SUBSYS parameter of the log stream DD statement in the DFHJUP JCL.

However, if you use local time on the SUBSYS parameter to specify the partitioning of a log stream for processing by DFHJUP, you must take steps to ensure the chronological sequence of time-stamps when adjusting clocks backwards. You can do this by stopping CICS regions until the new local time passes the old time at which the change was made.

User- or vendor-written journal utilities and DFHJUP exit programs may also be sensitive to local time changes. These should be checked to ensure that there are no problems posed by backwards time changes.

Forward recovery utilities (but not CICS VSAM Recovery 2.3) may also be sensitive to the time sequence of forward recovery log data. If you are not using CICSVR 2.3, check that your forward recovery utility can handle discontinuities in logged records.

The only circumstances in which forward recovery is jeopardized, while using CICSVR 2.3, are when you:

- Take a backup during the hour following the (local) time change (for example, at 01.30 after setting the time back from 02.00 to 01.00)
- Perform forward recovery using that backup with log records that span the time change
- Specify local time instead of GMT to CICSVR.

If you use a backup taken earlier than the new local time, or if you specify GMT, CICSVR handles forward recovery successfully.



---

## Chapter 12. Defining recoverability for CICS-managed resources

This chapter describes what to do to ensure that you can recover the resources controlled by CICS on behalf of your application programs. It covers the recoverability aspects of the various resources as follows:

- “Recovery for transactions”
- “Recovery for files” on page 118
- “Recovery for intrapartition transient data” on page 125
- “Recovery for extrapartition transient data” on page 127
- “Recovery for temporary storage” on page 128

---

### Recovery for transactions

CICS recoverability options for local transactions are limited to:

- Automatic restart when a transaction abends
- Time-out when a transaction has been waiting for resources for longer than a specified time interval, usually because the transaction is deadlocked with another transaction for the same resources
- Allowing you to purge transactions that “hang” for reasons that cannot otherwise be resolved

For remote transactions, in addition to the above, CICS provides in-doubt options to specify the recovery action in the event of in-doubt failures.

### Defining transaction recovery attributes

When defining user transactions that update **local** resources, you can specify the following options on the TRANSACTION resource definition for recovery purposes:

#### **RESTART({NO|YES})**

This option defines whether, in some circumstances, the transaction is eligible to be restarted automatically by CICS under the control of the DFHREST user replaceable module.

The default is RESTART(NO).

#### **DTIMOUT({NO|1–6800})**

If the task remains suspended (inactive) for the specified interval (and SPURGE(YES) is also specified), CICS initiates an abnormal termination of the task. (Specifying SPURGE(NO) overrides the DTIMOUT option.)

The default is DTIMOUT(NO).

#### **SPURGE({NO|YES})**

This option indicates whether the transaction is initially system-purgeable; that is, whether CICS can purge the transaction as a result of:

- Expiry of a deadlock timeout (DTIMOUT) delay interval
- A CEMT, or EXEC CICS, SET TASK(id) PURGE|FORCEPURGE command.

The default is SPURGE(NO).

#### **TPURGE({NO|YES})**

This option indicates whether the transaction is system-purgeable in the event of a (non-VTAM) terminal error.

The default is TPURGE(NO).

### **In-doubt options for distributed transactions**

When defining user transactions that update **remote** resources, you can specify the following options for remote recovery purposes (in addition to the local options above):

#### **ACTION({BACKOUT|COMMIT})**

Specifies the action to be taken when a failure occurs during two-phase commit processing, after the unit of work has entered the in-doubt period.

If you've specified WAIT(YES), the action is not taken unless the interval specified on WAITTIME expires before recovery occurs.

Whether you specify BACKOUT or COMMIT is likely to depend on the kinds of changes made to resources in the remote system.

#### **WAIT({YES|NO})**

Specifies whether a failed in-doubt unit of work is to wait, pending recovery from the failure, to resolve its in-doubt state, or whether CICS is to take immediately the action specified by the ACTION option.

**Note:** A WAIT(YES) option can be overridden by WAIT(NO) defined on an intrapartition transient data queue. If a TD queue that is access by a transaction specifies WAIT(NO), and the transaction specifies WAIT(YES), the TD queue definition forces the transaction to either backout or commit, as specified by the ACTION attribute on the transaction resource definition.

#### **WAITTIME({00,00,00|dd,hh,mm})**

Specifies, if WAIT(YES), how long the transaction is to wait before taking the action specified by ACTION.

You can use WAIT and WAITTIME to allow an opportunity for normal recovery and resynchronization to take place, while ensuring that a transaction commits or backs out within a reasonable time. See *CICS Intercommunication Guide* for information about defining wait times for distributed transactions.

For more information about recovery of distributed units of work, see the *CICS Intercommunication Guide*.

For more information about options on the TRANSACTION definition, see the *CICS Resource Definition Guide*.

---

## **Recovery for files**

A CICS **file** is a logical view of a physical data set, defined to CICS in a file resource definition with an 8-character file name. A CICS file is associated with a VSAM or BDAM data set by one of the following:

- By dynamic allocation, where the data set name is predefined on the DSNAME parameter in the file definition (or set by a CEMT, or EXEC CICS, SET FILE DSNAME(name) command)
- By allocation by JES at job step initiation, where the data set name is defined on a DD statement

More than one file can refer to the same data set.

A **data set** is defined to be the physical object residing on DASD. It has a 44-character DSNNAME. A VSAM data set, for example, is defined using VSAM access method services (AMS).

When designing your applications, ensure that application data is protected from transaction failures that could lead to data corruption, and that you can recover from accidental damage to storage devices.

When deciding on the access method, consider the recovery and restart facilities provided by each. These considerations are discussed in the following sections.

## VSAM files

CICS file control supports three VSAM access modes—local shared resources (LSR), non-shared resources (NSR), and record-level sharing (RLS). This section discusses recovery considerations for VSAM files accessed in these modes.

### Sharing data sets with batch jobs

Sharing data sets directly between online CICS update transactions and batch update programs using VSAM share options (where available) or job control sharing is **not** recommended for non-RLS access modes. Sharing risks the integrity of the data with the result that application programs may appear to function correctly, but with incorrect data. Such loss of data integrity can occur, for example, if a CICS unit of work updates a record that is later updated by a non-CICS job while the CICS unit of work is still running. If the CICS unit of work abends, CICS backs out the record to the value it had at the start of the CICS unit of work, thus destroying the update from the non-CICS job.

### File-owning regions and RLS access

To share data sets between more than one CICS region, use the RLS access mode or use a file-owning region (FOR) with function shipping from the application-owning regions (AORs). From a recovery point of view, RLS does not create distributed units of work, as happens between the AOR and FOR, because files accessed in RLS mode are all regarded as local to each CICS region. The SMSVSAM server takes the place of the FOR. However, there are special recovery considerations for data sets accessed in RLS mode, in connection with the role of SMSVSAM and its lock management.

### Forward recovery

For VSAM files, you can use a forward recovery utility, such as CICSVR, when online backout processing has failed as a result of some physical damage to the data set. For forward recovery:

- Create backup copies of data sets.
- Record after-images of file changes in a forward recovery stream. CICS does this for you automatically if you specify that you want forward recovery support for the file.
- Write a job to run a forward recovery utility, and keep control of backup data sets and log streams that might be needed as input. CICSVR automatically constructs the forward recovery job for you, using an ISPF dialog interface. (See “Chapter 18. Forward recovery with CICSVR” on page 193.)

### Backward recovery

To ensure that VSAM files can be backward recoverable, certain points should be considered:

- Key-sequenced data sets (KSDS) and both fixed- and variable-length relative record data sets (RRDS):

- If the files referring to KSDS or RRDS data sets are designated as recoverable with LOG(ALL) specified, CICS can back out any updates, additions, and deletions made by an interrupted unit of work.
- For information about backout failures, see “Backout-failed recovery” on page 73.
- Entry-sequenced data sets (VSAM-ESDS):
  - New records are added to the end of a VSAM-ESDS. After they have been added, records cannot be physically deleted. A logical deletion can be made only by modifying data in the record; for example, by flagging the record with a “logically deleted” flag, using an XFCLDEL global user exit program. See “Transaction backout” on page 69 for more information.

## Basic direct access method (BDAM)

CICS does not support forward recovery for BDAM files. You can implement your own forward recovery support using automatic journaling options.

Backout for BDAM data sets is the same as for ESDS data sets in that you cannot delete records from the data set.

## Defining files as recoverable resources

This section describes how to define the recovery attributes for files managed by CICS file control.

You specify recovery options, including forward recovery, either in the integrated catalog facility (ICF) catalog (if you are using DFSMS 1.3 or later), or in the CICS file resource definition, as follows:

- If your VSAM data sets are accessed by CICS in RLS mode, the recovery attributes must be defined in the ICF catalog.
- If your VSAM data sets are accessed by CICS in non-RLS mode, recovery attributes can be defined in either the file resource definition or the ICF catalog. Note that CICS uses the ICF catalog definitions only when you specify RLS=YES as a system initialization parameter—if you specify RLS=NO, recovery attributes are always taken from the CICS file definition.

If you use the ICF catalog to define attributes for data sets accessed in non-RLS mode, the ICF catalog entry recovery attributes override the CICS file resource definition.

- You define the recovery attributes for BDAM files in file entries in the file control table (FCT).

### VSAM files accessed in non-RLS mode

You can specify support for both forward and backward recovery for VSAM files using the RECOVERY and FWDRECOVLOG options. You define the type of data set backup you want using the BACKUPTYPE parameter.

### RECOVERY(ALL)

If you specify RECOVERY(ALL), CICS provides both forward and backout recovery for the file. Using the services of the CICS recovery manager and log manager, CICS file control writes:

- Before-images of updated records to the system log stream. These are used to back out file changes following a transaction abend or during an emergency restart after a CICS abnormal termination.
- After-images to the general log stream referenced by the FWDRECOVLOG option. The after-images comprise the following:

- A write\_add\_complete record when a new record is added
- A write\_delete record when a record is deleted
- A write\_update record when a record is updated

File control also writes the following to the forward recovery log:

FILE\_OPEN tie-up records  
 FILE\_CLOSE tie-up records  
 TAKE\_KEYPOINT tie-up records  
 Data set BACKUP tie-up records

See the *CICS Customization Guide* for details of all these forward recovery records.

CICS forward recovery support is totally independent of automatic journaling. However, autojournal records, which are controlled by the JOURNAL and associated JNLxxx options on the file resource definition, can be written to the same general log stream as forward recovery data. To do this, specify on the JOURNAL option a journal identifier that maps to the same forward recovery log stream. See the *CICS System Definition Guide* for information about mapping CICS journal identifiers to log streams through journal model resource definitions.

**Note:** The use of autojournal records for forward recovery purposes is not recommended for VSAM files.

#### **RECOVERY(BACKOUTONLY)**

If you specify RECOVERY(BACKOUTONLY), CICS provides backout recovery only, writing only before-images to the system log.

#### **BACKUPTYPE(DYNAMIC)**

If you specify BACKUPTYPE(DYNAMIC), CICS supports the DFSMS backup-while-open (BWO) facility, enabling the data set to be backed up while open. If you specify STATIC, all CICS files open against a data set must be closed before it can be backed up. For information about the backup-while-open (BWO) facility, see “Chapter 19. Backup-while-open (BWO)” on page 215.

#### **VSAM files accessed in RLS mode**

If you specify file definitions that open a data set in RLS mode, specify the recovery options in the ICF catalog. The recovery options on the CICS file resource definitions (RECOVERY, FWDRECOVLOG, and BACKUPTYPE) are ignored if the file definition specifies RLS access.

The VSAM parameters LOG and LOGSTREAMID, on the access methods services DEFINE CLUSTER and ALTER commands, determine recoverability for the entire sphere. Locating these recovery parameters in the ICF catalog enforces the same options, for all CICS regions in the sysplex, for all the files opened against a given sphere.

#### **LOG({NONE|UNDO|ALL})**

Specifies the type of recovery required for the VSAM sphere. Specify the LOG parameter for data sets that are to be used by CICS in RLS mode.

##### **NONE**

The sphere is not recoverable.

##### **UNDO**

The sphere is recoverable. CICS must maintain system log records for backout purposes.

## ALL

The sphere is recoverable for both backout and forward recovery. CICS must maintain system log records (as for UNDO) and forward recovery log records. If you specify LOG(ALL), also specify LOGSTREAMID to indicate the name of the forward recovery log.

**Note:** Forward recovery support is available for recoverable files only—you cannot have forward recovery without backout recovery.

## LOGSTREAMID(*log\_stream\_name*)

Specifies the name of the log stream to be used for forward recovery log records when LOG(ALL) is defined. Note that IDCAMS does not check for the presence of the LOGSTREAMID during DEFINE processing. CICS checks for a log stream name when attempting to open a data set defined with LOG(ALL), and the open fails if the log stream is not defined and cannot be created dynamically.

If you omit the LOG parameter when defining your VSAM data sets, recovery is assumed to be UNDEFINED, and the data set cannot be opened in RLS mode. You can also set the UNDEFINED status explicitly by specifying NULLIFY(LOG).

For information about the access methods services DEFINE and ALTER commands, see *DFSMS/MVS Access Method Services for ICF*, SC26-4906, and *DFSMS/MVS Using Data Sets*, SC26-4922.

**Inquiring on recovery attributes:** You can use CEMT, or EXEC CICS, INQUIRE FILE and INQUIRE DSNAME commands to determine the recovery options that are specified for files and data sets. The INQUIRE FILE command shows the options from the CICS file definition until the first file for the data set is opened. If the options are obtained from the ICF catalog when the first file is opened, the ICF catalog values are returned. The INQUIRE DSNAME command returns values from the VSAM base cluster block (BCB). However, because base cluster block (BCB) recovery values are not set until the first open, if you issue an INQUIRE DSNAME command before the first file is opened, CICS returns NOTAPPLIC for RECOVSTATUS.

## BDAM files

You can specify CICS support for backward recovery for BDAM files using the LOG parameter on the DFHFCT TYPE=FILE macro. You can also specify that you want automatic journaling of the various types of file access, using the JREQ and JID parameters of the FCT macro.

## LOG=YES

If you specify LOG=YES, CICS provides backout recovery for the file. Using the services of the CICS recovery manager and log manager, CICS file control writes before-images of updated records to the system log stream.

## JREQ=request-type(s) and JID=nn

Specify the file requests that you want CICS to journal automatically to the log stream mapped by the journal identifier specified on the JID parameter.

Although CICS does not provide forward recovery support for BDAM files, you can use the autojournal records to provide your own facility. JREQ=(WU,WN) is the equivalent of the CSD file definition parameters JNLUPDATE(YES) combined with JNLADD(BEFORE), providing the necessary images for forward recovery to a journal specified by JID=nn.

For information about defining file resource definitions, see the *CICS Resource Definition Guide*.

### **The CSD data set**

The CICS system definition (CSD) VSAM data set is unique in that it is a CICS system data set that is managed by CICS file control. For this reason the CSD can't be defined in the CSD, and is defined instead by system initialization parameters.

The recovery options equivalent to RECOVERY, FWDRECOVLOG, and BACKUPTYPE are CSDRECOV, CSDFRLOG, and CSDBKUP respectively. See the *CICS System Definition Guide* for information about defining the CSD.

## **File recovery attribute consistency checking (non-RLS)**

For data sets accessed in non-RLS mode, ensure you have consistent recovery attributes between files that refer to the same base data set cluster or its paths.

The first file open for the base data set determines the base data set recovery attributes, and these are stored in the base cluster block (BCB). If, on a subsequent file open request, CICS detects an inconsistency between the file definition recovery attributes and those stored in the BCB, the open request fails.

See page “Inquiring on recovery attributes” on page 122 for information about finding the recovery attributes for files and data sets.

### **Overriding open failures at the XFCNREC global user exit**

CICS provides a global user exit point, XFCNREC, to enable you to continue processing regardless of any inconsistencies in the backout setting for files associated with the same data set. If you use XFCNREC to suppress open failures that are a result of inconsistencies in the backout settings, CICS issues a message to warn you that the integrity of the data set can no longer be guaranteed.

Any CEMT, or EXEC CICS, INQUIRE DSNAME RECOVSTATUS command from this point onward will return NOTRECOVERABLE, regardless of the recovery attribute that CICS has previously enforced on the base cluster. This condition remains until you remove the data set base control block (with a CEMT, or EXEC CICS, SET DSNAME REMOVE command), or perform a cold start.

The order in which files are opened for the same base data set determines the content of the message received on suppression of an open failure using XFCNREC. If the base cluster block is set as unrecoverable and a mismatch has been allowed, access to the data set could be allowed through an unrecoverable file before the data set is fully recovered.

See the *CICS Customization Guide* for programming information about XFCNREC.

### **CICS responses to file open requests**

CICS file control uses the backout setting from the file definition to decide whether to log before-images for a file request.

CICS takes the actions shown in the following list when opening a file for update processing in non-RLS mode—that is, the file definition specifies RLSACCESS(NO), and the operations parameters specify ADD(YES), DELETE(YES) or UPDATE(YES) (or the equivalent SERVREQ parameters in the FCT entry.) If you set only READ(YES) and/or BROWSE(YES) CICS does not make these consistency checks. These checks are not made at resource definition or install time.

- If a file definition refers to an alternate index (AIX) path and RECOVERY is ALL or BACKOUTONLY, the AIX must be in the upgrade set for the base. This means that any changes made to the base data set are also reflected in the AIX. If the AIX is not in the upgrade set, the attempt to open the ACB for this AIX path fails.
- If a file is the first to be opened against a base cluster after the last cold start, the recovery options of the file definition are copied into the base cluster block.
- If a file is not the first to be opened for update against a base cluster after the last cold start, the recovery options in the file definition are checked against those copied into the base cluster block by the first open. There are the following possibilities:
  - Base cluster has RECOVERY(NONE):
    - File is defined with RECOVERY(NONE): the open proceeds.
    - File is defined with RECOVERY(BACKOUTONLY): the attempt to open the file fails, unless overridden by an XFCNREC global user exit program, which can allow inconsistencies in backout settings for files that are associated with the same base data set.
    - File is defined with RECOVERY(ALL): the open fails.
  - Base cluster has RECOVERY(BACKOUTONLY):
    - File is defined with RECOVERY(NONE): the attempt to open the file fails unless overridden by an XFCNREC global user exit program to allow inconsistencies in backout settings for files associated with the same base data set.
    - File is defined with RECOVERY(BACKOUTONLY): the open proceeds.
    - File is defined with RECOVERY(ALL): the open fails.
  - Base cluster has RECOVERY(ALL):
    - File is defined with RECOVERY(NONE): the open fails.
    - File is defined with RECOVERY(BACKOUTONLY): the open fails.
    - File is defined with RECOVERY(ALL): the open proceeds unless FWDRECOVLOG specifies a different journal id from the base cluster, in which case the open fails.

Any failure to open a file against a data set results in a message to the console. If necessary, the recovery options must be changed. To change the recovery attributes (held in the base cluster block) of a VSAM data set, you can use the CEMT, or EXEC CICS, SET DSNAME REMOVE command. This deletes the base cluster block, so CICS has no record of prior recovery settings for the VSAM data set. The next file to open against this data set causes a new base cluster block to be built and, if the file is opened for update, the data set takes on the recovery attributes of this file.

The base cluster block, together with its recovery attributes, and the inconsistency condition that may be set if you are using XFCNREC, are preserved even when all the files relating to the block are closed, and across warm and emergency restarts.

## Implementing forward recovery with user-written utilities

If you use your own forward recovery programs, you must ensure they use the after images from the forward recovery log streams. The use of autojournal records written to a general log stream is not recommended for VSAM forward recovery.

For details of procedures for performing forward recovery, see “Chapter 17. Forward recovery procedures” on page 177.



For programming information about the format of log and journal records, see the *CICS Customization Guide*.

## Implementing forward recovery with CICS VSAM Recovery MVS/ESA

You can use CICS VSAM Recovery MVS/ESA (CICSVR) to recover lost or damaged VSAM data sets. For details, see “Chapter 18. Forward recovery with CICSVR” on page 193.

---

## Recovery for intrapartition transient data

This section deals with both backward and forward recovery of intrapartition transient data.

### Backward recovery

CICS can recover only **intrapartition** transient data. The intrapartition data set is a VSAM-ESDS data set, with a file name of DFHINTRA. (For more information about allocation and space requirements, see the *CICS System Definition Guide*.) For **extrapartition** transient data considerations, see “Recovery for extrapartition transient data” on page 127.

You must specify the name of every intrapartition transient data queue that you want to be recoverable in the queue definition. The recovery attributes you can specify for an intrapartition transient data queue are:

- Logical
- Physical
- None

#### Logical recovery

If you request logical recovery on an intrapartition queue definition, changes to a transient data queue by an interrupted UOW are backed out. Backout occurs dynamically in the case of a task abend, or at a CICS emergency restart in the case of a CICS failure.

As a general rule, you should request logical recoverability. For example, if you make related changes to a set of resources that includes intrapartition transient data, and you want to commit (or back out) all the changes, you require logical recovery.

#### Physical recovery

Physical recoverability is unique to transient data and is effective on both warm and emergency restarts. By requesting physical recovery on an intrapartition queue definition, you ensure that changes to the queue are committed immediately and, with one exception, are not backed out.

The exception is in the case of the last read from a physically recoverable queue before a unit of work fails. CICS always backs out the *last* read from a physically recoverable transient data queue. In terms of the read and write pointers that CICS maintains for TD queues, this means that the read pointer is reset, but the write pointer never changes. This is illustrated by the diagram in Figure 12 on page 126. The sequence of TD actions in this example, and the subsequent recovery, is as follows:

- The unit of work has read items 1 and 2, leaving the read pointer at item 3.
- The unit of work has written item 4, leaving the write pointer ready for the next item to be written.
- CICS abends and is restarted with an emergency restart.

- As a result of the transient data recovery, the read pointer is reset to item 2, queue items 2, 3, and 4 are still available, and the write pointer is restored.

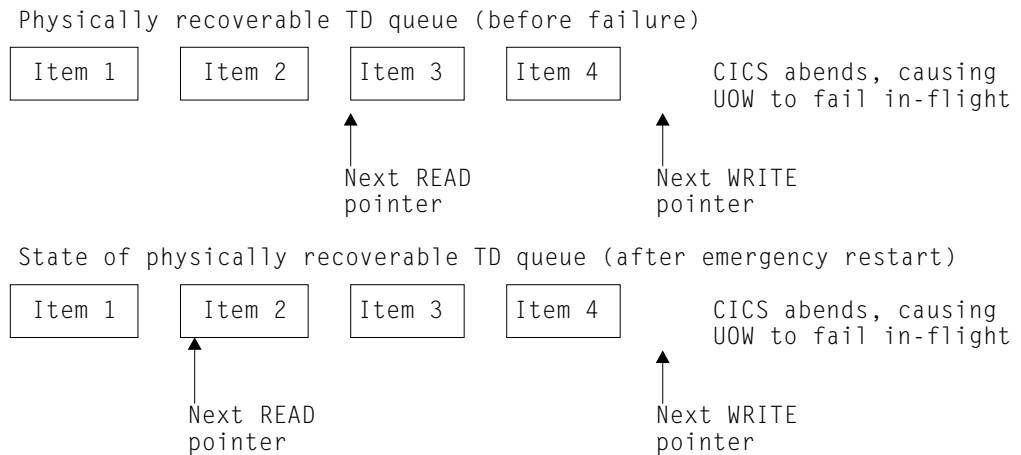

Figure 12. Illustration of recovery of a physically recoverable TD queue

Making intrapartition TD physically recoverable can be useful in the case of some CICS queues. For example, after a CICS failure, you might choose to restart CICS as quickly as possible, and then look for the cause of the failure. By specifying queues such as CSMT as intrapartition and physically recoverable, the messages produced just before the failure can be recovered and are therefore available to help you diagnose the problem.

### No recovery

Recovery is not performed if you specify NO on the recovery attribute of an intrapartition transient data definition.

## Forward recovery

CICS does not provide forward recovery support for transient data. If you want forward recovery of intrapartition transient data, provide application programs to record the changes made to the contents of your intrapartition transient data queues while CICS is running. Changes are recorded in a user journal. The information journaled must include:

- Each WRITEQ, including the data that is written
- Each READQ
- Each DELETEQ of a queue
- For logically recoverable queues, each backout, syncpoint, or syncpoint rollback

You must provide the application program to rebuild the data by reading the journaled information and applying that information to the transient data queue. Your application program could run in the program list table (PLT) phase or after emergency restart. Until the data set is fully recovered, do not write to the queue, because that would probably result in wrongly-ordered data, and a read might not provide valid data (or any data at all). For these reasons, running the recovery program in the PLT phase is probably preferable to running it after the restart.

If you do not have such a recovery strategy and you perform a cold start with a corrupted intrapartition data set, you will lose the contents of the intrapartition data set. You also lose the contents of the intrapartition data set if you specify TDINTRA=EMPTY as a system initialization parameter.

---

## Recovery for extrapartition transient data

CICS does not recover extrapartition data sets. If you depend on extrapartition data, you will need to develop procedures to recover data for continued execution on restart following either a controlled or an uncontrolled shutdown of CICS.

There are two areas to consider in recovering extrapartition data sets:

- Input extrapartition data sets
- Output extrapartition data sets

### Input extrapartition data sets

The main information required on restart is the number of records processed up to the time the system ended. This can be recorded during processing, using CICS journaling, as described in the following paragraphs.

Each application program that reads records from extrapartition input queues should first enqueue exclusive access to those queues. This prevents interleaved access to the same queues by other concurrently executing tasks.

The application programs then issue READQ TD commands to read and process extrapartition input records. In this way, they accumulate the total of input records read and processed during execution for each queue. The total number of READQ operations is written to a journal data set, together with the relevant destination identifications. This journaling should be done **immediately** before RETURN or SYNCPOINT commands.

Following output of the journal record, each application program dequeues itself from the extrapartition input queues to permit other application programs to access those queues.

If uncontrolled shutdown occurs before this journaling, no records will appear on the journal data set for that unit of work. The effect of that in-flight task is, therefore, automatically backed out on emergency restart. However, if the journal record is written before uncontrolled shutdown, this completed input data set processing will be recognized on emergency restart.

On emergency restart following uncontrolled shutdown or on a warm start following a controlled shutdown, use the following procedure, which will reposition the extrapartition input data sets to reflect the input and processing of their records during previous CICS operation.

You can identify an extrapartition input recovery program in the PLT for execution during the initialization phase. This program reads the journal data set forward. Each journaled record indicates the number of READQ operations performed on the relevant extrapartition input data set during previous execution of application programs. The same number of READQ TD commands is issued again by the recovery program, to the same input queue that was referenced previously.

On reaching the end of the journal data set, the extrapartition input data sets are positioned at the same point they had reached before the initiation of tasks that were in-flight at uncontrolled shutdown. The result is the logical recovery of these input data sets with in-flight task activity backed out.

## Output extrapartition data sets

The recovery of output extrapartition data sets is somewhat different from the recovery of input data sets.

For a tape output data set, use a new output tape on restart. You can then use the previous output tape if you need to recover information recorded before termination.

To avoid losing data in tape output buffers on termination, you can write unblocked records. Alternatively, write the data to an intrapartition disk destination (recovered by CICS on a warm start or emergency restart) and periodically copy it to the extrapartition tape destination through an automatically initiated task. On termination, the data is still available to be recopied on restart.

If a controlled shutdown of CICS occurs, the previous output tape closes correctly and writes a tape mark. However, on an uncontrolled shutdown such as a power failure or machine check, a tape mark is not written to indicate the end of the tape.

For a line printer output data set, you could just choose to carry on from where printing stopped when the system stopped. However, if you want to continue output from a defined point such as at the beginning of a page, you may need to use a journal data set. As each page is completed during normal CICS operation, write a record to a journal data set.

On restart, the page that was being processed at the time of failure can be identified from the journal data set, and that page can be reprocessed to reproduce the same output. Alternatively, use an intermediate intrapartition destination (as previously described) for tape output buffers.

## Using post-initialization (PLTPI) programs

You can use initialization (PLTPI) programs:

- As part of the processing required to recover extrapartition transient data
- To enable exits required during recovery

There are **two** PLT phases. The first phase occurs before the system initialization task is attached, and should not use CICS resources, because initialization is incomplete. The first phase is intended solely to enable exits that are needed during recovery processing. The second phase occurs after CICS initialization is complete and, at this point, you may use PLT programs to customize the environment.

For information on how to code the PLT, see the *CICS Resource Definition Guide*. For programming information about the special conditions that apply to PLT programs, see the *CICS Customization Guide*.

---

## Recovery for temporary storage

This section deals with both backward and forward recovery of temporary storage.

### Backward recovery

Temporary storage queues that are to be recoverable by CICS must be on auxiliary temporary storage.

Define temporary storage queues as recoverable using temporary storage model resource definitions as shown in the following example define statements:

```

CEDA DEFINE DESCRIPTION(Recoverable TS queues for START requests) TSMODEL(RECOV1)
          GROUP(TSRECOV) PREFIX(DF) LOCATION(AUXILIARY) RECOVERY(YES)

CEDA DEFINE DESCRIPTION(Recoverable TS queues for BMS) TSMODEL(RECOV2)
          GROUP(TSRECOV) PREFIX(**) LOCATION(AUXILIARY) RECOVERY(YES)

CEDA DEFINE DESCRIPTION(Recoverable TS queues for BMS) TSMODEL(RECOV3)
          GROUP(TSRECOV) PREFIX($$) LOCATION(AUXILIARY) RECOVERY(YES)

```

CICS continues to support temporary storage tables (TST) and you could define recoverable TS queues in a TST, as shown in the following example:

```

DFHTST TYPE=RECOVERY,
        DATAID=(DF,**,
                $$(:,character-string)...)

```

The DATAID DF makes the temporary storage queues used on CICS start requests recoverable.

The DATAIDs \*\* and \$\$ make the temporary storage queues used by BMS recoverable.

The DATAID character string represents the leading characters of each temporary storage queue identifier that you want to be recoverable. For example, DATAID=(R,ZIP) makes recoverable all temporary storage queues that have identifiers starting with the character "R" or the characters "ZIP".

For more information on allocation and space requirements, see the *CICS Operations and Utilities Guide*.

## Forward recovery

If you want forward recovery of temporary storage:

1. Record the changes made to temporary storage during the current CICS run; you must provide application programs to do this. At emergency restart time, you can then delay the emergency restart (by using PLTPI, for example) and, again using application programs, rebuild as much as possible of the temporary storage data using the records previously read.
2. Repeat the emergency restart but with the system initialization parameters amended to cold-start temporary storage (TS=(COLD)). Note, however, that this loses the contents of the entire temporary storage data set.



---

## Chapter 13. Programming considerations

This chapter discusses how you can include recovery facilities in your application program design, and use global user exits provided for backout recovery. It covers the following topics:

- “Application design”
- “Program design” on page 133
- “Coping with transaction and system failures” on page 138
- “Locking (enqueueing on) resources in application programs” on page 143
- “User exits for transaction backout” on page 149

---

### Application design

This section tells you how to design your applications so that they take advantage of the CICS recovery facilities.

Note the following terms used in this section:

#### Application

In this context, **application** refers to a set of one or more **transactions** designed to fulfill the particular needs of the user organization.

#### Transaction

This refers to a set of actions within an application which the designer chooses to regard as an entity. It corresponds to a unit of execution, which is typically started in a CICS region by invoking the transaction by its identifier from a terminal attached to CICS. It is for the designer to decide how (if at all) to subdivide an application into transactions, and whether the transactions should consist of just one unit of work, or more than one.

Ideally, but not necessarily, a transaction would correspond to a UOW. Dividing the business application into units of work that correspond to transactions simplifies the entire recovery process.

An example of a typical business application is an order-entry system. A typical order-entry application includes all the processes needed to handle one order from a customer, designed as a set of processing units, as follows:

1. Check the customer’s name and address and allocate an order number
2. Record the details of ordered items and update inventory files
3. Print the invoice and shipping documents

Depending on the agreed recovery requirements statement, noting details of ordered items and updating files can be implemented either as one large transaction or as several transactions—one for each item within the order.

### Splitting the application into transactions

Specify how to subdivide the application into transactions. Name each transaction, and describe its function in terms that the terminal user can understand.

Your application could include transactions to recover from failures, such as:

- *Progress transaction*, to check on progress through the application. Such a function could be used after a transaction failure or after an emergency restart, as well as at any time during normal operation. For example, it could be

designed to find the correct restart point at which the terminal user should recommence the interrupted work. This would be particularly relevant in a pseudo-conversation.

- *Catch-up function*, for entering data that the user may have been forced to accumulate by other means during a system failure.

### **Files accessed by each transaction**

Specify the files and databases that can be accessed in each processing unit.

Of the files and databases that can be accessed, specify those that are to be updated (as distinct from those that are only to be read).

### **Updates performed by each processing unit**

For those files and databases updated by an application processing unit, specify how to apply the updates; factors to consider here include the consistency and the immediacy of updates.

**Consistency of updates:** Specify which (if any) updates must happen in step with each other to ensure integrity of data. For example, in an order-entry application, it may be necessary to ensure that a quantity subtracted from the inventory file is, at the same time, added to the to-be-shipped file.

**Immediacy of updates:** Specify **when** newly entered data must or can be applied to the files or databases. Possibilities include:

- The application processing unit updates the files and databases as soon as the data is accepted from the user.
- The application processing unit accumulates updates for later action, for example:
  - By a later processing unit within the same application.
  - By a batch application that runs overnight. (If you choose this option, make sure that there is enough time for the batch work to complete the number of updates.)

You will need the above information when deciding on the internal design of application processing units.

### **Relationships between processing units**

Specify what data needs to be passed from one application processing unit to another.

For example, in an order-entry application, one processing unit may accumulate order items. Another, separate, processing unit may update the inventory file. Clearly, there is a need here for the data accumulated by the first processing unit to be passed to the second.

This information is needed when deciding what resources are required by each processing unit (see “Mechanisms for passing data between transactions” on page 134).

## **SAA-compatible applications**

The resource recovery element of the Systems Application Architecture (SAA) common programming interface (CPI) provides an alternative to the standard CICS application program interface (API) if you need to implement SAA-compatible applications. The resource recovery facilities provided by the CICS implementation of the SAA resource recovery interface are the same as those provided by CICS



API. Therefore, you have to change from CICS API to SAA resource recovery commands only if your application needs to be SAA-compatible.

To use the SAA resource recovery interface, you need to include SAA resource recovery commands in your applications in place of EXEC CICS SYNCPOINT commands. This book refers only to CICS API resource recovery commands; for information about the SAA resource recovery interface, see the *CPI Resource Recovery Reference* manual.

---

## Program design

This section tells you how to design your programs to use the CICS recovery facilities effectively.

### Dividing transactions into units of work

When deciding how to implement application processing units in terms of transactions, units of work, and programs, consider the following:

- In programs that support a dialog with the user, consider implementing each UOW to include only a single terminal read and a single terminal write. This can simplify the user restart procedures (see also “Processing dialogs with users”).

Short UOWs are preferable for several reasons:

- Data resources are locked for a shorter time. This reduces the chance of other tasks having to wait for the resource to be freed.
- Backout processing time (in dynamic transaction backout or emergency restart) is shortened.
- The user has less to re-enter when a transaction restarts after a failure.

In applications for which little or no re-keying is feasible (discussed in question 9 under “Questions relating to recovery requirements” on page 95), short units of work are essential so that all entered data is **committed** as soon as possible.

- Consider the recovery/restart implications when deciding whether to divide a transaction into many UOWs. CICS functions such as dynamic transaction backout and transaction restart work most efficiently for transactions that have only one UOW. But there can be situations in which multiple-UOW transactions are necessary, for example if a set of file or database updates must be irrevocably committed in **one** UOW, but the transaction is to continue with one or more UOWs for further processing.
- Where file or database updates must be kept in step, make sure that your application does them in the same UOW (see “Updates performed by each processing unit” on page 132). This ensures that those updates will all be committed together or—in the event of the UOW being interrupted—will back out together to a consistent state.

### Processing dialogs with users

An application may require several interactions (input and output) with the user. CICS provides the following basic techniques for program design for use in such situations:

- Conversational processing
- Pseudo-conversational processing

## **Conversational processing**

With conversational processing, the transaction continues to run as a task across all terminal interactions—including the time it takes for the user to read output and enter input. While it runs, the task retains resources that may be needed by other tasks. For example:

- The task occupies storage, and locks database records, for a considerable period of time. Also, in the event of a failure and subsequent backout, all the updates to files and databases made up to the moment of failure have to be backed out (unless the transaction has been subdivided into UOWs).
- If the transaction uses DL/I, and the number of scheduled PSBs reaches the maximum allowed, tasks needing to schedule further PSBs have to wait.

Conversational processing is not generally favored, but may be required where several file or database updates made by several interactions with the user must be related to each other—that is, they must all be committed together, or all backed out together, in order to maintain data integrity.

## **Pseudoconversational processing**

With pseudoconversational processing, successive terminal interactions with the user are processed as separate tasks—usually consisting of one UOW each. (This approach can result in a need to communicate between tasks or transactions (see “Mechanisms for passing data between transactions”) and the application programming can be a little more complex than for conversational processing.)

However, at the end of each task, the updates are committed, and the resources associated with the task are released for use by other tasks. For this reason, pseudoconversational transactions are generally preferred to the conversational type.

When several terminal interactions with the user are related to each other, data for updates should accumulate on a recoverable resource (see “CICS recoverable resources for communication between transactions” on page 135), and then be applied to the database in a single task (for example, in the last interaction of a conversation). In the event of a failure, emergency restart or dynamic transaction backout would need to back out only the updates made during that individual step; the application would be responsible for restarting at the appropriate point in the conversation. This may involve re-creating a screen format.

Bear in mind, however, that other tasks may try to update the database between the time when update information is accepted, and the time when it is applied to the database. Design your application to ensure that no other application can update the database at a time when it would corrupt your updating.

## **Mechanisms for passing data between transactions**

In those applications where one transaction needs to access working data created by a previous transaction, consider what mechanism should carry that data over.

The possible mechanisms are discussed under two broad headings:

- Main storage areas for communication between transactions
- CICS recoverable resources for communication between transactions

See also “Implications of interval control START requests” on page 137.

### **Main storage areas for communication between transactions**

Main storage areas that you can use to pass data between transactions include:

- The communication area (COMMAREA)

- The common work area (CWA)
- Temporary storage (main)
- The terminal control table user area (TCTUA)

CICS does not log changes to these areas (except as noted later in this section). Therefore, in the event of an uncontrolled shutdown, data stored in any of these areas is lost, which makes them unsuitable for applications needing to retain data between transactions across an emergency restart. Also, some of these storage areas can cause inter-transaction affinities, which are a hindrance to dynamic transaction routing. To avoid inter-transaction affinities, use either a COMMAREA or the TCTUA. For information about intertransaction affinities, see the *CICS Application Programming Guide*.

The advantages of main storage areas are realized only where recovery is not important, or when passing data between programs servicing the same task.

**Note:** Design programs so that they do **not** rely on the presence or absence of data in the COMMAREA to indicate whether or not control has been passed to the program for the first time (for example, by testing for a data length of zero). Consider the abend of a transaction where dynamic transaction backout and automatic restart are specified. After the abend, a COMMAREA could be passed to the next transaction from the terminal, even though the new transaction is unrelated. Similar considerations apply to the terminal control table user area (TCTUA).

### **CICS recoverable resources for communication between transactions**

Resources recoverable by backout that can be used for communication between transactions include:

- Temporary storage (auxiliary)
- Temporary storage data sharing
- Transient data queues
- User files and DL/I and DB2 databases
- Data tables (user-maintained)
- Coupling facility data tables

CICS can return all these to their status at the beginning of an in-flight UOW if an abnormal task termination occurs.

**Temporary storage (auxiliary):** You can use a temporary storage item to communicate between transactions. (For this purpose, the temporary storage item needs to be unique to the terminal ID. If the terminal becomes unavailable, the transaction sequence is interrupted until the terminal is again available.) The temporary storage queue-name (DATAID or QUEUE name) can be read and reread, but the application program must delete it when it is no longer needed to communicate between a sequence of transactions.

**Transient data queues:** Transient data (intrapartition) is similar to temporary storage (auxiliary) for communicating between transactions, the main difference being that you can each record in the queue only once. Transient data must be specified as **logically** recoverable to achieve backout to the start of any in-flight UOW.

**User files and DL/I and DB2 databases:** You can dedicate files or database segments to communicating data between transactions.

Transactions can record the completion of certain functions on the dedicated file or database segment. A progress transaction (whose purpose is to tell the user what updates have and have not been performed) can examine the dedicated file or segment.

In the event of physical damage, user VSAM files, DL/I, and DB2 databases can be forward recovered.

**User-maintained data tables:** User-maintained data tables (UMTs), which are recoverable after a unit of work failure can be a useful means of passing data between transactions. However, they are not forward recoverable, and not recoverable after a CICS restart.

**Coupling facility data tables:** Coupling facility data tables updated using the locking model, and which are recoverable after a unit of work failure, can be a useful means of passing data between transactions. Unlike UMTs, coupling facility data tables are recoverable in the event of a CICS failure, CFDT server failure, or an MVS failure. However, they are not forward recoverable.

## Designing to avoid transaction deadlock

To avoid transaction deadlock (see “Possibility of transaction deadlock” on page 147), consider the following techniques:

- Arrange for all transactions to access files in a sequence agreed in advance. This could be a suitable subject for installation standards. Be extra careful if you allow updates through multiple paths. More information is at the end of this section.
- Enforce explicit installation enqueueing standards so that all applications:
  1. Enqueue by the same character string
  2. Use those strings in the same sequence.
- Always access records within a file in the same sequence. For example, where you update several file or database records, ensure that you access them in ascending sequence.

Ways of doing this include the following:

1. The terminal operator always enters data in the existing data set sequence.  
This method requires special terminal operator action, which may not be practical within the constraints of the application. (For example, orders may be taken by telephone in random product number sequence.)
2. The application program first sorts the input transaction contents so that the sequence of data items matches the sequence on the data set.  
This method requires additional application programming, but imposes no external constraints on the terminal operator or the application.
3. The application program issues a SYNCPOINT command after processing each data item entered in the transaction.  
This method requires less additional programming than the second method. However, issuing a synchronization point implies that previously processed data items in the transaction are not to be backed out if a system or transaction failure occurs before the entire transaction ends. This may not be valid for the application, and raises the question as to which data items in the transaction were processed and which were backed out by CICS. If the entire transaction must be backed out, synchronization points should not be issued, or only one data item should be entered per transaction.

Of the three methods, the second (sorting data items into an ascending sequence by programming) is most widely accepted.

Note that, if you allow updates on a data set through the base and one or more alternate index (AIX) paths, or through multiple AIX paths, sequencing record updates may not provide protection against transaction deadlock. You are not protected because the different base key sequences will probably not all be in ascending (or descending) order. If you do allow updates through multiple paths, and if you need to perform several record updates, always use a single path or the base. Define such a procedure in your installation standards.

## Implications of interval control START requests

Interval control START requests initiate another task—for example, to perform updates accumulated by the START-issuing task; this allows the user to continue accumulating data without waiting for the updates to be applied.

The PROTECT option on a START request ensures that, if the task issuing the START fails during the UOW, the new task will not be initiated, even though its start time may have passed. (See “START requests” on page 70 for more information about the PROTECT option.)

Consider also the possibility of a started task that fails. Unless you include abend processing in the program, only the master terminal will know about the failure. The abend processing should analyze the cause of failure as far as possible, and restart the task if appropriate. Ensure that either the user or the master terminal operator can take appropriate action to repeat the updates. You could, for example, allow the user to reinitiate the task.

An alternative solution is for the started transaction to issue a START command specifying its **own** TRANSID. Immediately before issuing the RETURN command, the transaction should cancel the START command. The effect of this will be that, if a started task fails, it will automatically restart. (If the interval specified in the START command is too short, the transaction could be invoked again while the first invocation is still running. Ensure that the interval is long enough to prevent this.)

## Implications of automatic task initiation (TD trigger level)

Specifying the TRANSID operand in the DCT for an intrapartition transient data destination starts the named transaction when the trigger level is reached. Designate such a destination as **logically** recoverable. This ensures that the transient data records are committed before the task executes and uses those records.

## Implications of presenting large amounts of data to the user

Ideally, a transaction that updates files or databases should defer confirmation (to the user) until such updates are committed (by user syncpoint or end of task).

In cases where the application requires the reply to consist of a large amount of data that cannot all be viewed at one time (such as data required for browsing), several techniques are available, including:

- Terminal paging through BMS
- Using transient data queues

### Terminal paging through BMS

The application program (using the SEND PAGE BMS commands) builds pages of output data on a temporary storage queue for subsequent display using operator

page commands. (Such queues should, of course, be specified as recoverable, as described in “Recovery for temporary storage” on page 128.)

The application program should then send a committed output message to the user to say that the task is complete, and that the output data is available in the form of terminal pages.

If an uncontrolled termination occurs while the user is viewing the pages of data, those pages are not lost (assuming that temporary storage for BMS is designated as recoverable). After emergency restart, the user can resume terminal paging by using the CSPG CICS-supplied transaction and terminal paging commands. (For more information about CSPG, see the *CICS Supplied Transactions* manual.)

### **Using transient data queues**

When a number of tasks direct large amounts of data to a single terminal (for example, a printer receiving multipage reports initiated by the users), it may be necessary to queue the data (on disk) until the terminal is ready to receive it.

Such queuing can be done on a transient data queue associated with a terminal. A special transaction, triggered when the terminal is available, can then format and present the data.

For recovery and restart purposes:

- The transient data queue should be specified as logically recoverable.
- If the transaction that presents the data fails, dynamic transaction backout will be called.

If the terminal at which the transaction runs is a printer, however, dynamic transaction backout (and a restart of the transaction by whatever means) may cause a partial duplication of output—a situation that might require special user procedures. The best solution is to ensure that each UOW corresponds to a printer page or form.

---

## **Coping with transaction and system failures**

To cope with transaction failures and uncontrolled shutdown of the system, a number of facilities are available to help ensure that:

1. Files and databases remain in a coordinated and consistent state
2. Diagnostic and warning information is produced if a program fails
3. Communication between transactions is not affected by the failure

These facilities are discussed here under the following headings:

- Transaction failures
- System failures

The actions taken by CICS are described under “Chapter 8. Unit of work recovery and abend processing” on page 67 and “Processing operating system abends and program checks” on page 89.

### **Transaction failures**

When a transaction fails, the following CICS facilities can be invoked during and after the abend process:

- CICS condition handling
- HANDLE ABEND commands, and user exit code
- The SYNCPOINT ROLLBACK command
- Dynamic transaction backout (DTB)

- Transaction restart after DTB
- The program error program (DFHPEP)

These facilities can be used individually or together. During the internal design phase, specify which facilities to use and determine what additional (application or systems) programming may be involved.

The RESP option on a command returns a condition ID that can be tested. Alternatively, a HANDLE CONDITION command is used in the local context of a transaction program to name a label where control is passed if certain conditions occur.

For example, if file input and output errors occur (where the default action is merely to abend the task), you may wish to inform the master terminal operator, who may decide to terminate CICS, especially if one of the files is critical to the application.

Your installation may have standards relating to the use of RESP options or HANDLE CONDITION commands. Review these for each new application.

### **HANDLE ABEND commands**

As described in “How CICS handles transaction abends” on page 86, a HANDLE ABEND command can pass control to a routine within a transaction, or to a separately compiled program when the task abends.

The kind of things you might do in abend-handling code include:

- Capturing diagnostic information (in addition to that provided by CICS) before the task abends, and sending messages to the master terminal and end user
- Executing cleanup actions, such as canceling start requests (if the PROTECT option has not been used)
- Writing journal records to reverse the effects of explicit journaling performed before the abend

Your installation may have standards relating to the use of HANDLE ABEND commands; review these for each new application.

### **EXEC CICS SYNCPOINT ROLLBACK command**

ROLLBACK might be useful within your transaction if, for instance, the transaction discovers logically inconsistent input after some database updates have been initiated, but before they are committed by the syncpoint.

Before deciding to use it, however, consider the following:

- Rollback backs out updates to recoverable resources performed in the current UOW only.—not in the task as a whole.
- The SYNCPOINT command (with or without the ROLLBACK option) causes a new UOW to start.
- If you have a transaction abend, and you do not want the transaction to continue processing, issue an EXEC CICS ABEND and allow dynamic transaction backout to back out the updates and ensure data integrity. Use rollback only if you want the application to regain control after nullifying the effects of a unit of work.

For programming information about the SYNCPOINT command, see the *CICS Application Programming Reference* manual.

## Dynamic transaction backout (DTB)

DTB occurs automatically for all transactions that have recoverable resources. It is not an option you can specify on a transaction resource definition. (The actions of DTB are described under “Transaction backout” on page 69.)

Remember that:

- For transactions that access a recoverable resource, DTB helps to preserve logical data integrity.
- Resources that are to be updated should be made recoverable.
- DTB takes place only after program level abend exits (if any) have attempted cleanup or logical recovery.

## Transaction restart after DTB

For each transaction where DTB is specified, consider also specifying automatic transaction restart. For example, for transactions that access DL/I databases (and are subject to program isolation deadlock), automatic transaction restart is usually specified.

Even if transaction restart is specified, a task will restart automatically only under certain default conditions (listed under “Abnormal termination of a task” on page 87). These conditions can be changed, if absolutely necessary, by modifying the restart program DFHREST.

## Use of the program error program (DFHPEP)

Decide whether or not to include your own functions, examples of which are given in “The CICS-supplied PEP” on page 153. (DFHPEP is invoked during abnormal task termination as described at “Abnormal termination of a task” on page 87.)

## System failures

Specify how an application is to be restarted after an emergency restart.

Depending on how far you want to automate the restart process, application and system programming could provide the following functions:

- User exits for transaction backout processing to handle:
  - Logically deleting records added to BDAM or VSAM-ESDS files (see the *CICS Customization Guide* for details of the XFCLDEL global user exit point)
  - Backing out file control log records (see the *CICS Customization Guide* for details of the XFCBOUT global user exit point)
  - File errors during transaction backout (see the *CICS Customization Guide* for details of the XFCBFAIL global user exit point)
  - User recovery records read from the system log during emergency restart (see the *CICS Customization Guide* for details of the XRCINPT global user exit point).
- A progress transaction to help the user discover what updates have and have not been performed. For this purpose, application code can be written to search existing files or databases for the latest record or segment of a particular type.

## Handling abends and program level abend exits

“Chapter 8. Unit of work recovery and abend processing” on page 67 describes how CICS processes abend requests and executes program level abend exit code.

Information that is available to a program-level exit routine or program includes the following:



Command	Information provided
ADDRESS TWA	The address of the TWA
ASSIGN ABCODE	The current CICS abend code
ASSIGN ABPROGRAM	The name of the failing program for the latest abend
ASSIGN ASRAINTRPT	The PSW interrupt data for the latest ASRA or ASRB abend
ASSIGN ASRAKEY	The execution key at the time of the last ASRA, ASRB, AICA, or AEYD abend, if any
ASSIGN ASRAPSW	The PSW for the latest ASRA or ASRB abend
ASSIGN ASRAREGS	The general-purpose registers for the latest ASRA or ASRB abend
ASSIGN ASRASPC	The type of space in control at the time of the last ASRA, ASRB, AICA, or AEYD abend, if any
ASSIGN ASRASTG	The type of storage being addressed at the time of the last ASRA or AEYD abend, if any
ASSIGN ORGABCODE	Original abend code in cases of repeated abends

**Notes:**

1. If an abend occurs during the invocation of a CICS service, issuing a further request for the same service may cause unpredictable results because the reinitialization of pointers and work areas and the freeing of storage areas in the exit routine may not have been completed.
2. ASPx abends, which are task abends while in syncpoint processing, cannot be handled by an application program.

In program-level abend exit code, you might want to perform actions such as the following (although it is best to keep abend exit code to a minimum):

- Record application-dependent information relating to that task in case it terminates abnormally.  
If you want to initiate a dump, do so in the exit code at the same program level as the abend. If you initiate the dump at a program level higher than where the abend occurred, you may lose valuable diagnostic information.
- Attempt local recovery, and then continue running the program.
- Send a message to the terminal operator if, for example, you believe that the abend is due to bad input data.

For transactions that are to be dynamically backed out if an abend occurs, beware of writing exit code that ends with a RETURN command. This would indicate to CICS that the transaction had ended normally and would therefore prevent dynamic transaction backout (and automatic transaction restart where applicable). (See description of program level abend processing at “How CICS handles transaction abends” on page 86.)

Exit programs can be coded in any supported language, but exit routines must be in the same language as the program of which they are a part.

See the *CICS Messages and Codes* manual for the transaction abend codes for abnormal terminations that CICS initiates, their meanings, and the recommended actions.

Programming information relating to the coding of program-level exit code (such as addressability and use of registers) is in the *CICS Application Programming Reference* manual. For background information, see the *CICS Application Programming Guide*.

## Processing the IOERR condition

Any program that attempts to process an IOERR condition for a recoverable resource must not issue a RETURN or SYNCPOINT command, but must terminate by issuing an ABEND command. A RETURN or SYNCPOINT command causes the recovery manager to complete the unit of work and commit changes to recoverable resources.

## START TRANSID commands

In a transaction that uses the START TRANSID command to start other transactions, observe the following points to maintain logical data integrity:

1. Always use the PROTECT option of the START TRANSID command. This ensures that if the START-issuing task is backed out, the new task will not start.
2. If you pass data to the started transaction (on one of the data options FROM, RTERMID, RTRANSID, or QUEUE), ensure you define the associated temporary storage queue as recoverable. The temporary storage queue is named on the REQID option of the START command when using any of the data options. To make the temporary storage queue recoverable, define the queue in a temporary storage table using the DATAID option of the DFHTST TYPE=RECOVERY macro (see “Recovery for temporary storage” on page 128).

This ensures that data being passed to another task is deleted from the temporary storage queue if the START-issuing task fails and is backed out.

- If REQID is not used, the default DATAID is 'DFRxxx'.
- If REQID is used, that REQID is the DATAID designated as recoverable in the TST.

Use of a recoverable DATAID also ensures that, if a system failure occurs after the START-issuing task has completed its syncpoint, the START command is preserved. CICS starts the transaction specified on a recoverable START command after an emergency restart, when the expiry time is reached and provided the terminal specified the TERMID option is available. Note that a DATAID is relevant only if data is being passed to the started transaction.

**Note:** Consider using EXEC CICS RETURN TRANSID(...) with the IMMEDIATE option if the purpose is to start the next transaction in a sequence on the same terminal. This does not unlock the terminal, incurs less overhead, and, in a dynamic transaction routing (DTR) environment, the transaction is eligible for DTR.

## PL/I programs and error handling

ON-units are a standard method of error-handling in PL/I programs. If the execution-time option STAE is specified, CICS program control services set up an exit routine that activates the PL/I ON-units.

This exit routine can handle:

- All PL/I errors
- CICS abends that occur in the PL/I program and in associated CICS services
- Program checks

Note that, under CICS, PL/I execution-time options can be specified only by the PLIXOPT character string.

For details of PL/I coding restrictions in a CICS environment, see the appropriate PL/I programmer's guide for your compiler.

---

## Locking (enqueueing on) resources in application programs

This section describes locking (enqueueing) functions provided by CICS (and access methods) to protect data integrity. There are two forms of locking:

1. The implicit locking functions performed by CICS (or the access method) whenever your transactions issue a request to change data. These are described under:
  - "Implicit locking for files"
  - "Implicit enqueueing on logically recoverable TD destinations" on page 146
  - "Implicit enqueueing on recoverable temporary storage queues" on page 146
  - "Implicit enqueueing on DL/I databases with DBCTL" on page 147.
2. The explicit enqueueing function that you request by means of an EXEC CICS command. This is described under "Explicit enqueueing (by the application programmer)" on page 147.

**Note:** Locking (implicit or explicit) data resources protects data integrity in the event of a failure, but can affect performance if several tasks attempt to operate on the same data resource at the same time. The effect of locking on performance, however, is minimized by implementing applications with short UOWs, as discussed under "Dividing transactions into units of work" on page 133.

### Implicit locking for files

This section first describes the implicit locking provided while nonrecoverable files are being updated. It then describes the extended locking actions when recoverable files are being updated.

#### Nonrecoverable files

For BDAM files that are nonrecoverable (that is, LOG=NO is specified in the FCT entry), CICS does not lock records that are being updated. By default, you get BDAM exclusive control, which operates on a physical block, is system wide, but lasts only until the update is complete. If a transaction reads a record for update under BDAM exclusive control, and the transaction subsequently decides not to change the data, it must release the BDAM exclusive control. To do this, issue an EXEC CICS UNLOCK command, which causes CICS to issue a RELEX macro.

If you don't want BDAM exclusive control, specify SERVREQ=NOEXCTL on the file entry in the FCT.

For nonrecoverable VSAM files accessed in non-RLS mode, VSAM exclusive control locks the control interval during an update. For nonrecoverable VSAM files accessed in RLS mode, SMSVSAM locks the record during the update.

Figure 13 illustrates the extent of locking for nonrecoverable files.

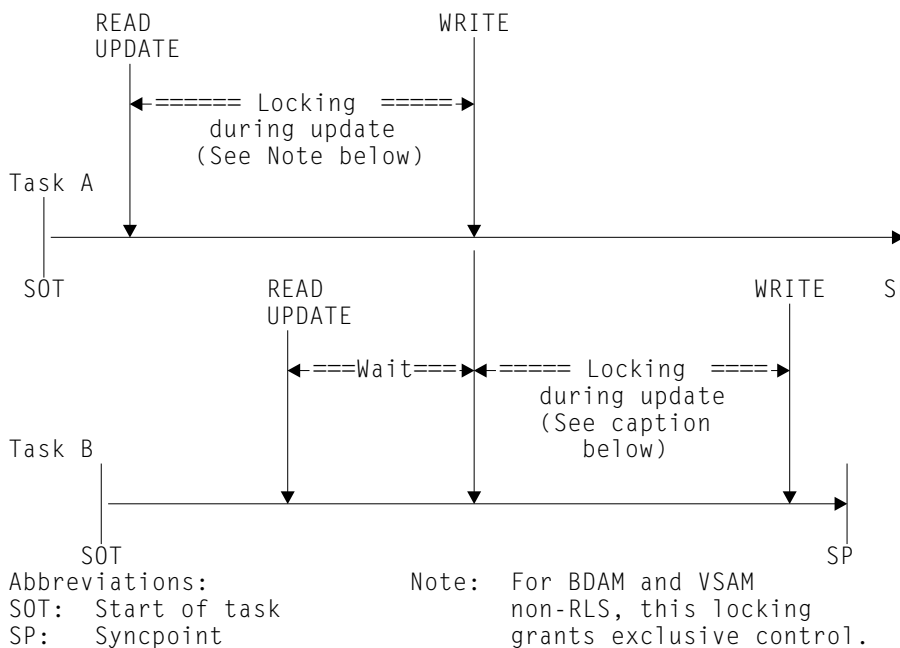

Figure 13. Locking during updates to nonrecoverable files. This figure illustrates two tasks updating the same record or control interval. Task A is given a lock on the record or control interval between the READ UPDATE and WRITE commands. During this period, task B waits.

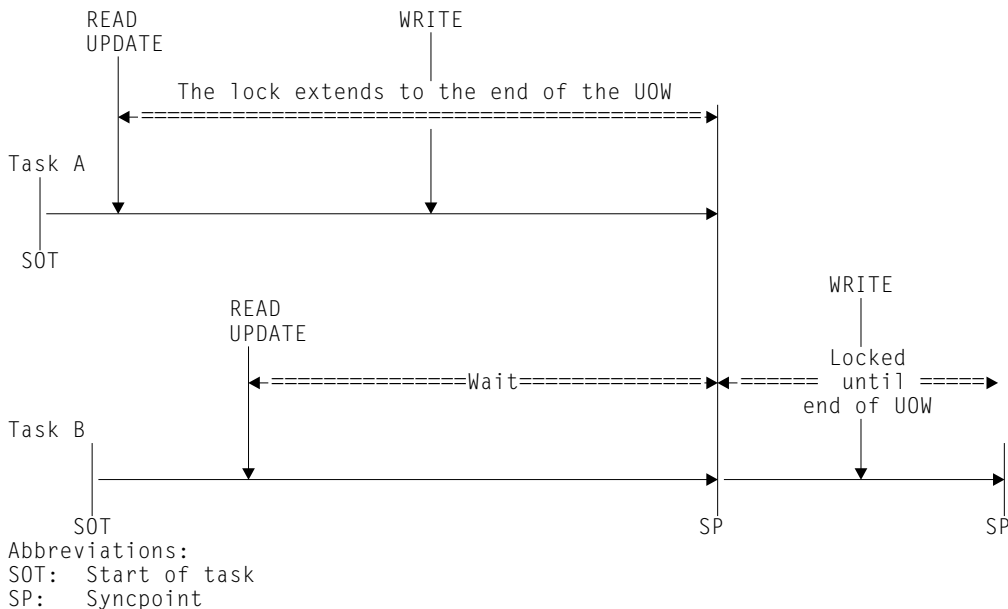

Figure 14. Locking (enqueuing on a resource) during updates to recoverable files. This figure illustrates two tasks updating the same record or control interval. Task A is given an exclusive lock on the record until the update is committed (at the end of the UOW). During this period, task B waits.

### Recoverable files

For VSAM or BDAM files designated as recoverable, the duration of the locking action is extended as shown in Figure 14. For VSAM files, the extended locking is on the updated record only, not the whole control interval.

The extended period of locking is needed to avoid an update committed by one task being backed out by another. (Consider what could happen if the nonextended locking action shown in Figure 13 on page 144 was used when updating a **recoverable** file. If task A abends just after task B has reached syncpoint and has thus committed its changes, the subsequent backout of task A returns the file to the state it was in at the beginning of task A, and task B's committed update is lost.)

To avoid this problem, whenever a transaction issues a command that changes a recoverable file (or reads from a recoverable file prior to update), CICS automatically locks the updated record until the change is committed (that is, until the end of the UOW). Thus in the above example, Task B would not be able to access the record until Task A had committed its change at the end of the UOW. Hence, it becomes impossible for Task B's update to be lost by a backout of Task A. For files opened in non-RLS mode, CICS provides this locking using the enqueue domain. For files opened in RLS mode, SMSVSAM provides the locking, and the locks are released at the completion of the unit of work at the request of CICS.

The file control commands that invoke automatic locking in this way are:

- READ (for UPDATE)
- WRITE
- DELETE

**Notes:**

1. Enqueuing as described above can lead to **transaction deadlock** (see "Possibility of transaction deadlock" on page 147).
2. The scope of locks varies according to the access method, the type of access, and who obtains the lock:
  - BDAM exclusive control applies to the physical block
  - Non-RLS VSAM exclusive control applies to the control interval
  - CICS locks for BDAM (with NOEXCTL specified) apply to the record only
  - CICS locks for non-RLS VSAM apply to the record only
  - SMSVSAM locks for RLS apply to the record only
3. **VSAM exclusive control.** The CICS enqueueing action on recoverable files opened in non-RLS mode, which always lasts until the end of the UOW, does not affect VSAM's exclusive control actions. When a transaction issues a READ UPDATE command (for any file, recoverable or not), VSAM maintains its exclusive control of the control interval containing the record until a REWRITE (or UNLOCK, DELETE, or SYNCPOINT) command is issued. Unless it specifies the TOKEN keyword, a second READ UPDATE command for records in the same control interval without an intervening REWRITE, DELETE, or UNLOCK command raises the INVREQ condition.
4. For recoverable files, do not use unique key alternate indexes (AIXs) to allocate unique resources (represented by the alternate key). If you do, backout may fail in the following set of circumstances:
  - a. A task deletes or updates a record (through the base or another AIX) and the AIX key is changed.
  - b. Before the end of the first task's UOW, a second task inserts a new record with the original AIX key, or changes an existing AIX key to that of the original one.
  - c. The first task fails and backout is attempted.

The backout fails because a duplicate key is detected in the AIX indicated by message DFHFC4701, with a failure code of X'F0'. There is no locking on the AIX key to prevent the second task taking the key before the end of the first

task's UOW. If there is an application requirement for this sort of operation, you should use the CICS enqueue mechanism to reserve the key until the end of the UOW.

5. To ensure that the data being read is up-to-date, the application program should:
  - For files accessed in non-RLS mode, issue a READ UPDATE command (rather than a simple READ), thus locking the data until the end of the UOW
  - For files accessed in RLS mode, use the consistent read integrity option.

## Implicit enqueueing on logically recoverable TD destinations

CICS provides an enqueueing protection facility for logically recoverable (as distinct from physically recoverable) transient data destinations in a similar way to that for recoverable files. There is one minor difference, however: CICS regards each recoverable destination as two separate recoverable resources—one for writing and one for reading.

Transient data control commands that invoke implicit enqueueing are:

- WRITEQ TD
- READQ TD
- DELETEQ TD

Thus, for example:

- If a task issues a WRITEQ TD command to a particular destination, the task is enqueued upon that write destination until the end of the task (or UOW). While the task is thus enqueued:
  - Another task attempting to write to the same destination is suspended.
  - Another task attempting to read from the same destination is allowed to read only **committed** data (not data being written in a currently incomplete UOW).
- If a task issues a READQ TD command to a particular destination, the task is enqueued upon that read destination until the end of task (or UOW). While the task is thus enqueued:
  - Another task attempting to read from the same destination is suspended.
  - Another task attempting to write to the same destination is allowed to do so and will itself enqueue on that write destination until end of task (or UOW).
  - If a task issues a DELETEQ TD request, the task is enqueued upon both the read and the write destinations. While the task is thus enqueued, no other task can read from, or write to, the queue.

## Implicit enqueueing on recoverable temporary storage queues

CICS provides the enqueueing protection facility for recoverable temporary storage queues in a similar way to that for recoverable files on VSAM data sets. There is one minor difference, however: CICS enqueueing is not invoked for READQ TS commands, thereby making it possible for one task to read a temporary storage queue record while another is updating the same record. To avoid this, use explicit enqueueing on temporary storage queues where concurrently executing tasks can read and change queue(s) with the same temporary storage identifier. (See “Explicit enqueueing (by the application programmer)” on page 147.)

Temporary storage control commands that invoke implicit enqueueing are:

- WRITEQ TS
- DELETEQ TS

## Implicit enqueueing on DL/I databases with DBCTL

IMS™ program isolation scheduling ensures that, when a task accesses a segment by a DL/I database call, it implicitly enqueuees on all segments in the same database record as the accessed segment. How long it is enqueuee depends on the access method being used:

- **Direct methods (HDAM, HIDAM)**—If an ISRT, DLET, or REPL call is issued against a segment, that segment, with all its child segments (and, for a DLET call, its parent segments as well), remains enqueuee upon until a DL/I TERM call is issued. The task dequeues from all other segments in the database record by accessing a segment in a different database record.
- **Sequential methods (HSAM, HISAM, SHISAM)**—If the task issues an ISRT, DLET, or REPL call against any segment, the entire database record remains enqueuee upon until a DL/I TERM call is issued. If no ISRT, DLET, or REPL call is issued, the task dequeues from the database record by accessing a segment in a different database record.

The foregoing rules for program isolation scheduling can be overridden using the 'Q' command code in a segment search argument (this command extends enqueueing to the issue of a DL/I TERM call), or by using PROCOPT=EXCLUSIVE in the PCB (this macro gives exclusive control of specified segment types throughout the period that the task has scheduled the PSB).

## Explicit enqueueing (by the application programmer)

CICS provides the following **explicit** enqueueing commands:

- EXEC CICS ENQ RESOURCE
- EXEC CICS DEQ RESOURCE

These commands can be useful in certain applications when, for example, you want to:

- Protect data written into the common work area (CWA), which is not automatically protected by CICS
- Prevent transaction deadlock by enqueueing on records that might be updated by more than one task concurrently
- Protect a temporary storage queue from being read and updated concurrently.

To be effective, however, all transactions must adhere to the same convention. A transaction that accesses the CWA without using the agreed ENQ and DEQ commands is not suspended, and protection is violated.

After a task has issued an ENQ RESOURCE(*data-area*) command, any other task that issues an ENQ RESOURCE command with the same *data-area* parameter is suspended until the task issues a matching DEQ RESOURCE(*data-area*) command, or until the UOW ends.

**Note:** Enqueueing on more than one resource concurrently might create a deadlock between transactions.

## Possibility of transaction deadlock

The enqueueing and program isolation scheduling mechanisms, which protect resources against double updating, can cause a situation known as **transaction deadlock**.<sup>10</sup>

---

10. Transaction deadlock is sometimes known as **enqueue deadlock**, **enqueue interlock**, or **deadly embrace**.

As shown in Figure 15, transaction deadlock means that two (or more) tasks cannot proceed because each task is waiting for the release of a resource that is enqueued upon by the other. (The enqueueing, DL/I program isolation scheduling action, or VSAM RLS locking action protects resources until the next synchronization point is reached.)

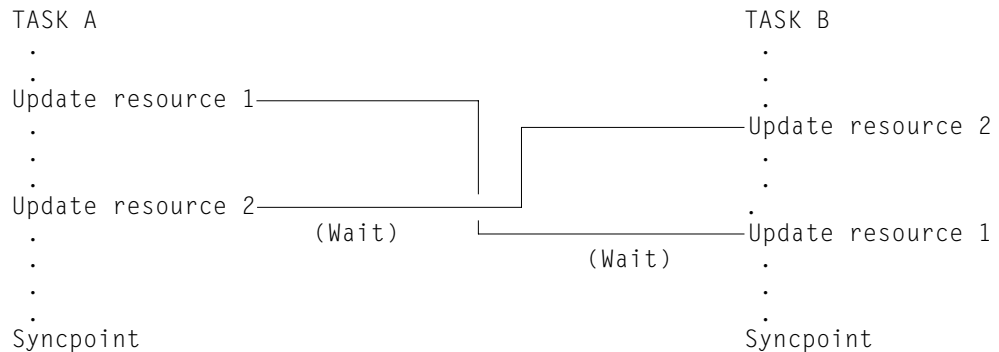

Figure 15. Transaction deadlock (generalized)

If transaction deadlock occurs, one task abends and the other proceeds.

- If both deadlocked resources are non-RLS resources, CICS file control detects the deadlock and abends one of the transactions with an AFCF abend code.
- If both deadlocked resources are VSAM RLS resources, deadlock detection is performed by VSAM. If VSAM detects an RLS deadlock condition, it returns a deadlock exception condition to CICS, causing CICS file control to abend the transaction with an AFCW abend code. CICS also writes messages and trace entries that identify the members of the deadlock chain.

**Note:** VSAM cannot detect a cross-resource deadlock (for example, a deadlock arising from use of RLS and DB2 resources) where another resource manager is involved. VSAM resolves a cross-resource deadlock when the timeout period expires, as defined by either the DTIMOUT or FTIMEOUT parameters, and the waiting request is timed out. In this situation, VSAM cannot determine whether the timeout is caused by a cross-resource deadlock, or by a timeout caused by another transaction acquiring an RLS lock and not releasing it.

- If the resources are both DL/I databases, DL/I itself detects the potential deadlock as a result of the tasks issuing their scheduling calls. In this case, DL/I causes CICS to abend the task that has the least update activity (with abend code ADCD).
- If both deadlocked resources are CICS resources (but not both VSAM resources), or one is CICS and the other DL/I, CICS abends the task whose DTIMOUT period elapses first. It is possible for both tasks to time out simultaneously. If neither task has a DTIMOUT period specified, they both remain suspended indefinitely, unless one of them is canceled by a master terminal command.

The abended task may then be backed out by dynamic transaction backout, as described in “Transaction backout” on page 69. (Under certain conditions, the transaction can be restarted automatically, as described under “Abnormal termination of a task” on page 87. Alternatively, the terminal operator may restart the abended transaction.)

For more information, see “Designing to avoid transaction deadlock” on page 136.



---

## User exits for transaction backout

This section describes how to include your own logic in global user exit programs that run during dynamic transaction backout and backout at emergency restart. There are exits in the file control recovery control program, and in the user log record recovery program (which is driven at emergency restart only). Transient data and temporary storage backouts do not have any exits.

For detailed programming information about the exits described in this chapter, see the *CICS Customization Guide*.

## Where you can add your own code

At emergency restart, you may add your own code in post-initialization programs that you nominate in the program list table (described under “Using post-initialization (PLTPI) programs” on page 128).

You may want to include functions in global user exit programs that run during emergency restart to:

- Process file control log records containing the details of file updates that are backed out
- Deal with the backing-out of additions to data set types that do not support deletion (VSAM ESDS and BDAM), by flagging the records as logically deleted
- Handle file error conditions that arise during transaction backout
- Process user recovery records (in the XRCINPT exit of the user log record recovery program during emergency restart)
- Deal with the case of a non-RLS batch program having overridden RLS retained locks (this should not occur very often, if at all)

The exits to consider are:

1. XRCINIT—invoked at the beginning and end of the user log record recovery program
2. XRCINPT—invoked whenever a user log record is read from the system log
3. XFCBFAIL—file backout failure exit
4. XFCLDEL—file logical delete exit
5. XFCBOVER—file backout non-RLS override exit
6. XFCBOUT—file backout exit

You can use any of these exits to add your own processing if you do not want the default action. To use these exits at emergency restart, either enable them in PLT programs in the first part of PLT processing, or specify them on the system initialization parameter, TBEXITS. This takes the form `TBEXITS=(name1,name2,name3,name4,name5,name6)`, where *name1*, *name2*, *name3*, *name4*, *name5*, and *name6* are the names of your global user exit programs for the XRCINIT, XRCINPT, XFCBFAIL, XFCLDEL, XFCBOVER, XFCBOUT exit points.

## Exit details

For programming information on the generalized interface for exits, how to write exit programs, and the input parameters and return codes for each exit, see the *CICS Customization Guide*.

Do not set the UERCPURG return code for these exits, because the exit tasks cannot be purged.

### **XRCINIT exit**

XRCINIT is invoked at warm and emergency restart:

1. When the first user log record is read from the system log, and before it is passed to the XRCINPT exit
2. After the last user log record has been read from the system log and passed to XRCINPT

The XRCINIT exit code must always end with a return code of UERCNORM. No choice of processing options is available to this exit.

CICS passes information in the global user exit parameter list about user-written log records presented at the XRCINPT exit. The parameters includes a flag byte that indicates the disposition of the user log records. This can indicate the state of the unit of work in which the user log records were found, or that the record is an activity keypoint record. The possible values indicate:

- The record is an activity keypoint record
- The UOW was committed
- The UOW was backed out
- The UOW was in-flight
- The UOW was in-doubt

### **XRCINPT exit**

XRCINPT is invoked at warm and emergency restart, once for each user log record read from the system log.

The default action at this exit is to do nothing.

If you want to ignore the log record, return with return code UERCBYP. This frees the record area immediately and reads a new record from the system log. Take care that this action does not put data integrity at risk.

### **XFCBFAIL global user exit**

XFCBFAIL is invoked whenever an error occurs during backout of a unit of work.

An XFCBFAIL global user exit program can decide whether to bypass, or invoke, CICS backout failure control, The processing performed by CICS backout failure control is described under "Backout-failed recovery" on page 73.

### **XFCLDEL global user exit**

XFCLDEL is invoked when backing out a unit of work that performed a write operation to a VSAM ESDS, or a BDAM data set.

### **XFCBOVER global user exit**

XFCBOVER is invoked whenever CICS is about to decide not to backout an uncommitted update, because the record could have been updated by a non-RLS batch program. This situation can occur after a batch program has opened a data set, even though it has retained locks, by overriding the RLS data set protection.

### **XFCBOUT global user exit**

XFCBOUT is invoked when CICS is about to backout a file update.

## Coding transaction backout exits

You have access to all CICS services, except terminal control services, during exit execution. However, consider the following restrictions:

- The exit programs must be written in assembler code.
- They must be quasi-reentrant. They may use the exit programming interface (XPI) and issue EXEC CICS commands.
- If an exit program acquires an area as a result of a file control request, it is the responsibility of the exit to release that area.
- An exit must not attempt to make any file control requests to a file referring to a VSAM data set opened in non-RLS mode with a string number of 1, unless no action is specified for that file during the initialization exit.
- Task-chained storage acquired in an exit should be released by the exit as soon as its contents are no longer needed.
- If an exit is not used, the default actions are taken.
- We strongly recommend that emergency restart global user exits do not change any *recoverable* resource. If you do try to use temporary storage, transient data, or file control, these resource managers may also be in a state of recovery. Access to these services will, therefore, at best cause serialization of the recovery tasks and, at worst, cause a deadlock.



---

## Chapter 14. Using a program error program (PEP)

This chapter gives an overview of the program error program (DFHPEP). The way this program works, and some design considerations for it, are described in “Actions taken at transaction failure” on page 88. For information on how to write a program error program, see the *CICS Customization Guide*.

As described under “Actions taken at transaction failure” on page 88, the program error program (PEP) gains control after all program-level ABEND exit code has executed and after dynamic transaction backout has been performed. The PEP can be:

- The CICS-supplied PEP
- Your own PEP created by modifying the CICS-supplied version

---

### The CICS-supplied PEP

The default DFHPEP is in CICSTS13.CICS.SDFHLOAD, and is defined in the CICS DFHMISC group in the CSD. DFHMISC is included in the DFHLIST group list, which you should specify on your GRPLIST system initialization parameter.

The CICS-supplied PEP performs no processing, and is effectively a no-op. Its only effect, when CICS links to it, is to avoid the DFHAC2259 message that would otherwise be issued.

---

### Your own PEP

During the early phases of operation with CICS, the master terminal commands can put abending transactions into disabled status while the cause of the abend is being investigated and corrected.

Where a program needs to handle this process, or where associated programs or transactions should also be disabled, you may decide to incorporate these actions in your own PEP. This will depend on the importance of the applications being served.

The program error program is a command-level program that can be written in any of the languages that CICS supports. The CICS abnormal condition program passes to the PEP a communications area (COMMAREA) containing information about the abend. You can add code to take appropriate actions to suit your requirements.

Functions you might consider including in a program error program include:

- Disabling a particular transaction identifier (to prevent other users using it) pending diagnostic and corrective actions. This avoids the need to use CEMT commands and the risk of several more abends in quick succession.
- Disabling other transactions or programs that depend on the satisfactory operation of a particular program.
- Keeping a count of errors by facility type (transaction or file).
- Abending CICS after a transaction abend. Conditions for this might be:
  - If the abended transaction was working with a critical file
  - If the abended transaction was critical to system operation
  - If the abend was such that continued use of the application would be pointless, or could endanger data integrity

- If the error count for a particular facility type (transaction or file) reached a predetermined level.
- Disabling the facility, which would keep the system running longer than if you cause CICS to abend.

If a task terminates abnormally (perhaps because of a program check or an ABEND command), code in a program-level exit or the PEP can flag the appropriate transaction code entry in the installed transaction definition as disabled. CICS will reject any further attempt by terminals or programs to use that transaction code until it is enabled again. Consequently, the effect of program checks can be minimized, so that every use of the offending transaction code does not result in a program check. Only the first program check is processed. If the PEP indicates that the installed transaction definition is to be disabled, CICS will not accept subsequent uses of that transaction code.

When you have corrected the error, you can re-enable the relevant installed transaction definition to allow terminals to use it. You can also disable transaction identifiers when transactions are not to be accepted for application-dependent reasons, and can enable them again later. The *CICS Supplied Transactions* manual tells you more about the master terminal operator functions.

If logic within DFHPEP determines that it is unsafe to continue CICS execution, you can force a CICS abend by issuing an operating system ABEND macro. If DFHPEP abends (transaction abend), CICS produces message DFHAC2263.

---

## Omitting the PEP

The CICS-supplied PEP is provided in the CICSTS13.CICS.SDFHLOAD library. The CICS abnormal condition program, however, will link to it only if a program resource definition for DFHPEP is installed. If CICS cannot link to DFHPEP (for this or any other reason), it sends a DFHAC2259 message to CSMT.

---

## Chapter 15. Resolving retained locks on recoverable resources

This chapter describes how you can locate and resolve retained locks that are preventing access to resources, either by CICS transactions or by batch jobs. Although the main emphasis in this chapter is on how you can switch from RLS to non-RLS access mode in preparation for batch operations involving the use of RLS-accessed data sets, it is also of interest for CICS online operation. It covers the following topics:

- “Quiescing RLS data sets”
- “Switching from RLS to non-RLS access mode” on page 162
- “Coupling facility data table retained locks” on page 171

---

### Quiescing RLS data sets

Data sets opened by CICS in RLS mode can also be accessed by batch programs, provided the batch programs open them in RLS mode for read-only processing. Batch programs cannot update recoverable data sets in RLS mode, because SMSVSAM prevents it. Thus, to update a recoverable data set from a batch program, first ensure that the data set is closed to all CICS regions. This allows the batch program to open the data set in non-RLS mode for update. (See “Switching from RLS to non-RLS access mode” on page 162.) To enable batch programs to access data sets opened in RLS mode, CICS supports the VSAM RLS data set **quiesce** and **unquiesce** functions.

The quiesce function enables you, with a single command, to close in an orderly manner throughout the sysplex any data sets that are open in RLS mode, and prevent the data sets being opened in RLS mode while they are in the quiesced state. This function is required in the data sharing environment because many CICS regions can have the same data set open for update at the same time. You can use the quiesce function to take a data set offline throughout the sysplex when:

- You want to switch between RLS and non-RLS VSAM access modes.
- You want to prevent data set access during forward recovery.

CICS supports the VSAM RLS quiesce interface by providing an RLS **quiesce exit** program that is driven for the quiesce and unquiesce functions. CICS regions initiating quiesce and unquiesce requests propagate these to other CICS regions, through the SMSVSAM control ACB and the CICS RLS quiesce exit program.

Other products such as DFSMSdss and CICSVR also communicate with CICS through their SMSVSAM control ACBs and the RLS quiesce exit.

### The RLS quiesce and unquiesce functions

The RLS quiesce and unquiesce functions are initiated by a CICS command in one region, and propagated by the VSAM RLS quiesce interface to other CICS regions in the sysplex.

When these functions are complete, the ICF catalog shows the quiesce state of the target data set. The state of the quiesce flag in the ICF catalog controls whether a data set can be opened in RLS mode:

- When a quiesce operation has been completed throughout the sysplex, SMSVSAM sets the quiesced flag to prevent applications (either CICS or batch) from opening the data set in RLS mode.

You can open a quiesced data set in non-RLS mode only.

- When an unquiesce operation has been completed, SMSVSAM clears the quiesced flag to permit the data set to be opened in RLS mode.

You can open an unquiesced data set in either RLS or non-RLS mode, the mode for the entire sysplex being determined by the first ACB opened.

Normally, a data set cannot be opened for update in non-RLS access mode if SMSVSAM is holding retained locks against the data set. Thus, to enable a non-RLS batch program to update a recoverable data set that CICS regions have open in RLS mode, take the following steps:

1. Resolve shunted UOWs that are holding retained locks
2. Quiesce the data set
3. Run the batch update job
4. Unquiesce the data set

CICS transactions that try to access a quiesced data in RLS-mode fail with a NOTOPEN condition. Non-RLS accesses are permitted subject to the data set's VSAM SHAREOPTIONS.

For more information, see "Switching from RLS to non-RLS access mode" on page 162.

## The CICS RLS quiesce support

To support the quiesce and unquiesce functions provided by the VSAM RLS quiesce interface, CICS provides a VSAM RLS quiesce exit program. The following general information gives an overview of the CICS support for the quiesce and unquiesce functions, and of the CICS RLS quiesce exit program:

### Enabling the quiesce exit

CICS passes the address of its RLS quiesce exit program when it registers with the SMSVSAM control ACB during CICS initialization. This ensures that the CICS-supplied RLS quiesce exit program is enabled for use from the start of CICS until CICS shutdown.

CICS can pass the address of a private copy of the exit program if it is loaded in the CICS address space, or the address of a shared copy if its RLS quiesce exit program is LPA-resident. Note that the RLS quiesce exit program is supplied and enabled by CICS, and is not one that requires any action from you.

### Communicating requests

Communication between CICS and SMSVSAM takes place either directly through the SMSVSAM control ACB or through the quiesce exit.

For example, a CICS region passes quiesce and unquiesce requests over the VSAM control ACB interface using the VSAM IDAQUIES macro. A CICS region receives notification of quiesce and unquiesce requests in which it is required to participate through the RLS quiesce exit (see Figure 16 on page 159).

### Starting the CICS quiesce long-running tasks

There are 2 new CICS-supplied transactions, CFQS and CFQR, which are started during CICS initialization as long-running tasks. These are the "send" and "receive" transactions for handling quiesce and unquiesce requests.

### Scheduling quiesce and unquiesce processing

When a CICS region receives notification of a quiesce or unquiesce



request, the CICS RLS quiesce exit program schedules a CICS region task (CFQR) to perform asynchronously any work associated with the quiesce or unquiesce function.

### Issuing a quiesce request

This is initiated in a CICS region (by CFQS) in response to a CEMT, or EXEC CICS, SET DSNAME(...) command to quiesce the specified data set. SMSVSAM propagates the request across the sysplex to all CICS regions that have open RLS ACBs by invoking each CICS region's RLS quiesce exit program, which uses CFQR to schedule any necessary work. All regions receiving the request are required to close and all files open against the specified data set, and set them to the UNENABLED state.

For a **normal** quiesce, UOWs accessing the data set are allowed to complete normally (or be shunted), whereupon all files open against the specified data set are closed and set to the UNENABLED state.

For an **immediate** quiesce, UOWs accessing the data set are force-purged and all files open against the specified data set are closed and set UNENABLED.

See the description of the QUIESCESTATE option on the CEMT, or EXEC CICS, SET DSNAME command for information about the effect of a quiesce request on in-flight tasks.

When SMSVSAM receives replies (see "Completion notification") from all the CICS regions to which the quiesce request was sent, it sets the ICF catalog quiesced indicator. This prevents any RLS opens against the data set until the data set is unquiesced.

**Note:** If enabled, the CICS XFCVSDS exit is invoked for this function, with the UEPVSACT parameter set to a value of UEQUIES.

If enabled, the CICS XFCQUIS exit is also invoked for this function, with the UEPQSTAT parameter set to a value of UEQSD or UEIMQSD, for a normal or an immediate quiesce respectively.

### Issuing an unquiesce request

This is initiated in a CICS region (by CFQS) in response to a CEMT, or EXEC CICS, SET DSNAME(...) command to unquiesce the specified data set. SMSVSAM updates the ICF catalog to indicate that the data set is unquiesced, and then propagates the request, through the CICS RLS quiesce exit program, to **all** CICS regions that are registered with an SMSVSAM control ACB. As soon as they receive the notification, CICS regions re-enable the data set, making it eligible to be reopened in RLS mode, and re-try any backout-failed shunted UOWs for that data set. (See also "Completion notification".)

**Note:** If enabled, the CICS XFCVSDS exit is invoked for this function, with the UEPVSACT parameter set to a value of UEUNQUIS.

If enabled, the CICS XFCQUIS exit is also invoked for this function, with the UEPQSTAT parameter set to a value of UEUNQSD.

### Notifying completion

The required completion notification for the quiesce function and the unquiesce function is as follows:

**Quiesce:** SMSVSAM does not change the ICF catalog state until it receives notification from all CICS regions with open RLS ACBs that

they have completed their quiesce processing. For this purpose, CICS issues a **quiesce completed** code (using an IDAQUIES macro QUICMP function) when it has finished its required processing for a data set quiesce operation.

SMSVSAM then issues a normal response to the initiating CICS region to signify that the operation is complete.

**Unquiesce:** SMSVSAM changes the ICF catalog state immediately on receipt of an unquiesce request from a CICS region. SMSVSAM then notifies all CICS regions that are registered with an SMSVSAM control ACB, through the CICS RLS quiesce exit program, that the data set is unquiesced. In this case, the CICS RLS quiesce exit issues a quiesce completed code to SMSVSAM immediately, with any associated unquiesce processing taking place asynchronously.

SMSVSAM then issues a normal response to the initiating CICS region to signify that the operation is complete.

#### **Canceling a quiesce request**

If SMSVSAM receives an unquiesce request before an in-progress quiesce request completes, it has the effect of canceling the quiesce request.

#### **Timing out a quiesce**

If the CICS region initiating a quiesce request does not receive a normal response from SMSVSAM within the specified quiesce time-out limit, CICS issues an unquiesce request to cancel the quiesce operation. You specify the quiesce time-out limit on the QUIESTIM system initialization parameter, for which the default value is 240 seconds.

#### **Illustration of the quiesce flow across two CICS regions**

Figure 16 on page 159 illustrates the operation of the CICS RLS quiesce operation. The notes that follow explain the numbered points.

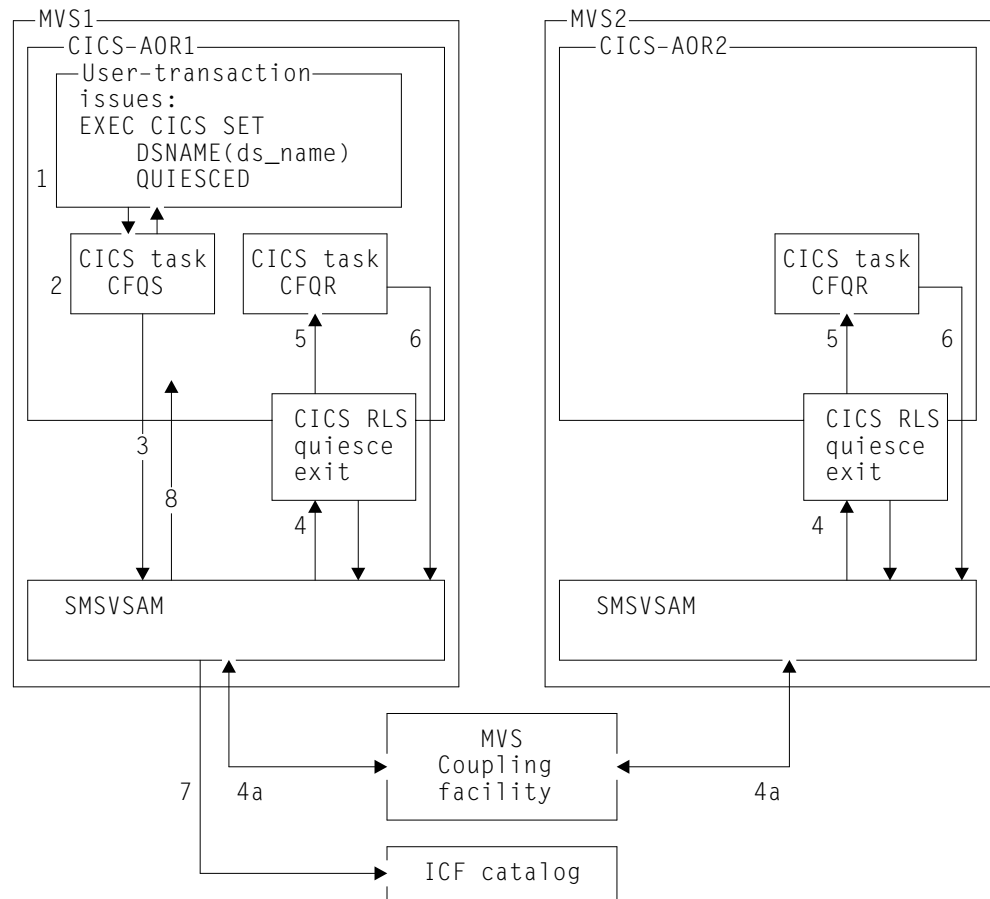

Figure 16. The CICS RLS quiesce operation with the CICS quiesce exit program

**Notes:**

1. A suitably-authorized user application program issues an EXEC CICS SET DSNAME(...) QUIESCED command (or a terminal operator issues the equivalent CEMT command).  
If the command specifies the BUSY(NOWAIT) option, all phases of the quiesce operation are asynchronous, and the user application program continues processing.  
If the command specifies BUSY(WAIT), control is not returned to the user application program until SMSVSAM replies to CFQS that the quiesce function has completed (or failed).
2. CICS file control invokes CFQS to send the quiesce request to SMSVSAM.
3. The long-running CICS CFQS task passes the quiesce request to SMSVSAM across the control ACB interface using the IDAQUIES macro QUICLOSE function.
4. SMSVSAM drives the CICS RLS quiesce exit program of each CICS region that has an open RLS ACB for the specified data set.

**Note:** This also applies to the CICS region in which a quiesce request is initiated if it has open RLS ACBs for the data set. Thus an initiator can also be a recipient of a quiesce request.

(4a) SMSVSAM uses the coupling facility to propagate the request to the other SMSVSAM servers in the sysplex.

5. The CICS RLS quiesce exit program schedules a CICS region task (CFQR) to perform asynchronously the required quiesce actions in that CICS region.
6. When CICS has closed all open RLS ACBs for the data set, CICS issues the “quiesce completed” notification (the IDAQUIES macro QUICMP function) direct to SMSVSAM through the control ACB interface.
7. When all CICS regions have replied with the IDAQUIES macro QUICMP function, SMSVSAM sets the quiesced flag in the ICF catalog. This prevents any files being opened in RLS mode for the data set, but allows non-RLS open requests that are initiated, either implicitly or explicitly, by user transactions.
8. SMSVSAM returns to the CICS region that initiated the quiesce request. If the BUSY(WAIT) option was specified on the request, CFQS resumes the waiting application program.

The flow of an unquiesce request is virtually the same as that illustrated in Figure 16 on page 159, with the following differences in operation:

- As soon as SMSVSAM receives the unquiesce request from the initiating CICS region, it immediately sets the quiesce flag in the ICF catalog to the unquiesce state.
- SMSVSAM invokes the RLS quiesce exit program of each CICS region registered with a control ACB to notify it of the change in the quiesce state.
- The CICS RLS quiesce exit program returns a “quiesce completed” code to SMSVSAM immediately, and then passes the request to CFQR for processing.

### Other quiesce interface functions

In addition to quiesce and unquiesce, there are some other data-set-related functions using the RLS quiesce interface that are not connected with quiescing or unquiescing activity on a data set. These are functions initiated by DFSMSdss, CICSVR, or VSAM RLS, and may require some processing in those CICS regions that are registered with SMSVSAM. These functions do not cause any change in the ICF catalog quiesced flag.

The other functions provided on the RLS quiesce interface for data-set-related activities are as follows:

#### Non-BWO data set backup start

A quiesce interface function initiated by DFSMSdss in readiness for non-BWO backup processing for a data set that is open in RLS mode. This function prevents CICS file control issuing RLS update requests against a sphere so that the VSAM sphere can be backed up.

SMSVSAM invokes the CICS RLS quiesce exit program in each region that has an open RLS ACB for the data set.

If any in-flight UOWs are using the data set when a QUICOPY notification is received, CICS allows them to complete (or be shunted). CICS then flags its data set name block (DSNB) for the data set to disable further updates. Any UOW that attempts to update the data set thereafter is abended with an AFCK abend, and SMSVSAM prevents any new file opens for update.

**Note:** If enabled, the CICS XFCVSDS exit is invoked for this function, with the UEPVSACT parameter set to a value of UENBWST.

With the new RLS quiesce mechanism, you do not have to close a data set to take a non-BWO backup. However, because this causes new transactions to be abended, you may prefer to quiesce your data sets before taking a non-BWO backup.

**Non-BWO data set backup end**

A quiesce interface function initiated by DFSMSdss at the end of non-BWO backup processing (or to cancel a non-BWO backup request). This function enables CICS file control to permit RLS update requests against the data set now that backup processing is complete.

SMSVSAM invokes the CICS RLS quiesce exit program in each region that is registered with an SMSVSAM control ACB.

In addition to permitting updates, CICS writes tie-up log records to the forward recovery log and the log of logs, and retries any shunted UOWs for the data set.

**Note:** If enabled, the CICS XFCVSDS exit is invoked for this function, with the UEPVSACT parameter set to a value of UENBWCMP.

**BWO backup start**

A quiesce interface function initiated by DFSMSdss in readiness for BWO backup processing for a data set that is open in RLS mode. This function enables CICS to ensure the data set is in a suitable state for a BWO backup to be taken.

SMSVSAM invokes the CICS RLS quiesce exit program in each region that has an open RLS ACB for the data set.

In response to this form of request, CICS writes tie-up records to the forward recovery log and log of logs, and waits for any in-flight UOWs to complete (or be shunted). New units of work can then update the data set.

**Note:** If enabled, the CICS XFCVSDS exit is invoked for this function, with the UEPVSACT parameter set to a value of UEBWOST.

**BWO backup end**

A quiesce interface function initiated by DFSMSdss at the end of BWO backup processing (or to cancel a BWO backup request). It notifies CICS that a BWO backup of a data set is complete.

SMSVSAM invokes the CICS RLS quiesce exit program in each region that is registered with an SMSVSAM control ACB.

CICS does not perform any processing for this form of request.

**Note:** If enabled, the CICS XFCVSDS exit is invoked for this function, with the UEPVSACT parameter set to a value of UEBWOCMP.

**Forward recovery complete**

A quiesce interface function initiated by VSAM in response to a request from CICSVR. VSAM takes action associated with a sphere having completed forward recovery, which includes notifying CICS.

SMSVSAM invokes the CICS RLS quiesce exit program in each region that is registered with an SMSVSAM control ACB.

CICS retries any backout-failed shunted UOWs for the data set.

**Lost locks recovery complete**

A quiesce interface function initiated by VSAM. VSAM takes action associated with a sphere having completed lost locks recovery on all CICS regions that were sharing the data set.

SMSVSAM invokes the CICS RLS quiesce exit program in each region that is registered with an SMSVSAM control ACB.

Until lost locks recovery is complete, CICS disallows any new requests to the data set (that is, only requests issued as part of the recovery processing are possible). When lost locks recovery is complete, CICS allows all requests to the data set.

#### **Quiesce coupling facility cache available**

A quiesce interface function initiated by VSAM. VSAM takes action associated with an MVS coupling facility cache structure being restored.

SMSVSAM invokes the CICS RLS quiesce exit program in each region that is registered with an SMSVSAM control ACB.

CICS retries any backout-failed shunted UOWs for all data sets.

---

## **Switching from RLS to non-RLS access mode**

The main reason why you might need to switch a data set from RLS access mode to non-RLS access mode is to run a batch update program that cannot be changed to run as a CICS transaction.

Non-RLS access mode is a generic term embracing NSR, LSR, and GSR access modes. It is likely that your existing batch programs open VSAM data sets in NSR access mode, although it is also possible for batch programs to use LSR or GSR.

As a general rule, you are recommended not to switch between RLS and non-RLS within CICS. After a data set is accessed in RLS mode by CICS, it should **always** be accessed in RLS mode by CICS.

### Exception for read-only operations

There is an exception to the general rule about not switching between RLS and non-RLS within CICS. You can switch to non-RLS access on a data set that is normally opened in RLS mode provided access is *restricted to read-only operations*. You might want to do this, for example, to allow continued access for read-only transactions while the data set is being updated by a batch job. CICS and VSAM permit quiesced data sets to be opened in non-RLS mode, but you must ensure that CICS transactions do not update a data set that is being updated concurrently by a batch program.

The recommended procedure for providing CICS read access to a recoverable data set while it is being updated by a batch job is:

- Resolve retained locks.
- Quiesce the data sets.
- Redefine the files as non-RLS and read-only mode in all relevant CICS regions. You can do this using the CEMT, or EXEC CICS, SET FILE command.

**Note:** If your file definitions specify an LSR pool id that is built dynamically by CICS, consider using the RLSTOLSR system initialization parameter.

- Open the files non-RLS read-only mode in CICS.
- Concurrently, run batch non-RLS.
- When batch work is finished:
  - Close the read-only non-RLS mode files in CICS.
  - Re-define the files as RLS mode and with update operations. You can do this using the CEMT, or EXEC CICS, SET FILE command.
  - Unquiesce the data sets.
  - Open the files in CICS, if not using open on first reference.
  - Resume normal running.

You should also take data set copies for recovery purposes before and after a batch run as you would normally, regardless of whether you are switching from RLS to non-RLS access mode.

## What can prevent a switch to non-RLS access mode?

You cannot open a data set in non-RLS access mode if there are any ACBs open against it in RLS access mode. To switch from RLS to non-RLS access mode, first ensure that all files that are open against the data set are closed. You can use the quiesce function for this purpose. As discussed in “Quiescing RLS data sets” on page 155, the VSAM RLS quiesce mechanism causes each CICS region in the sysplex to close any RLS ACBs that are open against a specified data set. Once closed under the quiesce mechanism, data sets can only be opened in non-RLS mode. To re-enable quiesced data sets to be reopened in RLS mode, all open non-RLS ACBs must be closed and then the data sets must be unquiesced.

The quiesce mechanism cannot inform batch programs that have the data set open in RLS access mode about the quiesce request. If you have such programs, use the access method services SHCDS LIST subcommand to check whether any

non-CICS jobs have ACBs open in RLS mode against the data set. For information about the SHCDS LIST subcommand, see *DFSMS/MVS Access Method Services for ICF*.

Quiescing a data set sets the quiesce flag in the ICF catalog so that the data set can be opened in non-RLS mode only. This way of making data sets available for batch programs without having to shut down all the CICS regions is particularly suited to the Parallel Sysplex environment. Note that if you do shut CICS regions down, it is best to avoid immediate shutdowns when you have not specified a shutdown transaction, because this could cause large numbers of locks to be retained. A shutdown transaction can enable you to perform a quick but controlled shutdown.

Even if a data set has been quiesced, you still cannot open it for update in non-RLS access mode if SMSVSAM is holding retained locks against the data set. This is because the locks are needed to preserve data integrity: they protect changes that are waiting to be either committed or backed out. It is possible to open a data set for input (read-only) in non-RLS mode even when there are retained locks, because a reader cannot corrupt the data integrity that such locks are preserving. Note that, when you are opening a data set in a batch job, there cannot be any active locks because, when an ACB is closed, any active locks are converted automatically into retained locks.

The remainder of this topic on switching to non-RLS access mode describes the options that are available if you need to switch to non-RLS mode and are prevented from doing so by retained locks.

## Resolving retained locks before opening data sets in non-RLS mode

VSAM sets an 'RLS-in-use' indicator in the ICF catalog cluster entry when a data set is successfully opened in RLS mode. This indicator remains set, even when a data set opened in RLS mode is closed by all CICS regions, to show that the data set was last accessed in RLS mode. The indicator is cleared only when a data set is successfully opened in non-RLS mode. However, if SMSVSAM also holds retained locks against a data set, a non-RLS open fails and the RLS-in-use indicator remains set. In this event, try to resolve retained locks before attempting to use a data set in non-RLS mode for batch processing.

The procedure described here lists the steps you can take to switch from RLS to non-RLS mode in readiness for batch processing. The procedure is for a single data set, and should be repeated for each data set that is to be accessed from batch in non-RLS mode. CICS provides a suite of sample programs designed to help you to automate most of this procedure, which you can tailor to suit your own requirements (see "The batch-enabling sample programs" on page 168):

1. Prevent further use of the applications that access the data set, so that no more locks can be created. One way to do this is to disable transactions that use the data set; but you may have your own technique for quiescing applications.
2. Check for any retained locks by using the INQUIRE DSNAME command on each CICS region that has been accessing the data set (see "INQUIRE DSNAME" on page 165). Generally there should not be any, and you can continue by quiescing the data set and running your batch program(s).
3. If there are retained locks, the RLS-in-use indicator prevents the data set being opened in non-RLS mode. In this case, use the CAUSE and REASON options on the INQUIRE UOWDSNFAIL command to find out what has caused them. You can then take steps to resolve the retained locks, preserving data integrity



or not, using the SET DSNAME command. Do this before you quiesce the data set, because in some instances the locks cannot be resolved while the data set is quiesced.

4. Use the access method services SHCDS LIST subcommand to check whether there are any locks held by CICS regions on which you have not issued INQUIRE DSNAME (for example, because the system is not currently running). (See *DFSMS/MVS Access Method Services for ICF*.)
5. If, for some reason, there are retained locks that you cannot resolve, you can choose to use the SHCDS PERMITNONRLSUPDATE subcommand that allows the batch program to override the retained locks and force the open for the data set.
6. When you are satisfied that there are no more retained locks, quiesce the data set and run your batch program(s).

### **Investigating which retained locks are held and why**

CICS does not know exactly which locks are held by VSAM RLS. However, it does know about the uncommitted changes that are protected by such locks, and why the changes have not yet been committed successfully. CICS uses this information to help you resolve any retained locks that are preventing you from switching to non-RLS access mode.

### **INQUIRE DSNAME**

You can use the INQUIRE DSNAME command to find out whether the data set has any retained locks or if it is waiting for lost locks recovery by any CICS region (see “A special case: lost locks” on page 170).

INQUIRE DSNAME(...) RETLOCKS returns a value of RETAINED if the CICS region has any shunted UOWs that have made uncommitted changes to the named data set, and NORETAINED if it does not. (RETLOCKS may return the value NORETAINED whilst changes are being made or units of work are being retried.) You can use this command to find out whether or not there are any retained locks that you need to resolve before running batch.

The INQUIRE DSNAME(...) LOSTLOCKS command returns:

- RECOVERLOCKS if the CICS region has lost locks recovery work to complete for the named data set. In this case, the RETLOCKS option returns RETAINED (except briefly while recovery work is being carried out, when RETLOCKS could be NORETAINED).
- REMLOSTLOCKS if the CICS region in which the command is issued does not have any lost locks recovery work to complete, but one or more other CICS regions in the sysplex do have. In this case the data set is still in a lost locks condition (but the RETLOCKS option in this CICS returns NORETAINED).
- NOLOSTLOCKS if the data set is not in a lost locks condition. This is the normal case. RETLOCKS could be either RETAINED or NORETAINED.

### **INQUIRE UOWDSNFAIL**

CEMT INQUIRE UOWDSNFAIL DSN(*datasetname*) can return information about shunted UOWs that have failed to commit changes to the named data set. The information includes the resource that caused the failure and, where there can be more than one reason, the reason for the failure. The EXEC CICS INQUIRE UOWDSNFAIL command provides a browse interface, allowing an application program to browse through all the shunted UOWs for a data set or a group of data sets.

There are three main categories of failure:

- **In-doubt failure**, where a communication failure has occurred while a commit participant is in the in-doubt state. The cause of an in-doubt failure is returned on an INQUIRE UOWDSNFAIL command as CONNECTION. In-doubt failures are retried automatically when the connection is resynchronized.
- **Backout failure**, where a unit of work that is backing out changes fails during the backout of:
  - One or more data sets (which returns a CAUSE of DATASET)
  - A number of data sets bound to a failing cache (which returns a CAUSE of CACHE)
  - All the RLS data sets updated in the unit of work when the SMSVSAM server fails (which returns a CAUSE of RLSSERVER with REASON RLSGONE).

Backout failures can be retried after the cause of the failure has been corrected. In some cases, the retry occurs automatically.

- **Commit failure**, where a unit of work has failed during the commit action. The commit action may be either to commit the changes made by a completed unit of work, or to commit the successful backout of a unit of work. This failure is caused by a failure of the SMSVSAM server, which is returned as RLSSERVER on the CAUSE option and COMMITFAIL or RRCOMMITFAIL on the REASON option of the INQUIRE UOWDSNFAIL command. (RLSSERVER is also returned as the WAITCAUSE on an INQUIRE UOW command.)

Commit failures can be retried after the cause of the failure has been corrected. The retry usually occurs automatically.

Note that INQUIRE UOWDSNFAIL displays information about UOWs that are currently failed with respect to one or more data sets. The command does not display information for a unit of work that was in backout-failed or commit-failed state and is being retried, or for a unit of work that was in-doubt and is being completed. The retry, or the completion of the in-doubt unit of work, could fail, in which case a subsequent INQUIRE UOWDSNFAIL displays the relevant information.

### SHCDS LIST subcommands

A CICS region that has been accessing a data set may not be running at the time you want to inquire on unit of work failures in readiness for a batch job. Instead of bringing up such a CICS region just to issue INQUIRE UOWDSNFAIL commands, you can use the SHCDS LISTDS, LISTSUBSYS, or LISTSUBSYS command. These commands enable you to find out which CICS regions (if any) hold retained locks, and to obtain other information about the status of your data sets with regard to each CICS region. You then know which regions you need to start in order to resolve the locks. These commands are described in *DFSMS/MVS Access Method Services for ICF*.

The SHCDS LIST commands could also be useful in the unlikely event of a mismatch between the information that CICS holds about uncommitted changes, and the information that the VSAM RLS share control data set holds about retained locks.

## Resolving retained locks and preserving data integrity

Unless prevented by time constraints, you are recommended to resolve retained locks by using the INQUIRE UOWDSNFAIL command and retrying shunted UOWs. (See the INQUIRE UOWDSNFAIL command in the *CICS System Programming Reference* for information about the actions that should be taken to allow each shunted unit of work to complete.) For example, for a unit of work that has been

shunted with a CAUSE of DATASET and a REASON of DELEXITERROR, enable a suitable global user exit program at the XFCLDEL (logical delete) global user exit point and then issue a SET DSNAME ACTION(RETRY) command to retry the backout and drive the global user exit. For a unit of work that has been shunted with a CAUSE of CONNECTION, use the SYSID and NETNAME returned by INQUIRE UOWDSNFAIL to find out what has caused the in-doubt condition and correct the failure, after which automatic resynchronization should allow the unit of work to complete, either by being backed out or by committing the changes.

## Choosing data availability over data integrity

There may be times when you cannot resolve all the retained locks correctly, either because you cannot easily remedy the situations preventing the changes from being committed, or because of insufficient time. In such a situation, you can still release the locks, using the SET DSNAME command, although in most cases you will lose some data integrity.

SET DSNAME UOWACTION(COMMIT, BACKOUT, or FORCE) operates on shunted in-doubt UOWs. It causes any in-doubt UOWs that have made changes to the data set (these will appear on an INQUIRE UOWDSNFAIL command with a CAUSE of CONNECTION) to complete in one of the following ways:

- By backing out or committing the changes according to the COMMIT or BACKOUT option on UOWACTION.
- By backing out or committing the changes according to the in-doubt ACTION attribute specified on the transaction resource definition (when you specify the FORCE option on UOWACTION).

When the unit of work completes, the locks are released. If the action chosen is backout (either by explicitly specifying BACKOUT or as a result of the FORCE option), diagnostic information is written to the CSFL transient data queue. Therefore BACKOUT is normally the best option, because you can use the diagnostic information to correct the data if backout was the wrong decision. Diagnostic messages DFHFC3004 and DFHFC3010 are issued for each backed-out update. Choose COMMIT for the UOWs only if you know this is the decision that would be communicated by the coordinator when resynchronization takes place following reconnection.

**Note:** The CEMT or EXEC CICS SET UOW command operates on a single unit of work and therefore gives better control of each unit of work. The SET DSN(...) UOWACTION operates on *all* in-doubt UOWs that have updated the specified data set. Because these may have also updated resources other than those in the specified data set, you may prefer to use the SET UOW command and consider the effect of your actions separately for each individual unit of work. However, if you are confident that the ACTION option specified on your transaction definitions indicates the best direction for each individual transaction, you can use SET DSNAME FORCE.

The SET DSNAME(*datasetname*) ACTION(RESETLOCKS) command operates on UOWs that are shunted for reasons other than in-doubt failure. CICS resets the locks for the named data set; that is, it:

- Releases any locks held against this data set by shunted UOWs (other than in-doubt failures)
- Discards the log records that represent the uncommitted changes made to the data set by those UOWs

- Writes diagnostic information to the CSFL transient data queue for each discarded log record.

Diagnostic messages DFHFC3003 and DFHFC3010 are issued for each log record.

If a data set has both indoubt-failed and other (backout- or commit-) failed UOWs, deal with the indoubt UOWs first, using SET DSNAME UOWACTION, because this might result in other failures which can then be cleared by the SET DSNAME RESETLOCKS command.

## The batch-enabling sample programs

CICS provides a suite of sample programs to help you automate batch preparation procedures. The three coordinating programs, which use CICS distributed program link (DPL) commands to run programs on a set of nominated CICS regions, are:

### DFH0BAT1

This sample program disables, through the programs to which it links, a set of nominated transactions.

### DFH0BAT2

This sample program identifies, through the programs to which it links, the retained lock information for nominated data sets:

- For each data set, it issues a SET DSNAME RETRY command to try to resolve any retained locks that are due to transient failures, or failures that have been corrected.
- After a timed delay to allow retries to run, it issues, for each data set, an INQUIRE DSNAME RETLOCKS command to determine whether there are any retained locks. If there are, it issues an INQUIRE UOWDSNFAIL command to obtain information about any remaining shunted UOWs that have made uncommitted changes to the data set. It displays the information returned by the command, together with recommended procedures for resolving the locks.

### DFH0BAT3

Through the programs to which it links, this sample program forces locks for nominated data sets:

- For each data set that has retained locks (determined by issuing INQ DSNAME RETLOCKS), it forces backout for the shunted in-doubt UOWs.
- After a timed delay to allow the forced backouts to run, it resets the locks for any commit-failed or backout-failed UOWs.

The DFH0BAT3 sample program is also useful for resolving pending backouts after a failure to forward recover a data set. See “Procedure for failed RLS mode forward recovery operation” on page 189.

For more information about these batch-enabling sample programs see the *CICS Operations and Utilities Guide*, which describes how to install the programs and how to prepare the required input for them. See also the comments contained in the source code supplied in the CICSTS13.CICS.SDFHSAMP library.

## CEMT command examples

The following is a series of CEMT command examples showing how you can use CEMT to resolve unit of work failures in preparation for batch processing.

1. A CEMT INQUIRE UOWDSNFAIL command for a specified data set shows in the following display that there are two failed UOWs:

```

CEMT INQUIRE UOWDSNFAIL DSN('RLS.ACCOUNTS.ESDS.DBASE1')
STATUS: RESULTS
Dsn(RLS.ACCOUNTS.ESDS.DBASE1          ) Dat Del
Uow(AA6DB080C40CEE01)                Rls
Dsn(RLS.ACCOUNTS.ESDS.DBASE1          ) Dat Ind
Uow(AA6DB08AC66B4000)                Rls

```

The display shows a REASON code of DELEXITERROR (Del) for one unit of work, and INDEXRECFULL (Ind) for the other.

2. A CEMT SET DSNAME(...) RETRY command, after fixing the delete exit error (caused because an XFCLDEL exit program was not enabled) invokes a retry of both UOWs with the following result:

```

SET DSNAME('RLS.ACCOUNTS.ESDS.DBASE1') RETRY
STATUS: RESULTS - OVERTYPE TO MODIFY
Dsn(RLS.ACCOUNTS.ESDS.DBASE1          ) Vsa      NORMAL
Fil(0001) Val Bas Rec Sta          Ava      Ret

```

3. Another CEMT INQ UOWDSNFAIL command shows that one of the two UOWs failed again. It is the unit of work with the INDEXRECFULL error, as follows:

```

INQUIRE UOWDSNFAIL
STATUS: RESULTS
Dsn(RLS.ACCOUNTS.ESDS.DBASE1          ) Dat Ind
Uow(AA6DB08AC66B4000) Dat Ind      Rls

```

This type of error can occur when adding a value to a non-unique alternate index while trying to back out a change to a record; after the original update was made, other UOWs have added values to the alternate index, filling all the available space. Such an error should be extremely rare. The solution is to define a larger alternate index record size for the data set.

4. However, the data set with the remaining failed unit of work is needed urgently for a batch run, so you may decide not to complete the unit of work now, and to resolve the problem later. In the meantime, to allow the batch job to start, you issue SET DSN('RLS.ACCOUNTS.ESDS.DBASE1') RESETLOCKS to release the retained locks associated with the unit of work.
5. To check that there are no retained locks left, you can issue another INQUIRE DSNAME command. The expanded display shows:

```

Dsname(RLS.ACCOUNTS.ESDS.DBASE1)
Accessmethod(Vsam)
Action(          )
Filecount(0001)
Validity(Valid)
Object(Base)
Recovstatus(Recoverable)
Backuptype(Static)
Frlog()
Availability( Available )
Lostlocks()
Retlocks(Noretained)
Quiescestate()
Uowaction(          )
Basedsname(RLS.ACCOUNTS.ESDS.DBASE1)
Fwdrecovlsn(RLS.ACCOUNTS.FWDRECOV.LOG)

```

6. Diagnostic messages have been written to the CSFL transient data queue about the locks that were reset.

```

DFHFC3003 01/04/95 12:08:03 CICSHDA1 Record not backed out because locks for a
backout-failed data set have been reset.
Diagnostic information follows in message DFHFC3010. The record was
updated by unit of work X'AA6DB08AC66B4000' for file ACCNT1 , base
data set RLS.ACCOUNTS.ESDS.DBASE1

```

```
DFHFC3010 01/04/95 12:08:03 CICSMDA1 Diagnostic information for unit of work
X'AA6DB08AC66B4000' and file ACCNT1 .
Update was a write-add made by transaction WKLY at terminal T583 under
task number 00027. Key length 4, data length 7, base ESDS RBA
X'00000DDF', record key X'00000DDF'
```

## A special case: lost locks

If a lost locks condition occurs (see “Lost locks recovery” on page 83), any affected data set remains in a lost locks state until all CICS regions have completed lost locks recovery for the data set.

Lost locks recovery is complete when all uncommitted changes, which were protected by the locks that were lost, have been committed. Therefore, after a lost locks condition occurs, you may need to follow the same procedures as those for preparing for batch jobs (described in “The batch-enabling sample programs” on page 168), to ensure that the data set is made available again as soon as possible. Preserving data integrity should be the priority, but you may decide to force in-doubt UOWs and to reset locks in order to make the data set available sooner.

## Overriding retained locks

There may be situations in which it is difficult or inconvenient to use CICS commands to remove all the retained locks held against a data set. For these situations, DFSMS access method services provides a SHCDS subcommand that allows you to run a non-RLS batch program despite the fact that there are retained locks.

### The PERMITNONRLSUPDATE subcommand

The SHCDS PERMITNONRLSUPDATE subcommand allows you to run a non-RLS batch job where it is not possible to resolve all the retained locks that are held against the data set. This subcommand overrides the DFSMS controls that prevent non-RLS opens-for-update when a data set still has retained locks. Use this option only as a last resort.

The effect of the PERMITNONRLSUPDATE command is canceled as soon as the data set is re-opened in RLS mode after the batch work is complete. Re-issue the command when you next want to override retained locks.

### The DENYNONRLSUPDATE subcommand

The SHCDS DENYNONRLSUPDATE subcommand allows you to reset the permit status of a data set to prevent non-RLS updates. This subcommand is provided for the situation where you issue the PERMITNONRLSUPDATE subcommand in error, and wish to turn the permit status off again without running any non-RLS work:

- Specify DENYNONRLSUPDATE if you do *not* run a non-RLS batch job after specifying PERMITNONRLSUPDATE. This is because CICS, when it next opens the data set in RLS mode, takes action assuming that the data set has been opened for update in non-RLS mode if the PERMITNONRLSUPDATE state is set.
- Do not use DENYNONRLSUPDATE if you run non-RLS work after specifying PERMITNONRLSUPDATE. The permit status is automatically reset by the CICS regions that hold retained locks when they open the data set in RLS mode.

### Post-batch processing

After a non-RLS program has been permitted to override retained locks, the uncommitted changes that were protected by those locks must not normally be allowed to back out. This is because the non-RLS program may have changed the protected records. To ensure this, all CICS regions that held retained locks are

notified by VSAM that a non-RLS update may have occurred because of the PERMITNONRLSUPDATE override. The CICS regions receive this notification when they open the affected data set in RLS mode.

CICS stores information about any uncommitted changes that are currently outstanding, and then informs VSAM RLS that the PERMITNONRLSUPDATE state can be cleared with respect to this CICS region. CICS uses the stored information to prevent automatic backouts during retries, because this could cause unpredictable results if backouts were applied to data modified by a batch program. Whenever a change made by one of these UOWs is about to be backed out, CICS detects its special status and invokes the XFCBOVER global user exit program. This allows you to determine what action to take over the uncommitted changes. The default action for these UOWs is not to retry the backouts.

Diagnostic information is provided to help you to correct the data if necessary. Diagnostic messages DFHFC3001 and DFHFC3010 are issued for each affected update. CICS uses an internal form of the SET DSNAME RETRY command to drive any pending backout failures immediately. In the case of in-doubt failures, CICS has to wait for the indoubt to be resolved following resynchronization before knowing whether the changes were to have been backed out.

Note that neither CICS nor VSAM knows whether the non-RLS program did change any of the locked records, only that it had the potential to do so. With your knowledge of the batch application, you may know that the records, or certain of the records, could not have been changed by batch and could therefore be safely backed out. For example, the batch application might only ever add records to the data set. CICS provides a global user exit point, XFCBOVER, which allows you to request that records are backed out, and which you can also use to perform other actions. If you choose to back out an update, CICS issues diagnostic message DFHFC3002 instead of DFHFC3001.

The SHCDS LISTDS subcommand shows whether the non-RLS batch update PERMITNONRLSUPDATE state is currently set. It also shows the status of a PERMIT first-time switch, which is a switch that is cleared as soon as a data set for which non-RLS update has been allowed is next opened for RLS access. The non-RLS permitted state is used to inform each contributing CICS region that a non-RLS program has potentially overridden its retained locks. The first-time switch is used to ensure that a subsequent non-RLS open for update requires a new PERMITNONRLSUPDATE to be issued even if some permitted states have not yet been cleared.

---

## Coupling facility data table retained locks

Recoverable coupling facility data table records can be the subject of retained locks, like any other recoverable CICS resource that is updated in a unit of work that subsequently fails.

A recoverable CFDT supports in-doubt and backout failures. If a unit of work fails when backing out an update to a CFDT, or if it fails in-doubt during syncpoint processing, the locks are converted to retained locks and the unit of work is shunted. If a CFDT record is locked by a retained lock, an attempt to modify the record fails with the LOCKED condition. This can be returned on the following API file control requests issued against CFDT records:

- DELETE with RIDFLD
- READ with UPDATE

- READNEXT with UPDATE
- READPREV with UPDATE
- WRITE

To resolve retained locks against CFDT records, use the CEMT INQUIRE UOWLINK command to find the unresolved units of work associated with links to the coupling facility data table pool containing the table. When you have found the UOW links, take the appropriate action to resolve the link failure or force completion of the UOWs.

The owner of the failed UOW could be another CICS region in the sysplex, and the cause of the retained lock could be one of the following:

- The CICS region cannot resolve the UOW because its CFDT server has failed.
- The CICS region that owns the UOW has failed to connect to its CFDT server.
- The CICS region that owns the UOW cannot resynchronize with its CFDT server.
- An in-doubt failure caused by the loss of the CICS region that is coordinating a distributed UOW.
- An in-doubt failure caused by the loss of connectivity to the CICS region that is coordinating a distributed UOW.



---

## Chapter 16. Moving recoverable data sets that have retained locks

There may be times when you need to re-define a VSAM data set by creating a new data set and moving the data from the old data set to the new data set. For example, you might need to do this to make a data set larger. In this case, note that special action is needed in the case of data sets that are accessed in RLS mode by CICS regions.

Recoverable data sets may have retained locks associated with them. For data sets accessed in RLS mode, SMSVSAM associates locks with the physical location of the data set on disk. If you move the data set from one disk location to another, ensure that any retained locks are associated with the new data set location after it is moved. DFSMS access method services provide some SHCDS subcommands that enable you to preserve these locks when moving a data set.

---

### Procedure for moving a data set with retained locks

This section outlines some procedures to follow when moving a data set from one location on DASD to another.

There are two basic methods that you can use to move a VSAM data set:

1. Use the REPRO function of the access method services utility, then delete the original data set.
2. Use the EXPORT and IMPORT functions of access method services.

With either of these methods, you need to take extra steps to preserve any retained locks for data sets accessed in RLS mode.

### Using the REPRO method

If the recoverable data set you want to move has not been used in RLS mode, you can simply use access method services commands to:

1. Create a new data set
2. Copy (REPRO) the data from the old data set to the new
3. Delete the old data set
4. Rename the new data set back to the old

In the case of a non-RLS mode data set, retained locks are not a problem and no other special action is needed.

The following access method services examples assume that CICS.DATASET.A needs to be redefined and the data moved to a data set named CICS.DATASET.B, which is then renamed:

```
DEFINE CLUSTER (NAME(CICS.DATASET.B) ...  
REPRO INDATASET(CICS.DATASET.A) OUTDATASET(CICS.DATASET.B)  
DELETE CICS.DATASET.A  
ALTER CICS.DATASET.B NEWNAME(CICS.DATASET.A)
```

If the recoverable data set has associated RLS locks, these steps are not sufficient because:

- The REPRO command copies the data from CICS.DATASET.A to CICS.DATASET.B but leaves the locks associated with the original data set CICS.DATASET.A.
- The DELETE command deletes both the original data set and its associated locks.
- After you issue the ALTER command, the data set has been moved but the new data set does not have any associated locks, which have been lost when you deleted the original data set.

To enable you to move data and keep the locks associated with the data, access method services provide the following SHCDS subcommands. These are subcommands of the VSAM sharing control SHCDS command, and must always be preceded by the SHCDS keyword:

#### **SHCDS FRSETRR**

This command marks the data set as being under maintenance, by setting a flag in the data set's ICF catalog entry. (This flag is shown as 'Recovery Required' in a catalog listing (LISTCAT).)

#### **SHCDS FRUNBIND**

This command unbinds any retained locks held against the data set. The locks are no longer associated with any specific disk location or data set.

#### **SHCDS FRBIND**

This command re-binds to the new data set all retained locks that were unbound from the old data set. The locks are now associated with the named data set. The data set name used in FRBIND must match the name used in the earlier FRUNBIND.

#### **SHCDS FRRESETRR**

This frees the data set from being under maintenance, resetting the flag in the ICF catalog.

Based on the above example of using REPRO to move a VSAM data set, the complete solution for a data set accessed in RLS mode, and which preserves the RLS locks, is as follows.

#### **1. Quiesce the data set**

Quiesce the data set that is being moved, to prevent access by CICS regions while maintenance is in progress.

#### **2. Create a new data set**

Create a new data set into which the data is to be copied. At this stage, it cannot have the same name as the old data set. For example:

```
DEFINE CLUSTER (NAME(CICS.DATASET.B) ...
```

#### **3. Issue SHCDS FRSETRR**

Use this access method services (AMS) SHCDS subcommand to mark the old data set as being under maintenance. This makes the data set unavailable while the move from old to new is in progress, and also allows the following unbind operation to succeed. For example:

```
SHCDS FRSETRR(CICS.DATASET.A)
```

#### **4. Issue SHCDS FRUNBIND**

Use this SHCDS subcommand to unbind any retained locks against the old data set. This enables SMSVSAM to preserve the locks ready for re-binding later to the new data set. For example:

```
SHCDS FRUNBIND(CICS.DATASET.A)
```

**Note:** You can include the SHCDS FRSETRR and FRUNBIND subcommands of steps 3 and 4 in the same IDCAMS execution, but they must be in the correct sequence. For example, the SYSIN input to IDCAMS would look like this:

```
//SYSIN DD *  
SHCDS FRSETRR(old_dsname)  
SHCDS FRUNBIND(old_dsname)  
/*
```

#### 5. Copy (REPRO) the data

After the unbind, use REPRO to copy the data from the old data set to the new data set created in step 1. For example:

```
REPRO INDATASET(CICS.DATASET.A) OUTDATASET(CICS.DATASET.B)
```

#### 6. SHCDS FRSETRR

Use this SHCDS subcommand to mark the new data set as being under maintenance. This is necessary to allow the later (step 8) re-bind operation to succeed. For example:

```
SHCDS FRSETRR(CICS.DATASET.B)
```

#### 7. Delete the old data set

Delete the old data set to enable you to rename the new data set to the name of the old data set. For example:

```
DELETE CICS.DATASET.A
```

#### 8. Alter the new data set name

Use access method services to rename the new data set to the name of the old data set. For example:

```
ALTER CICS.DATASET.B NEWNAME(CICS.DATASET.A)
```

You must give the new data set the name of the old data set to enable the following bind operation to succeed.

#### 9. FRBIND

Use this SHCDS subcommand to re-bind to the recovered data set all the retained locks that were unbound from the old data set. For example:

```
SHCDS FRBIND(CICS.DATASET.A)
```

#### 10. FRRESETRR

Use this SHCDS subcommand after the re-bind to reset the maintenance flag and enable the data set for use. For example:

```
SHCDS FRRESETRR(CICS.DATASET.A)
```

**Note:** You can include the SHCDS FRBIND and FRRESETRR subcommands of steps 8 and 9 in one IDCAMS execution, but they must be in the correct sequence. For example, the SYSIN input to IDCAMS would look like this:

```
//SYSIN DD *  
SHCDS FRBIND(dataset_name)  
SHCDS FRRESETRR(dataset_name)  
/*
```

## Using the EXPORT and IMPORT functions

Similar considerations to those for the REPRO method also apply to the use of IMPORT when recovering data from a copy created by EXPORT. The following steps are required to restore a data set copy that has been created by an access method services EXPORT command:

- Create a new empty data set into which the copy is to be restored, and use IMPORT to copy the data from the exported version of the data set to the new empty data set.
- Use SHCDS FRSETRR to mark the original data set as being under maintenance.
- Use SHCDS FRUNBIND to unbind the locks from the original data set.
- Use SHCDS FRSETRR to mark the new data set as being under maintenance.
- Delete the original data set.
- Rename the new data set back to the old name.
- Use SHCDS FRBIND to associate the locks with the new data set.
- Use SHCDS FRRESETRR to take the data set out of maintenance.

An example follows of the access method services commands used to restore a portable copy of a data set created by EXPORT. The example assumes that EXPORT has been used to create a copy of data set CICS.DATASET.A and that an empty data set with the correct VSAM characteristics called CICS.DATASET.B has been created into which the data will be imported.

```
IMPORT INTOEMPTY INDATASET(CICS.DATASET.A.COPY) OUTDATASET(CICS.DATASET.B)
SHCDS FRSETRR(CICS.DATASET.A)
SHCDS FRUNBIND(CICS.DATASET.A)
SHCDS FRSETRR(CICS.DATASET.B)
DELETE CICS.DATASET.A
ALTER CICS.DATASET.B NEWNAME(CICS.DATASET.A)
SHCDS FRBIND(CICS.DATASET.A)
SHCDS FRRESETRR(CICS.DATASET.A)
```

## Rebuilding alternate indexes

If you delete and rebuild an alternate index (using BLDINDEX) it is equivalent to moving the alternate index data set. It is possible that VSAM might be holding locks on a unique key alternate index when you want to delete and rebuild an alternate index. In this case, ensure that you preserve the locks over the delete and rebuild process by setting 'Recovery Required' and transferring the locks to the rebuilt index. The steps you need to preserve the locks across a rebuild are:

1. Issue SHCDS FRSETRR to indicate the data set is under maintenance.
2. Issue SHCDS FRUNBIND to get VSAM to save the locks, to be re-applied after the rebuild.
3. Delete and redefine the alternate index.
4. Rebuild the alternate index (using BLDINDEX).
5. Issue FRBIND to bind the retained locks to the newly built alternate index.
6. Issue SHCDS FRRESETRR to unset the under-maintenance flag.

---

## Chapter 17. Forward recovery procedures

If a data set that is being used by CICS fails, perhaps because of physical damage to a disk, you can recover the data by performing forward recovery of the data set. Your forward recovery procedures can be based either on your own, or an ISV-supplied, utility program for processing the relevant CICS forward recovery log streams, or you can use CICSVR 2.3.

This chapter deals with general forward recovery procedures. See “Chapter 18. Forward recovery with CICSVR” on page 193 for details of forward recovery using CICSVR.

This chapter covers the following topics:

- “Forward recovery of data sets accessed in RLS mode”
- “Forward recovery of data sets accessed in non-RLS mode” on page 188
- “Procedure for failed RLS mode forward recovery operation” on page 189
- “Procedure for failed non-RLS mode forward recovery operation” on page 191

---

### Forward recovery of data sets accessed in RLS mode

A recoverable data set that is updated in RLS mode can have retained locks held for individual records.

In the event of a data set failure, it is important to ensure that you preserve any retained locks as part of the data set recovery process. This is to enable the locks associated with the original data set to be attached to the new data set. If the data set failure is caused by anything other than a volume failure, retained locks can be “unbound” using the SHCDS FRUNBIND subcommand. The data set can then be recovered and the locks rebound to the recovered data using the SHCDS FRBIND subcommand.

**Note:** If you use CICSVR to recover a data set, the unbinding and subsequent binding of locks is handled by CICSVR. CICSVR also uses the SHCDS FRSETRR and FRRESETRR commands to prevent general access to the data set during the recovery process.

If a data set failure is caused by the loss of a volume, it is *not* possible to preserve retained locks using FRUNBIND and FRBIND because SMSVSAM no longer has access to the failed volume. When recovering from the loss of a volume, you can ensure data integrity only by deleting the entire IGWLOCK00 lock structure, which forces CICS to perform lost locks recovery. CICS uses information from its system log to perform lost locks recovery. (For more information about lost locks processing, see “Lost locks recovery” on page 83.) Recovering data from the loss of a volume requires a different procedure from the simple loss of a data set.

The procedures to recover data sets that could have retained locks are described in the following topics:

- For recovery of failed data sets where the volume remains operational, see “Recovery of data set with volume still available” on page 178
- For recovery of failed data sets where the volume itself has failed, see “Recovery of data set with loss of volume” on page 179.

## Recovery of data set with volume still available

The procedure described here is necessary to preserve any retained locks that are held by SMSVSAM against the data in the old data set. Unless you follow all the steps of this procedure, the locks will not be valid for the new data set, with potential loss of data integrity.

The following steps outline the procedure to forward recover a data set accessed in RLS mode. Note that the procedure described here refers to two data sets—the failed data set, and the new one into which the backup is restored. When building your JCL to implement this process, be sure you reference the correct data set at each step.

### 1. Quiesce the data set

To prevent further accesses to the failed data set, quiesce it using the CEMT, or EXEC CICS, SET DSNAME QUIESCED command.

### 2. Create a new data set

Create a new data set into which the backup is to be restored. At this stage, it cannot have the same name as the failed production data set.

### 3. Issue FRSETRR

Use this access method services SHCDS subcommand to mark the failed data set as being subject to a forward recovery operation. This makes the data set unavailable to tasks other than those performing recovery functions, and also allows the following unbind operation to succeed.

### 4. Issue FRUNBIND

Use this access method services SHCDS subcommand to unbind any retained locks against the failed data set. This enables SMSVSAM to preserve the locks ready for re-binding later to the new data set used for the restore. This is necessary because there is information in the locks that relates to the old data set, and it must be updated to refer to the new data set. Unbinding and re-binding the locks takes care of this.

**Note:** You can include the access method services SHCDS FRSETRR and FRUNBIND subcommands of steps 3 and 4 in the same IDCAMS execution, but they *must* be in the correct sequence. For example, the SYSIN input to IDCAMS would look like this:

```
//SYSIN DD *  
SHCDS FRSETRR(o1d_dsname)  
SHCDS FRUNBIND(o1d_dsname)  
/*
```

### 5. Restore the backup

After the unbind, restore a full backup of the data set to the new data set created in step 2. You can use the recovery function (HRECOVER) of DFSMSHsm™ to do this.

### 6. Issue the FRSETRR subcommand

Use this access method services SHCDS subcommand to mark the new data set as being subject to a forward recovery operation. This is necessary to allow the later bind operation to succeed.

### 7. Run the forward recovery utility

Run your forward recovery utility to apply the forward recovery log to the restored data set, to redo all the completed updates.

### 8. Delete the old data set

Delete the old data set to enable you to rename the new data set to the name of the failed data set.

### 9. Alter the new data set name

Use access method services to rename the new data set to the name of the old data set.

```
ALTER CICS.DATASETB NEWNAME(CICS.DATASETA)
```

You must give the restored data set the name of the old data set to enable the following bind operation to succeed.

### 10. Issue the FRBIND subcommand

Use this access method services SHCDS subcommand to re-bind to the recovered data set all the retained locks that were unbound from the old data set.

### 11. Issue the FRRESETRR subcommand

Use this access method services SHCDS subcommand after the re-bind to re-enable access to the data set by applications other than the forward recovery utility.

**Note:** You can include the SHCDS FRBIND and FRRESETRR subcommands of steps 10 and 11 in one IDCAMS execution, but they must be in the correct sequence. For example, the SYSIN input to IDCAMS would look like this:

```
//SYSIN DD *
SHCDS FRBIND(dataset_name)
SHCDS FRRESETRR(dataset_name)
/*
```

These steps are summarized in the following commands, where the data set names are labeled with A and B suffixes:

```
CEMT SET DSNAME(CICS.DATASETA) QUIESCED
DEFINE CLUSTER(NAME(CICS.DATASETB) ...
SHCDS FRSETRR(CICS.DATASETA)
SHCDS FRUNBIND(CICS.DATASETA)
HRECOVER (CICS.DATASETA.BACKUP) ... NEWNAME(CICS.DATASETB)
SHCDS FRSETRR(CICS.DATASETB)
EXEC PGM=fwdrecov_utility
DELETE CICS.DATASETA
ALTER CICS.DATASETB NEWNAME(CICS.DATASETA)
SHCDS FRBIND(CICS.DATASETA)
SHCDS FRRESETRR(CICS.DATASETA)
```

If you use CICSVR, the SHCDS functions are performed for you (see “Chapter 18. Forward recovery with CICSVR” on page 193).

After successful forward recovery, CICS can carry out any pending backout processing against the restored data set. Backout processing is necessary because the forward recovery log contains after images of all changes to the data set, including those that are uncommitted, and were in the process of being backed out when the data set failed.

## Recovery of data set with loss of volume

Moving a data set that has retained locks means the locks associated with the original data set have somehow to be attached to the new data set. In the event of a lost volume, a volume restore implicitly moves data sets. Even if you are using CICSVR, which normally takes care of re-attaching locks to a recovered data set, the movement of data sets caused by loss of a volume cannot be managed entirely automatically.

There are several methods you can use to recover data sets after the loss of a volume. Whichever method you use (whether a volume restore, a logical data set recovery, or a combination of both), you need to ensure SMSVSAM puts data sets into a lost locks state to protect data integrity. This means that, after you have carried out the initial step of recovering the volume, your data recovery process must include the following command sequence:

1. ROUTE \*ALL,VARY SMS,SMSVSAM,TERMINATESERVER
2. VARY SMS,SMSVSAM,FORCEDELETELOCKSTRUCTURE
3. ROUTE \*ALL,VARY SMS,SMSVSAM,ACTIVE

The first command terminates all SMSVSAM servers in the sysplex and temporarily disables the SMSVSAM automatic restart facility. The second command (issued from any MVS) deletes the lock structure. The third command restarts all SMSVSAM servers, as a result of which SMSVSAM records, in the sharing control data set, that data sets are in lost locks state. The automatic restart facility is also reenabled.

Each CICS region detects that its SMSVSAM server is down as a result of the TERMINATESERVER command, and waits for the server event indicating the server has restarted before it can resume RLS-mode processing. This occurs at step 3 in the above procedure.

It is important to realize the potential impact of these commands. Deleting the lock structure puts *all* RLS-mode data sets that have retained locks, or are open at the time the servers are terminated, into the lost locks condition. A data set which is in lost locks condition is not available for general access until all outstanding recovery on the data set is complete. This is because records are no longer protected by the lost locks, and new updates can only be permitted when all shunted UOWs with outstanding recovery work for the data set have completed.

When CICS detects that its server has restarted, it performs dynamic RLS restart, during which it is notified that it must perform lost locks recovery. During this recovery process, CICS does not allow new RLS-mode work to start for a given data set until all backouts for that data set are complete. Error responses are returned on open requests issued by any CICS region that was not sharing the data set at the time SMSVSAM servers were terminated, and on RLS access requests issued by any new UOWs in CICS regions that were sharing the data set. Also, in-doubt UOWs must be resolved before the data set can be taken out of lost locks state.

For RLS-mode data sets that are not on the lost volume, the CICS regions can begin lost locks recovery processing as soon as they receive notification from their SMSVSAM servers. For the data sets on these other volumes, recovery processing completes quickly and the data sets are removed from lost locks state.

For those data sets that are unavailable (for example, they are awaiting forward recovery because they are on the lost volume), CICS runs the backouts only when forward recovery is completed. In the case of CICSVR-managed forward recovery, completion is signalled automatically, and recovered data sets are removed from lost locks state when the associated backouts are run.

### **Volume recovery procedure using CFVOL QUIESCE**

If a volume is lost, and you logically recover the data sets using CICSVR, you do not need to use the CFVOL QUIESCE command (step 1 in the procedure described



below). This is because CICS cannot run the lost locks recovery process until the data sets are available, and the data sets are made available only after the CICSVR recovery jobs are finished.

If you physically restore the volume, however, the data sets that need to be forward recovered are immediately available for backout. In this case you need to use CFVOL QUIESCE before the volume restore to prevent access to the restored volume until that protection can be transferred to CICS (by using the CICS SET DSNAME(...) QUIESCED command). When all the data sets that need to be forward recovered have been successfully quiesced, you can enable the volume again (CFVOL ENABLE). The volume is then useable for other SMSVSAM data sets.

The command `D SMS,CFVOL(volser)` can be used to display the CFVOL state of the indicated volume.

CICS must not perform backouts until forward recovery is completed. The following outline procedure, which includes the three VARY SMS commands described above, prevents CICS opening for backout a data set on a restored volume until it is safe to do so. In this procedure *volser* is the volume serial of the lost volume:

1. VARY SMS,CFVOL(*volser*),QUIESCE

Perform this step before volume restore. Quiescing the volume ensures that the volume remains unavailable, even after the restore, so that attempts to open data sets on the volume in RLS mode will fail with RC=8, ACBERFLG=198(X'C6'). Quiescing the volume also ensures CICS can't perform backouts for data sets after the volume is restored until it is re-enabled.

2. ROUTE \*ALL,VARY SMS,SMSVSAM,TERMINATESERVER

3. VARY SMS,SMSVSAM,FORCEDELETELOCKSTRUCTURE

4. ROUTE \*ALL,VARY SMS,SMSVSAM,ACTIVE

Note at this point, as soon as they receive the "SMSVSAM available" event notification (ENF), CICS regions are able to run backouts for the data sets that are available. RLS-mode data sets on the lost volume, however, remain unavailable until a later ENABLE command.

5. At this point the procedure assumes the volume has been restored. This step transfers the responsibility of inhibiting backouts for those data sets to be forward recovered from SMSVSAM to CICS. Quiescing the data sets that need to be forward recovered is a first step to allowing the restored volume to be used for recovery work for other data sets:

a. SET DSNAME(...) QUIESCED

Use this command for all of the data sets on the lost volume that are to be eventually forward recovered. Issue the command before performing any of the forward recoveries.

**Note:** A later SET DSNAME(...) UNQUIESCED command is *not* needed if you are using CICSVR.

b. VARY SMS,CFVOL(*volser*),ENABLE

Issue this command when CICS regions have successfully completed the data set QUIESCE function. You can verify that data sets are successfully quiesced by inquiring on the quiesced state of each data set using the CEMT INQUIRE DSNAME(...) command. If a data set is still quiescing, CICS displays the words "BEING QUIESCED".

This clears the SMSVSAM CFVOL-QUIESCED state and allows SMSVSAM RLS access to the volume. CICS ensures that access is not allowed to the data sets that will eventually be forward recovered, but the volume is available for other data sets.

6. Run data set forward recovery jobs.

The following are two examples of forward recovery after the loss of a volume, based on the procedure outline above:

**Example of recovery using data set backup:** For this illustration, involving two data sets, we simulated the loss of a volume by varying the volume offline. The two data sets (RLSADSW.VF04D.DATAENDB and RLSADSW.VF04D.TELLCTRL) were being updated in RLS mode by many CICS AORs at the time the volume was taken offline. The CICS file names used for these data sets were F04DENDB and F04DCTRL.

The failed data sets were recovered onto another volume without first recovering the failed volume. For this purpose, you have to know what data sets are on the volume at the time of the failure. In “Example of recovery using volume backup” on page 186, we describe the recovery process by performing a volume restore before the forward recovery of data sets. Here are the steps followed in this example:

1. We simulated the volume failure using the MVS command:

```
ROUTE *ALL,VARY 4186,OFFLINE,FORCE
```

The loss of the volume caused I/O errors and transaction abends, producing messages on the MVS system log such as these:

```
DFHFC0157 ADSWA04B 030
TT1P 3326 CICSUSER An I/O error has occurred on base data set
RLSADSW.VF04D.TELLCTRL accessed via file F04DCTRL component code
X'00'.
DFHFC0158 ADSWA04B 031
96329,13154096,0005EDC00000,D,9S4186,A04B ,CICS
,4186,DA,F04DCTRL,86- OP,UNKNOWN COND. ,000000A5000403,VSAM

DFHFC0157 ADSWA03C 301
DE1M 0584 CICSUSER An I/O error has occurred on base data set
RLSADSW.VF04D.DATAENDB accessed via file F04DENDB component code
X'00'.
DFHFC0158 ADSWA03C 031
...
```

As a result of the transaction abends, CICS attempted to back out in-flight UOWs. The backouts failed because CICS couldn't access the data sets on the lost volume. The associated backout failures were reported by CICS, as follows:

```
+DFHFC4701 ADSWA03A 336
11/24/96 13:15:48 ADSWA03A Backout failed for transaction DE1H, VSAM
file F04DENDB, unit of work X'ADD18C07DCB70A05', task 46752, base
RLSADSW.VF04D.DATAENDB, path RLSADSW.VF04D.DATAENDB, failure code
X'24'.

+DFHFC0152 ADSWA03A 339
11/24/96 13:15:49 ADSWA03A ???? DE1H An attempt to retain locks for
data set within unit of work X'ADD18C07DCB70A05' failed. VSAM return
code X'00000008' reason code X'000000A9'.
+DFHME0116 ADSWA03A 340
(Module: DFHMEME) CICS symptom string for message DFHFC0152 is
PIDS/565501800 LVLS/510 MS/DFHFC0152 RIDS/DFHFCCA PTFS/UN92873
REGS/GR15 VALU/00000008 PCSS/IDARETLK PRCS/000000A9
+DFHFC0312 ADSWA03A Message DFHFC0152 data set RLSADSW.VF04D.DATAENDB
```

We used the CEMT command INQUIRE UOWDSNFAL IOERROR to display the UOWS that were shunted as a result of the I/O errors. For example, on the CICS region ADSWA01D the command showed the following shunted UOWs:

```
INQUIRE UOWDSNFAL IOERROR
STATUS: RESULTS
Dsn(RLSADSW.VF04D.TELLCTRL           ) Dat Ioe
Uow(ADD18C2DA4D5FC03)                Rls
Dsn(RLSADSW.VF04D.DATAENDB          ) Dat Ioe
Uow(ADD18C2E693C7401)                Rls
```

2. The next step was to stop the I/O errors by closing the RLS-mode files that were open against failed data sets. In our example, file F04DENDB was open against data set RLSADSW.FV04D.DATAENDB, and file F04DCTRL was open against data set RLSADSW.FV04D.TELLCTRL.

The normal way of closing RLS-mode files across a sysplex is to quiesce the data set using the CEMT command SET DSNAME QUIESCED in one CICS region. However, the quiesce operation requires access to the data set, and fails if the data set cannot be accessed. The alternative is to issue the SET FILE(F04DENDB) CLOSED and SET FILE(F04DCTRL) CLOSED commands, which we did using CICSplex<sup>®</sup> SM to send the command to all the relevant regions. (Without CICSplex SM, issue the CEMT SET FILE CLOSED command to each CICS region individually, either from the MVS console or from a CICS terminal).

3. To enable CICSVR to recover the failed data sets, we first deleted the catalog entries for the two affected data sets using the IDCAMS DELETE command:

```
DELETE RLSADSW.VF04D.TELLCTRL NOSCRATCH
DELETE RLSADSW.VF04D.DATAENDB NOSCRATCH
```

The impact of the recovery process is greater if there are inflight tasks updating RLS mode files. For this reason, it is recommended at this point that you quiesce the data sets that are being accessed in RLS mode on other volumes before terminating the SMSVSAM servers. To determine which data sets are being accessed in RLS-mode by a CICS region, use the SHCDS LISTSUBSYSDDS subcommand. For example, the following command lists those data sets that are being accessed in RLS-mode by CICS region ADSWA01D.

```
SHCDS LISTSUBSYSDDS('ADSWA01D')
```

For the purpose of this example, we did not quiesce data sets; hence there is no sample output to show.

**Note:** You can issue SHCDS subcommands as a TSO command or from a batch job.

4. We terminated the SMSVSAM servers using the MVS command:

```
ROUTE *ALL,VARY SMS,SMSVSAM,TERMINATESERVER
```

We received message IGW572 on each MVS image confirming that the servers are terminating:

```
IGW572I REQUEST TO TERMINATE SMSVSAM
ADDRESS SPACE IS ACCEPTED:
SMSVSAM SERVER TERMINATION SCHEDULED.
```

In our example, terminating the servers caused abends of all in-flight tasks that were updating RLS-mode data sets. This, in turn, caused backout failures and shunted UOWs, which were reported by CICS messages. For example, the

effect in CICS region ADSWA03C was shown by the following response to an INQUIRE UOWDSNFAIL command for data set RLSADSW.VF01D.BANKACCT:

```
INQUIRE UOWDSNFAIL DSN(RLSADSW.VF01D.BANKACCT)
STATUS: RESULTS
Dsn(RLSADSW.VF01D.BANKACCT) ) Dat Ope
Uow(ADD19B8166268E02) ) Rls
Dsn(RLSADSW.VF01D.BANKACCT) ) Rls Com
Uow(ADD19B9D93DE1200) ) Rls
```

After the SMSVSAM servers terminated, all RLS-mode files were automatically closed by CICS and further RLS access prevented.

5. When we were sure that all servers were down, we deleted the IGWLOCK00 lock structure with the MVS command:

```
VARY SMS,SMSVSAM,FORCEDELETELOCKSTRUCTURE
```

followed by the response "FORCEDELETELOCKSTRUCTURESMSVSAMYES" to allow the lock structure deletion to continue.

Successful deletion of the lock structure was indicated by the following message:

```
IGW527I SMSVSAM FORCE DELETE LOCK STRUCTURE PROCESSING IS NOW COMPLETE
```

6. It was safe at this point to restart the SMSVSAM servers with the MVS command:

```
ROUTE *ALL,VARY SMS,SMSVSAM,ACTIVE
```

Initialization of the SMSVSAM servers resulted in the creation of a new lock structure, shown by the following message:

```
IGW453I SMSVSAM ADDRESS SPACE HAS SUCCESSFULLY
CONNECTED TO DFSMS LOCK STRUCTURE IGWLOCK00
STRUCTURE VERSION: ADD1A77F0420E001 SIZE: 35072K bytes
MAXIMUM USERS: 32 REQUESTED:32
LOCK TABLE ENTRIES: 2097152 REQUESTED: 2097152
RECORD TABLE ENTRIES: 129892 USED: 0
```

The SMSVSAM server reported that there were no longer any retained locks but that instead there were data sets in the "lost locks" condition:

```
IGW414I SMSVSAM SERVER ADDRESS SPACE IS NOW ACTIVE.
IGW321I No retained locks
IGW321I 45 spheres in Lost Locks
```

CICS was informed during dynamic RLS restart about the data sets for which it must perform lost locks recovery. In our example, CICS issued messages such as the following to tell us that lost locks recovery was needed on one or more data sets:

```
DFHFC0555 ADSWA04A One or more data sets are in lost locks status.
CICS will perform lost locks recovery.
```

(If we had quiesced data sets before terminating the servers (see the comments between steps 3 and 4) this is the point at which we would unquiesce those data sets before continuing with the recovery.

If there were many data sets in lost locks it would take some time for lost locks recovery to complete. Error responses are returned on open requests issued by any CICS region that was not sharing the data set at the time SMSVSAM servers were terminated, and on RLS access requests issued by any new UOWs in CICS regions

that were sharing the data set. Also, it may be necessary to open explicitly files that suffer open failures during lost locks recovery.

Each data set in a lost locks state is protected from new updates until all CICS regions have completed lost locks recovery for the data set. This means that all shunted UOWs must be resolved before the data set is available for new work. Assuming that all CICS regions are active, and there are no in-doubt UOWs, lost locks processing, for all data sets except the ones on the failed volume, should complete quickly.

7. In this example, CEMT INQUIRE UOWDSNFAIL on CICS region ADSWA01D showed UOW failures only for the RLSADSW.VF04D.TELLCTRL and RLSADSW.VF04D.DATAENDB data sets:

```
INQUIRE UOWDSNFAIL
STATUS: RESULTS
Dsn(RLSADSW.VF04D.TELLCTRL)      ) Dat Ope
Uow(ADD18C2DA4D5FC03)           Rls
Dsn(RLSADSW.VF04D.DATAENDB)     ) Dat Ope
Uow(ADD18C2E693C7401)           Rls
```

The command INQUIRE DSN(RLSADSW.VF04D.DATAENDB) on the same region showed that the lost locks status for the data set was **Recoverlocks**. This meant that the data set had suffered lost locks and that CICS region ADSWA01D had recovery work to complete:

```
INQUIRE DSN(RLSADSW.VF04D.DATAENDB)
RESULT - OVERTYPE TO MODIFY
  Dsname(RLSADSW.VF04D.DATAENDB)
  Accessmethod(Vsam)
  Action(          )
  Filecount(0001)
  Validity(Valid)
  Object(Base)
  Recovstatus(Fwdrecovable)
  Backuptype()
  Frlog(00)
  Availability( Available )
  Lostlocks(Recoverlocks)
  Retlocks(Retained)
  Quiescestate()
  Uowaction(          )
  Basedsname(RLSADSW.VF04D.DATAENDB)
  Fwdrecovlsn(ADSW.CICSVR.F04DENDB)
```

8. At this point, all data sets were available for new work except the two data sets on the failed volume. It was now possible to recover these using CICSVR. For information on using CICSVR see “Chapter 18. Forward recovery with CICSVR” on page 193 and the *CICSVSAM Recovery User’s Guide and Reference*.

All CICS regions are automatically notified when CICSVR processing for a data set is complete. CICSVR preserves the lost locks state for the recovered data set and CICS disallows all new update requests until all CICS regions have completed lost locks recovery. When all CICS regions have informed SMSVSAM that they have completed their lost locks recovery, the data set lost locks state changes to **Nolostlocks**.

9. At this point recovery was complete and the recovered data sets were re-enabled for general access by issuing (through the CICSplex SM “LOCFILES” view) the CEMT commands:

```
SET FILE(F04DENDB) ENABLED
SET FILE(F04DCTRL) ENABLED
```

These commands are issued to each CICS AOR that requires access.

10. All data sets were now available for general access. We confirmed this using the SHCDS subcommand LISTSUBSYS(ALL), which showed that no CICS region had lost locks recovery outstanding.

If you follow the above example, but find that a CICS region still has a data set in lost locks, you can investigate the UOW failures on that particular CICS region using the CEMT commands INQUIRE UOWDSNFAIL and INQUIRE UOW. For in-doubt UOWs that have updated a data set that is in a lost locks condition, CICS waits for in-doubt resolution before allowing general access to the data set. In such a situation you can still release the locks immediately, using the SET DSNAME command, although in most cases you will lose data integrity. See “Lost locks recovery” on page 83 for more information about resolving in-doubt UOWs following lost locks processing.

**Example of recovery using volume backup:** In this example, we simulated the recovery from the loss of a volume by performing a volume restore before the forward recovery process. Backout-failed UOWs were the result of the I/O errors that occurred when the volume failed.

**Note:** It is important to ensure that CICS cannot retry the shunted UOWs when the volume is restored, until after the forward recovery work is complete. This is done by quiescing the volume before it is restored, as described under “Volume recovery procedure using CFVOL QUIESCE” on page 180 (step 1).

Many of the steps in this second example are the same as those described under the “Example of recovery using data set backup” on page 182, and are listed here in summary form only.

1. We simulated the volume failure using the MVS command.  
ROUTE \*ALL,VARY 4186,OFFLINE,FORCE
2. We stopped the I/O errors by closing the files that were open against failed data sets. In our example, file F04DENDB was open against data set RLSADSW.FV04D.DATAENDB and file F04DCTRL was open against data set RLSADSW.FV04D.TELLCTRL.
3. Because the failed data sets were restored from the same volume, there was no need to delete the catalog entries for these data sets.
4. Before restoring the failed volume, we quiesced the volume to ensure that CICS could not access the restored data sets. by issuing the command:  
VARY SMS,CFVOL(9S4186),QUIESCE

In this example, for volume serial **9S4186**, the command produced the message:

```
IGW462I DFSMS CF CACHE REQUEST TO QUIESCE VOLUME 9S4186 IS ACCEPTED
```

We confirmed that the volume was quiesced by issuing the MVS command:

```
DISPLAY SMS,CFVOL(9S4186)
```

which confirmed that the volume was quiesced with the message:

```
IGW531I DFSMS CF VOLUME STATUS  
VOLUME = 9S4186  
DFSMS VOLUME CF STATUS = CF QUIESCED  
VOLUME 9S4186 IS NOT BOUND TO ANY DFSMS CF CACHE STRUCTURE
```

5. We simulated the volume restore for this example by using the MVS VARY command to bring the volume back online:

```
ROUTE *ALL,VARY 4186,ONLINE
```

Because the volume was quiesced, attempts to open files on this volume failed, with messages such as the following:

```
DFHFC0500 ADSWA02A RLS OPEN of file F04DENDB failed. VSAM has
          returned code X'0008' in R15 and reason X'00C6'.
```

The impact of the recovery process is greater if there are inflight tasks updating RLS mode files. To minimize the impact, you are recommended at this point to quiesce all data sets that are being accessed in RLS mode.

6. We terminated the SMSVSAM servers with the MVS command:

```
ROUTE *ALL,VARY SMS,SMSVSAM,TERMINATESERVER
```

7. When all SMSVSAM servers were down, we deleted the IGWLOCK00 lock structure with the MVS command:

```
VARY SMS,SMSVSAM,FORCEDELETELOCKSTRUCTURE
```

8. We restarted the SMSVSAM servers with the MVS command:

```
ROUTE *ALL,VARY SMS,SMSVSAM,ACTIVE
```

CICS was informed during dynamic RLS restart about the data sets for which it must perform lost locks recovery. CICS issued messages such as the following to inform you that lost locks recovery was being performed on one or more data sets:

```
+DFHFC0555 ADSWA04A One or more data sets are in lost locks status.
          CICS will perform lost locks recovery.
```

If we had quiesced data sets prior to terminating the servers, this is the point at which we would unquiesce those data sets before proceeding.

If there were many data sets in lost locks it would take some time for lost locks recovery to complete. It may be necessary to explicitly open files which suffer open failures during lost locks recovery.

9. At this point it was possible that there were data sets on the restored volume which did not require forward recovery. In order to make these data sets available, we needed to re-allow access to the volume. Before doing this, however, we first had to quiesce the data sets that still required forward recovery, thus transferring the responsibility of preventing backouts from SMSVSAM to CICS. In our example, we quiesced our two data sets using the CEMT commands:

```
SET DSN(RLSADSW.VF04D.DATAENDB) QUIESCED
SET DSN(RLSADSW.VF04D.TELLCTRL) QUIESCED
```

10. When we were sure that all data sets requiring forward recovery were quiesced, we used the following MVS command to allow access to the restored volume:

```
VARY SMS,CFVOL(9S4186),ENABLE
```

The above command produced the following message:

```
IGW463I DFSMS CF CACHE REQUEST TO ENABLE
          VOLUME 9S4186 IS COMPLETED.
          DFSMS CF VOLUME STATUS = "CF_ENABLED"
```

11. At this point, all data sets were available for new work except the two quiesced data sets on the restored volume. We recovered these using CICSVR.

All CICS regions were automatically notified when CICSVR processing for each data set was complete, and each data set was automatically unquiesced by CICSVR to allow the backout shunted UOWs to be retried.

After all backout shunted UOWs were successfully retried, the recovery was complete and we re-enabled the recovered data sets for general access on each CICS region using the CEMT commands:

```
SET FILE(F04DENDB) ENABLED
SET FILE(F04DCTRL) ENABLED
```

12. Finally, we used the SHCDS command LISTSUBSYS(ALL) to confirm that no CICS region had lost locks recovery outstanding, indicating that recovery was complete.

### Catalog recovery

If a user catalog is lost, follow the procedures documented in *DFSMS/MVS Managing Catalogs*. Before making the user catalog available, run the SHCDS CFREPAIR command to reconstruct critical RLS information in the catalog. Note that before running SHCDS CFREPAIR, the restored user catalog must be import connected to the master catalog on all systems (see the “Recovering Shared Catalogs” topic in *DFSMS/MVS Managing Catalogs*).

---

## Forward recovery of data sets accessed in non-RLS mode

For data sets accessed in non-RLS mode, use the following forward recovery procedure:

### 1. Close all files

Close all the files that are open against the failed data set, by issuing CEMT, or EXEC CICS, SET FILE(...) CLOSED commands in the CICS region that owns the files.

### 2. Create a new data set

Create a new data set into which the backup is to be restored. At this stage, it cannot have the same name as the failed production data set.

### 3. Restore the backup

Restore a full backup of the data set to the new data set created in step 2. You can use the recovery function (HRECOVER) of DFSMSHsm to do this.

### 4. Run the forward recovery utility

Run your forward recovery utility to apply the forward recovery logs to the restored data set, to redo all the completed updates.

### 5. Delete the old data set

Delete the old data set to enable you to rename the new data set to the name of the failed data set.

### 6. Alter the new data set name

Use access method services to rename the new data set to the name of the old data set.

```
ALTER CICS.DATASETB NEWNAME(CICS.DATASETA)
```

Renaming is necessary to enable CICS to perform any outstanding backout processing.

These steps are summarized in the following commands, where the data set names are labeled with A and B suffixes:

```
CEMT SET FILE(...) CLOSED (for each file opened against
                           the failed data set)
DEFINE CLUSTER(NAME(CICS.DATASETB) ...
HRECOVER (CICS.DATASETA.BACKUP) ... NEWNAME(CICS.DATASETB)
EXEC PGM=fwdrecov_utility
DELETE CICS.DATASETA
ALTER CICS.DATASETB NEWNAME(CICS.DATASETA)
```



---

## Procedure for failed RLS mode forward recovery operation

There are some forward recovery failures that can be resolved. For example, when:

- FRSETRR fails because the data set is already allocated to another job
- The restore fails because the backup has gone to tape and operator intervention is required
- The forward recovery doesn't work because the log data sets have been migrated

In these cases, you can resolve the cause of the failure and try the whole process again.

This section describes what to do when the failure in forward recovery cannot be resolved. In this case, where you are unsuccessful in applying all the forward recovery log data to a restored backup, you are forced to abandon the forward recovery, and revert to your most recent full backup. For this situation, the access method services SHCDS command provides the FRDELETEUNBOUNDLOCKS subcommand, which allows you to delete the retained locks that were associated with the data set, instead of re-binding them to the recovered data set as in the case of a successful forward recovery.

The most likely cause of a forward recovery failure is the loss or corruption of one or more forward recovery logs. In this event, you probably have no alternative other than to restore the most recent backup and reapply lost updates to the data set manually. In this case, it is important that you force CICS to discard any pending (shunted) units of work for the data set that has failed forward recovery *before* you restore the most recent backup. This is because, during recovery processing, CICS assumes that it is operating on a data set that has been correctly forward recovered.

CICS performs most of its recovery processing automatically, either when the region is restarted, or when files are opened, or when a data set is unquiesced. There isn't any way that you can be sure of preventing CICS from attempting this recovery processing. How you force recovery processing before restoring the backup depends on whether or not the affected CICS regions are still running:

- For a CICS region that is still running, issue the appropriate CICS commands to initiate the retry of pending units of work.
- For a CICS region that is shut down, restart it to cause CICS to retry automatically any pending units of work.

**Note:** Ensure you issue any CICS commands, or restart a CICS region, *before* you restore the most recent backup, otherwise CICS will perform recovery processing against the restored data set, which you don't want.

In the event of a failed forward recovery of a data set, use the following procedure:

1. Tidy up any outstanding CICS recovery work, as follows:
  - a. Make sure that any CICS regions that are not running, and which could have updated the data set, are restarted to enable emergency restart processing to drive outstanding backouts.
  - b. Using information returned from the INQUIRE UOWDSNFAIL command issued in each CICS region that uses the data set, compile a list of all shunted UOWs that hold locks on the data set.

- c. If there are shunted in-doubt UOWs, try to resolve the in-doubts before proceeding to the next step. This is because the in-doubt UOWs may have updated resources other than the failed data set, and you don't want to corrupt these other resources.

If the resolution of an in-doubt unit of work results in backout, this will fail for the data set that is being restored, because it is still in a recovery-required state. The (later) step to reset locks for backout-failed UOWs allows you to tidy up any such backout failures that are generated by the resolution of in-doubts.

- d. In all CICS regions that could have updated the failed data set:

- 1) Force shunted in-doubt UOWs using SET DSNAME(...) UOWACTION(COMMIT | BACKOUT | FORCE).

Before issuing the next command, wait until the SET DSNAME(...) UOWACTION has completed against all shunted in-doubt units of work.

If the UOWACTION command for an in-doubt unit of work results in backout, this will fail for the data set that is being restored, because it is still in a recovery-required state. The (next) step to reset locks for backout-failed UOWs allows you to tidy up any such backout failures that are generated by the resolution of in-doubts.

- 2) Reset locks for backout-failed UOWs using SET DSNAME(...) RESETLOCKS.

Do not issue this command until the previous UOWACTION command has completed. RESETLOCKS operates only on backout-failed units of work, and does not affect units of work that are in the process of being backed out. If you issue RESETLOCKS too soon, and shunted in-doubt units of work fail during backout, the data set will be left with recovery work pending.

The DFH0BAT3 sample program provides an example of how you can do this.

There should not now be any shunted units of work on any CICS region with locks on the data set.

2. When you are sure that all CICS regions have completed any recovery work for the data set, delete the unbound locks using SHCDS FRDELETEUNBOUNDLOCKS.

**Note:** It is very important to enter this command (and the following SHCDS FRRESETRR) at this stage in the procedure. If you do not, and the failed data set was in a lost locks condition, the data set will remain in a lost locks condition unless you cold start all CICS regions which have accessed it. If you mistakenly issued this command before step 1 of the procedure, then the problem concerning lost locks will still arise even if you issue the command again at this stage.

3. Allow access to the data set again using SHCDS FRRESETRR (even if you use CICSVR, you have to allow access manually if you have abandoned the forward recovery).
4. Finally, restore the backup copy from which you intend to work.

If the restored data set is eligible for backup-while-open (BWO) processing, you may need to reset the BWO attributes of the data set in the ICF catalog. This is

because the failed forward recovery may have left the data set in a 'recovery-in-progress' state. You can do this using the CEMT, or EXEC CICS, SET DSNAME RECOVERED command.

If you do not follow this sequence of operations, the restored backup could be corrupted by CICS backout operations.

All the parts of step 1 of the above procedure may also be appropriate in similar situations where you do not want CICS to perform pending backouts. An example of this might be before you convert an RLS SMS-managed data set to non-SMS when it has retained locks, because the locks will be lost.

---

## Procedure for failed non-RLS mode forward recovery operation

If you are not successful in applying all the forward recovery log data to a restored backup, you are forced to abandon the forward recovery, and revert to your most recent full backup. However, during its recovery processing, CICS assumes that it is operating on a data set that has been correctly forward recovered, as in the case of recovery of a data set accessed in RLS mode (see "Procedure for failed RLS mode forward recovery operation" on page 189).

If you are not able to complete forward recovery on a data set, ensure that all CICS regions tidy up any pending recovery processing on the data set (as described below) before you restore the backup copy from which you intend to work. You can do this in the following way:

1. Make sure that any CICS regions that are not running, and which could have updated the data set, are restarted to enable emergency restart processing to drive outstanding backouts.
2. If there are shunted in-doubt UOWs, try to resolve the in-doubts before proceeding to the next step. This is because the in-doubt UOWs may have updated resources other than the failed data set, and you don't want to corrupt these other resources.
3. In all CICS regions that could have updated the failed data set:
  - Force shunted in-doubt UOWs using set DSNAME(...) UOWACTION(COMMIT | BACKOUT | FORCE).  
Before issuing the next command, wait until the SET DSNAME(...) UOWACTION has completed against all shunted in-doubt units of work.
  - Reset locks for backout-failed UOWs using SET DSNAME(...) RESETLOCKS.  
Do not issue this command until the previous UOWACTION command has completed. RESETLOCKS operates only on backout-failed units of work, and does not affect units of work that are in the process of being backed out. If you issue RESETLOCKS too soon, and shunted in-doubt units of work fail during backout, the data set will be left with recovery work pending.
4. Finally, when you are sure that all CICS regions have completed any recovery work for the data set, restore the backup.

If you do not follow this sequence of operations, the restored backup could be corrupted by CICS backout operations.



---

## Chapter 18. Forward recovery with CICSVR

This chapter describes how you can use IBM CICS VSAM Recovery MVS/ESA (CICSVR), Program Number 5695-010, to recover lost VSAM data. It covers the following topics:

- “Why should you have a forward recovery utility?”
- “How CICSVR protects your data” on page 194
- “Planning for CICSVR” on page 195
- “Running CICSVR” on page 197
- “CICSVR reports” on page 208

---

### Why should you have a forward recovery utility?

Without a forward recovery utility, you are forced to recover lost data sets manually. If each update is re-entered manually, the possibility of introducing errors increases, threatening the integrity of your VSAM data.

If you have high transaction volumes between backups, you want to avoid long work interruptions due to lost data. CICSVR minimizes your recovery labor and eliminates the possibility of introducing data errors as you recover your data sets.

CICSVR has automated functions that help you recover your CICS VSAM data sets if they are lost or damaged.

### CICSVR features

CICSVR:

- Automatically determines the DFSMSHsm backups that are available for forward recovery. Once you have selected the backup, CICSVR selects the appropriate CICS logs automatically.
- Uses the ISPF dialog interface, which complies with common user access (CUA<sup>®</sup>) standards, to generate automatically the JCL to run the forward recovery job.
- Interfaces to DFSMSHsm to recover the data set and apply the CICS logs to forward recover the data set. Data sets that have been lost or damaged generally require forward recovery.
- Works with backups taken with or without the backup-while-open (BWO) facility, and with or without concurrent copy.
- Provides the necessary RLS support to:
  1. Set recovery required
  2. Unbind the locks
  3. Forward recover the data set
  4. Bind the locks
  5. Indicate recovery complete.
- Supports the following logs:
  - CICS log of logs (used as an index to all forward recovery logs)
  - CICS forward recovery log streams
  - CICSVR QSAM copies of CICS forward recovery log streams.
- Uses log of logs scan to create automatically an inventory of all CICS forward recovery logs. You need only to register the log of logs to CICSVR.
- Applies all changes that were made to the base cluster directly to the base cluster only, regardless of the method used to access the base cluster (base, path, or alternate index).

If the data set is restored from a backup taken using BWO, the alternate indexes in the upgrade set can be rebuilt automatically.

- Recovers multiple data sets in a single run. Supports all VSAM data sets that are supported by CICS: KSDS, ESDS, and RRDS (fixed and variable types).
- Works independently of CICS.
- Produces reports and statistics.
- Provides shadow copy support.

## CICSVR benefits

CICSVR:

- Helps you recover your data quickly and easily
- Supports 24-hour CICS availability
- Reduces the risk of human error by creating the job for you
- Saves time by reducing the VSAM data set outage time
- Stores all the information you need for recovery

---

## How CICSVR protects your data

If a VSAM sphere updated by CICS is damaged and unusable, you can use CICSVR to re-create the VSAM sphere.

CICSVR:

- Restores the VSAM sphere from the DFSMSHsm backup. When CICSVR recovers a CICS data set, it preserves all RLS retained locks.
- Applies the after-images from the logs to the restored VSAM sphere.  
You can set up a periodic automatic invocation of CICSVR SCAN, which keeps track of all the CICS forward recovery logs.
- Sets a state of 'forward recovery in progress' during the forward recovery process until the forward recovery is complete.

When the forward recovery run is complete, CICSVR has re-created the updated data.

For more information about the CICSVR functions, see the *CICS VSAM Recovery MVS/ESA User's Guide and Reference*.

## Storing information in the recovery control data set

You can also use CICSVR to:

- Make copies of CICS logs
- Extract information from CICS logs and to store it in the recovery control data set (RCDS)
- Make copies of MVS log streams and store information about the copies in the RCDS

CICSVR lets you manage this RCDS information using the dialog interface.

You can use the dialog interface to remove information you no longer need about:

- Data sets
- Logs
- Copies of MVS log streams
- Log of logs

You can set an automatic function to delete and uncatalog logs after a specified time, and you can use CICSVR to delete parts of an MVS log stream. For added security, CICSVR maintains three copies of the RCDS.

Using CICSVR with DFSMSHsm ensures that you have all information about backups. You need not keep a separate record of backups or logs for each data set.

For more information about the CICSVR archive utility and the MVS log stream copy utility, see the *IBM CICS VSAM Recovery MVS/ESA Implementation Guide*.

## Automated job creation

To recover your VSAM data, start the CICSVR dialog interface. Select the data sets you want to work with, and then select “Complete recovery” from the main panel (see “Running CICSVR” on page 197). CICSVR guides you through the creation of your recovery job. An extensive help function ensures that you can always find out what to do next.

Use default values stored by CICSVR on previous runs, or use your own values. You decide which values to save for next time. You can browse, save, and, if necessary, edit the JCL before you submit it.

## CICSVR and 24-hour CICS availability

You need not withdraw services and close CICS regions to protect your data. You can maintain 24-hour availability of your data and ensure its integrity with CICSVR.

With BWO and the concurrent copy function, you can back up data while the data sets are open and being updated. CICSVR can recover using BWO copies, ensuring that the data is protected from loss at all times. If the data should become damaged or inaccessible, CICSVR can use BWO backups to retrieve the data. Because you can make backups without interrupting your CICS regions, you can make them more often.

---

## Planning for CICSVR

You must complete some tasks and make some decisions before you start using CICSVR. To implement a backup and recovery strategy for your organization, using CICSVR, consider these points:

- Making backups
- Using journals
- Identifying which VSAM spheres you need to protect
- Deciding which CICSVR exits to use
- Creating operational procedures and assigning responsibilities

## Establishing backup procedures

Establish procedures to produce regular backup copies of the VSAM spheres that you want to protect. Schedule a regular time to back up your VSAM spheres. If you change the physical characteristics of a VSAM sphere, such as the control interval (CI) size or the length or location of a key field, make a new backup of the VSAM sphere. This ensures that the latest attributes are preserved if you need to restore the VSAM sphere later.

If your CICS regions are operating only for a certain number of hours in each day, make backups of your VSAM spheres outside these hours, when the spheres are

unavailable to users. Consider using BWO and the concurrent copy function to make VSAM spheres continuously available. To take full advantage of CICSVR recovery control, use DFSMSHsm to make your backups. CICSVR automatically restores the DFSMSHsm backup before starting the recovery.

## Journaling considerations

The CICS log manager uses the services of the MVS system logger to write CICS log and journal data to MVS log streams. A log stream is a sequence of data blocks, with each log stream identified by its own log stream identifier—the log stream name (LSN). The CICS system log, forward recovery logs (including the log of logs), autojournals, and user journals map onto specific MVS log streams. CICS forward recovery logs, user journals, and autojournals are referred to as general logs, to distinguish them from system logs.

Both the MVS system logger and CICS log manager have extensive recovery procedures to prevent errors from causing the loss of your VSAM data. For CICS Transaction Server, CICSVR provides support only for the log of logs and forward recovery logs. You cannot use CICSVR to perform forward recovery from autojournals written by CICS Transaction Server regions. However, for earlier releases of CICS, CICSVR continues to support system logs and autojournals.

For more information about defining CICS logs and journals, see the *CICS System Definition Guide*.

## Which VSAM spheres to protect

You will probably want to be able to forward recover all VSAM spheres that are defined as CICS files. Of course, data sets that are read-only or browse-only do not need forward recovery, but it is wise to back them up regularly in case they become unusable.

To use CICSVR to recover your data, specify the required recovery attributes when you define your files to CICS. For details about the recovery attributes required by CICSVR, see the *IBM CICS VSAM Recovery MVS/ESA Implementation Guide*. If your files are accessed in RLS mode, you define the recovery attributes with the data set definition in the ICF catalog. For more information about RLS recovery definitions, see the *DFSMS/MVS Access Method Services for ICF*, SC26-4906.

## CICSVR exit considerations

Five exits are available for use with CICSVR:

- The **precopy** exit can be used by the archive utility to inspect and act on a copy of the log record.
- The **preapply** exit can be used by forward recovery and the archive utility to bypass or modify log records.
- The **error** exit can be used by forward recovery to force CICSVR to continue processing after an I/O error.
- The **ESDS delete** exit can be used by forward recovery to logically delete records from an ESDS. To logically delete records from an ESDS, you must provide an ESDS delete exit.
- The **termination** exit can be used by forward recovery and the archive utility to modify the return code with which CICSVR terminates.

Except for the ESDS delete exit, the use of CICSVR exits is optional.



For more information about the CICSVR exits, see the *IBM CICS VSAM Recovery MVS/ESA Implementation Guide*.

## Considerations for operational procedures and responsibilities

When you are ready to use CICSVR, define a concise set of operational procedures for use if VSAM data is lost or damaged. Document the procedures required to recover from all error situations concerning CICS VSAM data. Here are some topics to consider when designing your operational procedures:

### Technical responsibilities

- Who is responsible for the different duties associated with CICSVR recovery? These duties include:
  - Monitoring CICS for messages indicating a VSAM problem
  - Notifying users when a VSAM data set becomes unavailable and when it becomes available again after successful recovery
  - Authorizing a CICSVR recovery run
  - Locating logs
  - Performing the CICSVR run
  - Examining the CICSVR reports
  - Investigating the reasons for an unsuccessful CICSVR run, if necessary

### Terminal user considerations

- Terminal users might need new instructions to follow if their VSAM data is damaged. In the past, in organizations that had no forward-recovery capability, the usual way to recover from damaged data was for users to repeat the lost work. With CICSVR, the instructions and guidelines for users can be changed, because users need not be involved in the recovery process.
- You might need to broadcast message from the CICS master terminal, to notify users that their data is temporarily unavailable during recovery. A message to users after the recovery is complete is also advisable.

---

## Running CICSVR

This section describes how to use CICSVR to recover your VSAM data. For more information, see the *IBM CICS VSAM Recovery MVS/ESA User's Guide and Reference*.

The panels and secondary windows shown here are in the sequence that they appear for a CICSVR run if you accept the CICSVR default values:

1. Select option 1 from the main menu. A list of VSAM spheres appears.
2. Select the VSAM sphere(s) you want to recover.
3. Press the CompRec key (F4).
4. If you are using DFSMSHsm, select the backup you need. Otherwise, enter the start time for recovery.
5. Accept the CICSVR defaults in the secondary windows that appear.
6. Submit the job that CICSVR creates for you.

**Note:** References to CICSVR backout in the ISPF dialog are for compatibility with CICS releases earlier than CICS Transaction Server for OS/390 Release 1.

For information about other CICSVR functions, see the *IBM CICS VSAM Recovery MVS/ESA User's Guide and Reference*, and the *IBM CICS VSAM Recovery MVS/ESA Implementation Guide*.

## Using the main menu

When you start CICSVR, the main menu appears. If this is the first time you have run CICSVR, select option 5 to customize the JCL skeleton.

To begin recovery, select option 1 and press Enter.

```
Help
-----
                          CICSVR main menu

Select one and press Enter.

   ___  1. List of VSAM spheres
        2. List of archived logs
        3. List of copied log streams
        4. List of registered log of logs
        5. JCL skeleton

(C) Copyright IBM Corp. 1987, 1996. All rights reserved.

Command ==>> _____
F1=Help   F3=Exit   F10=Menu bar F12=Cancel
```

Figure 17. CICSVR main menu

From the panel in Figure 17 you can choose from these objects:

- A list of VSAM spheres
- A list of archived logs
- A list of MVS log streams
- A list of log of logs
- The JCL skeleton

## Selecting from the VSAM sphere list

To continue the recovery:

1. Type S beside each VSAM sphere that you want to recover
2. Press F10 to get to the menu bar, place the cursor under Utilities and press Enter

When the action is completed, the letter S appears in the select column beside each selected sphere on the CICSVR VSAM sphere list panel:

```

Administrate Utilities Tools List View Help
-----
CICSVR VSAM sphere list                               Row 1 to 12 of 33

Select one or more VSAM spheres, then select an action.

S VSAM sphere                                Last time      RLS RR
-                                     referenced     flag on
- CIC10.ACCOUNT1.BASE                     96.159 12:34.56 Yes
- CIC10.ACCOUNT2.BASE                     96.159 12:43.56 Yes
- CIC10.ACCOUNT3.BASE                     96.159 12:34.56 Yes
- PAYROLL.PROD1.BASE                      96.159 12:34.56 No
- PAYROLL.PROD2.BASE                      96.159 12:34.56 No
- PAYROLL.PROD3.BASE                      96.159 12:34.56 No
- CIC10.PROD1.BASE                        96.159 12:34.56 No
- CIC10.PROD2.BASE                        96.159 12:34.56 No
- CIC10.PROD3.BNSE                        96.159 12:34.56 No
- CIC10.PROD4.BASE                        96.159 12:34.56 No
- CIC10.PROD5.BASE                        96.159 12:34.56 No
- TEST.STMERRY.RLS                       96.159 12:34.56 Yes

Command ==>>> _____
F1=Help   F3=Exit   F4=CompRec  F5=FwdRec  F6=Backout  F7=Bkwd
F8=Fwd    F10=Menu bar F11=Dereg  F12=Cancel

```

Figure 18. CICSVR VSAM sphere list

From the CICSVR VSAM sphere list panel, you can select an action by using one of the shortcut function keys, or select one of these pull-downs from the menu bar:

- Administrate
- Utilities
- Tools
- List
- View
- Help

## Using the VSAM sphere list Utilities pull-down

Figure 19 shows a section of the CICSVR VSAM sphere list panel with the “Utilities” pull-down:

```

Administrate Utilities Tools List View Help
-----
1 1. Complete recovery... F4
  2. Forward recover only... F5
  3. Backout only... F6
Select one or _____ Row 1 to 12 of 33
ion

Last time      RLS RR
referenced     flag on
S VSAM sphere  96.159 12:34.56 Yes
S CICS10.ACCOUNT1.BASE 96.159 12:43.56 Yes
- CICS10.ACCOUNT2.BASE 96.159 12:34.56 Yes
- CICS10.ACCOUNT3.BASE 96.159 12:34.56 Yes
- PAYROLL.PROD1.BASE   96.159 12:34.56 No
- PAYROLL.PROD2.BASE   96.159 12:34.56 No
- PAYROLL.PROD3.BASE   96.159 12:34.56 No
- CICS10.PROD1.BASE    96.159 12:34.56 No
- CICS10.PROD2.BASE    96.159 12:34.56 No
- CICS10.PROD3.BNSE    96.159 12:34.56 No
- CICS10.PROD4.BASE    96.159 12:34.56 No
- CICS10.PROD5.BASE    96.159 12:34.56 No
- TEST.STMERRY.RLS     96.159 12:34.56 Yes

Command ==> _____
F1=Help      F3=Exit      F4=CompRec   F5=FwdRec    F6=Backout   F7=Bkwd
F8=Fwd       F10=Menu bar F11=Dereg   F12=Cancel

```

Figure 19. CICSVR VSAM sphere list—Utilities pull-down

From this pull-down, you can select “Complete recovery” for the VSAM spheres that you selected by using one of these methods:

- Select option 1
- Press the CompRec key (F4)
- Type comprec on the command line
- Move the cursor to the “Complete recovery” item in the pull-down, and press Enter

To get information about an item in the pull-down menu, move the cursor to the item and press the Help key (F1).

If you have the log of logs registered in the RCDS, CICSVR scans the logs and presents the results as an ISPF browse of the DWWMSG and DWWPRINT data sets. For an example of these reports, see “Report of log of logs scan” on page 213.

### Providing VSAM sphere parameters

When you have selected “Complete recovery” from the Utilities pull-down, and if you are using DFSMSHsm, you get this secondary window:

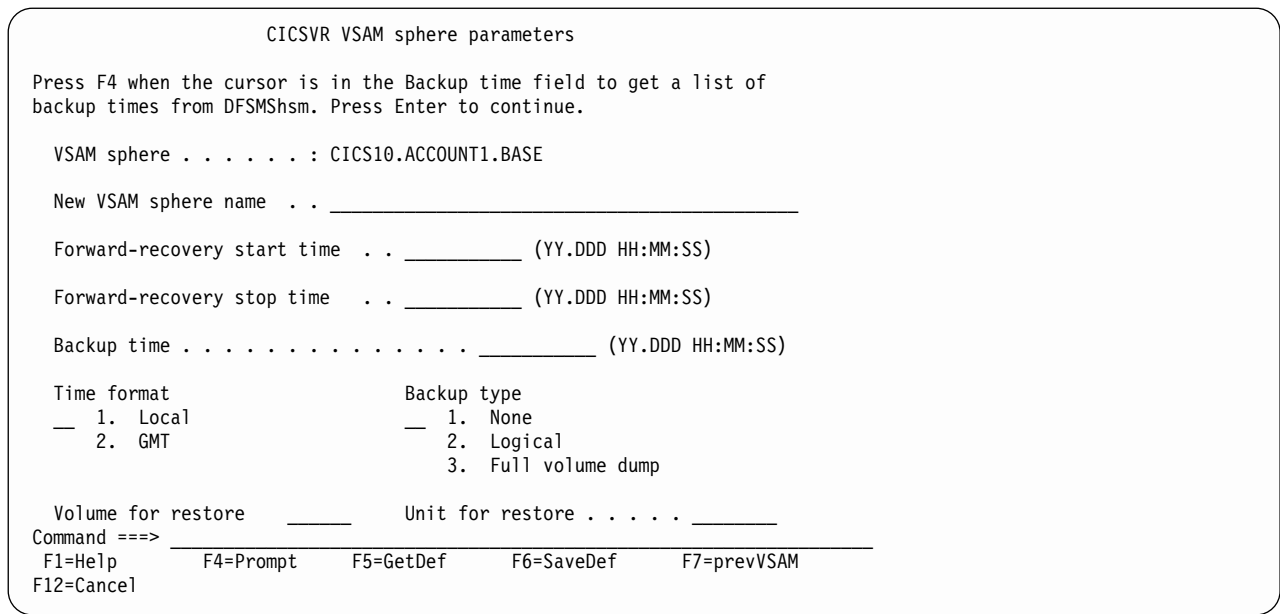

Figure 20. CICSVR VSAM sphere parameters

Here you can specify VSAM sphere parameters for inclusion in the recovery run. These parameters are:

- A new name for the recovered VSAM sphere
- The start time for forward recovery
- The stop time for forward recovery
- The backup time
- The backup type
- The time format used on the log (if you are using MVS log streams or QSAM copies of MVS log streams)
- The volume for the restored copy of the data if you are using full volume dumps
- The unit for the restored copy of the data if you are using full volume dumps

When you first see this secondary window, the CICSVR default values are displayed. Press:

- F4, to get a list of DFSMSHsm backups (Figure 24 on page 203).
- F5, to get the default values from the recovery control data set (RCDS).
- F6, to save the currently displayed values. The secondary window for default update verification (Figure 27 on page 205) appears.
- F7, to go back to the previous VSAM sphere.

While CICSVR is constructing the recovery job, the wait secondary window shown in Figure 21 on page 202 appears.

**Recovering with DFSMSHsm backups:** During a recovery run, CICSVR restores the VSAM sphere from a DFSMSHsm backup, if one exists for the VSAM sphere that you are recovering. The latest DFSMSHsm backup will appear as the default in the VSAM sphere parameters secondary window. If you provide a new VSAM sphere name in this secondary window, the recovered data set will have this name.

**Recovering with DFSMSHsm full volume dumps:** If you are using a DFSMSHsm full volume dump, these dumps do not appear in the backup list. Enter 3 in the Backup time field, and enter the date of the full volume dump for the recovery in the backup time field in the VSAM sphere parameters secondary window. If a new VSAM sphere name appears in the secondary window, the recovered data set will have this name.

**Notes:**

1. If the data set you are recovering is managed by DFSMS, the volume and unit values are ignored.
2. CICSVR can process DFSMSHsm backups, full volume dumps, and non-DFSMSHsm backups in the same run.

For more information about using DFSMSHsm with CICSVR, see the *CICSVR Implementation Guide*.

While CICSVR is constructing the recovery job, the secondary window shown in Figure 21 appears:

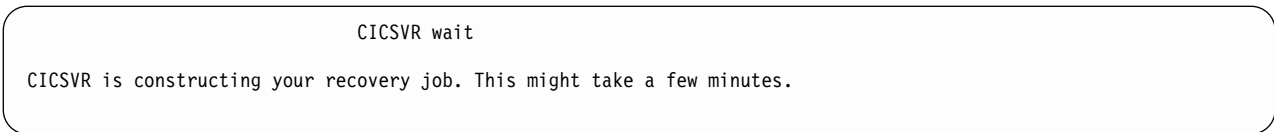

Figure 21. CICSVR wait window

If CICSVR detects errors while constructing the recovery job, the CICSVR recovery job error list (Figure 22) appears.

**Listing recovery job errors**

Use this secondary window to list errors found during the construction of the recovery job.

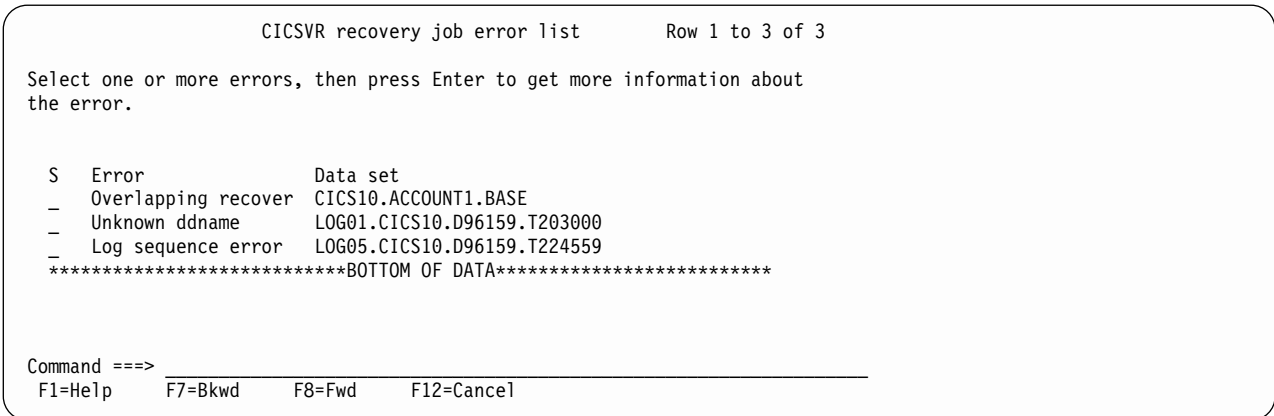

Figure 22. CICSVR recovery job error list

Select an error to get a secondary window that contains a detailed description of the error.

For general help information, press the Help key (F1).

## Specifying the log stream type

When you have selected Complete recovery from the Utilities pull-down, if you have QSAM copies of MVS log streams, you get this secondary window:

```
CICSVR log stream type

Specify log stream type. Press Enter to continue the job creation.

Log stream type . . _ 1. MVS logger log stream
                    2. QSAM copy

Command ==> _____
F1=Help    F5=GetDef  F6=SaveDef  F12=Cancel
```

Figure 23. CICSVR log stream type

Use this secondary window to specify the type of MVS log stream for this recovery job.

When you first see this secondary window, the CICSVR default values are displayed. Press F5 to get the default values from the recovery control data set (RCDS). Press F6 to save the currently displayed values, and display the default update verification secondary window (Figure 27 on page 205).

For detailed help information about a particular field, move the cursor to the field and press the Help key (F1).

## Listing DFSMSHsm backups

Figure 24 shows the secondary window that appears if you press the Prompt key (F4) on a CICSVR VSAM sphere parameters panel for a sphere you selected for recovery:

```
CICSVR backup prompt list                               Row 1 to 4 of 4

Select one backup time, then press Enter.

VSAM sphere . . . : PAYROLL.BASE

----- DFSMSHsm backup information -----
      Backup      Gen Ver BWO RLS      Recovery point
S   Date   Time   no. no.   Date   Time   Type
-   96.159 14:56:09 00 006 YES NO   96.159 14:51:10 GMT
-   96.158 14:55:32 01 005 YES YES  96.158 14:51:47 LOCAL
-   96.157 14:56:09 02 004 YES YES  96.157 14:50:43 GMT
-   96.158 14:36:09 03 005 NO  NO   96.158 14:51:47 LOCAL
*****BOTTOM OF DATA*****

Command ==> _____
F1=Help    F7=Bkwd    F8=Fwd     F12=Cancel
```

Figure 24. CICSVR backup prompt list

This secondary window appears once for every VSAM sphere that you select, and shows a list of DFSMSHsm backups for that sphere. Select the backup that you need from this list.

For general help information, press the Help key (F1).

### Entering recovery parameters

When you select one or more CICSVR parameters to change, the secondary windows for these parameters appear in the order in which the parameters appear in the list.

After you press Enter in the secondary window (Figure 20), you can enter the CICSVR recovery parameters here:

```
CICSVR complete recovery

Press Enter to create a job with default values. Or, select one or more
choices below, and press Enter to override current values.

  S Recovery and backout parameters related to:
  - Sequence checking
  - VSAM buffer pools
  - CICSVR exits

Command ==> _____
F1=Help   F12=Cancel
```

Figure 25. CICSVR recovery parameters

From this secondary window (Figure 25), you can create a recovery job for the VSAM sphere you selected. You can accept the CICSVR default values, or change the forward recovery parameters before continuing the recovery.

When you select “Complete recovery” from the Utilities pull-down, you can define these recovery parameters for your run:

- Sequence checking
- VSAM buffer pools
- CICSVR exits

For detailed help information about any of these choices, move the cursor to the field and press the Help key (F1).

### Sequence checking

Use this secondary window to set sequence checking parameters for your CICSVR run:



```

CICSVR sequence checking

Specify sequence checking parameters. Press Enter to use the displayed
values in the recovery.

LOG DATA SETS          ! LOG RECORDS
Gap in sequence 1  1. STOP      ! Gap in sequence 1  1.STOP
                  2. WARNING   !                      2.WARNING
                  3. IGNORE    !                      3.IGNORE
                  !
Out of sequence 1  1. STOP      ! Out of sequence 1  1.STOP
                  2. WARNING   !                      2.WARNING
                  3. IGNORE    !                      3.IGNORE
                  !
Reset sequence 1  1. STOP      ! Reset sequence 1  1.STOP
                 2. WARNING   !                      2.WARNING
                 3. IGNORE    !                      3.IGNORE

Command ==> _____
F1=Help   F5=GetDef  F6=SaveDef F12=Cancel

```

Figure 26. CICSVR sequence checking

When you first see this secondary window, the CICSVR default values are displayed. Press F5 to get the default values from the recovery control data set (RCDS). Press F6 to save the currently displayed values, and display the default update verification secondary window (Figure 27).

**Note:** Use this secondary window only if you want to force CICSVR to use logs that are not in time sequence order, or logs that contain old data.

For detailed help information about a particular field, move the cursor to the field and press the Help key (F1).

### Updating the CICSVR default values

Use this secondary window to confirm an update to the CICSVR command default values:

```

CICSVR default update verification

Press Enter to update stored defaults, or press F12 to cancel the request.

Command ==> _____
F1=Help   F12=Cancel

```

Figure 27. CICSVR default update verification

For help information press the Help key (F1).

### Defining the VSAM buffer pools

Use this secondary window to tune your CICSVR run by changing the number of VSAM buffers:

```

CICSVR VSAM buffer pools          Row 1 to 11 of 11

Specify the number of buffers needed for each buffer pool. Press Enter to
use the displayed values in the recovery.

Number of buffers  Pool size
-----          -
-----          B512
-----          B1K
-----          B2K
-----          B4K
-----          B8K
-----          B12K
-----          B16K
-----          B20K
-----          B24K
-----          B28K
-----          B32K

***** BOTTOM OF DATA *****
Command ==> _____
F1=Help   F5=Getdef  F6=SaveDef F12=Cancel

```

Figure 28. CICSVR VSAM buffer pools

When you first see this secondary window, the CICSVR default values are displayed. Press F5 to get the default values from the RCDS. Press F6 to save the currently displayed values, and display the default update verification secondary window (Figure 27 on page 205).

For detailed help information about a particular field, move the cursor to the field and press the Help key (F1).

**Defining exits**

Use this secondary window to define which CICSVR exits to use in this CICSVR run:

```

CICSVR exits

Specify member names for the CICSVR exits. Press Enter to use the
displayed member names in the recovery.

Preapply . . . _____
Error . . . . . _____
ESDS delete . . _____
Termination . . _____

Command ==> _____
F1=Help   F5=Getdef  F6=SaveDef F12=Cancel

```

Figure 29. CICSVR exits

When you first see this secondary window, the CICSVR default values are displayed. Press F5 to get the default values from the RCDS. Press F6 to save the currently displayed values, and display the default update verification secondary window (Figure 27 on page 205).

For detailed help information about a particular field, move the cursor to the field and press the Help key (F1).

## Submitting the job

When you have entered the CICSVR parameters that you need, press Enter to get the job submission secondary window (Figure 30). Use this secondary window to submit the job, or browse, or edit, if required. Select option 4 to save the JCL that CICSVR generated for you. Select option 5 to return to the VSAM sphere list:

```
CICSVR job submission

Select one and press Enter.

      1. Submit the job
      2. Browse the job
      3. Edit the job
      4. Save generated JCL
      5. Return to VSAM sphere list

Command ==> _____
F1=Help  F12=Cancel
```

Figure 30. CICSVR job submission

For detailed help information about any of these options, move the cursor to the option description and press the Help key (F1).

## Saving the generated JCL

This secondary window appears if you selected option 4 from the CICSVR job submission secondary window (Figure 30):

```
CICSVR save JCL

Type a member name for the CICSVR generated JCL. Press Enter to save the
generated JCL as this member name.

Member name . . _____

Command ==> _____
F1=Help  F12=Cancel
```

Figure 31. CICSVR save JCL

Here you can give a member name for the saved CICSVR JCL. The member will be saved in the data set you allocated to the ddname ISPFIL.

---

## CICSVR reports

Here are some examples of reports from forward recovery and archive tasks. See "Archive reports" on page 210 for the examples of the archive reports.

### Forward recovery reports

CICSVR can produce four statistical reports:

- Log data set statistics
- Statistics on data sets that have been recovered
- Exit action statistics
- Recovery progress report

#### Report of log data set statistics

CICSVR - CICS VSAM RECOVERY

DATE : 96/06/07

TIME : 09:05:31

PAGE : 1

MVS LOG STREAM STATISTICS:  
-----

KEY TO FIELD IDENTIFIERS  
-----

UPD-AFTER UPDATE AFTER IMAGE  
ADD-AFTER ADD AFTER IMAGE  
DEL-AFTER DELETE AFTER IMAGE  
DSNAME DDNAME TO SPHERE AND PATH NAME  
-----

NAME OF MVS LOG STREAM	NO OF RECORDS PROCESSED	NO OF DSNAME	NO OF UPD-AFTER	NO OF ADD-AFTER	NO OF DEL-AFTER
RETAIL.ACCOUNTS.MVSLG1.CUST	11	3	2	5	1
RETAIL.ACCOUNTS.MVSLG2.CUST	44	12	5	21	6
TOTAL	55	15	7	26	7

Figure 32. CICSVR log statistics report

## Report of recovered data set statistics

CICSVR - CICS VSAM RECOVERY DATE : 96/06/07    TIME : 09:05:31    PAGE : 2

### STATISTICS OF RECOVERED DATA SETS

BASE NAME OF RECOVERED DATA SET: RETAIL.ACCOUNTS.MAIN

BASE NAME OF ORIGINAL DATA SET: RETAIL.ACCOUNTS.MAIN

THE FOLLOWING ASSOCIATED PATHS ARE DEFINED IN THE VSAM CATALOG:  
RETAIL.ACCOUNTS.CUSTNO

FIRST AND LAST RECORDS APPLIED:

RECORDS	DATE YY/DDD	TIME HH.MM.SS
-----	-----	-----
FIRST LOG RECORD APPLIED	96/154	13:19:59
LAST LOG RECORD APPLIED	96/155	15:44:59
-----	-----	-----

NAME OF RECOVERED DATA SET: RETAIL.ACCOUNTS.MAIN

DATASET TYPE	FCT ENTRY NAME	:----- RECORDS FOUND ON THE LOG(S) -----:				:----- CHANGE RECORDS APPLIED -----:			:-- CHANGES IGNORED BY EXIT
		DSNAME	UPD-AFTER	ADD-AFTER	DEL-AFTER	ADDS	UPDATES	DELETES	
BASE	MAIN	4	2	14	3	2	2	1	0
TOTAL		4	2	14	3	2	2	1	0
-----									
OVERALL TOTAL		4	2	14	3	2	2	1	0
-----									
GRAND TOTAL		4	2	14	3	2	2	1	0
-----									

Figure 33. CICSVR recovered data sets report

## Report of exit action statistics

CICSVR - CICS VSAM RECOVERY DATE : 96/06/07    TIME : 09:05:31    PAGE : 3

### EXIT ACTION STATISTICS

:-----NUMBER OF ACTIONS TAKEN-----:

EXIT NAME	RECORD CHANGE	CONTINUE	IGNORE
PREAPPLY	0	0	0
ESDS DELETE	EXIT NOT TAKEN		
-----			

:--NUMBER OF ACTIONS TAKEN--:

EXIT NAME	CONTINUE	IGNORE
ERROR	EXIT NOT TAKEN	
-----		

:--NUMBER OF ACTIONS TAKEN--:

EXIT NAME	CODE CHANGED	CONTINUE
TERMINATION	EXIT NOT TAKEN	
-----		

Figure 34. CICSVR exit action report

## Report of recovery progress

RECOVERY PROGRESS REPORT  
-----

VSAM SPHERE NAME: VBFR.CICS390.TEST

THE PREVIOUS FORWARD RECOVERY REGISTERED FOR THIS VSAM SPHERE WHICH WAS  
RUN AT 96.159 20:57:16 COMPLETED SUCCESSFULLY.

THIS FORWARD RECOVERY WAS RUN AT: 96.159 21:01:39  
TYPE OF RECOVERY : FORWARD RECOVERY IN ONE STEP ONLY.

THE VSAM RECOVERY REQUESTED BIT WAS SUCCESSFULLY SET.  
THE VSAM RLS LOCKS WERE SUCCESSFULLY UNBOUND.  
DFSMESHM RECOVER WAS SUCCESSFUL.

THESE AIXS WERE REMOVED:

VBFR.CICS390.TEST.AIX1

FORWARD RECOVERY RAN SUCCESSFULLY.

AIXS AFTER AIX REBUILD:

VBFR.CICS390.TEST.AIX1 : SUCCESSFULLY REBUILT.

THE VSAM RLS LOCKS WERE SUCCESSFULLY BOUND.

A SUCCESSFUL FORWARD RECOVERY WAS RELATED TO VSAM.

*Figure 35. CICSVR recovery progress report*

## Archive reports

The CICSVR archive utility and log of logs scan utility can produce up to four different reports, shown here:

- Report of automatic de-register statistics
- Report of information for a forward recovery
- Report of archive statistics
- Report of log of log scans

## Report of automatic de-register statistics

```

CICSVR - ARCHIVE UTILITY                                DATE : 96/06/07    TIME : 17:50:36    PAGE : 1
AUTOMATIC DEREGISTER STATISTICS
=====
LOGS DEREGISTERED FROM RCDS
-----
CICSID           : CICS01
MVSID            : MVS1
LOG ID           : 01
CICS VERSION     : 3
FIRST TIME       : 96.159 13:24:18
LAST TIME        : 96.159 17:36:04

-- SVC 99 ERROR CODES --   LOCATE   CATALOG
   INFO  ERROR   REASON   MACRO   MACRO
RETURN REASON REASON   RETURN   RETURN
CODE   CODE   CODE     CODE     CODE
-----
LOG NAME                                DELE-  UNCA-  RETURN  REASON  REASON  LOCATE  CATALOG
-----  TED  TALOG  CODE   CODE   CODE   CODE   CODE
CICS01.DFHJ01A.D96159.T132418          YES   YES    0000   0000   0000   0000   0000

```

Figure 36. CICSVR archive de-register report

## Report of information for a forward recovery

```

CICSVR - ARCHIVE UTILITY                                DATE : 96/06/07    TIME : 18:20:10    PAGE : 1
INFORMATION FOR A FORWARD RECOVERY OF PAYROLL.TEST
=====
JOB STEP 1
START TIME      STOP TIME
-----
96.159 10:15:30 96.159 15:01:12

LOGS NEEDED
-----
CICSPROD.LOG03.D96158.T101530
CICSPROD.LOG03.D96158.T121530
CICSPROD.LOG03.D96158.T141530

RELATED PATHS
-----
PAYROLL.PATH1
PAYROLL.PATH2

FCTNAME  RECFORM  START TIME
-----
PAY1     VAR       96.159 10:15:32
PAY2     FXD       96.159 10:15:33
PAY3     VAR       96.159 10:15:37

```

Figure 37. CICSVR forward recovery archive report

## Report of archive statistics

CICSVR - ARCHIVE UTILITY DATE : 96/06/07 TIME : 18:14:10 PAGE : 1

### ARCHIVE STATISTICS FOR A CICS/ESA LOG

```
=====
CICSID          : CICSPROD
MVSID           : MVS2
LOG ID          : 02
CICS VERSION    : 3
FIRST TIME      : 96.159 14:15:30
LAST TIME       : 96.159 17:23:28
FIRST SEQUENCE NUMBER : 737
LAST SEQUENCE NUMBER : 994
INPUT LOG NAME  : CICSPROD.DFHJ02A
OUTPUT LOG NAME(S) : CICSPROD.LOG02.D96158.T141530
```

CICSVR - ARCHIVE UTILITY DATE : 96/06/07 TIME : 18:14:10 PAGE : 2

### VSAM DATA SET STATISTICS

```
=====
VSAM DATA SET NAME          DATE/TIME OF FIRST REFERENCE  DATE/TIME OF LAST REFERENCE
-----
CICS1.PROD1.BASE             96.159 14:19:23  96.159 16:47:18
CICS1.PROD2.BASE             96.159 14:21:37  96.159 17:23:27
CICS1.PROD3.BASE             96.159 14:44:02  96.159 16:23:05
```

CICSVR - ARCHIVE UTILITY DATE : 96/06/07 TIME : 18:14:10 PAGE : 3

### TIE-UP STATISTICS

```
=====
FCT NAME          DATE/TIME OF TIE-UP RECORD  FCT FORMAT  BASE DATA SET NAME          PATH DATA SET NAME
-----
BASE1A            96.159 14:19:23  FIX         CICS1.PROD1.BASE             CICS1.PROD1.PATHA
BASE2              96.159 14:21:37  FIX         CICS1.PROD2.BASE             CICS1.PROD2.PATH
BASE3              96.159 14:44:02  VAR         CICS1.PROD3.BASE             CICS1.PROD3.PATH
BASE1B            96.159 15:07:14  FIX         CICS1.PROD1.BASE             CICS1.PROD1.PATHB
```

CICSVR - ARCHIVE UTILITY DATE : 96/06/07 TIME : 18:14:10 PAGE : 4

### REDO FILE ID WITHOUT TIE-UPS

```
=====
FCT NAME          DATE/TIME OF FIRST REFERENCE  DATE/TIME OF LAST REFERENCE
-----
BASE1C            96.159 14:17:33  96.159 14:38:21
```

Figure 38. CICSVR archive statistics report



## Report of log of logs scan

CICSVR - LOG OF LOGS SCAN UTILITY DATE : 96/06/07    TIME : 11:01:09    PAGE : 1

STATISTICS FOR A LOG OF LOGS SCAN

```

=====
LOG OF LOGS NAME       : CICSVR1.MVSLOG.LOL1
FIRST TIME GMT        : 96.157 12:00:59
LAST TIME GMT         : 96.159 12:00:59
FIRST TIME LOCAL      : 96.157 12:00:59
LAST TIME LOCAL       : 96.159 12:00:59
FIRST BLOCK NUMBER    :                43282
LAST BLOCK NUMBER     :                67382
    
```

VSAM DATA SET STATISTICS

```

=====
VSAM DATA SET NAME   CICSID  FCT NAME  OPEN DATE/TIME  CLOSE DATE/TIME  MVS LOG STREAM NAME
-----
CICSPROD.ACC.VSAMA   CICSPROD  BASEA    96.157 12:00:00  96.159 12:11:10  CICSVR1.MVSLOG
CICSPROD.ACC.VSAMB   CICSPROD  BASE2    96.157 12:00:00                CICSVR1.MVSLOG
CICSPROD.ACC.VSAMC   CICSPROD  BASE3    96.157 12:00:00                CICSVR1.MVSLOG
    
```

- LOG OF LOGS SCAN UTILITY DATE : 96/06/07    TIME : 11:01:09    PAGE : 2

INFORMATION FOR A FORWARD RECOVERY OF CICSPROD.ACC.VSAMA

```

=====
JOB STEP 1
START TIME GMT  STOP TIME GMT
-----
96.157 12:00:00  96.158 12:11:10
MVS LOG STREAMS NEEDED
    
```

CICSVR1.MVSLOG DATE : 96/06/07    TIME : 11:01:09    PAGE : 3

INFORMATION FOR A FORWARD RECOVERY OF CICSPROD.ACC.VSAMB

```

=====
JOB STEP 1
START TIME GMT  STOP TIME GMT
-----
96.157 12:00:00  96.158 11:01:11
MVS LOG STREAMS NEEDED
    
```

CICSVR1.MVSLOG DATE : 96/06/07    TIME : 11:01:09    PAGE : 4

INFORMATION FOR A FORWARD RECOVERY OF CICSPROD.ACC.VSAMC

```

=====
JOB STEP 1
START TIME GMT  STOP TIME GMT
-----
96.157 12:00:00  96.158 11:01:11
MVS LOG STREAMS NEEDED
    
```

CICSVR1.MVSLOG

Figure 39. CICSVR log of logs scan report



---

## Chapter 19. Backup-while-open (BWO)

This chapter describes the CICS **backup-while-open (BWO)** facility. It tells you about:

- “Benefits of BWO”
- “What is needed to use BWO” on page 216
- “Which data sets are eligible for BWO” on page 217
- “How you request BWO” on page 218
- “Systems administration” on page 219
- “BWO processing” on page 220
- “An assembler program that calls DFSMS callable services” on page 230

---

### Benefits of BWO

Many CICS applications depend on their data sets being open for update over a long period of time. Normally, you cannot take a backup of the data set while the data set is open. Thus, if a failure occurs that requires forward recovery, all updates that have been made to the data set since it was opened must be recovered. This means that you must keep all forward recovery logs that have been produced since the data set was opened. A heavily used data set that has been open for update for several days or weeks may need much forward recovery.

The BWO facility, together with other system facilities and products, allows you to take a backup copy of a VSAM data set while it remains open for update. Then, only the updates that have been made since the last backup copy was taken need to be recovered. This could considerably reduce the amount of forward recovery that is needed.

### BWO and concurrent copy

Concurrent copy improves BWO processing by eliminating the invalidation of a BWO dump because of updates to the data set. The following is a comparison of various kinds of dumps that you can request:

- **Normal dump.** Use of the data set must be quiesced so that serialization is obtained, the data set is dumped, and serialization is released. The data set cannot be used for the entire time.
- **Concurrent copy dump.** Use of the data set must be quiesced so that serialization is obtained, concurrent copy utilization is completed within a very short time (compared with the actual time to dump the data set), serialization is released, and the data set is dumped. The data set can be used after concurrent copy initialization is complete.
- **BWO dump.** Serialization is attempted but is not required, and the data set is dumped. If it is eligible for BWO, the data set is dumped without serialization and can remain in use for the entire time, but the dump can be invalidated by update activity to the data set.
- **BWO dump using concurrent copy.** Serialization is attempted but is not required, concurrent copy initialization is completed, and the data set is dumped. If it is eligible for BWO, the data set is dumped without serialization and can remain in use for the entire time, and updates that occur do not cause the dump to be invalidated.

To use concurrent copy, specify the **CONCURRENT** keyword when you use **DFSMSHsm** to dump BWO data sets.

## BWO and backups

The BWO function allows backups to be taken by DFSMSdss when applications are running in continuous operation while the data set is open for update with full data integrity of copied data. (Continuous operation is typically 24 hours-a-day for five to seven days a week.) This is feasible only for CICS VSAM file control data sets for which CICS creates forward-recovery logs. Long-running transactions, automated teller machines, and continuously available applications require the database to be up and running when the backup is being taken.

The concurrent copy function used along with BWO by DFSMSdss allows backups to be taken with integrity even when control-area and control-interval splits and data set additions (new extents or add-to-end) are occurring for VSAM key sequenced data sets.

---

## What is needed to use BWO

To use the backup-while-open (BWO) support provided by CICS, you can use the **Data Facility Storage Management Subsystem/MVS (DFSMS/MVS)**, Version 1 IBM-licensed product, program number 5695-DF1, (or a program product that provides equivalent function), Use Release 2, or later, for data sets used in non-RLS access mode, and Release 3 for data sets used in RLS access mode.

The DFSMSdfp™ IGWAMCS2 callable services module must be installed in the link pack area (LPA). The IGWABWO module, supplied in SYS1.CSSLIB, must be installed in the LPA, or SYS1.CSSLIB must be included in the link list (do not include the library in the STEPLIB or JOBLIB library concatenations).

You need the DFSMSdfp, DFSMSdss, and DFSMSshsm components of DFSMS installed on the processors that perform backup and recovery.

**Note:** During initialization, CICS determines the availability of BWO support by issuing calls to the callable services modules IGWAMCS2 and IGWABWO. CICS also checks on the DFSMSdss release level by calling the DFSMSdss modules, ADRRELVL and ADRMCLVL. If access to these DFSMSdss modules is strictly controlled by an external security manager, such as RACF, security violation messages are issued against the CICS userid, unless the CICS region userid is authorized to access these modules.

Note that **CICS VSAM Recovery MVS/ESA (CICSVR)**, (program number 5695-0120), which performs forward recovery, must be installed on the processor where forward recovery is to be done. CICSVR is required for forward recovery and backout of CICS VSAM data sets backed up with BWO and concurrent copy functions of DFSMS/MVS.

Table 3 cross-references the storage management component names of DFSMS to the previous names of the individual licensed programs:

*Table 3. Cross-reference of DFSMS/MVS product terminology*

Component name	Full DFSMS/MVS name	Previous product name
DFSMSdfp	Data Facility Storage Management Subsystem data facility product	MVS/DFP™
DFSMSshsm	Data Facility Storage Management Subsystem hierarchical storage manager	DFHSM

Table 3. Cross-reference of DFSMS/MVS product terminology (continued)

Component name	Full DFSMS/MVS name	Previous product name
DFSMSdss	Data Facility Storage Management Subsystem data set services	DFDSS

## Hardware requirements

The concurrent copy function is supported by the IBM 3990 Model 3 with the extended platform and the IBM 3990 Model 6 control units.

---

## Which data sets are eligible for BWO

You can use BWO only for:

- Data sets that are on SMS-managed storage and that have an integrated catalog facility (ICF) catalog.
- VSAM data sets accessed by CICS file control and for the CICS system definition (CSD) file. ESDS, KSDS, and RRDS are supported. ESDS and KSDS are supported both with and without alternate indexes (AIX). DFSMSHsm imposes a limit (many thousands) on the number of AIXs for a data set.

BWO is supported at the VSAM sphere level; thus you cannot take BWO backup copies of some sphere components and not others. The first data set opened for update against a VSAM base cluster determines the BWO eligibility for the sphere. This includes base clusters that are accessed through a VSAM path key. For example, if the first data set is defined as eligible for BWO, CICS fails the file-open operation for any subsequent data set that is opened for update against that cluster and which is not defined as eligible for BWO.

You can take BWO volume backups if all data sets that are open for update on the volume are eligible for BWO.

### VSAM control interval or control area split

For a KSDS (or an ESDS with AIX) that has frequent insert or update activity, it is only practical (and safe) to take BWO backups during periods of reduced activity (for example, overnight). This is because it is possible for a VSAM control interval or control area split to occur during a BWO backup. Then, the integrity of the backup copy cannot be guaranteed because DFSMSdss copies the data set sequentially, and so certain portions of the data set might be duplicated or not represented at all in the backup copy.

DFSMSdfp indicates in the ICF catalog that a split has occurred. DFSMSHsm and DFSMSdss check the ICF catalog at the start and end of a backup. If a split is in progress at the start of a backup, the backup is not taken. If a split has occurred during a backup, or a split is still in progress at the end of a backup, the backup is discarded.

So, to take a BWO backup successfully, the normal time between splits must be greater than the time taken for DFSMSHsm and DFSMSdss to take a backup of the data set.

**Data tables:** You can use BWO with CICS-maintained data table base clusters. However, you cannot use BWO with user-maintained data tables, because no forward recovery support is provided.

**AIX:** CICS normally uses a base key or a path key to access data in a VSAM base cluster data set. It is also possible, but not normal, for CICS to access AIX records by specifying the AIX name as the data set name. If an AIX data set is used in this way, you cannot define the AIX as eligible for BWO. Instead, the AIX adopts the BWO characteristics already defined for the VSAM sphere.

---

## How you request BWO

There are two ways in which files can be defined as eligible for BWO:

1. By specifying the BWO option for the data set in the ICF catalog
2. By specifying the BWO option on the CICS file resource definition in the CSD

Defining BWO in the ICF catalog requires DFSMS 1.3. For datasets that are accessed in RLS mode, the BWO option must be defined in the ICF catalog. Datasets that are accessed only in non-RLS mode can be defined either in the ICF catalog or in the CICS file definition. If BWO is defined in the ICF catalog definition, it overrides any BWO option defined in a CICS file definition.

## Specifying BWO using access method services

There is a BWO parameter on the access method services DEFINE CLUSTER statement. You can specify the BWO parameter as follows:

### **TYPECICS**

The data set is eligible for BWO in CICS.

**NO** The data set is not eligible for BWO.

### **TYPEIMS**

The data set is eligible for BWO in IMS, but CICS treats this as NO.

### **TYPEOTHER**

The data set is eligible for BWO, but CICS treats this as NO.

If you specify BWO(TYPECICS), you must also specify LOG(ALL) and a forward recovery log stream name, LOGSTREAMID(*logstream\_name*).

If you omit the BWO parameter from the DEFINE statement, by default it is UNDEFINED in the ICF catalog, and the BWO attribute from the CICS file resource definition is used.

BWO(TYPECICS) is the equivalent of BACKUPTYPE(DYNAMIC) in a CICS file resource definition. All other values, including UNDEFINED, are treated by CICS as the equivalent of BACKUPTYPE(STATIC) in a CICS file resource definition. For simplicity, the CICS terms BACKUPTYPE(DYNAMIC) and BACKUPTYPE(STATIC) are used unless it is necessary to specifically mention the access method services BWO parameters.

### **Specifying BWO for the CSD**

The BWO options for the CSD are taken from the ICF catalog if they are defined there, and the system initialization parameters (CSDBKUP, CSDRECOV, and CSDFRLOG) are ignored.

## Specifying BWO on CICS file resource definitions

You define a file as eligible for BWO with the BACKUPTYPE attribute on a CICS FILE resource definition in the CSD.

If you specify BACKUPTYPE(DYNAMIC), the file is defined as eligible for BWO when the data set is opened. You must also specify RECOVERY(ALL) and FWDRECOVLOG(*nn*) to request forward recovery support.

BACKUPTYPE(STATIC), the default, defines a file as not eligible for BWO. In this case, if DFSMSshm is to back up a data set, all CICS files currently open for update against that data set must be closed before the backup can start.

All files opened against the same VSAM base cluster must have the same BACKUPTYPE value. That value is established by the first file opened against the cluster; it is stored in the CICS data set name block (DSNB) for the cluster. If the value for a subsequent file does not match, the file-open operation fails.

The BACKUPTYPE value in the DSNB persists across warm and emergency restarts. It is removed by a CICS cold start (unless a backout failure occurs) or by issuing EXEC CICS SET DSNAME ACTION(REMOVE) (or the CEMT equivalent) for the base cluster data set. To do this, all files that are open against the base cluster and via path definition must be closed, and the DSNB must have FILECOUNT of zero and NORMALBKOUT state.

The BACKUPTYPE attribute is ignored for user-maintained data table base clusters, because no forward recovery support is provided.

### BWO for CSD

To use BWO for the CSD file, specify the CSDBKUP=DYNAMIC system initialization parameter. Also specify CSDRECOV=ALL and CSDFRLOG=*nn* to request forward recovery support.

---

## Systems administration

The systems administrator must decide which VSAM user data sets are eligible for BWO, and then set up the appropriate operating procedures for taking the BWO backup copies and for forward recovery. These procedures should include:

- How to forward recover a data set by using the BWO backup copy, the forward recovery log, and the forward recovery utility to bring the data set to a point of consistency. Users must not have access to the file during the recovery process.
- How to forward recover a data set that may have been damaged while allocated to CICS. This operation may require backout of partially committed units of work during CICS emergency restart, after forward recovery has been done.

The procedures are simpler when using BWO than when not, because:

- Backups can be taken more frequently, so there are fewer forward recovery logs to manage. This also reduces the amount of processing that is required to forward recover the data set.
- The point from which forward recovery should start is recorded in the ICF catalog. The forward recovery utility uses this value to automate this part of the forward recovery process. This recovery point is saved with the backup copy and subsequently replaced in the ICF catalog when the backup copy is restored. For more information, see “Recovery point (non-RLS mode)” on page 227.

- During data set restore and forward recovery processing, CICS does not allow files to be opened for the same data set.

### Batch jobs

During the batch window between CICS sessions, it is possible for batch jobs to update a data set. Because batch jobs do not create forward recovery logs, any update that is made while a BWO backup is in progress, or after it has completed, would not be forward recoverable. Therefore, non-BWO backups should be taken, at least:

- At the start of the batch window so that, if a batch job fails, it can be restarted; and
- At the end of the batch window, for use with CICS forward recovery processing.

All update activity against the data set must be quiesced while the backups are taken, so that DFSMSHsm can have exclusive control of the data set.

After an uncontrolled or immediate shutdown, further BWO backups might be taken by DFSMSHsm, because the BWO status in the ICF catalog is not reset. These backups should be discarded; only the non-BWO backups taken at the end of the batch window should be used during forward recovery, together with the CICS forward recovery logs.

**Data set security:** CICS must have RACF ALTER authority for all data sets that are defined as BACKUPTYPE(DYNAMIC), because CICS needs to update the BWO attributes in the ICF catalog. The authority must apply either to the data set or to the ICF catalog in which the data set is cataloged. For information on defining RACF ALTER authority, see the *CICS RACF Security Guide*.

---

## BWO processing

The information in the remainder of this chapter might be required by the system administrator to recover from error situations due to incorrect operating procedures or hardware failures.

The main data fields used by the BWO facility are:

- Attribute flags in the ICF catalog, to control BWO activity. The DFSMSdftp field dictionary name is VVRSMFLG. For more information about the attribute flags used in connection with BWO, see *DFSMS/MVS Managing Catalogs*.
- Recovery point in the ICF catalog. This point is the time from which the forward recovery utility must start applying log records. It is always before the time that the last backup was taken. It is recorded in local time format (0CYDDDDF HHMMSSSTF) where:

C = century (0=1900, 1=2000, etc.)  
 YY = year  
 DDD = day  
 HH = hours  
 MM = minutes  
 SS = seconds  
 T = tenths of a second  
 F = + sign

The DFSMSdftp field dictionary name is VVRRDATA.



- The BACKUPTYPE attribute in the CICS file resource definition (for DFSMS 1.2), or the BWO option in the ICF catalog (for DFSMS 1.3). When CICS has determined the BWO option from one of these sources, it stores the value into the data set name block (DSNB) for the base cluster at the time the first file referencing the data set is opened.

The attribute flags and recovery point are managed by VSAM in the primary data VSAM volume record (VVR) of the base cluster, which is in the VSAM volume data set (VVDS). There is only one primary base cluster VVR for each VSAM sphere, which is why BWO eligibility is defined at the sphere level. For more information, see *DFSMS/MVS Managing Catalogs*.

BWO processing affects the following operations in a CICS system:

- File opening
- File closing
- Shutdown and restart
- Data set backup and restore
- Journaling and forward recovery logging
- Forward recovery

Each of these operations is discussed in the following sections.

## File opening

Different processing is done for each of the following three cases when a file is opened for update:

- First file opened for update against a cluster
- Subsequent file opened for update against a cluster while the previous file is still open (that is, the update use count in the DSNB is not zero)
- Subsequent file opened for update against a cluster after all previous files have been closed (that is, the update use count in the DSNB is zero)

Each case is described later in this section.

In all three cases, CICS issues warning message DFHFC5812 if BACKUPTYPE(DYNAMIC) is specified for a VSAM AIX data set that is being opened as a standalone base cluster data set. The AIX data set must default to the BACKUPTYPE already defined for the sphere.

Also, if the file-open operation fails during BWO processing, the ACB will be open. So CICS closes the ACB before indicating the file-open operation has failed. This affects CICS statistics.

If the file is opened for read-only, and the data set ICF catalog indicates that the data set is back-level, the file-open operation fails.

### Back-level data sets

In all cases, a file-open operation fails with error messages if the ICF catalog indicates that the data set is back-level. A back-level data set is one that:

- Has been restored from a backup copy, but not forward recovered
- Has been forward recovered, but the forward recovery operation has not completed successfully
- The ICF catalog indicates is corrupted

**Note:** This check<sup>11</sup> occurs irrespective of whether BACKUPTYPE(DYNAMIC) or BACKUPTYPE(STATIC) is specified.

### First file opened in non-RLS mode against a cluster

The following processing is done for the first file that is opened for update against a VSAM base cluster data set after a CICS cold start. (In this case, the update use count in the DSNB for the base cluster is always zero.)

CICS calls the DFSMSdfp IGWABWO callable service to inquire on the BWO attributes in the ICF catalog.

- If the file is defined with BACKUPTYPE(DYNAMIC), CICS calls IGWABWO to make the data set eligible for BWO and to set the recovery point to the current time. CICS also sets the BACKUPTYPE attribute in the DSNB to indicate eligibility for BWO.

However, if the ICF catalog indicates that the data set is already eligible for BWO, IGWABWO just sets the recovery point to the current time. CICS issues a message, and you can discard any BWO backups already taken in a previous batch window.

- If the file was defined with BACKUPTYPE(STATIC) and the ICF catalog indicates that the data set is already ineligible for BWO, CICS sets the BACKUPTYPE attribute in the DSNB to indicate ineligibility for BWO.

However, if the ICF catalog indicates that the data set is currently eligible for BWO, IGWABWO makes it ineligible for BWO and sets the recovery point to the current time. CICS issues a message, and you can discard any BWO backups already taken in a previous batch window.

If BWO support is requested and the appropriate level of DFSMSdfp (as described in “What is needed to use BWO” on page 216) is not correctly installed on the processor where CICS is running, the first file-open operation fails with error message DFHFC5811. Subsequent file-open operations are allowed, but CICS issues an attention message.

CICS also issues an attention message (DFHFC5813) for the first file-open operation if the appropriate levels of DFSMSshsm and DFSMSdss are not installed on the processor where CICS is running. Ensure that they are installed on the processor where the BWO backup is to be made.

---

11. On an initial access to the data set after a restart, this check also help CICS to detect a previous abend in an application or system during control-area or control-interval splits, and helps prevent possible data-integrity problems—particularly when alternate indices exist as part of the update set. This helps the administrator to decide whether to recover from forward-recovery logs or perform transaction backout.

### **Subsequent files opened when use count is not zero**

The following processing is done when a subsequent file is opened for update against a VSAM base cluster data set and the update use count in the DSNB for the base cluster is not zero.

The ICF catalog has already been validated and set by the first file-open operation, so CICS just checks the BACKUPTYPE attributes in the FCT and the DSNB. If they are not consistent, the file-open operation fails with error messages. You must then either correct the CEDA definition, or REMOVE the DSNB after closing all files that are open against the base cluster data set.

### **Subsequent files opened when use count is zero**

The following processing is done when a subsequent file is opened for update against a VSAM base cluster data set and the update use count in the DSNB for the base cluster is zero. This situation could exist in the following cases:

- After a warm or emergency restart of CICS, because the BACKUPTYPE attribute in the DSNB is cataloged in the global catalog (GCD) and is restored at CICS restart
- When all files that are open against a base cluster are closed, and then one or more are reopened

CICS checks the BACKUPTYPE attributes in the FCT and the DSNB. If they are inconsistent, the file-open operation fails with error messages. Either correct the CEDA definition, or REMOVE the DSNB after closing all files that are open against the base cluster data set. If the BACKUPTYPE attributes are consistent, CICS uses the DFSMSdfp IGWABWO callable service to inquire on the BWO attributes in the ICF catalog.

- If the file was defined with BACKUPTYPE(DYNAMIC), IGWABWO makes the data set eligible for BWO and sets the recovery point to the current time. However, if the ICF catalog indicates that the data set is already eligible for BWO, IGWABWO resets the recovery point to the current time. CICS issues an attention message; you can discard any BWO backup copies already taken in a previous batch window.
- If the file was defined with BACKUPTYPE(STATIC) and the ICF catalog indicates that the data set is already ineligible for BWO, the ICF catalog is not updated. However, if the ICF catalog indicates that the data set is currently eligible for BWO, IGWABWO makes it ineligible for BWO and sets the recovery point to the current time. CICS issues an attention message; you should discard any BWO backup copies already taken in a previous batch window.

## **File closing (non-RLS mode)**

When the last file that is open for update is closed against a VSAM base cluster data set, CICS uses the DFSMSdfp IGWABWO callable service to update the ICF catalog to indicate that the data set is no longer eligible for BWO and to reset the recovery point to the current time.

If a VSAM split has occurred while a file was open, CICS calls IGWABWO at file-close time to update the ICF catalog to prevent further BWO backups. If DFSMSshm is currently taking a BWO backup, it will discard the backup at the end of the backup operation.

The BWO attributes indicating that a split has occurred and that the data set is eligible for BWO are restored when the next file is opened for update against the data set. This ensures that DFSMSshm takes the correct action if a split occurs

during backup processing, which spans CICS updating a file (causing a VSAM split), the file being closed, and then the file being reopened.

When CICS is terminated by a normal shutdown, all CICS files are closed. The ICF catalog is updated to suppress BWO activity during the batch window between CICS sessions. After an uncontrolled or immediate shutdown, or if there is a failure during file closing, the data set remains open and the BWO flags are not reset. See “Shutdown and restart”.

#### **Restriction for VSAM upgrade set**

In some circumstances, it might not be possible to take either BWO or non-BWO backups of a data set. The VSAM UPDATE ACB ENQs for a sphere might remain, even though there are no files open for update against this sphere. This could happen if a VSAM sphere contains an AIX in the upgrade set and the following actions occur:

1. The sphere is opened for update via a VSAM path. This causes VSAM to open for update all upgrade clusters for this sphere.
2. A file is opened for read-only against this sphere.
3. The original VSAM path is closed.

The data set is now ineligible for BWO backups because CICS file control has reset the BWO attributes in the ICF catalog. But, until all open ACBs in the sphere are closed, VSAM will not close the internal ACBs that are open for update, and thus it is not possible to take non-BWO backups either.

To remedy this situation, either:

- Close all ACBs for the sphere, or
- Open for update against the base cluster data set a file that is defined with BACKUPTYPE(DYNAMIC).

## **Shutdown and restart**

The way CICS closes files is determined by whether the shutdown is controlled, immediate, or uncontrolled.

### **Controlled shutdown**

During a controlled shutdown, CICS closes all open files defined in the FCT. This ensures that, for files that are open for update and eligible for BWO, the BWO attributes in the ICF catalog are set to a ‘BWO disabled’ state

If a failure occurs during shutdown so that CICS is unable to close a file, CICS issues warning message DFHFC5804. In this case, check the BWO attributes and, if necessary, either use DFSMSdfp IGWABWO callable service to set the attributes, or discard any BWO backups that are taken in the batch window that follows the shutdown.

### **Immediate or uncontrolled shutdown**

During an immediate or uncontrolled shutdown, CICS does not close the files defined in the FCT, and so the BWO attributes in the ICF catalog are not updated.

Use the DFSMSdfp IGWABWO callable service to set the attributes (see “An assembler program that calls DFSMS callable services” on page 230 for an

example of how to do this). Do not run any batch jobs before the next CICS restart. If you do, for releases prior to DFSMS 1.2, discard any BWO backups that are taken in the batch window.

For DFSMS 1.2 onward, the controls in DFSMS allow DFSMSdss to detect a backup that is invalidated if CICS applications are shut down (normally or abnormally) and if batch programs are executed that update the data set while the BWO backup is in progress. This allows DFSMSdss to discard the backup, which prevents DFSMSShsm from erroneously discarding the oldest valid backup from the inventory maintained by DFSMSShsm.

### **Restart**

At the next CICS restart, the following BWO-dependent actions can occur when a data set is opened for update:

- If the BWO attributes in the ICF catalog are set to the 'BWO enabled' state, CICS issues warning message DFHFC5808.
- If the file has been redefined as BACKUPTYPE(STATIC), and:
  - CICS has been cold started
  - The original base cluster DSNB has been discarded
  - The BWO attributes in the ICF catalog are set to the 'BWO enabled' stateCICS issues warning message DFHFC5809.
- If the file has been redefined as BACKUPTYPE(STATIC), and:
  - CICS has been warm or emergency restarted
  - The original base cluster DSNB has been keptCICS fails the file-open operation with message DFHFC5807.

## **Data set backup and restore**

BWO backups are taken at the VSAM sphere level. You can use DFSMSShsm or DFSMSdss to take the backup copy. You are recommended to use DFSMSShsm because, without DFSMSShsm installed, you must supply automatic class selection (ACS) routines to fulfil the SMS requirements for BWO support.

When you use DFSMSShsm, you still use DFSMSdss as the data mover. You can specify this using the DFSMSShsm SETSYS command:

```
SETSYS DATAMOVER(DSS)
```

The DFSMS processing at the start of backup is dependent on the DFSMS release level. For releases prior to DFSMS 1.2, DFSMSdss first checks the BWO attributes in the ICF catalog to see if the data set is eligible for BWO. If it is, the backup is made without attempting to obtain exclusive control and serialize updates to this data set.

For DFSMS 1.2 onward, DFSMSdss first tries to obtain exclusive control of the data set. If DFSMSdss succeeds, an enqueued form of backup takes place. If this serialization fails, DFSMSdss checks the BWO attributes in the ICF catalog to see if the data set is eligible for BWO. If it is, a BWO backup is attempted. If it is not eligible, the backup attempt fails.

This change will prevent DFSMS starting a BWO backup after CICS has abnormally terminated.

At the end of the BWO backup, DFDSS again checks the BWO attributes. If the data set is no longer eligible for BWO, the backup is discarded. Events that cause this situation are:

- File closing during BWO, which sets the 'BWO disabled' state
- Start of VSAM split, which sets the 'BWO enabled and VSAM split in progress' state
- End of VSAM split, which sets the 'BWO enabled/disabled and VSAM split occurred' state.

At the start of a backup, if the state is 'BWO enabled and VSAM split occurred', DFSMSdss resets the state to 'BWO enabled'. Then, if another VSAM split occurs, the backup will be discarded at the end of the backup operation.

### **VSAM access method services**

DFSMS access method services import and export operations do not support BWO in releases earlier than DFSMS 1.2. Access method services always serializes the data set before exporting it; and when the IMPORT function is used, the BWO attributes in the ICF catalog are not updated.

For DFSMS 1.2 onward, access method services supports the import and export of BWO attributes.

### **Invalid state changes for BWO attributes**

CICS, DFSMSdfp, DFSMSdss, and an SMSVSAM server can all update the BWO attributes in the ICF catalog. To prevent errors, DFSMSdss fails a BWO backup if one of the following state changes is attempted during the backup:

- From 'BWO enabled and VSAM split in progress' to 'BWO enabled'. This state change could be attempted if:
  1. At the start of data set backup processing, a request is issued to change the 'BWO enabled and VSAM split occurred' state to the 'BWO enabled' state.
  2. But then, before the 'BWO enabled' state is set, a VSAM split occurs and sets the 'BWO enabled and VSAM split in progress' state.

DFSMSdfp must now disallow the pending change to 'BWO enabled' (and DFSMSdss must fail the backup) because, if the split did not finish before the end of the backup, the invalid backup would not be discarded.

- From 'BWO disabled and VSAM split occurred' to 'BWO enabled'. This state change could be attempted if:
  1. At the start of data set backup processing, a request is issued to change the 'BWO enabled and VSAM split occurred' state to the 'BWO enabled' state.
  2. But then, before the 'BWO enabled' state is set, CICS closes the last file opened for update, and the data set becomes ineligible for BWO. CICS sets the 'BWO disabled and VSAM split occurred' state to ensure that the BWO backup is discarded and that no more BWO backups are taken.

DFSMSdfp must now disallow the pending change to 'BWO enabled' (and DFSMSdss must fail the backup) to prevent the possibility of a BWO backup being taken during a subsequent batch window.

### **Data set restore**

When a BWO backup copy of a data set is restored, using DFSMSShsm RECOVER or DFSMSdss RESTORE, the data set must be serialized to prevent any updates during the restore operation. When the restore is complete, the BWO attributes in the ICF catalog are changed to a 'Backup restored by DFSMSShsm' state. CICS cannot open the data set until forward recovery has been completed successfully.

DFSMSdss also resets the recovery point in the ICF catalog to the value it contained when the backup was made. This ensures that forward recovery starts at the correct point. This value should not be used for forward recovery of a non-BWO backup.

**Non-SMS managed storage:** If a BWO backup is restored in storage that is not SMS-managed, the BWO attributes in the ICF catalog are lost. Thus forward recovery is not possible.

## Forward recovery logging

The forward recovery utility uses the forward recovery logs to recover a base cluster. To do this, it must know:

- The data set to associate with each record on the logs
- The point from which to start recovery

### Data sets

Each data set after-image record on the log is associated with a file name. However, there might be many files associated with the same data set; therefore, when a file is opened, the association between the file and the data set is recorded on the forward recovery log by a tie-up record. This information is also written to the log of logs. For non-BWO backups, the forward recovery utility uses this tie-up record to apply the log records to the correct data sets.

When a BWO is taken for a data set opened in RLS mode, DFSMSdss notifies each CICS region having an open ACB for the dataset. On receipt of this notification, each CICS allows all units of work with updates for the data set to complete, and then they write the tie-up records to the forward recovery log and the log of logs, and replies to DFSMSdss.

For BWO backups, it is usually not necessary for the forward recovery utility to process a log from file-open time. Therefore, the tie-up records for all open files are written regularly on the log during activity-keypoint processing, and the time that they are written is recorded. To reduce the number of tie-up records if the activity keypoint frequency is high (such as for some large systems), CICS ensures that there is at least 30 minutes' separation between sets of tie-ups on the log.

### Recovery point (non-RLS mode)

The recovery point is a time that can be converted to a position on a forward recovery log. Recovery of the data set requires only the records that are written after that position. Thus all previous records can be ignored by the forward recovery utility.

The recovery point is stored in the ICF catalog. It is initialized when the first file is opened for update against the data set, and updated during activity-keypoint processing and when the file is closed.

The recovery point is not the time of the current keypoint, as there might still be some uncommitted log records that have not been forced. Instead, it is the time of the start of the last keypoint that wrote a complete set of tie-up records and that completed earlier than the oldest uncommitted write to a forward recovery log.

### Notes:

1. Only one new recovery point is calculated during an activity keypoint. It is used for all data sets that are open for update and eligible for BWO. Thus a long-running task updating a data set that uses BWO will affect the amount of forward recovery needed for all data sets.

2. If you disable activity keypointing in your system (by specifying the AKPFREQ system initialization parameter as zero), BWO support is seriously affected because, after the file-open operation, no more tie-up records are written and the recovery point is not updated. So, forward recovery of a BWO data set must take place from the time that the data set was first opened for update.

## Forward recovery

CICSVR fully supports BWO and the log of logs. If you do not use CICSVR, ensure that your forward recovery utility is able to:

- Recognize whether a backup was made with BWO or not. The DFSMSshm ARCXTRCT macro can be used to determine this.
- Use the BWO attributes and recovery point in the ICF catalog. It should use the DFSMSdfp IGWABWO callable service to do this. See “An assembler program that calls DFSMS callable services” on page 230 for a sample program.
- Recognize the additional tie-up records on the forward recovery logs and, optionally, recognize tie-up records on the log of logs. These are written so that the forward recovery utility can quickly find the correct position without having to scan the entire forward recovery log.
- Recognize after-images that have already been applied to the data set.

The forward recovery utility should ALLOCATE, with DISP=OLD, the data set that is to be recovered. This prevents other jobs accessing a back level data set and ensures that data managers such as CICS are not still using the data set.

Before the data set is opened, the forward recovery utility should set the BWO attribute flags to the ‘Forward recovery started but not ended’ state. This prevents DFSMSshm taking BWO backups while forward recovery is in progress. To prevent CICS opening a back level data set, the utility should perform this state change for all data sets in a system that supports BWO, even if some do not use BWO.

The forward recovery utility should use the BWO time stamp for the data set in the ICF catalog, set by DFSMSdss when the data set is restored, to determine the starting point in the forward recovery log to start the forward recovery.

If forward recovery completes successfully, the utility should set the BWO attributes to the ‘BWO disabled’ state before the data set is closed.

If forward recovery does not complete successfully, the utility should leave the BWO attributes in the ‘Forward recovery started but not ended’ state to ensure that CICS does not open a back-level data set.

If forward recovery does not complete successfully:

1. Determine and correct the reason for the failure
2. Delete the partially-recovered data set
3. Restore the backup copy
4. Reattempt forward recovery

**Note:** The EXEC CICS SET DSNAME RECOVERED system programmer command (or the CEMT equivalent) resets the BWO attributes in the ICF catalog to indicate ‘BWO disabled’. If you use this command for a data set that has been restored but not forward recovered, and then you subsequently open this data set, CICS will be unaware that forward recovery has been overridden and CICS may access back level data. However, in



exceptional circumstances, it may be necessary to allow CICS to access back level data. This command has been provided to allow this to happen.

Alternatively, if you use a VSAM forward recovery utility that does not update the BWO attributes during forward recovery, you may use these commands to reset the backup-restored-by-DFSMSHsm state prior to subsequent CICS file control access.

## **Recovering VSAM spheres with AIXs**

Before you can forward recover a data set that was restored from a copy made using BWO, ensure that no AIXs are in the upgrade set. CICSVR checks the upgrade set of data sets restored from BWO copies and issues a message if AIXs are found.

To forward recover such a data set, after the restore, use the AMS ALTER or DELETE command to remove or delete the AIXs from the upgrade set. After forward recovery has completed successfully, you can re-create the upgrade set by rebuilding the AIXs using the access method services BLDINDEX command.

---

## An assembler program that calls DFSMS callable services

```
*ASM XOPTS(CICS,NOEPILOG,SP)
*
* A program that can be run as a CICS transaction to Read and Set
* the BWO Indicators and BWO Recovery Point via DFSMS Callable
* Services (IGWABWO).
*
* Invoke the program via a CICS transaction as follows:
*
* Rxxx 'data_set_name'
* Sxxx 100 'data_set_name'
*
* Where:
* Rxxx and Sxxx are the names of the transactions that will invoke
* this program. Specify Rxxx to read and Sxxx to set the BWO
* attributes.
* 'data_set_name' is the fully-qualified name of your data set
* 100 is the value the BWO indicators will be set to.
* The BWO Recovery Point time will be set to the current date and
* time returned from the CICS ASKTIME function.
*
DFHEISTG DSECT
INDATA DS 0CL53 Input data stream
*
* First character of tran id indicates transaction function
*
TRANFUNC DS C First char of tran id - S=SET R=READ
          DS 4C Remainder of tran id and space
BWO1 DS C First BWO indicator
BWO2 DS C Second BWO indicator
BWO3 DS C Third BWO indicator
          DS C Space
DSNAMES DS 44C Target data set name 1-44 chars
*
* 2 possible formats of input line, so overlay the definitions
*
          ORG INDATA
          DS 5C Tran id and space
DSNAMER DS 44C Target data set name 1-44 chars
          DS 4C Filler
*
INLENGTH DS H Length of input data stream
*
* Parmlist for IGWABWO call
*
PARMLST DS 10A
RETCODE DS F Return code
REASON DS F Reason
PROBDET DS D Problem determination code
FUNC DS F Function
READ EQU 0 Read
SET EQU 1 Set
DSNLEN DS F Data set name length
DSN DS 44C Data set name
BWOFLAGS DS 03F BWO indicator flags
          ORG BWOFLAGS
BWO1 DS F BWO indicator 1
BWO2 DS F BWO indicator 2
BWO3 DS F BWO indicator 3
BWOTIME DS D BWO recovery point time
RESERVED DS 2D Reserved
*
* Success message
*
SUCMSG DS 0CL66 Define storage for success message
```

```

DS 30C
DATEVAL DS 8C      Date value from BWO recovery point
SUCMSG1 DS 8C      Message text
TIMEVAL DS 8C      Time value from BWO recovery point
SUCMSG2 DS C       Message text
READMSG DS 0CL11  If function = READ put out BWO flags
DS 7C             Message text
BWOVAL1 DS C       BWO indicator 1
BWOVAL2 DS C       BWO indicator 2
BWOVAL3 DS C       BWO indicator 3
DS C             Message text
*
DATETIME DS D      Current date and time value
*
RECOVPT DS 0D      BWO recovery point
DTZERO DS B        Date dword
DTCENTRY DS B
DTDATE DS 5B
DTSIGN1 DS B
*
DTTIME DS 6B      Time dword
DTTENTHS DS B
DTSIGN2 DS B
*
RECOVPTP DS 0D     Packed recovery point
DATEPACK DS F      Packed version of date
TIMEPACK DS F      Packed version of time
*
DFHREGS
PROG CSECT
PROG AMODE 31
*
* Initialise INTO field for RECEIVE
*
MVC DSNAMER(48),BLANKS
MVC INLENGTH(2),INMAXLEN
*
EXEC CICS RECEIVE INTO(INDATA) LENGTH(INLENGTH)
*
CLI TRANFUNC,C'S'      Set or Read call?
BNE PRGREAD
*
* Set up the parameters for a SET call
*
SR R4,R4
LA R4,SET(0)
ST R4,FUNC             Set function
MVC DSN(44),DSNAMES   Set data set name
LH R4,INLENGTH
S R4,PRELENS          Subtract tran id + space + BWO ind
ST R4,DSNLEN          Set data set name length
*
EXEC CICS ASKTIME ABSTIME(DATETIME)
EXEC CICS FORMATIME ABSTIME(DATETIME) YYDDD(DTDATE)      *
TIME(DTTIME)
*
PACK KEYWORK(5),RECOVPT(9) Packed date field
MVC DATEPACK(4),KEYWORK
PACK KEYWORK(5),RECOVPT+8(9) Packed time field
MVC TIMEPACK(4),KEYWORK
XC RECOVPTP(1),RECOVPTP Set century 0=1900, 1=2000
OI RECOVPTP+3,X'0F' Set +ve sign for date
OI RECOVPTP+7,X'0F' Set +ve sign for time
MVC BWOTIME(8),RECOVPTP Set BWO recovery point time
*
EXEC CICS SYNCPOINT
*

```

```

        MVC  BWOF1(12),ZEROES
        LA   R4,1(0)
        CLI  BWOC1,C'0'
        BE   PRGBIT2
PRGBIT2 ST   R4,BWOF1           Set BWO indicator 1 if required
        DS   0H
        CLI  BWOC2,C'0'
        BE   PRGBIT3
PRGBIT3 ST   R4,BWOF2           Set BWO indicator 2 if required
        DS   0H
        CLI  BWOC3,C'0'
        BE   PRGCONT
        ST   R4,BWOF3           Set BWO indicator 3 if required
        B    PRGCONT
PRGREAD DS   0H
        CLI  TRANFUNC,C'R'
        BNE  PRGABORT           If tran id not R or S then abort
*
* Set up the parameters for a read call
*
        SR   R4,R4
        LA   R4,READ(0)
        ST   R4,FUNC           Set function
        MVC  DSN(44),DSNAMER   Set data set name
        LH   R4,INLENGTH
        S    R4,PRELENR        Subtract tranid + space
        ST   R4,DSNLEN        Set data set name length
PRGCONT DS   0H
*
* OK, our parameters are set up, so create the address list, and make
* the call
*
        LOAD EP=IGWABWO,ERRET=PRGABORT
        LR   R15,R0
        LA   R1,PARMLST       R1 -> parmlist
        LA   R4,RETCODE
        ST   R4,0(R1)         Pass addr of return code
        LA   R4,REASON
        ST   R4,4(R1)         Pass addr of reason code
        LA   R4,PROBDET
        ST   R4,8(R1)         Pass addr of problem determination
        LA   R4,FUNC
        ST   R4,12(R1)        Pass addr of function required
        LA   R4,DSNLEN
        ST   R4,16(R1)        Pass addr of data set name length
        LA   R4,DSN
        ST   R4,20(R1)        Pass addr of data set name
        LA   R4,SEL
        ST   R4,24(R1)        Pass addr of selection mask
        LA   R4,BWOF1
        ST   R4,28(R1)        Pass addr of BWO flags
        LA   R4,BWOTIME
        ST   R4,32(R1)        Pass addr of BWO recovery point
        LA   R4,RESERVED
        ST   R4,36(R1)        Pass addr of reserved field
        BALR 14,15           Call IGWABWO
*
* Back from the call, check return code
*
        SR   R4,R4
        CL   R4,RETCODE       Check return code
        BNE  PRGABORT
*
* All OK, set up minimum success message, decide if we need more
*
        MVC  SUCMSG(38),SUCTX  Set up message text

```

```

MVC SUCMSG1(8),SUCTXT1
MVC SUCMSG2(1),SUCTXT2
UNPK KEYWORK(9),BWOTIME(5)  Make date printable
TR  KEYWORK(8),HEXTAB-C'0'
MVC DATEVAL(8),KEYWORK
UNPK KEYWORK(9),BWOTIME+4(5)  Make time printable
TR  KEYWORK(8),HEXTAB-C'0'
MVC TIMEVAL(8),KEYWORK
CLI  TRANFUNC,C'S'           If READ then print BWO flags
BNE  PRGREADO

*
* Got all the info we need, so put it out and exit
*
EXEC CICS SEND TEXT FROM(SUCMSG) LENGTH(55) ERASE WAIT
*
B  PRGEXIT
*
* It's a read so we also need the BWO flags for output
*
PRGREADO DS  0H
MVC READMSG(11),READTXT      Set up message text
MVC BWOVAL1,BWOF1+3
OI  BWOVAL1,X'F0'           Set BWO indicator 1
MVC BWOVAL2,BWOF2+3
OI  BWOVAL2,X'F0'           Set BWO indicator 2
MVC BWOVAL3,BWOF3+3
OI  BWOVAL3,X'F0'           Set BWO indicator 3
*
* Now send the message
*
EXEC CICS SEND TEXT FROM(SUCMSG) LENGTH(66) ERASE WAIT
*
PRGEXIT DS  0H
EXEC CICS RETie-up recordN
*
PRGABORT DS  0D
EXEC CICS SEND TEXT FROM(FAILMSG) LENGTH(19) ERASE WAIT
*
EXEC CICS RETie-up recordN
*
* Constant declarations
BLANKS  DC  48C' '
INMAXLEN DC  H'53'
ZEROES  DC  3F'0'
PRELENS DC  F'9'
PRELENR DC  F'5'
SUCTXT  DC  C'IGWABWO call completed Date = '
SUCTXT1 DC  C' Time = '
SUCTXT2 DC  C'.'
READTXT DC  C' BWO = .'
FAILMSG DC  C'IGWABWO call failed'
KEYWORK DC  CL9' '
HEXTAB  DC  C'0123456789ABCDEF'
*
* Constant for IGWABWO SELECT parameter
*
SEL      DC  F'3'           Interested in BWO flags & recov point
*          F'1'           Interested in BWO flags
*          F'2'           Interested in BWO recovery point
*          F'3'           Interested in BWO flags & recov point
END PROG

```



---

## Chapter 20. Disaster recovery

If your CICS system is normally available about 99 percent of the time, it would be wise to look at your disaster recovery plan. The same pressure that drives high availability drives the need for timely and current disaster recovery.

This chapter describes what you need to consider when planning for disaster recovery in a CICS environment: It covers the following topics:

- “Why have a disaster recovery plan?”
- “Disaster recovery testing” on page 236
- “Six tiers of solutions for off-site recovery” on page 237
- “Disaster recovery and high availability” on page 247
- “Disaster recovery facilities” on page 251
- “CICS emergency restart considerations” on page 252
- “Final summary” on page 253

---

### Why have a disaster recovery plan?

There is one simple question to ask yourself to determine whether you need a disaster recovery plan: “*Can my business continue to function without my CICS system?*” An unqualified, “*Yes, my business can continue to function without my CICS system and the data it accesses*” is the only answer that indicates that you do not need a disaster recovery plan. To build a disaster recovery plan you need to take into account a number of items unique to disaster recovery. They include:

- What data is vital to my business?
- How long can the data be unavailable?
- How current does the data need to be?
- What is the cost of a disaster to my company?
- What is the cost of my disaster recovery plan?
- Is performance after a disaster a consideration?
- What type of disaster is possible, or even likely, and how long will it affect my system?

You may consider some, or all, of your CICS applications as vital to the operations of your business. If all applications are vital, you need to recover all the data that your CICS systems use. If only some of your applications are vital, you have to determine what data is associated with those applications.

The length of time between the disaster and recovery of your vital applications is a key factor. If your business cannot continue without access to your CICS data, your disaster recovery plan must take this into account.

The time-sensitive nature of your recovered data can be an overriding factor. If your vital application is a high volume, high change application, recovering week-old data may not be acceptable—even hour-old data may be unacceptable. You may need to recover right up to the point of the disaster.

The type of disaster from which you plan to recover can determine where your disaster recovery site is located. If you foresee only fire and water damage to your computer floor, a disaster recovery site in the building next door may be acceptable. If you are located in an area prone to hurricanes or earthquakes, for example, a disaster recovery site next door would be pointless.

When you are planning for disaster recovery, consider the cost of being unable to operate your business for a period of time. You have to consider the number of lost transactions, and the future loss of business as your customers go elsewhere. Your disaster recovery solution should not be more expensive than the loss from the disaster, unless your business would fail as a result of the outage caused by a disaster.

What is the real cost of your disaster recovery plan? Keeping track of the total cost of your disaster recovery procedures allows you to look at available options and judge the benefits and cost of each.

Your disaster recovery plan should include some performance considerations once you have recovered. Unless your disaster site mirrors your production site, you should determine acceptable levels of throughput and transaction times while operating from the disaster recovery site. The length of time it takes to recover your primary site can also determine what your disaster recovery site has to support in the interim.

Figure 40 shows that risk, speed of recovery, and completeness of recovery have to be balanced against cost.

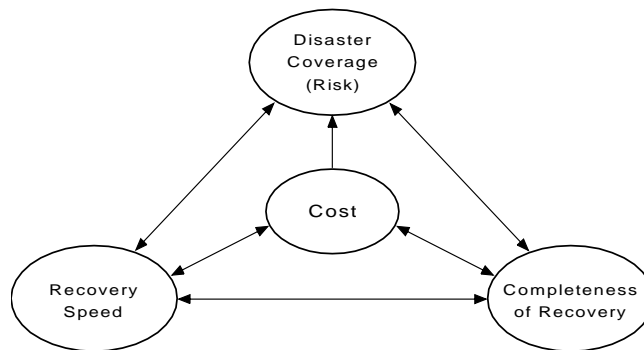

Figure 40. Disaster recovery: cost, completeness, speed, and risk

---

## Disaster recovery testing

Testing is an essential part of disaster recovery planning. All too frequently, just creating a disaster recovery plan results in a false sense of security. If you don't test your disaster recovery plan, there's a risk that it won't work when you really need it.

Whenever possible, you should choose a remote site recovery strategy that you can test frequently. Testing your disaster recovery process has the following benefits:

- You know that your recovery plan works.
- You discover problems, mistakes, and errors, and can resolve them before you have to use the procedures.
- Your staff are educated in executing tests and managing disaster recovery situations.
- Your recovery plan becomes a living document.
- Members of your IT organization recognize the necessity of such a disaster recovery concept, and plan accordingly.
- Awareness of your disaster recovery strategy is increased.



After each test, use the detailed logs and schedules to identify any errors in your procedures, and eliminate them. Retest the changed procedures, and then incorporate them into your recovery plan. After changing the recovery plan, completely revise all existing disaster recovery documents.

Make frequent tests early in the implementation of your disaster recovery plan. Once you have removed the major problems, you can test less frequently. The frequency will depend on:

- The interval between major changes in your hardware and software
- How current you want to keep the recovery plan
- How critical and sensitive your business processes are: the more critical they are, the more frequently testing may be required.

---

## Six tiers of solutions for off-site recovery

One blueprint<sup>12</sup> for recovery planning describes a scheme consisting of six tiers of off-site recoverability (tiers 1—6), with a seventh tier (tier 0) that relies on local recovery only, with no off-site backup. The tiers cover a full range of recovery options, ranging from no data moved off-site to full off-site copies with no loss of data. The following figures and text describe them from a CICS perspective.

### Tier 0—no off-site data

Figure 41 summarizes the tier 0 solution.

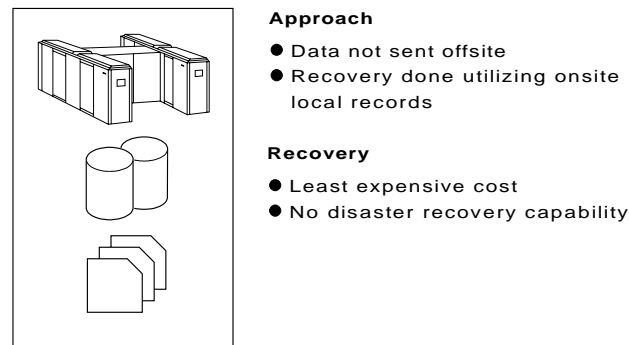

Figure 41. Disaster recovery tier 0: no off-site backup

Tier 0 is defined as having no requirements to save information off-site, establish a backup hardware platform, or develop a disaster recovery plan. Tier 0 is the no-cost disaster recovery solution.

Any disaster recovery capability would depend on recovering on-site local records. For most true disasters, such as fire or earthquake, you would not be able to recover your data or systems if you implemented a tier 0 solution.

---

12. In a paper presented to IBM SHARE, prepared by the SHARE automated remote site recovery task force.

## Tier 1—physical removal

Figure 42 summarizes the tier 1 solution.

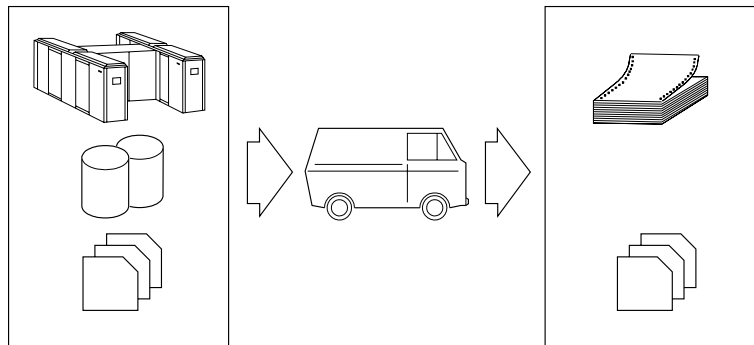

### Approach

- Backups kept offsite
- Procedures and inventory offsite
- Recovery - install required hardware, restore system and data, reconnect to network

### Recovery

- Relatively low cost
- Difficult to manage
- Most important applications resolved first
- Recovery possible, but may take a long time

Figure 42. Disaster recovery tier 1: physical removal

Tier 1 is defined as having:

- A disaster recovery plan
- Required data set backups physically removed and transported to an off-site storage facility
- Optionally, a backup site, but without the required hardware currently installed.

Your disaster recovery plan has to include information to guide the staff responsible for recovering your system, from hardware requirements to day-to-day operations.

The backups required for off-site storage must be created periodically. After a disaster, your data can only be as up-to-date as the last backup—daily, weekly, monthly, or whatever period you chose—because your recovery action is to restore the backups at the recovery site (when you have one).

This method may not meet your requirements if you need your online systems to be continuously available.

- If you require data from two or more subsystems to be synchronized, for example, from DB2 and VSAM, you would have to stop updates to both, then copy both sets of data.
- Such subsystems would both be unavailable for update until the longest running copy is finished.
- If you require a point-in-time copy for all your data, your application may be unavailable for updates for a considerable time.

The major benefit of tier 1 is the low cost. The major costs are the storage site and transportation.

The drawbacks are:

- Setting up a computer floor, and obtaining the necessary hardware after a disaster can take a long time.
- Recovery is to the point in time of your last backups. You have no computer record, such as forward recovery logs, of any transactions that took place after these backups were taken.
- The process is difficult to manage.
- Your disaster recovery plan is difficult to test.

#### **Tier 1**

Tier 1 provides a very basic level of disaster recovery. You will lose data in the disaster, perhaps a considerable amount. However, tier 1 allows you to recover and provide some form of service at low cost. You must assess whether the loss of data and the time taken to restore a service will prevent your company from continuing in business.

## Tier 2—physical removal with hot site

Figure 43 summarizes the tier 2 solution.

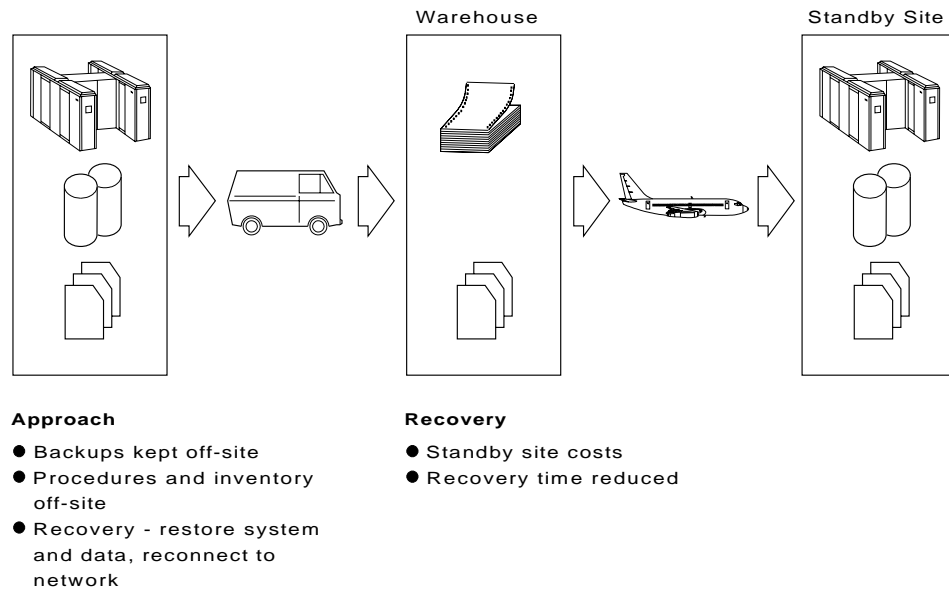

Figure 43. Disaster recovery tier 2: physical removal to a 'hot' standby site

Tier 2 is similar to tier 1. The difference in tier 2 is that a secondary site already has the necessary hardware installed, which can be made available to support the vital applications of the primary site. The same process is used to backup and store the vital data; therefore the same availability issues exist at the primary site as for tier 1.

The benefits of tier 2 are the elimination of the time it takes to obtain and setup the hardware at the secondary site, and the ability to test your disaster recovery plan.

The drawback is the expense of providing, or contracting for, a 'hot' standby site.

### Tier 2

Tier 2, like tier 1, provides a very basic level of disaster recovery. You will lose data in the disaster, perhaps a considerable amount. However, tier 2 allows you to recover and provide some form of service at low cost and more rapidly than tier 1. You must assess whether the loss of data and the time taken to restore a service will prevent your company from continuing in business.

## Tier 3—electronic vaulting

Figure 44 summarizes the tier 3 solution.

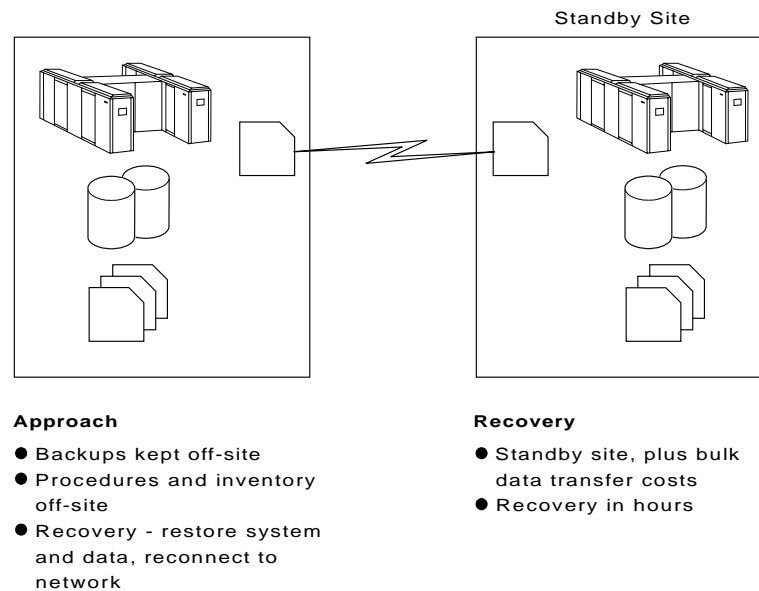

Figure 44. Disaster recovery tier 3: electronic vaulting

Tier 3 is similar to tier 2. The difference is that data is electronically transmitted to the hot site. This eliminates physical transportation of data and the off-site storage warehouse. The same process is used to backup the data, so the same primary site availability issues exist in tier 3 as in tiers 1 and 2.

The benefits of tier 3 are:

- Faster recovery, as the data does not have to be retrieved from off-site and down-loaded.
- No need to ship the backups manually to a warehouse and store them.

The drawbacks are the cost of reserving the DASD at the hot standby site, and that you must have a link to the hot site, and the required software, to transfer the data.

Procedures and documentation still have to be available at the hot site, but this can be achieved electronically.

### Tier 3

Tier 3, like tiers 1 and 2, provides a basic level of disaster recovery. You will lose data in the disaster, perhaps a considerable amount of data. The advantage of tier 3 is that you should be able to provide a service to your users quite rapidly. You must assess whether the loss of data will prevent your company from continuing in business.

## Tier 0–3 solutions

Figure 45 summarizes the solutions for tiers 0 through 3, and shows the approximate time required for a recovery with each tier of solution.

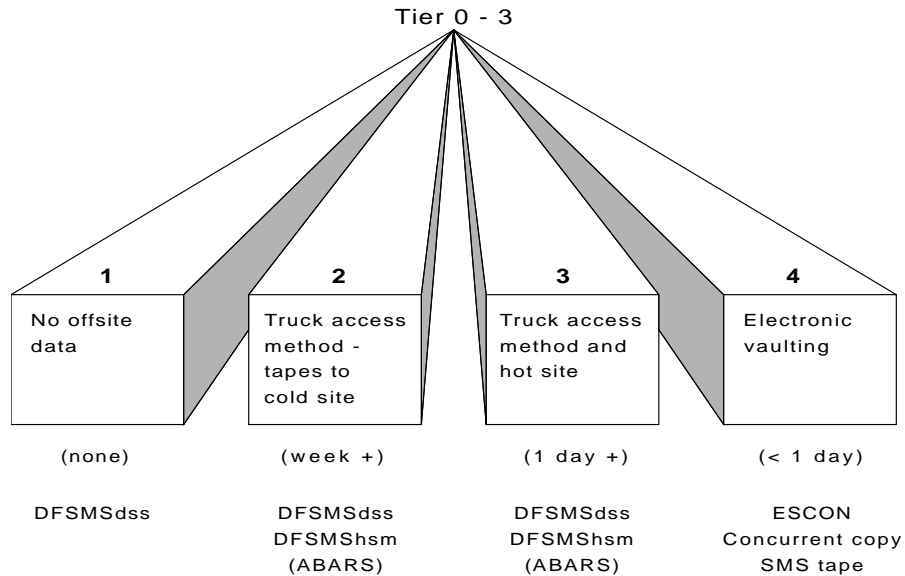

Figure 45. Disaster recovery tier 0-3: summary of solutions

Tiers 0 to 3 cover the disaster recovery plans of many CICS users. With the exception of tier 0, they employ the same basic design using a point-in-time copy of the necessary data. That data is then moved off-site to be used when required after a disaster.

The advantage of these methods is their low cost.

The disadvantages of these methods are:

- Recovery is slow, and it can take days or weeks to recover.
- Any recovery is incomplete, because any updates made after the point-in-time backup are lost.
- Disaster recovery is risky, and difficulties in testing your disaster recovery plan could lead to incomplete recovery.

## Tier 4—active secondary site

Figure 46 summarizes the tier 4 solution.

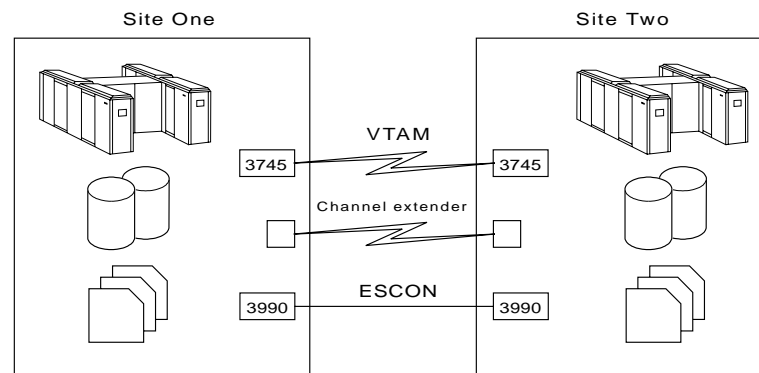

### Approach

- Workload may be shared
- Site one backs up site two and the reverse
- Critical applications and data are online
- Switch network
- Recover other applications

### Recovery

- Continuous transmission of data
- Dual online for critical data
- Network switching capability
- Recovery in minutes to hours

Figure 46. Disaster recovery tier 4: active secondary site

Tier 4 closes the gap between the point-in-time backups and current online processing recovery. Under a tier 4 recovery plan, site one acts as a backup to site two, and site two acts as a backup to site one.

Tier 4 duplicates the vital data of each system at the other's site. You must transmit image copies of data to the alternate site on a regular basis. You must also transmit CICS system logs and forward recovery logs, after they have been archived. Similarly, you must transmit logs for IMS and DB2 subsystems. Your recovery action is to perform a forward recovery of the data at the alternate site. This allows recovery up to the point of the latest closed log for each subsystem.

You must also copy to the alternate site other vital data that is necessary to run your system. For example, you must copy your load libraries and JCL. You can do this on a regular basis, or when the libraries and JCL change.

The benefits of tier 4 are:

- Recovery is fast, with the required hardware and software already in place at the secondary site.
- Recovery is more complete than in the tier 1 to 3 solutions. You can recover all data to the end of the log for each of your data subsystems.
- Recovery risk is low, because you can easily test your procedures.

The drawbacks are:

- Recovery is more difficult to manage, as you have to ensure that all the logs and copies are transmitted to the other system.
- This solution introduces synchronization problems. Logs for different data subsystems are transmitted at different times. When you complete your recovery at the secondary site, you could find that your VSAM data is complete up to 30 minutes before the disaster, whereas your DB2 data is complete up to 15

minutes before the disaster. If your data must be synchronized, you may have to develop further procedures to resynchronize data in different subsystems.

- Cost is higher than for the tier 1 to 3 solutions, because you need dedicated hardware, software, and communication links.

#### Tier 4

Tier 4 provides a more advanced level of disaster recovery. You will lose data in the disaster, but only a few minutes- or hours-worth. You must assess whether the loss of data will prevent your company from continuing in business, and what the cost of lost data will be.

## Tier 5—two-site, two-phase commit

Figure 47 summarizes the tier 5 solution.

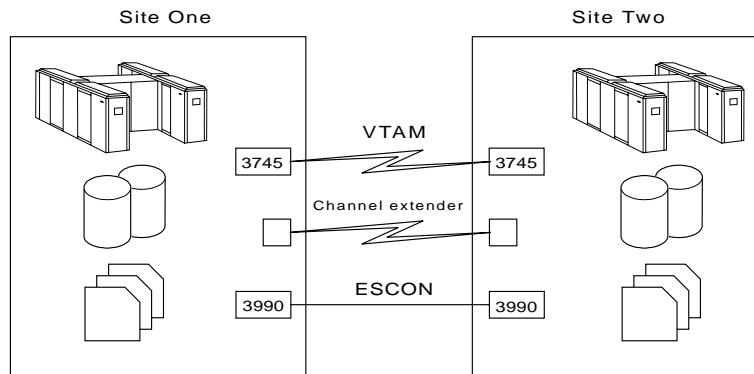

#### Approach

- Shadow data synchronized by remote two phase commit
- Reconnect network

#### Recovery

- Recovery time in minutes
- Only inflight data lost

Figure 47. Disaster recovery tier 5: two site, two-phase commit

Tier 5, remote two-phase commit, is an application-based solution to provide high currency of data at a remote site. This requires partially or fully dedicated hardware at the remote site to keep the vital data in image format and to perform the two-phase commit. The vital data at the remote site and the primary site is updated or backed out as a single unit of work (UOW). This ensures that the only vital data lost would be from transactions that are in process when the disaster occurs.

Other data required to run your vital application has to be sent to the secondary site as well. For example, current load libraries and documentation has to be kept up-to-date on the secondary site.

The benefits of tier 5 are fast recovery using vital data that is current. The drawbacks are:

- The cost of maintaining and running two sites.
- The solution is application program dependent. You must write your applications so that they write data both locally and remotely, by transmitting data to a partner application at the remote site that also writes the data.
- This solution increases the time transactions take to respond. Your application program waits every time it needs to transmit data to the remote site.



### Tier 5

A Tier 5 solution is appropriate for a custom-designed recovery plan with special applications. Because these applications must be designed to use this solution, it cannot be implemented at most CICS sites.

## Tier 6—minimal to zero data loss

Figure 48 summarizes the tier 6 solution.

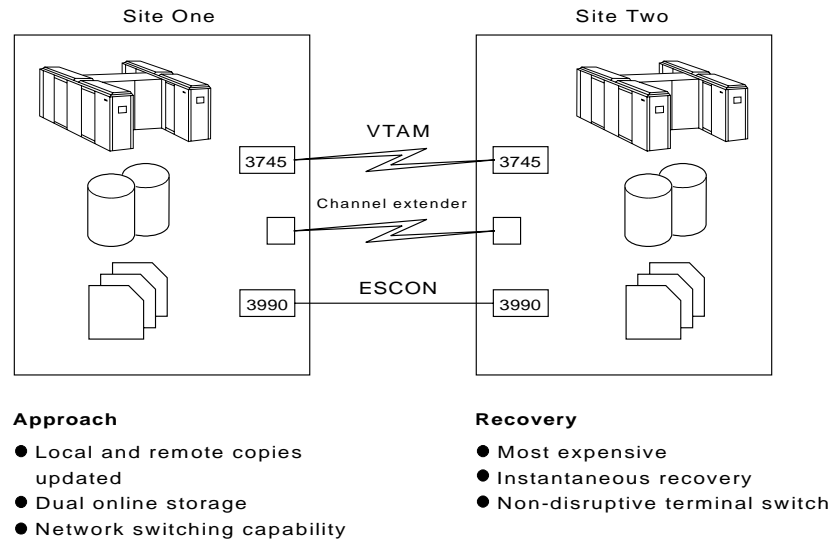

Figure 48. Disaster recovery tier 6: minimal to zero data loss

Tier 6, minimal to zero data loss, is the ultimate level of disaster recovery.

There are two tier 6 solutions, one hardware-based and the other software-based. For details of the hardware and software available for these solutions, see “Peer-to-peer remote copy (PPRC) and extended remote copy (XRC)” on page 247 (hardware) and “Remote Recovery Data Facility” on page 249 (software).

The hardware solution involves the use of IBM 3990-6 DASD controllers with remote and local copies of vital data. There are two flavors of the hardware solution: (1) peer-to-peer remote copy (PPRC), and (2) extended remote copy (XRC).

The software solution involves the use of Remote Recovery Data Facility (RRDF). RRDF applies to data sets managed by CICS file control and to the DB2, IMS, IDMS, CPCS, ADABAS, and SuperMICR database management systems, collecting real-time log and journal data from them. RRDF is supplied by E-Net Corporation and is available from IBM as part of the IBM Cooperative Software Program.

The benefits of tier 6 are:

- No loss of data.
- Recovery in a very short period of time.
- Emergency restart at remote site should be possible.

The drawbacks are the cost of running two sites and the communication overhead. If you are using the hardware solution based on 3990-6 controllers, you are limited in how far away your recovery site can be. If you use PPRC, updates are sent from the primary 3990-6 directly to the 3990-6 at your recovery site using enterprise systems connection (ESCON®) links between the two 3990-6 devices. The 3990-6 devices can be up to 43 km (26.7 miles) apart subject to quotation.

If you use XRC, the 3990-6 devices at the primary and recovery sites can be attached to the XRC DFSMS/MVS host at up to 43 km (26.7 miles) using ESCON links (subject to quotation). If you use three sites, one for the primary 3990, one to support the XRC DFSMS/MVS host, and one for the recovery 3990, this allows a total of 86 km (53.4 miles) between the 3990s. If you use channel extenders with XRC, there is no limit on the distance between your primary and remote site.

For RRDF there is no limit to the distance between the primary and secondary sites.

**Tier 6**

Tier 6 provides a very complete level of disaster recovery. You must assess whether the cost of achieving this level of disaster recovery is justified for your company.

**Tier 4–6 solutions**

Figure 49 summarizes the solutions for tiers 4 through 6, and shows the approximate time required for a recovery with each tier of solution.

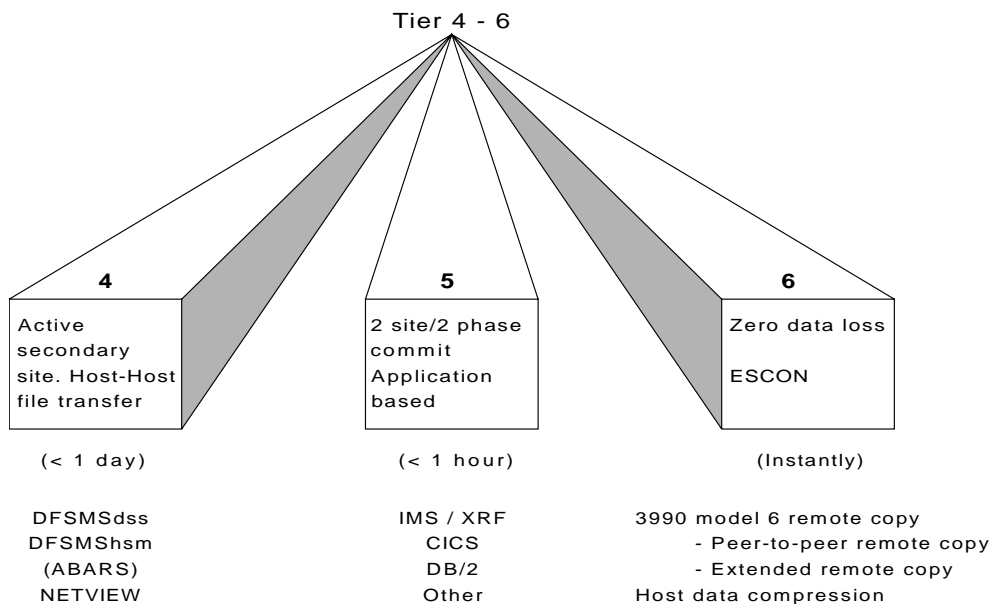

Figure 49. Disaster Recovery Tier 4-6: Summary of Solutions

This summary shows the three tiers and the various tools for each that can help you reach your required level of disaster recovery.

Tier 4 relies on automation to send backups to the remote site. NetView® provides the ability to schedule work in order to maintain recoverability at the remote site.

Tier 5 relies on the two-phase commit processing supported by various database products and your application program's use of these features. Tier 5 requires additional backup processing to ensure that vital data, other than databases, is copied to the remote system.

Tier 6 is divided into two sections: software solutions for specific access methods and database management systems, and hardware solutions for any data.

RRDF can provide very high currency and recoverability for a wide range of data. However, it does not cover all the data in which you may be interested. For example, RRDF does not support load module libraries.

The 3990-6 hardware solution is independent of the data being stored on the DASD. PPRC and XRC can be used for databases, CICS files, logs, and any other data sets that you need to ensure complete recovery on the remote system.

---

## Disaster recovery and high availability

This section describes the tier 6 solutions for high availability and data currency when recovering from a disaster.

### Peer-to-peer remote copy (PPRC) and extended remote copy (XRC)

PPRC and XRC are both 3990-6 hardware solutions that provide data currency to secondary, remote volumes. Updates made to secondary DASD are kept in time sequence. This ensures that updates are applied consistently across volumes. PPRC and XRC also ensure that updates are applied in time sequence across control units as well. This sequencing offers a very high degree of data integrity across volumes behind different control units.

Because PPRC and XRC are hardware solutions, they are application, and data, independent. The data can be DB2, VSAM, IMS, or any other type of data. All your vital data on DASD can be duplicated off-site. This reduces the complexity of recovery. These solutions can also make use of redundant array of independent disks (RAID) DASD to deliver the highest levels of data integrity and availability.

PPRC synchronously shadows updates from the primary to the secondary site. This ensures that no data is lost between the data committed on the primary and secondary DASD. The time taken for the synchronous write to the secondary unit has an impact on your application, increasing response time. This additional time (required for each write operation) is approximately equivalent to a DASD fastwrite operation. Because the implementation of PPRC is almost entirely in the 3990-6, you must provide enough capacity for cache and non-volatile storage (NVS) to ensure optimum performance.

XRC is an asynchronous implementation of remote copy. The application updates the primary data as usual, and XRC then passes the updates to the secondary site. The currency of the secondary site lags slightly behind the primary site because of updates in transit. As part of XRC data management, updates to the secondary site are performed in the same sequence as at the primary site. This ensures data integrity across controllers and devices. Because XRC does not wait for updates to be made at the secondary site, the application's performance is not directly affected. XRC uses cache and non-volatile storage, so you must provide enough capacity to ensure optimum performance.

In the event of a disaster, check the state of all secondary volumes to ensure data consistency against the shadowed log data sets. This ensures that the same sequence of updates is maintained on the secondary volumes as on the primary volumes up to the point of the disaster. Because PPRC and XRC do not require restores or forward recovery of data, your restart procedures on the secondary system may be the same as for a short-term outage at the primary site, such as a power outage.

When running with PPRC or XRC, the data you replicate along with the databases includes:

- CICS logs and forward recovery logs
- CICS system definition (CSD) data sets, SYSIN data sets, and load libraries
- Recovery control (RECON) and restart data set (RDS) for IMS
- IMS write-ahead data set (WADS) and IMS online log data set (OLDS)
- ACBLIB for IMS
- Boot-strap data set (BSDS), the catalog and the directory for DB2
- DB2 logs
- Any essential non-database volumes

CICS applications can use non-DASD storage for processing data. If your application depends on this type of data, be aware that PPRC and XRC do not handle it.

For more information on PPRC and XRC, see *Planning for IBM Remote Copy*, SG24-2595-00, and *DFSMS/MVS Remote Copy Administrator's Guide and Reference*.

### **PPRC or XRC?**

You need to choose between PPRC and XRC for transmitting data to your backup site. This section compares the two methods to help you make your choice.

Choose PPRC as your remote copy facility if you:

- Require data currency at the secondary site
- Have your recovery site within ESCON distance
- Can accept some performance degradation
- Have a duplicate DASD configuration available at the remote site

The synchronous nature of PPRC ensures that, if you have a disaster at your main site, you lose only in-flight transactions. The committed data recorded at the remote site is the same as that at the primary site.

#### **Use PPRC for high value transactions**

Consider PPRC if you deal with high value transactions, and data integrity in a disaster is more important to you than day-to-day performance. PPRC is more likely to be the solution for you if you characterize your business as being low volume, high value transactions; for example, a system supporting payments of thousands, or even millions, of dollars.

Choose XRC as your remote copy facility if you:

- Can accept that your data at the secondary site will be a few seconds behind the primary
- Have your secondary site outside ESCON distance
- Require high performance at the primary site

The asynchronous nature of XRC means that the remote site may have no knowledge of transactions that ran at the primary site, or does not know that they completed successfully. XRC ensures that the data recorded at the remote site is consistent (that is, it looks like a snapshot of the data at the primary site, but the snapshot may be several seconds old).

#### **Use XRC for high volume transactions**

Consider XRC if you deal with low value transactions, and data integrity in a disaster is less important to you than day-to-day performance. XRC is more likely to be the solution for you if you characterize your business as being high volume, low value transactions; for example, a system supporting a network of ATMs, where there is a high volume of transactions, but each transaction is typically less than 200 dollars in value.

#### **Other benefits of PPRC and XRC**

PPRC or XRC may eliminate the need for disaster recovery backups to be taken at the primary site, or to be taken at all. PPRC allows you to temporarily suspend the copying of updates to the secondary site. This allows you to suspend updates at the secondary site so that you can make image copies or backups of the data there. After the backups are complete, you can reestablish the pairing of data sets on the primary and secondary sites. Updates to the primary that have been recorded by the 3990-6 are applied to the secondary to resynchronize the pair.

XRC supports the running of concurrent copy sessions to its secondary volumes. This enables you to create a point-in-time copy of the data.

PPRC and XRC also allow you to migrate data to another or larger DASD of similar geometry, behind the same or different control units at the secondary site. This can be done for workload management or DASD maintenance, for example.

#### **Forward recovery**

Whether you use PPRC or XRC, you have two fundamental choices:

1. You can pair volumes containing both the data and the log records
2. You can pair only the volumes containing the log records

In the first case you should be able to perform an emergency restart of your systems, and restore service very rapidly. In the latter case you would need to use the log records, along with an image copy transmitted separately, to perform a forward recovery of your data, followed by an emergency restart.

Pairing the data volumes, as well as the log volumes, costs more because you have more data flowing between the sites, and therefore you need a greater bandwidth to support the flow. In theory you can restart much faster than if you have to perform a forward recovery. When deciding which to use, you must determine whether this method is significantly faster, and whether you think it is worth the additional costs.

## **Remote Recovery Data Facility**

The Remote Recovery Data Facility (RRDF), Version 2 Release 1, a product of the E-Net Corporation, minimizes data loss and service outage time in the event of a disaster by providing a real-time remote logging function. Real-time remote logging provides data currency at the remote site, enabling the remote site to recover databases within seconds of the outage—typically in less than 1 second.

RRDF runs in its own address space. It provides programs that run in the CICS or database management system address space. These programs are invoked through standard interfaces—for example, at exit points associated with writing out log records.

The programs that run in the CICS or database management system address space use MVS cross-memory services to move log data to the RRDF address space. The RRDF address space maintains a virtual storage queue at the primary site for records awaiting transmission, with provision for spill files if communication between the primary and secondary sites is interrupted. Remote logging is only as effective as the currency of the data that is sent off-site. RRDF transports log stream data to a remote location in real-time, within seconds of the log operation at the primary site.

When the RRDF address space at the remote site receives the log data, it formats it into archived log data sets. Once data has been stored at the remote site, you can use it as needed to meet business requirements. The recovery process uses standard recovery utilities. For most data formats, first use the log data transmitted by RRDF in conjunction with a recent image copy of the data sets and databases that you have to recover. Then perform a forward recovery. If you are using DB2, you have the option of applying log records to the remote copies of your databases as RRDF receives the log records.

If you use DB2, you can use the optional RRDF log apply feature. With this feature you can maintain a logically consistent “shadow” copy of a DB2 database at the remote site. The RRDF log apply feature updates the shadow database at selected intervals, using log data transmitted from the primary site. Thus restart time is shortened because the work needed after a disaster is minimal. The currency of the data depends on the log data transmitted by RRDF and on how frequently you run the RRDF log apply feature. The RRDF log apply feature also enhances data availability, as you have read access to the shadow copy through a remote site DB2 subsystem. RRDF supports DB2 remote logging for all environments, including TSO, IMS, CICS, batch, and call attach.

At least two RRDF licenses are required to support the remote site recovery function, one for the primary site and one for the remote site. For details of RRDF support needed for the CICS Transaction Server, see “Remote Recovery Data Facility support” on page 252.

## Choosing between RRDF and 3990-6 solutions

Table 4 summarizes the characteristics of the products you can use to implement a tier 6 solution. You must decide which solution or solutions is most appropriate for your environment.

*Table 4. Selecting a tier 6 implementation. This table compares the strengths of the tier 6 solutions.*

	RRDF	3990-6
Data type supported	Various data sets <sup>1</sup>	Any on DASD
Database shadowing	Optional. Available for DB2 and IDMS only	Optional
Forward recovery required	Yes	Depends on implementation
Distance limitation	None	About 40 km for ESCON. Unlimited for XRC with channel extenders

Table 4. Selecting a tier 6 implementation (continued). This table compares the strengths of the tier 6 solutions.

	RRDF	3990-6
<b>Note:</b> <sup>1</sup> Data sets managed by CICS file control and the DB2, IMS, IDMS, CPCS, ADABAS, and SuperMICR database management systems.		

## Disaster recovery personnel considerations

When planning for disaster recovery, you need to consider personnel issues.

You should ensure that a senior manager is designated as the disaster recovery manager. The recovery manager must make the final decision whether to switch to a remote site, or to try to rebuild the local system (this is especially true if you have adopted a solution that does not have a warm or hot standby site).

You must decide who will run the remote site, especially during the early hours of the disaster. If your recovery site is a long way from the primary site, many of your staff will be in the wrong place.

Finally, and to show the seriousness of disaster recovery, it is possible that some of your key staff may be severely injured and unable to take part in the recovery operation. Your plans need to identify backups for all your key staff.

## Returning to your primary site

One aspect of disaster recovery planning which can be overlooked is the need to include plans for returning operations from the recovery site back to the primary site (or to a new primary site if the original primary site cannot be used again). Build the return to normal operations into your plan. The worst possible time to create a plan for moving back to your primary site is after a disaster. You will probably be far too busy to spend time building a plan. As a result, the return to your primary site may be delayed, and may not work properly.

## Disaster recovery further information

If you require more information regarding the recovery of specific types of data, see the following publications:

- *IBM DATABASE 2 Administration Guide*, SC26-3265, for DB2 database recovery
- *IMS/ESA Operations Guide*, for IMS database recovery

See also the *ITSC Disaster Recovery Library: Planning Guide* for information that should help you set up a detailed disaster recovery plan if you use a combination of databases, such as DB2 and IMS.

---

## Disaster recovery facilities

This section looks at the various alternatives for achieving disaster recovery with CICS and also looks at utilities that can aid the process.

## MVS system logger recovery support

In OS/390 Release 3 and later, the MVS system logger provides support that enables a recovery resource manager to be associated with a log stream (that is, a local recovery resource manager operating on behalf of a remote site). The name of the recovery resource manager is specified when a new log stream definition is created or an existing log stream definition is updated. When a recovery resource

manager connects to the log stream, through the IXGCONN service, it requests that a resource manager-owned exit be given control when specified events occur. When such an event occurs, the MVS system logger invokes the exit specified by the resource manager and passes it details of the event. It is then the responsibility of the recovery resource manager to transmit log records to a remote site.

The remote site needs to be able to import log streams transmitted by the recovery resource manager; this too is provided by MVS system logger services. Importation is the process whereby log blocks resident in one log stream (the source log stream) are created in (or copied into) another log stream (the target log stream) while maintaining (in the target log stream) the same MVS system logger-assigned log block id and GMT time stamp that is assigned to the source log stream. The result of a log stream import is a copy of the source log stream in the target log stream.

## **CICS VSAM Recovery QSAM copy**

CICS VSAM Recovery (CICSVR) 2.3 provides a QSAM copy function that can copy MVS log streams to a QSAM data set. Copies of the QSAM data can be sent either electronically or physically to the remote site. On arrival at the remote site, you can use the MVS system logger import services to put the log records into an MVS system logger log stream. Alternatively, you can use CICSVR to perform forward recovery of a data set using the QSAM data directly.

## **Remote Recovery Data Facility support**

The Remote Recovery Data Facility (RRDF) product from the E-Net Corporation supports the CICS log manager. RRDF Version 2 Release 1 uses the disaster recovery services (for export and import of log streams) provided by the MVS system logger in OS/390 Release 3 and above. RRDF connects to a log stream at the local site where the resource manager exit is specified, to register its interest. The recovery manager is given control whenever writes or deletes occur. Typically, writes are intercepted for transmission to the remote site. Delete requests are intercepted to prevent CICS from deleting system log records before RRDF has sent them to the remote site. RRDF at the remote site receives the transmitted log records, establishes an import connection to a log stream, and imports the log records.

## **CICSVR 2.3 shadowing**

CICSVR 2.3 provides a data shadowing facility. Shadowing helps to reduce recovery time by applying forward recovery logs periodically at the remote site. See CICSVR 2.3 documentation for a complete explanation.

---

## **CICS emergency restart considerations**

It is important to consider the differences between CICS Transaction Server and earlier releases of CICS when planning for off-site recovery.

## **In-doubt and backout failure support**

Support during emergency restarts for units-of-work that failed in-doubt or failed during backout is provided by the CICS recovery manager. This support is available at the remote site only if the system log is transmitted and the CICS regions at the remote site are running under CICS Transaction Server.

It is possible for system log records to be transmitted to the remote site for units-of-work that subsequently become indoubt-failed or backout-failed. The log



records for failed units of work could be moved to the secondary log stream at the local site. However, resource managers such as RRDF are aware of such movements and act accordingly.

## Remote site recovery for RLS-mode data sets

CICS provides support for remote site recovery where VSAM data sets are used in RLS mode at the primary site. Using this RLS support for remote recovery, you can switch over to the remote site without suffering indeterminate or unreported loss of data integrity.

If a disaster occurs at the primary site, your disaster recovery procedures should include recovery of VSAM data sets at the designated remote recovery site. You can then emergency restart the CICS regions at the remote site so that they can backout any uncommitted data. Special support is needed for RLS because record locks, which were protecting uncommitted data from being updated by other transactions at the primary site, are not present at the remote site. You invoke CICS RLS support for off-site recovery using the OFFSITE system initialization parameter.

The OFFSITE system initialization parameter protects all RLS data sets until all emergency restart recovery is complete. You can specify this OFFSITE system initialization parameter at run-time only—it cannot be specified and assembled in the SIT—and it is valid only when START=AUTO is specified. You specify OFFSITE=YES when restarting CICS regions at a remote site when recovery involves VSAM data sets opened in RLS mode.

When you specify OFFSITE=YES, file control performs RLS off-site recovery processing, under which file control does not allow any new RLS access during startup. With RLS recovery in operation during an emergency restart, CICS does not allow any data sets to be accessed in RLS mode until:

- CICS has completed all outstanding RLS recovery work.
- CICS file control has issued a message requesting a “GO” response from an operator when all CICS regions have completed RLS recovery processing.
- An operator has replied to the message.

Operators should reply to the message only when all the CICS regions being restarted with OFFSITE=YES have issued the message, indicating that they have all completed their RLS recovery.

A CICS-supplied sample NetView EXEC, DFH\$OFAR, is provided to automate the detection of, and reply to, the WTOR console messages. For more information, see the prolog in the source member of the CICSTS13.CICSSDFHSAMP. library.

---

## Final summary

Your disaster recovery plan will be truly tested only at a very difficult time for your business—during a disaster. Careful planning and thorough testing may mean the difference between a temporary inconvenience and going out of business.

The goal of your disaster recovery plan is to get your CICS systems back online. The currency of the data and the time it takes to get back online is a function of which disaster recovery tier you use. Unless legal requirements for disaster recovery dictate the type of disaster recovery you must have, the choice of tiers is usually a business decision.

Making your disaster recovery work requires a good plan, up-to-date documentation, and regular testing.

---

# Glossary

**ACB** . See access control block.

**Access control block (ACB)**. The access control block that resides in the address space of an access method, such as ACF/VTAM®.

**ACID properties** . The term, coined by Haerder and Reuter [1983], and used by Jim Gray and Andreas Reuter to denote the properties of a transaction: <sup>13</sup>

## Atomicity

A transaction's changes to the state (of resources) are atomic: either all happen or none happen.

## Consistency

A transaction is a correct transformation of the state. The actions taken as a group do not violate any of the integrity constraints associated with the state.

## Isolation

Even though transactions execute concurrently, they appear to be serialized. In other words, it appears to each transaction that any other transaction executed either before it, or after it.

## Durability

After a transaction completes successfully (commits), its changes to the state survive failures.

**Note:** In CICS, the ACID properties apply to a unit of work (UOW). See also *unit of work*.

**BWO**. See backup-while-open.

**backup-while-open (BWO)** . A facility that allows a backup copy of a VSAM data set to be made while the data set remains open for update.

When you take a backup-while-open (BWO) copy of a data set, only the updates that are made after the BWO need to be recovered in the event of a disk failure. This considerably reduces the amount of forward recovery that is needed.

**CICSplex** . (1) A **CICS complex**—a set of interconnected CICS regions acting as resource managers, and combining to provide a set of coherent services for a customer's business needs. In its simplest form, a CICSplex operates within a single MVS image. Within a Parallel Sysplex environment, a CICSplex can be configured across all the MVS images in the sysplex.

The CICS regions in the CICSplex are generally linked through the CICS interregion communication (IRC) facility, using either the XM or IRC access method

(between regions in the same MVS image), or the XCF/MRO access method (between regions in different MVS images).

(2) The largest set of CICS regions or systems to be manipulated by a single CICSplex SM entity.

**CICSplex System Manager (CICSplex SM)**. An IBM CICS system-management product that provides a single-system image and a single point of control for one or more CICSplexes.

**cloned CICS regions** . CICS regions that are identical in every respect, except for their identifiers. This means that each clone has exactly the same capability. For example, all clones of an application-owning region can process the same transaction workload.

**dirty read** . A read request that does not involve any locking mechanism, and which may obtain invalid data—that is, data that has been updated, but is not yet committed, by another task. This could also apply to data that is about to be updated, and which will be invalid by the time the reading task has completed.

For example, if one CICS task rewrites an updated record, another CICS task that issues a read *before* the updating task has taken a syncpoint will receive the uncommitted record. This data could subsequently be backed out, if the updating task fails, and the read-only task would not be aware that it had received invalid data.

See also *read integrity*.

**general log** . A general purpose log stream used by CICS for any of the following:

- Forward recovery logs
- Autojournals
- User journals

Contrast with *system log*.

**heuristic decision** . A decision that enables a transaction manager to complete a failed in-doubt unit of work (UOW) that cannot wait for resynchronization after recovery from the failure.

Under the two-phase commit protocol, the loss of the coordinator (or loss of connectivity) that occurs while a UOW is in-doubt theoretically forces a participant in the UOW to wait forever for resynchronization. While a subordinate waits in doubt, resources remain locked and, in a CICS Transaction Server region, the failed UOW is shunted pending resolution.

Applying a heuristic decision provides an arbitrary solution for resolving a failed in-doubt UOW as an alternative to waiting for the return of the coordinator. In CICS, the heuristic decision can be made *in advance* by specifying in-doubt attributes on the transaction resource definition. These in-doubt attributes specify:

---

13. Transaction Processing: Concepts and Techniques (1993)

- Whether or not CICS is to wait for proper resolution or take heuristic action (defined by WAIT(YES) or WAIT(NO) respectively)
- The heuristic action that CICS is to take for the WAIT(NO) case (or is to take after the WAITTIME has expired, if a time other than zero is specified)
  - Back out all changes made by the unit of work
  - Commit all changes made by the unit of work

The heuristic decision can also be made by an operator when a failure occurs, and communicated to CICS using an API or operator command interface (such as CEMT SET UOW).

**in-doubt** . In CICS, the state at a particular point in a distributed UOW for which a two-phase commit syncpoint is in progress. The distributed UOW is said to be in-doubt when:

- A subordinate recovery manager (or transaction manager) has replied (voted) in response to a PREPARE request, and
- Has written a log record of its response to signify that it has entered the in-doubt state, and
- Does not yet know the decision of its coordinator (to commit or to back out).

The UOW remains in-doubt until the coordinator issues either the commit or backout request as a result of responses received from all UOW participants. If the UOW is in the in-doubt state, and a failure occurs that causes loss of connectivity between a subordinate and its coordinator, it remains in-doubt until either:

- Recovery from the failure has taken place and synchronization can resume, or
- The in-doubt waiting period is terminated by some built-in controls, and an arbitrary (heuristic) decision is then taken (to commit or back out).

**Note:** In theory, a UOW can remain in-doubt forever if a UOW participant fails or loses connectivity with a coordinator, and is never recovered (for example, if a system fails and is not restarted). In practice, the in-doubt period is limited by attributes defined in the transaction resource definition associated with the UOW. After expiry of the specified in-doubt wait period, the recovery manager commits or backs out the UOW, based on the UOW's in-doubt attributes.

For cases where data integrity is of paramount importance, CICS supports “wait forever”, indicated by a WAITTIME of zero, in which case manual intervention is required to force a heuristic decision.

See also *two-phase commit* and *heuristic decision*.

**log manager** . A new domain in CICS Transaction Server for OS/390 Release 1, which replaces the CICS

journal control management function of current CICS releases. The CICS log manager uses MVS system logger services to write CICS system logs, forward recovery logs, and user journals to log streams managed by the MVS system logger.

**logical unit of work (LUW)**. Old term used to describe a unit of work in earlier releases of CICS. The preferred term, adopted in CICS Transaction Server for OS/390 Release 1, is unit of work (UOW). UOW is used as a keyword in a number of CICS interfaces in CICS Transaction Server. UOW also replaces LUW on two existing API commands (EXEC CICS ENQUEUE and EXEC CICS DEQUEUE), but the translator treats LUW as a synonym for UOW and correctly translates the command.

See *unit of work*.

**LUW**. See logical unit of work.

**LUWID** . Logical unit of work identifier. See *UOW id*.

**orphan lock** . An orphan lock is an RLS lock that is held by VSAM RLS but is unknown to any CICS region.

An RLS lock becomes an orphan lock if it is acquired from VSAM by a CICS region that fails before it can log it. A VSAM interface enables CICS, during an emergency restart, to detect the existence of these locks and release them.

**Parallel Sysplex** . An MVS sysplex where all the MVS images are linked through a coupling facility.

**read integrity** . An attribute of a read request, which ensures the integrity of the data passed to a program that issues a read-only request. CICS recognizes two forms of read integrity:

#### 1. Consistent

A program is permitted to read only committed data—data that cannot be backed out after it has been passed to the program issuing the read request. Therefore, a consistent read request can succeed only when the data is free from all locks.

#### 2. Repeatable

A program is permitted to issue multiple read-only requests, with repeatable read integrity, and be assured that none of the records passed can subsequently be changed until the end of the sequence of repeatable read requests. The sequence of repeatable read requests ends either when the transaction terminates, or when it takes a syncpoint, whichever is the earlier.

Contrast with *dirty read*.

**recovery manager** . A domain in CICS Transaction Server, the function of which is to ensure the integrity and consistency of recoverable resources. These

recoverable resources, such as files and databases, can be within a single CICS region or distributed over interconnected systems. The recovery manager provides CICS unit of work (UOW) management in a distributed environment.

**shunted** . The status of a UOW that has failed at one of the following points:

- While in-doubt during a two-phase commit process
- While attempting to commit changes to resources at the end of the UOW
- While attempting to back out the UOW

If a UOW fails for one of these reasons, it becomes a candidate to be moved from the primary system log (DFHLOG) to the secondary system log (DFHSHUNT) at the next activity keypoint, pending recovery from the failure.

**SMSVSAM** . The name of the VSAM server that provides VSAM record-level sharing (RLS). See also *VSAM RLS*.

**sphere** . See *VSAM sphere*.

**system log** . A log stream maintained by CICS for back-out recovery purposes.

The system log is used by CICS to recover data to a consistent state following:

- The failure of an individual transaction
- The failure of a CICS region
- The failure of a connection with a partner in a distributed unit of work

User transactions are allowed to write their own recovery records to the system log for use in an emergency restart, but the system log cannot be used for forward recovery log or autojournal records.

Contrast with *general log*.

**system logger**. A central logging facility provided by OS/390 (and also MVS/ESA SP 5.2). The MVS system logger provides an integrated MVS logging facility that can be used by system and subsystem components. For example, it is used by the CICS log manager.

**two-phase commit** . In CICS, the protocol observed when taking a syncpoint in a distributed UOW. At syncpoint, all updates to recoverable resources must be either committed or backed out. At this point, the coordinating recovery manager gives each subordinate participating in the UOW an opportunity to vote on whether its part of the UOW is in a consistent state and can be committed. If all participants vote “yes”, the distributed UOW is committed. If any vote “no”, all changes to the distributed UOW’s resources are backed out.

This is called the **two-phase commit protocol**, because there is first a “voting” phase (the **prepare**

phase), which is followed by the actual **commit** phase. This can be summarized as follows:

### 1. Prepare

Coordinator invokes each UOW participant, asking each one if it is prepared to commit.

### 2. Commit

If all UOW participants acknowledge that they are prepared to commit (vote yes), the coordinator issues the commit request.

If only one UOW participant is not prepared to commit (votes no), the coordinator issues a back-out request to all.

**unit of work (UOW)** . A sequence of processing actions (database changes, for example) that must be completed before any of the individual actions performed by a transaction can be regarded as committed. After changes are committed (by successful completion of the UOW and recording of the syncpoint on the system log), they become durable, and are not backed out in the event of a subsequent failure of the task or system.

The beginning and end of the sequence may be marked by:

- Start and end of transaction, when there are no intervening syncpoints
- Start of task and a syncpoint
- A syncpoint and end of task
- Two syncpoints

Thus a UOW is completed when a transaction takes a syncpoint, which occurs either when a transaction issues an explicit syncpoint request, or when CICS takes an implicit syncpoint at the end of the transaction. In the absence of user syncpoints explicitly taken within the transaction, the entire transaction is one UOW.

In earlier releases of CICS, this was referred to as a *logical unit of work* (LUW).

**UOW**. See unit-of-work.

**UOW id** . Unit-of-work identifier.

CICS uses two unit of work identifiers for two purposes, one short and one long:

Short UOW id

An 8-byte value that CICS passes to resource managers, such as DB2 and VSAM, for lock management purposes.

Long UOW id

A 27-byte value that CICS uses to identify a distributed UOW. This is built from a short UOW id prefixed by two 1-byte length fields and by the fully-qualified NETNAME of the CICS region.

**VSAM RLS** . VSAM record-level sharing, an access mode supported by DFSMS to allow multiple applications to share data sets, with data locking at the record level. Access to data sets is through an SMSVSAM server. See also *SMSVSAM*.

**VSAM sphere** . The collection of all the component data sets associated with a given VSAM base data set—the base, index, alternate indexes, and alternate index paths.

**2-phase commit** . See two-phase commit.

---

# Index

## Numerics

2-phase commit 258

## A

abend handling 89, 140  
ACB  
    definition of 255  
ACID properties  
    definition of 255  
ACID properties, of a transaction 20  
active states for locks 14  
activity keypoints  
    description 21  
ADCD abend 148  
AFCF abend 148  
AFCW abend 148  
AILDELAY system initialization parameter 99  
AIRDELAY system initialization parameter 99  
AIX (alternate index) 124, 137  
AKPFREQ system initialization parameter 99  
alternate index (AIX) 124, 137  
alternate indexes  
    preserving locks over a rebuild 176  
application processing unit  
    designing 131  
applications  
    division into units of work 133  
archive reports 210  
archive statistics  
    report of 212  
archive utility  
    storing information for recovery using CICSVR 194  
ASRA abend 89  
atomic unit of work 20  
atomicity, definition of 255  
autojournals 22  
automated job creation 195  
automatic de-register statistics  
    report of 211  
automatic journaling 22  
automatic restart manager 61  
automatic transaction initiation (ATI) 137  
availability  
    CICSVR and 24-hour CICS 195

## B

backing up data 5  
backout 119  
    for temporary storage 128  
    for transient data 125  
    list of recoverable resources 5  
    overview 6  
backout, dynamic 6  
backout, emergency restart 7  
backout failure support 73

backup procedures  
    establishing 195  
backup while open (BWO) 195  
    attribute flags in ICF catalog 220  
    CICS processing 220  
    eligible data sets 217  
    how to define files 218  
    introduction 215  
    main data fields used 220  
    other products required 216  
    systems administration 219  
backup-while-open (BWO)  
    definition of 255  
backups  
    listing DFSMSHsm 203  
BACKUPTYPE attribute 218  
backward recovery 6, 119, 125, 128  
basic mapping support (BMS)  
    terminal paging 137  
    transaction backout recovery 72  
batch enabling sample programs 168  
batch jobs  
    effect on BWO 220  
batch operations  
    preparing for 155  
BDAM files  
    backout of 120  
    transaction backout 69  
buffer pools  
    defining VSAM 205

## C

cache failure support 82  
CANCEL requests  
    transaction backout recovery 72  
catalogs  
    failure 31  
    global catalog contents 31  
    use of in normal shutdown 26  
CEMT SET TASK PURGE/FORCEPURGE 67  
changing local time 115  
choosing data availability over data integrity 167  
CICS availability  
    CICSVR and 24-hour 195  
CICSplex, definition of 255  
CICSVR 197  
    24-hour CICS availability 195  
    archive utility  
        storing information for recovery 194  
    benefits 194  
    exit considerations 196  
    features 193  
    forward recovery with 193  
    main menu 198  
    planning for 195  
    protecting data 194  
    updating default values 205

- CICSVR 197 (*continued*)
  - VSAM sphere list 198
- CICSVR reports 208
  - archive 210
  - archive statistics 212
  - automatic de-register statistics 211
  - exit action statistics 209
  - forward recovery 208
  - information for forward recovery 211
  - journal data set statistics 208
  - log of logs scan 213
  - recovered data set statistics 209
  - recovery progress 210
- cloned CICS regions, definition of 255
- cold start 41
- cold start process 42
- COMMAREA (communication area) 134
- commit failure support 77
- communication between transactions 134
  - use of resources 135
- communication failure overview 9
- communication with terminals
  - BMS
    - dynamic transaction backout processing 72
    - errors/failures
      - CICS processing 91
      - external design considerations 97
  - condition handling 139
  - connection failure to a coupling facility cache structure 85
  - connection failure to a coupling facility lock structure 85
  - considerations, user 197
  - consistency, definition of 255
  - controlled shutdown
    - warm keypoints 27
  - conversational processing 134
  - CSD (CICS system definition) file
    - defining 123
  - CSDBKUP system initialization parameter 99
  - CSDFRLOG system initialization parameter 99
  - CSDRECOV system initialization parameter 99

## D

- data integrity 4
- data set backup
  - BWO processing 225
- data set name blocks (DSNBs)
  - recovery 50
- data set restore
  - BWO processing 226
- data sets
  - backup while open 215
  - eligible for BWO 217
- data sets, extrapartition
  - input 127
  - output 128
- data tables 5
  - coupling facility 136
  - intertransaction communication 136
  - user-maintained 136

- databases and files
  - application requirements questions 95
  - exclusive control 143
  - locking 143
  - used for intertransaction communication 135
- day-light saving time
  - changing clocks 115
  - impact on CICS 115
- deadlock
  - ADCD abend 148
  - AFCF abend 148
  - AFCW abend 148
- deadlock, transaction
  - avoiding 136, 147
  - effect of DTIMOUT 117, 147
- default values
  - updating CICSVR 205
- defining general log streams 103
- defining recovery attributes
  - files 120
- defining system log streams 103
  - activity keypoints 108
  - JOURNALMODELS 105
  - model log streams (coupling facility) 105
  - MVS log streams 104
  - preserving data integrity 104
- definition of CICS
  - for recovery 98
- DENYONRLSUPDATE subcommand 170
- DFH\$OFAR 253
- DFHLIST startup list
  - DFHMISC 153
- DFHPEP
  - defined in DFHMISC 153
- DFHPLT macro 100
- DFHREST (transaction restart program)
  - description 87
- DFHREST, user replaceable module 117
- DFHTST macro 100
  - TYPE=RECOVERY 129
- DFHXLT macro 100
- DFHXTEP/DFHXTEPT 91
- DFSMSshm
  - backups, listing 203
- dirty read, definition of 255
- disaster recovery
  - considerations 235
  - high availability 247
  - PPRC and XRC 247
  - RRDF 249
  - testing 236
  - tiered solutions 237
- disaster recovery facilities 251
  - CICS emergency restart 252
  - MVS system logger support 251
  - OFFSITE, system initialization parameter 253
  - support for RLS-mode data sets 253
- disposition of data sets after backout failures 74
- DL/I
  - application requirements 95
  - implicit enqueueing upon 147



- DL/I (*continued*)
  - intertransaction communication 135
  - scheduling
    - program isolation scheduling 147
- documenting recovery and restart programs 100
- DSNBs, data set name blocks
  - recovery 50
- DTIMOUT option (DEFINE TRANSACTION) 117
- dump table 46
- durability, definition of 255
- dynamic RLS restart 35
- dynamic transaction backout 6
  - basic mapping support 72
  - decision to use 140

## E

- emergency restart backout 7
- ENF, event notification facility
  - notifying CICS of SMSVSAM restart 35, 83
- enqueueing
  - explicit enqueueing by application program 147
  - implicit enqueueing on DL/I databases 147
  - implicit enqueueing on nonrecoverable files 143
  - implicit enqueueing on recoverable files 144
  - implicit enqueueing on temporary storage
    - queues 146
  - implicit enqueueing on transient data
    - destinations 146
- errors
  - listing recovery job 202
- exclusive control, VSAM
  - (see also enqueueing) 143
- exit action statistics
  - report of 209
- exit code
  - program-level abend exit 86
- exit considerations, CICSVR 196
- exits
  - defining 206
- EXPORT, access method services command
  - moving data sets 173
- extrapartition data set recovery
  - input data sets 127
  - output data sets 128

## F

- FCT system initialization parameter 99
- file backout
  - BDAM 120
- file closing
  - BWO processing 223
- file control recovery control program
  - exits 149
- file definitions
  - recovery attribute consistency checking 123
  - overriding open failures 123
- file opening
  - BWO processing 221

- files
  - defining recovery attributes 118, 120
  - external design considerations
    - use of application data 118
  - multiple path updating 124
  - transaction backout processing 69
- FORCEPURGE option
  - SET TASK 67
- forward recovery
  - BWO processing 228
  - defining for VSAM files 120
  - intrapartition transient data 126
  - overview 7
  - procedures for recovering a failed data set 177
  - recovery point for BWO 227
  - report of information for 211
  - report of progress 210
  - reports 208
  - temporary storage 129
  - with CICSVR 193
- forward recovery failures (non-RLS mode)
  - procedure for 191
- forward recovery failures (RLS mode)
  - procedure for 189
- forward recovery logging
  - BWO processing 227
- forward recovery logs 22
- forward recovery procedure
  - FRBIND command 179
  - FRRESETRR command 179
  - FRSETRR subcommand 178
  - FRUNBIND command 178
  - non-RLS mode data sets 188
  - quiescing the data set 178
  - RLS-mode data sets 177
- forward recovery procedure (non-RLS) 188
- forward recovery procedure (RLS) 177

## G

- general log
  - definition of 255
- global user exits
  - XFCBFAIL 150
  - XFCBOUT 150
  - XFCBOVER 150
  - XFCLDEL 150
- glossary 255

## H

- HANDLE ABEND command 139, 140
- HANDLE CONDITION command 139
- heuristic decision, definition of 255

## I

- ICP system initialization parameter 99
- immediate shutdown 28
- IMPORT, access method services command
  - moving data sets 173

- in-doubt
  - definition of 256
- in-doubt failure support 78
  - file control 78
    - repeatable read requests 78
- in-doubt units of work 92
- in-flight tasks
  - transaction backout 69
- initialization
  - cold start process 42
    - file control 42
    - journal model definitions 44
    - monitoring and statistics 45
    - programs 44
    - resource definitions 45
    - start requests 44
    - temporary storage 43, 46
    - terminal control resources 45
    - transactions 44
    - transient data 44
  - emergency restart process
    - journal models 58
    - journal names 58
    - monitoring 58
    - statistics 58
  - options 41
  - requirements for restart 56
  - warm start process
    - file control 49, 56
    - monitoring 53
    - programs, mapsets and partitionsets 52, 58
    - statistics 53
    - temporary storage 50, 57
    - transactions 52, 57
    - transient data 51, 57
- initialization (PLT) programs
  - defining 100
  - use of 128
- initialization and termination exit
  - for transaction backout 150
- input data sets 127
- INQUIRE DSNNAME 165
- INQUIRE UOWDSNFAIL 165
- integrity of data 4
- internal design phase 139
- intersystem communication failures
  - during syncpoint 92
- intertransaction communication 134
  - use of COMMAREA 134
  - use of resources 135
- interval control START requests 137
- intrapartition transient data
  - backout 125
  - forward recovery 126
  - implicit enqueueing upon 146
  - recoverability 125
- IOERR condition processing 142
- isolation, definition of 255

## J

- job creation, automated 195

- journal data set statistics
  - report of 208
- journaling 196
- journals
  - for extrapartition transient data set recovery 127
  - offline programs for reading 114

## K

- keypoints
  - warm 27

## L

- locking
  - implicit locking on nonrecoverable files 143
  - implicit locking on recoverable files 144
  - in application programs 143
- locks 14
- log manager
  - definition of 256
- log of logs
  - failures 114
- log stream
  - specifying type 203
- logging 4
- logical levels, application program 86
- logical recovery 125
- logical unit of work (LUW), definition of 256
- lost locks
  - recovery from 83
- LUWID, definition of 256

## M

- managing UOW state 18
- moving data sets
  - using EXPORT and IMPORT commands 176
  - using REPRO command 173
- moving data sets with locks
  - FRBIND command 175
  - FRRESETRR command 175
  - FRSETRR subcommand 174
  - FRUNBIND command 174
- MVS automatic restart manager 61
- MVS system recovery and sysplex recovery 85

## N

- NetView
  - DFH\$OFAR, 253
- NEWSIT system initialization parameter 99
- node error program (NEP) 91
- normal shutdown 25
- notifying CICS of SMSVSAM restart 83

## O

- off-site recovery
  - support for RLS-mode data sets 253
- OFFSITE, system initialization parameter 253

- on-units 142
- operating-system abend handling 89
- operating system requested shutdown 29
- operational procedures, considerations for 197
- orphan lock, definition of 256
- output data sets 128
- overriding retained locks 170

## P

- Parallel Sysplex, definition of 256
- PERFORM SHUTDOWN command 25
- PERFORM SHUTDOWN IMMEDIATE command 28
- performing lost locks recovery for failed UOWs 84
- PERMITNONRLSUPDATE subcommand 170
- persistent sessions, VTAM 36
- personnel for disaster recovery 251
- PGAICTLG system initialization parameter 99
- PGAEXIT system initialization parameter 99
- PGAIPGM system initialization parameter 99
- physical recovery 125
- PL/I
  - programs and error handling
    - on-units 142
- PLT (program list table)
  - definition of 100
- PLTPI system initialization parameter 99
- PLTSD system initialization parameter 99
- post-batch processing 170
- postinitialization (PLT) programs
  - (initialization programs)
    - defining 100
    - use of 128
- PPRC 247
- program check handling 89
- program error program (PEP) 153
  - CICS-supplied DFHPEP 153
  - design considerations 140
  - editing 153
  - omitting DFHPEP 154
  - task termination 88
  - user-supplied DFHPEP 153
- program isolation scheduling 147
- program-level user exits
  - execution of 86
- PROTECT option
  - on START command 70
- PSDINT system initialization parameter 99
- pseudoconversational processing 134
- PURGE option
  - SET TASK 67

## Q

- quiesce functions 155
- quiesce stages of normal shutdown 25
- quiescing files 155

## R

- read integrity
  - definition of 256

- rebuilding alternate indexes 176
- rebuilding the lock structure 83
- recording of recovery information
  - forward recovery logs 22
- recoverability
  - CICS required definitions 98
- recoverable resources
  - backout overview 5
- recovered data set statistics
  - report of 209
- recovery
  - backward 6, 119, 125, 128
  - logical 125
  - no recovery needed 126
  - physical 125
  - running CICSVR 197
  - using CICSVR archive utility
    - storing information for 194
- recovery for transactions
  - automatic restart using DFHREST 117
  - purging 117
  - time-out for long waits 117
- recovery job errors
  - listing 202
- recovery manager 17
  - coordinating recoverable remote conversations 20
  - coordinating resource updates 19
  - definition of 256
  - managing the UOW state 18
  - shunted state 13
- recovery parameters
  - entering 204
  - providing VSAM sphere 200
- recovery point for BWO 227
- recovery with CICSVR
  - forward 193
- Remote Recovery Data Facility 245
- reports, CICSVR 208
- REPRO, access method services command
  - moving data sets 173
- resolving retained locks before opening data sets in non-RLS mode 164
- resource recovery
  - SAA compatibility 132
- RESP option 139
- responsibilities, considerations for operational 197
- responsibilities, technical 197
- restart 97
  - BWO processing 225
- RESTART option (DEFINE TRANSACTION) 117
- restart transaction after backout
  - description 87
- retained states for locks 14
- RLS quiesce support 156
- ROLLBACK
  - considerations for use 139
- RRDF 245
- RST system initialization parameter 99

## S

- SAA resource recovery interface 132
- SDTRAN system initialization parameter 99

- security considerations
  - for BWO 220
  - for restart 98
- sequence checking 204
- SHCDS
  - FRBIND command 175, 179
  - FRRESETRR command 175, 179
  - FRSETRR subcommand 174, 178
  - FRUNBIND command 174, 178
- SHCDS LIST subcommands 166
- shunted
  - definition of 257
- shunted state, of unit of work 13
- shunted unit of work 18
- shutdown
  - BWO processing 224
  - immediate 28
  - normal 25
  - requested by operating system 29
  - uncontrolled 30
- SIT (system initialization table)
  - options and overrides for recovery and restart 99
- SMSVSAM, definition of 257
- sphere, definition of 257
- spheres, VSAM 196
- SPURGE option (DEFINE TRANSACTION) 117
- SRT system initialization parameter 99
- STAE option 142
- standby procedures 97
- START=COLD specification 41
- START option 99
- START requests 70
- START TRANSID command 142
- statistics
  - report of archive 212
  - report of automatic de-register 211
  - report of exit action 209
  - report of journal data set 208
  - report of recovered data set 209
- STGRCVY system initialization parameter 99
- switching from RLS to non-RLS access mode 162
- syncpoint
  - general description 15
  - rollback 139
- system abend extensions 89
- system activity keypoints
  - description 21
- system failures
  - designing for restart 140
  - overview 11
- system initialization parameters 99
  - OFFSITE 253
- system log
  - definition of 257
  - for backout 21
  - information recorded on 21
- system log stream
  - basic definition 99
- system logs
  - log-tail deletion 110
- system or abend exit creation 89

- system recovery table (SRT)
  - definition of 98
  - user extensions to 89
- system warm keypoints 27
- systems administration
  - for BWO 219

## T

- tables
  - for recovery 98
- task termination, abnormal 88
  - DFHPEP execution 88
  - DFHREST execution 87
- task termination, normal 87
- TBEXITS system initialization parameter 99
- technical responsibilities 197
- temporary storage
  - backout 128
  - forward recovery 129
  - implicit enqueueing upon 146
  - recoverability 128
  - used for intertransaction communication 135
- temporary storage table (TST)
  - definition of 100
- terminal error program (TEP)
  - sample 91
- terminal error recovery 91
- terminal I/O errors, recovery
  - terminal error program immediate shutdown 28
- terminal paging through BMS 137
- termination and initialization exit
  - for transaction backout 150
- testing recovery and restart programs 100
- tie-up record 227
- time changes 115
- TPURGE option (DEFINE TRANSACTION) 117
- transaction 131
- transaction abend processing 67
  - ASRA abend code 89
  - exit code at program levels 86
  - program error program (PEP)
    - user coding 153
  - program-level exit code 86
  - task termination, abnormal 87
    - DFHPEP execution 88
    - DFHREST execution 87
  - task termination, normal 87
  - transaction backout 69
- transaction backout 69
  - backout failure support 73
  - backout failures 68
  - BDAM files 70
  - data tables 70
  - entry-sequenced data set (ESDS) 70
  - files 69
  - ROLLBACK 68
  - START requests 70
  - temporary storage 70
  - transient data 70

- transaction backout during emergency restart
  - XRCINIT (initialization and termination) exit 150
- transaction failure
  - facilities to be invoked 138
  - overview 10
- transaction failure processing
  - task termination, abnormal 88
- transaction failure program (TFP) 88
- transaction list table (XLT) 26
  - definition of 100
- transaction restart 87
  - decision to use after DTB 140
- transactions allowed during normal shutdown 26
- TRANSID operand
  - use of 137
- transient data, extrapartition
  - recovery 127
- transient data, intrapartition
  - backout 125
  - forward recovery 126
  - implicit enqueueing upon 146
  - recoverability 125
  - used for intertransaction communication 135
- transient data queues 100
  - for large amounts of data 138
- transient data trigger level 137
- TS system initialization parameter 99
- TSAGE operand
  - of DFHTST macro 100
- TST (temporary storage table)
  - definition of 100
- TST system initialization parameter 99
- two-phase commit, definition of 257
- type-of-restart indicator
  - emergency-restart-needed 29
  - operation of 33
  - warm-start-possible 27

## U

- uncontrolled shutdown 30
- unit of recovery (see unit of work) 13
- unit of work
  - atomic 20
  - managing state of 18
  - overview 13
  - shunt 18
  - shunted state 13
  - unshunt 18
- unit of work (UOW)
  - definition of 257
- unit of work recovery 67
- UOW (unit of work)
  - short UOWs preferred 133
- UOW id, definition of 257
- UOWNETQL system initialization parameter 99
- updates to local resources 19
- user abend exit creation 153
- user considerations 197
- user exits
  - emergency restart 149

- user exits (*continued*)
  - transaction backout 149
- user journals 22
- user log record recovery program
  - exits 149

## V

- VSAM buffer pools
  - defining 205
- VSAM CI (or CA) split
  - effect on BWO 217
- VSAM exclusive control 145
- VSAM files
  - forward recovery considerations 119
  - transaction backout 69
- VSAM record-level sharing
  - definition of 258
- VSAM recovery
  - running CICSVR 197
- VSAM RLS
  - batch operations 155
- VSAM sphere, definition of 258
- VSAM sphere list
  - utilities pull-down, using the 199
- VSAM spheres 196
  - recovery parameters 200
- VSAM upgrade set
  - effect on BWO 224
- VTAM
  - persistent sessions 36

## W

- warm restart
  - rebuilding the CICS state 49
  - requirements for restart 49
  - START=AUTO 49

## X

- XCF/MRO
  - MVS failure 10
- XFCNREC
  - overriding open failures 123
- XLT (transaction list table) 26
  - definition of 100
- XRC 247
- XRCINIT global user exit 150



---

## Sending your comments to IBM

If you especially like or dislike anything about this book, please use one of the methods listed below to send your comments to IBM.

Feel free to comment on what you regard as specific errors or omissions, and on the accuracy, organization, subject matter, or completeness of this book.

Please limit your comments to the information in this book and the way in which the information is presented.

To request additional publications, or to ask questions or make comments about the functions of IBM products or systems, you should talk to your IBM representative or to your IBM authorized remarketer.

When you send comments to IBM, you grant IBM a nonexclusive right to use or distribute your comments in any way it believes appropriate, without incurring any obligation to you.

You can send your comments to IBM in any of the following ways:

- By mail, to this address:

Information Development Department (MP095)  
IBM United Kingdom Laboratories  
Hursley Park  
WINCHESTER,  
Hampshire  
SO21 2JN  
United Kingdom

- By fax:
  - From outside the U.K., after your international access code use 44-1962-870229
  - From within the U.K., use 01962-870229
- Electronically, use the appropriate network ID:
  - IBM Mail Exchange: GBIBM2Q9 at IBMMAIL
  - IBMLink™ : HURSLEY(IDRCF)
  - Internet: idrcf@hursley.ibm.com

Whichever you use, ensure that you include:

- The publication number and title
- The topic to which your comment applies
- Your name and address/telephone number/fax number/network ID.



Program Number: 5655-147



Printed in the United States of America  
on recycled paper containing 10%  
recovered post-consumer fiber.

SC33-1698-30





Spine information:



CICS TS for OS/390

CICS Recovery and Restart Guide

Release 3