

# **GENTRAN:Server® for UNIX®**

## **Installation and Setup Guide**

Version 6.0

***Sterling Commerce***  
*An IBM Company*

# Copyright Notice

February 2002

© Copyright 2002

Sterling Commerce, Inc.

ALL RIGHTS RESERVED

**WARNING: ANY UNAUTHORIZED DUPLICATION OF THIS DOCUMENTATION SHALL BE AN INFRINGEMENT OF COPYRIGHT.**

## Trade Secret Notice

This documentation, the software it describes, and the information and know-how they contain constitute the proprietary, confidential and valuable trade secret information of Sterling Commerce, Inc., its affiliated companies or its or their licensors, and may not be used for any unauthorized purpose, or disclosed to others without the prior written permission of the applicable Sterling Commerce entity. This documentation and the software that it describes have been provided pursuant to a license agreement that contains prohibitions against and/or restrictions on their copying, modification and use. Duplication, in whole or in part, if and when permitted, shall bear this notice and the Sterling Commerce, Inc. copyright notice. As and when provided to any governmental entity, government contractor or subcontractor subject to the FARs, this documentation is provided with RESTRICTED RIGHTS under Title 48 CFR 52.227-19. Further, as and when provided to any governmental entity, government contractor or subcontractor subject to DFARs, this documentation and the software it describes are provided pursuant to the customary Sterling Commerce license, as described in Title 48 CFR 227-7202 with respect to commercial software and commercial software documentation.

This documentation and the software which it describes are licensed either "AS IS" or with a limited warranty, as set forth in the applicable license agreement. Other than any limited warranties provided, NO OTHER WARRANTY IS EXPRESSED AND NONE SHALL BE IMPLIED, INCLUDING THE WARRANTIES OF MERCHANTABILITY AND FITNESS FOR USE OR FOR A PARTICULAR PURPOSE. The applicable Sterling Commerce entity reserves the right to revise this publication from time to time and to make changes in the content hereof without the obligation to notify any person or entity of such revisions or changes.

Product names mentioned herein may be trademarks and/or registered trademarks of their respective companies. GENTRAN and GENTRAN:Server are registered trademarks of Sterling Commerce, Inc.

Sterling Commerce, Inc.  
4600 Lakehurst Court Dublin, OH 43016-2000 \* 614/793-7000  
© Copyright 2002—Sterling Commerce, Inc.



# Table of Contents

## About this Guide

▶ Welcome .....	ii
▶ Optional Products .....	iv
▶ Installation Programs and Documentation .....	v
▶ Supported Configurations .....	vii
▶ How to Get Help .....	xi

## Installing GENTRAN:Server On the UNIX Host

### Overview

▶ Introduction .....	1-2
----------------------	-----

### Preparing for Installation

▶ Overview .....	1-4
▶ How to Create an Administrative User .....	1-5
▶ How to Create a GENTRAN:Server User .....	1-7

### Installing the Software on the UNIX Host

▶ Overview .....	1-9
▶ How to Load Security Installation Files .....	1-10
▶ How to Install Security Administration Software .....	1-12
▶ How to Load GENTRAN:Server Host Installation Files .....	1-19
▶ How to Install the GENTRAN:Server Host Software .....	1-21
▶ How to Load and Install the XML Translation Option .....	1-28
▶ How to Install Optional ODBC Database Drivers .....	1-32

### Setting Up GENTRAN:Server Security

▶ Overview .....	1-34
▶ Directories and Permissions .....	1-35
▶ How to Start and Exit Security Administration .....	1-36
▶ How to Add a New Environment Record .....	1-39
▶ How to Add a User Record .....	1-43
▶ Environment Access .....	1-50
▶ How to Assign Access to an Environment and Its Functions .....	1-55
▶ Starting GENTRAN:Server Processes .....	1-59
▶ How to Start GENTRAN:Server on the Host .....	1-59

## Setting Up Windows Clients

- ▶ Overview .....2-2
- ▶ How to Install the GENTRAN:Server Client Software .....2-4
- ▶ How to Install HyperACCESS .....2-13
- ▶ How to Install MDAC 2.6 Components .....2-20
- ▶ How to Install GENTRAN Standards .....2-22
- ▶ How to Install Online Documentation .....2-27
- ▶ How to Edit the Windows Hosts File .....2-34
- ▶ How to Identify the Host to DNS .....2-35
- ▶ How to Install Optional Components .....2-36

## Setting Up Communications

### Overview

- ▶ Introduction .....3-2
- ▶ What Is the Communications Toolkit? .....3-3
- ▶ COMM Subdirectory Structure .....3-5
- ▶ The Communications Toolkit Setup Process .....3-9

### Procedures

- ▶ How to Set Up Asynchronous Communications .....3-10
- ▶ How to Set Up Bisynchronous Communications .....3-12
- ▶ How to Start Up Cleo A+ .....3-14
- ▶ How to Start Up Cleo 3780Plus .....3-17
- ▶ Start-Up Procedure Examples .....3-19

### Troubleshooting

- ▶ Communications Session Error Recovery .....3-21
- ▶ Cleo 3780Plus Troubleshooting .....3-26
- ▶ Connecting to Other VANs and Directly to Trading Partners .....3-27

## Appendix A - Client Descriptions

# About this Guide

---

## Contents

- ▶ Welcome ..... ii
- ▶ Optional Products ..... iv
- ▶ Installation Programs and Documentation ..... v
- ▶ Supported Configurations ..... vii
- ▶ How to Get Help ..... xi

---

# Welcome

---

**Introduction**

Welcome to Sterling Commerce's GENTRAN:Server for UNIX<sup>®</sup> electronic data interchange (EDI) and electronic commerce (EC) software.

---

**What is in this guide**

This guide contains procedures to help you successfully install GENTRAN:Server for UNIX version 6.0 on the UNIX<sup>®</sup> host and Windows<sup>®</sup> client computers.

**WARNING**

**If additional installation instructions came with your GENTRAN:Server for UNIX shipment, those instructions take precedence over the instructions listed here.**

---

**Who should use this guide**

This guide is for administrators responsible for installing and setting up EDI or EC application software.

---

**UNIX knowledge required**

Some knowledge of UNIX is needed to successfully install and set up this product. GENTRAN:Server for UNIX is a client/server product that allows EDI users to use Windows client computers to access programs and data on the UNIX host.

This manual assumes the reader is familiar with basic UNIX concepts and commands, including:

- How UNIX identifies users and associates them into groups
- File ownership
- How to change the current directory
- How to set environment variables
- How to start and stop UNIX processes
- How to run UNIX scripts

---

(Continued on next page)

---

**GENTRAN:Server  
for UNIX product  
levels**

This guide provides instructions for installing the following GENTRAN:Server for UNIX product levels.

- ▶ GENTRAN:Server for UNIX
- ▶ GENTRAN:Server for UNIX with Process Control Manager (PCM)
- ▶ GENTRAN:Server for UNIX with EC Workbench
- ▶ GENTRAN:Server for UNIX with Advanced Data Distribution

The title of the *Installation Checklist* included with your software indicates which product you purchased.

---

**GENTRAN:Server  
utilities**

Depending on which level of GENTRAN:Server for UNIX you received, the following utilities may be included:

- ▶ Communications Toolkit
- ▶ Life Cycle

**Communications Toolkit**

The Communications Toolkit is included in all levels of GENTRAN:Server for UNIX. The toolkit scripts are automatically installed when you install GENTRAN:Server for UNIX with PCM or higher. If you want to use the Communications Toolkit, you must first install and configure GENTRAN:Server for UNIX, then set up the toolkit.

**Reference**

See the Setting Up Communications chapter in this guide.

**Life Cycle**

GENTRAN:Server for UNIX with PCM and higher product levels include the Life Cycle data tracking utility. Life Cycle requires additional database software. Life Cycle must be set up on the UNIX host by someone familiar both with your site's database and with UNIX.

**Reference**

See the *GENTRAN:Server Data Flow Administration Guide* for detailed requirements, and for instructions for setting up the Life Cycle tracking utility.

---

## Optional Products

### Introduction

There are several options available for GENTRAN:Server for UNIX 6.0. They include:

- ▶ XML Translation extension (available for purchase)
- ▶ ODBC Database Drivers (available for purchase)
- ▶ Visual Mapper (earlier version of mapper available to customers with versions of GENTRAN:Server earlier than 5.4)
- ▶ Health Insurance Portability and Accountability Act (HIPAA) features (available to all customers)
- ▶ Extensions (such as SAP)

These options are installed automatically on the client. Access is limited, however, to only those options that have been installed on the UNIX host.

### Installing options

You can install each option separately after completing the core GENTRAN:Server software. This table directs you to the procedure for each optional product.

To install the...	Use...
XML translation extension	the core installation CD. Reference See the <a href="#">How to Load and Install the XML Translation Option</a> topic in this guide.
ODBC Database Drivers	the core installation CD. <b>Reference</b> See the <a href="#">How to Install Optional ODBC Database Drivers</a> topic in this guide.
Visual Mapper	the Visual Mapper host installation CD. <b>Reference</b> See the separate installation card titled <i>Visual Mapper - UNIX Host Installation Instructions</i> .
HIPPA features	<i>Application Integration: HIPAA Compliance and NCPDP User's Guide</i> .
Extensions	the documentation shipped with other options or add-on software for installation instructions.



# Installation Programs and Documentation

---

## Installation process

We automated most of the installation process on both the UNIX host and the Windows client.

- ▶ The host installation process prompts you for the necessary environment variables. The process collects the variables in a file that you can copy into scripts or attach to the profile of the appropriate user.
- ▶ The client installation process helps configure the GENTRAN:Server connection to the UNIX host. The client installation now includes the ability to install online versions of the GENTRAN:Server documentation.

### Note

This guide contains an additional procedure for setting up client/host communication for networks that use Domain Name Services (DNS).

---

## Installation Checklist

The *Installation Checklist* contains the following features:

- ▶ Flow diagram of the installation process.
- ▶ Places to record all of the information you need during the installation process.

We recommend that you keep the *Installation Checklist* with you for reference throughout the installation process.

---

**Contents of Chapters**

This table describes the contents of each chapter within the *GENTRAN:Server Installation and Setup Guide*.

Chapter	Contents
About this Guide	This preface describes the purpose and contents of this guide. It describes the supported hardware and software configurations, and explains how to get help from Sterling Commerce support, training, or client services personnel.
Installing GENTRAN:Server on the UNIX Host	This chapter explains how to set up a new installation of GENTRAN:Server for UNIX on a UNIX host computer.  The procedures span: <ul style="list-style-type: none"><li>▶ preparing for installation</li><li>▶ installing GENTRAN:Server on the host</li><li>▶ setting up the GENTRAN:Server Security Administration utility.</li></ul>
Setting Up Windows Clients	This chapter explains how to install and set up client software for GENTRAN:Server for UNIX on the Windows client computers.
Setting Up Communications	This chapter explains how to set up the optional Communications Toolkit to work with GENTRAN:Server for UNIX.

# Supported Configurations

---

**Introduction** This topic describes the hardware and software configurations supported by Sterling Commerce for GENTRAN:Server for UNIX.

---

**Windows client** Each Windows client must have:

- A CD-ROM drive
- A Pentium-class or equivalent processor
- A minimum processor speed of 166 MHz (333 MHz recommended)
- A color VGA or SVGA monitor
- Microsoft Windows 98<sup>®</sup>, Windows ME<sup>®</sup>, Windows NT<sup>®</sup> 4.0 SP6a, or Windows 2000 (Server and Professional) SP1
- Internet Explorer<sup>®</sup> 5.0 or higher
- A minimum of 32 MB of memory (64 MB recommended)
- A minimum of 40 MB of free disk space for the client software
- A minimum of 10 MB of free disk space to install the EDI standards database to run from the CD or 238 MB to install and run the EDI standards from the client's hard drive

**Note**

Your Windows operating system may require updates to work correctly. You can download the latest service packs from Microsoft at this web address:

<http://www.microsoft.com/windows/downloads/default.asp>

---

**UNIX host** The UNIX host computer must have:

- A minimum of 100 MB free disk space
- A minimum of 32 MB memory
- Additional disk space for customer data, archives, etc.
- Additional 200 MB for the Visual Mapper

**WARNING**

**For GENTRAN:Server for UNIX with Process Control Manager and higher product levels, the UNIX host *must* include the Korn shell.**

---

(Continued on next page)

**Operating systems**

This table lists the operating systems required on the supported GENTRAN:Server for UNIX platforms.

Hardware Platform	Operating System and Version
HP 9000	HP-UX 11.0 or greater
IBM RS6000	AIX 4.3.2 or greater with C++ Runtime environment of 5.0.0.0 or higher
SUN	Solaris 2.7 or higher

**Patches**

Hewlett-Packard provides service patches to their operating systems. You may need the service patches if you experience problems with message queues, the dynamic loader, performance, or the translator. We recommend that you check the Hewlett-Packard web site, or contact your Hewlett-Packard representative to obtain the most recent information about service patches.

**Networking requirements**

Your installation must satisfy the following networking requirements.

- ▶ Appropriate software for the EDI administrator to access the UNIX command line (Telnet or an x-emulation package).
- ▶ TCP/IP connectivity between UNIX host and Windows client computers.

**Lifecycle requirements**

GENTRAN:Server's Life Cycle auditing facility interfaces with most versions of:

- ▶ Informix
- ▶ Oracle
- ▶ Sybase

Contact your GENTRAN:Server support representative to verify that a particular version of a database is supported.

This table lists, by vendor, the software that may be required to run Life Cycle.

Vendor	Required Software	Description
Informix	ESQL/C Openline	Embedded SQL precompiler
	I-SQL Openline	SQL statement interpreter
	Informix Standard Engine (SE)	Standard database engine (Continued on next page)

<b>(Contd) Vendor</b>	<b>Required Software</b>	<b>Description</b>
Oracle	PRO*C	Embedded SQL precompiler for C source code
	Oracle RDBMS	Database server
	PL/SQL	SQL statement interpreter
Sybase	Sybase SQL Server	Database server
	Open Client/C	Necessary libraries to communicate with Sybase
	Embedded SQL/C	Embedded SQL precompiler for C source code

Check with your database vendor for current requirements.

### **ODBC option - translation requirements**

GENTRAN:Server's ODBC translation option supports only these databases and versions:

<b>Operating System</b>	<b>Database</b>
HP-UX 11.0	Informix 7.x, 9.x (via Informix Connect)
	Informix Dynamic Server 9.x, Informix 2000
	Oracle 7.1, 7.2, 7.3 (7.x functionality via SQL*Net 2.x)
	Oracle 8.0.5+, 7.3, 8i (via NET 8, 8.04+)
	Oracle 8.16
	Sybase System 10, 11, Adaptive Server 11.x, 12.0
	Sybase ASE (System 10, 11, Adaptive Server 11.x, 12.0)

(Continued on next page)

<b>(Contd) Operating System</b>	<b>Database</b>
AIX 4.3.2	Informix 7.x, 9.x (via Informix Connect)
	Oracle 7.1, 7.2, 7.3 (7.x functionality via SQL*Net 2.x)
	Oracle 8.0.5+, 7.3, 8i (via NET 8, 8.04+)
	Oracle 8.16
	Sybase SQL Server 4.92
	Sybase System 10, 11, Adaptive Server 11.x, 12.0
	Sybase ASE (System 10, 11, Adaptive Server 11.x, 12.0)
Solaris 2.7, 2.8	Informix 7.x, 9.x (via Informix Connect)
	Informix Dynamic Server 9.x, Informix 2000
	Oracle 7.1, 7.2, 7.3 (7.x functionality via SQL*Net 2.x)
	Oracle 8.0.5+, 7.3, 8i (via NET 8, 8.04+)
	Oracle 8.16
	Sybase SQL Server 4.92
	Sybase System 10, 11, Adaptive Server 11.x, 12.0 Sybase ASE (System 10, 11, Adaptive Server 11.x, 12.0)
Windows 32-bit (9.x, ME, 2000, NT4.0)	Informix 7.x, 9.x (via Informix Connect)
	Informix Dynamic Server 9.x, Informix 2000
	Oracle 7.1, 7.2, 7.3 (7.x functionality via SQL*Net 2.x)
	Oracle 8.0.5+, 7.3, 8i (via NET 8, 8.04+)
	Oracle 8.16
	Sybase SQL Server 4.92
	Sybase System 10, 11, Adaptive Server 11.x, 12.0 Sybase ASE (System 10, 11, Adaptive Server 11.x, 12.0)

# How to Get Help

---

**Introduction** This topic explains how to contact Sterling Commerce Product Support if you need assistance with GENTRAN:Server.

---

**Scope of Support Services** Sterling Commerce Product Support can provide assistance and information for the following:

- Installing GENTRAN:Server
- GENTRAN:Server product questions
- Software revisions and upgrades
- Implementing a specific feature
- How to use GENTRAN:Server
- The status of your support call
- Requests for product enhancements

Unfortunately, Sterling Commerce Product Support cannot assist you with problems involving the following, but we may be able to suggest a next step or another vendor to call:

- Your hardware
- Your operating system or other system software
- Your application or user-written programs
- Software not developed by Sterling Commerce
- Scripts written by Sterling Commerce consultants or service partners

---

**Try this first** Before you call Sterling Commerce Product Support, use your online software manuals to locate the section that documents the program or feature where you are having problems. The documentation may explain the software's behavior or give you insight to help you solve the problem.

Consult the *GENTRAN:Server Maintenance and Troubleshooting Guide* to learn if your specific problem has been addressed.

---

(Continued on next page)

**Copy this page**

---

Please feel free to make a copy of this page to enable you to contact support quickly and with complete information for the Customer Support Representative.

---

**Necessary information**

Be ready to provide this information when you call Product Support.

Your name
Your company name
Your telephone number
Your GENTRAN:Server version number
Your GENTRAN:Server product level and platform
Any software add-ons to your GENTRAN:Server system
A detailed description of the problem

(Continued on next page)



The sequence of steps that led to the problem

What actions you have taken to try to diagnose or resolve the problem

---

**How to contact support**

To determine how to contact support for your geographical location, go to the Sterling Commerce home page ([www.sterlingcommerce.com](http://www.sterlingcommerce.com)) and then go to **Customer Support** for GENTRAN.

---



---

# Installing GENTRAN:Server On the UNIX Host

## Contents

### Overview

- ▶ Introduction ..... 2

### Preparing for Installation

- ▶ Overview ..... 4
- ▶ How to Create an Administrative User ..... 5
- ▶ How to Create a GENTRAN:Server User ..... 7

### Installing the Software on the UNIX Host

- ▶ Overview ..... 9
- ▶ How to Load Security Installation Files ..... 10
- ▶ How to Install Security Administration Software ..... 12
- ▶ How to Load GENTRAN:Server Host Installation Files ..... 19
- ▶ How to Install the GENTRAN:Server Host Software ..... 21
- ▶ How to Load and Install the XML Translation Option ..... 28
- ▶ How to Install Optional ODBC Database Drivers ..... 32

### Setting Up GENTRAN:Server Security

- ▶ Overview ..... 34
  - ▶ Directories and Permissions ..... 35
  - ▶ How to Start and Exit Security Administration ..... 36
  - ▶ How to Add a New Environment Record ..... 39
  - ▶ How to Add a User Record ..... 43
  - ▶ Environment Access ..... 50
  - ▶ How to Assign Access to an Environment and Its Functions ..... 55
  - ▶ Starting GENTRAN:Server Processes ..... 59
  - ▶ How to Start GENTRAN:Server on the Host ..... 59
-

# Overview

## Introduction

### Chapter contents

This chapter contains instructions for installing GENTRAN:Server for UNIX<sup>®</sup> into a new environment.

#### WARNING

**This installation method creates new, empty data files. Do not use this method to upgrade an existing GENTRAN:Server environment because it will overwrite existing data.**

#### Reference

See the *GENTRAN:Server Upgrade and Data Conversion Guide* for information about upgrading to a new version of GENTRAN:Server for UNIX.

### Stages of Installation

When installing GENTRAN:Server for UNIX, you must install at least one copy of the Security Administration utility and one copy of the GENTRAN:Server host installation software onto UNIX hosts on your network. The Security Administration and GENTRAN:Server installations must be on the same host. You must also load the GENTRAN:Server client software onto each Windows<sup>®</sup> client computer that will access the GENTRAN:Server for UNIX software.

This table describes the stages of a new installation process for GENTRAN:Server version 6.0. Detailed instructions for completing each stage are contained in the rest of this manual.

#### Reference

See the *GENTRAN:Server Upgrade and Data Conversion Guide* for information about upgrading to a new version of GENTRAN:Server for UNIX.

Stage	Description
1	Prepare for installation: <ul style="list-style-type: none"> <li>▶ Create an administrative user to own and load the Security Administration utility.</li> <li>▶ Create a GENTRAN:Server user to own the GENTRAN:Server host installation and processes.</li> </ul> <p style="text-align: right; color: red;">(Continued on next page)</p>

<b>(Contd) Stage</b>	<b>Description</b>
2	Install GENTRAN:Server on the host: <ul style="list-style-type: none"><li>▶ Load the Security Administration installation files into a temporary area on the UNIX host computer.</li><li>▶ Install the GENTRAN:Server Security Administration utility.</li><li>▶ Load the GENTRAN:Server host installation files into a temporary area on the UNIX host computer.</li><li>▶ Install the GENTRAN:Server host software, including any options.</li></ul>
3	Configure the environment security for the GENTRAN:Server installation.
4	Configure the user security for the GENTRAN:Server installation.
5	Start the GENTRAN:Server processes on the UNIX host.
6	Install GENTRAN:Server on the Windows client.

# Preparing for Installation

## Overview

---

**In this section**

This section contains procedures you must perform before installing the GENTRAN:Server for UNIX host and client software.

---

**Before you begin**

Use this table as a checklist to determine whether you are ready to install GENTRAN:Server for UNIX.

Done	Item
	<p>Make sure that you have:</p> <ul style="list-style-type: none"><li>▶ An <i>Installation Checklist</i></li><li>▶ The host software CD</li><li>▶ The client software CD</li><li>▶ The GENTRAN Standards CD</li><li>▶ The online documentation CD</li><li>▶ Any optional software that you want to install at this time, such as the Visual Mapper CD.</li></ul>
	<p>Complete the <i>Installation Checklist</i>.</p> <p>Collect all of the information requested in the <i>Installation Checklist</i>. Keep the checklist with you when performing the procedures in this chapter.</p>

---

# How to Create an Administrative User

## Introduction

If different users perform separate parts of the installation, each user must have the same permissions and belong to the same group.

### Recommendations

We recommend that you create an administrative user and use that login to install the Security Administration utility software, configure GENTRAN:Server security, and start the security processes.

We recommend that you also create a separate GENTRAN:Server user for each GENTRAN:Server installation. If you have an older version of GENTRAN:Server on the same machine, you must create a new user profile to run GENTRAN:Server 6.0. The GENTRAN:Server user should have access to GENTRAN:Server, but not to administrative functions. For instructions, see the [How to Create a GENTRAN:Server User](#) topic in this chapter.

## Procedure

Use this procedure to create an administrative user to install and own the Security Administration software, start the processes, and configure security.

### Comment

Depending on how system security is handled at your site, a system administrator may have to create this user for you.

Step	Action
1	Log on to the UNIX host as root.
2	Create a UNIX user login. <b>Example</b> gsadmin
3	Create a group containing the new user. <b>Example</b> gsuser

(Continued on next page)

(Contd) Step	Action
4	<p>Create a directory to contain the GENTRAN:Server Security Administration utility. Set ownership of this directory to the user and group you created in Steps 2 and 3.</p> <p><b>Comment</b> For the GENTRAN:Server Security Administration utility to work properly, the user must be the owner or a member of the group that owns the GENTRAN:Server Security directory.</p>
5	<p>Is the GENTRAN:Server for UNIX software that you are installing at the Process Control Manager product level or higher?</p> <ul style="list-style-type: none"> <li>▶ If NO, GO TO to Step 6.</li> <li>▶ If YES, give the administrator <b>at</b> privileges to allow the administrator to start scripts.</li> </ul> <p><b>WARNING</b> <b>The GENTRAN:Server data flow software will work properly only if the user has the ability to start scripts.</b></p> <p><b>Comment</b> Permission to start <b>at</b> jobs is maintained in the <i>at.allow</i> or <i>at.deny</i> files. These files are normally found in <i>/usr/admin/cronq</i> or <i>/usr/lib/cron</i>, depending on the version of UNIX you are running.</p>
6	<p>Give the administrator <b>cron</b> privileges to allow the administrator to start <b>cron</b> jobs.</p> <p><b>WARNING</b> <b>The GENTRAN:Server Scheduler requires cron privileges to function.</b></p> <p><b>Comment</b> Permission to start <b>cron</b> jobs is maintained in the <i>cron.allow</i> or <i>cron.deny</i> files. These files are normally found in <i>/usr/admin/cronq</i> or <i>/usr/lib/cron</i>. The actual location may vary, depending on the version of the UNIX system you are running.</p>



## How to Create a GENTRAN:Server User

---

**Introduction** We recommend that you create a separate GENTRAN:Server user login to each environment and that you use that login to start the GENTRAN:Server processes within that environment.

---

**Procedure** Use this procedure to create a GENTRAN:Server user to install and run the GENTRAN:Server installation.

**Comment**

Depending on how system security is handled at your site, a system administrator may have to create this user.

Step	Action
1	Log on to the UNIX host as root.
2	Create a UNIX user login. <b>Example</b> gsprod
3	Add the user to the group containing the administrative login. <b>Example</b> gsuser
4	Create a directory for the GENTRAN:Server installation. Set ownership of this directory to the user and group you created in Steps 2 and 3.  <b>WARNING</b> <b>Do not use spaces or other punctuation within the directory name.</b>  (Continued on next page)

(Contd) Step	Action
5	<p>Is the level of GENTRAN:Server software that you are installing Process Control Manager or higher?</p> <ul style="list-style-type: none"> <li>▶ If NO, continue to Step 6.</li> <li>▶ If YES, give the user <b>at</b> privileges. This allows the administrator to start scripts.</li> </ul> <p><b>WARNING</b></p> <p><b>The GENTRAN:Server data flow software will work properly only if you have privileges to start scripts.</b></p> <p><b>Comment</b></p> <p>Permission to start <b>at</b> jobs is maintained in the <i>at.allow</i> or <i>at.deny</i> files. These files are normally stored in <i>/usr/admin/cronq</i> or <i>/usr/lib/cron</i>. The location is dependent on which version of the UNIX system you are running.</p>
6	<p>Give the user <b>cron</b> privileges to allow the user to start <b>cron</b> jobs.</p> <p><b>WARNING</b></p> <p><b>The GENTRAN:Server Scheduler requires cron privileges to function.</b></p> <p><b>Comment</b></p> <p>Permission to start <b>cron</b> jobs is maintained in the <i>cron.allow</i> or <i>cron.deny</i> files. These files are normally found in <i>/usr/admin/cronq</i> or <i>/usr/lib/cron</i>. The location is dependent on which version of the UNIX system you are running.</p>

# Installing the Software on the UNIX Host

## Overview

---

**In this section** This section explains how to load GENTRAN:Server from the installation CD into the proper directories on the UNIX host computer.

---

**Installation Checklist** We recommend that you keep the *Installation Checklist* with you for reference throughout the installation process.

The *Installation Checklist* contains the following features:

- Flow diagram of the installation process.
  - Places to record all of the information you need during the installation process.
-

## How to Load Security Installation Files

### Introduction

During installation, you must run a transfer program to copy the compressed software files from the installation CD into the proper directories on the UNIX host computer. This topic explains how to use the transfer program to read the security installation files from a CD in a Windows client computer into a temporary directory on the UNIX host.

### Before you begin

Before you begin loading the GENTRAN:Server security installation files onto the UNIX host computer, you must have a UNIX login to install and own the Security Administration utility.

### References

See the [How to Create an Administrative User](#) topic in this chapter for detailed instructions on creating this login.

### Copying installation files from the CD

Use this procedure to copy the security installation files from a CD-ROM drive on the Windows client computer to the UNIX host.

### Note

Before you begin, verify that

- ▶ The connection between the Windows client and the UNIX host supports TCP/IP
- ▶ The Windows client computer is connected to the UNIX host.

Step	Action
1	Insert the GENTRAN:Server host installation CD into a CD-ROM drive in the Windows client.
2	Open the Windows <b>Start</b> menu.
3	Select the <b>MS-DOS Prompt</b> from the Programs menu.  <b>System Response</b> Windows opens an MS-DOS Prompt window.
4	Change directories to the CD-ROM drive on the Windows computer.  (Continued on next page)

<b>(Contd) Step</b>	<b>Action</b>
5	<p>Type the following command to copy the security installation files from the CD to a temporary area on the UNIX host.</p> <pre>ftpprod security &lt;host&gt; &lt;path&gt; &lt;user&gt; &lt;password&gt;</pre> <p>Where</p> <ul style="list-style-type: none"><li>▶ &lt;host&gt; is the system name for the UNIX host</li><li>▶ &lt;path&gt; is the path to a temporary directory (The <b>ftpprod</b> process creates the directory if necessary)</li><li>▶ &lt;user&gt; is the user login for the administrative user you created</li><li>▶ &lt;password&gt; is the user password for the administrative user</li></ul>
6	<p>Press ENTER.</p> <p><b>System Response</b></p> <p>The transfer program displays information about the transfer process. The message "Files transferred" indicates that the process completed successfully.</p>
7	<p>Close the DOS window.</p>
8	<p>Continue to <a href="#">How to Install Security Administration Software</a> to install the security software from the temporary directory.</p>

# How to Install Security Administration Software

---

## Introduction

The GENTRAN:Server Security Administration utility controls the GENTRAN:Server software. Run the `secsetup.sh` script to install the software for this utility into the appropriate directories on the UNIX host.

The `secsetup.sh` script

- reads the installation files
- installs them into the specified location on the UNIX host
- temporarily sets the UNIX environment variables that the security software needs
- places those variables into a file that you can include in scripts and UNIX users' profiles.

This topic explains how to run `secsetup.sh` to install the security software files into a security administration directory. It also explains how to add the environment variables into the security administrator's profile.

---

(Continued on next page)

**Before you begin**

Use this checklist to ensure that you are ready to begin installing the GENTRAN:Server Security Administration utility onto the UNIX host computer.

Done	Task
	<p>Log onto the UNIX host machine as the administrative user that was set up to install and own the security administration installation.</p> <p><b>Reference</b> See the <a href="#">How to Create an Administrative User</a> topic in this chapter for detailed instructions on creating this user.</p>
	<p>Verify that the compressed security installation files reside in a temporary directory on the UNIX host that this login is accessing.</p> <p><b>Reference</b> See the <a href="#">How to Load Security Installation Files</a> topic in this chapter for detailed instructions.</p>

**CAUTION**

**During the setup process, the setup program prompts you for a required environment variable if it is not set. If the setup program finds a value for a required environment variable, it continues to the next step without displaying a prompt.**

(Continued on next page)

## Installing the Security Administration utility

Use this procedure to install the GENTRAN:Server Security Administration utility on the UNIX host computer. Refer to the completed *Installation Checklist* as needed.

Step	Action
1	<p>Log onto the UNIX host as the administrative user that will install and own this installation.</p> <p><b>WARNING</b></p> <p><b>You must log on as the user who will own the security directories and start the security processes. Using another login will result in conflicts with permissions.</b></p> <p><b>Do <i>not</i> log on as root. The root login is unable to run the installation program.</b></p> <p><b>Reference</b> See the topic <a href="#">How to Create an Administrative User</a> in this chapter for instructions.</p>
2	<p>Change directories to the temporary directory.</p> <p><b>Example</b> cd temp</p>
3	<p>Give yourself “execute” privileges for the <b>secsetup.sh</b> script file. This gives you permission to run the script.</p> <p><b>Example</b> chmod +x secsetup.sh</p>
4	<p>Type the following command at the UNIX prompt and then press ENTER:</p> <p><code>./secsetup.sh</code></p> <p><b>System Response</b> The <b>secsetup.sh</b> script displays information about the installation process and prompts you to enter a value for SADMIN_ROOT.</p> <p style="text-align: right;">(Continued on next page)</p>



<b>(Contd) Step</b>	<b>Action</b>
5	<p>Type the complete path you want <b>secsetup.sh</b> to use when installing the security utility and press ENTER.</p> <p><b>Example</b> /usr1/gentran/security</p> <p><b>System Response</b> The <b>secsetup.sh</b> script displays the path entered and prompts you to confirm that the path is correct.</p>
6	<p>Is the path displayed correct?</p> <ul style="list-style-type: none"> <li>▶ If YES, type <b>Y</b> and then press ENTER.</li> <li>▶ If NO, type <b>N</b>, and then press ENTER. The <b>secsetup.sh</b> script again prompts you to enter a value for ADMIN_ROOT. Return to Step 5.</li> </ul> <p><b>System Response</b> The <b>secsetup.sh</b> script prompts you for the complete path to the <i>vvtermcap</i> file.</p>
7	<p>Do you want to use the <i>vvtermcap</i> file supplied by Sterling Commerce?</p> <ul style="list-style-type: none"> <li>▶ If YES, press ENTER to accept the default path.</li> </ul> <p><b>Note</b> We recommend that you accept the default. Use another file only if your system requires a proprietary terminal emulator.</p> <ul style="list-style-type: none"> <li>▶ If NO, type the path to where your proprietary <i>vvtermcap</i> file is stored, and then press ENTER. (Contact your system administrator if you do not know the path.)</li> </ul> <p><b>System Response</b> The <b>secsetup.sh</b> script displays the path entered for the <i>vvtermcap</i> file and prompts you to confirm that value.</p> <p style="text-align: right; color: red;">(Continued on next page)</p>

(Contd) Step	Action
8	<p>Is the displayed VVTERMCAP value correct?</p> <ul style="list-style-type: none"> <li>▶ If YES, type <b>Y</b> and press ENTER.</li> <li>▶ If NO, type <b>N</b> and press ENTER. The <b>secsetup.sh</b> script prompts you a second time to enter a value for VVTERMCAP. Return to Step 7.</li> </ul> <p><b>System Response</b> The <b>secsetup.sh</b> script prompts you for a value for the VVTERM environment variable.</p> <p><b>Comment</b> This value reflects the terminal emulation setting to use for GENTRAN:Server. It normally equals the TERM environment variable value set in your profile.</p>
9	<p>Do you want to use the default value, which sets VVTERM to the same value as TERM?</p> <ul style="list-style-type: none"> <li>▶ If YES, then press ENTER.</li> <li>▶ If NO, type the value you want to use for VVTERM, and then press ENTER.</li> </ul> <p><b>Comment</b> A common value is <b>vt100</b>.</p> <p><b>System Response</b> The <b>secsetup.sh</b> script displays the value entered and prompts you to confirm the value.</p>
10	<p>Is the displayed VVTERM value correct?</p> <ul style="list-style-type: none"> <li>▶ If YES, type <b>Y</b> and then press ENTER.</li> <li>▶ If NO, type <b>N</b>, and then press ENTER. The <b>secsetup.sh</b> script prompts you to enter a value for VVTERM a second time. Return to Step 9.</li> </ul> <p><b>System Response</b> The <b>secsetup.sh</b> script prompts you for a value for the NAMEBROKER environment variable.</p>
11	<p>Type the system name for the UNIX computer that will run the broker process that controls this security installation.</p> <p><b>System Response</b> The <b>secsetup.sh</b> script displays the value entered and prompts you to confirm the value.</p> <p style="text-align: right; color: red;">(Continued on next page)</p>

<b>(Contd) Step</b>	<b>Action</b>
12	<p>Is the displayed NAMEBROKER value correct?</p> <ul style="list-style-type: none"> <li>▶ If YES, type <b>Y</b> and press ENTER.</li> <li>▶ If NO, type <b>N</b> and press ENTER. The <b>secsetup.sh</b> script prompts you a second time to enter a value for NAMEBROKER. Return to Step 11.</li> </ul> <p><b>System Response</b> The <b>secsetup.sh</b> script displays status messages and lists the path to the file that contains the environment variables.</p>
13	<p>View the installation log to confirm that the installation completed successfully.</p> <p><b>Comment</b> The system creates the installation log (<i>secsetup.log</i>) in the directory where you started the <b>secsetup.sh</b> script.</p>
14	<p>Do you want to install another copy of the Security Administration utility to control a second GENTRAN:Server environment?</p> <ul style="list-style-type: none"> <li>▶ If YES, then return to Step 1 and repeat this procedure.</li> <li>▶ If NO, then continue with the next procedure, <a href="#">Adding environment variables to the owner's profile</a>.</li> </ul> <p><b>Note</b> You can use a single security installation to control multiple GENTRAN:Server environments on the same UNIX host machine. Each UNIX host machine running GENTRAN:Server must have a security installation.</p>

---

(Continued on next page)

### Adding environment variables to the owner's profile

Use this procedure to add the environment variables saved by **secsetup.sh** into the profile of the security administrator.

Step	Action
1	If you logged off of the UNIX host, log back on as the administrative user.  <b>Reference</b> See the <a href="#">How to Create an Administrative User</a> topic in this guide for instructions.
2	Change directories to the home directory for the administrative user.
3	Use a text editor to open the profile ( <i>.profile</i> or <i>.login</i> ) of the administrative user.  <b>Reference</b> See the documentation provided with the text editor for more information about opening files.
4	Open a second session on the UNIX host while keeping the first session open.
5	Open the <i>gentran.security.vars</i> file and add the last set of values to the end of the profile.  <b>CAUTION</b> <b>The installation process appends new values at the end of the <i>gentran.security.vars</i> file each time you run <i>secsetup.sh</i> using the same UNIX login.</b> <b>Depending on the size of the file and the text editor you are using, it may be easier to locate the values that you need to copy by printing the file first.</b>
6	Save the modified profile.
7	Log the administrative user off the system.
8	Log onto the system again as the administrative user.  <b>System Response</b> The system sets the environment variables for the administration user using the values from the edited profile.

# How to Load GENTRAN:Server Host Installation Files

## Introduction

During installation, you must run a transfer program to copy the compressed software files from the installation CD into the proper directories on the UNIX host computer. This topic explains how to use the transfer program to read the installation files from a CD in a Windows client computer into a temporary directory on the UNIX host.

## Before you begin

Before you begin loading the GENTRAN:Server installation files onto the UNIX host computer, you must have a UNIX login to install and own the Security Administration utility.

### IMPORTANT

**You must load the Security Installation files and install the Security Administration software before loading the GENTRAN:Server installation files.**

### References

See the [How to Create an Administrative User](#) topic in this chapter for detailed instructions on creating this login.

## Copying installation files from the CD

Use this procedure to copy the installation files from a CD-ROM drive on the Windows client computer to the UNIX host.

### Note

Before you begin, verify that

- The connection between the Windows client and the UNIX host supports TCP/IP
- The Windows client computer is connected to the UNIX host.

Step	Action
1	Insert the GENTRAN:Server host installation CD into a CD-ROM drive in the Windows client.
2	Open the Windows <b>Start</b> menu.
3	Select the <b>MS-DOS Prompt</b> from the Programs menu.  <b>System Response</b> Windows opens an MS-DOS Prompt window.  (Continued on next page)

(Contd) Step	Action
4	Change directories to the CD-ROM drive on the Windows computer.  <b>Example</b> D:
5	Type the following command to transfer installation files from the CD to a temporary area on the UNIX host:  <pre>ftpprod &lt;product&gt; &lt;host&gt; &lt;path&gt; &lt;user&gt; &lt;password&gt;</pre> Where <ul style="list-style-type: none"> <li>▶ &lt;product&gt; is the product code for the GENTRAN:Server product level you purchased. Use one of the following values.  <b>server</b>=GENTRAN:Server for UNIX  <b>pcm</b>=GENTRAN:Server for UNIX with Process Control Manager  <b>wb</b>=GENTRAN:Server for UNIX with EC Workbench  <b>add</b>=GENTRAN:Server for UNIX with Advanced Data Distribution (includes EC Workbench)</li> <li>▶ &lt;host&gt; is the system name for the UNIX host</li> <li>▶ &lt;path&gt; is the path to a temporary directory (The <b>ftpprod</b> process will create the directory if necessary)</li> <li>▶ &lt;user&gt; is the user login for the administrative user you created</li> <li>▶ &lt;password&gt; is the user password for the administrative user</li> </ul> <b>Example</b> <pre>ftpprod add sun2 /usr/gentran/temp secuser secpassword</pre>
6	Press ENTER.  <b>System Response</b> The transfer program displays information about the transfer process. The message "Files transferred" indicates that the process completed successfully.
7	Close the DOS window.
8	Continue to <a href="#">How to Install the GENTRAN:Server Host Software</a> to install the security software from the temporary directory.

# How to Install the GENTRAN:Server Host Software

## Introduction

You run the `setup.sh` script to install the GENTRAN:Server host software into the appropriate directories on the UNIX host.

The `setup.sh` script reads the installation files and installs them into the specified location on the UNIX host. This script also sets temporary values for some of the UNIX environment variables that the GENTRAN:Server software needs. The installation script places those variables into a file that you can include in scripts and UNIX users' profiles.

This topic explains how to run `setup.sh` to install the GENTRAN:Server software files into a directory and then add the environment variables into the administration user's profile or to scripts.

### IMPORTANT

**You must load the Security Installation files and install the Security Administration software before installing the GENTRAN:Server host software.**

## Before you begin

Use this checklist to determine that you are ready to install GENTRAN:Server onto the UNIX host computer.

Done	Task
	Verify that you created a GENTRAN:Server user to own the environment and the processes run within it.
	Verify that you correctly installed a copy of the Security Administration utility to control the GENTRAN:Server environment.

### CAUTION

**During the setup process, the setup program prompts you for a required environment variable if it is not set. If the setup program finds a value for a required environment variable, it continues to the next step without displaying a prompt.**

(Continued on next page)

### Installing the GENTRAN:Server software

Use this procedure to install the GENTRAN:Server software onto the UNIX host computer. Refer to the completed *Installation Checklist* as needed.

Step	Action
1	<p>Log on to the UNIX host as the GENTRAN:Server user that owns the host software.</p> <p><b>WARNING</b></p> <p>You must log on as the user who will own the GENTRAN:Server environment. Using another login will result in conflicts with permissions.</p> <p>Do <i>not</i> log on as root. The root login is unable to run the installation program.</p> <p><b>Reference</b></p> <p>See the topic <a href="#">How to Create a GENTRAN:Server User</a> for instructions on this task.</p>
2	Change directories to the temporary directory.
3	<p>Give “execute” privileges for the <b>setup.sh</b> script file so it can be run by the GENTRAN:Server user.</p> <p><b>Example</b></p> <pre>chmod +x setup.sh</pre>
4	<p>Type the following command and then press ENTER.</p> <pre>./setup.sh</pre> <p><b>System Response</b></p> <p>The <b>setup.sh</b> script displays information about the installation process and prompts you to provide the product key for the GENTRAN:Server product you want to install.</p>
5	<p>Type the product key; then press ENTER.</p> <p><b>System Response</b></p> <p>The <b>setup.sh</b> script prompts you for the path to the location where GENTRAN:Server will be installed.</p> <p style="text-align: right;">(Continued on next page)</p>



(Contd) Step	Action
6	<p>Type the complete path to where you want <b>setup.sh</b> to install the GENTRAN:Server software and press ENTER.</p> <p><b>Example</b> /usr1/gentran/edi</p> <p><b>System Response</b> The <b>setup.sh</b> script displays the path you entered and prompts you to confirm that the path is correct.</p>
7	<p>Is the displayed path correct?</p> <ul style="list-style-type: none"> <li>▶ If YES, type <b>Y</b> and then press ENTER.</li> <li>▶ If NO, type <b>N</b> and press ENTER. The <b>setup.sh script</b> prompts you a second time to enter a value for EDI_ROOT and ENV_ROOT. Return to Step 6.</li> </ul> <p><b>System Response</b> The <b>setup.sh</b> script prompts you for the complete path to the <i>vttermcap</i> file.</p>
8	<p>Do you want to use the <i>vttermcap</i> file supplied by Sterling Commerce?</p> <ul style="list-style-type: none"> <li>▶ If YES, press ENTER to accept the default path.</li> </ul> <p><b>Note</b> We recommend that you accept the default. Use another file only if your system requires a proprietary terminal emulator.</p> <ul style="list-style-type: none"> <li>▶ If NO, type the path to where your proprietary <i>vttermcap</i> file is stored and press ENTER. (Your system administrator can provide this path if you need it.)</li> </ul> <p><b>System Response</b> The <b>setup.sh</b> script displays the path entered for the <i>vttermcap</i> file and prompts you to confirm that value.</p>
9	<p>Is the displayed VVTERMCAP value correct?</p> <ul style="list-style-type: none"> <li>▶ If YES, type <b>Y</b> and press ENTER.</li> <li>▶ If NO, type <b>N</b> and press ENTER. The <b>setup.sh script</b> prompts you a second time to enter a value for VVTERMCAP. Return to Step 8.</li> </ul> <p><b>Comment</b> This value reflects the terminal emulation setting to use for GENTRAN:Server, and normally is the same as the value for the TERM environment variable as set in your profile.</p> <p style="text-align: right;">(Continued on next page)</p>

(Contd) Step	Action
10	<p>Do you want to install in the &lt;filename&gt; directory?</p> <ul style="list-style-type: none"> <li>▶ If YES, type <b>y</b> and then press ENTER.</li> <li>▶ If NO, type <b>n</b> and then the directory you want to use. Then press ENTER.</li> </ul> <p><b>System Response</b> The <b>setup.sh</b> script runs. It creates directories, installs the EDI software, and creates empty data files. After all files are installed, the installation validation program verifies that GENTRAN:Server can run successfully. Validation collects the validated environment variable settings in a file, and creates a log file that records any problems detected.</p> <p><b>Note</b> The validation stage lasts several minutes for the lowest product level. This stage lasts longer for higher product levels.</p> <p>Eventually, the <b>setup.sh</b> script displays status messages and lists the path to the file that contains the environment variables.</p>
11	<p>View the installation log to confirm that the installation completed successfully.</p> <p><b>Comment</b> The system creates the installation log (<i>setup.log</i>) in the directory where you started <b>setup.sh</b>.</p>
12	<p>Continue with the next procedure, <a href="#">Adding environment variables to the owner's profile</a></p>

---

(Continued on next page)

### Adding environment variables to the owner's profile

Use this procedure to add the required environment variables saved by `secsetup.sh` and by `setup.sh` into the profile of the environment's owner.

#### Note

This procedure requires you to open two sessions on the UNIX host.

Step	Action
1	If you logged off the UNIX host, log back onto the UNIX host as the GENTRAN:Server user created to own this environment.  <b>Reference</b> See the <a href="#">How to Create a GENTRAN:Server User</a> topic for instructions.
2	Change directories to the home directory for the GENTRAN:Server user.
3	Use any text editor to open the profile ( <code>.profile</code> or <code>.login</code> ) of the GENTRAN:Server user.
4	Open a second session on the UNIX host while keeping the first session open.
5	Log onto the second session as the GENTRAN:Server user.  <b>Comment</b> You can make the rest of this procedure easier to perform by resizing the session windows side-by-side.
6	Change directories in the second session to the home directory of the owner of the security installation.
7	Open the <code>gentran.security.vars</code> file and copy the command that sets NAMEBROKER from the last set of values.  <b>CAUTION</b> <b>The installation process appends new values at the end of the <code>gentran.security.vars</code> file each time you run <code>secsetup.sh</code> using the same UNIX login.</b>  Depending on the size of the file and the text editor you are using, it may be easier to locate the values that you need to copy by printing the file first.
8	Paste the NAMEBROKER command into the profile in the first session window.  <p style="text-align: right;">(Continued on next page)</p>

(Contd) Step	Action
9	From the <i>gentran.security.vars</i> file in the second session window, copy the command that sets SADMIN_ROOT.
10	Paste the SADMIN_ROOT command into the profile in the first session window.
11	Change directories in the second session window to the home directory for the GENTRAN:Server user.
12	Open the <i>gentran.server.vars</i> file and copy the environment variables.  <b>WARNING</b> <b>The installation process appends new values at the end of the <i>gentran.server.vars</i> file each time you run <i>setup.sh</i> using the same UNIX login.</b> <b>Depending on the size of the file and the text editor you are using, it may be easier to locate the values that you need to copy by printing the file first.</b>
13	Paste the commands at the end of the profile in the first session.
14	Save the modified profile.
15	Log the GENTRAN:Server user off of both sessions and then log this user back on to the host again.  <b>System Response</b> The system sets the environment variables for the GENTRAN:Server user using the values from the edited profile.
16	Do you want to install the optional XML Translation extension? <ul style="list-style-type: none"> <li>▶ If YES, see <a href="#">How to Load and Install the XML Translation Option</a> for further instructions.</li> <li>▶ If NO, continue to the next step.</li> </ul>
17	Do you want to install the optional ODBC Database Drivers? <ul style="list-style-type: none"> <li>▶ If YES, see <a href="#">How to Install Optional ODBC Database Drivers</a> for further instructions.</li> <li>▶ If NO, continue to the next step.</li> </ul> <p style="text-align: right;">(Continued on next page)</p>

(Contd) Step	Action
18	Do you want to install the optional Visual Mapper? <ul style="list-style-type: none"><li>▶ If YES, see separate card titled <i>Visual Mapper - UNIX Host Installation Instructions</i> for further instructions.</li><li>▶ If NO, continue to the next step.</li></ul>
19	Do you want to install another copy of the GENTRAN:Server software? <ul style="list-style-type: none"><li>▶ If YES, then repeat the previous procedure, <a href="#">Installing the GENTRAN:Server software</a>.</li><li>▶ If NO, then you are ready to set up security for your new installation. Continue with the next section, <a href="#">Setting Up GENTRAN:Server Security</a>.</li></ul>

---

## How to Load and Install the XML Translation Option

### Introduction

To install the optional XML translation extension, you copy the compressed software files from the installation CD into a temporary directory on the host, and then run the installation script `xmlsetup.sh` to install the software into the appropriate directory on the host.

#### Note

The XML translation extension is automatically installed on the Windows client computer. It cannot be accessed until this installation process is completed on the host computer, however.

### Before you begin

You must first install the core GENTRAN:Server for UNIX software before you can install the optional XML extension. See [How to Install the GENTRAN:Server Host Software](#) for instructions.

#### CAUTION

**During the setup process, the setup program prompts you for a required environment variable, if the variable has not been set. If the setup program finds a value for a required environment variable, it continues to the next step without displaying a prompt.**

### Procedure

Use this procedure to load and install the optional XML translation extension.

Step	Action
1	<p>Log on to the UNIX host as the GENTRAN:Server user that owns this environment.</p> <p><b>WARNING</b></p> <p><b>You must log on as the user who owns the GENTRAN:Server environment. Using another login will result in conflicts with permissions.</b></p> <p><b>Do <i>not</i> log on as root. The root login is unable to run the installation program.</b></p> <p><b>Reference</b></p> <p>See the topic <a href="#">How to Create a GENTRAN:Server User</a> for instructions on this task.</p> <p style="text-align: right;">(Continued on next page)</p>

<b>(Contd) Step</b>	<b>Action</b>
2	Insert the GENTRAN:Server host installation CD into a CD-ROM drive in the Windows client.
3	Open the Windows <b>Start</b> menu.
4	Select the <b>MS-DOS Prompt</b> from the Programs menu.  <b>System Response</b> Windows opens an MS-DOS Prompt window.
5	Change directories to the CD-ROM drive on the Windows computer.
6	Type the following command to transfer XML installation files from the CD to a temporary area on the UNIX host:  <pre>ftpprod xml &lt;host&gt; &lt;path&gt; &lt;user&gt; &lt;password&gt;</pre> Where <ul style="list-style-type: none"> <li>▶ &lt;host&gt; is the system name for the UNIX host</li> <li>▶ &lt;path&gt; is the path to a temporary directory (The <b>ftpprod</b> process will create the directory if necessary)</li> <li>▶ &lt;user&gt; is the user login for the administrative user you created</li> <li>▶ &lt;password&gt; is the user password for the administrative user</li> </ul> <b>Example</b> <pre>ftpprod xml sun2 /usr/gentran/tempxml secuser secpassword</pre>
7	Press ENTER.  <b>System Response</b> The transfer program displays information about the transfer process. The message "Files transferred" indicates that the process completed successfully.
8	On the UNIX host, change directories to the temporary directory specified by <path> in Step 6.
9	Give "execute" privileges for the <b>xmlsetup.sh</b> script file so it can be run by the GENTRAN:Server user.  <b>Example</b> <pre>chmod +x xmlsetup.sh</pre> <p style="text-align: right; color: red;">(Continued on next page)</p>

<b>(Contd) Step</b>	<b>Action</b>							
10	Type the following command and then press ENTER.  ./xmlsetup.sh  <b>System Response</b> The <code>xmlsetup.sh</code> script displays information about the installation process. The system then prompts you to enter the serial number for your XML Translation software.							
11	Type the serial number at this prompt:  <b>Please enter the key for GENTRAN:Server XML Extension:</b>  <b>System Response</b> <table border="1" data-bbox="607 823 1424 1314"> <thead> <tr> <th data-bbox="607 823 1019 940"><b>IF the EDI_ROOT and ENV_ROOT environment variables...</b></th> <th data-bbox="1019 823 1424 940"><b>THEN...</b></th> </tr> </thead> <tbody> <tr> <td data-bbox="607 940 1019 1096">are set</td> <td data-bbox="1019 940 1424 1096">               the system installs the software under EDI_ROOT.                 GO TO Step 13.             </td> </tr> <tr> <td data-bbox="607 1096 1019 1314">are NOT set</td> <td data-bbox="1019 1096 1424 1314">               the system prompts you to enter a value for the EDI_ROOT and ENV_ROOT environment variables.                 Continue with the next step.             </td> </tr> </tbody> </table>		<b>IF the EDI_ROOT and ENV_ROOT environment variables...</b>	<b>THEN...</b>	are set	the system installs the software under EDI_ROOT.  GO TO Step 13.	are NOT set	the system prompts you to enter a value for the EDI_ROOT and ENV_ROOT environment variables.  Continue with the next step.
<b>IF the EDI_ROOT and ENV_ROOT environment variables...</b>	<b>THEN...</b>							
are set	the system installs the software under EDI_ROOT.  GO TO Step 13.							
are NOT set	the system prompts you to enter a value for the EDI_ROOT and ENV_ROOT environment variables.  Continue with the next step.							
12	At the prompt, type values for the EDI_ROOT and ENV_ROOT environment variables.  <b>Example</b> /edibox1/server60/60server-add921  <b>System Response</b> The system displays this prompt: Is this correct: [value for variables] (y/n)							
13	Do you want to run the validation program? <ul style="list-style-type: none"> <li>▶ If YES, type <b>y</b> at the prompt and then continue with Step 14.</li> <li>▶ If NO, type <b>n</b> at the prompt to complete the installation process.</li> </ul>							



<b>(Contd) Step</b>	<b>Action</b>
14	View the installation log to confirm that the installation completed successfully.  <b>Comment</b> The system creates the installation log ( <i>xmlsetup.log</i> ) in the directory where you started <b>xmlsetup.sh</b> .

---

## How to Install Optional ODBC Database Drivers

### Introduction

To install the optional ODBC database drivers, you run the installation script `odbc_setup.sh` to install the software into the appropriate directory on the UNIX host.

### Note

Your GENTRAN:Server client software automatically installs ODBC database drivers on the Windows client computer. However, you cannot access ODBC functions on the client until you install the ODBC software on the UNIX host.

### Before you begin

You must first install the core GENTRAN:Server for UNIX software before you can install the optional ODBC database drivers. See [How to Install the GENTRAN:Server Host Software](#) for instructions.

### Procedure

Use this procedure to install the optional ODBC database drivers.

Step	Action
1	<p>Log on to the UNIX host as the GENTRAN:Server user that owns this environment.</p> <p><b>WARNING</b></p> <p><b>You must log on as the user who owns the GENTRAN:Server environment. Using another login will result in conflicts with permissions.</b></p> <p><b>Do <i>not</i> log on as root. The root login is unable to run the installation program.</b></p> <p><b>Reference</b></p> <p>See the topic <a href="#">How to Create a GENTRAN:Server User</a> for instructions on this task.</p>
2	<p>Change directories to the temporary directory you created when loading the core installation files. See <a href="#">How to Load Security Installation Files</a> for instructions.</p> <p>Alternatively, the script is also included in <code>\$EDI_ROOT/bin</code> of the core GENTRAN:Server for UNIX 6.0 installation.</p> <p style="text-align: right;">(Continued on next page)</p>

<b>(Contd) Step</b>	<b>Action</b>							
3	Give “execute” privileges for the <b>odbc_setup.sh</b> script file so the GENTRAN:Server user can run it.  <b>Example</b> chmod +x odbc_setup.sh							
4	Type the following command and then press ENTER.  ./odbc_setup.sh  <b>System Response</b> GENTRAN:Server checks for the value of the EDI_ROOT environment variable.  <table border="1" data-bbox="607 793 1427 1060"> <thead> <tr> <th data-bbox="607 793 922 877"><b>IF the installation script...</b></th> <th data-bbox="922 793 1427 877"><b>THEN it ...</b></th> </tr> </thead> <tbody> <tr> <td data-bbox="607 877 922 972">cannot find a value for EDI_ROOT</td> <td data-bbox="922 877 1427 972">prompts you to enter the directory path for EDI_ROOT.</td> </tr> <tr> <td data-bbox="607 972 922 1060">finds a value for EDI_ROOT</td> <td data-bbox="922 972 1427 1060">displays the path and prompts you to verify it.</td> </tr> </tbody> </table>		<b>IF the installation script...</b>	<b>THEN it ...</b>	cannot find a value for EDI_ROOT	prompts you to enter the directory path for EDI_ROOT.	finds a value for EDI_ROOT	displays the path and prompts you to verify it.
<b>IF the installation script...</b>	<b>THEN it ...</b>							
cannot find a value for EDI_ROOT	prompts you to enter the directory path for EDI_ROOT.							
finds a value for EDI_ROOT	displays the path and prompts you to verify it.							
5	Depending on the prompt, either enter values for the required environment variables or verify the displayed values.							
6	Type the product key; then press ENTER.  <b>System Response</b> The <b>odbc_setup.sh</b> script displays information about the installation process and prompts you to enter a serial number for the ODBC drivers.							
7	Enter the serial number on the label provided with your GENTRAN:Server for UNIX installation CD.  <b>System Response</b> The <b>odbc_setup.sh</b> script runs. When finished, the system displays this message:  ODBC Drivers enabled  <b>Note</b> The program creates a log file, odbc_setup.log, in the directory in which you ran the odbc_setup script.							

# Setting Up GENTRAN:Server Security

## Overview

---

**In this section**

This section explains how to use the Security Administration utility to:

- ▶ Set up each newly-installed GENTRAN:Server 6.0 environment.
  - ▶ Set up the GENTRAN:Server users for each newly-configured environment.
-

## Directories and Permissions

### Directory names

The Security Administration Utility is installed into the directory you specified for the `SADMIN_ROOT` environment variable. The directory `SADMIN_ROOT` contains the following subdirectories:

Subdirectory	Contents
broker	Executable and database files for the NAMEBROKER
admin	Security Administration executable files
db	Security Administration database files
temp	Security Administration temporary files

### Directory permissions

This table shows the recommended read (r), write (w), execute (x), and no permission (-) file permissions for the Security Administration directories.

Directory	Permission Group		
	Owner	Group	User/Other
broker	r w x	r w x	---
admin	r w x	r w x	---
db	r w x	r w x	---
temp	r w x	r w x	---

## How to Start and Exit Security Administration

---

**Login screen** This is the Security Administration login screen.

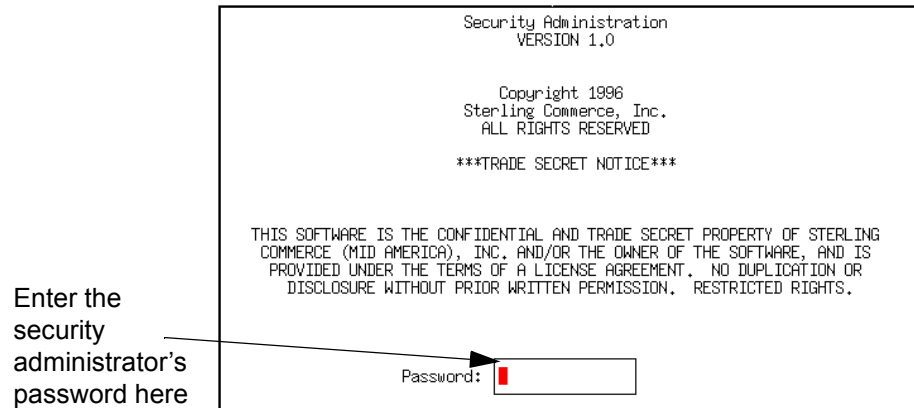

---

**Before you begin** Before you attempt to start Security Administration, check with your UNIX administrator to ensure that you have the appropriate file permissions to the Security Administration directories.

---

(Continued on next page)

## Starting Security Administration

Use this procedure to start Security Administration.

Step	Action						
1	Go to the UNIX command line.						
2	Use this table to determine your next action.						
	<table border="1"> <thead> <tr> <th>IF the Security Administration subdirectory <i>security/admin</i> is...</th> <th>THEN...</th> </tr> </thead> <tbody> <tr> <td>In your path</td> <td>Enter the command: secadmin</td> </tr> <tr> <td>Not in your path</td> <td>Change to the <i>admin</i> subdirectory.  Enter the command: <b>secadmin</b></td> </tr> </tbody> </table>	IF the Security Administration subdirectory <i>security/admin</i> is...	THEN...	In your path	Enter the command: secadmin	Not in your path	Change to the <i>admin</i> subdirectory.  Enter the command: <b>secadmin</b>
	IF the Security Administration subdirectory <i>security/admin</i> is...	THEN...					
	In your path	Enter the command: secadmin					
Not in your path	Change to the <i>admin</i> subdirectory.  Enter the command: <b>secadmin</b>						
<b>System Response</b> The system displays the Security Administration login screen.							
3	<p>Enter the security administrator's password in the Password field and then press <code>ENTER</code>.</p> <p><b>System Response</b> The system displays the Main Menu.</p> <p><b>CAUTION</b> If you are logging in for the first time, the password is <b>ADMIN</b>. You should change this password immediately after logging in. See the topic "How to Change the Security Administrator Password" in the "Security Administration Overview" chapter of the <i>GENTRAN:Server Maintenance and Troubleshooting Guide</i>.</p>						

### If you forget your password

If you forget your security administrator's password, you must call customer support to reset it.

(Continued on next page)

## Exiting Security Administration

Use this procedure to exit Security Administration.

Step	Action
1	Press Esc twice to return to the Main Menu.
2	Press x to exit.

### Example

This illustration shows how to exit Security Administration.

To exit Security Administration press X

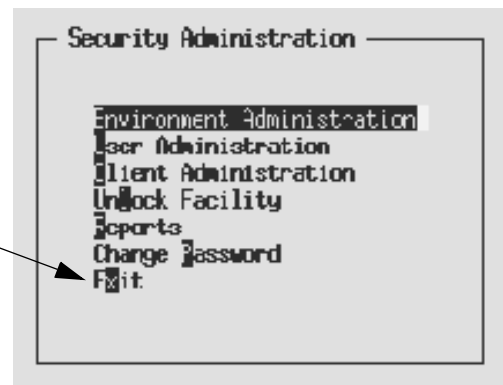



## How to Add a New Environment Record

**Introduction** To create a new environment on a host, you enter all of the new environment data into a blank Environment Administration screen. Security Administration copies required files from the *db* subdirectory into the new environment record.

**Before you begin** Make sure you are logged on to the Security Administration utility as the UNIX user who installed the GENTRAN:Server Security Administration utility. This ensures that you have the appropriate permissions for the security directories.

**Procedure** Use this procedure to add an environment record.

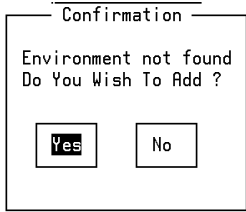
Step	Action
1	Select <b>Environment Administration</b> from the Security Administration Main Menu to display the Environment Administration screen.
2	Enter the name of the new environment in the <b>Environment</b> field.
3	Press ENTER.  <b>System Response</b> The system displays the prompt "Environment not found. Do You Wish to Add?"  
4	Select <b>Yes</b> and press ENTER to continue.  <b>System Response</b> Security Administration enters the name from Step 2 into the Environment field of the Environment Administration screen.  <p style="text-align: right;">(Continued on next page)</p>

(Contd) Step	Action
5	<p>Type the complete path to <code>\$EDI_ROOT</code> into the first field on the Environment Administration screen and then press ENTER.</p> <p><b>WARNING</b></p> <p><b>The path of the root directory must be unique to the environment. All other paths may either be unique or shared among two or more environments.</b></p> <p><b>System Response</b></p> <p>Security Administration creates appropriate entries for all of the other fields, basing them on the root directory you enter.</p> <pre data-bbox="695 793 1365 1050"> Environment Administration ----- Environment:          srv60ADD Root Directory:      /home/gentran/srv60ADD Standards/Codes:     /home/gentran/srv60ADD/stds/ Implement Guides:    /home/gentran/srv60ADD/igs/ App/DDF Files:       /home/gentran/srv60ADD/apps/ Maps:                /home/gentran/srv60ADD/maps/ Trading Partner:     /home/gentran/srv60ADD/tp/ EDI History Audit:   /home/gentran/srv60ADD/edihist/ Data:                /home/gentran/srv60ADD/data/ HIPAA Features[Y/N]: N </pre> <p style="text-align: center;">&lt;ESC&gt;-Exit F1-Help F10-Save</p>
6	<p>Check the path in every field on the Environment Administration screen and edit them if necessary.</p>
7	<p>Do you want to enable GENTRAN:Server features that support the Health Insurance Portability and Accountability Act (HIPAA)?</p> <ul style="list-style-type: none"> <li>▶ If YES, type <b>Y</b> in the HIPAA Features field.</li> <li>▶ If NO, type <b>N</b> in the HIPAA Features field.</li> </ul> <p><b>Reference</b></p> <p>See the HIPAA Compliance and NCPDP User's Guide for information about the HIPAA features of GENTRAN:Server.</p>
8	<p>Press F10 to save the record.</p> <p><b>Comment</b></p> <p>Press ESC+0 if your terminal emulator is set to vt100.</p> <p style="text-align: right; color: red;">(Continued on next page)</p>

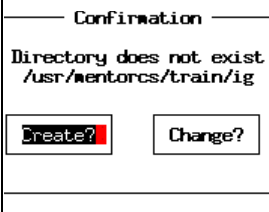
(Contd) Step	Action		
9	Use this table to determine your next action.		
	IF...	THEN Security Administration...	AND you should...
	All the directories you specified exist	Saves the environment record and refreshes the screen	Add another environment or exit the screen.
	Either the root or temporary directory is not unique	Displays an error message	Correct the record by typing a unique directory path name in the <b>Root Directory</b> or <b>Temporary</b> field.
A specified directory does not exist	Displays a confirmation panel for each directory that does not exist   <p style="text-align: center;">Confirmation</p> <p>Directory does not exist /usr/mentorcs/train/ig</p> <p><input type="button" value="Create?"/> <input type="button" value="Change?"/></p>	Select <b>Create</b> to create the directory or select <b>Change</b> to specify another directory.	

**CAUTION**

**Security Administration automatically creates the parent directories when you choose to create the subordinate directory.**

(Continued on next page)

### Example of completed Environment Administration screen

The following is an example of a completed Environment Administration screen. For field descriptions, see the [The Environment Administration Screen](#) topic in the Maintenance and Troubleshooting Guide.

```
Environment Administration
-----
Environment:          13.test
Xcop Directory:      /13/home/srvr/60test
Standards/Codes:     /13/home/srvr/60test/stds/
Implement Guides:    /13/home/srvr/60test/igs/
App/TMF Files:      /13/home/srvr/60test/apps/
Xcpe:                /13/home/srvr/60test/nops/
Trading Partner:     /13/home/srvr/60test/tp/
EII History Audit:   /13/home/srvr/60test/edihist/
Data:                /13/home/srvr/60test/dats/
HIPAA Features(Y/N): Y

<ESC>-Exit F1-Help F3-Delete F10-Save
```

# How to Add a User Record

## Introduction

You can add a new user record by doing one of the following:

IF you...	THEN...
Need to build your user ID records	Enter all user information into the blank fields on the User Administration screen.
Do not have an existing user ID record that is similar to the one you need	Enter all user information into the blank fields on the User Administration screen.
Have an existing user ID record that is similar to the one you need	Copy the entire user record, including all the environmental-level and function-level access permissions, and modify it as necessary.

(Continued on next page)

### Entering new user information on blank panels

Use this procedure to add a new user record.

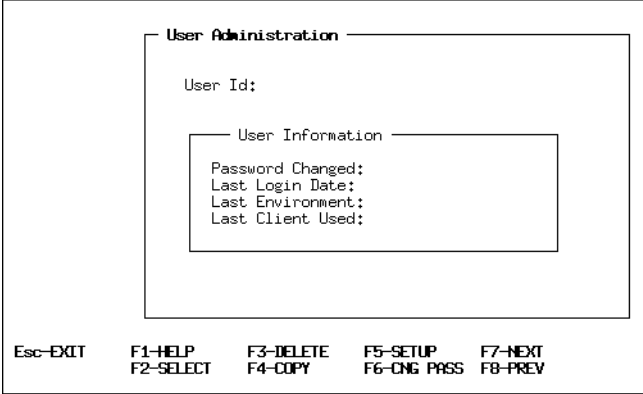
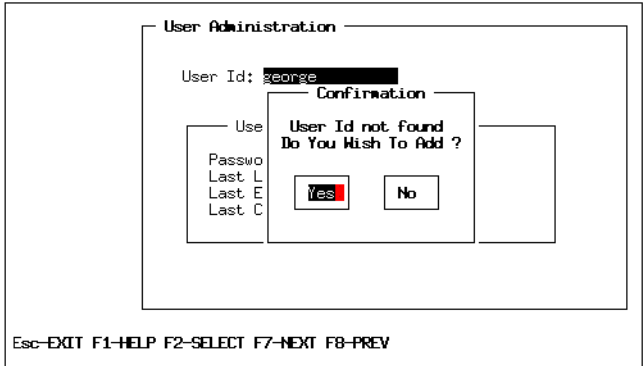
Step	Action
1	<p>Select <b>User Administration</b> from the Main Menu.</p> <p><b>System Response</b> The system displays the User Administration screen.</p> 
2	<p>Type the new user ID in the <b>User ID</b> field and then press ENTER.</p> <p><b>Comment</b> The field accepts up to 15 alphanumeric characters. Do not use spaces or any punctuation.</p> <p><b>System Response</b> If the user ID does not exist, the system displays the following panel:</p> 

(Continued on next page)

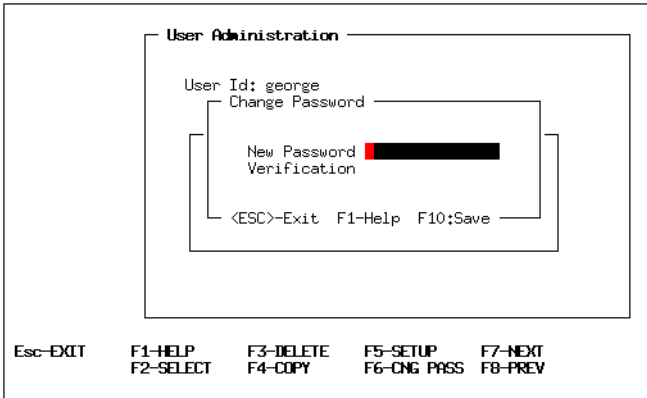
(Contd) Step	Action
3	<p>Select <b>Yes</b> to add the new user ID.</p> <p><b>System Response</b> The system displays the Change Password panel. This panel is used to set the user's initial password.</p> 
4	<p>Type the password you want to assign to this user in the <b>New Password</b> field and then press ENTER.</p> <p><b>Comment</b> The field accepts up to 15 alphanumeric characters. Do not use spaces or any punctuation.</p>
5	<p>Type the password again in the <b>Verification</b> field.</p>
6	<p>Press F10.</p> <p><b>Comment</b> Press ESC-0 if your terminal emulator is vt100.</p> <p><b>WARNING</b> <b>If the password entered in the New Password field does not match the password entered in the Verification field, Security Administration displays the message "Verification error - Retry." Press Esc to remove the error message from your display. Retype the password in the New Password and Verification fields.</b></p> <p style="text-align: right;">(Continued on next page)</p>

(Contd) Step	Action	
7	Use this table to determine your next action.	
	<b>IF you...</b>	<b>THEN...</b>
	Do not need to create more users	Continue with the topic <a href="#">How to Assign Access to an Environment and Its Functions</a> .
	Need to create more users and some of the users need the same access to the environment	Continue with the topic <a href="#">How to Assign Access to an Environment and Its Functions</a> .  <b>Suggestion</b> After you set all security access for this user, use the procedure <a href="#">Copying a user record</a> to create new users with the same access.
	Need to create more users and all of the users need different environment access	Repeat Steps 1 through 6 for each additional user.

---

(Continued on next page)



**Copying a user record**

Use this procedure to copy a user record.

Step	Action
1	<p>Select <b>User Administration</b> from the Main Menu.</p>
2	<p>Press F2 and choose the user ID from the choice list.</p> <p><b>Comment</b> Press ESC-2 if your terminal emulator is vt100.</p> <p><b>System Response</b> The system displays the user information.</p> <div data-bbox="704 751 1344 1142" style="border: 1px solid black; padding: 10px; margin: 10px auto; width: fit-content;"> <pre> User Administration ----- User Id:  ohnp  User Information ----- Password Changed: 05/23/96 15:58:52 Last Login Date: 06/21/96 11:41:38 Last Environment: test Last Client Used: aJ0&gt;Jc*           </pre> <p style="text-align: center;">Esc-EXIT    F1-HELP    F3-DELETE    F5-SETUP    F7-NEXT               F2-SELECT    F4-COPY        F6-CHG PASS    F8-PREV</p> </div>
3	<p>Press F4.</p> <p><b>Comment</b> Press ESC-4 if your terminal emulator is vt100.</p> <p><b>System Response</b> The system displays the Copy User ID panel.</p> <div data-bbox="734 1398 1305 1751" style="border: 1px solid black; padding: 10px; margin: 10px auto; width: fit-content;"> <pre> User Administration ----- User Id:  ohnp  Copy User Id ----- New User Id:    &lt;ESC&gt;-Exit    F1-Help    F10:Save           </pre> <p style="text-align: center;">Esc-EXIT    F1-HELP    F3-DELETE    F5-SETUP    F7-NEXT               F2-SELECT    F4-COPY        F6-CHG PASS    F8-PREV</p> </div> <p style="text-align: right; color: red;">(Continued on next page)</p>

(Contd) Step	Action
4	<p>On the <b>Copy User ID</b> panel, type the ID of the new user in the <b>New User ID</b> field.</p> <p><b>Comment</b> The field accepts up to 15 alphanumeric characters. Do not use spaces or any punctuation.</p>
5	<p>Press F10.</p> <p><b>Comment</b> Press <code>ESC-0</code> if your terminal emulator is vt100.</p> <p><b>System Response</b> The system displays the Change Password panel.</p> <div data-bbox="737 814 1313 1167" style="border: 1px solid black; padding: 10px; margin: 10px auto; width: fit-content;"> <pre> User Administration ----- User Id: george Change Password ----- New Password ██████████ Verification ----- &lt;ESC&gt;-Exit  F1-Help  F10:Save </pre> <p style="font-size: small; margin-top: 5px;"> Esc-EXIT    F1-HELP    F3-DELETE    F5-SETUP    F7-NEXT  F2-SELECT    F4-COPY    F6-CNG PASS    F8-PREV </p> </div>
6	<p>In the <b>New Password</b> field, type the password you want to assign to this user and then press <code>ENTER</code>.</p>
7	<p>Type the password again in the <b>Verification</b> field.</p>
8	<p>Press F10.</p> <p><b>Comment</b> Press <code>ESC-0</code> if your terminal emulator is vt100.</p> <p><b>WARNING</b></p> <p><b>If the password you typed in the New Password field does not match the password you typed in the Verification field, Security Administration displays the message “Verification error - Retry.” Press <code>Esc</code> to remove the error message from your display and then retype the password in the New Password and Verification fields.</b></p>

(Continued on next page)

**Comment**

After you have created the new user ID record, you can modify it as needed. See the topic [How to Assign Access to an Environment and Its Functions](#) in this chapter for instructions.

---

# Environment Access

---

## Introduction

You can assign a single environment to any number of user IDs. You can also assign a number of environments to a single user ID. After assigning an environment to a user, select the function groups of the environment and assign an access code to each function in each group.

---

## Function levels and classifications

Environments have two function groups: **editor** and **program**.

### Editor group

The editor functions enable the user to modify files.

Editor functions have three access levels:

- No access (user has no access to the function or the files)
- View-only access (user can only view files)
- Full access (user has access to all capabilities of editor, such as viewing, copying, editing, loading, unloading, and renaming files)

### Program Group

Program functions are executable programs.

Program functions have two access levels:

- Full access (user can run the program)
- No access (user cannot run the program)

---

## Screens used to assign environment level access

These screens are used to assign the environment and function-level access:

- User Environment Administration
- User Function Administration

Descriptions of these two screens follow this topic.

---

(Continued on next page)

## User Environment Administration screen

This illustration shows the User Environment Administration screen.



## Purpose

The User Environment Administration screen is used to assign an environment to a user ID.

## Fields and functions

This table describes the fields of the User Environment Administration screen and their functions.

Field	Function
User ID	The characters that identify the user record to the system.
Environment	The name of the environment to which the user ID is granted access.

## Function keys

This table lists the function keys on the User Environment Administration screen and their functions.

Key	Function
ESC	Exits the screen. <b>Comment</b> Press <code>ESC-ESC</code> if your terminal emulator is vt100.
F1	Displays Help information. <b>Comment</b> Press <code>ESC-1</code> if your terminal emulator is vt100.

(Continued on next page)

(Contd) Key	Function
F2	Displays a list of all possible choices for the field that contains the cursor.  <b>Comment</b> Press ESC-2 if your terminal emulator is vt100.
F6	Displays a list of values already assigned to the field that contains the cursor.  <b>Comment</b> Press ESC-6 if your terminal emulator is vt100.

### User Function Administration screen

This illustration shows the User Function Administration screen (Program function group) for the EC Workbench product level of GENTRAN:Server for UNIX.

```

User Function Administration
-----
User ID:      mle
Environment:  13_60
Function Group: Editors

      Function Description                Type  Access
-----
Archive Retrieval                       E     F
Check In, Check Out Files                E     F
File Browser                             E     F
Trading Partner Preferences Settings     E     F
Trading Partner Editor                   E     F

<ESC>-EXIT  F1-HELP  F3-NO ACCESS FOR ALL  F5-VIEW FOR ALL  F7-NEXT
              F4-FULL ACCESS FOR ALL  F8-PREV  F10-SAVE

```

(Continued on next page)

---

**Purpose** The purpose of this screen is to assign the type of access the user is to have to each function in the environment.

---

**Fields and functions** This table describes the fields of the User Function Administration screen and their functions.

Field	Function
User ID	The characters that identify the user record to the system.
Environment	The name of the environment to which the user ID is granted access.
Function Group	The predefined name of the function group (Editors or Programs).
Function Description	The predefined functions within the function group.
Type	The function type: <ul style="list-style-type: none"> <li>▶ E = Editor</li> <li>▶ N = Non-Editor</li> </ul>
Access	The access code: <ul style="list-style-type: none"> <li>▶ F = Full access</li> <li>▶ N = No access</li> <li>▶ V = View-only access</li> </ul>

---

**Function keys** This table lists the function keys on the User Function Administration screen and their functions.

Key	Function
ESC	Exits the screen.
F1	Displays Help information.
F3	Denies access for every function (places an N in every field.)
F4	Grants access for every function (Places an F in every field.)

(Continued on next page)

<b>(Contd) Key</b>	<b>Function</b>
F5	Grants view-only access for every editor function (Places a V in every access field.) This option is not available for Programs.
F7	Displays this screen for the next User ID.
F8	Displays this screen for the previous User ID.
F10	Saves the information you entered.

---



# How to Assign Access to an Environment and Its Functions

**Procedure** To assign access to an environment, complete the following steps.

Step	Action
1	Select <b>User Administration</b> from the Main Menu.
2	<p>Press F2 and select the user ID from the list displayed.</p> <p><b>Comment</b> Press ESC-2 if your terminal emulator is vt100.</p> <p><b>System Response</b> The system displays the User Information screen.</p> <div data-bbox="695 926 1333 1318" style="border: 1px solid black; padding: 10px; margin: 10px auto; width: fit-content;"> <pre> User Administration ----- User Id: jhnp  User Information ----- Password Changed: 05/23/96 15:58:52 Last Login Date: 06/21/96 11:41:38 Last Environment: test Last Client Used: aJ0&gt;Jc*                     </pre> <p style="text-align: center; margin-top: 5px;"> Esc-EXIT    F1-HELP    F3-DELETE    F5-SETUP    F7-NEXT  F2-SELECT    F4-COPY    F6-CHG PASS    F8-PREV                     </p> </div> <p style="text-align: right; color: red;">(Continued on next page)</p>

(Contd) Step	Action
3	<p>Press F5 to set up the user environment.</p> <p><b>Comment</b> Press <code>ESC-5</code> if your terminal emulator is vt100.</p> <p><b>System Response</b> The system displays the User Environment Administration screen.</p> <div data-bbox="776 625 1318 951" style="border: 1px solid black; padding: 10px; margin: 10px auto; width: fit-content;"> <pre> User Administration ----- User Id: johnp  User Environment Administration ----- User Id: johnp Environment: </pre> </div>
4	<p>Press F2 and choose the environment you want to assign to this user or type the name of the environment in the field</p> <p><b>Comment</b> Press <code>ESC-2</code> if your terminal emulator is vt100.</p> <p><b>Comment</b> To view a list of environments already assigned to this user, press F6. Press <code>ESC-6</code> if your terminal emulator is vt100.</p> <p style="text-align: right; color: red;">(Continued on next page)</p>

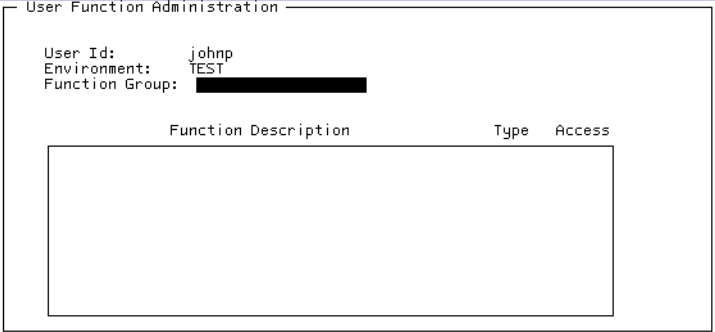
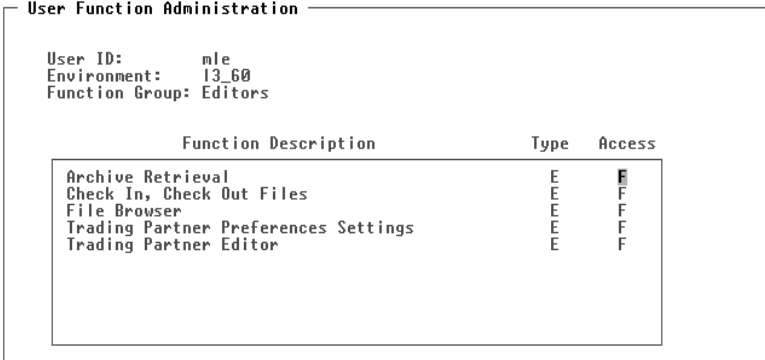
(Contd) Step	Action
5	<p>Press ENTER.</p> <p><b>System Response</b> Because this is a new environment for this user, Security Administration displays the User Function Administration screen so that you can assign function-level access to the user ID for this environment.</p>  <pre> User Function Administration ----- User Id:      johnp Environment:  TEST Function Group: ██████████  Function Description      Type  Access ----- </pre> <p>Esc-EXIT F1-HELP F2-SELECT F6-FIND F7-NEXT F8-PREV</p>
6	<p>Press F2 and choose the function group.</p> <p><b>Comment</b> Press ESC-2 if your terminal emulator is vt100.</p>
7	<p>Press ENTER.</p> <p><b>System Response</b> The system displays the function group and descriptions. Note that these are predefined and you cannot edit them.</p>  <pre> User Function Administration ----- User ID:      mle Environment:  13_60 Function Group: Editors  Function Description      Type  Access ----- Archive Retrieval        E     F Check In, Check Out Files E     F File Brouser             E     F Trading Partner Preferences Settings E     F Trading Partner Editor   E     F </pre> <p>&lt;ESC&gt;-EXIT F1-HELP F3-NO ACCESS FOR ALL F5-VIEW FOR ALL F7-NEXT F4-FULL ACCESS FOR ALL F8-PREV F10-SAVE</p> <p style="text-align: right; color: red;">(Continued on next page)</p>

<b>(Contd) Step</b>	<b>Action</b>
8	<p>In the Access column, enter the access code you want to assign this user or press a function key to assign the same access to all the functions.</p> <p><b>Comment</b> The valid access codes are:</p> <ul style="list-style-type: none"><li>▶ N=No access</li><li>▶ F=Full access</li></ul>
9	<p>Press F10.</p> <p><b>System Response</b> Security Administration refreshes the screen so you can choose and set up the next function group assignments.</p>
10	<p>Do you want to set up another function group assignment?</p> <ul style="list-style-type: none"><li>▶ If YES, then GO TO Step 6.</li><li>▶ If NO, press Esc twice to return to the User Environment Administration screen. The system retains the user ID.</li></ul> <p><b>Comment</b> Press ESC-0 if your terminal emulator is vt100.</p>

---

# Starting GENTRAN:Server Processes

## How to Start GENTRAN:Server on the Host

### Introduction

You must start processes on the UNIX host in order to test the connection of the client to the EDI installations and verify that the GENTRAN:Server environment is set up correctly. This topic describes the procedure you must perform to correctly start the processes that control your GENTRAN:Server installation.

### Starting processes

Use this procedure to start processes on the host computer.

#### CAUTION

**The installation process for GENTRAN:Server for UNIX turns off the s-bit (also known as the “set-userID/set-group-ID” bit). If your environment normally turns on the s-bit, it must be restored before you start the GENTRAN:Server processes.**

#### WARNING

**Make sure that you are logged into the host as the owner of the environment for which you want to start the processes.**

Step	Action
1	If you have not already done so, log on as the owner of the environment whose processes you want to start.
2	Change directory to the root of the host environment.
3	Enter the command <b>ps -ef   grep ltb_server</b> at the UNIX command line to check whether the broker process is running on the host.
4	<p>Is the broker running on the host?</p> <ul style="list-style-type: none"> <li>▶ If YES, then GO TO Step 6.</li> <li>▶ If NO, then login as owner of security and enter the following command to start the broker process.</li> </ul> <p><code>\$(SADMIN_ROOT)/broker/startnb.sh</code></p> <p style="text-align: right;">(Continued on next page)</p>

(Contd) Step	Action	
5	Is the Korn shell in use? ▶ If YES, continue with next step. ▶ If NO, enter the following command to start the Korn shell. <b>ksh -m</b>	
6	Enter the following command as owner of the host software to start the <b>mhs_server</b> and <b>mhp_server</b> processes in the affected environment.  startrpc.sh	
7	Use this table to determine your next step.	
	IF...	THEN...
	You need to create another GENTRAN:Server environment on this host	Repeat the instructions in the following sections: ▶ <a href="#">Preparing for Installation</a> ▶ <a href="#">Installing the Software on the UNIX Host</a> ▶ <a href="#">Setting Up GENTRAN:Server Security</a> ▶ <a href="#">Starting GENTRAN:Server Processes</a>
You are finished creating environments on this host	Continue with the <a href="#">Setting Up Windows Clients</a> chapter in this guide.	

---

# Setting Up Windows Clients

---

## Contents

▶ Overview .....	2
▶ How to Install the GENTRAN:Server Client Software .....	4
▶ How to Install HyperACCESS .....	13
▶ How to Install MDAC 2.6 Components .....	20
▶ How to Install GENTRAN Standards .....	22
▶ How to Install Online Documentation .....	27
▶ How to Edit the Windows Hosts File .....	34
▶ How to Identify the Host to DNS .....	35
▶ How to Install Optional Components .....	36

---

## Overview

### Introduction

This chapter explains how to set up a GENTRAN:Server® client computer.

### Before You Begin

Use this table to determine whether you are ready to install GENTRAN:Server.

Done	Task
	Install the Security Administration utility and the GENTRAN:Server host software.  <b>Reference</b> See the <a href="#">Installing GENTRAN:Server On the UNIX Host</a> chapter in this guide for instructions.
	Use the Security Administration utility to: <ul style="list-style-type: none"> <li>▶ Set up the GENTRAN:Server environment.</li> <li>▶ Set up the GENTRAN:Server users.</li> <li>▶ Give each user appropriate access to the environment.</li> </ul> <b>Reference</b> See the chapter <a href="#">Installing GENTRAN:Server On the UNIX Host</a> in this guide for instructions.
	Start GENTRAN:Server processes on the host.  <b>Reference</b> See the <a href="#">Installing GENTRAN:Server On the UNIX Host</a> chapter in this guide for instructions.
	Complete the installation checklist. Keep the checklist with you as a reference throughout the procedure.

(Continued on next page)



**Client setup  
process**

This table describes the stages in the setup process for a GENTRAN:Server client.

Stage	Description
1	Install the GENTRAN:Server client software.
2	Install HyperACCESS® for use by GENTRAN:Server with Process Control Manager (PCM) and higher product levels
3	Install Microsoft Data Access Components.
4	Install GENTRAN Standards.
5	Edit the Windows Hosts file or identify the host to DNS.
6	Install the GENTRAN:Server online documentation.
7	Install optional components, including XML translation, ODBC Database Drivers and the Visual Mapper.
8	Set Trading Partnership Administration preferences.  <b>Reference</b> See the <a href="#">Setting Preferences and Default Values</a> section in the <a href="#">Application Integration Basics</a> chapter of the <i>GENTRAN:Server Application Integration User's Guide</i> .

## How to Install the GENTRAN:Server Client Software

Use this procedure to install GENTRAN:Server on each client computer.

Step	Action
1	Close all programs running on the client computer.
2	Insert the installation CD into the CD-ROM drive of the client computer.
3	Did the installation program start automatically and display the Welcome dialog box? <ul style="list-style-type: none"> <li>▶ If YES, GO TO to Step 6.</li> <li>▶ If NO, then continue to the next step.</li> </ul>
4	Select <b>Run</b> from the <b>Start</b> menu.  <b>System Response</b> Setup displays the Run dialog box.
5	Enter the following command in the <b>Run</b> dialog box, then click <b>OK</b> :  <drive>:\setup  where <drive> represents the drive letter of the CD-ROM drive  <b>System Response</b> Setup displays the Welcome dialog box.
6	Click <b>Next</b> to continue.  <b>System Response</b> Setup displays the GENTRAN:Server 6.0 License Agreement dialog box.  <div style="text-align: right; color: red;">(Continued on next page)</div>

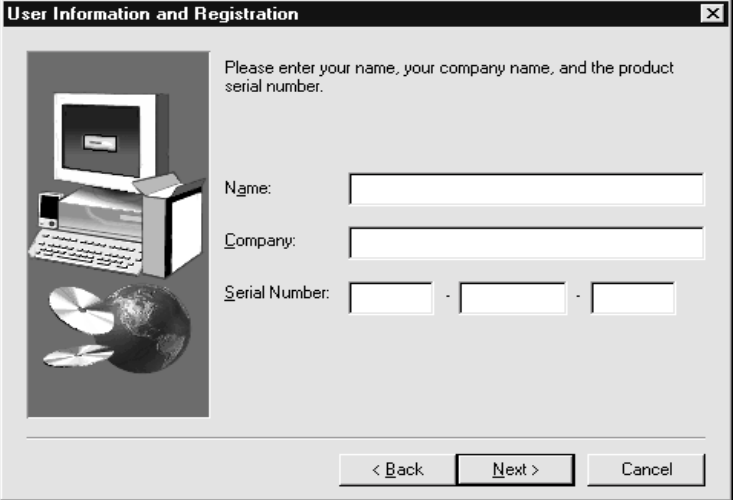
(Contd) Step	Action
7	<p>Click <b>Yes</b> to accept the license agreement and continue installation.</p> <p><b>System Response</b> Setup displays the Registration dialog box.</p> 
8	<p>Type your name, company, and one of the serial numbers from the label on the <i>Installation Checklist</i>. Click <b>Next</b>.</p> <p><b>Note</b> You must enter values in each field to continue.</p> <p><b>Comment</b> Write the serial numbers you used on the form provided in Appendix A, Client Descriptions.</p> <p><b>WARNING</b> <b>Use a different serial number on each client computer. GENTRAN:Server controls access by serial number and will not allow a second login of an active number. If you accidentally assign a serial number twice, you must reinstall GENTRAN:Server on the second client and assign an unused serial number.</b></p> <p><b>System Response</b> Setup displays the Choose Destination Location dialog box.</p> <p style="text-align: right;">(Continued on next page)</p>

(Contd) Step	Action								
9	<p>Do you want to change the directory where GENTRAN:Server is installed?</p> <ul style="list-style-type: none"> <li>▶ If NO, click <b>Next</b>, then GO TO Step 12.</li> <li>▶ If YES, click <b>Browse</b>, then continue with the next step.</li> </ul> <p><b>WARNING</b></p> <p><b>If you have an earlier version of GENTRAN:Server, use a different root directory for your GENTRAN:Server 6.0 software. If you install version 6.0 on top of a previous installation, you will lose existing data on the client.</b></p>								
10	<p>Browse to the directory into which you want to install GENTRAN:Server. If the directory does not exist, type into the <b>Browse</b> box a path for Setup to create during installation. Click <b>OK</b>.</p> <p><b>WARNING</b></p> <p><b>Do not use spaces in the path you specify.</b></p> <p><b>System Response</b></p> <table border="1" data-bbox="618 1035 1422 1528"> <thead> <tr> <th data-bbox="618 1035 930 1094">IF the directory...</th> <th data-bbox="930 1035 1422 1094">THEN...</th> </tr> </thead> <tbody> <tr> <td data-bbox="618 1094 930 1251">Already contains a copy of GENTRAN:Server or GENTRAN:Mentor</td> <td data-bbox="930 1094 1422 1251">Setup prompts you to confirm that you want to install into this directory and overwrite the existing files. Click <b>Yes</b> and GO TO Step 15.</td> </tr> <tr> <td data-bbox="618 1251 930 1381">Does not yet exist</td> <td data-bbox="930 1251 1422 1381">Setup prompts you to confirm that you want to create this directory. GO TO Step 11.</td> </tr> <tr> <td data-bbox="618 1381 930 1528">Exists, but does not contain a copy of GENTRAN:Server or GENTRAN:Mentor</td> <td data-bbox="930 1381 1422 1528">Setup displays the Select Program Folder dialog box. GO TO Step 16.</td> </tr> </tbody> </table>	IF the directory...	THEN...	Already contains a copy of GENTRAN:Server or GENTRAN:Mentor	Setup prompts you to confirm that you want to install into this directory and overwrite the existing files. Click <b>Yes</b> and GO TO Step 15.	Does not yet exist	Setup prompts you to confirm that you want to create this directory. GO TO Step 11.	Exists, but does not contain a copy of GENTRAN:Server or GENTRAN:Mentor	Setup displays the Select Program Folder dialog box. GO TO Step 16.
IF the directory...	THEN...								
Already contains a copy of GENTRAN:Server or GENTRAN:Mentor	Setup prompts you to confirm that you want to install into this directory and overwrite the existing files. Click <b>Yes</b> and GO TO Step 15.								
Does not yet exist	Setup prompts you to confirm that you want to create this directory. GO TO Step 11.								
Exists, but does not contain a copy of GENTRAN:Server or GENTRAN:Mentor	Setup displays the Select Program Folder dialog box. GO TO Step 16.								
11	<p>Confirm that you want to create the directory.</p> <p><b>System Response</b></p> <p>The Destination Folder field displays the selected location.</p> <p style="text-align: right;"><b>(Continued on next page)</b></p>								

<b>(Contd) Step</b>	<b>Action</b>								
12	<p>Click <b>Next</b> to accept the destination folder.</p> <p><b>System Response</b> Use this table to determine the system response.</p> <table border="1" data-bbox="618 520 1427 989"> <thead> <tr> <th data-bbox="618 520 930 575"><b>IF the directory...</b></th> <th data-bbox="930 520 1427 575"><b>THEN...</b></th> </tr> </thead> <tbody> <tr> <td data-bbox="618 575 930 705">Already contains a copy of GENTRAN:Server or GENTRAN:Mentor</td> <td data-bbox="930 575 1427 705">Setup prompts you to confirm that you want to install into this directory. Continue with Step 15.</td> </tr> <tr> <td data-bbox="618 705 930 835">Does not yet exist</td> <td data-bbox="930 705 1427 835">Setup prompts you to confirm that you want to create this directory. Continue with Step 13.</td> </tr> <tr> <td data-bbox="618 835 930 989">Exists, but does not contain a copy of GENTRAN:Server or GENTRAN:Mentor</td> <td data-bbox="930 835 1427 989">Setup displays the Select Program Folder dialog box. GO TO Step 15.</td> </tr> </tbody> </table>	<b>IF the directory...</b>	<b>THEN...</b>	Already contains a copy of GENTRAN:Server or GENTRAN:Mentor	Setup prompts you to confirm that you want to install into this directory. Continue with Step 15.	Does not yet exist	Setup prompts you to confirm that you want to create this directory. Continue with Step 13.	Exists, but does not contain a copy of GENTRAN:Server or GENTRAN:Mentor	Setup displays the Select Program Folder dialog box. GO TO Step 15.
<b>IF the directory...</b>	<b>THEN...</b>								
Already contains a copy of GENTRAN:Server or GENTRAN:Mentor	Setup prompts you to confirm that you want to install into this directory. Continue with Step 15.								
Does not yet exist	Setup prompts you to confirm that you want to create this directory. Continue with Step 13.								
Exists, but does not contain a copy of GENTRAN:Server or GENTRAN:Mentor	Setup displays the Select Program Folder dialog box. GO TO Step 15.								
13	Click <b>Yes</b> to continue.								
14	<p>Click <b>Next</b> to accept the destination.</p> <p><b>System Response</b> Setup displays the Select Program Folder dialog box.</p>								
15	<p>Do you want to change the Program Folder to which Setup will add program icons?</p> <ul style="list-style-type: none"> <li>▶ If NO, click <b>Next</b>.</li> <li>▶ If YES, type a new folder name or select one from the existing Folders list, and click <b>Next</b>.</li> </ul> <p><b>System Response</b> Setup displays the Sub-Directory Name prompt.</p>  <p style="text-align: right; color: red;">(Continued on next page)</p>								

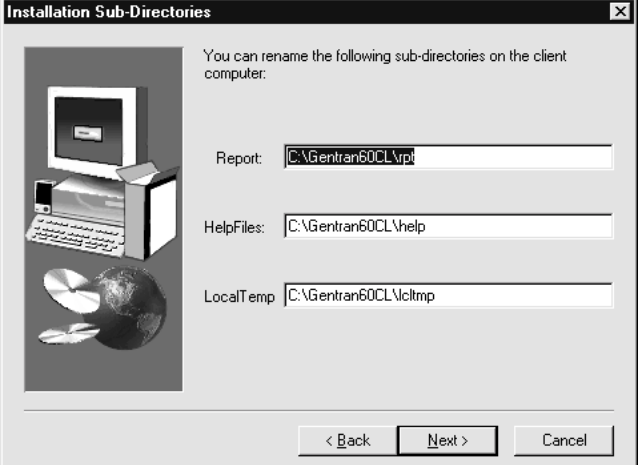
(Contd) Step	Action
16	<p>Do you want to accept the default sub-directory names?</p> <ul style="list-style-type: none"> <li>▶ If YES, click <b>Yes</b> and GO TO Step 18.</li> </ul> <p><b>System Response</b> Setup displays the Add IP Address dialog box.</p> <ul style="list-style-type: none"> <li>▶ If NO, click <b>No</b> to display the Installation Sub-Directories dialog box and continue with the next step.</li> </ul>
17	<p>Enter the <i>Report</i>, <i>HelpFiles</i>, and <i>LocalTemp</i> sub-directories to which you are installing the GENTRAN:Server files.</p> <p>When you are finished, click <b>Next</b> to accept your changes.</p> <p><b>WARNING</b> <b>Do not use spaces in the paths you specify.</b></p> <p><b>Example</b></p> <div data-bbox="711 919 1344 1388" style="border: 1px solid black; padding: 5px;">  </div> <p><b>Note</b> All other subdirectories reside on the UNIX host and therefore cannot be changed in this process.</p> <p><b>System Response</b> Setup displays the Add IP Address dialog box.</p> <p style="text-align: right; color: red;">(Continued on next page)</p>

<b>(Contd) Step</b>	<b>Action</b>
18	<p>Does the displayed list of UNIX hosts contain the IP address of the host that is running NAMEBROKER (ltb_server)?</p> <ul style="list-style-type: none"> <li>▶ If YES, click <b>Next</b> and GO TO Step 21.</li> </ul> <p><b>System Response</b> Setup displays the Namebroker dialog box.</p> <ul style="list-style-type: none"> <li>▶ If NO, click <b>Add</b>, click <b>Next</b>, and then continue with the next step.</li> </ul> <p><b>System Response</b> Setup displays a dialog box to add an IP address.</p>
19	Type the missing address into the <b>Server IP Address</b> field, then press Tab to move the cursor to the <b>Host Name</b> field.
20	<p>Type the system name for the host into the <b>Hostname</b> field, then click <b>Add</b>.</p> <p><b>System Response</b> Setup displays the Namebroker dialog box.</p>
21	<p>Double-click on the IP address and name of the host that is running NAMEBROKER (ltb_server) through which you want the user to log on to GENTRAN:Server.</p> <p><b>Comment</b> This selection should match the name and address you entered on the checklist for the NAMEBROKER.</p> <p><b>System Response</b> Setup displays the selected host information in the <b>Namebroker</b> field.</p> <p style="text-align: right; color: red;">(Continued on next page)</p>

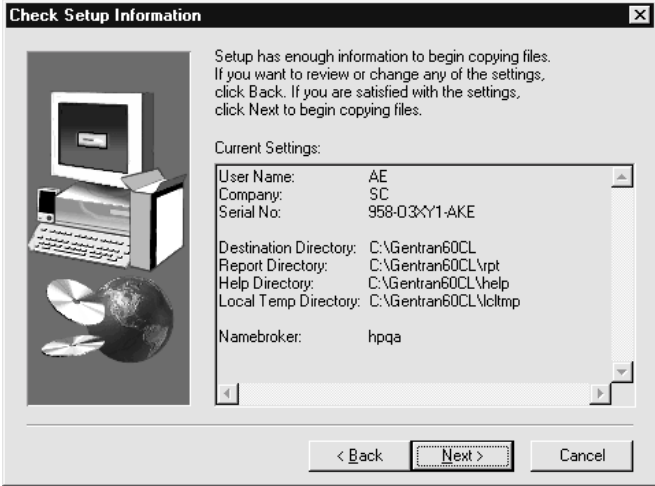
(Contd) Step	Action
22	<p>Click <b>Next</b> to continue.</p> <p><b>System Response</b> Setup displays the Check Setup information dialog box.</p> 
23	<p>Are the displayed current settings correct?</p> <ul style="list-style-type: none"> <li>▶ If YES, click <b>Next</b> to continue.</li> <li>▶ If NO, click <b>Back</b> until you find the dialog you must change. Make your changes, then click <b>Next</b> until you return to the Check Setup Information dialog box. Click <b>Next</b> to continue.</li> </ul> <p><b>System Response</b> Setup displays progress information as it installs the software.</p> <p><b>WARNING</b> <b>The Setup script displays warning messages if it cannot copy one or more GENTRAN:Server files to the destination. Write down each message before you click OK to dismiss it.</b></p>
24	<p>Did the Setup program display any warning messages during the installation process?</p> <ul style="list-style-type: none"> <li>▶ If YES, click <b>Exit</b> and continue to the next step.</li> <li>▶ If NO, Setup displays the View Readme File dialog box. GO TO Step 26.</li> </ul> <p style="text-align: right;">(Continued on next page)</p>



<b>(Contd) Step</b>	<b>Action</b>						
25	<p>Are any programs running on the client other than the GENTRAN:Server Setup program?</p> <ul style="list-style-type: none"> <li>▶ If YES, then close those programs and return to Step 4.</li> <li>▶ If NO, call Customer Support with a list of the warning messages.</li> </ul>						
26	<p>Do you want to want to view the README file at this time?</p> <ul style="list-style-type: none"> <li>▶ If YES, click <b>Yes</b>, and close the window when finished.</li> <li>▶ If NO, click <b>No</b>.</li> </ul> <p><b>System Response</b> if you have EC Workbench or Advanced Data Distribution.</p> <table border="1" data-bbox="618 814 1422 1157"> <thead> <tr> <th data-bbox="618 814 930 877"><b>IF you...</b></th> <th data-bbox="930 814 1422 877"><b>THEN...</b></th> </tr> </thead> <tbody> <tr> <td data-bbox="618 877 930 1003">Have EC Workbench or Advanced Data Distribution</td> <td data-bbox="930 877 1422 1003">Setup displays the Install HyperACCESS dialog box. Continue with Step 27.</td> </tr> <tr> <td data-bbox="618 1003 930 1157">Do not have EC Workbench or Advanced Data Distribution</td> <td data-bbox="930 1003 1422 1157">Setup displays the Setup Complete dialog box. GO TO Step 28.</td> </tr> </tbody> </table>	<b>IF you...</b>	<b>THEN...</b>	Have EC Workbench or Advanced Data Distribution	Setup displays the Install HyperACCESS dialog box. Continue with Step 27.	Do not have EC Workbench or Advanced Data Distribution	Setup displays the Setup Complete dialog box. GO TO Step 28.
<b>IF you...</b>	<b>THEN...</b>						
Have EC Workbench or Advanced Data Distribution	Setup displays the Install HyperACCESS dialog box. Continue with Step 27.						
Do not have EC Workbench or Advanced Data Distribution	Setup displays the Setup Complete dialog box. GO TO Step 28.						
27	<p>Do you want to install HyperACCESS?</p> <ul style="list-style-type: none"> <li>▶ If YES, GO TO the topic <a href="#">How to Install HyperACCESS</a> in this chapter.</li> <li>▶ If NO, click No and continue to the next step.</li> </ul> <p><b>System Response</b> Setup displays the Setup Complete dialog box.</p>						
28	<p>Do you want to install Microsoft Data Access Components (MDAC)?</p> <ul style="list-style-type: none"> <li>▶ If YES, GO TO the topic <a href="#">How to Install MDAC 2.6 Components</a> in this chapter.</li> <li>▶ If NO, clear the checkbox and continue to the next step.</li> </ul> <p><b>Note</b> You must have MDAC to use the GENTRAN EDI Standards database. The minimum version required is 2.1sp1a. This MDAC installation process installs version 2.6.</p> <p style="text-align: right; color: red;">(Continued on next page)</p>						

(Contd) Step	Action
29	Click <b>Finish</b> .  <b>System Response</b> Setup finishes copying files to your computer and displays restart options.
30	Do you want to let Setup restart the client computer now? <ul style="list-style-type: none"><li>▶ If YES, click <b>Yes, I want to restart my computer now</b> and remove any disks from the client's disk drive.</li><li>▶ If NO, click <b>No, I will restart my computer later</b>.</li></ul>
31	Click <b>Finish</b> to complete setup.

---

# How to Install HyperACCESS

## Introduction

GENTRAN:Server for UNIX with Process Control Manager, GENTRAN:Server for UNIX with EC Workbench, and the GENTRAN:Server for UNIX with Advanced Data Distribution product levels use HyperACCESS communications software as an interface between the client computer and the data flow software on the UNIX host. This topic explains how to install HyperACCESS on the client computer.

## Installing HyperACCESS



Use this procedure to install HyperACCESS on a client computer.

### CAUTION

**Perform this procedure for only the GENTRAN:Server for UNIX with PCM, GENTRAN:Server EC Workbench, and GENTRAN:Server with Advanced Data Distribution product levels. Other product levels of GENTRAN:Server for UNIX do not use HyperACCESS.**

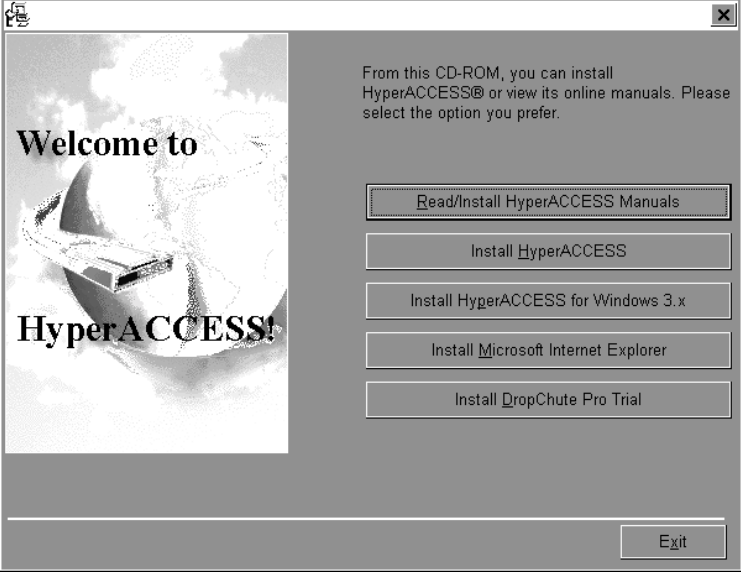
Step	Action	
1	Use this table to determine your first action.	
	<b>IF you are ...</b>	<b>THEN...</b>
	Continuing from the client setup program	Click <b>Yes</b> on the <b>Install HyperACCESS</b> dialog box. Go to Step 5.
	Starting HyperACCESS installation after exiting the client setup program	Continue with Step 2.
2	Insert the installation CD into the CD-ROM drive of the client computer.	
3	Select <b>Run</b> from the Windows <b>Start</b> menu.	
	<b>System Response</b> Windows displays the Run dialog box.	
	(Continued on next page)	

(Contd) Step	Action
4	<p>Enter the following command in the <b>Run</b> dialog box and click <b>OK</b>.</p> <pre>&lt;drive&gt;:\Cdsetup.exe</pre> <p>where &lt;drive&gt; represents the drive letter of the CD-ROM drive.</p> <p><b>System Response</b> Setup displays the HyperACCESS CD-ROM Setup dialog box.</p> 
5	<p>Click <b>Install HyperACCESS</b>.</p> <p><b>System Response</b> Setup displays the Installation dialog box.</p> <p style="text-align: right; color: red;">(Continued on next page)</p>

<b>(Contd) Step</b>	<b>Action</b>
6	<p>Click <b>Next</b> on the Installation dialog box.</p> <p><b>System Response</b> Setup displays the Select Program Folder prompt.</p> 
7	<p>Do you want HyperACCESS installed in the displayed location?</p> <ul style="list-style-type: none"> <li>• If YES, then click <b>Next</b>.</li> <li>• If NO, then click <b>Browse</b> and select the location where you want the software installed. Click <b>Next</b>.</li> </ul> <p><b>System Response</b> Setup displays the Select Data Folder prompt.</p>  <p style="text-align: right; color: red;">(Continued on next page)</p>

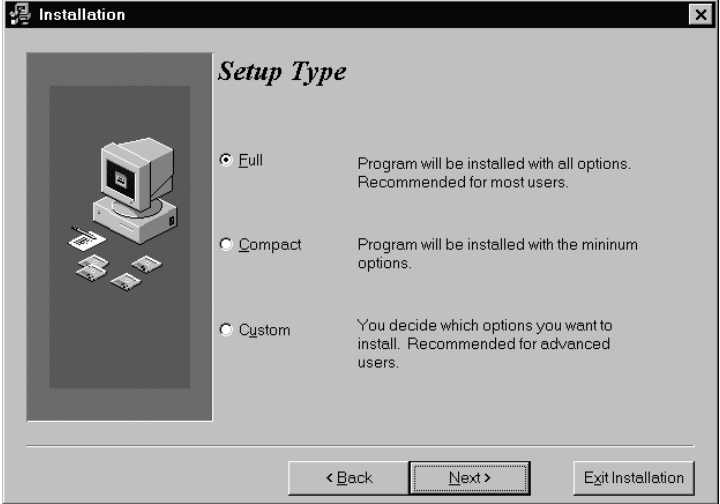
(Contd) Step	Action
8	<p>Do you want HyperACCESS data stored in the displayed location?</p> <ul style="list-style-type: none"> <li>▶ If YES, then click <b>Next</b>.</li> <li>▶ If NO, then click <b>Browse</b> and select the location where you want the data stored. Click <b>Next</b>.</li> </ul> <p><b>System Response</b> Setup displays the Setup Type prompt.</p> 
9	<p>Select <b>Full</b> and click <b>Next</b>.</p> <p><b>System Response</b> Setup displays the Ready to Install dialog box and lists the installation options you have chosen.</p>
10	<p>Do you want to change any of the options?</p> <ul style="list-style-type: none"> <li>▶ If NO, click <b>Next</b>.</li> <li>▶ If YES, click <b>Back</b> until you reach the option you want to change. Change the option, click <b>Next</b> until the Ready to Install dialog box is displayed. Then, click <b>Next</b> again.</li> </ul> <p><b>System Response</b> The installation process copies the files.</p> <p style="text-align: right; color: red;">(Continued on next page)</p>

<b>(Contd) Step</b>	<b>Action</b>	
11	Use this table to determine your next action. <b>System Response</b>	
	<b>IF you started installing HyperACCESS...</b>	<b>THEN...</b>
	From the client installation process	The system displays this prompt: <b>Do you want to install MDAC 2.6 Files?</b> GO TO the <a href="#">How to Install MDAC 2.6 Components</a> topic.
	From the Windows Run dialog	Setup displays the Install dialog box with two restart options.  Continue with the next step.
12	Do you want to reboot the client now? <ul style="list-style-type: none"> <li>▶ If YES, click the <b>Yes, I want to restart the computer</b> option and then click <b>Finish</b> to reboot.</li> <li>▶ If NO, click the <b>No, I will restart the computer later</b> option and then click the <b>Finish</b> button.</li> </ul> <b>Comment</b> We recommend that you choose to reboot at this time. This allows you to complete the HyperACCESS installation in one session.	
13	Did you reboot the client computer? <ul style="list-style-type: none"> <li>▶ If YES, complete the <a href="#">Registering the HyperACCESS client software</a> procedure now.</li> <li>▶ If NO, complete the <a href="#">Registering the HyperACCESS client software</a> procedure later, after you restart the client computer.</li> </ul>	

(Continued on next page)

## Registering the HyperACCESS client software

Use this procedure to register the HyperACCESS client software.

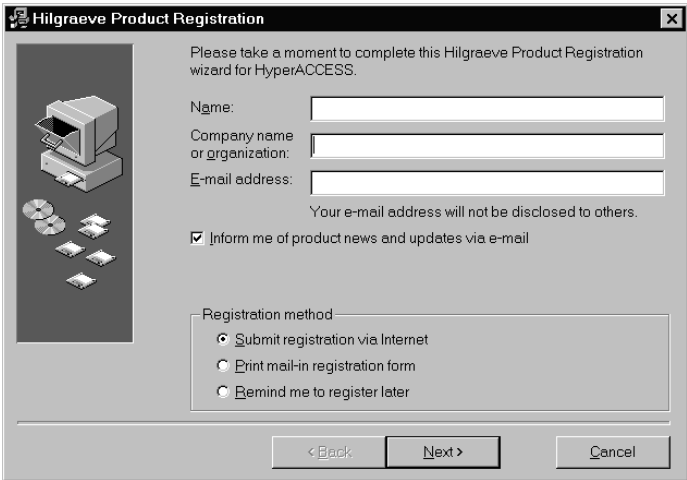
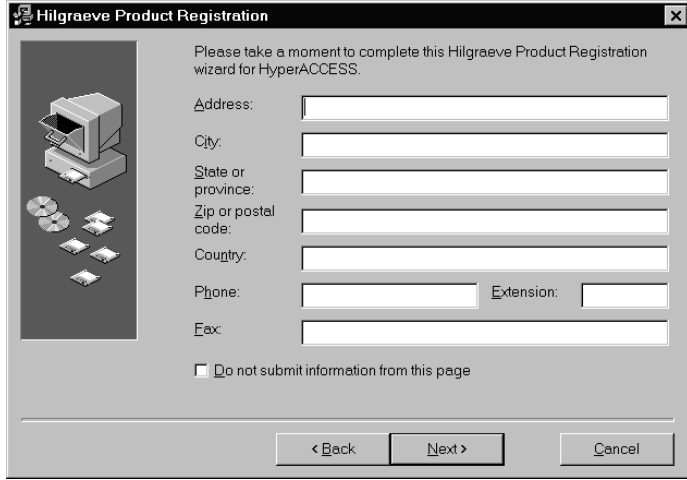
Step	Action
1	<p>Log onto the client computer.</p> <p><b>System Response</b> Setup displays the Product Registration wizard for HyperACCESS.</p> 
2	<p>Complete the Name, Company name, and E-mail address boxes.</p>
3	<p>Select a registration method and then click <b>Next</b>.</p> <p><b>System Response</b> The wizard prompts for address and telephone information.</p> 

(Continued on next page)



<b>(Contd) Step</b>	<b>Action</b>
4	Do one of the following: <ul style="list-style-type: none"><li>▶ Complete the address and telephone information.</li><li>▶ Click the <b>Do not submit information from this page</b> option.</li></ul>
5	Click <b>Next</b> to continue.
6	Follow the instructions on the subsequent screens to complete registration.

---

## How to Install MDAC 2.6 Components

### Introduction

To read the EDI standards provided with GENTRAN:Server for UNIX, you must have Microsoft Data Access Components (MDAC) 2.1sp1a or higher installed on each PC or client. MDAC include ActiveX® Data Objects (ADO), OLE DB, and Open Database Connectivity (ODBC). Data-driven client/server applications use these ODBC drivers and other components to integrate information from a variety of sources.

If you do not already have MDAC on the PC or client, you must install it before you install the EDI standards. This topic explains how to install MDAC.

### Installing MDAC

Use this procedure to install MDAC 2.6 on a PC or client computer.

Step	Action	
1	Use this table to determine your first action.	
	IF you are ...	THEN...
	Continuing from the PC or client setup program	Leave the <b>I would like to install Microsoft MDAC 2.6</b> check box selected on the Setup Complete dialog box. Click <b>Finish</b> and GO TO Step 5.
	Installing MDAC after exiting the PC or client setup program	Continue with Step 2.
2	Insert the installation CD into the CD-ROM drive of the PC or client computer.	
3	Select <b>Run</b> from the Windows <b>Start</b> menu.	
	<b>System Response</b> Windows displays the Run dialog box.	
	(Continued on next page)	

<b>(Contd) Step</b>	<b>Action</b>
4	<p>Enter the following command in the <b>Run</b> dialog box and click <b>OK</b>.</p> <p>&lt;drive&gt;:\mdac_typ.exe</p> <p>where &lt;drive&gt; represents the drive letter of the CD-ROM drive.</p> <p><b>System Response</b> Your system loads the Microsoft Data Access Components 2.6 Setup program and displays the Microsoft Data Access Components 2.6 Setup dialog box.</p>
5	<p>Click the checkbox on the End User License Agreement of the Microsoft Data Access Components 2.6 Setup dialog box to accept the terms of the licensing agreement; then click <b>Next</b>.</p> <p><b>System Response</b> Setup displays the Microsoft Data Access Components 2.6 Setup dialog box.</p>
6	Click <b>Next</b> .
7	Click <b>Finish</b> .
8	<p>Click <b>Close</b>.</p> <p><b>System Response</b> Setup displays the GENTRAN:Server Setup complete dialog box, which asks whether you want to reboot the PC or client now or later.</p>
9	<p>Do you want to restart the PC or client now?</p> <ul style="list-style-type: none"> <li>▶ If YES, click <b>Yes</b>.</li> <li>▶ If NO, click <b>No</b>.</li> </ul> <p><b>Comment</b> If you installed HyperACCESS but did not reboot during this installation of the client software, you should restart the client now.</p>
10	Remove any disks from the PC or client's disk drives.
11	Click <b>Finish</b> to complete setup.

## How to Install GENTRAN Standards

---

### System requirements

The amount of hard disk space required to use the GENTRAN EDI Standards database depends on the following:

- ▶ New install (run from standards CD)  
**Approximately 10 MB** of hard disk space to install the EDI Standards database to run from the CD.
- ▶ New install (install on hard drive)  
**Approximately 300 MB** of hard disk space to install the EDI Standards database to run from your hard drive.

---

### Before you begin

You must install Microsoft Data Access Components (MDAC) 2.1sp1a or higher before you install GENTRAN EDI Standards.

#### Recommendation

We strongly recommend that you install your GENTRAN product before you install the EDI Standards database.

#### Note

If you have already set up this machine to run EDI standards from the CD-ROM drive, you only have to exchange the old standards CD for the most current Standards CD. You do *not* have to complete the installation procedure below.

---

### Updated versions included

Please refer to the readme.txt file provided on the GENTRAN:Server Standards CD for the most current information about the standards.

For fast access, we recommend installing the GENTRAN EDI Standards database on your hard drive. This requires approximately 10 MB of free space for the temporary installation files and 300 MB for the EDI Standards database. You can also access the GENTRAN Standards database directly from the CD-ROM.

The GENTRAN EDI Standards database is updated periodically, produced on CD-ROM separate from products, and available at your request (usually on a quarterly basis).

---

### Additional standards included

The Standard CD also contains folders for NCPDP and VDA standard templates. See the *GENTRAN:Server NCPDP User's Guide* and the *GENTRAN:Server VDA User's Guide* for instructions on how to copy the templates.

---

(Continued on next page)

## Installing the Standards Database

Complete the following steps to install the EDI Standards database:

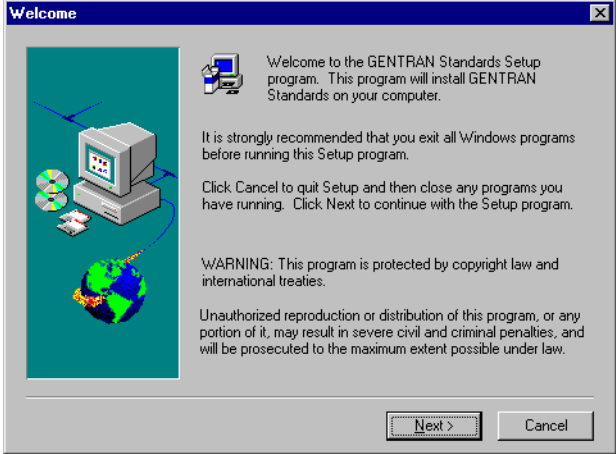
Step	Action
1	Close all programs on your computer.
2	Insert the GENTRAN Standards CD into your CD-ROM drive.
3	Select <b>Run</b> from the <b>Start</b> menu.
4	<p>Enter &lt;drive&gt;:\I386\setup.exe</p> <p>Where: &lt;drive&gt; is the drive letter for your CD-ROM drive (for example, <b>D:\</b> or <b>E:\</b>)</p> <p><b>System Response</b> Setup prepares the wizard that guides you through the install program. This may take several seconds. When the wizard is ready, the system displays the Welcome dialog box.</p>  <p style="text-align: right; color: red;">(Continued on next page)</p>

(Contd) Step	Action
5	<p>Click <b>Next&gt;</b> to continue the Setup program.</p> <p><b>System Response</b> Setup displays the Install Standards dialog box.</p>  <p style="text-align: right;">(Continued on next page)</p>

(Contd) Step	Action		
6	Use the following table to determine your next action.		
	<b>IF you select...</b>	<b>THEN...</b>	<b>AND...</b>
	Install to run from the CD-ROM	Click <b>Next&gt;</b> to install the EDI Standards database and the ODBC components  <b>System Response</b> Setup displays the Select ODBC Data Source dialog box.	Proceed with Step 7.
	Install to run without CD-ROM	Click <b>Next&gt;</b> to install the EDI Standards database and ODBC components.  <b>System Response</b> The system displays the Standards Destination dialog box.	Type the destination or click <b>Browse</b> and select where you want the EDI Standards database to be stored. Proceed with Step 7.  <b>System Response</b> The system displays the Select ODBC Data Source dialog box.  <b>Note</b> At least 300 MB must be available. If there is insufficient space available on the drive you specified, you will be prompted to select another location or increase the amount of space available in the target directory.
	Map an ODBC Data Source to an existing Database	Do not select this option.	(Continued on next page)

(Contd) Step	Action	
7	Use the table to determine your next step.	
	<b>IF...</b>	<b>THEN...</b>
	Accept the default GENTRAN Standards	Click <b>Next</b>
	Specify a new data source name	Type the name in the field and the Click <b>Next</b> .
<p><b>System Response</b> The system displays the prompt: Setup is ready to install GENTRAN Standards. Would you like to proceed?</p>		
8	<p>Click <b>Yes</b> to install GENTRAN Standards.</p> <p><b>Note</b> If you receive messages that a .DLL is currently in use, click <b>Ignore</b> to continue the installation. You receive these messages when a service (like the SQL Executive service) is running in the background. The system will still install the EDI Standards database correctly.</p> <p><b>System Response</b> Setup displays a message indicating that the EDI Standards database installation is complete.</p>	
9	Click <b>OK</b> .	



# How to Install Online Documentation

## Introduction

Sterling Commerce provides online copies of all manuals for GENTRAN:Server for UNIX. This topic explains how to install the online documentation onto a Windows client computer.

## Before you begin

Before you start installing online documentation to a client computer, you must decide whether you are installing the documentation files to the hard drive or whether you will read them from the documentation CD.

Does the hard drive on the client computer have at least 30 MB of free space?

- If YES, we recommend that you install to the hard drive. Use the [Installing documentation files to the hard drive](#) procedure in this topic.
- If NO, we recommend that you read the documentation files from the CD. Use the [Installing to read documentation from the CD](#) procedure in this topic.

### Note

If you read the documentation files from the CD, you can view the online documentation only when the documentation CD is in the CD-ROM drive of the client computer.

## Installing documentation files to the hard drive

Use this procedure to install online documentation for GENTRAN:Server onto the hard drive of a Windows client computer.

Step	Action
1	Insert the documentation installation CD into the CD-ROM drive of the GENTRAN:Server for UNIX client computer.
2	Select <b>Run</b> from the Windows <b>Start</b> menu.  <b>System Response</b> Windows displays the Run dialog box.  (Continued on next page)

(Contd) Step	Action
3	<p>In the Run dialog box, enter the following command and click <b>OK</b>.</p> <p>&lt;drive&gt;:\setup</p> <p>where &lt;drive&gt; represents the drive letter for the CD-ROM drive.</p> <p><b>System Response</b> Setup displays the Welcome dialog box.</p>
4	<p>Click <b>Next</b>.</p> <p><b>System Response</b> Setup displays the Select Components dialog box.</p>
5	<p>Select <b>Install to Hard Disk</b> and click <b>Next</b>.</p> <p><b>System Response</b> Setup displays the Location of Documentation Files dialog box.</p>
6	<p>Do you want to install the to the displayed location?</p> <ul style="list-style-type: none"> <li>▶ If YES, click <b>Next</b>.</li> <li>▶ If NO, <b>Browse</b> to the location where you want to install the documentation. Then, select the desired folder and click <b>Next</b>.</li> </ul> <p><b>System Response</b> Setup displays the Program Folder Name dialog box.</p>
7	<p>Do you want to create icons at the displayed location?</p> <ul style="list-style-type: none"> <li>▶ If YES, click <b>Next</b>.</li> <li>▶ If NO, <b>Browse</b> to the location where you want to create the icons. Then, select the desired folder and click <b>Next</b>.</li> </ul> <p><b>System Response</b> Setup asks you to confirm that you are ready to install the documentation.</p> <p style="text-align: right;">(Continued on next page)</p>

(Contd) Step	Action
8	Click <b>Yes</b> to continue installing the documentation.  <b>System Response</b> Setup installs the online documentation, then asks whether you want to install the Acrobat Reader <sup>®</sup> software with search.
9	Does the Windows client computer contain version 4.0 or higher of Adobe Acrobat?  <ul style="list-style-type: none"> <li>▶ If YES, exit the setup program by clicking <b>No</b>. Setup displays a message confirming that documentation installation is complete. Click <b>OK</b> to exit.</li> <li>▶ If NO, start installation of the Acrobat Reader with search by clicking <b>Yes</b>. Continue with the <a href="#">Installing Acrobat Reader</a> procedure in this topic.</li> </ul>

### Installing to read documentation from the CD

Use this procedure to install on the client computer only the files needed to read the online documentation from the CD.

Step	Action
1	Insert the documentation installation CD into the CD-ROM drive of the GENTRAN:Server for UNIX client computer.
2	Select <b>Run</b> from the Windows <b>Start</b> menu.  <b>System Response</b> Windows displays the Run dialog box.
3	In the <b>Run</b> dialog box, enter the following command and click <b>OK</b> :  <drive>:\setup  where <drive> represents the drive letter for the CD-ROM drive.  <b>System Response</b> Setup displays the Welcome dialog box.
4	Click <b>Next</b> .  <b>System Response</b> Setup displays the Select Components dialog box.  (Continued on next page)

<b>(Contd) Step</b>	<b>Action</b>
5	<p>Select <b>Run from CD</b> and click <b>Next</b>.</p> <p><b>System Response</b> Setup displays the Program Folder Name dialog box.</p>
6	<p>Do you want to install the files into to the location displayed?</p> <ul style="list-style-type: none"> <li>▶ If YES, click <b>Next</b>.</li> <li>▶ If NO, <b>Browse</b> to the location where you want to install the files. Select the desired folder and click <b>Next</b>.</li> </ul> <p><b>System Response</b> Setup prompts you to confirm the installation of files.</p>
7	<p>Click <b>Yes</b> to continue.</p> <p><b>System Response</b> Setup installs the files needed to access the documentation from the CD, then asks whether you want to install the Acrobat Reader software.</p>
8	<p>Does the Windows client computer contain version 4.0 or higher of Adobe Acrobat?</p> <ul style="list-style-type: none"> <li>▶ If YES, exit the setup program by clicking <b>No</b>. Setup displays a message confirming that documentation installation is complete. Click <b>OK</b> to exit.</li> <li>▶ If NO, start installation of the Acrobat Reader with search by clicking <b>Yes</b>. Continue with the <a href="#">Installing Acrobat Reader</a> procedure in this topic.</li> </ul>

## Installing Acrobat Reader

Use this procedure to install Adobe Acrobat Reader onto the Windows client computer.

Step	Action	
1	Use this table to determine your first action.	
	<b>IF you are ...</b>	<b>THEN...</b>
	Continuing from the documentation installation program	Click <b>OK</b> on the Information dialog box and GO TO Step 6.
	Starting Acrobat Reader installation after exiting the documentation setup program	Continue with Step 2.
2	Insert the installation CD into the CD-ROM drive of the client computer.	
3	Select <b>Run</b> from the Windows <b>Start</b> menu.  <b>System Response</b> Windows displays the Run dialog box.	
4	In the Run dialog box, enter the following command and click <b>OK</b> :  <drive>:\rs32e40.exe  where <drive> represents the drive letter of the CD-ROM drive.  <b>System Response</b> Setup displays the InstallShield Self-extracting EXE dialog box.	
5	Click <b>Yes</b> .  <b>System Response</b> Setup displays a progress indicator, then the Welcome dialog box.	
6	Click <b>Next</b> to continue.  <b>System Response</b> Setup displays the Software License Agreement dialog box.  <p style="text-align: right;">(Continued on next page)</p>	

(Contd) Step	Action
7	Click <b>Yes</b> to continue.  <b>System Response</b> Setup displays the Choose Best Location dialog box.
8	Do you want to accept the displayed location? <ul style="list-style-type: none"> <li>▶ If YES, then click <b>Next</b>.</li> <li>▶ If NO, browse to the desired location and then click <b>Next</b>.</li> </ul> <b>System Response</b> Setup installs the Adobe Acrobat program files. Setup then displays the Setup Complete dialog box and allows you to choose whether to view the <i>Readme</i> file at this time.
9	Do you want to view the Readme file now? <ul style="list-style-type: none"> <li>▶ IF YES, then click <b>Finish</b>.</li> <li>▶ IF NO, then deselect <b>Display Acrobat Reader 4.0 Readme File</b> and click <b>Finish</b>.</li> </ul> <b>System Response</b> Setup displays a message that the setup completed successfully.
10	Click <b>OK</b> .  <b>Comment</b> You have successfully installed the Adobe Acrobat Reader.

### Accessing online documentation

Follow this procedure to access the online documentation.

Step	Action
1	Select <b>Programs</b> from the <b>Start</b> menu.
2	Select <b>GENTRAN</b> from the <b>Programs</b> menu.  (Continued on next page)

<b>(Contd) Step</b>	<b>Action</b>
3	<p>Click <b>GENTRAN Online Documentation</b> from the GENTRAN submenu.</p> <p><b>System Response</b> The system opens the Acrobat Reader and displays the main page of the online documentation.</p> <p><b>Note</b> You can page down to view the procedures for searching and navigating through the documentation.</p>
4	<p>Locate the GENTRAN:Server product level you are running and click the document you want to view.</p> <p><b>System Response</b> The system displays the first page of the selected document.</p>

---

## How to Edit the Windows Hosts File

**Introduction**    This topic explains how to edit a Windows hosts file to specify the broker process (NAMEBROKER) after you have finished running Setup.

### WARNING

**Perform this procedure only if Setup did not add a NAMEBROKER entry in the *hosts* file.**

**Procedure**    Use this procedure to identify the namebroker by adding it to the Windows *hosts* file.

Step	Action
1	<p>Open the <i>hosts</i> or <i>host.sam</i> file using any text editor.</p> <p><b>Note</b> These files are usually located in the <i>Win95</i> or <i>Windows</i> installation directory on the client.</p> <p><b>Example</b> c:\win95\hosts or c:\windows\hosts</p> <p><b>Comment</b> If the <i>hosts</i> file does not exist, look for the file <i>hosts.sam</i>. Save the edited file as both <i>hosts</i>, and <i>hosts.sam</i>.</p>
2	<p>Enter the IP address and host name of the server on which the GENTRAN:Server host program was installed. Use the following format:</p> <p>&lt;IPAddress&gt; &lt;hostname&gt; NAMEBROKER</p> <p><b>Note</b> Separate the fields with spaces or tabs.</p>
3	<p>Save and close the updated <i>hosts</i> file.</p> <p><b>Note</b> You must reboot the computer to activate this change.</p>



# How to Identify the Host to DNS

**Introduction** The network at your installation must be able to identify the host that is running the broker process.

Many networks use the Windows *hosts* file to determine the IP addresses and host names of all host computers. Setup allows you to add addresses and names to the *hosts* file.

There are several ways in which you can identify the host that is running the broker process. This topic describes one way—by adding the name of the host running the GENTRAN:Server broker process to Domain Name Services (DNS). This method assumes that you have the NAMEBROKER environment variable set. You do not have to use this method if you prefer to use another.

**Note**

The DNS ignores the *hosts* file. Instead, it uses environment variables such as those set in the *autoexec.bat* file.

**Procedure** Use this procedure to add the broker process to the client computer's *autoexec.bat* file. This will allow the DNS to identify the GENTRAN:Server host.

Step	Action
1	Open the <i>autoexec.bat</i> file in a DOS text editor.
2	Set the NAMEBROKER environment variable to the name of the UNIX host on which you will run GENTRAN:Server. <b>Example</b> set NAMEBROKER=<machine name>  Where  <machine name> is the system name for the UNIX host. Your system administrator can provide this information.
3	Save your changes to the <i>autoexec.bat</i> file.
4	Reboot the client computer to apply the changes.

## How to Install Optional Components

---

**Introduction**

The optional components - XML translation, ODBC Database Drivers, and the Visual Mapper - are installed automatically when you install the client software. However, these options are not enabled until they are installed on the host.

---

**XML translation option**

See the [How to Load and Install the XML Translation Option](#) topic for instructions on installing the XML translation option on the host.

---

**ODBC database drivers option**

See the [How to Install Optional ODBC Database Drivers](#) topic for instructions on installing ODBC Database Drivers on the host.

---

**Visual Mapper**

See the separate card titled "Visual Mapper - UNIX Host Installation Instructions" for detailed instructions.

---

# 3

---

# Setting Up Communications

---

## Contents

### Overview

- ▶ Introduction ..... 2
- ▶ What Is the Communications Toolkit? ..... 3
- ▶ COMM Subdirectory Structure ..... 5
- ▶ The Communications Toolkit Setup Process ..... 9

### Procedures

- ▶ How to Set Up Asynchronous Communications ..... 10
- ▶ How to Set Up Bisynchronous Communications ..... 12
- ▶ How to Start Up Cleo A+ ..... 14
- ▶ How to Start Up Cleo 3780Plus ..... 17
- ▶ Start-Up Procedure Examples ..... 19

### Troubleshooting

- ▶ Communications Session Error Recovery ..... 21
  - ▶ Cleo 3780Plus Troubleshooting ..... 26
  - ▶ Connecting to Other VANs and Directly to Trading Partners ..... 27
-

# Overview

## Introduction

---

### The Communications Toolkit

The Communications Toolkit enables GENTRAN:Server<sup>®</sup> to use Cleo A+<sup>®</sup> or Cleo 3780Plus<sup>®</sup> communication software to access a Value-Added Network (VAN).

Among other services, VANs provide store-and-forward messaging in a dial-on-demand environment. This means that the VAN stores files in a mailbox until the recipient to whom they are addressed dials into the VAN and picks them up.

---

### When to use the Communications Toolkit

Use the Communications Toolkit if you connect to the Commerce Net<sup>®</sup>, Advantis<sup>®</sup>, or GEIS<sup>®</sup> networks and you use or plan to use either Cleo A+ or Cleo 3780Plus.

---

### What do I need to buy?

The Communications Toolkit is included with GENTRAN:Server Workstation<sup>®</sup> and all product levels of GENTRAN:Server for UNIX<sup>®</sup>.

However, Cleo A+ and Cleo 3780Plus are not part of the GENTRAN:Server product; you must purchase Interface Systems' Cleo A+ or Cleo 3780Plus communication software.

---

### How to activate the Communications Toolkit

To activate the toolkit functions, you need to configure the Communications Toolkit and then install the Cleo software.

Communications Toolkit files are included in the GENTRAN:Server for UNIX host CD and are installed automatically with the GENTRAN:Server host software.

---

### In this chapter

This chapter provides instructions for setting up the toolkit.

---

## What Is the Communications Toolkit?

### Command scripts

Sterling Commerce provides command scripts for the third-party communication packages, Cleo 3780Plus and Cleo A+. The scripts control the processes of:

- ▶ Dialing the VAN
- ▶ Logging in
- ▶ Transmitting waiting files
- ▶ Receiving any files waiting on the VAN
- ▶ Logging off
- ▶ Exiting.

### Supported VANs

This table describes the VANs and protocols supported by the Communications Toolkit.

VAN	Supported Protocols
COMMERCE:Network (Sterling Commerce)	Asynchronous-ASCII Bisynchronous
<b>Advantis</b> (IBM)	Asynchronous-Xmodem Bisynchronous
<b>GEIS</b> (General Electric Information System)	Asynchronous-Xmodem Bisynchronous

### Toolkit parts

There are two primary parts to the Communications Toolkit provided with GENTRAN:Server:

- ▶ Cleo A+ scripts and configuration files
- ▶ Cleo 3780Plus scripts and configuration files

(Continued on next page)

**Cleo software****Cleo A+**

Interface Systems' Cleo A+ is an asynchronous communications package that uses sophisticated scripting to handle various types of communications. It supports several file transfer methods, including raw ASCII, Xmodem, Ymodem, Zmodem, Kermit, and ANSI CLEAR. It can also perform as an FTP tool, using SLIP, PPP, Telnet, or local modes.

**Cleo 3780Plus**

Interface Systems' Cleo 3780Plus is a bisynchronous communications package that uses scripting to handle various types of communications. It supports 2780/3780 bisync protocols by using a piece of hardware to convert ASCII data to EBCDIC data for transmission and EBCDIC data to ASCII data upon receipt of the EBCDIC data.

**WARNING**

**The scripts in the Communications Toolkit expect to find the Cleo software in a specific directory relative to the GENTRAN:Server directories. To prevent complications, install the Cleo software *after* you install and set up GENTRAN:Server and the Communications Toolkit.**

---

## COMM Subdirectory Structure

**Diagram** The following diagram illustrates the directory structure required by the Communications Toolkit. Installation of GENTRAN:Server for UNIX automatically installs the Communications Toolkit files for you.

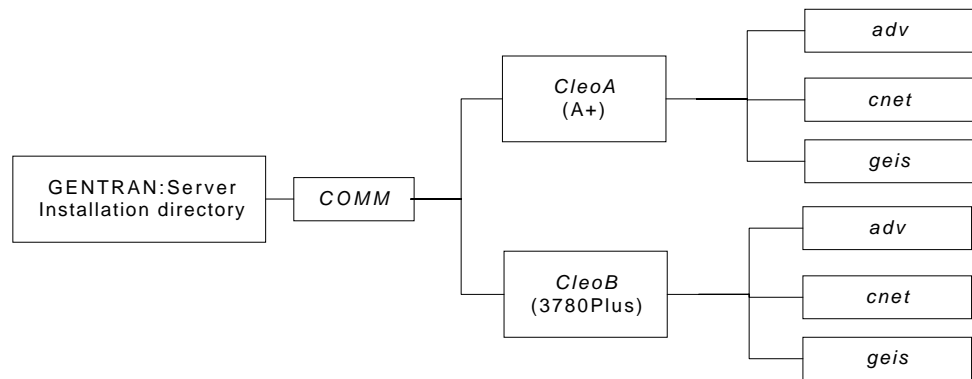

### Location of communication scripts and configuration files

The Cleo communications script and configuration files reside in subdirectories of the COMM CleoA or CleoB subdirectory of the Server directory.

Directory	Contents
Server/COMM/CleoA (A+)	Holds Cleo A+ asynchronous package
Server/COMM/CleoB (3780Plus)	Holds Cleo 3780Plus bisynchronous package

(Continued on next page)

### VAN subdirectories

Under the CleoA and CleoB subdirectories, each VAN has its own subdirectory:

- ▶ *cnet* for COMMERCE:Network
- ▶ *adv* for Advantis
- ▶ *geis* for GEIS.

### Subdirectory contents

The *adv*, *cnet*, and *geis* subdirectories contain the files that enable the communications application to communicate with that particular VAN.

You should use the subdirectory appropriate to your network to hold the outbound file <van>s that you are transmitting to the VAN.

#### Note

You should place files you are sending in the communications subdirectory before a session. For example, to send a file to Advantis via an asynchronous communication session, place the file in Server/COMM/CleoA/adv/adv.s.

During a session, the system places the inbound file <van>.r.000 in the communication subdirectory. This file contains any files received during a communications session.

### Important files

This table lists the important files that the Communications Toolkit uses or creates.

Filename	Description
<van>.cfg	A configuration file specific to the VAN indicated in the file name.
edilog.fil	A log file produced by each bisynchronous Advantis session.  <b>WARNING</b> <b>The program overwrites this file after each session. To save this file, you must copy or move it to another location.</b>
advmsg.fil	A file containing messages produced by each bisynchronous Advantis session.  <b>WARNING</b> <b>The program overwrites this file after each session. To save this file, you must copy or move it to another location.</b>

(Continued on next page)



<b>(Contd) Filename</b>	<b>Description</b>
<van>*.job	<p>Cleo job file for connecting to the supported networks. The individual files connect as follows:</p> <ul style="list-style-type: none"> <li>▶ <i>cnetsr.job</i> - COMMERCE:Network via the MCI or CompuServe network local access nodes.</li> <li>▶ <i>advsr.job</i> - IBM Advantis network</li> <li>▶ <i>geissr.job</i> - GEIS network</li> </ul>
<van>.log	A log file specific to the last connection made to the indicated VAN.
<van>.mon	A monitor file specific to the last connection made to the indicated VAN.
<van>.ovr	A data translation file that provide protocol transfer information that Cleo requires.
cnet.rpts	A file containing COMMERCE:Network reports.
<van>s	<p>The user data file to be sent to the network. Must be placed in the directory for the specific VAN before connecting to the VAN.</p> <p><b>WARNING</b></p> <p><b>You must move or delete this file after completing the session successfully.</b></p> <p><b>GENTRAN:Server will send a duplicate transmission unless this file is overwritten or deleted before the next session.</b></p> <p><b>GENTRAN:Server may overwrite the file if you do not move it before the next session. The file will then be unavailable to retransmit data.</b></p> <p style="text-align: right;">(Continued on next page)</p>

(Contd) Filename	Description
<van>r.nnn	<p>The user data file that GENTRAN:Server receives from the VAN. The first file received has an extension of .000. If the file is moved from the VAN directory before another file arrives, the next file received also has an extension of .000.</p> <p><b>WARNING</b></p> <p><b>The file extension is incremented by one with the receipt of each new file unless the prior version is moved or deleted before the session. If your site uses automated file processing, it may not recognize the incremented file.</b></p>
geisrpt.*	<p>A session log report generated by GEIS under 3780Plus or AllSync.</p> <p><b>WARNING</b></p> <p><b>The program overwrites this file after each session. To save this file, you must copy or move it to another location.</b></p>

---

# The Communications Toolkit Setup Process

---

**Process flow**

This diagram shows the flow of the setup process required to prepare the Communications Toolkit to work with GENTRAN:Server.

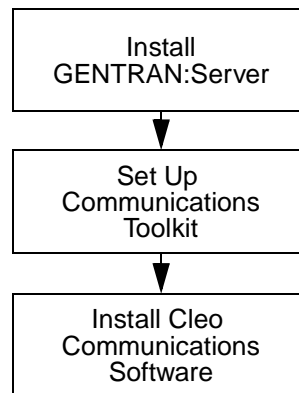

## Procedures

# How to Set Up Asynchronous Communications

### Introduction

This topic contains the procedures for setting up asynchronous communications using the VAN scripts that are located in the COMM directory structure. Follow the instructions for the VAN to which you are linking.

### Microcom Network Protocol (MNP)

The Microcom Network Protocol (MNP) enables error correction during transmissions. It is particularly important when connecting to CNET. If MNP is not used, the default is TTY, which performs no error correction.

### Modifying the VAN Configuration File

Your Cleo A+ VAN configuration file (*cnet.cfg*, *adv.cfg*, or *geis.cfg*) contains all or most of the required network configurations. However, you may have hardware issues that require you to modify the file.

This table lists the environment parameters you may need to modify. The Parameter column lists the name of the parameter and the related file.

Parameter	Description
Modem Initialization ( <i>modeminit.cfg</i> )	This parameter normally contains the async factory default setting for your modem. To use another setting, check the AT commands in your modem user's guide. Usually, the setting & F0 sets up most asynchronous modems in standard asynchronous mode.
Port ( <i>device.cfg</i> )	This is the port to which the modem is installed. <ul style="list-style-type: none"> <li>▶ If you use DOS or Windows, you may use COM2 or a similar setting.</li> <li>▶ If you use UNIX, you may use <i>/dev/tty3</i> or a similar setting.</li> </ul>
Port Speed ( <i>speed.cfg</i> )	This parameter identifies to Cleo the baud rate of the port so that Cleo knows how fast to write to the port. This is NOT the dial-up connection speed or the modem's baud rate.

(Continued on next page)

<b>(Contd) Parameter</b>	<b>Description</b>	
Terminal Type ( <i>terminal.cfg</i> )	The terminal type is usually VT100 or VT220, depending on the terminal type to be emulated. Refer to the Cleo documentation for more information.	
Dial Initialization	This is the most important configuration parameter. It is used to set the unique configuration that a particular VAN expects. Use the following table to guide you in setting this parameter.	
	<b>VAN</b>	<b>Dial-Initialization Settings</b>
	COMMERCE: Network	<ul style="list-style-type: none"> <li>▶ MNP error correction protocol</li> <li>▶ Software Flow Control (also known as XON/XOFF Flow Control)</li> </ul>
	Advantis	<ul style="list-style-type: none"> <li>▶ MNP error correction protocol</li> <li>▶ Hardware Flow Control (RTS/CTS)</li> <li>▶ FTP: Xmodem (in addition to the MNP protocol)</li> </ul>
	GEIS	<ul style="list-style-type: none"> <li>▶ Either Hardware Flow Control (RTS/CTS) or Software Flow Control</li> </ul> <p><b>CAUTION</b></p> <p><b>If you use Software Flow Control, make sure the Dial Init and FLOWCONTROL setting in the configuration file are compatible.</b></p> <ul style="list-style-type: none"> <li>▶ FTP: Xmodem</li> </ul>

# How to Set Up Bisynchronous Communications

## Introduction

This topic contains the procedure for setting up bisynchronous communications using the VAN scripts that are located in the COMM directory structure. Follow the instructions for the VAN to which you are linking.

## Editing the configuration file

Your Cleo 3780Plus VAN configuration file (*cnet.cfg*, *adv.cfg*, or *geis.cfg*) contains all or most of the required network configurations. However, you may have hardware issues that require you to modify the file.

The parameter settings that sometimes need to be increased are:

- ▶ Wait Limit
- ▶ Retransmission Limit

### Important

The configuration file does not contain any labels. Consult the Cleo documentation to determine which lines to edit within the file.

Use this procedure to edit the configuration file for COMMERCE:Network, Advantis, and GEIS.

Step	Action
1	Open the VAN Configuration File in a text editor.
2	Set the <b>Wait Limit</b> as needed.
3	Set the <b>Retransmission limit</b> as needed.
4	Initiate a Cleo session so you can test communications to the VAN.
5	<p>Check whether a completion status of '0' was returned.</p> <ul style="list-style-type: none"> <li>▶ If the status was 0, you are finished editing the configuration file.</li> <li>▶ If a non-zero was returned, use the &lt;van&gt;.log and &lt;van&gt;.mon files to troubleshoot.</li> </ul> <p><b>Reference</b> See the topic <a href="#">Cleo 3780Plus Troubleshooting</a> for more information.</p>

(Continued on next page)

**Editing the job file**

Use this procedure to edit the job file for cnet bisync communications.

Step	Action
1	Open the job file in a text editor.
2	<p>Set the dialing command.</p> <p><b>Example</b> AUTODIAL n-<i>nnn</i>-<i>nnn</i>-<i>nnnn</i> T60 R3</p> <p>Where n-<i>nnn</i>-<i>nnn</i>-<i>nnnn</i> is the connection telephone number T60 is the time in seconds to wait for a connection to complete R3 is the number of times to retry a connection attempt.</p> <p><b>Comment</b> We recommend that you use the default time and retry settings.</p>
3	<p>Set mailbox ID and password. You must set it in three separate places:</p> <p>KEY \$\$REQ ID=<i>xxxxx</i>R BID='nnnnnnnnn' -x</p> <p>KEY \$\$REQ ID=<i>xxxxx</i>D BID='nnnnnnnnn' -x</p> <p>KEY \$\$ADD ID=<i>xxxxx</i>D BID='nnnnnnnnn' -x</p> <p>Where <i>xxxxx</i> is the five character network mailbox ID <i>nnnnnnn</i> is the seven digit password.</p> <p><b>Warning</b> <b>These are the only changes to the job file approved by Sterling Commerce. Any other changes will NOT be supported by Sterling Commerce Support personnel.</b></p>

## How to Start Up Cleo A+

---

**Description** Interface Systems' Cleo A+ is an asynchronous communications package that uses sophisticated scripting to handle various types of communications. It supports several file transfer methods, including raw ASCII, Xmodem, Ymodem, Zmodem, Kermit, and ANSI CLEAR. It can also perform as an FTP tool, using SLIP, PPP, Telnet, or local modes.

---

**Cleo A+ start-up command** The Cleo A+ start-up command consists of the command to execute the application A+ and several parameters. The two most important parameters are the jobfile and tokens, which are explained below.

The rest of the information that you can place in the start-up command is identified within the *job* file. A log file is generated automatically.

---

**.job file** This parameter identifies the job file to use for the session. The job file determines how Cleo manages a communication session. There is a separate job file for each VAN which ends with the extension *.job*. For example, the Advantis job file is *advsr.job*.

This table lists the job file that corresponds to each supported VAN.

VAN Async (COMM/CleoA/.)	Job File
COMMERCE:Network via MCI or CompuServe	.cnetsr.job
Advantis Expedite/Async	.advsr.job
GEIS EDI*Express	.geissr.job

---

(Continued on next page)



**Tokens**

A "token" is a piece of information that is passed to a job, such as the VAN telephone number or your VAN ID. The token parameter identifies the tokens to be passed to the job as it is running.

This table lists the available A+ tokens for each VAN.

<b>VAN</b>	<b>Token Number</b>	<b>Description</b>
Advantis	1	Telephone/modem access number. (n- <u>nnn</u> - <u>nnn</u> - <u>nnnn</u> )
	2	IBM Network Account ID.
	3	IBM Network User ID.
	4	IBM Network Password.
	5	Information Exchange Network Account ID.
	6	Information Exchange Network User ID.
	7	Information Exchange Network Password.
COMMERCE: Network	1	Telephone/modem access number. (n- <u>nnn</u> - <u>nnn</u> - <u>nnnn</u> )
	2	Mailbox ID. (Sxxxx)
	3	Mailbox password. (nnnnnnn)
	4	Mailbox Application ID obtained from network support. (EDIx)
	5	Report slot ID. (xxx)
	6	Data slot ID. (xxx)
	7	Node access host. (compu or mci)
GEIS	1	Telephone/modem access number. (n- <u>nnn</u> - <u>nnn</u> - <u>nnnn</u> )
	2	GEIS Network User Number.
	3	GEIS Network User Password.
	4	Last three digits of the GEIS User Number.

(Continued on next page)

**Example start-up  
command**

---

```
A+ jobfile=./cnet/cnetsr.job "tokens=18005551212 SX999 1234567 EDIx R D mci"
```

---

## How to Start Up Cleo 3780Plus

**Description** Interface Systems' Cleo 3780Plus is a bisynchronous communications package that uses scripting to handle various types of communications. It supports 2780/3780 bisync protocols by using a piece of hardware to convert ASCII data to EBCIDIC data for transmission and EBCIDIC data to ASCII data upon reception of the EBCIDIC data.

### Cleo 3780Plus start-up command

The Cleo 3780Plus start-up command consists of the Cleo command 3780Plus' along with several other parameters. These are required parameters:

Parameter	Description	
-d	Identifies the device or communications port to use this session.	
-j	Identifies the <i>.job</i> file to run.	
	VAN Bisync (COMM/CleoB/..)	Job File
	COMMERCE:Network	<i>.cnetsr.job</i>
	Advantis Expedite/Direct	<i>.advsr.job</i>
	GEIS EDI*Express	<i>.geissr.job</i>
-k	Used to pass the tokens to the <i>.job</i> file as it is running.	

You can use the following optional parameters in the start-up command.

Parameter	Description
-c	Identifies the configuration file to use. The <i>.job</i> file includes this information.
-LO	Directs Cleo to generate a new log for the session if one does not exist in the COMM directory or overwrite an existing one. This command is recommended.

#### Note

The log is not required. However, GENTRAN:Server support personnel must have the log to assist you in troubleshooting any communication difficulties you may encounter.

(Continued on next page)

## GEIS and Advantis tokens

This table lists the available 3780Plus or AllSync tokens for GEIS and Advantis.

### Note

To control startup of bisynchronous communications for COMMERCE:Network, you need to edit the job file instead of using tokens.

### Reference

See the [How to Set Up Bisynchronous Communications](#) topic in this chapter.

VAN	Token Number	Description
Advantis	1	Connection telephone number.
	2	IBM Network Account ID.
	3	IBM Network User ID.
	4	IBM Network Password.
	5	Information Exchange Network Account ID.
	6	Information Exchange Network User ID.
	7	Information Exchange Network Password.
GEIS	1	Connection telephone number.
	2	GEIS Network User Number.
	3	GEIS Network User Password.
	4	Last three digits of the GEIS User Number.

## Example start-up command

```
3780Plus -d /dev/tty03 -j ./geis/geissr.job -k 18005551212 GEISID GEISPSWDnnn -LO
```

# Start-Up Procedure Examples

---

## Introduction

Communications is not a GENTRAN:Server application and the procedures to start communications can vary from environment to environment. Once communications are set up, you use the same commands to start it regardless of the platform.

---

## Initiating communications through automated procedures

The communications toolkit has certain expectations regarding file placement. You can automate processes to move the file to and from the VAN directories. You can also automate the start-up process using *.bat* files created in DOS or Windows, or shell scripts created in UNIX or open systems.

---

## Examples

The following examples show what you can implement into an automated communications procedure.

### DOS or Windows Users .BAT File Example

```
copy C:\Server\ediout?.fil C:\Server\comm\cleoa\cnet\cnets
del C:\Server\ediout?.fil
cd \Server\comm\cleoa
aplus jobfile=.\cnet\cnetsr.job "tokens=5551212 SX999 1234567 EDIx R D mci"
copy C:\Server\comm\cleoa\cnet\cnetr C:\Server\comm\cleoa\ediin?.fil
del C:\Server\comm\cleoa\cnet\cnetr
```

### UNIX Systems Users Shell Example

```
cp /Server/ediout?.fil /Server/comm/cleoa/cnet/cnets
rm /Server/ediout?.fil
cd /Server/comm/cleoa
A+ jobfile=./cnet/cnetsr.job "tokens=5551212 SX999 1234567 EDIx R D mci"
```

---

(Continued on next page)

```
***error recovery procedures ie; if$? =gt 0 ...****
```

```
cp /Server/comm/cleoa/cnet/cnetr /Server/ediin?.fil
```

```
rm /Server/comm/cleoa/cnet/cnetr
```

**Example start-up  
command**

---

```
3780Plus -d /dev/tty03 -j ./geis/geissr.job -k 18005551212 GEISID GEISPSWD -LO
```

---

# Troubleshooting

## Communications Session Error Recovery

### Introduction

With communications applications, failures can occur. The communications scripts developed by Sterling Commerce are designed to handle common communications errors.

### Error messages and end codes

The communications script files (<van>sr.job files), have an "error Fall Thru" section. This section lists the messages that the Cleo application writes to the *.log* file. Each time a session error occurs, the *.job* file posts a relevant error message to the log and returns an end code when it exits the Cleo application. You can use this end code in a shell script (UNIX) or *.bat* file (DOS/Windows) to decide whether communications ended successfully. An end code of 0 indicates success and a non-zero value indicates a failure. The various end code values indicate why the failure occurred.

### COMMERCE: Network Async end codes

This table describes the possible end codes generated by a Cleo application in Async (A+) mode and the meaning of each.

COMMERCE:Network Async (A+)	
End Code	Meaning
0	Session successful; continue processing
Non-zero values:	Require further examination
35	Error occurred during dial attempts; connection never established.
50	Error occurred at some point during the logon process to the network. Connection established to communication node but no session established with host.
60	Error occurred while attempting to transmit your outbound data to the network; resend data.
70	Error occurred while attempting to receive inbound data or reports from the network; any data to be sent during that session was NOT sent; retry may be required.

**COMMERCE:  
Network Bisync  
end codes**

This table describes the possible end codes generated by a Cleo application in Bisync (3780Plus) mode and the meaning of each.

<b>COMMERCE:Network Bisync (3780Plus)</b>	
<b>End Code</b>	<b>Meaning</b>
0	Session successful; continue processing
Non-zero values:	Requires further examination
35	Error occurred during dial attempts; connection never established.
40	Error occurred during receive process for inbound data or reports from the network; retry may be required.
50	Error may have occurred at some point during transmittal of 'request cards', 'add' card', or outbound data file; retry may be required.

**Advantis  
Expedite/Direct  
Async end codes**

This table describes the possible end codes generated by a Cleo application in Async (A+) mode and the meaning of each.

<b>Advantis Expedite/Direct Async (A+)</b>	
<b>End Code</b>	<b>Meaning</b>
0	Session successful; continue processing
Non-zero values:	Requires further examination
35	Error occurred during dial attempts; connection never established.
40	Error occurred during logon process; session never established to Advantis network, even though connection was made.
50	Error occurred during transmittal of outbound data to Advantis network.
55	Error occurred during transmittal of outbound flat file data to Advantis network.

(Continued on next page)



<b>(Contd)</b> <b>Advantis Expedite/Direct Async (A+)</b>	
<b>End Code</b>	<b>Meaning</b>
60	Error occurred during reception of inbound data from Advantis network; retry may be needed.
65	Although data may have been collected by communications, Advantis may not recognize this because the session failed after the data was received; they may send duplicate data in following session.
70	Logoff process failed and Advantis may not have collected or acknowledge your receipt of data.

**Advantis  
Expedite/Direct  
Bisync end  
codes**

This table describes the possible end codes generated by a Cleo application in Bisync (3780Plus) mode and the meaning of each.

<b>Advantis Expedite/Direct Bisync (3780Plus)</b>	
<b>End Code</b>	<b>Meaning</b>
0	Session successful; continue processing
Non-zero values:	Requires further examination
35	Error occurred during dial attempts; connection never established.
40	Error occurred during logon process; session never established to Advantis network even though connection was made.
50	Error occurred during transmittal of data.
55	Error occurred during transmittal of 'receive' and 'receive log' commands occurred, or acknowledgment from Advantis never received.
60	Error occurred during receive process for inbound data file or reports from Advantis.

(Continued on next page)

**GEIS  
EDI\*Express  
Async end codes**

This table describes the possible end codes generated by a Cleo application in Async (A+) mode and the meaning of each.

<b>GEIS EDI*Express Async (A+)</b>	
<b>End Code</b>	<b>Meaning</b>
0	Session successful; continue processing.
Non-zero values:	Require further examination
35	Error occurred during dial attempts; connection never established.
40	Error occurred during logon process; session never established to GEIS network, even though connection was made.
50	Error occurred during transmittal of commands associated with sending outbound data to Advantis network; data never sent.
55	Error occurred during transmittal of outbound data to GEIS network.
60	Error occurred during transmittal of receive commands for inbound data from GEIS network.
65	Error occurred during reception of data from GEIS network.
70	Error occurred during logoff.

(Continued on next page)

**GEIS  
EDI\*Express  
Bisync end  
codes**

This table describes the possible end codes generated by a Cleo application in Bisync (3780Plus) mode and the meaning of each.

<b>GEIS EDI*Express Bisync (3780Plus)</b>	
<b>End Code</b>	<b>Meaning</b>
0	Session successful; continue processing
Non-zero values:	Requires further examination
35	Error occurred during dial attempts; connection never established.
40	Error occurred during logon process; session never established to GEIS network even though connection was made.
50	Error occurred during transmittal of commands associated with sending outbound data to Advantis network; data was never sent.
55	Error occurred during transmittal of outbound data to GEIS network.
60	Error occurred during transmittal of receive commands for inbound data from GEIS network, or failure occurred receiving data from GEIS network.
65	Error occurred during transmission of *EOS command; session may not even be recorded on GEIS network side.

## Cleo 3780Plus Troubleshooting

---

### Introduction

This section offers possible solutions to three of the most common situations. See your Cleo documentation for further information.

---

### Problem and solution table

This table lists common problems and solutions.

Problem	Possible Solution
During a RECEIVE process, you encounter a WAIT error	Increase the Wait Limit parameter in the Cleo configuration file (cnet.cfg, adv.cfg, or geis.cfg)
During a SEND process, you encounter a RETRAN error	Increase the Retransmission Limit parameter in the Cleo configuration file (cnet.cfg, adv.cfg, or geis.cfg)
At any point in the session, you encounter a BIDLMT error.	<p>Check the documentation for your modem and verify that it can handle synchronous communications, then try again.</p> <p>If the problem continues, contact Cleo Support of Sterling Support for information and assistance.</p> <p><b>Note</b> The BIDLMT error can occur when you attempt to connect to a bisynchronous line at a speed other than that of the line. For example, if you attempt to connect to a 9600 bisynchronous line at 2400 baud.</p>

---

# Connecting to Other VANs and Directly to Trading Partners

---

## Introduction

If you need to connect to a trading partner directly or to a VAN that is not supported by the Communications Toolkit, you will need to create a Cleo communications script to connect to the VAN. You may also need to create a configuration file.

---

## About creating communications scripts

Scripts are usually created as ASCII text files, which you do not need to compile.

---

## Cleo 3780Plus

The Cleo 3780Plus communications application software enables an ASCII system to emulate a 2780 or 3780 terminal. With 3780Plus, you can transmit and receive data from any system that supports the 2780 or 3780 bisynchronous protocols.

The scripting facility in Cleo 3780Plus is relatively simple to use. However, you must understand the session protocol that the remote system requires.

---

(Continued on next page)

### Basic Cleo 3780Plus commands

The table below lists some *basic* Cleo commands and descriptions. See your Cleo 3780Plus documentation for more detailed information.

Command	Description
AUTODIAL tel# Txx Rxx	<p>Used to dial remote system's modems for a communications connection.</p> <ul style="list-style-type: none"> <li>▶ tel# = The number to connect to</li> <li>▶ Txx = The timer delay for waiting for an answer from the remote modem</li> <li>▶ Rxx = The retry parameter for number of attempts to retry if the dial attempt fails</li> </ul>
KEY msg -ENRX	<p>Used to send a user a specified message. Often used to send commands such as a system logon to a remote system. Unless otherwise specified, cleo automatically transmits an End of Transmission (EOT) character when the message transmission is complete.</p> <p>The switches that follow the command are used for protocol and translation functions.</p> <ul style="list-style-type: none"> <li>▶ -E = Suppress an EOT character after the message is transmitted.</li> <li>▶ -X = Suppress an ETX character as well as an EOT character after the message is sent.</li> <li>▶ -N = Send non-transparent data from the message through "as is" (no translation)</li> <li>▶ -R = Suppress inter-record separators from the transmitted message</li> </ul>
TEXT path/filename - ENRX	<p>Used to transmit specified files to the remote system. The switches that follow the command (-ENRX) are used for protocol and translation functions. See descriptions above.</p> <p style="text-align: right;">(Continued on next page)</p>

(Contd) Command	Description
RECEIVE path/filename - NX	<p>Used to receive files from the remote system to a specified path and filename. A received EOT character terminates the command. A received ETX character causes Cleo to terminate the write to the specified file and start writing into an incremented filename. Depending on the user filename, Cleo may overwrite the previous data in the specified file.</p> <p>Switches:</p> <ul style="list-style-type: none"> <li>▶ -X = Ignore incoming ETX characters</li> <li>▶ -N = Allow transparent data to be received "as is" (no translation)</li> </ul>
VOICE	<p>Hangs up the phone and terminates a session. Usually, the command to terminate the cleo 3780Plus application (QUIT) follows this command.</p>

---

### Suggestions

- ▶ Reference the 3780Plus documentation to learn about the many other session script commands, startup options, and other functions not discussed in this appendix.
- ▶ Make sure you are familiar with all the options on the commands before you use them.
- ▶ Use the 3780.LOG file to review sessions for errors that may have occurred during the previous communications sessions.
- ▶ There is a Monitor file you can use as a line scope to determine what is being transferred to and from your system. This monitor is in EBCDIC Hexadecimal code. There is a conversion chart in the 3780Plus documentation that may help you read this trace.

---

### Cleo A+

Cleo A+ enables users to transmit and receive files from systems that support asynchronous file transfer protocols. You can run sessions interactively or use scripts you have written to perform unattended functions. Several configuration options are available for file transfer: raw ASCII, Xmodem, Ymodem, Zmodem, Kermit, Ansi, and FTP (slip, ppp, telnet).

The scripting facility in Cleo 3780Plus is relatively simple to use. However, you must understand the session protocol that the remote system requires. A+ allows use of environment variables, user-defined variables, and the ability to control file naming during a session.

---

(Continued on next page)

### Basic Cleo A+ commands

This table includes descriptions of *basic* Cleo A+ commands used to start a dialup, send commands to a remote system, receive files, send files, and terminate the connection. See your CleoA+ documentation for more detailed information.

Command	Description
AUTODIAL tel# Txx Rxx	<ul style="list-style-type: none"> <li>▶ Used to dial remote system's modems for a communications connection.</li> <li>▶ tel# = The number to connect to</li> <li>▶ Txx = The timer delay for waiting for an answer from the remote modem</li> <li>▶ Rxx = The retry parameter for number of attempts to retry if the dial attempt fails</li> </ul>
KEY msg -NTR	<p>Used to send a user a specified message. Often used to send commands such as a system logon to a remote system. Unless otherwise specified, Cleo automatically transmits a CR character when the message transmission is complete.</p> <p>The switches that follow the command are used for protocol and translation functions.</p> <ul style="list-style-type: none"> <li>▶ -N= Send non-transparent data from the message through "as is" (no translation)</li> <li>▶ -T= Force message through the translation table</li> <li>▶ -R= Suppress carriage return (CR) from the end of the transmitted message</li> </ul>
SEND path/filename / remote filename -TN	<p>Used to transmit specified files to the remote system. The remote filename parameter is used to send the same filename to the remote system. The switches that follow the command (-TN) are used for translation functions.</p> <ul style="list-style-type: none"> <li>▶ -T= Force message through the translation table</li> <li>▶ -N= Send non-transparent data from the message through "as is" (no translation)</li> </ul> <p style="text-align: right; color: red;">(Continued on next page)</p>



<b>(Contd) Command</b>	<b>Description</b>
RECEIVE path/filename - NT	<p>Used to receive files from the remote system to a specified path and filename. Depending on the file transfer type you are using, when the receive is complete, A+ attempts to write to the specified file or into an incremented filename. A+ may overwrite the previous data in the specified file, depending on the filename.</p> <p>Switches:</p> <ul style="list-style-type: none"> <li>▶ -N= Allow transparent data to be received "as is" (no translation)</li> <li>▶ -T= Force the outbound data through the translation table</li> </ul>
VOICE	<p>Hangs up the phone and terminates a session. Usually, the command to terminate the Cleo 3780Plus application (QUIT) follows this command.</p>

---

### Suggestions

- ▶ Reference the A+ documentation to learn about the many other session script commands, startup options, and other functions not discussed in this appendix.
- ▶ Make sure you are familiar with all the options on the commands before you use them.
- ▶ Use the A+.LOG file to review sessions for errors that may have occurred during the previous communications sessions.

---

### Configuration file

Depending on your partner's requirements, you may need to create a configuration file. The important thing to remember is that the settings defined in the configuration file that pertains to your system or your modem should always be in sync with each other. Be sure to talk to staff at the remote site to determine its requirements for connection. Never assume anything will work. Even if you guess on how to establish the connection you will still need to determine the session protocol. Talk to your remote staff!

(Continued on next page)

**Extended  
Communications  
Support  
Services (ECS)**

---

If you do not have the resources required to develop the communications or configuration file, Sterling Commerce offers consulting services to create, maintain, install, and test communications. Contact Sterling Support and ask for communications support for information.

---

# A

---

## Client Descriptions

### Using This Table

---

This table is provided to help you maintain the locations of your clients. Use the table to record client serial numbers, IP addresses, and descriptions of the client PCs in your organization. The first line contains a sample entry.

Client Serial #	IP Address	Description
12345678	000.00.0.00	PC in John Smith's office

Client Serial #	IP Address	Description