

Gentran:Server[®] for Windows[®]

Extension for SAP User's Guide

Version 5.2

Sterling Commerce
An IBM Company

Copyright Notice

Gentran:Server for Windows

© Copyright 1995–2008
Sterling Commerce, Inc.
ALL RIGHTS RESERVED

Sterling Commerce Software Trade Secret Notice

THE GENTRAN:SERVER FOR WINDOWS SOFTWARE ("STERLING COMMERCE SOFTWARE") IS THE CONFIDENTIAL AND TRADE SECRET PROPERTY OF STERLING COMMERCE, INC., ITS AFFILIATED COMPANIES OR ITS OR THEIR LICENSORS, AND IS PROVIDED UNDER THE TERMS OF A LICENSE AGREEMENT. NO DUPLICATION OR DISCLOSURE WITHOUT PRIOR WRITTEN PERMISSION. RESTRICTED RIGHTS.

This documentation, the Sterling Commerce Software it describes, and the information and know-how they contain constitute the proprietary, confidential and valuable trade secret information of Sterling Commerce, Inc., its affiliated companies or its or their licensors, and may not be used for any unauthorized purpose, or disclosed to others without the prior written permission of the applicable Sterling Commerce entity. This documentation and the Sterling Commerce Software that it describes have been provided pursuant to a license agreement that contains prohibitions against and/or restrictions on their copying, modification and use. Duplication, in whole or in part, if and when permitted, shall bear this notice and the Sterling Commerce, Inc. copyright notice.

As and when provided to any governmental entity, government contractor or subcontractor subject to the FARs, this documentation is provided with RESTRICTED RIGHTS under Title 48 CFR 52.227-19. Further, as and when provided to any governmental entity, government contractor or subcontractor subject to DFARs, this documentation and the Sterling Commerce Software it describes are provided pursuant to the customary Sterling Commerce license, as described in Title 48 CFR 227-7202 with respect to commercial software and commercial software documentation.

These terms of use shall be governed by the laws of the State of Ohio, USA, without regard to its conflict of laws provisions. If you are accessing the Sterling Commerce Software under an executed agreement, then nothing in these terms and conditions supersedes or modifies the executed agreement.

Product names mentioned herein may be trademarks and/or registered trademarks of their respective companies. Gentran and Gentran:Server are registered trademarks of Sterling Commerce, Inc.

Third Party Software:

Portions of the Sterling Commerce Software may include products, or may be distributed on the same storage media with products, ("Third Party Software") offered by third parties ("Third Party Licensors").

Warranty Disclaimer

This documentation and the Sterling Commerce Software which it describes are licensed either "AS IS" or with a limited warranty, as set forth in the Sterling Commerce license agreement. Other than any limited warranties provided, NO OTHER WARRANTY IS EXPRESSED AND NONE SHALL BE IMPLIED, INCLUDING THE WARRANTIES OF MERCHANTABILITY AND FITNESS FOR USE OR FOR A PARTICULAR PURPOSE. The applicable Sterling Commerce entity reserves the right to revise this publication from time to time and to make changes in the content hereof without the obligation to notify any person or entity of such revisions or changes.

The Third Party Software is provided 'AS IS' WITHOUT ANY WARRANTY AND ANY EXPRESSED OR IMPLIED WARRANTIES, INCLUDING BUT NOT LIMITED TO, THE IMPLIED WARRANTIES OF MERCHANTABILITY, AND FITNESS FOR A PARTICULAR PURPOSE ARE DISCLAIMED. FURTHER, IF YOU ARE LOCATED OR ACCESSING THIS SOFTWARE IN THE UNITED STATES, ANY EXPRESS OR IMPLIED WARRANTY REGARDING TITLE OR NON-INFRINGEMENT ARE DISCLAIMED.

Table of Contents

Preface	About this Guide	
	▶ Overview	iv
	▶ Contents of this Guide	v
	▶ Conventions in this Guide	vi
	▶ Getting Support	vii
Chapter 1	Configuring the Extension	
	▶ Overview	1-2
	▶ Connection Parameters Tab	1-4
	▶ General Tab	1-13
	▶ System Tab	1-15
Chapter 2	Extension Program Functions	
	▶ Overview	2-2
	▶ Translate Function	2-3
	▶ Update Function	2-4
	▶ Extract Function	2-5
	▶ StartRFC Function	2-7
	▶ POSTPROC Function	2-9
Chapter 3	Configuring and Testing the Sample Maps	
	▶ Overview	3-2
	▶ Sample Map Naming Conventions	3-3
	▶ Customizing Mapping Instructions	3-4
	▶ Finalizing the Map	3-6
Chapter 4	Using ALE to Transfer Documents	
	▶ Overview	4-2
	▶ Processing in ALE Mode	4-3
Appendix A	Supported SAP Status Codes	
	▶ Overview	A-2

- Status Codes A-3

Appendix B Setup Recommendations for SAP System on Windows

- Overview B-2
- Sample Inbound Processing Setup B-3
- Sample Outbound Processing Setup B-5
- Sample Update Processing Setup B-6
- Sample Extract Processing Setup B-7
- Describing Gentran:Server Process Control B-8

Appendix C Setup Recommendations for SAP System on a UNIX Host

- Overview C-2
- Sample Inbound Processing Setup C-3
- Sample Outbound Processing Setup C-5
- Sample Update Processing Setup C-6
- Sample Extract Processing Setup C-8
- Gentran:Server Process Control C-11

Appendix D Multi-Port Processing

- Overview D-2

Appendix E Using the IDoc Utility

- Overview E-2
- Installing and Configuring the IDoc Utility E-4
- Running the IDoc Utility E-6

About this Guide

Contents

▶ Overview	iv
▶ Contents of this Guide	v
▶ Conventions in this Guide	vi
▶ Getting Support	vii

Overview

Introduction

Welcome to the Gentran:Server® for Windows® Extension for SAP®. This release is compatible with Gentran:Server for Windows release 5.2 and higher, and assists you in your e-business solution implementations of SAP. This is Sterling Commerce's interface between the receipt and transmission of electronic commerce transactions and SAP application software.

Product overview

This easy-to-use product facilitates your electronic commerce processes to directly benefit your business. The Extension for SAP passes status information to SAP for outbound IDocs, and enables you to send IDocs into SAP automatically in unattended processing mode.

The difference between the SAP Extension and the SAP Gateway

The Gentran:Server for Windows Extension for SAP allows communication between your Gentran:Server system and your SAP system. This includes tracking an IDoc sent from your Gentran:Server system as the IDoc is translated, interchanged, sent to your trading partner, and the acknowledgement through SAP status codes. Therefore, you can send status messages back to your SAP system regarding the status of a specific IDoc.

The SAP Gateway is sold separately and is installed from the Gentran:Server Options Pack. The gateway processes IDocs to and from your SAP system, but does not track the status of the IDocs sent from SAP to Gentran:Server. Therefore, no status messages are sent back to your SAP system regarding the status of a specific IDoc.

Installing the Extension for SAP

Reference

See the *Installation and Upgrade Instructions Card* for more information on how to install or upgrade the Extension for SAP.

Contents of this Guide

-
- Introduction** This document provides instructions for installing the Gentran:Server for Windows Extension for SAP. It also contains configuration and administration information you need to operate the extension properly.
-
- Purpose** This guide supplements the following documentation:
- Gentran:Server for Windows Administration Guide
 - Gentran:Server for Windows User's Guide
 - Online Help systems for Gentran:Server.
-
- Prerequisite knowledge** This document assumes that you are familiar with the following:
- Microsoft® Windows operating system
 - General administrative functions
 - Standard Windows and SAP terminology
 - SAP administration
-

Conventions in this Guide

Typeface styles

These are the typeface styles used in this document:

Introduction This typeface is used for emphasis or to indicate a chapter in this guide.

New This typeface indicates a button in the program. Click the button with your mouse, or press **TAB** until the button is highlighted, then press **ENTER** to execute that command.

ALT This typeface indicates a key that you need to press on your keyboard. A plus sign (+) between key names indicates a combination of keys to be pressed together (such as **ALT + T**).

Getting Support

Introduction The Sterling Commerce Gentran:Server software is supported by trained product support personnel who are available to help you with product questions or concerns.

Note

Gentran:Server Customer Support does not support non-Sterling Commerce products (e.g., SQL Server, Oracle, etc.), but can assist you in configuring non-Sterling Commerce products to work with Gentran:Server.

Phone number For assistance, please refer to your *Getting Started Guide* to determine which support phone number you should use.

Before calling support

To help us provide prompt service, we ask that you do the following:

- Attempt to recreate any problem that you encounter and record the exact sequence of events.
- When you call product support, you should be prepared to provide us with the information below.

Information	Description
Identification	Your company name, your name, telephone number and extension, and the case number (if the question refers to a previously reported issue).
System Configuration	The Gentran:Server version (and any service packs installed) and information about the primary Gentran system controller and all machines experiencing problems, including: the Windows operating system version, amount of memory, available disk space, database version, Microsoft Data Access (MDAC) version, and Internet Explorer version. Also, please describe any recent changes in your hardware, software, or the configuration of your system.
System Data Store	Which machines contain folders in the system data store?
Error Messages	Record the exact wording of any error messages you receive and the point in the software where the error occurred, as well as any log files.
Attempted Solutions	Record any steps that you took attempting to resolve the problem and note all the outcomes, and provide an estimate on how many times the problem occurred and whether it can be reproduced.

Accessing the Sterling Commerce Support Web Site

The Sterling Commerce Customer Support Web Site contains valuable information about getting support for Gentran:Server for Windows, including the following:

- scope of support services
- customer support policies
- call prioritizing
- customer support phone directory
- how to create new Support on Demand cases
- how to check the status of Support on Demand cases
- how to add information to Support on Demand cases

The Customer Support Web Site is constantly updated and all Sterling Commerce customers have access to it. This web site also contains the most recent product updates and is a valuable source of product information.

Reference

Refer to the *Getting Started Guide* for information on how to access the Customer Support World Wide Web Site.

Documentation

The Customer Support Web Site contains a documentation library, which has the entire Gentran:Server for Windows documentation set. You can download the product manuals in PDF format from this library at any time.

Configuring the Extension

Contents

- ▶ Overview 1 - 2
 - ▶ Connection Parameters Tab 1 - 4
 - ▶ General Tab 1 - 13
 - ▶ System Tab 1 - 15
-

Overview

Introduction

The **Gentran:Server for Windows SAP Configuration** program, which is part of the Extension for SAP package, enables you to specify how you want the extension to operate. You can start this program by clicking **Start** and selecting **Programs**, **Gentran:Server**, and **Gentran:Server for Windows SAP Configuration**.

Gentran:Server for Windows SAP Configuration diagram

This diagram shows the **Gentran:Server for Windows SAP Configuration** dialog box.

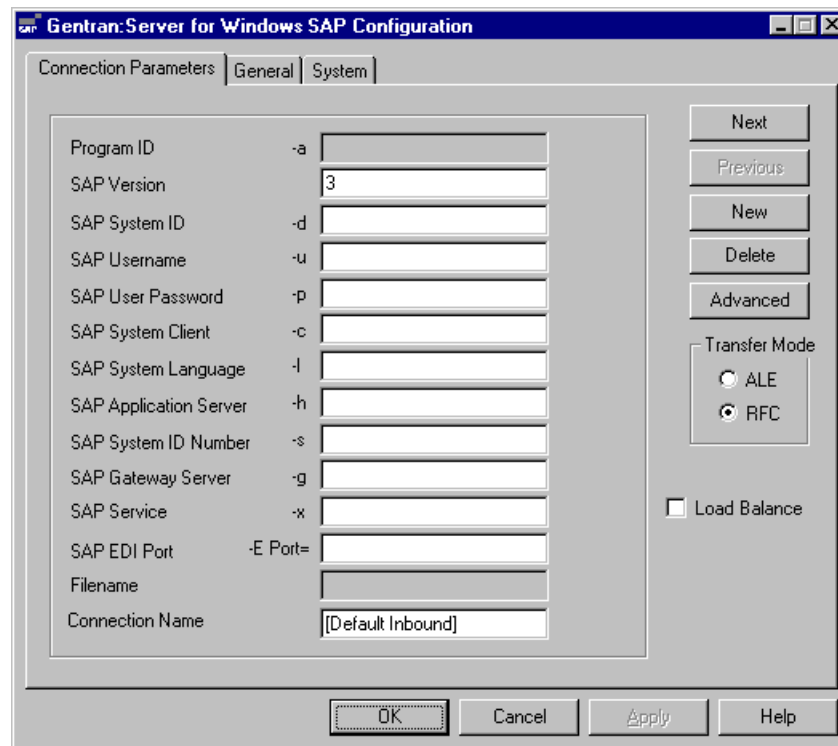

Tabs

The configuration options are grouped into three tabs, each controlling a different operation of the Extension for SAP. The following table lists and describes each tab:

This tab	Specifies
Connection Parameters	Particular SAP systems that are to receive data transmitted from the Extension for SAP.
General	The type of status messages you want the Extension for SAP to collect and the location of the SAP program STARTRFC.

(Continued on next page)

(Contd) This tab	Specifies
System	The machine in the network where you want the Extension for SAP to run the actual translation and the tables which contain the database and database access information used by the extension.

The sections in this chapter describe the contents of each tab in detail.

Buttons

At the bottom of the **Gentran:Server for Windows SAP Configuration** dialog box, there is a row of buttons. These buttons are accessible from all of the tabs. This table describes each of these buttons.

Button	Description
OK	Saves the values you selected on the currently selected tab and exits the dialog box.
Cancel	Exits the dialog box without saving any of the values you selected on the currently selected tab.
Apply	Saves the values you selected on the currently selected tab and keeps the dialog box opened.
Help	Displays the online help for the currently selected tab.

Connection Parameters Tab

Introduction

The **Connection Parameters** tab is used to specify the SAP system that is to receive the data sent from the Extension for SAP.

Typically, there is more than one SAP system with which the Extension for SAP will be interacting. For instance, there is usually a test system, development system, and production system. Therefore, when the Extension for SAP is sending status messages or EDI documents to SAP, it needs to know exactly which SAP system is to receive this data. To provide this information to the Extension for SAP, you must specify values for the group of boxes listed on the **Connection Parameters** tab. The group of values *as a whole* identifies a specific SAP system. Each group of values is written as a database entry using the Connection Name as the identifier.

The settings on this tab are used when you execute the Extension for SAP program **SAPINT.EXE** with a function that sends status or EDI data to SAP. You indicate the target SAP system by passing the connection name, (that is, the identifier for that set of configuration parameters that you specified in the **Connection Name** box) as a parameter for the SAPINT.EXE program. The Extension for SAP program then invokes a program provided by SAP called **STARTRFC** or **ALECLIENT** and fills in its parameters with the specified group of values from the **Connection Parameters** tab. The STARTRFC (or ALECLIENT) program accomplishes the actual transfer of data.

Reference

See Chapter 3, “Extension Program Functions,” for more information on the SAPINT.EXE program and its functions.

Connection Parameters diagram

This is the **Connection Parameters** tab on the **Gentran:Server for Windows SAP Configuration** dialog box.

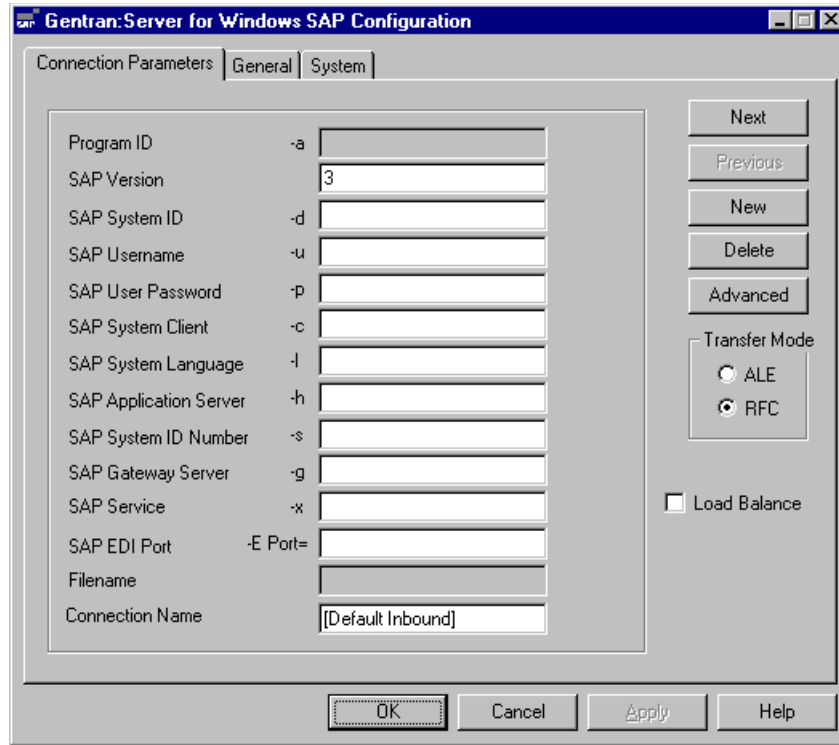

Connection Parameters tab parts and functions

This table describes the parts of the **Connection Parameters** tab and their functions, and provides examples where applicable.

For this box...	Do the following...	Example
Program ID (-a)	Displays the program identifier that was passed into ALEServer. Note This parameter is only available if ALE Transfer Mode is selected.	<machine-name>. aleserver
SAP Version	Type the IDoc version number.	3 or 4
SAP System ID (-d)	Type the system ID of the SAP system. To Locate Use SM51; the second part of the field separated by underscores represents the SAP system ID. Note This box disabled for ALE mode.	SSW

(Continued on next page)



(Contd) For this box...	Do the following...	Example
SAP Username (-u)	Type the user ID to access the SAP system. Note A special CPI-C user is not required.	ED17
SAP User Password (-p)	Type the user password to access the SAP system. Note The password you type in the SAP User Password box is encrypted before it is committed to the database RFC table.	STERLING
SAP System Client (-c)	Type the SAP system client as contained in the MANDT field of the EDI_DC or EDI_DC40 control record. Note The default is 000 . Note that no default values are prompted for new records.	040
SAP System Language (-l)	Type the SAP user language. Note The default is E for English. Note that no default values are prompted for new records.	E
SAP Application Server (-h)	Type the application server. To Locate Use SM51; the first part of the field separated by underscores represents the application server. Note This parameter is case-sensitive and is only available if Load Balance is deselected.	hwll38
SAP Message Server (-h)	Type the name of the message server into which the users will log in. Note This parameter is case-sensitive and is only available if Load Balance is selected. <i>(Continued on next page)</i>	

(Contd) For this box...	Do the following...	Example
SAP System ID Number (-s)	Type the two-digit system identification number. To Locate Use SM51, the third part of the field separated by underscores represents the system ID number. Note This parameter is only available if Load Balance is deselected.	95
SAP System Name (-s)	Type the name of the SAP system into which the users will log in. Note This parameter is only available if Load Balance is selected.	
SAP Gateway Server (-g)	Type the gateway server. To Locate Do the following: 1. Use SE38. 2. Type the report name rsparam . 3. Choose <i>Execute</i> . 4. Choose <i>System</i> → <i>List</i> → <i>Find String</i> . 5. Type rdisp/sna_g . 6. Position the cursor by double-clicking the first line. 7. Find the gateway server in the line rdisp/sna_gateway . Scroll right. Note This parameter is only available if Load Balance is deselected.	hwl139
SAP Group Name (-g)	Type the name of the group that is logging in to the SAP system. Note This parameter is only available if Load Balance is selected. (Continued on next page)	

(Contd) For this box...	Do the following...	Example
SAP Service (-x)	Type the gateway service as in /etc/services1 To Locate Do the following: 1. Use SE38. 2. Type the report name rsparam . 3. Choose <i>Execute</i> . 4. Choose <i>System</i> → <i>List</i> → <i>Find String</i> . 5. Type rdisp/sna_g . 6. Position the cursor by double-clicking the first line. 7. Find the gateway server in the line rdisp_gw_service . Scroll right.	sapgw95
SAP EDI Port (-E Port=)	Type the logical name of the EDI subsystem as stipulated in the port definition. The name can be a maximum of 10 characters.	PORT= STERLING
Filename	Type the name of the file that the ALESERVER will write the IDoc which was downloaded or transferred from SAP. Note This parameter is only available if ALE Transfer Mode is selected.	N/A
Connection Name	Type the name you want to use to identify each unique set of Connection Parameters.	Inbound Data
Transfer Mode	Indicates the mode you want to use to transfer data.	ALE or RFC
Load Balance	Select this check box if you want more than one user to be able to log in to the SAP system. Note Enabling this parameter changes the functionality of several boxes on this dialog box.	N/A

Advanced Multi-Port Features dialog box

This is the **Advanced Multi-Port Features** dialog box, which is displayed when you click **Advanced** on the **Connection Parameters** tab.

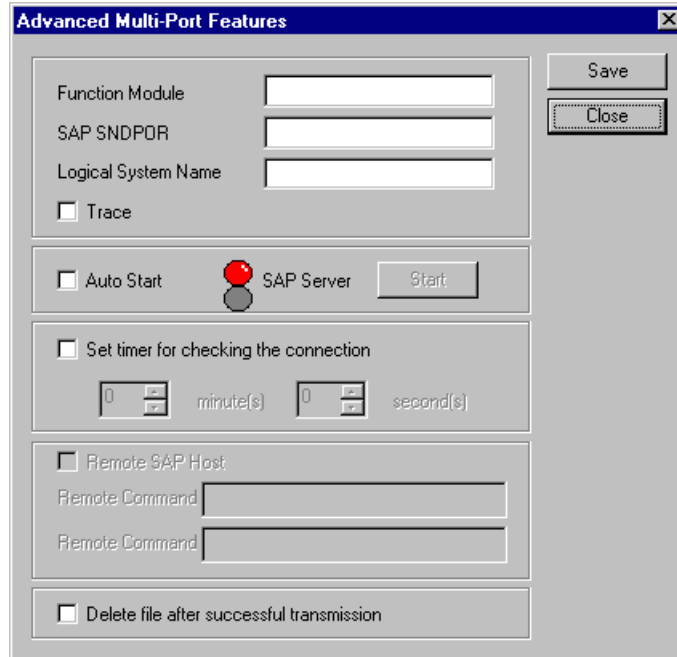

Advanced Multi-Port parts and functions

This table describes the parts listed on the **Advanced Multi-Port Features** dialog box and their functions.

For this box...	Do the following...
Function Module	Type one of the following values, which indicate the type of data being sent to the SAP system: <ul style="list-style-type: none"> ▶ EDI_STATUS_INCOMING—a file of status messages is being sent for STARTRFC processing ▶ EDI_DATA_INCOMING—an EDI document from a Trading Partner is being sent for STARTRFC processing ▶ IDOC_INBOUND_ASYNCHRONOUS—used for both status and EDI documents to send to your SAP system for ALE processing
SAP SNDPOR	Type the SAP port that is to receive the status messages from the Extension for SAP. The port identifier is made up of the following: <ul style="list-style-type: none"> ▶ the first part is SAP ▶ the second part is the SAP system ID <p style="text-align: right; color: green;">(Continued on next page)</p>



(Contd) For this box...	Do the following...
Logical System Name	Type a logical system name in the text box if you plan to use ALE to transfer data between your Gentran:Server system (on Windows) and your SAP system (on UNIX).
Trace	Select this check box if you want SAP's STARTRFC program to generate a trace file that shows the parameters it used, the machine it connected to, the data buffers that went back and forth, and whether it terminated successfully. Trace files are normally written to the GENSRVNT\Bin directory.
Auto start	Select this check box if you want the SAP service to start automatically when RPCSRV is started (for ALESERVER). Note Only one ALESERVER should be running for any one set of Configuration parameters.
Start	Click this button to initiate the SAP service (for ALESERVER).
Set timer for checking the connection	Select this check box if you want to set the an interval at which the system should poll to ensure the connection is still valid (the SAP system is still running).
minute(s)	Select or type the number of minutes at which the system should poll to determine if the connection is still valid.
second(s)	Select or type the number of seconds at which the system should poll to determine if the connection is still valid.
Remote SAP Host	Select this check box if your SAP system is running on UNIX and you intend to use file-based transfer between Gentran:Server and SAP.
Remote Command	Type the command you want to use to perform a file-based transfer from Gentran:Server to SAP (on UNIX). It is used to transmit IDocs containing status messages. (For example, ftp or rcopy.) This box becomes active only when you select the Remote SAP Host check box.
Remote Command	Type the UNIX directory and filename to which you want the transmitted IDoc containing status messages written. This box becomes active only when you select the Remote SAP Host check box. (Continued on next page)

(Contd) For this box...	Do the following...
Delete file after successful transmission	Select this check box if you want the system to delete the file after it is transmitted successfully.
Save	Saves your changes and closes the dialog box.
Close	Exits the dialog box without saving changes.

Procedure Use this procedure to type values on the **Connection Parameters** tab to describe a particular SAP system.

Step	Action
1	Start the Gentrans:Server for Windows SAP Configuration program. Reference See the “Overview” section of this chapter for more information on starting this program.
2	Select the Connection Parameters tab.
3	Type values in each box. Reference See the section “Connection Parameters tab boxes” for information on the appropriate values.
4	Click Advanced . System Response The Advanced Multi-Port Features dialog box appears.
5	Type values for the relevant boxes. Reference See the section “Advanced Multi-Port Features boxes” for information on the appropriate values.
6	Click Save and then click Close . System Response The Advanced Multi-Port Feature dialog box is closed and the Connection Parameters tab is visible again.
7	Click Apply to save the group of values. <p style="text-align: right;">(Continued on next page)</p>

(Contd) Step	Action
8	<p>Do you want to add another group of values for a different SAP system?</p> <p>If yes, click New and repeat Steps 2 - 6. If no, you can either</p> <ul style="list-style-type: none"> ▶ leave the Gentran:Server for Windows SAP Configuration dialog box opened for further use, or ▶ close it by clicking OK.

Navigating and Deleting Groups

To navigate through the multiple groups of values you've created, click **Next** and **Previous**.

To delete any group, navigate to it so that it appears on the tab and click **Delete**. The system deletes the group without asking for confirmation.

General Tab

Introduction

The **General** tab on the **Gentran:Server for Windows SAP Configuration** dialog box enables you to specify where to find the SAP-supplied program STARTRFC and the types of status messages you want the Extension for SAP to collect.

General tab diagram

This is the **General** tab on the **Gentran:Server for Windows SAP Configuration** dialog box.

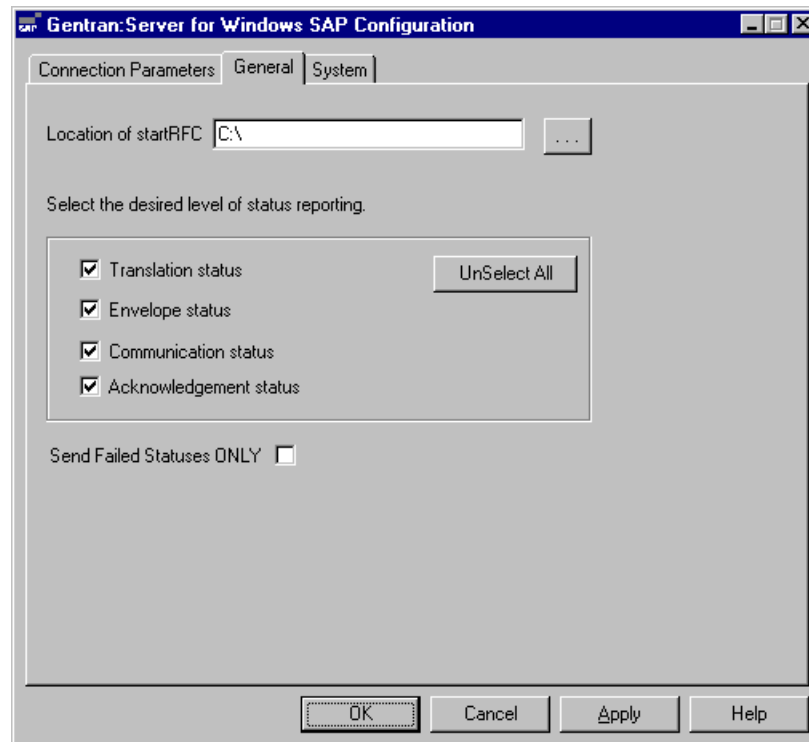

General tab parts and functions

This table describes the parts of the **General** tab and their functions.

For this box...	Do the following...
Location of startRFC	<p>Type the directory where the SAP-supplied STARTRFC program resides. You can click the browse button to help you locate it.</p>  <p>Note A test version of the startRFC program is copied to the GENSRVNT\bin folder when you installed Gentrans:Server for Windows. This version of the program is to used only for testing purposes.</p>
Translation status	Select this check box to return status messages reflecting the progress of the translation of the IDoc into an EDI document.
Envelope status	Select this check box to return status messages reflecting the progress of the enveloping of the EDI document to send to the Trading Partner.
Communication status	Select this check box to return status messages reflecting the progress of the transmission of the EDI document to the Trading Partner.
Acknowledgement status	Select this check box to return status messages indicating whether functional and interchange acknowledgements have been received from the Trading Partner.
UnSelect All	To quickly clear the check boxes in the status reporting area, click UnSelect All . The check boxes are all cleared at once.
Send Failed Status ONLY	Select this check box to return only status messages indicating the failure of any of the processes.

System Tab

Introduction

The **System** tab enables you to specify the machine where you want to run the actual translation of IDocs into EDI documents. You can also specify the database that contains the tables that store IDocs data and other information generated and used by the Extension for SAP.

System tab diagram

This is the **System** tab on the **Gentran:Server for Windows SAP Configuration** dialog box.

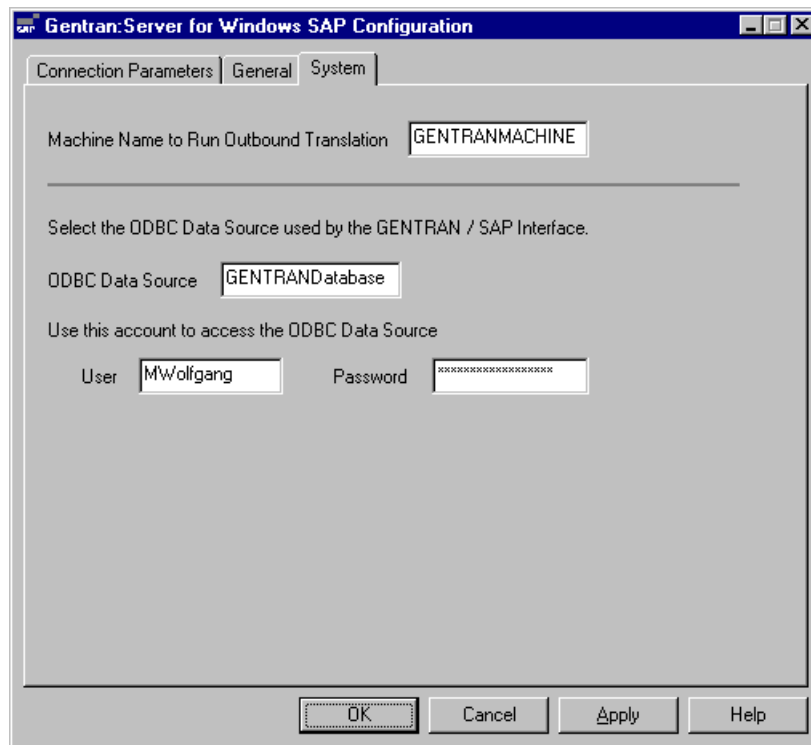

System tab parts and functions

This table describes the boxes found on the **System** tab.

For this box...	Do the following...
Machine Name to Run Outbound Translation	Type the name of the machine, in the network, that is to run the actual translation of IDocs into EDI documents. (Continued on next page)

For this box...	Do the following...
ODBC Data Source	<p>Type the name of the ODBC data source used by your Gentrans:Server system. The database corresponding to this ODBC data source should contain the Extension for SAP tables created during the installation process.</p> <p>Reference See the section “Completing the Pre-Installation Checklist” on the <i>Installation and Upgrade Instructions Card</i> for more information.</p>
User	<p>Type the user ID of the account that can access the ODBC data source.</p> <p>Reference See the section “Completing the Pre-Installation Checklist” on the <i>Installation and Upgrade Instructions Card</i> for more information.</p>
Password	<p>Type the password for the account that can access the ODBC data source.</p> <p>Reference See the section “Completing the Pre-Installation Checklist” on the <i>Installation and Upgrade Instructions Card</i> for more information.</p>

Extension Program Functions

Contents

• Overview	2 - 2
• Translate Function	2 - 3
• Update Function	2 - 4
• Extract Function	2 - 5
• StartRFC Function	2 - 7
• POSTPROC Function	2 - 9

Overview

Introduction

The Extension for SAP program **SAPINT.EXE** can be executed with four different functions that perform various steps in the process of exchanging data between your SAP system and your Gentran:Server system.

It is through **Gentran:Server Process Control sessions** that you'll execute this program with one of its functions.

Reference

See Appendix B or C (depending on whether your SAP system is running on Windows or UNIX, respectively) for sample Gentran:Server Process Control sessions that contain the SAPINT.EXE program with each of its functions. These sample sessions show you one way of establishing a seamless exchange of documents between SAP and Gentran:Server.

Troubleshooting connection problems

To troubleshoot connection problems with invoking the Extension Program Functions through the **SAPINT.EXE** program, view the **sapint.log** which is written to the **GENSRVNT\BIN\SAPINT.LOG** file.

Functions grouped by document flow

The functions can be grouped according to the direction of the flow of documents. They are as follows:

Functions for processing IDocs from SAP to Gentran:Server

- Translate
- Update
- Extract

Function for processing EDI documents from Gentran:Server to SAP

- StartRFC

The sections in this chapter describe each function in detail.

Translate Function

Description The Translate function calls the Gentran:Server command that translates the IDoc data into EDI format; it also populates the SAPStatus_tb table in the database with

- the unique IDoc number
- other important information from the IDoc
- status messages reflecting the progress of the translation process.

Syntax Use the following syntax when entering the SAPINT.EXE program with the Translate function in a Gentran:Server session:

```
SAPINT.EXE -TRANSLATE:unc_filename
```

Where

unc_filename is the name of the file to be used by the Translate function. This file contains the IDoc(s) to be imported into Gentran:Server.

Process diagram

This diagram depicts the path of IDocs from SAP through Gentran:Server to the Trading Partner. It shows the role the Translate function plays in the process of exchanging data between your SAP system and your Gentran:Server system.

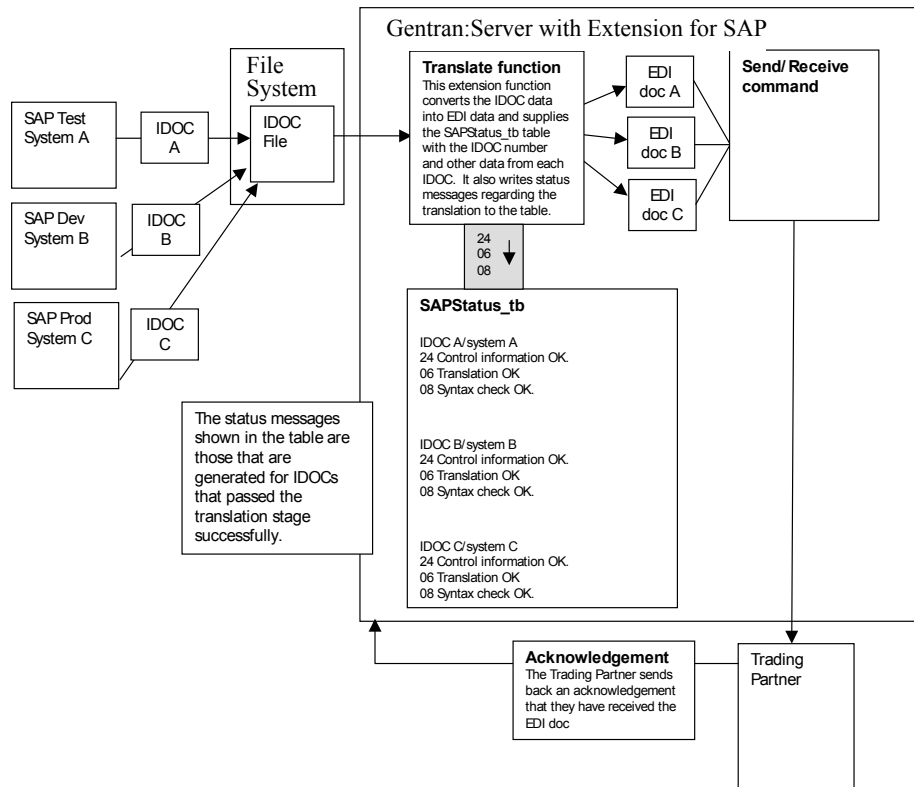

Update Function

Description The Update function tracks the progress of the IDoc through the Gentran:Server system, specifically the following stages:

- enveloping of the data
- transmission to the Trading Partner
- acknowledgement from the Trading Partner.

It populates the SAPStatus_tb table with the appropriate status messages to reflect the success or failure of each stage.

Syntax Use the following syntax when entering the SAPINT.EXE program with the Update function in a Gentran:Server session:

SAPINT.EXE -UPDATE:

Note

There are no parameters for the Update function.

Process diagram This diagram depicts the path of IDocs from SAP through Gentran:Server to the Trading Partner. It shows the role the Update function plays in the process of exchanging data between your SAP system and your Gentran:Server system.

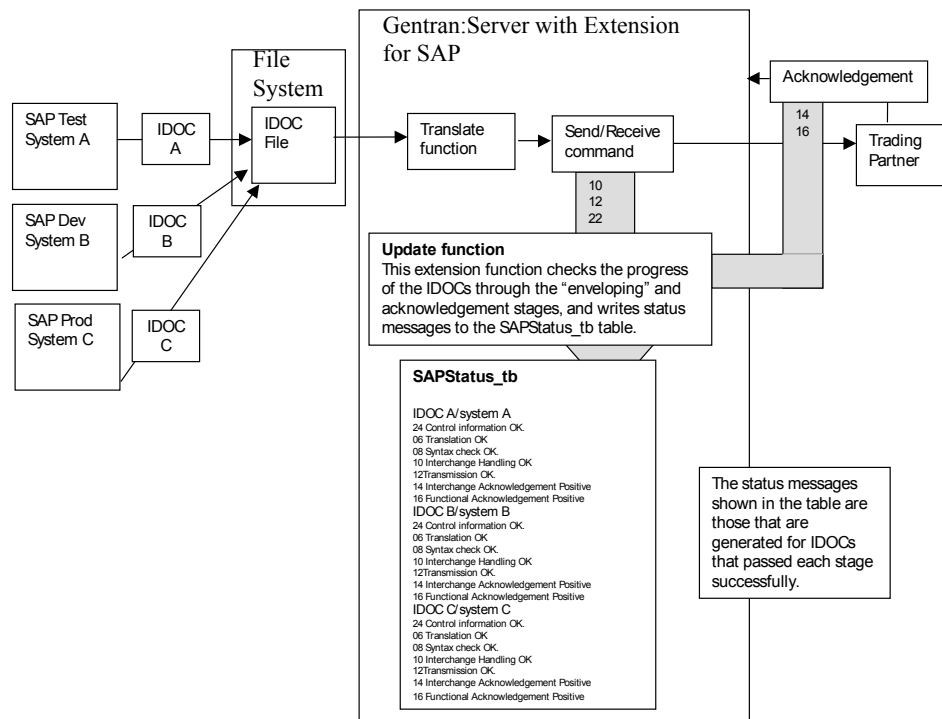

Extract Function

- Description** The Extract function creates a file and writes all the status messages (from the SAPStatus_tb table) associated with each processed IDoc that originated from a particular SAP system (for example, production, test, or development system). To send this file of status messages to the SAP system, the Extract function invokes one of the following:
- ▶ SAP STARTRFC program—if the systems are using file-based transfer
 - ▶ **aleclient** command provided with the Extension for SAP—if the systems are using ALE to transfer data

Syntax Use the following syntax when entering the SAPINT.EXE program with the Extract function in a Gentran:Server session:

SAPINT.EXE -EXTRACT:*unc_pathname -PATH:connection name*

Where

unc_pathname is the fully-qualified path you want to give to the status message file generated by the Extract function.

Note

The file name is generated by Gentran:Server for Windows. For Unix, you must supply the file name.

connection name is used to identify a unique set of RFC parameters to be used by SAP's STARTRFC program. This group of parameters indicates the exact SAP system to receive the status message file. The *connection name* value can be found on the Extension for SAP **SAP Configuration** dialog box in the **Connection Name** box.

Note

If the name on the RFC Parameters tab is longer than 8 characters, enclose the Connection Name value in quotation marks.

Reference

See the “Configuring the Extension” chapter (the “RFC Parameters Tab” section) for more information about the **Connection Name** box on the **SAP Configuration** dialog box.

Process diagram

This diagram depicts the path of a status message file to the specific SAP system. It shows the role the Extract function plays in the process of exchanging data between your SAP system and your Gentran:Server system.

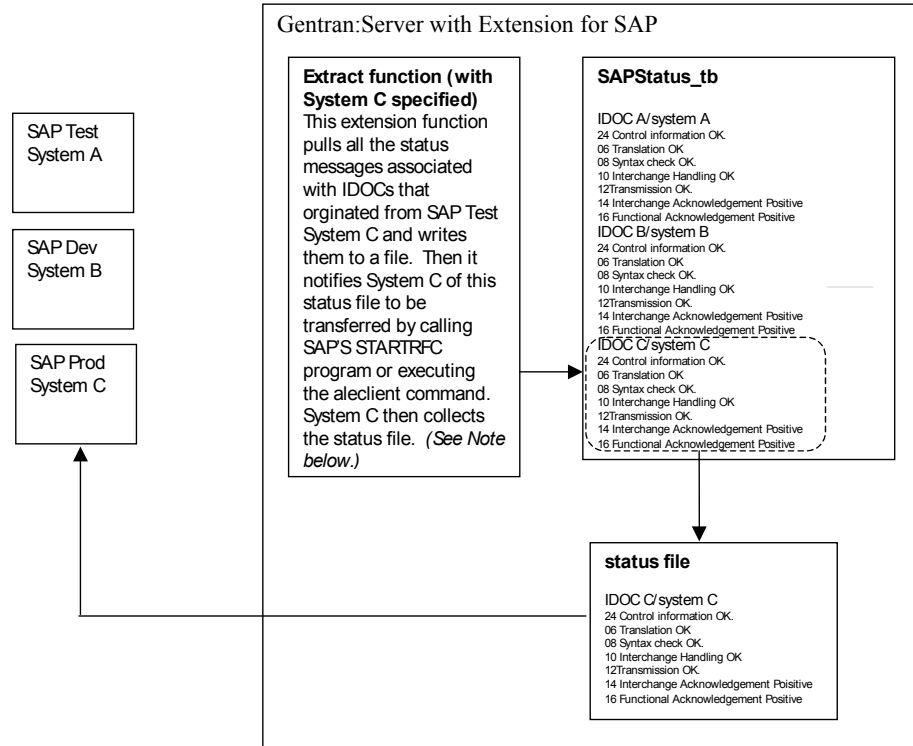
**Note**

Two more commands—one with System A specified and one with System B specified—would be needed to repeat the same process for Systems A and B (as illustrated for System C).

StartRFC Function

Description After an EDI document has been converted to an IDoc, you use the StartRFC function to call SAP's STARTRFC program, which in turn, contacts the SAP system for data transfer to take place. The IDoc is then transferred to the SAP system.

Note

Be sure to understand the distinction between the StartRFC function and SAP's STARTRFC program. The Extension for SAP provides the StartRFC function to enable you to *indirectly* invoke SAP's STARTRFC program. In this way, the Extension for SAP can automate the process of providing parameter values for SAP's STARTRFC program via the StartRFC function's *connection name* parameter or invoke the **aleclient** command provided with the Extension for SAP—if the systems are using ALE to transfer data.

Syntax Use the following syntax when entering the SAPINT.EXE program with the StartRFC function in a Gentrans:Server session:

SAPINT.EXE -STARTRFC:*unc_pathname -PATH:connection name*

Where

unc_pathname is the fully-qualified filename of the file that has been converted from an EDI document to an IDoc, and that is to be transmitted to the SAP system.

connection name is used to identify a unique set of RFC parameters to be used by SAP's STARTRFC program. This group of parameters indicates the exact SAP system to receive the IDoc. The *connection name* value can be found on the Extension for SAP **SAP Configuration** dialog box in the **Connection Name** box.

Note

If the name on the RFC Parameters tab is longer than 8 characters, enclose the Connection Name value in quotation marks.

Reference

See the "Configuring the Extension" chapter (the "RFC Parameters Tab" section) for more information about the **Connection Name** box on the **SAP Configuration** dialog box.

Process Diagram

This diagram depicts the path of an EDI document from the Trading Partner through Gentran:Server to the SAP system. It shows the role the StartRFC function plays in the process of exchanging data between your SAP system and your Gentran:Server system.

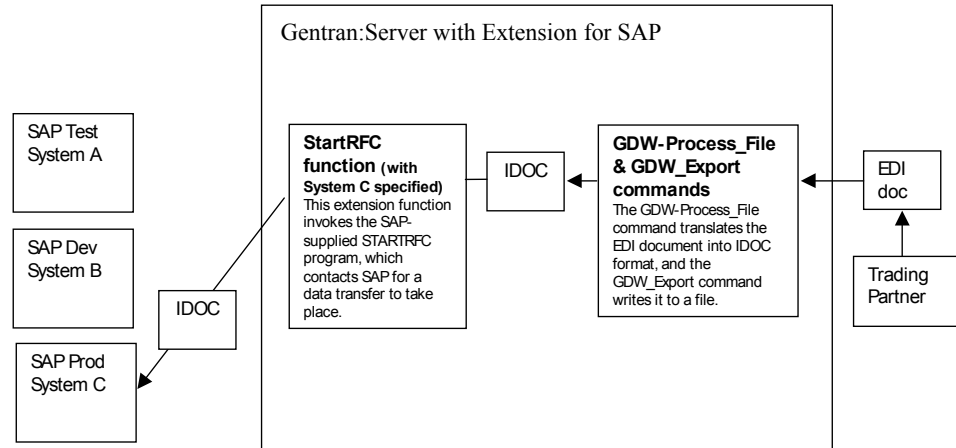

POSTPROC Function

Description The POSTPROC function of SAPINT.EXE is used to create a new IDoc with a modified header segment based on an IDoc that was exported from within Gentran:Server and before it is sent to SAP via the StartRFC function of SAPINT.EXE.

This function updates the MANDT (client), RCVPR1, SNDR1, and DOCREL fields of the header segment with information from the Connection Parameters specified in the command.

The POSTPROC function of SAPINT.EXE will not alter the original file that is referenced in the *filename_and_path_to_exported_IDoc* parameter; it creates a new file in the same directory as the original IDoc and names it **sapidoc.new**.

Syntax Use the following syntax when entering the SAPINT.EXE program with the POSTPROC function in a Gentran:Server session:

**D:\GENSRVNT\Bin\SAPINT.EXE -
POSTPROC:***filename_and_path_to_exported_IDoc* **-PATH:***Connection Name/Scan
Directory*

SAPINT.EXE -STARTRFC:*unc_pathname* **-PATH:***connection name*

Where

filename_and_path_to_exported_IDoc is the fully-qualified filename and path (either a local path or a UNC path) of the exported IDoc that will be modified and is to be transmitted to the SAP system.

Connection Name/Scan Directory is used to identify the Connection Name/Scan Directory of the Connection Parameters to be used to modify the IDoc. This group of parameters indicates the exact SAP system to receive the IDoc. The *connection name* value can be found on the Extension for SAP **SAP Configuration** dialog box in the **Connection Name** box.

Note

If the name on the RFC Parameters tab is longer than 8 characters, enclose the Connection Name value in quotation marks.

Reference

See the “Configuring the Extension” chapter (the “RFC Parameters Tab” section) for more information about the **Connection Name** box on the **SAP Configuration** dialog box.

Configuring and Testing the Sample Maps

Contents

- ▶ Overview 3 - 2
 - ▶ Sample Map Naming Conventions 3 - 3
 - ▶ Customizing Mapping Instructions 3 - 4
 - ▶ Finalizing the Map 3 - 6
-

Overview

Introduction

The Gentran:Server Application Integration subsystem enables you to translate your application files to EDI standard formats for documents you send to your partners (outbound mapping), and to translate EDI standard formats to your application format for documents that you receive from your partners (inbound mapping).

Reference

See the *Gentran:Server Application Integration User's Guide* for more information on using the Application Integration subsystem.

In this chapter

This chapter describes how to locate SAP IDoc numbers with a procedure for all outbound maps. This chapter also provides the steps required to save, compile, and test the completed map.

Sample Map Naming Conventions

Introduction

Sample maps and translation objects are provided for you with the Extension for SAP software. When you installed the Extension for SAP, the sample maps were installed in the Extensions subdirectory where Gentran:Server is installed.

The map that you modify is a *source map*, and contains the .MAP file extension. After you compile that source map, the result is a *compiled translation object*, which contains the .TPL file extension.

Sample naming convention for ANSI

This is a sample map or translation object that uses ANSI format.

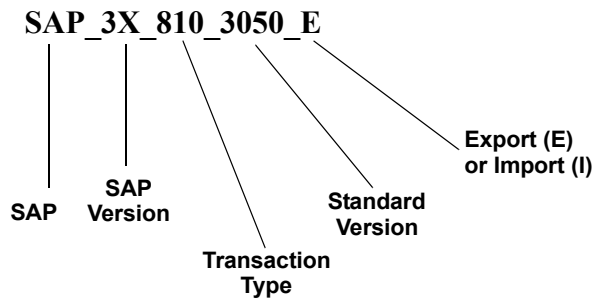

Sample naming convention for EDIFACT

This is a sample map or translation object that uses EDIFACT format.

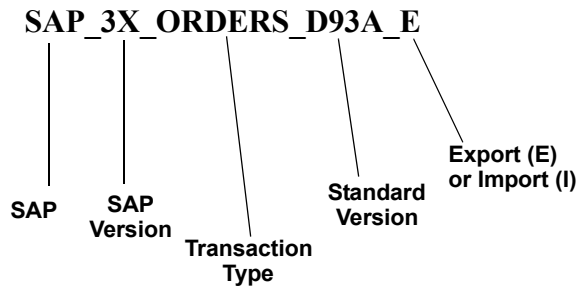

Customizing Mapping Instructions

Introduction Mapping instructions must be customized to save the SAP IDoc number in the appropriate application field in the Gentran Document Tracking database.

Requirements

- The IDoc number must be present in the Document_tb so matches can be made with the numbers stored in the array during preprocessing of outbound data.
- Save the IDoc number so the Extension for SAP can create status records (EDI_DS) containing the DOCNUM (IDoc number).

Status record use SAP uses the status records to provide a status of all outbound IDocs you create. SAP rejects status records that do not contain a DOCNUM.

IDoc number location SAP IDoc numbers are contained in the DOCNUM field of the EDI_DC or EDI_DC40 control record of each IDoc created outbound from SAP.

Requirements

- Save the IDoc number in the user-defined Application Field 3 of Document_tb.
- Use the DOCNUM field in the EDI_DC or EDI_DC40 record of the IDoc.

How to locate SAP IDoc numbers Use this procedure to instruct the Extension for SAP where to locate SAP IDoc numbers.

Step	Action
1	Start the Application Integration program.
2	Open the translation object you want to use with the Extension for SAP and select the EDI_DC control record.
3	Right-click the DOCNUM field in the EDI_DC or EDI_DC40 record and select Properties . System response The system displays the Field Properties dialog box. (Continued on next page)

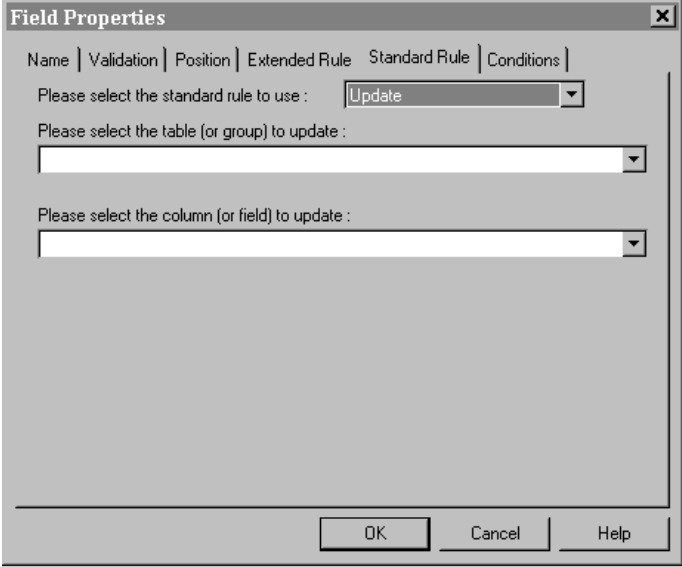
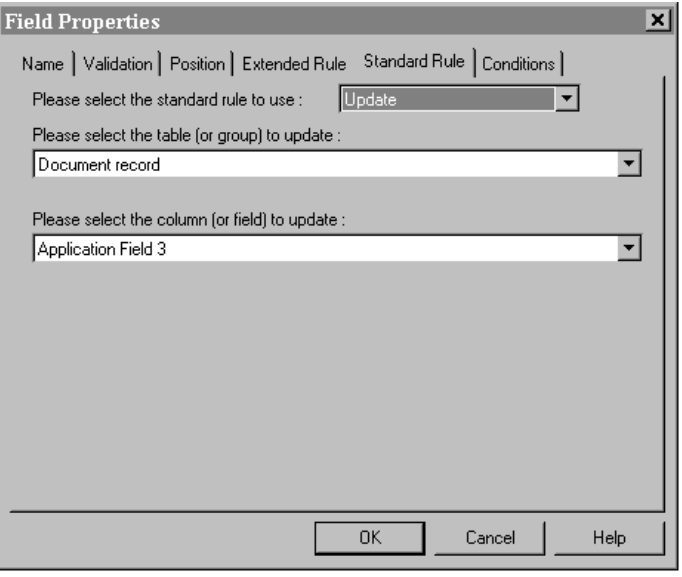
(Contd) Step	Action
4	<p>Select the Standard Rule tab and then select the Update option.</p> 
5	<p>Select Document record from the table (or group) to update list.</p>
6	<p>Select Application Field 3 from the column (or field) to update list, and click OK .</p>  <p>Restriction Do not map anything to Application Fields 4 and 5. They are reserved for use by the SAPINT program.</p>

Finalizing the Map

Introduction

After you customize your map and define your IDoc number, you need to finalize the map. To complete the mapping process, you need to compile the map, register the translation object, and test the translation object.

When you save and recompile the Extension for SAP maps provided in the SAPMaps subdirectory, you will overlay the original maps and compiled translation objects with the newly-customized ones. You may choose to store your customized maps and compiled translation objects or to simply replace the original files.

How to compile the map

The Compile function compiles the map and generates a translation object. After you save the translation object, you must register it with Gentran:Server before using it.

Use this procedure to compile a map and generate a translation object.

Step	Action
1	Start the Application Integration program.
2	Select Save from the File menu to save the source map, prior to using the Compile function.
3	<p>Select Compile from the File menu to display the Run-Time Translation Object Name dialog box.</p> <p>Note The File name field already contains the translation object name with the .TPL file extension. Preserving the same file name (with different file extensions) means that the relationship between the source map and the compiled translation object remains evident.</p> <p>CAUTION DO NOT OVERLAY THE SOURCE MAP WITH THE COMPILED TRANSLATION OBJECT. USE THE .TPL FILE EXTENSION TO DISTINGUISH THE TRANSLATION OBJECT FROM THE SOURCE MAP.</p>
4	<p>Change the Drive and Folder where the compiled translation object is stored, if necessary.</p> <p>CAUTION DO NOT STORE THE COMPILED TRANSLATION OBJECT IN THE GENSRVNT\REGTRANSOBJ SUBDIRECTORY. THIS SUBDIRECTORY IS RESERVED FOR STORING A COPY OF EACH TRANSLATION OBJECT YOU REGISTER WITH GENTRAN:SERVER.</p> <p style="text-align: right;">(Continued on next page)</p>

(Contd) Step	Action
5	Click Save and the system compiles the map and generates a translation object. System Response The Compile Error dialog is displayed.
6	Verify that no errors occurred and click OK to exit the dialog box. System Response The date on which the translation object was compiled is automatically loaded into the Compiled on field on the Translation Object Details dialog box.
7	Select Save from the File menu to save the source map with the compiled on date. Note You must register this translation object with the Gentran:Server system before you can use it. Reference See the <i>Gentran:Server User's Guide</i> for information on registering a translation object.

How to test the system import and import translation objects

Use this procedure to test the system import and import translation objects, which are provided with the system. These translation objects must be functioning before you can test your translation object from the previous procedure.

Step	Action
1	Register the translation objects with Gentran:Server. Reference See the <i>Gentran:Server User's Guide</i> for more information on registering a translation object.
2	If you have not already done so, import the SAP partner relationship (.PAR file) into Gentran:Server. Reference See the <i>Gentran:Server User's Guide</i> for more information on importing a partner. (Continued on next page)



(Contd) Step	Action
3	<p>Verify (in Partner Editor) that the import translation object is selected for the outbound relationship.</p> <p>Reference See the <i>Gentran:Server User's Guide</i> for more information on selecting outbound translation objects.</p>
4	<p>Ask your system administrator to add the system import translation object to the System Configuration program.</p> <p>Reference See the <i>Gentran:Server Administration Guide</i> for more information about how your system administrator must modify the system configuration program.</p>
5	<p>Use the Import option in Gentran:Server to process the data file (.TXT file) through the translation object.</p> <p>Reference See the <i>Gentran:Server User's Guide</i> for more information on importing files.</p>
6	<p>After the document is translated, it is located in the Workspace in Gentran:Server. View the EDI data to ensure that the document was translated correctly.</p> <p>Reference See the <i>Gentran:Server User's Guide</i> for more information on viewing raw EDI data.</p>

Note

See Appendix B and Appendix C of this guide for further system testing recommendations.

How to test the translation object

After compiling the map and registering the translation object with Gentran:Server, you should test the translation object. For this test, you may use test data from your Extensions directory. The data files referred to in the following steps (SAPMAPS40) are located in the SAPMaps subdirectory where Gentran:Server is installed.

(Continued on next page)

How to test the translation object (contd)

Use this procedure to test the inbound (export) translation object you just created.

Step	Action
1	<p>Register the translation object with Gentran:Server.</p> <p>Reference See the <i>Gentran:Server User's Guide</i> for more information on registering a translation object.</p>
2	<p>If you have not already done so, import the SAP partner relationship (.PAR file) into Gentran:Server.</p> <p>Reference See the <i>Gentran:Server User's Guide</i> for more information on importing a partner.</p>
3	<p>Verify (in Partner Editor) that the export translation object is selected for the inbound relationship.</p> <p>Reference See the <i>Gentran:Server User's Guide</i> for more information on selecting inbound translation objects.</p>
4	<p>Use the Process File option in Gentran:Server to process the data file (EDI file) through the translation object. The data file is located in the SAPMAPS40 subdirectory under the directory where Gentran:Server is installed.</p>
5	<p>After the document is translated, it is located in the In Documents in Gentran:Server. Export the document to ensure that it was translated correctly.</p> <p>Reference See the <i>Gentran:Server User's Guide</i> for more information on exporting files.</p>

Using ALE to Transfer Documents

Contents	▶ Overview	4 - 2
	▶ Processing in ALE Mode	4 - 3

Overview

Introduction

This chapter is for those running SAP on Windows and UNIX and using ALE to transfer documents from SAP to Gentran:Server and vice versa.

Processing in ALE Mode

Introduction

Application Linking and Enabling (ALE)-based IDoc transfer enables SAP to transfer IDocs to the Extension for SAP program **aleserver** through your Application Program Interface (API).

Note

ALE is an alternative to remote copy (rcp) and NFS/FTP with STARTRFC.

Before you begin

You must set up the following information before you begin processing in ALE mode:

- SAP Port Definition—set in SAP Port Setup
- RFC Destination—set in the SAP Partner Profile
- Method used (Transactional RFC)—set in the Partner Profile; designated by **T** on Screen SM59.
- Designate where the Transaction ID tables are placed during processing. Follow the procedure the next page to set this environment variable.

Reference

See your SAP documentation for details about setting up the Port Definition, RFC Destination, and Transactional RFC information.

Transaction ID table environment variable

Before you begin processing in ALE mode you must specify the location where the Transaction ID tables are placed during processing. Use this procedure to set the Transaction ID environment variable.

Step	Action
1	From the Windows Control Panel, select the System icon. System Response The System Properties dialog box is displayed.
2	Select the Environment Property tab.
3	Add the environment variable TRFC_WORK_DIR and enter the path name where this directory is located. Note This step assumes that the directory has already been created.

ALE outbound processing diagram

This diagram illustrates the outbound processing in an ALE-based environment.

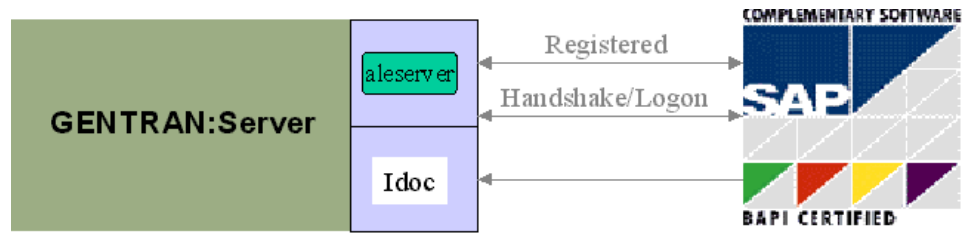

Processing in ALE from Register mode

Use this procedure to perform processing in an ALE environment using Register mode.

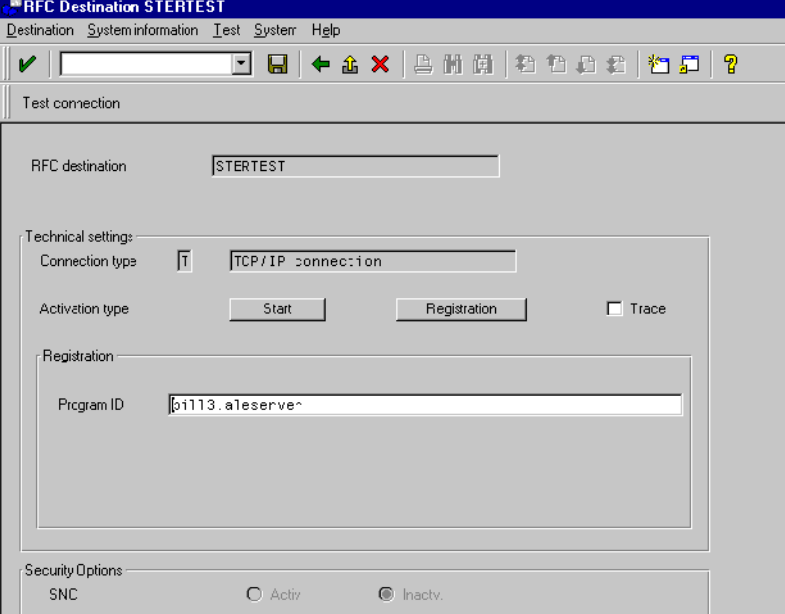
Step	Action
1	<p>Start Screen SM59* from your SAP system.</p>  <p>Note This is also called the SAP RFC Destination screen.</p> <p style="text-align: right; color: green;">(Continued on next page)</p>

(Contd) Step	Action										
2	<p>Set up Gateway options for:</p> <ul style="list-style-type: none"> ▶ Host ▶ Service. <p>Note A destination in transaction SM59 can be defined as follows:</p> <table border="0"> <tr> <td>Connection type:</td> <td>T</td> </tr> <tr> <td>Activate type:</td> <td>Registering</td> </tr> <tr> <td>Program-ID:</td> <td>hssfds05.aleserver</td> </tr> <tr> <td>Gateway host:</td> <td>hssfds05</td> </tr> <tr> <td>Gateway service:</td> <td>sapgw00</td> </tr> </table>	Connection type:	T	Activate type:	Registering	Program-ID:	hssfds05.aleserver	Gateway host:	hssfds05	Gateway service:	sapgw00
Connection type:	T										
Activate type:	Registering										
Program-ID:	hssfds05.aleserver										
Gateway host:	hssfds05										
Gateway service:	sapgw00										
3	<p>Enter the program ID as on the Windows Run command line.</p> <p>The program_ID parameter syntax is <i><machine_name>.aleserver</i> where the <i>machine_name</i> is the name of the machine on which Gentran:Server is installed. This parameter is case-sensitive.</p> <p>Command Format aleserver -a <program_ID> -g <SAP_gateway> -x <SAP_gateway_service> file=<file_name></p> <p>where <i>file_name</i> is the output filename (usually a file in a folder on the Gentran:Server system).</p> <p>Command Example aleserver -ahssfds05.aleserver -ghssfds05 -xsapgw00 file=\\GENSRVNT\from_sap\sapout.idoc</p>										
4	<p>Select the Registration button from Screen SM59 to begin processing on the machine where Gentran:Server Extension for SAP resides.</p> <p>System Response You see the IP name (Program ID): hssfds05.aleserver</p> <p style="text-align: right; color: green;">(Continued on next page)</p>										

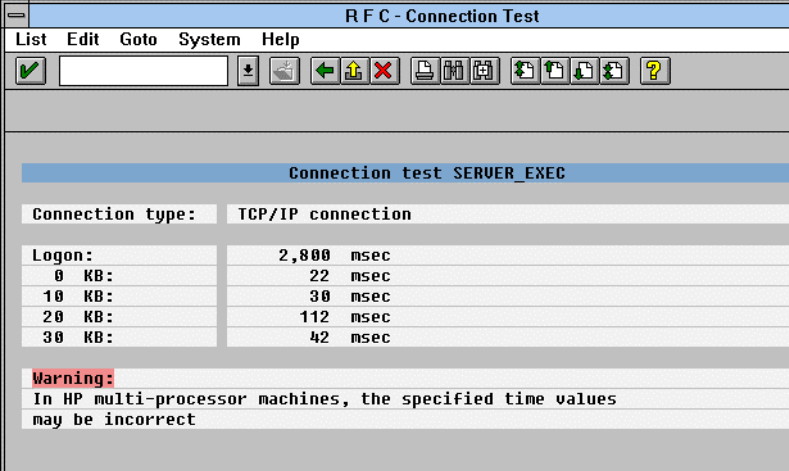
(Contd) Step	Action
5	<p>Select Test* connection.</p>  <p>System Response You see a screen with connection information. If unsuccessful, you receive an <i>unable to connect</i> error message.</p>

*Copyright 1997 by SAP AG. All Rights Reserved.

ALE status messaging for 3.1G and above

ALE handles status messages differently from the standard IDoc interface. Instead of an EDI_DS status record (or EDI_DS40 for version 4.0), ALE uses IDoc type SYSTAT01. This IDoc type consists of control and data records, with the segment as the status record. To enable status messaging, you must set up your system to use ALE processing.

See your SAP documentation for instructions on using this IDoc type. You will need a partner profile to process code STA1. The port type is FILE.

aleserver command format

This is the syntax for the **aleserver** command.

```
aleserver -a <program_ID> -g <SAP_gateway> -x <SAP_gateway_service>
file=<file_name>
```

aleserver parameters This table describes the parameters defined for the aleserver command. The aleserver command uses STARTRFC parameters to make the connection to the SAP system and to receive IDocs from SAP.

Utility Parameter	Flag	Parameter (example)	Description	Your Value
program ID	-a	gentranhost.aleserver	Identifies the program ID to SAP.	
sap_gateway	-g	hwll39	Identifies the gateway server. Steps to Locate 1. Use SE38. 2. Enter the report name rsparam . 3. Choose <i>Execute</i> . 4. Choose <i>System</i> → <i>List</i> → <i>Find String</i> . 5. Enter <i>rdisp/sna_g</i> . 6. Position the cursor by double-clicking the first line. 7. Find the gateway server in the line <i>rdisp/sna_gateway</i> . Scroll right.	
sap_gateway_service	-x	sapgw95	Identifies gateway service as in /etc./services1. Steps to Locate 1. Use SE38. 2. Enter the report name rsparam . 3. Choose <i>Execute</i> . 4. Choose <i>System</i> → <i>List</i> → <i>Find String</i> . 5. Enter <i>rdisp/sna_g</i> . 6. Position the cursor by double-clicking the first line. 7. Find the gateway server in the line <i>rdisp_gw_service</i> . Scroll right.	
trace (optional)	-t	N/A	Creates a <i>dev_rfc</i> file that contains RFC errors.	
file			A fully qualified UNC output filename.	

aleclient command The **aleclient** command is used to process inbound information.

Note

Inbound means data is sent to SAP from Gentran.

aleclient diagram This diagram illustrates inbound processing using the **aleclient** program.

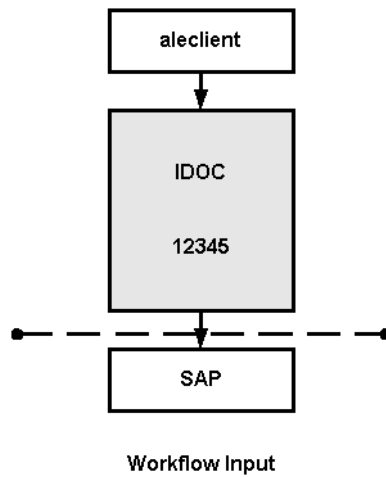

aleclient parameters

This table describes the parameters defined for the aleclient command. The aleclient programs use STARTRFC parameters to make the connection to the SAP system and to send IDocs to SAP.

Utility Parameter	Flag	Parameter (example)	Description	Your Value
client	-c	040	Identifies the SAP system client contained in the MANDT field of the EDI_DC or EDI_DC40 control record. Default 000	
host	-h	hw1138	Identifies the application server; the first part of the field separated by underscores represents the application server. Recommendation Use SM51.	
userid	-u	random-j	Identifies the SAP system user ID.	

(Continued on next page)

(Contd) Utility Parameter	Flag	Parameter (example)	Description	Your Value
userpw	-p	sapuser	Identifies the user ID password.	
sap_gateway	-g	hwll39	Identifies the gateway server. Steps to Locate 1. Use SE38. 2. Enter the report name rsparam . 3. Choose <i>Execute</i> . 4. Choose <i>System</i> → <i>List</i> → <i>Find String</i> . 5. Enter <i>rdisp/sna_g</i> . 6. Position the cursor by double-clicking the first line. 7. Find the gateway server in the line <i>rdisp/sna_gateway</i> . Scroll right.	
trace (optional)	-t	N/A	Creates a <i>dev_rfc</i> file that contains RFC errors.	
sap_gateway_ service	-x	sapgw95	Identifies gateway service as in <i>/etc./services1</i> . Steps to Locate 1. Use SE38. 2. Enter the report name rsparam . 3. Choose <i>Execute</i> . 4. Choose <i>System</i> → <i>List</i> → <i>Find String</i> . 5. Enter <i>rdisp/sna_g</i> . 6. Position the cursor by double-clicking the first line. 7. Find the gateway server in the line <i>rdisp_gw_service</i> . Scroll right.	

Shared RFC library

A shared RFC library (DLL)—*librfc32.dll*—is provided with the SAP Graphical User Interface and is used only with the STARTRFC program.

Supported SAP Status Codes

Contents	• Overview	A - 2
	• Status Codes	A - 3

Overview

Introduction

This chapter describes the SAP status codes used by the Extension for SAP during outbound processing of IDocs created by SAP.

Status Codes

Status code table

This table describes the SAP status codes used by the Extension for SAP during outbound processing of IDocs. The Extension for SAP creates one or more of the statuses listed below for each IDoc.

SAP Status/Description	Description Returned to SAP
04 Error within control information	Trading partner not found
24 Control information OK	Trading partner found and translator started
05 Translation Error	No EDI data created. Missing or inaccessible tpcode or map.
06 Translation OK	Translation OK. EDI data created.
07 Syntax Error	Error message from translator if available. Syntax errors. No EDI data created (default text).
08 Syntax check OK	Compliance check OK
10 Interchange Handling OK	Interchange Handling OK
12 Transmission OK Acknowledgement Due	Transmission OK.
22 Transmission OK Acknowledgement Due	Transmission OK — Acknowledgement Due.
14 Interchange Acknowledgement Positive	Interchange Acknowledgement OK.
15 Interchange Acknowledgement Negative	<ul style="list-style-type: none"> ▶ Interchange Acknowledgement with Errors. ▶ Interchange Acknowledgement Partial. ▶ Interchange Acknowledgement Rejected.

(Continued on next page)

(Contd) SAP Status/Description	Description Returned to SAP
16 Functional Acknowledgement Positive	Functional Acknowledgement OK.
17 Functional Acknowledgement Negative	<ul style="list-style-type: none">▶ Functional Acknowledgement with Errors.▶ Functional Acknowledgement Partial.▶ Functional Acknowledgement Rejected.

Setup Recommendations for SAP System on Windows

Contents

- ▶ Overview B - 2
 - ▶ Sample Inbound Processing Setup B - 3
 - ▶ Sample Outbound Processing Setup B - 5
 - ▶ Sample Update Processing Setup B - 6
 - ▶ Sample Extract Processing Setup B - 7
 - ▶ Describing Gentrans:Server Process Control B - 8
-

Overview

Introduction

This appendix contains setup examples and explains processing in inbound, outbound, and update/extract modes for users using the Extension for SAP on Windows.

Reference

See Appendix C, “Setup Recommendations for SAP System on a Unix Host,” if you are using SAP on a UNIX host.

Sample sessions

The sample sessions installed with the Extension for SAP and described in this appendix need to be copied to the unattended folder before they can be seen in the **Process Control** dialog box.

Reference

See “Using Process Control” in the *Gentran:Server User’s Guide* for more information on using Process Control.

Sample Inbound Processing Setup

Starting an inbound session

From the **Gentran:Server Process Control** dialog box, select the **Sessions** tab and then **SAP Inbound** to setup an inbound session.

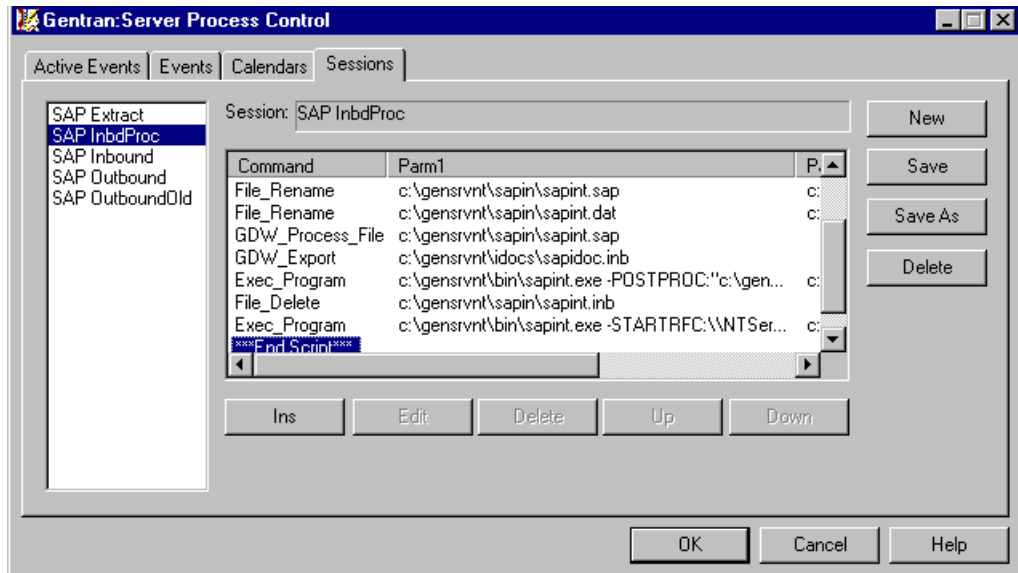

Inbound process table

This table describes the Extension for SAP inbound processing.

Stage	Description
1	Deletes the backup file from the processing of the previous inbound event (file extension .BAK).
2	Creates the new backup file by renaming the last file processed from .SAP to .BAK.
3	Renames the incoming file from .DAT to .SAP. Note This renaming must occur because processing is set up so that it is triggered by the .DAT extension; the name change keeps the extension from processing the same file twice.
4	Places the incoming file in the IN Box to be picked up for translation by using the GDW_Process_File command.
5	Performs the export function; it picks up the file in the IN Box and translates it into an IDoc file (.INB file extension) by using the GDW_Export command.

(Continued on next page)

(Contd) Stage	Description
6	<p>(Optional) Performs the Postprocessing function, updating the inbound IDoc with the MANDT, and SNDPOR fields, if you choose not to map these fields. These fields are needed for multi-port processing.</p> <p>Note This step is required for multi-port processing, but is otherwise optional.</p>
7	<p>(Optional) Executes the sapsplit.exe program. This program splits an inbound IDoc (post-translation) for proper routing in a multiple SAP instance environment. You can choose to route based on the following SAP EDI_DC fields and combinations:</p> <ul style="list-style-type: none"> ▶ sndprn ▶ rcvprn ▶ sndprt ▶ scvprt ▶ sndpor ▶ rcvpor ▶ doctyp ▶ mandt ▶ rcvprt, rcvprn ▶ sndprt, sndprt ▶ mandt, sndpor ▶ mandt, rcvpor
8	<p>Invokes the extension (SAPINT.EXE) to perform STARTRFC and sends the IDoc file to SAP. STARTRFC deletes the .INB file.</p> <p>Reference See Appendix C of the <i>Gentran:Server for Windows Administration Guide</i> for more information about process control session setup.</p>

Sample Outbound Processing Setup

Starting an outbound session

From the **Gentran:Server Process Control** dialog box, select the **Session** tab and then **SAP Outbound** to setup an outbound session.

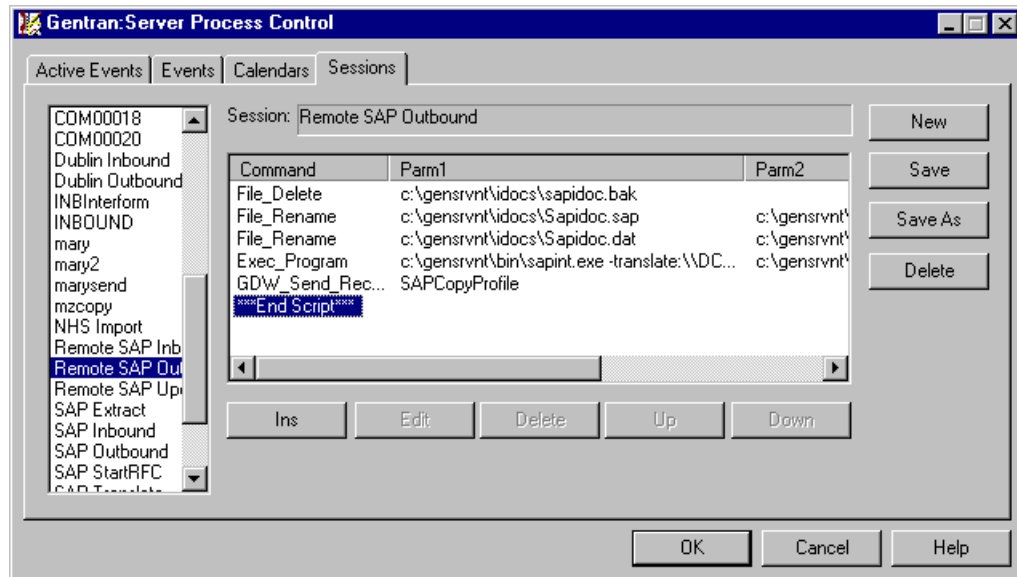

Outbound process table

This table describes the Extension for SAP outbound processing.

Stage	Description
1	Deletes the backup file from the processing of the previous outbound event (file extension .BAK).
2	Creates the new backup file by renaming the last file processed from .SAP to .BAK.
3	Renames the outgoing file from .DAT to .SAP. Note This renaming must occur because processing is set up so that it is triggered by the .SAP extension; the name change keeps the extension from processing the same file twice.
4	Invokes the extension (SAPINT.EXE) to translate the outbound IDoc file (.SAP file extension) to EDI.
5	Packages and transmits outbound EDI interchanges by using the GDW_Send_Receive command.

Sample Update Processing Setup

Introduction In Update mode, the Extension for SAP adds new status information and sends it to SAP.

How processing is set up Update processing is set up to occur on the hour every hour from 7 a.m. to 5 p.m., Monday through Friday.

Starting an update/extract session From the **Gentran:Server Process Control** dialog box, select the **Sessions** tab and then **SAP Update** to set up an update session.

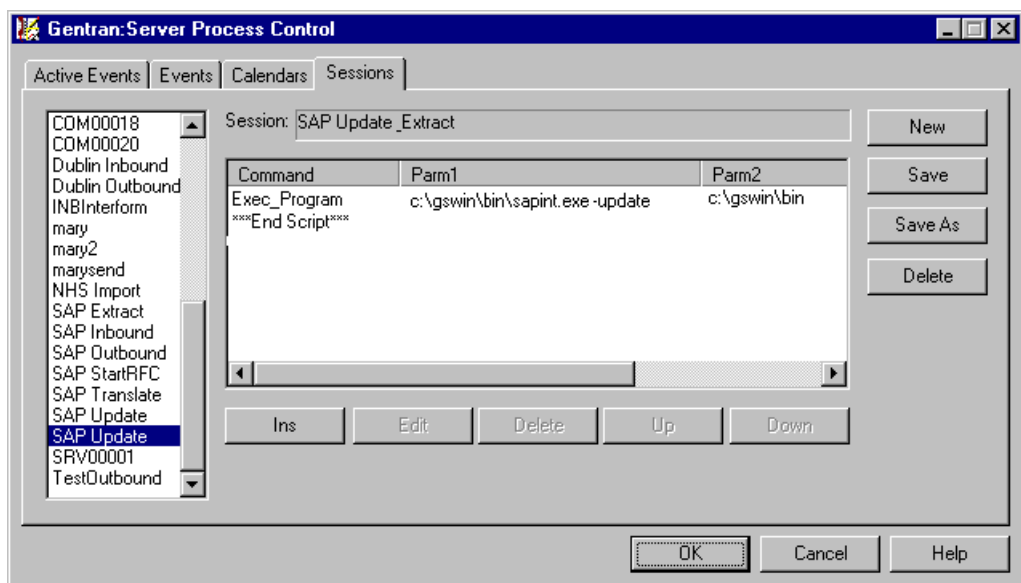

Update process table This table describes the Extension for SAP update processing.

Stage	Description
1	Invokes SAPINT.EXE to update the SAP Status database table by using the Exec_Program command.
2	Invokes SAPINT.EXE to extract all statuses in the database table and sends them to SAP by using the Exec_Program command.

Sample Extract Processing Setup

Introduction In Extract mode, the Extension for SAP adds new status information and sends it to SAP.

How processing is set up Extract processing is set up to occur on the hour every hour from 7 a.m. to 5 p.m., Monday through Friday.

Starting an extract session From the **Gentran:Server Process Control** dialog box, select the **Sessions** tab and then **SAP Extract** to set up an extract session.

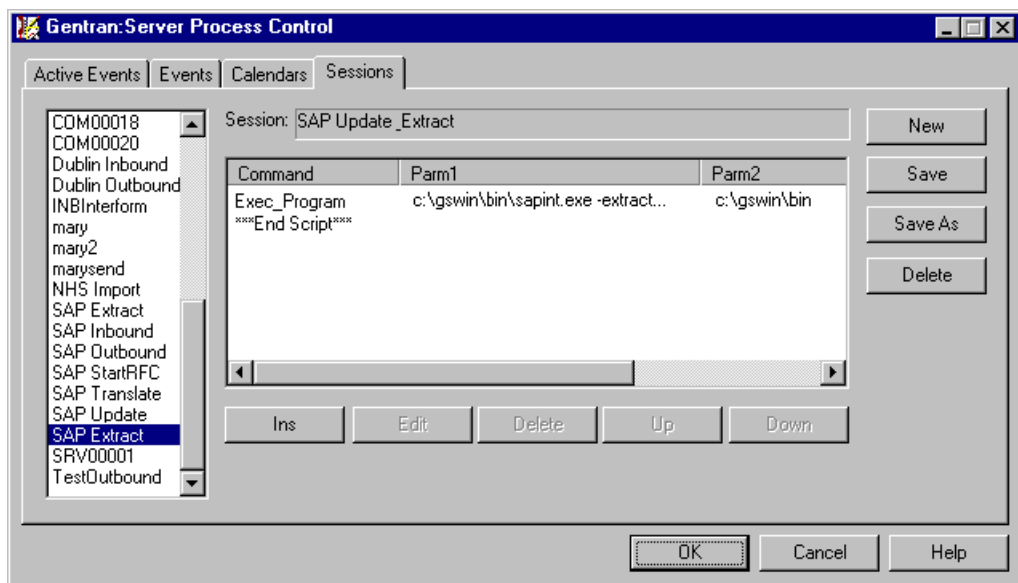

Extract process table This table describes the Extension for SAP extract processing.

Stage	Description
1	Invokes SAPINT.EXE to update the SAP Status database table by using the Exec_Program command.
2	Invokes SAPINT.EXE to extract all statuses in the database table and sends them to SAP by using the Exec_Program command.

Describing Gentran:Server Process Control

Introduction Select the **Events** tab on the **Gentran:Server Process Control** dialog box to see a list of events.

The Description list contains these event types:

- ▶ Inbound
- ▶ Outbound
- ▶ Update
- ▶ Extract.

Reference

See “Appendix C” of the *Gentran:Server for Windows Administration Guide* for more information about events.

Note

You must set up these events if you want to use them.

How processing is set up

Inbound and outbound processing is set up to occur any time a file is present for processing.

Update/extract processing is set up to occur on the hour every hour from 7 a.m. to 5 p.m., Monday through Friday.

Events tab sample

This illustration shows a sample **Events** tab on the **Gentran:Server Process Control** dialog box.

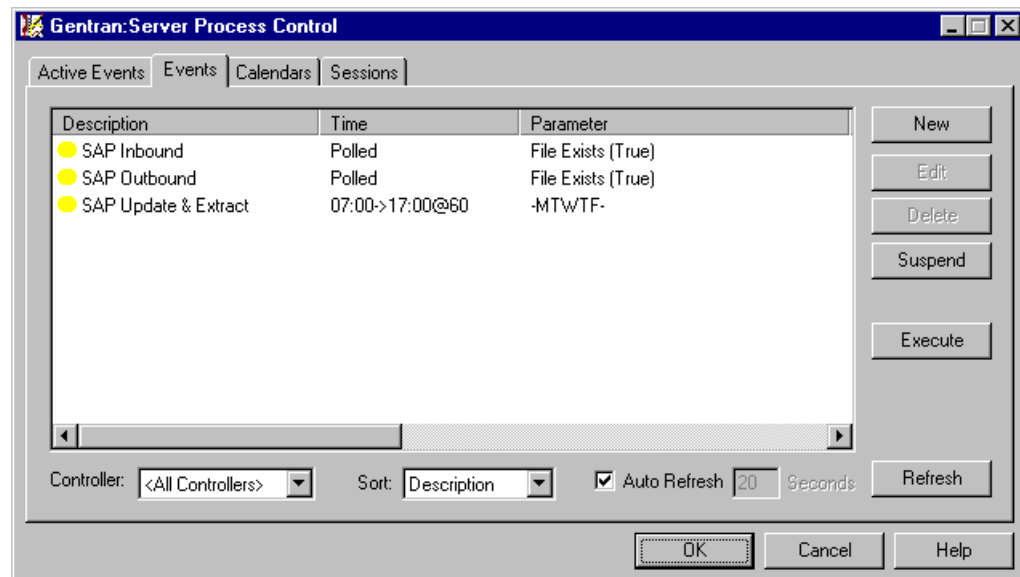

Setup

Recommendations for SAP System on a UNIX Host

Contents

- ▶ Overview C - 2
 - ▶ Sample Inbound Processing Setup C - 3
 - ▶ Sample Outbound Processing Setup C - 5
 - ▶ Sample Update Processing Setup C - 6
 - ▶ Sample Extract Processing Setup C - 8
 - ▶ Gentrans:Server Process Control C - 11
-

Overview

Introduction

This appendix contains setup examples and explains processing in inbound, outbound, and update/extract modes for users using the Extension for SAP on a UNIX host.

Reference

See Appendix B, “Setup Recommendations for SAP System for Windows” if you are using SAP on Windows.

Sample sessions

The sample sessions installed with the Extension for SAP and described in this appendix need to be copied to the unattended folder before they can be seen in the **Process Control** dialog box.

Reference

See “Using Process Control” in the *Gentran:Server User’s Guide* for more information on using Process Control.

Sample Inbound Processing Setup

Starting an inbound session

From the **Gentran:Server Process Control** dialog box, select the **Sessions** tab and then **SAP Inbound** to setup an inbound session.

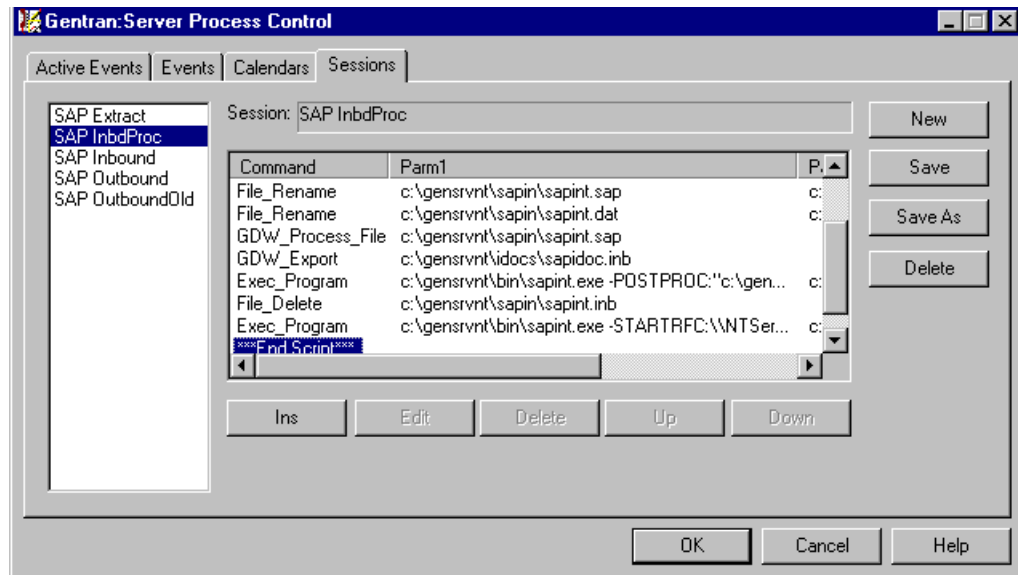

Inbound process table

This table describes the Extension for SAP inbound processing.

Stage	Description
1	Deletes the backup file from the processing of the previous inbound event (file extension .BAK).
2	Creates the new backup file by renaming the last file processed from .SAP to .BAK.
3	Places the incoming file in the IN box to be picked up for translation by using the GDW_Process_File command.
4	Performs the export function; it picks up the file in the IN box and translates it into an IDoc file (.INB file extension) by using the GDW_Export command.

(Continued on next page)

(Contd) Stage	Description
5	<p>(Optional) Executes the sapsplit.exe program. This program splits an inbound IDoc (post-translation) for proper routing in a multiple SAP instance environment. You can choose to route based on the following SAP EDI_DC fields and combinations:</p> <ul style="list-style-type: none"> ▶ sndprn ▶ rcvprn ▶ sndprt ▶ scvprt ▶ sndpor ▶ rcvpor ▶ doctyp ▶ mandt ▶ rcvprt, rcvprn ▶ sndprt, sndprt ▶ mandt, sndpor ▶ mandt, rcvpor
6	<p>FTP sends the .INB file to the SAP remote host.</p> <p>Example Script File</p> <pre>open <unix machine> user <User ID> <Password> cd /SAP/IDocS send C:\GENSRVNT\IDocS\SAPIDoc.INB close quit</pre>
7	<p>Invokes the Extension for SAP (SAPINT.EXE) to perform STARTRFC and sends the IDoc file to SAP. STARTRFC deletes the .INB file.</p> <p>Reference See Appendix C of the <i>Gentran: Server for Windows Administration Guide</i> for more information about process control session setup.</p>

Sample Outbound Processing Setup

Starting an outbound session

From the **Gentran:Server Process Control** dialog box, select the **Sessions** tab and then **SAP Outbound** to setup an outbound session.

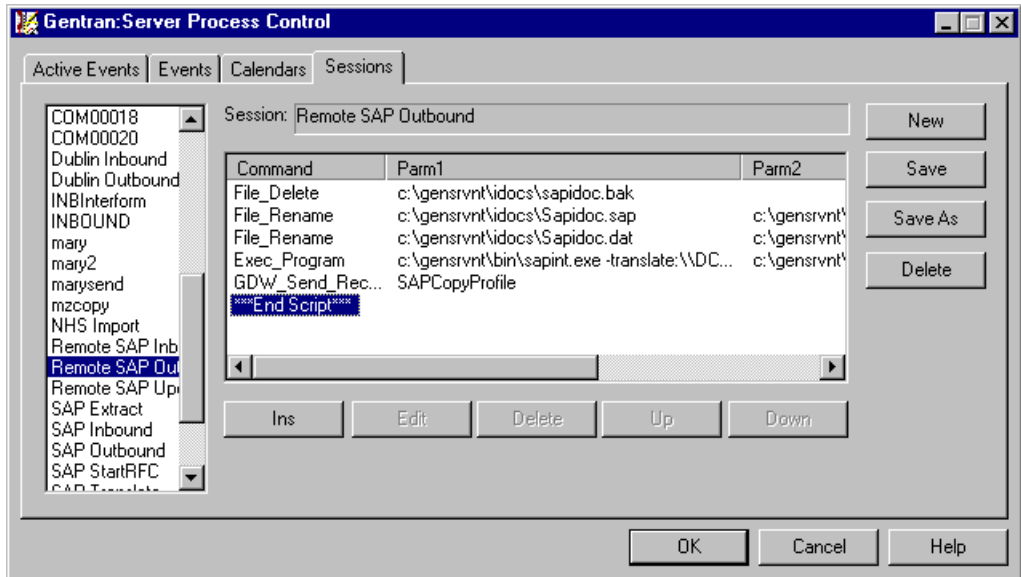

Outbound process table

This table describes the system's outbound processing.

Stage	Description
1	Deletes the backup file from processing of the previous outbound event (.BAK file extension).
2	Creates the new backup file by renaming the last file processed from .SAP to .BAK.
3	Renames the outgoing file from .DAT to .SAP. Note This renaming must occur because processing is set up so that it is triggered by the .SAP extension; the name change keeps the Extension for SAP from processing the same file twice.
4	Invokes the Extension for SAP (SAPINT.EXE) to translate the outbound IDoc file (.SAP file extension) to EDI.
5	Packages and transmits outbound EDI interchanges by using the GDW_Send_Receive command.

Sample Update Processing Setup

Introduction In Update mode, the Extension for SAP adds new status information and sends it to SAP.

How processing is set up Update processing is set up to occur on the hour every hour from 7 a.m. to 5 p.m., Monday through Friday.

Starting an update session From the **Gentran:Server Process Control** dialog box, select the **Sessions** tab and then **Remote SAP Update** to set up an update session.

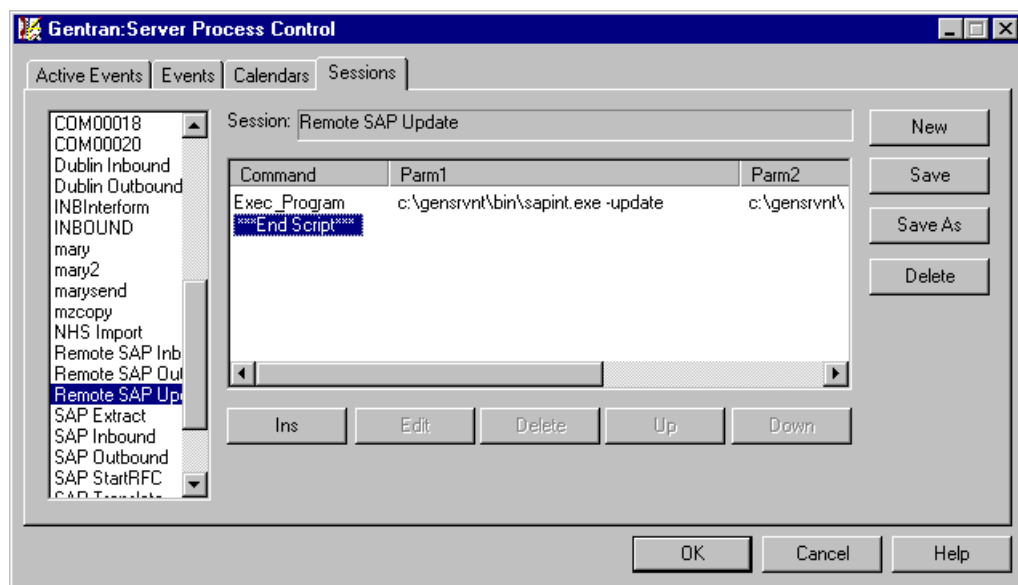

**Update process
table**

This table describes the Extension for SAP update processing.

Stage	Description
1	Invokes SAPINT.EXE to update the SAP Status database table by using the Exec_Program command.
2	<p>Example FTP script</p> <pre>open <unix_machine> user <user_ID> <password> cd /SAP/STATUS send C:\GENSRVNT\SAPSTAT\SAPSTAT.DAT close quit</pre> <p>Note The second Remote Command field contains the remote path and filename to be used in the STARTRFC command.</p> <p>Caution Remote Host configuration is not required when using ALE. You would configure a Remote Host only when using STARTRFC.</p>
3	Deletes the status flat file when processing is complete.

Sample Extract Processing Setup

Introduction In Extract mode, the Extension for SAP adds new status information and sends it to SAP.

How processing is set up Extract processing is set up to occur on the hour every hour from 7 a.m. to 5 p.m., Monday through Friday.

Starting an extract session From the **Gentran:Server Process Control** dialog box, select the **Sessions** tab and then **Remote SAP Update & Extract** to set up an extract session.

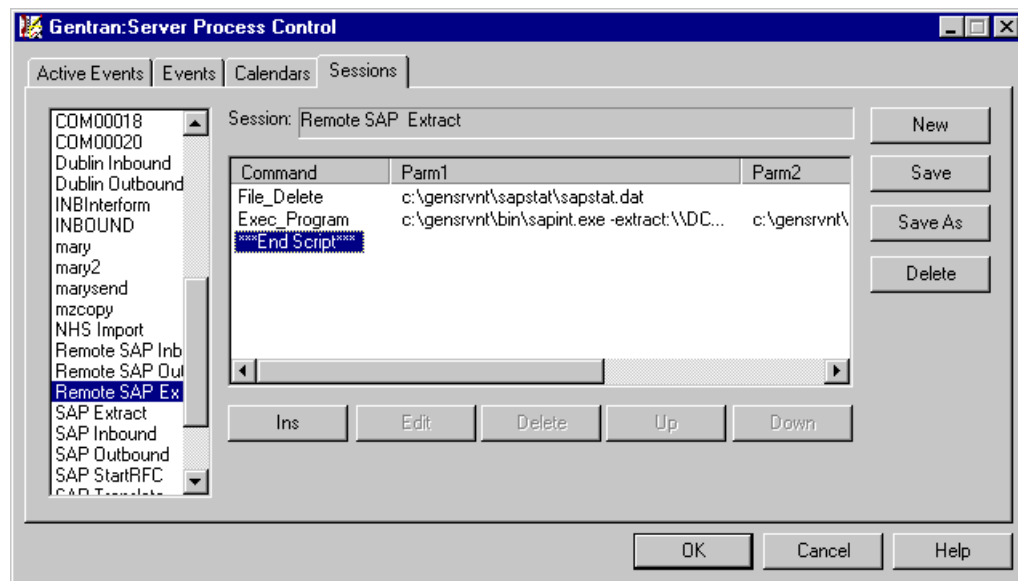

Extract process table

This table describes the Extension for SAP extract processing.

Stage	Description
1	Deletes the previous status file.
2	<p>Invokes SAPINT.EXE to extract all statuses in the database table and sends them to SAP by using the Exec_Program command.</p> <p>Notes</p> <ul style="list-style-type: none"> ▶ When you designate the criteria for the Execute Program and Working Directory for the Exec_Program command, specify a local drive path instead of a UNC file path. ▶ The Extract function needs additional configuration information to perform this task for a remote SAP host. The needed information is contained on the System tab of the SAP Configuration dialog box. The STARTRFC program deletes the status flat file when processing is complete. <p>References</p> <ul style="list-style-type: none"> ▶ See “Using Process Control” in the <i>User’s Guide</i> for more information on using the Exec_Program command. ▶ See <i>Extract Function</i> on page 2 - 5 more information about processing in Extract mode.
3	<p>Executes the STARTRFC automatically by using the Extract function of SAPINT.EXE. The extract function needs additional configuration information to perform this task for a remote SAP host. The needed information is contained on the Advanced Multi-Port Features dialog box accessed through the RFC Parameters tab on the SAP Configuration dialog box.</p> <p>User Action</p> <p>Select the Remote SAP Host check box and type the name of an FTP to send the Windows file to the SAP host in the first Remote Command field.</p> <p style="text-align: right;">(Continued on next page)</p>

(Contd) Stage	Description
4	<p>Example FTP script</p> <pre>open <unix_machine> user <user_ID> <password> cd /SAP/STATUS send C:\GENSRVNT\SAPSTAT\SAPSTAT.DAT close quit</pre> <p>Note The second Remote Command field contains the remote path and filename to be used in the STARTRFC command.</p> <p>Caution Remote Host configuration is not required when using ALE. You would configure a Remote Host only when using STARTRFC.</p>
5	Deletes the status flat file when processing is complete.

Gentran:Server Process Control

Introduction Select the **Events** tab on the **Gentran:Server Process Control** dialog box to see a list of events.

The Description list contains these event types:

- ▶ Inbound
- ▶ Outbound
- ▶ Update
- ▶ Extract

Reference

See Appendix C of the *Gentran:Server for Windows Administration Guide* for further information on events.

Note

You must set up these events if you want to use them.

How processing is set up

Inbound and outbound processing is set up to occur any time a file is present for processing.

Update/extract processing is set up to occur on the hour every hour from 7 a.m. to 5 p.m., Monday through Friday.

Events tab sample

This illustration shows a sample **Events** tab on the **Gentran:Server Process Control** dialog box.

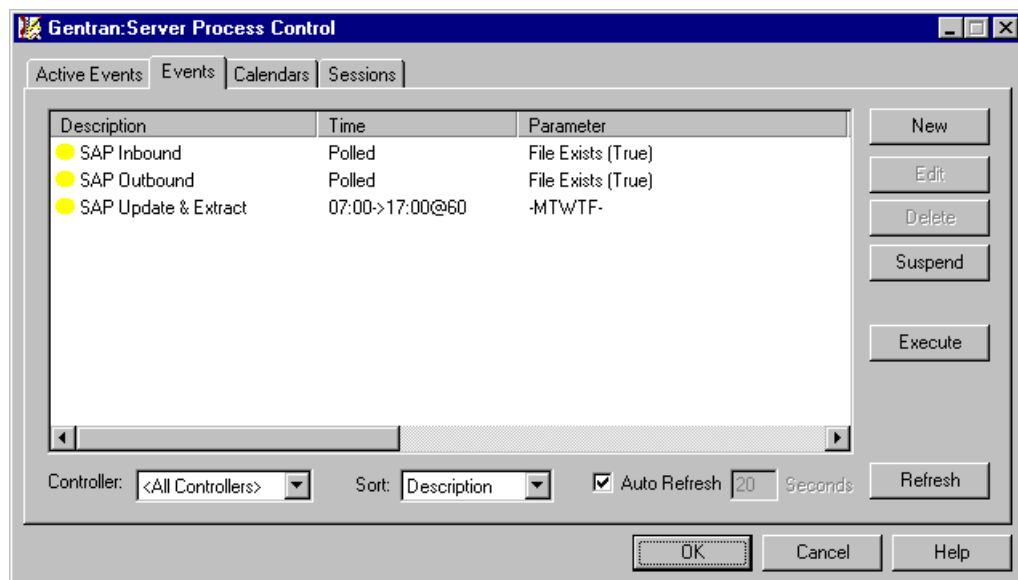

Multi-Port Processing

Contents	• Overview	D - 2
-----------------	------------------	-------

Overview

Introduction

The Extension for SAP is multi-port enabled via the RFC table.

Before you begin

The following are required for using multi-port processing:

- ▶ Set up SAP with unique port numbers.
- ▶ Ensure that your connection name is unique for each client/port.
- ▶ Outbound status messaging requires the use of Extract mode with the PORT attribute.

Directory name parameters

The directory name parameter (e.g., c:\GENSRVNT\sapin) must vary by port. The pathname is the key value for inbound processing.

Outbound status messages

To handle outbound status messages, the client and port must be unique.

Advanced Multi-Port Features dialog

The Extension for SAP can be enabled for multi-port processing using the **Advanced Multi-Port Features** dialog box accessed through the **Connection Parameters** tab on the **SAP Configuration** dialog box. This illustration shows the **Advanced Multi-Port Features** dialog box.

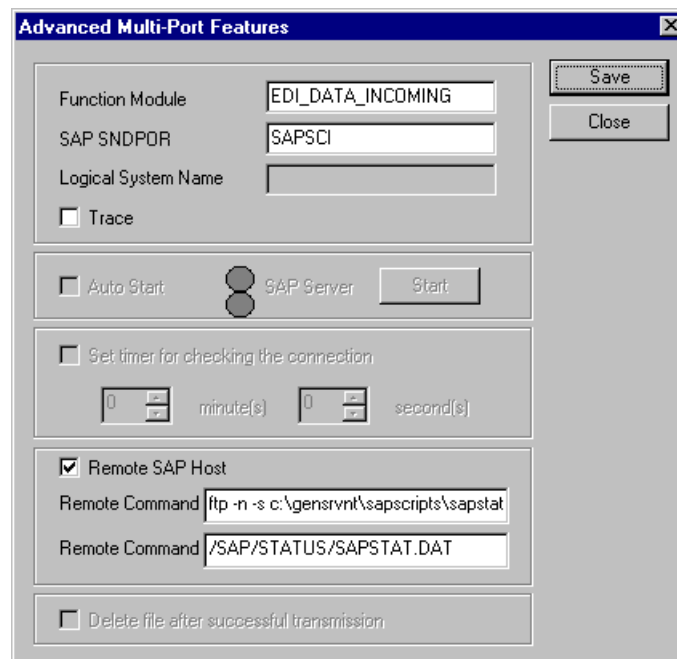

Using the IDoc Utility

Contents

- ▶ Overview E - 2
 - ▶ Installing and Configuring the IDoc Utility E - 4
 - ▶ Running the IDoc Utility E - 6
-

Overview

Introduction

The IDoc utility is a report within the SAP system that can be executed like a program. This utility converts IDoc structures into XML format based on the rules of the 'gentran_ddf.dtd' file version 1.0. The XML format can then be loaded into the Gentran Application Integration program to automatically provide the IDoc half of a map. In this way, the user avoids re-keying this information manually.

The overall environment of this function is

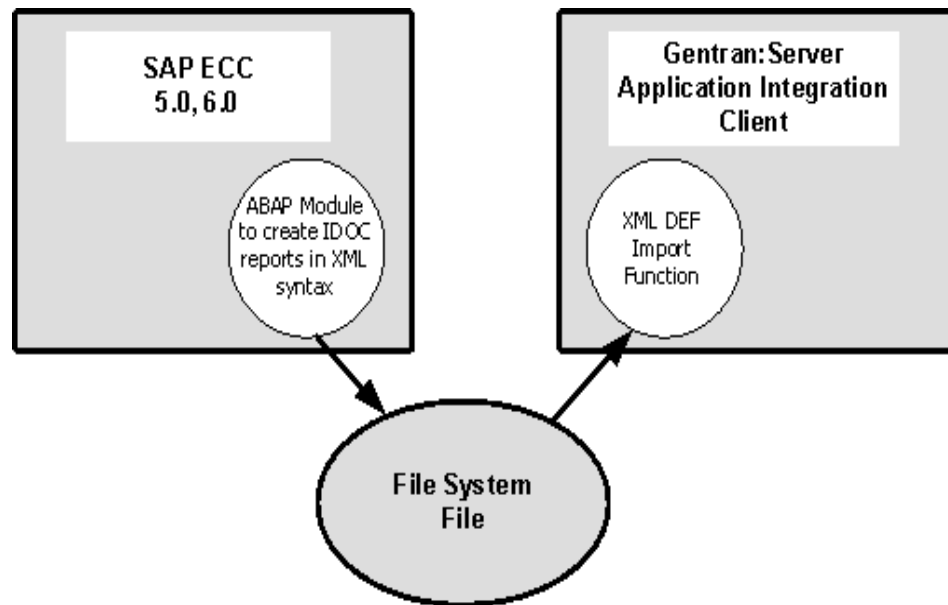

Report names

There are two versions of the IDoc utility, one for each type of SAP release. This table shows the two versions, which are also known as reports.

This report	Is to be executed on
ZIDXML50	SAP Systems ECC 5.0
ZIDXML60	SAP Systems ECC 6.0

SAP system help functionality

The IDoc utility comes with the following types of online help:

- The report documentation is available following the menu path **Help/Extended help**.
- Descriptions for fields on the Selection screen are available by placing the cursor on the desired field and pressing the **F1** key.
- For the **Object name** box and the **Local directory** box on the Selection screen, you can get a list of the possible entries by placing the cursor on the desired box and pressing the **F4** key.

Installing and Configuring the IDoc Utility

Requirements

The following items are necessary for the installation and running of the IDoc utility:

- SAP System ECC 5.0 or 6.0
- Appropriate Operating System

Reference

See the *Getting Started Guide* for the operating system that are supported for use with Gentran:Server.

- Imported transport containing the utility report.
- SAP user type 'dialog' for the relevant clients. This user needs at least a profile containing the authorization objects S_PROGRAM with an authorization to submit reports, and S_IDocDEFT with an authorization to display the documentation of IDocS.

IDoc Utility Report Names Overview

The files which are needed to generate the IDoc layout that is necessary to import into the Gentran:Server Application Integration subsystem are located in the `\GENSRVNT\Extensions\SAPMAPS\XML iDoc Export\Cofiles\` directory and the `\GENSRVNT\Extensions\SAPMAPS\XML iDoc Export\Data\` directory.

ZIDXML5X:K901600.VRD and R901600.VRD are for use with SAP ECC 5.0

ZIDXML6X:K900012.E01 and R900012.E01 are for use with SAP ECC 6.0

The files listed above are referred to as **Transport Change Requests**. Their purpose is to import the ABAP/4 report program ZIDXML50 or ZIDXML60 into the SAP system. The source code is imported but you will need to compile the program. To import the ABAP/4 code, you must use a utility provided by SAP called **tp**.

Reference

Please see the appropriate SAP documentation to determine how to use this utility with your particular SAP version and configuration, or contact your Basis consultant.

One the ABAP/4 code is imported, if the object contains the source of a ABAP/4 program, the source must be compiled and executed from within SAP.

Reference

Please contact your system administrator or developer for assistance with this function.

Process Overview

This table describes the process for using the IDoc utility.

Stage	Description
1	Install reports ZIDXML50 or ZIDXML60 from the transport file. (SAP system administration support is required to perform this step.)
2	Set up an SAP user. Reference See the Requirements section in this topic for information on setting up the SAP user.
3	Log on using the SAP client.
4	Execute the report and create an XML file.
5	Load the created file into the Gentran Application Integration program.

Running the IDoc Utility

Procedure Use this procedure to run the IDoc utility:

Step	Description
1	<p>On your SAP system, execute one of the reports (ZIDXML50 or ZIDXML60) by using the SAP transaction SA38.</p> <p>Note You may get this transaction either by following the menu path System/Services/Reporting or by entering the transaction code SA38 into the command field on the screen.</p>
2	<p>Type the name of the report (ZIDXML50 or ZIDXML60) into the screen and press F8.</p> <p>Result The Selection screen of the program is displayed.</p>
3	<p>Enter all mandatory and desired optional input.</p> <p>Reference See the appropriate “Sample Screen and Entry Descriptions” section at the end of this chapter.</p>
4	<p>Press F8 to run the report.</p> <p>Note The reports have to be executed in online mode because the necessary download functionality is not available in background mode.</p>

File Names Each IDoc structure includes the following necessary components:

- Controlrecord (EDI_DC / EDI_DC40)
- Datarecord (EDI_DD / EDI_DD40)
- IDoctype (for example: ORDERS02)

At the end of each run, the selected IDoc types are transferred to a specified directory of the local workstation. The default directory is the current SAP working directory.

**File Names
(contd.)**

In the case of multiple IDoc selections, each structure will get its own file. The filenames are generated as follows:

File name	Description
<IDoctype>_<release>.ddf	Extended filename
<IDoctype>.ddf	Short filename

After all transfers have been processed, a list is displayed on the screen. This list provides information on successful processed structures, created files and pathnames, as well as useful information in case of failures.

**ZIDXML60
Sample Screen and
Entry Descriptions**

This diagram illustrates the **Selection** screen for the report **ZIDXML60**.

Mandatory Entries

This table describes each mandatory entry.

Field	Description
IDOC Name	<p>Enter the name of a valid SAP IDoc structure.</p> <p>Example ORDERS02</p> <p>You must specify the requested type of the structure using the options Basic IDoc type and IDoc type (basic IDoc type plus user extension). Multiple selection and the use of patterns is possible.</p> <p style="text-align: right;">(Continued on next page)</p>

Field	Description
Version	Enter the version of the IDoc record types (for example, 1, 2, or 3).
SAP Release	Enter a valid SAP Release (e.g., 600 or 700). This reflects the SAP release where the requested IDoc structure is released, not the actual system release of SAP.
Local directory	Enter a valid directory on the local workstation or network. The default directory is the current SAP working directory. If you use F4 to select the local directory, do not enter any filenames on the subscreen that appears. All filenames are generated by the report.

Optional Entries

This table describes each optional entry.

Field	Description
Extended filenames	Select this option to use extended filenames for the transfer of the XML files. This is the default for operating systems that support extended filenames.
Short filenames	Select this option to use short filenames for the transfer of the XML files.